

**USB KEYBOARD STUDIO**

**KX25/KX49/KX61/KX8**

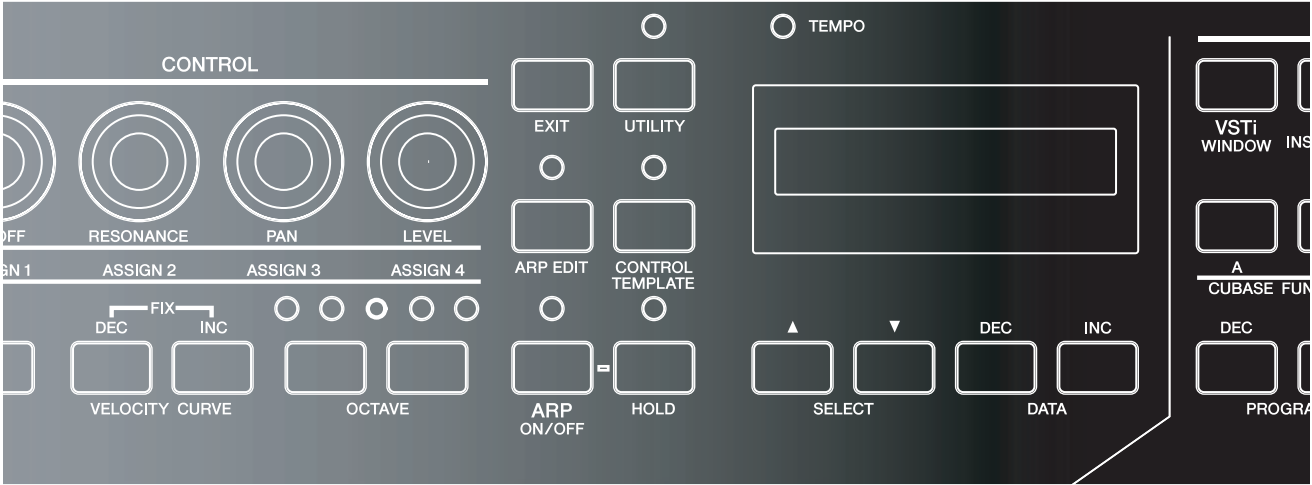

# SPECIAL MESSAGE SECTION

This product utilizes batteries or an external power supply (adapter). DO NOT connect this product to any power supply or adapter other than one described in the manual, on the name plate, or specifically recommended by Yamaha.

**WARNING:** Do not place this product in a position where anyone could walk on, trip over, or roll anything over power or connecting cords of any kind. The use of an extension cord is not recommended! If you must use an extension cord, the minimum wire size for a 25' cord (or less) is 18 AWG. NOTE: The smaller the AWG number, the larger the current handling capacity. For longer extension cords, consult a local electrician.

This product should be used only with the components supplied or; a cart, rack, or stand that is recommended by Yamaha. If a cart, etc., is used, please observe all safety markings and instructions that accompany the accessory product.

## **SPECIFICATIONS SUBJECT TO CHANGE:**

The information contained in this manual is believed to be correct at the time of printing. However, Yamaha reserves the right to change or modify any of the specifications without notice or obligation to update existing units.

This product, either alone or in combination with an amplifier and headphones or speaker/s, may be capable of producing sound levels that could cause permanent hearing loss. DO NOT operate for long periods of time at a high volume level or at a level that is uncomfortable. If you experience any hearing loss or ringing in the ears, you should consult an audiologist.

**IMPORTANT:** The louder the sound, the shorter the time period before damage occurs.

Some Yamaha products may have benches and / or accessory mounting fixtures that are either supplied with the product or as optional accessories. Some of these items are designed to be dealer assembled or installed. Please make sure that benches are stable and any optional fixtures (where applicable) are well secured BEFORE using.

Benches supplied by Yamaha are designed for seating only. No other uses are recommended.

## **NOTICE:**

Service charges incurred due to a lack of knowledge relating to how a function or effect works (when the unit is operating as designed) are not covered by the manufacturer's warranty, and are therefore the owners responsibility. Please study this manual carefully and consult your dealer before requesting service.

## **ENVIRONMENTAL ISSUES:**

Yamaha strives to produce products that are both user safe and environmentally friendly. We sincerely believe that our products and the production methods used to produce them, meet these goals. In keeping with both the letter and the spirit of the law, we want you to be aware of the following:

## **Battery Notice:**

This product MAY contain a small non-rechargeable battery which (if applicable) is soldered in place. The average life span of this type of battery is approximately five years. When replacement becomes necessary, contact a qualified service representative to perform the replacement.

This product may also use "household" type batteries. Some of these may be rechargeable. Make sure that the battery being charged is a rechargeable type and that the charger is intended for the battery being charged.

When installing batteries, do not mix batteries with new, or with batteries of a different type. Batteries MUST be installed correctly. Mismatches or incorrect installation may result in overheating and battery case rupture.

## **Warning:**

Do not attempt to disassemble, or incinerate any battery. Keep all batteries away from children. Dispose of used batteries promptly and as regulated by the laws in your area. Note: Check with any retailer of household type batteries in your area for battery disposal information.

## **Disposal Notice:**

Should this product become damaged beyond repair, or for some reason its useful life is considered to be at an end, please observe all local, state, and federal regulations that relate to the disposal of products that contain lead, batteries, plastics, etc. If your dealer is unable to assist you, please contact Yamaha directly.

## **NAME PLATE LOCATION:**

The name plate is located on the bottom of the product. The model number, serial number, power requirements, etc., are located on this plate. You should record the model number, serial number, and the date of purchase in the spaces provided below and retain this manual as a permanent record of your purchase.

**Model**

---

**Serial No.**

---

**Purchase Date**

---

# PLEASE KEEP THIS MANUAL

# FCC INFORMATION (U.S.A.)

## 1. IMPORTANT NOTICE: DO NOT MODIFY THIS UNIT!

This product, when installed as indicated in the instructions contained in this manual, meets FCC requirements. Modifications not expressly approved by Yamaha may void your authority, granted by the FCC, to use the product.

## 2. IMPORTANT:

When connecting this product to accessories and/or another product use only high quality shielded cables. Cable/s supplied with this product MUST be used. Follow all installation instructions. Failure to follow instructions could void your FCC authorization to use this product in the USA.

## 3. NOTE:

This product has been tested and found to comply with the requirements listed in FCC Regulations, Part 15 for Class "B" digital devices. Compliance with these requirements provides a reasonable level of assurance that your use of this product in a residential environment will not result in harmful interference with other electronic devices. This equipment generates/uses radio frequencies and, if not installed and used according to the instructions found in the users manual, may cause interference harmful to the operation of other electronic devices. Compliance with FCC regulations

does not guarantee that interference will not occur in all installations. If this product is found to be the source of interference, which can be determined by turning the unit "OFF" and "ON", please try to eliminate the problem by using one of the following measures:

Relocate either this product or the device that is being affected by the interference.

Utilize power outlets that are on different branch (circuit breaker or fuse) circuits or install AC line filter/s.

In the case of radio or TV interference, relocate/reorient the antenna. If the antenna lead-in is 300 ohm ribbon lead, change the lead-in to co-axial type cable.

If these corrective measures do not produce satisfactory results, please contact the local retailer authorized to distribute this type of product. If you can not locate the appropriate retailer, please contact Yamaha Corporation of America, Electronic Service Division, 6600 Orangethorpe Ave, Buena Park, CA90620

The above statements apply ONLY to those products distributed by Yamaha Corporation of America or its subsidiaries.

\* This applies only to products distributed by YAMAHA CORPORATION OF AMERICA.

(class B)

## COMPLIANCE INFORMATION STATEMENT (DECLARATION OF CONFORMITY PROCEDURE)

Responsible Party : Yamaha Corporation of America  
Address : 6600 Orangethorpe Ave., Buena Park, Calif. 90620  
Telephone : 714-522-9011  
Type of Equipment : USB KEYBOARD STUDIO  
Model Name : KX25 / KX49 / KX61 / KX8

This device complies with Part 15 of the FCC Rules.

Operation is subject to the following two conditions:

- 1) this device may not cause harmful interference, and
- 2) this device must accept any interference received including interference that may cause undesired operation.

See user manual instructions if interference to radio reception is suspected.

\* This applies only to products distributed by YAMAHA CORPORATION OF AMERICA.

(FCC DoC)

## OBSERVERA!

Apparaten kopplas inte ur växelströmskällan (nätet) så länge som den är ansluten till vägguttaget, även om själva apparaten har stängts av.

**ADVARSEL:** Netspændingen til dette apparat er IKKE afbrudt, så længe netledningen sidder i en stikkontakt, som er t endt — også selvom der er slukket på apparatets afbryder.

**VAROITUS:** Laitteen toisiopiiriin kytketty käyttökytin ei irroita koko laitetta verkosta.

(standby)

# PRECAUTIONS

## PLEASE READ CAREFULLY BEFORE PROCEEDING

\* Please keep this manual in a safe place for future reference.



### WARNING

Always follow the basic precautions listed below to avoid the possibility of serious injury or even death from electrical shock, short-circuiting, damages, fire or other hazards. These precautions include, but are not limited to, the following:

#### Power supply/AC power adaptor

- Only use the voltage specified as correct for the instrument. The required voltage is printed on the name plate of the instrument.
- Use the specified adaptor (PA-3C, PA-130 or an equivalent recommended by Yamaha) only. Using the wrong adaptor can result in damage to the instrument or overheating.
- Check the electric plug periodically and remove any dirt or dust which may have accumulated on it.
- Do not place the AC adaptor cord near heat sources such as heaters or radiators, and do not excessively bend or otherwise damage the cord, place heavy objects on it, or place it in a position where anyone could walk on, trip over, or roll anything over it.

#### Do not open

- Do not open the instrument or attempt to disassemble the internal parts or modify them in any way. The instrument contains no user-serviceable parts. If it should appear to be malfunctioning, discontinue use immediately and have it inspected by qualified Yamaha service personnel.

#### Water warning

- Do not expose the instrument to rain, use it near water or in damp or wet conditions, or place containers on it containing liquids which might spill into any openings. If any liquid such as water seeps into the instrument, turn off the power immediately and unplug the power cord from the AC outlet. Then have the instrument inspected by qualified Yamaha service personnel.
- Never insert or remove an electric plug with wet hands.

#### Fire warning

- Do not put burning items, such as candles, on the unit. A burning item may fall over and cause a fire.

#### If you notice any abnormality

- If the AC adaptor cord, plug or USB cable becomes frayed or damaged, or if there is a sudden loss of sound during use of the instrument, or if any unusual smells or smoke should appear to be caused by it, immediately turn off the power switch, disconnect the adaptor plug from the outlet, disconnect the USB cable and have the instrument inspected by qualified Yamaha service personnel.



### CAUTION

Always follow the basic precautions listed below to avoid the possibility of physical injury to you or others, or damage to the instrument or other property. These precautions include, but are not limited to, the following:

#### Power supply/AC power adaptor

- When removing the electric plug from the instrument or an outlet, always hold the plug itself and not the cord.
- Unplug the AC power adaptor when not using the instrument, or during electrical storms.
- Do not connect the instrument to an electrical outlet using a multiple-connector. Doing so can result in lower sound quality, or possibly cause overheating in the outlet.

#### Location

- Do not expose the instrument to excessive dust or vibrations, or extreme cold or heat (such as in direct sunlight, near a heater, or in a car during the day) to prevent the possibility of panel disfiguration or damage to the internal components.
- Do not use the instrument in the vicinity of a TV, radio, stereo equipment, mobile phone, or other electric devices. Otherwise, the instrument, TV, or radio may generate noise.
- Do not place the instrument in an unstable position where it might accidentally fall over.
- Before moving the instrument, remove all connected adaptor and other cables.

- When setting up the product, make sure that the AC outlet you are using is easily accessible. If some trouble or malfunction occurs, immediately turn off the power switch and disconnect the plug from the outlet. Even when the power switch is turned off, electricity is still flowing to the product at the minimum level. When you are not using the product for a long time, make sure to unplug the power cord from the wall AC outlet.

## Connections

- Before connecting the instrument to other electronic components, turn off the power for all components. Before turning the power on or off for all components, set all volume levels to minimum. Also, be sure to set the volumes of all components at their minimum levels and gradually raise the volume controls while playing the instrument to set the desired listening level.

## Maintenance

- When cleaning the instrument, use a soft, dry cloth. Do not use paint thinners, solvents, cleaning fluids, or chemical-impregnated wiping cloths.

## Handling caution

- Do not insert a finger or hand in any gaps on the instrument.

- Never insert or drop paper, metallic, or other objects into the gaps on the panel or keyboard. If this happens, turn off the power immediately and unplug the power cord from the AC outlet. Then have the instrument inspected by qualified Yamaha service personnel.
- Do not place vinyl, plastic or rubber objects on the instrument, since this might discolor the panel or keyboard.
- Do not rest your weight on, or place heavy objects on the instrument, and do not use excessive force on the buttons, switches or connectors.
- Do not use the instrument/device or headphones for a long period of time at a high or uncomfortable volume level, since this can cause permanent hearing loss. If you experience any hearing loss or ringing in the ears, consult a physician.

## Saving data

### Saving and backing up the created Control Template

- The Control Template created by using a computer or via the panel operation of the KX will be stored on internal memory of the KX. Stored data may be lost due to malfunction or incorrect operation. Save important data to a computer by using the special KX Editor software (page 6).

Yamaha cannot be held responsible for damage caused by improper use or modifications to the instrument, or data that is lost or destroyed.

Always turn the power off when the instrument is not in use.

Even when the power switch is in the "STANDBY" position, electricity is still flowing to the instrument at the minimum level. When you are not using the instrument for a long time, make sure you unplug the AC power adaptor from the wall AC outlet.

## SPECIAL NOTICES

- The contents of this Owner's Manual and the copyrights thereof are under exclusive ownership by Yamaha Corporation.
- The screen displays as illustrated in this manual are for instructional purposes, and may appear somewhat different from the screens which appear on your computer.
- This product incorporates and bundles computer programs and contents in which Yamaha owns copyrights or with respect to which it has license to use others' copyrights. Such copyrighted materials include, without limitation, all computer software, style files, MIDI files, WAVE data, musical scores and sound recordings. Any unauthorized use of such programs and contents outside of personal use is not permitted under relevant laws. Any violation of copyright has legal consequences. DON'T MAKE, DISTRIBUTE OR USE ILLEGAL COPIES.
- Copying of the commercially available musical data including but not limited to MIDI data and/or audio data is strictly prohibited except for your personal use.
- Steinberg and Cubase are the registered trademarks of Steinberg Media Technologies GmbH.
- Windows is a registered trademark of Microsoft® Corporation in the United States and other countries.
- Apple, Mac and Macintosh are trademarks of Apple Inc., registered in the U.S. and other countries.

The company names and product names in this manual are the trademarks or registered trademarks of their respective companies.

### About the latest Firmware Version

Yamaha may from time to time update firmware of the KX without notice for improvement. Likewise, the DAW software used together with the KX may be updated from time to time. As a result, the link functions between the KX and the DAW software may not work properly depending on the firmware version of the KX and the software version of the DAW. If such a situation occurs, refer to the website below to find the latest information.

<http://www.yamahasynt.com/>

Note that the explanations in this Owner's Manual apply to the version of firmware when this Owner's Manual was produced. For details about the additional functions due to later releases, refer to the above website.

# Introduction

Thank you for purchasing the Yamaha KX25 / KX49 / KX61 / KX8 USB KEYBOARD STUDIO.

Included in the package are the KX MIDI keyboard for controlling a computer via USB as well as the DAW application software, Cubase AI4. Simply connect the KX to a computer via USB, and you've got a comprehensive control center and seamless environment for complete music production.

In order to take full advantage of the KX's superior functionality and enjoy years of trouble-free use, please read this manual before you begin using the product. Also, keep this book in a safe place for future reference.

## Features

### Link with Cubase

The KX keyboard is equipped with link functions specifically designed for Cubase software (Cubase 4, Studio 4, Essential 4 and AI4), providing tremendous efficiency and speed in your workflow.

### Track operations on VST plug-in instruments (VSTi)

The KX has no built-in tone generator; it is a keyboard controller designed to play the sounds of VST plug-in instruments (VSTi) on your connected computer. The KX lets you conveniently perform certain VSTi operations in your DAW directly from the KX panel, including creating tracks and selecting programs (instrument voices).

### Four knobs for real-time control of various parameters

These versatile knobs give you real-time control over parameters in your VSTi software. Simply select the Control Template for the VSTi you wish to control (30 pre-programmed templates are built in), and you can use the four knobs to control the sound of your VSTi remotely. Many popular VSTi are covered by the templates; however, you can also create/customize your own to use with your favorite VSTi.

### Powerful Arpeggio feature

The KX also has a built-in Arpeggio feature that lets you easily play various rhythmic patterns and 'sequenced' phrases, depending on the notes you press. These include a wide variety of vintage analog synthesizer-like arpeggios, guitar/bass riffs, and drum/percussion rhythm patterns—all of which can be triggered instantly and held automatically to provide dynamic, realistic backing for your performance.

### USB bus-powered

The KX can be powered by the USB connection to your computer. This means you can simply connect the KX to a USB terminal on your computer, get full power, and not have to worry about setting up an AC adaptor.

## Included Accessories

- AC power adaptor (PA-3C, PA-130, or equivalent)\*
- Owner's Manual (this book)
- USB cable
- Cubase AI4 DVD-ROM
- TOOLS for KX DVD-ROM

\* May not be included depending on your particular area. Please check with your Yamaha dealer.

### KX Editor

KX Editor is a special software that gives you convenient editing tools for the KX and its settings. You can download this software from the following Yamaha website.

<http://www.yamahasyth.com/>

# About the Included Software

## Special Notices about the Accessory Disks

### CAUTION

- This disk containing the software is not meant for use with an audio/visual system (CD player, DVD player, etc.). Do not attempt to use the disk on equipment other than a computer.

### Special Notice

- The copyrights of the USB-MIDI Driver and Extensions for Steinberg DAW (contained in the TOOLS for KX DVD-ROM) are under exclusive ownership by Yamaha Corporation.
- The software included in the Cubase AI4 DVD-ROM and the copyrights thereof are under exclusive ownership by Steinberg Media Technologies GmbH. Note that Yamaha does not offer technical support for Cubase AI4 in the DVD-ROM.
- The VSTi tools included in the "VSTis" folder of the TOOLS for KX DVD-ROM and the copyrights thereof are under exclusive ownership by the respective companies. Note that Yamaha does not offer technical support for the DAW software in the DVD-ROM.
- Use of the software and this manual is governed by the license agreement which the purchaser fully agrees to upon breaking the seal of the software packaging. (Please read carefully the Software Licensing Agreement at the end of this manual before installing the application.)
- Copying of the software in whole or in part by any means is expressly forbidden without the written consent of the manufacturer.
- Yamaha makes no representations or warranties with regard to the use of the software and cannot be held responsible for the results of the use of the software.
- Future upgrades of application and system software and any changes in specifications and functions will be announced separately on Yamaha site.

### About support for Cubase

Support for Cubase in the accessory disk is provided by Steinberg on its website at the following address.

<http://www.steinberg.net>

You can visit the Steinberg site also via the Help menu of Cubase. (The Help menu also includes the PDF manual and other information on the software.)

### NOTE

To view PDF files on Windows, you must install Adobe Reader on your computer. If you do not have Adobe Reader, you can download the application from the Adobe website at the following URL:  
<http://www.adobe.com>

## System Requirements for Software

The system requirements below are necessary for installing and using the software contained in the accessory disk (Cubase AI4 and TOOLS for KX).

### Windows

OS:	Windows XP Professional/XP Home Edition/Vista 32-bit version
Computer:	Intel Pentium 1.4 GHz or higher
Memory:	512MB
Display	
Resolution:	1280 x 800 pixels
Interface:	Equipped with the USB connector
Hard Disk:	Free disk space of 1GB or more; high-speed hard disk

### Macintosh

OS:	Mac OSX 10.4.x or 10.5.x
Computer:	Power Mac G4 1GHz or Core Solo 1.5GHz or higher
Memory:	512MB
Display	
Resolution:	1280 x 800 pixels
Interface:	Equipped with the USB connector
Hard Disk:	Free disk space of 1GB or more; high-speed hard disk

### NOTE

- Regarding the USB-MIDI Driver contained in the TOOLS for KX DVD-ROM, you can download the latest version from the following URL. Information on system requirements is also available at the following URL.  
[http://www.global.yamaha.com/download/usb\\_midi/](http://www.global.yamaha.com/download/usb_midi/)
- Regarding the Extensions for Steinberg DAW contained in the TOOLS for KX DVD-ROM, you can download the latest version from the following URL. Information on system requirements is also available at the following URL.  
<http://www.yamahasyth.com/>
- For details on system requirements of Cubase AI4, refer to the following URL:  
<http://www.yamahasyth.com/>
- For details on system requirements of the DAW software other than Cubase AI4, refer to the corresponding manual or the web site.
- For details on system requirements of the VSTi software synthesizers (contained in the TOOLS for KX DVD-ROM), refer to the corresponding manual in the folder on which the VSTi resides.

### Important

- A DVD drive is required for installation.
- To activate your software license, install Cubase AI4 while the computer is connected to the Internet.



# Table of Contents

<b>Introduction .....</b>	<b>6</b>	Controlling the VSTi by Using the CONTROL Knobs .....	24
<b>Features .....</b>	<b>6</b>	Controlling the Transport and Tracks .....	25
<b>Included Accessories .....</b>	<b>6</b>	<b>Basic Operation on the KX .....</b>	<b>26</b>
<b>About the Included Software .....</b>	<b>7</b>	Display Indications.....	26
Special Notices about the Accessory Disks .....	7	Top display .....	26
System Requirements for Software .....	7	Arpeggio Edit display .....	26
Windows.....	7	Control Template display .....	26
Macintosh.....	7	Utility display.....	26
<b>Turning the Power On and Off.....</b>	<b>9</b>	Changing the Octave Range .....	27
Power Supply .....	9	Selecting the Velocity Curve.....	27
Connecting the AC power adaptor .....	9	<b>Control Templates .....</b>	<b>28</b>
Using the KX as a USB bus-powered device .....	9	Selecting a Control Template .....	28
Turning the Power On and Off .....	9	Editing a Control Template .....	29
<b>Front and Rear Panels .....</b>	<b>10</b>	Changing the message type generated by using the CONTROL knobs .....	29
<b>What You Can Do With the KX.....</b>	<b>12</b>	Changing the Control Change number generated by using the CONTROL knob .....	30
Keyboard Performance .....	12	<b>Arpeggio .....</b>	<b>31</b>
Transport/Track Operations on the DAW Software.....	12	Selecting an Arpeggio Type .....	31
Window Operations on the VSTi .....	12	Using MIDI Clock to control Arpeggio tempo ...	32
Real-time Parameter Control .....	12	Editing an Arpeggio .....	33
Phrase/Rhythm Performance with Arpeggio Feature.....	12	Arpeggio Parameters.....	33
<b>Setting Up .....</b>	<b>13</b>	<b>Using the KX with a DAW Other than Cubase .....</b>	<b>34</b>
Installation Using the Cubase AI4 DVD-ROM .....	13	When using Digital Performer (Macintosh): .....	35
For Windows: .....	13	<b>Utility Settings .....</b>	<b>36</b>
For Macintosh: .....	13	Basic Operation .....	36
Installation Using the TOOLS for KX DVD-ROM .....	13	Utility Parameters .....	36
For Windows: .....	14	Restoring the Factory-programmed System Settings (Factory Set) .....	37
For Macintosh: .....	15	Setting the MIDI Thru Parameter .....	38
Connection .....	16	<b>Troubleshooting .....</b>	<b>39</b>
<b>Using the KX with Cubase.....</b>	<b>17</b>	<b>Message List .....</b>	<b>40</b>
Setting up on the KX .....	17	<b>TOOLS for KX LICENSE AGREEMENT ..</b>	<b>41</b>
Setting up on Cubase.....	17	<b>Cubase AI4 LICENSE AGREEMENT .....</b>	<b>42</b>
MIDI ports on the KX.....	18	<b>Appendix .....</b>	<b>44</b>
Setting up the VSTi .....	19	Specifications .....	44
Creating a track for the VSTi.....	19	Control Template List .....	45
Opening the VSTi window and selecting an instrument .....	19	Arpeggio Type List.....	46
Playing the Keyboard .....	20	<b>MIDI Implementation Chart .....</b>	<b>50</b>
Playing an Arpeggio .....	20	<b>Index .....</b>	<b>52</b>
Trigger the Arpeggio with one finger .....	20		
Holding Arpeggio playback .....	21		
Trying out other notes on the keyboard .....	21		
Using the CUBASE FUNCTION Buttons .....	23		
Default functions .....	23		
Assigning different functions to the buttons .....	23		



# Turning the Power On and Off

## Power Supply

The KX can be powered from one of the following two sources.

- Power supply from the AC power adaptor
- Power supply from the connected host computer (USB bus-power)

### Connecting the AC power adaptor

1. Make sure that the **STANDBY/ON** switch of the KX is in the **STANDBY** position.
2. Connect the plug of the power adaptor to the **DC IN** connector on the rear panel.
3. Plug the power adaptor into a standard household power outlet.

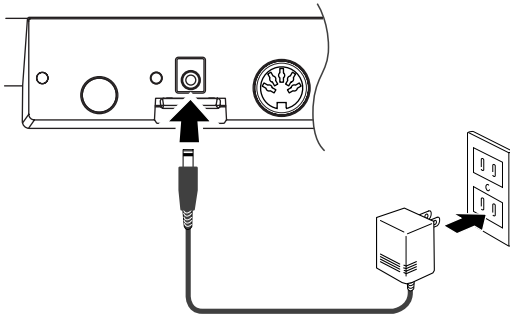

### ⚠ WARNING

- Use only the included power adaptor (PA-3C or PA-130) or an equivalent recommended by Yamaha. Use of a different adaptor may result in equipment damage, overheating, or fire. Doing so will also immediately void the product warranty, even if the effective warranty period has not expired.

### ⚠ CAUTION

- Wrap the DC output cable of the adaptor around the cable clip (as shown below) to prevent accidental unplugging of the cable during operation. Avoid tightening the cord more than necessary or pulling on the cord strongly while it is wrapped around the cable clip to prevent wear on the cord or possible breakage of the clip.

KX61

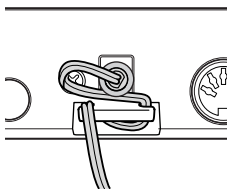

KX8

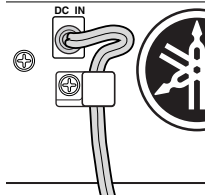

## Using the KX as a USB bus-powered device

The KX is a bus-powered type device which can be powered by the host computer connected via a USB cable. In this case, the AC power adaptor is not necessary.

1. Make sure that the **STANDBY/ON** switch of the KX is in the **STANDBY** position.
2. Connect a computer to the **USB TO HOST** connector of the KX by using a USB cable.

### NOTE

- While the KX is turned ON, the Macintosh computer connected to the KX via USB cannot enter the power-saving mode (such as sleep and suspended) even if you do not operate the computer for a long time. When connected in this condition, the KX continues to draw power from the computer, even if you are not using it. Particularly when the computer is under battery power, you should make sure to set the **STANDBY/ON** switch of the KX to **STANDBY** in order to save power and avoid draining the computer's battery.
- The USB bus-power function can be used only when connecting the KX to a computer directly without using a hub or connecting the KX to a computer via a self-powered USB hub. This function cannot be used when connecting the KX to a computer via a bus-powered USB hub.
- The USB bus-power function will not work when using the AC adaptor.

## Turning the Power On and Off

1. Turn the power **ON** by pressing the **[STANDBY/ON]** switch to set it to the **ON** position.
2. Turn the power **off** by pressing the **[STANDBY/ON]** switch again to set it to the **STANDBY** position.

### ⚠ CAUTION

- Note that a small amount of current continues to flow while the switch is in the **STANDBY** position. If you do not plan to use the KX again for a long while, be sure to unplug the adaptor from the wall outlet and unplug the USB cable from the KX.

# Front and Rear Panels

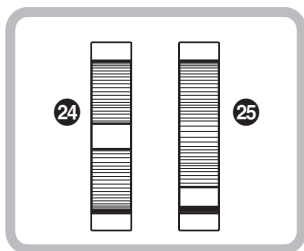
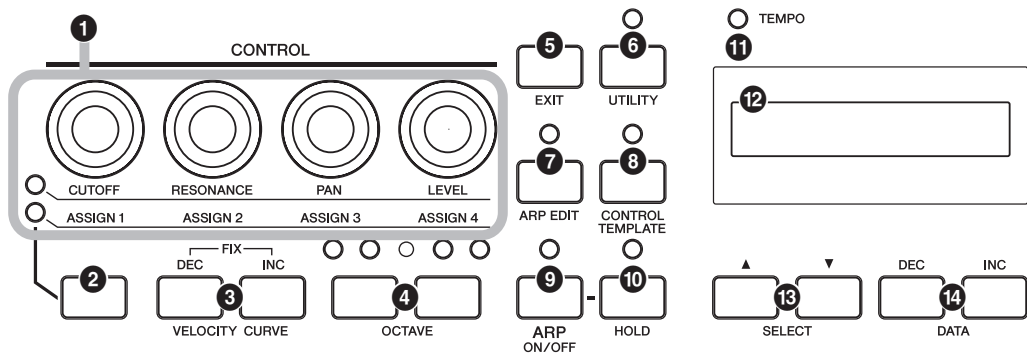

- 1 CONTROL knobs .....Page 24**  
Use these knobs to adjust the parameter values of the VSTi in your computer.
- 2 Knob Functions Select button .....Page 24**  
Use this button to select one of the two functions assigned to each knob.
- 3 VELOCITY CURVE [DEC] and [INC] buttons .....Page 27**  
Use these buttons to select one of the velocity curves of the keyboard.
- 4 OCTAVE buttons .....Page 27**  
Use these buttons to change the note range of the keyboard by octave.
- 5 [EXIT] button .....Page 26**  
Press this button to return to the original display.
- 6 [UTILITY] button .....Page 36**  
Press this button to call up the display for setting the system related parameters.
- 7 [ARP EDIT] button .....Page 31**  
Press this button to call up the display for selecting the Arpeggio type and setting the related parameters.
- 8 [CONTROL TEMPLATE] button.....Page 28**  
Use this button to select a template assigned to CONTROL knobs.
- 9 [ARP ON/OFF] button ..... Page 20**  
Press this button to enable or disable Arpeggio playback. Turning on the button lights up the LED lamp.
- 10 [HOLD] button ..... Page 21**  
This button turns the Arpeggio Hold function on and off.
- 11 TEMPO LED ..... Page 32**  
This LED lamp flashes in time with the tempo of the Arpeggio.
- 12 Display ..... Page 26**  
Shows the related information according to your panel operations.
- 13 SELECT buttons..... Page 26**  
Use these buttons to select the parameter to be edited.
- 14 DATA [DEC] and [INC] buttons ..... Pages 17, 31**  
Use each of these buttons to increase or decrease the value of the selected parameter.
- 15 [VSTi WINDOW] button..... Page 19**  
Press this button to switch between displaying and hiding the VSTi window in Cubase.
- 16 [ADD INSTRUMENT TRACK] button ..... Page 19**  
Press this button to create a VSTi track in Cubase.

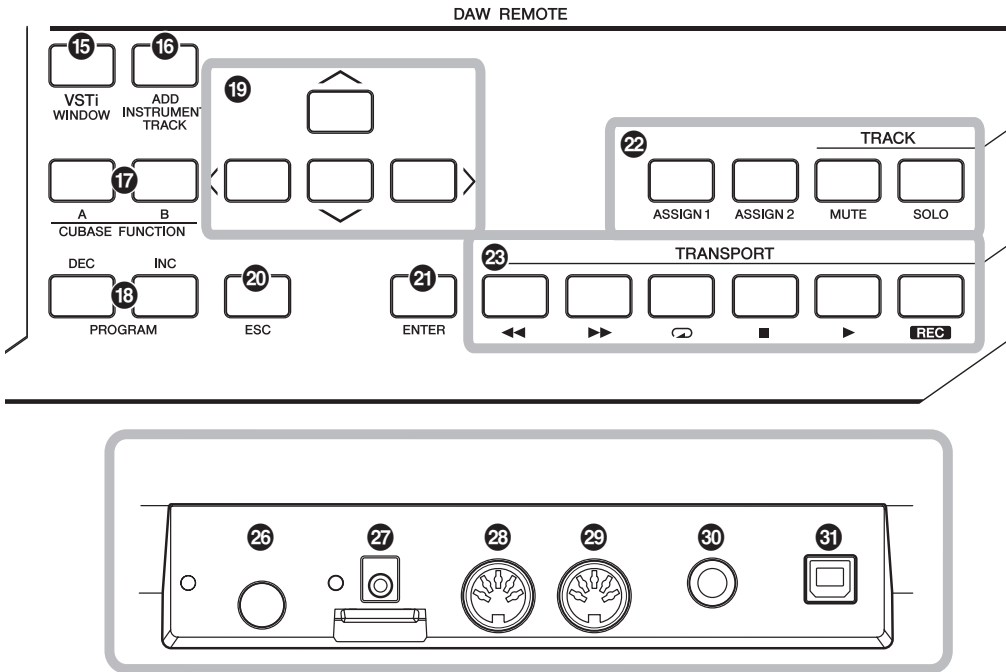

- 17 CUBASE FUNCTION [A] and [B] buttons** .....Page 23  
These buttons let you control certain assignable functions within Cubase.
- 18 PROGRAM [DEC] and [INC] buttons** .....Page 19  
Use these buttons to select the particular instrument of the VSTi assigned to the selected track.
- 19 Cursor buttons** .....Page 25  
These buttons function the same as the cursor keys on your computer.
- 20 [ESC] button** .....Page 25  
This button functions the same as the ESC key on your computer.
- 21 [ENTER] button**.....Page 25  
This button functions the same as the ENTER key on your computer.
- 22 Track Control buttons**.....Page 25  
These buttons let you control the Mute and Solo functions on the selected track within Cubase.
- 23 Transport Control buttons**.....Page 25  
These buttons let you control transport functions, including record and play, within Cubase.

- 24 Pitch Bend wheel** ..... Pages 12, 17  
Controls the pitch bend effect, making continuous pitch change.
- 25 Modulation wheel**..... Pages 12, 17  
Controls the modulation effect.
- 26 [STANDBY/ON] switch**..... Page 9  
Press this switch to turn the power on or off (STANDBY).
- 27 DC IN connector**..... Page 9  
Connect an AC adaptor to this jack.
- 28 MIDI IN connector** ..... Page 16  
This connector is used to receive MIDI messages transmitted from an external MIDI device.
- 29 MIDI OUT connector** ..... Page 16  
This connector is used to transmit MIDI messages to an external MIDI device.
- 30 SUSTAIN jack** ..... Page 16  
Connect an optional footswitch (such as Yamaha FC4 and FC5) to this jack.
- 31 USB TO HOST connector** ..... Page 16  
This connector is used to connect the keyboard and the computer by using a USB cable. Since the KX is bus-powered, the power can be supplied from the computer to the KX via this connector.

# What You Can Do With the KX

The KX is, of course, a MIDI keyboard—however, it also provides a wealth of other convenient and powerful features for use with your computer and DAW software. Here's a short introduction to what you can do with your KX.

## Keyboard Performance

Play the keyboard and use the various controllers (including the Pitch Bend and Modulation wheels) to play/change the sounds of the VSTi on the computer (via USB) or a connected MIDI tone generator (via MIDI).

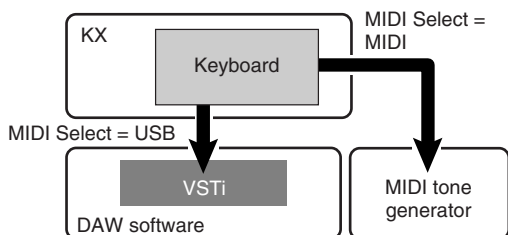

## Real-time Parameter Control

Use the CONTROL knobs on the KX to control various sound-shaping parameters on the VSTi or a connected tone generator.

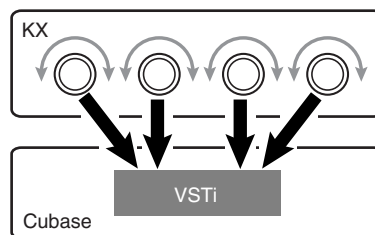

## Transport/Track Operations on the DAW Software

Use the KX to control transport functions (such as Play, Record and Stop), as well as mute and solo selected tracks within Cubase.

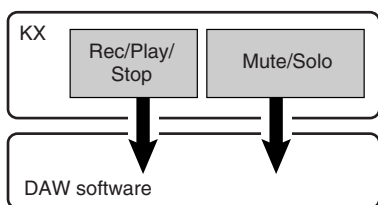

**NOTE** Track operations such as Mute and Solo are available only for Cubase.

## Phrase/Rhythm Performance with Arpeggio Feature

This powerful feature lets you easily play various rhythmic patterns and 'sequenced' phrases. These include a wide variety of vintage analog synthesizer-like arpeggios, guitar/bass riffs, and drum/percussion rhythm patterns—all of which can be triggered instantly and held automatically to provide dynamic, realistic backing for your performance.

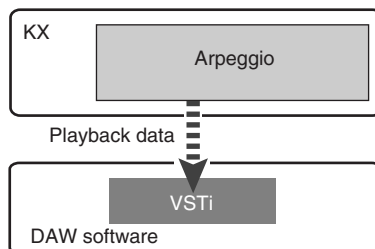

## Window Operations on the VSTi

When using Cubase, you can instantly open or close the VSTi related window and create a track for the VSTi from the KX.

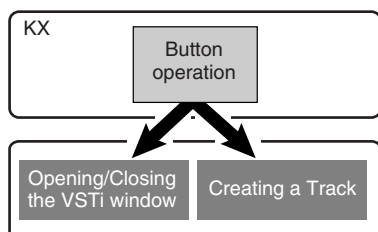

# Setting Up

## Installation Using the Cubase AI4 DVD-ROM

### Important!

Since the End-User Software License Agreement (EUSLA) shown on your computer display when you install the “DAW” software is replaced by the agreement on page 42, you should disregard the EUSLA. Read the Cubase AI4 License Agreement on page 42 carefully, and install the software if you agree to it.

**NOTE** If you have already installed Cubase, the instructions below are not necessary. Jump to the next section “Installation using the TOOLS for KX DVD-ROM.”

### For Windows:

1. Start the computer and log on to the Administrator account.
2. Insert the Cubase AI4 DVD-ROM into the DVD-ROM drive.
3. Open the DVD-ROM, then double-click the file “CubaseAI4.msi.”  
Follow the on-screen instructions to install Cubase AI4.

### For Macintosh:

1. Start the computer and log on to the Administrator account.
2. Insert the Cubase AI4 DVD-ROM into the DVD-ROM drive.
3. Open the DVD-ROM, then double-click the file “CubaseAI4.mpkg.”  
Follow the on-screen instructions to install Cubase AI4.

**NOTE**

- In order to have continuous use of Cubase AI 4, including support and other benefits, you will need to register the software and activate your software license by starting it while the computer is connected to the Internet. Click the “Register Now” button shown when the software is started, then fill in all required fields for registration. If you do not register the software, you will be unable to use it after a limited period of time expires.
- If you are using Cubase 4, Cubase Studio 4 or Cubase Essential 4, install either application before you install Extensions for Steinberg DAW.

## Installation Using the TOOLS for KX DVD-ROM

The TOOLS for KX DVD-ROM includes the following application software tools.

- Installer of Extensions for Steinberg DAW
- USB-MIDI driver
- VSTi installers developed by other companies

In particular, you should install Extensions for Steinberg DAW to ensure optimum control over Cubase. You should also install the USB-MIDI Driver to enable proper communication between the KX and your computer. Other VSTi software can be installed as desired.

By installing Extensions for Steinberg DAW, the following functions are available when using the KX and Cubase on your computer.

- Cubase can recognize the KX as a remote controller when connecting the KX to the computer.
- Performing panel operations on the KX (such as with the knobs and buttons) automatically edits the relevant parameters on the VSTi software.
- Changing the VSTi on the computer will select the appropriate Control Template (page 28) on the KX automatically.

**NOTE**

- If you want to install VSTi software developed by other companies, follow the Installation Guide for each VSTi located in the “VSTis” folder.
- For information on how to uninstall each software, refer to the Installation Guide located in the respective folder of each software.

### For Windows:

**NOTE** Make sure to install Cubase before installing Extensions for Steinberg DAW described in step 5 below.

1. Make sure that the power to the KX is turned off.
2. Disconnect all MIDI cables that connect MIDI devices to MIDI IN/OUT connectors on the KX.
3. Start the computer and log on to the Administrator account.
4. Insert the TOOLS for KX DVD-ROM into the DVD-ROM drive.
5. Open the “Extensions for Steinberg DAW” folder in the DVD-ROM, then double-click the file “setup.exe”  
The first display for installing Extensions for Steinberg DAW appears.
6. Click [Next] to call up the InstallShield Wizard for Yamaha Extensions for Steinberg DAW.

**NOTE**

- If the same version of Extensions for Steinberg DAW has already been installed in your computer, a window appears indicating completion. In this case, click [Finish].
- If a newer version of Extensions for Steinberg DAW has already been installed in your computer, a dialog box appears indicating that the newer software has already been installed. In this case, you do not need to install the software. Click [OK] in the dialog box.
- If an older version of Extensions for Steinberg DAW has been installed in your computer, the software should be updated. (The procedure is the same as for installing it from scratch.)

7. Click [Next] to start the installation.  
To cancel the installation procedure, click [Cancel].

**NOTE** During the installation procedure, you can select the type of Extensions for Steinberg DAW by selecting “Custom” in the Setup Type dialog.

8. When the installation is complete, a message indicating so appears. Click [Finish].

9. After disconnecting all other USB devices from the computer, connect the KX directly to the computer (without using a hub) by using a USB cable.

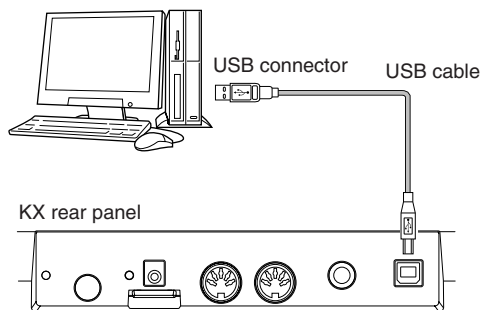

10. Turn the power on of the KX by pressing the [STANDBY/ON] switch.

The KX will be recognized by the connected computer.

11. Install the USB-MIDI driver.

**NOTE** Installation of the USB MIDI driver is described in “installationguide\_en.pdf” stored in the “USB-MIDI\_Driver” folder.

The installation is now complete.

### **Important!**

Make sure to use the same USB connector as the one used in the installation procedure when you connect the KX and the Windows computer again. If you connect the USB cable to a different connector, you will have to install the USB-MIDI driver again.

## For Macintosh:

**NOTE** Make sure to install Cubase before installing Extensions for Steinberg DAW described in step 5 below.

1. Make sure that the power to the KX is turned off.
2. Disconnect all MIDI cables that connect MIDI devices to MIDI IN/OUT connectors on the KX.
3. Start the computer and log on to the Administrator account.
4. Insert the TOOLS for KX DVD-ROM into the DVD-ROM drive.
5. Open the “Extensions for Steinberg DAW” folder in the DVD-ROM, then double-click the file “Yamaha Extensions for Steinberg DAW.mpkg.”  
This calls up the InstallShield Wizard for Yamaha Extensions for Steinberg DAW.
6. Click [Continue].

**NOTE**

- If a dialog box appears asking if you want to install the software, click [Continue].
- If Extensions for Steinberg DAW has been installed, it will be overwritten by the new installed version.

7. Execute the installation by following the on-screen directions.

**NOTE**

- You can select only the startup disk as installation destination.
- During the installation procedure, you can select the type of Extensions for Steinberg DAW by selecting “Customize” in the “Installation Type” dialog.

8. When the installation is complete, a message indicating so appears. Click [Close].

9. Install the USB-MIDI driver.

**NOTE**

- Installation of the USB MIDI driver is described in “installationguide\_en.pdf” stored in the “USB-MIDI\_Driver” folder.
- The “Keyboard Setup Assistant” window appears when connecting the KX to a computer via USB. In this case, click the red circle at the top left corner to close this window.



10. After disconnecting all other USB devices from the computer, connect the KX directly to the computer (without using a hub) by using a USB cable.

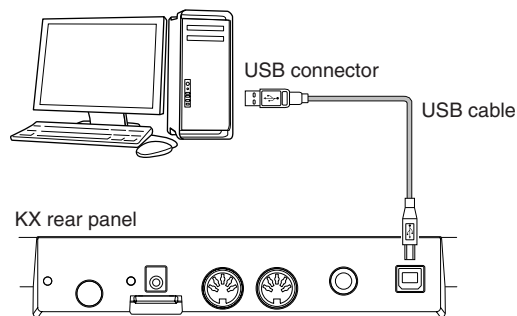

11. Turn the power on of the KX by pressing the [STANDBY/ON] switch.

The KX will be recognized by the connected Macintosh computer.

The installation is now complete.

### Precautions when using the USB TO HOST connector

When connecting the computer to the USB TO HOST connector, make sure to observe the following points. Failing to do so risks freezing the computer and corrupting or even losing the data.

If the computer or the instrument freezes, restart the application software or the computer OS, or turn the power to the instrument off then on again.

### ⚠ CAUTION

- Use an AB type USB cable of less than about 3 meters.
- Before connecting the computer to the USB TO HOST connector, exit from any power-saving mode (such as suspended, sleep, standby) of the computer.
- Before turning on the power to the instrument, connect the computer to the USB TO HOST connector.
- Execute the following before turning the power to the instrument on/off or plugging/unplugging the USB cable to/from the USB TO HOST connector.
  - Quit any open applications.
  - Make sure that data is not being transmitted from the instrument. (Data is transmitted only by playing notes on the keyboard or playing back an Arpeggio.)
- While a USB device is connected to the instrument, you should wait for six seconds or more between these operations: (1) when turning the power of the instrument off then on again, or (2) when alternately connecting/disconnecting the USB cable.



## Connection

If you've followed the instructions on pages 13–15, you've connected your KX and computer as shown below. (Additional devices shown below have been included to cover other possible setups.) Keep in mind that all further instructions in this manual assume the connection has been made properly. Also remember that you'll need a set of headphones or a speaker system to hear the sounds from your computer.

**NOTE** As necessary, connect the MIDI devices such as synthesizer, tone generator and sequencer to the KX.

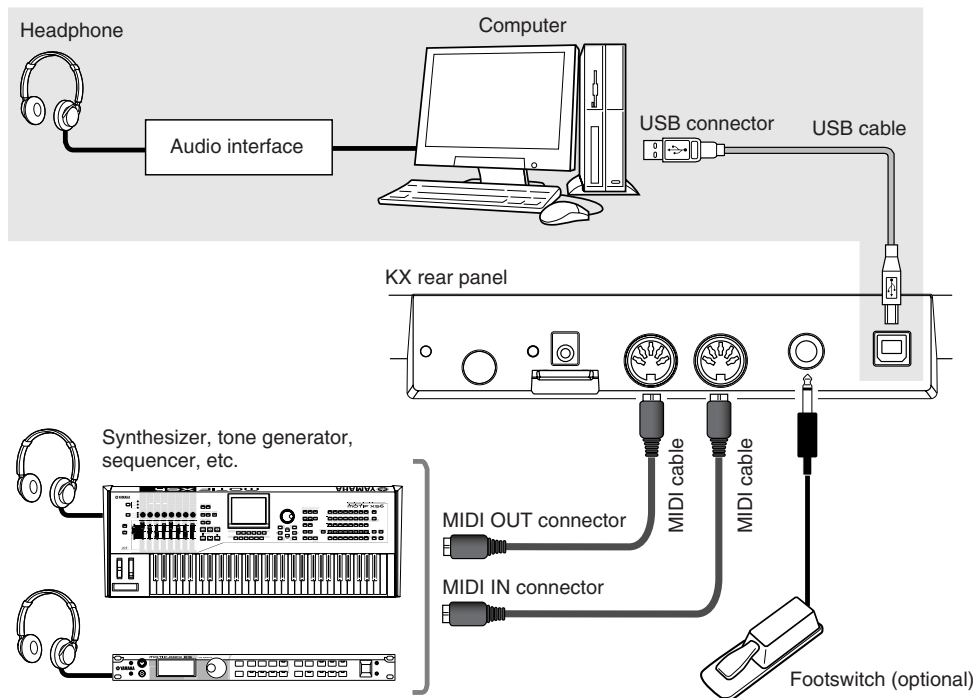

- NOTE**
- Once all software and drivers have been properly installed (pages 13–15), and with the initial default settings (MIDI Select = USB, on page 37; MIDI Thru = MIDI → USB, on page 38), the KX can control the DAW software on your computer via a USB cable. This allows you to play the voices of plug-in instruments (including VSTi) on your computer from the keyboard of the KX. Also, MIDI messages generated on a connected MIDI device (such as the synthesizer shown above) can be transmitted through the KX to the computer. This allows you to play back songs on a MIDI device and have the voices of your plug-in software sound.
  - When the MIDI Select parameter (page 37) is set to "MIDI," the USB connector will be inactive. This means that MIDI communication is only possible via the MIDI connectors (and not via USB). In the example illustration above, this setting lets you play the sound of the tone generator from the KX keyboard.

### Footswitch

While holding an optional footswitch (Yamaha FC4 or FC5) connected to the SUSTAIN jack, the note you pressed then released works as if you held it. For organ sounds that have no natural decay, holding down the footswitch will maintain the sound at the same level even if you release the note. For piano sounds that have a natural decay, holding down the footswitch will decay the sound naturally even if you release the note. For the Arpeggio function (page 31), holding down the footswitch will maintain playback of the Arpeggio. Keep in mind that such operations are available only when devices (such as a connected MIDI tone generator or a VSTi on the connected computer) that can recognize Control Change #64 are active.

**NOTE** Be sure to connect or disconnect the footswitch to the SUSTAIN jack while the power of the KX is turned off. If you disconnect the footswitch while the power is turned on, the footswitch function becomes "stuck"—in other words, the sound will continue to sustain, or Arpeggio playback will continue indefinitely.

## Using the KX with Cubase

The KX features a special Link feature that allows you seamless control over various functions in Cubase and provides enormous efficiency and speed in your music production workflow. Make sure you've connected all devices and properly set up your system (as described on pages 13–16), then try using the KX with Cubase according to the instructions here.

### Setting up on the KX

To use the Link function with Cubase, it is necessary to change the settings of the KX according to the DAW on your computer.

1. Turn the power ON by pressing the [STANDBY/ON] switch to set it to the ON position.

The top display (page 26) appears.

2. Press the [UTILITY] button to call up the Utility display.

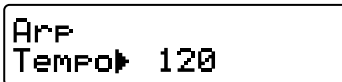

3. Use the SELECT buttons to call up “DAW Select.”

In this state, you can select the DAW software controlled from the KX.



4. Use the DATA [DEC] and [INC] buttons to select the desired DAW software.

■ When using Cubase 4/Cubase Studio 4/  
Cubase Essential 4:

Select “Cubase4.”

■ When using Cubase AI4:

Select “CubaseAI.”

5. Press the [EXIT] button to return to the original display.

### Setting up on Cubase

The MIDI messages generated on the KX (by playing the keyboard, controlling the Pitch Bend Wheel and the Modulation Wheel, and so on) are transmitted via USB-MIDI Port 1 from the KX to Cubase. Keep in mind that MIDI data transmitted via the USB-MIDI Ports 2 and 3 are not related to music performance (including the instrument change). This means that any messages received over these ports may be recognized as instrument change and hence may result in unexpected sounds. To avoid this, you should remove the checkmark of “All MIDI Input” for USB-MIDI Port 2 and Port 3.

#### NOTE

- The explanations here use screen examples taken from Windows. The instructions for using Macintosh are the same.
- For further details about the USB-MIDI Ports 1–3, refer to page 18.

1. Start Cubase on your computer.

#### **Important!**

Cubase cannot recognize the KX if you turn the power of the KX on after starting Cubase. Make sure to start Cubase after turning on the power of the KX.

2. Select “Device Setup” from the “Device” menu of Cubase.

The Device dialog appears.

3. Click “MIDI Port Setup” in the Devices column.

The MIDI ports of Cubase appear at right of the dialog.

**4. Remove the checkmarks by clicking the check boxes of “All MIDI Inputs” corresponding to the KX MIDI Ports 2 and 3 respectively.**

“Yamaha KX-2” and “Yamaha KX-3” on Windows and “YAMAHA KX Port 2” and “YAMAHA KX Port 3” on Macintosh correspond to MIDI Port 2 and MIDI Port 3 respectively. MIDI Ports 2 and 3 of the KX handle the messages generated via the operations other than keyboard performance such as operations via the CONTROL knobs and operations on the KX Editor of the computer. Removing the checkmarks corresponding to these MIDI ports will avoid accidentally recording non-keyboard data to a track in Cubase.

**NOTE** The checkmark of “All MIDI Inputs” corresponding to the KX MIDI Port 2 should be removed since “Extensions for Steinberg DAW” is included normally in “TOOLS for KX.” Remove the checkmark of “All MIDI Inputs” corresponding to the KX MIDI Port 2 only if the checkmark is checked for some reasons.

Click “MIDI Port Setup.”

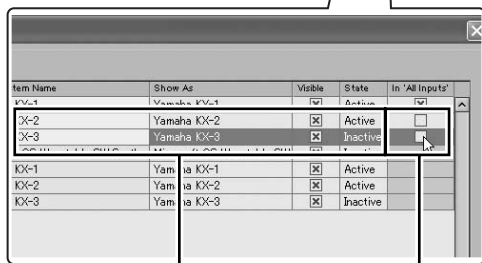
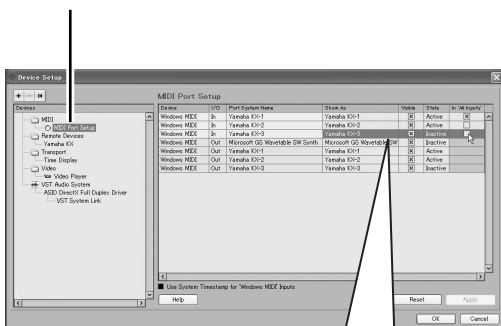

This is an example screen when using Windows. The corresponding Macintosh indications are “YAMAHA KX Port 2” and “YAMAHA KX Port 3.”

Remove the checkmark.

**5. Click [OK] to close the dialog.**

**MIDI ports on the KX**

For data transfer via a USB cable between the KX and the computer, you can use three MIDI ports by installing the USB-MIDI driver. Each of three MIDI ports can handle the different MIDI messages as described below.

**MIDI Port 1:**

This port is indicated as “Yamaha KX-1” on Windows and “YAMAHA KX Port 1” on Macintosh. This port is used for data transfer of the musical performance such as keyboard performance (note on/off), Modulation wheel operation (Control Change) and Pitch Bend wheel operation.

**MIDI Port 2:**

This port is indicated as “Yamaha KX-2” on Windows and “YAMAHA KX Port 2” on Macintosh. This port is used for data transfer generated by using the DAW REMOTE buttons (with the exception of the Cursor buttons, [ESC] button and [ENTER] button) and CONTROL knobs.

**MIDI Port 3:**

This port is indicated as “Yamaha KX-3” on Windows and “YAMAHA KX Port 3” on Macintosh. This port is used for data transfer generated by operating the KX Editor on the computer.

- NOTE**
- When the MIDI Select parameter is set to “MIDI” (page 37) and the USB TO HOST connector becomes inactive, the data communication described above cannot be performed.
  - When using DAW software other than Cubase, perform the MIDI setup manually on the DAW software so that MIDI Port 1 can handle performance data (such as note on/off) and MIDI Port 2 can handle data generated by controlling the Transport function.
  - When using DAW software other than Cubase, the MIDI messages generated by using the CONTROL knob will be transmitted via USB-MIDI Port 1. Also when using Cubase, the MIDI messages generated by using the CONTROL knob will be transmitted via USB-MIDI Port 1 only when the KnobOutSel parameter is set to “CC.”
  - On Windows XP, “USB 0-1” (different from the above port name) may be shown as the port name. If this happens, select [Start] → [Control Panel], double-click [Yamaha USB-MIDI Driver], enter the checkmark to the check box of “Use Device Name As Port Name (Valid after system restart.)” then restart the computer.

## Setting up the VSTi

You can create a track for the VSTi and open/close the VSTi window from the KX panel operation remotely. Performing such operations (normally performed on Cubase) from the KX panel is a great convenience and significantly speeds up your workflow.

### Creating a track for the VSTi

This lets you easily create a VSTi track remotely by using the KX panel controls.

1. On Cubase, open an already-created Project or open a new Project.
2. Press the [ADD INSTRUMENT TRACK] button of the KX. The [Add Instrument Track] dialog appears.



**NOTE** For Cubase 4 / Cubase Studio 4 / Cubase Essential 4, pressing the [ADD INSTRUMENT TRACK] button while the [Add Instrument Track] dialog is shown will switch between calling up and hiding the “Browse Presets” section.

3. Move the focus to the desired VSTi by using the Cursor buttons on the KX, then press the [ENTER] button on the KX. In this case, select “HALionOne.”
4. Press the [ENTER] button on the KX again to close the [Add Instrument Track] dialog, then create a new Instrument Track. To create a new Instrument Track, you can click [OK] in the [Add Instrument Track] dialog.

### Opening the VSTi window and selecting an instrument

When the Instrument Track or the MIDI track for which the destination is set to VSTi is selected on the Project window or the other window, you can open the VSTi window quickly at the touch of a button on the KX’s panel.

1. On the KX, use the Cursor buttons to select the track corresponding to the desired VSTi.



2. On the KX, press the [VSTi WINDOW] button to open the VSTi window.

The VSTi window of the track selected in step 1 will appear.

Instrument Select box

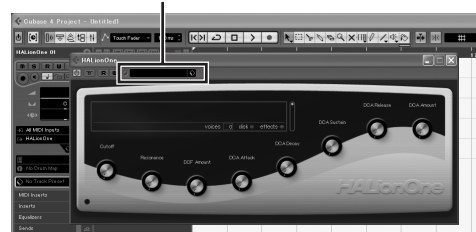

3. On the KX, press the CUBASE FUNCTION [A] button twice to call up the window (Preset Browser) shown below.

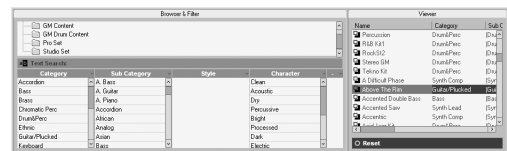

4. On the KX, use the cursor button and CUBASE FUNCTION [B] button to select a category of instruments. Move the focus to “Drum&Perc” in the Category field then press the CUBASE FUNCTION [B] button to actually select “Drum&Perc.” Move the focus to the Sub Category by using the Cursor [▶] button, move the focus to “DrumSet GM” in the Sub Category field by using the Cursor [▲] and [▼] buttons, then press the CUBASE FUNCTION [B] button to actually select “DrumSet GM.”
5. On the KX, use the PROGRAM [DEC] or [INC] button to select the desired instrument. In this case, select “RockSt2” in the Search & Viewer.

## Playing the Keyboard

Try playing the keyboard on the KX to hear the sound of "RockSt2" selected in step 4 on the previous page. Depending on the pressed note, a different instrument's sound will be played back, allowing you to play your own rhythm pattern in real time by pressing various notes rhythmically.

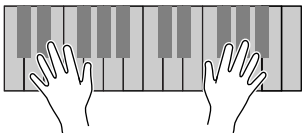

### NOTE

By pressing the [OCTAVE] button and playing in the same octave area as before, you can call up a completely different set of drum sounds. Try shifting the octave setting and call up your favorite drum instruments and percussion sounds. To reset the octave to the default status, press both [OCTAVE] buttons simultaneously. For details about the [OCTAVE] buttons, see page 27.

## Playing an Arpeggio

The Arpeggio feature is a powerful tool for both real-time performance and recording. It lets you easily play (in many cases, with just a single finger) a wide variety of specially programmed rhythm patterns, riffs and phrases using the currently selected instrument on the computer.

This section shows you how to play Arpeggios by using "RockSt2" selected in step 4 on the previous page. You can hear the rhythm pattern play back automatically.

### Trigger the Arpeggio with one finger

1. Press the [ARP ON/OFF] button (the lamp lights).

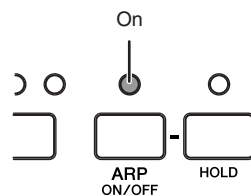

2. Press a single note on the keyboard.

The Arpeggio (rhythm pattern) starts just by playing a single note with one finger.

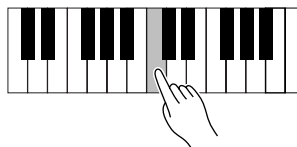

### NOTE

The Arpeggio plays back according to the internal tempo set in the Utility display (page 36) or the external tempo set on the DAW software depending on the current status. For details, see page 32.

3. Release the note to stop the Arpeggio.

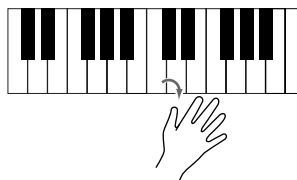

## Holding Arpeggio playback

4. Press the [HOLD] button (the lamp lights).

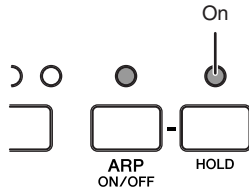

5. Press a single note on the keyboard.

The Arpeggio (rhythm pattern) starts just by playing a single note. While the [HOLD] lamp is turned on, Arpeggio playback will not stop even if you release the note meaning that you can perform another operation during playback.

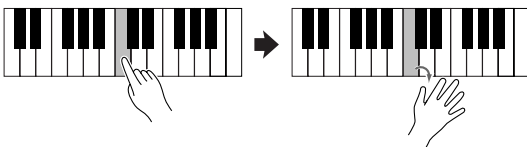

6. Press the [HOLD] button again (the lamp goes out). To stop Arpeggio playback.

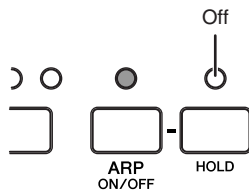

### NOTE

By pressing a footswitch connected to the SUSTAIN jack (page 16), the Arpeggio continues to play, even if you release the note. In this case, you can stop Arpeggio playback by releasing the footswitch.

## Trying out other notes on the keyboard

7. Press the lowest C (leftmost note).  
A rhythm pattern starts playing.

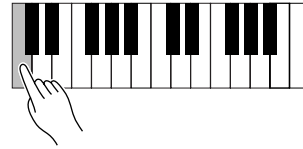

### NOTE

If you are using the KX8, press the lowest C key on the keyboard (the C a third above the lowest key).

8. Next, press the G located a fifth above the C pressed in step 7.

A different rhythm pattern starts.

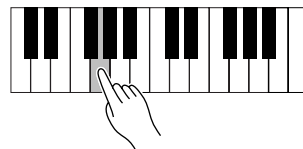

9. Next, press the C located a fourth above the G pressed in step 8.

A rhythm pattern different from the previous two patterns starts.

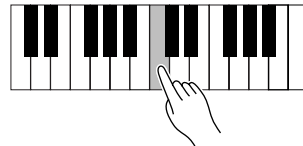

10. Next, press the G located a fifth above the C pressed in step 9.

A rhythm pattern different from the previous three patterns starts.

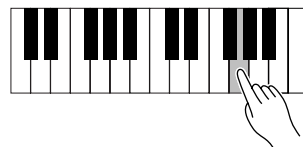

11. Finally, press the C located a fourth above the G pressed in step 10 (the highest C of the KX25).

The rhythm pattern same as that played in step 7 starts.

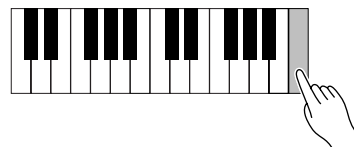

In this way you can play different rhythms from the same Arpeggio type simply by playing just a few notes. In fact, you can create the rhythmic basis for a complete song by letting each rhythm repeat for several measures and changing patterns as desired. Each of the Arpeggio types in the Category “DrPc” (selected with the default initial setting) features four different rhythm patterns recorded respectively to four different tracks. Each of these patterns is assigned to a specific area of the keyboard. You can call up the desired pattern by pressing any note in a specific area, as shown below.

For these “DrPc” (Drum/Percussion) Arpeggio types, the keyboard of the KX is divided into four six-note groups, each group having a different rhythm pattern. The note ranges of these four groups are: C – F, F# – B, C – F, F# – B...and so on, repeating up the keyboard. Playing any note in the group will trigger the assigned Arpeggio/rhythm pattern.

On the KX61, for example, the rhythm patterns are assigned to note groups like this:

C1 – F1 : Track 1 rhythm pattern  
F#1 – B1 : Track 2 rhythm pattern  
C2 – F2 : Track 3 rhythm pattern  
F#2 – B2 : Track 4 rhythm pattern  
C3 – F3 : Track 1 rhythm pattern  
(...and so on up the keyboard.)



Each note on the keyboard has a note name like C3, D3, and E3 according to the octave. This octave setting can be shifted by using the [OCTAVE] buttons. For details, see page 27.



## Using the CUBASE FUNCTION Buttons

### Default functions

When using Cubase, the functions related to the operations of the Preset Browser are assigned to the CUBASE FUNCTION [A] and [B] buttons.

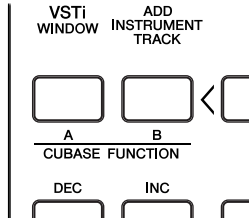

#### ■ CUBASE FUNCTION [A]:

Pressing this button calls up the Preset Browser. Pressing this button while the Preset Browser is shown switches between calling up and hiding the Filter section at left half of the Preset Browser.

#### ■ CUBASE FUNCTION [B]:

Pressing this button while the Preset Browser is shown enables or removes a selection of the item to which you have already moved the focus. Move the focus to the item which is not selected currently then press this button to actually select the item. To remove the selection of the item, move the focus to the item which is currently selected, then press this button.

#### ■ CUBASE FUNCTION [A] + [B]:

Pressing these two buttons simultaneously resets the Filter settings. In other words, selection of all the items in the Filter section will be removed.

You can assign the different functions from the above to the CUBASE FUNCTION [A] and [B] buttons as desired. For details, refer to the next section.

**NOTE** For information on the assigned functions of these buttons when using DAW software other than Cubase, see page 34.

## Assigning different functions to the buttons

The buttons for controlling Cubase can be changed as desired. To do this, follow the instructions below:

1. Select “Device Setup” from the Device menu.  
The “Device Setup” dialog appears.
2. Click “Yamaha KX” in the Device column.

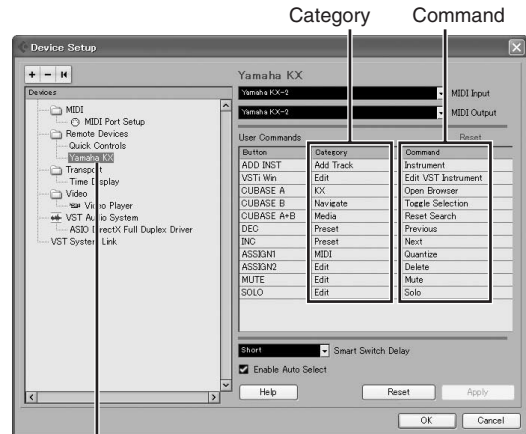

Click “Yamaha KX.”

The following buttons are assignable.

- [ADD INSTRUMENT TRACK] button
- [VSTi WINDOW] button
- CUBASE FUNCTION[A] and [B] buttons
- PROGRAM[DEC] and [INC] buttons
- [ASSIGN 1] and [ASSIGN 2] buttons
- [MUTE] button
- [SOLO] button

3. Click the Category column of the desired button, then select the desired Category from the pop-up menu.

When selecting a Category that includes multiple commands, click the Command column, then select the desired function from the pop-up menu.

The commands available for assignment depend on the selected category. For example, selecting the “MIDI” category allows you to call up various MIDI-related commands, such as Quantize, Velocity, etc.

4. Click [OK] after completing the setup.

The “Device Setup” dialog closes.

### HINT

There are many Categories and many Commands within each Category. You may want to spend some time and check them out at your leisure. That way you can find the commands you need to use the most in your music production, and find the ones that best suit your personal preferences and your own workflow.

## Controlling the VSTi by Using the CONTROL Knobs

Operating the CONTROL knobs on the KX panel edits or controls various parameters of the VSTi used on the computer. The KX provides 30 Control Templates which can be used for various VSTi plug-ins. By selecting the desired one from 30 Control Templates, you can assign the functions appropriate for the current VSTi to the CONTROL knobs.

When using Cubase, any time you select an Instrument track or select a MIDI track for which the destination is set to VSTi, or change the VSTi assigned to the current track, the Control Template on the KX will automatically change. This means that you need not select the Control Template manually when using Cubase.

Use these knobs to adjust the values of the VSTi parameters.  
A total of eight different parameters can be controlled. Pressing the Function Select button switches between the two groups of parameter assignments.

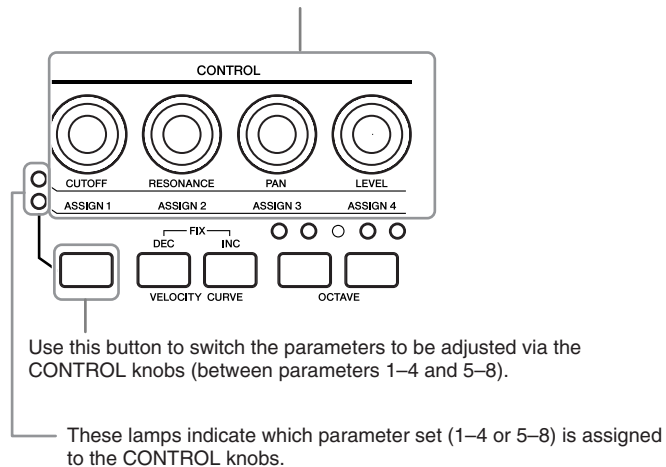

When the Top display is shown, the names of the parameters to be adjusted via the CONTROL knobs are shown normally. When controlling the knob, the values of the parameters are shown for a while, then the original display appears again. You can scroll the display to confirm the entire parameter name by pressing the [EXIT] button.

Using the Automation function of Cubase lets you record your knob operations to an Instrument track. For details about the Automation function, refer to the Cubase owner's manual.

- NOTE**
- For details about the available Control Template, refer to the Control Template List on page 45.
  - The time that the value remains displayed can be changed. For details, refer to "Utility Settings" on page 36.
  - When using a DAW other than Cubase, you need to change the Control Template manually on the KX.

### Changing the functions assigned to the CONTROL knobs

When using the VSTi compatible with VST3 in Cubase, you can change the functions assigned to the CONTROL knobs via the following operation.

- On the computer, move the mouse cursor to the VSTi controller whose function you want to assign to one of the CONTROL knobs.**
- On the KX, hold the Knob Functions Select button then rotate one of the CONTROL knobs to which the function of the VSTi controller selected in step 1 is assigned.**  
“(Learning knob.)” is shown on the display.
- On the KX, release the Knob Functions Select button.**  
The function of the VSTi controller selected in step 1 is assigned to the knob rotated in step 2.

- NOTE** When using the VSTi which is not compatible with VST3, you can assign the desired function to the CONTROL knobs by using the KX Editor (even though you cannot do this from the KX panel).

## Controlling the Transport and Tracks

You can use the panel controls on the KX to control transport functions (such as Play, Record and Stop) within Cubase, and perform other operations, such as muting and soloing of selected tracks.

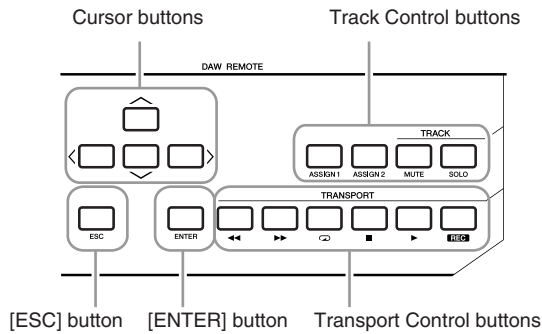

### Cursor buttons

These buttons function the same as the cursor keys on your computer.

### [ENTER] button

This button functions the same as the ENTER key on your computer.

### [ESC] button

This button functions the same as the ESC key on your computer, letting you cancel operations and close windows.

### Track Control buttons

Select the desired track in Cubase and use these buttons to perform the desired function.

[ASSIGN 1] button ..... Executes the MIDI Quantize command.

[ASSIGN 2] button ..... Executes the Delete command.

[MUTE] button ..... Switches Mute of the selected track On or Off.

[SOLO] button ..... Switches Solo of the selected track On or Off.

### Transport Control buttons

Use these buttons to control the transport functions.

[ <<< ] button ..... Rewind

[ >>> ] button ..... Fast forward

[ ↺ ] button ..... Repeat on/off

[ ■ ] button ..... Stop

[ ▶ ] button ..... Play

[ REC ] button ..... Record

### NOTE

- The functions assigned to the Track Control buttons can be changed as desired. For details, see page 23.
- If you are using a DAW software other than Cubase, make the appropriate setting in the DAW Select parameter (page 34).

# Basic Operation on the KX

This section describes the basic operations of the KX, such as how to shift the octave range of the keyboard and use the display interface.

## Display Indications

The display shows various parameters depending on your panel operation.

### Top display

This display appears when turning the power ON. Parameters edited via the CONTROL knobs are shown on the display.

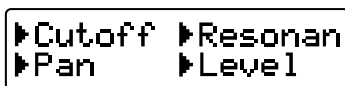

**NOTE**

The display illustrated below may appear when turning the power ON. This indicates that Cubase and VSTi have not been started on the computer connected to the KX via USB. If you intend to use Cubase, start Cubase then set the VSTi (the indication below disappears and the Top display shown above appears). If you intend to use a DAW other than Cubase, change the DAW Select parameter (page 37) to the appropriate setting (other than "Cubase4" or "CubaseAI").



Operating any of the CONTROL knobs calls up the values on the display. After a while, the display returns to the original indication.

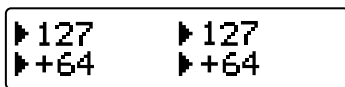

**NOTE**

You can set the desired amount of time that the values remain in the display. For instructions, see page 36.

### Arpeggio Edit display

Call up this display by pressing the [ARP EDIT] button (the lamp lights). This display lets you select the Arpeggio type and set the related parameters. Press the [EXIT] button to return to the original Top display.



### Control Template display

Call up this display by pressing the [CONTROL TEMPLATE] button (the lamp lights). This display lets you select a template of CONTROL knob assignments. Press the [EXIT] button to return to the original Top display.



### Utility display

Call up this display by pressing the [UTILITY] button (the lamp lights). This display lets you set the system related parameters. Press the [EXIT] button to return to the original Top display.



From these displays, you can call up the desired parameters by using the SELECT [▲] and [▼] buttons. The arrow indication at the current parameter flashes, indicating the parameter can be edited.



## Changing the Octave Range

Use these buttons to shift the note range of the keyboard by octave (three octaves, up or down). The initial default setting (no shift) is recalled by pressing both the buttons simultaneously.

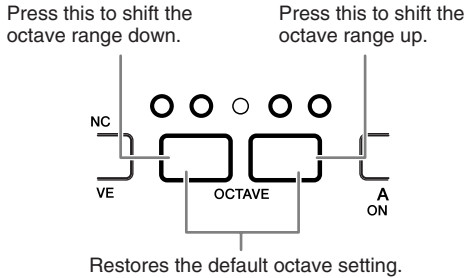

The current octave range can be confirmed via the status of the LED lamp above the button.

● ○ ○ ○ ○ (Flashes)	Three octaves lower
● ○ ○ ○ ○	Two octaves lower
○ ● ○ ○ ○	One octave lower
○ ○ ○ ○ ○	Initial default setting
○ ○ ○ ● ○	One octave higher
○ ○ ○ ○ ●	Two octaves higher
○ ○ ○ ○ ● (Flashes)	Three octaves higher

**NOTE** You can reverse the LED status (on or off) of the OCTAVE buttons. For information about how to reverse the LED status (on or off), refer to “Utility Settings” on page 36.

### Note names of the keyboard

The range of the keyboard is indicated by note name, as described below.

Model	Range
KX25	C2 .. C4
KX49	C2 .. C6
KX61	C1 .. C6
KX8	A-1 .. C7

The note name assignment above depends on the initial default setting of the KX. This assignment can be shifted by using the [OCTAVE] buttons.

## Selecting the Velocity Curve

You can select the desired Velocity Curve which determines how velocities are applied according to your playing strength. Use the VELOCITY CURVE [DEC] and [INC] buttons to select the desired Velocity Curve.

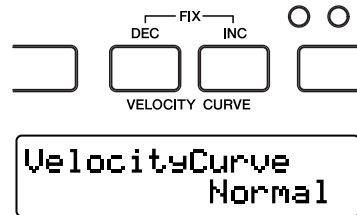

The following Velocity Curves are available:

<b>Soft2</b>	This curve produces high velocity values even for low playing strength. Select this if you want a high volume even when you play softly.
<b>Soft1</b>	This curve produces relatively high velocity values even for low playing strength. It is a more moderate curve than Soft 2 above.
<b>Normal</b>	This is a normal, linear curve that has a one-to-one correspondence between your playing strength and the resulting velocity.
<b>Hard1</b>	This curve produces relatively low velocity values even for high playing strength. Select this if you don't want the volume to change much when you play strongly.
<b>Hard2</b>	This curve produces low velocity values even for high playing strength. It is a more extreme curve than Hard 1 above. This curve is also the optimum Velocity Curve for use with the HALionOne VSTi.

Press the VELOCITY CURVE [DEC] and [INC] buttons simultaneously to select “Fix.” The Fix setting lets you play the notes with a fixed velocity no matter how hard or soft you play the notes.



You can set the fixed velocity by pressing one of the VELOCITY CURVE [DEC] and [INC] buttons. Pressing both the buttons simultaneously exits from this status (Fix setting) to the last selected Velocity Curve.

**NOTE** From the Utility display (page 26), you can select a Velocity Curve and specify a specific velocity value to be used when Fix is selected. For details, refer to “Utility Settings” on page 36.

## Control Templates

The KX provides 30 Control Templates which can be used for VSTi plug-in software. By selecting the desired Control Template, you can automatically call up the appropriate function assignments for controlling the currently selected VSTi with the CONTROL knobs.

When using Cubase, selecting an Instrument track or changing the VSTi assigned to the current track will automatically change the Control Template for the VSTi on the KX, meaning that you don't have to select the template manually.

On the other hand, if you are using a DAW other than Cubase, you will need to manually select the appropriate Control Template on the KX.

**NOTE**  A special KX Editor (page 6), available as a free download from the Yamaha website, provides tools for editing all KX Control Templates.

### Selecting a Control Template

#### 1. Press the [CONTROL TEMPLATE] button.

The LED lamp lights and the Control Template selection display appears.

Lights

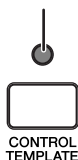

In this state, you can select the Control Template.

**NOTE**  If a different, unrelated display appears even when you press the [CONTROL TEMPLATE] button, press the [CONTROL TEMPLATE] button again or press the SELECT [▲] button once or twice to call up the Control Template selection display.

#### 2. Use the DATA [DEC] and [INC] buttons to select the desired Control Template.



**NOTE**  You can increase the value by 10 by simultaneously holding down the [DEC] button and pressing the [INC] button, or decrease the value by 10 by simultaneously holding down the [INC] button and pressing the [DEC] button.

#### 3. Press the [EXIT] button to return to the Top display which appears when turning the power on.

## Editing a Control Template

### Changing the message type generated by using the CONTROL knobs

The MIDI messages generated by operating the CONTROL knobs are divided into two types: Remote and CC (Control Change). Only one of these two types can be active, and the type is set with the KnobOutSel parameter.

#### Remote (Remote Control message dedicated to Cubase)

When this is selected, Remote Control messages dedicated to Cubase will be generated by operating the CONTROL knobs and transmitted to Cubase via USB-MIDI Port 2. This type of data is transmitted via USB-MIDI Port 2, while keyboard performance data is transmitted via USB-MIDI Port 1, meaning that the messages generated by operating the CONTROL knobs do not affect the keyboard performance but only the VSTi parameters.

#### CC (Control Change)

When this is selected, Control Change messages will be generated by operating the CONTROL knobs and transmitted to the computer via USB-MIDI Port 1. When using a DAW other than Cubase, only this setting is available.

#### NOTE

- When using Cubase, you generally won't need to change this parameter from the initial default setting (Remote), although there may be times that you should set this parameter to "CC" depending on the VSTi you're using.
- Setting the DAW Select parameter to a value other than "Cubase4" or "CubaseAI" will change the KnobOutSel parameter to "CC" automatically even when it is set to "Remote."

#### 1. Press the [CONTROL TEMPLATE] button.

The LED lamp lights and the Control Template selection display appears.

#### NOTE

If a different, unrelated display appears even when you press the [CONTROL TEMPLATE] button, press the [CONTROL TEMPLATE] button again or press the SELECT [▲] button once or twice to call up the Control Template selection display.

#### 2. Use the DATA [DEC] and [INC] buttons to select the desired Control Template.

#### 3. Use the SELECT [▲] and [▼] buttons to call up "KnobOutSelect."



KnobOutSelect  
▶Remote

#### 4. Use the DATA [DEC] and [INC] buttons to select the desired type of message.

CC ..... Control change  
Remote ..... Remote Control exclusive for  
Cubase

#### 5. Press the [EXIT] button to return to the original display.



### Changing the Control Change number generated by using the CONTROL knob

You can change the Control Change number assigned to the CONTROL knob from the default setting as desired.

**NOTE**  The setting here is automatically stored to the internal memory of the KX. If you want to back up the setting here, use the KX Editor (page 6) to store the setting to a computer.

**1. Press the [CONTROL TEMPLATE] button.**

The LED lamp lights and the Control Template selection display appears.

**NOTE**  If a different, unrelated display appears even when you press the [CONTROL TEMPLATE] button, press the [CONTROL TEMPLATE] button again or press the SELECT [▲] button once or twice to call up the Control Template selection display.

**2. Use the DATA [DEC] and [INC] buttons to select the desired Control Template.**

**3. Use the SELECT [▲] and [▼] buttons to select the desired CONTROL knob.**



```
Assign1  CC:111
Assign2  CC:112
```

**NOTE**  The Control Change numbers available for adjusting the parameters may differ depending on the particular VSTi. For details, refer to the relevant owner's manual of your VSTi.

**4. Use the DATA [DEC] and [INC] buttons to change the Control Change number of the selected CONTROL knob.**

**NOTE**  The display of the KX shows the Control Change number in decimal. Keep in mind that the Control Change number may be described in hexadecimal depending on the manual of the VSTi.

**5. Press the [EXIT] button to return to the original display.**

## Arpeggio

The KX features a powerful Arpeggio function, that lets you play various phrases or rhythm pattern depending on the notes you press. Among the preset 342 Arpeggio types provided in the KX, each of 66 types for drum/percussion sounds consists of four phrases (rhythm patterns) which can be called up according to the area of the pressed note—giving you a total of 540 phrases/rhythm patterns (66 types with 4 phrases each, plus 276), which can be played simply by pressing a note on the keyboard.

The basic instructions for using the Arpeggio feature are given on page 20. This section shows you how to select an Arpeggio type and edit the related parameters.

### Selecting an Arpeggio Type

The KX features 342 different Arpeggio types. You can select an Arpeggio type as desired then start playback simply by pressing any note on the keyboard.

- NOTE**  · The Arpeggio plays back according to the internal tempo value set in the Utility display or in synchronization with the tempo of the external DAW software, depending on the setup of the related parameter. For details, see page 32.
- Each of the Arpeggio types is created assuming that a specific instrument sound is used. The type of the specific instrument (appropriate for each type) is indicated in the Arpeggio Type List on page 46 as “Instrument Type.” Refer to this Instrument Type when selecting an Arpeggio Type.

#### 1. Press the [ARP EDIT] button.

The LED lamp of the [ARP EDIT] button lights and the Arpeggio Edit display appears.

#### 2. Use the SELECT buttons to select “Cat” (Category).

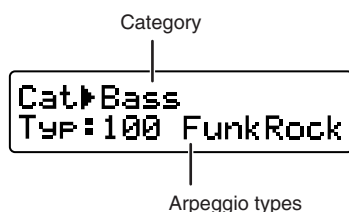

The KX provides a wide variety of Arpeggio types (page 46) divided into Categories. Since there are so many Arpeggio types, it is quicker and more convenient to select a general Category first, then the specific type.

#### 3. Use the DATA [DEC] and [INC] buttons to select the category of the desired Arpeggio type.

#### 4. Use the SELECT buttons so that the “Typ:” indication flashes, then use the DATA [INC] or [DEC] button to select the Arpeggio type.

#### 5. Select the Arpeggio type by using the DATA [DEC] and [INC] buttons.

- NOTE**  · If you change the Arpeggio type during playback, the new Arpeggio type may not start immediately.
- You can operate the CONTROL knobs, Pitch Bend wheel and Modulation Wheel and change the sound in real time while selecting an Arpeggio type.
  - Hold the [DEC] or [INC] button to continuously change the value.
  - You can increase the value by 10 by simultaneously holding down the [INC] button and pressing the [DEC] button, or decrease the value by 10 by simultaneously holding down the [DEC] button and pressing the [INC] button.

#### 6. Press the [EXIT] button to return to the Top display.

##### Arpeggio Category

The Arpeggio types provided in the KX are divided into various categories as listed below.

DrPc	Drum / Percussion
CPrc	Chromatic Percussion
Bass	Bass
Seq	Synth Sequence
ChSq	Chord Sequence
HySq	Hybrid Sequence
ApKb	Acoustic Piano / Keyboard
Orgn	Organ
GtPl	Guitar / Plucked
Strn	Strings
Bras	Brass
RdPp	Reed / Pipe
Lead	Synth Lead

## Using MIDI Clock to control Arpeggio tempo

With the initial default setting (Sync = Auto on page 36), the Arpeggio is played back according to the tempo determined by the internal or external clock as described below.

### When MIDI clock is received from an external MIDI device:

The Arpeggio will play back according to the tempo of the received MIDI clock.

### When MIDI clock is not received:

The Arpeggio will play back according to the internal tempo set on the KX.

When MIDI clock is received from an external MIDI device:

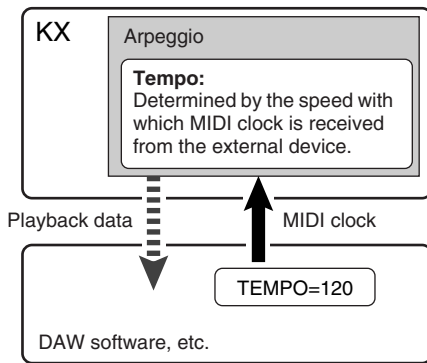

When MIDI clock is not received:

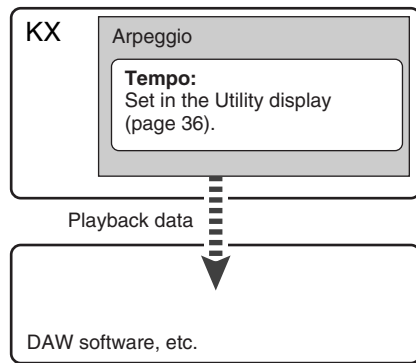

When using Cubase, you can transmit MIDI clock from the computer to the KX by following the procedure below.

1. Select “Project Synchronization Setup” from the “Transport” menu on Cubase to call up the “Project Synchronization Setup” dialog.

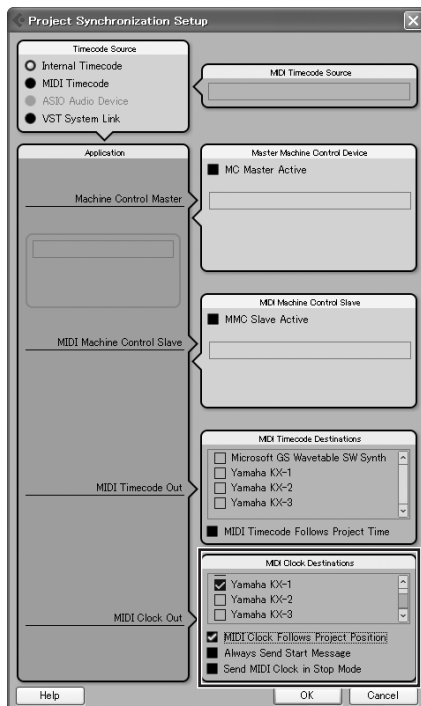

2. Enter checkmarks to the “Yamaha KX-1” (when using Windows) and “MIDI Clock Follows Project Position” of the “MIDI Clock Destination” at the lower right of the dialog.

When using Mac OS, enter a checkmark to “YAMAHA KX Port 1.”

**NOTE** The KX provides three USB MIDI Ports each of which has a different, specific use. For details, see page 18.

3. Click [OK] to close the “Project Synchronization Setup” dialog.

**NOTE**

- Without checkmark to the “Send MIDI Clock in Stop Mode” of the “MIDI Clock Destination”, MIDI clock is transmitted from Cubase (on the computer) only when recording or playback is performed on Cubase. If entering checkmark, MIDI clock is always transmitted.
- For information about DAW software other than Cubase and how to transmit clock data from the MIDI device, refer to the owner’s manual of the DAW software/MIDI device.
- You can select the setting which lets you always use the internal MIDI clock of the KX to play the Arpeggio even if an external clock are received from the external MIDI device. For details, refer to “Utility Settings” on page 36.

## Editing an Arpeggio

The Arpeggio can be edited as desired. For example, you can alter the rhythmic feel of the Arpeggio by changing the amount of Swing, adjust the gate time (length) of the notes, or even select a different variation to completely change the Arpeggio pattern.

### 1. Press the [ARP EDIT] button.

The LED lamp above the button lights and the Arpeggio Edit display will appear.

```
Cat: Bass
Typ: 100 FunkRock
```

### 2. Use the SELECT buttons to call up the desired parameter.

For details about the Arpeggio parameters, see the chart below.

### 3. Use the DATA [DEC] and [INC] buttons to change the value.

#### NOTE

Editing of an Arpeggio can be done even during playback. Any changes made here are immediately applied to playback, meaning that you can check the results of your edits in real time. Keep in mind that editing a parameter during playback may cause glitches in playback. If such a situation occurs, stop Arpeggio playback then press the note to trigger the Arpeggio again.

### 4. When you are satisfied with the result, press the [EXIT] button to return to the Control Top display.

The settings made here are stored automatically. The settings here will be maintained even if you turn the power off or change the Arpeggio type.

#### NOTE

If you want to initialize the settings, use the Factory Set operation (page 37).

## Arpeggio Parameters

Display	Settings	Description
Cat	DrPc, CPrc, Bass, Seq, ChSq, HySq, ApKb, Orgn, GtPl, Strn, Bras, RdPp, Lead	Determines the Category of the Arpeggio type you want to call up. For details, see pages 31 and 46.
Typ	1-342	Determines the Arpeggio type you want to call up. For details, see page 46.
Variation	Orig, Up, Down, Alt1, Alt2, Rnd	Determines the playback variation of the Arpeggio. When any value other than "Orig" is selected, you can shift the pitch up and down in octave for Arpeggio playback by adjusting the "OctRange" parameter. Orig ..... The original data preprogrammed in the KX will play back. Up ..... An Arpeggio of ascending notes will play. Down ..... An Arpeggio of descending notes will play. Alt1 ..... Alternates Up and Down arpeggios. The turnaround note is played once. Alt2 ..... Alternates Up and Down arpeggios. The turnaround note is played twice. Rnd ..... The Arpeggio will play randomly according to the pressed notes.
OctRange	-3 - 0 - +3	Determines the octave setting of Arpeggio playback. When the Variation parameter is set to "Orig," this parameter is indicated as "—," meaning that it cannot be edited.
GateTime	0%–200%	Determines the gate time of Arpeggio notes.
BeatStretch	50, 66, 75, 100, 133, 150, 200%	Adjusts the tempo of Arpeggio playback based on the current original tempo. When "50%" is selected, for example, the playback time will be halved (tempo is doubled). When "200%" is selected, on the other hand, the playback time will be doubled (tempo is halved).
Swing	-120% - 0% - +120%	Adjusts the timing of the even-numbered back-beat notes (according to the note type specified in the SwingValue parameter below) to produce a swing feel.
SwingValue	1/32 (32nd note), 3/16 (16th note triplet), 1/16 (16th note), 3/8 (8th note triplet), 1/8 (8th note), 3/4 (1/4 note triplet), 1/4 (1/4 note)	Determines the type of note that serves as the basis for the Swing parameter.
VelMode	Orig, Thru	Determines how the velocities are applied to playback notes of the selected Arpeggio type. Orig ..... The Arpeggio type is played back with the velocity values preprogrammed in the Arpeggio sequence data. Thru ..... The Arpeggio type is played back with the velocity value determined by how strongly you play the keys.

## Using the KX with a DAW Other than Cubase

This section shows you how to set up the KX for controlling DAW software other than Cubase. For more information on setting up on your particular DAW, refer to the manual of the DAW software.

**1. Press the [UTILITY] button.**

The LED lamp above the button lights and the Utility display appears.

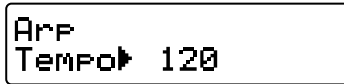

**2. Use the SELECT buttons to call up “DAW Select.”**



**3. Use the DATA [DEC] and [INC] buttons to select one of the following DAW software tools.**

Settings	DAW
LogicPro	Apple Logic Pro 7.2
DigiPerf	MOTU Digital Performer 5.1
SONAR	Cakewalk Sonar 6

**4. Press the [EXIT] button to return to the Top display.**

The setup has been completed.

The following operations are available for the selected DAW software.

Button on the KX	Operation
[ ◀◀ ]	Rewind
[ ▶▶ ]	Fast Forward
[ ↺ ]	Repeat On/off
[ ■ ]	Stop
[ ▶ ]	Play
REC	Record
CUBASE FUNCTION [A]	This button functions the same as the F1 key on the Mackie Control. *
CUBASE FUNCTION [B]	This button functions the same as the F2 key on the Mackie Control. *
[ASSIGN 1]	This button functions the same as the F3 key on the Mackie Control. *
[ASSIGN 2]	This button functions the same as the F4 key on the Mackie Control. *
[MUTE]	This button functions the same as the F5 key on the Mackie Control. *
[SOLO]	This button functions the same as the F6 key on the Mackie Control. *
[VSTi WINDOW]	This button functions the same as the F7 key on the Mackie Control. *
[ADD INSTRUMENT TRACK]	This button functions the same as the F8 key on the Mackie Control. *
Program [DEC]	Transmits the Program Change number decreased by 1 from the current number.
Program [INC]	Transmits the Program Change number increased by 1 from the current number.
Cursor buttons	These buttons function the same as the cursor keys on your computer.
[ENTER]	This button functions the same as the ENTER key on your computer.
[ESC]	This button functions the same as the ESC key on your computer.

\* Mackie Control is a hardware DAW controller. Mackie Control is the trade mark of the Mackie Designs Inc.

**NOTE**

If you perform the Remote Control setup for the Remote Control on the DAW software, you can assign various functions to the Cubase buttons such as the CUBASE FUNCTION [A] button and [ADD INSTRUMENT TRACK] button. For instructions on assigning the function to the button, refer to the manual of the DAW software.

## When using Digital Performer (Macintosh):

In each of these cases, you need to set the MIDI Port in the “Audio MIDI setup.”

**1. In the start up disk of Mac OS X (normally named “Macintosh HD”), open “Application” then “Utilities” and double click “Audio MIDI Setup”.**

**2. Click [MIDI Devices] if the [Audio Device] window is indicated.**

The YAMAHA KX icon appears if the KX is recognized by the Macintosh computer.

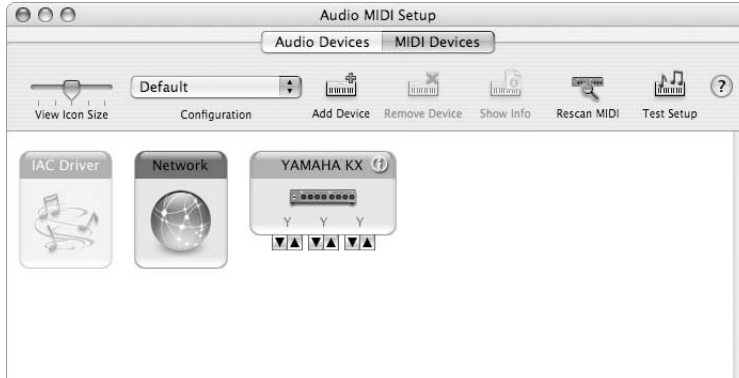

**3. Add two new external devices by clicking the [Add Device] icon twice.**

Each new external device corresponds to each of the MIDI Ports in the KX. It is a good idea to input your desired device name in the Properties of the new external device in order to easily recognize the MIDI port later.

**4. Connect the MIDI input/output plugs of the KX icon to the MIDI input/output plugs of the new external device.**

Assign the names as listed below to the newly added devices respectively.

- USB-MIDI Port 1 (left plug) : YAMAHA KX YAMAHA KX Port 1
- USB-MIDI Port 2 (right plug) : YAMAHA KX YAMAHA KX Port 2

Connect the virtual plugs so that each port can handle MIDI messages.

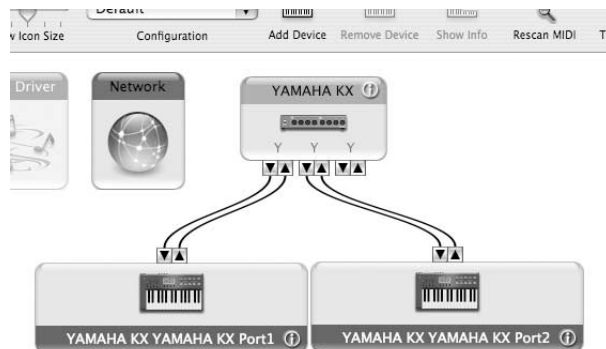

**NOTE** YAMAHA KX YAMAHA KX Port 3 (rightmost plug) used for data communication of the KX Editor does not need to be set.

## Utility Settings

In the Utility display, you can make various settings such as the Arpeggio tempo, MIDI transmit/receive settings, and display related settings.

### Basic Operation

#### 1. Press the [UTILITY] button.

The LED lamp above the button lights and the Utility display appears.

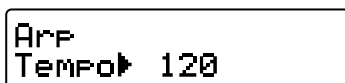

#### 2. Use the SELECT buttons to select the parameter to be edited.

For details on the parameters, refer to "Utility Parameters" listed below.

#### 3. Use the DATA [INC] and [DEC] buttons to change the value.

**NOTE** For the Bulk Transmit and Factory Set parameters, you can execute these operations by simply pressing the DATA [INC] button.

#### 4. After making the desired settings, press the [ENTER] button to return to the Utility Top display.

The settings you made here will be stored automatically without the special operation. The settings will be maintained until executing the Factory Set operation.

### Utility Parameters

Display	Range	Initial Value	Description
Tempo	10–300	120	Determines the tempo (BPM) of Arpeggio playback. The Arpeggio will play according to the speed of the MIDI clock transmitted from an external device or computer when the Sync parameter is set to "Auto" (only when MIDI clock is transmitted continuously) or "External."
Sync	Auto, Internal, External	Auto	Determines the tempo source transmitting the MIDI clock to which Arpeggio playback is synchronized. Auto..... When MIDI clock is transmitted continuously from an external MIDI device or computer, the internal clock of the KX is not effective and Arpeggio playback is synchronized with the external clock. When MIDI clock is not transmitted from the external MIDI device or computer, the internal clock of the KX is effective meaning that the Tempo value set on the KX is available. Internal .... The Arpeggio will play with the Tempo value set on the KX. External ... The Arpeggio will play according to the speed of the MIDI clock transmitted from an external device or computer. When the KX does not receive MIDI clock, the Arpeggio does not play.
Clock	Off, On	On	Determines whether the tempo clock of Arpeggio playback is output as a MIDI message. On ..... When this is selected, MIDI clock will be transmitted while an Arpeggio plays back with the tempo specified on the Tempo parameter above. Off ..... When this is selected, MIDI clock will not be transmitted.
VeloCurve	Soft2, Soft1, Normal, Hard1, Hard2, Fix	Normal	Determines the Velocity Curve. For information about each value, see page 27.
VeloFix	1–127	100	Determines the velocity value when the VeloCurve is set to "Fix."



Display	Range	Initial Value	Description
DAW Select	CubaseAI, Cubase4, LogicPro, DigiPerf, SONAR	CubaseAI	Determines the DAW software you use on the computer with the KX.
ProgChgMode	PC+Remot, ProgChg, Remote	PC+Remot	Determines the type of the MIDI message generated by pressing the PROGRAM [INC] and [DEC] buttons. PC+Remot. When this is selected, the Program Change message is transmitted via USB-MIDI Port 1 and the Remote Control message dedicated to Cubase is transmitted via USB-MIDI Port 2. ProgChg.. When this is selected, only the Program Change message is transmitted via USB-MIDI Port 1. Remote.... When this is selected, only the Remote Control message dedicated to Cubase is transmitted via USB-MIDI Port 2.
MIDI Select	USB, MIDI	USB	Determines which connector is used for MIDI transmit/receive: USB TO HOST or MIDI IN/OUT. USB..... The USB TO HOST connector is used for MIDI communication between the computer and the KX. When the MIDI Thru parameter below is set to "MIDI → MIDI" or "MIDI → USB" or "USB → MIDI," MIDI can also be transmitted via the MIDI OUT connector (MIDI Thru only), even if "USB" is selected here. MIDI..... Only the MIDI connectors are available for MIDI communication.
MIDI Transmit Ch	1–16	1	Determines the MIDI channel over which the KX transmits MIDI messages (generated via your keyboard performance).
MIDI In Thru	Off, MIDI→MIDI, MIDI→USB, USB→MIDI	MIDI→USB	Determines whether the MIDI messages received via the MIDI IN connector will be transmitted via the MIDI OUT connector or USB connector.
Device Number	Off, 1–16, All	All	Determines the MIDI Device Number of the KX.
Display Time	Off, 1.0sec, 1.5sec, 2.0sec, 3.0sec, 4.0sec, 5.0sec, Hold	1.5sec	Determines the duration (time) for which the value (like the one called up by operating the CONTROL knob) is shown temporarily on the display.
Octave LED	Normal, Reverse	Normal	Determines the status of OCTAVE LED lamps. When "Normal" is selected, the LED lamps work as described on page 27. When "Reverse" is selected, the right and left of the LED status are reversed.
BulkTransmit	—	—	Transmits all the settings of the KX to the DAW software or external MIDI device as bulk data. Press the DATA [INC] button to start transmission.
FactorySet	—	—	Restores the factory-programmed system settings of the KX.

## Restoring the Factory-programmed System Settings (Factory Set)

You can restore the factory default settings of the KX. Follow the instructions below to execute Factory Set.

### ⚠ CAUTION

- The edited Arpeggio types and Control Templates will be lost by executing Factory Set. Important data should be saved to the computer by using the KX Editor (page 6).

- From the Top display, press the [UTILITY] button (the lamp lights).
- Use the SELECT buttons to call up "FactorySet."
- Press the DATA [INC] button.  
"Are you sure?" appears on the display.
- Press the DATA [INC] button again to execute Factory Set.

After Factory Set has been completed, the display called up in step 2 appears.



Factory Set  
▶Yes→Inc

## Setting the MIDI Thru Parameter

With the initial default settings (MIDI Select = USB, MIDI Thru = MIDI → USB), MIDI messages received via the MIDI IN connector of the KX will be transmitted through the USB TO HOST connector (USB MIDI Port 1). As necessary, you can change the MIDI Thru setting so that MIDI messages received via the MIDI IN connector can be transmitted through the MIDI OUT connector, or the MIDI messages received via the USB TO HOST connector (USB MIDI Port 1) can be transmitted through the MIDI OUT connector.

- 1. Press the [UTILITY] button.**  
The LED lamp above the button lights and the Utility display appears.
- 2. Use the SELECT [▲] and [▼] buttons to call up the “MIDI Thru” parameter.**



- 3. Use the DATA [DEC] and [INC] buttons to select the desired setting (from the available ones described below).**

Off	When this is selected, the MIDI Thru function is not available.
MIDI → MIDI	When this is selected, MIDI messages received via the MIDI IN connector will be transmitted through the MIDI OUT connector. This setting is available even when the MIDI Select parameter is set to “USB.”
MIDI → USB	When this is selected, MIDI messages received via the MIDI IN connector will be transmitted through the USB TO HOST connector (USB MIDI Port 1).
USB → MIDI	When this is selected, MIDI messages of USB MIDI Port 1 received via the USB TO HOST connector will be transmitted through the MIDI OUT connector.

**NOTE** “MIDI → USB” and “USB → MIDI” can be selected only when the MIDI Select parameter is set to “USB” (page 37).

- 4. After selecting, press the [EXIT] button to return to the Top display.**

**NOTE** Keep in mind that the KX cannot be used as a MIDI interface for the computer and another MIDI device. Although MIDI messages are transferred from the computer to the MIDI device when the MIDI Thru parameter is set to “USB→MIDI” and vice versa when the MIDI Thru parameter is set to “MIDI→USB,” two-way communication between the computer and the MIDI device are not possible.

# Troubleshooting

## The power of the instrument does not turn on.

- If the KX is not connected to a computer, confirm whether or not the AC power adaptor is properly plugged into the KX.
- If you are not using an AC power adaptor, confirm whether or not a USB cable is properly plugged into the KX and computer.
- Confirm whether or not a proper USB cable is used. If the USB cable is broken or damaged, have the USB cable replaced with a known working one.
- Confirm whether or not the USB hub with the bus-powered type is used for connecting the KX and computer. If you must use USB hub, use the self-powered type or use the AC power adaptor of the KX.

## Communication problem between the computer and the KX.

- Confirm whether or not a USB cable is properly plugged into the KX and computer.
- Confirm whether or not the USB-MIDI driver is installed properly.
- Confirm whether or not the MIDI Select parameter is set to "MIDI." When using the KX and a computer, set MIDI Select parameter to "USB."

## DAW software on a computer cannot be remotely controlled.

- Confirm whether or not the DAW software specified in the DAW Select parameter on the Utility display matches the DAW software you actually use on your computer.
- Confirm whether or not the Remote Control setting of the DAW software is proper. Refer to the Owner's Manual of your particular DAW software.

## No sound of a software synthesizer such as VSTi on the computer is produced even when playing the KX keyboard.

- Confirm whether or not a USB cable is properly plugged into the KX and computer.
- Confirm whether or not the volume settings are set properly, such as the volume/mute/solo setup for each track on the DAW, volume setup on the computer, and the related setup on the audio interface (when used).
- Confirm whether or not the MIDI Select parameter is set to "MIDI." When using the KX and computer, set the MIDI Select parameter to "USB."
- Confirm whether or not the Control Template corresponding to the VSTi used on the computer is currently selected on the KX. If not, call up the corresponding Control Template. If the corresponding Control Template is not provided

on the KX by default, create an appropriate Control Template by using the KX Editor.

## A MIDI tone generator (connected via MIDI cable to the KX) does not sound, even when playing the KX keyboard.

- Confirm whether or not the MIDI cable is connected properly.
- Confirm whether or not the MIDI Select parameter is set to "USB." When using the KX and MIDI device, set the MIDI Select parameter to "MIDI."

## The Arpeggio does not play back.

- Confirm whether or not the [ARP ON/OFF] button is turned on.
- Confirm whether or not the Sync parameter of the Utility display is set to "External." If so, start playback or recording on the DAW to transmit MIDI clock from the computer to the KX, or set the Sync parameter to "Auto" or "Internal."

## Releasing the notes does not stop Arpeggio playback even though the [HOLD] button is turned off.

- Confirm whether or not you disconnected the footswitch from the SUSTAIN jack while the power of the KX was turned ON. Keep in mind that the arpeggio may be "stuck" if you disconnect the footswitch from the SUSTAIN jack.

## The sound continues even when notes are released.

- Confirm whether or not you disconnected the footswitch from the SUSTAIN jack while the power of the KX was turned ON. Keep in mind that the sustain effect may be "stuck" if you disconnect the footswitch from the SUSTAIN jack.

## Cubase does not recognize the KX.

- Confirm whether or not the "USB-MIDI Driver" and "Extensions for Steinberg DAW" have been installed. If not, install them.
- Confirm whether or not the KX is turned on before starting Cubase. If not, do so.

### NOTE

For other problems regarding no sound or noise, refer to the troubleshooting section in the manual of your particular DAW software.

## Message List

LCD Indication	Description
MIDI buffer full.	Failed to process the MIDI data because too much data was received at one time.
MIDI checksum error.	The check sum for the data received is incorrect.
MIDI data error.	An error occurred when receiving MIDI data.
USB error.	An error related to the USB TO HOST connector occurred.
Keyboard error.	An error related to the keyboard occurred.
Memory error.	An error related to data storage memory occurred.
Device number is off.	The device number is set to "off."
Device number mismatch.	The device numbers do not match.
Executing...	Displayed while the operation is being performed. Please wait.
Completed	Displayed when the operation has been completed.
Template No.xx <xxxxxxx>	Displayed when the Control Template is selected automatically.
Are you sure? No→Dec/Yes→Inc	Prompts you to confirm whether or not you want to perform the operation. Pressing the [INC] button performs the operation while pressing the [DEC] button cancels the operation.
Receiving MIDI bulk.	The KX is receiving MIDI bulk data.

**ATTENTION****TOOLS for KX LICENSE AGREEMENT**

PLEASE READ THIS SOFTWARE LICENSE AGREEMENT ("AGREEMENT") CAREFULLY BEFORE USING THIS SOFTWARE. YOU ARE ONLY PERMITTED TO USE THIS SOFTWARE PURSUANT TO THE TERMS AND CONDITIONS OF THIS AGREEMENT. THIS AGREEMENT IS BETWEEN YOU (AS AN INDIVIDUAL OR LEGAL ENTITY) AND YAMAHA CORPORATION ("YAMAHA").

BY BREAKING THE SEAL OF THIS PACKAGE YOU ARE AGREEING TO BE BOUND BY THE TERMS OF THIS LICENSE. IF YOU DO NOT AGREE WITH THE TERMS, DO NOT INSTALL, COPY, OR OTHERWISE USE THIS SOFTWARE.

**1. GRANT OF LICENSE AND COPYRIGHT**

Yamaha hereby grants you the right to use one copy of the software program(s) and data ("SOFTWARE") accompanying this Agreement. The term SOFTWARE shall encompass any updates to the accompanying software and data. The SOFTWARE is owned by Yamaha and/or Yamaha's licensor(s), and is protected by relevant copyright laws and all applicable treaty provisions. While you are entitled to claim ownership of the data created with the use of SOFTWARE, the SOFTWARE will continue to be protected under relevant copyrights.

- **You may** use the SOFTWARE on a single computer.
- **You may** make one copy of the SOFTWARE in machine-readable form for backup purposes only, if the SOFTWARE is on media where such backup copy is permitted. On the backup copy, you must reproduce Yamaha's copyright notice and any other proprietary legends that were on the original copy of the SOFTWARE.
- **You may** permanently transfer to a third party all your rights in the SOFTWARE, provided that you do not retain any copies and the recipient reads and agrees to the terms of this Agreement.

**2. RESTRICTIONS**

- **You may not** engage in reverse engineering, disassembly, decompilation or otherwise deriving a source code form of the SOFTWARE by any method whatsoever.
- **You may not** reproduce, modify, change, rent, lease, or distribute the SOFTWARE in whole or in part, or create derivative works of the SOFTWARE.
- **You may not** electronically transmit the SOFTWARE from one computer to another or share the SOFTWARE in a network with other computers.
- **You may not** use the SOFTWARE to distribute illegal data or data that violates public policy.
- **You may not** initiate services based on the use of the SOFTWARE without permission by Yamaha Corporation. Copyrighted data, including but not limited to MIDI data for songs, obtained by means of the SOFTWARE, are subject to the following restrictions which you must observe.
  - Data received by means of the SOFTWARE may not be used for any commercial purposes without permission of the copyright owner.
  - Data received by means of the SOFTWARE may not be duplicated, transferred, or distributed, or played back or performed for listeners in public without permission of the copyright owner.
  - The encryption of data received by means of the SOFTWARE may not be removed nor may the electronic watermark be modified without permission of the copyright owner.

**3. TERMINATION**

This Agreement becomes effective on the day that you receive the SOFTWARE and remains effective until terminated. If any copyright law or provisions of this Agreement is violated, the Agreement shall terminate automatically and immediately without notice from Yamaha. Upon such termination, you must immediately destroy the licensed SOFTWARE, any accompanying written documents and all copies thereof.

**4. LIMITED WARRANTY ON MEDIA**

As to SOFTWARE sold on tangible media, Yamaha warrants that the tangible media on which the SOFTWARE is recorded will be free from defects in materials and workmanship under normal use for a period of fourteen (14) days from the date of receipt, as evidenced by a copy of the receipt. Yamaha's entire liability and your exclusive remedy will be replacement of the defective media if it is returned to Yamaha or an authorized Yamaha dealer within fourteen days with a copy of the receipt. Yamaha is not responsible for replacing media damaged by accident, abuse or misapplication. TO THE FULLEST EXTENT PERMITTED BY LAW, YAMAHA EXPRESSLY DISCLAIMS ANY IMPLIED WARRANTIES ON THE TANGIBLE MEDIA, INCLUDING THE IMPLIED WARRANTIES OF MERCHANTABILITY AND FITNESS FOR A PARTICULAR PURPOSE.

**5. DISCLAIMER OF WARRANTY ON SOFTWARE**

You expressly acknowledge and agree that use of the SOFTWARE is at your sole risk. The SOFTWARE and related documentation are provided "AS IS" and without warranty of any kind. NOTWITHSTANDING ANY OTHER PROVISION OF THIS AGREEMENT, YAMAHA EXPRESSLY DISCLAIMS ALL WARRANTIES AS TO THE SOFTWARE, EXPRESS, AND IMPLIED, INCLUDING BUT NOT LIMITED TO THE IMPLIED WARRANTIES OF MERCHANTABILITY, FITNESS FOR A PARTICULAR PURPOSE AND NON-INFRINGEMENT OF THIRD PARTY RIGHTS. SPECIFICALLY, BUT WITHOUT LIMITING THE FOREGOING, YAMAHA DOES NOT WARRANT THAT THE SOFTWARE WILL MEET YOUR REQUIREMENTS, THAT THE OPERATION OF THE SOFTWARE WILL BE UNINTERRUPTED OR ERROR-FREE, OR THAT DEFECTS IN THE SOFTWARE WILL BE CORRECTED.

**6. LIMITATION OF LIABILITY**

YAMAHA'S ENTIRE OBLIGATION HEREUNDER SHALL BE TO PERMIT USE OF THE SOFTWARE UNDER THE TERMS HEREOF. IN NO EVENT SHALL YAMAHA BE LIABLE TO YOU OR ANY OTHER PERSON FOR ANY DAMAGES, INCLUDING, WITHOUT LIMITATION, ANY DIRECT, INDIRECT, INCIDENTAL OR CONSEQUENTIAL DAMAGES, EXPENSES, LOST PROFITS, LOST DATA OR

OTHER DAMAGES ARISING OUT OF THE USE, MISUSE OR INABILITY TO USE THE SOFTWARE, EVEN IF YAMAHA OR AN AUTHORIZED DEALER HAS BEEN ADVISED OF THE POSSIBILITY OF SUCH DAMAGES. In no event shall Yamaha's total liability to you for all damages, losses and causes of action (whether in contract, tort or otherwise) exceed the amount paid for the SOFTWARE.

### 7. THIRD PARTY SOFTWARE

Third party software and data ("THIRD PARTY SOFTWARE") may be attached to the SOFTWARE. If, in the written materials or the electronic data accompanying the Software, Yamaha identifies any software and data as THIRD PARTY SOFTWARE, you acknowledge and agree that you must abide by the provisions of any Agreement provided with the THIRD PARTY SOFTWARE and that the party providing the THIRD PARTY SOFTWARE is responsible for any warranty or liability related to or arising from the THIRD PARTY SOFTWARE. Yamaha is not responsible in any way for the THIRD PARTY SOFTWARE or your use thereof.

- Yamaha provides no express warranties as to the THIRD PARTY SOFTWARE. IN ADDITION, YAMAHA EXPRESSLY DISCLAIMS ALL IMPLIED WARRANTIES, INCLUDING BUT NOT LIMITED TO THE IMPLIED WARRANTIES OF MERCHANTABILITY AND FITNESS

FOR A PARTICULAR PURPOSE, as to the THIRD PARTY SOFTWARE.

- Yamaha shall not provide you with any service or maintenance as to the THIRD PARTY SOFTWARE.
- Yamaha is not liable to you or any other person for any damages, including, without limitation, any direct, indirect, incidental or consequential damages, expenses, lost profits, lost data or other damages arising out of the use, misuse or inability to use the THIRD PARTY SOFTWARE.

### 8. GENERAL

This Agreement shall be interpreted according to and governed by Japanese law without reference to principles of conflict of laws. Any dispute or procedure shall be heard before the Tokyo District Court in Japan. If for any reason a court of competent jurisdiction finds any portion of this Agreement to be unenforceable, the remainder of this Agreement shall continue in full force and effect.

### 9. COMPLETE AGREEMENT

This Agreement constitutes the entire agreement between the parties with respect to use of the SOFTWARE and any accompanying written materials and supersedes all prior or contemporaneous understandings or agreements, written or oral, regarding the subject matter of this Agreement. No amendment or revision of this Agreement will be binding unless in writing and signed by a fully authorized representative of Yamaha.

## **ATTENTION**

## **Cubase AI4 LICENSE AGREEMENT**

PLEASE READ THIS SOFTWARE LICENSE AGREEMENT ("AGREEMENT") CAREFULLY BEFORE USING THIS SOFTWARE. YOU ARE ONLY PERMITTED TO USE THIS SOFTWARE PURSUANT TO THE TERMS AND CONDITIONS OF THIS AGREEMENT. THIS AGREEMENT IS BETWEEN YOU (AS AN INDIVIDUAL OR LEGAL ENTITY) AND YAMAHA CORPORATION ("YAMAHA").

BY BREAKING THE SEAL OF THIS PACKAGE YOU ARE AGREEING TO BE BOUND BY THE TERMS OF THIS LICENSE. IF YOU DO NOT AGREE WITH THE TERMS, DO NOT INSTALL, COPY, OR OTHERWISE USE THIS SOFTWARE.

THIS AGREEMENT PROVIDES YOUR USE-CONDITIONS ABOUT THE "DAW" SOFTWARE OF STEINBERG MEDIA TECHNOLOGIES GMBH("STEINBERG") WHICH IS BUNDLED WITH THIS PRODUCT. SINCE THE END-USER SOFTWARE LICENSE AGREEMENT (EUSLA) SHOWN ON YOUR PC-DISPLAY IN YOUR INSTALLING THE "DAW" SOFTWARE IS REPLACED BY THIS AGREEMENT, YOU SHOULD DISREGARD THE EUSLA. THAT IS, IN THE INSTALLING PROCESS, YOU SHOULD SELECT "AGREE" WITH THE EUSLA, WITHOUT YOUR JUDGMENT THERETO, SO AS TO PROCEED TO THE NEXT PAGE.

### 1. GRANT OF LICENSE AND COPYRIGHT

Yamaha hereby grants you the right to use one copy of the software program(s) and data ("SOFTWARE") accompanying this Agreement. The term SOFTWARE shall encompass any updates to the accompanying software and data. The SOFTWARE is owned by STEINBERG, and is protected by relevant copyright laws and all applicable treaty provisions. Yamaha has acquired the sublicense right to license you to use the SOFTWARE. While you are entitled to claim ownership of the data created with the use of SOFTWARE, the SOFTWARE will continue to be protected under relevant copyrights.

You may use the SOFTWARE on a single computer.

You may make one copy of the SOFTWARE in machine-readable form for backup purposes only, if the SOFTWARE is on media where such backup copy is permitted. On the

backup copy, you must reproduce Yamaha's copyright notice and any other proprietary legends that were on the original copy of the SOFTWARE.

You may permanently transfer to a third party all your rights in the SOFTWARE only when you transfer this product together, provided that you do not retain any copies and the recipient reads and agrees to the terms of this Agreement.

### 2. RESTRICTIONS

You may not engage in reverse engineering, disassembly, decompilation or otherwise deriving a source code form of the SOFTWARE by any method whatsoever.

You may not reproduce, modify, change, rent, lease, or distribute the SOFTWARE in whole or in part, or create derivative works of the SOFTWARE.

You may not electronically transmit the SOFTWARE from one computer to another or share the SOFTWARE in a network with other computers.

You may not use the SOFTWARE to distribute illegal data or data that violates public policy.

You may not initiate services based on the use of the SOFTWARE without permission by Yamaha Corporation. Copyrighted data, including but not limited to MIDI data for songs, obtained by means of the SOFTWARE, are subject to the following restrictions which you must observe.

Data received by means of the SOFTWARE may not be used for any commercial purposes without permission of the copyright owner.

Data received by means of the SOFTWARE may not be duplicated, transferred, or distributed, or played back or performed for listeners in public without permission of the copyright owner.

The encryption of data received by means of the SOFTWARE may not be removed nor may the electronic watermark be modified without permission of the copyright owner.

### 3. TERMINATION

This Agreement becomes effective on the day that you receive the SOFTWARE and remains effective until terminated. If any copyright law or provisions of this Agreement is violated, the Agreement shall terminate automatically and immediately without notice from Yamaha. Upon such termination, you must immediately destroy the licensed SOFTWARE, any accompanying written documents and all copies thereof.

### 4. LIMITED WARRANTY ON MEDIA

As to SOFTWARE sold on tangible media, Yamaha warrants that the tangible media on which the SOFTWARE is recorded will be free from defects in materials and workmanship under normal use for a period of fourteen (14) days from the date of receipt, as evidenced by a copy of the receipt. Yamaha's entire liability and your exclusive remedy will be replacement of the defective media if it is returned to Yamaha or an authorized Yamaha dealer within fourteen days with a copy of the receipt. Yamaha is not responsible for replacing media damaged by accident, abuse or misapplication. TO THE FULLEST EXTENT PERMITTED BY LAW, YAMAHA EXPRESSLY DISCLAIMS ANY IMPLIED WARRANTIES ON THE TANGIBLE MEDIA, INCLUDING THE IMPLIED WARRANTIES OF MERCHANTABILITY AND FITNESS FOR A PARTICULAR PURPOSE.

### 5. DISCLAIMER OF WARRANTY ON SOFTWARE

You expressly acknowledge and agree that use of the SOFTWARE is at your sole risk. The SOFTWARE and related documentation are provided "AS IS" and without warranty of any kind. NOTWITHSTANDING ANY OTHER PROVISION OF THIS AGREEMENT, YAMAHA EXPRESSLY DISCLAIMS ALL WARRANTIES AS TO THE SOFTWARE, EXPRESS, AND IMPLIED, INCLUDING BUT NOT LIMITED TO THE IMPLIED WARRANTIES OF MERCHANTABILITY, FITNESS FOR A PARTICULAR PURPOSE AND NON-INFRINGEMENT OF THIRD PARTY RIGHTS. SPECIFICALLY, BUT WITHOUT LIMITING THE FOREGOING, YAMAHA DOES NOT WARRANT THAT THE SOFTWARE WILL MEET YOUR REQUIREMENTS, THAT THE OPERATION OF THE SOFTWARE WILL BE UNINTERRUPTED OR ERROR-FREE, OR THAT DEFECTS IN THE SOFTWARE WILL BE CORRECTED.

### 6. LIMITATION OF LIABILITY

YAMAHA'S ENTIRE OBLIGATION HEREUNDER SHALL BE TO PERMIT USE OF THE SOFTWARE UNDER THE TERMS HEREOF. IN NO EVENT SHALL YAMAHA BE LIABLE TO YOU OR ANY OTHER PERSON FOR ANY DAMAGES, INCLUDING, WITHOUT LIMITATION, ANY DIRECT, INDIRECT, INCIDENTAL OR CONSEQUENTIAL DAMAGES, EXPENSES, LOST PROFITS, LOST DATA OR OTHER DAMAGES ARISING OUT OF THE USE, MISUSE OR INABILITY TO USE THE SOFTWARE, EVEN IF YAMAHA OR AN AUTHORIZED DEALER HAS BEEN ADVISED OF THE POSSIBILITY OF SUCH DAMAGES. In no event shall Yamaha's total liability to you for all damages, losses and causes of action (whether in contract, tort or otherwise) exceed the amount paid for the SOFTWARE.

### 7. GENERAL

This Agreement shall be interpreted according to and governed by Japanese law without reference to principles of conflict of laws. Any dispute or procedure shall be heard before the Tokyo District Court in Japan. If for any reason a court of competent jurisdiction finds any portion of this Agreement to be unenforceable, the remainder of this Agreement shall continue in full force and effect.

### 8. COMPLETE AGREEMENT

This Agreement constitutes the entire agreement between the parties with respect to use of the SOFTWARE and any accompanying written materials and supersedes all prior or contemporaneous understandings or agreements, written or oral, regarding the subject matter of this Agreement. No amendment or revision of this Agreement will be binding unless in writing and signed by a fully authorized representative of Yamaha.



# Appendix

## Specifications

<b>Keyboard</b>	KX25	25 keys (Initial Touch)
	KX49	49 keys (Initial Touch)
	KX61	61 keys (Initial Touch)
	KX8	88 keys (Initial Touch)
<b>Sequencer block</b>	Arpeggio	342 types 540 phrases (DrPc: 66 x 4; plus 276)
<b>Remote Control block</b>	DAW	For Windows: Cubase 4, Cubase Studio 4, Cubase AI4, SONAR 6 For Macintosh: Cubase 4, Cubase Studio 4, Cubase AI4, Logic7.2, Digital Performer 5.1 * Functions to be controlled differ depending on the software.
<b>Controller</b>	Pitch Bend Wheel x 1 Modulation Wheel x 1 CONTROL knobs x 4 (assignable)	
<b>Display</b>	16 characters x 2 lines LED lamp (backlit)	
<b>Connectors</b>	USB (TO HOST) MIDI IN/OUT DC-IN FOOT SWITCH (SUSTAIN)	
<b>Power Consumption</b>	1.9 W (when using the AC power adaptor) 0.6 W (when using this product as a bus-powered device)	
<b>Dimensions, weight</b>	KX25: 508(W) x 286.6(D) x 92(H) mm, 2kg	
	KX49: 830(W) x 286.6(D) x 92(H) mm, 3kg	
	KX61: 937(W) x 343.9(D) x 114.6(H) mm, 4.3kg	
	KX8: 1340(W) x 445(D) x 157(H) mm, 15.1kg	
<b>Accessories</b>	AC power adaptor (PA-3C, PA-130, or an equivalent) USB cable, Disks x 2, Owner's Manual (this book)	

\* Specifications and descriptions in this owner's manual are for information purposes only. Yamaha Corp. reserves the right to change or modify products or specifications at any time without prior notice. Since specifications, equipment or options may not be the same in every locale, please check with your Yamaha dealer.



## Control Template List

No.	Manufacturer	Product name	Indication on the KX display
1	Steinberg	HALion One	HALionOne
2		Mystic	Mystic
3		Prologue	Prologue
4		Spector	Spector
5		Embracer	Embracer
6		Monologue	Monologue
7		Hypersonic2	Hypersonic
8		HALion3	HALion
9	Native Instruments	PRO-53	Pro-53
10		FM8	FM8
11		MASSIVE	Massive
12	KORG	Polysix	Polysix
13		WAVESTATION	Wavestation
14		Mono/Poly	MonoPoly
15		M1	M1
16		MS-20	MS-20
17	M-AUDIO / GForce	impOSCar	impOSCar
18		Minimonsta	Minimonsta
19		Oddity	Oddity
20	Arturia	Analog Factory	AnalogFactory
21		CS-80V	CS-80V
22		Jupiter-8V	Jupiter-8V
23		Minimoog V	Minimoog V
24	Novation Music	V-Station	V-Station
25		Bass Station	BassStation
26	reFX	VANGUARD	Vanguard
27	IK Multimedia	SampleTank2	SampleTank
28	Spectrasonics	ATMOSPHERE	Atmosphere
29		TRILOGY	Trilogy
30	--	--	Generic

For details about what function is assigned to each knob when each Template is selected, refer to the following page:

<http://www.yamahasyth.com/>

## Arpeggio Type List

General Instrument types which can be selected on HALionOne and are most suitable for the respective Arpeggio Types are listed in the "Instrument Type" column.

Category	Arp. No.	Arp. Name	Time Signature	Length	Original Tempo	Instrument Type
DrPc	1	ContmpRk	4 / 4	4	126	Stereo GM
DrPc	2	StdRock	4 / 4	4	131	:
DrPc	3	PowerRck	4 / 4	4	120	:
DrPc	4	AlternRk	4 / 4	4	100	RockSI2
DrPc	5	MondoRck	4 / 4	4	94	:
DrPc	6	XoverRk	4 / 4	2	100	:
DrPc	7	Rck&Roll	4 / 4	4	172	Stereo GM
DrPc	8	GuitrPp1	4 / 4	2	90	:
DrPc	9	GuitrPp2	4 / 4	4	100	:
DrPc	10	Unpluggd	4 / 4	4	120	:
DrPc	11	FingrPck	4 / 4	4	94	:
DrPc	12	Brit Pop	4 / 4	2	86	:
DrPc	13	EP Balld	4 / 4	2	60	:
DrPc	14	8BtBasic	4 / 4	4	120	:
DrPc	15	8Bt Soft	4 / 4	4	100	:
DrPc	16	16BtBld1	4 / 4	4	75	:
DrPc	17	16BtBld2	4 / 4	2	64	:
DrPc	18	16Bt Pop	4 / 4	4	103	:
DrPc	19	6/8 Pop	4 / 4	4	100	:
DrPc	20	6/8Balld	4 / 4	2	58	:
DrPc	21	Funk	4 / 4	4	107	:
DrPc	22	FunkRock	4 / 4	4	95	:
DrPc	23	JazzFunk	4 / 4	4	120	:
DrPc	24	SlowEasy	4 / 4	4	72	:
DrPc	25	ClubJazz	4 / 4	4	125	:
DrPc	26	PopShuff	4 / 4	4	94	:
DrPc	27	GospIFnk	4 / 4	4	106	:
DrPc	28	StdDisco	4 / 4	4	120	:
DrPc	29	PhilyDsc	4 / 4	2	100	:
DrPc	30	ChartPop	4 / 4	4	92	Hip Hop 1
DrPc	31	New R&B	4 / 4	1	97	:
DrPc	32	Smooth	4 / 4	4	64	:
DrPc	33	HipHop1	4 / 4	2	94	:
DrPc	34	HipHop2	4 / 4	2	105	:
DrPc	35	HipHop3	4 / 4	2	104	R&B Kit 1
DrPc	36	Hip Rock	4 / 4	4	132	:
DrPc	37	Regeton	4 / 4	4	98	Hip Hop 1
DrPc	38	RegetnPc	4 / 4	4	98	Percussion
DrPc	39	SoulBeat	4 / 4	4	124	Stereo GM
DrPc	40	SoulShuf	4 / 4	4	98	:
DrPc	41	Big Beat	4 / 4	4	115	RockSI2
DrPc	42	Breakbt	4 / 4	4	115	Tekno Kit
DrPc	43	Lo Beat	4 / 4	2	140	R&B Kit 1
DrPc	44	DrumBas	4 / 4	2	154	:
DrPc	45	Techno	4 / 4	8	135	Tekno Kit
DrPc	46	Trance	4 / 4	4	140	:
DrPc	47	DreamDnc	4 / 4	4	136	:
DrPc	48	Ibiza	4 / 4	2	135	R&B Kit 1
DrPc	49	EuroTeck	4 / 4	2	140	Tekno Kit
DrPc	50	Club Hus	4 / 4	2	128	R&B Kit 1

Category	Arp. No.	Arp. Name	Time Signature	Length	Original Tempo	Instrument Type
DrPc	51	House	4 / 4	2	123	:
DrPc	52	Garage	4 / 4	2	127	Tekno Kit
DrPc	53	AcoJazz	4 / 4	4	204	Jazz Kit
DrPc	54	ModernJz	4 / 4	16	218	:
DrPc	55	ShfBlues	4 / 4	4	115	Stereo GM
DrPc	56	SlwBlues	4 / 4	2	49	:
DrPc	57	PnBoogie	4 / 4	8	160	:
DrPc	58	Reggae	4 / 4	4	102	:
DrPc	59	ReggeShf	4 / 4	4	90	:
DrPc	60	Salsa	4 / 4	2	123	:
DrPc	61	SalsaPc	4 / 4	4	123	:
DrPc	62	Samba	4 / 4	4	120	:
DrPc	63	SambaPc	4 / 4	4	120	:
DrPc	64	Bossa	4 / 4	4	124	:
DrPc	65	BossaPc	4 / 4	4	124	:
DrPc	66	Spanish	4 / 4	2	120	:
CPrc	67	R&B Dsc	4 / 4	2	110	Vibes
CPrc	68	Trance	4 / 4	4	140	Marimba
CPrc	69	Ethnic1	6 / 4	5	118	Celeste
CPrc	70	Ethnic2	7 / 4	3	120	Music Box
CPrc	71	MOD	4 / 4	2	120	Glocken
CPrc	72	Trill	4 / 4	1	120	Marimba
Bass	73	CntmpRk1	4 / 4	4	126	Pick Bass
Bass	74	CntmpRk2	4 / 4	4	126	:
Bass	75	StdRck1	4 / 4	4	131	FingerBass
Bass	76	StdRck2	4 / 4	4	131	:
Bass	77	PowerRk1	4 / 4	4	120	Pick Bass
Bass	78	PowerRk2	4 / 4	4	120	:
Bass	79	AlternRk	4 / 4	4	100	FingerBass
Bass	80	XoverRk	4 / 4	1	100	:
Bass	81	Rck&Roll	4 / 4	4	172	Pick Bass
Bass	82	GuitrPp1	4 / 4	2	90	FingerBass
Bass	83	GuitrPp2	4 / 4	4	100	Pick Bass
Bass	84	Unpluggd	4 / 4	4	113	Acoustic
Bass	85	FingrPck	4 / 4	1	120	FingerBass
Bass	86	Brit Pop	4 / 4	2	86	:
Bass	87	EP Balld	4 / 4	2	60	:
Bass	88	8BtBasic	4 / 4	4	120	:
Bass	89	8BtSoft	4 / 4	4	100	:
Bass	90	16BtBld	4 / 4	4	75	:
Bass	91	16Bt Pop	4 / 4	4	103	SimpleSlap
Bass	92	6/8 Pop	4 / 4	4	100	FingerBass
Bass	93	6/8Balld	4 / 4	2	58	:
Bass	94	FingrBs1	4 / 4	1	115	:
Bass	95	FingrBs2	4 / 4	3	115	:
Bass	96	FingrBs3	4 / 4	2	150	:
Bass	97	FingrBs4	4 / 4	2	89	:
Bass	98	FingrBs5	4 / 4	1	115	:
Bass	99	SlapBass	4 / 4	3	120	SimpleSlap
Bass	100	FunkRock	4 / 4	4	95	FingerBass

Category	Arp. No.	Arp. Name	Time Signature	Length	Original Tempo	Instrument Type
Bass	101	JazFunk1	4 / 4	2	120	:
Bass	102	JazFunk2	4 / 4	4	120	:
Bass	103	SlowEasy	4 / 4	4	72	:
Bass	104	ClubJazz	4 / 4	4	125	:
Bass	105	PopShuff	4 / 4	4	94	Velo Slap
Bass	106	GospIFnk	4 / 4	4	106	FingerBass
Bass	107	StdDisco	4 / 4	1	120	:
Bass	108	PhilyDsc	4 / 4	2	100	:
Bass	109	ChartPop	4 / 4	4	92	SynthBass2
Bass	110	NewR&B1	4 / 4	1	97	:
Bass	111	NewR&B2	4 / 4	1	97	:
Bass	112	Smooth	4 / 4	2	64	:
Bass	113	HipHop1	4 / 4	2	105	:
Bass	114	HipHop2	4 / 4	2	94	:
Bass	115	HipHop3	4 / 4	2	94	:
Bass	116	HipHop4	4 / 4	2	94	:
Bass	117	Hip Rock	4 / 4	4	132	FingerBass
Bass	118	Regeton	4 / 4	4	98	SynthBass1
Bass	119	GruvBass	4 / 4	2	120	SynthBass2
Bass	120	SoulBeat	4 / 4	4	124	FingerBass
Bass	121	SoulShuf	4 / 4	4	98	:
Bass	122	ChillOut	4 / 4	2	79	:
Bass	123	Big Beat	4 / 4	4	115	:
Bass	124	Breakbt1	4 / 4	4	115	SynthBass1
Bass	125	Breakbt2	4 / 4	4	88	SynthBass2
Bass	126	DrumBas	4 / 4	4	170	:
Bass	127	Techno	4 / 4	8	135	:
Bass	128	Trance	4 / 4	4	140	:
Bass	129	Tek Bass	4 / 4	1	138	:
Bass	130	DreamDnc	4 / 4	2	136	:
Bass	131	Ibiza	4 / 4	2	135	:
Bass	132	DiscoHus	4 / 4	4	126	:
Bass	133	ClubHus1	4 / 4	1	128	:
Bass	134	ClubHus2	4 / 4	1	128	:
Bass	135	Garage	4 / 4	2	127	:
Bass	136	HouseBas	4 / 4	4	120	:
Bass	137	AcidBass	4 / 4	1	120	:
Bass	138	AcoJazz1	4 / 4	4	204	Acoustic
Bass	139	AcoJazz2	4 / 4	4	204	:
Bass	140	ModrnJz1	4 / 4	16	218	:
Bass	141	ModrnJz2	4 / 4	16	218	:
Bass	142	ShfBlues	4 / 4	4	115	Pick Bass
Bass	143	SlwBlues	4 / 4	2	49	FingerBass
Bass	144	PnBoogie	4 / 4	8	160	Acoustic
Bass	145	Reggae	4 / 4	4	102	FingerBass
Bass	146	ReggeShf	4 / 4	4	90	:
Bass	147	Salsa	4 / 4	4	123	Acoustic
Bass	148	Montuno	4 / 4	4	100	FingerBass
Bass	149	Samba	4 / 4	2	120	:
Bass	150	Bossa	4 / 4	4	124	:
Bass	151	LatinHus	4 / 4	4	138	:
Bass	152	Spanish	4 / 4	1	120	:
Seq	153	Classic	4 / 4	1	120	Saw Ld
Seq	154	Oct Seq	4 / 4	1	130	Bass&Ld
Seq	155	RandmSeq	4 / 4	1	90	Sci-Fi

Category	Arp. No.	Arp. Name	Time Signature	Length	Original Tempo	Instrument Type
Seq	156	Vel Gruv	4 / 4	1	134	Saw Ld
Seq	157	X-Sweep	4 / 4	1	140	:
Seq	158	Simple1	4 / 4	1	130	Chiff Ld
Seq	159	Simple2	4 / 4	1	130	:
Seq	160	Simple3	4 / 4	1	130	:
Seq	161	Basic	4 / 4	1	130	Brightness
Seq	162	FifthSQ1	4 / 4	1	130	5th Ld
Seq	163	FifthSQ2	4 / 4	1	130	:
Seq	164	MuteLine	4 / 4	1	134	Saw Ld
Seq	165	Chodal	4 / 4	2	150	:
Seq	166	AlternRk	4 / 4	4	100	Charan Ld
Seq	167	Trance1	4 / 4	4	115	Chiff Ld
Seq	168	Trance2	4 / 4	1	140	Poly Synth
Seq	169	Trance3	4 / 4	4	140	:
Seq	170	Trance4	4 / 4	1	140	Square Ld
Seq	171	Trance5	4 / 4	1	140	:
Seq	172	Trance6	4 / 4	4	140	Bass&Ld
Seq	173	Trance7	4 / 4	1	140	Poly Synth
Seq	174	Trance8	4 / 4	1	130	:
Seq	175	Trance9	4 / 4	2	145	:
Seq	176	Trance10	4 / 4	2	145	:
Seq	177	DreamDnc	4 / 4	1	136	Square Ld
Seq	178	Ibiza1	4 / 4	2	135	Charan Ld
Seq	179	Ibiza2	4 / 4	2	135	Square Ld
Seq	180	Tekno	4 / 4	2	120	Saw Ld
Seq	181	SynArp1	4 / 4	1	130	:
Seq	182	SynArp2	4 / 4	1	130	:
Seq	183	SynArp3	4 / 4	1	130	:
Seq	184	SynArp4	4 / 4	1	90	:
Seq	185	SynArp5	4 / 4	1	138	:
Seq	186	Melody1	4 / 4	1	70	Brightness
Seq	187	Melody2	4 / 4	1	70	:
Seq	188	Electro1	4 / 4	1	130	Saw Ld
Seq	189	Electro2	4 / 4	1	130	:
Seq	190	Electro3	4 / 4	1	130	:
Seq	191	Electro4	4 / 4	1	130	:
Seq	192	Electro5	4 / 4	1	130	:
Seq	193	Electro6	4 / 4	1	130	:
Seq	194	CompuBas	4 / 4	1	130	Bass&Ld
Seq	195	Poly Arp	4 / 4	1	120	Saw Ld
Seq	196	Tek Echo	4 / 4	2	120	:
Seq	197	SuperArp	4 / 4	2	120	:
Seq	198	AcidLine	4 / 4	1	120	:
Seq	199	Doves	4 / 4	1	150	:
Seq	200	PulsLine	4 / 4	2	120	:
Seq	201	SyncpEco	4 / 4	2	120	Poly Synth
Seq	202	Waggle	4 / 4	1	140	Saw Ld
ChSq	203	SynChrd1	4 / 4	1	130	Poly Synth
ChSq	204	SynChrd2	4 / 4	1	90	Bass&Ld
ChSq	205	BasChrd1	4 / 4	2	130	:
ChSq	206	BasChrd2	4 / 4	1	130	:
ChSq	207	ChillChd	4 / 4	1	90	Poly Synth
ChSq	208	TrancRtm	4 / 4	4	140	:
ChSq	209	Ibiza	4 / 4	2	135	Bass&Ld
ChSq	210	Garage	4 / 4	2	127	:

## Appendix

Category	Arp. No.	Arp. Name	Time Signature	Length	Original Tempo	Instrument Type
ChSq	211	Syncopat	4 / 4	2	120	Saw Ld
HySq	212	Hybrid1	4 / 4	1	130	:
HySq	213	Hybrid2	4 / 4	1	95	:
HySq	214	Hybrid3	4 / 4	1	130	:
HySq	215	Hybrid4	4 / 4	1	130	Bass&Ld
HySq	216	Hybrid5	4 / 4	1	106	:
ApKb	217	Pf Arp1	4 / 4	2	64	Acoustic Piano
ApKb	218	Pf Arp2	4 / 4	2	74	:
ApKb	219	Pf Arp3	4 / 4	2	130	:
ApKb	220	Pf Arp4	4 / 4	1	116	:
ApKb	221	Pf Arp5	4 / 4	1	82	:
ApKb	222	Pf Arp6	4 / 4	2	130	:
ApKb	223	Pf Arp7	4 / 4	2	130	:
ApKb	224	Pf Arp8	4 / 4	1	74	:
ApKb	225	70sRock1	4 / 4	2	130	:
ApKb	226	70sRock2	4 / 4	4	130	:
ApKb	227	EP Balld	4 / 4	2	60	E_Piano 1
ApKb	228	Slowfeel	4 / 4	1	74	:
ApKb	229	16Bt Pop	4 / 4	4	103	:
ApKb	230	AnalgPop	4 / 4	2	93	:
ApKb	231	ClubJazz	4 / 4	4	125	Acoustic Piano
ApKb	232	ChartPop	4 / 4	1	92	E_Piano 1
ApKb	233	Swing EP	4 / 4	1	101	:
ApKb	234	6/8 R&B	4 / 4	2	61	:
ApKb	235	HipHop1	4 / 4	2	105	:
ApKb	236	HipHop2	4 / 4	2	105	:
ApKb	237	HipHop3	4 / 4	2	105	Harpsichord
ApKb	238	Clavi1	4 / 4	1	110	Brite Clav
ApKb	239	Clavi2	4 / 4	1	110	:
ApKb	240	Clavi3	4 / 4	1	124	:
ApKb	241	DrumBas	4 / 4	4	170	E_Piano 1
ApKb	242	ClubHus	4 / 4	2	128	:
ApKb	243	HousePf	4 / 4	2	130	Rock Piano
ApKb	244	Reggae	4 / 4	2	92	Brite Clav
ApKb	245	Salsa	4 / 4	1	123	Rock Piano
ApKb	246	Montuno	4 / 4	2	100	:
ApKb	247	PnoLatin	4 / 4	2	120	:
Orgn	248	HouseOrg	4 / 4	1	130	Perc Organ
Orgn	249	Reggae	4 / 4	1	92	Draw Organ
Orgn	250	LatinOrg	4 / 4	1	110	Rock Organ
GiPI	251	Strum1	4 / 4	2	120	Steel
GiPI	252	Strum2	4 / 4	2	120	:
GiPI	253	Strum3	4 / 4	2	120	:
GiPI	254	SteelGr	4 / 4	4	120	:
GiPI	255	GtrArp1	4 / 4	1	120	:
GiPI	256	GtrArp2	4 / 4	1	120	:
GiPI	257	OvdrGtr1	4 / 4	4	120	Overdrive
GiPI	258	OvdrGtr2	4 / 4	4	120	:
GiPI	259	OvdrGtr3	4 / 4	4	120	:
GiPI	260	OvdrGtr4	4 / 4	4	120	:
GiPI	261	ContmpRk	4 / 4	4	126	:
GiPI	262	StndRck1	4 / 4	4	131	:
GiPI	263	StndRck2	4 / 4	4	131	:
GiPI	264	PowerRk1	4 / 4	4	120	Distortion
GiPI	265	PowerRk2	4 / 4	4	120	:

Category	Arp. No.	Arp. Name	Time Signature	Length	Original Tempo	Instrument Type
GiPI	266	PowerRk3	4 / 4	4	120	:
GiPI	267	AlterRk1	4 / 4	4	97	Overdrive
GiPI	268	AlterRk2	4 / 4	4	97	:
GiPI	269	XoverRk1	4 / 4	2	100	:
GiPI	270	XoverRk2	4 / 4	2	100	Distortion
GiPI	271	Rck&Roll	4 / 4	4	172	Clean
GiPI	272	GuitrPp1	4 / 4	2	90	Nylon
GiPI	273	GuitrPp2	4 / 4	1	90	:
GiPI	274	GuitrPp3	4 / 4	4	100	Steel
GiPI	275	GuitrPp4	4 / 4	4	100	Clean
GiPI	276	GuitrPp5	4 / 4	1	90	Nylon
GiPI	277	Unplug1	4 / 4	4	120	Steel
GiPI	278	Unplug2	4 / 4	2	120	:
GiPI	279	Unplug3	4 / 4	2	120	:
GiPI	280	FingrPk1	4 / 4	2	120	:
GiPI	281	FingrPk2	4 / 4	2	120	:
GiPI	282	BritPop1	4 / 4	2	86	:
GiPI	283	BritPop2	4 / 4	2	86	Clean
GiPI	284	EP Balld	4 / 4	2	60	:
GiPI	285	8BtBasic	4 / 4	4	120	:
GiPI	286	8BtSoft	4 / 4	4	100	Steel
GiPI	287	16BtBlld	4 / 4	4	75	Clean
GiPI	288	6/8 Pop	4 / 4	4	100	:
GiPI	289	6/8Balld	4 / 4	2	58	:
GiPI	290	Funky1	4 / 4	2	120	:
GiPI	291	Funky2	4 / 4	2	120	:
GiPI	292	Funky3	4 / 4	1	120	:
GiPI	293	CleanGt1	4 / 4	4	107	:
GiPI	294	CleanGt2	4 / 4	2	120	:
GiPI	295	CleanGt3	4 / 4	2	120	:
GiPI	296	CleanGt4	4 / 4	4	127	:
GiPI	297	CleanGt5	4 / 4	4	107	:
GiPI	298	Spanky	4 / 4	2	105	:
GiPI	299	FunkRock	4 / 4	4	94	:
GiPI	300	JazzFunk	4 / 4	4	120	:
GiPI	301	SlowEasy	4 / 4	4	72	:
GiPI	302	GospIFnk	4 / 4	4	106	:
GiPI	303	PopShuff	4 / 4	4	94	:
GiPI	304	StdDisco	4 / 4	4	120	:
GiPI	305	PhilyDsc	4 / 4	2	100	:
GiPI	306	New R&B	4 / 4	1	97	Steel
GiPI	307	Smooth	4 / 4	2	64	Nylon
GiPI	308	HipHop1	4 / 4	2	94	Mute
GiPI	309	HipHop2	4 / 4	2	94	:
GiPI	310	HipRock1	4 / 4	4	90	Overdrive
GiPI	311	HipRock2	4 / 4	4	132	:
GiPI	312	SoulBeat	4 / 4	4	124	Clean
GiPI	313	SoulShuf	4 / 4	4	98	:
GiPI	314	Big Beat	4 / 4	4	115	Overdrive
GiPI	315	AcoJazz	4 / 4	4	204	ModernJazz
GiPI	316	ModernJz	4 / 4	16	218	:
GiPI	317	ShlBlues	4 / 4	4	115	Mute
GiPI	318	SlwBlues	4 / 4	2	49	Overdrive
GiPI	319	PnBoogie	4 / 4	4	160	Clean
GiPI	320	Reggae	4 / 4	2	102	:

Category	Arp. No.	Arp. Name	Time Signature	Length	Original Tempo	Instrument Type
GIPI	321	ReggeShf	4 / 4	4	90	:
GIPI	322	Samba	4 / 4	4	120	Nylon
GIPI	323	Bossa	4 / 4	4	124	:
GIPI	324	Spanish1	4 / 4	2	120	:
GIPI	325	Spanish2	4 / 4	2	120	Steel
GIPI	326	Lick1	4 / 4	4	120	Distortion
GIPI	327	Lick2	4 / 4	4	120	:
GIPI	328	Lick3	4 / 4	2	120	:
GIPI	329	Lick4	4 / 4	4	120	:
GIPI	330	Lick5	4 / 4	1	120	:
Strn	331	Strings	4 / 4	1	101	StereoSt1
Strn	332	New R&B	4 / 4	2	90	:
Strn	333	Pizz	4 / 4	1	120	Pizz
Bras	334	Funk1	4 / 4	4	132	Brass Sect
Bras	335	Funk2	4 / 4	1	132	:
Bras	336	Samba	4 / 4	2	120	:
RdPp	337	Hip Hop	4 / 4	2	105	TenorSax 2
RdPp	338	Soul	4 / 4	4	120	:
RdPp	339	Flutter	4 / 4	1	120	:
Lead	340	R&B Dsc1	4 / 4	1	110	Bass&Ld
Lead	341	R&B Dsc2	4 / 4	2	110	:
Lead	342	Regeton	4 / 4	4	98	Caliop Ld

Date :10-JAN-2008  
Version : 1.0

[ USB KEYBOARD STUDIO ]  
Model KX25/KX49/KX61/KX8 MIDI Implementation Chart

YAMAHA

# MIDI Implementation Chart

Function...	Transmitted	Recognized	Remarks
Basic Channel	1 - 16 1 - 16	x x	Memorized
Mode	3 x *****	x x x	
Note Number : True voice	0 - 127 *****	x x	
Velocity	o 9nH, v=1-127 o 8nH, v=0	x x	
After Touch	x x	x x	
Pitch Bend	o	x	
Control Change	o 0,32 1,7,10,11 o 6,38 64 65 66 71-75 o 91,93 96-97 100-101 o 0-127	x x x x x x x x x x x x x	Bank Select Data Entry Sustain Sw Portamento Sw Sostenuto Sound Controller Effect Depth RPN Inc,Dec RPN LSB,MSB Assignable Cntrl

Prog Change : True #	o 0 - 127 *****	x		
System Exclusive	o	o		
Common : Song Pos.	x	x		
: Song Sel.	x	x		
: Tune	x	x		
System : Clock	o	o		
Real Time : Commands	x	x		
Aux Messages : All Sound Off	x	x		
: Reset All Cntrl's	x	x		
: Local ON/OFF	x	x		
: All Notes OFF	x	x		
: Active Sense	o	x		
: Reset	x	x		

Mode 1 : OMNI ON, POLY  
 Mode 3 : OMNI OFF, POLY  
 Mode 2 : OMNI ON, MONO  
 Mode 4 : OMNI OFF, MONO  
 o : Yes  
 x : No

# Index

## A

AC power adaptor .....	9
ADD INSTRUMENT TRACK.....	10, 19
ARP EDIT .....	10, 33
ARP ON/OFF .....	10, 20
Arpeggio.....	31
Arpeggio type .....	46
ASSIGN 1.....	25, 34
ASSIGN 2.....	25, 34
Auto .....	36

## B

BeatStretch .....	33
BulkTransmit .....	37

## C

Clock .....	36
Control Change .....	29
CONTROL knobs.....	10, 24
CONTROL TEMPLATE.....	10, 28
Control Template .....	28
Cubase .....	17
Cubase AI4 .....	13
CUBASE FUNCTION .....	11, 23
Cursor.....	11, 25

## D

DATA .....	10, 17, 31
DAW Select.....	34, 37
DC IN connector.....	9, 11
Device Number .....	37
Display.....	10, 26
Display Time .....	37

## E

ENTER .....	11, 25, 34
ESC.....	11, 25, 34
EXIT .....	10
Extensions for Steinberg DAW .....	13
External.....	36

## F

Factory Set.....	37
Fast forward .....	25, 34
Fix.....	27, 36
Footswitch.....	16

## G

GateTime .....	33
----------------	----

## H

Hard1 .....	27, 36
Hard2 .....	27, 36
HOLD .....	10, 21

## I

Installation .....	13
Internal .....	36

## K

Knob.....	24
Knob Functions Select button.....	10
KX Editor.....	6

## M

MIDI.....	37
MIDI IN .....	11
MIDI OUT.....	11
MIDI port.....	18
MIDI Select.....	37
MIDI Thru.....	37, 38
MIDI Transmit Ch .....	37
Modulation wheel .....	11
MUTE .....	25

## N

Normal.....	27, 36
-------------	--------

## O

OCTAVE .....	10, 27
Octave LED .....	37
OctRange .....	33

## P

PC+Remot .....	37
Pitch Bend wheel .....	11
Play .....	25, 34
Power Supply.....	9
ProgChg .....	37
ProgChgMode .....	37
PROGRAM.....	11, 34



**R**

REC .....	25, 34
Record .....	25, 34
Remote .....	37
Repeat on/off .....	25, 34
Rewind .....	25, 34

**S**

SELECT .....	10, 26
Soft1 .....	27, 36
Soft2 .....	27, 36
SOLO .....	25, 34
STANDBY/ON .....	9, 11
Stop .....	25, 34
SUSTAIN .....	11, 16
Swing .....	33
SwingValue .....	33
Sync .....	36

**T**

TEMPO .....	10
Tempo .....	32, 36
TOOLS for KX .....	13
Top display .....	26
TRACK (Track Control buttons) .....	11, 25
TRANSPORT (Transport Control buttons) .....	11, 25

**U**

USB .....	37
USB bus-powered device .....	9
USB MIDI port .....	18
USB TO HOST .....	11
USB-MIDI Driver .....	13
UTILITY .....	10, 36

**V**

VELOCITY CURVE .....	10, 27
Velocity Curve .....	27
VeloCurve .....	36
VeloFix .....	36
VSTi .....	19
VSTi Remote .....	29
VSTi WINDOW .....	10, 34

---

MEMO

## NORTH AMERICA

### CANADA

**Yamaha Canada Music Ltd.**  
135 Milner Avenue, Scarborough, Ontario,  
M1S 3R1, Canada  
Tel: 416-298-1311

### U.S.A.

**Yamaha Corporation of America**  
6600 Orangethorpe Ave., Buena Park, Calif. 90620,  
U.S.A.  
Tel: 714-522-9011

## CENTRAL & SOUTH AMERICA

### MEXICO

**Yamaha de México S.A. de C.V.**  
Calz. Javier Rojo Gómez #1149,  
Col. Guadalupe del Moral  
C.P. 09300, México, D.F., México  
Tel: 55-5804-0600

### BRAZIL

**Yamaha Musical do Brasil Ltda.**  
Rua Joaquim Floriano, 913 - 4º andar, Itaim Bibi,  
CEP 04534-013 Sao Paulo, SP. BRAZIL  
Tel: 011-3704-1377

### ARGENTINA

**Yamaha Music Latin America, S.A.**  
**Sucursal de Argentina**  
Olga Cossetini 1553, Piso 4 Norte  
Madero Este-C1107CEK  
Buenos Aires, Argentina  
Tel: 011-4119-7000

### PANAMA AND OTHER LATIN AMERICAN COUNTRIES/ CARIBBEAN COUNTRIES

**Yamaha Music Latin America, S.A.**  
Torre Banco General, Piso 7, Urbanización Marbella,  
Calle 47 y Aquilino de la Guardia,  
Ciudad de Panamá, Panamá  
Tel: +507-269-5311

## EUROPE

### THE UNITED KINGDOM

**Yamaha Music U.K. Ltd.**  
Sherbourne Drive, Tilbrook, Milton Keynes,  
MK7 8BL, England  
Tel: 01908-366700

### IRELAND

**Danfay Ltd.**  
61D, Sallynoggin Road, Dun Laoghaire, Co. Dublin  
Tel: 01-2859177

### GERMANY

**Yamaha Music Central Europe GmbH**  
Siemensstraße 22-34, 25462 Rellingen, Germany  
Tel: 04101-3030

### SWITZERLAND/LIECHTENSTEIN

**Yamaha Music Central Europe GmbH,**  
**Branch Switzerland**  
Seefeldstrasse 94, 8008 Zürich, Switzerland  
Tel: 01-383 3990

### AUSTRIA

**Yamaha Music Central Europe GmbH,**  
**Branch Austria**  
Schleiergasse 20, A-1100 Wien, Austria  
Tel: 01-60203900

### CZECH REPUBLIC/SLOVAKIA/ HUNGARY/SLOVENIA

**Yamaha Music Central Europe GmbH,**  
**Branch Austria, CEE Department**  
Schleiergasse 20, A-1100 Wien, Austria  
Tel: 01-602039025

### POLAND

**Yamaha Music Central Europe GmbH**  
**Sp.z o.o. Oddział w Polsce**  
ul. 17 Stycznia 56, PL-02-146 Warszawa, Poland  
Tel: 022-868-07-57

### THE NETHERLANDS/ BELGIUM/LUXEMBOURG

**Yamaha Music Central Europe GmbH,**  
**Branch Benelux**  
Clarissenhof 5-b, 4133 AB Vianen, The Netherlands  
Tel: 0347-358 040

### FRANCE

**Yamaha Musique France**  
BP 70-77312 Marné-la-Vallée Cedex 2, France  
Tel: 01-64-61-4000

### ITALY

**Yamaha Musica Italia S.P.A.**  
**Combo Division**  
Viale Italia 88, 20020 Lainate (Milano), Italy  
Tel: 02-935-771

### SPAIN/PORTUGAL

**Yamaha Música Ibérica, S.A.**  
Ctra. de la Corona km. 17, 200, 28230  
Las Rozas (Madrid), Spain  
Tel: 91-639-8888

### GREECE

**Philippos Nakas S.A. The Music House**  
147 Skiathou Street, 112-55 Athens, Greece  
Tel: 01-228 2160

### SWEDEN

**Yamaha Scandinavia AB**  
J. A. Wettergrens Gata 1, Box 30053  
S-400 43 Göteborg, Sweden  
Tel: 031 89 34 00

### DENMARK

**YS Copenhagen Liaison Office**  
Generatørvej 6A, DK-2730 Herlev, Denmark  
Tel: 44 92 49 00

### FINLAND

**F-Musiikki Oy**  
Kluuvikatu 6, P.O. Box 260,  
SF-00101 Helsinki, Finland  
Tel: 09 618511

### NORWAY

**Norsk filial av Yamaha Scandinavia AB**  
Grini Næringspark 1, N-1345 Østerås, Norway  
Tel: 67 16 77 70

### ICELAND

**Skifan HF**  
Skeifan 17 P.O. Box 8120, IS-128 Reykjavik, Ice-  
land  
Tel: 525 5000

### RUSSIA

**Yamaha Music (Russia)**  
Office 4015, entrance 2, 21/5 Kuznetskii  
Most street, Moscow, 107996, Russia  
Tel: 495 626 0660

### OTHER EUROPEAN COUNTRIES

**Yamaha Music Central Europe GmbH**  
Siemensstraße 22-34, 25462 Rellingen, Germany  
Tel: +49-4101-3030

## AFRICA

**Yamaha Corporation,**  
**Asia-Pacific Music Marketing Group**  
Nakazawa-cho 10-1, Naka-ku, Hamamatsu,  
Japan 430-8650  
Tel: +81-53-460-2312

## MIDDLE EAST

### TURKEY/CYPRUS

**Yamaha Music Central Europe GmbH**  
Siemensstraße 22-34, 25462 Rellingen, Germany  
Tel: 04101-3030

### OTHER COUNTRIES

**Yamaha Music Gulf FZE**  
LOB 16-513, P.O.Box 17328, Jubel Ali,  
Dubai, United Arab Emirates  
Tel: +971-4-881-5868

## ASIA

### THE PEOPLE'S REPUBLIC OF CHINA

**Yamaha Music & Electronics (China) Co.,Ltd.**  
25/F, United Plaza, 1468 Nanjing Road (West),  
Jingan, Shanghai, China  
Tel: 021-6247-2211

### HONG KONG

**Tom Lee Music Co., Ltd.**  
11/F, Silvercord Tower 1, 30 Canton Road,  
Tsimshatsui, Kowloon, Hong Kong  
Tel: 2737-7688

### INDIA

**Yamaha Music India Pvt. Ltd.**  
5F Ambience Corporate Tower Ambience Mall Complex  
Ambience Island, NH-8, Gurgaon-122001, Haryana, India  
Tel: 0124-466-5551

### INDONESIA

**PT. Yamaha Music Indonesia (Distributor)**  
**PT. Nusantik**  
Gedung Yamaha Music Center, Jalan Jend. Gatot  
Subroto Kav. 4, Jakarta 12930, Indonesia  
Tel: 21-520-2577

### KOREA

**Yamaha Music Korea Ltd.**  
8F, 9F, Dongsung Bldg. 158-9 Samsung-Dong,  
Kangnam-Gu, Seoul, Korea  
Tel: 080-004-0022

### MALAYSIA

**Yamaha Music Malaysia, Sdn., Bhd.**  
Lot 8, Jalan Perbandaran, 47301 Kelana Jaya,  
Petaling Jaya, Selangor, Malaysia  
Tel: 3-78030900

### PHILIPPINES

**Yupangco Music Corporation**  
339 Gil J. Puyat Avenue, P.O. Box 885 MCPO,  
Makati, Metro Manila, Philippines  
Tel: 819-7551

### SINGAPORE

**Yamaha Music Asia Pte., Ltd.**  
#03-11 A-Z Building  
140 Paya Lebar Road, Singapore 409015  
Tel: 747-4374

### TAIWAN

**Yamaha KHS Music Co., Ltd.**  
3F, #6, Sec.2, Nan Jing E. Rd. Taipei,  
Taiwan 104, R.O.C.  
Tel: 02-2511-8688

### THAILAND

**Siam Music Yamaha Co., Ltd.**  
4, 6, 15 and 16<sup>th</sup> floor, Siam Motors Building,  
891/1 Rama 1 Road, Wangmai,  
Pathumwan, Bangkok 10330, Thailand  
Tel: 02-215-2626

### OTHER ASIAN COUNTRIES

**Yamaha Corporation,**  
**Asia-Pacific Music Marketing Group**  
Nakazawa-cho 10-1, Naka-ku, Hamamatsu,  
Japan 430-8650  
Tel: +81-53-460-2317

## OCEANIA

### AUSTRALIA

**Yamaha Music Australia Pty. Ltd.**  
Level 1, 99 Queensbridge Street, Southbank,  
Victoria 3006, Australia  
Tel: 3-9693-5111

### NEW ZEALAND

**Music Works LTD**  
P.O.BOX 6246 Wellesley, Auckland 4680,  
New Zealand  
Tel: 9-634-0099

### COUNTRIES AND TRUST TERRITORIES IN PACIFIC OCEAN

**Yamaha Corporation,**  
**Asia-Pacific Music Marketing Group**  
Nakazawa-cho 10-1, Naka-ku, Hamamatsu,  
Japan 430-8650  
Tel: +81-53-460-2312

## HEAD OFFICE

**Yamaha Corporation, Pro Audio & Digital Musical Instrument Division**  
Nakazawa-cho 10-1, Naka-ku, Hamamatsu, Japan 430-8650  
Tel: +81-53-460-2445



Yamaha Web Site (English only)  
<http://www.yamahasynt.com/>  
Yamaha Manual Library  
<http://www.yamaha.co.jp/manual/>

U.R.G., Pro Audio & Digital Musical Instrument Division, Yamaha Corporation  
© 2008 Yamaha Corporation

WQ82380 8??APTY?.-??C0  
Printed in China