



Barletta

B O A T S

OWNER'S MANUAL

Table of Contents

Certifications & Specifications 7

Manufacturer's Certifications.....	7
Manufacturer's Specifications	9

Introduction 11

Warranty & Construction Standards.....	11
Specific Data	11
Education	11
Owner/Operator Responsibilities.....	12
Nautical Terms.....	13

Safety 17

Explanation of Safety Precautions	17
Fire	18
Fire Suppression Equipment.....	19
Flooding, Swamping.....	19
Lifesaving Equipment.....	20
Impaired Operation.....	21
Carbon Monoxide Poisoning	21
Information	24
Load Capacity	25
Power Capacity	25
Stability.....	25
Warning Labels	26
Weather.....	28
Accident Report.....	28
Hotlines	28
Minimum Required Equipment.....	29
Additional Recommended Equipment.....	30
Barletta Floorplan - Occupant Positions.....	31

Navigation 33

Rules of the Road.....	33
Basic Rules	34
Boat Navigation Lights	35
Charts & Aids to Navigation.....	37

Environmental Considerations 39

Fuel & Oil Spillage.....	39
Waste Disposal	39
Garbage Discharge Restrictions	40
Excessive Noise.....	41
Wake/Wash	41
Exhaust Emissions.....	41
Paint, Cleaning Agents & Other Substances.....	42

Emergency Procedures 45

Explosion & Fire	45
Flooding, Swamping or Capsizing.....	47
Collision.....	47
Grounding.....	47
Leaks.....	47
Towing	48
Person Overboard.....	49
Drowning	49
Medical Emergency.....	49
Carbon Monoxide.....	50
Propulsion, Control or Steering Failure	50
Radio Communication.....	50
Distress Signals.....	51

Operational Inspection 53

Before Departure.....	53
After Return.....	54

Operation 55

Fueling.....	55
General.....	56
Boarding (Wear a PFD!).....	57
Reboarding - Unassisted.....	58
Starting, Stopping.....	58
Shifting	60
Casting Off	60
Approaching Dock.....	61
Handling Dock Lines	64
Anchoring	65
Maneuvering/Maintaining Control.....	68
Operating In Shallow Water	72
Water Skiing, Swimming & Diving	73

Maintenance 77
Service Schedule 77
Maintenance Log..... 77
Maintaining Hull & Deck 78
Housekeeping 80
Lifting..... 81
Winterizing/Storing 81
Recommissioning 83
Troubleshooting..... 84

Systems..... 87

Trailerling..... 103

Certifications & Specifications

Manufacturer's Certifications

A "CE Mark" means that the boat complies with all applicable European directives for recreational boats. International Organization for Standardization (ISO) standards are widely used within the certification process.

"NMMA Certification" means that the boat has been determined by the National Marine Manufacturers Association to be in compliance with applicable United States Federal Regulations and American Boat and Yacht Council (ABYC) Standards.

The following information is furnished in compliance with European directives (Recreational Craft Directive, RCD) and Recreational Craft Sectoral Group (RSG) Guidelines in effect as of the date of publication of this manual. The boat manufacturer will provide additional information if standards are amended.

Manufacturer

Name Barletta Boat Company, LLC

Address 51687 County Road 133

City, State, Country Bristol, IN USA

Hull Identification Number (HIN) _____

Engine Serial Number _____

Model Name _____

Boat Type:

Non-powered

Power Inboard

Sail

Power Outboard

Power Multi-hull

Sail Multi-hull

Design Category:

Ocean

Inshore

Offshore

Sheltered Waters

Definition of the relevant design category(ies)

Length of hull - meters (feet) _____

Beam of hull - meters (feet) _____

Maximum Rated Engine Power - kilowatts (horsepower) _____

Mass of boat for trailering _____

Unladen Weight - kilograms (pounds) _____

Maximum Load recommended - kilograms (pounds) _____

Maximum Number of Persons Recommended _____

Conformity to Standards listed as follows: _____

Manufacturer's Specifications

ISO 10240 requires specific information to be provided. ABYC Technical Information Report T-24 recommends additional data be provided. The following may be included in an owner's packet supplied with the boat.

- **Warranty Terms and Conditions**
- **Hull Identification Number**
- **Engine/Outdrive Serial Numbers**
- **Type of Boat/Series Name**
- **Dimensions - meters (feet):**
 - Length
 - Beam
 - Vertical Clearance
 - Draft
- **General Arrangements:**
 - Deck Plan
 - Interior Plan
 - Profile
- **Sail and Rigging Plan**
- **Propulsion:**
 - Engine Type
 - Engine Layout
 - Propeller
 - Shafting
 - Instructions on the safe operation of the engine(s) and generator
- **Electrical:**
 - Information on fire or explosion hazards
 - Rated Amperage
 - Voltages, Frequency, Phases
 - Battery Capacity
 - Switches, Fuses, Circuit Breakers (location, type)
 - Description of Switch Panels
- **Lightning Protection System**
- **Tank Capacities - liters (gallons):**
 - Fuel
 - Fresh Water
 - Waste Holding Tanks
 - Gas Cylinders (LPG) and Information on the safe operation of gas (LPG) appliances
 - Information on the useable capacity of tanks depending on boat trim and loading
- **System Diagrams:**
 - Potable Water
 - Gray Water
 - Black Water (Waste)
 - Information on all water systems including the location of through hull and deck fittings and the draining point. Also, use of a Y-valve and pump-out procedures for holding tanks.
 - Exhaust
 - Ventilation
 - Bilge Pump(s)
 - Steering
 - Engine Cooling
- **Openings in the Hull:**
 - Location of seacocks and through hull openings
 - Advice on keeping hull openings closed or open as appropriate, to minimize the risk of flooding.
 - Advice on keeping other openings closed when appropriate, e.g. in rough water.

- **Instrument Use & Calibration**
- **Stability and Buoyancy and Flotation Capability and Explanation**
- **Strong Points for Docking, Lifting, Trailing**
- **Safety Labels, Part Numbers, and Ordering Procedure**
- **Bilge Pumps:**
 - Advice that the bilge pump is not for damage control
 - Location of each pump and its capacity
 - Operating Instructions
 - Advice to check function at regular intervals
- **Fire Protection Equipment:**
 - Instructions on the location and use of the fire fighting equipment
 - Identification and location
 - of means of escape from the interior in case of fire
- **Recommended Spare Parts**
- **Standard Equipment**
- **Optional Equipment**
- **Reference Manuals for Other Equipment**
- **Contacting Manufacturers of Other Systems**
- **Contacting Factory Service Department**
- **Construction Features**
- **Construction Standards**

Introduction

This manual has been compiled to help you operate your craft with safety and pleasure. It contains details of the craft, typical equipment supplied or fitted, its systems and information on its operation and maintenance. Please read this manual carefully, and familiarize yourself with the craft before using it.

If this is your first boat, or if you are changing to a type of boat that is unfamiliar to you, for your own safety and comfort, please ensure that you obtain handling and operating instruction/experience before “assuming command” of your boat. Your dealer, local yacht club, local Coast Guard Auxiliary, or the US Coast Guard office will be pleased to assist you in finding sources of instruction.

Please keep this manual in a secure place, and hand it over to the new owner when you sell the craft.

Warranty & Construction Standards

Your boat manufacturer may provide a Warranty Statement describing terms and conditions under which defects in your boat will be repaired. Familiarize yourself with the warranty and follow instructions regarding proper operation and maintenance. Lack of attention to instructions can void the warranty.

A copy of the factory warranty for the boat is included with the documents you received when the boat was delivered.

The manufacturer may also provide a Construction Standards Statement detailing industry standards followed in building your boat. Consult your marine dealer for additional information.

Specific Data

You must know specific data about your boat’s capabilities and requirements. This information is available from the manufacturer and/or your dealer. See the Manufacturer’s Certifications & Specifications sections in the front of this manual for specific data that you should expect to have provided.

The owner’s manuals for equipment installed on or associated with your boat is included with the documents you received when the boat was delivered. Before operating equipment, particularly the engine, read the owner’s manual accompanying the equipment.

Education

Learn how to operate your boat safely!!!! This manual is not intended to teach you everything you need to know about the operation of your boat. It is strongly recommended that you receive training in proper boat handling and navigation before using your boat.

Some agencies which offer boating courses are:

- Coast Guard Auxiliary
- United States Power Squadrons
- Canadian Power and Sail Squadrons
- Red Cross
- State Boating Offices
- Yacht Clubs

Ask your marine dealer or check local listings for agencies near you. Information is also available from the BoatUS Foundation by calling 1.800.368.5647, or you can go to the Internet to check for boating courses.

www.boatus.com

www.boatsafe.com

www.uscgboating.org

www.boat-ed.com

www.nationalsafeboatingcouncil.org

For international information, consult your dealer.

Owner/Operator Responsibilities

The law requires the owner/operator to assist any person or boat in distress as long as he does not endanger his boat. The owner/operator is also responsible for understanding and complying with the following regulations, procedures and operational requirements:

- Registration - Register your boat in the area where it is used most frequently. Many areas require additional registration when an out-of-area boat is used within their boundaries. Contact boating authorities or your marine dealer for registration requirements and forms.
- Insurance required, liability and hull coverage.
- Manufacturer's warranty registration, procedures, terms and conditions.
- Safety equipment.
- Maintenance and safe conduct of the vessel and its systems.
- Safety and safety training of the passengers and crew.
- Rules of the Road for navigation and boat handling.
- Knowledge of boating safety courses.
- Knowledge of boat systems and capabilities/limitations of the boat.
- Break-in procedure.
- Seaworthiness and operational inspection of the boat.
- Safe operating practices and avoidance of product misuse.
- Avoiding use of alcohol or drugs while boating.
- Knowledge of federal, state, and/or local environmental regulations.
- Knowledge of accident reporting requirements (See USCG Accident Report form).

Nautical Terms

Abeam	Object 90 degrees to center line on either side of boat.
Abaft	A point on a boat that is aft of another, or toward or at the stern of the boat.
Aft	Toward the rear or stern of the boat.
Beam	The width of a boat.
Bow	The forward part of a boat.
Bulkhead	Vertical partition in a boat.
Chine	Meeting juncture of side and bottom of boat.
Chock	Deck fitting, used as guide for mooring or anchor lines. Also a wedge to stop wheels from rolling.
Cleat	A deck fitting with arms or horns on which lines may be secured for mooring. (Mooring cleats are not for towing or being towed.)
Cockpit	An open space from which a boat is operated.
Deck	Upper structure which covers the hull between gunwales.
Draft	Depth of water required to float the boat and its propulsion system.
Fathom	Six feet.
Fenders	Rope, plastic, wood, or rubber pieces hung over the side to protect the hull from chafing.
Freeboard	The minimum distance from the waterline to the top edge of the side of the boat.
Ground Tackle	General term referring to anchors, anchor lines, etc.
Gunwale	(Pronounced as gunnel) The top edge of the side of the boat.
Hatch	An opening in deck to provide access below.
Head	Toilet or toilet area in a boat.
Headroom	Vertical distance between the deck and cabin or canopy top.
Helm	Steering console.
Hull	The basic part of a boat that provides buoyancy to float the weight of the vessel and its load.
Keel	The major longitudinal member of a hull; the lowest external portion of a boat.
Knot	Unit of speed in nautical miles per hour. 1 knot= 1.15 MPH
Lee	The side that is sheltered from the wind.

PFD	Personal flotation device; life preserver.
Port	A term designating the left side of the boat when facing forward.
Rudder	Movable fixture at the stern used for steering.
Scupper	Hole permitting water to drain overboard from deck or cockpit.
Sheer	Curve or sweep of the deck as viewed from the side.
Snub	To check or tighten a line suddenly.
Starboard	A term designating the right side of the boat when facing forward.
Stem Eye	Bolt with looped head mounted on extreme forward part of bow.
Stern	The aft end of a boat.
Transom	The main member of the boat structure at the stern of the boat extending from deck to keel.
Wake	Disturbed water that a boat leaves behind as a result of forward motion.
Windward	Toward the direction from which the wind is blowing.

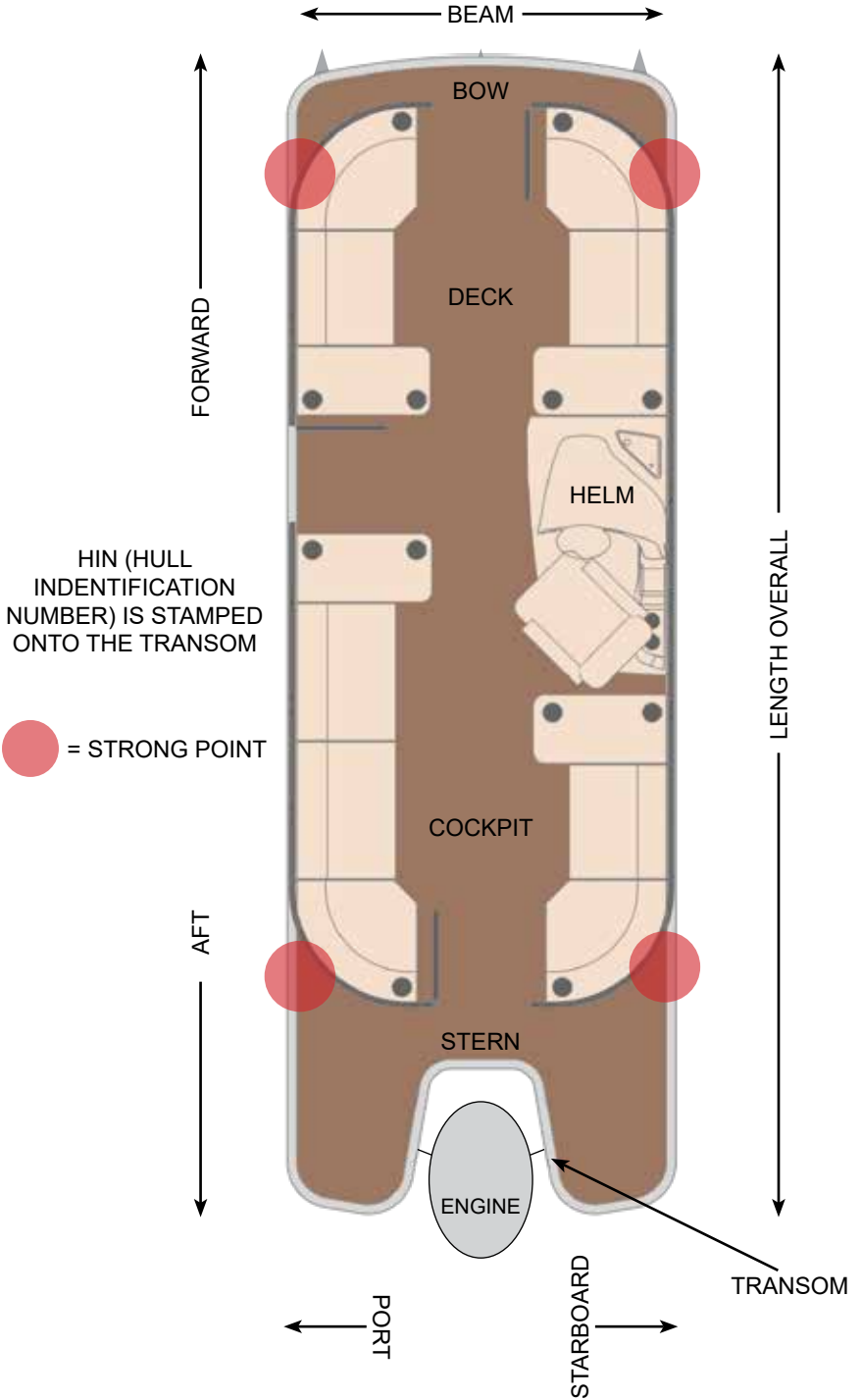

Section I

Safety

The freedom of boating is a magnificent feeling. However, fun can be over taken by disaster if you ignore safety precautions. This book presents basic guidelines, but it cannot describe every possible risk you may encounter. You are strongly urged to:

- Take a boating safety course and get hands-on training from your boat dealer.
- Regularly review safety requirements.
- Maintain your boat and its systems.
- Have your boat inspected at least annually by a qualified mechanic or dealer.

Explanation of Safety Precautions

⚠ DANGER
Indicates an imminently hazardous situation, that if not avoided, WILL result in death or serious injury. Limited to the most extreme situations. Red, if color is used.
⚠ WARNING
Indicates a potentially hazardous situation that, if not avoided, COULD result in death or serious injury. Orange, if color is used.
⚠ CAUTION
Indicates a potentially hazardous situation that, if not avoided, MAY result in minor or moderate injury or property damage. It may also be used to alert against unsafe practices. Yellow, if color is used.
NOTICE
Information that is important to proper operation or maintenance, but is not hazard-related. Any color can be used.

This manual contains safety precautions which must be observed when operating or servicing your boat. Review and understand these instructions and warnings. Labels are used to alert the boater to potential hazards. Each label will contain all four of the following messages:

1. Signal Word; Danger, Warning or Caution.
2. The nature of the hazard.

3. The consequences that can result if the instructions to avoid the hazard are not followed.
4. Message panel - Instructions on how to avoid the hazard.

Fire



Fire is always serious, but it usually can be brought under control if you are prepared and act quickly. Extinguishers required by the Coast Guard or other boating law enforcement agencies are only the minimum needed. Install fire extinguishers where they might be needed, and test equipment and emergency plans regularly.

Prevention is the safest method of fighting fire. Remember:

- Use extreme caution and do not smoke while fueling.
- Extinguish smoking material carefully.
- Keep hatches and hull/cabin openings shut while fueling.
- Keep blowers off while fueling.
- Use the “sniff test” to check for fumes in the bilge and engine compartment after fueling and at regular intervals.
- Remove canvas before starting engine.
- Run exhaust blowers at least 4 minutes before starting engine(s).
- Ensure that ventilation systems are clear and not obstructed.
- Use only marine safety approved cooking and heating systems.
- Open flames demand constant attention.
- Be extremely careful when using liquified petroleum gas (LPG) or compressed natural gas (CNG).
- Close valves to LPG/CNG cylinders and supply lines when not in use.
- Ensure fuel does not leak. Regularly inspect all fuel systems including LPG/CNG.
- Store flammable material in safety-approved containers.
- Keep flammable material containers in a locker sealed from the boat interior and vented overboard.
- Use special care with flames or high temperatures near urethane foam, if used.
- Check cleaning products for flammability.
- Ventilate when cleaning or painting.
- Disconnect electrical system from its power source before performing maintenance. (See Systems - Electrical.)
- Replace breaker or fuse with same amperage device.
- Electrical appliances must be within rated amperage of boat circuits.
- Observe the boat carefully while the electrical system is energized.
- Only a qualified marine electrical technician may service the boat's electrical system.

Fire Suppression Equipment

General

- Fire suppression equipment can be either fixed or portable. Fixed systems are located in the machinery compartments. They should be supplemented by portable extinguishers mounted at key sites, for example, near the engine compartment, galley and helm.
- Coast Guard or other boating law enforcement agency regulations govern the number and type of devices on board. (See *Safety - Minimum Required Equipment.*)

Fixed System

- An automatic fire extinguishing system may be installed permanently in one or more machinery spaces. In the event of a fire, the system releases fire-extinguishing material into the compartment.
- Fixed system is wired to the ignition and turns on with the engine.
- An indicator light on the helm is lit when the fire suppression system is available. The light goes out when the system discharges.

Portable Extinguishers

Fire extinguishers are classified according to fire type:

- “A” - Combustible solids (wood, plastic)
- “B” - Flammable liquids (oil, gasoline)
- “C” - Electrical fires

Sizes are identified by Roman numerals - from I (smallest) to V (largest). Small size provides only a few seconds of firefighting capability.

Flooding, Swamping

Flooding or swamping can be caused by many factors. Operator disregard for hazardous weather and water conditions is one of the most common causes, along with improper loading, handling and anchoring. Be aware of the possible consequences of your actions. Have everyone wear a personal flotation device when boating. **STAY WITH THE BOAT!**

Remember:

- Certification Label states maximum weight/number of persons the boat will handle safely under normal conditions. Give yourself an extra margin in rough water. (See *Safety - Load Capacity.*)
- Install drain plugs before launching.
- Ensure proper bilge pump operation.
- Anchor from bow if using only one anchor.
- Match speed to sea conditions.
- Adjust trim and close openings in rough weather.

- Reverse engine only when headway slows to prevent following sea from swamping boat.
- Operate boat within maneuvering speed limitations.

Lifesaving Equipment

Wear a personal flotation device (PFD) when boating. Boat operators are required to carry one wearable personal flotation device (type I, II, III or V) for every person on board. Boats must also have at least one throwable device (type IV). Classifications of PFDs are:

- **Off-Shore Life Jacket (type I)** - most buoyant, it is designed to turn an unconscious person face up; used in all types of waters where rescue may be slow.
- **Near-Shore Life Vest (type II)** - "keyhole" vest with flotation-filled head and neck support is also designed to turn a person face up, but the turning action is not as pronounced; used in calm, inland waters or where quick rescue is likely.
- **Flotation Aid (type III)** - vest is designed so conscious wearers can turn face up; often designed for comfort while engaged in sports such as skiing.
- **Throwable Devices (type IV)** - horseshoe buoys, ring buoys, and buoyant cushions are designed to be grasped, not worn.
- **Special-Use Devices (type V)** - sailboat harnesses, white-water vests, float coats, and hybrid vests.

When purchasing PFDs look for a tag that says they are approved by the U.S. Coast Guard and there should be an approval number on the tag. PFDs come in different shapes, colors, and materials, and they are designed for different uses. Choose your PFD with your planned activities and water conditions in mind. Also, be sure you understand the requirements and regulations of the state or region in which you are boating.

Children and non-swimmers must wear PFDs at all times when aboard. All passengers and crew should wear them, since an unworn PFD is often useless in an emergency. The law requires that PFDs, if not worn, must be readily accessible, that is, removed from storage bags and unbuckled. Throwable devices must be readily available, that is, right at hand. The operator is responsible for instructing everyone on their location and use.

Size PFDs for the wearer. Children require special attention. Check state boating law regulation for child PFD wear requirements.

PFDs require regular maintenance and service. Always dry your PFD before storage. Take your PFD to your dealer or call the manufacturer for other instructions about service and maintenance.

Test PFD buoyancy at least once a year.

Impaired Operation

⚠ WARNING

CONTROL HAZARD - Federal laws prohibit operating a boat under the influence of alcohol or drugs. These laws are vigorously enforced.



Give special attention to the effects of alcohol and drugs while boating. No other single factor causes so many marine accidents and deaths. Wind, waves and sun, heighten the effects of alcohol and drugs, so your reactions may be quickly impaired.

Carbon Monoxide Poisoning

Each year, boaters are injured or killed by carbon monoxide. Most poisonings occur on older boats and within the cabin or other enclosed areas. Virtually all of them are preventable.

Carbon monoxide is a potentially deadly gas produced any time a carbon-based fuel, such as gasoline, propane, charcoal or oil, burns. Sources on your boat include gasoline engines and generators, cooking ranges, space heaters and water heaters. Cold or poorly tuned engines produce more carbon monoxide than warm, properly tuned engines.

Carbon monoxide is colorless, odorless and tasteless and mixes evenly with the air. It enters your blood stream through the lungs and displaces the oxygen your body needs. Early symptoms of carbon monoxide poisoning are irritated eyes, headache, nausea, weakness and dizziness are often confused with sea sickness. Prolonged exposure can lead to death.

Carbon monoxide concentrations can be hazardous on the open deck of a boat, on a deck with an open bimini top, in an open cockpit, on a deck with canvas enclosures, on the decks of adjacent boats, on nearby docks, or in any open area that is in the vicinity of an engine exhaust. The area of concern can be a considerable distance from the engine exhaust and still be dangerous if the prevailing wind blows the carbon monoxide into the area. Be alert to the symptoms of carbon monoxide poisoning described in this section.

Carbon monoxide can collect within a boat in a variety of ways. Exhaust leaks, the leading cause of death by carbon monoxide, can allow carbon monoxide to migrate throughout the boat and into enclosed areas. Even properly vented exhaust can re-enter a boat if it's moored too close to a dock or another boat, or if the exhaust is pushed back by prevailing winds. Exhaust can also re-enter boats when cruising under certain conditions-the station wagon effect-especially with canvas enclosures in place.

Carbon monoxide awareness and regular & proper boat main tenance and operation are your best defenses against injury from carbon monoxide.

What To Do

- 1. Schedule regular engine and exhaust system maintenance inspections by experienced and trained technicians.**
- 2. Be aware that dangerous concentrations of carbon monoxide can accumulate** when a boat, generator or other fueled device is operated while the boat is at a dock or seawall or alongside another boat. Do not run the boat or equipment for an extended time under these conditions or without continuous monitoring. Even if your boat is diesel powered, carbon monoxide can accumulate from proximity to other boats.
- 3. Keep forward-facing hatches open, even in inclement weather, to allow fresh air circulation in accommodation spaces.** When possible, run the boat so that the prevailing winds will help dissipate the exhaust.
- 4. Do not confuse carbon monoxide poisoning with seasickness or intoxication.** If someone on board complains of irritated eyes, head ache, nausea, weakness or dizziness, immediately move the person to fresh air, investigate the cause and take corrective action. Seek medical attention, if necessary.
- 5. Do not let people swim in the areas near engine or generator exhaust.**
- 6. Install a carbon monoxide detector in each accommodation space on your boat.** Check the detectors periodically for proper functioning.

Checklist

Each trip:

- Make sure all exhaust clamps are in place and secure.
- Look for exhaust leaking from the exhaust system components, indicated by rust and/or black streaking, water leaks, or corroded or cracked fittings.
- Inspect rubber exhaust hoses for burned or cracked sections. All rubber hoses should be pliable and free of kinks.
- Confirm that water flows from the exhaust outlet when the engines and generator are started.
- Listen for any change in exhaust sound that could indicate an exhaust component failure.
- Test the operation of each carbon monoxide detector by pressing the test button.

Do not operate the vessel if any of these problems exist!

At least annually: (performed by a qualified marine technician)

- ❑ Replace exhaust hoses if any evidence of cracking, charring or deterioration is found.
- ❑ Replace each water pump impeller and inspect the condition of the water pump housing. Replace if worn. (Refer to the engine and generator manuals for further information.)
- ❑ Inspect each of the metallic exhaust components for cracking, rusting, leaking or looseness. Pay particular attention to the cylinder head, exhaust manifold, water injection elbow, and the threaded adapter nipple between the manifold and the elbow.
- ❑ Clean, inspect and confirm the proper operation of the generator cooling water anti-siphon valve (if equipped).

WARNING!

These Conditions May Cause Carbon Monoxide to Accumulate:

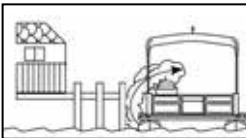

Blockage of exhaust outlets can cause carbon monoxide to accumulate in the cabin and cockpit area—even when the hatches, windows, portholes and doors are closed.

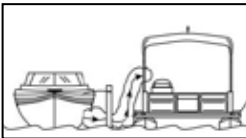

Exhaust from another vessel that is docked or anchored alongside your boat can emit poisonous carbon monoxide gas into the cabin and cockpit of your boat.

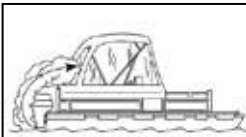

The station wagon effect, or backdrafting, can cause carbon monoxide to accumulate inside the cabin, cockpit and bridge when operating the boat at a high bow angle or with improper or heavy loading.

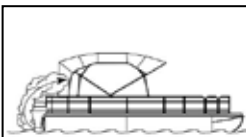

Slow speeds or having boat stopped (idling) in the water can cause carbon monoxide gas to accumulate in the cabin, cockpit and bridge. A tail wind (force of wind entering from aft section of yacht) can also increase accumulation.

DANGER

EXTREME HAZARD -

- 1. Carbon monoxide can accumulate on the open deck of a boat or on the open deck of an adjacent boat. This accumulation can be more concentrated if the wind direction is unfavorable or if an open bimini top is in use.**
- 2. Carbon monoxide can accumulate on nearby docks on in the open air near the exhaust of any engine.**
- 3. Carbon monoxide concentrations can be extremely high at the transom of any boat with engine exhaust through the transom. Never swim near the back of a boat or near any engine or generator exhaust.**
- 4. Never play on the swim platform or ride on the swim platform while the engine(s) is running. Never allow anyone to hold onto the swim platform and be dragged by the boat. There is danger of carbon monoxide poisoning and death from drowning.**

Information

To find out more about making boating safer - including how you can prevent carbon monoxide poisoning on recreational boats - contact:

National Marine Manufacturers Association
200 E. Randolph Drive, Suite 5100
Chicago, IL 60601-6528
www.nmma.org 312.946.6200

United States Coast Guard Office of Boating Safety
CG Headquarters G-OPB-3
2100 Second Street SW
Washington, DC 20593
www.uscgboating.org 202.267.0984

American Boat & Yacht Council, Inc.
3069 Solomon's Island Road
Edgewater, MD 21037-1416
www.abycinc.org 410.956.1050

Load Capacity

- The Coast Guard requires boats less than 6.4 meters (20 feet) to have a Certification Label stating the maximum number of persons and the maximum weight the boat will handle safely under normal conditions. ISO international directives require a builder's plate on boats up to 24 meters (78.7 feet).
- Certification Label is attached to the hull or superstructure near the helm or transom.
- Overloading violates regulations. Do not carry more weight or passengers than indicated on the Certification Label.
- The number of seats is not necessarily an indication of the number of persons a boat can carry safely.
- When operating the boat above the idle speed, carry no more passengers than there are real, safe seats, and insist that passengers sit down in those seats. Follow the instructions of seating chart labels if provided.
- The presence of the Certification Label does not relieve the owner/operator from responsibility for using common sense and sound judgment.
- Overloading, improper loading and distribution of weight are significant causes of accidents. Give yourself an extra margin of safety in rough water.

MAXIMUM CAPACITIES

X PERSONS OR X LBS.

X LBS, PERSONS, MOTOR, GEAR
X H.P. MOTOR

THIS BOAT COMPLIES WITH U.S. COAST GUARD SAFETY STANDARDS IN EFFECT ON THE DATE OF CERTIFICATION

MEETS U.S. EPA EVAP STANDARDS USING CERTIFIED COMPONENTS
MANUFACTURER: BARLETTA BOAT CO., LLC

MODEL: X BRISTOL, IN

DESIGN COMPLIANCE WITH NMMA REQUIREMENTS IS VERIFIED.
MANUFACTURER RESPONSIBLE FOR PRODUCTION CONTROL.



NMMA
CERTIFIED
BY THE ABYC, DIVISION

NATIONAL MARINE
MANUFACTURERS ASSOCIATION

Power Capacity

Do not exceed the maximum engine power rating stated on the Certification Label attached to your boat.

Stability



- The manufacturer may provide a statement with the owner's information packet indicating the stability and flotation standards for your boat.
- Stability may be reduced if passengers or equipment are added to the boat. Stability is more severely reduced if the added weight is placed on the superstructure of the boat.
- Stability is substantially reduced by loose fluids or weight within the hull. Keep bilge area as dry as possible, and close openings in rough weather.
- It is important to know the sea and wind conditions for which your boat is assessed to be suitable. Consult the boat manufacturer to determine the design category for your boat: A-Ocean, B-Offshore, C-Inshore, D-Sheltered waters.

Warning Labels

Warning labels are mounted at key locations to advise you of safety precautions when operating or servicing equipment. Do not remove or cover warning labels. Replace when illegible. Contact an authorized Barletta Pontoon Boat dealer for replacement warning labels.

⚠ WARNING

Failure to follow these warnings could cause SEVERE INJURY or DEATH.

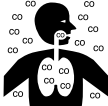
- **PROPELLER INJURY.** Avoid serious injury turn engine OFF while swimming and or using boarding ladders. 
- **VISION OBSTRUCTION.** Do not operate boat while full canopy enclosures are installed. Your forward, aft and side vision is obstructed by the canopy enclosures.
- **DO NOT STORE FUEL IN COMPARTMENTS.** Proper ventilation has not been provided. **Serious injury could result if ignored.**
- **FUEL SYSTEM IS UNDER PRESSURE.** Release cap slowly to avoid injury. No smoking, vapors are combustible.
- **AVOID SERIOUS INJURY OR DEATH** from fire or explosion resulting from leaking fuel. Inspect system for leaks at least once a year.
- **DO NOT OPERATE UNDERDECK LIGHTS** when navigation lights are required.
- **AVOID PERSONAL INJURY.** Do not sit in front of rails and stay inside of deck rails when boat is underway. Avoid the risk of falling into water and being struck by hull or propeller.
- **WHILE ANCHORED OR UNDER WAY** stern light must be vertical. Monitor regularly - USCG Regulation.
- **PASSENGERS SHOULD NOT RIDE IN BOW AND STERN FISHING SEATS WHEN BOAT IS UNDERWAY!**
 - Too much weight in the bow could cause the boat to nosedive.
 - Passengers in bow and stern are in danger of falling overboard. 
- **SEAT PASSENGERS FROM REAR TO FRONT.** Heavy bow loading may cause poor handling while underway.
- **SUDDEN TURNS ABOVE 25 mph** may cause loss of boat control, reduce speed before attempting a turn.
- **SKI BAR IS NOT A TOWING DEVICE.** Towing items or equipment other than a single skier may result in damage and or personal injury.
- **CARBON MONOXIDE (CO) CAN CAUSE BRAIN DAMAGE OR DEATH.**
 - Engine and generator exhaust contains odorless and colorless carbon monoxide gas.
 - Signs of carbon monoxide poisoning include nausea, headache, dizziness, drowsiness, and lack of consciousness.
 - **MOVE TO FRESH AIR** if anyone shows signs of carbon monoxide poisoning.
 - See Owners's Manual for information regarding carbon monoxide poisoning. 
- **BOATER'S CHECKLIST.** For maximum enjoyment and safety, check each of these items.
BEFORE STARTING YOUR ENGINE:
 - **DRAIN PLUG** (Securely in place?)
 - **LIFE-SAVING DEVICES** (One for every person on board, plus a throw-able?)
 - **STEERING SYSTEM** (Working smoothly and properly?)
 - **FUEL SYSTEM** (Adequate fuel? Leaks? Fumes?)
 - **BATTERY** (Full charged? Cable terminals clean and Tight?)
 - **ENGINE** (In neutral?)
 - **CAPACITY PLATE** (Are you overloaded or overpowered?)
 - **WEATHER CONDITIONS** (Safe to go out?)
 - **ELECTRICAL EQUIPMENT** (Lights, horn, pump, etc?)
 - **EMERGENCY GEAR**
(Fire extinguisher, bailer, paddle, anchor and line, signaling device, tool kit, etc?)

www.barlettapontoonboats.com

BLANK FOR FUTURE

WARNING

LADDER SAFETY

AVOID PERSONAL INJURY

- Do not sit, when motor is running
- Do not lean when entering boat or water
- Do not grip ladder near hinges
- Do not grip ladder where it contacts boat

BLANK FOR FUTURE

DANGER



Carbon Monoxide (CO) can cause brain damage or death.

Engine and generator exhaust contains odorless and colorless carbon monoxide gas.

Carbon monoxide will be around the back of the boat when engines or generators are running.

Move to fresh air if you feel nausea, headache, dizziness, or drowsiness.

CAUTION

Persons not to be seated here while boat is in motion.

WARNING



Carbon Monoxide (CO) can cause brain damage or death.

Engine and generator exhaust contains odorless and colorless carbon monoxide gas. Signs of carbon monoxide poisoning include nausea, headache, dizziness, drowsiness, and lack of consciousness.

Get fresh air if anyone shows signs of carbon monoxide poisoning.

See Owners' Manual for information regarding carbon monoxide poisoning.

WARNING

Ski bar is not a towing device. Towing items or equipment other than a single skier may result in damage and/or personal injury.

WARNING

Avoid personal injury. Do not sit in front of rails and stay inside of deck rails when boat is underway. Avoid the risk of falling into water and being struck by hull or propeller.

DO NOT SIT ON GATE

To open, lift here & swing in

WARNING

Avoid personal injury. Do not sit in front of rails and stay inside of deck rails when boat is underway. Avoid the risk of falling into water and being struck by hull or propeller.

DO NOT SIT ON GATE

To open, lift here & swing in

WARNING

Avoid personal injury. Do not sit in front of rails and stay inside of deck rails when boat is underway. Avoid the risk of falling into water and being struck by hull or propeller.

DO NOT SIT ON GATE

To open, lift here & swing in

WARNING

Avoid personal injury. Do not sit in front of rails and stay inside of deck rails when boat is underway. Avoid the risk of falling into water and being struck by hull or propeller.

DO NOT SIT ON GATE

To open, lift here & swing in

WARNING

To avoid personal injury, do not use this as a grab handle.

WARNING

PROPELLER INJURY

Avoid serious injury turn engine OFF while swimming and/or using boarding ladders.

WARNING

FUEL SYSTEM UNDER PRESSURE

Release cap slowly to avoid injury. No smoking, vapors are combustible.

CAUTION

Avoid blow back when filling the fuel tank on the initial fill. Fill the tank SLOWLY for the first several gallons.

Weather

Learn to understand weather patterns and signs of change. Bad weather and sea conditions can cause an uncomfortable and unsafe situation. Here are a few basic weather-related rules:

- Check the forecast and sea conditions before leaving and while underway.
- A sudden change in wind direction or speed or an increase in wave height indicates deteriorating weather.
- Be aware of the hazards of thunderstorms, downbursts, microbursts, and tornados. Monitor National Weather Service broadcasts and Coast Guard marine weather information including small craft advisories on VHF channel 22 on your marine radio.
- Wear a personal flotation device.
- If a storm approaches, immediately seek a safe harbor.
- If a storm hits, head the bow of your boat into the wind.
- If you encounter fog, determine your position, set a safe course, slow down and alert other boats of your presence with a sound signal.
- The best lightning protection is a properly grounded lightning rod that is high enough to provide a protective umbrella over the boat. Stay clear of the rod and all attached wiring. See your dealer for more information.

Accident Report

The U.S. Coast Guard and state agencies require a report to be filed by the operator of a boat involved in an accident involving loss of life, disappearance, injury requiring treatment beyond first aid, loss of boat or property damage exceeding \$500. Contact the state boating agency where the accident occurs for a copy of the state's accident report form. In the absence of a state enforcement agency, contact the Coast Guard office nearest the accident site. Other countries have other reporting requirements. Consult your nation's boating law enforcement agency. A copy of the USCG Accident Report Form is included in the back of this manual.

Hotlines

The Coast Guard offers many pamphlets on safety and other information not covered in this book. Contact your local Coast Guard unit or call these toll-free safety hotlines:

- U.S. Coast Guard 1-800-368-5647, www.uscgboating.org
- Canadian Coast Guard 1-800-267-6687, www.ccg-gcc.gc.ca

Minimum Required Equipment

Consult your national boating law enforcement agency.

Equipment	Class A	Class 1	Class 2	Class 3
	<i>(Less than 4.8 meters [16 feet])</i>	<i>(4.8 to less than 7.9 meters {16 to less than 20 feet})</i>	<i>(7.9 to less than 12.2 meters [26 to less than 40 feet])</i>	<i>(12.2 meters to less than 19.8 meters [40 to less than 65 feet])</i>
Engine backfire flame arrester	One approved device on each carburetor of all gasoline engines, except outboard motors.			
Bell, Whistle	Some means of making efficient sound signal, for example, whistle or air horn.			Must carry a whistle and a bell audible for .5 nautical mile
Fire Extinguisher - Portable (if no fixed fire extinguishing system is installed in machinery spaces)	At least one B-1 type Coast Guard approved portable marine fire extinguisher. (Not required on outboard motor boats less than 7.9 meters [26 feet] in length without permanently installed fuel tanks and not carrying passengers for hire, provided construction of boat will not permit entrapment of explosive or flammable gases or vapors.)		At least two B-1 type Coast Guard approved portable marine fire extinguishers, or at least one B-1 type approved portable marine fire extinguisher.	At least three B-1 type Coast Guard approved portable marine fire extinguishers, or at least one B-1 type plus one B-1 type approved portable marine fire extinguisher.
Navigation Lights	Required between sunset and sunrise or in reduced visibility.			
Muffling Device	Efficient muffling device or system to prevent excessive or unusual engine noise.			
Personal Flotation Devices (PFDs)	One Coast Guard approved type I, II or III device for each person aboard, plus one throwable Type IV device. Type V device is acceptable if worn for approved use. Always wear a PFD when boating.			
Ventilation	Boats with closed compartments or permanently installed fuel tanks must be equipped with an efficient natural or mechanical bilge ventilator or meet applicable Coast Guard construction standards for fuel and electrical systems.			

Additional Recommended Equipment

A wise boater will include many of the following items:

- Visual distress signals for day and night use (required in some areas; consult local regulations)
- Sound signal devices such as horn, bell, whistle, or gong
- Marine radiotelephone
- Compass
- Depth sounder
- Charts
- Spare keys
- Emergency position-indicating radio beacon
- Portable radio with weather band
- Waterproof flashlight
- Batteries
- Mooring lines
- Fenders
- Extra propeller
- Ground tackle (at least 2 anchors, rhode, shackles)
- Paddles or oars
- Boat hook
- Safety approved gas can, properly stowed
- Bailer
- Spare parts kit (spark plugs, fuses, etc.)
- Tool kit
- First aid kit
- Carbon monoxide detection system if your boat has an enclosed accommodation compartment

Barletta Floorplan - Occupant Positions

Designated Occupant Position - a standing or seated area with a minimum width of 16 inches (40.6 cm) designed to be occupied at boat speeds in excess of five mph (4.3 kts).

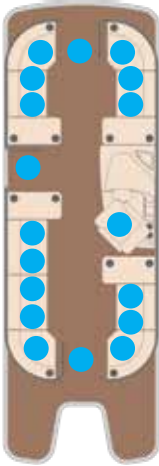

L23Q

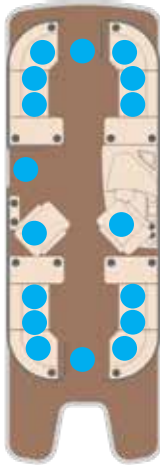

L23QC



L23U

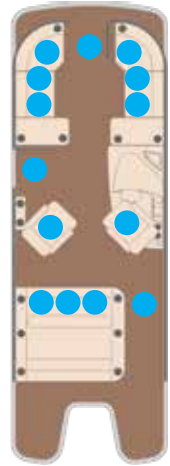

L23UC

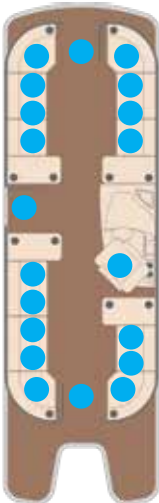

L25Q

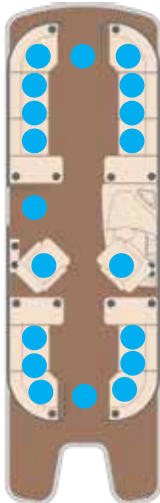

L25QC



L25U

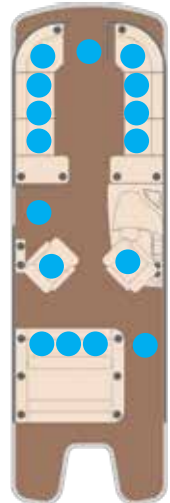

L25UC

● = seated

Navigation

Rules of the Road

⚠ CAUTION

- Follow navigation rules to avoid collisions.
- Less maneuverable boats generally have the right of way. Steer clear of the stand-on (right-of-way) boat and pass to its stern.
- If a collision appears unavoidable, both vessels must act. Prudence takes precedence over right-of-way rules if a crash is imminent.
- The Rules do not relieve the give-way vessel of the obligation to keep out of the way.

Navigational rules are commonly called Rules of the Road. There are two types: **Inland Rules** apply to vessels on United States inland waters; **International Rules** apply to vessels on the high seas. Basic principles agree, but some differences exist. Learn and follow the rules that apply to your area.

It is impossible to establish rules for every situation. Therefore, it is important to act prudently.

This manual is not intended to teach all the rules of navigation. It presents a general overview, and you are strongly urged to get training before taking command of your boat.

Understand important terminology distinctions:

- **Power-Driven Vessel** - A boat propelled by an engine (including a sailboat propelled by engine and sail).
- **Sailing Vessel** - A boat propelled by sail only, with no engine in operation.
- **Underway** - A boat not anchored, not made fast to shore and not aground.
- **Vessel Engaged in Fishing** - A commercial fishing boat with gear that restricts maneuverability (does not include trolling lines or other gear that does not restrict maneuverability).

Basic Rules

Power-Driven Vessels must keep out of the way of:

- A vessel unable to maneuver or not under command
- A vessel whose maneuverability is restricted
- A vessel engaged in commercial fishing
- A sailing vessel

Sailing Vessels must keep out of the way of:

- A vessel unable to maneuver or not under command
- A vessel whose maneuverability is restricted
- A vessel engaged in commercial fishing

Vessels Engaged in Commercial Fishing must keep out of the way of:

- A vessel unable to maneuver or not under command
- A vessel whose maneuverability is restricted

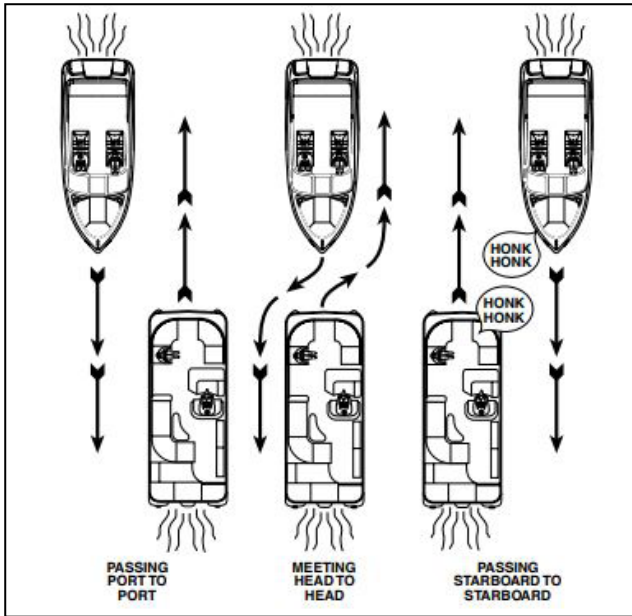

MEETING

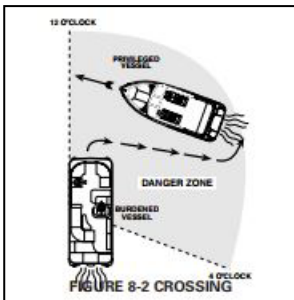

CROSSING

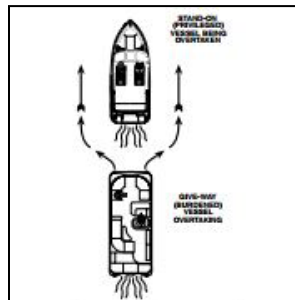

OVERTAKING

Boat Navigation Lights



Boats must display navigation lights when operating between sunset and sunrise and during periods of reduced visibility, e.g., fog or rain, to alert other boats to their presence and course. Although boat manufacturers usually provide lights to comply with these rules, it is the operator's responsibility to know and comply with local laws.

Learn to recognize light groupings from different positions:

- **Masthead Light** - 225 degrees of visibility - white light forward, 8 o'clock to 4 o'clock (approximate).
- **Sidelight** - 112 degrees of visibility - green light starboard, 12 o'clock to 4 o'clock (approximate); red light port, 8 o'clock to 12 o'clock (approximate.)
- **Sternlight** - 135 degrees of visibility - white light aft, 4 o'clock to 8 o'clock (approximate).
- **All-Round Light** - 360 degrees of visibility - white light showing in all directions.
- **Anchor Light** - 360 degrees of visibility - white all-round light. Inland Rules exempt boats in special anchorage areas.

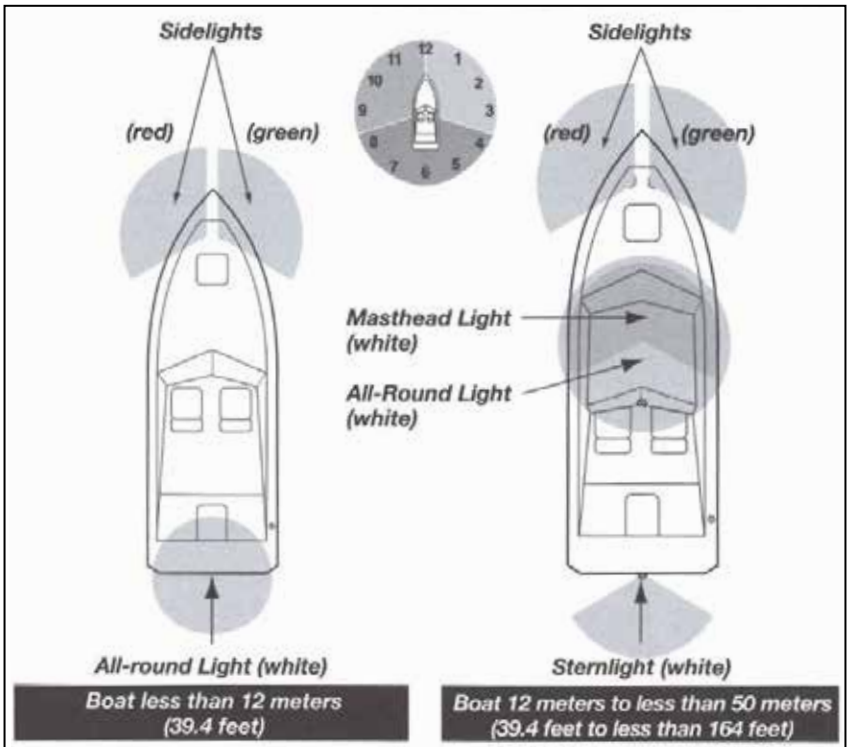

Some other types of navigational lights include:

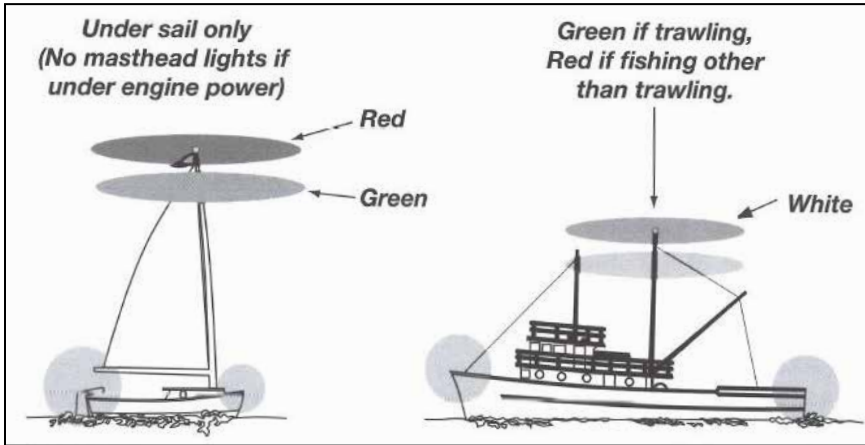

- Sailboats operating under engine power must display the same lights as other power-driven vessels.
- Sailboats under sail only must display green and red sidelights and a white sternlight, but not a white masthead light. Boats under sail may display two all-round lights, red over green, near the top of the mast. Sailboats under 7 meters (23 feet) should display such lights if possible, but if not, the boat must have an electric torch or lighted lantern to show a white light in time to prevent collision.
- Commercial fishing vessels stopped while trawling must display a green all-round light over a white all-round light.
- Commercial fishing vessels stopped while engaged in other than trawling operations must display a red all-round light over a white all-round light.
- Towing vessels may display a yellow flashing or fixed light.
- Enforcement vessels may display a flashing blue light.
- White strobe light is used as a distress signal.

Special use vessels such as public safety, pilot, dive boats and dredges have other light requirements.

International and Inland Rules differ slightly on navigational light placement. Understand the basics and learn the boat lights in your area. Avoid lights you do not recognize.

Charts & Aids to Navigation

A vast expanse of open water off your bow might appear to be a go anywhere playground or a place to become hopelessly lost. It is neither. How do you know where to go? Just as maps and signs guide you on land, nautical charts and buoys guide you afloat.

Nautical Charts provide vital information on water hazards and safe channels. Several government agencies are responsible for charts for different types of waterways: U.S. Army Corps of Engineers, Canadian Hydrographic Service, National Oceanic and Atmospheric Administration, and Defense Mapping Agency. Charts are also available from the following web sites:

www.usace.army.mil
www.nima.mil
www.charts.gc.ca
www.noaa.gov/charts.html
www.nauticalcharts.com

We strongly urge you to attend boating classes to learn charting and navigation skills before taking the helm of your vessel. (*See Introduction - Education.*)

Buoys are strategically placed to keep you on course and out of hazardous areas. Know their meaning and use them appropriately. Buoys are identified by shape, color, light, and in reduced visibility by sound. There are two international buoyage systems, one using Red Right Returning as a guide (Region B) and the other using Green Right Returning (Region A). The following map indicates regions using each system. The illustration on the next page indicates placement of basic navigational aids and colors for each region.

Example: Red Right Returning - when returning from sea or going up-stream, keep red markers to starboard (right) and green markers to port (left). When outbound, reverse the colors - red to port and green to starboard.

Buoys are sometimes not on station due to currents, heavy seas or other conditions. Consult Local Notice to Mariners publication for information on buoys off station and light outages. This information is available at www.navcen.uscg.gov/lnm.

Buoyage Regions A & B

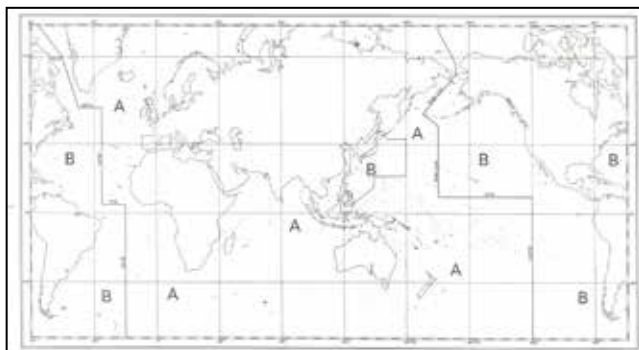

Navigational Aids

MID CHANNEL

Pass close on either side.



CHANNEL

Can Buoy
Red—Region A
Green—Region B
(See map)
Navigate to starboard facing upstream.



INFORMATION

Tells directions, distances, places, food, repairs, supplies and other non-regulatory messages.



DIVERS DOWN FLAGS

Boats exercise caution. Required by federal law to be displayed by divers.

UP
STREAM

CHANNEL

Nun Buoy
Green—Region A
Red—Region B
(See map)
Navigate to port facing upstream.



CAUTION!

Controlled area as indicated in circle such as speed limit, no fishing, no anchoring, ski only, slow-no wake, no prop boats or no ski.



MOORING BUOY

White with reflectorized blue band. May have white light or reflector.



SHOAL

SWIM
AREA

SHOAL



BOATS KEEP OUT!

Nature of danger may be placed outside crossed diamond such as waterfalls, swim areas or rapids.



DANGER!

Nature of danger may be indicated inside the diamond shape such as rocks, reefs, dams, construction or snags.

Environmental Considerations

Fuel & Oil Spillage

Federal Regulations prohibit discharging fuel or oily waste in navigable waters. Discharge is defined as any action which causes a film, sheen or discoloration on the water surface, or causes a sludge or emulsion beneath the water surface. A common violation is bilge discharge. Use rags or sponges to soak up fuel or oily waste, then dispose of it properly ashore. If there is much fuel or oil in the bilge, contact a knowledgeable marine service to remove it. Never pump contaminated bilge overboard. Help protect your waters.

If your boat is 26 feet or more in length, it must have a "Discharge of Oil Prohibited" placard that is at least 5" x 8" posted in a prominent place on the boat. This placard must say the following:

The Federal Water Pollution Control Act prohibits the discharge of oil or oily waste into or upon the navigable waters of the United States, or the waters of the contiguous zone, or which may affect natural resources belonging to, appertaining to, or under the management authority of the United States, if such discharge causes a film or discoloration of the surface of the water or causes a sludge or emulsion beneath the surface of the water. Violators are subject to substantial civil penalties and/or criminal sanctions including fines and imprisonment.

Fill your fuel tank(s) and oil tank(s) to less than rated capacity to allow for expansion of the liquids.

Waste Disposal

The use of Marine Sanitation Devices (MSD or head) is controlled by Federal Law to eliminate the discharge of untreated sewage from vessels into the waters of the United States. Discharge includes, but is not limited to, any soiling, leaking, pouring, pumping, emitting, emptying, or dumping. If your boat is equipped with a MSD, it must be a Certified Type I, or Type II, or Type III. The boat owner must be familiar with the different types of MSDs and the allowable types that can be used in the boating area.

CAUTION

Do not place facial tissue, paper towels or sanitary napkins in head. Such material can damage the waste disposal system and the environment.

NOTICE

- **There is a possibility of being fined for having an operable direct overboard discharge of waste in some waters. Closing the seacock and removing the handle, or other means must be used to avoid fine.**
- **It is illegal for any vessel to dump plastic trash anywhere in the ocean or navigable waters of the United States.**

- Use of Holding Tanks - If your boat is fitted with a sewage holding tank you must be knowledgeable about its operation and maintenance, the use of a "Y" valve if one is installed, its capacity, chemicals that are to be used, pump out procedures, storage procedures to be followed if temperatures are below freezing, and the location of discharge shutoff valve(s).
- You must be aware of local environmental laws and you must respect local discharge codes. Holding tanks are not to be discharged close to shore or in prohibited areas. Use marina pump out facilities to empty the tank prior to leaving the marina. Respect international regulations against marine pollution.
- Many areas prohibit overboard sewage discharge. Close and disable flow-through waste system to prevent discharge in such areas.
- Bag all refuse until it can be disposed of ashore. Regulations prohibit disposal of plastic anywhere in the marine environment and restrict other garbage disposal within specified distances from shore.

Garbage Discharge Restrictions

NOTICE

- **If your boat is over 40 feet in length, you may be required to have a written Waste Management Plan.**
- **If your boat is over 26 feet in length, you may be required to display a placard that is 9 inches wide and 4 inches high which notifies the reader of the applicable restrictions.**
- **Operation of your boat in the Great lakes may require a different placard.**

The placard referenced above must contain the following information:

1. The discharge of plastic or garbage mixed with plastic into any waters is prohibited.
2. The discharge of all garbage is prohibited in the navigable waters of the United States, and in all other waters within three nautical miles from the nearest marina.

3. The discharge of dunnage, lining, and packing materials that float is prohibited within 25 nautical miles of the nearest land.
4. Other unground garbage may be discharged beyond 12 nautical miles of the nearest land.
5. Other garbage ground to less than one inch may be discharged beyond three nautical miles of the nearest land.
6. A person who violates the above requirements is liable for a civil penalty of up to \$25,000, a fine of up to \$50,000, and imprisonment of up to five years for each violation.
7. Regional, State, and local restrictions on garbage discharges also may apply.

Note: Check with your dealer or the Coast Guard for clarification.

Excessive Noise

Many areas regulate noise limits. Even if there are no laws, courtesy demands that boats operate quietly.

Local restrictions and international standards are constantly changing. It is advisable to check with your dealer to be sure that your boat complies with the local or international sound emission requirements that are applicable to your boat and your particular usage area.

Wake/Wash

 **CAUTION**

Reduce speed in congested waterways.

Powerboat wakes can endanger people and vessels. Each powerboat operator is responsible for injury or damage caused by the boat's wake. Be especially careful in confined areas such as channels or marinas. Observe "no wake" warnings. Some areas have no-wake or speed limit zones for other reasons, such as protection of wildlife. The boat operator must comply with these added restrictions.

Exhaust Emissions

Enclosed cabins or cockpits may accumulate carbon monoxide. You can be overcome by fumes from your own engine or from neighboring boats. Ensure continuous movement of fresh air. Install one or more carbon monoxide detectors in boat's enclosed cabin or cockpit. Exhaust emissions can accumulate in an open boat with only an open bimi ni top installed, on the open decks and especially on the swim platform or the aft deck. Ensure continuous airflow in this situation.

⚠ DANGER

EXTREME HAZARD - Ensure adequate ventilation. Gasoline engines produce carbon monoxide gas (CO). Prolonged exposure can cause serious injury or death. Depending on the concentration of CO in an area inside or outside a boat, even brief exposure can cause serious injury or death. To reduce CO accumulation, increase air movement by opening windows or adjusting canvas. The following conditions require special attention:

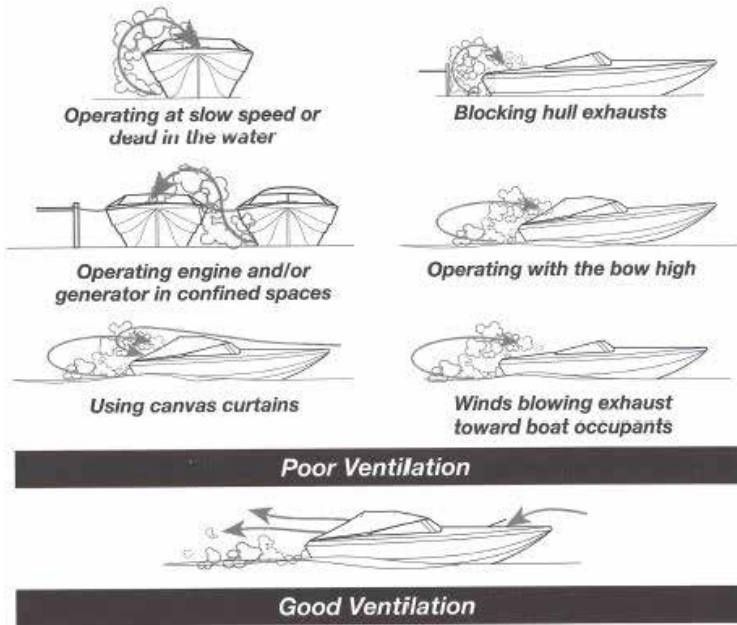

Paint, Cleaning Agents & Other Substances

⚠ WARNING

EXPLOSION/FIRE HAZARD - Ventilate when painting or cleaning. Ingredients may be flammable and/or explosive.

NOTICE

Refer to cleaning product specifications and directions before use.

Consult your marine dealer about environmental regulations before painting the hull.

Common household cleaning agents may cause hazardous reactions. Fumes can last for hours, and chemical ingredients can attack people, property and the environment. Avoid products containing chlorine, phosphates, and non-biodegradable ingredients.

Anti-freeze used in the boat's engine(s) should be propylene glycol instead of the more common ethylene glycol, so that potential spillage will not harm wildlife.

Emergency Procedures

The time to think about emergencies is before they happen. Plan ahead. Know what to do before you encounter any of these situations. Wear a PFD when boating.

Explosion & Fire

⚠ WARNING

EXPLOSION/FIRE/ASPHYXIATION HAZARD

- **Open flame cooking appliances consume oxygen. This can cause asphyxiation or death.**
- **Maintain open ventilation.**
- **Liquid fuel may ignite, causing severe burns.**
- **Use fuel appropriate for type of stove.**
- **Turn off stove burner before changing the fuel source.**
- **Do not use stove for comfort heating.**

FIRE/ASPHYXIATION HAZARD - Use special care with flames or high temperatures near urethane foam, if used in construction of your boat. Burning, welding, lights, cigarettes, space heaters and the like can ignite urethane foam. Once ignited, it burns rapidly, producing extreme heat, releasing hazardous gases and consuming much oxygen.

Explosion

- If explosion seems to be imminent, put on PFDs, grab distress signals and survival gear, and immediately abandon ship.

Fire

- Turn off engines, generators, stoves and blowers. Extinguish smoking materials.
- Fixed fire suppression system, if equipped, has heat sensors that automatically flood machinery space with a fire extinguishant. Allow extinguishant to “soak” compartment for at least 15 minutes to cool hot metals or fuel before cautiously inspecting fire area. Have portable fire extinguishers ready. Do not breathe fumes or vapors caused by the fire or extinguishant.
- If no fixed firefighting system is installed and fire is in engine compartment, discharge portable fire extinguishers through engine compartment access plate, if equipped. Do not open engine hatch as this feeds oxygen to the fire.

- If you have access to fire, direct contents of extinguishers at base of flames, not at the top.
- Throw burning materials overboard if possible.
- Move anyone not needed for firefighting operations away from the flames.
- Signal for help.
- Put on PFDs, grab distress signals and survival gear, and prepare to abandon ship.

The boat owner/operator shall:

- Know the location of the fire extinguishers and their capacities.
- Have fire extinguishing equipment checked at the intervals specified on the equipment.
- Replace portable fire extinguishers, if expired or discharged, by devices of identical fire fighting capacity.
- Have fixed fire extinguishing system(s) refilled or replaced when expired or discharged.
- Ensure that fire fighting equipment is readily accessible.
- Inform members of the crew about the location and operation of the fire fighting equipment.
- Keep the bilges clean and free from fuel and gas vapors.
- Replace parts of the fire fighting installation with matching components.
- Keep combustible materials away from the open flame devices.
- Never stow combustible material in the engine spaces.
- Identify exits from the boat.

The boat owner/operator shall never:

- Obstruct exits.
- Obstruct safety controls.
- Obstruct portable fire extinguishers.
- Leave the craft unattended when appliances are in use.
- Use gas (LPG) lights on the boat.
- Fill fuel tanks or gas (LPG) bottles when machinery is running.
- Modify any of the craft's systems.
- Smoke while fueling or handling LPG.

Abandoning Ship

WARNING

BURN HAZARD - Swim against the current or wind if you abandon ship. Leaking fuel will float with the current and may ignite.

- When clear of danger, account for all who were on board, and help those in need.
- Use distress signal.
- Keep everyone together to make rescue easier.

Flooding, Swamping or Capsizing

- **STAY WITH THE BOAT!** A boat will usually float even if there is major hull damage. Rescuers can spot a boat much easier than a head bobbing in water.
- Signal for help.

Collision

- Account for everyone on board.
- Check for injuries.
- Inspect structural damage.
- Reduce flooding.
- Signal for help.
- **STAY WITH THE BOAT!**

Grounding

Action depends on how hard the boat hits bottom and whether the boat remains stranded. If it is a simple touch, you may need only to inspect the hull. If you are aground, assess the situation before reacting. In some cases, throwing the boat into reverse can cause more damage.

Basic Guidelines

- Check for leaks. If water is coming in, stopping the flow takes priority over getting free.
- Inspect damage to hull, propulsion and steering systems.
- Determine water depth all around the boat and type of bottom (sand, mud, rocks, etc.). This will help you decide which way to move the boat.
- Determine if tide, wind or current will drive the boat harder aground or will help free it.

Leaks

- Immediately switch on bilge pumps.
- Assign crew to operate manual pumps if needed.
- Check extent of leaks.
- If boat is taking on water, have someone take the helm while you manage damage control.
- Slow or stop to minimize inflow. However, if you can keep a hole above water by maintaining speed, do so.
- If possible, patch the outside with whatever material is available (tape or plastic for example). Also, try to stop the leak from the inside by stuffing rags, clothing, cushions or any material that will slow or stop the leak.

Towing

⚠ WARNING

PERSONAL INJURY HAZARD - Towing or being towed stresses the boats hardware and lines. Failure of any part can seriously injure people or damage the boats.

A recreational boat towing another is usually a last resort because of possible damage to one or both boats. The Coast Guard or a private salvage company is better equipped. A recreational boat may assist by standing by, and possibly keeping the disabled boat's bow at a proper angle until help arrives. Only when conditions are ideal—that is, seas are calm, disabled boat is small, and one or both skippers know correct technique—should a recreational boat tow another.

Towing Vessel

- Take care that your boat will not run aground, if attempting to tow a grounded boat.
- Pass the towline to the disabled boat, since the towing boat is more maneuverable.
- Use double-braided or braid-on-braid line. Never use three-strand twisted nylon; it has too much elasticity and can snap back dangerously.
- Fasten the towline as far forward as possible on the upwind or upcurrent side of the towing boat. Fastening it to the stern will restrict maneuverability of the towing boat.
- If possible, use a bridle.
- Move slowly to prevent sudden strain on slack line.
- Be ready to cast loose or cut the line if the towing situation becomes hazardous.

Vessel Being Towed

- Attach the towline to the stern eye or bow eye. Never use a mooring cleat for towing!!!!
- If the boat has eyebolts in the transom for pulling skiers, a towline may be attached to a small bridle hooked to both eyebolts.
- If it is necessary to be towed after being freed, keep someone aboard the boat to steer.

Both Vessels

- If you attach the towline to a fitting, be sure that the fitting is through bolted and reinforced with a backing plate. Never use a mooring cleat for towing!!!!
- Creating a bridle with a line around the hull or superstructure will distribute the load over a wide area; pad pressure points. This technique can be used on both the towing and towed boat.

- Keep lines clear of propellers on both boats.
- Keep passengers on both boats clear of the towline that is pulled taut.
- Never hold a towline while it is feeding out or after it is pulled taut.

Person Overboard

- Immediately sound an alarm and keep pointing to the person over board.
- Throw a life preserver even if the person is wearing a PFD. It will serve as a marker.
- Immediately stop or slow the boat, then circle toward the person.
- Keep person overboard on helm side so operator has the person constantly in sight.
- Approach from downwind and move alongside into the wind for pickup.
- When almost alongside, stop the engine in gear to prevent dangerous propeller “windmilling.”
- As part of your emergency plan, consider what to do if you were alone and fell overboard (e.g., wear PFD, keep signal device in PFD, attach emergency stop switch lanyard to yourself).
- Be sure that there is a functional reboarding device or procedure that will enable the person overboard or yourself to get back on board the boat unassisted.
- Be sure that all passengers on board know the details of the reboarding procedure and the operation of the equipment required.

Drowning

- If a person is drowning, follow the standard lifesaving procedure. Reach to pull the victim to safety. If they cannot be reached, throw a life-saving device to them. Swim to rescue a drowning victim only as a last resort. (Reach-Throw-Go)
- Immediate resuscitation is critical! At least two people on board should be certified in CPR.
- Keep the victim warm.
- Use care in handling. Spinal injury may exist if the victim fell overboard.
- Signal for help and/or take the victim to shore for medical assistance.

Medical Emergency

In an emergency, you may be far from professional medical assistance. Be prepared. Take a first aid course, and carry a first aid kit. Be aware of special conditions that may affect anyone on board. Become familiar with the effects of fatigue and hypothermia so that you can respond to these emergencies properly.

Carbon Monoxide

Carbon monoxide is an odorless, colorless, extremely toxic gas. Symptoms of carbon monoxide poisoning are dizziness, ears ringing, headaches, nausea and unconsciousness. A poisoning victim's skin often turns cherry red.

Have the victim breathe fresh air deeply. If breathing stops, resuscitate. A victim often revives, then relapses because organs are damaged by lack of oxygen. Seek immediate medical attention. See Section 1 - Safety, for more information on Carbon Monoxide Poisoning.

Propulsion, Control or Steering Failure

- Shut off engine.
- Put out an anchor to prevent drifting.
- Determine if you can fix the problem yourself. See engine operator's manual if engine is flooded.
- Signal for help.
- Have equipment available and be prepared to rig emergency steering system, if equipped.

Radio Communication

Radio is the boat operator's main method of receiving safety information and summoning aid. VHF-FM radio is the primary means of short-range communication. Single sideband radio (SSB) is used for longer range communication.

VHF-FM Channel 16 and SSB 2182 kHz are designated for emergency use. Such situations can be categorized as:

- **Emergency** - "**MAYDAY, MAYDAY, MAYDAY**" - Used when a life or vessel is in imminent danger.
- **Urgency** - "**PAN-PAN, PAN-PAN, PAN-PAN**" (pronounced PAHN-PAHN) - Used when a person or vessel is in some jeopardy less than indicated by a Mayday call.
- **Safety** - "**SECURITY, SECURITY, SECURITY**" (pronounced SAY-CURE-IT-TAY) - Used for navigational safety or weather warning.

An emergency situation will be hectic and there will not be time to learn proper radio procedure. **LEARN WHAT TO DO BEFORE YOU NEED TO DO IT.**

If you hear a distress call, stop all radio transmissions. If you can directly assist, respond on the emergency frequency. If you cannot assist, do not transmit on that frequency. However, continue to monitor until it is obvious that help is being provided.

Distress Signals

Consult your national boating law enforcement agency.

Visual Distress Signals

- Coast Guard regulations require boats in coastal waters and the Great Lakes to carry visual distress signals for day or night use, as appropriate for the time of operation. Exempt from the day signals requirement, but not night signals, are boats less than 4.8 meters (16 feet), open sailboats less than 7.9 meters (26 feet), boats participating in organized events, and manually propelled boats.
- If you are required to have visual distress signals, at least three safety-approved pyrotechnic devices in serviceable condition must be readily accessible. They must be marked with a date showing the service life, which must not be expired.
- Carry three signals for day use and three signals for night use. Some pyrotechnic signals, such as red flares, meet both day and night use requirements.
- Store pyrotechnic signals in a cool, dry location. An orange or red watertight container prominently marked "Distress Signals" is recommended.

Other recognized visual distress signals include:

- Code flags November and Charlie
- Square flag and ball
- Black square and ball on orange background flag
- Orange flag (certified)
- Electric distress light (certified) - for night use only
- Dye marker (any color)
- Person waving arms
- U.S. ensign flown upside down

Audible Distress Signals

Coast Guard regulations require one hand, mouth or power-operated whistle or horn, audible for at least a half mile.

Other recognized audible distress signals include:

- Radio communication (see Emergency Procedures - Radio Communication)
- Radio-telegraph alarm
- Position indicating radio beacon
- Morse Code SOS (3 short, 3 long, 3 short) sounded by any means
- Fog horn sounded continuously

Operational Inspection

These inspection checklists should be updated/reviewed when equipment is replaced, updated, or modified.

Before Departure

- Weather-Forecast is safe. Evaluate the weather with consideration of the type of seas (Design category) for which the boat is assessed to be suitable. Category A, waves over 4 meters (13 feet), Category B, waves up to 4 meters (13 feet), Category C, waves up to 2 meters (6.5 feet), Category D, waves up to 0.5 meters (1.5 feet).
- Required documents on board.
- Navigation charts and equipment on board.
- Safety equipment on board, including PFD for each person, throwable life saving device, fire fighting equipment, anchor and lines.
- Emergency stop lanyard operational.
- Safety training-passengers and crew instructed on safety procedures and use of safety equipment and abandon ship procedures.
- Proper loading of passengers and gear according to Capacity Label and for proper trim.
- Engine(s) running and shifting properly.
- Drain plug(s) installed.
- Seacocks and thru hull hatches shut or open as appropriate.
- Portlights and hatches shut or open as appropriate.
- Bilge pumps working - suction and discharge clear.
- Bilge blower (Engine compartment ventilation) working properly - intakes and exhausts clear and hoses proper.
- Navigation lights working.
- Horn working.
- Fuel tank(s) - filled to less than rated capacity to allow for expansion.
- Fuel system checked for leaks and fumes.
- Fuel filter(s) tight and clean.

- Power steering or hydraulic steering fluid checked.
- Steering system checked and working properly.
- Engine oil level or oil mixture is proper.
- Battery terminals clean and connected properly and electrolyte level proper.
- Float plan filed with friend or relative - include destination, route and boat identification.
- Boat and equipment operational check lists - completed.
- Carbon monoxide monitor - operational.

Trailer (if applicable):

- Boat position - secure on trailer
- Tiedowns - tight
- Winch - locked
- Trailer hitch - connected
- Engine clearance - in trailering position
- Safety chains - attached
- Electrical - lights, brake lights, turn signals working
- Mirrors - adjusted for trailering

After Return

- PFDs and other safety gear - dry, stowed for next use
- Fuel tanks - filled (allow for expansion) to prevent condensation
- Fuel system - no leaks
- Bilge pump - operating properly
- Bilge - clean, no leaks
- Float plan - notify person with whom you filed plan
- Hull and deck exterior - washed with fresh water

Fueling

WARNING

EXPLOSION/FIRE HAZARD

- Shut all engine compartment openings and accesses to cabin while fueling.
- Store flammable material in safety-approved containers. Keep containers in a locker designed by the boat manufacturer for that purpose. Never store flammable material in a non-vented space.
- Never smoke while fueling.
- Keep exhaust blower off while fueling.
- Keep ventilation system free of obstructions. Never modify the vent system.
- Fill to less than rated capacity of tank. Allow for fuel expansion.
- Do not let fuel overflow through the tank vent.
- If fuel enters bilge, do not start engine. Determine cause and severity. Contact a knowledgeable marine service to remove fuel. Do not pump bilge overboard. Contact the boating law enforcement agency for additional advice. (See Environmental Considerations - Fuel & Oil Spillage.)
- Inspect fuel system regularly for leaks.

CAUTION

Follow engine manufacturer's recommendations for types of fuel and oil. Use of improper products can damage the engine and void the warranty.

NOTICE

- Use fresh fuel. Fuel that has been in a tank too long can form gum and varnish, which may affect performance.
- Inspect diesel fuel filters regularly. Diesel fuel must be kept as clean as possible.

General

- Fuel during daylight.
- Check fuel fill plate label to ensure fuel is placed only in fuel tank and that the proper type of fuel is being used.
- Avoid spills.
- Know your fuel capacity and consumption. Record the amount of fuel used since your last fill-up, and compute the engine's hourly fuel usage. As a backup check to your fuel gauge, deduct the average hourly fuel usage from fuel tank capacity.
- Observe the "rule of thirds": one-third fuel for trip out, one-third for return, one-third for reserve.
- Allow an additional 15 percent fuel reserve when operating in rough seas because of greater fuel usage.

Before & During Fueling - Checklist:

- Fire extinguisher - close at hand
- Mooring - boat tied securely to fueling pier
- Crew - at least one knowledgeable person present
- Passengers - unnecessary people off boat
- Engines - stopped
- Electrical equipment, including blowers - power off
- Windows, doors, hatches - closed
- Smoking material - extinguished
- Inboard tanks - grounded
- Portable cans - placed on pier during filling
- Fuel fill deck fitting - marked "gasoline" or "diesel" or with ISO symbol
- Fuel nozzle - in contact with can or filler pipe to prevent static sparks
- Fill level - fill less than rated capacity of tank; allow for fuel expansion
- Trim - fuel weight distributed equally if more than one tank



After Fueling - Checklist:

- Windows, doors, hatches - open
- Blower - operate at least 4 minutes before starting engine
- Sniff test - if fuel fumes remain, operate blower until fumes are gone. If fuel odor remains, determine cause and correct before starting engine.
- Fuel tank - secure filler cap
- Spills - wipe up spillage and dispose of rags ashore

Boarding (Wear a PFD!)

⚠ WARNING

STABILITY HAZARD

- Load boat properly. The manufacturer's load rating is the maximum allowed under normal conditions. Reduce the load if weather conditions are adverse (high winds, rough seas, fog, storm warnings, or small craft advisories).
- Allow passengers to ride only in areas that do not pose a hazard to themselves or the boat. Do NOT allow passengers to ride on the bow of a closed bow boat. Do NOT allow several passengers to ride in the bow of a small, open-bow boat, causing the boat to "plow" into the water. Do NOT allow passengers to ride on the stern cushion or gunwales. Do NOT overload the stern.
- Observe manufacturer's recommended on-plane seating locations.
- Passengers should remain seated while boat is moving.

PERSONAL INJURY HAZARD - Stay alert. Use of drugs, alcohol or other substances which impair judgment poses a serious threat to yourself and others. The boat operator is responsible for the behavior of passengers.

DROWNING HAZARD - Boats must carry one USCG approved properly-sized, wearable personal flotation device (PFD) for every person on board. Boats must also have at least one throwable life preserver.

SLIPPING HAZARD - Wet decks are slippery. Wear proper footwear and use extreme caution on wet surfaces.

- Board only one person at a time.
- Step or climb into the cockpit. Never jump into a boat.
- Load gear after you are on board. Carrying heavy items while climbing aboard can cause you to lose your balance and injure yourself and/or others.
- Distribute weight evenly.
- Instruct passengers where to sit during on-plane operation to reduce possibility of falling overboard during high speed maneuvers.
- If gear is not immediately needed, stow it in secure area.
- Safety gear must be immediately and readily accessible at all times.
- Children and non-swimmers must wear properly sized personal flotation device (PFD) at all times while on board. All passengers and crew should wear a PFD, since an unworn PFD is often useless in an emergency. Federal law requires that PFDs if not worn, must be readily accessible. This means removed from storage bags and unbuckled, not stored in a locker or other area that is difficult to access. Throwable devices must be

conveniently located to make their use in an emergency easy and effective. The boat operator is responsible for instructing everyone onboard in the location and use of all life-saving equipment. The best precaution is to wear a PFD while boating.

Reboarding - Unassisted

All Barletta Pontoon Boats are equipped with a stern ladder that is deep and ergonomically designed for easy re-boarding into the boat from the water. The stern ladder is mounted on the starboard side of the boat so that the captain does not have to approach anyone in the water from their “blind” side.

WARNING

PERSONAL INJURY HAZARD

- Keep hands and fingers away from ladder hinge to prevent injury
- Never approach or use ladder when the motor is running. Severe injury or death will result from contact with rotating propeller.
- Shut off motor when near swimmers. Severe injury or death will result from contact with the rotating propeller.
- To prevent injury, swim platform and transom entry area must not be occupied while engine is running and/or boat is underway.

Starting, Stopping

DANGER

EXTREME HAZARD - When engine is running, boarding ladder and swim platform must not be used, and transom door (if equipped) must be closed and locked.

WARNING

EXPLOSION/FIRE HAZARD

- Run exhaust blower at least 4 minutes before starting engine.
- Check bilge and engine compartment for fumes before starting engine.
- Remove accessory canvas/curtains that could obstruct the flow of air into or out of the ventilation system.

CARBON MONOXIDE HAZARD - Operate the engine(s) only in a well-ventilated area. Other boats and/or other obstructions to air flow could cause an increase of Carbon Monoxide around and/or in your boat. Carbon Monoxide is extremely toxic and could kill you or your passengers.

- Attach emergency stop switch lanyard to operator.

WARNING

OPERATION HAZARD

- The operator must be in correct position - facing forward, hands on controls - when the engine is running.
- Ensure all gear is secured. Loose objects can be hazardous when sliding or flying around onboard a boat.

PERSONAL INJURY HAZARD

- Shift to neutral before starting.
- Keep all parts of your body and clothing away from the engine and propulsion system.
- Attach emergency stop switch lanyard to operator.

CAUTION

Stop engine immediately if oil pressure is too low or engine temperature rises above normal. Do not restart engine until problem is corrected.

NOTICE

Operate starter for 10 seconds maximum. Wait 2 minutes for the starter and battery to recover and cool down before trying to start the engine again.

- See the engine operator's manual for detailed instructions.
- **Do not ignore any alarm from the engine, generator, or any onboard alarm system. Seek out the source of the alarm and correct the problem before casting off.**

Starting Engine - General Checklist:

- Fuel - supply adequate, including reserve
- Oil - level adequate
- Battery(s) - power adequate
- Drain plugs - installed
- Gear - neutral
- Bilge blower - run at least 4 minutes before starting
- "Sniff test" - no leaks or fumes
- Emergency stop switch - attached to operator and stop switch
- Gauges (after engine warm-up) - readings normal (see engine operator's manual for normal range of gauge readings)

Stopping Engine General Checklist:

! CAUTION

Turn off engine at idle speed. Racing the engine before switching off can draw water into the engine through the exhaust, causing internal damage.

If boat is equipped with an emergency stop switch, wear the lanyard at all times when operating the boat but use it to stop only in an emergency. Do not use it to shut off the engine during normal operation.

- Gear - neutral
- Mooring lines - secure
- Engine - idle 5 minutes to cool
- Ignition - off

Shifting

! CAUTION

Pause in neutral while shifting, wait for the boat to lose headway (forward motion), and then shift quickly. Easing into or out of gear can cause damage to gears or drive mechanisms.

Do not shift into or out of forward or reverse with the engine above idle speed. Severe damage to the drive mechanism could result.

- Shift to neutral and allow boat to lose almost all headway before shifting into forward or reverse.
- Reversing gear acts as a braking mechanism. Use caution. Sudden slowing of forward motion may cause following sea to swamp the boat.
- Become thoroughly familiar with the boat's response to movement of the controls. (See Systems - Controls.)

Casting Off

Procedures vary depending on wind, current and other boat traffic. Some general guidelines are as follows:

- Start engine and allow time for it to warm-up before casting off.
- Put adequate space between the boat and the dock by "shoving off" before trying to move away using the engine(s).
- Three secrets to successful maneuvering are:

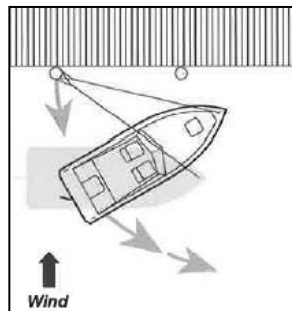

- Operate the boat slowly and deliberately after planning your maneuver.
- Since a boat turns at its stern, the stern must have enough clearance to move back toward the dock as the bow moves away from the dock.
- Use wind and current to move a boat whenever possible, aided by spring lines as needed.
- Power slowly ahead about 1 meter (3 feet) with the after bow spring line fastened. (See Operation -
- Handling Dock Lines.) At the same time, turn the wheel toward the dock. The combination of rudder/propeller action and the spring line will swing the stern away from the dock.
- Bring the spring line and fenders aboard.
- Check for loose or trailing lines that could foul the propeller and secure them onboard.
- Back the boat with rudder/propeller centered until well clear of the dock.
- Swing the bow away from the dock. The stern will move toward the dock. Allow enough space between the boat and the dock so that the boat will not hit the dock as the stern swings around.
- Proceed slowly, sounding a long horn blast to alert other boats.

Leaving Mooring

- When a boat is secured to a mooring (anchoring buoy) it is heading into the wind or current and the stern is already clear. Departing the mooring is easier than casting off.
- Start the engine(s) and allow for warm-up. Untie from the buoy and back slowly away for several boat lengths. Be certain that the area behind the boat is clear before moving.
- When you can see the mooring buoy, it is safe to move forward, giving the buoy wide clearance.

Approaching Dock

Procedures vary depending on whether you tie up at a:

- Pier (parallel to shore) or wharf (not parallel)
- Slip (between pilings, at right angle to pier or wharf)
- Mooring (anchoring buoy away from shore)

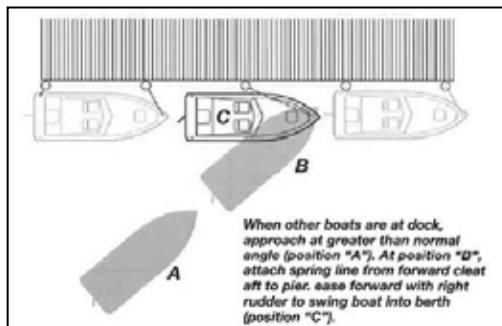

Some procedures apply in all situations:

- Move slowly.
- Plan maneuvers ahead of time.
- Use wind and current whenever possible to move or slow the boat.
- If there is more than one way to approach a berth, use the most conservative maneuver:
 - High Wind/Current - Approach against the wind or current.
 - Mild Wind/Current - Approach against the stronger of wind or current.
- Boats do not have brakes. Begin your approach in an open area, before maneuvering room is restricted, to test the effects of the wind and current on your boat operation at the slower maneuvering speed. To slow forward motion, back off on the throttle. After the boat slows and the engine idles, shift to reverse and gradually increase throttle until the boat stops. (See Systems - Controls - Gear Shift & Throttle.)
- Use fenders to protect the boat. Never use arms or legs to try to stop a boat's movement. Boat materials are more easily repaired than broken bones.

Pier/Wharf

- Approach at a 45 degree angle.
- When the boat is a few feet from the dock, bring the stern closer by turning the wheel away from the dock, keeping the engine at idle. Then shift to reverse and turn the wheel toward the dock. Remember that some boats do not steer well in reverse, and tight turns are difficult.
- Have adequate docking gear ready for use. Put fenders out and attach lines on side of boat that will be next to the dock.
- If possible, station experienced crew at the bow and stern, each with dock lines.
- When the boat is fairly close, throw the first line under-handed to a person on the dock, aiming it over his head and upwind. The bow line is usually the first line.
- If no one is on the dock, get as close as you can and loop any line over a piling or cleat.
- Wait for boat to lose headway before securing lines. Secure the after bow spring line first.
- Keep engine running at idle and in neutral until all lines are secured.

Slip

- Put out fenders.
- Turn the stern toward the slip, much like preparing to back a car into a garage.
- Shift to reverse and maneuver slowly into slip.
- Shift to forward as you enter, turn wheel to other side and give throttle a short burst of power to align the boat with the slip.
- Shift to reverse. Back slowly.
- When almost completely in, shift to forward to stop.

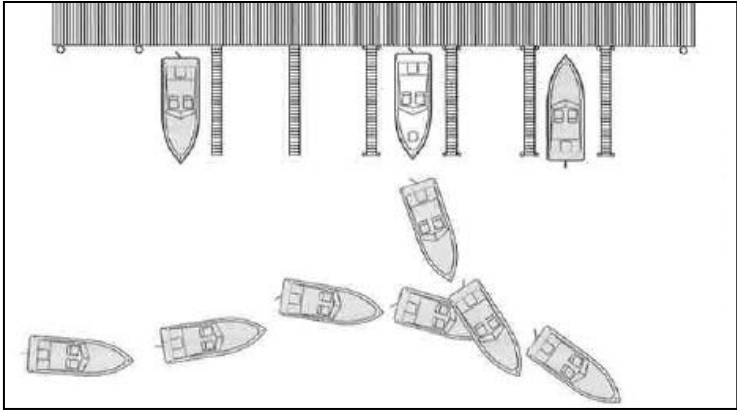

- Keep engine running at idle and in neutral until all lines are secured.
- In conditions of high wind and/or heavy current, it may be safer and easier to enter the slip bow first and follow the same safety procedures as you secure the boat.

Mooring

- Moor only in designated areas. Never moor to a navigational buoy.
- As you approach, note how other boats lie at mooring buoys. Since they are heading into the wind/current, approach your mooring at the same heading. If there are no other boats, estimate the wind/current direction as best you can.

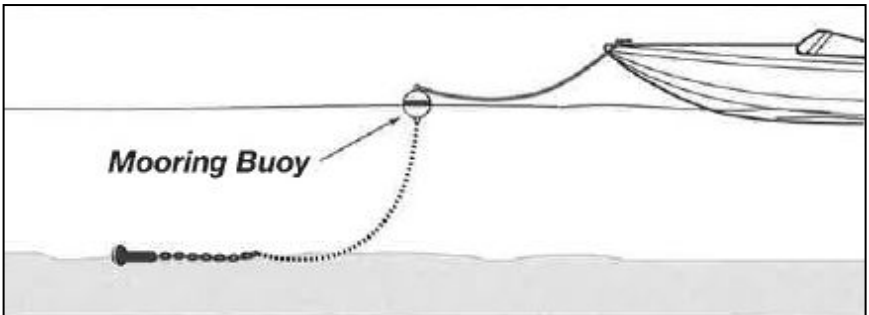

- Shift to neutral when you think you have enough headway to reach your buoy.
- Station a crew member at the bow with a boat hook to pick up the mooring line. As the boat gets closer, you will lose sight of the buoy from the helm so the crew member forward must signal direction and distance.
- Keep engine running until the crew member signals that the mooring line is secured.

- When securing to a mooring buoy, use only an anchor bitt or anchor cleat.

Handling Dock Lines

- Dock lines secure a boat in its berth and help maneuver the boat close to the pier.
- Dock lines for recreational boats are usually made of nylon because it stretches, is durable and is easy on the hands. Dock lines may be twisted strands or braided. Dock lines are subject to degradation by exposure to the sun. Inspect lines periodically.

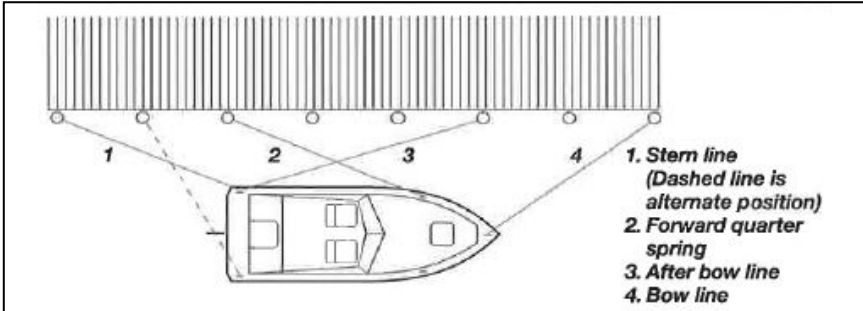

- The number and size of dock lines increase as the size of the boat increases.
- **Bow Line** - Fastened to the boat's forward cleat and run forward at about a 45 degree angle to a dock cleat or piling to prevent the boat from moving astern. (Dock line 4 in the picture below).
- **Stern Line**- Fastened to the boat's after cleat and run astern at about a 45 degree angle to a dock cleat or pile to prevent the boat from moving forward. (Dock line 1 in the above picture).
- **Spring Lines** - As many as four, but generally two:
 - **After Bow Spring** - Fastened to the after bow cleat (Dock line 3 in the above picture) and run aft to a dock cleat or piling;
 - **Forward Quarter Spring** - Fasten near the stern and run forward to a cleat on the dock or piling (Dock line 2 in the above picture).
- Spring lines are especially valuable when tide movement is significant. They also help in controlling the boat when leaving a dock.
- If there are changes in water level from tidal effects, or even if the mooring is a floating dock, there should always be allowance for some movement of the boat when it is secured.

Anchoring

The **rhode** is the line connecting the anchor to the boat.

- Nylon line is ideal because it is light, strong, stretches, can be stowed wet and is easy to handle.
- Add a short chain between the anchor and the nylon line to prevent abrasion of the line. The length of the chain will vary depending on the boat size and the anchoring condition.

The **scope** is technically defined as the ratio of the rhode length to the vertical distance from the bow to the sea floor.

$$\text{Scope} = \frac{\text{Rhode Length}}{\text{Bow Height} + \text{Water Depth}}$$

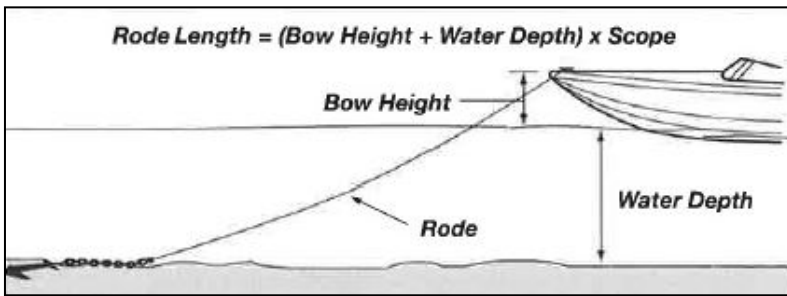

- Scope depends on the type of anchor, type of bottom (mud, sand, rock, etc.), tide, wind and sea conditions.
- Minimum is 5:1 for calm conditions; norm is 7:1; severe conditions may require 10:1.

Since you want to know how much rhode to use when anchoring, the formula is:

$$\text{Rhode Length} = (\text{Bow Height} + \text{Water Depth}) \times \text{Scope}$$

Example:

$$\text{Rhode Length} = (3 \text{ feet} + 10 \text{ feet}) \times 7^*$$

$$\text{Rhode Length} = 13 \text{ feet} \times 7^*$$

$$\text{Rhode Length} = 91 \text{ feet}$$

* Scope factor may range from 5 to 10 or more. Less than 5, the anchor breaks out too easily.

Lowering Anchor

WARNING

SINKING HAZARD - Anchor from the bow. A small current can make a stern-anchored boat unsteady; a heavy current can drag a stern-anchored craft under water.

COLLISION HAZARD - Anchor only in areas where your boat will not disrupt other boats. Do not anchor in a channel or tie up to any navigational aid. It is dangerous and illegal.

- Be sure there is adequate rhode.
- Secure rhode to both the anchor and the boat.
- Stop completely before lowering anchor.
- Be sure the anchor line is clear and not entangled in other gear or knotted up.
- If using windlass, refer to windlass operator's manual.
- Be sure the end of the anchor line is secured to the boat and that the line is removable from this attachment point in case of an emergency or if the anchor is not recoverable.
- Keep feet clear of coiled line.
- Turn on anchor light at night and in reduced visibility.

Setting Anchor

- There is no best way to set an anchor. Experiment to see how your anchor performs.
- One method is to turn the rhode around a bit and slowly pay out as the boat backs from the anchor site. When the proper scope has been reached, snub the rhode quickly, causing the anchor to dig into the bottom.
- Reverse engine slowly to drive the anchor in and prevent it from dragging.
- Secure the rhode to the anchor bitt or the anchor cleat.

Weighing Anchor

- Run the boat slowly up to the anchor, taking in rhode as you go.
- The anchor will usually break out when the rhode becomes vertical.
- Coil lines to let them dry before stowing. Clean the anchor and rhode before stowing.
- Be careful that trailing lines do not foul in the propeller.

Clearing a Fouled Anchor

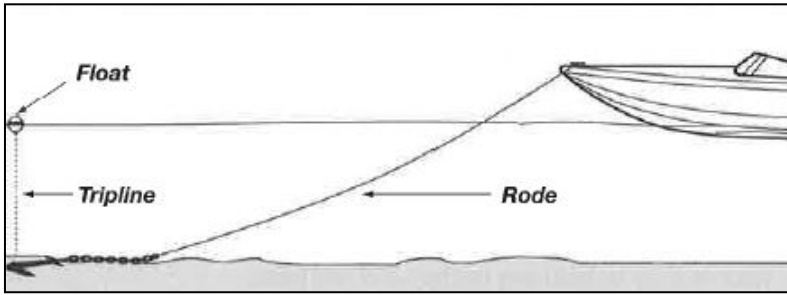

A fouled anchor can test your patience and ingenuity. One of the best methods of breaking free is to set a tripline before you lower anchor.

- Attach a line to the crown or head of the anchor and the other end to a float.
- The line should be just long enough to reach the surface of the water, allowing for tides.
- A 9.5 mm (3/8-inch) polypropylene line is a good choice because it is light, strong and floats.
- If the anchor snags, pull vertically on the tripline to lift the anchor by the crown.

A Final Word

An anchored boat is affected by wind and sea conditions. Because there is no headway, there is no control. Be alert! Never leave an anchored boat without a knowledgeable operator in board. If you must leave the boat unattended, be sure that the anchor will hold under all circumstances.

We suggest you read this section on anchoring again and fully understand rode and scope and their effect on anchor performance.

Maneuvering/Maintaining Control

DANGER

EXTREME HAZARD

Ensure adequate ventilation. Gasoline powered engines produce odorless, colorless carbon monoxide gas (CO). Prolonged or brief exposure, depending on the concentration of CO, can cause serious injury or death. Symptoms include dizziness, nausea, drowsiness. To reduce accumulation of CO, increase air movement by opening windows or adjusting canvas. The following conditions require special attention:

- Operating at slow speed or not moving through the water (dead in the water).
- Operating with the bow high.
- Operating engine in confined spaces. Be aware of possible CO from nearby boats in a confined docking area.
- Using canvas curtains that hinder proper ventilation.
- Blocking the intake or exhaust openings of the ventilation system with improper position of fenders or rafting too close to other boats.
- Winds blowing exhaust toward boat occupants.
- The danger of carbon monoxide poisoning is complex because it is dependent on the concentration of the gas. Be aware that high concentrations can cause injury or death very quickly.

WARNING

MANEUVERING HAZARD

- Always operate within maneuvering speed limitations.
- Exercise constant attention to the direction of the boat when underway.
- Always keep a firm grip on the steering control and be ready to adjust the throttle and/or shift controls.

PERSONAL INJURY HAZARD

- When underway, keep passengers clear of areas not designed for riding. Especially hazardous areas include seat backs, bow, gunwale, transom or forward platform and aft sundeck.
- Passengers in bow rider seats must exercise constant caution. When water is rough, move from bow rider area to aft passenger seats.
- Remain alert. Use of drugs, alcohol or other substances which impair judgement poses a serious threat to yourself and others. The boat operator is responsible for the behavior of passengers.
- Ensure emergency stop switch lanyard is always attached to operator while boat is in operation.

WARNING

SPEED HAZARD

- Operate boat at speeds within the operator's ability to maintain control and react if an emergency occurs.
- Reduce speed in congested waterways.
- Avoid showboating! Turning suddenly, jumping waves, or steering close to other boats, docks or obstacles can cause personal injury and boat damage.
- Observe and obey speed limits and all NO WAKE areas.

COLLISION HAZARD

- Turn on navigation lights at dusk and when visibility is reduced in low light situations. Cruise at a reduced speed to allow more time to avoid dangerous situations.
- Use extra caution when underwater/floating objects may be present. Hitting an object at high speed or severe angle can seriously injure people and damage your boat. Use extreme care when operating in shallow water or when operating in reverse.
- Scan the water continuously for swimmers and other boats.

CAUTION

If stern drive or outboard engine is equipped with power tilt for trailering, use it only for that purpose. Tilting drive unit into the trailering zone while underway may damage the drive unit or engine.

General Considerations

- You are responsible for passengers' actions. If they place themselves or the boat in danger, immediately correct them.
- Know how your boat handles under different conditions. Recognize your limitations and the boat's limitations. Modify speed in keeping with weather, sea and traffic conditions.
- Instruct at least one passenger on the proper operation of your boat in case something should happen to you. At least one passenger must know how to override the emergency stop switch and restart the engine if the operator should fall overboard with the stop switch lanyard attached.
- Instruct passengers and crew on location and use of safety equipment and procedures.

Note: When underway, be sure all passengers are seated in designated "seated while underway" positions. Improper seating is considered illegal in some states.

Visibility

WARNING

VISIBILITY HAZARD

- **Designate a lookout to watch for obstacles and other vessels when the field of vision from the helm is limited due to operating conditions.**
 - **It is the responsibility of the boat operator to keep the field of visibility from the helm clear. It may be necessary to move passengers, gear, bimini tops, weather curtains or any other obstacles that obstruct the operator's field of vision.**
- Federal Law requires the operator to maintain a proper lookout by sight and hearing.
 - Operator must insist on unobstructed vision, particularly to the front. Move passengers if they block the view when boat is above idle speed.
 - Post a lookout to watch for obstacles when visibility from the helm is limited due to operating conditions.

Steering

WARNING

CONTROL HAZARD

- **Boat steering usually is not self-centering. Steering is affected by engine and propeller torque, trim plane, wave and current action, and the speed of the hull through the water. Constant attention and control of the boat's direction is required for safe operation.**
 - **Some steering systems are especially sensitive to engine torque, operator seating, passenger and gear loading and gear stowage locations. Practice operating the boat under varying load conditions to prevent accidents from loss of steering control.**
- Boat steering differs from automobile steering in several important ways:
 - Turn the boat steering wheel in the direction you want the bow to go, but remember that the boat actually turns at the stern.
 - Boat steering is not self-centering.
 - Boat steering is affected by engine and propeller torque, trim setting, waves, current, and the speed of the hull through the water.
 - Boat steering is usually less precise in reverse. Some single engine boats have very limited control when backing. Learn how to back up your boat by practicing in a safe and open area.

- Boats need headway for proper control. At low speed on some boats, steering tends to veer from side to side. Keep steering wheel centered to avoid overcorrecting. Make small corrections and observe how your boat reacts, to avoid weaving to the left and/or right.
- Under certain engine trim positions and/or bow-up attitude, such as when getting up on plane, there may be a noticeable pull on the steering wheel. This steering torque may be only temporary, such as when planing off. The effect may be eliminated or reduced by changing engine trim so that the propeller shaft is more parallel to the water surface. In any case, the operator must always keep a firm grip on the steering wheel.

⚠ WARNING

MANEUVERING/CONTROL HAZARD

- Ensure continuous visibility of other boats, swimmers, and obstacles during bow-up transition to planing.
- Adjust engine to an intermediate trim setting as soon as the boat is on plane or at your desired operating speed. This procedure will avoid possible ejection of passengers due to loss of control of the boat.
- Maximum control for turning, maneuvering, and cruising is achieved when the boat is in the intermediate trim position.

Trimming

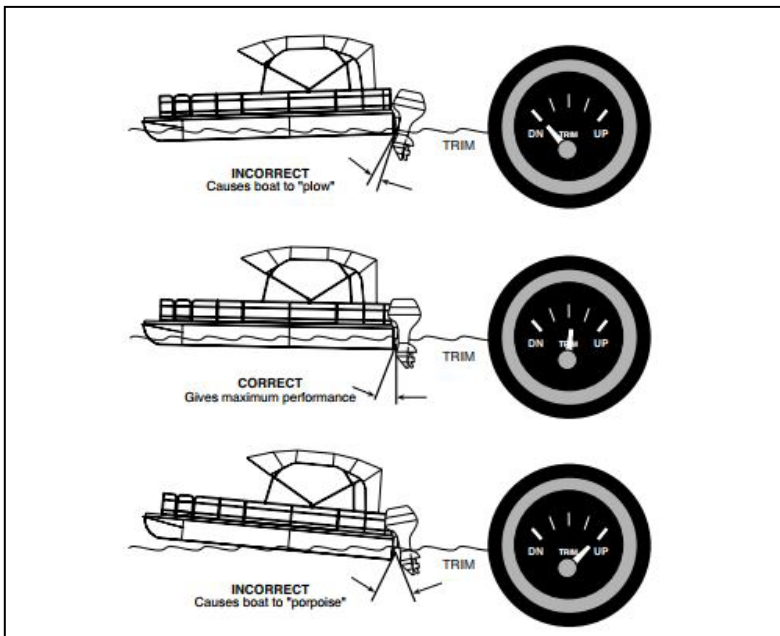

- Most stern drive and outboard engines have a power trim which enables you to change the angle of your drive unit by pressing a but ton. See your engine operator’s manual for a complete discussion of characteristics resulting from different trim settings.
- Power trim is designed to give quick acceleration with minimum time in the bow-up transition to planing. This is most easily accomplished by trimming the engine fully down/under/in and setting the throttle at moderate to maximum.
- Once on plane, trim the engine up/out slightly to avoid a bow-down condition called “plowing.” Plowing can cause inefficient and unpredictable “bow steering” or “oversteering.” In this condition, attempting to turn or encountering a moderate wave may result in an abrupt turn or loss of control.
- Trimming the engine too far up/out can cause a bow-up condition leading to “porpoising” (bouncing) or propeller overspeeding. If you notice a sudden increase in propeller speed, reduce engine RPM and trim the drive unit down/under/in until propeller overspeeding stops.
- In most cases, best performance is obtained with the drive unit positioned so that the boat runs at a 3 to 5 degree angle to the water (front of hull just slightly out of the water).
- Some boats have planes (tabs) at the transom to control trim. Use short bursts of rocker switches to adjust trim planes. Pushing switches too far at once may cause sudden steering problems. Adjusting one trim plane more than the other will correct list caused by improper storage, too many people on one side, or a strong cross wind.
- Outboard engines may have a trim tab to compensate for steering torque which causes the boat to pull to one side. Torque is a result of the propeller shaft not being parallel to the water surface. See your engine operator’s manual if adjustment is necessary.

Operating In Shallow Water

WARNING

COLLISION HAZARD - Use extra caution in shallow water or where underwater/floating objects may be present. Hitting an object at high speed or sever angle can seriously injure people and damage your boat.

- Shallow water presents obvious hazards including insufficient water depth, sand bars, stumps, or other unmarked obstructions.
- Other hazards in shallow water include mud, sand, weeds, rocks, logs, and debris. These hazards can damage your boat hull or underwater gear and can foul your engine cooling water intakes, which could cause overheating.

- Know the area in which you are operating. Consult charts and ask local boaters. If you know or suspect shallow water, post a lookout and proceed slowly.
- When beaching, be aware how tide can affect the boat. Never leave a beached boat unattended or unanchored.

Water Skiing, Swimming & Diving

⚠ WARNING

SWIMMING/DIVING HAZARD

- Keep clear of areas designated only for swimmers and skin divers. Recognize markers used for such areas.
- Never swim or dive when there are approaching storms or lightning in the area.

SKIING HAZARD

- Skiers must use a safety-approved personal flotation device.
- Ski only during daylight when visibility is good.
- Avoid shallow water, other boats, navigational aids and other obstructions.
- Keep at least 30 meters (100 feet) from other objects.
- Never drive directly behind a water skier. If the skier falls, you will not be able to react quickly enough to avoid hitting the fallen skier. The result could be severe injury or death.
- A competent observer must watch the skier at all times. A competent observer is a person who has the ability to assess when a skier is in trouble, knows and understands water skiing hand signals and is capable of helping a skier.
- Keep a downed skier in sight constantly.
- Turn off engine in gear before you get close to a person in the water. This practice stops the propeller quickly to reduce the risk of injury to the skier you are retrieving.
- Never back up to anyone in the water.
- Passengers in the boat should use caution while towing a skier. Sudden release of the tow rope can cause it to backlash into the boat and injure a passenger(s).

PERSONAL INJURY HAZARD - Use transom tow ring or tow pylon to pull skiers (Never use a mooring cleat to tow a skier!) Unless specified by the manufacturer, any other use, such as parasailing, kite flying, towing other boats, etc., may create too much stress on the tow ring, resulting in personal injury and/or equipment damage.

Water Skiing

- Always have at least two people in the boat, one at the controls and one who can easily and continuously look at the skier.
- Insist that anyone who water skis must know how to swim.
- Insist that skiers wear an approved personal flotation device.

- Ski only during daylight when visibility is good.
- Never drive boat directly behind a water skier. You may hit a skier with- in seconds after a fall.
- Ski only in areas where skiing is permitted.
- Observe local restrictions on length of tow line.
- Know and use water skiing hand signals.

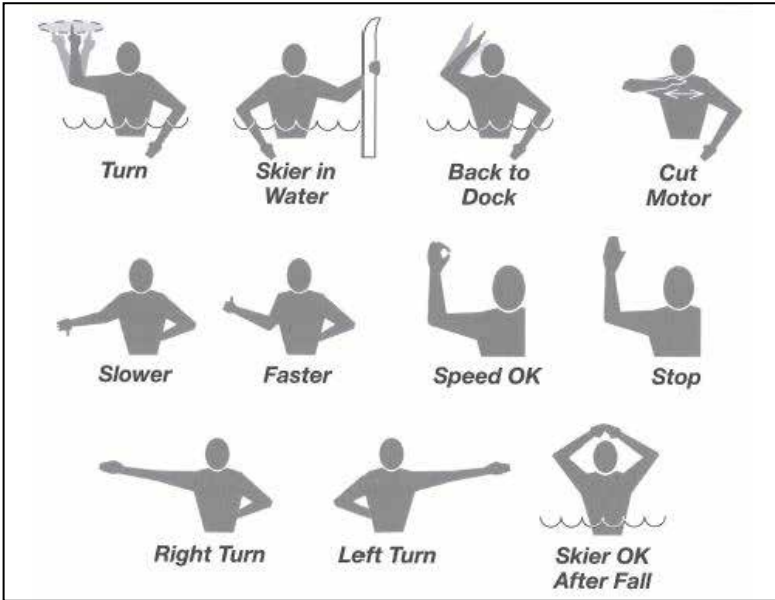

Turn - Arm raised, circle extended finger

Pick Me Up, or Fallen Skier, Watch Out - One ski extended vertically out of water

Back to Dock - Pat top of head

Cut Motor - Finger drawn across throat

Slower - Palm or thumb pointing down

Faster - Palm or thumb pointing up

Speed OK - Arm raised with thumb and finger joined to form circle

Stop - Hand up, palm forward, policeman style

Right Turn - Arm outstretched pointing to the right

Left Turn - Arm outstretched pointing to the left

Skier OK After Fall - Hands clenched together overhead

- Boat will handle differently when towing a skier; experiment carefully to learn the differences.
- Skiers may start from shore or dock if boat traffic allows. When returning, pick up skiers from water; do not ski back to shore or dock.
- Give immediate attention to fallen skier.
- Approach skier in the water from helm side so operator can keep

skier in sight.

- Turn off engine in gear (to prevent propeller “windmilling”) before picking up skier.
- Never back up to anyone in the water.

Swimming

- Do not swim from a moving boat.
- Many areas prohibit swimming from boats except in designated areas.
- Turn off engine and leave in gear (to prevent propeller “windmilling”) while swimming.
- Be sure that the boat reboarding means (swim ladder or swim step) is deployed before leaving the boat, or that the reboarding means is deployable by the swimmer from the water.

Diving

Recognize and respect diving flags. Keep at least 30 meters (100 feet) away.



- **Sport Divers Flag** - Red flag with diagonal white stripe marks a diver in the water.
- **Code Alpha Flag** - Blue and white pennant designates boat being used in dive operations.

Maintenance

This section contains information that requires use and disposal of oils, fuels, and chemicals. Pay particular attention to the environment during the use and disposal of these materials. Some geographical areas have special requirements regarding the use of chemicals mentioned in this section. Check local codes for proper use and disposal of these chemicals, including possible required permits.

Service Schedule

The manufacturer of each system in your boat should provide a recommended service schedule, listing items requiring routine attention, type of maintenance, and frequency.

The schedule is a guide based on average operating conditions. Under severe operating conditions, shorten service intervals.

Maintenance Log

Keep a record of all maintenance performed on your boat, using a form similar to the following:

Date	Component or System	Description of Maintenance	Engine Hours

Maintaining Hull & Deck

Fiberglass/Gelcoat

WARNING

SLIPPING HAZARD

- **Gelcoat surfaces are slippery when wet. Use extreme care when walking on wet surface.**
- **Use care in waxing to ensure walkways are not made dangerously slippery.**

EXPLOSION/FIRE HAZARD - Cleaning products may be flammable or explosive and may cause personal injury. Read cleaning product directions before use.

- The hull and deck consist of a molded shell and exterior gelcoat. Gelcoat is the finished outer surface with the shiny appearance associated with fiberglass.
- Wash fiberglass surfaces regularly with clean, fresh water. Wax gel coated surfaces to maintain luster. In northern climates, semiannual waxing may suffice. In southern climates, quarterly waxing is required.
- If waxing does not restore shine, power buff with a quality rubbing compound or use a heavy duty color restorer and boat cleaner/polish. If gelcoat is heavily oxidized, sand lightly before buffing. Use care when buffing and/or sanding because the finished surface of the gelcoat can be damaged if this process is not done properly. Seek the help of a professional boat service person if you are not sure about your abilities in refinishing fiberglass.
- Remove common stains with diluted detergent that is ammonia and chlorine-free. Never use gasoline, acetone or any ketone solvents.

Aluminum

- Wash aluminum with clear water and mild detergent. Protect surface with liquid cleaner or wax. Do not use harsh chemicals or abrasives.
- Remove stains with metal polish or fine rubbing compound.
- Use a rubber mallet or auto body tools to repair small dents. More extensive repairs require special skills and equipment. See your marine dealer.
- To minimize corrosion from contact between dissimilar metals, use high quality caulking compound when mounting non-aluminum metallic hardware.

Inflatables

- Wash inflatables with clear water and mild detergent. Use a mild abrasive scrubber for stains.
- Patch minor holes and abrasions, following patch manufacturer's instructions. Extensive repairs must be done by a professional.
- Clean valves regularly with mild detergent and a toothbrush. Do not use silicone, petroleum jelly or petroleum distillates.
- Replace O-rings if cracked or pitted.

Bottom Paint

WARNING

EXPLOSION/FIRE HAZARD - Ventilate when painting or cleaning. Ingredients may be flammable/explosive.

NOTICE

Environmental regulations govern painting the hull. Some areas have regulations regarding the use of pesticides and metals contained in some bottom paints. Check your local codes for required permits and restrictions.

- A slight algae or slime forms on all vessels. The painted hull can be wiped off with a coarse turkish towel or a piece of old rug while the boat is in the water. Do not use a stiff brush or abrasive material.
- Service bottom paint seasonally. If painting is necessary, consult your marine dealer.
- Do not paint zinc used to protect underwater hardware from corrosion. Do not paint the metal that zinc contacts.

Wood

- Clean teak occasionally with teak cleaner, available at your marine dealer.
- Use bronze wool, not steel wool, on teak.
- A penetrating coating like teak oil will help protect teak.
- Read directions before using any cleaner. Some products will damage gelcoat and aluminum. Follow manufacturer's disposal instructions for application equipment.
- Treat interior wood trim like household furniture, dusting and polishing occasionally.
- To repair scratches in lacquered wood surfaces, sand lightly with very fine sandpaper. Apply sealer and let dry. Sand lightly again with very fine sandpaper, feathering adjoining surface. Apply as many coats of moisture resistant lacquer as required.

Deck Hardware

- Clean frequently with soap and water. A glass cleaner is usually safe for stainless.
- Remove rust spots as soon as possible with a brass, silver or chrome cleaner.
- Never use an abrasive like sandpaper or steel wool on stainless.

Acrylic Plastic Windshields

CAUTION

Use care when cleaning acrylic. A dry cloth and many glass cleaners will scratch. Solvents will attack the surface.

- Flood acrylic with water to wash off as much dirt as possible. Use bare hand and water to dislodge caked dirt. Next, use a soft cloth and non abrasive soap. Blot dry with a clean, damp chamois.
- Remove fine scratches with fine automotive acrylic rubbing and polishing compound.

Upholstery

CAUTION

Remove sun pads from deck when not in use. They may cause the gelcoat finish to discolor and/or blister and crack.

- Clean fabrics with sponge or very soft brush, mild soap and warm water.
- Rinse with cold, clean water and allow to air dry in a well ventilated area away from direct sunlight.
- Mildew can occur if ventilation is inadequate. Heat alone will not prevent mildew.

Housekeeping

There is a reason any well organized and cared for area is said to be “ship shape.” Order and cleanliness are important elements of boating safety and pleasure.

- Put items in their proper place to ensure you can find them when you need them.
- Coil or flemish lines to keep them snarl-free and reduce the possibility of tripping.
- Clean and inspect systems to find and fix loose or damaged parts before they become a critical need.

Lifting

CAUTION

Do not use cleats, stem eye or stern eyes for lifting unless manufacturer labels them for such use.

- Pump water from bilge before hoisting boat.
- Keep bow higher than stern when lifting to allow water to drain.
- Use flat, wide, belt-type slings and spreaders long enough to keep pressure from gunwales to avoid squeezing the boat.
- Do not place slings where they may lift on underwater fittings.

Winterizing/Storing

CAUTION

Remove battery(ies) when boat is in long-term storage

Refer to the owner's manuals for boat, engine, and trailer to obtain details in preparation for winter storage.

Storing Boat on Land/Trailer - Checklist

- **Boat:**
 - Bow - store higher than stern
 - Bilge sump pump - pour in approximately 1/2 liter (1 pint) of 50/50 water/antifreeze solution
 - Cover - support to prevent pooling of water
 - Ventilation - allow air flow to prevent mildew
 - Tiedowns - slack off to reduce hull strain
 - Inspection - regularly during storage
 - In-Floor Storage - The floor from the in-floor storage compartment should be removed. Vacuum the compartment to insure there is no moisture prior to storage or shrink wrap.
- **Engine:**
 - Cooling system - drained
 - Exhaust system - drained
- **Batteries:**
 - Batteries - remove from boat; remove negative (-) cable, then positive(+) cable
 - Surface - clean
 - Terminal bolts - apply protective corrosion inhibitor
 - Storage site - wood pallet or thick plastic in a cool, dry place; do not store on concrete
 - Trickle charge - on. Do not keep the charger on and hooked up continuously. Cycle it on and off periodically during the storage period.

- **Generators:**
 - Generators - flush with fresh water
 - Drain plugs - remove from generator and muffler
 - Petcocks, seacocks - open
 - Some raw water pumps require removal of the end cover to drain properly. Check your owner's manual for proper draining procedure.

- **Air Conditioner:**
 - Seacock - close
 - Sea water pump - remove hoses
 - Water lines - blow out with air pressure
 - Pump - loosen screws on pump head, allowing water to drain
 - Condenser - remove hoses
 - Strainer - remove plug
 - Circulate a 50/50 antifreeze/water solution throughout the system after all of the above is completed and the system reassembled. Check for leaks.

- **Fuel System:**

⚠ WARNING

EXPLOSION/FIRE/POLLUTION HAZARD - Fill to less than rated capacity of tank. Filling until fuel flows from vents can cause explosion, fire, or environmental pollution. Allow for fuel expansion.

Gasoline:

- Fuel tank - filled with gasoline and a gasoline stabilizer/conditioner
- Engine - run for 10 minutes to ensure that gasoline in carburetor and fuel lines is treated with gasoline stabilizer/conditioner

Diesel:

- Fuel treatment - add biocide to prevent bacteria and fungi from contaminating diesel
- Fuel treatment - use petroleum distillate additive to help assimilate water in fuel and prevent freezing
- Fuel tank - fill with treated diesel fuel
- Engine - run for 10 minutes to ensure that diesel fuel in injectors and fuel lines is treated

- **Fresh Water System:**

- Faucets - all open
- Lines - open connection at lowest point to completely drain lines; blow out lines to clean
- Water pump - turn on until lines are clear of water, then turn off; remove hoses from both sides of pump
- Head(s) - drained
- Water heater - drained; hoses removed. Some water heaters require pump out in order to remove all contained water.

- Shower sump - pour approximately 1/2 liter (1 pint) of 50/50 water/ antifreeze solution in shower drain and run the shower pump to be sure that the solution is circulated throughout the drain system.
- **Head System:**
 - System - flush with fresh water D Holding tank - pump out
 - Water lines - remove

CAUTION

Use an automotive or commercial propylene glycol base antifreeze. Do not use alcohol base products.

- Antifreeze - flush approximately 7-1/2 liters (2 gallons) of 50/50 water/antifreeze solution through toilet and let pump run for 1 to 2 minutes
- Holding tank - pump out again
- **Trailer (if used):**
 - Security - protect against theft; install a lock on the trailer
 - Support - jack up trailer and install blocks to take weight off wheels and springs
 - Bolsters - add as necessary to support entire hull
 - Trailer frame - ensure there is no trailer frame distortion, which can distort the hull
- **Cradle:**
 - Size - be sure it fits your boat
 - Design - each cradle cross member (bunk) should be just forward of the sling tags on the deck
 - Support - ensure there are no gaps along the entire length of supports

Recommissioning

Boat Stored on Land/Trailer - Checklist

- **Boat:**
 - Components - inspect and clean
 - Hull drain plugs - install
- **Engine:**
 - Refer to engine operator's manual for detailed information on fitting out after winter storage
- **Batteries:**
 - Terminal posts - clean with wire brush or steel wool

- Cable clamps - attach positive (+) cable first, then negative (-) cable; tighten
- Terminals and clamps - apply protective corrosion inhibitor
- Wiring - inspect for deterioration of insulation and corrosion of end connections

- **Fuel System:**
 - System - inspect for loose connections, worn or cracked hoses, especially at the hose clamps, and check for leaks. Repair as necessary.

- **Miscellaneous:**
 - Thru-hull fittings - check to ensure water passage is unobstructed and hoses/fittings are serviceable
 - Navigation lights - check for proper operation
 - Wiring - check for loose connections
 - Switches - check for proper operation
 - Equipment - check for proper operation
 - Bilge blowers - check for proper operation; turn on blowers and place hand over hull blower vent to make sure air is coming from vent. Be sure that the ventilation hoses are not obstructed or collapsed.
 - Anchor lines and gear - clean, inspect, and replace as necessary
 - Hull drain plugs - installed
 - Bilge - clean thoroughly
 - Engine and generator fluids - check for proper levels

Troubleshooting

Problem	Possible Solutions
Performance	
Goes too slow	<ul style="list-style-type: none"> • Change load distribution • Adjust propulsion trim • Clean hull, drive unit, propeller • Change propeller • Check engine*
Rides Rough	<ul style="list-style-type: none"> • Slow down • Adjust propulsion trim • Change load distribution

Passengers get wet	<ul style="list-style-type: none"> • Change load distribution • Lighten load • Adjust propulsion trim
Vibrates	<ul style="list-style-type: none"> • Reverse propeller to clear debris • Have dealer check for bent propeller/shaft • Check engine mounting or part hitting boat structure
Engine*	
Coughs and sputters	<ul style="list-style-type: none"> • Check fuel supply • Turn on tank valves (if equipped) • Clear obstructed or pinched fuel line • Replace fuel pump • Clean fuel filters/strainers • Check fuel filter/sediment bowl for water in fuel • Free choke movement • Clean or replace spark plugs
Runs hot	<ul style="list-style-type: none"> • Check oil level • Replace broken/stretched cooling system belt • Clear raw water intake • Replace raw water pump • Replace thermostat • Replace pump impeller
Stops suddenly	<ul style="list-style-type: none"> • Check ignition wiring and fuse • Check battery connections • Tighten distributor and spark plug wires • Replace cracked distributor cap • Replace rotor • Do not attempt to modify or repair electronic control modules. Check with your dealer.

Steering

- Steers erratically
- Clean and adjust cable(s)
 - Adjust propulsion trim
 - Tighten cable brackets
 - Tighten steering wheel
-

*Check engine operator's manual for more detailed information.

Systems

Controls

Steering

Controls vary by manufacturer. Consult your owner's information packet for specific precautions and procedures for your boat.



WARNING

CONTROL HAZARD

- See engine operator's manual and warning label posted on boat if maneuvering speed is less than top speed. Maneuverability is limited above specified speed. Sudden turns may cause loss of control.
- Inspect and maintain steering system regularly. An improperly maintained system may fail, causing sudden loss of steering control, resulting in personal injury and property damage.



CAUTION

- Follow instructions in owner's information packet for hydraulic steering system operation, filling and bleeding procedures, alternative means of operation, maintenance procedures, troubleshooting, fluid specifications, systems or piping diagrams and replacement parts list.
- Follow instructions in owner's information packet for mechanical steering system inspection and lubrication.

- In a hydraulic system, steering wheel movement pumps hydraulic fluid through lines to a cylinder which transfers movement to the rudder, stern drive or outboard drive. A reservoir holds extra fluid; a valve protects against overpressure.
- In a mechanical system, the steering wheel connects to a cable which transfers movement to the rudder, stern drive or outboard drive.
- The operator must inspect the entire steering system frequently for smooth, free, full-range operation. Steering cables, lines, and connections are critical to safe operation. It is important to thoroughly check all hardware, especially the **self-locking nuts** used to fasten the steering link rod between the steering cable(s) and the engine. Never replace these nuts with common or non-self-locking nuts, which can vibrate off. **A loose connection can result in sudden loss of steering and control.**

Gear Shift & Throttle



WARNING

PERSONAL INJURY HAZARD - Shift to neutral before starting.



CAUTION

- **Shift only when engine is running. Some manufacturers recommend NOT stopping engine in gear.**
- **Pause in neutral while shifting, wait for boat to lose headway, and then shift quickly. Easing into gear can damage transmissions.**
- **Handle throttle and shift cables with care when performing maintenance to avoid kinking or twisting.**

- With common single lever control, gear shift/throttle lever controls engine thrust direction and speed.
- Moving the lever forward to the first detent position engages the forward gear and then further movement increases the throttle. To reverse propeller direction, move the lever back to the neutral (middle) position, and then move the lever back to the first detent position to engage the reverse gear. Increase the throttle with further aft movement of the lever.
- A release on the lever prevents accidental shifting.
- The “throttle only” option disengages the throttle from the shift mechanism for starting.
- Some engine manufacturers recommend NOT stopping engine in gear. See your engine operator’s manual.
- Test operation of system before getting underway. Visually inspect condition of cable or hydraulic lines at least twice a year.

Ignition

- Key-operated switch at the helm or control box allows engine startup.
- A buzzer may indicate power is ready before ignition.
- Start-in-gear protection prevents engine ignition unless gear is in neutral. Inspect and test periodically to ensure system works.
- Key or toggle switch at the helm starts engine.

Emergency Engine Stop Switch With Lanyard



WARNING

PERSONAL INJURY HAZARD - Wear the lanyard at all times when operating the boat but use it to stop only in an emergency. Do not use it to shut off the engine during normal operations.

- An emergency engine stop switch turns off the engine when the operator leaves the helm in an unsafe situation, for example by falling. Familiarize yourself with its operation and always use it.
- Before operating boat, attach one end of the lanyard to the operator and the other end to the stop switch, usually located on the control or near the helm.
- The lanyard should be long enough to prevent inadvertent activation. Do not let lanyard become entangled.
- Accidental loss of power can be hazardous, particularly when docking or in heavy seas, strong current, or high winds. Passengers and crew may lose balance and the boat may lose steering control.
- Should the operator fall out of the boat while it is moving and the safety stop switch turns the engine off, it will take several seconds for the propeller to stop turning. The boat will continue to coast for some distance and may cause injury to anyone in its path and/or cause damage to other boats or property.

NOTE: The switch on your boat may be different from the typical switch illustrated here. Refer to the engine manual for more information.



Power Trim & Tilt

- Power trim and tilt adjusts a stern drive or outboard propeller's angle to the hull. The switch is often on the gear shift/throttle lever. (See Operation - Manuevering/Maintaining Control - Trimming and Systems - Instruments - Trim Gauge.)
- Trim generally refers to an approximate 20-degree range used for normal in-water operation. Tilt refers to more extreme angles of adjustment.



CAUTION

Operating boat with the outboard engine tilted up may expose cooling water intake holes, causing engine to overheat or the water pump to fail. To avoid damage due to overheating, keep water intake holes below the water line.

- Tilt may be used at low idle speed when operating in shallow water. See engine operator's manual for precautions regarding shallow water operation.
- Tilt is also used to raise the engine for trailering. Turn off engine first. Support outboard engine; do not rely on tilt support lever for trailering. (See Trailering - Using Trailer.)

Instruments

Cockpit layout varies by manufacturer. Gauges and switches at the helm may include:

Tachometer With Hour Meter

- Tachometer indicates engine speed in revolutions per minute (RPM). See the engine operator's manual for maximum full throttle RPM. Do not exceed the maximum engine RPM.
- Hour meter measures cumulative hours of engine operation. Use it to log engine maintenance, performance data and fuel consumption.



Speedometer

- The speedometer indicates kilometers per hour and miles per hour by measuring water pressure against a small hole in a device mounted on the bottom of the transom. Another type uses the flow of water over a paddle wheel transmitter mounted on the bottom of the boat.
- To ensure accuracy, keep the water pressure hole clear and the paddle wheel transmitter free of obstructions. Consult the instructions in the owner's information packet or consult your dealer for proper cleaning and calibration.



Oil Pressure Gauge



CAUTION

If oil pressure drops toward zero, stop the engine at once. Do not restart until the problem has been corrected.

- Oil pressure gauge monitors the engine's internal lubricating system.
- Note gauge reading when engine is new; it is the "norm" to be referenced during the life of the engine.
- Slight gauge fluctuations are common. Greater fluctuations should be investigated. (Note: Increasing engine RPM causes oil pressure to increase slightly).
- Check oil level if pressure drops significantly. If level is normal, consult your dealer.



Water Temperature Gauge



CAUTION

If water temperature indication moves above normal, turn off the engine at once. Do not restart until the problem is corrected.

- Water temperature gauge indicates temperature of engine cooling water.
- A thermostat brings water to a predetermined temperature soon after starting and maintains it while the engine is running.
- See the engine operator's manual for proper gauge readings.
- Engine temperature readings below normal while operating the engine can indicate a problem with the cooling system and should be corrected to avoid engine damage. Consult your dealer for guidance.



Voltmeter

- Voltmeter indicates battery voltage.
- See the engine operator's manual for proper gauge readings. Significantly higher or lower readings indicate a battery or alternator problem.
- This reading should be higher than 12 volts when the engine is running if the alternator is functioning properly.



Fuel Gauge

- Fuel gauge indicates amount of fuel in the tank.
- The most accurate reading is at idle speed when boat is approximately level.
- Because gauge is approximate, compare to known fuel consumption rate and hours of use.



Trim Gauge (Outboard and Stern Drive)

- Trim gauge indicates the angle of the propeller to the hull. (See Systems - Controls - Power Trim & Tilt.)



Propulsion



CAUTION

- **Boat power capacity has been rated for maximum performance and safety. Do not exceed the engine rating posted by the manufacturer. Exceeding power capacity is illegal in many areas.**
- **Never use a propeller which allows the engine to exceed recommended RPM under normal wide-open throttle operations.**

- Propulsion system consists of an engine turning a shaft which transfers power to a propeller. Mounting may be outboard, stern drive (inboard engine/outboard propeller), or inboard.
- Propeller pitch and diameter affect performance. Diameter is often restricted by the engine installation, but pitch can be changed. Consult your dealer for proper propeller selection for your particular needs. For example, higher top speed may result in less acceleration and a longer time to reach planning speed, while better load-pulling performance may result in a lower top speed.
- Small electric or single-cylinder gasoline powered motors are used for trolling. Disconnect when not in use. Do not operate two-cylinder or larger gasoline engines at trolling speed for an extended time.
- Consult the engine operator's manual for operation and maintenance instructions.

Outboard Motor Installation



WARNING

PERSONAL INJURY HAZARD - Failure to securely install and maintain outboard motor mounting may cause motor to eject during operation, causing death, serious injury or property damage.

- Motor may be installed directly onto transom or onto a mounting bracket. See engine operator's manual for instructions.
- Ensure installation is tight before each use.

Bilge

- Bilge systems on deck style boat includes one or more drain plugs and pumps to remove water.
- Before every use, inspect drain plugs and pumps. Routinely clean pump strainer, float switches, intakes and area under pumps.
- It is a violation of federal law to pump overboard bilge which contains oil or fuel. (*See Environmental Considerations- Fuel & Oil Spillage.*)

Drain Plugs



WARNING

SINKING HAZARD - Install drain plugs before launching.

- At least one plug is located in the transom to allow water to drain before trailering or storing. In larger boats, other plugs may be located forward.

Bilge Pumps



WARNING

SINKING HAZARD - Ensure proper bilge pump operation.



CAUTION

Run bilge pump only as long as necessary to remove water. Running dry can damage bilge pump motor.

- Bilge pumps are wired to the battery through a fuse or breaker and operated by a switch at the helm.
- If the pump is not automatic, check bilge periodically for rising water. Turn bilge pump switch on until water is pumped out, then switch off.
- A float switch on an automatic bilge pump activates the pump when the bilge water reaches the switch level. The bilge pump will turn off when the water level decreases below the switch level. An automatic pump must also have a readily accessible manual switch, usually located at the helm.

Ventilation

- Ventilation systems on stern drive or inboard boats remove gasoline fumes from the bilge and engine compartment.
- Keep vents free from obstructions.

Bilge Blowers



WARNING

EXPLOSION/FIRE HAZARD - Run blower at least 4 minutes before starting engine. Check bilge and engine compartment for fumes.

- Blowers remove fuel fumes from the bilge.
- No ventilation system can remove the vapors of liquid fuel in the bilge. (See *Operation - Fueling*.)
- Run blowers before starting, when the boat is idling, stopped or operating below cruising speed, and when the generator is

running.

- Check periodically to ensure hoses and wires are fastened.
- Do not move blower hoses or modify the ventilation system in any manner.

Other

- Store flammables only in approved, vented containers securely fastened in a locker sealed from the interior of the boat and vented overboard. Storing flammables in areas not designed for vapor removal creates a hazard.
- Be aware of carbon monoxide from your own or other boats. Allow air movement to dissipate fumes. (See *Emergency Procedures*.)

Fuel System



WARNING

EXPLOSION/FIRE HAZARD - Fuel system connections that are too loose or too tight can leak, resulting in fuel loss, environmental pollution, and explosion/fire hazard.

- See engine operator's manual for fill locations and recommended types of fuel and oil.
- Stop engine before refueling.
- Fill tank less than rated capacity. Allow for fuel expansion. (See Operation - Fueling.)
- Stop engine, disconnect battery and drain fuel before servicing fuel system.
- Lines, tanks, filters and pump are critical to safe operation. Inspect integrity regularly. Look for rust, abrasions, loose fittings and dry, cracked or mushy hoses. Replace with comparable marine parts, not automotive parts.

Outboard

- Fuel tank(s) may be installed or portable.
- Remove portable fuel tanks from boat before refueling.
- Open portable fuel tank vent before operating.
- Connect fuel line to outboard engine according to engine manufacturer's recommended procedure.
- Primer bulb or choke lever prepares fuel system for starting. Models with electronic fuel injection do not require priming before starting.
- If the fuel tank is permanently installed, it must have a clearly marked fill fitting on the hull or deck, a gauge to indicate fuel level and a fuel tank vent to the outside of the boat.

Stern Drive & Inboard

- Tank is usually under the cockpit deck or against the transom.
- Fill plate is located on the deck and is clearly marked for fuel only.

Fuel Quality

- Follow the engine manufacturer's recommendations on fuel type.
- Keep tank full (allow for expansion) to reduce condensation and contamination.

Engine Exhaust



WARNING

CARBON MONOXIDE HAZARD - Ensure engine exhaust system is working properly. Carbon monoxide poison is extremely toxic and can kill.

- Exhaust system removes gases created by the engine and vents them aft.
- Inspect entire system for tightness before each use. Leaks may permit carbon monoxide exposure.
- Many areas require a muffler. Do not change the standard system.
- On inboard engines, raw water is pumped through exhaust manifolds, hoses, and mufflers and then overboard through hull fittings. Make sure that water is flowing from exhaust outlets while the engine is running,

Engine Cooling

- Most marine engines circulate raw seawater around components or through a heat exchanger on the engine to reduce temperature. To ensure system is working, look for water flowing from exhaust while engine is running (cannot do this with stern drive). See the engine operator's manual for flow diagrams and thermostat replacement.
- Additionally, marine engines used in saltwater or in fresh water may have an internal coolant system to dissipate heat. Recirculating coolant must be replenished periodically with a water/antifreeze mixture. See the engine operator's manual for coolant mixture, capacity and location of the heat exchanger/coolant reservoir.

Electrical

DANGER

EXTREME HAZARD

- Never use an open flame in battery storage area.
- Prevent sparks near battery.
- Battery will explode if a flame or spark ignites the free hydrogen gas given off during charging.

WARNING

SHOCK/FIRE HAZARD

- Disconnect electrical system from its power source before performing maintenance. Never work on the electrical system while it is energized.
- Electrical appliances must not exceed the rated amperage of the boat circuits.
- Observe the electrical system carefully while it is energized. The only electrical components which can be left unattended are the automatic bilge pump, fire protection and alarm circuits.
- Only a qualified marine electrical technician may service the boat's electrical system.

CAUTION

- Turn off engine before inspecting or servicing battery.
- Disconnect battery cables before working on electrical system to prevent arcing or damage to alternator. Disconnect negative (-) cable first, then positive (+) cable.

- The battery powers the direct current (DC) electrical system.
- An engine-driven alternator, or an AC battery charger, or an inverter/ charger, or a converter recharges the battery(s).
- A voltage regulator controls alternator output to protect the battery and accessories.
- Ask the marine dealer to analyze power needs if you add accessories.
- Do not exceed rated amperage of electrical circuits.
- Fire can result from an overloaded electrical circuit.

Batteries

- The manufacturer selects batteries for their ability to furnish power for starting and operating the DC system. Refer to the manufacturer's specification when replacing a battery.
- Battery switches, usually located near batteries, allow you to turn on/ off battery current to the engine and accessories except bilge pumps. Switch must be on to start the engine. To extend battery life, turn off switch when leaving the boat for an extended time.

- Some boats have battery equalizers to balance voltage applied between the batteries, cross over charging to send current from the engine alternators to the low battery, or emergency start systems to parallel batteries when one battery does not have sufficient crank ing amps to start the engine. See your owner's information packet or check with your dealer for the operation of the particular system that may be installed on your boat.
- The battery must be in a well-ventilated area. If necessary, open the battery compartment while charging the battery.
- Disconnecting battery:
 - Turn off items drawing power.
 - Turn off battery switch, if equipped.
 - Remove negative (-) cable first, then positive (+) cable.
 - To replace cables, replace positive (+) first, then negative(-).
- Battery maintenance includes:
 - Inspect battery and charging system before every use.
 - Inspect cell fluid level monthly, more often in hot weather. Replenish with distilled water.
 - Coat terminal posts with corrosion inhibitor.
 - Keep battery clean and dry.
 - Remove battery during cold weather or long term storage.
- See engine operator's manual for safeguards if boat is equipped with battery switches.

Ignition Protection



WARNING

EXPLOSION HAZARD - Gasoline vapors can explode. Use only marine-rated, ignition-protected parts when replacing engine components.

- All electrical components in the bilge are ignition-protected to avoid creating sparks in a gasoline environment. Replacement parts must be marine-rated for ignition protection.
- Prevent sparks in the engine compartment. Cover battery terminals with a nonconductive boot or install the battery in a vented battery box or install the battery in a separate dedicated compartment.

Breakers and/or Fuses



WARNING

SHOCK/FIRE HAZARD - Replace breaker or fuse with same amperage device. Never alter overcurrent protection.

Note - Fuse size is especially critical in motor circuits like bilge blowers and bilge pumps.

- Breakers and/or fuses are usually located under or near the dash panel.
- Bilge pump fuses are usually located in the bilge adjacent to the battery or at the main electrical distribution panel.
- If a breaker trips, determine and correct the fault, then reset by pushing the breaker button.
- If a fuse blows, determine and correct the fault, then replace the fuse.

Corrosion & Zinc Anodes

- Engines have zinc anodes to protect underwater hardware from corrosion.
- Do not paint over zinc or between zinc and metal it contacts.

Fresh Water

Owner's information packet will explain operation and maintenance of fresh water system (if equipped).

Head

 CAUTION
Do not place facial tissue, paper towels, or sanitary napkins in head. Such material can damage waste disposal system and the environment.
NOTICE
There is a possibility of being fined for having an operable direct over-board discharge system in some waters. Close discharge seacock and remove handle, or take other security measures to avoid being fined for breaking the law.

Owner's information packet will explain operation and maintenance of head system (if equipped). Read the information supplied before operating or maintaining the head or holding tank system installed on your boat.

Galley



WARNING

EXPLOSION/FIRE/ASPHYXIATION HAZARD

- Open flames demand constant attention.
- Open flame cooking appliances consume oxygen. This can cause asphyxiation or death. Maintain open ventilation. If not sure of ventilation openings, ask manufacturer or dealer.
- Liquid fuel may ignite, causing severe burns.
- Use fuel appropriate for type of stove.
- Turn off stove burner before filling
- Do not use stoves for comfort heating.
- Never use flames to check for leaks
- Know the location of all emergency cut-off valves or switches and how to use them.

- The owner's information packet will explain operation and maintenance of your galley systems. Read it and understand it before you operate or maintain your galley systems.
- Several types of galley stoves or appliances are available:
 - Alcohol stoves often have an integral tank and pump to pressurize system.
 - Electric stoves and microwave ovens have a breaker at the main distribution panel. Turn breaker off when not in use.
 - Liquefied petroleum gas (LPG) and compressed natural gas (CNG) stoves have an external fuel tank and a valve to provide fuel to the stove and to ignite the burner.
- LPG/CNG systems: Never leave these systems unattended while in use.
 - Do not obstruct access to LPG/CNG system components in any way.
 - Turn off fuel cylinder supply valve when stove is not in use.
 - Close appliance valves before turning on fuel cylinder supply valve.
 - Keep valves on empty cylinders closed and disconnected. Keep protective covers, caps or plugs in place. Store reserve or empty cylinders on open decks or in gas-tight lockers vented overboard in the same way that the cylinders in use are stored. Do not use LPG/ CNG cylinder housings or lockers for storage of any other equipment.
 - Do not smoke or use open flames when replacing LPG/CNG cylinders.



CAUTION

Do not use solutions containing ammonia for leak-testing.

- Test regularly for leaks. With appliance valves shut, open the cylinder valve and observe the reading on the cylinder gauge. Shut the cylinder valve and check the cylinder gauge after 3 minutes. If the reading is less than initially observed, there is a leak. Discontinue use and repair. Additionally, with cylinder and system valves open and appliance valves shut, apply soapy water solution to all joints and fittings and look for bubbles to indicate leaks. If leaks are present, discontinue use and have a qualified person repair the system.

Alarms & Monitors



WARNING

PERSONAL INJURY HAZARD - Alarm systems are intended to warn of unsafe conditions. Do not ignore any alarm!

Some boats have alarms to indicate problems with high engine water temperature, low oil pressure, carbon monoxide, flooding, or explosive fumes. The manufacturer will provide information on those features, if available, as well as on monitors or gauges not provided as standard equipment. (*See Systems - Instruments.*)

Carbon Monoxide Monitor

- Carbon monoxide (CO) monitor systems are required equipment when a boat has gasoline engine(s) or a gasoline generator and has accommodation spaces.
- The CO monitor system will monitor the air in the main cabin and each sleeping area. Its alarm will be heard in each of these areas.
- The electronic sensor detects the presence of CO and an increasing concentration of CO and flashes a visual and emits an audible signal.
- There is no switch for this system, but the breaker or fuse for it will likely be near the helm or electrical distribution panel.
- If there is a breaker, it will require the removal of a cover or strap in order to turn it off.
- Always keep the CO monitor on.

Navigational Equipment

Compass

- A marine compass is optional on some boats. However, a compass is invaluable in determining position and course.
- A qualified technician must adjust the compass for errors caused by nearby iron, steel, magnets, or electric wires.
- Since a compass seldom can be corrected to zero deviation on all headings, the technician who adjusts your boat's compass will give you a deviation card showing the correction to be applied in navigational calculations. Keep this card at the helm at all times.

Horn

- A horn is considered an accessory, but is often included as standard equipment. The horn button or switch is usually at the helm.
- Test the horn periodically to ensure proper operation.
- Avoid spraying water directly into the horn.

Other

- If the boat is equipped with navigational equipment, such as Depth Sounder, Radar, Loran, or Global Positioning System, the manufacturer of that equipment will provide operation and maintenance information.

Communication Equipment

- Communication equipment is optional but an important safety feature.
- VHF-FM is the primary short-range (32 kilometers [20 miles]) radio telephone service.
- Some areas may require a license to operate radiotelephone equipment. Consult your marine dealer.
- The radio/telephone manufacturer provides information on its operation and maintenance.

Anchor

- Anchors are available in different shapes, sizes and weights to suit different boats, uses and conditions. Consult your marine dealer.

Trailer

Choosing Equipment

Choosing a Trailer & Tow Vehicle

- Trailer must match boat and load. Consult your marine dealer.
- Check area requirements for brakes, lights, emergency break-away system and registration.
- Ensure tow vehicle has adequate power, cooling, transmission, tires, brakes, wheelbase and suspension.
- Tow vehicle should weigh at least as much as the load it will pull.

Choosing a Hitch

- There are three basic hitch types:
 - **Weight-Carrying** - The simple, relatively inexpensive bumper hitch supports the entire trailer tongue weight at the hitch. It is adequate for towing light trailers, but is banned in some areas.
 - **Weight-Distributing** - This hitch distributes the load to all wheels of both the tow vehicle and the trailer. It can handle heavier loads safely with less wear on the tow vehicle. Some hitches have anti-sway bars to improve control by minimizing trailer fishtailing.
 - **Receiver Hitch** - This hitch has greater capacity than a bumper hitch, but less capacity than a Weight-distributing hitch. This hitch has a square tube receiver, a hitch ball insert, and a securing pin.
- The hitch ball is a critical component and must be the right size.
- Consult your marine dealer to select the right hitch, hitch ball and weight capacity. For example, all 2-inch hitch balls are not rated for the same weight capacity.

Using Trailer

Hooking Up

- To maintain control, ensure tongue weight is 5 to 10 percent of the total weight.

Example:

2587.6 kg (3500 pounds)

 x5%

79.38 kg (175 pounds)

158.76 kg (350 pounds)

Total weight of boat and trailer

Maximum tongue weight

Maximum tongue weight (10%)

- To determine tongue weight:
 - Use commercial truck scale to determine total weight of boat and trailer.
 - Park loaded trailer on a level, paved surface.
 - Place bathroom scale on the ground under the coupler.
 - On the scale, place a sturdy box to support the tongue jack so that the trailer tongue is exactly parallel to the ground.
 - Read tongue weight on the scale.
- If the tongue weight is not between 5-10 percent, adjust equipment on the boat, the position of the boat on the trailer or the placement of the axle on the trailer frame.

Securing Outboard When Trailering

NOTICE

Use outboard support bar if engine must be tilted up for ground clearance. Outboard tilt support lever is not intended to support the engine when trailering.

- Place outboard in vertical operating position if ground clearance is adequate.
- If additional ground clearance is needed, use an outboard support bar to secure engine. Do not rely on tilt support lever for trailering.
- Shift outboard to forward gear to prevent propeller from spinning freely in wind while vehicle is moving.
- See engine operator's manual for other pre cautions and instructions related to trailering.

Securing Boat to Trailer

! CAUTION

Use adequate tiedowns for load and trip conditions.

- Attach bow to trailer with safety chain or U-bolt. Winch line should be tight, but do not rely on winch line to fasten bow to trailer.
- Use at least two nylon web tiedowns to secure transom to trailer.
- Add tiedowns on side of boat if load or road conditions require. Place sidetiedowns near the stern where most of the boat's weight is located.
- Pad tiedowns where they contact the boat to prevent damage to the finish.
- If boat cover is used, ensure drawstring is drawn tight. Add ropes if necessary.
- Stow any loose gear whether or not you use a boat cover.

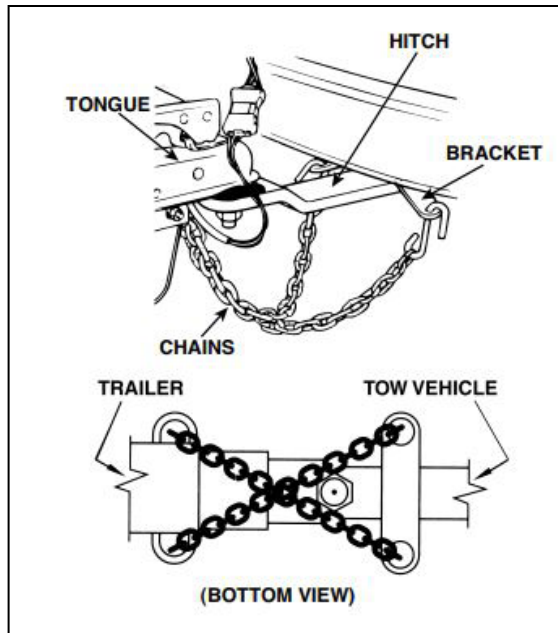

Pre-trip Checklist:

- Trailer wheel bearings - greased
- Trailer and tow vehicle tires - correct pressure
- Trailer and tow vehicle lights and brakes - operating
- Spare tires, jacks, parts - usable
- Boat steering mechanism - lubricated
- Boat connections and linkages - tight
- Tongue weight - 5 to 10 percent of total boat and trailer weight
- Tiedowns - secured
- Winch line - taut
- Winch anti-reverse gear - engaged
- Turnbuckle/safety hook - secured
- Motor - up in traveling position
- Coupler - tight
- Hitch ball - greased lightly to reduce friction and secured to the trailer with the latching mechanism
- Safety chains - crossed under trailer tongue and secured
- Tongue jack- raised
- Spring bars and/or stern tie downs - adjusted
- Boat canvas - down and secured
- Boat cover - secured
- Boating gear - secured
- Electrical connection to tow vehicle - plugged in and lights checked
- Registration, proof of insurance, other documentation - present

Pre-launch Checklist:

- Drain plugs - installed
- Boat cover - removed
- Wheel chocks - available
- Equipment - loaded for proper trim
- Bow and stern lines - fastened
- Fenders - rigged
- Tiedowns - removed
- Fuel and water tanks - filled
- Live/bait wells - filled
- Outboard or stern drive - tilted up
- Electrical connection to tow vehicle - unplugged
- Trailer wheel bearings - cooled
- Ramp conditions, water depth, current - checked (watch other boats)
- Drain plugs - check again to be sure they are installed

Launching

- Station someone to help direct.
- Back straight down the ramp.

CAUTION

Allow trailer wheel bearings to cool before submerging.

- Stop with trailer wheels at water's edge.
- Set brake and place chocks behind wheels of tow vehicle.
- Station helper to hold bow and stern lines from the ramp.
- Tighten winch brake and release anti-reverse lock. Do not disconnect winch cable.

WARNING

PERSONAL INJURY HAZARD - Severe injury is possible if winch system malfunctions or cable breaks. Do not let anyone stand near the winch or cable.

- Release tilt latch (if equipped).
- Allow boat to slide off trailer.
- Unhook winch cable from bow and rewind or secure to trailer. Use gloves to handle cable.
- Pull bow of boat to pier or float and secure.
- Return trailer tilt to horizontal and lock.
- Remove chocks and drive tow vehicle and trailer from ramp.
- Lower outboard or stern drive unit.
- Connect fuel lines (outboard engine).
- Start engine and allow to warm up.
- Depart launch area slowly. (See Operation- Casting Off.)
-

Hauling Out

- Prepare before approaching ramp.
- Secure fuel lines (outboard).
- Tilt outboard or stern drive unit up.
- Back trailer down ramp.
- Set brake and place chocks behind wheels of tow vehicle.
- If trailer has tilt mechanism, move it to up position.
- Guide boat onto trailer. Use bow and stern lines to help.
- Hook winch cable to boat's stem eye. Use gloves to handle cable.

WARNING

PERSONAL INJURY HAZARD - Severe injury is possible if winch system malfunctions or cable breaks. Do not let anyone stand near the winch or cable.

- Keep clear as boat is cranked onto trailer.
- Open drain plugs while boat is tilted.
- Rig sufficient tiedowns to temporarily secure boat to trailer.
- Remove chocks and drive tow vehicle and trailer from ramp.
- If in salt water, wash down hull and trailer with fresh water as soon as possible.
- Inspect propeller for nicks or other damage.
- Wipe hardware, including canvas snaps, with clean, soft cloth.
- Complete tiedown and secure gear for road. (See Using Trailer - Pre-Trip Checklist.)

Maneuvering With Trailer

- Start with the basics - accelerating, slowing, stopping smoothly and steadily.
- Increase distance from vehicle ahead. More stopping distance is required because of the added weight of the boat and trailer.
- Do not pass other vehicles until you feel comfortable pulling trailer.
- Maintain steady control in the wake of large trucks and buses.
- When turning, signal your intention well ahead of time.
- Swing a little wider than you would turn without a trailer.
- Stop every hour or so to inspect wheel bearings, connections, tie downs, cover and other fastenings.
- Back up slowly with a trailer:
 - Practice with an empty trailer in an empty parking lot.
 - Get the feel of backing straight. Small, S-shaped steering corrections will be needed.
 - When you're ready to turn while going backward, put your hands on the bottom of the vehicle's steering wheel. The trailer turns opposite the towing vehicle's direction. By moving the bottom of the steering wheel in the direction you want the trailer to go, the towing vehicle will go the opposite way.
 - As the trailer starts to turn, move the bottom of the steering wheel back to center. The trailer will continue to turn. Move the bottom of the steering wheel opposite the direction of the trailer motion in

order to slow the turning rate.

- If the trailer turns too sharply (“jackknifes”) or does not turn enough, stop, pull ahead and try again.
- General Rule - Start the trailer in the direction you want it to go and then follow it with the tow vehicle.
- Practice, practice, practice!

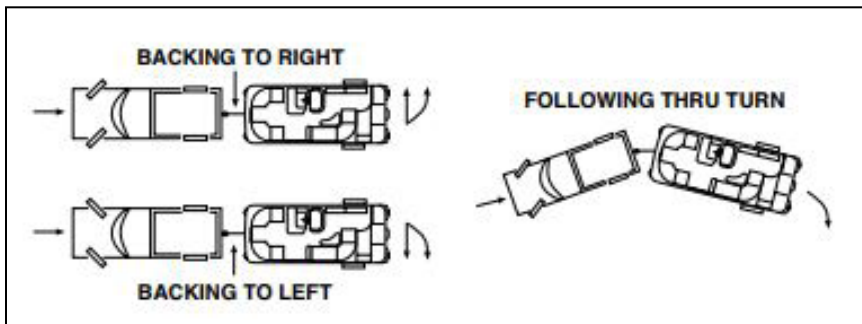
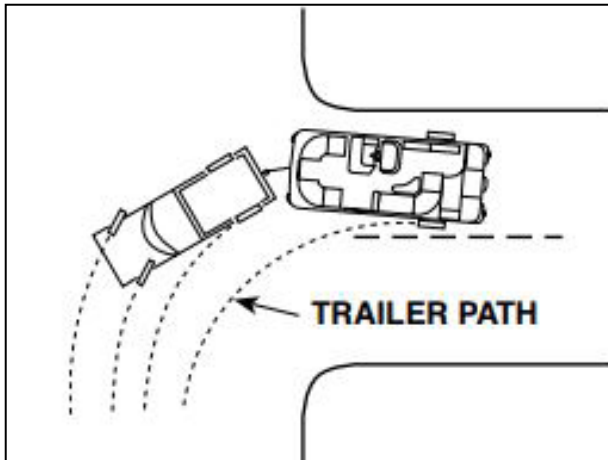



51687 County Road 133, Bristol, IN 46507

574.825.8900 BarlettaPontoonBoats.com