

---

# **FCC Regulatory Certification Guide**

## **for**

# **Murata WLAN and Bluetooth Modules**

**Rev. 1.5**

## Revision History

| Revision | Date      | Contributors                                 | Change Description                                      |
|----------|-----------|--|---|
| 0.1      | 5/27/2016 | Team Connectivity                            | Initial draft   |
| 0.7      | 9/16/2016 | J. Chang                                     | Review update   |
| 1.0      | 9/23/2016 | J. Chang                                     | First release (pending review)                          |
| 1.2      | 5/30/2019 | J. Chang                                     | Update with information on country setting based on CLM |
| 1.3      | 7/12/2019 | J. Chang                                     | Editorial changes                                       |
| 1.4      | 8/14/2019 | T. Garcia, J. Chang                          | Review updates  |
| 1.5      | 2/20/2020 | T. Inoue, Koki Teraoka,<br>Hidetaka Kuwahara | Proof review for release                                |

## Table of Contents

|          |  |           |
|----------|--|-----------|
| <b>1</b> | <b>DOCUMENT SCOPE</b> .....  | <b>3</b>  |
| <b>2</b> | <b>FCC CERTIFICATION BACKGROUND</b> .....                                    | <b>3</b>  |
| 2.1      | Categories of tests.....   | 3         |
| 2.2      | Authorized test labs .....   | 4         |
| 2.3      | FCC Grant .....  | 4         |
| <b>3</b> | <b>MURATA CERTIFIED WI-FI AND BT MODULES</b> .....                           | <b>5</b>  |
| <b>4</b> | <b>INTEGRATION OF PRE-CERTIFIED MODULES</b> .....                            | <b>6</b>  |
| 4.1      | FCC requirement for reusing modular certification ID .....                   | 6         |
| 4.2      | Customer responsibility .....  | 6         |
| <b>5</b> | <b>INTEGRATION OF REFERENCE-CERTIFIED MODULES</b> .....                      | <b>7</b>  |
| 5.1      | Description of reference certified modules .....                             | 7         |
| 5.2      | Reference certified module use options.....                                  | 8         |
|          | • Option 1: fully adopt Murata reference antenna design.....                 | 8         |
|          | • Option 2: use custom antenna design as illustrated in Figure 6. ....       | 8         |
| 5.3      | Reference certified module adoption procedure .....                          | 8         |
| 5.4      | Customer responsibility .....  | 9         |
| 5.5      | Supporting files.....  | 10        |
| 5.6      | FCC requirement for reusing limited modular certificate.....                 | 10        |
| <b>6</b> | <b>INTEGRATION OF NON-CERTIFIED MODULES</b> .....                            | <b>10</b> |
| <b>7</b> | <b>APPENDICES</b> .....  | <b>11</b> |
| 7.1      | RF test procedure.....   | 11        |
| 7.1.1    | Test setup for WLAN.....   | 12        |
| 7.1.2    | Test setup for BT .....  | 13        |
| 7.2      | RF test for Cypress WICED platforms .....                                    | 13        |
| 7.3      | Device and supporting exhibits required for FCC certification.....           | 14        |
| 7.4      | Power level setting and SKU planning with CLM Blob .....                     | 14        |
| 7.4.1    | What are the means for Tx power adjustments? .....                           | 14        |
| 7.4.2    | How to adjust power level at the test lab to accommodate custom antenna..... | 15        |
| 7.4.3    | How to plan for product SKU for different countries .....                    | 15        |
| 7.5      | Example of Declaration Letter of Change in ID for FCC ID transfer.....       | 16        |

# 1 Document Scope

This Application Note provides basic information on the Federal Communications Commission (FCC) Part 15C regulatory certification for wireless communication modules. It introduced and explained the *pre-certified* and *reference certified* module concepts. It allows a custom device to reuse the *intentional* radiation testing report portion thus *save time and cost for the host device certification*.

This document does not cover other regulatory certification tests required for FCC such as *unintentional* radiation or RF exposure test. Details for complete regulatory certification tests are available from regulatory test lab.

This updated version focuses specifically on 802.11 WLAN and Bluetooth modules on *Linux* platforms. For RTOS based *WICED* platforms, it provides some pointer information for users' reference.

The application note will provide some lab test procedures for reference at the later sections. We use Cypress chipset based modules for examples since the test utility is dependent on radio chipset makers.

## 2 FCC Certification Background

FCC regulates radio frequency (RF) devices contained in electronic-electrical products that are capable of emitting radio frequency energy by radiation, conduction, or other means. These products have the potential to cause interference to radio services operating in the radio frequency range of 9 KHz to 3,000 GHz.

FCC ruling Part 15C regulates a device that intentionally generates and emits radio frequency energy by radiation or induction that may be operated *without* an individual license. WI-FI, and Bluetooth radios fall into this category. Further description can be found at <https://www.fcc.gov/oet/ea/rfdevice>. The [FCC Knowledge Database](#) (KDB) provides additional guidance on testing devices subject to the FCC rules.

Note that the document also mentioned ISED (Innovation, Science and Economic Development) Certification for Canada since much information and procedure here can be referenced.

### 2.1 Categories of tests

The following three test categories are requested:

- *Radiated Emissions (or EMI) testing*

The electric device under testing (DUT) generates electromagnetic *signals* as well as *spurious emissions and harmonics* that may spill into other frequency bands and cause interference. A TCB (Telecommunication Certification Body) lab measures the electromagnetic field strength of the emissions in-band and off-band generated by your product. Both *intentional* and *unintentional* radiations will be measured. The limits for radiated emissions vary by country/region and by product type.

The test focuses are given to *spectrum occupancy, band-edge conformance, and spurious spectrums*.

- *Conducted Emissions testing*

The electric DUT generates electromagnetic energy and a certain portion of it may be conducted to the power supply side. A TCB lab measures these emissions (usually from 150 kHz - 30 MHz), and verifies if they comply with specified limits.

- *Exposure tests*

The specific absorption rate (SAR) is a value that corresponds to the relative amount of RF energy absorbed in the head/body of a user from a wireless device. For devices operating within proximity to human body, FCC has adopted SAR limits to be regulated.

## 2.2 Authorized test labs

A TCB accredited test lab provides certification, verification, and/or Declaration of Conformity (DOC) testing.

To find authorized test labs, one can go to FCC OET (Office of Engineering and Technology) website (<https://apps.fcc.gov/oetcf/eas/reports/TestFirmSearch.cfm>) where one can search by state, country or download the XML for offline reference.

The regulatory test should be scheduled when the host design is finalized as it would be for production. Depending on what needs to be tested, certification can take anywhere from 2 to 6 months for final approval.

It is recommended to contact multiple labs and discuss the project and ask for a *quote and schedule*; they can vary wildly between labs.

The selected test lab will provide *the Test Plan or check list for Equipment Exhibits* required for FCC Certification.

If reuse or transfer Murata modular certification IDs, the certification procedure will be much simplified. We provide some details in later sections.

## 2.3 FCC Grant

After completing the FCC lab testing, a TCB will review the test documentation and issue your certification on behalf of the FCC. Once the TCB submits results to the FCC database, the FCC will list your product on its official website. (<https://apps.fcc.gov/oetcf/eas/reports/GenericSearch.cfm> or <https://www.fcc.gov/oet/ea/fccid>) The TCB will send you a *Grant of Equipment Authorization* certification, which allows you to legally market and sell your product in the U.S.

The FCC certification contains the following information where the FCC ID consists of

XXX = Grantee Code (3-5 characters)

! Customer needs to register this code

YYYYY = Product Identifier (maximum of 14 characters)

! Customer needs assign this code

Note: Murata will need this information to provide the Declaration Letter of Change in ID for FCC ID transfer. See appendices for reference.

| Example         |   |
|-----------------|---|
| FCC ID          | VPY LB1DX                                 |
| Name of grantee | Murata Manufacturing Co., Ltd.            |
| Equipment class | Part 15 Spread Spectrum Transmitter       |
| Notes           | Communication Module                      |
| Modular type    | <i>Limited Single Modular<sup>1</sup></i> |

<sup>1</sup> The certification is Limited due to SAR is not performed.

### 3 Murata Certified Wi-Fi and BT modules

Murata designs and manufactures IEEE802.11 WLAN and Bluetooth radio modules that can be FCC certified or non-certified.

A customer device that installs a non-certified radio module shall go through full FCC certification process to obtain the certified FCC ID.

Murata has two types of certified Wi-Fi and BT module products that can significantly reduce the customer FCC certification effort.

1. Pre (or fully) certified module that has integrated radio (s) and RF antenna as a stand-alone product.
2. Reference certified module that is targeted for embedded module applications.

Each type comes with benefits and associated effort and cost. Refer to Figure 1 to see the highlights.

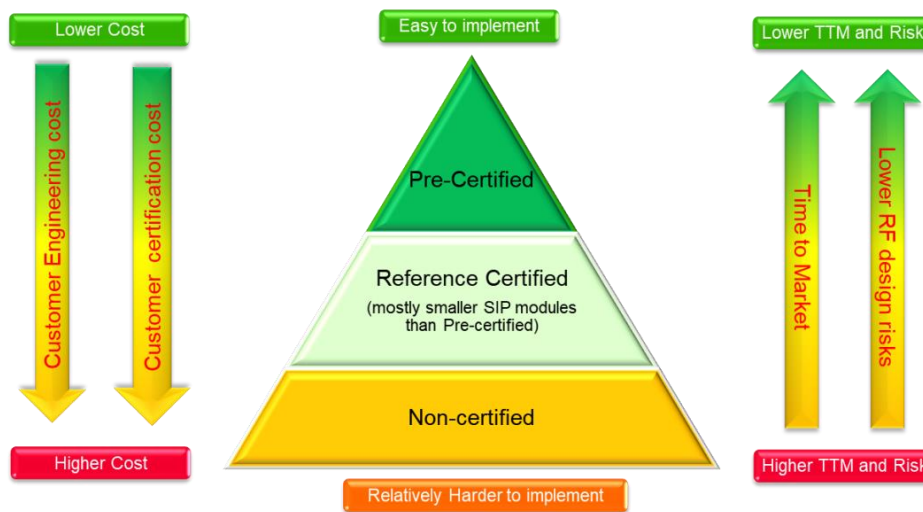

Figure 1 Certification classifications and benefits

Table 1 Difference between the two types of certified modules

|                           | Pre-Certified   | Reference Certified   |
|---------------------------|---|---|
| Antenna                   | Special antenna embedded on the module or with connector for pre-approved antenna                   | Antenna to be designed to specifications provided (reference antenna)                 |
| Certification reuse       | Certification can be fully reused   | Certification can be reused when reference antenna design is copied                   |
| RF engineering complexity | RF design all self-contained  | RF frontend/antenna needs to be designed to specification and optimized               |
| RF tests required         | No RF testing needed, only unintentional transmission for overall product                           | RF radiated testing may be required per TCB test lab                                  |
| Customer Responsibility   | Follow procedure to apply customer device FCC ID (mostly just paperwork, see Section 4 for details) | Follow procedure to apply customer device FCC ID with or without reduced lab testing. |

Table 2 lists some Murata Wireless Modules with different certification types as examples.

**Table 2 Example Murata Wireless Modules Certification Types**

| Module | Technology  | Certification status        | On-module antenna | Reference antenna | Custom antenna |
|--------|---|-----------------------------|-------------------|-------------------|----------------|
| 1HD    | 802.11b/g/n + ARM Cortex- M4 WICED                        | FCC/IC pre-certified        | ✓                 |                   |                |
| 1DX    | 802.11b/g/n, BT v4.2                                      | FCC reference certified     | N/A               | ✓ PCB             |                |
| 1MW    | 802.11a/b/g/n/ac, BT v5.0                                 |                             | N/A               | ✓ PCB             |                |
| 1LV    | 802.11a/b/g/n/ac-friendly, BT v5.0, low power consumption |                             | N/A               | ✓ PCB             |                |
| 1CX    | 802.11a/b/g/n/ac, BT v5.0 2x2 MIMO                        | Custom certification needed | N/A               | N/A               | ✓              |

## 4 Integration of Pre-certified modules

Murata provides pre-certified wireless modules. They are designed with an integrated antenna (PCB trace antenna or ceramic antenna) of specific RF characteristics. They have a modular FCC certification that can be reused in a customer design.

Figure 2 below shows just an example module *Type 1HD* (802.11 WLAN with embedded MCU). It has the on-module antenna and is *fully FCC certified*.



**Figure 2 Pre-certified module 1HD**

### 4.1 FCC requirement for reusing modular certification ID

Regulatory certification of a customer device with a pre-certified module is made easier since the intentional radiation test is covered by the modular certification of the module.

The FCC requirement for reusing a *modular certification* includes adding specific label and user manual statements. For a specific module a user shall look for *FCC ID installation* information in the corresponding *module datasheet* or *user guide* and check with the TCB test lab for guidance as well.

### 4.2 Customer responsibility

The manufacturer of the host product (customer) has additional responsibilities when installing a pre-certified module.

- Customer is still responsible for any additional testing covered by the Class (Device Class A and B) of the product.
- Customer still needs to take their product through other FCC/ISED testing such as unintentional radiators (FCC sub part 15B) and any other required regional product certifications including but not limited to EU directives.
- Murata modular certification will not be valid if multiple radios are included in a customer product.
- Customer should consult a TCB test lab for guidance on other requirements for the device certification.

## 5 Integration of reference-certified modules

### 5.1 Description of reference certified modules

The *reference certified* module is a module Murata takes through *modular certification* with a carrier board that has an integrated PCB or ceramic antenna as the Device Under Test (DUT)<sup>2</sup>.

Module Types 1DX, 1MW, 1LV are in this category.

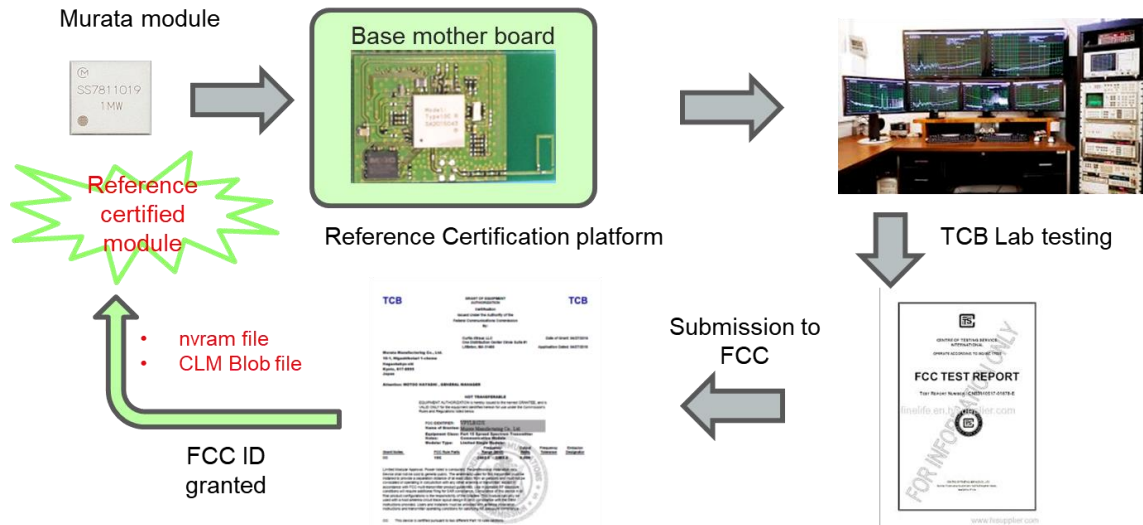

Figure 3 Process of reference certification for a module

Figure 4 further illustrates the assembly of a reference certified module. The key to note is that a reference certified module is always associated with *a reference antenna* of a defined RF performance such as peak gain and radiation pattern, and *a nvrAm file* that calibrates the module's RF performance. The *CLM Blob* (country locale matrix) file is default to FCC, which can be customized to support different countries and/or specific Tx power requirement.

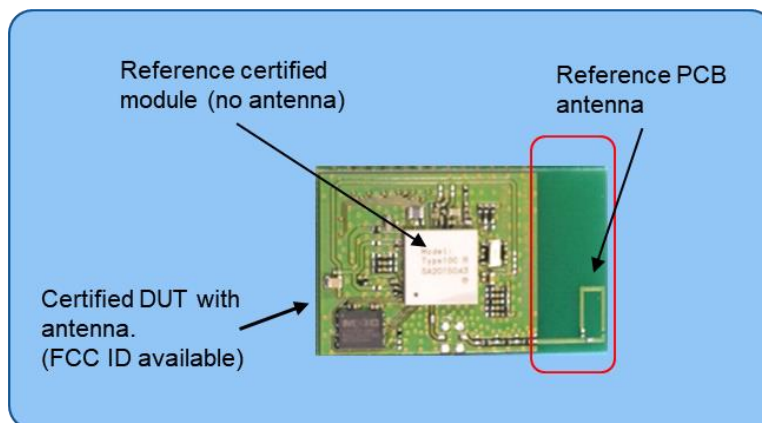

Figure 4 Illustration of reference certified module

<sup>2</sup> This integrated modular DUT is not intended for sale as a product.



## 5.2 Reference certified module use options

There are two options to integrate a Murata reference certified module into the user host device.

- **Option 1: fully adopt Murata reference antenna design**

In this case, the host device integrates a reference-certified module and copies the Murata antenna design exactly. Many of the FCC testing can be reused as-is so the host device certification could be quite straightforward.

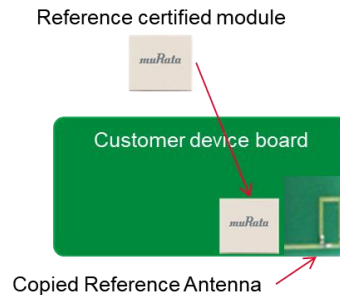

Figure 5. Option 1 module integration: copy Murata antenna design

- **Option 2: use custom antenna design as illustrated in Figure 6.**

If a host device uses a different antenna design pattern and/or with different peak gain, or uses an external antenna, it falls into so-called *class II permissive changes*. The radiated emission tests must be performed again to obtain a new FCC ID for this host device. Most conducted RF test results may still be reused to reduce the test cost.

Customer shall check with the selected test lab for details.

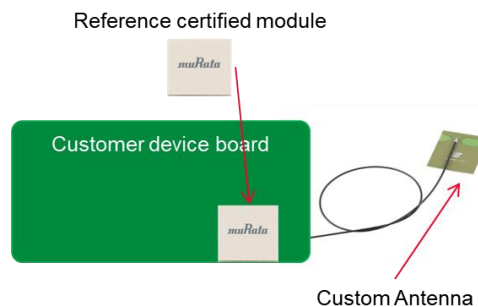
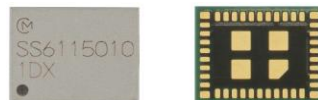

Figure 6. Option 2 module integration: custom antenna

## 5.3 Reference certified module adoption procedure

Here we use the *reference certified* module 1DX as an example to illustrate the conditions for FCC ID reuse with option 1.



Module 1DX FCC ID: **VPYLB1DX**



In order to reuse Murata FCC ID, the product host device shall:

- Conform to the specified electrical spec such as *supply voltages* as in the reference design
- Conform to *the antenna design specifications* as in the Type 1DX reference antenna design provided by Murata, specifically the following three points:
  1. It uses the same antenna type as the reference antenna specifications.  
Confirm the same size, pattern, PCB material as *the .dxf file provided by Murata*
  2. The peak antenna gain is equal or lower than the peak gain given by the reference antenna specification.  
Examine the host device antenna spec, measure the radiation pattern, and confirm the peak gain is less than the reference antenna peak gain<sup>3</sup>
  3. The overall emission level is not worsening.  
Measure radiated spurious emissions, and confirm the degradation is less than 3dB for the worst case spurious emission in the Murata test report for the reference certification.
- FCC ID change request need be performed. Check with the selected test lab for procedures. Murata will provide **Declaration Letter of Change in ID** to customers for the ID change.  
A customer can request the letter from its Rep or Murata support contact and upcoming *Community Forum* for WLAN and BT modules.

## 5.4 Customer responsibility

Figure 7 shows the customer responsibilities with reference certified module option 1.

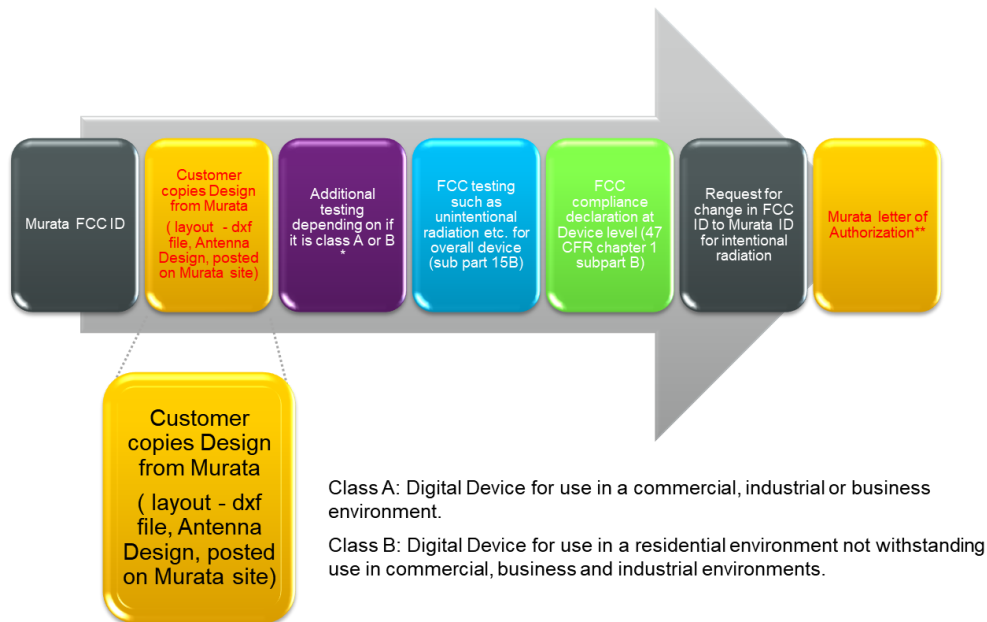

**Figure 7 Customer responsibility with reference certified modules**

<sup>3</sup> If the only difference is the larger antenna peak gain issue, there are ways to lower the module Tx power to meet the FCC power limits. The user must consult the TCB lab for discretion if the Murata reference test report is still applicable.

Even when the Murata reference certified module installation guidelines have been followed, a user still has the responsibility to ensure full FCC compliance, the same as using the pre-certified modules (Section 4.2).

## 5.5 Supporting files

The test lab will provide a check list for required host device exhibitions. An example checklist is shown in Appendix section 7.2.

To enable a customer to integrate a reference certified module, Murata will provide necessary reference files for using reference-certified modules.

- Module FCC ID and link to the FCC test reports (available on FCC website)
- Configuration setup files (WLAN nvram text file, Bluetooth .hcd file)
- CLM Blob file(s) for Cypress chipset based WLAN modules (default to FCC areas)
- Reference antenna design .dxf file
- RF design guide and antenna performance reference
- Module specific RF test procedure and/or test commands (refer to the Appendices)
- *Declaration Letter of Change in ID* for FCC and/or ISED certification(s)

## 5.6 FCC requirement for reusing limited modular certificate

In order to reuse the Murata *limited modular* FCC ID, the host device shall include specific labeling and statements required by the FCC. Users can find the reference language in datasheet corresponding to the module.

Users should also check *Murata* webpage for the rich set of module design support information.

## 6 Integration of non-certified modules

This section describes the procedure to follow when a host device installs a Murata wireless module that does not have a reference antenna available. In this situation the module requires *a full regulatory certification*. This is also applicable to the host device using a custom antenna with higher peak gains than that of the reference-certified modules<sup>4</sup>.

The procedure below is recommended for Cypress chipset based modules.

1. Set the host device under test (DUT) in working condition
2. Request manufacturing testing (MFG) firmware
3. Load the configuration files provided by Murata into designated directory for the selected module
  - a. *nvram* file for Wi-Fi
  - b. *hcd* file for BT
  - c. *MFG firmware*

---

<sup>4</sup> See footnote 3 for a special case

4. Test the module using Cypress WL commands as needed for Wi-Fi testing at regulatory test lab. Example WL commands are listed in the Appendix section.
5. Test the module using HCI test commands as needed for Bluetooth/BLE testing at regulatory test lab. Example HCI test commands are listed in the Appendix. Note some test lab may use *signaling-based* tester for Bluetooth tests
6. The test lab conducts the tests according to the FCC test plan

The test lab may need to adjust the module Tx (EIRP) power using *wl-tool* in order to meet the FCC power limits. The device owner should provide this operation expertise.

The device owner should record the passing power levels<sup>5</sup> to requests a custom CLM blob file to accompany with the device regulatory certification. Refer to Section 7.4 for the info on CLM blob customization process.

7. The test lab creates a test report and submits to FCC for certification grant

The procedures above are for intentional radiation regulatory testing. The selected test lab may advise other regulatory testing requirements such as unintentional radiation testing, RF exposure, etc. as necessary.

The test lab will handle the final test report submission for approval.

## 7 Appendices

### 7.1 RF test procedure

There are two system architectures with an integrated WLAN module:

- WLAN/BT radio-only modules that need to work with a host processor (MCU or CPU)
- WLAN/BT modules with embedded processor (MCU)

For the most part, the first case will be running on an embedded Linux OS. A device driver is necessary and may need to be ported as necessary for the OS versions. The host processor can run custom applications and specific RF test tool commands.

For the second case, some RTOS will be running on the embedded MCU. A device driver is included in the SDK for that MCU. The built-in MCU runs the networking protocols and stack (e.g., TCP/IP and network layer security), as well as small applications.

A manufacturing test utility is used to test the radio performance of the DUT and to assist with regulatory certification. For a module based on Cypress chipset, the WLAN manufacturing test utility is known as *wl\_tool*.

To enable production test, a UART interface should be made available for test command communications.

The information below applies to modules such as 1DX, using *wl\_tool* on *Linux platforms* with the NXP i.MX family of processors.

---

<sup>5</sup> A user can use the CLM power table template for this recording.

## 7.1.1 Test setup for WLAN

- Tools and FW required:
  - Cypress *wl\_tool* for 1DX
  - MFG FW for 1DX
  - Correct nvram file and CLM Blob file for the module

The best location for the SW package is on Murata github site at <https://github.com/murata-wireless>.
- Command sequences per FCC test plan
  - Setting DUT operation mode to MFG (e.g., loading MFG firmware)
  - Setting DUT operation frequency band, channel
  - Setting data rate (modulation coding scheme)
  - Setting Tx power level (optional or as required)
  - Enable DUT testing
  - Start continuous transmission or given data length/duration per test requirement
  - Lab operator to collect test data
- For a specific module, ***Murata will provide the test command scripts for various tests***. A customer can request them from local reps or Murata support contact.

Sample WL commands are shown here for reference.

```
# Filename: 2G_Tx_11g_54Mbps_CH7_13dBm.txt
# To Modify:
# Channel: change "wl chanspec" line. Default is channel 7.
# Data rate: modify "wl 2g_rate -r 54 -b 20"
# Output power: modify "wl txpwr1" line. Default is 13 dBm.
# Duration of packet transmission: modify "sleep" line. Default is 60 sec.
#
wl down
wl mpc 0
wl phy_watchdog 0
wl glacial_timer 0x7fffffff
wl country ALL
wl band b
wl 2g_rate -r 54 -b 20
wl chanspec 7/20
wl scansuppress 1
wl phy_forcecal 1
wl phy_txpwrctrl 1
wl txpwr1 -1
wl txpwr1 -o -d 13
wl up
wl pkteng_start 00:11:22:33:44:55 tx 20 1024 0
sleep 60
wl pkteng_stop tx
```

## 7.1.2 Test setup for BT

Bluetooth test setup depend on the test lab requirement. It can be signaling based or non-signaling based.

The former will use a special Bluetooth tester to drive Bluetooth DUT into RF test mode using normal firmware. The non-signaling based approach will need to use Bluetooth test commands sent from the host controller to device test firmware over the Bluetooth HCI (host controller interface) via UART transport.

The general Linux HCI tool command format is

```
hcidtool [-i <hciX>] [command [command parameters]]
```

Specific HCI commands may vary with specific Bluetooth chipset. A user should contact Murata support for supporting HCI tool test scripts for the module to be tested.

## 7.2 RF test for Cypress WICED platforms

WICED SDK is Cypress' solution for WLAN and BT integration. A user should select/configure the proper SDK for their host processor and the wireless chipset. Murata provides many integrated MCU + WLAN/BT modules (host-less modules) that are supported by WICED SDK.

The test firmware for WLAN is at <WICED-SDK>\43xxx\_Wi-Fi\apps\test\mfg\_test. The *wl\_tool* test scripts are supported natively. It is at <WICED-SDK>\43xxx\_Wi-Fi\libraries\test\wl\_tool\scripts.

The test firmware for BT is at <WICED-SDK>\43xxx\_Wi-Fi\apps\test\bt\_mfg\_test. This will pass through HCI commands from the PC to BT.

The utility reads packetized *IOCTL* commands from the PC via a serial UART and forwards the commands to the Cypress Wi-Fi device on the WICED module. Responses to the *IOCTLs* from the Wi-Fi device are returned over the UART to the PC.

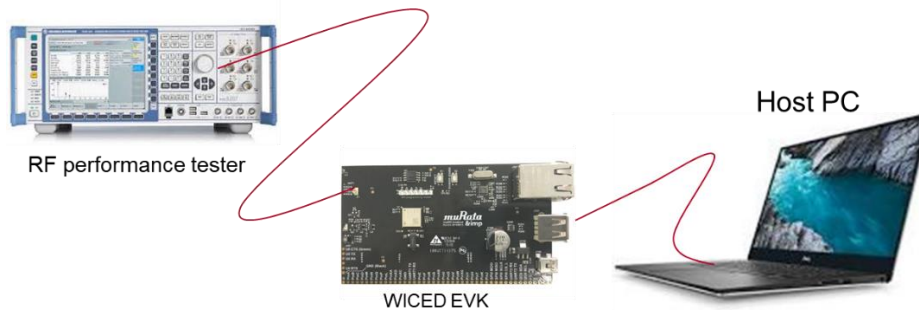

**Figure 8 WICED RF test connectivity setup**

The “*WICED Development System Manufacturing Test User Guide*” is available from the Cypress WICED Community. A test engineer shall read it for more information.

## 7.3 Device and supporting exhibits required for FCC certification

The TCB test lab will provide a checklist for the required exhibits. Here is a table for example only with reference certified module for Class 2 Permissive Change<sup>6</sup>.

| Item | Description   | Provider   |
|------|---|--|
| 1    | FCC ID, XXXX YYYY<br>XXX Grantee Code (3~5 characters);<br>YYYY Product Identifier (maximum of 14 characters) | Applicant  |
| 2    | FCC ID Label Artwork  | Applicant  |
| 3    | Label Location  | Applicant  |
| 4    | User's Manual   | Applicant  |
| 5    | Device photos / external  | Applicant  |
| 6    | Device photos / internal  | Applicant  |
| 7    | Block Diagram   | In Murata FCC application                              |
| 8    | Theory of Operation/Technical Description   |  |
| 9    | <b>Authorization Letter for ID change</b>   | Murata to the end customer and then submit to test lab |
| 10   | Other TCB lab requirement   |  |

## 7.4 Power level setting and SKU planning with CLM Blob

There are times when the transmit power level of the system (module integrated with a custom antenna) may need to be adjustment for various objectives, such as to meet the regional regulations and to pass the regulatory emission limits.

This section gives a brief introduction for power level setting with Cypress' chipset based WLAN modules. A user is recommended to study the App Notes "Cypress Wi-Fi Regulatory Manual"

<https://www.cypress.com/documentation/application-notes/an225347-cypress-wi-fi-clm-regulatory-manual>

### 7.4.1 What are the means for Tx power adjustments?

For Cypress based WLAN, two file types could support that purpose: *NVRAM* and *CLM Blob files*.

*NVRAM* is a module configuration file provided with every Murata WLAN module that ensures the RF performance conforms to the IEEE 802.11 spec and the regulatory requirements such as FCC, IC, and CE for the fully and reference certified modules. *A user shall not alter the parameters in the file* to ensure the performance integrity.

Cypress introduced a concept called CLM (Country Locale Matrix) blob that is used to specify the regulatory requirements such as operation bands, channels, modulations, and associated power levels. This CLM blob file works with the chipset firmware to configure the WLAN radio to work as required in each specified country or a region to pass the local regulation.

CLM blob is an important configuration mechanism for planning production SKU(s) of the host device that satisfy the specific regulatory requirements for the desired countries / regions of operation.

---

<sup>6</sup> For non-certified module with full certifications, more documents will be requested. Contact Murata for support.

## 7.4.2 How to adjust power level at the test lab to accommodate custom antenna

Sometimes in the TCB test lab, the DUT is required to adjust the Tx power to meet the Tx power and spectrum distribution behavior. In case of the Cypress based WLAN modules, *the utility to adjust the power is wl\_tool*.

*The final passing power levels in each channel, band, and modulation shall be recorded carefully for the custom CLM Blob file generation.*

## 7.4.3 How to plan for product SKU for different countries

A customer is requested to work with Cypress Regulatory Engineering team to complete the custom CLM template(s). Please check with your Murata contact for reference.

For FMAC (Full Medium Access Control) architecture, the custom CLM blob goes to the wireless drivers directory at /lib/firmware/brcm/ that contains

- o clm\_blob: brcmfmac<chip\_name>-<interface>.clm\_blob
- o Firmware: brcmfmac<chip\_name>-<interface>.bin
- o Nvram.txt: brcmfmac<chip\_name>-<interface>.txt

For WICED SDK, the custom CLM blob file goes to the firmware directory located at

- o 43xxx\_Wi-Fi/resources/firmware/<chip\_specific\_directory>

Below is the process of a custom CLM Blob generation.

- ❖ Users should create a **Cypress Case** to request the custom CLM Blob service and provide necessary information.

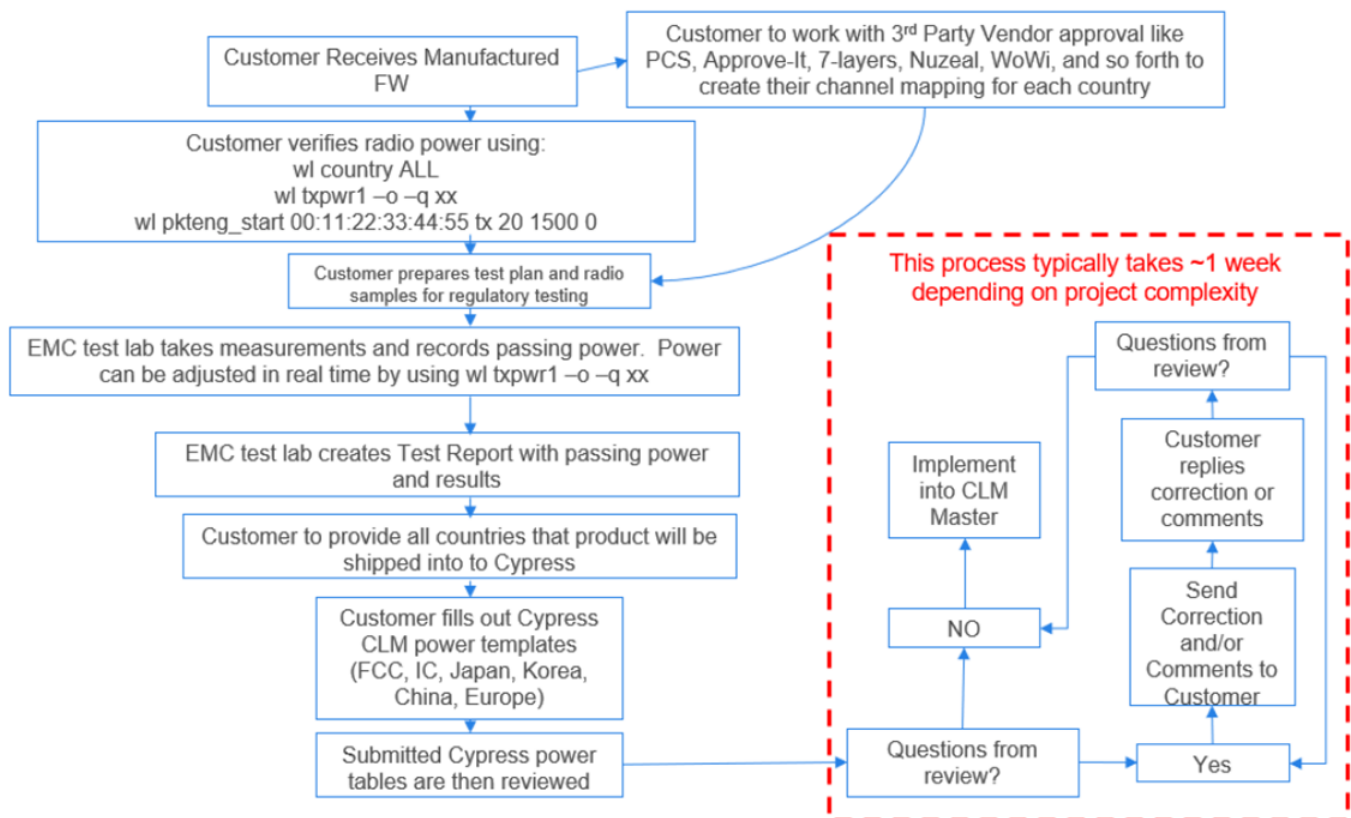

Figure 9 CLM Blob handling process (From Cypress Wi-Fi Regulatory Manual)



## 7.5 Example of Declaration Letter of Change in ID for FCC ID transfer

Below is an example of Declaration Letter of Change in ID for FCC ID transfer. You can see what customer information is requested.



### Declaration Letter of Change in ID

February 11, 2019

Federal Communications Commission  
Equipment Authorization Division,  
Application Processing Branch  
7435 Oakland Mills Road  
Columbia, MD 21046

We Murata Manufacturing Co., Ltd. agree to give the permission to file the change in the following FCC ID.

Product Name: Communication Module  
Model No.: 1DX  
FCC ID: VPYLB1DX  
Approval Date: April 27, 2016  
Brand Name: Murata Manufacturing Co., Ltd.

For a new FCC ID application as below.

Company Name: [REDACTED]  
Product Name: [REDACTED]  
Model No.: [REDACTED]  
FCC ID: [REDACTED]  
Brand Name: [REDACTED]

There is no change in the design, circuitry, or construction with the aforementioned communication module, and the documents on file with FCC from the original certification remain unchanged and continue to be valid.

The new application has its own brand name and FCC ID number.

We accept for FCC officials to use the documents on file from the existing certification in processing of applicant's FCC ID with Class II Permissive Changes.

Sincerely,

---

Murata Manufacturing Co., Ltd.