



## Process to Instrument Valves

Shell MES-C Compliant Slimline Monoflange, Monoflange (Ball) and Instrument Manifolds

EFA: PT3740



ENGINEERING YOUR SUCCESS.

# Shell MESC Slimline Monoflange, Monoflange Ball and Instrument Manifolds

**Page 3** Introduction

**Pages 4 - 7** Shell Certificates of Acceptance

**Pages 8 - 14** Slimline Monoflange

**Pages 15 - 21** Monoflange (Ball)

**Pages 22 - 27** MESC Manifolds DIN 19213 / IEC 61518

**Page 28 - 29** Instrument Monoflanges

**Pages 30 - 37** Enclosures, Protective Shades and Back Plates

**Pages 38 - 39** Seal Pots, Purge and Heating Blocks

**Page 40** Filling Connector and Port Protector

**Pages 41 - 46** Complementary Products

## **WARNING**

FAILURE, IMPROPER SELECTION OR IMPROPER USE OF THE PRODUCTS AND/OR SYSTEMS DESCRIBED HEREIN OR RELATED ITEMS CAN CAUSE DEATH, PERSONAL INJURY AND PROPERTY DAMAGE.

This document and other information from Parker Hannifin Corporation, its subsidiaries or its authorized distributors provide product and/or system options for further investigation by users having technical expertise. It is important that you analyze all aspects of your application and review the information concerning the product or system in the current product catalog. Due to the variety of operating conditions and applications for these products or systems, the user, through its own analysis and testing, is solely responsible for making the final selection of the products and systems and assuring that all performance, safety and warning requirements of the application are met.

The products described herein, including without limitation, product features, specifications, designs, availability and pricing, are subject to change by Parker Hannifin Corporation and its subsidiaries at any time without notice.

## **Offer of Sale**

The items described in this document are available for sale by Parker Hannifin Corporation, its subsidiaries or its authorized distributors. Any sale contract entered into by Parker will be governed by the provisions stated in Parker's standard terms and conditions of sale (copy available upon request).

# Introduction

## What is MESOC?

Material and Equipment Standards and Code (MESOC) is a materials standardisation system created by Shell to allow buyers to purchase standardised materials all over the world. It was created in 1932 for internal use, but was later licensed to any company who wished to pay for it.

With a single 10 digit code materials can be purchased independent of the manufacturer or brand.

## In this catalogue

This catalogue details design innovation - based around Shell's MESOC standardisation - that Parker believes will save significant engineering and installation time and costs for users of process fluid instrumentation.

The following pages detail a range of slimline monoflange, monoflange ball, and modular range of manifolds and accessories for small-bore instrumentation requirements that allow anyone to configure and order a part in a few minutes.

Once you have made your selection, Parker assembles and delivers the finished product to you - ready for immediate installation!

The benefits of this approach are wide ranging, and include:

- Being able to source all your process instrumentation needs from a single supplier and a proven inter-compatible range of components
- Eliminating on-site assembly time, and last-minute compatibility problems that can arise when using components from different suppliers
- Using an advanced flow path design that provides close coupling for high measurement integrity and avoidance of gauge line errors
- Gaining access to a connection system designed for ease of installation and subsequent lifecycle maintenance
- Manufacturing quality based on what Parker believes is the best materials sourcing and quality control systems in the industry today.

The products in this catalogue stem from Parker's Enterprise Framework Agreement with Shell as a single source supplier for the provision of instrumentation valves, manifolds, process-to-instrument valves, fittings, tubing, protective enclosures and related products. This agreement provided the platform for Parker to invest and produce the products detailed in this catalogue for use by Shell and its affiliates - as well as any other process instrumentation users interested in the benefits of modular instrumentation technology.

## Need any help?

If you would like to discuss the benefits of modular instrumentation systems for your plant, or would like help in configuring a solution, Parker welcomes your contact - see the back page of this brochure to find your local office.

### Technical Support Helpdesk

E. [ipde.shell@parker.com](mailto:ipde.shell@parker.com)

## Commonly used terms when conducting business with Shell

Acronym	Title	Description
EFA	Enterprise Frame Agreement	This is a commercial frame agreement between Shell Global Solutions and Parker Instrumentation Products Division which enables Parker to sell to Shell globally
MESOC	Materials Equipment Standards Code	These are Shell's standard specifications that they use for all products
DEP	Design Engineering Practises	The objective is to set the standard for good design and engineering practise to be applied by Shell companies in oil and gas production, oil refining, gas handling, gasification, chemical processing, or any other such facility, and thereby to help achieve maximum technical and economic benefit from standardization
TAMAP	Technical Approval for Manufacturers and Products	This is a list of qualified manufacturers and products
DVT	Design Validation Testing	This is a performance test carried out on a product to ensure compliance to a Shell specification. Parker has a type approved valve to MESOC SPE 77/300A
	Type A+	Denotes EFA holder's category of valves



SHELL GLOBAL SOLUTIONS

# CERTIFICATE OF ACCEPTANCE

This is to certify that Supplier Technical Assessment Record (STAR) level 2 has been awarded to:

**Company:** Parker Hannifin Ltd.  
**Manufacturing Location:** Instrumentation Products Division Europe  
Riverside road, Pottington Business Park  
Barnstaple, EX31 1NP, United Kingdom

**Brand:** **Parker Hannifin**

**Technical Qualification Result:** TAMAP/Enterprise Frame Agreement PT3740

Based on the Shell Global Solutions Technical Qualification carried out in December 2013 in accordance with testing procedure SPE 77/300 has been accepted by Shell Global Solutions International B.V. based on successful Type Acceptance Testing (TAT) result of:

Valve Type	Pressure Class	Size	Emission class	MESC No	TAT Date
Mono flange process to instrument valve: Ball valve design	150 to 2500	DN15 to DN20	BH	77.85.56.XXX.1	11 <sup>th</sup> to 19 <sup>th</sup> of June 2012 (week 24 & 25)
Mono flange process to instrument valve: Ball valve design	150 to 2500	DN15 to DN20	AH	77.85.58.XXX.1	11 <sup>th</sup> to 19 <sup>th</sup> of June 2012 (week 24 & 25)

The 2-STAR rating in the Shell Global Solutions Technically Accepted Manufacturers And Products (TAMAP) database is applicable to the MESC Sub-sub Groups, listed in Technical Specification MESC SPE 77/300B in accordance with tested valves description on page 2.

<b>Restrictions &amp; Conditions</b>	The qualification is performed on components (ball valves) applied in all monoflange design process to instrument valves and is valid for all combinations of components as used for block or double block with/without bleed.
<b>Sealing Materials</b>	Packing: Graphite for FE class: BH and Graphite & PTFE for FE class: AH

Shell GSI Report No: SR.12.13013	Original acceptance: 2013 - 08 - 01
Shell GSI contract no: EFA PT3740	Current Certificate: 2013 - 08 - 01
Acceptance Certificate no: 2013-08-001	Certificate Expiry: 2021 - 11 - 30
Issued By: Shell Global Solutions International B.V. GSNL-PTE/MMI	

Signature / Stamp:

 20-201 Mach Valves Support  
 Shell Enterprise Accepted  
 Name: Tony Batten  
 Date & Time: 2017/12/04

Date: 10/07/2019

Tested Valve Description:

**Test Valve-3 with Shell MESC - 77.85.56.XXX.1**

TEC code: PI-BA-ST-UD-MF-XX-SB-I17292-ST

DN20xDN15 BSP(F) pressure class 2500, Monoflange process to instrument valves

Single block & bleed, Soft seated, seat supported Ball valve, with seat supported Ball bleed valve.

Design to ISO 17292, Sour service, NACE MR-0175

Body material: ASTM A182 Grade F316L; Stem Material ASTM A479 Grade UNS31603

Seat material: PEEK; Packing material: Graphite

Fugitive Emissions (FE) Tightness class: BH

Design temperature range: -29 °C to +150 °C

Test temperature range: -50 °C non operable, -29 °C to +150 °C

Size Qualification Range (Bore ID): DN15 and DN20

Pressure class range qualification: 150, 300, 600, 900, 1500 and 2500

**Test Valve-4 with Shell MESC - 77.85.58.XXX.1**

TEC code: PI-BA-ST-UD-MF-XX-SB-I17292-ST

DN20xDN15 BSP(F) pressure class 2500, Monoflange process to instrument valves

Single block & bleed, Soft seated, seat supported Ball valve, with seat supported Ball bleed valve.

Design to ISO 17292, Sour service, NACE MR-0175

Body material: ASTM A182 Grade F316L; Stem Material ASTM A479 Grade UNS31603

Seat material: PEEK; Packing material (lower): Graphite; Packing material (upper): PTFE

Fugitive Emissions (FE) Tightness class: AH

Design temperature range: -29 °C to +150 °C

Test temperature range: -50 °C non operable, -29 °C to +150 °C

Size Qualification Range (Bore ID): DN15 and DN20

Pressure class range qualification: 150, 300, 600, 900, 1500 and 2500

VS-021 Mech Valves Support  
Shell Enterprise Agreement  
Name: Tony Bolton  
Date & Sign: 10/12/2019

405



# CERTIFICATE OF ACCEPTANCE

This is to certify that Supplier Technical Assessment Record (STAR) level 2 has been awarded to:

Company: Parker Hannifin Ltd.  
 Manufacturing Location: Instrumentation Products Division Europe  
 Riverside Road, Pottington Business Park  
 Barnstaple, EX31 1NP, United Kingdom

Brand: **Parker Hannifin**

Technical Qualification Result: TAMAP/Enterprise Frame Agreement PT3740

Based on the Shell Global Solutions Technical Qualification carried out in June 2012 and December 2013 in accordance with testing procedure SPE 77/300 has been accepted by Shell Global solutions International B.V. based on successful Design Validation Testing (DVT) result of:

Valve Type	Pressure Class	Size	Emission class	MESC No	TAT Date
Mono flange process to instrument valve: Slimline design	150 to 2500	DN15 to DN20	B	77.85.57.XXX.1	11 <sup>th</sup> to 19 <sup>th</sup> of June 2012 (week 24 & 25)
Mono flange process to instrument valve: Slimline design	150 to 2500	DN15 to DN20	A(HS)	77.85.57.XXX.1	09 <sup>th</sup> to 10 <sup>th</sup> of December 2013 (week 50)

The 2-STAR rating in the Shell Global Solutions Technically Accepted Manufacturers And Products (TAMAP) database is applicable to the MESC Sub-sub Groups, listed in Technical Specification MESC SPE 77/300B in accordance with tested valves description on page 2.

Restrictions & Conditions	The qualification is performed on components (needle & bleed valves) applied in all slimline design process to instrument valves and is valid for all combinations of components as used for block or double block with/without bleed.
Sealing Materials	Packing: Graphite

Shell GSI Report No: SR.12.13013 & SR.13.14032	Original acceptance: 2014 - 01 - 01
Shell GSI contract no: EFA PT3740	Current Certificate: 2014 - 01 - 01
Acceptance Certificate no: 2014-01-001	Certificate Expiry: 2021 - 11 - 30
Issued By: Shell Global Solutions International B.V. GSNL-PTE/MMI	

Signature / Stamp:

Date: 5/09/2018

 VS-021 Meeh.Valves Support  
 Shell Enterprise Accepted  
 Name: Tony Bolton  
 Date & Sign: 5/9/2018

Tested Valve Description:

Test Valve-2 with Shell MESC - 77.85.57.XXX.1

TEC code: PHND-MG-BD-OP-XX-SL-AS1634-ST

DN20xDN15 BSP(F) pressure class 2500, Monoflange process to instrument valves

Single block & bleed, slimline Globe valve, needle type with bleed, OS&Y bonnet.

Design to ASME B16.34, Sour service, NACE MR-0175

Body material: ASTM A182 Grade F316L; Trim material: SS (lower stem material: Alloy 625)

Fugitive Emissions (FE) Tightness class: Class B

Design temperature range: -20 °C to +150 °C

Test temperature range: -50 °C non operable, -20 °C to +150 °C

Size Qualification Range (Bore ID): DN15 and DN 20

Pressure class range qualification: 150, 300, 600, 900, 1500 and 2500

Test Valve-5 with Shell MESC - 77.85.57.XXX.1

TEC code: PHND-MT-BD-OP-XX-SL-AS1634-ST

DN25xDN15 BSP(F) pressure class 2500, Monoflange process to instrument valves

Single block & bleed, Slimline Globe valve, needle type with bleed, OS&Y bonnet.

Design to ASME B16.34, Sour service, NACE MR-0175

Body material: ASTM A182 Grade F316L; Trim material: SS (lower stem material: Alloy 625)

Fugitive Emissions (FE) Tightness class: A(HS)

Design temperature range: -29 °C to +150 °C

Test temperature range: -50 °C non operable, -29 °C operable to +150 °C

Size Qualification Range (Bore ID): DN15 and DN 20

Pressure class range qualification: 150, 300, 600, 900, 1500 and 2500

 VS-021 Mech.Valves Support  
Shell Enterprise Accepted  
Name: Tony Bolton  
Date & Sign: 5/9/2018

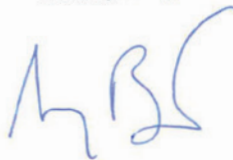

# Slimline Monoflanges

## Single Block and Bleed - OS&Y

Flange class 136 - covering 150, 300, and 600

- DN15 (1/2")
- Type A+
- Pancake style

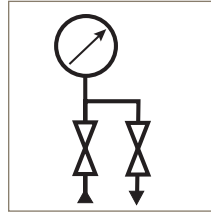

Emission Class	Material	Size: Outlet / Bleed	MESC	Part Number
Class A (HS)	AISI 316	1/2" (F) NPT	7785598331	MMFY120B8F1368FNAHS
		1/2" (F) BSP +3/8" A-LOK	7785598411	MMFY120B8F1368R6A8RVAHS
		1/2" (F) BSP +1/2" A-LOK	7785598401	MMFY120B8F1368R8ARVAHS
		1/2" (F) BSP + 10MM A-LOK	7785598421	MMFY120B8F1368RM10A8RVAHS
	625	1/2" (F) NPT	7785828231	MMFY120M8F1368FNAHS
		1/2" (F) BSP +3/8" A-LOK	7785828711	MMFY120M8F1368R6A8RVAHS
		1/2" (F) BSP + 1/2" A-LOK	7785828701	MMFY120M8F1368R8A8RVAHS
		1/2" (F) BSP + 10MM A-LOK	7785828721	MMFY120M8F1368RM10A8RVAHS
	Super Duplex	1/2" (F) NPT	7785648331	MMFY120F8F1368FNAHS
		1/2" (F) BSP +3/8" A-LOK	7785648411	CONTACT PARKER
		1/2" (F) BSP +1/2" A-LOK	7785648401	CONTACT PARKER
		1/2" (F) BSP + 10MM A-LOK	7785648421	CONTACT PARKER
Class B	AISI 316	1/2" (F) NPT	7785598231	MMFY120B8F1368FNB
		1/2" (F) BSP + 3/8" A-LOK	7785598711	MMFY120B8F1368R6A8RVB
		1/2" (F) BSP + 1/2" A-LOK	7785598701	MMFY120B8F1368R8A8RVB
		1/2" (F) BSP + 10MM A-LOK	7785598721	MMFY120B8F1368RM10A8RVB
	625	1/2" (F) NPT	7785829231	MMFY120M8F1368FN8FNB
		1/2" (F) BSP +3/8" A-LOK	7785829711	MMFY120M8F1368R6A8RVB
		1/2" (F) BSP +1/2" A-LOK	7785829701	MMFY120M8F1368R8A8RVB
		1/2" (F) BSP + 10MM A-LOK	7785829721	MMFY120M8F1368RM10A8RVB
	Super Duplex	1/2" (F) NPT	7785648231	MMFY120F8F1368FNB
		1/2" (F) BSP +3/8" A-LOK	7785648711	CONTACT PARKER
		1/2" (F) BSP +1/2" A-LOK	7785648701	CONTACT PARKER
		1/2" (F) BSP + 10MM A-LOK	7785648721	CONTACT PARKER



## Flange Class 600

- DN20 (3/4")
- Type A+
- Pancake style

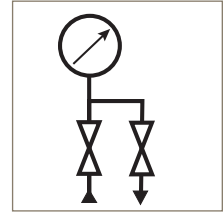

Emission Class	Material	Size: Outlet / Bleed	MESC	Part Number
Class B	AISI 316	1/2" (F) NPT		MMFY120B126008FNB
		1/2" (F) BSP +3/8" A-LOK	7785599711	MMFY120B12F6008R6A8RVB
		1/2" (F) BSP +1/2" A-LOK	7785599701	MMFY120B12F6008R8A8RVB
		1/2" (F) BSP + 10MM A-LOK	7785599721	MMFY120B12F6008RM10A8RVB
	Super Duplex	1/2" (F) NPT		MMFY120F126008FNB
		1/2" (F) BSP +3/8" A-LOK	7785649711	CONTACT PARKER
		1/2" (F) BSP +1/2" A-LOK	7785649701	CONTACT PARKER
		1/2" (F) BSP + 10MM A-LOK	7785649721	CONTACT PARKER

## Flange Class 150

- DN20 (3/4")
- Type A+
- Pancake style

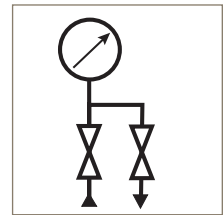

Emission Class	Material	Size: Outlet / Bleed	MESC	Part Number
Class B	AISI 316	1/2" (F) NPT		
		1/2" (F) BSP +3/8" A-LOK	7785599211	MMFY120B12F1508R6A8RVB
		1/2" (F) BSP +1/2" A-LOK	7785599201	MMFY120B12F1508R8A8RVB
		1/2" (F) BSP + 10MM A-LOK	7785599221	MMFY120B12F1508RM10A8RVB
	Super Duplex	1/2" (F) NPT		
		1/2" (F) BSP +3/8" A-LOK	7785649211	CONTACT PARKER
		1/2" (F) BSP +1/2" A-LOK	7785649201	CONTACT PARKER
		1/2" (F) BSP + 10MM A-LOK	7785649221	CONTACT PARKER

# Slimline Monoflanges

## Double Block and Bleed - OS&Y

Flange class 136 - covering 150, 300 and 600

- DN15 (1/2")
- Type A+
- Pancake style

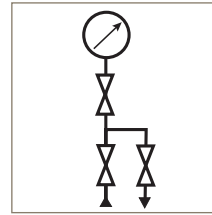

Emission Class	Material	Size: Outlet / Bleed	MESC	Part Number
Class A (HS)	AISI 316	1/2" (F) NPT	7785598511	MMFY100B8F1368FNAHS
		1/2" (F) BSP + 3/8" A-LOK		MMFY100B8F1368R6A8RVAHS
		1/2" (F) BSP + 1/2" A-LOK		MMFY100B8F1368R8ARVAHS
		1/2" (F) BSP + 10MM A-LOK		MMFY100B8F1368RM10A8RVAHS
	625	1/2" (F) NPT		MMFY100M8F1368FNAHS
		1/2" (F) BSP + 3/8" A-LOK		MMFY100M8F1368R6A8RVAHS
		1/2" (F) BSP + 1/2" A-LOK		MMFY100M8F1368R8A8RVAHS
		1/2" (F) BSP + 10MM A-LOK		MMFY100M8F1368RM10A8RVAHS
	Super Duplex	1/2" (F) NPT		MMFY100F8F1368FNAHS
		1/2" (F) BSP + 3/8" A-LOK		CONTACT PARKER
		1/2" (F) BSP + 1/2" A-LOK		CONTACT PARKER
		1/2" (F) BSP + 10MM A-LOK		CONTACT PARKER
Class B	AISI 316	1/2" (F) NPT	7785598241	MMFY100B8F1368FNB
		1/2" (F) BSP + 3/8" A-LOK	7785598811	MMFY100B8F1368R6A8RVB
		1/2" (F) BSP + 1/2" A-LOK	7785598801	MMFY100B8F1368R8A8RVB
		1/2" (F) BSP + 10MM A-LOK	7785598821	MMFY100B8F1368RM10A8RVB
	625	1/2" (F) NPT	7785829241	MMFY100M8F1368FNB
		1/2" (F) BSP + 3/8" A-LOK	7785829811	MMFY100M8F1368R6A8RVB
		1/2" (F) BSP + 1/2" A-LOK	7785829801	MMFY100M8F1368R8A8RVB
		1/2" (F) BSP + 10MM A-LOK	7785829821	MMFY100M8F1368RM10A8RVB
	Super Duplex	1/2" (F) NPT	7785648241	MMFY100F8F1368FNB
		1/2" (F) BSP + 3/8" A-LOK	7785648811	CONTACT PARKER
		1/2" (F) BSP + 1/2" A-LOK	7785648801	CONTACT PARKER
		1/2" (F) BSP + 10MM A-LOK	7785648821	CONTACT PARKER

## Flange Class 150

- DN20 (3/4")
- Type A+
- Pancake style

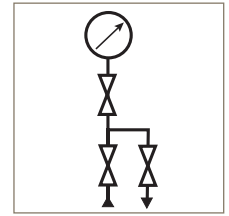

Emission Class	Material	Size: Outlet / Bleed	MESC	Part Number
Class A (HS)	AISI 316	1/2" (F) NPT	7785599041	MMFY100B12F1508FNAHS
		1/2" (F) BSP + 3/8" A-LOK	7785599111	MMFY100B12F150R6A8RVAHS
		1/2" (F) BSP + 1/2" A-LOK	7785599101	MMFY100B12F150R8A8RVAHS
	625	1/2" (F) BSP + 10MM A-LOK	7785599121	MMFY100B12F150RM10A8RVAHS
		1/2" (F) BSP + 3/8" A-LOK	7785829311	MMFY100M12F150R6A8RVAHS
		1/2" (F) BSP + 1/2" A-LOK	7785829301	MMFY100M12F150R8A8RVAHS
	Super Duplex	1/2" (F) BSP + 10MM A-LOK	7785829321	MMFY100M12F150RM10A8RVAHS
		1/2" (F) BSP + 3/8" A-LOK	7785649111	MMFY100F12F150R6A8RVAHS
		1/2" (F) BSP + 1/2" A-LOK	7785649101	CONTACT PARKER
Class B	AISI 316	1/2" (F) BSP + 10MM A-LOK	7785649121	CONTACT PARKER
		1/2" (F) BSP + 3/8" A-LOK	7785599311	MMFY100B12F150R6A8RVB
		1/2" (F) BSP + 1/2" A-LOK	7785599301	MMFY100B12F150R8A8RVB
	625	1/2" (F) BSP + 10MM A-LOK	7785599321	MMFY100B12F150RM10A8RVB
		1/2" (F) BSP + 3/8" A-LOK	7785829411	MMFY100M12F150R6A8RVB
		1/2" (F) BSP + 1/2" A-LOK	7785829401	MMFY100M12F150R8A8RVB
	Super Duplex	1/2" (F) BSP + 10MM A-LOK	7785829421	MMFY100M12F150RM10A8RVB
		1/2" (F) BSP + 3/8" A-LOK	7785649141	CONTACT PARKER
		1/2" (F) BSP + 1/2" A-LOK	7785649131	CONTACT PARKER
		1/2" (F) BSP + 10MM A-LOK	7785649151	CONTACT PARKER

# Slimline Monoflanges

Double Block and Bleed - OS&Y

## Flange Class 600

- DN20 (3/4")
- Type A+
- Pancake style

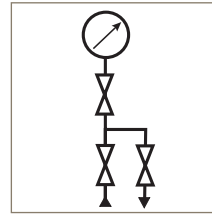

Emission Class	Material	Size: Outlet / Bleed	MESC	Part Number
Class A (HS)	AISI 316	1/2" (F) NPT	778598341	MMFY100B12F6008FNAHS
		1/2" (F) BSP + 3/8" A-LOK	778598511	MMFY100B12F6008R6A8RVAHS
		1/2" (F) BSP + 1/2" A-LOK	778598501	MMFY100B12F6008R8ARVAHS
		1/2" (F) BSP + 10MM A-LOK	778598521	MMFY100B12F6008RM10A8RVAHS
	625	1/2" (F) NPT		MMFY100M12F6008FNAHS
		1/2" (F) BSP + 3/8" A-LOK	778548511	MMFY100M12F6008R6A8RVAHS
		1/2" (F) BSP + 1/2" A-LOK	778548501	MMFY100M12F6008R8A8RVAHS
		1/2" (F) BSP + 10MM A-LOK	778548521	MMFY100M12F6008RM10A8RVAHS
	Super Duplex	1/2" (F) NPT		MMFY100F12F6008FNAHS
		1/2" (F) BSP + 3/8" A-LOK	7785828811	CONTACT PARKER
		1/2" (F) BSP + 1/2" A-LOK	7785828801	CONTACT PARKER
		1/2" (F) BSP + 10MM A-LOK	7785828821	CONTACT PARKER
Class B	AISI 316	1/2" (F) NPT		MMFY100B12F6008FNB
		1/2" (F) BSP + 3/8" A-LOK	7785589811	MMFY100B12F6008R6A8RVB
		1/2" (F) BSP + 1/2" A-LOK	7785589801	MMFY100B12F6008R8ARVB
		1/2" (F) BSP + 10MM A-LOK	7785589821	MMFY100B12F6008RM10A8RVB
	625	1/2" (F) NPT		MMFY100M12F6008FNB
		1/2" (F) BSP + 3/8" A-LOK	778558111	MMFY100M12F6008R6A8RVB
		1/2" (F) BSP + 1/2" A-LOK	778558101	MMFY100M12F6008R8A8RVB
		1/2" (F) BSP + 10MM A-LOK	778558121	MMFY100M12F6008RM10A8RVB
	Super Duplex	1/2" (F) NPT		MMFY100F12F6008FNB
		1/2" (F) BSP + 3/8" A-LOK	7785539541	CONTACT PARKER
		1/2" (F) BSP + 1/2" A-LOK	7785539531	CONTACT PARKER
		1/2" (F) BSP + 10MM A-LOK	7785539551	CONTACT PARKER

### Flange class 1525 - covering 900, 1500 and 2500

- DN15 (1/2")
- Type A+
- Pancake style

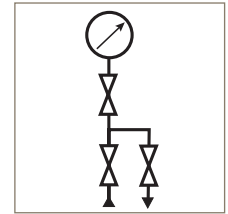

Emission Class	Material	Size: Outlet / Bleed	MESC	Part Number
Class A (HS)	625	1/2" (F) NPT	7785828271	MMFY100M8F15258FNAHS
		1/2" (F) BSP + 3/8" A-LOK	7785828911	MMFY100M8F15258R6A8RVAHS
		1/2" (F) BSP + 1/2" A-LOK	7785828901	MMFY100M8F15258R6A8RVAHS
		1/2" (F) BSP + 10MM A-LOK	7785828921	MMFY100M8F15258RM10A8RVAHS
	Super Duplex	1/2" (F) NPT	7785648371	MMFY100F8F15258FNAHS
		1/2" (F) BSP + 3/8" A-LOK	7785648611	CONTACT PARKER
		1/2" (F) BSP + 1/2" A-LOK	7785648601	CONTACT PARKER
		1/2" (F) BSP + 10MM A-LOK	7785648621	CONTACT PARKER
Class B	AISI 316	1/2" (F) NPT	7785598271	MMFY100B8F15258FNB
		1/2" (F) BSP + 3/8" A-LOK	7785598911	MMFY100B8F15258R6A8RV
		1/2" (F) BSP + 1/2" A-LOK	7785598901	MMFY100B8F15258R8A8RV
		1/2" (F) BSP + 10MM A-LOK	7785598921	MMFY100B8F15258RM10A8RV
	625	1/2" (F) NPT	7785829271	MMFY100M8F15258FNB
		1/2" (F) BSP + 3/8" A-LOK	7785829911	MMFY100M8F15258R6A8RV
		1/2" (F) BSP + 1/2" A-LOK	7785829901	MMFY100M8F15258R8A8RV
		1/2" (F) BSP + 10MM A-LOK	7785829921	MMFY100M8F15258RM10A8RV
	Super Duplex	1/2" (F) NPT	7785648271	MMFY100F8F15258FNB
		1/2" (F) BSP + 3/8" A-LOK	7785648911	CONTACT PARKER
		1/2" (F) BSP + 1/2" A-LOK	7785648901	CONTACT PARKER
		1/2" (F) BSP + 10MM A-LOK	7785648921	CONTACT PARKER

### Flange class 1525 - covering 900, 1500 and 2500

- DN20 (3/4")
- Type A+
- Pancake style

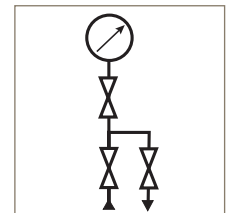

Emission Class	Material	Size: Outlet / Bleed	MESC	Part Number
Class A (HS)	Super Duplex	1/2" (F) BSP + 3/8" A-LOK	7785649611	CONTACT PARKER
		1/2" (F) BSP + 1/2" A-LOK	7785649601	CONTACT PARKER
		1/2" (F) BSP + 10MM A-LOK	7785649621	CONTACT PARKER
Class B	AISI 316	1/2" (F) BSP + 3/8" A-LOK	7785599911	MMFY100B1215258R6A8RVB
		1/2" (F) BSP + 1/2" A-LOK	7785599901	MMFY100B1215258R8A8RVB
		1/2" (F) BSP + 10MM A-LOK	7785599921	MMFY100B1215258RM10A8RVB
	625	1/2" (F) BSP + 3/8" A-LOK	7785829531	MMFY100M1215258R6A8RVB
		1/2" (F) BSP + 1/2" A-LOK	7785829971	MMFY100M1215258R8A8RVB
		1/2" (F) BSP + 10MM A-LOK	7785829981	MMFY100M1215258RM10A8RVB
	Super Duplex	1/2" (F) BSP + 3/8" A-LOK	7785649911	CONTACT PARKER
		1/2" (F) BSP + 1/2" A-LOK	7785649901	CONTACT PARKER
		1/2" (F) BSP + 10MM A-LOK	7785649921	CONTACT PARKER

# Slimline Monoflanges

## Part Number Builder

<b>MMFY</b>		<b>1</b>	<b>00</b>	<b>B</b>	<b>8</b>	<b>F</b>	<b>136</b>	<b>8R</b>	<b>8R</b>	<b>A1</b>	<b>AHS</b>
Needle Valve Bore Size		Style		Material		Face Style		Outlet Options		Valve Handle Options	
5 mm		Flange x Screw: <b>1</b> Flange x Flange: <b>2</b>		Stainless Steel <sup>1</sup> : <b>B</b> Super Duplex <sup>1</sup> : <b>F</b> Inconel 625 <sup>2</sup> : <b>M</b>		Raised Face: <b>F</b> Ring Type Joint: <b>T</b>		1/2" BSPP: <b>8R</b> 1/2" FNPT: <b>8FN</b>		Anti Tamper Needle Valve Only: <b>A*</b> Padlock Handle Locking: <b>L*</b>	
		Arrangement		Flange Size		Flange Class		Vent		FE Class	
		Block Bleed Block 1st Isolate: OS&Y 2nd Isolate: Needle Vent: Needle: <b>00</b>		DN15 (1/2"): <b>8</b> DN20 (3/4"): <b>12</b>		136 <sup>3</sup> : <b>150, 300, 600</b> 150: <b>150</b> 300: <b>300</b> 600: <b>600</b> 900: <b>900</b> 1500: <b>1500</b> 1525 <sup>3</sup> : <b>900, 1500, 2500</b> 2500: <b>2500</b>		1/2" BSPP: <b>8R</b> 1/2" NPT: <b>8FN</b> 1/2" ALOK: <b>8A</b> 3/8" ALOK: <b>6A</b> 10 mm ALOK: <b>M10A</b>		Class A (HS): <b>AHS</b> Class B: <b>B</b>	
		Block Block Bleed 1st Isolate: OS&Y 2nd Isolate: Needle Vent: Needle: <b>10</b>									
		Block and Bleed 1st Isolate: OS&Y Vent: Needle: <b>20</b>									
		Block and Bleed 1st Isolate: OS&Y Vent: Needle: <b>30</b>									
		Double Block 1st Isolate: OS&Y 2nd Isolate: Needle: <b>40</b>									
		Single Block 1st Isolate: OS&Y: <b>50</b>									

1. Stainless Steel and Super Duplex are close to shape forgings, single piece  
2. 625 are modular design, three-piece forged bar

\* Insert valve number  
1 = Primary  
2 = Secondary  
3 = Vent  
4 = All  
NB: Padlocks not supplied

3. Limitations on sizes available, please consult the factory in Barnstaple, UK 0044 1271 313131 or email ipd\_shell@parker.com

- Notes:
- All valves are graphite packed as standard, No PTFE option available
  - All valves are Fire Safe as standard
  - Materials are offered to NACE as standard

# Monoflanges (Ball)

## Single Block and Bleed

### Flange class 136 - covering 150, 300 and 600

- DN15 (1/2")
- 10 MM bore
- Type A+

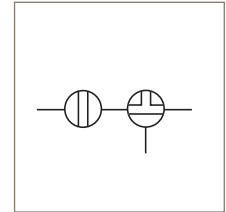

Emission Class	Material	Size: Outlet / Bleed	MESC	Part Number
Class A (HS)	AISI 316	1/2" (F) NPT	7785588331	MPBY140B8F1368FAU
		1/2" (F) BSP + 3/8" A-LOK	7785588411	MPBY140B8F1368R6AAU
		1/2" (F) BSP + 1/2" A-LOK	7785588401	MPBY140B8F1368R8AAU
		1/2" (F) BSP + 10MM A-LOK	7785588421	MPBY140B8F1368RM10AAU
	625	1/2" (F) NPT	7785818231	MPBY140M8F1368FAU
		1/2" (F) BSP + 3/8" A-LOK	7785818711	MPBY140M8F1368R6AAU
		1/2" (F) BSP + 1/2" A-LOK	7785818701	MPBY140M8F1368R8AAU
		1/2" (F) BSP + 10MM A-LOK	7785818721	MPBY140M8F1368RM10AAU
	Super Duplex	1/2" (F) NPT	7785538331	MPBY540F8F1368FA
		1/2" (F) BSP + 3/8" A-LOK	7785538411	CONTACT PARKER
		1/2" (F) BSP + 1/2" A-LOK	7785538401	CONTACT PARKER
		1/2" (F) BSP + 10MM A-LOK	7785538421	CONTACT PARKER
Class B	AISI 316	1/2" (F) NPT	7785588231	MPBY140B8F1368FBU
		1/2" (F) BSP + 3/8" A-LOK	7785588711	MPBY140B8F1368R6ABU
		1/2" (F) BSP + 1/2" A-LOK	7785588701	MPBY140B8F1368R8ABU
		1/2" (F) BSP + 10MM A-LOK	7785588721	MPBY140B8F1368RM10ABU
	625	1/2" (F) NPT	7785819231	MPBY140M8F1368FBU
		1/2" (F) BSP + 3/8" A-LOK	7785819711	MPBY140M8F1368R6ABU
		1/2" (F) BSP + 1/2" A-LOK	7785819701	MPBY140M8F1368R8ABU
		1/2" (F) BSP + 10MM A-LOK	7785819721	MPBY140M8F1368RM10ABU
	Super Duplex	1/2" (F) NPT	7785538231	MPBY540F8F1368FB
		1/2" (F) BSP + 3/8" A-LOK	7785538711	CONTACT PARKER
		1/2" (F) BSP + 1/2" A-LOK	7785538701	CONTACT PARKER
		1/2" (F) BSP + 10MM A-LOK	7785538721	CONTACT PARKER

## Flange class 300 and 600

- DN20 (3/4")
- 10 MM bore
- Type A+

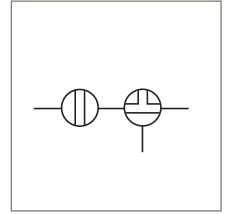

Emission Class	Material	Size: Outlet / Bleed	MESC	Part Number
Class A (HS)	AISI 316	1/2" (F) BSP + 3/8" A-LOK	7785589711	MPBY140B12F6008R6AA
		1/2" (F) BSP + 1/2" A-LOK	7785589701	MPBY140B12F6008R8AA
		1/2" (F) BSP + 10MM A-LOK	7785589721	MPBY140B12F6008RM10AA
	Super Duplex	1/2" (F) BSP + 3/8" A-LOK	7785539711	CONTACT PARKER
		1/2" (F) BSP + 1/2" A-LOK	7785539701	CONTACT PARKER
		1/2" (F) BSP + 10MM A-LOK	7785539721	CONTACT PARKER

## Flange Class 150

- DN20 (3/4")
- 10 MM bore
- Type A+

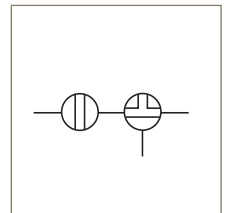

Emission Class	Material	Size: Outlet / Bleed	MESC	Part Number
Class B	AISI 316	1/2" (F) BSP + 3/8" A-LOK	7785589211	MPBY140B12F1508R6AB
		1/2" (F) BSP + 1/2" A-LOK	7785589201	MPBY140B12F1508R8AB
		1/2" (F) BSP + 10MM A-LOK	7785589221	MPBY140B12F1508RM10AB
	Super Duplex	1/2" (F) BSP + 3/8" A-LOK	7785539211	CONTACT PARKER
		1/2" (F) BSP + 1/2" A-LOK	7785539201	CONTACT PARKER
		1/2" (F) BSP + 10MM A-LOK	7785539221	CONTACT PARKER



# Monoflanges (Ball)

## Double Block and Bleed

Flange class 136 - covering 150, 300 and 600

- DN15 (1/2")
- 10 MM bore
- Type A+

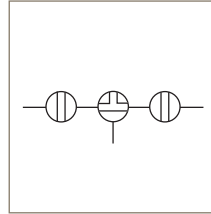

Emission Class	Material	Size: Outlet / Bleed	MESC	Part Number
Class A (HS)	AISI 316	1/2" (F) NPT	785588341	MPBY120B8F1368FAU
		1/2" (F) BSP + 3/8" A-LOK	785588511	MPBY120B8F1368R6AAU
		1/2" (F) BSP + 1/2" A-LOK	785588501	MPBY120B8F1368R8AAU
		1/2" (F) BSP + 10MM A-LOK	785588521	MPBY120B8F1368RM10AAU
	625	1/2" (F) NPT	7785818241	MPBY120M8F1368FAU
		1/2" (F) BSP + 3/8" A-LOK	7785818811	MPBY120M8F1368R6AAU
		1/2" (F) BSP + 1/2" A-LOK	7785818801	MPBY120M8F1368R8AAU
		1/2" (F) BSP + 10MM A-LOK	7785818821	MPBY120M8F1368RM10AAU
	Super Duplex	1/2" (F) NPT	7785538341	MPBY520F8F1368FA
		1/2" (F) BSP + 3/8" A-LOK	785538511	CONTACT PARKER
		1/2" (F) BSP + 1/2" A-LOK	785538501	CONTACT PARKER
		1/2" (F) BSP + 10MM A-LOK	785538521	CONTACT PARKER
Class B	AISI 316	1/2" (F) NPT	7785588241	MPBY120B8F1368FBU
		1/2" (F) BSP + 3/8" A-LOK	7785588811	MPBY120B8F1368R6ABU
		1/2" (F) BSP + 1/2" A-LOK	7785588801	MPBY120B8F1368R8ABU
		1/2" (F) BSP + 10MM A-LOK	7785588821	MPBY120B8F1368RM10ABU
	625	1/2" (F) NPT	7785819241	MPBY120M8F1368FBU
		1/2" (F) BSP + 3/8" A-LOK	7785819811	MPBY120M8F1368R6ABU
		1/2" BSP (F) + 1/2" A-LOK	7785819801	MPBY120M8F1368R8ABAU
		1/2" (F) BSP + 10MM A-LOK	7785819821	MPBY120M8F1368RM10ABU
	Super Duplex	1/2" (F) NPT	7785538241	MPBY520F8F1368FB
		1/2" (F) BSP + 3/8" A-LOK	785538811	CONTACT PARKER
		1/2" (F) BSP + 1/2" A-LOK	785538801	CONTACT PARKER
		1/2" (F) BSP + 10MM A-LOK	785538821	CONTACT PARKER

## Flange class 300 and 600

- DN20 (3/4")
- 10 MM bore
- Type A+

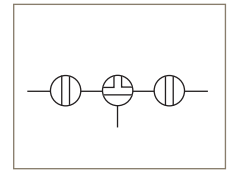

Emission Class	Material	Size: Outlet / Bleed	MESC	Part Number	
Class A (HS)	AISI 316	1/2" (F) NPT	7785589341	MPBY120B12F6008FA	
		1/2" (F) BSP + 3/8" A-LOK	7785589511	MPBY120B12F6008R6AA	
		1/2" (F) BSP + 1/2" A-LOK	7785589501	MPBY120B12F6008R8AA	
		1/2" (F) BSP + 10MM A-LOK	7785589521	MPBY120B12F6008RM10AA	
	625	1/2" (F) NPT			MPBY120M12F6008FA
		1/2" (F) BSP + 3/8" A-LOK	7785819861		MPBY120M12F6008R6AA
		1/2" (F) BSP + 1/2" A-LOK	7785819851		MPBY120M12F6008R8AA
		1/2" (F) BSP + 10MM A-LOK	7785819871		MPBY120M12F6008RM10AA
	Super Duplex	1/2" (F) NPT			MPBY520F12F6008FA
		1/2" (F) BSP + 3/8" A-LOK	7785539511		CONTACT PARKER
		1/2" (F) BSP + 1/2" A-LOK	7785539501		CONTACT PARKER
	Class B	AISI 316	1/2" (F) BSP + 10MM A-LOK	7785539521	CONTACT PARKER
1/2" (F) BSP + 3/8" A-LOK			7785589811		MPBY120B12F6008R6AB
1/2" (F) BSP + 1/2" A-LOK			7785589801		MPBY120B12F6008R8AB
625		1/2" (F) BSP + 10MM A-LOK	7785589821		MPBY120B12F6008RM10AB
		1/2" (F) BSP + 3/8" A-LOK	7785829111		MPBY120M12F6008R6AB
		1/2" (F) BSP + 1/2" A-LOK	7785829101		MPBY120M12F6008R8AB
Super Duplex		1/2" (F) BSP + 10MM A-LOK	7785829121		MPBY120M12F6008RM10AB
		1/2" (F) BSP + 3/8" A-LOK	7785539541		CONTACT PARKER
		1/2" (F) BSP + 1/2" A-LOK	7785539531		CONTACT PARKER
		1/2" (F) BSP + 10MM A-LOK	7785539551		CONTACT PARKER

## Flange class 150

- DN20 (3/4")
- 10 MM bore
- Type A+

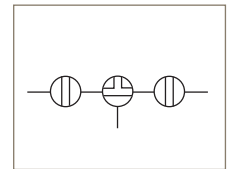

Emission Class	Material	Size: Outlet / Bleed	MESC	Part Number	
Class A (HS)	AISI 316	1/2" (F) NPT	7785589041	MPBY120B12F1508FA	
		1/2" (F) BSP + 3/8" A-LOK	7785589111	MPBY120B12F1508R6AA	
		1/2" (F) BSP + 1/2" A-LOK	7785589101	MPBY120B12F1508R8AA	
		1/2" (F) BSP + 10MM A-LOK	7785589121	MPBY120B12F1508RM10AA	
	625	1/2" (F) BSP + 3/8" A-LOK	7785819311		MPBY120M12F1508R6AA
		1/2" (F) BSP + 1/2" A-LOK	7785819301		MPBY120M12F1508R8AA
		1/2" (F) BSP + 10MM A-LOK	7785819321		MPBY120M12F1508RM10AA
	Super Duplex	1/2" (F) BSP + 3/8" A-LOK	7785539111		CONTACT PARKER
		1/2" (F) BSP + 1/2" A-LOK	7785539101		CONTACT PARKER
		1/2" (F) BSP + 10MM A-LOK	7785539121		CONTACT PARKER
Class B	AISI 316	1/2" (F) BSP + 10MM A-LOK	7785539151	CONTACT PARKER	
		1/2" (F) BSP + 3/8" A-LOK	7785589311		MPBY120B12F1508R6AB
		1/2" (F) BSP + 1/2" A-LOK	7785589301		MPBY120B12F1508R8AB
	625	1/2" (F) BSP + 10MM A-LOK	7785589321		MPBY120B12F1508RM10AB
		1/2" (F) BSP + 3/8" A-LOK	7785829021		MPBY120M12F1508R6AB
		1/2" (F) BSP + 1/2" A-LOK	7785829011		MPBY120M12F1508R8AB
	Super Duplex	1/2" (F) BSP + 10MM A-LOK	7785829031		MPBY120M12F1508RM10AB
		1/2" (F) BSP + 3/8" A-LOK	7785539141		CONTACT PARKER
		1/2" (F) BSP + 1/2" A-LOK	7785539131		CONTACT PARKER
1/2" (F) BSP + 10MM A-LOK	7785539151		CONTACT PARKER		

# Monoflanges (Ball)

## Double Block and Bleed

Flange class 1525 - covering 900, 1500 and 2500

- DN15 (1/2")
- 10 MM bore
- Type A+

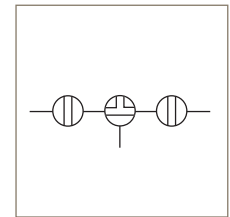

Emission Class	Material	Size: Outlet / Bleed	MESC	Part Number
Class A (HS)	625	1/2" (F) NPT	7785818271	MPBY120M8F15258FAU
		1/2" (F) BSP + 3/8" A-LOK	7785818911	MPBY120M8F15258R6AAU
		1/2" (F) BSP + 1/2" A-LOK	7785818901	MPBY120M8F15258R8AAU
		1/2" (F) BSP + 10MM A-LOK	7785818921	MPBY120M8F15258RM10AAU
	Super Duplex	1/2" (F) NPT	7785538371	MPBY520F8F15258FA
		1/2" (F) BSP + 3/8" A-LOK	7785538611	CONTACT PARKER
		1/2" (F) BSP + 1/2" A-LOK	7785538601	CONTACT PARKER
		1/2" (F) BSP + 10MM A-LOK	7785538621	CONTACT PARKER
Class B	AISI 316	1/2" (F) NPT	7785588271	MPBY120B8F15258FBU
		1/2" (F) BSP + 3/8" A-LOK	7785588911	MPBY120B8F15258R6ABU
		1/2" (F) BSP + 1/2" A-LOK	7785588901	MPBY120B8F15258R8ABU
		1/2" (F) BSP + 10MM A-LOK	7785588921	MPBY120B8F15258RM10ABU
	625	1/2" (F) NPT	7785819271	MPBY120M8F15258FBU
		1/2" (F) BSP + 3/8" A-LOK	7785819911	MPBY120M8F15258R6ABU
		1/2" BSP (F) + 1/2" A-LOK	7785819901	MPBY120M8F15258R8ABU
		1/2" (F) BSP + 10MM A-LOK	7785819921	MPBY120M8F15258RM10ABU
	Super Duplex	1/2" (F) NPT	7785538271	MPBY520F8F15258FB
		1/2" (F) BSP + 3/8" A-LOK	7785538911	CONTACT PARKER
		1/2" (F) BSP + 1/2" A-LOK	7785538901	CONTACT PARKER
		1/2" (F) BSP + 10MM A-LOK	7785538921	CONTACT PARKER

# Monoflanges (Ball)

## Brunei Shell Petroleum Part Numbers

The following part numbers are specific to the contract signed between Parker Hannifin Malaysia and Brunei Shell Petroleum.

Parker Part Number	Description (Shell Part Number)
MPBY120B8F15258R8ABU	1001832617
MPBY140B12F6008R8AB	1001902334
MPBY540F8F1368RV8RB	1001832513
MPBY120B8F15258FBU	1001832615
MPBY140B8F1368FBU	1001855272
MPBY540F8F1367785538231B	1001855270
MPBY520F8F15258RV8RB	1001832803
MPBY120B12F15258R8ABU	1001902328
MPBY520F12F15258RV8RB	1001902362
MPBY140B12F1508R8AB	1001902428
MPBY140B8F1368R8ABU	1001832577
MPBY520F8F15257785538271B	1001855269
MPBY540F12F6008FNB	1002365589
MSPBY160E24F158FNB-230	1000294358
MSPBY160E24F6008FNB-195	1000285754
MPBY140B12F6008FB	1002366582
MPBY130B12F1508FB	1002366583
MPBY520F12F2500B	1002365588

# Monoflanges (Ball)

## Part Number Builder

<b>MPBY</b>	<b>1</b>	<b>00</b>	<b>B</b>	<b>8</b>	<b>F</b>	<b>136</b>	<b>8R</b>	<b>6A</b>	<b>A1</b>	<b>A</b>	<b>U</b>
-------------	----------	-----------	----------	----------	----------	------------	-----------	-----------	-----------	----------	----------

Ball Valve Bore Size	
10 mm	<b>MPBY</b>
15 mm	<b>MPBX</b>

1. Limitations on sizes available, please consult the factory in Barnstaple, UK  
0044 1271 313131 or email ipd\_shell@parker.com

Style	
Flange x Screw	<b>1</b>
Flange x Flange	<b>2</b>
Flange x Screw <sup>2</sup>	<b>5</b>
Flange x Flange <sup>2</sup>	<b>6</b>

2. For Alloy 625 and Super Duplex only

Material	
Stainless Steel <sup>3</sup>	<b>B</b>
Super Duplex <sup>3</sup>	<b>F</b>
Inconel 625 <sup>4</sup>	<b>M</b>

3. Stainless Steel and Super Duplex are close to shape forgings, single piece  
4. 625 are modular design, three-piece forged bar

Face Style	
Raised Face	<b>F</b>
Ring Type Joint	<b>T</b>

Outlet Options	
1/2" BSPP	<b>8R</b>
1/2" FNPT	<b>8F</b>

Valve Handle Options	
Anti Tamper Needle Valve Only	<b>A*</b>
Padlock Handle Locking	<b>L*</b>

\* Insert valve number  
1 = Primary  
2 = Secondary  
3 = Vent  
4 = All  
NB: Padlocks not supplied

Arrangement	
Block Bleed Block 1st Isolate: Ball 2nd Isolate: Ball Vent: Needle	<b>00</b>
Block Bleed Block 1st Isolate: Ball 2nd Isolate: Ball Vent: Ball	<b>20</b>
Block and Bleed 1st Isolate: Ball Vent: Needle	<b>30</b>
Block and Bleed 1st Isolate: Ball Vent: Ball	<b>40</b>
Double Block 1st Isolate: Ball 2nd Isolate: Ball	<b>60</b>
Single Block 1st Isolate: Ball	<b>65</b>

Flange Size	
DN15 (1/2")	<b>8</b>
DN20 (3/4")	<b>12</b>

Flange Class	
150, 300, 600 <sup>5</sup>	<b>136</b>
150	<b>150</b>
300	<b>300</b>
600	<b>600</b>
900	<b>900</b>
1500	<b>1500</b>
900, 1500, 2500 <sup>5</sup>	<b>1525</b>
2500	<b>2500</b>

5 Limitations on sizes available, please consult the factory in Barnstaple, UK  
0044 1271 313131 or email ipd\_shell@parker.com

Vent	
3/8" ALOK	<b>6A</b>
1/2" BSPP	<b>8R</b>
1/2" NPT	<b>8F</b>
1/2" ALOK	<b>8A</b>
10 mm ALOK	<b>M10A</b>

FE Class	
Class A (HS)	<b>A</b>
Class B	<b>B</b>

For combination flange classes	
• 1/2" with Flange Classes 136 or 1525 • 3/4" with Flange Class 1525 in Styles 1 and 2, single piece.	<b>U</b>

**! Reminder - Shell specification refers to a Parker ProBloc as Monoflange Ball**

- Notes:
- All valves are graphite packed as standard, No PTFE option available
  - All valves are Fire Safe as standard
  - All ball valves are PEEK seated
  - Materials are offered to NACE as standard

# MESC Manifolds

DIN 19213

## 4 Valve Manifold - Type A - double isolate/equalise/vent block for general applications

- DIN 19213 PT2 1980 instrument connections
- Dual isolate, equalise and vent valves
- G1/4" BSPP female port supplied with either 1/2" or 3/8" OD or 10mm OD A-LOK®/CPI™ compression fittings fitted and pinned
- PTFE seal kit included as standard
- Graphite valve packing as standard

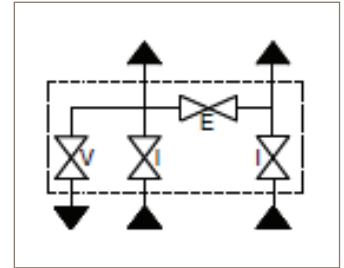
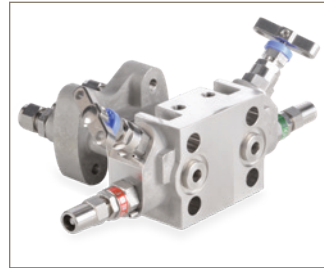

Type	MESC	Process/Vent	A-LOK® Part Number	CPI™ Part Number
A	609856.205.1	10 mm	MMHOMDS4L6098562051	MMHOMDS4B6098562051
A	609856.207.1	3/8"	MMHOMDS4L6098562071	MMHOMDS4B6098562071
A	609856.209.1	1/2"	MMHOMDS4L6098562091	MMHOMDS4B6098562091

## 4 Valve Manifold - Type B - double isolate/vent block for applications where contamination of process streams and not permitted

- Dual isolate and dual vent valves
- G1/4 BSPP female port supplied with either 3/8" OD or 10mm OD A-LOK®/CPI™ compression fittings fitted and pinned
- PTFE seal kit included as standard
- Graphite valve packing as standard

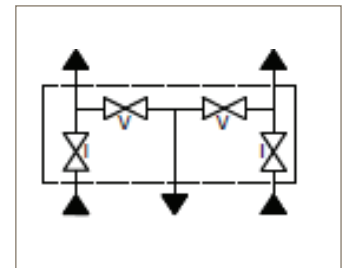

Type	MESC	Process/Vent	A-LOK® Part Number	CPI™ Part Number
B	609856.215.1	10 mm	MMHOMDS4L6098562151	MMHOMDS4B6098562151
B	609856.217.1	3/8"	MMHOMDS4L6098562171	MMHOMDS4B6098562171
B	609856.219.1	1/2"	MMHOMDS4L6098562191	MMHOMDS4B6098562191

## 2 Valve Manifold - Type C - single isolate/vent block for pressure applications and level measurement on atmospheric tanks

- Single isolate and vent valve
- G1/4 BSPP female port supplied with either 3/8" OD or 10mm OD A-LOK®/CPI™ compression fittings fitted and pinned
- PTFE seal kit included as standard
- Graphite valve packing as standard

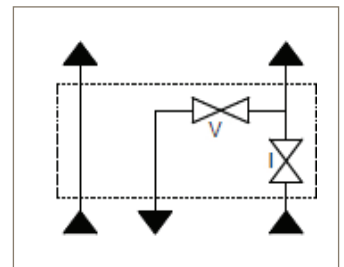
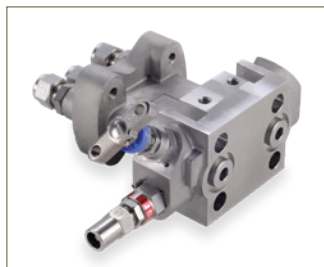

Type	MESC	Process/Vent	A-LOK® Part Number	CPI™ Part Number
C	609856.225.1	10 mm	MMHOMDS2L6098562251	MMHOMDS2B6098562251
C	609856.227.1	3/8"	MMHOMDS2L6098562271	MMHOMDS2B6098562271
C	609856.229.1	1/2"	MMHOMDS2L6098562291	MMHOMDS2B6098562291

## 2 Valve Manifold - Type D - single isolate/vent block for pressure transmitters of the differential body design

- Single isolate and vent valve
- G1/4" BSPP female port supplied with either 1/2" or 3/8" OD or 10mm OD A-LOK®/CPI™ compression fittings fitted and pinned
- PTFE seal kit included as standard
- Graphite valve packing as standard

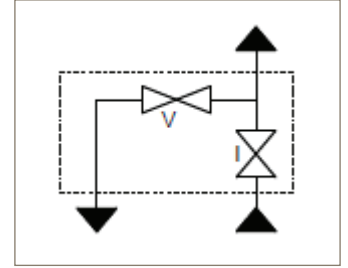
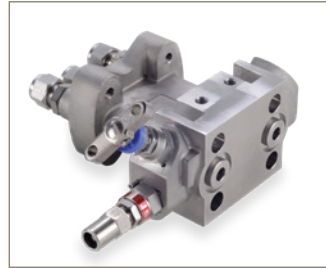

Type	MESC	Process/Vent	A-LOK® Part Number	CPI™ Part Number
D	609856.235.1	10 mm	MMHOMDS2L6098562351	MMHOMDS2B6098562351
D	609856.237.1	3/8"	MMHOMDS2L6098562371	MMHOMDS2B6098562371
D	609856.239.1	1/2"	MMHOMDS2L6098562391	MMHOMDS2B6098562391

## 2 Valve Manifold - Type E, F & G- single isolate/vent block for pressure transmitters

- Single isolate and vent
- G1/4 BSPP female port supplied with either 3/8" OD or 10mm OD A-LOK®/CPI™ compression fittings fitted and pinned

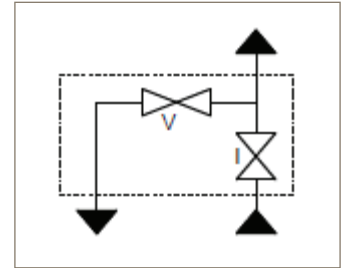

Type	MESC	Process/Vent	A-LOK® Part Number	CPI™ Part Number	Outlet
E	609856.305.1	10 mm	MMHOMLS2L6098563051	MMHOMLS2B6098563051	1/2" NPT M
E	609856.325.1	3/8"	MMHOMLS2L6098563251	MMHOMLS2B6098563251	1/2" NPT M
E	609856.345.1	1/2"	MMHOMLS2L6098563451	MMHOMLS2B6098563451	1/2" NPT M
F	609856.315.1	10 mm	MMHOMLS2L6098563151	MMHOMLS2B6098563151	1/2" NPT F
F	609856.335.1	3/8"	MMHOMLS2L6098563351	MMHOMLS2B6098563351	1/2" NPT F
F	609856.355.1	1/2"	MMHOMLS2L6098563551	MMHOMLS2B6098563551	1/2" NPT F
G	609856.317.1	10 mm	MMHOMLS2L6098563171	MMHOMLS2B6098563171	1/2" BSPP F
G	609856.337.1	3/8"	MMHOMLS2L6098563371	MMHOMLS2B6098563371	1/2" BSPP F
G	609856.357.1	1/2"	MMHOMLS2L6098563571	MMHOMLS2B6098563571	1/2" BSPP F

- Type E/F Outlet 1/2" NPT female manifold connection as standard fitted with swivel gauge adapter to above outlet options
- Type G Outlet 1/2" BSPP Female

- Notes:
- Part numbers shown are manufactured from 316 stainless steel. Other materials on request
  - Direct mount interface in accordance with DIN 19213 PT2 1980 with 54mm (2 1/8") centers
  - Bolt material ASTM A193-B8 CL2, (7/16 bolts)
  - Cast manifold body ASTM A351/CF3M
  - Equalise and vent valves with anti-tamper feature as standard - keys should be ordered separately
  - Supplied with four M8 mounting plate screws and washers

# MESC Manifolds

IEC 61518

## 4 Valve Manifold - Type A - double isolate/equalise/vent block for general applications

- IEC 61518:2001
- Dual isolate, equalise and vent valves
- G1/4" BSPP female port supplied with either 1/2" or 3/8" OD or 10mm OD A-LOK®/CPI™ compression fittings fitted and pinned
- PTFE seal kit included
- Graphite valve packing as standard

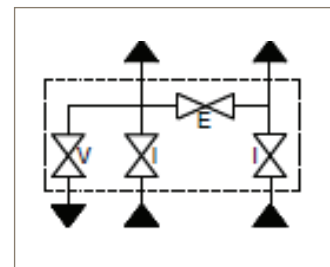
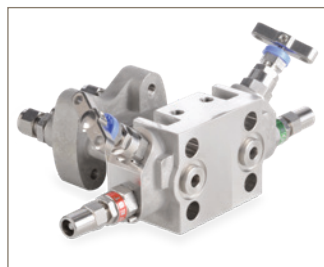

Type	MESC	Process/Vent	A-LOK® Part Number	CPI™ Part Number
A	609856.405.1	10 mm	MMHOMDS4L6098564051	MMHOMDS4B6098564051
A	609856.407.1	3/8"	MMHOMDS4L6098564071	MMHOMDS4B6098564071
A	609856.409.1	1/2"	MMHOMDS4L6098564091	MMHOMDS4B6098564091

## 4 Valve Manifold - Type B - double isolate/vent block for applications where contamination of process streams and not permitted

- IEC 61518:2001
- Dual isolate, equalise and vent valves
- G1/4" BSPP female port supplied with either 1/2" or 3/8" OD or 10mm OD A-LOK®/CPI™ compression fittings fitted and pinned
- PTFE seal kit included
- Graphite valve packing as standard

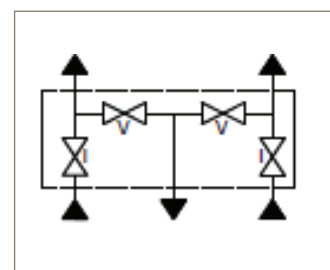
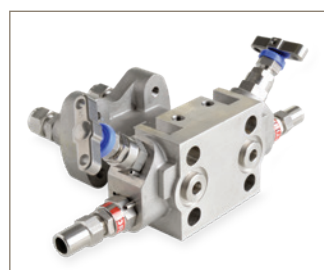

Type	MESC	Process/Vent	A-LOK® Part Number	CPI™ Part Number
B	609856.415.1	10 mm	MMHOMDS4L6098564151	MMHOMDS4B6098564151
B	609856.417.1	3/8"	MMHOMDS4L6098564171	MMHOMDS4B6098564171
B	609856.419.1	1/2"	MMHOMDS4L6098564191	MMHOMDS4B6098564191

## 2 Valve Manifold - Type C - single isolate/vent block for pressure applications and level measurement on atmospheric tanks

- IEC 61518:2001
- Single isolate, equalise and vent valves
- G1/4" BSPP female port supplied with either 1/2" or 3/8" OD or 10mm OD A-LOK®/CPI™ compression fittings fitted and pinned
- PTFE seal kit included
- Graphite valve packing as standard

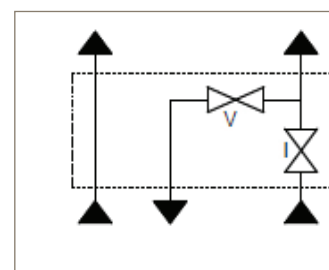
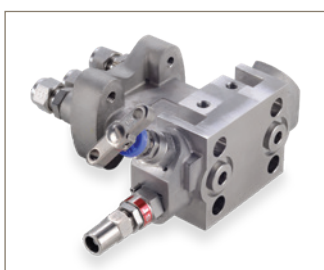

Type	MESC	Process/Vent	A-LOK® Part Number	CPI™ Part Number
C	609856.425.1	10 mm	MMHOMDS2L6098564251	MMHOMDS2B6098564251
C	609856.427.1	3/8"	MMHOMDS2L6098564271	MMHOMDS2B6098564271
C	609856.429.1	1/2"	MMHOMDS2L6098564291	MMHOMDS2B6098564291



## 2 Valve Manifold - Type D - single isolate/vent block for pressure transmitters of the differential body design

- IEC 61518:2001
- Single isolate, equalise and vent valves
- G1/4" BSPP female port supplied with either 1/2" or 3/8" OD or 10mm OD A-LOK®/CPI™ compression fittings fitted and pinned
- PTFE seal kit included
- Graphite valve packing as standard

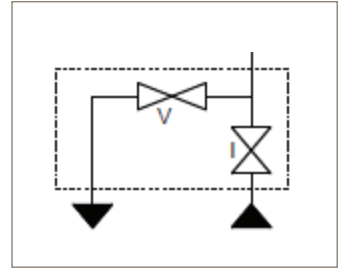
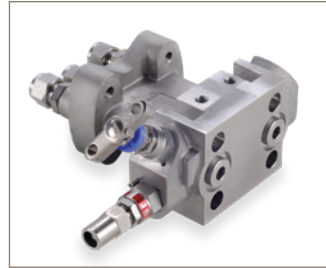

Type	MESC	Process/Vent	A-LOK® Part Number	CPI™ Part Number
D	609856.435.1	10 mm	MMHOMDS2L6098564351	MMHOMDS2B6098564351
D	609856.437.1	3/8"	MMHOMDS2L6098564371	MMHOMDS2B6098564371
D	609856.439.1	1/2"	MMHOMDS2L6098564391	MMHOMDS2B6098564391

## 2 Valve Manifold - Type E, F & G- single isolate/vent block for pressure transmitters

- IEC 61518:2001
- Single isolate and vent
- G1/4 BSPP female port supplied with either 1/2" or 3/8" OD or 10mm OD A-LOK®/CPI™ compression fittings fitted and pinned

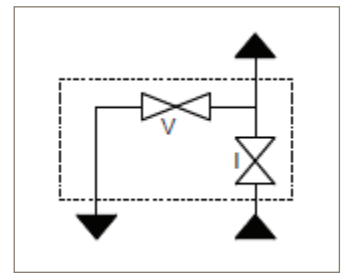

Type	MESC	Process/Vent	A-LOK® Part Number	CPI™ Part Number	Outlet
E	609856.305.1	10 mm	MMHOMLS2L6098563051	MMHOMLS2B6098563051	1/2" NPT M
E	609856.325.1	3/8"	MMHOMLS2L6098563251	MMHOMLS2B6098563251	1/2" NPT M
E	609856.345.1	1/2"	MMHOMLS2L609856345.1	MMHOMLS2B6098563451	1/2" NPT M
F	609856.315.1	10 mm	MMHOMLS2L6098563151	MMHOMLS2B6098563151	1/2" NPT F
F	609856.335.1	3/8"	MMHOMLS2L6098563351	MMHOMLS2B6098563351	1/2" NPT F
F	609856.355.1	1/2"	MMHOMLS2L609856355.1	MMHOMLS2B6098563551	1/2" NPT F
G	609856.317.1	10 mm	MMHOMLS2L6098563171	MMHOMLS2B6098563171	1/2" BSPP F
G	609856.337.1	3/8"	MMHOMLS2L6098563371	MMHOMLS2B6098563371	1/2" BSPP F
G	609856.357.1	1/2"	MMHOMLS2L609856357.1	MMHOMLS2B6098563571	1/2" BSPP F

- Type E/F Outlet 1/2" NPT female manifold connection as standard fitted with swivel gauge adapter to above outlet options
- Type G Outlet 1/2" BSPP Female fitted with swivel gauge adapter

- Notes:
- Part numbers shown are manufactured from 316 stainless steel. Other materials on request
  - Direct mount interface in accordance with IEC 61518:2001 54mm (2 1/8") centers
  - Bolt material ASTM A193-B8 CL2, (7/16 bolts)
  - Cast manifold body ASTM A351/CF3M
  - Equalise and vent valves with anti-tamper feature - keys should be ordered separately
  - Supplied with four M8 mounting plate screws and washers

# Manifold Orientation

For Liquid and Gas Applications

Valve head pointing up / Vent pointing down - Orientation for gas service

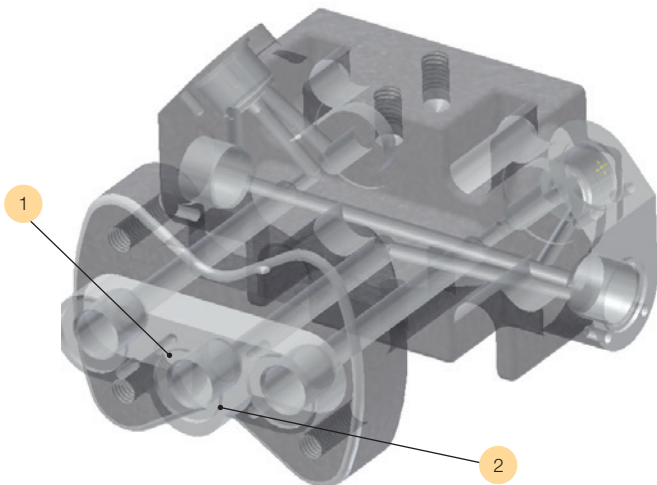

Reference	Feature
1	Vent down gas service
2	Vent lower than process ports - Liquid will vent from the system in gas service

Valve head pointing down / Vent pointing up - Orientation for Liquid service

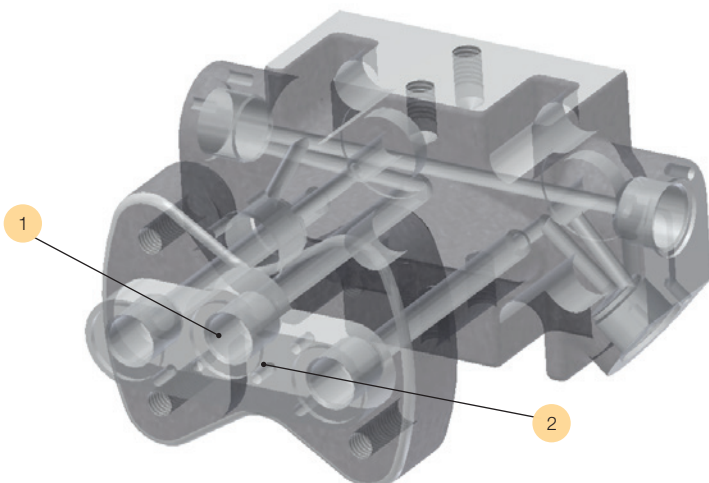

Reference	Feature
1	Vent up liquid service
2	Vent higher than process ports - Gas will vent from the system in liquid service

# MESC Manifolds

## Part Number Builder

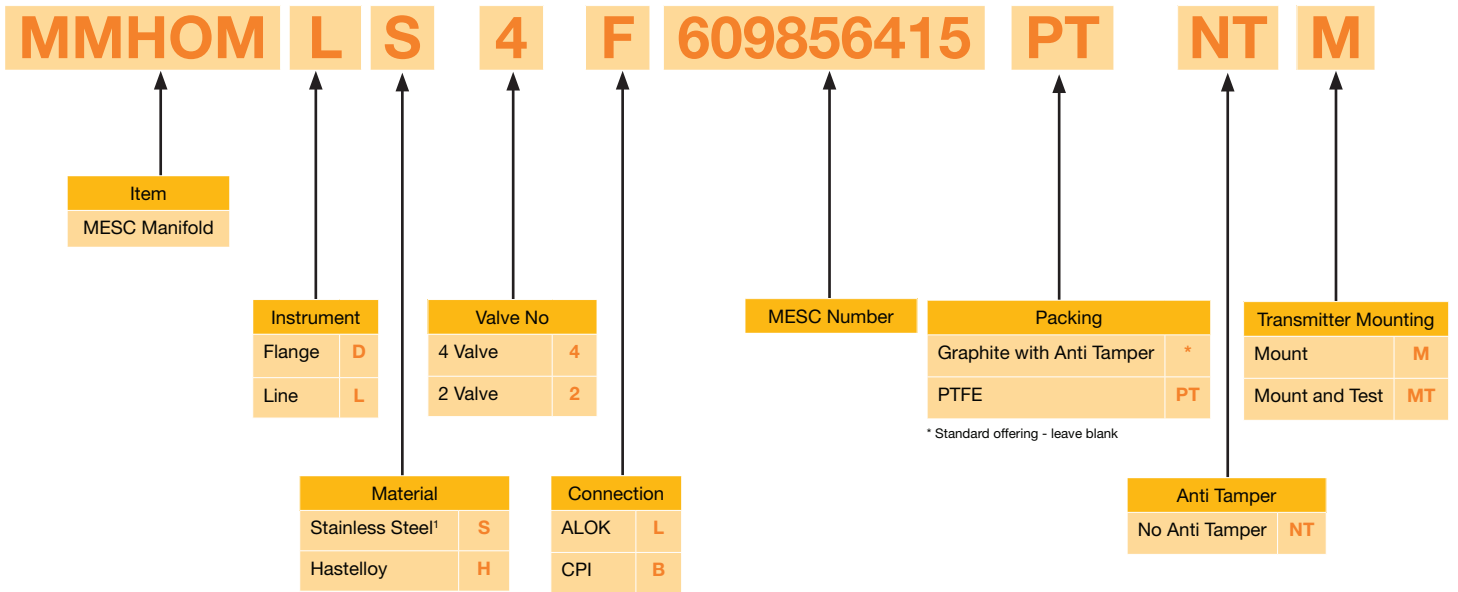

**CRN Number: 0C11191.5ADD2**

### Information required for specifying an enclosure system

Please provide the following details with your quotation request.

Quote Questionnaire		
1	Item number	
2	Quantity	
3	Liquid or level	
4	Differential Pressure/Pressure Transmitter	
5	Material	
6	External design temperature	
7	Process temperature	
8	Transmitter reference	
9	Enclosure required	
10	Sun shade required	
11	A-LOK <sup>®</sup> or CPI <sup>™</sup>	
12	Other comments	

# Instrument Monoflanges

## For Liquid and Gas Applications

The Parker instrument monoflange is an Isolate / Vent gauge block for instrumentation transmitters and pressure gauges using screwed connections on liquid or gas applications. The gauge connection is equipped with a Parker swivel gauge adaptor which enables the easy positioning of the gauge in any direction. It is suitable for horizontal or vertical mounting and can be easily assembled directly to the primary isolation valve.

### Rating

Maximum working pressure:

100 bar @ 38°C (LPR 150-600 lbs)

413 bar @ 38°C (HPR 900-2500 lbs)

Maximum working temperature:

538°C

De-rated based on ASME B16.5 Flange Class

### Connection

Instrument:

Swivel Gauge Adaptor with 1/2 NPT and G 1/2 female threads available. It can be supplied as an Integral Syphon type.

Process:

1/2" flange acc. to ASME B16.5

Available as LPR (150-600 lbs) and HPR (900-2500 lbs) RF smooth finish

Vent:

G 1/4 Female Can be equipped with A-LOK or CPI Compression Fittings

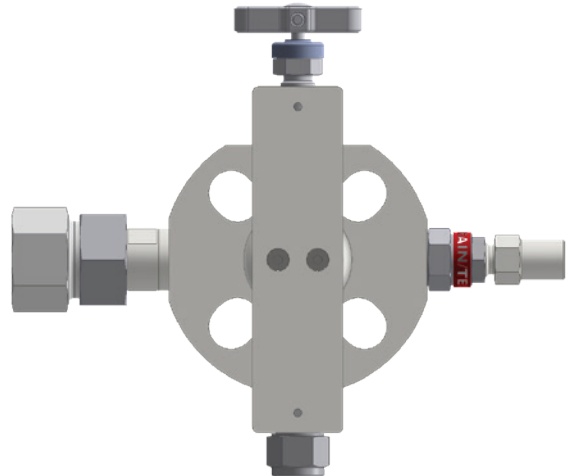
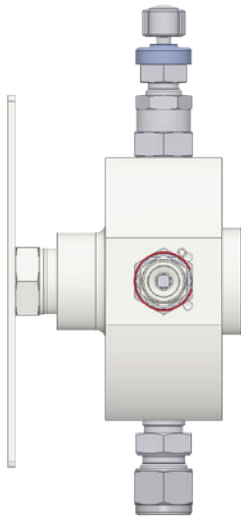

MESC	Process	Vent Connection	Gauge Connection	Description	Parker Part Number
MESC 60.98.55.200.1	1/2" [DN15] CL 150/300/600	G 1/4 (F) - 10mm	1/2" NPT (F)	Instrument Gauge Block - TYPE G ISOALTE/VENT	MMFH-6098552001-M10A
MESC 60.98.55.200.1	1/2" [DN15] CL 150/300/600	G 1/4 (F) - 3/8"	1/2" NPT (F)	Instrument Gauge Block - TYPE G ISOALTE/VENT	MMFH-6098552001-6A
MESC 60.98.55.210.1	1/2" [DN15] CL 900/1500/2500	G 1/4 (F) - 10mm	1/2" NPT (F)	Instrument Gauge Block - TYPE G ISOALTE/VENT	MMFH-6098552101-M10A
MESC 60.98.55.210.1	1/2" [DN15] CL 900/1500/2500	G 1/4 (F) - 3/8"	1/2" NPT (F)	Instrument Gauge Block - TYPE G ISOALTE/VENT	MMFH-6098552101-6A
MESC 60.98.55.220.1	1/2" [DN15] CL 150/300/600	G 1/4 (F) - 10mm	G 1/2" (F)	Instrument Gauge Block - TYPE G ISOALTE/VENT	MMFH-6098552201-M10A
MESC 60.98.55.220.1	1/2" [DN15] CL 150/300/600	G 1/4 (F) - 3/8"	G 1/2" (F)	Instrument Gauge Block - TYPE G ISOALTE/VENT	MMFH-6098552201-6A
MESC 60.98.55.230.1	1/2" [DN15] CL 900/1500/2500	G 1/4 (F) - 10mm	G 1/2" (F)	Instrument Gauge Block - TYPE G ISOALTE/VENT	MMFH-6098552301-M10A
MESC 60.98.55.230.1	1/2" [DN15] CL 900/1500/2500	G 1/4 (F) - 3/8"	G 1/2" (F)	Instrument Gauge Block - TYPE G ISOALTE/VENT	MMFH-6098552301-6A
MESC 60.98.55.300.1	1/2" [DN15] CL 150/300/600	G 1/4 (F) - 10mm	1/2" NPT (F)	Instrument Gauge Block - TYPE S ISOALTE/VENT	MMFH-6098553001-M10A
MESC 60.98.55.300.1	1/2" [DN15] CL 150/300/600	G 1/4 (F) - 3/8"	1/2" NPT (F)	Instrument Gauge Block - TYPE S ISOALTE/VENT	MMFH-6098553001-6A
MESC 60.98.55.310.1	1/2" [DN15] CL 900/1500/2500	G 1/4 (F) - 10mm	1/2" NPT (F)	Instrument Gauge Block - TYPE S ISOALTE/VENT	MMFH-6098553101-M10A
MESC 60.98.55.310.1	1/2" [DN15] CL 900/1500/2500	G 1/4 (F) - 3/8"	1/2" NPT (F)	Instrument Gauge Block - TYPE S ISOALTE/VENT	MMFH-6098553101-6A
MESC 60.98.55.320.1	1/2" [DN15] CL 150/300/600	G 1/4 (F) - 10mm	G 1/2" (F)	Instrument Gauge Block - TYPE S ISOALTE/VENT	MMFH-6098553201-M10A
MESC 60.98.55.320.1	1/2" [DN15] CL 150/300/600	G 1/4 (F) - 3/8"	G 1/2" (F)	Instrument Gauge Block - TYPE S ISOALTE/VENT	MMFH-6098553201-6A
MESC 60.98.55.330.1	1/2" [DN15] CL 900/1500/2500	G 1/4 (F) - 10mm	G 1/2" (F)	Instrument Gauge Block - TYPE S ISOALTE/VENT	MMFH-6098553301-M10A
MESC 60.98.55.330.1	1/2" [DN15] CL 900/1500/2500	G 1/4 (F) - 3/8"	G 1/2" (F)	Instrument Gauge Block - TYPE S ISOALTE/VENT	MMFH-6098553301-6A

**Note:** Vent connection is for two ferrule compression. For single ferrule compression, replace 'A' with a 'Z'.

# Enclosures and Protective Shades

## Introduction

Parker is able to supply a range of robust Glass Reinforced Plastic (GRP) Enclosures and Protective Shades to protect field mounted instrumentation from harsh environments.

An enclosure or shade covering the instrument will protect from severe weather, either extreme sunshine or sub-zero temperatures, and prevent damage to the instrumentation by airborne dirt particles settling, falling debris or even accidental breakage.

### Value

- Available with wide range of Parker manifolds
- Units available single, double and triple instruments
- Weight saving - GRP enclosures are 25% of the weight of the equivalent stainless steel units
- Corrosion free with excellent chemical resistance
- Suitable for all proprietary instruments

Parker 'PEX' Enclosure Systems are supplied 'pre-fitted' with Parker 'EXT' style Manifolds.

Parker can offer a single source supply for fully fitted packages

that are ready to install on site. Manifolds, instruments (sourced or free-issued), fittings and heating systems can be pre-fitted by Parker's assembly service, so when an enclosure arrives at the installation point it can be mounted straight on to a 2" NB pipe stand. The process and vent tubing can then be connected to the compression fittings and the instrument signal cable wired in. The system is then ready for commissioning and use.

Single source supply of instrumentation products reduces procurement costs by simplifying the process of collation and source of individual components from many suppliers and reduces engineering costs after delivery by having a ready-to-install product.

### Why Protect?

- Extend instrumentation life
- Reduce plant downtime
- Eliminate high maintenance costs

### Need any help?

If you would like to discuss the benefits of modular instrumentation systems for your plant, or would like help in configuring a manifold solution, Parker welcomes your contact - see the back page of this brochure to find your local office.

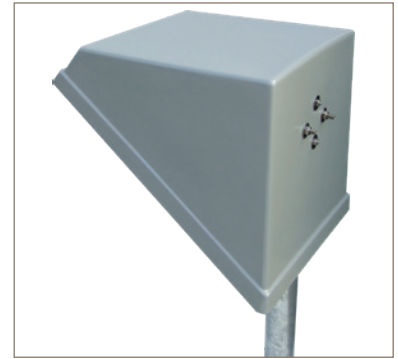

# Overview

Fully assembled systems can be supplied based on your specific project or site requirements. They can be fitted with various pressure or flow transmitters and can manage the harsh environmental and process conditions.

Item	Description
1	Parker Enclosure
2	Identification Label
3	Thermostat
4	Finned Space Heater
5	Viewing Window
6	Mounting Hub (for 2" NB Pipe Stand)
7	Propstay
8	Junction Box
9	Transmitter
10	Parker Manifold
11	Instrument and Signal Cable Gland

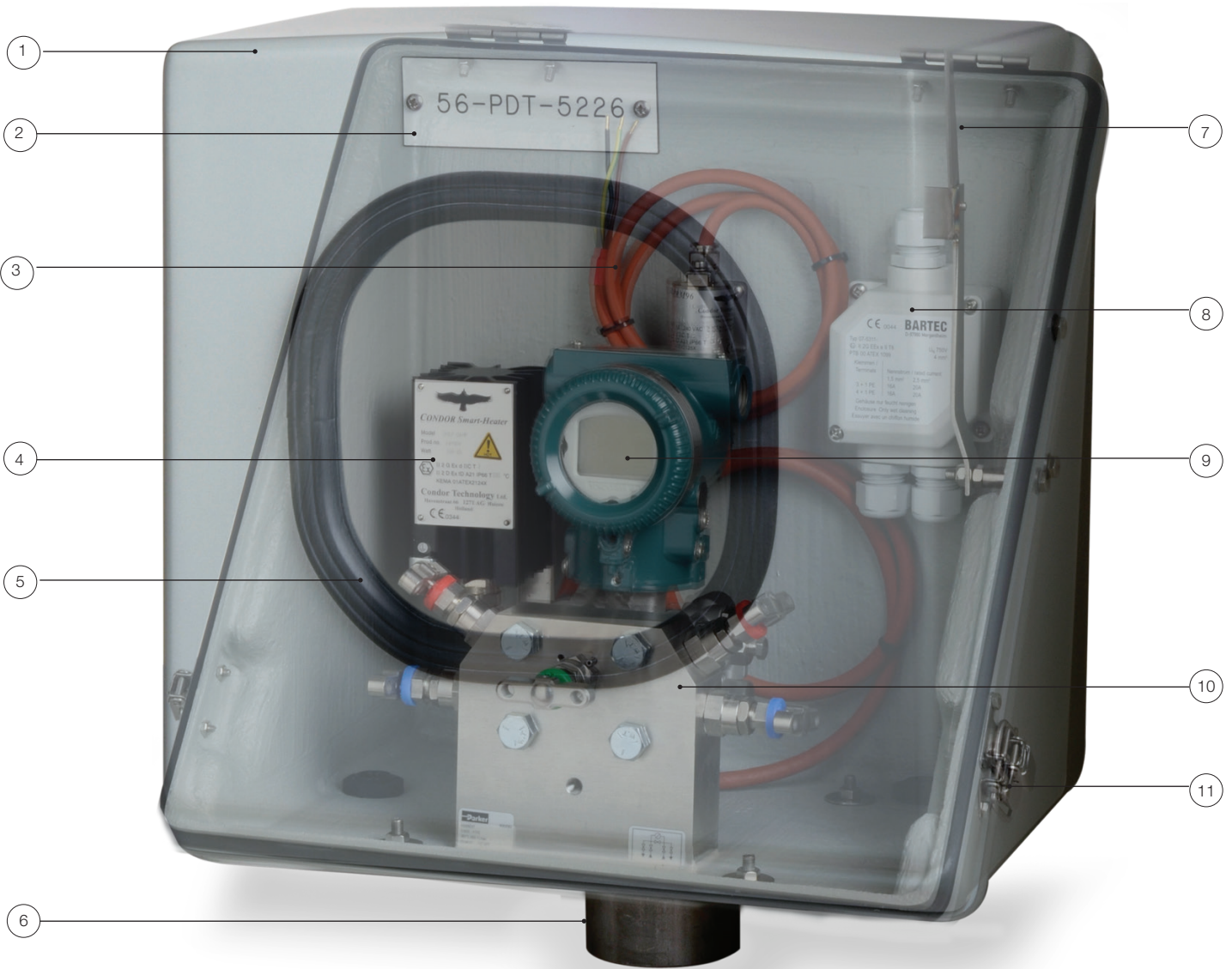

# Enclosures and Protective Shades

## MESC Manifold Enclosure System

Fully assembled systems can be supplied based on your specific project or site requirements. It can be fitted with various pressure or flow transmitters and can manage the harsh environmental and process conditions. Please contact us with your requirements.

Item	Description
1	Parker Enclosure
2	Parker Sun Shade
3	Parker Manifold
4	Parker Filling Connector
5	Parker Electrical Heater Block
6	Parker Vent & Purge Block
7	Parker Back Plate
8	Parker A-LOK® - Cat 4190-FMTG
9	Parker Grade Tube - Cat 4190-PGT
10	Terminal Box
11	Stand Pipe

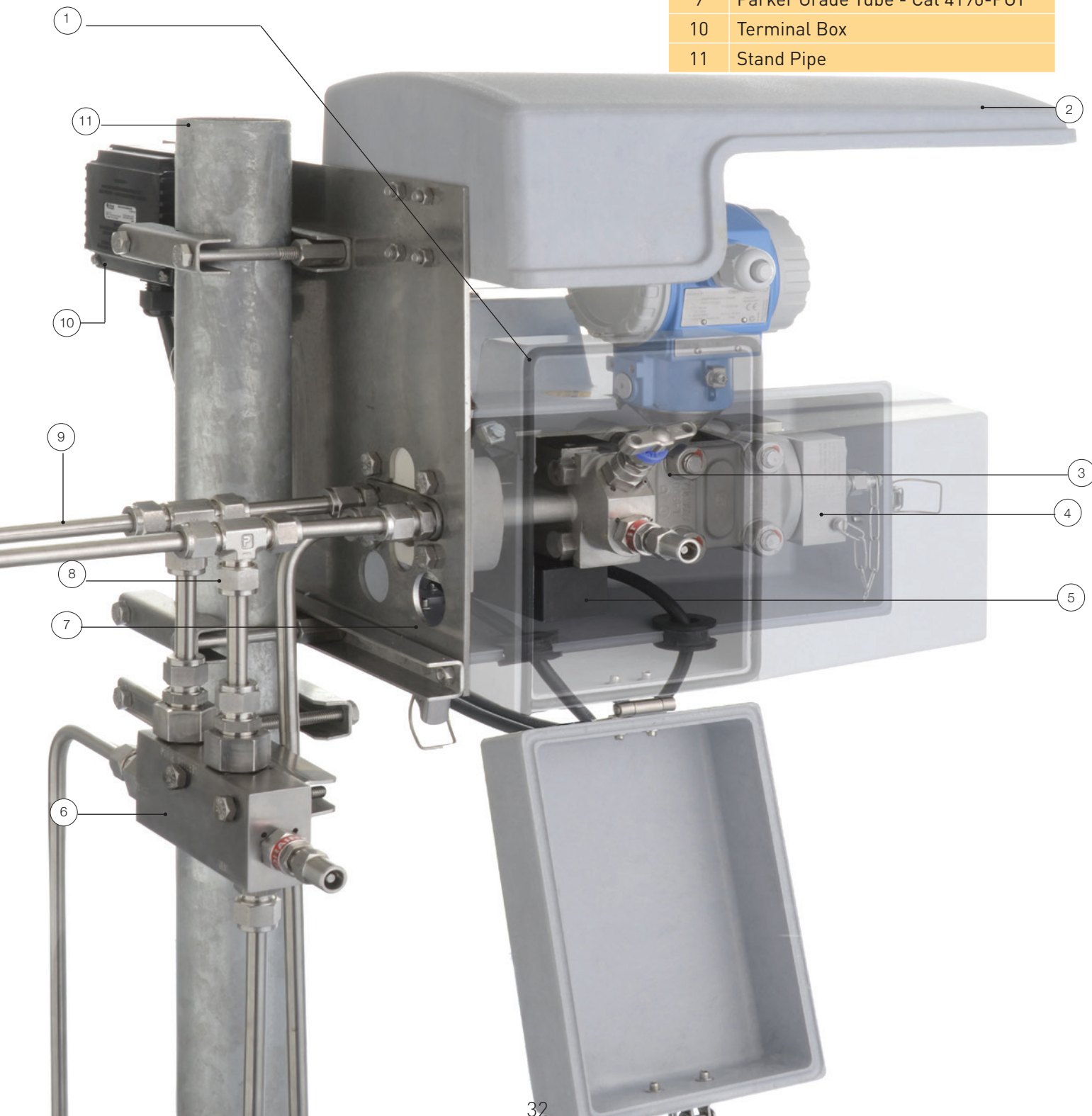



## Enclosures

The Parker instrument enclosure offering consists of a comprehensive range to suit a wide range of instrumentation applications. The enclosures have a shiny gel-coat external finish that is the same as used in the construction of boats and marine vessels. This enables Parker enclosures to withstand the demands of hostile environments.

## Other Enclosure Assembly Styles

Where Parker EXT style manifolds are not suitable (for example, where process & vent lines require 'inter-connection' within the enclosure), or the type of instrument does not require a manifold (for example transmitter with remote seals, temperature transmitter, remote indicator) Parker has alternative solutions.

## Soft Cover Enclosures

Soft cover enclosures provide insulation and protection of equipment where weight, space and access concerns exclude the use of GRP enclosures. Manufactured from silicone injected fibreglass as standard, soft cover enclosures are available in various thicknesses to suit the application conditions. Light weight yet robust construction means that the enclosures are self-supporting, removing the need for support frames, or brackets.

## Protective Shades

The Parker instrument protective shade system is a range of single, double and triple width shades that are designed to protect single instruments, two instruments side-by-side or a panel installation.

Mounting arrangements are flexible and can include 316 Stainless Steel mounting for a single or twin 2" NB pipestand, clearance holes to suit panel or wall mounting, or individual transmitter 'head' mounted applications.

Manufactured from robust GRP with an external gel-coat finish, the protective shades can protect sensitive instrumentation from the temperature damage that can be caused by direct sunshine and also falling debris and airborne dirt particles.

## Accessories

Frost protection or internal temperature maintenance within the enclosure can be achieved by either electrical or steam heating and mechanically protected polyurethane foam insulation that is encapsulated between GRP layers during manufacture. Instrumentation with indicating displays can be observed through suitably positioned viewing windows.

A complete range of options and accessories are available to enable full customisation of the enclosures to suit individual applications.

## Manifolds

Parker EXT Manifolds, purpose designed and best suited for use with enclosures, can be supplied installed within the enclosures in the following:

- 2 Valve In-Line (remote) Mount
- 2 Valve Direct Mount
- 3 Valve Direct Mount
- 5 Valve Direct Mount formats

Enclosures that are sized to suit single, double, triple or multiple instrument installations are available within the Parker enclosure system.



# Enclosure and Protective Shades

## PEX Enclosure System

### Product Description

All of the Parker 'PEX' range of enclosures have hinged lids and are fitted with Stainless Steel hinges, catches and prop stay(s). As standard each enclosure is fitted with a 316 Stainless Steel base plate with a welded stub to suit mounting the enclosure to a 2" NB pipe stand. Triple and Multi size enclosures have two welded stubs to suit either mounting to two 2" NB pipe stands, or a 'twin' 2" NB pipe stand. If required, rear mounting options are available.

The Parker 'EXT' enclosure style manifolds are fitted to either the enclosure base, or rear wall via a 316 Stainless Steel plate. Clearance holes are provided in the plate to suit the Process & Vent ports.



### Features

- GRP Fire Retardant to BS476, part 7, class 2
- Weather protection to IP66 (EN60529, NEMA 4X)
- Maintenance free 'gel-coated' inner and outer surfaces, providing superior weathering, corrosion and UV resistance (1000 hrs - QUV Accelerated Weathering Test)
- Austenitic stainless steel fittings and fixings (hinges, catches, prop stays)
- Reduced Surface Resistance (Anti-Static) option, to EN60079 (see 'finish' option) Colour = 'Mid Grey'
- Operating temperatures: -55 to +80°C (-67 to +176°F)
- Colour options include Light Grey (RAL 7032) & most other RAL / BS colour codes.
- Thermal insulation option – PU foam encapsulated between GRP layers during manufacture, providing a sealed and rigid inner surface to protect against absorption of fluids and physical damage
- Non-Absorption of Oil, Hydrocarbons & Water
- Impact resistance to ISO 179 (55kJ/m<sup>2</sup>)
- Bending Strength: 80N/mm<sup>2</sup>

Part Number	Description	Width mm	Height mm	Depth mm
PEX-S1	Compact Single Instrument Enclosure	380	395	310
PEX-S2	Standard Single Instrument Enclosure	400	450	400
PEX-D1	Enclosure to suit Double Pressure Application	600	450	400
PEX-D2	Enclosure to suit Double DP Application	700	450	400
PEX-T1	Enclosure to suit Triple Instrument Application	900	450	400
PEX-M1	Enclosure for Multi-Instrument Assemblies	500	600	500

**Note:** Listed above are standard part numbers, please use the options (opposite page) to fully specify your requirements. For other basic configurations of soft or bespoke enclosures, please contact us on 00 44 1271 313131, or email: [ipde\\_technical@parker.com](mailto:ipde_technical@parker.com)

## Options

Each option is provided with an 'Option Code' to enable the option to be specified at enquiry, or order stage. Listed below are various options that are available for all enclosures in the PEX range.

Option	Description	Code
Finish / Colour	Standard finish colour is 'Light Grey' (RAL 7032)	GR
	Other RAL / BS colours are available upon request	OC
	Reduced Surface Resistance (Anti-Static) to EN60079 Colour - 'Mid Grey'	AS
Viewing Window	Safety Glass Viewing Window(s)	SG
Insulation	Thermal Insulation to prevent 'heat loss'	IN
Tag Label	Traffolyte Tag Label - Engraved with Instrument Tag number	TT
	316 Stainless Steel Tag Label - Engraved with Instrument Tag number	TS
Instrument Signal Cable Entry Gland	'Stuffing' / 'Entry' Cable Gland to suit Instrument Signal Cable (one per instrument) - Fitted. Please specify cable OD if greater than 11.90mm	
	M20 Plastic (Blue Cap).	GP
	Brass	GB
	Brass / Nickel Plated	GN
	Stainless Steel	GS
Manifold Orientation:	The 'EXT' style of manifold (pages 10 & 11) can be installed on the base, or rear of the enclosure. Where more than one Instrument is fitted there can be a combination of base and rear mounting	
	Base mounted	MB
	Rear mounted - High	MH
	Rear mounted - Low	ML
	Base & Rear mounted manifold combination (please specify)	MC
Enclosure Mounting	Use the option code below if the enclosure requires 'Rear Mounting', instead of the standard base mount to a 2"NB pipe stand(s). Details should be supplied	
	Rear mounted enclosure	RM

## How to Order

To enquire or order a Parker PEX Enclosure the required enclosure model & enclosure options can be specified as illustrated in the example below:

For a RAL7032 Light Grey PEX-S1 enclosure that has a viewing window, with the EXT manifold mounted on the base, the following part number should be provided: PEX-S1/GR/SG/MB

NB: Required enclosure accessories and manifold part numbers will also need to be provided.

# Enclosure and Protective Shades

## PS Protective Shades

### Product Description

The Parker 'PS' protective shades are available in a wide range of sizes (single, double or triple width) to protect various instrumentation applications. 316 Stainless Steel shade mounting accessories are available to suit 2" NB pipe stand mounting and 'Instrument Head' mounting (mainly suitable for the smaller of the shade range, such as the PS-S5). Shades can be drilled to suit clients requirements, or 'bespoke' mounting can be designed and manufactured by Parker's specialist team.

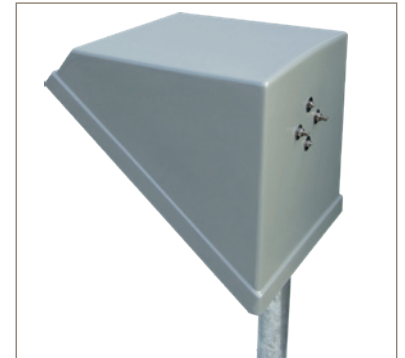

### Features

- GRP Fire Retardant to BS476, part 7, class 2
- Maintenance free 'gel-coated' inner and outer surfaces, providing superior weathering, corrosion and UV resistance (1000 hrs - QUV Accelerated Weathering Test)
- 316 Stainless Steel shade mounting options
- Reduced Surface Resistance (Anti-Static) option, to EN60079 (see 'finish' option) Colour = 'Mid Grey'
- Operating temperatures: -55 to +80°C (-67 to +176°F)
- Colour options include Light Grey (RAL 7032), White (RAL 9010) & most other RAL / BS colour codes
- Impact resistance to ISO 179 (55kJ/m<sup>2</sup>)
- Bending Strength: 80N/mm<sup>2</sup>

### Protective Shade Models

Part Number	Width mm	Height mm	Depth mm
PS-S1	360	370	455
PS-S2	500	400	450
PS-S3	450	400	600
PS-S4	530	430	640
PS-S5	220	125	365
PS-S6	345	160	405
PS-S7	300	240	250
PS-S8	405	165	315
PS-D1	700	400	450
PS-D2	600	400	600
PS-T1	1000	400	450
PS-T2	900	400	600
PS-T3	1100	400	600

## Options

Each option is provided with an 'Option Code' to enable the option to be specified at enquiry, or order stage. Listed below are various options that are available for all shades in the PS range.

Option	Description	Code
Finish / Colour	Standard finish colours are	
	'Light Grey' (RAL 7032)	GR
	'White' (RAL 9010)	WH
	Other RAL / BS colours are available upon request	OC
Shade Mounting	Reduced Surface Resistance (Anti-Static) to EN60079. Colour - 'Mid Grey'	AS
	316 Stainless Steel Mounting Kit to suit 2" NB Pipe stand mounting	M2
	316 Stainless Steel Mounting kit to suit shade mounting to the head of an Instrument (please specify Make / Model of Instrument)	MI
	Shade drilled to suit plate, wall, or clients requirements (please provide details)	MD
	Bespoke Shade Mounting (mounting designed to suit client application)	MB

## How to Order

To enquire or order a Parker PS Protective Shade the required shade model & shade options can be specified as illustrated in the example below:

For a RAL9010 White PS-S1 shade suitable for mounting to a 2" pipestand, the following part number should be provided: PS-S1/WH/M2

## Back Plates

### Product Description

Parker's range of back plates ensure the straightforward installation mounting of MESC-compliant manifolds with different accessories.

There are four types of back plates available, all featuring a clamp that allows easy mounting on a two-inch pipestand. If a protective sun shade (page 12) is required to protect your instrumentation then the type A1 or A2 back plates recommended. The plates are made of 316 stainless steel.

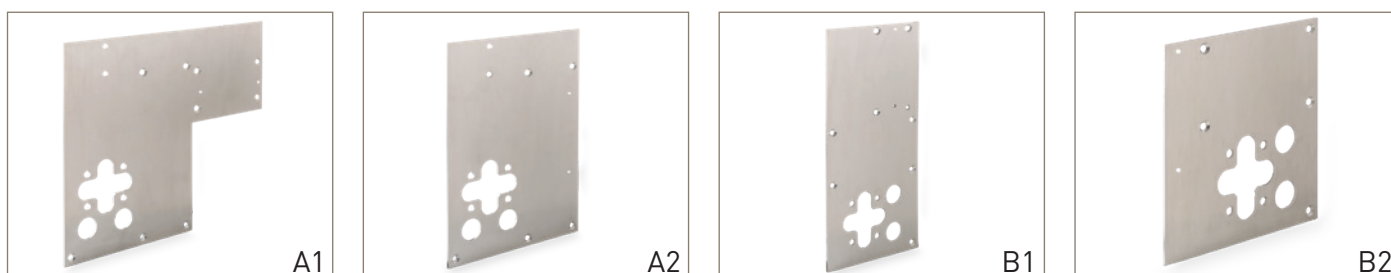

MESC	Description	Part Number
609891.105.1	Back Plate A1	MMMP-6098911051-A1
609891.110.1	Back Plate A2	MMMP-6098911101-A2
609891.118.1	Back Plate B1	MMMP-6098911181-B1
609891.120.1	Back Plate B2	MMMP-6098911201-B2

# Manifold Accessories

## Seal Pots, Purge and Heating Blocks

### Seal Pot

Parker's seal pot is designed for instrumentation systems requiring an open seal such as toxic, corrosive or high temperature service. An immiscible seal fluid is used with the seal pot. A barrier is formed in front of the manifold and instrument due to the difference in density to the process media.

### Rating

Maximum working pressure:  
413 bar (5990 psi) @ 38°C (100.4°F)  
Maximum working temperature:  
450°C (842°F)

### Volume

Approx. 50 cm<sup>3</sup>



### Placement

If the seal pot is located below the orifice plate, a seal fluid with higher specific gravity than the process medium is required.

If the seal pot is located above the orifice plate, a seal fluid with lower specific gravity is to be used.

MESC	Description	Vent	A-LOK® Part Number	CPI™ Part Number
609870.510.1	Seal Pot	10mm	MMHMSPSL6098705101	MMHMSPSB6098705101
609870.600.1		1/2"	MMHMSPSL6098706001	MMHMSPSB6098706001
609870.610.1		3/8"	MMHMSPSL6098706101	MMHMSPSB6098706101

### Purge Blocks

Parker offer a choice of single and double vent and purge blocks for MESC-compliant manifolds.

The single-vent is suitable for static pressure instrumentation applications. The double-vent is suitable for differential pressure applications, and is designed to connect to impulse lines on 54 mm (2 1/8") centres.

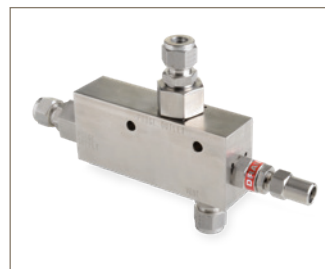

MESC	Description	Vent	A-LOK® Part Number	CPI™ Part Number
609870210.1	Single Vent Purge Block	10mm	MMVPBSSL6098702101	MMVPBSSB6098702101
609870.310.1		3/8"	MMVPBSSL6098703101	MMVPBSSB6098703101
609870.220.1	Double Vent Purge Block	10mm	MMVPBDSL6098702201	MMVPBDSB6098702201
609870.320.1		3/8"	MMVPBDSL6098703201	MMVPBDSB6098703201

Steam tracing and electrical heating blocks are available to provide frost protection or to maintain the process temperature of the media being measured. The blocks mount directly onto the manifold, providing a highly efficient conductive heat transfer to the manifold and transmitter body.

### Steam Heating

A separate stainless steel steam block which mounts directly onto the manifold is used to provide steam heating.

Two G 1/4 female ports with tube fittings provide the connection to the steam line.



MESC	Description	Vent	A-LOK® Part Number	CPI™ Part Number
609870.010.1	Steam Tracing Block	10mm	MMSTBL6098700101	MMSTBB6098700101
609870.110.1		3/8"	MMSTBL6098701101	MMSTBB6098701101

### Electrical Heating

This aluminium block mounts directly onto the manifold to provide efficient conduction heating, with a self-limiting output characteristic. The block is supplied with a cable length of 1m.

Attribute	Value
Material	Aluminium, sea water resistant
Size	90 x 40 x 30 mm
Voltage	110V - 265V
Rating	50W
Type of Protection	IP68, NEMA 4X
Explosion Proof	II 2 GD EEx d IIC T4
Certificate Number (PTB)	02 ATEX 1116X



MESC	Description	Part Number
609870.050.1	Electrical Heater	CONTACT PARKER*

**\* Note:** Heating requirements can vary depending on service. To contact the division, please telephone 00 44 1271 313131, or email: [ipde\\_technical@parker.com](mailto:ipde_technical@parker.com)

# Manifold Accessories

## Filling Connector and Port Protector

### Filling Connector

Parker's filling connector is available for use when purge protection is required but no purge block is installed. The purge medium flows through the instrument cavities allowing the system to be filled. It comes with an integral check valve.



### Rating

Maximum working pressure:  
IEC - 413 bar (5990 psi) @ 38°C  
(100.4°F)

DIN - 400BAR (5800PSI @ 38 (100.4°F)  
Maximum working temperature:  
200°C (392°F)

MESC	SEAL	Description	Part Number - DIN 19213 PT2 1980
609890.106.1	PTFE	Filling Connector 6mm	MMHFCS-6098901061
609890.107.1	PTFE	Filling Connector 1/4"	MMHFCS-6098901071
609890.307.1	PTFE	Blind Flange	MMBLFG-6098903071

MESC	SEAL	Description	Part Number - IEC 61518
609890.406.1	Graphite	Filling Connector 6mm	MMHFCS-6098904061
609890.407.1	Graphite	Filling Connector 1/4"	MMHFCS-6098904071
609890.507.1	Graphite	Blind Flange	MMBLFG-6098905071

### Port Protector

Parker's port protectors (mud dauber fittings) protect open ends of instruments, tubing, outlet vents, etc. The mesh wire screen prevents foreign bodies such as insects or debris from entering and clogging various systems and causing damage.



- Pipe plug, bored-through design
- 40 x 40 mesh .010 µm diameter wire screen
- Designed to vent female pipe, straights, elbows or tees

Description	Connection	Part Number
Port Protector 316 SS	1/4 NPT Male	4MDF - SS
Port Protector 316 SS	1/2 NPT Male	8MDF - SS
Port Protector 316 SS	1/4 BSPP Male	4RMDF - SS
Port Protector 316 SS	1/2 BSPP Male	8RMDF - SS



# Complementary Products

## Instrument Connections, Valves and Tube

### Compression Fitting Options

Products featured within this catalogue can be specified with two options of compression fittings



- Two ferrule design
- Precision machined
- Burnished cones for enhanced sealing
- Suparcase® back ferrule provides superior grip and anti corrosion properties
- Silver plated nut ensures no galling



- Suparcase® single ferrule providing superior grip and anti corrosion properties
- Molybdenum disulfide coated nut for enhanced lubrication
- Precision machined
- Vibration resistant

### H Series Manifold Features

- Rolled spindle operating threads for low torque operation
- Gland packing in PTFE or Graphite for bubble tight sealing
- Colour coded close contact dust cap and function label for easy identification
- Available in 316L, and other corrosion resistant alloys on application
- T-bar operating handle for low torque function
- Self centering crimped needle tip for bubble tight seat sealing

- Close contact dust cap for operating thread protection
- Back seated spindle for blow out prevention and minimum atmospheric leakage
- Adjustable gland with easy access
- Gland lock nut for vibration protection
- Pressure rating up to 6,000 psig (414 barg)
- Temperature rating -54°C to -538°C (-65°F to 1000°F)
- Heat code trace certification available

### For safe, reliable and repeatable performance

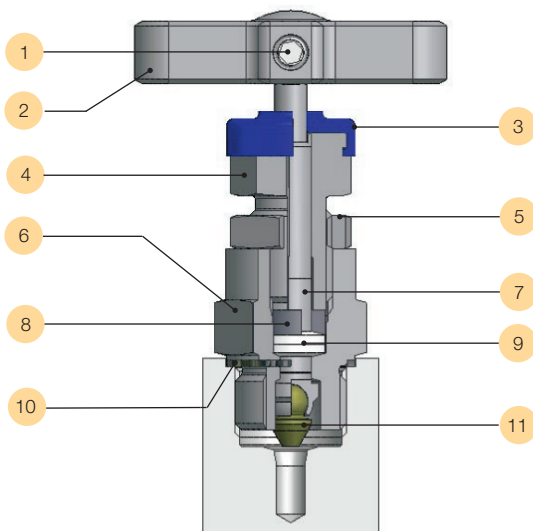

Item	Description
1	Positive handle retention
2	'T' bar
3	Dust Cap
4	Gland Packing Adjuster
5	Gland Adjuster Lock Nut
6	Valve Bonnet
7	Anti Blowout Spindle
8	Thrust Bush
9	Gland Packing (Adjustable)
10	Bonnet/Body Washer
11	Spindle Tip

# Complementary Products

Instrument Connections, Valves and Tube

## Flange Connector-Flange to Parker Tube Fittings

- Two Ferrule Compression Fitting (A-LOK®)
- Stainless Steel
- ANSI Flange Class 600



Designation	Flange Face	Part Number
316 12 mm O.D. 1/2" 600RF	Raised Face	FCBM12A8F600
316 12 mm O.D. 3/4" 600RF	Raised Face	FCBM12A12F600
316 12 mm O.D. 1/2" 600RTJ	Ring Type Joint	FCBM12A8T600
316 12 mm O.D. 3/4" 600RTJ	Ring Type Joint	FCBM12A12T600
316 12 mm O.D. 2" 600RF	Raised Face	FCBM12A32F600

## Parker Grade Tube

- Range of sizes up to 2"
- Corrosion resistant alloys
- Pressures from vacuum to 150,000 PSI



Inlet	Outlet O.D.	Part Number
1/4" NB SW	10 mm	HNVSMSW4NB60MMM10A3DRPT
1/4" NB SW	12 mm	HNVSMSW4NB60MMM12A3DRPT

## HiPro Ball Valve

- PEEK seals
- Gland packing: Graphite



Tube O.D.	Part Number
12 mm	HPBYBM12APK3

### Ball Valves B Series (Catalogue 4121-BV)

- 2-way, 3-way diverting or spring-leaded 3-way selector designs
- Wide temperature application range
- Rated up to 6000 psi (413.7 bar)



### Metering Valves HR Series (Catalogue 4170-MV)

- Bubble tight shut-off capability
- High resolution metering valve with limited hysteresis
- Seven optional valve stem tapers



### Check Valves C Series (Catalogue 4135-CV)

- Resilient, custom molded seat design
- Back stopped poppet to minimise spring stress
- Cracking Pressures: 1/3, 1, 5, 10, 25, 50, 75 and 100 psi (.023, .069, .345, .69, 1.72, 3.45, 5.17, 6.9 bar)
- Port connections include male and female NPT, CPI™, A-LOK®, UltraSeal™, VacuSeal™, BSP, SAE and Seal-Lok®



### Filters FT Series (Catalogue 4135-CV)

- Filter elements are easily replaced without disconnecting the tube lines
- Fast Loop bypass option enables a continuous self cleaning flow
- Replaceable sintered 316 stainless steel filter element
- Optional 250 and 450 micron wire cloth filter elements

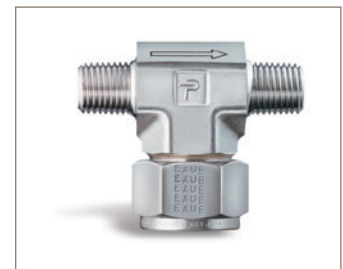

### 2, 3, 5 Valve Manifolds (Catalogue 4190-FM and 4190-PM)

- Remote and direct mount static pressure manifolds
- Integral ended connections
- Pressures up to 10,000 PSI



# Complementary Products

## Instrument Connections, Valves and Tube

### Accessories

#### **Multitube® Instrument and Heat Trace Tubing** (Catalogue 4200-M-2)

- Available in a variety of configurations
- For containment, transmission and control of pneumatic signals, gases and liquids
- Materials include copper, stainless steel, metal alloys and PFA/PTFE



#### **Sample Cylinders** (Catalogue 4160-SC)

- 1800 psig (124 barg) DOT rated sample cylinders
- Stainless steel construction
- ANSI/ASME B1.20.1 internal pipe threads



#### **Lapped Joint Tube Adaptor**

- Full heat code traceability to EN10204-3.1
- Integrally machined body, no welding.
- Eliminates additional connections.
- P.T.F.E tape or liquid thread sealants not required.
- Appropriate slipover flanges available.
- NACE MR 0175 / ISO 15156 compliance available on request.



#### **Modular Valve - Sampling**

- Specified to Customer Requirements
- Designed to replace conventional multiple-valve installations where sampling of the process stream is required
- Developed to remove a sample directly from the process stream at full system pressure



#### **Air Distribution Manifolds** (Catalogue 4190-DM)

- Specified to Customer Requirements



## Analytical Systems

### IntraFlow™ (Catalogue 4250)

- Modular instrument system
- ISA/ANSI 76.00.02 compliant
- Every component can be upgraded to Gen 2 & 3 NeSSI Technologies
- Vacuum to 500 psig (34 barg)
- Optional pressure up to 3000 psig (207 barg)

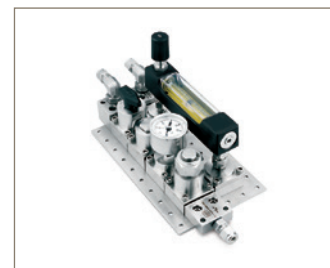

### R-max™ Gen II (Catalogue 4141-R)

- Surface mount technology for stream switching valves
- Low internal volume to reduce system purge time
- Low pressure actuation of valves-40 psig (-2.76)
- Rated from vacuum to 500 psig (34 barg)



### ChangeOver System (Catalogue 25000214)

- Compact turn-key module designed for continuous gas management
- Optional outlet regulator to control application specific outlet pressure
- Audio/visual alarm annunciator available
- Available in 316L stainless steel and brass
- Suitable for oxygen service



### Vent Master™ (Catalogue 4142-VM)

- Pre-engineered compact instrument panel that includes regulators, gauges, rotometer, an eductor and a separate pressure controller
- Creates a stable pressure within the analyzer shelter vent header system
- Provide analysis accuracy with .06% over a vent header flow of 0-18SLPM



# Complementary Products

## Instrument Connections, Valves and Tube

### Regulators

#### **Pressure Regulator IR4000 Series** (Catalogue 25000226)

- Internally threadless design
- Convoluted Hastelloy C-22® diaphragm
- Available in 316L SST, Brass, Hastelloy C-22®, Monel®
- Seals available for nitrous oxide and hydrocarbon applications
- Low dead volume
- General purpose for instrument/analyzer and semiconductor applications



#### **Pressure Regulator IR6000 Series** (Catalogue 25000141)

- Dual stage regulator
- Internally threadless design
- Convoluted Hastelloy C-22® diaphragm
- Virtually eliminates supply pressure effect
- Provides cylinder gas pressure reduction in refineries, process analytical systems and specialty gases



#### **Vaporising Regulator AVR3** (Catalogue 25000138)

- Steam heat design
- Internally threadless design
- Internal liquid volume only .5cc
- Convoluted Hastelloy C-22® diaphragm



#### **Vaporising Regulator AVR4** (Catalogue 25000137)

- Electrical heat design
- Field serviceable heat transfer element
- CSA, Cenelec and ATEX certified
- Internally threadless design
- 120v or 240v, 50/60 Hz
- Convoluted Hastelloy C-22® diaphragm





# Parker Worldwide

## Europe, Middle East, Africa

### AE – United Arab Emirates, Dubai

Tel: +971 4 8127100  
parker.me@parker.com

### AT – Austria, Wiener Neustadt

Tel: +43 (0)2622 23501-0  
parker.austria@parker.com

### AT – Eastern Europe, Wiener Neustadt

Tel: +43 (0)2622 23501 900  
parker.easteurope@parker.com

### AZ – Azerbaijan, Baku

Tel: +994 50 2233 458  
parker.azerbaijan@parker.com

### BE/LU – Belgium, Nivelles

Tel: +32 (0)67 280 900  
parker.belgium@parker.com

### BG – Bulgaria, Sofia

Tel: +359 2 980 1344  
parker.bulgaria@parker.com

### BY – Belarus, Minsk

Tel: +48 (0)22 573 24 00  
parker.poland@parker.com

### CH – Switzerland, Etoy

Tel: +41 (0)21 821 87 00  
parker.switzerland@parker.com

### CZ – Czech Republic, Klecany

Tel: +420 284 083 111  
parker.czechrepublic@parker.com

### DE – Germany, Kaarst

Tel: +49 (0)2131 4016 0  
parker.germany@parker.com

### DK – Denmark, Ballerup

Tel: +45 43 56 04 00  
parker.denmark@parker.com

### ES – Spain, Madrid

Tel: +34 902 330 001  
parker.spain@parker.com

### FI – Finland, Vantaa

Tel: +358 (0)20 753 2500  
parker.finland@parker.com

### FR – France, Contamine s/Arve

Tel: +33 (0)4 50 25 80 25  
parker.france@parker.com

### GR – Greece, Piraeus

Tel: +30 210 933 6450  
parker.greece@parker.com

### HU – Hungary, Budaörs

Tel: +36 23 885 470  
parker.hungary@parker.com

### IE – Ireland, Dublin

Tel: +353 (0)1 466 6370  
parker.ireland@parker.com

### IT – Italy, Corsico (MI)

Tel: +39 02 45 19 21  
parker.italy@parker.com

### KZ – Kazakhstan, Almaty

Tel: +7 7273 561 000  
parker.easteurope@parker.com

### NL – The Netherlands, Oldenzaal

Tel: +31 (0)541 585 000  
parker.nl@parker.com

### NO – Norway, Asker

Tel: +47 66 75 34 00  
parker.norway@parker.com

### PL – Poland, Warsaw

Tel: +48 (0)22 573 24 00  
parker.poland@parker.com

### PT – Portugal, Leca da Palmeira

Tel: +351 22 999 7360  
parker.portugal@parker.com

### RO – Romania, Bucharest

Tel: +40 21 252 1382  
parker.romania@parker.com

### RU – Russia, Moscow

Tel: +7 495 645-2156  
parker.russia@parker.com

### SE – Sweden, Spånga

Tel: +46 (0)8 59 79 50 00  
parker.sweden@parker.com

### SK – Slovakia, Banská Bystrica

Tel: +421 484 162 252  
parker.slovakia@parker.com

### SL – Slovenia, Novo Mesto

Tel: +386 7 337 6650  
parker.slovenia@parker.com

### TR – Turkey, Istanbul

Tel: +90 216 4997081  
parker.turkey@parker.com

### UA – Ukraine, Kiev

Tel: +48 (0)22 573 24 00  
parker.poland@parker.com

### UK – United Kingdom, Warwick

Tel: +44 (0)1926 317 878  
parker.uk@parker.com

### ZA – South Africa, Kempton Park

Tel: +27 (0)11 961 0700  
parker.southafrica@parker.com

## North America

### CA – Canada, Milton, Ontario

Tel: +1 905 693 3000

### US – USA, Cleveland

Tel: +1 216 896 3000

## Asia Pacific

### AU – Australia, Castle Hill

Tel: +61 (0)2-9634 7777

### CN – China, Shanghai

Tel: +86 21 2899 5000

### HK – Hong Kong

Tel: +852 2428 8008

### IN – India, Mumbai

Tel: +91 22 6513 7081-85

### JP – Japan, Tokyo

Tel: +81 (0)3 6408 3901

### KR – South Korea, Seoul

Tel: +82 2 559 0400

### MY – Malaysia, Shah Alam

Tel: +60 3 7849 0800

### NZ – New Zealand, Mt Wellington

Tel: +64 9 574 1744

### SG – Singapore

Tel: +65 6887 6300

### TH – Thailand, Bangkok

Tel: +662 186 7000

### TW – Taiwan, Taipei

Tel: +886 2 2298 8987

## South America

### AR – Argentina, Buenos Aires

Tel: +54 3327 44 4129

### BR – Brazil, Sao Jose dos Campos

Tel: +55 800 727 5374

### CL – Chile, Santiago

Tel: +56 2 623 1216

### MX – Mexico, Toluca

Tel: +52 72 2275 4200

European Product Information Centre

Free phone: 00 800 27 27 5374

(from AT, BE, CH, CZ, DE, DK, EE, EI, ES, FI, FR, IT, NL, NO, PL, RU, SE, SK, UK, ZA)

© 2021 Parker Hannifin Corporation. All rights reserved  
4190-MESC

Parker Hannifin Manufacturing Ltd  
Instrumentation Products Division Europe  
Riverside Road  
Pottington Business Park  
Barnstaple, Devon, EX31 1NP  
United Kingdom  
Tel.: +44 (0) 1271 313131  
www.parker.com/mesc

Parker Hannifin Corporation  
Instrumentation Products Division  
1005 A Cleaner Way  
Huntsville  
Alabama  
AL 35805  
USA  
Tel: + 1 (256) 881-2040  
www.parker.com/mesc

