

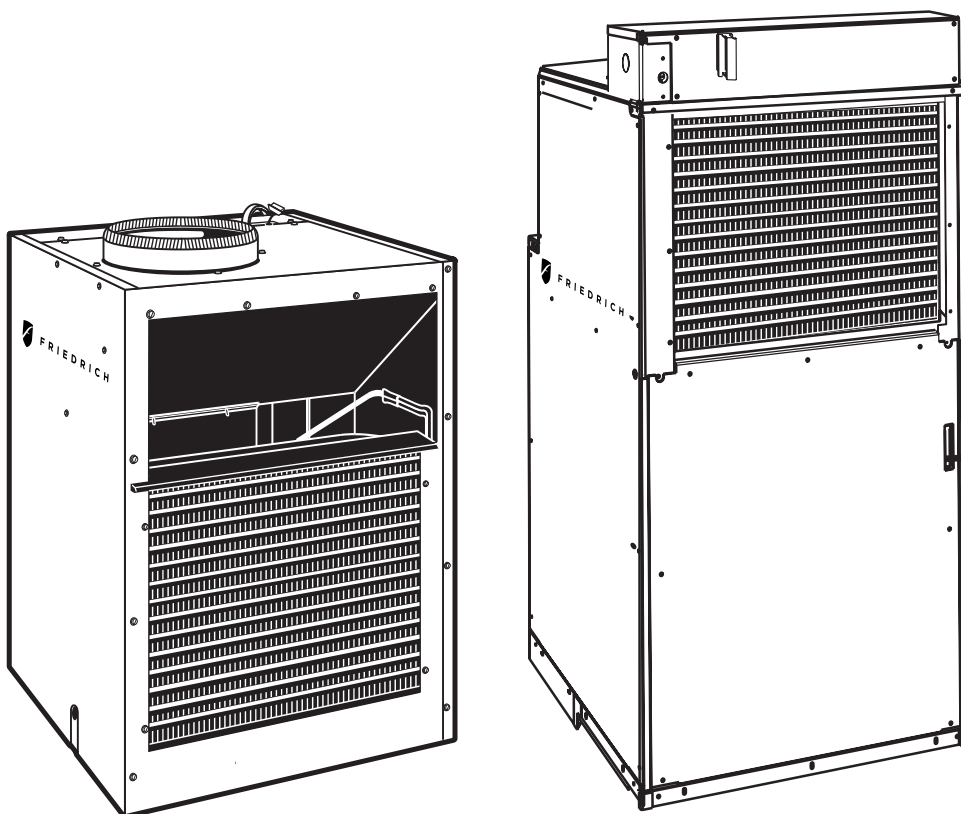

FRIEDRICH

VERT-I-PAK



Standard Chassis Models

9K VEA - 09K25RTN, 09K34RTN, 09K50RTN, 09K25RTP, 09K34RTP, 09K50RTP
VHA - 09K25RTN, 09K34RTN, 09K50RTN, 09R25RTN, 09R34RTN, 09R50RTN

12K VEA - 12K25RTN, 12K34RTN, 12K50RTN, 12K25RTP, 12K34RTP, 12K50RTP
VHA - 12K25RTN, 12K34RTN, 12K50RTN, 12R25RTN, 12R34RTN, 12R50RTN

18K VEA - 18K25RTN, 18K34RTN, 18K50RTN, 18K25RTP, 18K34RTP, 18K50RTP
VHA - 18K25RTN, 18K34RTN, 18K50RTN, 18R25RTN, 18R34RTN, 18R50RTN

24K VEA - 24K10RTP, 24K25RTP, 24K34RTP, 24K50RTP, 24K75RTP
VHA - 24K10RTN, 24K25RTN, 24K34RTN, 24K50RTN, 24K75RTN
VHA - 24R10RTN, 24R25RTN, 24R34RTN, 24R50RTN, 24R75RTN

Table of Contents

INTRODUCTION	4
Important Safety Information	4
Personal Injury Or Death Hazards	5
Operation of Equipment in During Construction	7
Equipment Identification	8
Model and Serial Number Location	8
Model and Serial Number information is found on the Manufacturer's DATA TAG, located on the front or top.	8
Model Number Reference Guide	9
SERIAL NUMBER REFERENCE GUIDE	10
SPECIFICATIONS	11
Chassis Specifications	11
Small Chassis Dimensions	11
Large Chassis Dimensions	12
Electrical Data	13
Electrical Requirements	16
Electrical Ratings Table	16
Supply Air Flow and Data	17
OPERATION	19
Electronic Control Board Features	19
Electronic Sequence of Operation	20
Compressor Lock Out Time	21
Cooling Fan Delay	21
Heating Fan Delay	21
Fan Speed Change Delay	21
Room Air Sampling Feature	21
Low Voltage Interface Connections	21
Interface Connector Definitions	21
Remote Wall Thermostat	22
Remote Wall Thermostat Location	23
Desk Control	23
Auxiliary Fan Control	23
Unit Heat Control Operation - Heat Pump With Electric Heat	24
Refrigeration Sequence Of Operation	25
REMOVE AND INSTALL THE CHASSIS	27
Remove The Chassis	27
Servicing / Chassis Quick Changeouts	27
To Remove the Chassis from the Closet:	27
R-410A SEALED SYSTEM REPAIR	28
Refrigerant Charging	29
Undercharged Refrigerant Systems	30
Overcharged Refrigerant Systems	31
Restricted Refrigerant System	32
Sealed System Method of Charging/ Repairs	33
EXTERNAL STATIC PRESSURE	34
Checking External Static Pressure	34
Explanation of charts	35
Indoor Airflow Data	35
Ductwork Preparation	35
Fresh Air Door	36
Checking Approximate Airflow	36
Electric Heat Strips	36
COMPONENT TESTING	37
Hermetic Components Check	37
Reversing Valve Description And Operation	38
Testing The Reversing Valve Solenoid Coil	39
Checking The Reversing Valve	40
Touch Test Chart : To Service Reversing Valves	42
Compressor Checks	43
Compressor Replacement -Special Procedure in Case of Compressor Burnout	46

Fan Motor	47
Capacitors	47
Heating Element and Limit Switch	48
Heater Elements And Limit Switches' Specifications	48
Drain Pan Valve	49
Thermistor Resistance Values (This Table Applies to All Thermistors)	50
Testing the Diagnostic Service Module	51
Testing the Electronic Control Board	51
Electronic Control Board Components Identification And Testing	52
TRUBLESHOOTING	53
Error Codes and Alarm Status	53
Electrical Troubleshooting Chart - Cooling	55
9K Btu, 12K Btu, & 18K Btu	55
24K Btu	56
Electrical Troubleshooting Chart - Heat Pump	57
Troubleshooting Chart - Cooling	58
WIRING DIAGRAMS	59
9-18K VEA 208/230V	59
9-18K VHA 208/230V	60
9-18K VHA 265V	61
24K VEA 208/230V 2.5/3.4/5.0	62
24K VEA 208/230V 7.5/10.0	63
24K VHA 208/230V 2.5/3.4/5.0	64
24K VHA 208/230V 7.5/10	65
24K VHA 265V 2.5/3.4/5.0	66
24K VHA 265V 7.5/10.0	67
PARTS CATALOG	68
VEA9K, VHA9K, VEA12K, VHA12K, VEA18K	68
VHA18K, VEA24K, VHA24K Figure 902	76
AVAILABLE ACCESSORIES	85
Thermostat - Rt6	86
Thermostat - Rt6p	94
Thermostat - WRT1	102
Drain Pan	116

INTRODUCTION

IMPORTANT SAFETY INFORMATION

The information in this manual is intended for use by a qualified technician who is familiar with the safety procedures required for installation and repair, and who is equipped with the proper tools and test instruments required to service this product.

Installation or repairs made by unqualified persons can result in subjecting the unqualified person making such repairs as well as the persons being served by the equipment to hazards resulting in injury or electrical shock which can be serious or even fatal.



Safety warnings have been placed throughout this manual to alert you to potential hazards that may be encountered. If you install or perform service on equipment, it is your responsibility to read and obey these warnings to guard against any bodily injury or property damage which may result to you or others.



Your safety and the safety of others is very important.

We have provided many important safety messages in this manual and on your appliance. Always read and obey all safety messages.

 This is a safety Alert symbol. This symbol alerts you to potential hazards that can kill or hurt you and others.



All safety messages will follow the safety alert symbol with the word "WARNING" or "CAUTION". These words mean:

 WARNING	Indicates a hazard which, if not avoided, can result in severe personal injury or death and damage to product or other property.
 CAUTION	Indicates a hazard which, if not avoided, can result in personal injury and damage to product or other property.
NOTICE	All safety messages will tell you what the potential hazard is, tell you how to reduce the chance of injury, and tell you what will happen if the instructions are not followed. Indicates property damage can occur if instructions are not followed.

 WARNING	
	<p style="text-align: center;">Refrigeration system under high pressure</p> <p>Do not puncture, heat, expose to flame or incinerate.</p> <p>Only certified refrigeration technicians should service this equipment.</p> <p>R410A systems operate at higher pressures than R22 equipment. Appropriate safe service and handling practices must be used.</p> <p>Only use gauge sets designed for use with R410A. Do not use standard R22 gauge sets.</p>

INTRODUCTION

PERSONAL INJURY OR DEATH HAZARDS

	 WARNING	 AVERTISSEMENT	 ADVERTENCIA
SAFETY FIRST	Do not remove, disable or bypass this unit's safety devices. Doing so may cause fire, Doing so may cause fire, injuries, or death.	Ne pas supprimer, désactiver ou contourner cette l'unité des dispositifs de sécurité, faire vous risqueriez de provoquer le feu, les blessures ou la mort.	No eliminar, desactivar o pasar por alto los dispositivos de seguridad de la unidad. Si lo hace podría producirse fuego, lesiones o muerte.

ELECTRICAL HAZARDS:

- Unplug and/or disconnect all electrical power to the unit before performing inspections, maintenance, or service.
- Make sure to follow proper lockout/tag out procedures.
- Always work in the company of a qualified assistant if possible.
- Capacitors, even when disconnected from the electrical power source, retain an electrical charge potential capable of causing electric shock or electrocution.
- Handle, discharge, and test capacitors according to safe, established, standards, and approved procedures.
- Extreme care, proper judgment, and safety procedures must be exercised if it becomes necessary to test or troubleshoot equipment with the power on to the unit.
- Do not spray water on the air conditioning unit while the power is on.
- Electrical component malfunction caused by water could result in electric shock or other electrically unsafe conditions when the power is restored and the unit is turned on, even after the exterior is dry.
- Use air conditioner on a single dedicated circuit within the specified amperage rating.
- Use on a properly grounded outlet only.
- Do not cut or modify the power supply cord or remove the ground prong of the plug.
- Never operate the unit on an extension cord.
- Follow all safety precautions and use proper and adequate protective safety aids such as: gloves, goggles, clothing, properly insulated tools, and testing equipment etc.
- Failure to follow proper safety procedures and/or these warnings can result in serious injury or death.

INTRODUCTION

PERSONAL INJURY OR DEATH HAZARDS

- **REFRIGERATION SYSTEM REPAIR HAZARDS:**

- Use approved standard refrigerant recovering procedures and equipment to relieve high pressure before opening system for repair.
- Do not allow liquid refrigerant to contact skin. Direct contact with liquid refrigerant can result in minor to moderate injury.
- Be extremely careful when using an oxy-acetylene torch. Direct contact with the torch's flame or hot surfaces can cause serious burns.
- Make certain to protect personal and surrounding property with fire proof materials and have a fire extinguisher at hand while using a torch.
- Provide adequate ventilation to vent off toxic fumes, and work with a qualified assistant whenever possible.
- Always use a pressure regulator when using dry nitrogen to test the sealed refrigeration system for leaks, flushing etc.

- **MECHANICAL HAZARDS:**

- Extreme care, proper judgment and all safety procedures must be followed when testing, troubleshooting, handling, or working around unit with moving and/or rotating parts.
- Be careful when, handling and working around exposed edges and corners of the sleeve, chassis, and other unit components especially the sharp fins of the indoor and outdoor coils.
- Use proper and adequate protective aids such as: gloves, clothing, safety glasses etc.
- Failure to follow proper safety procedures and/or these warnings can result in serious injury or death.

- **PROPERTY DAMAGE HAZARDS**

- **FIRE DAMAGE HAZARDS:**

- Read the Installation/Operation Manual for the air conditioning unit prior to operating.
- Use air conditioner on a single dedicated circuit within the specified amperage rating.
- Connect to a properly grounded outlet only.
- Do not remove ground prong of plug.
- Do not cut or modify the power supply cord.
- Do not use extension cords with the unit.
- Be extremely careful when using acetylene torch and protect surrounding property.
- Failure to follow these instructions can result in fire and minor to serious property damage.

- **WATER DAMAGE HAZARDS:**

- Improper installation, maintenance or servicing of the air conditioner unit can result in water damage to personal items or property.
- Insure that the unit has a sufficient pitch to the outside to allow water to drain from the unit.
- Do not drill holes in the bottom of the drain pan or the underside of the unit.
- Failure to follow these instructions can result in damage to the unit and/or minor to serious property damage.

INTRODUCTION

Operation of Equipment in During Construction

- **OPERATION OF EQUIPMENT MUST BE AVOIDED DURING CONSTRUCTION PHASES WHICH WILL PRODUCE AIRBORNE DUST OR CONTAMINATES NEAR OR AROUND AIR INTAKE OPENINGS:**
- Wood or metal framing;
- Drywalling or sheathing,
- Spackling or applying joint compound.
- Sanding or grinding.
- Moulding or trimwork.

NOTICE

Operating the equipment during any phase of active construction noted above can void the equipment's warranty, also leading to poor performance and premature failure

INTRODUCTION

This service manual is designed to be used in conjunction with the installation and operation manuals provided with each air conditioning system.

This service manual was written to assist the professional service technician to quickly and accurately diagnose and repair malfunctions.

Installation procedures are not given in this manual. They are given in the Installation and Operation Manual which can be acquired on the Friedrich [website \(www.friedrich.com\)](http://www.friedrich.com).

Equipment Identification



<p>MODEL NO SERIAL NO FRIEDRICH AIR CONDITIONING CO. SAN ANTONIO, TEXAS</p> <p>VOLTS: VOLTAGE RANGE: REFRIG CHARGE: DESIGN PRESSURE: COOLING: BTU/HR SEER: COP: HEAT PUMP BTU/HR: TOTAL COOLING AMPS: TOTAL ELEC. HEAT AMPS: ELECTRIC HEAT WATTS:</p> <p><u>FOR PERMANENTLY CONNECTED UNITS ONLY:</u> COMP: PLA LRA MOTOR: FLA HP HEATER AMPS: MIN. CKT AMP ~0 USE ~1 MAX. TIME DELAY FUSE OR HACR TYPE CIRCUIT BREAKER.</p> <p>GENERAL UNIT INFORMATION: MAX OUTLET AIR TEMPERATURE: 200°F MAX EXTERNAL STATIC PRESSURE ELECTRIC HEAT: .5 IN. WATER "0" CLEARANCE TO COMBUSTIBLE MATERIAL</p> <p>USE ON SINGLE OUTLET CIRCUIT ONLY</p>	<h3>WARNING</h3> <p>ELECTRICAL SHOCK AND MOVING PARTS HAZARD CAN CAUSE INJURY OR DEATH PULL OUT DISCONNECT HEAD LOCATED ON THE FRONT OF THIS UNIT TO DISABLE POWER BEFORE SERVICING.</p> 	 LISTED HEATING AND APPLICABLE PATENTS: US 6,065,296 NY MEA NO.: 295-00-E USE ONE OF THE FROM EACH CATEGORY TO COMPLETE THE ASSEMBLY WALL PLENUM: VPAWP1 -8 VPAWP1 -14 VPAL2 VPRG1 VPRG2 VPRG5
---	--	--

Figure 101 (Equipment Identification Example)

Model and Serial Number Location

Model and Serial Number information is found on the Manufacturer's DATA TAG, located on the front or top.

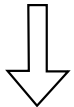
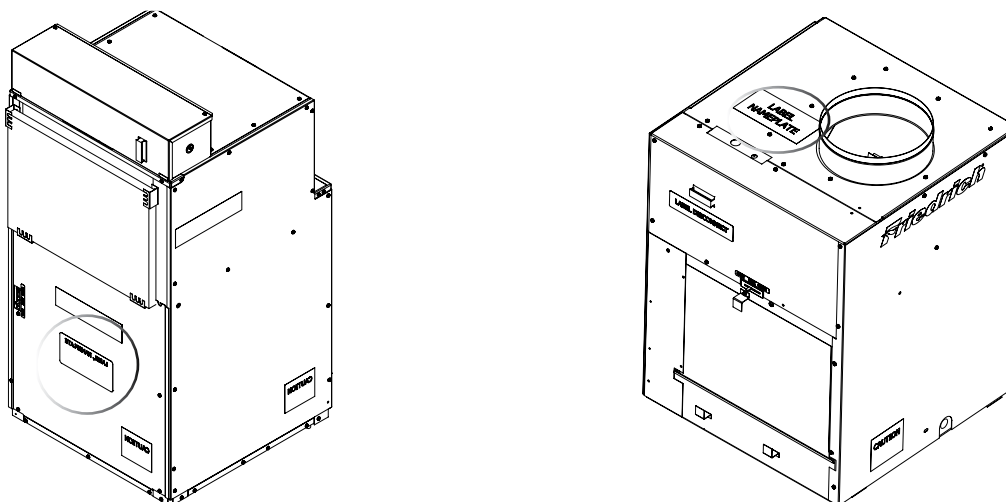
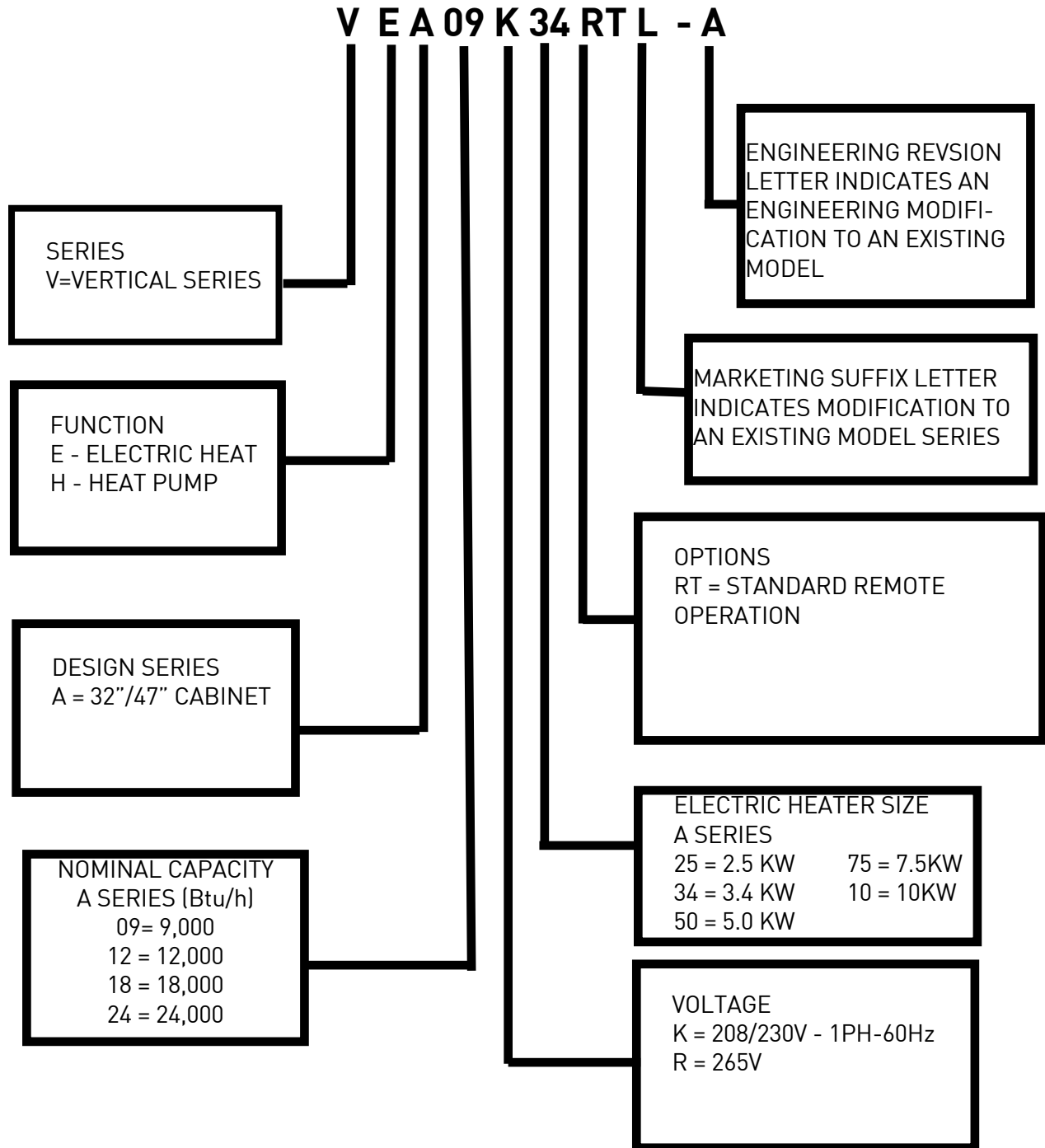

Figure 102 (Model and Serial Number Location)

INTRODUCTION

Model Number Reference Guide



IMPORTANT: It will be necessary for you to accurately identify the unit you are servicing, so you can be certain of a proper diagnosis and repair.

Figure 103

INTRODUCTION

SERIAL NUMBER REFERENCE GUIDE

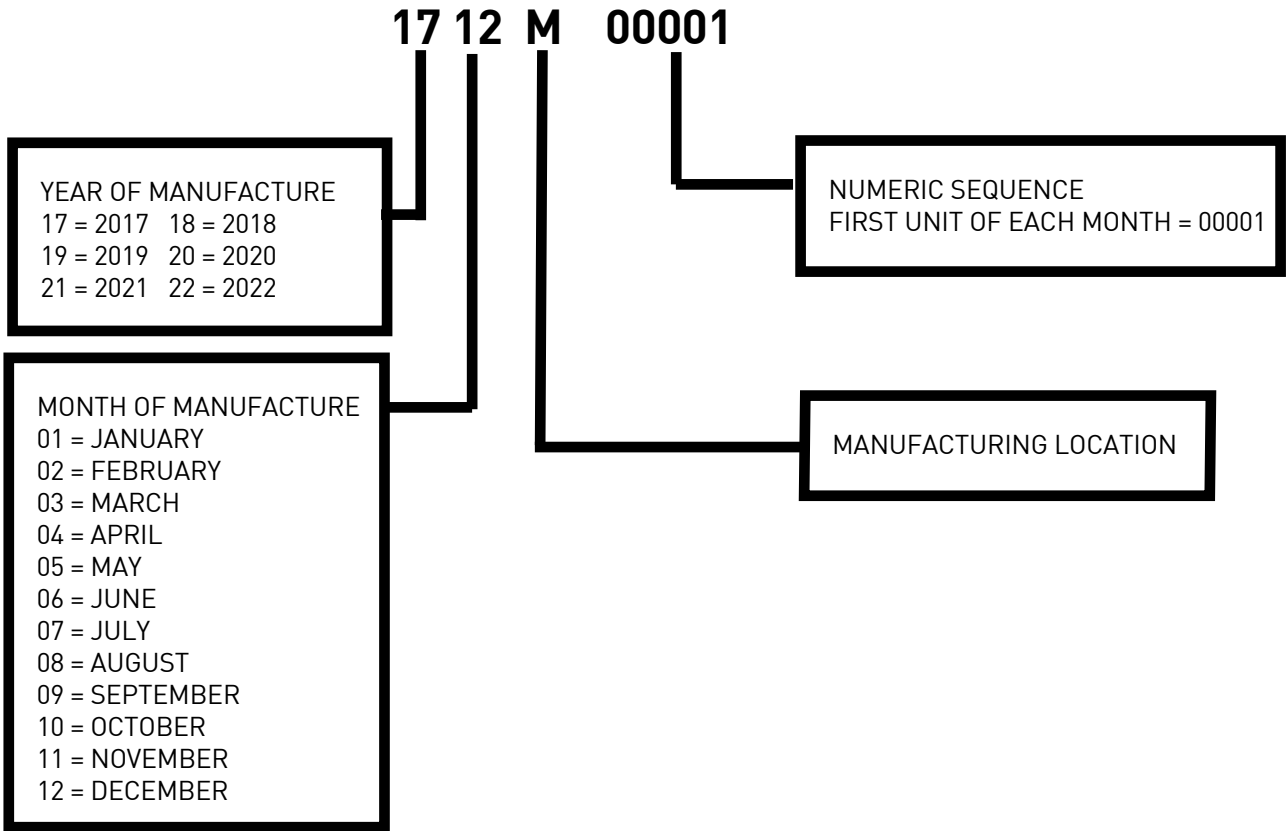

Refer to the Chart below for Serial Numbers beginning with an Alpha Sequence

SERIAL NUMBER	A	K	A	N	00001
YEAR MANUFACTURED LJ = 2009 AE = 2015 AK = 2010 AF = 2016 AA = 2011 AG = 2017 AB = 2012 AH = 2018 AC = 2013 AJ = 2019 AD = 2014					PRODUCTION RUN NUMBER
MONTH MANUFACTURED A = Jan D = Apr G = Jul K = Oct B = Feb E = May H = Aug L = Nov C = Mar F = Jun J = Sep M = Dec					PRODUCT LINE N = VPAK

Figure 104

SPECIFICATIONS

Chassis Specifications

MODEL	VEA09, VEA12, VEA18, VHA09, VHA12	VEA 24, VHA18, VHA 24
Voltage	230/208 or 265	230/208 or 265
Refrigerant	R-410A	R-410A
Chassis Width	23 1/8"	23 1/8"
Chassis Depth	23 1/8"	23 1/8"
Chasis Height**	32 1/4"	47 1/4"
Shipping W x D x H	26 x 28 1/2" x 35"	26" x 25" x 52"
Supply Factory Collar ***	10"	10"
Drain Connection	3/4" FPT	3/4" FPT
NOTE: ** Height includes 2" duct collar and isolators under unit *** Factory collar accepts 10" flex duct		

Small Chassis Dimensions

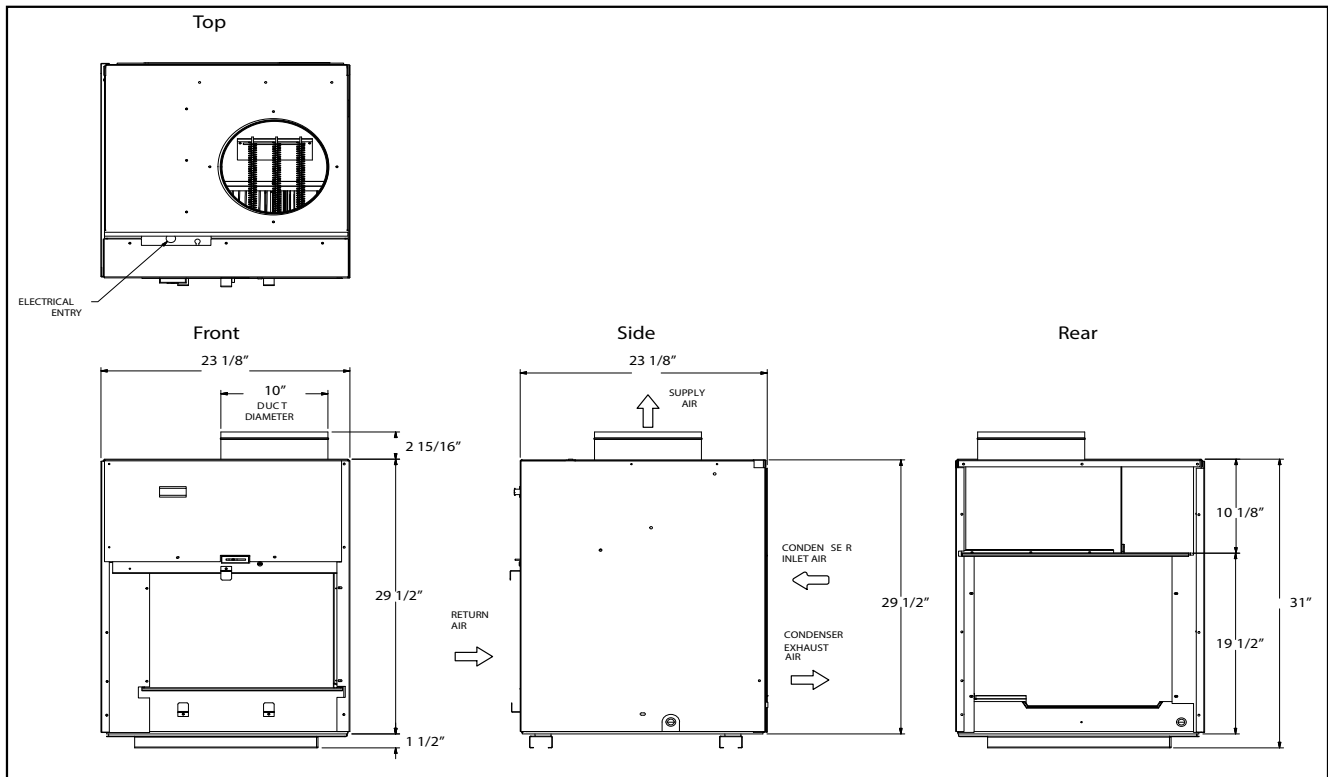

Figure 105

SPECIFICATIONS

Large Chassis Dimensions

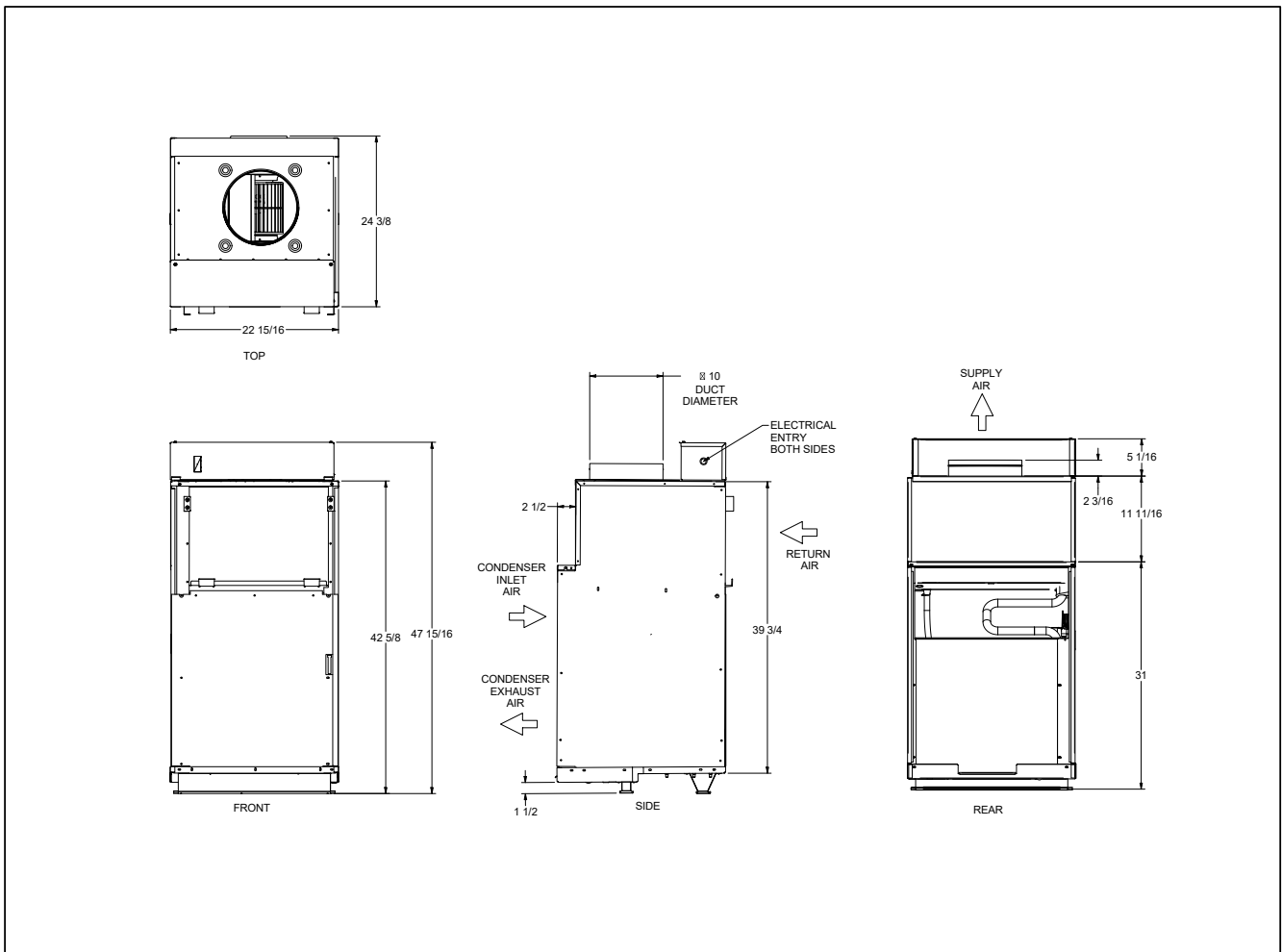

Figure 106

SPECIFICATIONS

Electrical Data

MODEL	VEA09K			VEA12K			VEA18K		
HEATER WATTS	2500/ 2050	3400/ 2780	5000/ 4090	2500/ 2050	3400/ 2780	5000/ 4090	2500/ 2050	3400/ 2780	5000/ 4090
VOLTAGE	230/208			230/208			230/208		
ELEC. HEATING CURRENT (AMPS)	12.0/11.1	16.0/14.6	22.9/20.9	12.0/11.1	16.0/14.6	22.9/20.9	12.0/11.1	16.0/14.6	22.9/20.9
MINIMUM CIRCUIT AMPACITY	15	19.9	28.6	15	19.9	28.6	15	19.9	28.6
BRANCH CIRCUIT FUSE (AMPS)	15	20	30	15	20	30	15	20	30
LRA - COMPRESSOR (AMPS)	21.0	21.0	21.0	29.5	29.5	29.5	42.0	42.0	42.0
COOLING CURRENT (AMPS)	4.2/4.4	4.2/4.4	4.2/4.4	5.2/5.6	5.2/5.6	5.2/5.6	8.8/9.5	8.8/9.5	8.8/9.5
BASIC HEATER SIZE	2.5 KW	3.4 KW	5.0 KW	2.5 KW	3.4 KW	5.0 KW	2.5 KW	3.4 KW	5.0 KW
POWER CONNECTION	HARD WIRED			HARD WIRED			HARD WIRED		
RECOMMENDED BRANCH CIRCUIT WIRE SIZES* AWG-AMERICAN WIRE GAUGE	14	12	10	14	12	10	14	12	10

MODEL	VEA24K				
HEATER WATTS	2500/ 2050	3400/ 2780	5000/ 4090	7500/ 6135	10000/ 8180
VOLTAGE	230/208				
ELEC. HEATING CURRENT (AMPS)	10.9/9.9	14.8/13.4	21.7/19.7	32.6/29.5	43.5/39.3
MINIMUM CIRCUIT AMPACITY	17.2	22.1	30.7	44.3	57.9
BRANCH CIRCUIT FUSE (AMPS)	20	25	35	45	60
LRA - COMPRESSOR (AMPS)	46.0	46.0	46.0	46.0	46.0
COOLING CURRENT (AMPS)	10.0/10.4	10.0/10.4	10.0/10.4	10.0/10.4	10.0/10.4
BASIC HEATER SIZE	2.5 kW	3.4 kW	5.0 kW	7.5 kW	10.0 kW
POWER CONNECTION	HARD WIRED				
RECOMMENDED BRANCH CIRCUIT WIRE SIZES* AWG-AMERICAN WIRE GAUGE	14	12	8	6	4

Figure 201

SPECIFICATIONS

Electrical Data

MODEL	VHA09K			VHA12K		
HEATER WATTS	2500/2050	3400/2780	5000/4090	2500/2050	3400/2780	5000/4090
VOLTAGE	230/208			230/208		
ELEC. HEATING CURRENT (AMPS)	12.0/11.1	16.0/14.6	22.9/20.9	12.0/11.1	16.0/14.6	22.9/20.9
MINIMUM CIRCUIT AMPACITY	15	19.9	28.6	15	19.9	28.6
BRANCH CIRCUIT FUSE (AMPS)	15	20	30	15	20	30
LRA - COMPRESSOR (AMPS)	21.0	21.0	21.0	30.0	30.0	30.0
COOLING CURRENT (AMPS)	4.3/4.3	4.3/4.3	4.3/4.3	5.7/5.9	5.7/5.9	5.7/5.9
BASIC HEATER SIZE	2.5 kW	3.4 kW	5.0 kW	2.5 kW	3.4 kW	5.0 kW
POWER CONNECTION	HARD WIRED			HARD WIRED		
RECOMMENDED BRANCH CIRCUIT WIRE SIZES* AWG-AMERICAN WIRE GAUGE	14	12	10	14	12	10

MODEL	VHA18K			VHA24K				
HEATER WATTS	2500/2050	3400/2780	5000/4090	2500/2050	3400/2780	5000/4090	7500/6135	10000/8180
VOLTAGE	230/208							
ELEC. HEATING CURRENT (AMPS)	10.9/9.9	14.8/13.4	21.7/19.7	10.9/9.9	14.8/13.4	21.7/19.7	32.6/29.5	43.5/39.3
MINIMUM CIRCUIT AMPACITY	14.3	19.2	27.8	17.2	22.1	30.7	44.3	57.8
BRANCH CIRCUIT FUSE (AMPS)	15	20	30	25	25	30	45	60
LRA - COMPRESSOR (AMPS)	42.0	42.0	42.0	46.0	46.0	46.0	46.0	46.0
COOLING CURRENT (AMPS)	8.6/9.2	8.6/9.2	8.6/9.2	10.6/10.9	10.6/10.9	10.6/10.9	10.6/10.9	10.6/10.9
BASIC HEATER SIZE	2.5 kW	3.4 kW	5.0 kW	2.5 kW	3.4 kW	5.0 kW	7.5 kW	10.0 kW
POWER CONNECTION	HARD WIRED							

Figure 202

SPECIFICATIONS

Electrical Data

MODEL	VHA09R			VHA12R		
HEATER WATTS	2500	3400	5000	2500	34000	5000
VOLTAGE	265			265		
ELEC. HEATING CURRENT (AMPS)	10.5	13.9	19.9	10.5	13.9	19.9
MINIMUM CIRCUIT AMPACITY	13.1	17.4	24.9	13.1	17.4	24.9
BRANCH CIRCUIT FUSE (AMPS)	15	20	30	15	20	30
LRA - COMPRESSOR (AMPS)	21.0	21.0	21.0	30.0	30.0	30.0
COOLING CURRENT (AMPS)	3.5	3.5	3.5	5.1	5.1	5.1
BASIC HEATER SIZE	2.5 kW	3.4 kW	5.0 kW	2.5 kW	3.4 kW	5.0 kW
POWER CONNECTION	HARD WIRED			HARD WIRED		
RECOMMENDED BRANCH CIRCUIT WIRE SIZES* AWG-AMERICAN WIRE GAUGE	14	12	10	14	12	10

MODEL	VHA18K			VHA24K				
HEATER WATTS	2500	3400	5000	2500	34000	5000	5000	5000
VOLTAGE	265							
ELEC. HEATING CURRENT (AMPS)	9.4	12.8	18.9	9.4	12.8	18.9	28.3	37.7
MINIMUM CIRCUIT AMPACITY	12.3	16.6	27.1	12.3	16.6	27.1	38.9	50.7
BRANCH CIRCUIT FUSE (AMPS)	15	20	30	15	20	30	40	60
LRA - COMPRESSOR (AMPS)	42.0	42.0	42.0	46.0	46.0	46.0	46.0	46.0
COOLING CURRENT (AMPS)	7.6	7.6	7.6	9.7	9.7	9.7	9.7	9.7
BASIC HEATER SIZE	2.5 kW	3.4 kW	5.0 kW	2.5 kW	3.4 kW	5.0 kW	7.5 kW	10.0 kW
POWER CONNECTION	HARD WIRED							
RECOMMENDED BRANCH CIRCUIT WIRE SIZES* AWG-AMERICAN WIRE GAUGE	14	12	10	14	12	10	6	4

Figure 203

SPECIFICATIONS

Electrical Requirements

ELECTRICAL REQUIREMENTS	
WIRE SIZE	USE ONLY WIRE SIZE RECOMMENDED FOR SINGLE OUTLET BRANCH CIRCUIT.
FUSE/CIRCUIT BREAKER	USE ONLY TYPE AND SIZE FUSE OR HACR CIRCUIT BREAKER INDICATED ON UNIT'S RATING GUIDE. PROPER OVER CURRENT PROTECTION TO THE UNITS IS THE RESPONSIBILITY OF THE OWNER.
GROUNDING	UNIT MUST BE GROUNDED FROM BRANCH CIRCUIT TO UNIT, OR THROUGH SEPARATE GROUND WIRE PROVIDED ON PERMANENTLY CONNECTED UNITS. ENSURE THAT BRANCH CIRCUIT OR GENERAL PURPOSE OUTLET IS GROUNDED.
WIRE SIZING	USE RECOMMENDED WIRE SIZE GIVEN IN TABLES AND INSTALL A SINGLE BRANCH CIRCUIT. ALL WIRING MUST COMPLY WITH LOCAL AND NATIONAL CODES. NOTE: USE COPPER CONDUCTORS ONLY.

Electrical Ratings Table

Recommended Branch Circuit Sizes*	
Nameplate Maximum Circuit Breaker Size	AWG Wiring Size**
15A	14
20A	12
30A	10
45A	6
60A	4

NOTE: Use copper conductors ONLY. Wire sizes are per NEC.
 AWG - American Wire Gauge
 * Single circuit from main box.
 ** Based on 100' or less of copper, single insulated conductor at 60° C

WARNING

Electrical Shock Hazard.

Turn OFF electric power before service or installation.

Unit must be properly grounded.

Unit must have correct fuse or circuit breaker protection. Unit's supply circuit must have the correct wire conductor size. All electrical connections and wiring must be installed by a qualified electrician and conform to the National Electrical Code and all local codes which have jurisdiction. Failure to do so can result in property damage, personal injury and/or death.

NOTE: ALL 230/208 CHASSIS MUST BE HARD WIRED WITH A PROPERLY SIZED BREAKER. SEE UNIT NAMEPLATE FOR SPECIFIC ELECTRICAL REQUIREMENTS.
 USE HACR TYPE BREAKERS TO AVOID NUISANCE TRIPS. ALL FIELD WIRING MUST BE DONE IN ACCORDANCE WITH NEC AND LOCAL CODES. IT IS THE INSTALLER'S RESPONSIBILITY TO ENSURE THAT THE ELECTRICAL CODES ARE MET.

SPECIFICATIONS

Supply Air Flow and Data

Indoor CFM & External Static Pressure

	MODEL					
	VEA09		VHA09/VEA12/ VHA12		VEA18	
FAN SPEED	LOW	HIGH	LOW	HIGH	LOW	HIGH
ESP (")	CFM					
.10"	405	450	420	450	400	480
.15"	375	420	405	425	375	465
.20"	345	385	385	400	350	450
.25"	325	365	355	375	330	390
.30"	305	340	320	350	310	330

Figure 204

	Model					
	VEA24		VHA18		VHA24	
Fan Speed	Low	High	Low	High	Low	High
ESP (")	CFM					
.10"	610	700	420	465	610	700
.15"	585	670	390	420	585	670
.20"	560	640	345	380	560	640
.25"	535	610	300	325	535	610
.30"	510	580	255	280	510	580

Figure 205

Indoor air flow may be determined by measuring the external static pressure (ESP) of the duct system using an inclined manometer or magnahelic gauge and consulting the above chart to derive actual air flow. Under no circumstances should the large chassis Vert-I-Pak equipment be operated at an external static pressure in excess of 0.4" W.C. Operation of the Vert-I-Pak under these conditions will result in inadequate air flow, leading to poor performance and/or premature component failure.

Control

For LOW speed only operation, connect the fan output terminal from the thermostat to the GL terminal of the electronic control.

For HIGH speed only operation, connect the fan output terminal from the thermostat to the GH terminal of the electronic control.

For thermostats with two-speed capability, connect the LOW speed output to the GL terminal and the HIGH speed output to the GH terminal.

SPECIFICATIONS

Supply Air Flow and Data

Building Exterior Unit Opening Requirements

VPAK units must be installed on an outside wall. Confined spaces and/or covered areas should be avoided. Units must be installed no closer than 12" apart when two units are side by side. If three or more units are to operate next to one another, maintain a minimum of 60" between units or pairs of units (Figure B). If more than two units are sharing a floor with adjacent, outset units, a minimum distance of 64" must be kept between units (Figure C). Also, a vertical clearance of 60" must be maintained (Figure A) between units. Units installed on the bottom floor must be mounted at least 6" off of the ground.

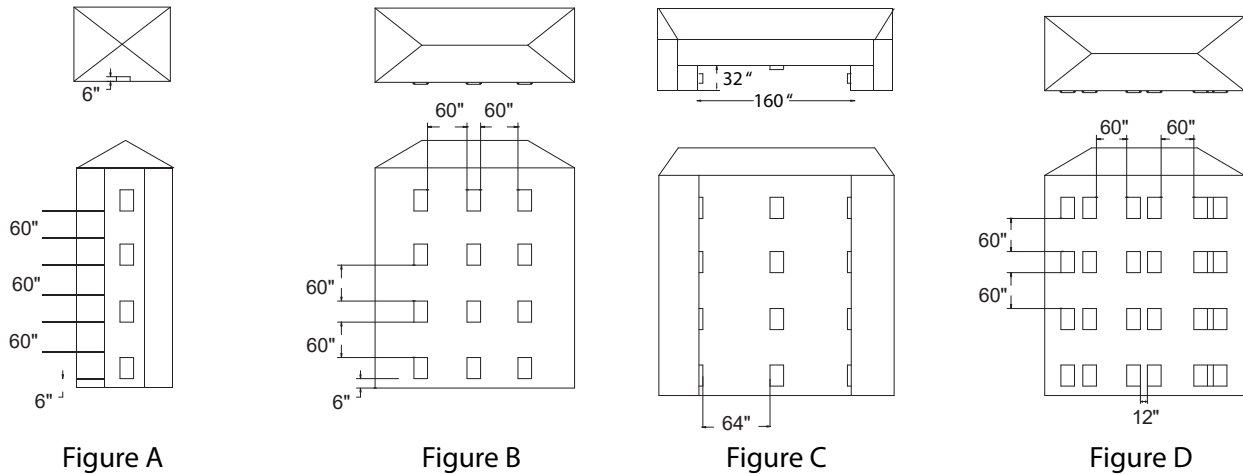

Grill Clearance Requirements

Where obstructions are present use the following guidelines for proper spacing from the VPAK exterior louvered grill. Friedrich recommends that ALL obstructions are a minimum of 72" from the exhaust.

For minor obstruction(s) such as lamp poles or small shrubbery, a clearance of 24" from the outdoor louver must be maintained.

For major obstructions such as a solid fence, wall, or other heat rejecting devices like a condensing unit, a minimum distance of 72" must be kept.

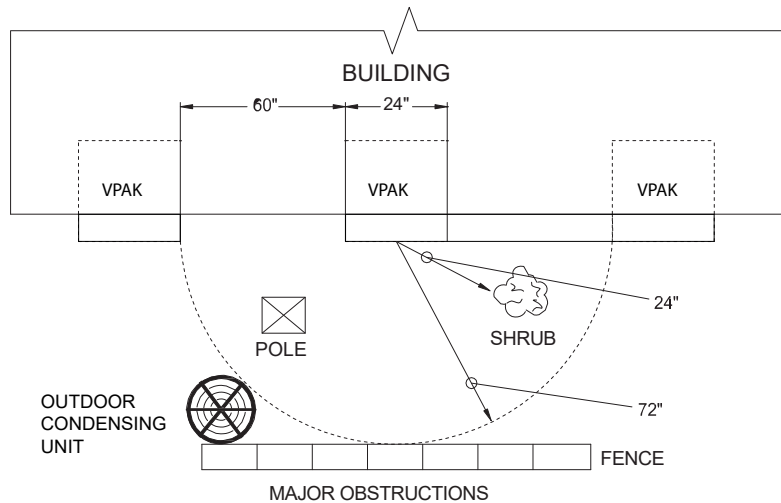

The example pictured above is for reference only and does not represent all possible installations. Please contact Friedrich Air Conditioning for information regarding effects of other installation arrangements.

Figure 206

OPERATION

ELECTRONIC CONTROL BOARD FEATURES

The Friedrich Vert-I-Pak has state of the art features to improve guest comfort and conserve energy. Below is a list of standard features on every Friedrich VPAK and their benefit to the owner.

Quiet Start/ Stop Fan Delay	The fan start and stop delays prevent abrupt changes in room acoustics due to the compressor energizing or stopping immediately. Upon call for cooling or heating the unit fan will run for 15 seconds prior to energizing the compressor. Also, the fan off delay allows for "free cooling" by utilizing the already cool indoor coil to its maximum capacity by running for 30 seconds after the compressor.
Remote Thermostat Operation	VPAK units are controlled by a wired remote wall thermostat.
Internal Diagnostic Program	The new Friedrich digital VPAK features a self diagnostic program that can alert maintenance to component failures or operating problems. The internal diagnostic program saves properties valuable time when diagnosing running problems.
Service Error Code Storage	The self diagnosis program will also store error codes in memory if certain conditions occur and correct themselves such as extreme high or low operating conditions or activation of the room freeze protection feature. Storing error codes can help properties determine if the unit faced obscure conditions or if an error occurred and corrected itself.
Random Compressor Restart	Multiple compressors starting at once can often cause electrical overloads and premature unit failure. The random restart delay eliminates multiple units from starting at once following a power outage or initial power up. The compressor delay will range from 180 to 240 seconds.
Heat Pump Units Digital Defrost Thermostat	The new Friedrich VPAK uses a digital thermostat to accurately monitor the outdoor coil conditions to allow the heat pump to run whenever conditions are correct. Running the VPAK in heat pump mode save energy and reduces operating costs. The digital thermostat allows maximization of heat pump run time.
Instant Heat Heat Pump Mode	Heat pump models will automatically run the electric heater during compressor lock-out to quickly provide heat when initially energized, then return to heat pump mode. This ensures that the room is heated quickly without the usual delay associated with heat pump units.
Room Air Sampling Feature	The room air sampling feature maintains a balanced temperature throughout the room by circulating the air for 90 seconds once every 9 minutes that the unit is not running when it is set to cooling or heating mode. By circulating the air, the unit can detect hot or cold areas in the room and operate the unit to cool or warm the room as necessary. This function is only available when the fan mode is set to 'AUTO' during COOL or HEAT Mode.
Desk Control Ready	All electronic VPAK units have low voltage terminals ready to connect a desk control energy management system. Controlling the unit's on/off operation from a remote location like the front desk can reduce energy usage and requires no additional accessories at the VPAK.
Indoor Coil Frost Sensor	The frost sensor protects the compressor from damage in the event that airflow is reduced or low outdoor temperatures cause the indoor coil to freeze. When the indoor coil reaches 30°F the compressor is disabled and the fan continues to operate based on demand. Once the coil temperature returns to 45°F the compressor returns to operation.
Auxiliary Fan Ready	The VPAK features a 24V AC terminal for connection to a relay that may be used to operate an auxiliary fan to transfer air to adjoining rooms. Auxiliary fans can provide air conditioning to odd shaped rooms.

Operation

Electronic Sequence of Operation

Note: Unit is operated by a wired remote wall t-stat which is connected to an electronic control board at the VPAK unit.

Compressor and Reversing Valve Control

Active Mode	Compressor	Reversing Valve
Cooling	On	De-Energized
Heat - Pump	On	Energized
Heat - Electric	Off	
Fan Only	Off	

Figure 341 (Compressor Operation)

Reversing Valve

The reversing valve stays in the last state until a call for heat or cooling .

The reversing valve only changes when required to provide cooling or heat pump. Leave the reversing valve in it's last state until it's required to change.

Unit Cooling Mode

Once the ambient temperature rises past the cool demand set point of the t-stat (see figure below), and the compressor is not locked out, the cooling cycle begins. As shown in the figure below, the fan is started 5 seconds prior to the compressor. Once the ambient temperature has been lowered to the cool set point, the cooling cycle starts to terminate by shutting off the compressor. After a 30 seconds delay, the fan is shut off.

Heating Mode Control Operation

There are two heating methods: Heat Pump and Electric Resistance Heat.

There are 2 Types of units that provide heating:

Cool / Heat Pump with Electric Heat and Cool with Electric heat.

Heat Mode in Cool with Electric Heat Units

When the t-stat is in the Heat Mode, if the indoor ambient temperature is below the heat set point, the fan turns on 5 seconds prior then the electric heat will turn on. When the t-stat is satisfied, the electric heat will turn off. The fan turns off 15 seconds later.

Heat Pump With Electric Heat Operation

This heating has two heating methods. If the ambient indoor temperature is below the heat set point and the compressor is not locked out, the compressor turns on. If the ambient temperature rises above the t-stat's heat set point, the compressor turns off.

If the Compressor is Locked Out on the 3 Minute Time Delay and Electric Heat is Available

1. The control turns on the electric heat until the compressor is not locked out.
2. After lockout, the control turns off the electric heat, waits 5 seconds, then turns on the compressor.(The wired remote wall t-stat's time delay may override this feature).

Condition 1

If the outdoor coil temperature sensor drops to 30 degrees F for less than 2 consecutive minutes, the unit will switch to electric heat if available. Thereafter, the unit will switch back to Heat Pump heat until the outdoor coil temperature sensor rises to 45 degrees F or greater.

OPERATION

Compressor Lock Out Time

The lockout feature ensures that the compressor is de-energized for a period of time. The timer varies randomly from 180 to 240 seconds.

The compressor lockout is initiated every time the compressor is "off" due to:

- (1) Satisfying the T-stat temperature set point
- (2) Changing mode to fan only or heat
- (3) Turning the unit off
- (4) Power is restored after failure
- (5) Line power is restored from a brown out condition

Cooling Fan Delay

This is only for t-stat Fan Auto Mode only.

When unit cycles cooling ON – starts the fan 5 seconds EARLY. When unit cycles cooling OFF – DELAYS the fan off for 30 seconds

Heating Fan Delay

This is only for Fan Auto Mode (Fan cycles with cool/heat operation) and not for continuous fan mode. When unit cycles Heating ON – starts the fan 5 seconds EARLY. When unit cycles Heating OFF – DELAYS the fan off for 15 seconds. Continuous fan operation enables fan to run continuously.

Fan Speed Change Delay

Relay activation is delayed by a minimum number of seconds. The default for this value is 2 seconds and is used to eliminate relay chatter.

Room Air Sampling Feature

The room air sampling feature maintains a balanced temperature throughout the room by circulating the air for 90 seconds once every 9 minutes that the unit is not running when it is set to cooling or heating mode. By circulating the air, the unit can detect hot or cold areas in the room and operate the unit to cool or warm the room as necessary. This function is only available when the fan mode is set to 'AUTO' during COOL or HEAT Mode.

Low Voltage Interface Connections

All Vert-I-Pak units have a low voltage interface connector through which a Remote Wall Thermostat, Desk Control and Auxiliary Fan's Relay can be connected. The interface connector is located on the electronic control board.

Interface Connector Definitions	
FP	Factory use only. (Ensure there is no jumper at FP an F2)
F2	Used with F1 to provide 24 VAC to external fan relay. (Ensure there is no jumper at FP an F2)
F1	Used with F2 to provide 24 VAC to external fan relay.
D2	Used with D1 for desk control on or off operation.
D1	Used with D2 for desk control on or off operation.
C	Common Ground Terminal
GH	Call for high fan
GL	Call for low fan
B	Call for heat pump reversing valve
Y	Call for compressor
W	Call for heating
R	24V Power from Electronic Control to Wall

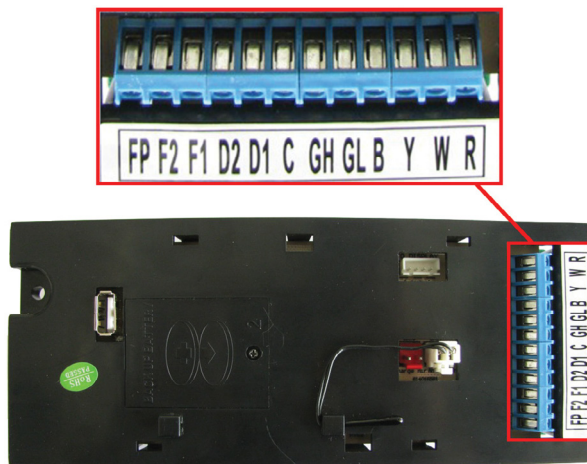

OPERATION

Remote Wall Thermostat

All Friedrich Vert-I-Pak units are factory configured to be controlled by using a single stage heat/cool remote wired wall mounted thermostat.

Thermostat Selection

Friedrich recommends the use of the Friedrich RT4 and RT6. These thermostats are single stage heat/cool, manual change-over. The RT4 is a digital display thermostat with single speed fan control. The RT6 features a digital display, two fan speed selection, temperature limiting, status indicator light, room temperature offset, and backlight. Other thermostats may be used as long as they are single stage heat/cool and are configured correctly for the unit.

Thermostat terminals requirements:

For cooling with electric heat units: C, R, G, Y, W.

For heat pump units: C, R, G, Y, W, B.

For two fan speeds, thermostat must have 2 fan speed selection.

HEAT PUMP UNITS During Heat Mode:

The B terminal must be continuously energized. The W terminal must have 24 VAC output to call for heat. The control board decides on whether to turn on the Heat Pump Heat (compressor) or Electric Heat. The Y terminal should not have 24 VAC output during heat mode.

Connecting a Remote Wall Thermostat

CONNECT THERMOSTAT USING FIGURES ON FOLLOWING PAGE AS A GUIDE.

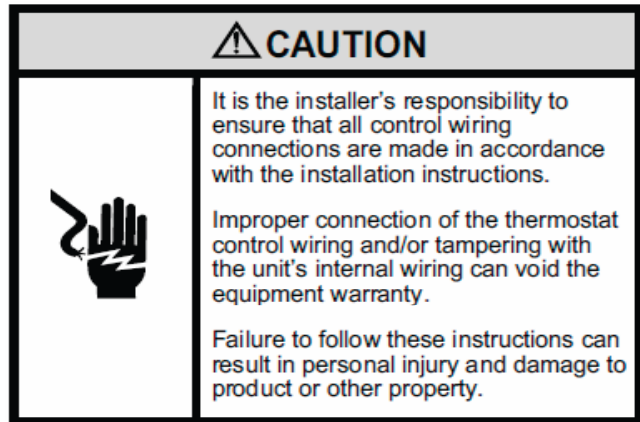
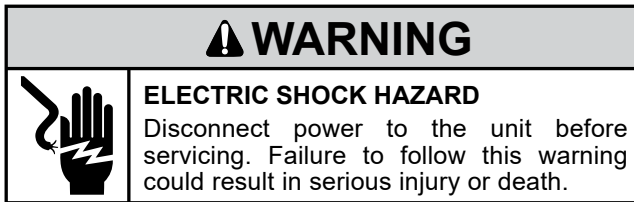

- 1) Ensure jumper Is not Installed At FP And F2
- 2) Disconnect power to the unit.
- 3) Unscrew and remove the electrical control box's cover.
- 4) Locate the Interface Connector (24 VAC terminal strip (See figure 1 at left).
- 5) Make the wire connections according to the con figuration needed for your unit Use #18 gauge wire size.
- 6) Once each wire is matched and connected, the unit is now ready to be controlled by the thermostat.
- 7) Reattach the electrical control box's cover.

OPERATION

Remote Wall Thermostat Location

The thermostat should not be mounted where it may be affected by drafts, discharge air from registers (hot or cold), or heat radiated from the sun appliances, windows etc.. The thermostat should be located about 5 Ft. above the floor in an area of average temperature, with good air circulation.

Mercury bulb type thermostats **MUST** be level to control temperature accurately to the desired set-point. Electronic digital type thermostats should be level for aesthetics.

Note: An improperly operating or poorly located remote wall thermostat can be the source of perceived equipment problems. A careful check of the thermostat's location and wiring must be made then to ensure that it is not the source of problems.

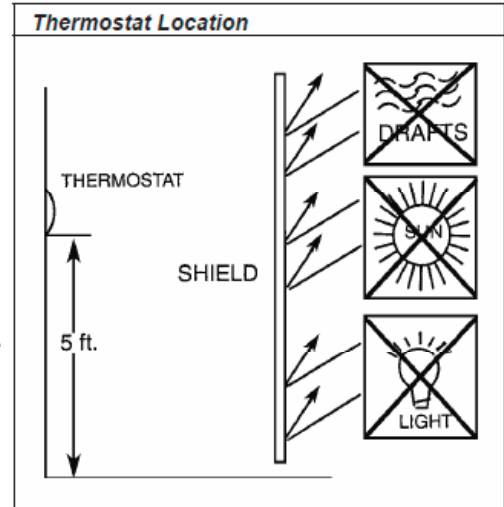

Desk Control

The unit's electronic control has built-in provisions for connection to an external switch to control power to the unit. The switch can be a central desk control system or even a normally open door switch.

For desk control operation, connect one side of the switch to the D1 terminal and the other to the D2 terminal (See page 12). Whenever the switch closes, the unit operation will stop.

Wire Size	Maximum Length
#24	400 ft.
#22	600 ft.
#20	900 ft.
#18	1500 ft.
#16	2000 ft.

Auxiliary Fan Control

The electronic control also has the ability to control a 24 VAC relay to activate an auxiliary, or transfer fan. The outputs are listed as F1 and F2 on the interface connector (See page 12).

To connect the relay, simply wire one side of the relay to F1 and the other side to F2. Anytime that the fan runs, the terminals will send a 24 VAC signal to the relay. The relay must be 24 VAC, 50mA or less.

Note: The Desk Control, Auxiliary Fan relay and wires must be field supplied.

OPERATION

Unit Heat Control Operation - Heat Pump With Electric Heat

Automatic Emergency Heat

If the sealed system fails with a bad reversing valve or anything that causes the indoor coil to get colder than the indoor ambient temperature:

- 1) If the indoor coil thermistor senses a 5 degree temperature drop as compared to the ambient temperature thermistor and this lasts up to 5 minutes, the control board will switch the unit to electric heat and continue heating with it.
- 2) At this point, error code 15 is generated; heat pump failure. Indoor coil temperature lower than indoor ambient temperature for 5 or more degrees for 5 consecutive minutes.

Note: It is Ok to continue to use the unit with the electric heater until the heat pump is repaired.

Heat Control Operation - Electric Heat Only

When in the Heat mode, with and without Fan Mode Auto (Fan cycling):

If the indoor ambient temperature is below the Heat Demand Threshold (Heat Set Point minus 1.5 °F), turn on electric heat. If Ambient is 0.3 °F above the Heat Set Point turn off the electric heat.

System Mode Auto

This mode provides automatic change over between cool and heat. The auto mode runs based on the room ambient temperature vs. the Demand Thresholds. It is only available in Heat-Cool Unit.

Notes:

There is a buffer zone between the cool and heat set points where no heating or cooling is allowed to occur. It is critical that the Cool Demand Threshold be greater than the Heat Demand Threshold by a minimum of 3° while in the Auto System Mode. For example, if a user enters a value for the Auto Cooling Set Point that violates the minimum delta 3° rule, the Auto Heating Set Point will adjust accordingly.

Automatic Change Over Delay (Cool with Heat Units)

The change over delay ensures that any system heating or cooling over shoot does not trigger an opposite demand cycle. The change over delay = 15 min. This timer blocks the opposite demand cycle from running until the timer expires. As an example, if the last demand was a cool cycle, and another cool cycle is requested, the timer will not block the request. However, if the last demand cycle was a cool cycle, and heat cycle is requested, the timer will block the request until the change over delay is expired.

Compressor Lock Out Time

The lockout feature ensures that the compressor is de-energized for a period of time. The timer varies randomly from 180 to 240 seconds

The compressor lockout is initiated every time the compressor is "off" due to:

- (1) Satisfying the temperature set point
- (2) Changing mode to fan only or heat
- (3) Turning the unit off
- (4) Control is first plugged in or power is restored after failure
- (5) Line power is restored from a brown out condition

Cooling Fan Delay

Fan cycle/Auto mode only

When unit cycles cooling ON – starts the fan 5 seconds EARLY. When unit cycles cooling OFF – DELAYS the fan off for 30 seconds.

OPERATION

Refrigeration Sequence Of Operation

A good understanding of the basic operation of the refrigeration system is essential for the service technician. Without this understanding, accurate troubleshooting of refrigeration system problems will be more difficult and time consuming, if not (in some cases) entirely impossible. The refrigeration system uses four basic principles in its operation which are as follows:

1. "Heat always flows from a warmer body to a cooler body."
2. "Heat must be added to or removed from a substance before a change in state can occur"
3. "Flow is always from a higher pressure area to a lower pressure area."
4. "The temperature at which a liquid or gas changes state is dependent upon the pressure."

The refrigeration cycle begins at the compressor when a demand is received from the thermostat. Starting the compressor creates a low pressure in the suction line which draws refrigerant gas (vapor) into the compressor. The compressor then "compresses" this refrigerant vapor, raising its pressure and its (heat intensity) temperature.

The refrigerant leaves the compressor through the discharge line as a hot high pressure gas (vapor). The refrigerant enters the condenser coil where it gives up some of its heat. The condenser fan moving air across the coil's finned surface facilitates the transfer of heat from the refrigerant to the relatively cooler outdoor air.

When a sufficient quantity of heat has been removed from the refrigerant gas (vapor), the refrigerant will "condense" (i.e. change to a liquid). Once the refrigerant has been condensed (changed) to a liquid it is cooled even further by the air that continues to flow across the condenser coil.

The design determines at exactly what point (in the condenser) the change of state (i.e. gas to a liquid) takes place. In all cases, however, the refrigerant must be totally condensed (changed) to a liquid before leaving the condenser coil.

The refrigerant leaves the condenser coil through the liquid line as a warm high pressure liquid. It next will pass through the refrigerant drier (if equipped). It is the function of the drier to trap any moisture present in the system, contaminants, and large particulate matter.

The liquid refrigerant next enters the metering device. The metering device is called a capillary tube. The purpose of the metering device is to "meter" (i.e. control or measure) the quantity of refrigerant entering the evaporator coil. In the case of the capillary tube this is accomplished (by design) through size (and length) of device, and the pressure difference present across the device. Since the evaporator coil is under a lower pressure (due to the suction created by the compressor) than the liquid line, the liquid refrigerant leaves the metering device entering the evaporator coil. As it enters the evaporator coil, the larger area and lower pressure allows the refrigerant to expand and lower its temperature (heat intensity). This expansion is often referred to as "boiling" or atomizing. Since the unit's blower is moving indoor air across the finned surface of the evaporator coil, the expanding refrigerant absorbs some of that heat. This results in a lowering of the indoor air temperature, or cooling.

The expansion and absorbing of heat cause the liquid refrigerant to evaporate (i.e. change to a gas). Once the refrigerant has been evaporated (changed to a gas), it is heated even further by the air that continues to flow across the evaporator coil.

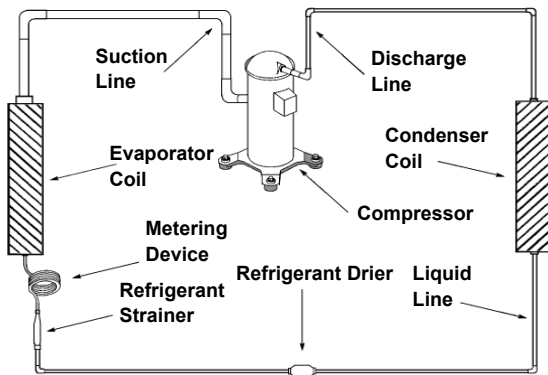

The particular system design determines at exactly what point (in the evaporator) the change of state (i.e. liquid to a gas) takes place. In all cases, however, the refrigerant must be totally evaporated (changed) to a gas before leaving the evaporator coil.

The low pressure (suction) created by the compressor causes the refrigerant to leave the evaporator through the suction line as a cool low pressure vapor. The refrigerant then returns to the compressor, where the cycle is repeated.

Routine Maintenance

Coils & Chassis

NOTE: Do not use a caustic cleaning agent on coils or base pan. Use a biodegradable cleaning agent and degreaser. The use of harsh cleaning materials may lead to deterioration of the aluminum fins or the coil end plates.

The indoor coil and outdoor coils and base pan should be inspected periodically (annually or semi-annually) and cleaned of all debris (lint, dirt, leaves, paper, etc.) as necessary. Under extreme conditions, more frequent cleaning may be required. Clean the coils with and base pan with a coil comb or soft brush and compressed air or vacuum. A low pressure washer device may also be used; however, you must be careful not to bend the aluminum fin pack. Use a sweeping up and down motion in the direction of the vertical aluminum fin pack when pressure cleaning coils.

NOTE: It is extremely important to insure that none of the electrical and/or electronic parts of the unit get wet when cleaning. Be sure to cover all electrical components to protect them from water or spray.

NOTE: When installed on or near sea coast environments, it recommended that all coils be cleaned at minimum biannually.

Decorative Front

Use a damp (not wet) cloth when cleaning the control area to prevent water from entering the unit, and possibly damaging the electronic control.

The decorative front and the cabinet can be cleaned with warm water and a mild liquid detergent. Do NOT use solvents or hydrocarbon based cleaners such as acetone, naphtha, gasoline, benzene, etc.

The indoor coil can be vacuumed with a dusting attachment if it appears to be dirty. DO NOT BEND FINS. The outdoor coil can be gently sprayed with a garden hose.

The air filter should be inspected weekly and cleaned if needed by vacuuming with a dust attachment or by cleaning in the sink using warm water and a mild dishwashing detergent. Dry the filter thoroughly before reinstalling. Use caution, the coil surface can be sharp.

Fan Motor & Compressor

The fan motor & compressor are permanently lubricated and require no additional lubrication.

Wall Sleeve

Inspect the inside of the wall sleeve and drain system periodically (annually or semi-annually) and clean as required. Under extreme conditions, more frequent cleaning may be necessary. Clean both of these areas with an antibacterial and antifungal cleaner. Rinse both items thoroughly with water and ensure that the drain outlets are operating correctly. Check the sealant around the sleeve and reseal areas as needed.

Inspect for mold or mildew periodically. If present, ensure the sealing gasket around the unit is in good condition and not allowing outside air (or light) through the gasket.

Blower Wheel / Housing / Condenser Fan / Shroud

Inspect the indoor blower and its housing, evaporator blade, condenser fan blade and condenser shroud periodically (yearly or bi-yearly) and clean of all debris (lint, dirt, mold, fungus, etc.). Clean the blower housing area and blower wheel with an antibacterial / antifungal cleaner. Use a biodegradable cleaning agent and degreaser on condenser fan and condenser shroud. Use warm or cold water when rinsing these items. Allow all items to dry thoroughly before reinstalling them.

Electrical / Electronic

Periodically (at least yearly or bi-yearly) inspect all control components: electronic, electrical and mechanical, as well as the power supply. Use proper testing instruments (voltmeter, ohmmeter, ammeter, wattmeter, etc.) to perform electrical tests. Use an air conditioning or refrigeration thermometer to check room, outdoor and coil operating temperatures.

Air Filter

To ensure proper unit operation, the air filter should be cleaned at least monthly, and more frequently if conditions warrant. The unit must be turned off before the filter is cleaned.

REMOVE AND INSTALL THE CHASSIS

Remove The Chassis

⚠ WARNING	
	<p>ELECTRIC SHOCK HAZARD</p> <p>Turn off electric power before service or installation.</p> <p>All electrical connections and wiring MUST be installed by a qualified electrician and conform to the National Electrical Code and all local codes which have jurisdiction.</p> <p>Failure to do so can result in personal injury or death.</p>

⚠ WARNING	
	<p>CUT/SEVER HAZARD</p> <p>Be careful with the sharp edges and corners. Wear protective clothing and gloves, etc.</p> <p>Failure to do so could result in serious injury.</p>

Servicing / Chassis Quick Changeouts

The chassis is designed for quick disconnect and change out. For minor electrical service, the control box cover lifts straight up after the screws & disconnect head are removed. For major electrical, refrigeration and fan service the chassis may be removed from utility closet.

To Remove the Chassis from the Closet:

- A. Disconnect the power coming into the unit from the main breaker panel or the closet mounted disconnect.
- B. Switch the wall Thermostat off.
- C. Pull the Power Disconnect located in the front of the chassis.
- D. Disconnect the electrical connection.
- E. Disconnect the duct work.
- F. Disconnect condensate drain on 9-18,000 BTU models (2018 18,000 BTU models excluded).
- G. Slide the chassis out of the wall plenum.
- H. Lift the chassis out of the utility closet.

R-410A SEALED SYSTEM REPAIR

⚠ WARNING



Refrigeration system under high pressure

Do not puncture, heat, expose to flame or incinerate.
Only certified refrigeration technicians should service this equipment.
R410A systems operate at higher pressures than R22 equipment. Appropriate safe service and handling practices must be used.
Only use gauge sets designed for use with R410A. Do not use standard R22 gauge sets.

The following is a list of important considerations when working with R-410A equipment

1. R-410A pressure is approximately 60% higher than R-22 pressure.
2. R-410A cylinders must not be allowed to exceed 125 F, they may leak or rupture.
3. R-410A must never be pressurized with a mixture of air, it may become flammable.
4. Servicing equipment and components must be specifically designed for use with R-410A and dedicated to prevent contamination.
5. Manifold sets must be equipped with gauges capable of reading 750 psig (high side) and 200 psig (low side), with a 500-psig low-side retard.
6. Gauge hoses must have a minimum 750-psig service pressure rating
7. Recovery cylinders must have a minimum service pressure rating of 400 psig, (DOT 4BA400 and DOT BW400 approved cylinders).
8. POE (Polyol-Ester) lubricants must be used with R-410A equipment.
9. To prevent moisture absorption and lubricant contamination, do not leave the refrigeration system open to the atmosphere longer than 1 hour.
10. Weigh-in the refrigerant charge into the high side of the system.
11. Introduce liquid refrigerant charge into the high side of the system.
12. For low side pressure charging of R-410A, use a charging adaptor.
13. Use Friedrich approved R-410A filter dryers only.

⚠ WARNING

EPA 608 Warning:
It is a violation of the environmental Protection Agency, Claus608A, to service refrigeration systems without proper certification

IMPORTANT

SEALED SYSTEM REPAIRS TO COOL-ONLY MODELS REQUIRE THE INSTALLATION OF A LIQUID LINE DRIER.

EQUIPMENT REQUIRED:

1. Electrical Multimeter
2. E.P.A. Approved Refrigerant Recovery System
3. Vacuum Pump (capable of 200 microns or less vacuum.)
4. Acetylene Welder
5. Electronic Halogen Leak Detector capable of detecting HFC (Hydrofluorocarbon) refrigerants.
6. R410A Refrigerant Manifold
7. 1/4" Braze-type Access Ports
8. Pinch Tool
9. Refrigerant Scale
10. Vacuum Gauge - (0 - 1000 microns)
11. Facilities for flowing nitrogen through refrigeration tubing during all brazing processes.

EQUIPMENT MUST BE CAPABLE OF:

1. Recovering refrigerant to EPA required levels.
2. Evacuation from both the high side and low side of the system simultaneously.
3. Introducing refrigerant charge into high side of the system.
4. Accurately weighing the refrigerant charge introduced into the system.

R-410A SEALED SYSTEM REPAIRS

⚠ WARNING	
	RISK OF ELECTRIC SHOCK Unplug and/or disconnect all electrical power to the unit before performing inspections, maintenances or service. Failure to do so could result in electric shock, serious injury or death.

⚠ WARNING	
	HIGH PRESSURE HAZARD Sealed Refrigeration System contains refrigerant and oil under high pressure. Proper safety procedures must be followed, and proper protective clothing must be worn when working with refrigerants. Failure to follow these procedures could result in serious injury or death.

Refrigerant Charging

NOTE: Because the refrigerant system is a sealed system, service process tubes will have to be installed. First install a line tap and remove refrigerant from system. Make necessary sealed system repairs and vacuum system. Crimp process tube line and solder end shut. Do not leave a service valve in the sealed system.

Proper refrigerant charge is essential to proper unit operation. Operating a unit with an improper refrigerant charge will result in reduced performance (capacity) and/or efficiency. Accordingly, the use of proper charging methods during servicing will insure that the unit is functioning as designed and that its compressor will not be damaged.

Too much refrigerant (overcharge) in the system is just as bad (if not worse) than not enough refrigerant (undercharge). They both can be the source of certain compressor failures if they remain uncorrected for any period of time. Quite often, other problems (such as low air flow across evaporator, etc.) are misdiagnosed as refrigerant charge problems. The refrigerant circuit diagnosis chart will assist you in properly diagnosing the systems.

An overcharged unit will return liquid refrigerant (slugging) back to the suction side of the compressor eventually causing a mechanical failure within the compressor. This mechanical failure can manifest itself as valve failure, bearing failure, and/or other mechanical failure. The specific type of failure will be influenced by the amount of liquid being returned, and the length of time the slugging continues.

Not enough refrigerant (undercharge) on the other hand, will cause the temperature of the suction gas to increase to the point where it does not provide sufficient cooling for the compressor motor. When this occurs, the motor winding temperature will increase causing the motor to overheat and possibly cycle open the compressor overload protector. Continued overheating of the motor windings and/or cycling of the overload will eventually lead to compressor motor or overload failure.

R-410A SEALED SYSTEM REPAIRS

⚠ WARNING	
	RISK OF ELECTRIC SHOCK Unplug and/or disconnect all electrical power to the unit before performing inspections, maintenances or service. Failure to do so could result in electric shock, serious injury or death.

Undercharged Refrigerant Systems

An undercharged system will result in poor performance (low pressures, etc.) in both the heating and cooling cycle.

Whenever you service a unit with an undercharge of refrigerant, always suspect a leak. The leak must be repaired before charging the unit.

To check for an undercharged system, turn the unit on, allow the compressor to run long enough to establish working pressures in the system (15 to 20 minutes).

During the cooling cycle you can listen carefully at the exit of the metering device into the evaporator; an intermittent hissing and gurgling sound indicates a low refrigerant charge. Intermittent frosting and thawing of the evaporator is another indication of a low charge, however, frosting and thawing can also be caused by insufficient air over the evaporator or partial restriction in the refrigeration system besides the metering device..

Checks for an undercharged system can be made at the compressor. If the compressor seems quieter than normal, it is an indication of a low refrigerant charge.

⚠ WARNING	
	HIGH PRESSURE HAZARD Sealed Refrigeration System contains refrigerant and oil under high pressure. Proper safety procedures must be followed, and proper protective clothing must be worn when working with refrigerants. Failure to follow these procedures could result in serious injury or death.

A check of the amperage drawn by the compressor motor should show a lower reading. (Check the Unit Specification.) After the unit has run 10 to 15 minutes, check the gauge pressures. Gauges connected to system with an undercharge will have low head pressures and substantially low suction pressures.

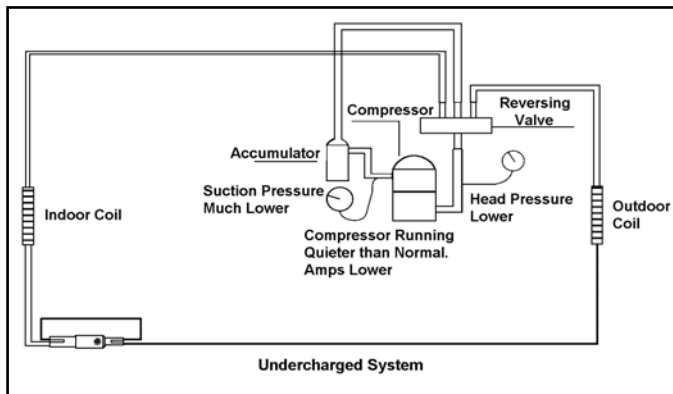



Figure 601 (Undercharged System)

R-410A SEALED SYSTEM REPAIRS

⚠ WARNING	
	RISK OF ELECTRIC SHOCK Unplug and/or disconnect all electrical power to the unit before performing inspections, maintenances or service.
	Failure to do so could result in electric shock, serious injury or death.

Overcharged Refrigerant Systems

Whenever an overcharged system is indicated, always make sure that the problem is not caused by air flow problems. Improper air flow over the evaporator coil may indicate some of the same symptoms as an overcharged system.

An overcharge can cause the compressor to fail, since it would be "slugged" with liquid refrigerant. The charge for any system is critical. When the compressor is noisy, suspect an overcharge, when you are sure that the air quantity over the evaporator coil is correct. Icing of the evaporator will not be encountered because the refrigerant will boil later if at all. Gauges connected to system will usually have higher head pressure (depending upon amount of over charge). Suction pressure should be slightly higher.

⚠ WARNING	
	HIGH PRESSURE HAZARD Sealed Refrigeration System contains refrigerant and oil under high pressure.
	Proper safety procedures must be followed, and proper protective clothing must be worn when working with refrigerants.
	Failure to follow these procedures could result in serious injury or death.

Compressor amps will be near normal or higher. Noncondensables can also cause these symptoms. To confirm, reclaim some of the charge, if conditions improve, system may be overcharged. If conditions don't improve, Noncondensables are indicated.

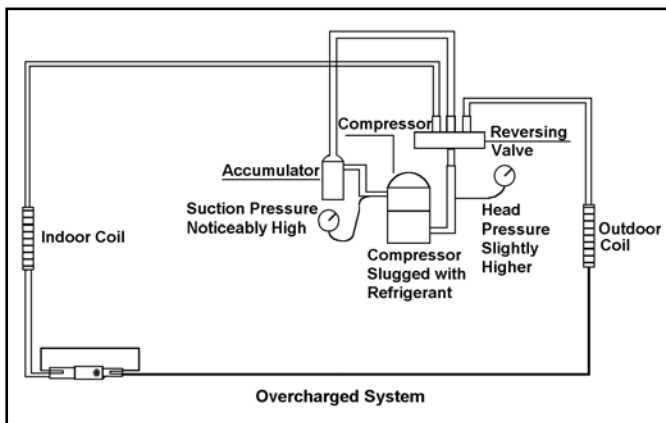

Figure 602 (Overcharged System)

R-410A SEALED SYSTEM REPAIRS

Restricted Refrigerant System

Troubleshooting a restricted refrigerant system can be difficult. The following procedures are the more common problems and solutions to these problems. There are two types of refrigerant restrictions: Partial restrictions and complete restrictions.

A partial restriction allows some of the refrigerant to circulate through the system.

With a complete restriction there is no circulation of refrigerant in the system. Restricted refrigerant systems display the same symptoms as a "low-charge condition."

When the unit is shut off, or the compressor disengages, the gauges may equalize very slowly.

A quick check for either condition begins at the evaporator. With a partial restriction, there may be gurgling sounds at the metering device entrance to the evaporator. The evaporator in a partial restriction could be partially frosted or have an ice ball close to the entrance of the metering device. Frost may continue on the suction line back to the compressor.

Often a partial restriction of any type can be found by feel, as there is a temperature difference from one side of the restriction to the other.

With a complete restriction, there will be no sound at the metering device entrance. An amperage check of the compressor with a partial restriction may show normal current when compared to the unit specification. With a complete restriction the current drawn may be considerably less than normal, as the compressor is running in a deep vacuum (no load.) Much of the area of the condenser will be relatively cool since most or all of the liquid refrigerant will be stored there.

The following conditions are based primarily on a system in the cooling mode.

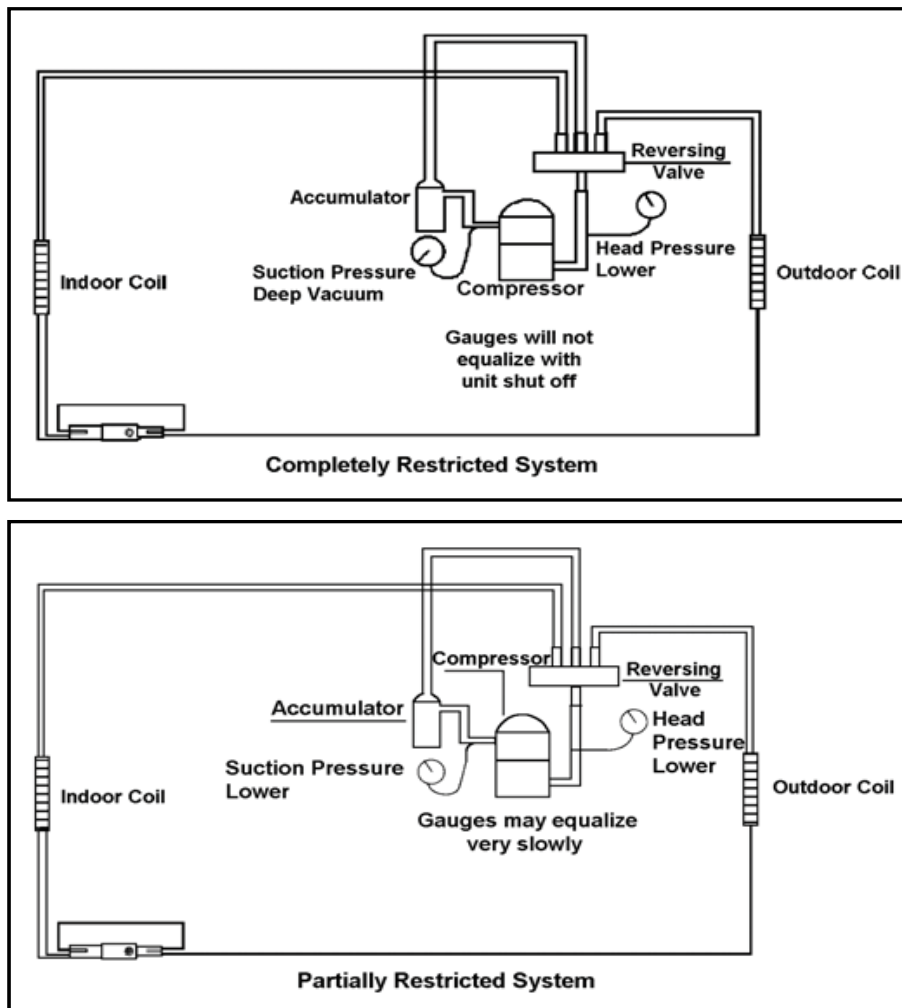



Figure 603 (Restricted System)

R-410A SEALED SYSTEM REPAIRS

Sealed System Method of Charging/ Repairs

⚠ WARNING	
	BURN HAZARD Proper safety procedures must be followed, and proper protective clothing must be worn when working with a torch. Failure to follow these procedures could result in moderate or serious injury.

⚠ CAUTION	
	FREEZE HAZARD Proper safety procedures must be followed, and proper protective clothing must be worn when working with liquid refrigerant. Failure to follow these procedures could result in minor to moderate injury.

The refrigerant cycle is critically charged. The only acceptable method for charging the sealed system is the Weighed in Charge Method.

The weighed in method should always be used whenever a charge is removed from a unit such as for a leak repair, compressor replacement, or when there is no refrigerant charge left in the unit. To charge by this method, requires the following steps:

1. Install a piercing valve to remove refrigerant from the sealed system. (Piercing valve must be removed from the system before recharging.)
2. Recover Refrigerant in accordance with EPA regulations.
3. Install a process tube to sealed system.
4. Make necessary repairs to system.
5. Evacuate system to 200 microns or less.
6. Weigh in refrigerant with the property quantity of R-410A refrigerant.
7. Start unit, and verify performance.
8. Crimp the process tube and solder the end shut.

EXTERNAL STATIC PRESSURE

External Static Pressure can best be described as the pressure difference (drop) between the Positive Pressure (discharge) and the Negative Pressure (intake) sides of the blower. External Static Pressure is developed by the blower as a result of resistance to airflow (Friction) in the air distribution system EXTERNAL to the VERT-I-PAK cabinet.

Resistance applied externally to the VERT-I-PAK (i.e. duct work, filters, etc.) on either the supply or return side of the system causes an INCREASE in External Static Pressure accompanied by a REDUCTION in airflow.

External Static Pressure is affected by two factors.

1. Resistance
2. Blower Speed (Changing to a higher or lower blower speed will raise or lower the External Static Pressure accordingly).

These affects must be understood and taken into consideration when checking External Static Pressure/Airflow to insure that the system is operating within design conditions.

Operating a system with insufficient or excessive airflow can cause a variety of different operating problems. Among these are problems such as, reduced capacity, freezing evaporator coils, premature compressor heating component failures, and/ or other air local distribution issues..

System airflow should always be verified upon completion of a new installation, or before a change-out, compressor replacement, or in the case of heat strip failure to insure that the failure was not caused by improper airflow.

Checking External Static Pressure

The airflow through the unit can be determined by measuring the external static pressure of the system, and consulting the blower performance data for the specific VERT-I-PAK.

1. Set up to measure external static pressure at the supply and return air.
2. Ensure the coil and filter are clean, and that all the registers are open.
3. Determine the external static pressure with the blower operating.

Use an incline or dual port manometer to measure. Measurement should be taken roughly 3-6" from the Vert-I-Pak collar and the center of the indoor coil with the filter installed.

4. Refer to the Air Flow Data for your VERT-I-PAK system to find the actual airflow for factory-selected fan speeds.

5. If the actual airflow is either too high or too low, the blower speed will need to be changed to appropriate setting

or the ductwork will need to be reassessed and corrections made as required.

6. Select a speed, which most closely provides the required airflow for the system.

7. Recheck the external static pressure with the new speed. External static pressure (and actual airflow) will have changed to a higher or lower value depending upon speed selected. Recheck the actual airflow (at this "new" static pressure) to confirm speed selection.

8. Repeat steps 8 and 9 (if necessary) until proper airflow has been obtained.

EXAMPLE: Airflow requirements are calculated as follows: (Having a wet coil creates additional resistance to airflow. This additional resistance must be taken into consideration to obtain accurate airflow information.

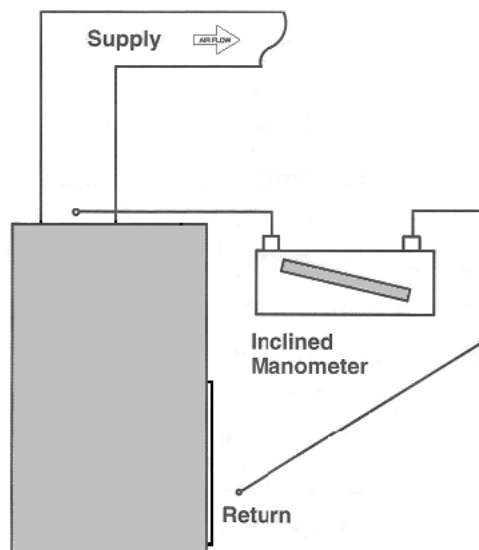

Figure 604

External Static Pressure

Determining the Indoor CFM								
ESP (")	VEA 09 / VHA 09		VEA 12 / VHA 12		VEA 18 / VHA 18		VEA 24 / VHA 24	
.00"	340	385	420	470	430	480	690	740
.10"	300*	340	350*	420*	400	450*	610*	700
.20"	230	280	290	350	340	400	560	640
.30"	140	190	250	300	290	330	510	580
.40"							450	520

* values indicate rated performance point
Table XXX (determining Indoor CFM)

Correct CFM (if needed): Correction Multipliers	
230V	1.00
208V	0.97
265V	
Heating	1.00
Cooling	0.95

Explanation of charts

Chart A is the nominal dry coil VERT-I-PAK CFMs. Chart B is the correction factors beyond nominal conditions.

1 ½ TON SYSTEM (18,000 Btu)

Operating on high speed @ 230 volts with dry coil

measured external static pressure .10

Air Flow = 450 CFM

In the same SYSTEM used in the previous example but having a WET coil you must use a correction factor of .95 (i.e. 450 x .95=428 CFM) to allow for the resistance (internal) of the condensate on the coil.

It is important to use the proper procedure to check external Static Pressure and determine actual airflow. Since in the case of the VERT-I-PAK, the condensate will cause a reduction in measured External Static Pressure for the given airflow.

It is also important to remember that when dealing with VERT-I-PAK units that the measured External Static Pressure increases as the resistance is added externally to the cabinet. Example: duct work, filters, grilles.

Indoor Airflow Data

The Vert-I-Pak A series units must be installed with a free return air configuration. The table below lists the indoor airflow at corresponding static pressures. All units are rated at low speed.

The Vert-I-Pak units are designed for either single speed or two fan speed operation. For single speed operation refer to the airflow table below and select the most appropriate CFM based on the ESP level. Connect the fan output from the thermostat to the unit on either the GL terminal for low speed or to the GH terminal for high speed operation.

For thermostats with two-speed fan outputs connect the low speed output to the unit GL terminal and the high speed output to the GH terminal.

Ductwork Preparation

If flex duct is used, be sure all the slack is pulled out of the flex duct. Flex duct ESP can increase considerably when not fully extended. DO NOT EXCEED a total of .30 ESP, as this is the MAXIMUM design limit for the VERT-I-PAK A-Series unit.

IMPORTANT: FLEX DUCT CAN COLLAPSE AND CAUSE AIRFLOW RESTRICTIONS. DO NOT USE FLEX DUCT FOR: 90 DEGREE BENDS, OR UNSUPPORTED RUNS OF 5 FT. OR MORE.

External Static Pressure

Fresh Air Door

The Fresh Air Door is an "intake" system. The fresh air door opened via a slide on the front of the chassis located just above the indoor coil. Move the slide left to open and right to close the fresh air door. The system is capable of up to 60 CFM of fresh air @ ~.3" H2O internal static pressure.

Checking Approximate Airflow

If an inclined manometer or Magnehelic gauge is not available to check the External Static Pressure, or the blower performance data is unavailable for your unit, approximate air flow can be calculated by measuring the temperature rise, then using the following criteria.

$$CFM = \frac{\text{Kilowatts} \times 3413}{\text{Temp Rise} \times 1.08}$$

Electric Heat Strips

The approximate CFM actually being delivered can be calculated by using the following formula:

DO NOT simply use the Kilowatt Rating of the heater (i.e. 2.5, 3.4, 5.0) as this will result in a less-than-correct airflow calculation. Kilowatts may be calculated by multiplying the measured voltage to the unit (heater) times the measured current draw of all heaters (ONLY) in operation to obtain watts. Kilowatts are then obtained by dividing by 1000.

EXAMPLE: Measured voltage to unit (heaters) is 230 volts. Measured Current Draw of strip heaters is 11.0 amps.

$$230 \times 11.0 = 2530$$

$$2530/1000 = 2.53 \text{ Kilowatts}$$

$$2.53 \times 3413 = 8635$$

$$\text{Supply Air} = 95^\circ\text{F}$$

$$\text{Return Air} = 75^\circ\text{F}$$

$$\text{Temperature Rise} = 20^\circ\text{F}$$

$$20 \times 1.08 = 21.6$$

$$\frac{8635}{21.6} = 400 \text{ CFM}$$

COMPONENT TESTING

Hermetic Components Check

⚠ WARNING	
	<p>BURN HAZARD</p> <p>Proper safety procedures must be followed, and proper protective clothing must be worn when working with a torch.</p> <p>Failure to follow these procedures could result in moderate or serious injury.</p>

⚠ WARNING	
	<p>CUT/SEVER HAZARD</p> <p>Be careful with the sharp edges and corners. Wear protective clothing and gloves, etc.</p> <p>Failure to do so could result in serious injury.</p>

Metering Device - Capillary Tube Systems

All units are equipped with capillary tube metering devices. Checking for restricted capillary tubes.

1. Connect pressure gauges to unit.
2. Start the unit in the cooling mode. If after a few minutes of operation the pressures are normal, the check valve and the cooling capillary are not restricted.
3. Switch the unit to the heating mode and observe the gauge readings after a few minutes running time. If the system pressure is lower than normal, the heating capillary is restricted.
4. If the operating pressures are lower than normal in both the heating and cooling mode, the cooling capillary is restricted.

Check Valve

A unique two-way check valve is used on the reverse cycle heat pumps. It is pressure operated and used to direct the flow of refrigerant through a single filter drier and to the proper capillary tube during either the heating or cooling cycle.

NOTE: The slide (check) inside the valve is made of teflon. Should it become necessary to replace the check valve, place a wet cloth around the valve to prevent overheating during the brazing operation.

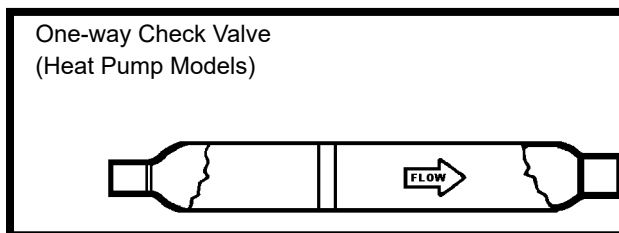

Figure 701 (Check Valve)

CHECK VALVE OPERATION

In the cooling mode of operation, high pressure liquid enters the check valve forcing the slide to close the opposite port (liquid line) to the indoor coil. Refer to refrigerant flow chart. This directs the refrigerant through the filter drier and cooling capillary tube to the indoor coil.

In the heating mode of operation, high pressure refrigerant enters the check valve from the opposite direction, closing the port (liquid line) to the outdoor coil. The flow path of the refrigerant is then through the filter drier and heating capillary to the outdoor coil.

Failure of the slide in the check valve to seat properly in either mode of operation will cause flooding of the cooling coil. This is due to the refrigerant bypassing the heating or cooling capillary tube and entering the liquid line.

COOLING MODE

In the cooling mode of operation, liquid refrigerant from condenser (liquid line) enters the cooling check valve forcing the heating check valve shut. The liquid refrigerant is directed into the liquid dryer after which the refrigerant is metered through cooling capillary tubes to evaporator. (Note: liquid refrigerant will also be directed through the heating capillary tubes in a continuous loop during the cooling mode).

HEATING MODE

In the heating mode of operation, liquid refrigerant from the indoor coil enters the heating check valve forcing the cooling check valve shut. The liquid refrigerant is directed into the liquid dryer after which the refrigerant is metered through the heating capillary tubes to outdoor coils. (Note: liquid refrigerant will also be directed through the cooling capillary tubes in a continuous loop during the heating mode).

COMPONENT TESTING

Reversing Valve Description And Operation

The Reversing Valve controls the direction of refrigerant flow to the indoor and outdoor coils. It consists of a pressure-operated, main valve and a pilot valve actuated by a solenoid plunger. The solenoid is energized during the heating cycle only. The reversing valves used in the RAC system is a 2-position, 4-way valve.

The single tube on one side of the main valve body is the high-pressure inlet to the valve from the compressor. The center tube on the opposite side is connected to the low pressure (suction) side of the system. The other two are connected to the indoor and outdoor coils. Small capillary tubes connect each end of the main valve cylinder to the "A" and "B" ports of the pilot valve. A third capillary is a common return line from these ports to the suction tube on the main valve body. Four-way reversing valves also have a capillary tube from the compressor discharge tube to the pilot valve.

The piston assembly in the main valve can only be shifted by the pressure differential between the high and low sides of the system. The pilot section of the valve opens and closes ports for the small capillary tubes to the main valve to cause it to shift.

NOTE: System operating pressures must be near normal before valve can shift.

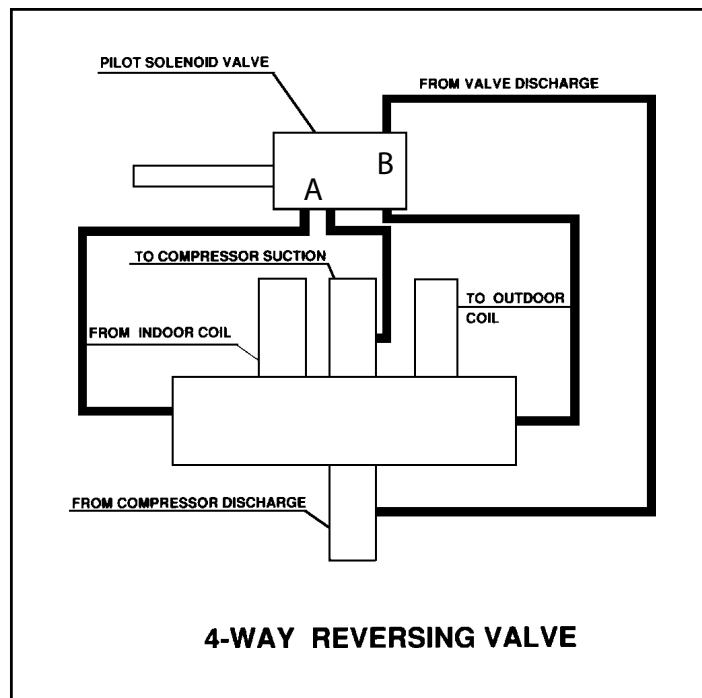

Figure 702 (Reversing Valve)

COMPONENT TESTING

Testing The Reversing Valve Solenoid Coil



The solenoid coil is an electromagnetic type coil mounted on the reversing valve and is energized during the operation of the compressor in the heating cycle.

1. Turn off high voltage electrical power to unit.
2. Unplug line voltage lead from reversing valve coil.
3. Check for electrical continuity through the coil. If you do not have continuity replace the coil.
4. Check from each lead of coil to the copper liquid line as it leaves the unit or the ground lug. There should be no continuity between either of the coil leads and ground; if there is, coil is grounded and must be replaced.
5. If coil tests okay, reconnect the electrical leads.
6. Make sure coil has been assembled correctly.

NOTE: Do not start unit with solenoid coil removed from valve, or do not remove coil after unit is in operation. This will cause the coil to burn out.

Touch Test in Heating/Cooling Cycle

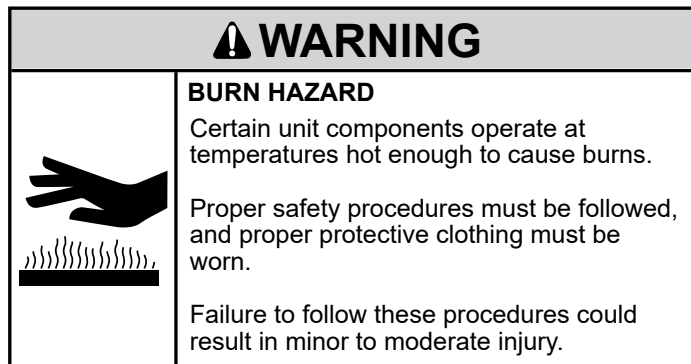

The only definite indications that the slide is in the mid-position is if all three tubes on the suction side of the valve are hot after a few minutes of running time.

NOTE: If both tubes shown as hot or cool are not the same corresponding temperature, refer to figure 703, then the reversing valve is not shifting properly.

COMPONENT TESTING

Checking The Reversing Valve

⚠ WARNING	
	HIGH PRESSURE HAZARD Sealed Refrigeration System contains refrigerant and oil under high pressure.
	Proper safety procedures must be followed, and proper protective clothing must be worn when working with refrigerants.
	Failure to follow these procedures could result in serious injury or death.

NOTE: You must have normal operating pressures before the reversing valve can shift.

Check the operation of the valve by starting the system and switching the operation from “Cooling” to “Heating” and then back to “Cooling”. Rapidly cycle. Do not hammer on valve.

Occasionally, the reversing valve may stick in the heating or cooling position or in the mid-position. When sluggish or stuck in the mid-position, part of the discharge gas from the compressor is directed back to the suction side, resulting in excessively high suction pressure.

Should the valve fail to shift from cooling to heating, block the air flow through the outdoor coil and allow the discharge pressure to build in the system. Then switch the system from heating to cooling.

If the valve is stuck in the heating position, block the air flow through the indoor coil and allow discharge pressure to build in the system. Then switch the system from heating to cooling.

Should the valve fail to shift in either position after increasing the discharge pressure, replace the valve.

Dented or damaged valve body or capillary tubes can prevent the main slide in the valve body from shifting. If you determine this is the problem, replace the reversing valve.

After all of the previous inspections and checks have been made and determined correct, then perform the “Touch Test” on the reversing valve.

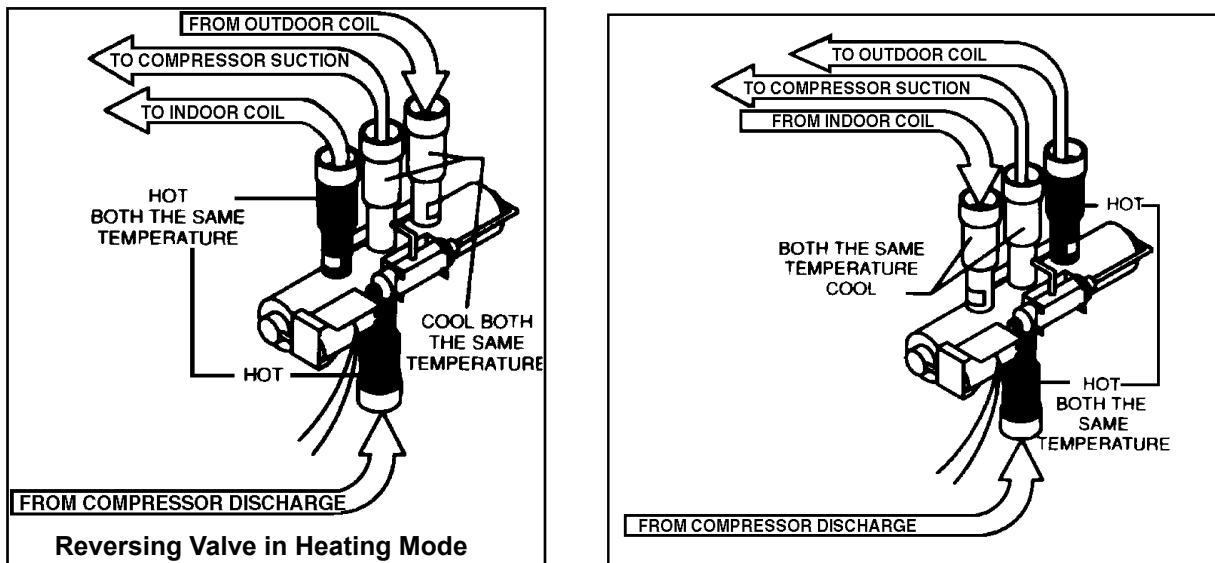



Figure 703 (Checking The Reversing Valve)

COMPONENT TESTING

Replace The Reversing Valve

⚠ WARNING	
	HIGH PRESSURE HAZARD Sealed Refrigeration System contains refrigerant and oil under high pressure.
	Proper safety procedures must be followed, and proper protective clothing must be worn when working with refrigerants.
	Failure to follow these procedures could result in serious injury or death.

NOTICE
FIRE HAZARD The use of a torch requires extreme care and proper judgment. Follow all safety recommended precautions and protect surrounding areas with fire proof materials. Have a fire extinguisher readily available. Failure to follow this notice could result in moderate to serious property damage.

1. Install Process Tubes. Recover refrigerant from sealed system. PROPER HANDLING OF RECOVERED REFRIGERANT ACCORDING TO EPA REGULATIONS IS REQUIRED.
2. Remove solenoid coil from reversing valve. If coil is to be reused, remove solenoid and protect from heat while changing valve.
3. Unbrazed all lines from reversing valve.
4. Clean all excess braze from all tubing so that they will slip into fittings on new valve.
5. Remove solenoid coil from new valve.
6. Protect new valve body from heat while brazing with plastic heat sink (Thermo Trap) or wrap valve body with wet rag.
7. Fit all lines into new valve and braze lines into new valve.

⚠ WARNING	
	EXPLOSION HAZARD The use of nitrogen requires a pressure regulator. Follow all safety procedures and wear protective safety clothing etc.
	Failure to follow proper safety procedures could result in serious injury or death.

8. Pressurize sealed system with a combination of R-410A and nitrogen. Pressurize system to 550 psi and triple evacuate. Check for leaks, using a suitable leak detector. Recover refrigerant per EPA guidelines.
9. Once the sealed system is leak free, install solenoid coil on new valve and charge the sealed system by weighing in the proper amount and type of refrigerant as shown on rating plate. Crimp the process tubes and solder the ends shut. Do not leave Schrader or piercing valves in the sealed system.

NOTE: When brazing a reversing valve into the system, it is of extreme importance that the temperature of the valve does not exceed 250°F at any time.

Wrap the reversing valve with a large rag saturated with water. "Re-wet" the rag and thoroughly cool the valve after each brazing operation of the four joints involved.

The wet rag around the reversing valve will eliminate conduction of heat to the valve body when brazing the line connection.

COMPONENT TESTING

Touch Test Chart : To Service Reversing Valves

NORMAL FUNCTION OF VALVE								
VALVE OPERATING CONDITION	DISCHARGE TUBE from Compressor	SUCTION TUBE	COIL	Tube to OUTSIDE COIL	LEFT Pilot	RIGHT Pilot	NOTES:	
	1	2	3	4	5	6	* TEMPERATURE OF VALVE BODY ** WARMER THAN VALVE BODY	
							POSSIBLE CAUSES	CORRECTIONS
Normal Cooling	Hot	Cool	Cool as (2)	Hot as (1)	*TVB	TVB		
Normal Heating	Hot	Cool	Hot as (1)	Cool as (2)	*TVB	TVB		
MALFUNCTION OF VALVE								
Valve will not shift from cool to heat.	Check Electrical circuit and coil						No voltage to coil.	Repair electrical circuit.
							Defective coil.	Replace coil.
	Check refrigeration charge						Low charge.	Repair leak, recharge system.
							Pressure differential too high.	Recheck system.
	Hot	Cool	Cool, as (2)	Hot, as (1)	*TVB	Hot	Pilot valve okay. Dirt in one bleeder hole.	Deenergize solenoid, raise head pressure, reenergize solenoid to break dirt loose. If unsuccessful, remove valve, wash out. Check on air before installing. If no movement, replace valve, add strainer to discharge tube, mount valve horizontally.
						Piston cup leak	Stop unit. After pressures equalize, restart with solenoid energized. If valve shifts, reattempt with compressor running. If still no shift, replace valve.	
Valve will not shift from cool to heat.	Hot	Cool	Cool, as (2)	Hot, as (1)	*TVB	*TVB	Clogged pilot tubes.	Raise head pressure, operate solenoid to free. If still no shift, replace valve.
	Hot	Cool	Cool, as (2)	Hot, as (1)	Hot	Hot	Both ports of pilot open. (Back seat port did not close).	Raise head pressure, operate solenoid to free partially clogged port. If still no shift, replace valve.
	Warm	Cool	Cool, as (2)	Hot, as (1)	*TVB	Warm	Defective Compressor.	Replace compressor
Starts to shift but does not complete reversal.	Hot	Warm	Warm	Hot	*TVB	Hot	Not enough pressure differential at start of stroke or not enough flow to maintain pressure differential.	Check unit for correct operating pressures and charge. Raise head pressure. If no shift, use valve with smaller port.
							Body damage.	Replace valve
	Hot	Warm	Warm	Hot	Hot	Hot	Both ports of pilot open.	Raise head pressure, operate solenoid. If no shift, use valve with smaller ports.
	Hot	Hot	Hot	Hot	*TVB	Hot	Body damage.	Replace valve
							Valve hung up at mid-stroke. Pumping volume of compressor not sufficient to maintain reversal.	Raise head pressure, operate solenoid. If no shift, use valve with smaller ports.
Apparent leap in heating.	Hot	Cool	Hot, as (1)	Cool, as (2)	*TVB	*TVB	Piston needle on end of slide leaking.	Operate valve several times, then recheck. If excessive leak, replace valve.
	Hot	Cool	Hot, as (1)	Cool, as (2)	**WVB	**WVB	Pilot needle and piston needle leaking.	Operate valve several times, then recheck. If excessive leak, replace valve.
Will not shift from heat to cool.	Hot	Cool	Hot, as (1)	Cool, as (2)	*TVB	*TVB	Pressure differential too high.	Stop unit. Will reverse during equalization period. Recheck system
							Clogged pilot tube.	Raise head pressure, operate solenoid to free dirt. If still no shift, replace valve.
	Hot	Cool	Hot, as (1)	Cool, as (2)	Hot	*TVB	Dirt in bleeder hole.	Raise head pressure, operate solenoid. Remove valve and wash out. Check on air before reinstalling, if no movement, replace valve. Add strainer to discharge tube. Mount valve horizontally.
	Hot	Cool	Hot, as (1)	Cool, as (2)	Hot	*TVB	Piston cup leak.	Stop unit. After pressures equalize, restart with solenoid deenergized. If valve shifts, reattempt with compressor running. If it still will not reverse while running, replace the valve.
	Hot	Cool	Hot, as (1)	Cool, as (2)	Hot	Hot	Defective pilot.	Replace valve.
	Warm	Cool	Warm, as (1)	Cool, as (2)	Warm	*TVB	Defective compressor.	Replace compressor

Figure 704 (Touch Test Chart)

COMPONENT TESTING

Compressor Checks

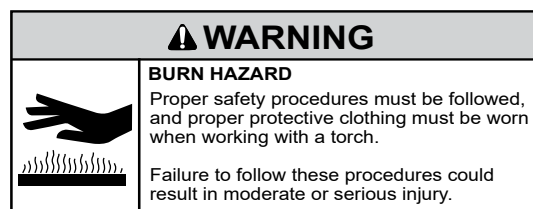
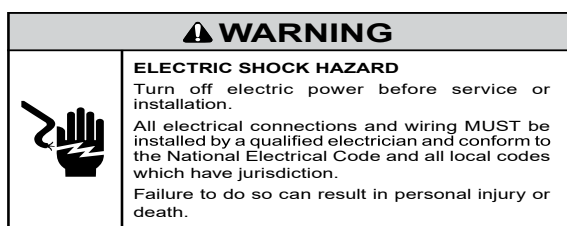

Locked Rotor Voltage (L.R.V.) Test

Locked rotor voltage (L.R.V.) is the actual voltage available at the compressor under a stalled condition.

Single Phase Connections

Disconnect power from unit. Using a voltmeter, attach one lead of the meter to the run "R" terminal on the compressor and the other lead to the common "C" terminal of the compressor. Restore power to unit.

Determine L.R.V.

Start the compressor with the volt meter attached; then stop the unit. Attempt to restart the compressor within a couple of seconds and immediately read the voltage on the meter. The compressor under these conditions will not start and will usually kick out on overload within a few seconds since the pressures in the system will not have had time to equalize. Voltage should be at or above minimum voltage of 197 VAC, as specified on the rating plate. If less than minimum, check for cause of inadequate power supply; i.e., incorrect wire size, loose electrical connections, etc.

Amperage (R.L.A) Test

The running amperage of the compressor is the most important of these readings. A running amperage higher than that indicated in the performance data indicates that a problem exists mechanically or electrically.

Single Phase Running and L.R.A. Test

NOTE: Consult the specification and performance section for running amperage. The L.R.A. can also be found on the rating plate.

Select the proper amperage scale and clamp the meter probe around the wire to the "C" terminal of the compressor.

Turn on the unit and read the running amperage on the meter. If the compressor does not start, the reading will indicate the locked rotor amperage [L.R.A.).

Overloads

The compressor is equipped with either an external or internal overload which senses both motor amperage and winding temperature. High motor temperature or amperage heats the overload causing it to open, breaking the common circuit within the compressor. Heat generated within the compressor shell, usually due to recycling of the motor, is slow to dissipate. It may take anywhere from a few minutes to several hours for the overload to reset.

Checking the Overloads

External Overloads VPAK 9, 12, and 18K Btus

With power off, remove the leads from compressor terminals. If the compressor is hot, allow the overload to cool before starting check. Using an ohmmeter, test continuity across the terminals of the external overload. If you do not have continuity; this indicates that the overload is open and must be replaced.

Internal Overloads VPAK 24k Btus

The overload is embedded in the motor windings to sense the winding temperature and/or current draw. The overload is connected in series with the common motor terminal.

Should the internal temperature and/or current draw become excessive, the contacts in the overload will open, turning off the compressor. The overload will automatically reset, but may require several hours before the heat is dissipated.

Checking the Internal Overload

1. With no power to unit, remove the leads from the compressor terminals.
2. Using an ohmmeter, test continuity between terminals C-S and C-R. If no continuity, the compressor overload is open and the compressor must be replaced.

COMPONENT TESTING

Compressor Checks

⚠ WARNING	
	ELECTRIC SHOCK HAZARD Turn off electric power before service or installation. Extreme care must be used, if it becomes necessary to work on equipment with power applied.
	Failure to do so could result in serious injury or death.

⚠ WARNING	
	HIGH PRESSURE HAZARD Sealed Refrigeration System contains refrigerant and oil under high pressure.
	Proper safety procedures must be followed, and proper protective clothing must be worn when working with refrigerants. Failure to follow these procedures could result in serious injury or death.

Single Phase Resistance Test

Remove the leads from the compressor terminals and set the ohmmeter on the lowest scale [R x 1].

Touch the leads of the ohmmeter from terminals common to start ("C" to "S"). Next, touch the leads of the ohmmeter from terminals common to run ("C" to "R").

Add values "C" to "S" and "C" to "R" together and check resistance from start to run terminals ("S" to "R"). Resistance "S" to "R" should equal the total of "C" to "S" and "C" to "R."

In a single phase PSC compressor motor, the highest value will be from the start to the run connections ("S" to "R"). The next highest resistance is from the start to the common connections ("S" to "C"). The lowest resistance is from the run to common. ("C" to "R") Before replacing a compressor, check to be sure it is defective.

GROUND TEST

Use an ohmmeter set on its highest scale. Touch one lead to the compressor body (clean point of contact as a good connection is a must) and the other probe in turn to each compressor terminal. If a reading is obtained the compressor is grounded and must be replaced.

Check the complete electrical system to the compressor and compressor internal electrical system, check to be certain that compressor is not out on internal overload.

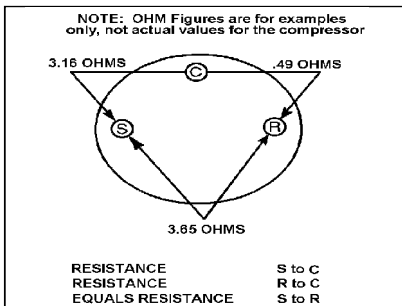

Figure 705 (Resistance Chart)

Complete evaluation of the system must be made whenever you suspect the compressor is defective. If the compressor has been operating for sometime, a careful examination must be made to determine why the compressor failed.

Many compressor failures are caused by the following conditions:

1. Improper air flow over the evaporator.
2. Overcharged refrigerant system causing liquid to be returned to the compressor.
3. Restricted refrigerant system.
4. Lack of lubrication.
5. Liquid refrigerant returning to compressor causing oil to be washed out of bearings.
6. Noncondensables such as air and moisture in the system. Moisture is extremely destructive to a refrigerant system.
7. Capacitor.

CHECKING COMPRESSOR EFFICIENCY

The reason for compressor inefficiency is normally due to broken or damaged suction and/or discharge valves, reducing the ability of the compressor to pump refrigerant gas.

This condition can be checked as follows:

1. Install a piercing valve on the suction and discharge or liquid process tube.
2. Attach gauges to the high and low sides of the system.-
3. Start the system to operate the compressor and run a "cooling or heating performance test." If test shows:
 - A. Below normal high side pressure
 - B. Above normal low side pressure
 - C. Low temperature difference across coil

The compressor valves are faulty - replace the compressor.

COMPONENT TESTING

Compressor Replacement

⚠ WARNING	
	<p>ELECTRIC SHOCK HAZARD Turn off electric power before service or installation. Extreme care must be used, if it becomes necessary to work on equipment with power applied.</p> <p>Failure to do so could result in serious injury or death.</p>

⚠ WARNING	
	<p>HIGH PRESSURE HAZARD Sealed Refrigeration System contains refrigerant and oil under high pressure.</p> <p>Proper safety procedures must be followed, and proper protective clothing must be worn when working with refrigerants.</p> <p>Failure to follow these procedures could result in serious injury or death.</p>

⚠ WARNING	
	<p>EXPLOSION HAZARD The use of nitrogen requires a pressure regulator. Follow all safety procedures and wear protective safety clothing etc.</p> <p>Failure to follow proper safety procedures could result in serious injury or death.</p>

⚠ CAUTION	
	<p>FREEZE HAZARD Proper safety procedures must be followed, and proper protective clothing must be worn when working with liquid refrigerant.</p> <p>Failure to follow these procedures could result in minor to moderate injury.</p>

1. Be certain to perform all necessary electrical and refrigeration tests to be sure the compressor is actually defective before replacing.

2. Recover all refrigerant from the system through the process tubes. **PROPER HANDLING OF RECOVERED REFRIGERANT ACCORDING TO EPA REGULATIONS IS REQUIRED.** Do not use gauge manifold for this purpose if there has been a burnout. You will contaminate your manifold and hoses. Use a Schrader valve adapter and copper tubing for burnout failures.

3. After all refrigerant has been recovered, disconnect suction and discharge lines from the compressor and remove compressor. Be certain to have both suction and discharge process tubes open to atmosphere.

4. Carefully pour a small amount of oil from the suction stub of the defective compressor into a clean container.

5. Using an acid test kit (one shot or conventional kit), test the oil for acid content according to the instructions with the kit.

6. If any evidence of a burnout is found, no matter how slight, the system will need to be cleaned up following proper procedures.

7. Install the replacement compressor.

8. Pressurize with a combination of R-410A and nitrogen and leak test all connections with an electronic or Halide leak detector. Recover refrigerant and repair any leaks found.

8a. If leak detector is unavailable remove all refrigerant from system and pressurize with nitrogen to 350 psi. Check that system holds pressure.

Repeat Step 8 to insure no more leaks are present



9. Evacuate the system with a good vacuum pump capable of a final vacuum of 200 microns or less. The system should be evacuated through both liquid line and suction line gauge ports. While the unit is being evacuated, seal all openings on the defective compressor. Compressor manufacturers will void warranties on units received not properly sealed. Do not distort the manufacturers tube connections.



10. Recharge the system with the correct amount of refrigerant. The proper refrigerant charge will be found on the unit rating plate. The use of an accurate measuring device, such as a charging cylinder, electronic scales or similar device is necessary.



COMPONENT TESTING



Compressor Replacement -Special Procedure in Case of Compressor Burnout

1. Recover all refrigerant and oil from the system.
2. Remove compressor, capillary tube and filter drier from the system.
3. Flush evaporator condenser and all connecting tubing with dry nitrogen or equivalent. Use approved flushing agent to remove all contamination from system. Inspect suction and discharge line for carbon deposits. Remove and clean if necessary. Ensure all acid is neutralized.
4. Reassemble the system, including new drier strainer and capillary tube.
5. Pressurize with a combination of R-410A and nitrogen and leak test all connections with an electronic or Halide leak detector. Recover refrigerant and repair any leaks found.
- 5a. If leak detector is unavailable remove all refrigerant from system and pressurize with nitrogen to 350 psi. Check that system holds pressure.

 WARNING	
	HIGH PRESSURE HAZARD Sealed Refrigeration System contains refrigerant and oil under high pressure.
	Proper safety procedures must be followed, and proper protective clothing must be worn when working with refrigerants.
	Failure to follow these procedures could result in serious injury or death.

 WARNING	
	ELECTRIC SHOCK HAZARD Turn off electric power before service or installation. Extreme care must be used, if it becomes necessary to work on equipment with power applied.
	Failure to do so could result in serious injury or death.

 WARNING	
	EXPLOSION HAZARD The use of nitrogen requires a pressure regulator. Follow all safety procedures and wear protective safety clothing etc.
	Failure to follow proper safety procedures could result in serious injury or death.

 WARNING	
	NEVER , under any circumstances, liquid charge a rotary-compressor through the LOW side. Doing so would cause permanent damage to the new compressor. Use a charging adapter.

Repeat Step 5 to insure no more leaks are present

6. Evacuate the system with a good vacuum pump capable of a final vacuum of 200 microns or less. The system should be evacuated through both liquid line and suction line gauge ports. While the unit is being evacuated, seal all openings on the defective compressor. Compressor manufacturers will void warranties on units received not properly sealed. Do not distort the manufacturers tube connections.

7. Recharge the system with the correct amount of refrigerant. The proper refrigerant charge will be found on the unit rating plate. The use of an accurate measuring device, such as a charging cylinder, electronic scales or similar device is necessary.

ROTARY AND SCROLL COMPRESSOR SPECIAL TROUBLESHOOTING AND SERVICE

Troubleshooting and servicing rotary compressors is basically the same as on the reciprocating compressor with only one main exception:

COMPONENTS TESTING

Fan Motor

A single phase permanent split capacitor motor is used to drive the evaporator blower and condenser fan. A self-resetting overload is located inside the motor to protect against high temperature and high amperage conditions.

⚠ WARNING	
	<p>ELECTRIC SHOCK HAZARD Turn off electric power before service or installation. Extreme care must be used, if it becomes necessary to work on equipment with power applied.</p> <p>Failure to do so could result in serious injury or death.</p>

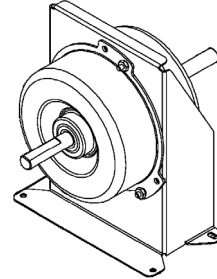



Figure 706 (Blower/ Fan Motor)

Blower / Fan Motor Test

1. Visually inspect the motor's wiring, housing etc., and determine that the capacitor is serviceable.
2. Make sure the motor has cooled down.
3. Disconnect the fan motor wires from the control board.
4. Test for continuity between the windings also, test to ground.
5. If any winding is open or grounded replace the motor.
6. Apply "live" test cord probes on black wire and common terminal of capacitor. Motor should run at high speed.
7. Apply "live" test cord probes on red wire and common terminal of capacitor. Motor should run at low speed.
8. Apply "live" test cord probes on each of the remaining wires from the speed switch or system switch to test intermediate speeds.

Capacitors

⚠ WARNING	
	<p>ELECTRIC SHOCK HAZARD Turn off electric power before service or installation. Extreme care must be used, if it becomes necessary to work on equipment with power applied.</p> <p>Failure to do so could result in serious injury or death.</p>

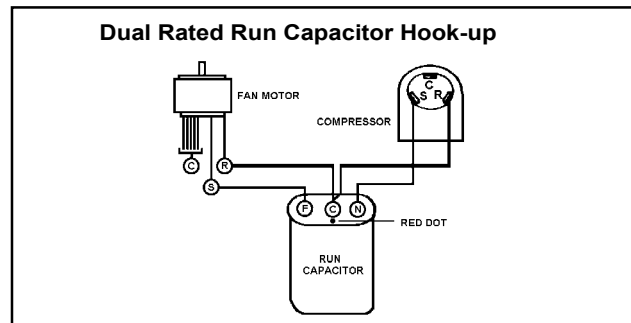

Figure 707 Dual Rated Capacitor Hook-Up

Many motor capacitors are internally fused. Shorting the terminals will blow the fuse, ruining the capacitor. A 20,000 ohm 2 watt resistor can be used to discharge capacitors safely. Remove wires from capacitor and place resistor across terminals. When checking a dual capacitor with a capacitor analyzer or ohmmeter, both sides must be tested.

Capacitor Check with Capacitor Analyzer

The capacitor analyzer will show whether the capacitor is "open" or "shorted." It will tell whether the capacitor is within its micro farads rating and it will show whether the capacitor is operating at the proper power-factor percentage. The instrument will automatically discharge the capacitor when the test switch is released.

Capacitor Connections

The starting winding of a motor can be damaged by a shorted and grounded running capacitor. This damage usually can be avoided by proper connection of the running capacitor terminals.

From the supply line on a typical 230 volt circuit, a 115 volt potential exists from the "R" terminal to ground through a possible short in the capacitor. However, from the "S" or start terminal, a much higher potential, possibly as high as 400 volts, exists because of the counter EMF generated in the start winding. Therefore, the possibility of capacitor failure is much greater when the identified terminal is connected to the "S" or start terminal. The identified terminal should always be connected to the supply line, or "R" terminal, never to the "S" terminal.

When connected properly, a shorted or grounded running capacitor will result in a direct short to ground from the "R" terminal and will blow the line fuse. The motor protector will protect the main winding from excessive temperature.

COMPONENTS TESTING

Heating Element and Limit Switch

⚠ WARNING	
	ELECTRIC SHOCK HAZARD Turn off electric power before service or installation. Extreme care must be used, if it becomes necessary to work on equipment with power applied.
	Failure to do so could result in serious injury or death.

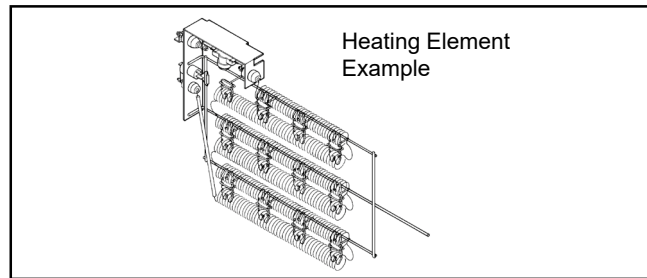

Figure 708 (Heating Element)

All heat pumps and electric heat models are equipped with a heating element and a limit switch (bimetal thermostat). The limit is in series with the element and will interrupt the power at a designed temperature. Should the blower motor fail, filter become clogged or air-flow be restricted etc., the high limit switch will open and interrupt the power to the heater before reaching an un-safe temperature condition.

HEATER ELEMENTS AND LIMIT SWITCHES' SPECIFICATIONS

VPAK 9K, 12K and 18K BTUs Models:

2.5 KW, 230 V, Resistance 18.61 Ohms + - 5%.

Has 1 Limit Switch, Opens at 120° F, Closes at 90° F,
It has a One Time Open Temp. of 145° F.

3.4 KW, 230 V, Resistance 13.68 Ohms + - 5%.

Has 1 Limit Switch, Opens at 120° F, Closes at 90° F,
It has a One Time Open Temp. of 145° F.

5 KW, 230 V, Resistance 9.31 Ohms + - 5%.

Has 1 Limit Switch, Opens at 130° F, Closes at 100° F, It has a One Time Open Temp. of 155° F.
VPAK 24K BTUs Models:

2.5 KW, 230 V, Resistance 18.61 Ohms + - 5%.

Has 2 Limit Switches, Primary Opens at 155° F,
Closes at 125° F, Secondary's Open Temp. is 200° F.

3.4 KW, 230 V, Resistance 13.68 Ohms + - 5%.

Has 2 Limit Switches, Primary Opens at 155° F,
Closes at 125° F, Secondary's Open Temp. is 200° F.

5 KW, 230 V, Resistance 9.31 Ohms + - 5%.

Has 2 Limit Switches, Primary Opens at 155° F,
Closes at 125° F, Secondary's Open Temp. is 200° F.

7.5 KW, 230 V (composed of 2, 3.7 KW Elements) Each Has a Resistance of 12.41 Ohms + - 5%.

Each Has 2 Limit Switches, Primary Opens at 165° F, Closes at 135° F With a 1 time Open Temp. of 210° F. Secondary Limit's Open Temp. is 200° F.

10 KW, 230 V (composed of 2, 5 KW Elements)

Each Has a Resistance of 9.31 Ohms + - 5%.

Each Has 2 Limit Switches, Primary Opens at 165° F, Closes at 135° F With a 1 time Open Temp. of 210° F. Secondary Limit's Open Temp. is 200° F.

NOTE: Always replace with an exact replacement.

TESTING THE HEATING ELEMENT

Testing of the elements can be made with an ohmmeter across the terminals after the connecting wires have been removed. A cold resistance reading of approximately 14.5 ohms for the 3.3 KW heater, 11.9 ohms for the 4.0 KW heater and 9.15 ohms for the 5.2 KW heater should be registered.

COMPONENTS TESTING

⚠ WARNING	
	ELECTRIC SHOCK HAZARD Turn off electric power before service or installation. Extreme care must be used, if it becomes necessary to work on equipment with power applied. Failure to do so could result in serious injury or death.

Drain Pan Valve

During the cooling mode of operation, condensate which collects in the drain pan is picked up by the con-denser fan blade and sprayed onto the condenser coil. This assists in cooling the refrigerant plus evaporating the water.

During the heating mode of operation, it is necessary that water be removed to prevent it from freezing during cold outside temperatures. This could cause the con-denser fan blade to freeze in the accumulated water and prevent it from turning. To provide a means of draining this water, a bellows type drain valve is installed over a drain opening in the base pan. This valve is temperature sensitive and will open when the outside temperature reaches 40°F. The valve will close gradually as the temperature rises above 40°F to fully close at 60°F.

To test the drain pan valve;

- 1) Place a pack of ice on the capillary
- 2) Ensure that the valve opens as it cools down.
- 3) remove the pack of ice.
- 4) Ensure that the valve closes fully as the valve warms back up.

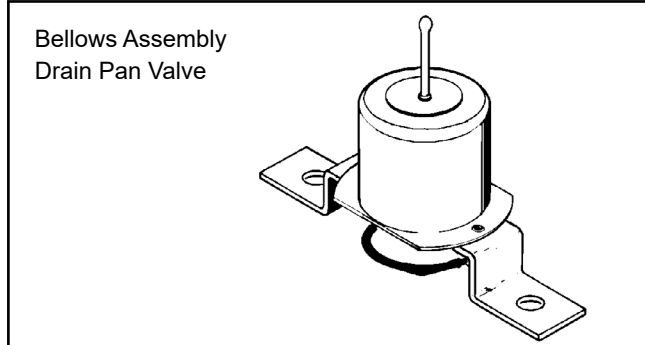

Figure 709 Drain Pan Valve

COMPONENTS TESTING

Thermistor Resistance Values (This Table Applies to All Thermistors)

TEMP	RESISTANCE (K Ohms)			RESISTANCE TOLERANCE %	
	MIN	CENTR	MAX	MIN	MAX
-25	210.889	225.548	240.224	6.50	6.51
-20	178.952	190.889	202.825	6.25	6.25
-15	151.591	161.325	171.059	6.03	6.03
-10	128.434	136.363	144.292	5.81	5.81
-5	108.886	115.340	121.794	5.60	5.60
0	92.411	97.662	102.912	5.38	5.38
5	78.541	82.812	87.083	5.16	5.16
10	66.866	70.339	73.812	4.94	4.94
15	57.039	59.864	62.688	4.72	4.72
20	48.763	51.060	53.357	4.50	4.50
25	41.786	43.654	45.523	4.28	4.28
30	35.896	37.415	38.934	4.06	4.06
31	34.832	36.290	37.747	4.02	4.02
32	33.803	35.202	36.601	3.97	3.97
33	32.808	34.150	35.492	3.93	3.93
34	31.846	33.133	34.421	3.89	3.89
35	30.916	32.151	33.386	3.84	3.84
36	30.016	31.200	32.385	3.80	3.80
37	29.144	30.281	31.418	3.75	3.75
38	28.319	29.425	30.534	3.76	3.77
39	27.486	28.532	29.579	3.67	3.67
40	26.697	27.701	28.704	3.62	3.62
45	23.116	23.931	24.745	3.40	3.40
50	20.071	20.731	21.391	3.18	3.18
55	17.474	18.008	18.542	2.96	2.96
60	15.253	15.684	16.115	2.75	2.75
65	13.351	13.697	14.043	2.53	2.53
66	13.004	13.335	13.666	2.48	2.48
67	12.668	12.984	13.301	2.44	2.44
68	12.341	12.644	12.947	2.39	2.39
69	12.024	12.313	12.603	2.35	2.35
70	11.716	11.993	12.269	2.31	2.31
71	11.418	11.682	11.946	2.26	2.26
72	11.128	11.380	11.633	2.22	2.22
73	10.846	11.088	11.329	2.18	2.18
74	10.574	10.804	11.034	2.13	2.13
75	10.308	10.528	10.748	2.09	2.09
76	10.051	10.260	10.469	2.04	2.04
77	9.800	10.000	10.200	2.00	2.00
78	9.550	9.748	9.945	2.03	2.03
79	9.306	9.503	9.699	2.07	2.07
80	9.070	9.265	9.459	2.10	2.10
81	8.841	9.033	9.226	2.13	2.13
82	8.618	8.809	9.000	2.17	2.17
83	8.402	8.591	8.780	2.20	2.20
84	8.192	8.379	8.566	2.23	2.23
85	7.987	8.172	8.358	2.27	2.27
86	7.789	7.972	8.155	2.30	2.30
87	7.596	7.778	7.959	2.33	2.33
88	7.409	7.589	7.768	2.37	2.37
89	7.227	7.405	7.583	2.40	2.40
90	7.050	7.226	7.402	2.43	2.43
91	6.878	7.052	7.226	2.47	2.47
92	6.711	6.883	7.055	2.50	2.50
93	6.548	6.718	6.889	2.53	2.53
94	6.390	6.558	6.727	2.57	2.57
95	6.237	6.403	6.569	2.60	2.60
96	6.087	6.252	6.417	2.63	2.63
97	5.942	6.105	6.268	2.67	2.67
98	5.800	5.961	6.122	2.70	2.70
99	5.663	5.822	5.981	2.73	2.73
100	5.529	5.686	5.844	2.77	2.77
105	4.912	5.060	5.208	2.93	2.93
110	4.371	4.511	4.651	3.10	3.10
115	3.898	4.030	4.161	3.27	3.27
120	3.482	3.606	3.730	3.43	3.43

Figure 710 Thermistor Values

COMPONENTS TESTING

Testing the Diagnostic Service Module

Testing the Electronic Control Board

⚠ WARNING	
	ELECTRIC SHOCK HAZARD Turn off electric power before service or installation. Extreme care must be used, if it becomes necessary to work on equipment with power applied. Failure to do so could result in serious injury or death.

If the Diagnostic Service Module does not turn on:

1. Make sure there is 208/230 VAC to the unit and that it is turned on.
2. Disconnect the diagnostic service module's wire harness on the control board.
3. Using a voltmeter, check the first two pins to the left of the female connector (see picture below). There should be up to 5VDC.
4. If there is no voltage, replace the electronic control board.
5. If there is voltage, check the wire harness and connections at the electronic control board and the diagnostic service module.
6. IF THE CONNECTIONS AND THE WIRE HARNESS ARE GOOD, REPLACE THE DIAGNOSTIC SERVICE MODULE.

DIAGNOSTIC SERVICE MODULE

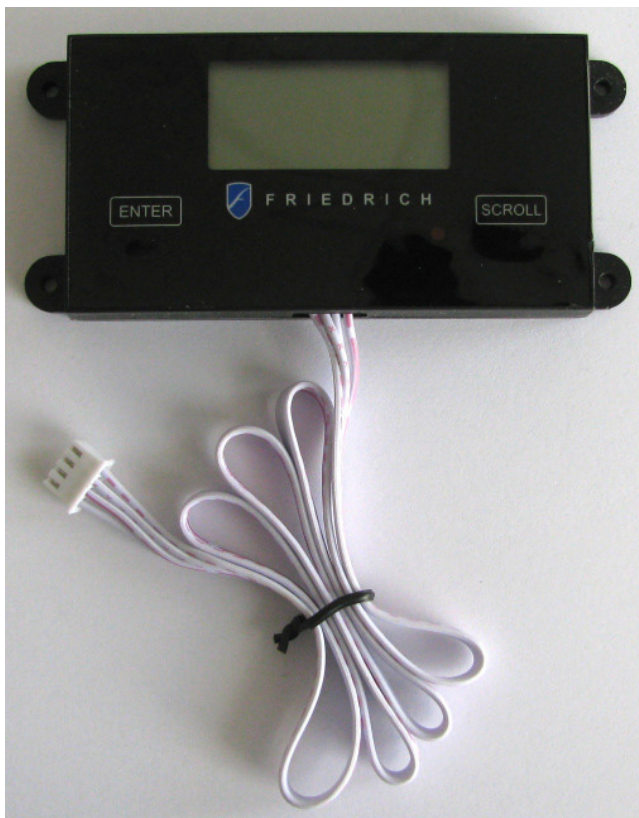

SERVICE MODULE CONNECTOR

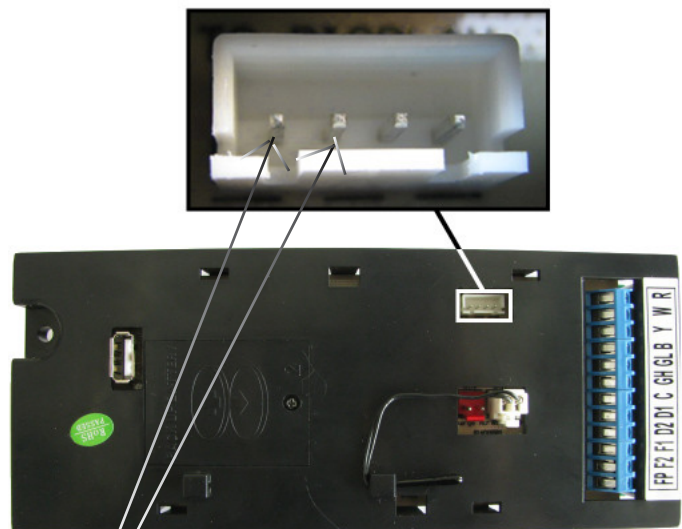

TEST HERE UP TO 5VDC.
IF NO VOLTAGE, REPLACE BOARD.
IF THERE IS 5VDC, CHECK CONNECTIONS AND CABLE.
IF OK, REPLACE SERVICE MODULE.

COMPONENT TESTING

ELECTRONIC CONTROL BOARD COMPONENTS IDENTIFICATION AND TESTING

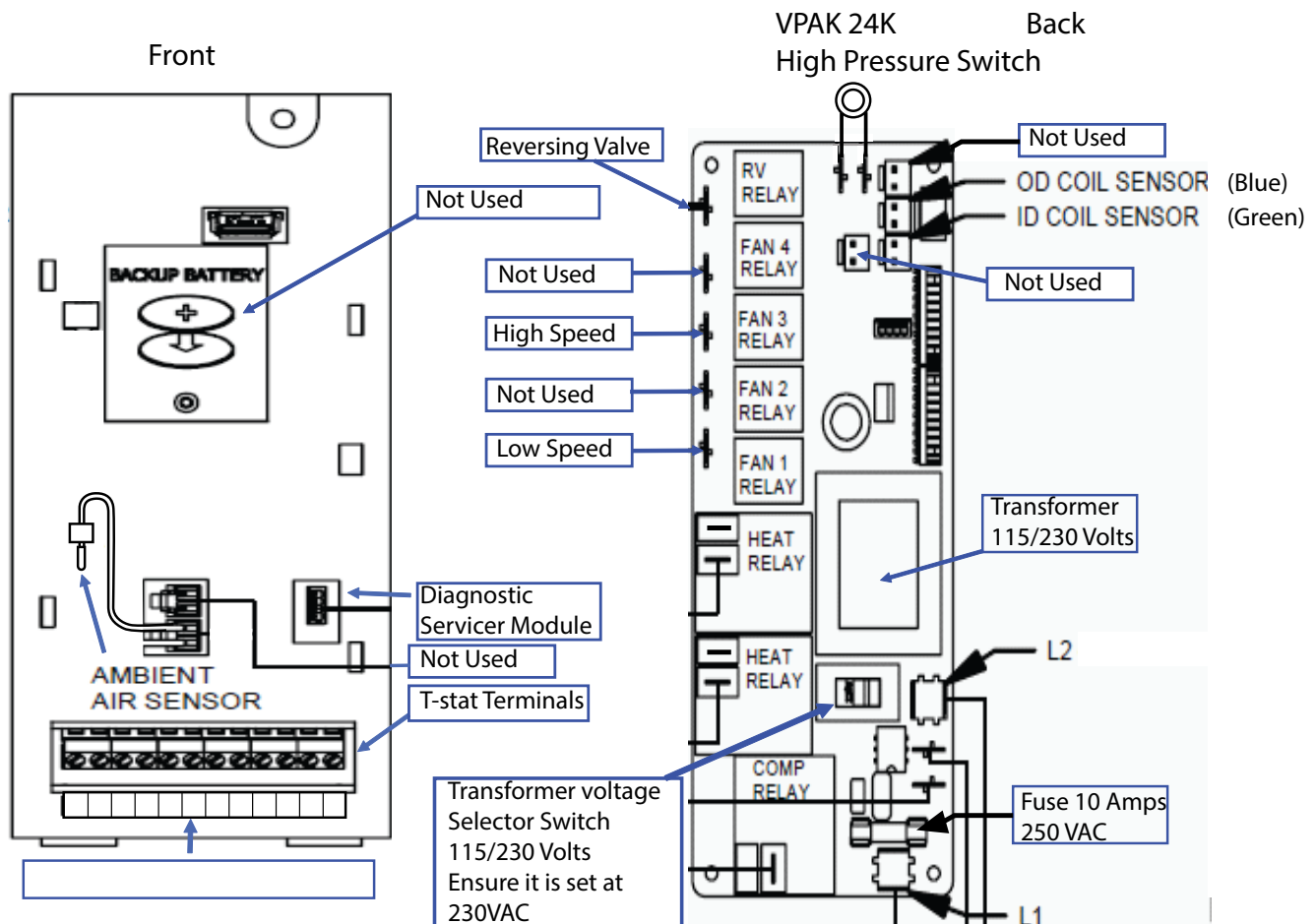

1. Test for power at L1 and L2 for 208/230 VAC. (Ensure the transformer voltage selector switch is set for 230 VAC)
2. TEST THE 10 AMP/250 VAC FUSE FOR CONTINUITY.

FOR THE FOLLOWING TESTS, ENSURE THE UNIT IS IN THE APPROPRIATE SETTINGS FOR THE TEST BEING PERFORMED. ENSURE THERE ARE NO ERROR CODES ACTIVE.

3. Testing the compressor relay and heat relays:
Test for power in and power out. If there is power in and no power out, replace the electronic control board.(208/230 to L2)
4. Testing the fan and reversing valve relays:
Test for power at the reversing valve and fan relays 1 or 3. (208/230 to L2)
5. Testing the transformer:
Test the low voltage terminal strip at:
R and C for 24 VAC
F2 and F1 for 24 VAC
D2 and D1 for 24 VAC
Test the service module connector for 5 VDC (see prior page)
Test the connectors for the thermistors for up to 5 VDC
If there is no voltage at any of the above, replace electronic control board.
6. Testing the thermistors:
Disconnect the thermistor and test for resistance value (see page 35)
7. Testing the high pressure switch (VPAK 24K only)
Test for 24 VAC at board, if there is no voltage, replace the electronic control.
Test the pressure switch for continuity, if none, replace it (switch is normally closed)

TROUBLESHOOTING

Error Codes and Alarm Status

Unit control panel

The display shown below has four digits. The left two digits indicate the error code # (1 to 24), the on/off icons above these two digits ; The Display contains a maintenance icon (Wrench) that will illuminate to indicate when that unit needs service.

The wrench indicates an error code is active. Check all error codes to identify the specific code that is on.

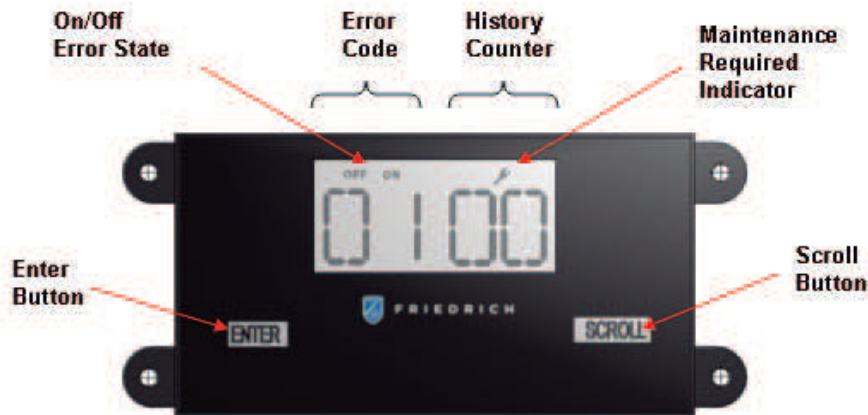

CHECK ERROR CODES

1. Press the Enter key to activate the display.
2. Each press of the scroll key display the next error code.

Clear History Counters

1. Press & hold the Enter key and the Scroll Key for 6 seconds.

TROUBLESHOOTING

Error Codes and Alarm Status

DIAG CODE	PROBLEM	CONTROL BOARD'S ACTION
1	Front Panel Button Stuck For More Than 20 Seconds	Continue to monitor for "OPEN" (Unstuck) switch. Do not process switch input.
2	Input Voltage Out of Specification (187 - 253)	Unit stops, open all relays until voltage is back within specs then resume operation.
3	Indoor Temperature Sensor is Open or Shorted	Unit defaults to 75°F in COOLING or 68°F in HEATING and will continue to operate if setting is below 75°F in cool mode or if above 68°F in heat mode.
4	Indoor Coil Temperature Sensor is Open or Shorted	The unit's control board defaults to 40°F. It will override the sensor and the unit will continue to operate.
5	Outdoor Coil Temperature Sensor is Open or Shorted	The unit defaults to 20°F, overriding the sensor. The unit will continue to operate. Using Elec Heat if available for HEATING. If not available, it will use HEAT PUMP if the outdoor temperature allows.
6	Outdoor Coil > (grater than) 175 F	The unit will shut down for 5 minutes. resume operation for 3 minutes. If test fails 3 times, the unit operation is locked out. See troubleshooting page 42. To reset, turn power off and on.
7	Indoor Coil < (less than) 30 F for 2 consecutive minutes	The compressor will turn off and the High Fan speed will run. When coil temp reaches 45°F the unit will resume operation after lockout time.
8	Unit Cycles > (greater than) 9 Times per hour	The unit will continue to operate and be monitored.
9	Unit Cycles < (less than) 3 Times per Hour	The unit will continue to operate and be monitored.
11	WallStat Problem or Connection Issue	The unit will not operate.
13	VPAK 24K Unit Only High Pressure Limit Switch is Open	If unit is cooling or heat pump is on, shut down compressor. Run high fan until switch closes, then resume operation. The third occurrence in 1 hour locks unit out. Applicable to 24K unit only. To reset, turn power off and on.
15	Heat Pump Error	If indoor coil temperature is less than ambient temperature for 3 minutes, the unit will use electric heat to satisfy the heating demand. Causes could be bad reversing valve, heat load too high.
16	Temperature beyond operating limits	Occurs if the indoor ambient temperature range falls below 0°F or greater than 130°F. The error code will remain on until the temperature reaches the operating range and then the unit will return to normal operation.
17	Equipment Doesn't Meet Minimum Configuration	The compressor must be enabled and have at least 2 fan speeds.
22	(Not an error code) Outdoor Coil Temperature < 30 F for 2 consecutive minutes	Unit will use electric heat to satisfy heating demands until the temperature equals or exceeds 45°F. Applicable for Heat Pump models only.

TROUBLESHOOTING

Electrical Troubleshooting Chart - Cooling

9K Btu, 12K Btu, & 18K Btu

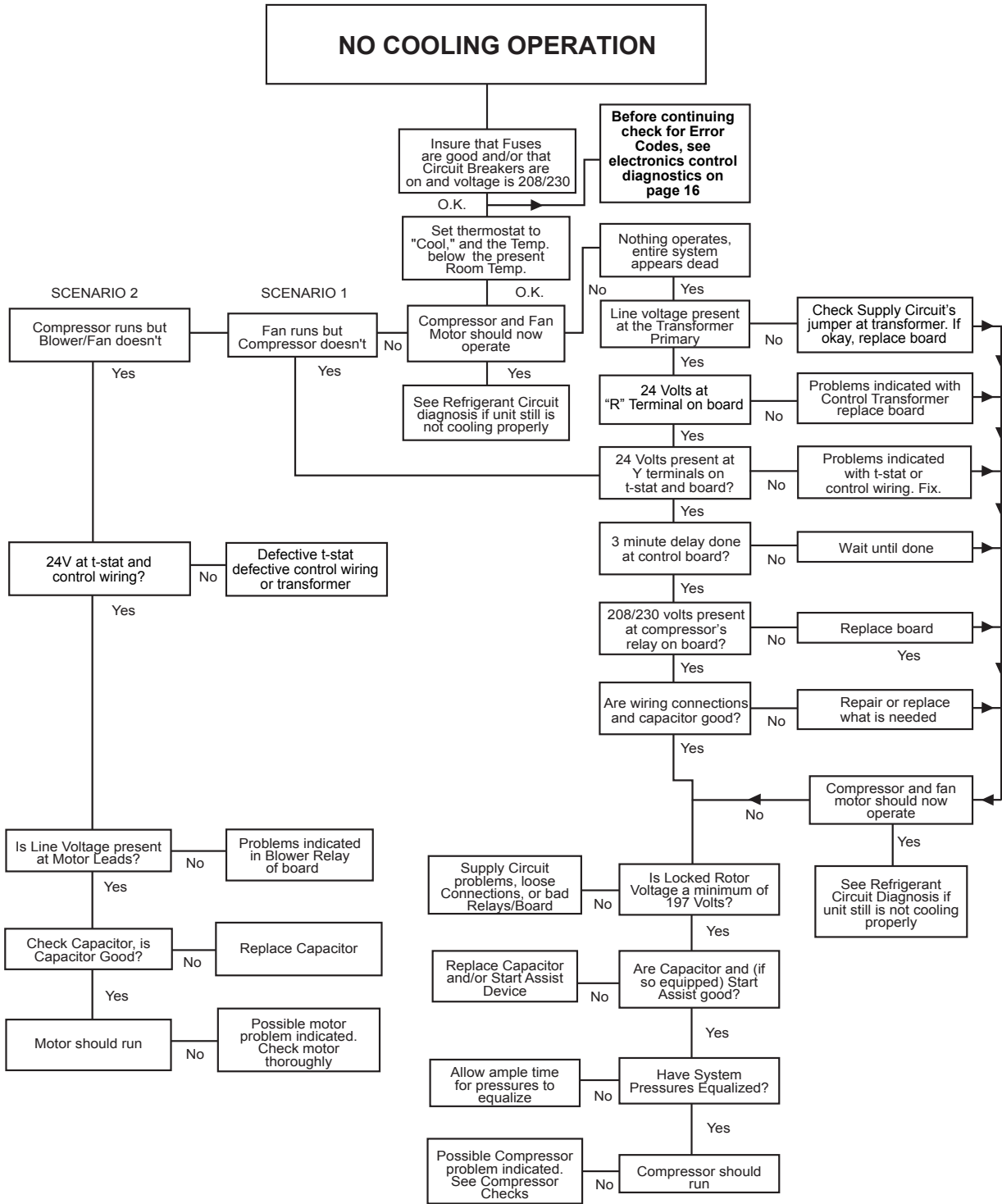

TROUBLESHOOTING

Electrical Troubleshooting Chart - Cooling

24K Btu

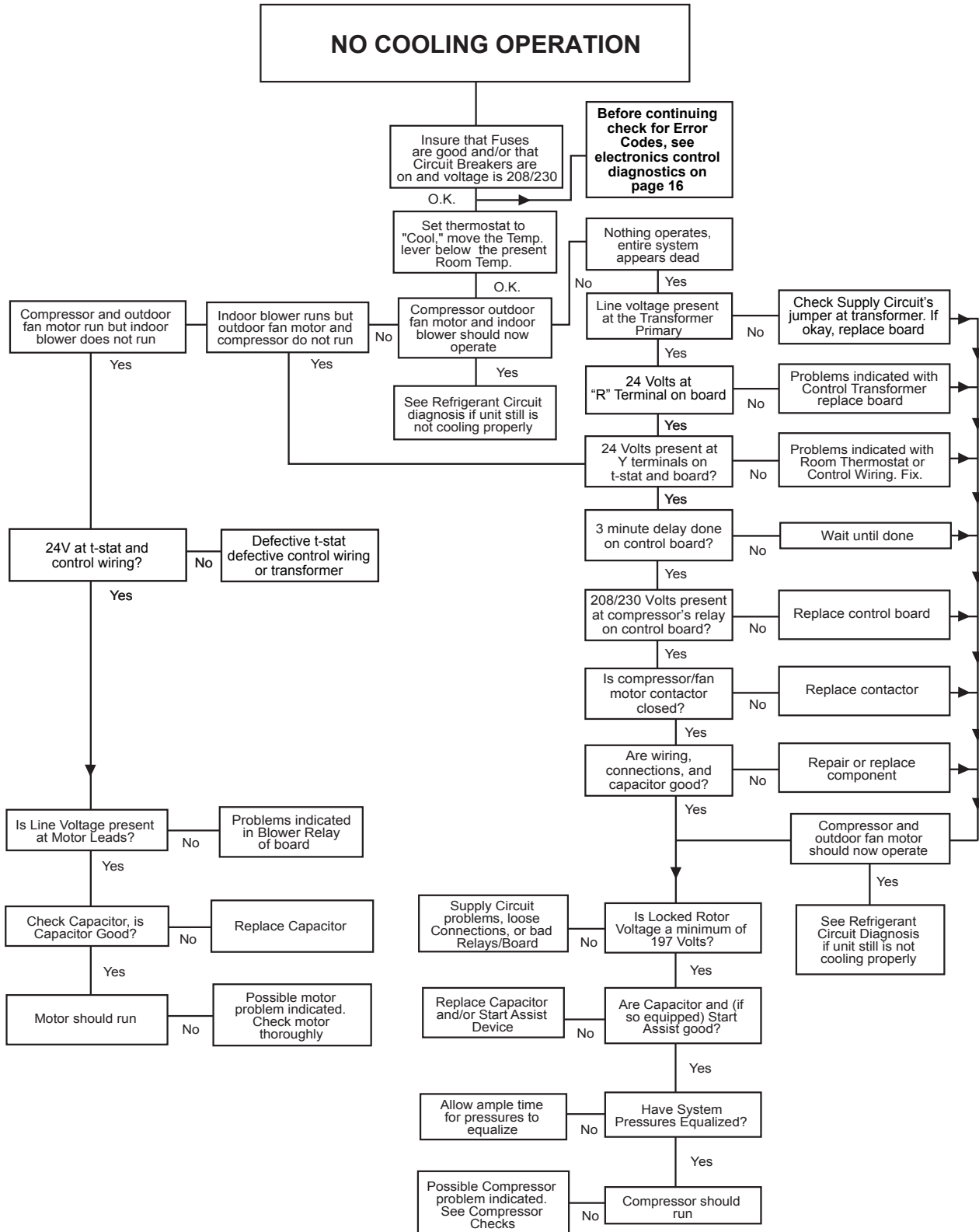

TROUBLESHOOTING

Electrical Troubleshooting Chart - Heat Pump

HEAT PUMP MODE

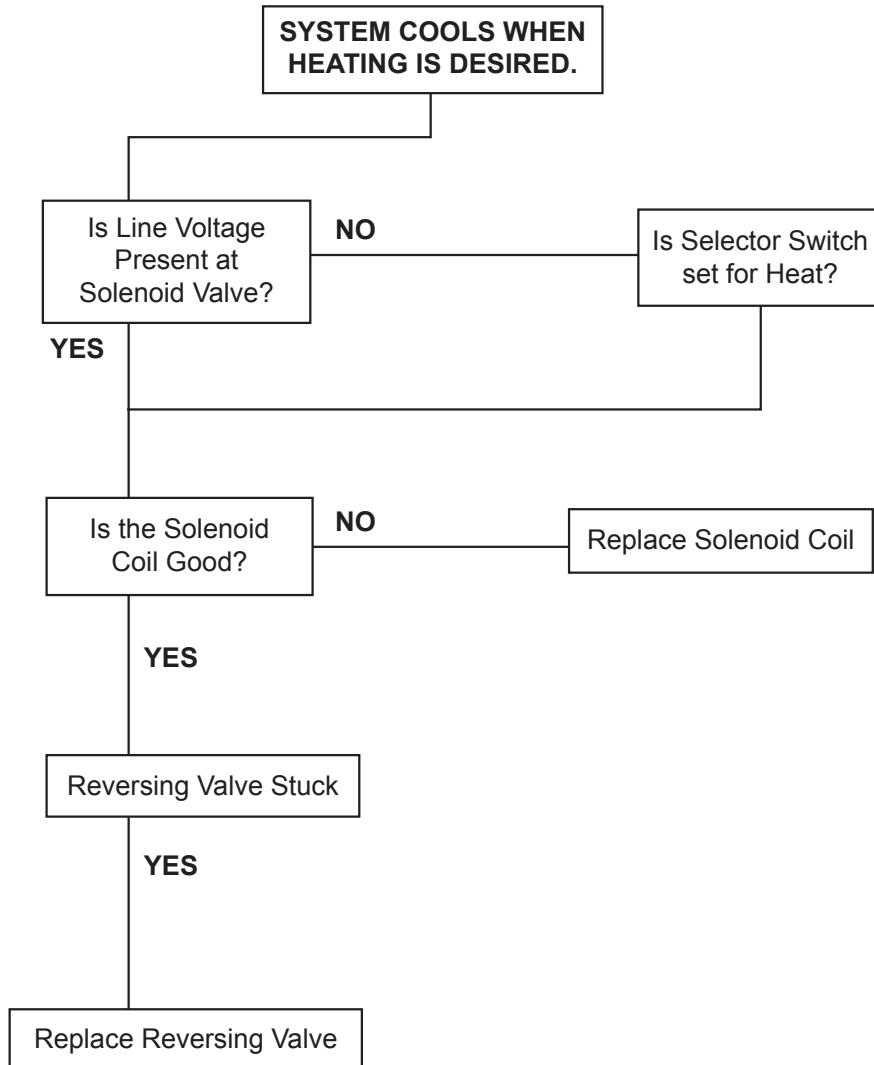

TROUBLESHOOTING

Troubleshooting Chart - Cooling

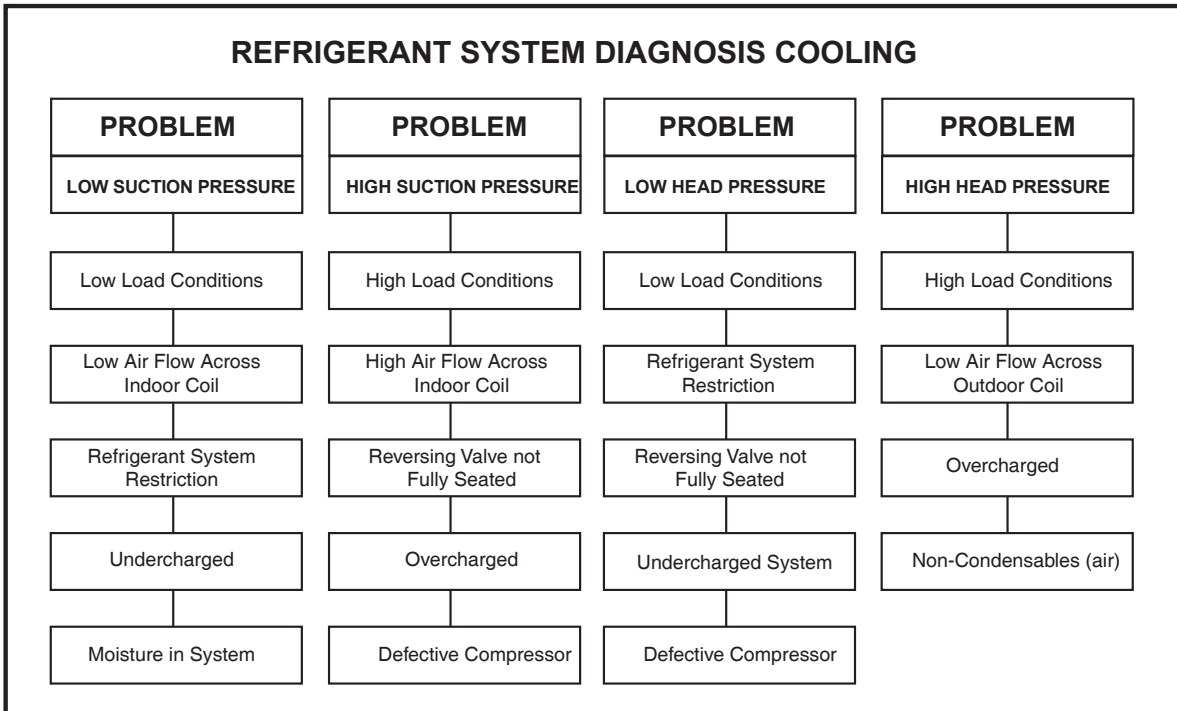

TROUBLESHOOTING CHART - HEATING (HEAT PUMP)

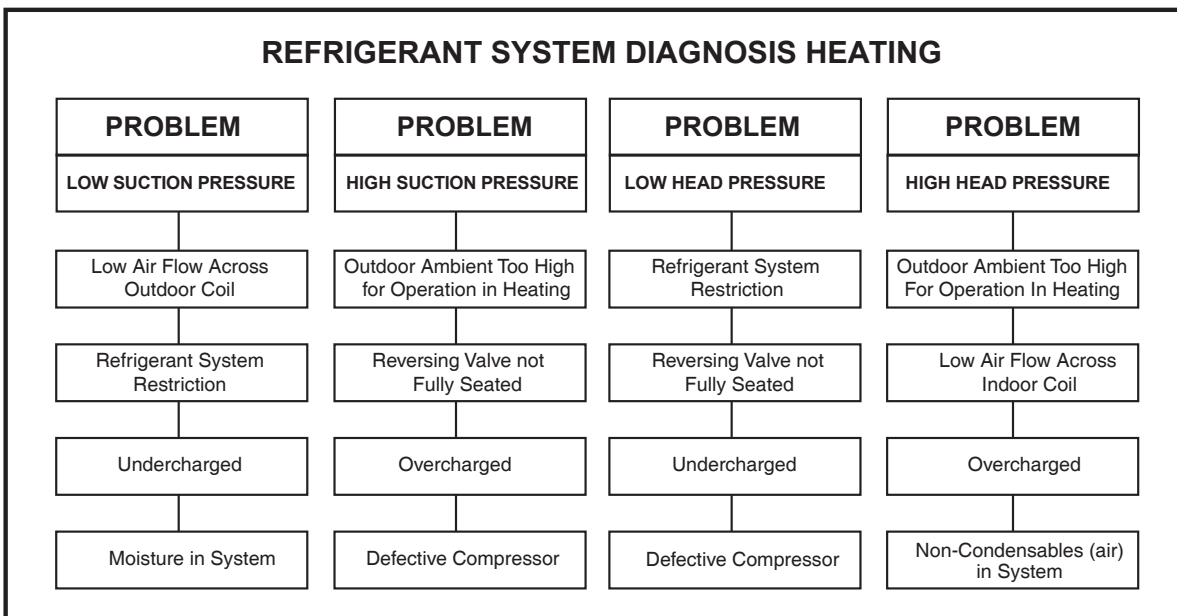

WIRING DIAGRAMS

9-18K VEA 208/230V

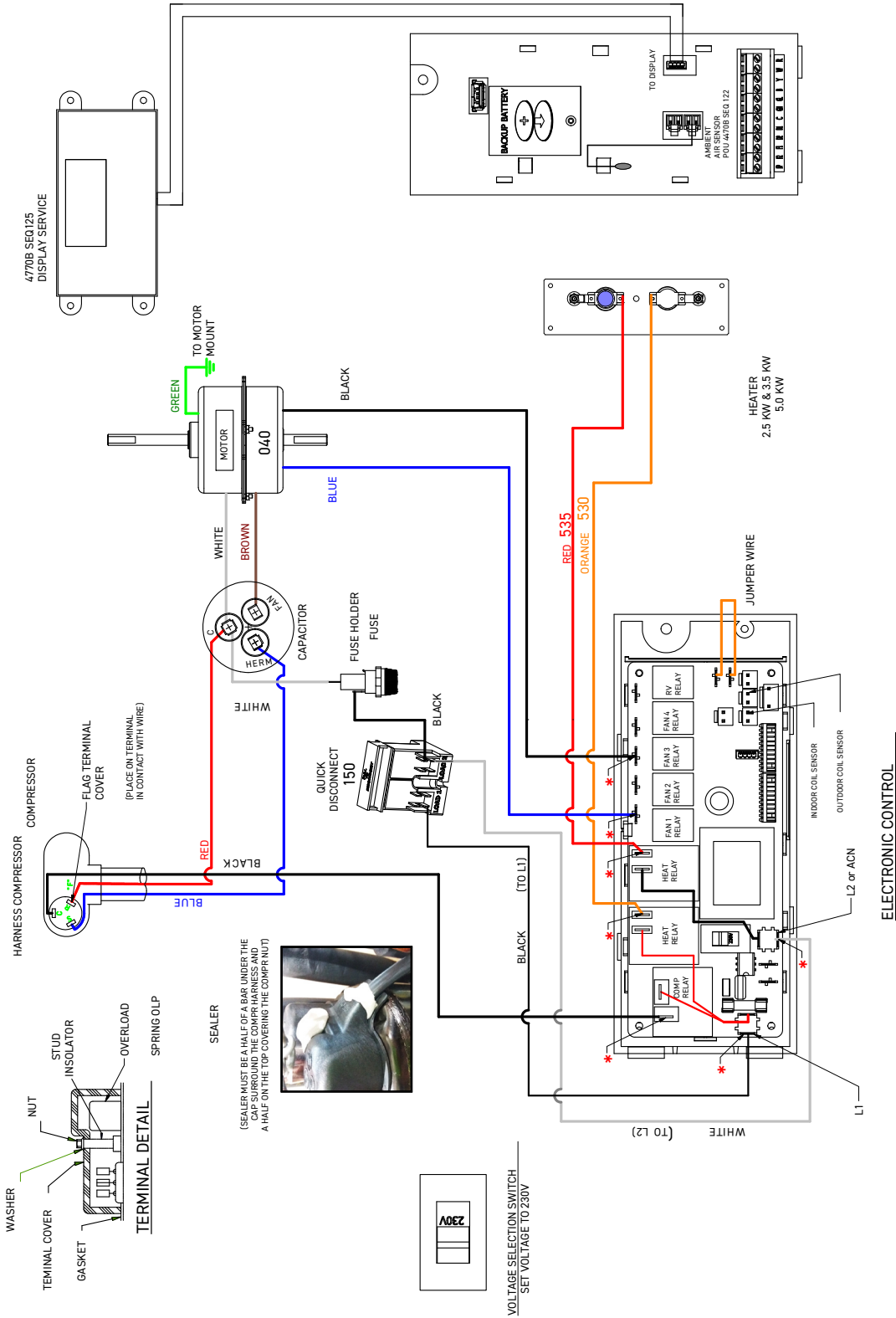

Figure 801 (80061802)

WIRING DIAGRAMS

24K VEA 208/230V 2.5/3.4/5.0

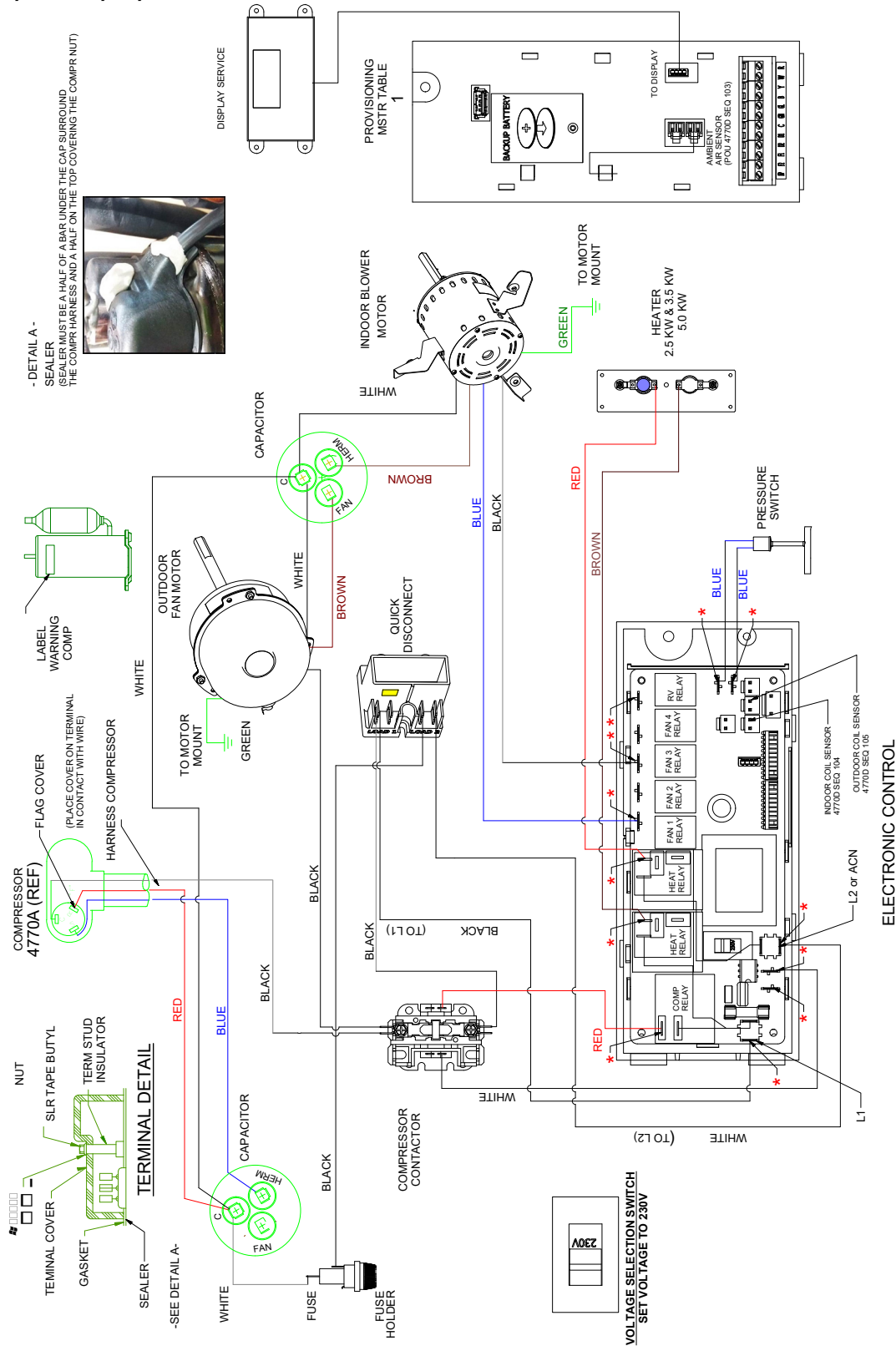
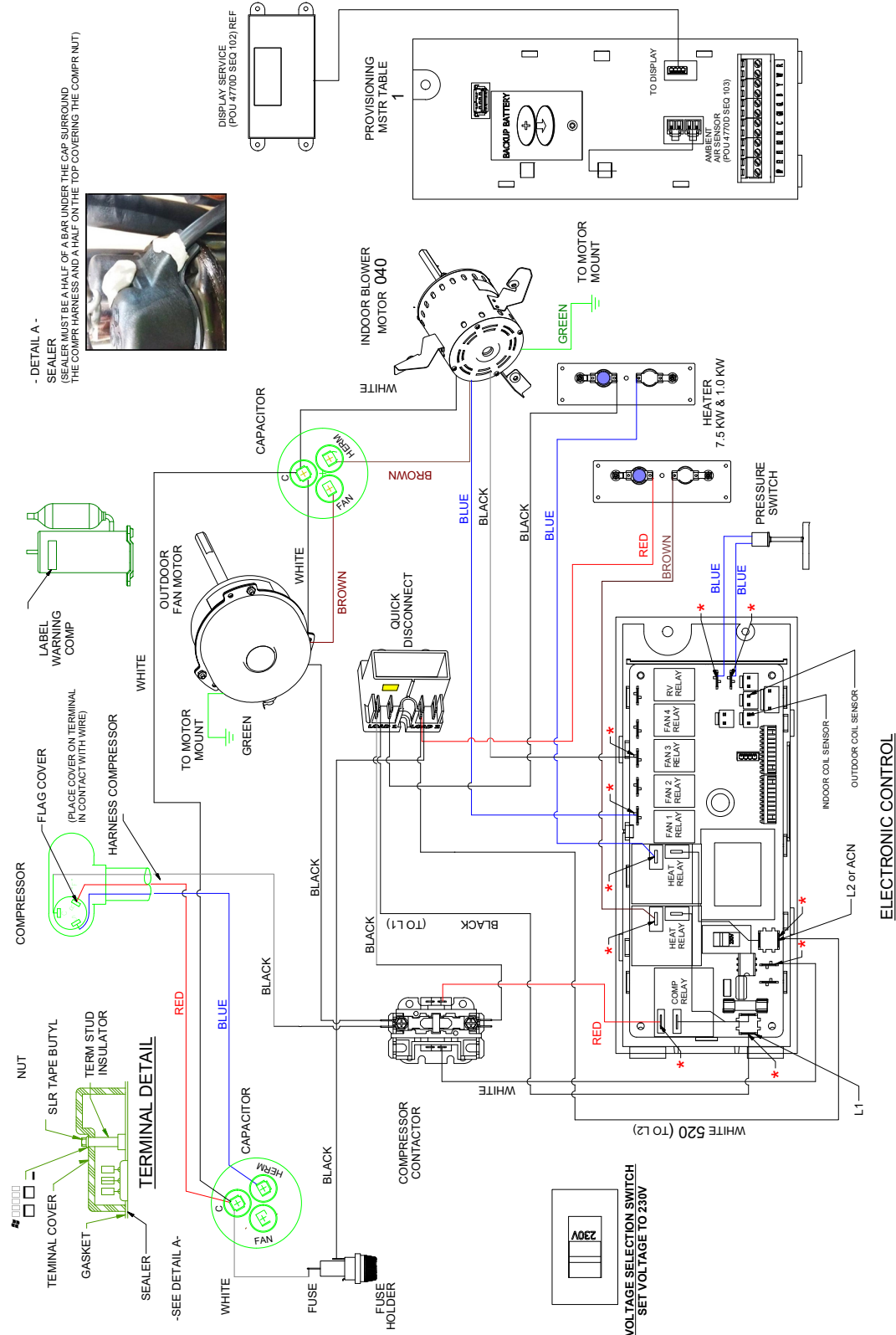

Figure 804 (80127302)

WIRING DIAGRAMS

24K VEA 208/230V 7.5/10.0



-DETAIL A -
SEALER MUST BE A HALF OF A BAR UNDER THE CAP SURROUND.
THE COMPRESSOR HARNESS AND A HALF ON THE TOP COVERING THE COMPRESSOR NUT



Figure 805 (80127401)

WIRING DIAGRAMS

24K VHA 208/230V 2.5/3.4/5.0

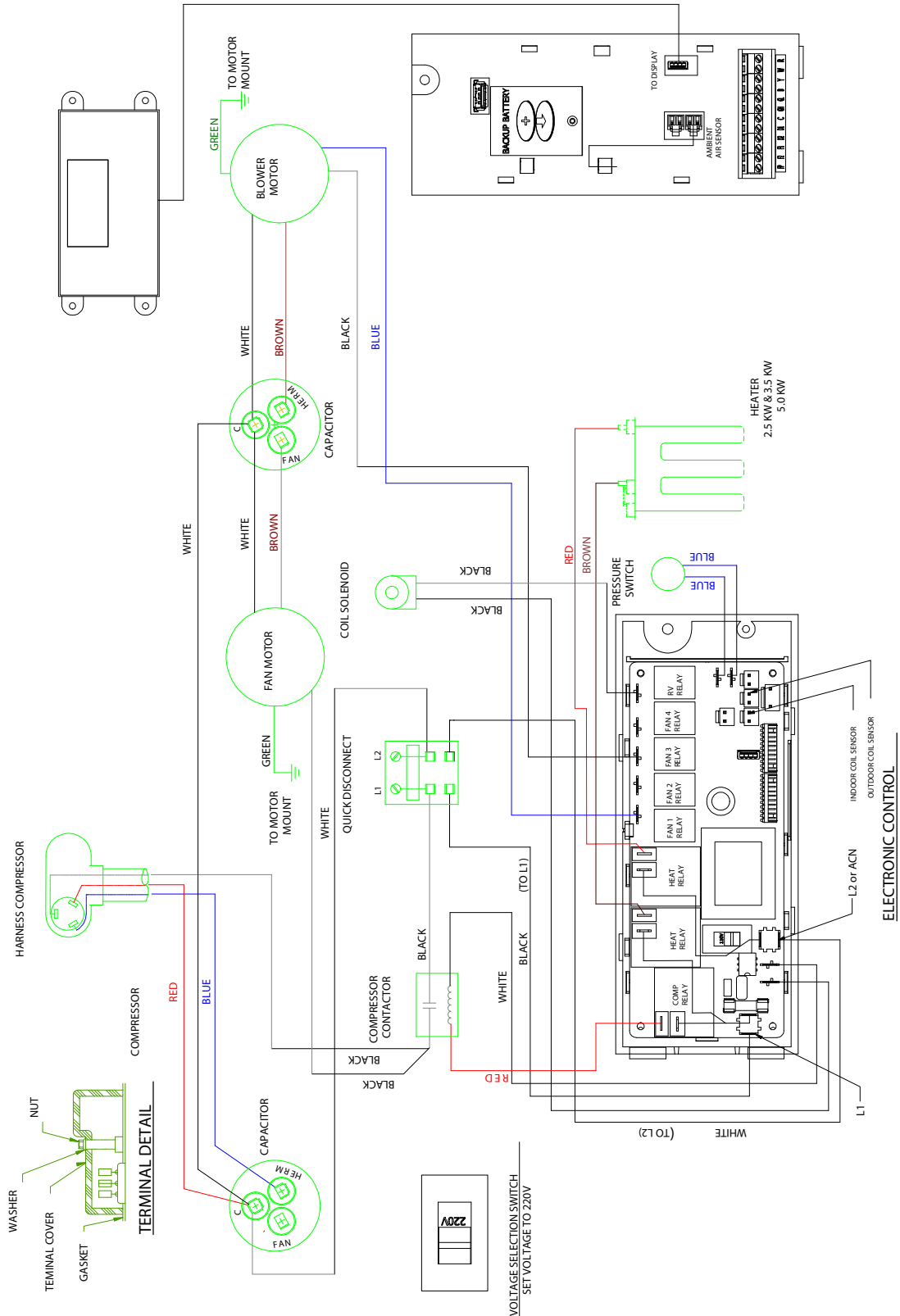

Figure 806 (80126301)

WIRING DIAGRAMS

24K VHA 208/230V 7.5/10

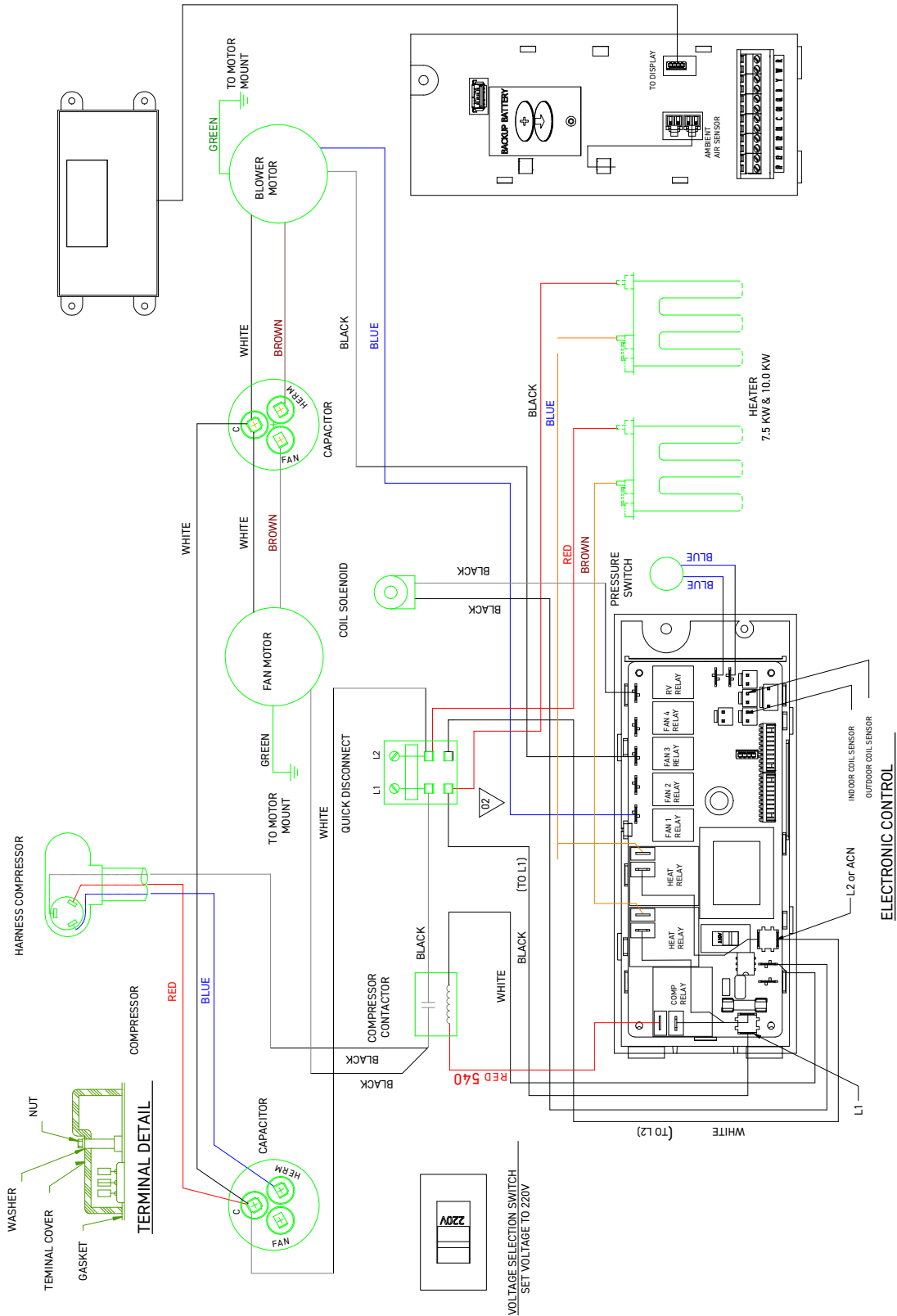

Figure 807 (80126401)

WIRING DIAGRAMS

24K VHA 265V 7.5/10.0

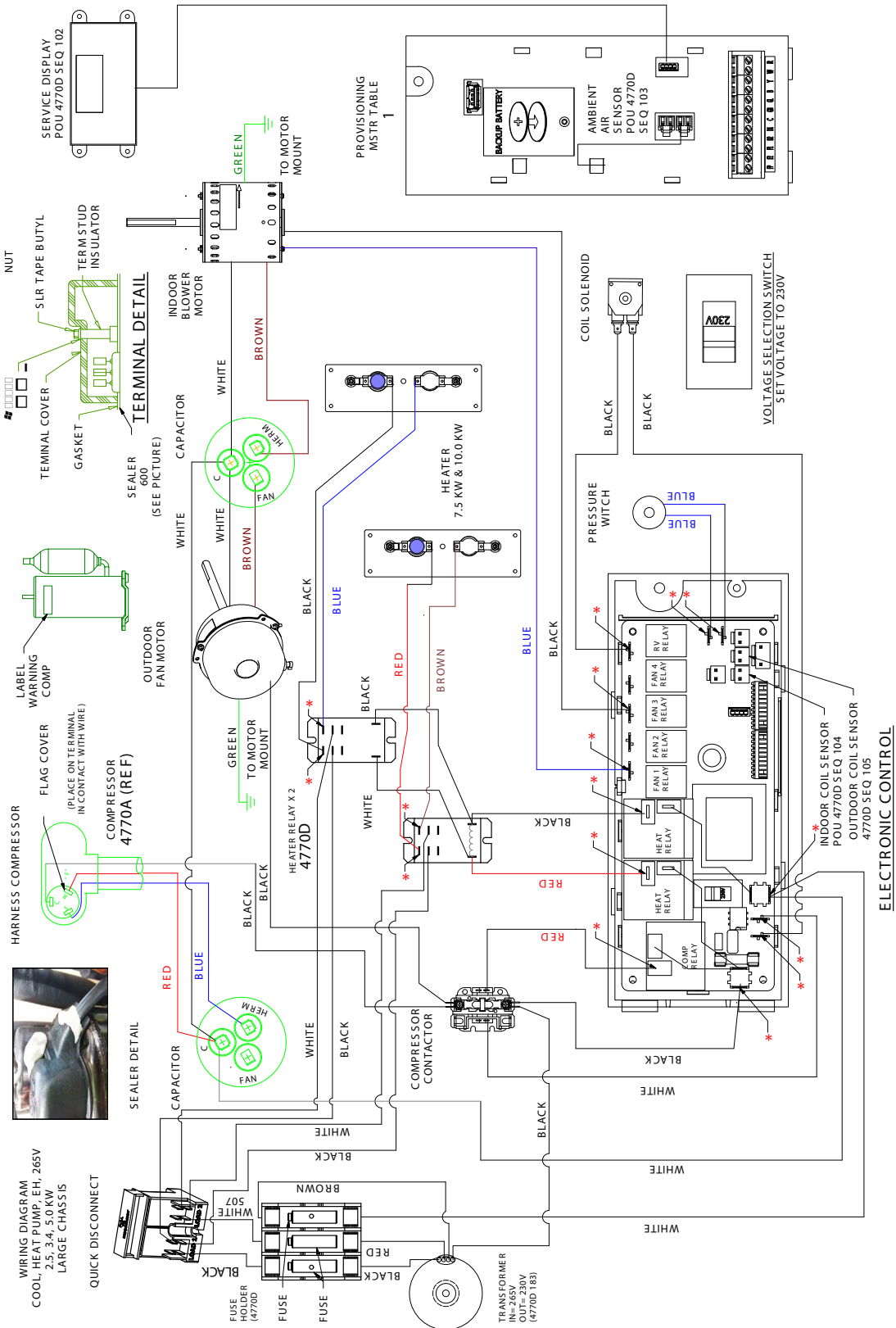
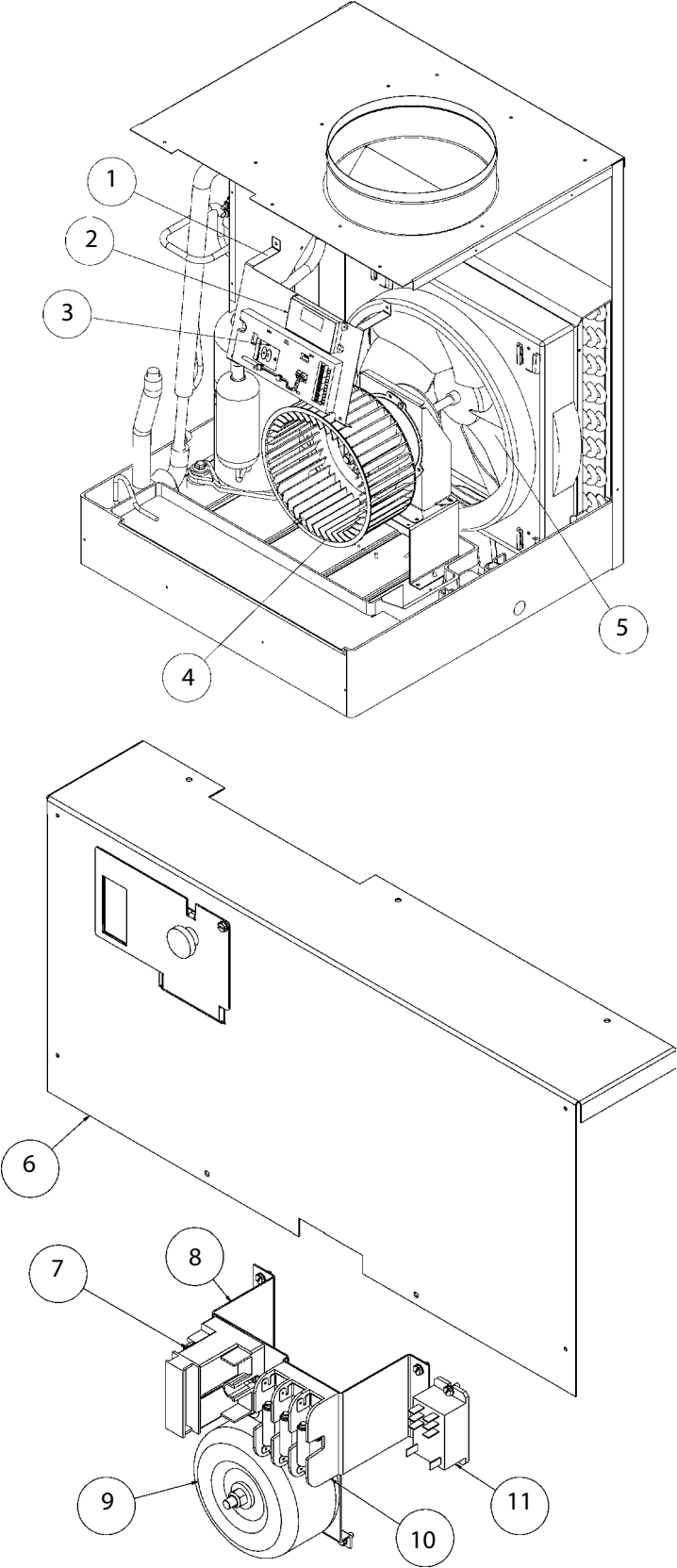

Figure 809 (80126402)

PARTS CATALOG

VEA9K, VHA9K, VEA12K, VHA12K, VEA18K

Figure 901



PARTS CATALOG

VEA9K, VHA9K, VEA12K, VHA12K, VEA18K

Figure 901

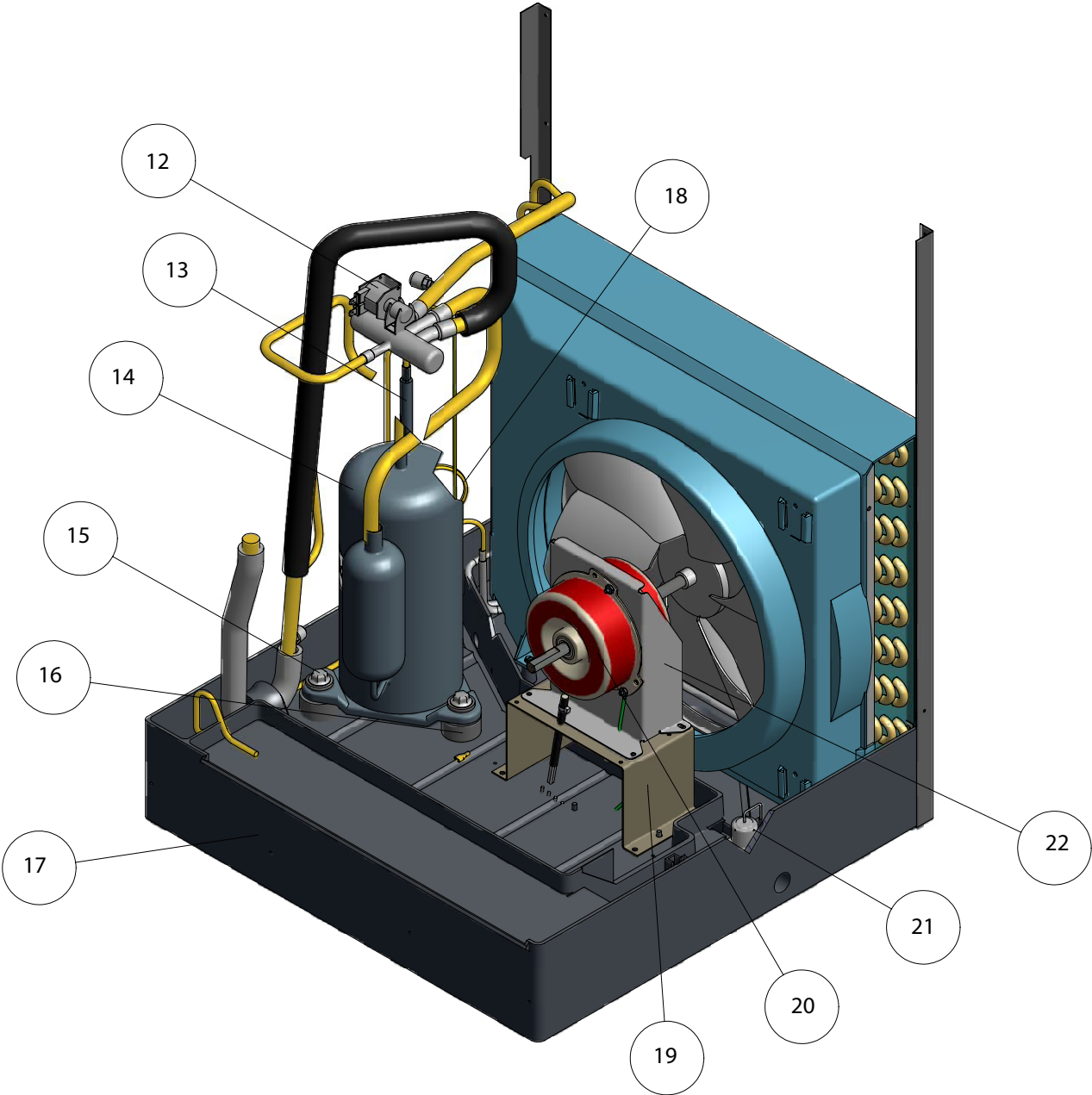

PARTS CATALOG

VEA9K, VHA9K, VEA12K, VHA12K, VEA18K

Figure 901

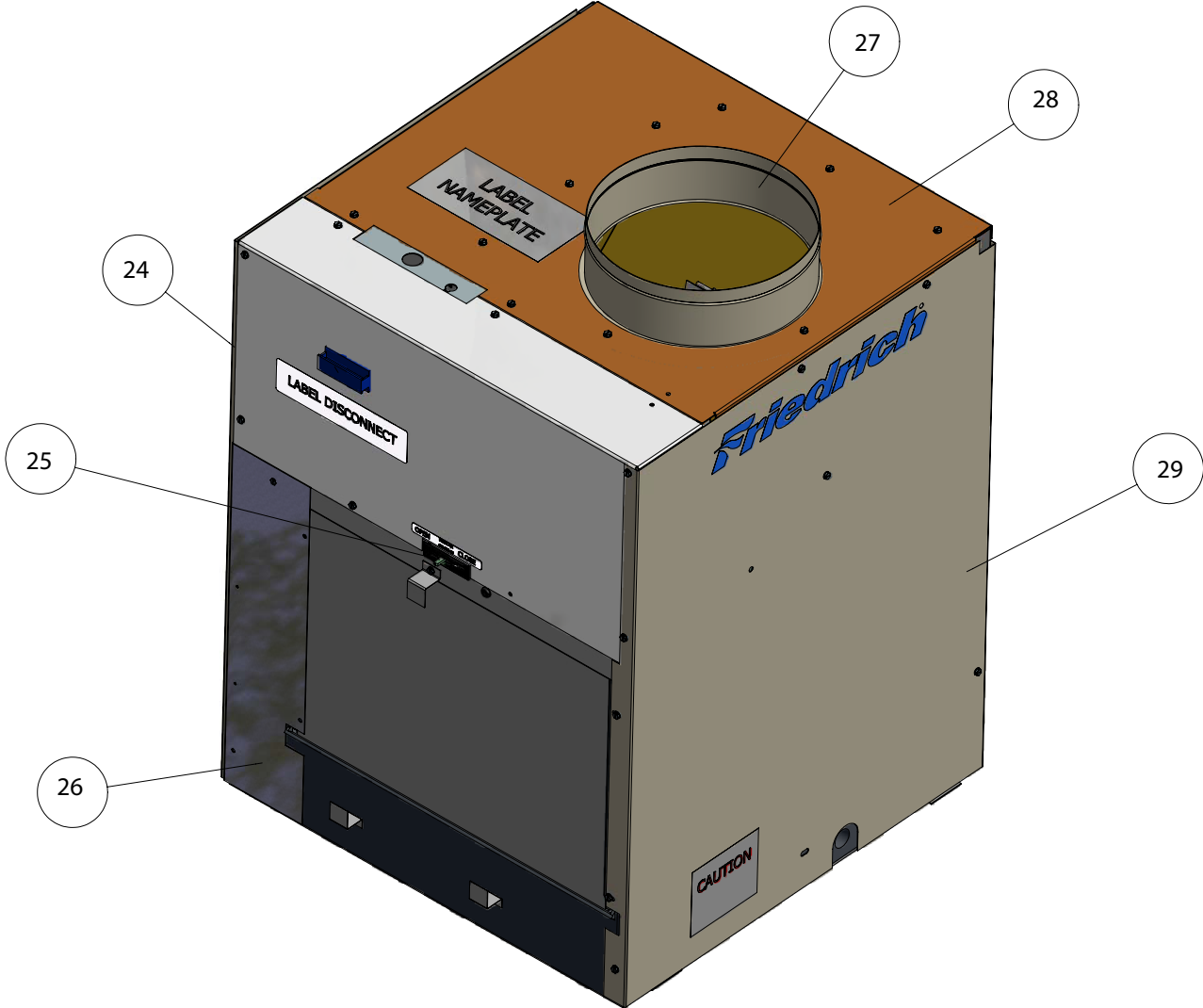

PARTS CATALOG

VEA9K, VHA9K, VEA12K, VHA12K, VEA18K

Figure 901

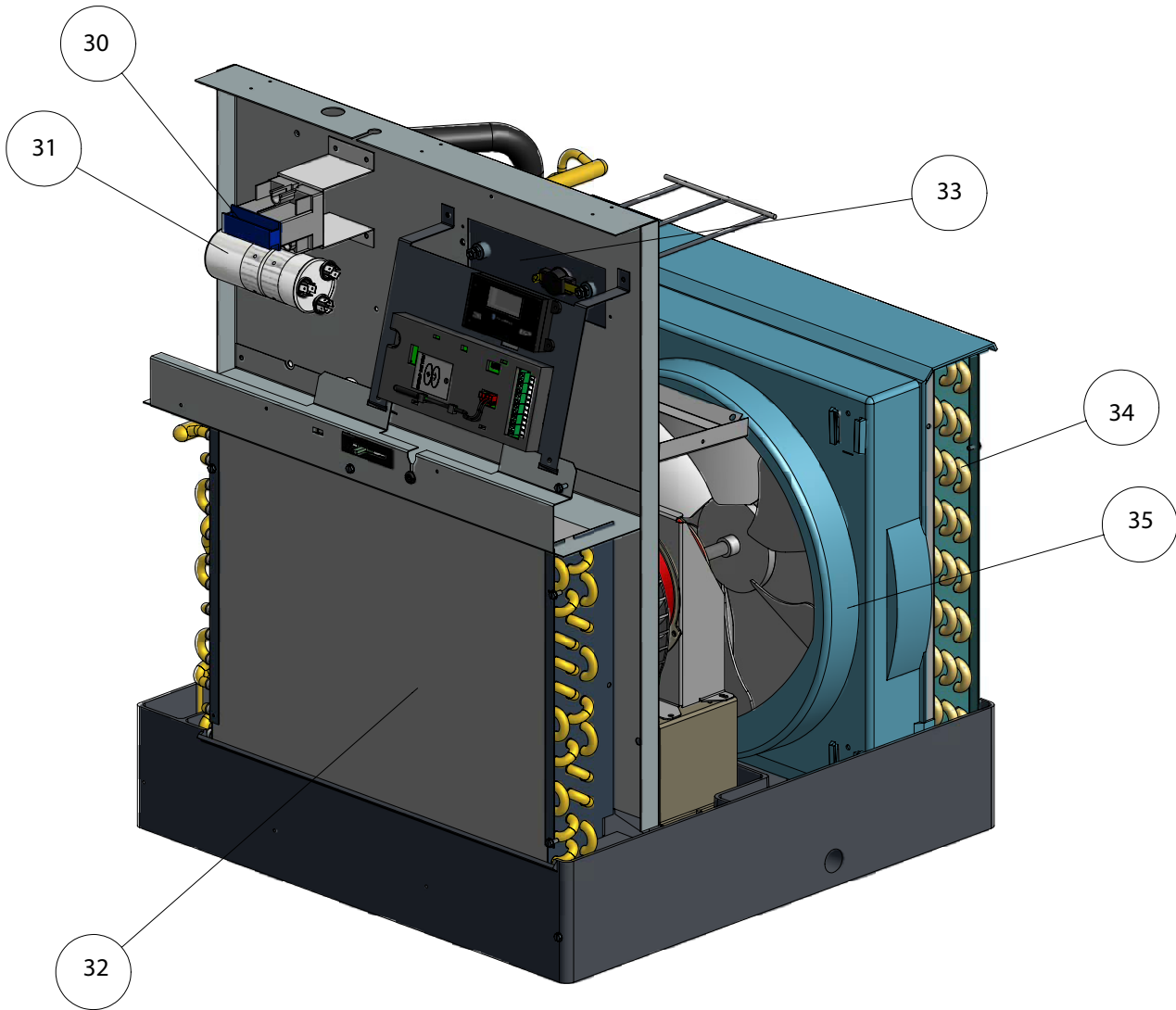

PARTS CATALOG

VEA9K, VHA9K, VEA12K, VHA12K, VEA18K

Figure 901

ITEM	PART NUMBER	PART DESCRIPTION	USED ON MODEL	QTY
1	80050634	BRACKET ELECT CTRL KUHL HEM	ALL	1
2	62600601	DISPLAY SERVICE VPAK GE	ALL	1
3	62601008	KIT E-CNTL SERV COOL VEA	VEA09K25RTN, VEA09K34RTN, VEA09K50RTN, VEA12K25RTN, VEA12K34RTN, VEA12K50RTN, VEA09K25RTP, VEA09K34RTP, VEA09K50RTP, VEA12K25RTP, VEA12K34RTP, VEA12K50RTP, VEA18K25RTP, VEA18K34RTP, VEA18K50RTP	1
3	62601009	KIT E-CNTL SERV COOL HP VHA	VHA09K25RTN ,VHA09K34RTN, VHA09K50RTN, VHA09R25RTN, VHA09R34RTN, VHA09R50RTN VHA12K25RTN, VHA12K34RTN, VHA12K50RTN, VHA12R25RTN, VHA12R34RTN, VHA12R50RTN, VHA18K25RTN, VHA18K34RTN, VHA18K50RTN, VHA18R25RTN, VHA18R34RTN, VHA18R50RTN	1
3	62600118	ASSY E-CNTRL COOL/EH AMP JMPR	ALL	1
4	60610616	WHEEL BLOWER TA0755	VEA09K25RTN, VEA09K34RTN, VEA09K50RTN, VEA12K25RTN, VEA12K34RTN, VEA12K50RTN, VEA09K25RTP, VEA09K34RTP, VEA09K50RTP, VEA12K25RTP, VEA12K34RTP, VEA12K50RTP, VEA18K25RTP, VEA18K34RTP, VEA18K50RTP, VHA09K25RTN ,VHA09K34RTN, VHA09K50RTN, VHA09R25RTN, VHA09R34RTN, VHA09R50RTN, VHA12K25RTN, VHA12K34RTN, VHA12K50RTN, VHA12R25RTN, VHA12R34RTN, VHA12R50RTN,	1
4	60610605	WHEEL BLOWER 9.10 X 4.000	VEA18K25RTP, VEA18K34RTP, VEA18K50RTP	1
5	60542004	FAN PLASTIC 14.5" TA1004	ALL	1
6	80015705	PANEL CONTROL BOX PREPNTD	VEA09K25RTN, VEA09K34RTN, VEA09K50RTN, VEA12K25RTN, VEA12K34RTN, VEA12K50RTN, VEA09K25RTP, VEA09K34RTP, VEA09K50RTP, VEA12K25RTP, VEA12K34RTP, VEA12K50RTP, VEA18K25RTP, VEA18K34RTP, VEA18K50RTP, VHA09K25RTN ,VHA09K34RTN, VHA09K50RTN, VHA12K25RTN, VHA12K34RTN, VHA12K50RTN,	1
6	80015706	PANEL CONTROL BOX PREPAINTED 18K265	VHA09R25RTN, VHA09R34RTN, VHA09R50RTN, VHA12R25RTN, VHA12R34RTN, VHA12R50RTN,	1
7	80007600	NONFUSED DISCONNECT	ALL	1
8	80002100	BRACKET DISCONNECT	ALL	1
8	80118502	BRACKET FUSE HOLDER	VHA09R25RTN, VHA09R34RTN, VHA09R50RTN, VHA12R25RTN, VHA12R34RTN, VHA12R50RTN	1
9	61670803	TRANSFORMER IN 265V OUT 235V	VHA09R25RTN, VHA09R34RTN, VHA09R50RTN, VHA12R25RTN, VHA12R34RTN, VHA12R50RTN	1
10	61776111	FUSE BLOCK 3 POLES 30 AMP	VHA09R25RTN, VHA09R34RTN, VHA09R50RTN, VHA12R25RTN, VHA12R34RTN, VHA12R50RTN	1

PARTS CATALOG

VEA9K, VHA9K, VHA12K, VEA12K, VEA18K

Figure 901

ITEM	PART NUMBER	PART DESCRIPTION	USED ON MODEL	QTY
10	21058443	FUSE HOLDER 20A HPF 13/32 X 1-1/2	VEA09K25RTN, VEA09K34RTN, VEA09K50RTN, VEA12K25RTN, VEA12K34RTN, VEA12K50RTN, VEA09K25RTP, VEA09K34RTP, VEA09K50RTP, VEA18K25RTP, VEA18K34RTP, VEA18K50RTP, VHA09K25RTN, VHA09K34RTN, VHA09K50RTN, VHA12K25RTN, VHA12K34RTN, VHA12K50RTN, VEA18K25RTP, VEA18K34RTP, VEA18K50RTP	1
10	61773319	FUSE 600V 15A CC TD	VHA09R25RTN, VHA09R34RTN, VHA09R50RTN, VHA12R25RTN, VHA12R34RTN, VHA12R50RTN	2
10	61773317	FUSE 600V 20A CC TD	VHA09R25RTN, VHA09R34RTN, VHA09R50RTN, VHA12R25RTN, VHA12R34RTN, VHA12R50RTN	1
10	61773323	FUSE 250V 20A 1.5X13/32 TIME DELAY	ALL	1
11	61643311	RELAY 230V COIL DPDT 30A 208/240VAC	VHA09R25RTN, VHA09R34RTN, VHA09R50RTN, VHA12R25RTN, VHA12R34RTN, VHA12R50RTN	1
12	80043209	ASSY VALVE REVERSING	VHA09K25RTN, VHA09K34RTN, VHA09K50RTN, VHA09R34RTN, VHA09R50RTN, VHA12K25RTN,	1
12	80043211	ASSY VALVE REVERSING	VHA12K25RTN, VHA12K34RTN, VHA12K50RTN, VHA12R25RTN, VHA12R34RTN, VHA12R50RTN,	1
13	80109305	ASSY CHECK VALVE	VHA09K25RTN, VHA09K34RTN, VHA09K50RTN, VHA09R25RTN, VHA09R34RTN, VHA09R50RTN,	1
13	80042919	ASSY VALVE CHECK & CAPLRY	VHA12K25RTN, VHA12K34RTN, VHA12K50RTN, VHA12R25RTN, VHA12R34RTN, VHA12R50RTN,	1
14	61718146	KIT COMPR REPLMT 62200507	VEA09K25RTN, VEA09K34RTN, VEA09K50RTN, VHA09K25RTN, VHA09K34RTN, VHA09K50RTN, VHA09R25RTN, VHA09R34RTN, VHA09R50RTN, VEA09K25RTP, VEA09K34RTP, VEA09K50RTP	11
14	61718125	KIT COMPR RPLMNT 62200313	VEA12K25RTN, VEA12K34RTN, VEA12K50RTN, VHA12K25RTN, VHA12K34RTN, VHA12K50RTN, VHA12R25RTN, VHA12R34RTN, VHA12R50RTN, VEA12K25RTP, VEA12K34RTP, VEA12K50RTP	1
14	80074938	KIT COMPR REPLMT 62200503	VEA18K25RTP, VEA18K34RTP, VEA18K50RTP	1
15	91400402	STUD COMPR MTG	ALL	3
16	61028904	GROMMET COMPR LOW DENSITY	ALL	3
17	80023703	BASEPAN VPAK	VEA09K25RTN, VEA09K34RTN, VEA09K50RTN, VHA09K25RTN, VHA09K34RTN, VHA09K50RTN, VHA09R25RTN, VHA09R34RTN, VHA09R50RTN, VEA09K25RTP, VEA09K34RTP, VEA09K50RTP	1
17	80023702	BASEPAN VPAK	VEA12K25RTN, VEA12K34RTN, VEA12K50RTN, VHA12K25RTN, VHA12K34RTN, VHA12K50RTN, VHA12R25RTN, VHA12R34RTN, VHA12R50RTN, VEA12K25RTP, VEA12K34RTP, VEA12K34RTP, VEA18K25RTL, VEA18K34RTL, VEA18K50RTL, VEA18K25RTP, VEA18K34RTP, VEA18K50RTP	1
18	03760451	TUBE CAP .049 IDX.0990DX19.5" RED	VHA09K25RTN, VHA09K34RTN, VHA09K50RTN, VHA09R25RTN, VHA09R34RTN, VHA09R50RTN	1
18	03760548	TUBE CAP .054 X.1060D X 39.25 WHITE	VHA12K25RTN, VHA12K34RTN, VHA12K50RTN, VHA12R25RTN, VHA12R34RTN, VHA12R50RTN	1

PARTS CATALOG

VEA9K, VHA9K, VEA12K, VHA12K, VEA18K

Figure 901

ITEM	PART NUMBER	PART DESCRIPTION	USED ON MODEL	QTY
18	03760573	TUBE CAPLRY .042"IDX.087X30" REDWHITE	VEA09K25RTN, VEA09K34RTN, VEA09K50RTN, VEA09K25RTP, VEA09K34RTP, VEA09K50RTP	1
18	03760574	TUBE CAPLRY .046"ID X.097"X25" ALUM	VEA12K25RTN, VEA12K34RTN, VEA12K50RTN, VEA12K25RTP, VEA12K34RTP, VEA12K34RTP	1
18	01390212	TUBE CAP .059 ID X.112 OD X 37 BLUE	VHA12K25RTN, VHA12K34RTN, VHA12K50RTN, VHA12R25RTN, VHA12R34RTN, VHA12R50RTN,	1
18	03760513	TUBE CAP .049 X .099 OD X 30 RED	VHA09K25RTN , VHA09K34RTN, VHA09K50RTN, VHA09R25RTN, VHA09R34RTN, VHA09R50RTN	1
18	01389915	TUBE CAP .059 X.112 OD X 20.4 BLUE	VEA18K25RTP, VEA18K34RTP, VEA18K50RTP	1
19	80050200	MOTOR RISER FOR WELLING	ALL	1
20	80006870	MTR 1/4 4 GP CCW 2 PSC 10.0 WELLING	ALL	1
21	60179904	CONDENSATE DRAIN VALVE	ALL	1
22	61776900	MOTOR MOUNT XQ	ALL	1
24	80013809	ASSY INSUL LEFT SIDE PANEL	ALL	1
25	61814800	CONNECTOR FRESH AIR S/M	ALL	1
26	80049601	ASSY PANEL UFRONT INSUL	ALL	1
27	80001800	COLLAR 24 GA	ALL	1
28	80013503	ASSY INSULATION TOP COVER PREPAI	ALL	1
29	80013808	ASSY INSUL RIGHT SIDE PANEL	ALL	1
30	80019001	ASSY INNERWALL INSUL	ALL	1
31	61080538	CAPCTR 25/10 MF 370V 2.0	VEA09K25RTN, VEA09K34RTN, VEA09K50RTN, VEA09K25RTP, VEA09K34RTP, VEA09K50RTP, VHA09K25RTN , VHA09K34RTN, VHA09K50RTN, VHA09R25RTN, VHA09R34RTN, VHA09R50RTN,	1
31	61080558	CAPCTR 30/10 MF 370V 2.0	VEA12K25RTN, VEA12K34RTN, VEA12K50RTN, VEA12K25RTP, VEA12K34RTP, VEA12K50RTP, VHA12K25RTN, VHA12K34RTN, VHA12K50RTN, VHA12R25RTN, VHA12R34RTN, VHA12R50RTN,	1
31	61080554	CAPCTR 40/10MF 370V 2.0	VEA18K25RTP, VEA18K34RTP, VEA18K50RTP,	1
32	80041761	EVAPORATOR COIL VES.312X4X16XU9V45A18X13H	VEA09K25RTN, VEA09K34RTN, VEA09K50RTN, VEA12K25RTN, VEA12K34RTN, VEA12K50RTN, VEA09K25RTP, VEA09K34RTP, VEA09K50RTP, VHA09K25RTN , VHA09K34RTN, VHA09K50RTN, VHA09R25RTN, VHA09R34RTN, VHA09R50RTN, VEA12K25RTP, VEA12K34RTP, VEA12K50RTP, VHA12K25RTN, VHA12K34RTN, VHA12K50RTN, VHA12R25RTN, VHA12R34RTN, VHA12R50RTN,	1
32	80048150	EVAPORATOR COIL VES.375X3X18RC2V45A18X13H6	VEA18K25RTP, VEA18K34RTP, VEA18K50RTP	1
33	80017090	HEATER VPAK-A NXT 2.5KW 230V	VEA09K25RTP, VEA09K25RTN, VHA09K25RTN, VHA12R25RTN, VEA12K25RTN, VEA12K25RTP, VHA12K25RTN, VHA12R25RTN, VEA18K25RTP	1

PARTS CATALOG

VEA9K, VHA9K, VEA12K, VHA12K, VEA18K, VHA18K

Figure 901

ITEM	PART NUMBER	PART DESCRIPTION	USED ON MODEL	QTY
33	80017091	HEATER VPAK-A NXT 3.4KW 230V	VEA09K34RTN, VEA09K34RTP, VHA09K34RTN, VHA12R34RTN, VEA12K34RTN, VEA12K34RTP, VHA12K34RTN, VHA12R34RTN, VEA18K34RTP	1
33	80017092	HEATER VPAK-A NXT 5.0KW 230V	VEA09K50RTN, EA09K50RTP, VHA09K50RTN, VHA12R50RTN, VEA12K50RTN, VEA12K50RTP, VHA12K50RTN, VHA12R50RTN, VEA18K50RTP	1
33	80017102	HEATER VPAK-A NXT 2.5KW 265V	VHA09R25RTN, VHA12R25RTN	1
33	80017101	HEATER VPAK-A NXT 3.4KW 265V	VHA09R34RTN, VHA12R34RTN	1
33	80017100	HEATER VPAK-A NXT 5.0KW 265V	VHA09R50RTN, VHA12R50RTN	1
34	80101265	CONDENSER COIL VCS .250X4X16XC9K45A17X15H3	VEA09K25RTN, VEA09K34RTN, VEA09K50RTN, VHA09K25RTN, VHA09K34RTN, VHA09K50RTN, VHA09R25RTN, VHA09R34RTN, VHA09R50RTN, VHA12K25RTN, VHA12K34RTN, VHA12K50RTN, VHA12R25RTN, VHA12R34RTN, VHA12R50RTN, VEA09K25RTP, VEA09K34RTP, VEA09K50RTP	1
34	80101266	CONDENSER COIL VCS .250X4X16XC9K45A17X15H3	VEA12K25RTN, VEA12K34RTN, VEA12K50RTN, VEA12K25RTP, VEA12K34RTP, VEA12K50RTP	1
34	80048050	CONDENSER COIL VCS .375X3X18RC2V45B 19X17H3	VEA18K25RTL, VEA18K34RTL, VEA18K50RTL, VEA18K25RTP, VEA18K34RTP, VEA18K50RTP	1
35	61804901	SHROUD MED W/FD RESTRAINT	ALL	1
-36	21058443	FUSE HOLDER 20A HPF 13/32 X 1-1/2	ALL	1
-37	61773323	FUSE 250V 20A 1.5X13/32 TIME DELAY	ALL	
-38	61764607	OLP B180-140B-241C 60343539	VEA09K25RTN, VEA09K34RTN, VEA09K50RTN, VEA09K25RTP, VEA09K34RTP, VEA09K50RTP, VHA09K25RTN, VHA09K34RTN, VHA09K50RTN, VHA09R25RTN, VHA09R34RTN, VHA09R50RTN,	1
-39	61764613	OLP B245-140B-141 H FSTB	VEA12K25RTN, VEA12K34RTN, VEA12K50RTN, VEA12K25RTP, VEA12K34RTP, VEA12K50RTP, VHA12K25RTN, VHA12K34RTN, VHA12K50RTN, VHA12R25RTN, VHA12R34RTN, VHA12R50RTN	1
-40	62600203	SENSOR ID RIA TEMPERATURE (WHITE)	ALL	1
-41	62600205	SENSOR ID COIL TEMPERATURE (GREEN)	ALL	1
-42	62600206	SENSOR OD COIL TEMPERATURE (BLUE)	ALL	1
-ITEMS ARE NON- ILLUSTRATED				
*ITEMS ARE NON-STOCKED, WILL NORMALLY REQUIRE 2-3 WEEKS LEAD TIME				

PARTS CATALOG

VHA18K, VEA24K, VHA24K

Figure 902

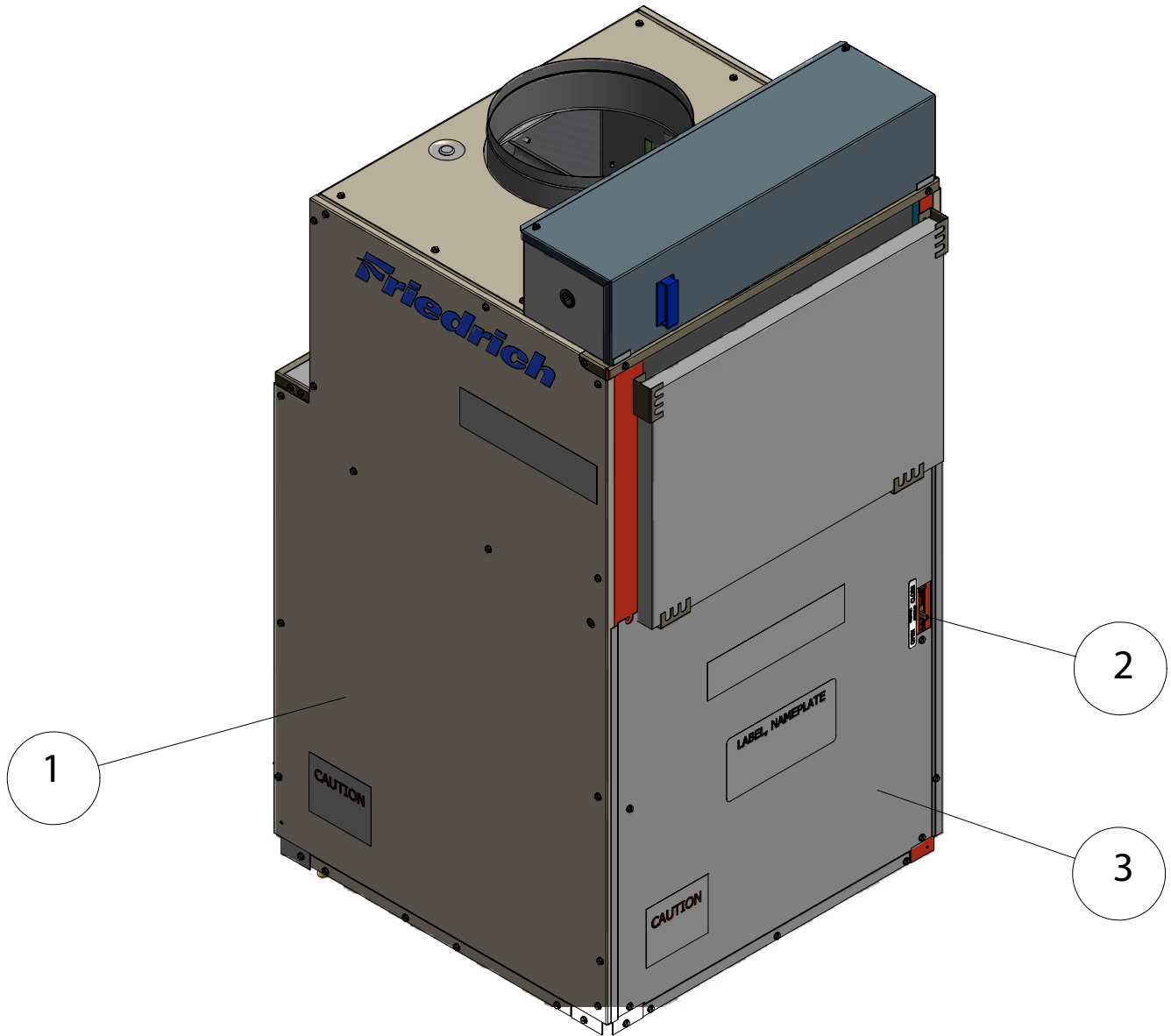

PARTS CATALOG

VHA18K, VEA24K, VHA24K

Figure 902

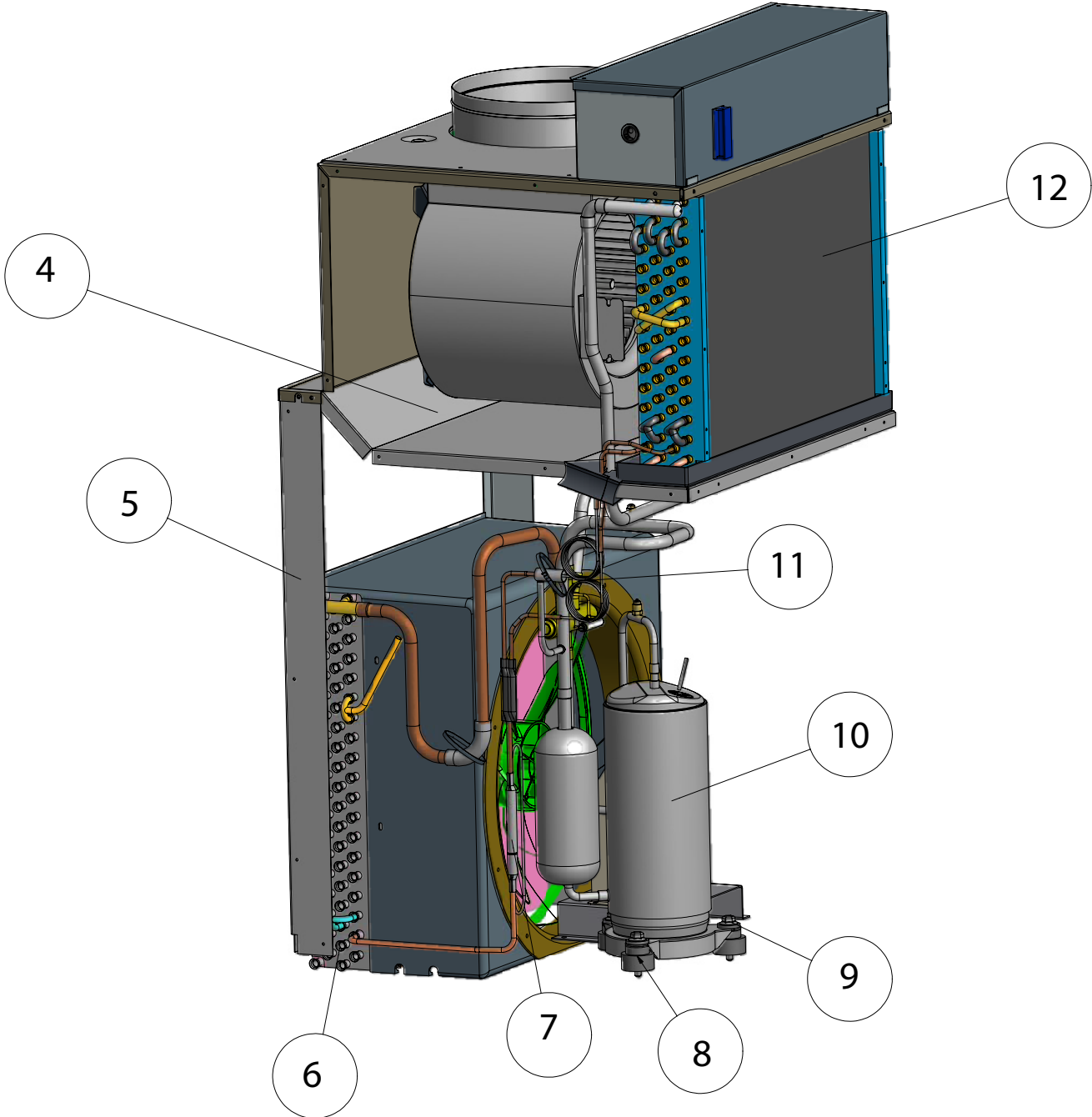

PARTS CATALOG

VHA18K, VEA24K, VHA24K

Figure 902

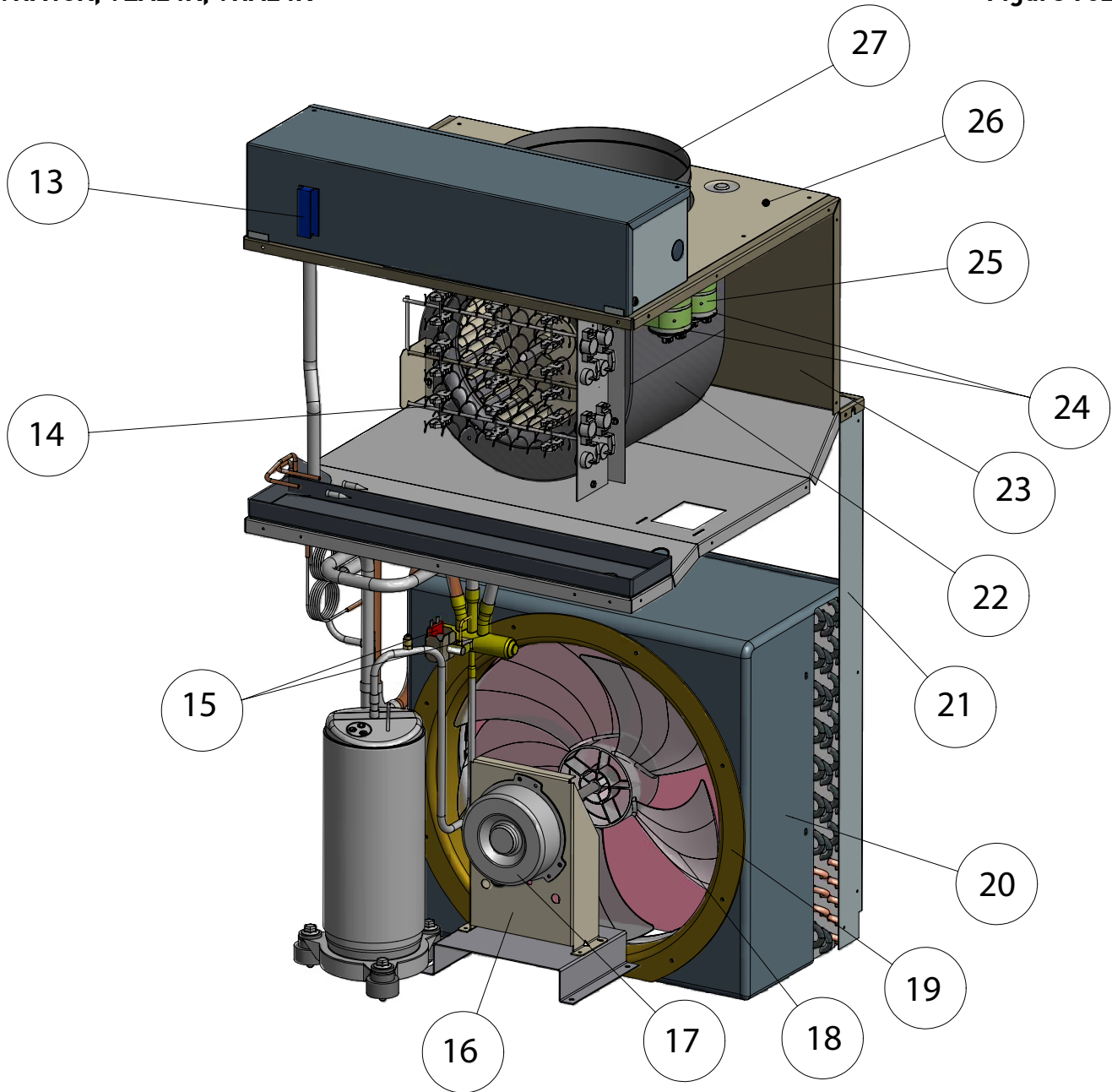

PARTS CATALOG

VHA18K, VEA24K, VHA24K

Figure 902

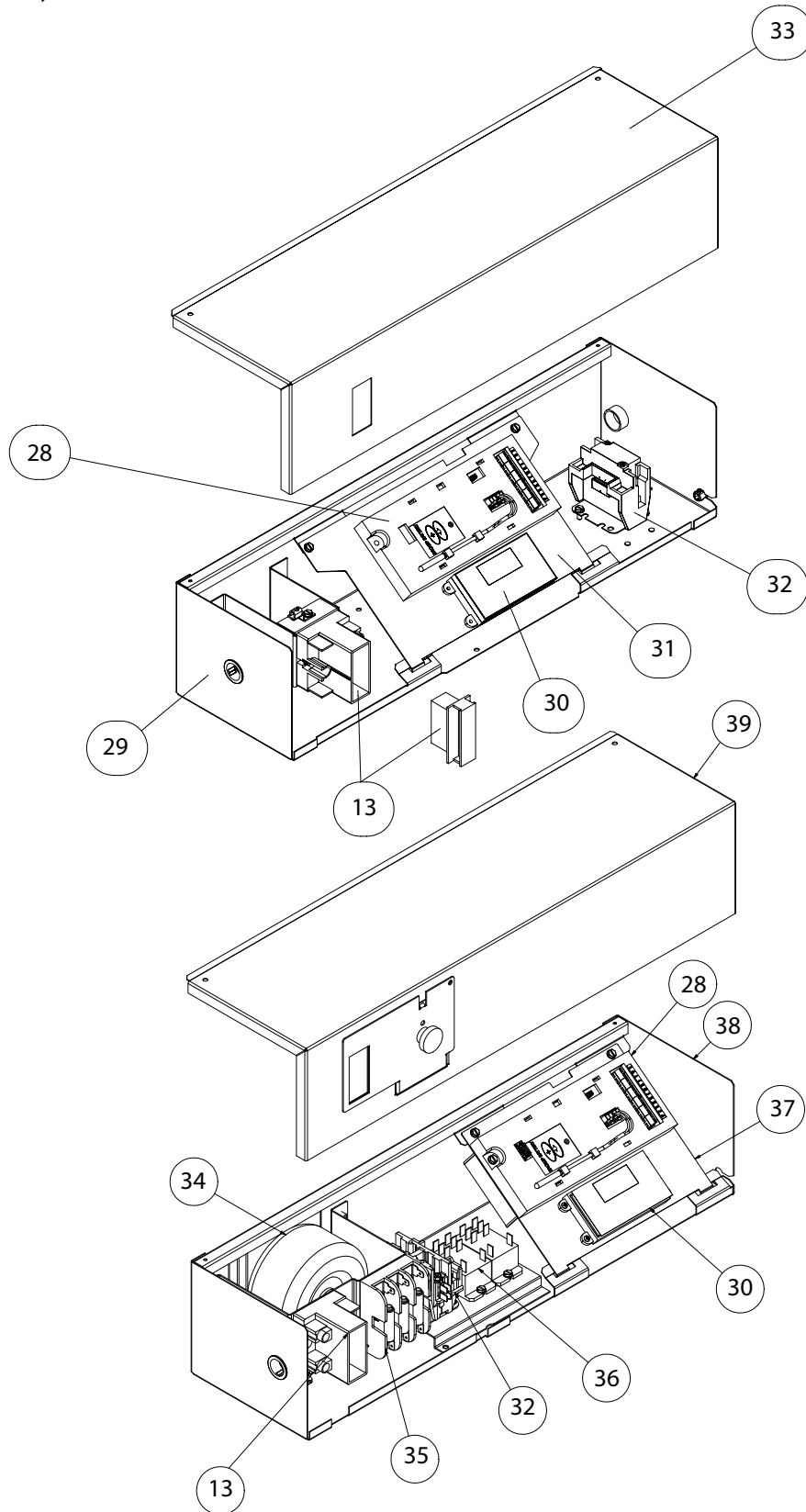

PARTS CATALOG

VHA18K, VEA24K, VHA24K

Figure 902

ITEM	PART NUMBER	PART DESCRIPTION	USED ON MODEL	QTY
1	80106401	ASSY RIGHT PANEL INSUL PREPNTD	ALL	1
-1A	80106501	ASY LEFT PANEL INSUL PREPNTD	ALL	1
2	61814801	CONNECTOR FRESH AIR LRG	ALL	1
3	80106601	ASSY REAR PANEL INSUL PREPNTD	ALL	1
4	80106201	ASSY INNERWALL INSULATION	ALL	1
5	80101300	LOWER LEFT POST	ALL	1
-5A	80101500	UPPER LEFT POST	ALL	1
6	80101261	COIL, CONDENSOR VCS.312X4X14RC2V45A20X19H6	VHA18K25RTN, VHA18K34RTN, VHA18K50RTN, VHA18R25RTN, VHA18R34RTN , VHA18R50RTN	1
6	80101260	COIL, CONDENSOR VCS.312X5X14RC2E45A20X19H6	VEA24K10RTP, VEA24K25RTP, VEA24K34RTP, VEA24K50RTP, VEA24L75RTP, VHA24K10RTN, VHA24K25RTN, VHA24K34RTN, VHA24K50RTN, VHA24K75RTN, VHA24R10RTN, VHA24R25RTN, VHA24R34RTN, VHA24R50RTN, VHA24R75RTN	1
7	80109305	ASSY CHECK VALVE	VHA18K25RTN, VHA18K34RTN, VHA18K50RTN, VHA18R25RTN, VHA18R34RTN , VHA18R50RTN	1
7	80109302	ASSY CHECK VALVE	VHA24K10RTN, VHA24K25RTN, VHA24K34RTN, VHA24K50RTN, VHA24K75RTN, VHA24R10RTN, VHA24R25RTN, VHA24R34RTN, VHA24R50RTN, VHA24R75RTN	1
8	91400402	STUD COMPR MTG	ALL	3
9	01150941	GROMMET COMP HI DENSITY	ALL	3
10	61718132	KIT COMPR REPLMT 62200316	VHA18K25RTN, VHA18K34RTN, VHA18K50RTN, VHA18R25RTN, VHA18R34RTN , VHA18R50RTN	1
10	80077118	REPLMT COMP KIT PA200M2CS- 3MUU GMC	VEA24K10RTP, VEA24K25RTP, VEA24K34RTP, VEA24K50RTP, VEA24L75RTP, VHA24K10RTN, VHA24K25RTN, VHA24K34RTN, VHA24K50RTN, VHA24K75RTN, VHA24R10RTN, VHA24R25RTN, VHA24R34RTN, VHA24R50RTN, VHA24R75RTN	1
11	03760511	TUBE CAP .059X.1120D X 23.25 BLUE	VHA18K25RTN, VHA18K34RTN, VHA18K50RTN, VHA18R25RTN, VHA18R34RTN , VHA18R50RTN	1
11	03760548	TUBE CAP .054 X.1060D X 39.25 WHITE	VEA24K10RTP, VEA24K25RTP, VEA24K34RTP, VEA24K50RTP, VEA24K75RTP, VHA24K25RTN, VHA24K25RTN, VHA24K34RTN, VHA24K50RTN, VHA24K75RTN, VHA24R10RTN, VHA24R25RTN, VHA24R34RTN, VHA24R50RTN, VHA24R75RTN	1
11	03760501	TUBE CAP .064 X .125 OD X 30.25 YEL	VHA18K25RTN, VHA18K34RTN, VHA18K50RTN, VHA18R25RTN, VHA18R34RTN , VHA18R50RTN	1
11	03760507	TUBE CAP .064X.1250D X 13.75 YELLOW	VHA24K25RTN, VHA24K25RTN, VHA24K34RTN, VHA24K50RTN, VHA24K75RTN, VHA24R10RTN, VHA24R25RTN, VHA24R34RTN, VHA24R50RTN, VHA24R75RTN	1
12	62050004	COIL, EVAPORATOR LES.375X4X14RC2V45A20X14H6	VHA18K25RTN, VHA18K34RTN, VHA18K50RTN, VHA18R25RTN, VHA18R34RTN , VHA18R50RTN	1

PARTS CATALOG

VHA18K, VEA24K, VHA24K

Figure 902

ITEM	PART NUMBER	PART DESCRIPTION	USED ON MODEL	QTY
12	80103450	COIL, EVAPORATOR VES.375X4X12RC2W45A20X14H6	VEA24K10RTP, VEA24K25RTP, VEA24K34RTP, VEA24K50RTP, VEA24L75RTP, VHA24K10RTN, VHA24K25RTN, VHA24K34RTN, VHA24K50RTN, VHA24K75RTN, VHA24R10RTN, VHA24R25RTN, VHA24R34RTN, VHA24R50RTN, VHA24R75RTN	1
13	80007600	NONFUSED DISCONNECT	ALL	1
14	80102290	HEATER VPAK-A24 NXT 2.5KW 230V	VHA18K25RTN, VEA24K25RTP, VHA24K25RTN	1
14	80102291	HEATER VPAK-A24 NXT 3.4KW 230V	VHA18K34RTN, VEA24K34RTP, VHA24K34RTN	1
14	80102292	HEATER VPAK-A24 NXT 5.0KW 230V	VHA18K50RTN, VEA24K50RTP, VHA24K50RTN	1
14	80102293	HEATER VPAK-A24 NXT 7.5KW 230V	VEA24K75RTP, VHA24K75RTN	1
14	80102295	HEATER VPAK-A NXT 2.5KW 265V	VHA18R25RTN, VEA24R25RTP, VHA24R25RTN	1
14	80102296	HEATER VPAK-A NXT 3.4KW 265V	VHA18R34RTN, VEA24R34RTP, VHA24R34RTN	1
14	80102297	HEATER VPAK-A NXT 5.0KW 265V	VHA18R50RTN, VEA24R50RTP, VHA24R50RTN	1
14	80102298	HEATER VPAK-A24 NXT 7.5KW 265V	VHA24R75RTN	1
14	80102294	HEATER VPAK-A24 NXT 10.0KW 230V	VEA24K10RTP, VHA24K10KRTN	1
14	80102299	HEATER VPAK-A24 NXT 10.0KW 265V	VHA24R10RTN	1
15	80109908	ASSY REVERSING VALVE	VHA18K25RTN, VHA18K34RTN, VHA18K50RTN, VHA18R25RTN, VHA18R34RTN , VHA18R50RTN	1
15	80109905	ASSY REVERSING VALVE	VHA24K10RTN, VHA24R\K25RTN, VHA24K34RTN, VHA24K50RTN, VHA24K75RTN, VHA24K10RTN, VHA24K25RTN, VHA24K34RTN, VHA24K50RTN, VHA24K75RTN	1
-15A	25063605	COIL SOLENOID 208/230VAC DUNAN	VHA18K25RTN, VHA18K34RTN, VHA18K50RTN, VHA18R25RTN, VHA18R34RTN , VHA18R50RTN, VHA24K10RTN, VHA24R\K25RTN, VHA24K34RTN, VHA24K50RTN, VHA24K75RTN, VHA24K10RTN, VHA24K25RTN, VHA24K34RTN, VHA24K50RTN, VHA24K75RTN	1
16	25014400	MOTOR MOUNT	ALL	1
17	80102171	MTR 1/4 6P CCW 1 PSC 5.0 BLOWER WHEEL	VHA18K25RTN, VHA18K34RTN, VHA18K50RTN, VHA18R25RTN, VHA18R34RTN , VHA18R50RTN	1
17	80102170	MTR 1/4 4 6P CCW 1PSC 5.0 BLOWER WHEEL	VEA24K10RTP, VEA24K25RTP, VEA24K34RTP, VEA24K50RTP, VEA24L75RTP, VHA24K10RTN, VHA24K25RTN, VHA24K34RTN, VHA24K50RTN, VHA24K75RTN, VHA24R10RTN, VHA24R25RTN, VHA24R34RTN, VHA24R50RTN, VHA24R75RTN	1
18	60542007	FAN PLASTIC 16" LRG; VPAC	ALL	1
19	80101010	SHROUD RING VPAK 24	ALL	1
20	80114101	SHROUD ASY, VPAK LARGE	ALL	1

PARTS CATALOG

VHA18K, VEA24K, VHA24K

Figure 902

ITEM	PART NUMBER	PART DESCRIPTION	USED ON MODEL	QTY
21	80101400	LOWER RIGHT POST	ALL	1
-21A	80101600	UPPER RIGHT POST	ALL	1
22	80103200	BLOWER HOUSING	ALL	1
23	80106702	ASY TOP PANEL INSUL PREPNTD	ALL	1
24	61080530	CAPCTR 40/5/ MF 370V 2.0	VHA18K25RTN, VHA18K34RTN, VHA18K50RTN, VHA18R25RTN, VHA18R34RTN , VHA18R50RTN	1
24	61080580	CAPCTR 50/5/370VAC 2.0	VEA24K10RTP, VEA24K25RTP, VEA24K34RTP, VEA24K50RTP, VEA24L75RTP, VHA24K10RTN, VHA24K25RTN, VHA24K34RTN, VHA24K50RTN, VHA24K75RTN, VHA24R10RTN, VHA24R25RTN, VHA24R34RTN, VHA24R50RTN, VHA24R75RTN	1
-24A	61080525	CAPCTR 25/3.0 MF 370V 2.0	VHA18K25RTN, VHA18K34RTN, VHA18K50RTN, VHA18R25RTN, VHA18R34RTN , VHA18R50RTN	1
-24A	61080573	CAPCTR 15/5 MF 440V 2.0	VEA24K10RTP , VEA24K25RTP, VEA24K34RTP, VEA24K50RTP, VEA24L75RTP, VHA24K10RTN, VHA24K25RTN, VHA24K34RTN, VHA24K50RTN, VHA24K75RTN, VHA24R10RTN, VHA24R25RTN, VHA24R34RTN, VHA24R50RTN, VHA24R75RTN	1
25	20709185	CLAMP, CAPACITOR	ALL	2
26	80113200	TOP COVER INSUL ASSY	ALL	1
27	80001800	COLLAR 24 GA	ALL	1
28	62600118	ASSY E-CNTRL COOL/EH AMP JMPR	ALL	1
29	80118400	ASSY CONTROL BOX WELD VPAK 24	ALL	1
30	62600601	DISPLAY SERVICE VPAC KUHL	ALL	1
31	80116905	BRACKET ELECT CNTRL KUHL	VEA24K10RTP , VEA24K25RTP, VEA24K34RTP, VEA24K50RTP, VEA24L75RTP, VHA24K10RTN, VHA24K25RTN, VHA24K34RTN, VHA24K50RTN, VHA24K75RTN, VHA24R10RTN, VHA24R25RTN, VHA24R34RTN, VHA24R50RTN, VHA24R75RTN	1
32	80118601	CONTACTOR 240VAC HCL- 1NU01AAC	ALL	1
33	80116602	CONTROL BOX LID PREPNTD	VHA18K25RTN, VHA18K34RTN, VHA18K50RTN, VEA24K10RTP , VEA24K25RTP, VEA24K34RTP, VEA24K50RTP, VEA24L75RTP, VHA24K10RTN, VHA24K25RTN, VHA24K34RTN, VHA24K50RTN, VHA24K75RTN,	1
33	80116603	CONTROL BOX LID PREPNTD	VHA18R25RTN, VHA18R34RTN , VHA18R50RTN, VHA24R10RTN, VHA24R25RTN, VHA24R34RTN, VHA24R50RTN, VHA24R75RTN	1
34	61670803	TRANSFORMER IN 265V OUT 235V	VHA18R25RTN, VHA18R34RTN , VHA18R50RTN, VHA24R10RTN, VHA24R25RTN, VHA24R34RTN, VHA24R50RTN, VHA24R75RTN	1

PARTS CATALOG

VHA18K, VEA24K, VHA24K

Figure 902

ITEM	PART NUMBER	PART DESCRIPTION	USED ON MODEL	QTY
35	61776111	FUSE BLOCK 3 POLES 30 AMP	VHA18K25RTN, VHA18K34RTN, VHA18K50RTN, VHA18R25RTN, VHA18R34RTN, VHA18R50RTN, VHA24K10RTN, VHA24R\K25RTN, VHA24K34RTN, VHA24K50RTN, VHA24K75RTN, VHA24K10RTN, VHA24K25RTN, VHA24K34RTN, VHA24K50RTN, VHA24K75RTN	1
-35A	61773319	FUSE 600V 15A CC TD	VHA18K25RTN, VHA18K34RTN, VHA18K50RTN, VHA18R25RTN, VHA18R34RTN, VHA18R50RTN, VHA24K10RTN, VHA24R\K25RTN, VHA24K34RTN, VHA24K50RTN, VHA24K75RTN, VHA24K10RTN, VHA24K25RTN, VHA24K34RTN, VHA24K50RTN, VHA24K75RTN	2
-35B	61773317	FUSE 600V 20A CC TD	VHA18K25RTN, VHA18K34RTN, VHA18K50RTN, VHA18R25RTN, VHA18R34RTN, VHA18R50RTN, VHA24K10RTN, VHA24R\K25RTN, VHA24K34RTN, VHA24K50RTN, VHA24K75RTN, VHA24K10RTN, VHA24K25RTN, VHA24K34RTN, VHA24K50RTN, VHA24K75RTN	1
36	61643311	RELAY 230V COIL DPDT 30A 208/240VAC	VHA18R25RTN, VHA18R34RTN, VHA18R50RTN, VHA24R10RTN, VHA24R25RTN, VHA24R34RTN, VHA24R50RTN, VHA24R75RTN	1
37	80116906	BRACKET ELECT CNTRL 24R	VHA18R25RTN, VHA18R34RTN, VHA18R50RTN, VHA24R10RTN, VHA24R25RTN, VHA24R34RTN, VHA24R50RTN, VHA24R75RTN	1
38	80118401	ASSY CONTROL BOX WELD VPAK24R	VHA18R25RTN, VHA18R34RTN, VHA18R50RTN, VHA24R10RTN, VHA24R25RTN, VHA24R34RTN, VHA24R50RTN, VHA24R75RTN	1
39	80116603	CONTROL BOX LID PREPNTD	VHA18R25RTN, VHA18R34RTN, VHA18R50RTN, VHA24R10RTN, VHA24R25RTN, VHA24R34RTN, VHA24R50RTN, VHA24R75RTN	1
-40	21058443	FUSE HOLDER 20A HPF 13/32 X 1-1/2	ALL	1
-41	61773323	FUSE 250VAC 10A 1.5X13/32 TD FNM-10	ALL	1
-42	62601008	KIT E-CNTL SERV COOL VEA	VEA24K10RTP, VEA24K25RTP, VEA24K34RTP, VEA24K50RTP, VEA24K75RTP,	1
-43	62601009	KIT E-CNTL SERV COOL HP VHA	VHA18K25RTN, VHA18K34RTN, VHA18K50RTN, VHA18R25RTN, VHA18R34RTN, VHA18R50RTN, VHA24K10RTN, VHA24K25RTN, VHA24K34RTN, VHA24K50RTN, VHA24K75RTN, VHA24R10RTN, VHA24R25RTN, VHA24R34RTN, VHA24R50RTN, VHA24R75RTN.	1
-44	61656200	CHANNEL EXHAUST DOOR	ALL	1
-40	62600203	SENSOR ID RIA TEMPERATURE [WHITE]	ALL	1
-41	62600205	SENSOR ID COIL TEMPERATURE [GREEN]	ALL	1
-42	62600206	SENSOR OD COIL TEMPERATURE [BLUE]	ALL	1

PARTS CATALOG

VHA18K, VEA24K, VHA24K

Figure 902

ITEM	PART NUMBER	PART DESCRIPTION	USED ON MODEL	QTY
-45	61656201	SLIDE EXHAUST DOOR	ALL	1
-46	60179904	DRAIN VALVE	ALL	1
-47	80115225	ASSY BASEPAN DRAIN	ALL	1

-ITEMS ARE NON- ILLUSTRATED
*ITEMS ARE NON-STOCKED, WILL NORMALLY REQUIRE 2-3 WEEKS LEAD TIME

AVAILABLE ACCESSORIES

ARCHITECTURAL LOUVER

VPAL2 and VPSC2

Extruded aluminum grille that attaches to the outdoor section of the wall plenum. Takes in fresh air and returns condensed air. VPSC2 can be ordered in custom colors.

DIMENSIONS: 25 9/16" W x 31 1/16" H



VPAL2



VPAWP1-8

WALL PLENUM (Required)

VPAWP1-8, VPAWP1-14

Two-part sleeve that telescopes in and out; sits inside the exterior wall penetration.

VPAWP1-8 telescopes from 5 1/2" – 8"

VPAWP1-14 telescopes from 8" – 14"

DIMENSIONS : 24 1/8" W x 30 3/8" H

CUTOUT DIMENSIONS: 24 5/8" W x 30 7/8" H

RETURN AIR GRILLE/ACCESS PANEL

VPRG4/VPRG4R

Hinged panel allows access to unit and return air filter.

A field-supplied filter (25" x 20") should be mounted on the inside grille. Panel can be mounted with return air openings high or low on the door for optimum sound attenuation.

DIMENSIONS: 29" W x 58" H

CUTOUT DIMENSIONS: 27" W x 55 3/4" H



VPRG4/
VPRG4R

FIRST COMPANY SLEEVE ADAPTER

VPASA1

Single piece, welded adapter allows retrofit into existing First Company® SPXR-series single package vertical unit wall sleeve and louver. Easily connects to Friedrich chassis. Only compatible with Friedrich's smaller sized VPAK 9k and 12k units.



VPASA1

SINGLE STAGE THERMOSTATS

RT6P, RT7P

Wired, single stage, wall-mounted programmable thermostat has two fan speeds and backlight.

RT6, RT7

Wired, single stage, wall-mounted digital thermostat has two fan speeds and backlight.

WRT1

Wireless, single stage, wall-mounted digital thermostat has two fan speeds and backlight.



RT6, RT6P



WRT1

ENERGY MANAGEMENT THERMOSTATS

EMRT1, EMRT2

Wired thermostat has occupancy sensor.

EMWRT1, EMWRT2

Wireless thermostat has occupancy sensor.

EMOCT

EMRAF

EMRHCF

Online connection kit. Remote access fee. Remote humidity control fee.



EMRT1, EMWRT1



EMRT2, EMWRT2

DRAIN PAN (Required for large chassis models)

VPDP1

For VHA18 and VHA24 models. May be installed prior to chassis for easy installation/removal.



VPDP1

AVAILABLE ACCESSORIES

Thermostat - Rt6

- 1-Stage Heat/1-Stage Cool Systems
- Configurable to: 2-stage heat pump
- Large Display With Backlight
- Selectable Fahrenheit or Celsius

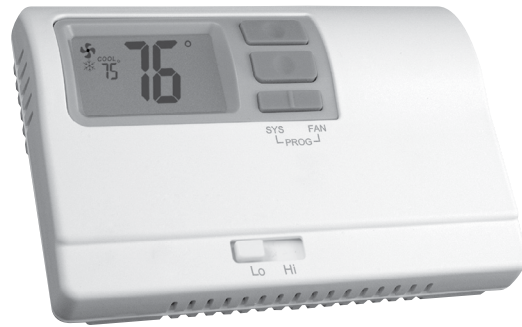

Installation, Operation & Application Guide



F R I E D R I C H

Parts Diagram

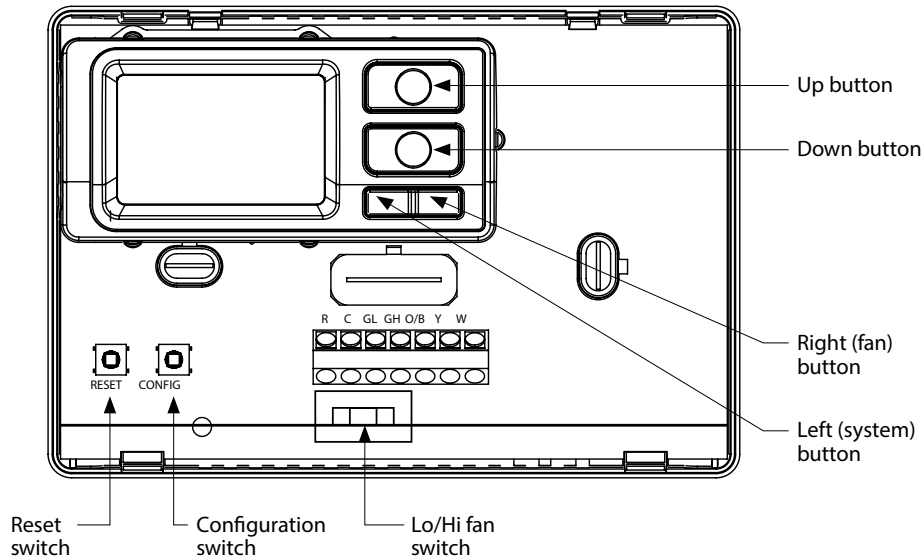

Icon Descriptions

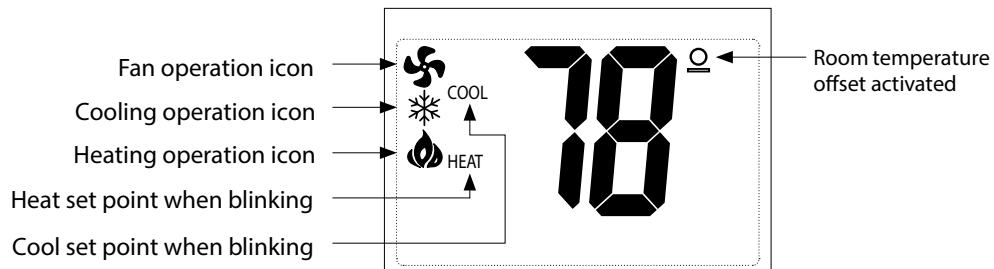

AVAILABLE ACCESSORIES

Thermostat - Rt6

Specifications

Electrical rating:

- 24 VAC (18-30 VAC)
- 1 amp maximum per terminal
- 3 amp maximum total load

Temperature control range: 45°F to 90°F (7°C to 32°C) Accuracy: $\pm 1^\circ\text{F}$ ($\pm 0.5^\circ\text{C}$)

System configurations: 2-stage heat, 1-stage cool, heat pump, electric

Timing: Anti-short cycle: 4 minutes (bypass anti-short cycle delay by returning to OFF mode for 5 seconds)

Backlight Operation: 10 seconds

Terminations: R, C, GL, GH, O/B, Y, W

Important Safety Information

WARNING! : *Always turn off power at the main power supply before installing, cleaning, or removing thermostat.*

- This thermostat is for 24 VAC applications only; do not use on voltages over 30 VAC
- All wiring must conform to local and national electrical and building codes
- Do not use air conditioning when the outdoor temperature is below 50 degrees; this can damage your A/C system and cause personal injuries
- Use this thermostat only as described in this manual

Package Contents/Tools Required

Package includes: RT6 thermostat on base, thermostat cover, wiring labels, screws and wall anchors, Installation, Operation and Application Guide

Tools required for installation: Drill with 3/16" bit, hammer, screwdriver

To Remove Existing Thermostat



ELECTRICAL SHOCK HAZARD – *Turn off power at the main service panel by removing the fuse or switching the appropriate circuit breaker to the OFF position before removing the existing thermostat.*

1. Turn off power to the heating and cooling system by removing the fuse or switching the appropriate circuit breaker off.
2. Remove cover of old thermostat. This should expose the wires.
3. Label the existing wires with the enclosed wire labels before removing wires.
4. After labeling wires, remove wires from wire terminals.
5. Remove existing thermostat base from wall.
6. Refer to the following section for instructions on how to install this thermostat.

AVAILABLE ACCESSORIES

Thermostat - Rt6

To Install Thermostat



ELECTRICAL SHOCK HAZARD – Turn off power at the main service panel by removing the fuse or switching the appropriate circuit breaker to the OFF position before removing the existing thermostat.

IMPORTANT: Thermostat installation must conform to local and national building and electrical codes and ordinances.

** Note: Mount the thermostat about five feet above the floor. Do not mount the thermostat on an outside wall, in direct sunlight, behind a door, or in an area affected by a vent or duct.

1. Turn off power to the heating and cooling system by removing the fuse or switching the appropriate circuit breaker off.
2. To remove cover, pull gently at the seam at the top.
3. Put thermostat base against the wall where you plan to mount it (Be sure wires will feed through the wire opening in the base of the thermostat).
4. Mark the placement of the mounting holes.
5. Set thermostat base and cover away from working area.
6. Using a 3/16" drill bit, drill holes in the places you have marked for mounting.
7. Use a hammer to tap supplied anchors in mounting holes.
8. Align thermostat base with mounting holes and feed the control wires through slit in thermal intrusion barrier and into wire opening.
9. Use supplied screws to mount thermostat base to wall.
10. Insert stripped, labeled wires in matching wire terminals.
CAUTION!: Be sure exposed portion of wires does not touch other wires.
11. Gently tug wire to be sure of proper connection. Double check that each wire is connected to the proper terminal.
12. Turn on power to the system at the main service panel.
13. Configure thermostat to match the type of system you have.
14. Replace cover on thermostat by snapping it in place.
15. Test thermostat operation as described in "Testing the Thermostat".

Wiring Diagrams

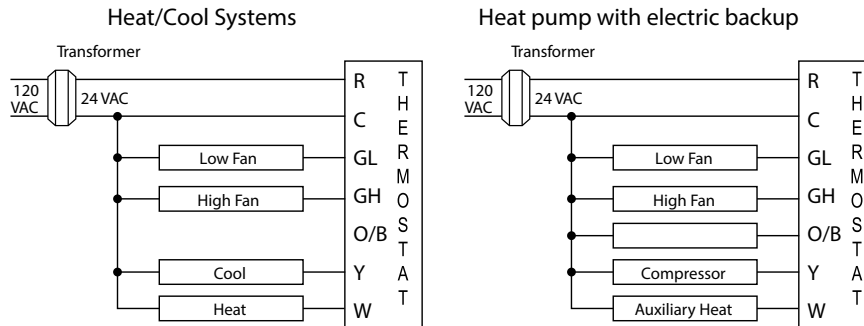

Terminal Designator Descriptions

- R – 24 VAC hot
- C – 24 VAC common
- O/B – Configurable
 - O – Cool active reversing valve
 - B – Heat active reversing valve
- Y – 1st stage cool, 1st stage heat for heat pumps
- W – 1st stage heat for non-heat pump systems, auxiliary heat for HP systems
- GL – Low fan
- GH – High fan

AVAILABLE ACCESSORIES

Thermostat - Rt6

RT6 Output Chart

Configuration	1 ST Cool	1 ST Heat	2 ND Heat
ELC	Y, G	W, G, B	N/A
HP 'O' config	Y, G, O	Y, G	Y, W, G
HP 'B' config	Y, G	Y, G, B	Y, G, B, W

The RT6 thermostat is configurable for different systems. The configuration directly affects the outputs. Use the output chart to correctly configure and wire the thermostat to your system.

Configuration Mode

The configuration mode is used to set the thermostat to match your heating/cooling system. The functions with heat pump, air conditioning, or electric heat systems.

** Thermostat comes configured for 1-stage heat / 1-stage cooling for use with all heat/cool and single-stage heat pump models.

To configure the thermostat, perform the following steps:

1. Verify the thermostat is in the OFF mode.
Press the SYS (left) button until off mode displays.
2. Remove the cover of the thermostat by gently pulling near one of the corners at the top of the thermostat.
3. Press the CONFIG button for 1 second while the thermostat is in OFF mode.

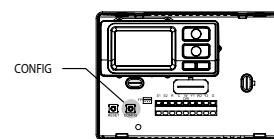
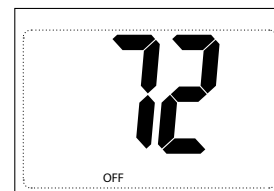

Press the up or down button to change settings within each screen.



Press the right button to advance to the next screen.

** Note: Pressing the left button will return you to the previous screen.

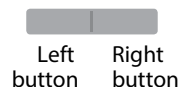

To exit configuration mode, press the CONFIG switch for 1 second.

AVAILABLE ACCESSORIES

Thermostat - Rt6

Configuration Mode Settings

To setup screens for configuration mode are as follows:

1. System – Set for heat pump, non-heat pump, reversing valve operation

System	Setting	Reversing Valve Setting
Heat Pump	HP 'O'	O - Energized in Cooling
Heat Pump	HP 'B'	B - Energized in Heating
Heat/Cool and Single-Stage Heat Pump Only	ELC	N/A

Press the up or down button to select.

Press the right button to advance to the next screen.

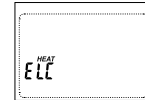

2. Temperature Scale (F or C)

Choose Fahrenheit or Celsius.

Press the up or down button to select.

Press the right button to advance to the next screen.

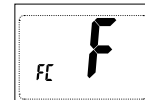

3. 1st Stage Temperature Differential (1°F to 5°F) (0.5°C to 2.5°C)

Set the number of degrees between your "setpoint" temperature and your "turn on" temperature.

Press the up or down button to set differential value.

Press the right button to advance to the next screen.



4. 2nd Stage Temperature Differential (1°F to 5°F) (0.5°C to 2.5°C) (For HP O and HP B only)

Set the number of degrees between when stage 1 turns on and when stage 2 turns on.

Press the up or down button to set differential value.

Press the right button to advance to the next screen.



5. Staged Off Outputs (For HP O and HP B only)

Select whether the outputs for heating and cooling are staged off independently or are satisfied simultaneously.

1 = outputs staged off independently

0 = outputs off simultaneously

Press the up or down button to set.

Press the right button to advance to the next screen.



6. Auxiliary Delay ON – (0-30 minutes) (For HP O and HP B only)

Set the delay time in minutes for auxiliary heat to be locked out after a call for second stage. This extra savings feature is used to temporarily lock out auxiliary heat devices, allowing just heat pump to try to satisfy heat call.

Press the up or down button to select.

Press the right button to advance to the next screen.

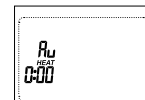

7. (45°F to 90°F) (7°C to 32°C)

Adjust to control the maximum heat set temperature allowed.

Press the up or down button to select.

Press the right button to advance to the next screen.



8. Minimum Cool Setpoint (45°F to 90°F) (7°C to 32°C)

Adjust to control the minimum cool set temperature allowed.

Press the up or down button to select.

Press the right button to advance to the next screen.



9. (+9°F to -9°F) (+4.5°C to -4.5°C)

Adjust to calibrate displayed room temperature to match actual room temperature.

⌘ When not set to 0, ⌘ will display.

Press the up or down button to select.

Press the right button to advance to the next screen.



AVAILABLE ACCESSORIES

Thermostat - Rt6

Mode of Operation

The RT6 is a 1-stage or 2-stage heat thermostat. It functions with air conditioning, heat pumps, or electric heat systems.

The thermostat activates the heating appliance when the room temperature is below the set heat temperature (by the differential temperature). The RT6 will stop outputting when the call for heat has been satisfied. With heat pumps, the thermostat will not let the compressor come on for 4 minutes after it turns off. This protects your compressor.

When the room temperature is greater than the set cool temperature (by the differential temperature), the cooling device is activated. The RT6 will stop outputting when the call for cooling is satisfied. The thermostat will not let the compressor come on for 4 minutes after it turns off. This protects your compressor.

The RT6 has three possible operating modes: OFF, Heat, and Cool mode. In off mode, the thermostat will not turn on heating or cooling devices. The manual fan can be turned on in all operating modes using the fan button. In heat mode, the thermostat controls the heating system. In the cool mode, the thermostat controls the cooling system.

Button Functions

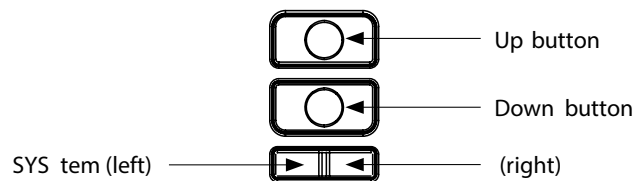

UP – Used to increase the set temperatures and to adjust configuration settings.

DOWN – Used to decrease the set temperatures and to adjust configuration settings.

SYS (left) – Used to change from OFF, HEAT, and COOL modes

FAN (right) – Used to turn on and off the indoor fan.

Available Accessories

Thermostat - Rt6

Operating Modes

There are three possible operating modes for the RT6 . Off, Heat, and Cool modes are accessed by pressing the SYS (left) button.

OFF Mode

- In this mode, the thermostat will not turn on the heating or cooling devices
- ✳️ Note: The indoor fan can be turned on manually in every operating mode by pressing the FAN (right) button. The word FAN shows on the display and the fan icon appears when the fan operates.

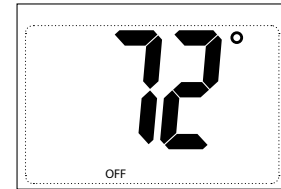

Heat Mode

- In this mode, the thermostat controls the heating system. When the heat outputs, the flame icon appears on the display.
- ✳️ Note: For heat pumps, there is a four minute delay for your compressor to restart after it has turned off. To bypass the compressor time delay, go to OFF mode for 5 seconds.

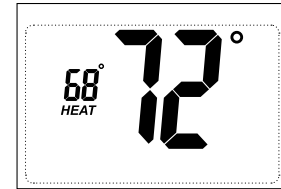

Cool Mode

- In this mode, the thermostat controls the cooling system. When the cooling outputs, the snowflake icon appears on the display.
- ✳️ Note: There is a four minute delay for your compressor to restart after it has turned off. To bypass the compressor time delay, go to OFF mode for 5 seconds.

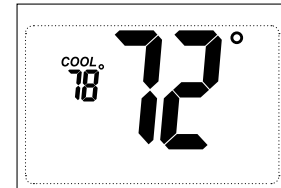

Set Point Adjustment

Heat Set Point

- Use the SYS button to select Heat Mode. Press the up or down button to view the current heat set point larger on the display. When the large set point is displayed, the HEAT icon will blink. The up or down buttons can be used to adjust the set point. After 5 seconds of inactivity the screen will display the room temperature and the HEAT icon will not blink.

HEAT icon will blink.

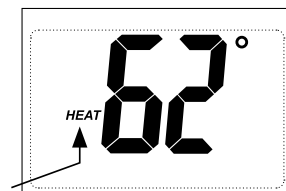

Cool Set Point

- Use the SYS button to select Cool Mode. Press the up or down button to view the current cool set point larger on the display. When the large set point is displayed, the COOL icon will blink. The up or down buttons can be used to adjust the set point. After 5 seconds of inactivity the screen will display the room temperature and the COOL icon will not blink.

COOL icon will blink.

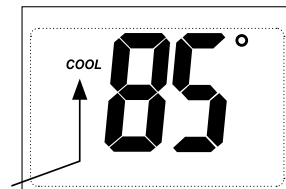

Available Accessories

Thermostat - Rt6

Testing the Thermostat

Once the thermostat is configured, it should be thoroughly tested.

CAUTION! : Do not energize the air conditioning system when the outdoor temperature is below 50 degrees. It can result in equipment damage or personal injury.

Heat Test

1. Press **SYS** (left) button until heat mode is displayed.
2. Adjust the set temperature so it is 5 degrees above the room temperature.
3. Heat should come on within a few seconds.
4. Adjust the set temperature 2 degrees below the room temperature and the heat should turn off. There may be a fan delay on your system.

** Note: For heat pumps, there is a four-minute delay to protect your compressor after it turns off. To bypass the compressor time delay, go to OFF mode for 5 seconds.

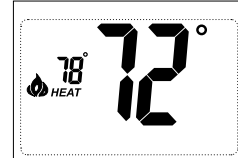

Cool Test

1. Press **SYS** (left) button until cool mode is displayed.
2. Adjust set temperature so it is 5 degrees below room temperature.
3. A/C should come on within a few seconds.
4. Adjust the set temperature 2 degrees above the room temperature and the A/C should turn off. There may be a fan delay on your system.

** Note: There is a four-minute time delay to protect the compressor after it. To bypass the compressor time delay, go to OFF mode for 5 seconds.

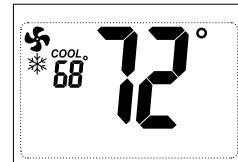

Fan Test

1. Press **FAN** (right) button. Fan displays. Indoor fan turns ON.
2. Press **FAN** (right) button. Indoor fan turns OFF.

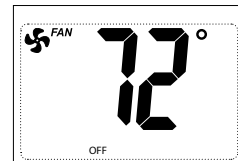

Troubleshooting

Symptom	Remedy
No display	Check for 24 VAC at thermostat; display is blank when 24 VAC is not present
All thermostat buttons are inoperative	Verify 24 VAC is present; unit locks out when 24 VAC is not present
No response with first button press	First button press activates backlight only
Thermostat turns on and off too frequently	Adjust temperature differential (see Configuration Mode Settings 3 & 4)
Fan runs continuously	Press FAN (right) button to turn fan off
Room temperature is not correct	Calibrate thermostat (see Configuration Mode Setting 10)
Heat or Cool not coming on	Verify wiring is correct, gently pull on each wire to verify there is a good connection at terminal block
HEAT blinking	In heat set point screen, this is normal operation
COOL blinking	In cool set point screen, this is normal operation
Problem not listed above	Press Reset button once*

* Reset Button Function : Display is refreshed, configuration settings are unchanged.

AVAILABLE ACCESSORIES

Thermostat - Rt6p

- 7 Day Programmable
- Auto Changeover
- 1-Stage Heat/1-Stage Cool Systems
- Configurable to: 2-stage heat pump
- Large Display With Backlight
- Selectable Fahrenheit or Celsius

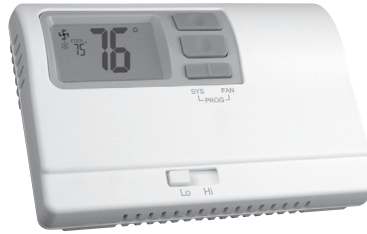

Installation, Operation & Application Guide



Parts Diagram

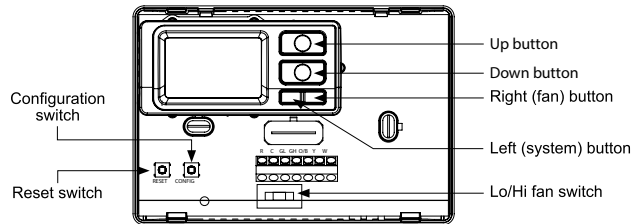

Icon Descriptions

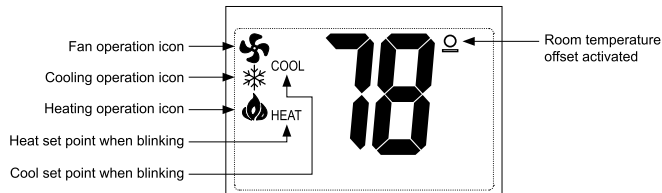

Specifications

Electrical rating:

- 24 VAC (18-30 VAC)
- 1 amp maximum per terminal
- 3 amp maximum total load

Temperature control range: 45°F to 90°F (7°C to 32°C) Accuracy: ± 1°F (± 0.5°C)

System configurations: 2-stage heat, 1-stage cool, heat pump, electric

Timing: Anti-short Cycle: 4 minutes (bypass anti-short cycle delay by returning to OFF mode for 5 seconds)

Backlight Operation: 10 seconds

Terminations: R, C, GL, GH, O/B, Y, W

Important Safety Information

WARNING! :

- This thermostat is for 24 VAC applications only; do not use on voltages over 30 VAC
- All wiring must conform to local and national electrical and building codes
- Do not use air conditioning when the outdoor temperature is below 50 degrees; this can damage your A/C system and cause personal injuries
- Use this thermostat only as described in this manual

Package Contents/Tools Required

Package includes: RT6P thermostat on base, thermostat cover, wiring labels, screws and wall anchors, Installation, Operation and Application Guide

Tools required for installation: Drill with 3/16" bit, hammer, screwdriver

AVAILABLE ACCESSORIES

Thermostat - Rt6p

Mode of Operation

RT6P is a 1-stage cool/2-stage heat thermostat. It functions with air conditioning, heat pumps, or electric heat systems. It is programmable for 7 days a week and has auto changeover capability.

The thermostat activates the heating appliance when the room temperature is below the set heat temperature (by the differential temperature). The RT6P will stop outputting when the call for heat has been satisfied. With heat pumps, the thermostat will not let the compressor come on for 4 minutes after it turns off to protect your compressor.

When the room temperature is greater than the set cool temperature (by the differential temperature), the cooling device is activated. The RT6P will stop outputting when the call for cooling is satisfied. The thermostat will not let the compressor come on for 4 minutes after it turns off to protect your compressor.

The RT6P has four possible operating modes: OFF, Heat, Cool and Heat/Cool mode. In off mode, the thermostat will not turn on heating or cooling devices. In heat mode, the thermostat controls the heating system. In the cool mode, the thermostat controls the cooling system. In the Heat/Cool mode, the thermostat controls the heating and cooling system.

The manual fan can be turned on in all operating modes using the fan button.

In program mode, the thermostat will automatically be controlled by the set program. Program mode can function with heat mode, cool mode, or heat & cool mode. The clock display alternates with the set temperature display for heat & cool mode.

The program schedule can be overridden by changing the set temperature (up or down button). This puts the RT6P thermostat into a 2-hour temporary hold. After 2 hours, it will automatically return to the program schedule.

Button Functions

UP – Used to increase the set temperatures and to adjust configuration settings

DOWN – Used to decrease the set temperatures and to adjust configuration settings

SYS (left) – Used to change from OFF, HEAT, COOL and HEAT/COOL modes

FAN (right) – Used to turn on and off the indoor fan

SYS (left) and FAN (right) – Used to enter and exit program operation

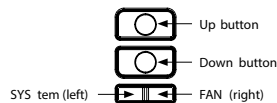

To Remove Existing Thermostat



ELECTRICAL SHOCK HAZARD – Turn off power at the main service panel by removing the fuse or switching the appropriate circuit breaker to the OFF position before removing the existing thermostat.

1. Turn off power to the heating and cooling system by removing the fuse or switching the appropriate circuit breaker off.
2. Remove cover of old thermostat. This should expose the wires.
3. Label the existing wires with the enclosed wire labels before removing wires.
4. After labeling wires, remove wires from wire terminals.
5. Remove existing thermostat base from wall.
6. Refer to the following section for instructions on how to install this thermostat.

To Install Thermostat



ELECTRICAL SHOCK HAZARD – Turn off power at the main service panel by removing the fuse or switching the appropriate circuit breaker to the OFF position before removing the existing thermostat.

IMPORTANT: Thermostat installation must conform to local and national building and electrical codes & ordinances.

- * Note: Mount the thermostat about five feet above the floor. Do not mount the thermostat on an outside wall, in direct sunlight, behind a door, or in an area affected by a vent or duct.
1. Turn off power to the heating and cooling system by removing the fuse or switching the appropriate circuit breaker off.
 2. To remove cover, pull gently at the seam at the top.
 3. Put thermostat base against the wall where you plan to mount it (Be sure wires will feed through the wire opening in the base of the thermostat).
 4. Mark the placement of the mounting holes.
 5. Set thermostat base and cover away from working area.
 6. Using a 3/16" drill bit, drill holes in the places you have marked for mounting.
 7. Use a hammer to tap supplied anchors in mounting holes.
 8. Align thermostat base with mounting holes and feed the control wires through slit in thermal intrusion barrier and into wire opening.
 9. Use supplied screws to mount thermostat base to wall.
 10. Insert stripped, labeled wires in matching wire terminals.
CAUTION! Be sure exposed portion of wires does not touch other wires.
 11. Gently tug wire to be sure of proper connection. Double check that each wire is connected to the proper terminal.
 12. Turn on power to the system at the main service panel.
 13. Configure thermostat to match the type of system you have.
 14. Replace cover on thermostat by snapping it in place.
 15. Test thermostat operation as described in "Testing the Thermostat".

AVAILABLE ACCESSORIES

Thermostat - Rt6p

Wiring Diagrams

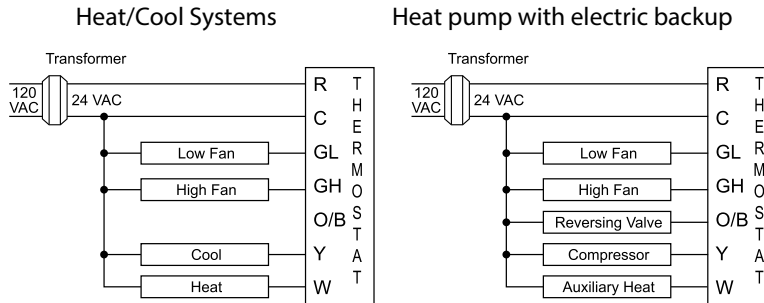

Terminal Designator Descriptions

- R – 24 VAC hot
- C – 24 VAC common
- O/B – Configurable
 - O – Cool active reversing valve
 - B – Heat active reversing valve
- Y – 1st stage cool, 1st stage heat for heat pumps
- W – 1st stage heat for non-heat pump systems, auxiliary heat for HP systems
- GL – Low fan
- GH – High fan

RT6P Output Chart

Configuration	1 ST Cool	1 ST Heat	2 ND Heat
ELC	Y, G	W, G, B	N/A
HP 'O' config	Y, G, O	Y, G	Y, W, G
HP 'B' config	Y, G	Y, G, B	Y, G, B, W

The RT6P thermostat is configurable for different systems. The configuration directly affects the outputs. Use the output chart to correctly configure and wire the thermostat to your system.

Configuration Mode

The configuration mode is used to set the RT6P to match your heating/cooling system. The RT6P functions with heat pump, air conditioning, or electric heat systems.

* Note: Thermostat comes configured for 1-stage heat / 1-stage cooling for use with all heat/cool and single-stage heat pump models. For Friedrich PTHP models follow the instructions below to configure the thermostat for two-stage heat pump operation using the 'O' terminal.

To configure the RT6P, perform the following steps:

- Verify the RT6P is in the OFF mode.
Press the SYS (left) button until off mode displays.
- Remove the cover of the thermostat by gently pulling near one of the corners at the top of the thermostat.
- Press the CONFIG button for 1 second while the RT6P is in OFF mode.

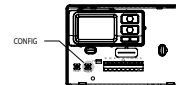
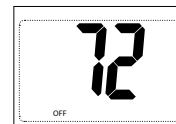

Press the up or down button to change settings within each screen.

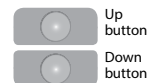

Press the button to advance to the next screen.

* Pressing the left button will return you to the previous screen.



To exit configuration mode, press the CONFIG switch for 1 second.

AVAILABLE ACCESSORIES

Thermostat - Rt6p

Configuration Mode Settings

The setup screens for Configuration Mode are as follows:

1. System – Set for heat pump, non-heat pump, reversing valve operation

System	Setting	Reversing Valve Setting
Heat Pump	HP 'O'	O - Energized in Cooling
Heat Pump	HP 'B'	B - Energized in Heating
Heat/Cool and Single-Stage Heat Pump Only	ELC	N/A

Press the **up** or **down** button to select.
Press the **right** button to advance to the next screen.

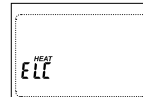

2. Temperature Scale (F or C)
Choose Fahrenheit or Celsius.
Press the **up** or **down** button to select.
Press the **right** button to advance to the next screen.

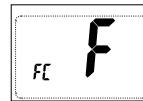

3. 1st Stage Temperature Differential (1°F to 5°F) (0.5°C to 2.5°C)
Set the number of degrees between your "setpoint" temperature and your "turn on" temperature.
Press the **up** or **down** button to set differential value.
Press the **right** button to advance to the next screen.

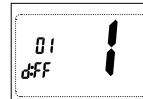

4. 2nd Stage Temperature Differential (1°F to 5°F) (0.5°C to 2.5°C)
(For HP O and HP B only)
Set the number of degrees between when stage 1 turns on and when stage 2 turns on.
Press the **up** or **down** button to set differential value.
Press the **right** button to advance to the next screen.



5. Staged Off Outputs (For HP O and HP B only)
Select whether the outputs for heating and cooling are staged off independently or are satisfied simultaneously.
1 = outputs staged off independently
0 = outputs off simultaneously
Press the **up** or **down** button to set.
Press the **right** button to advance to the next screen.



6. Deadband (1°F to 9°F) (1°C to 5°C)
Select the minimum difference between heat set point and cool set point when in auto changeover mode.
Press the **up** or **down** button to set.
Press the **right** button to advance to the next screen.



7. Auxiliary Delay ON – (0-30 minutes) (For HP O and HP B only)
Set the delay time in minutes for auxiliary heat to be locked out after a call for second stage. This extra savings feature is used to temporarily lock out auxiliary heat devices, allowing just heat pump to try to satisfy heat call.
Press the **up** or **down** button to set.
Press the **right** button to advance to the next screen.

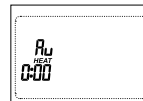

8. Maximum Heat Setpoint (45°F to 90°F) (7°C to 32°C)
Adjust to control the maximum heat set temperature allowed.
Press the **up** or **down** button to select.
Press the **right** button to advance to the next screen.



9. Minimum Cool Setpoint (45°F to 90°F) (7°C to 32°C)
Adjust to control the minimum cool set temperature allowed.
Press the **up** or **down** button to select.
Press the **right** button to advance to the next screen.



10. Room Temperature Offset (+9°F to -9°F) (+4.5°C to -4.5°C)
Adjust to calibrate displayed room temperature to match actual room temperature.
* Note: When not set to 0, 0 will display.
Press the **up** or **down** button to select.
Press the **right** button to advance to the next screen.



AVAILABLE ACCESSORIES

Thermostat - Rt6p

Setting the Time and Day of the Week

The time and day of the week must be set for your program schedule to operate correctly.

1. Press the **SYS** (left) button until you are in the OFF mode.
2. Press and hold the **PROG** button (**SYS** (left) and **FAN** (right) buttons pressed simultaneously) in for 6 seconds.

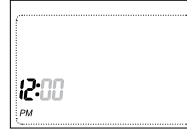

3. Time displays (hour flashing).
Press the **up** or **down** button to adjust the hour.

4. Press the **FAN** (right) button once to select minutes (minutes flashing).
Press the **up** or **down** button to adjust the minutes.



5. Press the **FAN** (right) button once to select day of the week (**TODAY** flashing).
Press the **up** or **down** button to select current day of the week.

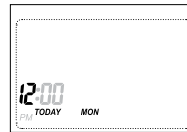

** Note: At any time, press the **SYS** (left) button to return to the previous screen or press the **FAN** (right) button to advance to the next screen.

Press the **PROG** button in for 2 seconds to lock values into memory and return to the OFF mode or press the **FAN** (right) button once to enter programming.

Programming

Program Overview

This programmable thermostat has four periods (MORN, DAY, EVE, NITE) that are customizable for each day of the week. Each period will have a start time, heat temperature, cool temperature and programmable fan option. The thermostat monitors the day and time, while maintaining the specific conditions you have chosen for each period in your program.

Setting the program schedule:

1. Press the **SYS** (left) button until you are in **OFF** mode.
2. Press and hold the **PROG** button (**SYS** and **FAN** buttons pressed simultaneously) for 6 seconds.
3. Press the **FAN** (right) button 3 times.
4. **SUN** thru **SAT** are blinking.



From this screen you have 2 options:

1. Press the **FAN** (right) button to begin programming all 7 days at one time, or
2. Press the **up** button to see the other programming options.

** Note: The days of the week shown on the display will be programmed simultaneously.
The screens are listed below.

Screen 1	SUN	MON	TUE	WED	THU	FRI	SAT
Screen 2		MON	TUE	WED	THU	FRI	
Screen 3		MON					
Screen 4			TUE				
Screen 5				WED			
Screen 6					THU		
Screen 7						FRI	
Screen 8	SUN						SAT
Screen 9							SAT
Screen 10	SUN						

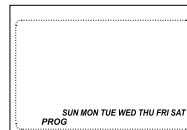

AVAILABLE ACCESSORIES

Thermostat - Rt6p

Programming (continued)

From any of the screens above, you can press the **FAN** (right) button to begin entering your program schedule. The days shown on the display will all be programmed simultaneously.

Once the **FAN** (right) button is pressed, **MORN** blinks.

Use the **up** or **down** button to select a different period (**MORN** , **DAY** , **EVE** , **NITE**).

Press **FAN** (right) button to advance to the next screen. Transition time **hour** blinks.

Use the **up** or **down** button to select a different hour.

Press **FAN** (right) button to advance to the next screen. Transition time **minutes** blink.

Use the **up** or **down** button to select different minutes.

Press **FAN** (right) button to advance to the next screen. Heat set temperature **displays**.

Use the **up** or **down** button to adjust the heat set temperature.

Press **FAN** (right) button to advance to the next screen. Cool set temperature **displays**.

Use the **up** or **down** button to adjust the cool set temperature.

Press **FAN** (right) button to advance to the next screen. Programmable fan **screen displays**.

Use the **up** or **down** button to select:

Choose: **Off** – P programmable fan disabled >OR< **On** – Indoor fan on continuously

* Note: Programmable fan operates in Program mode only.

Repeat above steps to program the four periods per day.

When the program schedule is complete, press and hold the **PROG** button (SYS and FAN buttons pressed simultaneously) in for 2 seconds to return to the **OFF** mode.

Factory Preprogramming

The thermostat comes pre programmed with the following schedule:

	MORN	6:00 AM	DAY	8:00 AM	EVE	6:00 PM	NITE	10:00 PM
MONDAY	HEAT	70°F	HEAT	62°F	HEAT	70°F	HEAT	62°F
thru	COOL	78°F	COOL	85°F	COOL	78°F	COOL	82°F
SUNDAY	FAN	Off	FAN	Off	FAN	Off	FAN	Off

Personal Program Schedule

Use the following personal program schedule to record your settings:

	MORN	DAY	EVE	NITE
MONDAY 1	HEAT COOL FAN	HEAT COOL FAN	HEAT COOL FAN	HEAT COOL FAN
TUESDAY 2	HEAT COOL FAN	HEAT COOL FAN	HEAT COOL FAN	HEAT COOL FAN
WEDNESDAY 3	HEAT COOL FAN	HEAT COOL FAN	HEAT COOL FAN	HEAT COOL FAN
THURSDAY 4	HEAT COOL FAN	HEAT COOL FAN	HEAT COOL FAN	HEAT COOL FAN
FRIDAY 5	HEAT COOL FAN	HEAT COOL FAN	HEAT COOL FAN	HEAT COOL FAN
SATURDAY 6	HEAT COOL FAN	HEAT COOL FAN	HEAT COOL FAN	HEAT COOL FAN
SUNDAY 7	HEAT COOL FAN	HEAT COOL FAN	HEAT COOL FAN	HEAT COOL FAN

AVAILABLE ACCESSORIES

Thermostat - Rt6p

Operating Modes

There are four possible operating modes for the RT6P . Off, Heat, Cool and Heat/Cool modes are accessed by pressing the SYS (left) button. The RT6P also lets you operate in any mode as a programmable thermostat.

OFF Mode

- In this mode, the thermostat will not turn on the heating or cooling devices
- ** Note: The indoor fan can be turned on manually in every operating mode by pressing the FAN (right) button. The word FAN shows on the display and the fan icon appears when the fan operates.



Heat Mode

- In this mode, the thermostat controls the heating system. When the heat outputs, the flame icon appears on the display.
- ** Note: For heat pumps, there is a four minute delay for your compressor to restart after it has turned off. To bypass the compressor time delay, go to OFF mode for 5 seconds.

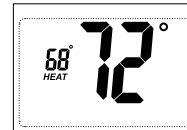

Cool Mode

- In this mode, the thermostat controls the cooling system. When the cooling outputs, the snowflake icon appears on the display.
- ** Note: There is a four minute delay for your compressor to restart after it has turned off. To bypass the compressor time delay, go to OFF mode for 5 seconds.

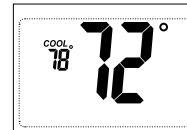

Cool and Heat Mode (Auto Changeover)

- In this mode, the thermostat controls the cooling and heating systems, automatically changing over from one to the other as needed.
- The timing display alternates with the set temperature every 10 seconds in the cool and heat mode.

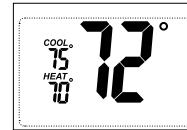

Program Mode

- In this mode, the program function is on (PROG displays), and the thermostat will automatically be controlled by the set program schedule. Program mode can function with heat mode, cool mode, or heat & cool mode. The program schedule can be overridden by changing the set temperature (up or down button). After 2 hours, the program schedule will automatically be resumed. To manually return to the program schedule, press the PROG button twice.

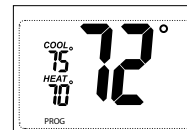

Set Point Adjustment

Heat Set Point

- Use the SYS button to select Heat Mode. Press the up or down button to view the current heat set point larger on the display. When the large set point is displayed, the HEAT icon will blink. The up or down buttons can be used to adjust the set point. After 5 seconds of inactivity the screen will display the room temperature and the HEAT icon will not blink.

HEAT icon will blink.

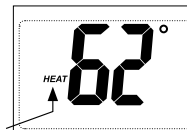

Cool Set Point

- Use the SYS button to select Cool Mode. Press the up or down button to view the current cool set point larger on the display. When the large set point is displayed, the COOL icon will blink. The up or down buttons can be used to adjust the set point. After 5 seconds of inactivity the screen will display the room temperature and the COOL icon will not blink.

COOL icon will blink.

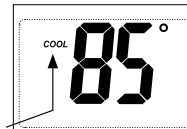

Heat & Cool Set Points

- Use the SYS button to select Heat/Cool Mode. Press the up or down button to adjust the current set points. When the set points are displayed for adjustment, the ROOM temperature leaves the screen. The up or down buttons can be used to adjust the set points. After 5 seconds of inactivity, the screen will display the Heat and Cool set points and the room temperature.

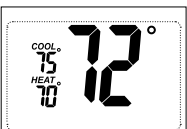

AVAILABLE ACCESSORIES

Thermostat - Rt6p

Testing the Thermostat

Once the thermostat is configured, it should be thoroughly tested.

CAUTION! : Do not energize the air conditioning system when the outdoor temperature is below 50 degrees. It can result in equipment damage or personal injury.

Heat Test

1. Press **SYS** (left) button until heat mode is displayed.
2. Adjust the set temperature so it is 5 degrees above the room temperature.
3. Heat should come on within a few seconds.
4. Adjust the set temperature 2 degrees below the room temperature and the heat should turn off. There may be a fan delay on your system.

** Note: For heat pumps, there is a four-minute delay to protect your compressor after it turns off. To bypass the compressor time delay, go to OFF mode for 5 seconds.

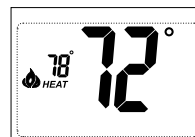

Cool Test

1. Press **SYS** (left) button until cool mode is displayed.
2. Adjust set temperature so it is 5 degrees below room temperature.
3. A/C should come on within a few seconds.
4. Adjust the set temperature 2 degrees above the room temperature and the A/C should turn off. There may be a fan delay on your system.

** Note: There is a four-minute time delay to protect the compressor after it turns off. To bypass the compressor time delay, go to OFF mode for 5 seconds.

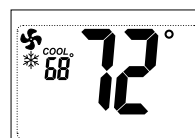

Fan Test

1. Press **FAN** (right) button. Fan displays. Indoor fan turns ON.
2. Press **FAN** (right) button. Indoor fan turns OFF.

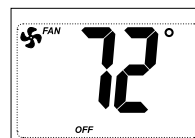

Troubleshooting

Symptom	Remedy
No display	Check for 24 VAC at thermostat; display is blank when 24 VAC is not present.
All thermostat buttons are inoperative	Verify 24 VAC is present; unit locks out when 24 VAC is not present
No response with first button press	First button press activates backlight only
Thermostat turns on and off too frequently	Adjust temperature differential (see Configuration Mode Settings 3 & 4)
Fan runs continuously	Press FAN (right) button to turn fan off
Room temperature is not correct	Calibrate thermostat (see Configuration Mode Setting 10)
Heat or Cool not coming on	Verify wiring is correct, gently pull on each wire to verify there is a good connection at terminal block
HEAT blinking	In heat set point screen, this is normal operation
COOL blinking	In cool set point screen, this is normal operation
Not following program schedule	Verify time is correct, check am/pm, verify it is in program mode (PROG displays)
"PROG" on display	Press both SYS (left) and Fan (right) to enter or exit the program mode
Problem not listed above	Press Reset button once*

* Reset Button Function : Display is refreshed, configuration settings are unchanged.

AVAILABLE ACCESSORIES

Thermostat - WRT1

This manual covers the following models:

- **WRT1 PTAC Wireless Remote Thermostat**
- **Base Module**

Description	
Gas or Oil Heat	Yes
Electric Furnace	Yes
Heat Pump (No Aux. or Emergency Heat)	Yes
Heat Pump (with Electric Aux.)	Yes
Heat Pump (with Gas Aux.)	No
Multi-stage Systems	No
Heat Only Systems	Yes
Heat Only Systems - Floor or Wall Furnaces	Yes
Cool Only Systems	Yes
High and Low Fan Speed	Yes
Millivolt	No
Emergency Heat	No
Conventional Single Stage Furnace	Yes
Geothermal	Yes

Power Type

Battery Power
Hardwire (Common Wire)
Hardwire (Common Wire) with Battery Backup

A trained, experienced technician must install this product.

Carefully read these instructions. You could damage this product or cause a hazardous condition if you fail to follow these instructions.

Need Help?

For assistance with this product, please call Friedrich Technical Assistance Center at 877-599-5665 ext. 261 between the hours of 8:00 AM - 5:00 PM CST.

AVAILABLE ACCESSORIES

Thermostat - WRT1

Quick Reference

Getting to know your thermostat

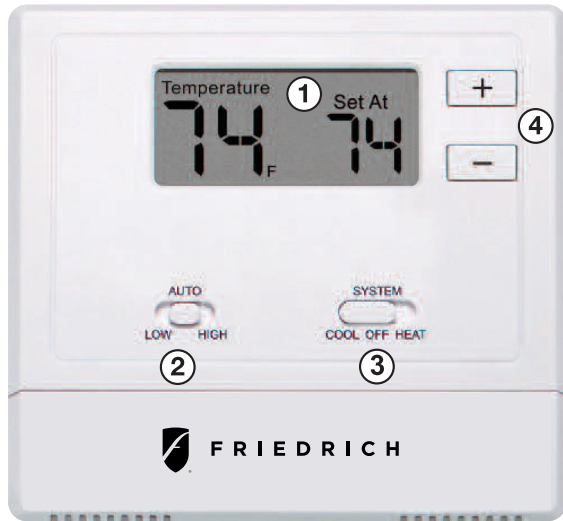

① LCD

Indicates the current room temperature.

Low Battery Indicator:
Replace batteries when indicator is shown.

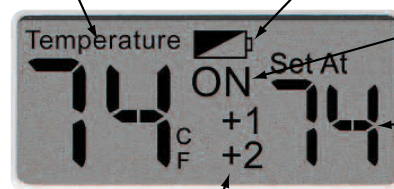

System operation indicators: ON will display when the **COOL** or **HEAT** is on.

Displays the user selectable setpoint temperature.

+1 will appear in the display when the auxiliary heat is active.

② Fan Switch

③ System Switch

④ Setpoint Buttons



Important:



The low battery indicator is displayed when the AA battery power is low. If the user fails to replace the battery within 21 days, the thermostat display will only show the low battery indicator as a final warning before the thermostat becomes inoperable.

AVAILABLE ACCESSORIES

Thermostat - WRT1



Thermostat Operation

Easy to use controls



Caution:

When the battery icon  appears replace your AA batteries immediately. Failure to do so may result in your heating & cooling system becoming inoperable.

- ① **LCD Display:**
See page 2 for details about this display read out.
- ② **Fan Switch:**
AUTO will cycle the fan on only when the heating or cooling system is on. Select **LOW** or **HIGH** for the fan to run continuously at the selected speed.
- ③ **System Switch:**
Selects the operation mode of your HVAC system. Selecting **HEAT** turns on the heat mode. Selecting **COOL** turns on the air conditioning mode. Selecting **OFF** turns both heating and cooling off.
- ④ **Temperature Setpoint Buttons:**
Press the  or  buttons to select the desired room temperature.

A Note About Two-Speed Fan:

When the fan switch is set to **AUTO** and the system is in **HEAT** or **COOL**, the thermostat will switch from **LOW** fan to **HIGH** fan when the ambient temperature is 2x swing away from setpoint. The thermostat will switch back to **LOW** fan at 1x swing away from setpoint.

AVAILABLE ACCESSORIES

Thermostat - WRT1

Installation Tips

Wall locations

The thermostat should be installed approximately 4 to 5 feet above the floor. Select an area with average temperature and good air circulation.

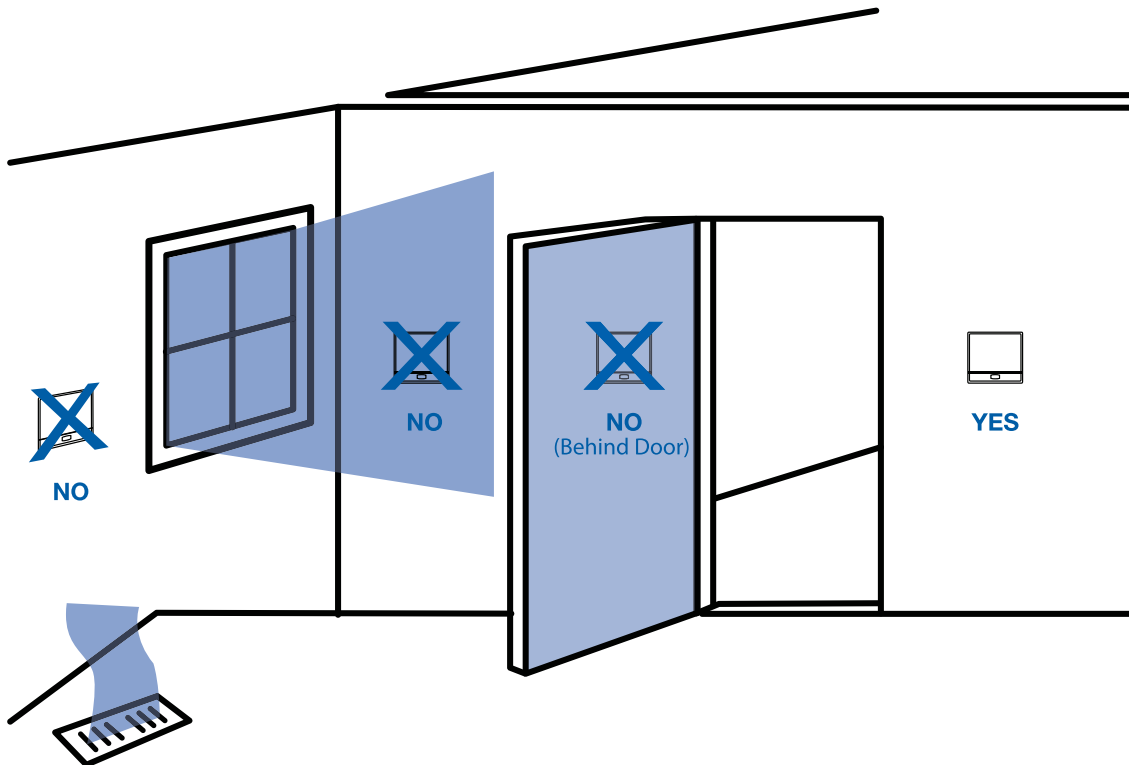

Do not install thermostat in locations:

- Close to hot or cold air ducts
- That are in direct sunlight
- With an outside wall behind the thermostat
- In areas that do not require conditioning
- Where there are dead spots or drafts (in corners or behind doors)
- Where there might be concealed chimneys or pipes

Friedrich Tip

Pick an installation location that is easy for the user to access. The temperature of the location should be representative of the building.

AVAILABLE ACCESSORIES

Thermostat - WRT1

Base Module Tips

Base Module - PTAC Installation

Wireless Range

Range between the WRT1 and the base module is up to 100 feet with no obstructions and up to 50 feet through standard building materials. To optimize the range try placing the base unit higher if in a basement or further away from large metal objects.

The base module is designed to be mounted behind the front grille of a packaged terminal air conditioner (PTAC). Refer to Friedrich PTAC Installation and Operation Manual for instruction in removing the front grill. Check clearance to ensure the fit of front grille after base module installation. Ensure if mounting with screws that wires and lines are not damaged. See below for a few suggested options to mount the base module.

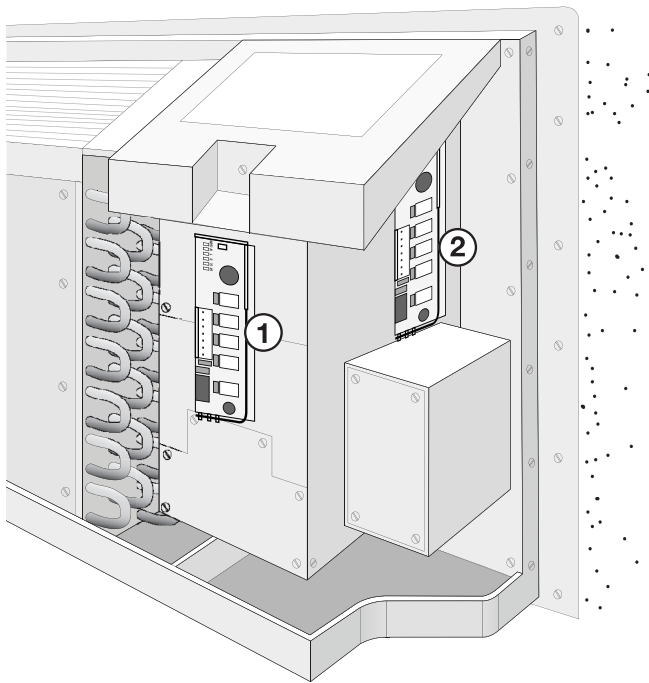

- ① **Front Mount:**
Inside PTAC Housing
- ② **Side Mount:**
Inside PTAC Housing

Note:

It is recommended to use an adhesive tape instead of screws when mounting the Base Module inside the PTAC housing.

Friedrich Tip

Do not install the base module in locations:

- That are behind a chimney
- That require the signal to pass through significant metal or concrete blocks
- Where temperature could exceed 150°F
- Where rain or snow or extreme hot or cold is possible



Caution: Electrical Hazard

Failure to disconnect the power before beginning to install this product can cause electrical shock or equipment damage.

AVAILABLE ACCESSORIES

Thermostat - WRT1

Sub-Base Installation



Caution: Electrical Hazard

Failure to disconnect the power before beginning to install this product can cause electrical shock or equipment damage.



Mercury Notice:

The WRT1 thermostat is mercury free. However, if the product you are replacing contains mercury, dispose of it properly. Your local waste management authority can give you instructions on recycling and proper disposal.

For vertical mount put one screw top and one screw bottom.

For horizontal mount put one screw left and one screw right.

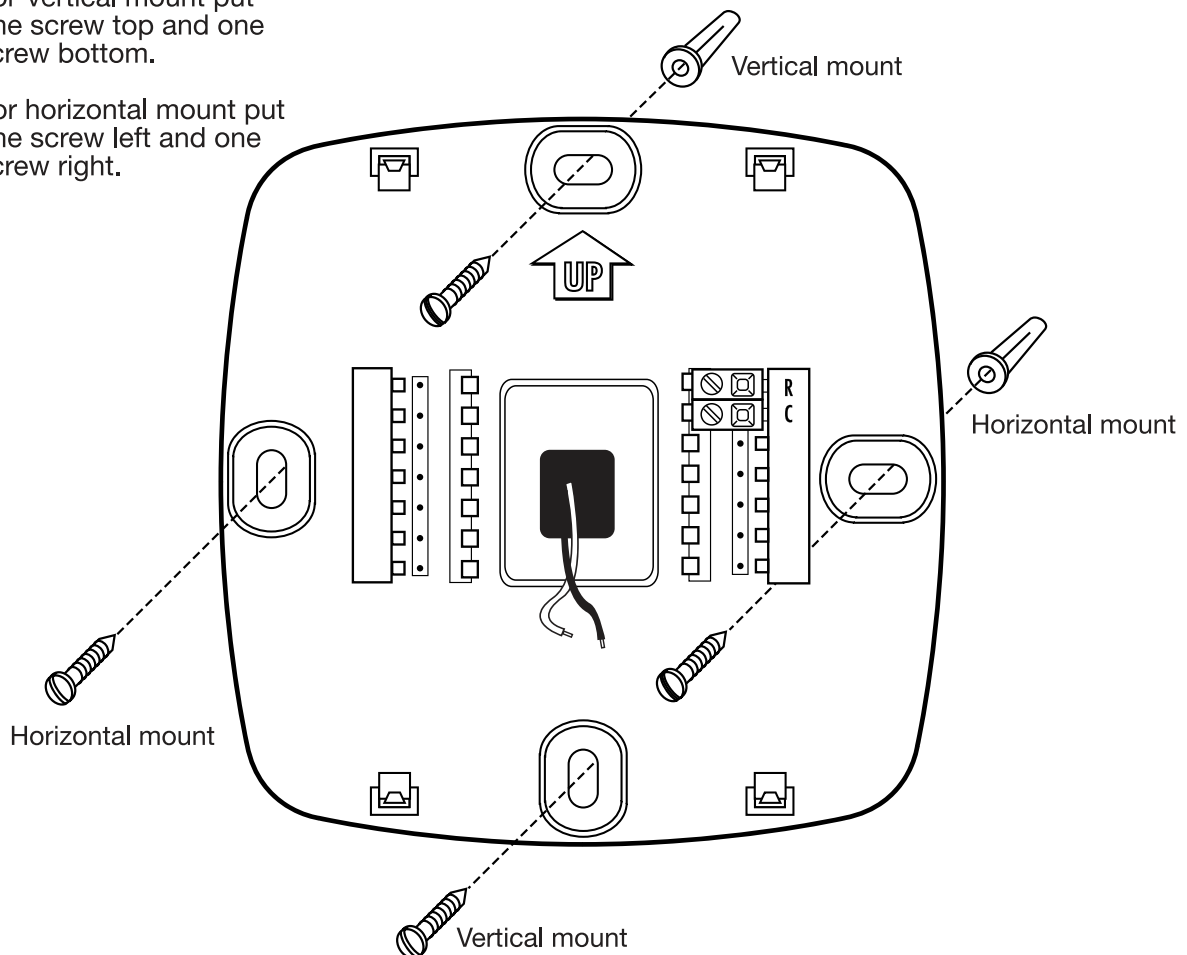

Friedrich Tip

The thermostat can be hardwired to a 24V power supply, however, it is not required. Batteries should be checked annually if 24V power is not connected.

AVAILABLE ACCESSORIES

Thermostat - WRT1

Base Module Installation

Wiring Note:

The base module is packaged with labeled thermostat wire. Wire appropriately into the PTAC board terminals.

Note:

The Thermostat and Base Module are “linked” for communication, at the factory. However, if for any reason the link has failed, use the process on page 12 to re-link the devices.

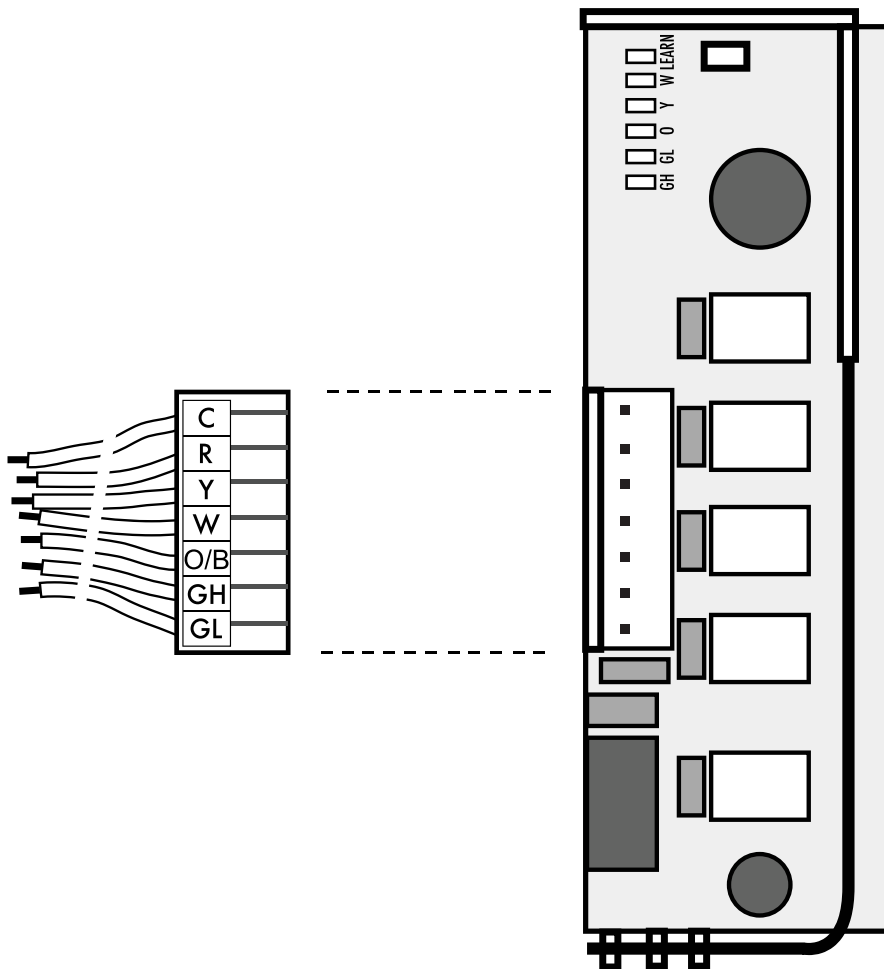

Note:

The Base Module may be mounted using adhesive tape, such as double-sided tape or hook and loop strips when drilling is not practical.

The Base Module must be hardwired (C and R terminals connected to 24V power).

Connecting to a PTAC:

When connecting the Base Module to a PTAC, refer to Friedrich PTAC Installation and Operation Manual for instructions to enable remote thermostat operation.

AVAILABLE ACCESSORIES

Thermostat - WRT1

Wiring

Wiring

1. If you are replacing a thermostat, make note of the terminal connections on the thermostat that is being replaced. In some cases the wiring connections will not be color coded. For example, the green wire may not be connected to the **G** terminal.
2. Loosen the terminal block screws. Insert wires then retighten terminal block screws.



Warning:

All components of the control system and the thermostat installation must conform to Class II circuits per the NEC Code.

Wire specifications

Use shielded or non-shielded
18 - 22 gauge thermostat wire.

Terminal Designations on Base Module

This thermostat is shipped from the factory to operate a conventional heating and cooling system. This thermostat will also operate a heat pump system. See the “heat pump” configuration step on page 9 of this manual to configure the thermostat for heat pump applications.

Terminal	1 Heat 1 Cool Conventional System	1 Heat 1 Cool Heat Pump System
R	24 VAC Transformer power	24 VAC Transformer power
C	Transformer common	Transformer common
B	Energized in heating	Heat pump changeover valve energized in heating
O	Energized in cooling	Heat pump changeover valve energized in cooling
GL	Fan relay, Low	Fan relay, Low
GH	Fan relay, High	Fan relay, High
W	First stage of heat	Second stage of heat
Y	First stage of cool	First stage of heat & cool

Terminal Designations on WRT1 Master Thermostat

Terminal	1 Heat 1 Cool Conventional System	1 Heat 1 Cool Heat Pump System
R	24 VAC Transformer power	24 VAC Transformer power
C	Transformer common	Transformer common

Connecting to a PTAC:

When connecting the Base Module to a PTAC, refer to the Friedrich PTAC or Vert-I-PAK® Installation and Operation Manual to enable remote thermostat operation.

AVAILABLE ACCESSORIES

Thermostat - WRT1

Wiring

- 1 Power supply
- 2 Jumper (not supplied) to connect GL and GH terminals
- 3 The thermostat must be set to O or B to match the changeover valve, O is cool changeover valve, B is heat changeover valve.
- 4 The Aux Heat Relay is energized as the second stage of heat.

Friedrich PTAC 1H/1C system: 2 speed fan

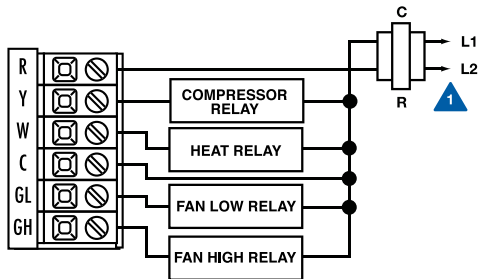

Friedrich PTAC 1H/1C system: 1 speed fan

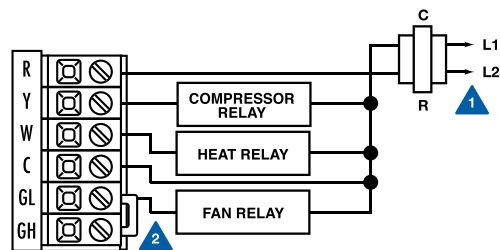

Note:

In Friedrich PTAC units with single speed fan operation, a jumper (not supplied) should be installed between GL and GH.

Friedrich PTAC and Vert-I-PAK Heat Pump system: 2 speed fan

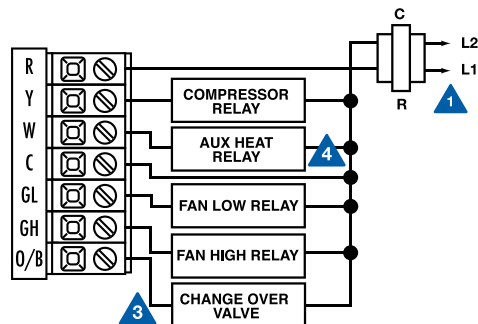

AVAILABLE ACCESSORIES

Thermostat - WRT1

Technician Setup

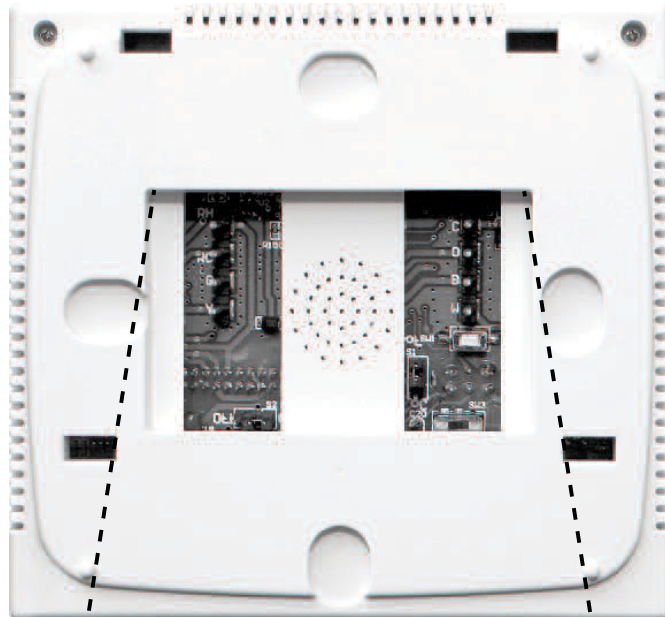

Select **F** or **C** with the jumper pin **①** Reset button

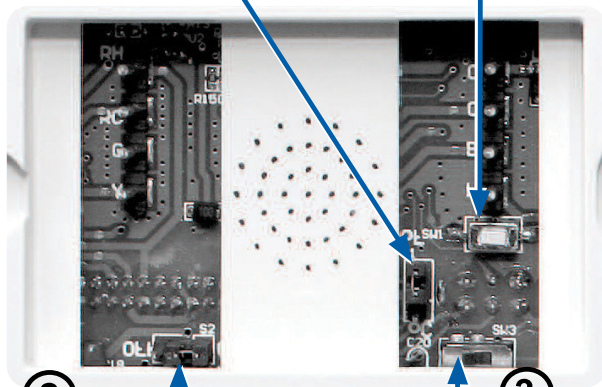

② Select delay **ON** or **OFF** with the jumper pin

③ Select **ELEC** with this switch

Fahrenheit/Celsius Display **①**

Select **F** or **C** with the jumper pin on the back of the thermostat.



Important:

The **RESET** button must be pressed after changing any switch or jumper pin setting. Batteries must be installed for this operation.

Compressor Short Cycle Delay **②**

The compressor short cycle delay protects the compressor from “short cycling”. This feature will not allow the compressor to be turned on for 5 minutes after it was last turned off.

Using the jumper on the back of the thermostat, selecting **ON** will not allow the compressor to be turned on for 5 minutes after the last time the compressor was on. Selecting **OFF** will remove this delay.

Electric Setup **③**

Electric: The thermostat operation switch should be put in the **ELEC** position. This setting allows the thermostat to operate the fan when the fan relay is connected to the **G** terminal. Friedrich PTAC units will require ELEC fan relay.

AVAILABLE ACCESSORIES

Thermostat - WRT1

Technician Setup

Technician Setup Menu

This thermostat has 3 different setup configurations. To setup the thermostat for your particular application:

1. Set the thermostat system switch to **OFF**.
2. Press and hold and together for 3 seconds. This 3 second delay is designed so that users do not accidentally access installer settings.

3. Configure the installer options as desired using the table below.

Use and to change settings.

Tap and together to move to the next step.

NOTE: When you want to exit Tech Setup options, move the system switch to **HEAT** or **COOL**.

Tech Setup Options							
P for PTAC configuration			V for Vert-I-Pak configurations				
Room Temperature Calibration	Change Over Valve Selection	Heat Pump	Heating Temperature Setpoint Limit	Cooling Temperature Setpoint Limit	Link Establish	Cooling Swing (SYSTEM COOL)	Heating Swing (SYSTEM HEAT)
This feature allows the installer to change the calibration of the room temperature display. For example, if the thermostat reads 70° and you would like it to read 72° then select +2.	Select 0 for a changeover valve that energizes in cooling. Select b for a change over valve that energizes in heating.	When turned on the thermostat will operate a heat pump. Y will be first stage of heat & cool, W will be second stage heat.	This feature allows you to set a maximum heat setpoint value. The setpoint temperature cannot be raised above this value.	This feature allows you to set a minimum cool setpoint value. The setpoint temperature cannot be lowered below this value.	This step is used to connect WRT1 to Base Module. Refer to page 12 for connection instructions.	The swing setting, often called "cycle rate", "differential" or "anticipation" is adjustable. A smaller swing setting will cause more frequent cycles and a larger swing setting will cause fewer cycles.	The swing setting, often called "cycle rate", "differential" or "anticipation" is adjustable. A smaller swing setting will cause more frequent cycles and a larger swing setting will cause fewer cycles.
LCD Will Show							
CA 0	CO 0	HU OFF	HE 90	CL 45	LE	08	08
Adjustment Options							
You can adjust the room temperature display to read -4°F to +4°F above or below the factory calibrated reading.	0 for cooling changeover valve <input type="button" value="P"/> b for heating changeover valve <input type="button" value="V"/>	ON configures the thermostat for heat pump systems.* <input type="button" value="P"/> OFF configures the thermostat for non heat pump systems. <input type="button" value="V"/>	45.0 °F - 90.0 °F	45.0 °F - 90.0 °F	NA	The cooling swing setting is adjustable from ±0.2°F to ±2°F. For Example: A swing setting of 0.5°F will turn the cooling on at approximately 0.5°F above the setpoint and turn the cooling off at approximately 0.5°F below the setpoint.	The heating swing setting is adjustable from ±0.2°F to ±2°F. For Example: A swing setting of 0.5°F will turn the heating on at approximately 0.5°F below the setpoint and turn the heating off at approximately 0.5°F above the setpoint.**
Factory Default Settings							
0 °F	0	OFF	90 °F	45.0 °F	NA	0.8 °F	0.8 °F

* Select OFF on HU configuration for Friedrich models with the following suffix: A, B, C, D or E

** The second stage will turn on at 2x the swing setting. The second stage will turn off when 1x the swing is reached. For example, if the swing setting is 0.8° for heating and the thermostat is set at 70°F, the first stage will turn on at approximately 69.2°F. The second stage will turn on at 68.4°F. The second stage will turn off at 69.2°F and the first will turn off at 70.8°F.

AVAILABLE ACCESSORIES

Thermostat - WRT1

Establishing Communication

Establishing Communication between WRT1 and the Base Module

The thermostat and base module come factory linked out of the box. If however, communication is lost, follow this easy- **Two Step** process to re-establish the communication link.

1. Press and hold the **base module Learn** button for 3 seconds. The **Blue LED** will flash when ready to receive initial signal from **WRT1**. (Base module must be powered by 24V. **Blue LED** will be continuously on when 24V power is present.)
2. Set the thermostat system switch to OFF. Press and hold and for 3 seconds. Tap and together until LE is displayed. Press and hold until LE flashes 3 times, the Blue LED on the base module will stop flashing after communication has been established between base module and WRT1.

Note:

The **Blue LED** on the **base module** will be on when power is present. The **Blue LED** will flash 3 times every time it receives a signal from **WRT1**. When a relay is on the corresponding LED relay indicator will be on.

Note:

If the base module does not receive a signal from the **WRT1** for 15 minutes it will turn off all relays until communication is reestablished. The **Blue LED** on the base module will also turn off to show communication has been lost.

Blue LED

Step 1. LED Relay Indicators

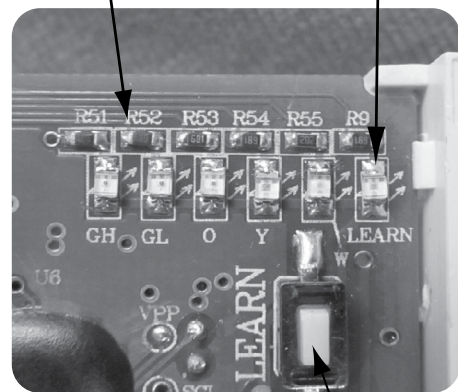

Base Module Learn Button

Step 2.



Important:

DO NOT hold the button when **LE** is displayed after **Step 2**, above has been completed. This will break the communication link and the base module button will need to be pressed again to reestablish communication.

AVAILABLE ACCESSORIES

Thermostat - WRT1

Mount Thermostat and Battery Installation

Mount Thermostat

Align the 4 tabs on the subbase with corresponding slots on the back of the thermostat, then push gently until the thermostat snaps in place.



Battery Installation

Battery installation is optional if thermostat is hardwired.

- R & C terminal connected to 24 VAC, Class II power

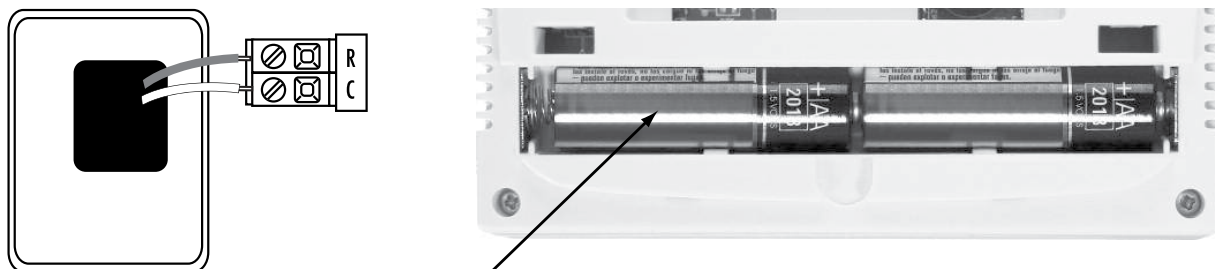

Insert 2 AA Alkaline batteries (included).

AVAILABLE ACCESSORIES

Thermostat - WRT1

Specifications

Specifications

WRT1 Thermostat

The display range of temperature	41°F to 95°F (5°C to 35°C)
The control range of temperature	44°F to 90°F (7°C to 32°C)
Load rating	1 amp per terminal, 1.5 amp maximum all terminals combined
Display accuracy	± 1°F (± 17.2°C)
Swing (cycle rate or differential)	Heating is adjustable from 0.2°F to 2.0°F (-17.67°C to -16.67°C) Cooling is adjustable from 0.2°F to 2.0°F (-17.67°C to -16.67°C)
Power source	18 to 30 VAC, NEC Class II, 50/60 Hz for hardwire (common wire) Battery power from 2 AA Alkaline batteries
Operating ambient	32°F to +105°F (0° to +41°C)
Operating humidity	90% non-condensing maximum
Dimensions of thermostat	4.7"W x 4.4"H x 1.1"D
Radio transmission frequency	916 MHz

Base Module

Load rating	1 amp per terminal, 1.5 amp maximum all terminals combined
Power source	18 to 30 VAC, NEC Class II, 50/60 Hz
Operating ambient	32°F to +150°F (0° to +65°C)
Operating humidity	90% non-condensing maximum

AVAILABLE ACCESSORIES

Drain Pan

Model VPDP1

Installation Instructions

DRAIN PAN

For VEA24, VHA18, and VHA24 units only.

Please read these instructions completely before attempting installation.

NOTE: This drain pan must be installed with all VEA24, VHA18 and VHA24 units.

STEP 1: CUT OPENING IN GASKET

Remove an 8" portion of the weather seal gasket from the bottom left surface of the plenum.

To remove: Cut the gasket in the lower left corner of the plenum. Then make a second cut 8" from the left corner. The gasket should peel away from the plenum leaving a clean mounting surface (See detail A).

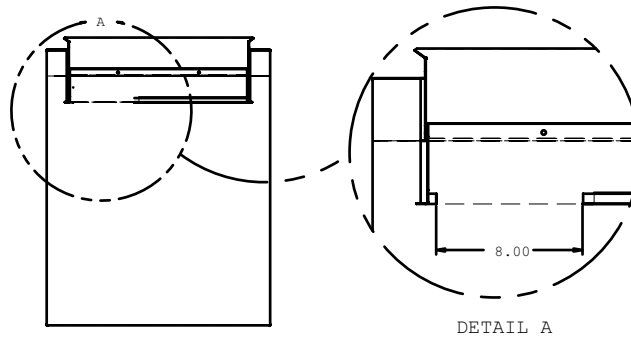

STEP 2: SEAL AND SET PAN

Prior to placing the drain pan into the opening run a 1/4" bead of sealant the entire width of the removed gasket. The secondary overflow lip must extend into the plenum to prevent water leaks. The pan should be mounted against the 3/4" flange of the plenum, refer to view A.

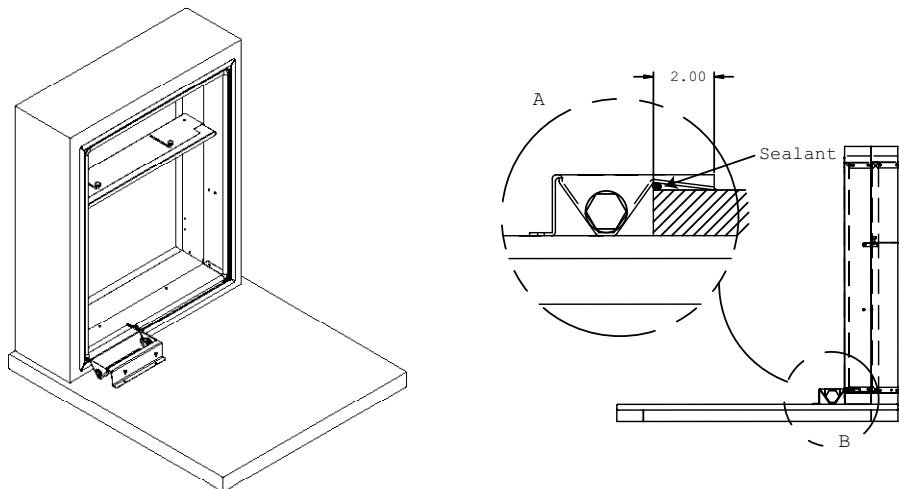

AVAILABLE ACCESSORIES

Drain Pan

STEP 3: INSTALL DRAIN PAN

Attach the drain pan to the closet floor with the appropriate field supplied hardware.

IMPORTANT - To prevent water leaks use only the factory supplied mounting holes. **NEVER** make penetrations in the drain pan itself.

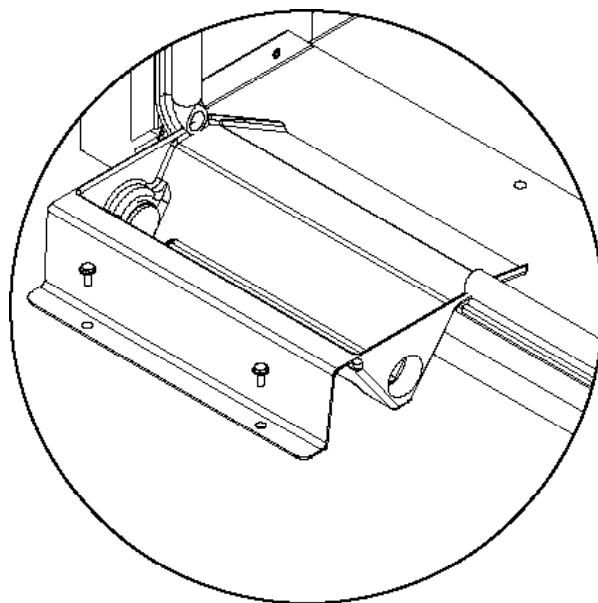

STEP 4: INSTALL DRAIN PLUG

The drain pan comes with both left and right-hand drain connections locations. Determine which of the two connections will be used to drain the condensate. Then, with the factory supplied drain plug, plug the unused opening.

NOTE - proper sealant must be applied to the connection to prevent leaks.

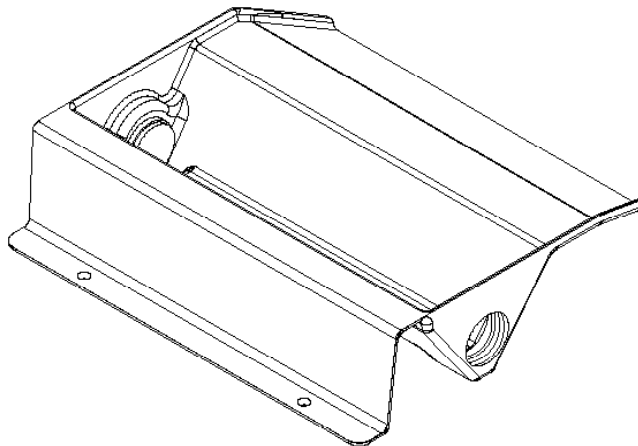

AVAILABLE ACCESSORIES

Drain Pan

STEP 5: INSTALL DRAIN LINE

Condensate line routing options are shown below. Choose the one that best suits your installation. Never run the condensate line as shown in Option 4 below, as the drain line will come into contact with the factory-installed isolators beneath the unit.

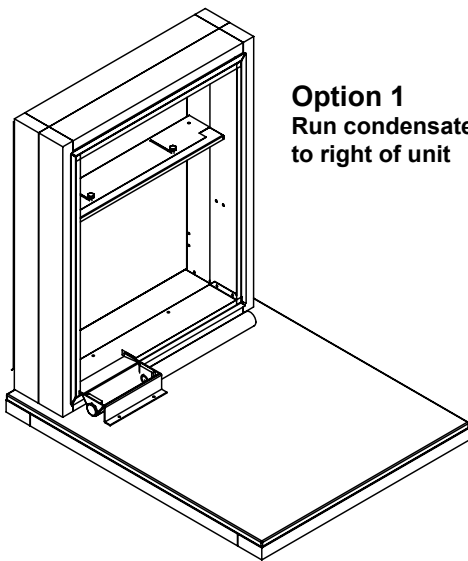

Option 1
Run condensate line
to right of unit

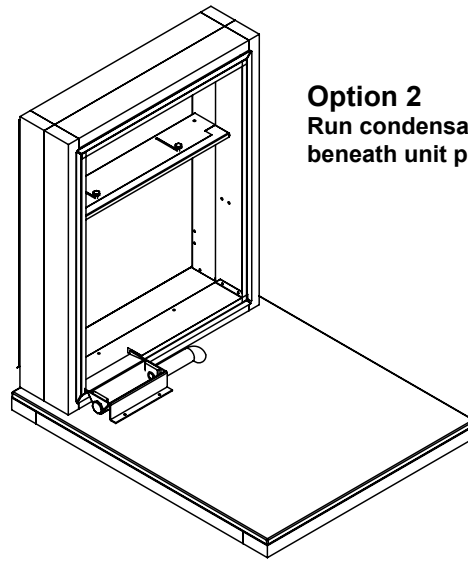

Option 2
Run condensate line
beneath unit platform

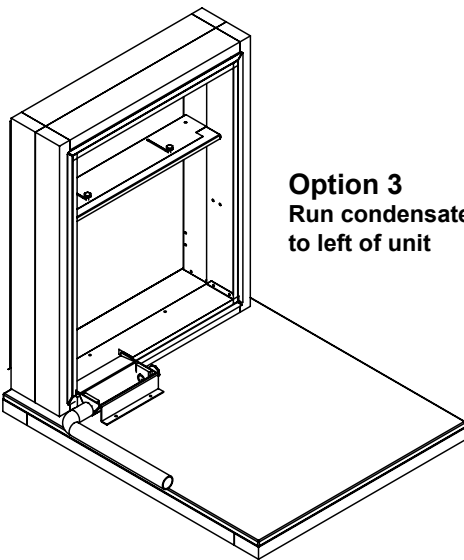

Option 3
Run condensate line
to left of unit

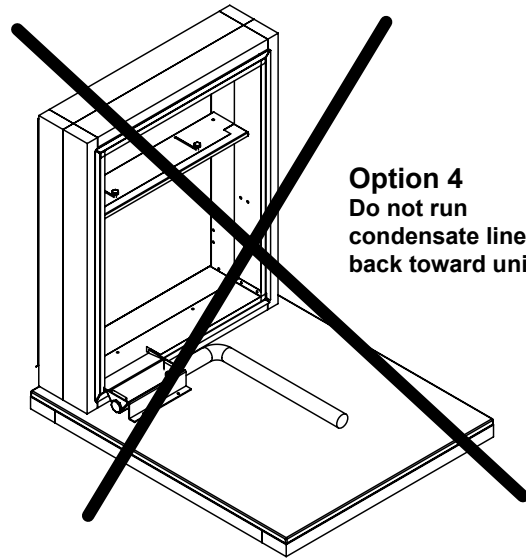

Option 4
Do not run
condensate line
back toward unit

IMPORTANT - The drain pan and line must be kept free from debris. Prior to installing the chassis ensure that there are no blockages in the drain pan or line.



Friedrich Air Conditioning Company
10001 Reunion Place, Suite 500
San Antonio, Tx 78216
800.541.6645
www.friedrich.com

VERT-I-PAK® A SERIES SINGLE PACKAGE VERTICAL AIR CONDITIONERS LIMITED WARRANTY

SAVE THIS CERTIFICATE. It gives you specific rights. You may also have other rights which may vary from state to state and province to province.

In the event that your unit needs servicing, contact your nearest authorized service center. If you do not know the nearest service center, ask the company that installed your unit or contact us - see address and telephone number above. To obtain service and/or warranty parts replacement, you must notify an authorized FRIEDRICH Air Conditioning Co. service center, distributor, dealer, or contractor of any defect within the applicable warranty period.

When requesting service: please have the **model** and **serial number** from your unit readily available.

Unless specified otherwise herein, the following applies:
FRIEDRICH VERT-I-PAK A SERIES HEAT PUMPS & AIR CONDITIONERS

LIMITED WARRANTY - FIRST YEAR (Twelve (12) months from the date of installation). Any part found to be defective in the material or workmanship will be repaired or replaced free of charge by our authorized service center during the normal working hours; and

LIMITED WARRANTY - SECOND THROUGH FIFTH YEAR (Sixty (60) months from the date of installation). ON THE SEALED REFRIGERATION SYSTEM. Any part of the sealed refrigeration system that is defective in material or workmanship will be repaired or replaced free of charge (excluding freight charges) by our authorized service center during normal working hours. The sealed refrigeration system consists of the compressor, metering device, evaporator, condenser, reversing valve, check valve, and the interconnecting tubing.

These warranties apply only while the unit remains at the original site and only to units installed inside the continental United States, Alaska, Hawaii, Puerto Rico, Mexico and Canada. The warranty applies only if the unit is installed and operated in accordance with the printed instructions and in compliance with applicable local installation and building codes and good trade practices. For international warranty information, contact the Friedrich Air Conditioning Company - International Division.

Any defective part to be replaced must be made available to **FRIEDRICH** in exchange for the replacement part. Reasonable proof must be presented to establish the date of install, otherwise the beginning date of this certificate will be considered to be our shipment date plus sixty days. Replacement parts can be new or re-manufactured. Replacement parts and labor are only warranted for any unused portion of the unit's warranty.

We will not be responsible for and the user will pay for:

1. Service calls to:
A) Instruct on unit operation. B) Replace house fuses or correct house wiring. C) Clean or replace air filters. D) Remove the unit from its installed location when not accessible for service required. E) Correct improper installations.
2. Parts or labor provided by anyone other than an authorized service center.
3. Damage caused by:
A) Accident, abuse, negligence, misuse, riot, fire flood or acts of God. B) Operating the unit where there is a corrosive atmosphere containing chlorine, fluorine, or any damaging chemicals (other than in a normal residential environment). C) Unauthorized alteration or repair of the unit, which in turn affects its stability or performance. D) Failing to provide proper maintenance and service. E) Using and incorrect power source. F) Faulty installation or application of the unit. G) Operation of the unit during construction.

We shall not be liable for any incidental, consequential, or special damages or expenses in connection with any use or failure of this unit. We have not made and do not make any representation or warranty of fitness for a particular use or purpose and there is no implied condition of fitness for a particular use or purpose. We make no expressed warranties except as stated in this certification No one is authorized to change this certificate or to create for us any other obligation or liability in connection with this unit. Any implied warranties shall last for one year after the original purchase date. Some states and provinces do not allow limitations on how long an implied warranty or condition lasts, so the above limitation or exclusions may not apply to you. The provisions of this warranty are in addition to and not a modification of or subtraction from the statutory warranties and other rights and remedies provided by law.

Performance of Friedrich's Warranty obligation is limited to one of the following methods:

1. Repair of the unit
2. A refund to the customer for the prorated value of the unit based upon the remaining warranty period of the unit.
3. Providing a replacement unit of equal value

The method of fulfillment of the warranty obligation is at the sole discretion of Friedrich Air Conditioning.

In case of any questions regarding the provisions of this warranty, the English version will govern.

CUSTOMER SATISFACTION and QUALITY ASSURANCE

Friedrich is a conscientious manufacturer, concerned about customer satisfaction, product quality, and controlling warranty costs. As an Authorized Service Provider you play a vital role in these areas. By adhering to the policies and procedures you provide us with vital information on each warranty repair you complete. This information is used to identify product failure trends, initiate corrective action, and improve product quality, thereby further reducing warranty expenses while increasing customer satisfaction levels.

FRIEDRICH AUTHORIZED PARTS DEPOTS

AAA Refrigeration Service

1322 24th Street, Suite B Kenner,
Louisiana 70062 504-464-7444
877-813-7444

Alamo Service Company

1450 North Flores Street San
Antonio, Texas 78212 210-227-
2450
800-328-2450

The Gabbert Company

6868 Ardmore
Houston, Texas 77054

713-747-4110
800-458-4110

Johnstone Supply of Woodside

27-01 Brooklyn Queens Expway
Woodside, New York 11377 718-
545-5464
800-431-1143

Reeve Air Conditioning, Inc.

2501 South Park Road Hallandale, Florida
33009 954-962-0252
800-962-3383

**FRIEDRICH****TECHNICAL SUPPORT
CONTACT INFORMATION**

Friedrich Air Conditioning Co.
10001 Reunion Place, Suite 500 • San Antonio, Texas 78216
1-800-541-6645
www.friedrich.com