



BOSCH



Register your
new device on
MyBosch now and
get free benefits:
**[bosch-home.com/
welcome](https://www.bosch-home.com/welcome)**

Washing machine Top-loader

en Instruction Manual and Installation Instructions



Your new washing machine

You have chosen a Bosch washing machine.

Please take a few minutes to read and become familiar with the advantages of your washing machine.

To meet the high quality demands required by Bosch, every washing machine that leaves our factory is carefully checked to ensure that it functions correctly and is in perfect condition.

For more information on our products, accessories, replacement parts and services, see our website www.bosch-home.com or contact our after-sales service centres.

If the operating and installation instructions describe different models, any differences will be pointed out at the relevant points in the text.



Read these operating and installation instructions before switching on the washing machine.

Display rules

Warning!

This combination of symbol and signal word indicates a possibly dangerous situation. Not heeding the warning can cause death or injuries.

Caution!

This signal word indicates a possibly dangerous situation. Not heeding the caution can cause property and/or environmental damage.

Note/tip

Information about the optimum use of the appliance/any other useful information.

1. 2. 3. / a) b) c)

The steps are represented by numbers or letters.

■ / -

Lists are represented by a small box or a dash.

Contents

	Installing and connecting the appliance	4
	Scope of delivery	4
	Installing the appliance	5
	Installing rat-mesh	5
	Installation surface	5
	Hose and pipe lengths	6
	Connecting the appliance	6
	Water inflow	7
	Water outlet	8
	Electrical connection	9
	Aligning the appliance	9
	Before using the appliance for the first time	10
	Quick reference guide	11
	Familiarising yourself with your appliance	12
	Appliance overview	12
	Fascia	13
	Display	14
	Programme overview*	17
	Settings	20
	Laundry	22
	Preparing laundry	22
	Sorting laundry	22
	Operating the appliance	23
	Switching on the appliance and setting a programme	23
	Programme settings	23
	Placing the laundry into the drum	24
	Adding detergent and fabric care products	24
	Starting the programme	25
	Child lock	25
	Pausing programmes and adding more laundry	26
	Cancelling the programme	26

	End of programme	26
	Removing laundry and switching off the appliance	26

	Sensors	27
---	--------------------------	-----------

	Unbalanced load detection system	27
	Automatic load sensing	27

	Cleaning and maintenance	27
---	---	-----------

	Cleaning/Maintenance	27
	Cleaning the drum	28
	Descaling the appliance	28
	Cleaning the lint filter	29

	What to do in the event of a fault	30
---	---	-----------

	Help with the appliance	30
	Cleaning the water inlet filter	32

	Transporting the appliance	33
---	---	-----------

	Technical data	34
---	---------------------------------	-----------

	Warranty terms and conditions	35
---	--	-----------

	Environmental Protection	38
--	---	-----------

	Customer Service	38
---	-----------------------------------	-----------



Installing and connecting the appliance

Scope of delivery

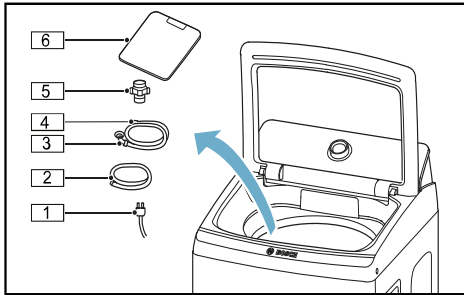

- 1 Mains cable
- 2 Water drain hose
- 3 Water supply hose
- 4 Second water supply hose (identified by a red marking) on models with a hot water supply hose*/**

- 5 Snap connector
- 6 Rat-mesh

* Depending on the appliance specifications

** If a second inlet hose is required (only for appliances with hot water connection), this can be ordered at no cost from the after-sales service.

1. Remove any packaging and protective covers completely from the appliance.
2. Remove the protective film from the control panel.
3. Remove the appliance from the base padding.

Note: Operating the appliance on the base padding is strictly forbidden.

4. Open the lid on the appliance and take out the cover and all the accessories.

You can now install and connect the appliance.

Caution!

Risk of material damage and damage to the appliance

Objects remaining in the drum that are not designed for operation with the appliance may result in material damage and damage to the appliance. Remove these objects, along with all accessories, from the drum.

Installing the appliance

Warning **Risk of injury!**

- The appliance is very heavy. Lifting it may result in injury. Do not lift the appliance on your own.
- The appliance has sharp edges on which you could cut your hands. Do not take hold of the appliance by its sharp edges. Wear protective gloves to lift it.
- If the hoses and mains cables are not correctly routed, they may constitute a tripping hazard, which may result in injury. Route hoses and cables such that they do not constitute a tripping hazard.

Installing rat-mesh

1. Tilt the appliance from front slightly.

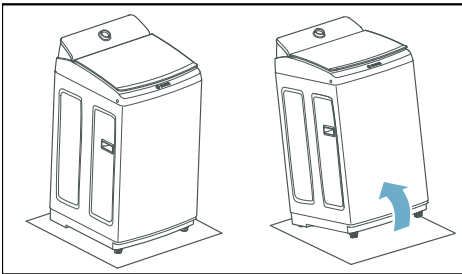

2. Push the rat-mesh onto the underside of the appliance and screw it in place.

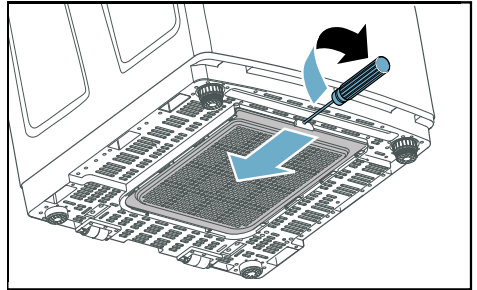

Installation surface

Caution! **Damage to the appliance**

Frozen hoses may rupture or burst. Do not install the appliance outdoors or in areas that may be exposed to frost.

Note: The appliance must be stable so that it does not "wander".

- The installation surface must be firm and level.
- Soft floors/floor coverings are not suitable.
- All four of the appliance's feet must stand firmly on the ground.

en Installing and connecting the appliance

Hose and pipe lengths

■ Connecting

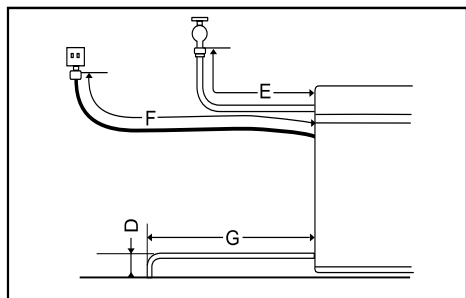

- D Max. 15 cm
- E 150 cm
- F Max. 150 cm
- G Max. 85cm

Connecting the appliance

Caution!

Risk of material damage and damage to the appliance

If the water pressure is too high or too low, the appliance may not be able to operate properly, and this may also result in material damage or damage to the appliance.

Ensure that the water pressure in the water supply facility is at least 20 kPa (0.2 bar), and does not exceed 1000 kPa (10 bar).

Caution!

Material damage/damage to the appliance

If the water hoses are altered or damaged, this may result in material damage or damage to the appliance. The water hoses must not be kinked, crushed, altered or severed.

Caution!

Material damage/damage to the appliance

The use of hoses supplied by other brands to connect to the water supply may result in material damage or damage to the appliance.

Use the hoses supplied with the appliance or genuine spare part hoses only.

Notes

- In addition to the information listed here, the local water and electricity supplier may have special requirements.
- If in doubt, have your appliance connected by a professional.

Water inflow

Notes

- When using a spanner/screw driver, use the correct size and apply controlled force.
- Only operate the appliance using mains water.

Connection to the universal tap adapter

Note: When connecting to a threadless tap, fit the supplied adapter first.

1. Slide the sliding sleeve downwards from the snap connector (all balls must be exposed) and then disconnect the snap connector from the connection socket.

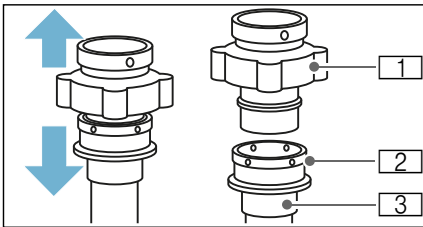

- 1 Connection socket
- 2 Exposed balls
- 3 Snap connector

2. Turn part B of the connection socket until the clearance between part A and part B is at least 5 mm.

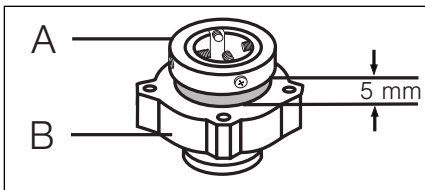

3. Unscrew all of the screws from part A.
4. Slide the connection socket over the tap opening and then screw the screws tightly back into part A.

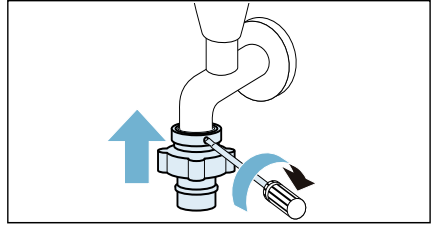

Note: Ensure the following:

- The tap's opening is smooth and even.
 - The seal is positioned centrally with respect to the tap opening.
5. Retighten part B.
 6. Slide the sliding sleeve downwards from the snap connector (all balls must be exposed), insert the snap connector into the connection socket and slide it upwards.

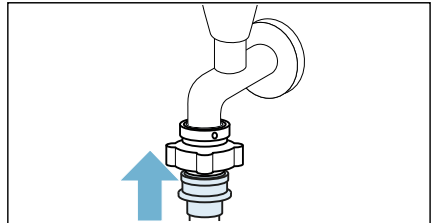

Model with hot water supply:

1. Connect the red-marked hot water supply hose to the hot water tap (max. 60 °C) and to the red valve on the appliance, and connect the blue-marked cold water supply hose to the cold water tap and to the blue valve on the appliance.

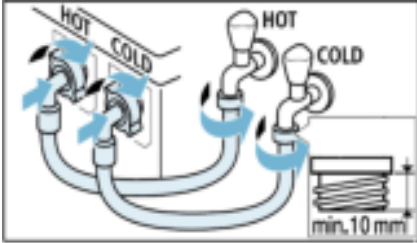

2. Carefully turn on the taps and check that there are no leaks.

Notes

- The threaded connection is subjected to high water pressures.
- Both hoses must be connected in order for the appliance to work correctly.

Model without hot water supply:

1. Connect the water supply hose to the tap and to the valve on the appliance.



2. Carefully turn on the taps and check that there are no leaks.

Note: The threaded connection is subjected to high water pressures.

Water outlet

Caution!

Water damage

When water is being drained away, the drain hose is under high water pressure and may slip out of the connection point.

Secure the outlet hose so that it cannot slip out.

Caution!

Damage to the appliance/fabrics

If the end of the outlet hose is immersed in the drained water, water may not be drained properly.

Make sure that:

- The end of the drain hose is not immersed in the drained water,
- The water drains away quickly enough.

Connect the water drain hose as follows:

1. Use the spring clip to secure the water drain hose to the outlet on the appliance.

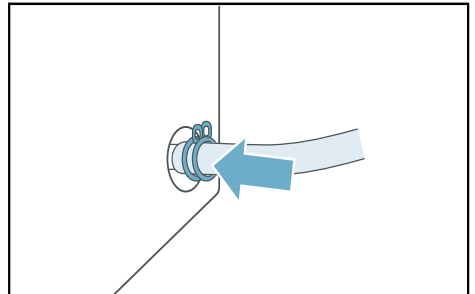

- Second end of the water drain hose to be properly laid to a floor drain.

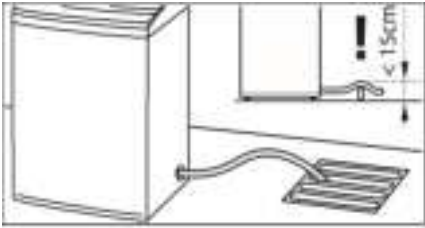

Notes

- The height difference between the surface on which the appliance is installed and the water drain hose should be no more than 15 cm.
- If you extend the drain hose, its total length should be no more than 3 m. Otherwise, the water will not be able to drain away properly.

Electrical connection

Warning

Risk of electric shock/fire/material damage/damage to the appliance!

If the appliance is not installed properly, this may lead to a dangerous situation. Ensure the following:

- The mains voltage on your power socket must match the rated voltage specified on the appliance (identification plate). The connected loads and the required fuse protection are specified on the identification plate.
- The mains plug and the protective contact socket must match and the earthing system must be correctly installed.
- The installation must have an adequate cross section.

- The mains plug must be freely accessible at all times. If this is not possible, in order to comply with the relevant safety regulations, a switch (all pole disconnection) must be built into the permanent installation in accordance with electrical installation regulations.
- If using a residual current circuit breaker, only use one that bears the following mark: . The presence of this mark is the only way to be sure that it fulfils all the applicable regulations.

Connect the appliance to the mains power supply as follows:

- Plug the appliance's mains plug into the designated socket.
- Check that the mains plug is in securely.

Aligning the appliance

Align the appliance as follows:

Adjust the height of the appliance feet to level the appliance. Tighten the lock nuts on all the appliance's adjustable feet against the housing. As you do so, hold the foot tight and do not adjust its height. Use the spirit level on the top panel to check whether the appliance is leveled or not.

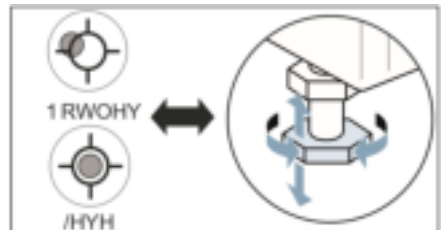

Note: If the appliance is ever moved, check that it is still level and re-level it if necessary.

Before using the appliance for the first time

Before you switch on the appliance:

Check that there is no visible damage to the appliance. Do not operate the appliance if it is damaged. Should you have any problems, please contact your specialist dealer or our after-sales service.

Your appliance has been thoroughly tested before leaving the factory. To remove any water that may be left over from testing, run the first wash cycle **without** any laundry.

Run a program without laundry as follows:

1. Press **I** to switch on the appliance.
2. Set the **Tub Clean** program.
3. Open the appliance lid (but do not place any laundry inside).
4. Pull out the detergent drawer.

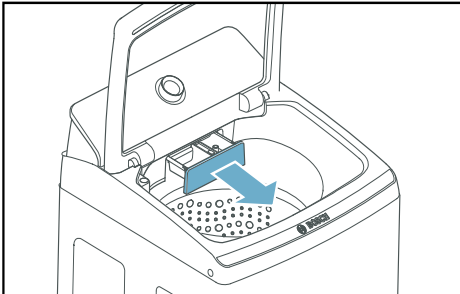

5. Fill compartment **I** with powder or liquid detergent.
 - **Powder detergent**
Fill directly in the compartment **I**.
 - **Liquid Detergent**
Place the liquid detergent cup **III** as shown in the picture and then pour the liquid detergent

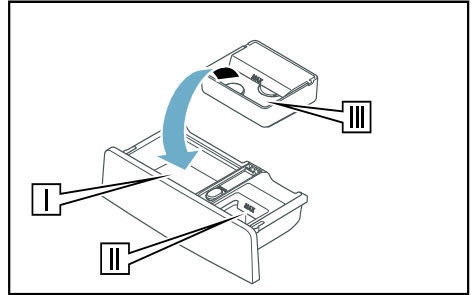

6. Close the detergent drawer.
7. Close the lid.
8. Press **D**.
The program will start.
9. Switch off the appliance at the end of the program.
Your appliance is now ready to use.



Quick reference guide



Familiarising yourself with your appliance

Appliance overview

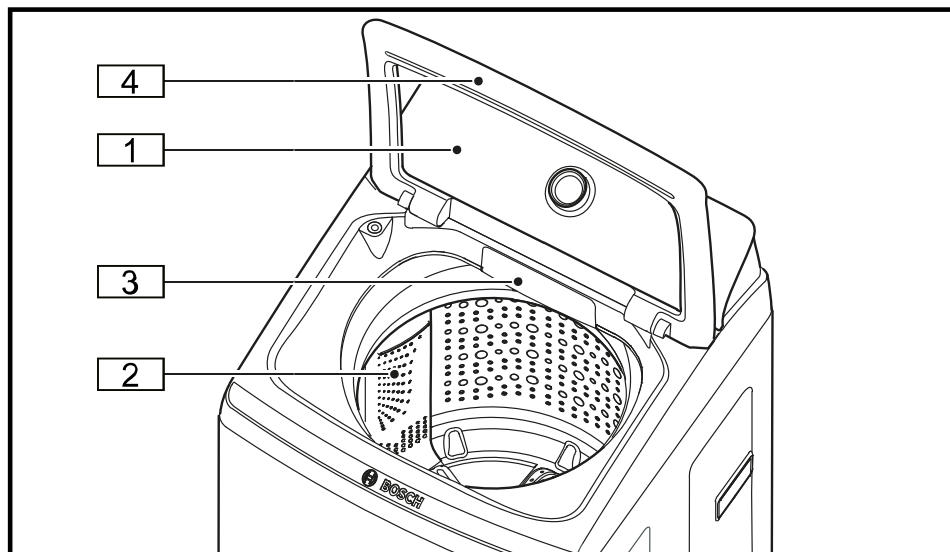

- 1 **Control and display panel**
- 2 **Filter box**
- 3 **Detergent drawer**
- 4 **Appliance lid**

Fascia

Model without a hot water supply hose or built-in heater:

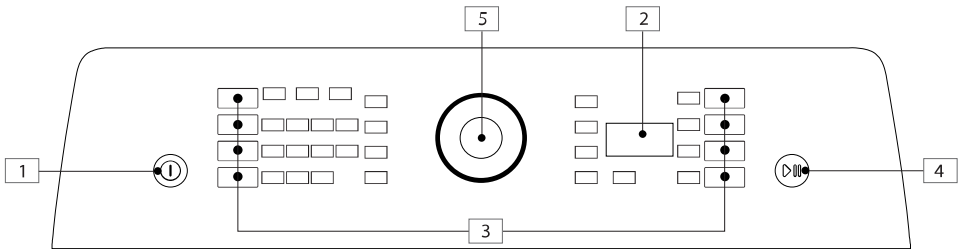

Models with built-in heater or a hot water supply hose:

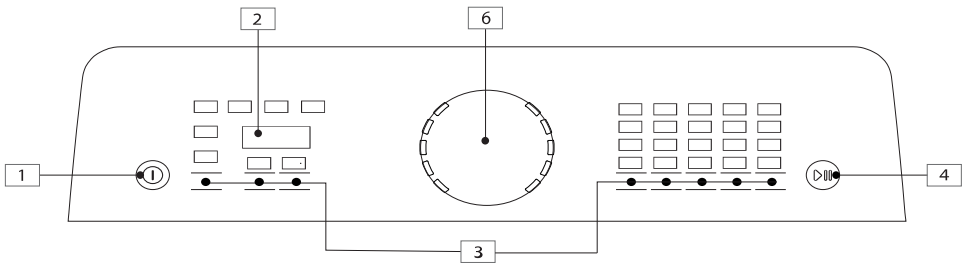

- 1 Main switch**
Press this button to switch the appliance on or off.
- 2 Display**
Displays settings and information. → *Page 14*
- 3 Buttons**
To set a program and adjust the program settings. → *Page 20*
- 4 Start button**
To start or interrupt a program or select the automatic program.
- 5 Program button**
To select the programs. → *Page 17*
- 6 Knob**
To select the programs. → *Page 17*

Display

Model:

Heater models

Display:



Models with a hot water supply hose



Models without a hot water supply hose



Number/ code	Description	Heater models	Models with a hot water supply hose	Models without a hot water supply hose
e.g. 00:09 (Wash), 7 (Spin)	Wash/spin cycle duration	NA	NA	Expected wash/spin cycle duration (🌀 Wash and 🌀 Spin) in minutes.
e.g. 2	Rinse cycles	NA	NA	Number of rinse cycles (🌀 Rinse) in the set pro- gram.
e.g. 08 h	Program start delay	Delay to the program start in hours if you have activated the Delay button.	Delay to the program start in hours if you have activated the Delay but- ton.	Delay to the program start in hours if you have activated the Delay ⏸ button.
e.g. 00:15	Soak Duration	Soak duration in hours and minutes if you have selected the Soak button.	Soak duration in hours and minutes if you have selected the Soak button.	Soak duration if you have selected the Soak 🌀 button.
e.g. ADD 1 CUP	Detergent Recommen- dation	Detergent recommen- dation (1 CUP, 1.5 CUP, 2 CUP) 1 CUP is equivalent to 60 gms of powder deter- gent.In case of liquid detergent follow the detergent manufac- turer's guideline	Detergent recommenda- tion (1 CUP, 1.5 CUP, 2 CUP) 1 CUP is equivalent to 60 gms of powder detergent.In case of liquid detergent follow the detergent manufac- turer's guideline	Detergent recommenda- tion (1 CUP, 1.5 CUP, 2 CUP) 1 CUP is equivalent to 60 gms of powder detergent.In case of liq- uid detergent follow the detergent manufac- turer's guideline
e.g. 01:20	Cycle display duration	Cycle duration in hours and minutes based on the selected program and corre- sponding level set- tings.	Cycle duration in hours and minutes based on the selected program and corresponding level set- tings.	Duration of selected pro- gram cycle in hours and minutes and change in phase settings duration.
e.g. Its time to clean the Tub	Reminders	Text reminders for Tub clean and Deter- gent recommenda- tion.		



Number/ code	Description	Information
E1	Water supply	The machine is not filling with water properly (unable to reach default water level). Make sure that: <ul style="list-style-type: none"> ■ The water pressure is sufficient and tap is fully open ■ The supply hose is not kinked or trapped. ■ The filter in the water supply is not blocked. → Page 32
E2	Water outlet	The drain hose is blocked: <ul style="list-style-type: none"> ■ Clean the drain hose ■ Lay the drain hose down in to a floor drain
E3	Lid is open	The lid must be fully closed when a program is in progress. <ul style="list-style-type: none"> ■ Close the lid and press the Start button ■ Remove any trapped laundry
E4	Unbalanced load	<ul style="list-style-type: none"> ■ The laundry is not evenly distributed in the drum, creating an unbalance. <p>Note: The appliance has an unbalanced load detection system, which interrupts the spin cycle when the laundry is unevenly distributed. Redistribute the laundry by hand to eliminate the unbalance and press the start button..</p> <ul style="list-style-type: none"> ■ Adjust the height of the appliance feet to level the appliance → Page 9.
E5	Safety switch failure	Safety switch is not functioning. <ul style="list-style-type: none"> ■ Adjust the height of the appliance feet to level the appliance → Page 9. <p>If the fault occurs repeatedly, call the after-sale service.</p>
E6	Water level too high	Water level is more than the required level. <ol style="list-style-type: none"> 1. Make sure the drain hose is properly laid to a floor drain. 2. Wait for 10 seconds. 3. If the fault occurs repeatedly, call the after sale service.
EH	Heater/heat pipe malfunction (only for heater models)	Heater/heat pipe is not functioning properly. Call the after-sale service.
CL	Note	The buttons have been pressed while the Child Lock was active <ol style="list-style-type: none"> 1. Switch off the appliance. 2. Wait for 5 seconds. 3. Switch the appliance on again.
F1-F8 C1-C3	Other faults	<ol style="list-style-type: none"> 1. Switch off the appliance. 2. Wait for 5 seconds. 3. Switch the appliance on again. <p>If the fault occurs repeatedly, call the after-sale service.</p>

Programme overview*

*Programs will vary based on the models.

Refer the user interface in the machine for available programs.

Program/type of laundry/information	Load size
Name of program Brief explanation of the program and the items for which it is suitable.	Recommended load (in relation to the maximum load → <i>Page 34</i>)
Anti-bacteria Hot water wash for bacteria free clothes. Suitable for heavily soiled or dirty clothes.	1/3 load
Cotton 30°C Hard-wearing items made of cotton, linen or blended fabrics	Full load
Delicates For delicate washable items, e.g. made of satin, synthetic fibres or blended fabrics. Note: Use a detergent that is suitable for machine-washing delicate fabrics.	1/2 load
Mix Suitable for mix of different fabric types and colours.	Full load
Bedsheets Suitable for heavily soiled laundry, bigger loads like curtains, bedsheets, liners, etc.	2/3 load
Jeans Suitable for heavily soiled clothes and heavy clothes like denims, jeans and trousers.	2/3 load
Synthetics Program for synthetic material clothes, gym wear or sports wear.	1/2 load
Quick Wash Suitable for small items of lightly soiled laundry.	1/3 load
Whites Program suitable for lighter tones and white fabric.	1/2 load

<p>Tub Clean</p> <p>Programme for cleaning and caring for the drum and the impeller, e.g. before running the first wash cycle or if an odour has developed after an extended period of non-use.</p> <p>Notes</p> <ul style="list-style-type: none"> ■ We recommend running this programme once in 3 months. ■ Run the Tub Clean programme without any laundry. ■ Use standard washing powder or a detergent that contains a bleaching agent. To prevent foaming, only use half the amount of detergent recommended by the detergent manufacturer. Do not use detergents intended for woollens or delicates. 	<p>Empty</p>
<p>Smart Suggest</p> <p>The washing program and water level are set automatically depending on the load.</p> <p>Note: The washing program starts immediately and the program duration is shown on the display. Ensure the following beforehand:</p> <ul style="list-style-type: none"> ■ The laundry is placed into the drum. ■ The detergent has been added. <p>Setting Smart Suggest:</p> <ol style="list-style-type: none"> 1. Press  to switch on the appliance. 2. Press . <p>Note: If laundry is heavily soiled, chose a program suitable for the type of fabric.</p>	<p>Full load</p>
<p>Spin only</p> <p>To activate Spin only option, deactivate/turn off Wash and Rinse.</p>	<p>-</p>
<p>Wash only</p> <p>To activate Wash only option, deactivate/turn off Spin and Rinse.</p>	<p>-</p>
<p>Rinse only</p> <p>To activate Rinse only option, deactivate /turn off Spin and Wash.</p>	<p>-</p>
<p>Deactivation of Wash / Rinse / Spin</p> <ol style="list-style-type: none"> 1. To deactivate Wash cycle, press Wash Type or Wash button until Wash is deactivated. 2. To deactivate Spin cycle, press Spin button until Spin is deactivated. 3. To deactivate Rinse cycle, press Rinse button until Rinse is deactivated. 	<p>-</p>

Favourite



Allows to save a selected program with your favourite settings:

1. Switch on the appliance.
2. Adjust the program settings.
3. Long press **Favourite** button to save the settings..

To activate favourite settings when you wash the laundry next time, press **Favourite** button.

Note: To change the Favorite settings follow all steps from the beginning.

P+ Settings

Program setting	Function
<p>Once you have set a program, you will be shown default program settings. These are recommendations for the set program and may vary. Depending on the program, you can adjust or activate/deactivate the program settings to optimise the washing process for your laundry.</p> <p>You can find out how to adjust program settings on → Page 23</p>	
 Wash	<p>Once the programme has been set, the wash cycle's preset duration will be applied. For models without a hot water supply hose or built-in heater, duration of wash time can be seen by clicking on Wash button and you can adjust the duration of the wash cycle in order of 10m – 15m – 20m – 25m – 0m.</p> <p>For heater and hot water supply hose models wash time cannot be edited.</p>
 Rinse	<p>Adjusting the number of rinse cycles:</p> <p>Once the program has been set, the preset number of rinse cycles will be displayed. You can adjust the number of rinse cycles in the following order for heater and hot water supply hose models: 1X, 2X, 3X and for models without a hot water supply hose or built-in heater: 1,2,3.</p> <p>Anti-Tangle</p> <p>Choose this option for reduced amount of tangle while taking out the laundry.</p> <p>Note: For models without a hot water supply hose or built-in heater, press and hold Rinse button for 3 seconds to activate Anti-Tangle.</p>
 Spin	<p>Adjusting the duration of the spin cycle:</p> <p>Once the program has been set, the spin cycle's default duration will be displayed. You can adjust spin levels in the following order: Gentle, Normal, Extra and Max Dry for heater models or hot water supply hose models. For models without a hot water supply hose or built-in heater, spin levels can be adjusted in minutes by following order 4m – 6m – 10m – 20m – 0m.</p>
Program	<p>When you switch on the appliance, the Smart Suggest program is set by default. If required, you can change the program before the program starts.</p>
Water Level	<p>Once the program has been set, the program's default water level will be displayed. You can adjust the water level if required.</p> <p>Notes</p> <ul style="list-style-type: none"> ■ The appliance automatically adjusts the water level according to the size of the load. You can still manually adjust the water level when using these programs if you need to. ■ Only set a low water level for light loads.

<p>Temp.* * Depending on the model</p>	<p>Cold: Draw water from the cold water supply hose only. Warm: Draw water from the hot and cold water supply hoses. Hot: Draw water from the hot water supply hose only. Note: Depending on the appliance specifications, water may be drawn from both hot and cold water supply hoses in the Hot setting.</p> <p>For heater models temperature options can be selected by toggling through temperature options.</p>
<p>Delay</p>	<p>You can use the Delay button to delay the time at which the program starts by up to 24 hours.</p> <p>Your chosen time in hours, e.g. 08 h, is shown on the display and counts down until the program starts. Once the program has started, the program duration will be displayed.</p>
<p>Soak</p>	<p>To soak clothes in machine you can use the Soak button to add Soak time for any selected program in all models in the following order -15 min – 30 min – 60 min- 90 min. For heater or hot water supply hose models, soak time will be displayed in display. For models without hot water supply hose, LED icon will indicate soak time</p> <p>For hot water soak</p> <p>For heater models, you can select temperature. The hot water will be used for soaking. Same applies for hot water supply hose models, if you select Hot or Warm option from temperature.</p>
<p>Wash Type</p>	<p>You can specify wash levels for your laundry. The appliance adjusts the settings based on selected Wash Type.</p> <p>Intense Suitable for heavily soiled laundry.</p> <p>Normal Suitable for medium soiled laundry.</p> <p>Mild Suitable for mildly soiled clothes or to remove odour with mild wash</p>



Laundry

Preparing laundry

Caution!

Damage to the drum and laundry

Leaving objects in the pockets of your clothing can cause damage to the drum and laundry when the appliance is in operation. Remove all objects (e.g. metal items) from clothing pockets.

Prepare the laundry as follows:

- Empty pockets.

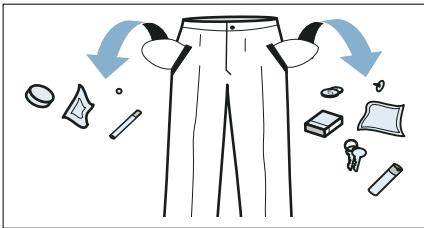





- Tie cloth belts, apron strings, etc. together. For small, extremely delicate items of laundry, such as socks and stockings, use a laundry bag.
- Always wash small and large items of laundry together.
- Close any zips, Velcro, hooks, loops or buttons.
- Brush sand out of pockets and collars.
- Remove curtain fittings or place curtains in a laundry bag.
- Pre-treat stains while they are fresh. First, dab stains with soapy water without rubbing them.

Note: Stubborn or dried-in stains can sometimes only be removed by washing several times.

Sorting laundry

Sort your laundry according to the care instructions and the manufacturer's information on the care labels, using the following criteria:

- **Type of fabric/fibre**
- **Colour:**
Laundry may become discoloured. Wash white and coloured laundry separately. Wash new coloured items on their own the first time you wash them.
- **Soiling:**
Wash laundry with the same level of soiling together.
- **Care labels:**
The following symbols tell you which programs you can and cannot use. The numbers in the symbols indicate the maximum recommended washing temperature.

-  Suitable for a normal washing process, e.g. the Cotton 30°C/Mix program.
-  A gentle washing process is required, e.g. the Delicates/Soft program.
-  A particularly gentle washing process is required, e.g. the Delicates/Soft program.
-  Do not machine wash.



Operating the appliance

Switching on the appliance and setting a programme

Note: The appliance must be correctly installed and connected. → Page 4

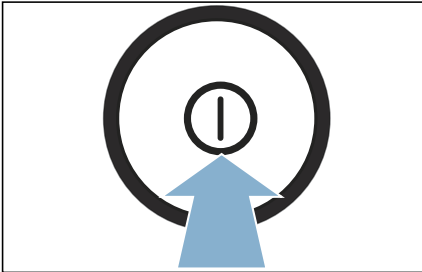
1. Press  to switch on the appliance.



2. Model without a hot water supply hose:
Press **Program** repeatedly to set the washing program you require.
Note: To set the  **Rinse** and  **Spin** programs, follow the instructions in the program overview → Page 17.



The corresponding indicator light will light up and the default program settings will be shown on the display panel.

3. Model with a hot water supply hose or heater models:
Select the program by rotating knob in bidirectional way. For each knob movement respective program will be selected.



4. Adjust the **programme settings** if required.

Programme settings

Once you have set a program, you will be shown default program settings. Before the program starts, you can adjust or activate/deactivate the settings that can be selected. An overview of all the settings that can be selected can be found from → Page 20 onwards.

You can do the following to program settings:

- Activate/deactivate them
- Adjust them

Adjusting or activating/deactivating:

Press the button for the relevant programme setting repeatedly.

The indicator lights for the activated programme settings will be continuously lit and the values shown on the display may change.

Placing the laundry into the drum

Note: Do not exceed the appliance's maximum load. If you overload the appliance, it will not be able to wash the laundry as effectively and the laundry is more likely to crease → *Page 34*.

1. Prepare and sort the laundry.
2. Open the lid.
Check that the drum is completely empty. Empty it if necessary.

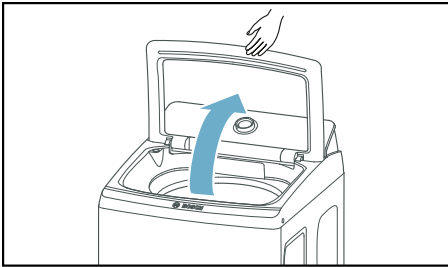

3. Load the laundry unfolded into the drum.

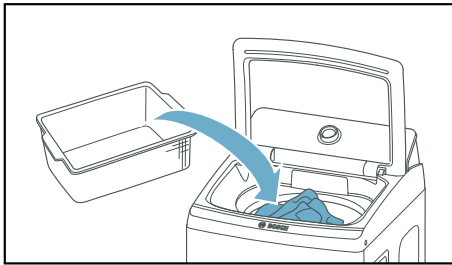

4. Close the lid.

Caution!

Risk of material damage to the appliance or laundry.

Make sure that laundry is not trapped in the lid.

Adding detergent and fabric care products

Caution!

Risk of material damage and damage to the appliance

If you use the wrong quantity of detergent or cleaning product, this may cause material damage or damage to the appliance.

Use detergents/care products/cleaning products in accordance with the manufacturers' instructions.

Caution!

Risk of material damage and damage to the appliance

Cleaning products and products for pre-treating laundry (e.g. stain removers, prewash sprays, etc.) may cause damage if they come into contact with the surfaces of the appliance. Therefore please note:

- Do not allow these products to come into contact with the surfaces of the appliance.
- Clean the appliance with nothing but water and a soft, damp cloth.
- Remove all detergent residue, spray residue or other residues immediately.

1. Pull out the detergent drawer.

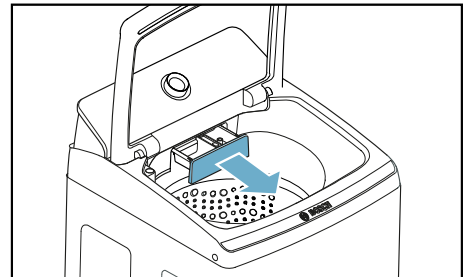

2. Add detergent and/or laundry care products.



- I Powder detergent.
- II Compartment for softener, bleaching agents.
- III Compartment for liquid detergent.

3. Push in the detergent drawer.

Notes

- Do not mix different detergents.
- Follow the detergent dosage instructions on the label on the detergent packaging.
- To remove the detergent drawer fully out, press down the insert as shown in the picture above.

Starting the programme

Press **▷|||**.

Either the programme duration or, if you have delayed the programme start, the **Delay**, is shown in the display.

Note: If you want to prevent the programme from being adjusted inadvertently, you can activate the child lock.

Child lock

Once the programme has started, you can lock the appliance to prevent the functions you have set from being changed inadvertently. To do this, activate the childproof lock.

Activating/deactivating the Child Lock:



Press and hold the **Water** and **Favourite** buttons at the same time for approximately three seconds in model without a hot water supply hose and **Spin** and **Favourite** buttons together for approximately three seconds in Heater and hot water supply hose models.

The **Child Lock** indicator light changes depending on the previous status.

Notes

- If you open the lid while the child lock is activated, a signal sounds and the error code E3 is displayed. If the lid is not closed and the **▷|||** button is pressed within 20 seconds, the appliance automatically drains water away and displays the error code CL until you switch off the appliance.
- When the child lock is active, the appliance can be switched off via the main switch. The child lock is deactivated when the appliance is switched off.

Pausing programmes and adding more laundry



1. Press .
The appliance will pause the program.
2. If you need to, you can add more laundry or remove laundry.
3. Press  to resume the program.

Notes

- If you pause the appliance for more than 1 hour, it will automatically switch off.
- When the wash and spin cycles are in progress, make sure that you pause the appliance before opening the lid.

Cancelling the programme

Once the program has started, you can cancel it at any time:

1. Press  to switch off the appliance.
2. Press  to switch the appliance back on.
3. Choose a new program.

Notes

- When you start a new program, the appliance will first check the current water level and, if necessary, drain some of the water away.
- If the water level is high or there is a high level of residual moisture in the laundry, run the **Spin** program before taking out your laundry.

End of programme

At the end of the program, a signal will sound and then the appliance will switch off automatically.

Removing laundry and switching off the appliance

1. Remove the laundry.
2. Turn off the tap.

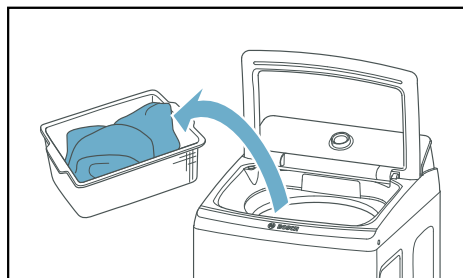

Notes

- **Risk of rusting:** Remove any foreign objects from the drum.
- Leave the lid and detergent drawer open so that residual water can evaporate.



Sensors

Unbalanced load detection system

The automatic unbalanced load detection system detects imbalances and ensures that laundry is distributed evenly by repeatedly starting to spin the drum and activating additional rinse cycles.

Note: Mix items of laundry of varying sizes. Laundry items of different sizes distribute themselves better during the spin cycle. Individual laundry items may cause an unbalanced load.

Automatic load sensing

The continuous automatic load adjustment function adjusts the water level according to the load in the drum.



Cleaning and maintenance

Cleaning/Maintenance

Warning **Risk of death!**

The appliance is powered by electricity. There is a risk of electric shock if you come into contact with live components. Therefore please note:

- Switch off the appliance. Disconnect the appliance from the power supply (pull out the plug).
- Never take hold of the mains plug with wet hands.
- When removing the mains plug from the socket, always take hold of the plug itself and never the mains cable, otherwise this may damage the mains cable.
- Do not make any technical modifications to the appliance or its features.
- Repairs and any other work on the appliance must only be conducted by our customer service or by an electrician. The same applies for replacing the mains cable (when necessary).
- Spare mains cables can be ordered from our customer service.

Warning **Risk of poisoning!**

Poisonous fumes may be given off by cleaning agents that contain solvents, e.g. cleaning solvent. Do not use cleaning agents that contain solvents.



Warning

Risk of electric shock/material damage/damage to the appliance!

If moisture penetrates the appliance, this may cause it to short circuit. Do not use a pressure washer, steam cleaner, hose or spray gun to clean your appliance.



Warning

Risk of injury/material damage/damage to the appliance!

The use of spare parts and accessories supplied by other brands is dangerous and may result in injury, material damage or damage to the appliance. For safety reasons, use genuine spare parts and accessories only.

Caution!

Material damage/damage to the appliance

Cleaning agents and agents for pretreating laundry (e.g. stain removers, prewash sprays, etc.) may cause damage if they come into contact with the surfaces of the appliance. Therefore please note:

- Do not allow these agents to come into contact with the surfaces of the appliance.
- Clean the appliance with nothing but water and a soft, damp cloth.
- Remove any detergent, spray or other residues immediately.

Cleaning the drum

To prevent odours from developing and to clean the drum:

- Run the **Tub Clean** program, adding standard washing powder but not any laundry.

Note: Do not use steel wool or cleaning products containing chlorine.

- Make sure that the area in which the appliance is installed is well ventilated.

Descaling the appliance

Descaling should not be necessary if the detergent is measured out correctly. If you still wish to use descaler, follow the manufacturer's instructions for use.

Caution!

Risk of material damage and damage to the appliance

Unsuitable descaling agents, such as dishwasher tablets or coffee machine descalers, may cause material damage and damage to the appliance. Do not use any unsuitable descaling agents for this appliance. You can order suitable descaling agents from our website or from our after-sales service.

Cleaning the lint filter

During the wash cycle, washing powder residue and lint accumulate in the drum's filters. Clean these filters after every wash, as follows:

1. Remove the filter from the holder.



2. Open the flap as shown, clean it with running water and put it back in.

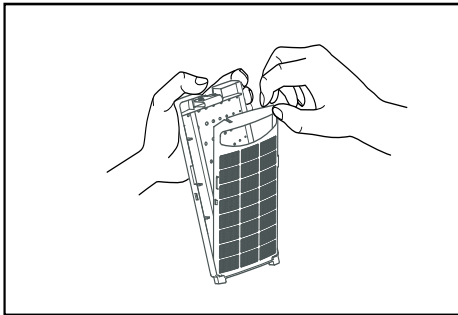

3. Place the filter back into the holder.





You have now successfully cleaned the filter.

What to do in the event of a fault.

Warning **Risk of injury!**

If you reach into the drum while it is still rotating, you risk injuring your hands. Wait until the drum has stopped rotating.

Help with the appliance

Faults	Cause/remedy
The appliance will not start.	Check the mains plug and the fuses.
The appliance is not filling with water.	<p>Check that:</p> <ul style="list-style-type: none"> ■ You have pressed  ■ The tap has been turned on and the water pressure is not too low. ■ The filter in the water supply is not blocked → <i>Page 32</i>. ■ The supply hose is not kinked or trapped. ■ Hot/Warm program has been selected and hot water supply hose is not connected
The washing water is not draining.	<p>Make sure that:</p> <ul style="list-style-type: none"> ■ The drain hose is clean. ■ The maximum height difference between the surface on which the appliance is installed and the water drain hose has not been exceeded → <i>Page 6</i>.
The program will not start.	<p>Make sure that:</p> <ul style="list-style-type: none"> ■ The lid is closed. ■ You have pressed . <p>Note: If the program start has been delayed by setting Delay, the program will start later.</p> <p>Check for volt check warning. If there is a voltage fluctuation machine will start only after the voltage is within the operating limit of 170V - 280V.</p>
Water is leaking from the appliance.	<ul style="list-style-type: none"> ■ Make sure that the drain hose is properly secured and is not damaged. ■ Check the threaded joint on the supply hose, and tighten it if necessary.
More detergent than usual is accumulating in the filter and drum.	You have been using too much detergent. Make sure you follow the detergent manufacturer's instructions.
There is detergent residue on the laundry.	<ul style="list-style-type: none"> ■ Some phosphate-free detergents contain water-insoluble residue. ■ Start the  Rinse program.
The machine spins the drum back and forth several times.	<p>Not a fault – the unbalanced load detection system is adjusting an imbalance.</p> <p>Note: If the error E4 appears on the display, redistribute the laundry by hand to eliminate the imbalance.</p>

Loud noises, vibrations or machine movement during the spin cycle.

Make sure that the appliance is completely leveled → *Page 9*.

Odours in the washing machine.

Run the **Tub Clean** program.

Add standard washing powder or a detergent that contains a bleaching agent.



Note: To prevent foaming, only use half of the amount of detergent recommended by the detergent manufacturer. Do not use detergents intended for woollens or delicates.

If you cannot rectify a fault yourself (after switching the machine off and then on again) or a repair is required:

- Switch off the appliance and pull the mains plug out of the socket.
- Turn off the tap and call the after-sales service.

Cleaning the water inlet filter

Preparation:

1. Turn off the tap.
2. Set any programme (except Rinse/Spin).
3. Press . Allow the programme to run for approximately 40 seconds.
4. Press  to switch off the appliance.

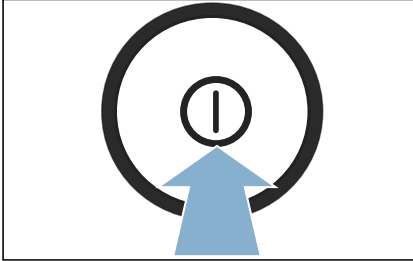

5. Disconnect the appliance's mains plug from the power supply.

Clean the filter on the tap as follows:

1. Disconnect the hose from the water tap.

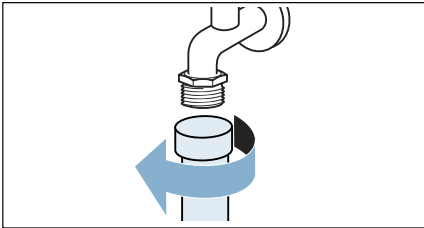

2. Clean the filter with a small brush.

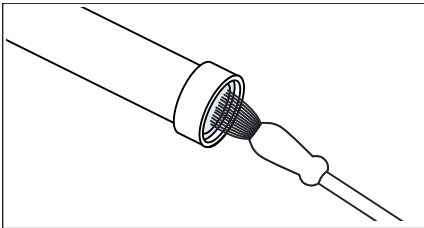

3. Connect the hose and check for leaks.

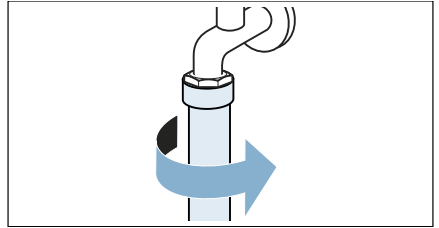

Clean the filter on the back of the appliance:

1. Remove the hose from the rear of the appliance.

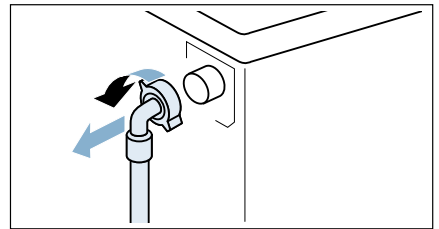

2. Clean the filter with a small brush.

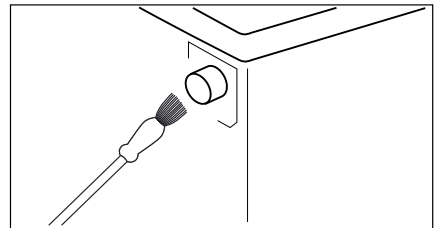

3. Reconnect the hose at the rear of the appliance and check for leaks.

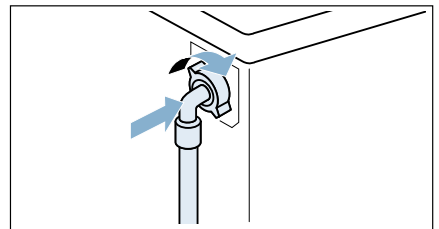



Transporting the appliance

Prepare the appliance for transportation as follows:

1. Turn off the tap.
2. Press  to switch on the appliance.

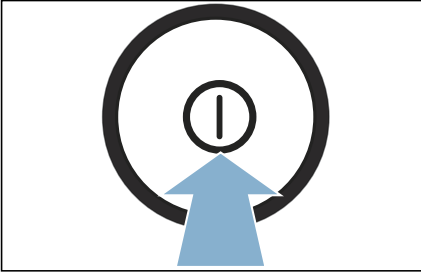

3. Run the **Spin** program without any residual water or laundry
→ *Page 17*.
Note: Place the drain hose on the floor and drain the water.
4. Disconnect the appliance's mains plug from the power supply.
5. Detach all the hoses.

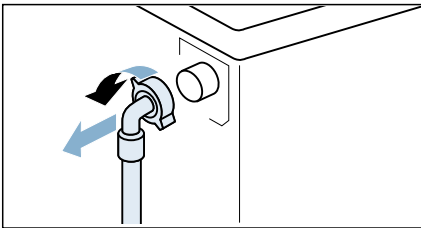

Note: Always transport the appliance upright.



Technical data

Note:

Check the voltage, frequency and maximum load on your appliance's rating plate.

Models:

Dimensions (in mm)	Weight (in kg)	Rated voltage (in V)	Rated power (in W)	Rated frequency (in Hz)	Maximum load (in kg)
542 x 552 x 995	35-37	220-240	250-450	50	6.5
542 x 552 x 1015	35-37	220-240	250-450	50	7.0
605 x 620 x 1045	40-42	220-240	300-500	50	7.5
605 x 620 x 1045	40-42	220-240	300-500	50	8.0
605 x 620 x 1060	41-43	220-240	300-500	50	9.0
605 x 620 x 1060	41-43	220-240	300-500	50	10.0

Water pressure (for all models):

0.2–10 bar



Warranty terms and conditions

Product	Standard warranty period	Warranty on parts
Top loading washing machine	2 years	10 years (only on motor)

1. The warranty is confined only to the first purchase of the appliance and is non-transferable. This warranty card shall be presented to our staff at the time of service and the warranty shall be void if the warranty card is altered / tampered with or lost.
2. The Warranty period (both Standard Warranty Period and Extended Warranty Period) starts from the date of purchase of the appliance.
3. The warranty covers only manufacturing defect in material and workmanship that may arise despite normal operation and usage of the appliance, as prescribed in the instruction manual.
4. Repairs, installations and removal of the appliance shall be carried out only by an Authorized Service Personnel, failing which this warranty will be void.
5. In the event of change of address, the new address shall be intimated to the Authorised Service Center by calling our after-sales service. Enclosed after-sales service directory.
6. Repairs & replacements of parts would be purely at the discretion of the Authorised Service Personnel only. The company's obligation under this warranty shall be limited to repair and providing replacement of defective parts only. It is hereby clarified that after the Standard Warranty Period, visiting charges will be applicable for all visits and the same will be borne by the customer. In the Extended Warranty period, in case the appliance needs to be transported to the Authorised Service Centre for repair, the transportation charges from and to the place of installation shall be borne by the customer.
7. The customer shall provide a reasonable, sufficient and safe working space to access the appliances for service. The customer is liable to move away all blocking objects or move the appliance to an appropriate location with electricity/ water supply and drainage for testing of the appliance.
8. In case repair cannot be completed onsite, the company reserves the right to carry the appliance to its authorised service centre and return the same after repair.

en Warranty terms and conditions

- 9.** In case of appliances installed beyond municipal limits of the jurisdiction of company's Authorised Service Center, all expenses incurred in transportation of the appliance or parts thereof from and to the company's Authorised Service Center, as well as expenses incurred on deputing of service personnel/ technician towards conveyance and other incidental expenses, will be borne by the customer.
- 10.** In case of repairs the appliance and/ or the replaced spare part will be warranted only for the remaining of the original warranty period and the replaced components will become property of the company.
- 11.** The company shall be under no obligation or deemed to be in default for any delay or failure in performance resulting from causes beyond its reasonable control (e.g. strikes, floods, earthquakes etc.) including but not limited to delay in servicing due to non-availability of spare parts and / or accessories.
- 12.** In case of repair, the company owns the right to repair or replace the spare part, which are tested thoroughly to ensure the appliance is operational.
- 13.** Authorised Personnel appointed and trained by the company will provide installation, demonstration and repair services to the customer.

WARRANTY CARD

Customer's name:
Address:
City:
Pin:
State:
Mobile:
Email:
Model/E-Nr:
Serial No:
Date of Purchase:
Date of Expiry:

BSH Home Appliances Private Limited

WARRANTY CARD - copy

Customer's name:
Address:
City:
Pin:
State:
Mobile:
Email:
Model/E-Nr:
Serial No:
Date of Purchase:
Date of Expiry:

BSH Home Appliances Private Limited

Dealer's name:

Customer's Signature:



Environmental Protection



Dispose of packaging and the appliance in an environmentally responsible manner.

This appliance is certified in accordance with the guidelines on E-waste (Management) Rules 2016 which govern waste electrical and electronic equipment. The guidelines provide a framework for the return and recycling of used Appliances.

Note: This product doesn't contain any of hazardous substances as specified in the E-waste.

Do's

- Please visit our website: <https://www.bosch-home.in/Metapages/e-waste-management> to find out more details regarding e-waste disposal.
- Consult the authorized service center as to whether the Electronic Equipment can be repaired or not, before discarding.
- Consult the retailer about appliance take back schemes.

Don'ts

- Don't dump the discarded Electronic Equipment in the open or in any land fill site, as this will result in contamination of the soil and the ground water.
- Don't dispose of the discarded Electronic Equipment in household bins or Municipal bins.
- The product is not meant for re-sale to any unauthorized agencies/scrap dealers.
- Don't keep any replaced spare parts from the product in an exposed area.



Customer Service

If you cannot rectify the error yourself by turning the appliance off and on again, please contact our after-sales service. → Enclosed after-sales service directory

We will always find an appropriate solution and, where possible, prevent the need for an engineer to visit.

Please provide the after-sales service with the product number (E no.) and the production number (FD) of the appliance.

E-Nr. _____	FD _____
-------------	----------

E no. Product number
FD Production number

You can find this information:

On the inside of the lid and on the back of the appliance.

You can trust in the manufacturer's expertise.

Contact us for assistance. This will ensure that the repair is carried out by trained service engineers with genuine spare parts.



Thank you for buying a Bosch Home Appliance!

Register your new device on MyBosch now and profit directly from:

- **Expert tips & tricks for your appliance**
- **Warranty extension options**
- **Discounts for accessories & spare-parts**
- **Digital manual and all appliance data at hand**
- **Easy access to Bosch Home Appliances Service**

Free and easy registration – also on mobile phones:

www.bosch-home.com/welcome



Looking for help? You'll find it here.

Expert advice for your Bosch home appliances, need help with problems or a repair from Bosch experts.

Find out everything about the many ways Bosch can support you:

www.bosch-home.com/service

Contact data of all countries are listed in the attached service directory.

Robert Bosch Hausgeräte GmbH

Carl-Wery-Straße 34

81739 München, GERMANY

www.bosch-home.com



9001610103 (0109)

en