

# R&S®FPS-K91

## WLAN Measurements

### User Manual



1176.8551.02 – 07

This manual applies to the following R&S®FPS models with firmware version 1.40 and higher:

- R&S®FPS4 (1319.2008K04)
- R&S®FPS7 (1319.2008K07)
- R&S®FPS13 (1319.2008K13)
- R&S®FPS30 (1319.2008K30)
- R&S®FPS40 (1319.2008K40)

The following firmware options are described:

- R&S FPS-K91 WLAN 802.11a/b/g (1321.4191.02)
- R&S FPS-K91ac WLAN 802.11ac (1321.4210.02)
- R&S FPS-K91n WLAN 802.11n (1321.4204.02)
- R&S FPS-K91p WLAN 802.11p (1321.4391.02)

© 2016 Rohde & Schwarz GmbH & Co. KG  
Mühlhofstr. 15, 81671 München, Germany  
Phone: +49 89 41 29 - 0  
Fax: +49 89 41 29 12 164  
Email: [info@rohde-schwarz.com](mailto:info@rohde-schwarz.com)  
Internet: [www.rohde-schwarz.com](http://www.rohde-schwarz.com)

Subject to change – Data without tolerance limits is not binding.

R&S® is a registered trademark of Rohde & Schwarz GmbH & Co. KG.

Trade names are trademarks of the owners.

The following abbreviations are used throughout this manual: R&S®FPS is abbreviated as R&S FPS.

# Contents

|          |   |            |
|----------|---|------------|
| <b>1</b> | <b>Preface</b> .....  | <b>5</b>   |
| 1.1      | About this Manual.....  | 5          |
| 1.2      | Documentation Overview.....   | 6          |
| 1.3      | Typographical Conventions.....  | 7          |
| <b>2</b> | <b>Welcome to the WLAN Application</b> .....  | <b>8</b>   |
| 2.1      | Starting the WLAN Application.....  | 9          |
| 2.2      | Understanding the Display Information.....  | 9          |
| <b>3</b> | <b>Measurements and Result Displays</b> .....   | <b>12</b>  |
| 3.1      | WLAN I/Q Measurement (Modulation Accuracy, Flatness and Tolerance).....                 | 12         |
| 3.2      | Frequency Sweep Measurements.....   | 49         |
| <b>4</b> | <b>Measurement Basics</b> .....   | <b>56</b>  |
| 4.1      | Signal Processing for Multicarrier Measurements (IEEE 802.11a, g (OFDM), j, p)<br>..... | 56         |
| 4.2      | Signal Processing for Single-Carrier Measurements (IEEE 802.11b, g (DSSS))... 63        |            |
| 4.3      | Signal Processing for MIMO Measurements (IEEE 802.11ac, n).....                         | 69         |
| 4.4      | Channels and Carriers.....  | 78         |
| 4.5      | Recognized vs. Analyzed PPDU.....   | 78         |
| 4.6      | Demodulation Parameters - Logical Filters.....  | 79         |
| 4.7      | Receiving Data Input and Providing Data Output.....                                     | 80         |
| 4.8      | Preparing the R&S FPS for the Expected Input Signal - Frontend Parameters....           | 81         |
| 4.9      | Triggered Measurements.....   | 82         |
| 4.10     | WLAN I/Q Measurements in MSRA Operating Mode.....                                       | 86         |
| <b>5</b> | <b>Configuration</b> .....  | <b>88</b>  |
| 5.1      | Multiple Measurement Channels and Sequencer Function.....                               | 88         |
| 5.2      | Display Configuration.....  | 90         |
| 5.3      | WLAN IQ Measurement (Modulation Accuracy, Flatness, Tolerance...).....                  | 90         |
| 5.4      | Frequency Sweep Measurements.....   | 151        |
| <b>6</b> | <b>Analysis</b> .....   | <b>156</b> |
| <b>7</b> | <b>I/Q Data Import and Export</b> .....   | <b>157</b> |
| 7.1      | Import/Export Functions.....  | 157        |

|           |   |            |
|-----------|---|------------|
| 7.2       | How to Export and Import I/Q Data.....  | 158        |
| <b>8</b>  | <b>How to Perform Measurements in the WLAN Application.....</b>                               | <b>161</b> |
| 8.1       | How to Determine Modulation Accuracy, Flatness and Tolerance Parameters for WLAN Signals..... | 161        |
| 8.2       | How to Determine the OBW, SEM, ACLR or CCDF for WLAN Signals.....                             | 163        |
| <b>9</b>  | <b>Basic Measurement Examples.....</b>  | <b>164</b> |
| 9.1       | Measurement Example: Setting up a MIMO measurement.....                                       | 164        |
| <b>10</b> | <b>Optimizing and Troubleshooting the Measurement.....</b>                                    | <b>171</b> |
| 10.1      | Optimizing the Measurement Results.....   | 171        |
| 10.2      | Error Messages and Warnings.....  | 172        |
| <b>11</b> | <b>Remote Commands for WLAN Measurements.....</b>   | <b>174</b> |
| 11.1      | Common Suffixes.....  | 174        |
| 11.2      | Introduction.....   | 175        |
| 11.3      | Activating WLAN Measurements.....   | 180        |
| 11.4      | Selecting a Measurement.....  | 184        |
| 11.5      | Configuring the WLAN IQ Measurement (Modulation Accuracy, Flatness and Tolerance).....        | 191        |
| 11.6      | Configuring Frequency Sweep Measurements on WLAN Signals.....                                 | 247        |
| 11.7      | Configuring the Result Display.....   | 249        |
| 11.8      | Starting a Measurement.....   | 265        |
| 11.9      | Retrieving Results.....   | 269        |
| 11.10     | Analysis.....   | 303        |
| 11.11     | Status Registers.....   | 306        |
| 11.12     | Commands for Compatibility.....   | 311        |
| 11.13     | Programming Examples (R&S FPS WLAN application).....  | 312        |
|           | <b>Annex.....</b>   | <b>317</b> |
| <b>A</b>  | <b>Annex: Reference.....</b>  | <b>317</b> |
| A.1       | Sample Rate and Maximum Usable I/Q Bandwidth for RF Input.....                                | 317        |
| A.2       | I/Q Data File Format (iq-tar).....  | 321        |
|           | <b>List of Remote Commands (WLAN).....</b>  | <b>327</b> |
|           | <b>Index.....</b>   | <b>335</b> |

# 1 Preface

## 1.1 About this Manual

This WLAN User Manual provides all the information **specific to the application**. All general instrument functions and settings common to all applications and operating modes are described in the main R&S FPS User Manual.

The main focus in this manual is on the measurement results and the tasks required to obtain them. The following topics are included:

- [Chapter 2, "Welcome to the WLAN Application"](#), on page 8  
Introduction to and getting familiar with the application
- [Chapter 3, "Measurements and Result Displays"](#), on page 12  
Details on supported measurements and their result types
- [Chapter 4, "Measurement Basics"](#), on page 56  
Background information on basic terms and principles in the context of the measurement
- [Chapter 5, "Configuration"](#), on page 88 and [Chapter 6, "Analysis"](#), on page 156  
A concise description of all functions and settings available to configure measurements and analyze results with their corresponding remote control command
- [Chapter 7.1, "Import/Export Functions"](#), on page 157  
Description of general functions to import and export raw I/Q (measurement) data
- [Chapter 8, "How to Perform Measurements in the WLAN Application"](#), on page 161  
The basic procedure to perform each measurement and step-by-step instructions for more complex tasks or alternative methods
- [Chapter 10, "Optimizing and Troubleshooting the Measurement"](#), on page 171  
Hints and tips on how to handle errors and optimize the test setup
- [Chapter 11, "Remote Commands for WLAN Measurements"](#), on page 174  
Remote commands required to configure and perform WLAN measurements in a remote environment, sorted by tasks  
(Commands required to set up the environment or to perform common tasks on the instrument are provided in the main R&S FPS User Manual)  
Programming examples demonstrate the use of many commands and can usually be executed directly for test purposes
- [Chapter A, "Annex: Reference"](#), on page 317  
Reference material
- **List of remote commands**  
Alphabetic list of all remote commands described in the manual
- **Index**

## 1.2 Documentation Overview

The user documentation for the R&S FPS consists of the following parts:

- "Getting Started" printed manual
- Online Help system on the instrument
- User manuals and online manual for base unit and options provided on the product page
- Service manual provided on the internet for registered users
- Instrument security procedures provided on the product page
- Release notes provided on the product page
- Data sheet and brochures provided on the product page
- Application notes provided on the Rohde & Schwarz website



You find the user documentation on the R&S FPS product page mainly at:

<http://www.rohde-schwarz.com/product/FPS> > "Downloads" > "Manuals"

Additional download paths are stated directly in the following abstracts of the documentation types.

---

### Getting Started

Introduces the R&S FPS and describes how to set up and start working with the product. Includes basic operations, typical measurement examples, and general information, e.g. safety instructions, etc.

### Online Help

Offers quick, context-sensitive access to the information needed for operation and programming. It contains the description for the base unit and the software options. The Online Help is embedded in the instrument's firmware; it is available using the ? icon on the toolbar of the R&S FPS.

### User Manuals and Online Manual

Separate manuals are provided for the base unit and the software options:

- **Base unit manual**  
Contains the description of the graphical user interface, an introduction to remote control, the description of all SCPI remote control commands, programming examples, and information on maintenance, instrument interfaces and error messages. Includes the contents of the **Getting Started** manual.
- **Software option manuals**  
Describe the specific functions of the option. Basic information on operating the R&S FPS is not included.

The **online manual** provides the contents of the user manuals for the base unit and all software options for immediate display on the internet.

**Service Manual**

Describes the performance test for checking the rated specifications, module replacement and repair, firmware update, troubleshooting and fault elimination, and contains mechanical drawings and spare part lists.

The service manual is available for registered users on the global Rohde & Schwarz information system (GLORIS).

**Instrument Security Procedures**

Deals with security issues when working with the R&S FPS in secure areas.

**Data Sheet and Brochures**

The data sheet contains the technical specifications of the R&S FPS. Brochures provide an overview of the instrument and deal with the specific characteristics, see:

<http://www.rohde-schwarz.com/product/FPS> > "Downloads" > "Brochures and Data Sheets"

**Release Notes**

Describes the firmware installation, new and modified features and fixed issues according to the current firmware version. You find the latest version at:

<http://www.rohde-schwarz.com/product/FPS> > "Firmware"

**Application Notes, Application Cards, White Papers, etc.**

These documents deal with special applications or background information on particular topics, see:

<http://www.rohde-schwarz.com/> > "Downloads" > "Applications".

## 1.3 Typographical Conventions

The following text markers are used throughout this documentation:

| Convention                          | Description  |
|-------------------------------------|--|
| "Graphical user interface elements" | All names of graphical user interface elements on the screen, such as dialog boxes, menus, options, buttons, and softkeys are enclosed by quotation marks. |
| KEYS                                | Key names are written in capital letters.  |
| File names, commands, program code  | File names, commands, coding samples and screen output are distinguished by their font.  |
| <i>Input</i>                        | Input to be entered by the user is displayed in italics.   |
| <a href="#">Links</a>               | Links that you can click are displayed in blue font.   |
| "References"                        | References to other parts of the documentation are enclosed by quotation marks.  |

## 2 Welcome to the WLAN Application

The R&S FPS WLAN application extends the functionality of the R&S FPS to enable accurate and reproducible Tx measurements of a WLAN device under test (DUT) in accordance with the standards specified for the device. The following standards are currently supported (if the corresponding firmware option is installed):

- IEEE standards 802.11a
- IEEE standards 802.11ac (SISO + MIMO)
- IEEE standards 802.11b
- IEEE standards 802.11g (OFDM)
- IEEE standards 802.11g (DSSS)
- IEEE standards 802.11j
- IEEE standards 802.11n (SISO + MIMO)
- IEEE standards 802.11p

The R&S FPS WLAN application features:

### Modulation measurements

- Constellation diagram for demodulated signal
- Constellation diagram for individual carriers
- I/Q offset and I/Q imbalance
- Modulation error (EVM) for individual carriers or symbols
- Amplitude response and group-delay distortion (spectrum flatness)
- Carrier and symbol frequency errors

### Further measurements and results

- Amplitude statistics (CCDF) and crest factor
- FFT, also over a selected part of the signal, e.g. preamble
- Payload bit information
- Freq/Phase Err vs. Preamble

This user manual contains a description of the functionality that is specific to the application, including remote control operation.

Functions that are not discussed in this manual are the same as in the Spectrum application and are described in the R&S FPS User Manual. The latest version is available for download at the product homepage

<http://www2.rohde-schwarz.com/product/FPS.html>.

### Installation

You can find detailed installation instructions in the R&S FPS Getting Started manual or in the Release Notes.



## 2.1 Starting the WLAN Application

The WLAN measurements require a special application on the R&S FPS.



### Manual operation via an external monitor and mouse

Although the R&S FPS does not have a built-in display, it is possible to operate it interactively in manual mode using a graphical user interface with an external monitor and a mouse connected.

It is recommended that you use the manual mode initially to get familiar with the instrument and its functions before using it in pure remote mode. Thus, this document describes in detail how to operate the instrument manually using an external monitor and mouse. The remote commands are described in the second part of the document. For details on manual operation see the R&S FPS Getting Started manual.

### To activate the WLAN application

1. Select the MODE key.

A dialog box opens that contains all operating modes and applications currently available on your R&S FPS.

2. Select the "WLAN" item.

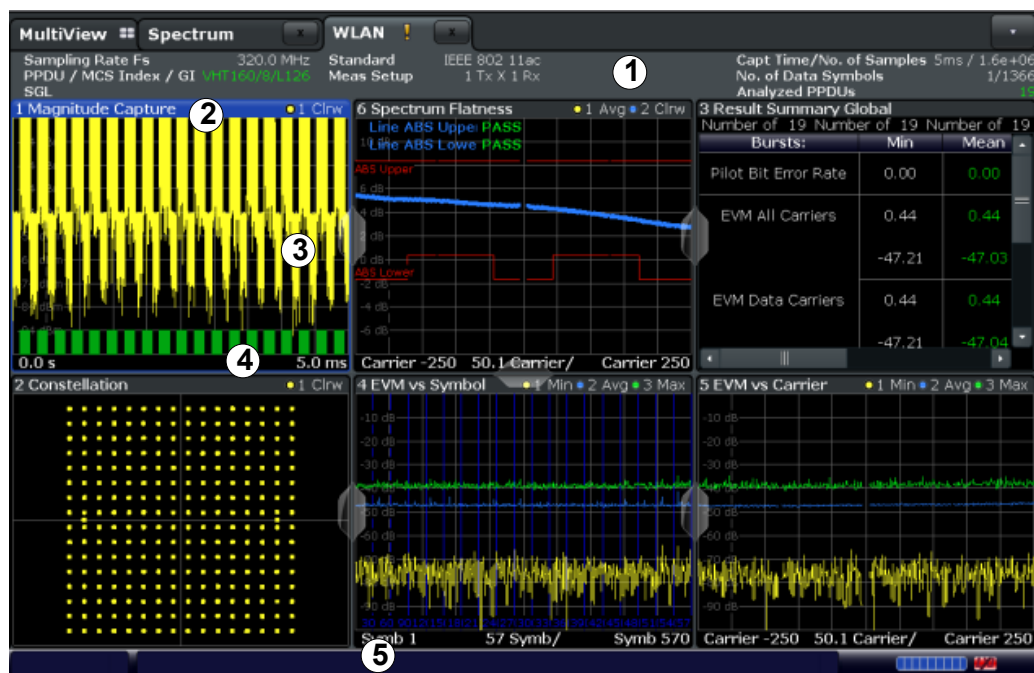


The R&S FPS opens a new measurement channel for the WLAN application.

The measurement is started immediately with the default settings. It can be configured in the WLAN "Overview" dialog box, which is displayed when you select the "Overview" softkey from any menu (see [Chapter 5.3.1, "Configuration Overview"](#), on page 91).

## 2.2 Understanding the Display Information

The following figure shows a measurement diagram during analyzer operation. All information areas are labeled. They are explained in more detail in the following sections.



- 1 = Channel bar for firmware and measurement settings
- 2 = Window title bar with diagram-specific (trace) information
- 3 = Diagram area with marker information
- 4 = Diagram footer with diagram-specific information, depending on result display
- 5 = Instrument status bar with error messages, progress bar and date/time display



### MSRA operating mode

In MSRA operating mode, additional tabs and elements are available. A colored background of the screen behind the measurement channel tabs indicates that you are in MSRA operating mode.

For details on the MSRA operating mode see the R&S FPS MSRA User Manual.

### Channel bar information

In the WLAN application, the R&S FPS shows the following settings:

**Table 2-1: Information displayed in the channel bar in the WLAN application**

| Label                 | Description   |
|-----------------------|---|
| Sample Rate Fs        | Input sample rate   |
| PPDU / MCS Index / GI | WLAN 802.11a, ac, n, j, p:<br>The PPDU type, MCS Index and Guard Interval used for the analysis of the signal; Depending on the demodulation settings, these values are either detected automatically from the signal or the user settings are applied. |
| PPDU / Data Rate      | WLAN 802.11b:<br>The PPDU type and data rate used for the analysis of the signal; Depending on the demodulation settings, these values are either detected automatically from the signal or the user settings are applied.                              |

| Label                      | Description  |
|----------------------------|--|
| Standard                   | Selected WLAN measurement standard   |
| Meas Setup                 | Number of Transmitter (Tx) and Receiver (Rx) channels used in the measurement (for MIMO)   |
| Capt time / No. of Samples | Duration of signal capture and number of samples captured  |
| No. of Data Symbols        | The minimum and maximum number of data symbols that a PPDU may have if it is to be considered in results analysis.   |
| Analyzed PPDU [x of y (z)] | For statistical evaluation over PPDU (see " <a href="#">PPDU Statistic Count / No of PPDU to Analyze</a> " on page 139):<br><x> PPDU of totally required <y> PPDU have been analyzed so far.<br><z> PPDU were analyzed in the most recent sweep. |

In addition, the channel bar also displays information on instrument settings that affect the measurement results even though this is not immediately apparent from the display of the measured values (e.g. transducer or trigger settings). This information is displayed only when applicable for the current measurement. For details see the R&S FPS Getting Started manual.

### Window title bar information

For each diagram, the header provides the following information:



**Figure 2-1: Window title bar information in the WLAN application**

- 1 = Window number
- 2 = Window type
- 3 = Trace color
- 4 = Trace number
- 6 = Trace mode

### Diagram footer information

The diagram footer (beneath the diagram) contains the start and stop values for the displayed x-axis range.

### Status bar information

Global instrument settings, the instrument status and any irregularities are indicated in the status bar beneath the diagram. Furthermore, the progress of the current operation is displayed in the status bar. Click on a displayed warning or error message to obtain more details (see also .

### 3 Measurements and Result Displays

The R&S FPS WLAN application provides several different measurements in order to determine the parameters described by the WLAN 802.11 specifications.

For details on selecting measurements see "Selecting the measurement type" on page 88.

- [WLAN I/Q Measurement \(Modulation Accuracy, Flatness and Tolerance\)](#).....12
- [Frequency Sweep Measurements](#)..... 49

#### 3.1 WLAN I/Q Measurement (Modulation Accuracy, Flatness and Tolerance)

The default WLAN I/Q measurement captures the I/Q data from the WLAN signal using a (nearly rectangular) filter with a relatively large bandwidth. The I/Q data captured with this filter includes magnitude and phase information, which allows the R&S FPS WLAN application to demodulate broadband signals and determine various characteristic signal parameters such as the modulation accuracy, spectrum flatness, center frequency tolerance and symbol clock tolerance in just one measurement.

Other parameters specified in the WLAN 802.11 standard require a better signal-to-noise level or a smaller bandwidth filter than the I/Q measurement provides and must be determined in separate measurements (see [Chapter 3.2, "Frequency Sweep Measurements"](#), on page 49).

- [Modulation Accuracy, Flatness and Tolerance Parameters](#).....12
- [Evaluation Methods for WLAN IQ Measurements](#)..... 21

##### 3.1.1 Modulation Accuracy, Flatness and Tolerance Parameters

The default WLAN I/Q measurement (Modulation Accuracy, Flatness,...) captures the I/Q data from the WLAN signal and determines all the following I/Q parameters in a single sweep.

*Table 3-1: WLAN I/Q parameters for IEEE 802.11a, g (OFDM), ac, j, n, p*

| Parameter   | Description  |
|---|--|
| <b>General measurement parameters</b>   |  |
| Sample Rate Fs  | Input sample rate  |
| PPDU  | Type of analyzed PPDU  |
| MCS Index   | Modulation and Coding Scheme (MCS) index of the analyzed PPDU    |
| Data Rate   | Data rate used for analysis of the signal<br>(IEEE 802.11A ONLY) |
| *) the limits can be changed via remote control (not manually, see <a href="#">Chapter 11.5.9, "Limits"</a> , on page 241); in this case, the currently defined limits are displayed here |  |

## WLAN I/Q Measurement (Modulation Accuracy, Flatness and Tolerance)

| Parameter   | Description  |
|---|--|
| GI  | Guard interval length for current measurement  |
| Standard  | Selected WLAN measurement standard   |
| Meas Setup  | Number of Transmitter (Tx) and Receiver (Rx) channels used in the measurement  |
| Capture time  | Duration of signal capture   |
| No. of Samples  | Number of samples captured   |
| No. of Data Symbols   | The minimum and maximum number of data symbols that a PPDU may have if it is to be considered in results analysis.   |
| Analyzed PPDUs  | For statistical evaluation of PPDUs (see " <a href="#">PPDU Statistic Count / No of PPDUs to Analyze</a> " on page 139): <x> PPDUs of totally required <y> PPDUs have been analyzed so far. <z> indicates the number of analyzed PPDUs in the most recent sweep.   |
| Number of recognized PPDUs (global)   | Number of PPDUs recognized in capture buffer   |
| Number of analyzed PPDUs (global)   | Number of analyzed PPDUs in capture buffer   |
| Number of analyzed PPDUs in physical channel  | Number of PPDUs analyzed in entire signal (if available)   |
| <b>TX and Rx carrier parameters</b>   |  |
| I/Q offset [dB]   | Transmitter center frequency leakage relative to the total Tx channel power (see <a href="#">Chapter 3.1.1.1, "I/Q Offset"</a> , on page 16)   |
| Gain imbalance [%/dB]   | Amplification of the quadrature phase component of the signal relative to the amplification of the in-phase component (see <a href="#">Chapter 3.1.1.2, "Gain Imbalance"</a> , on page 16)   |
| Quadrature offset [°]   | Deviation of the quadrature phase angle from the ideal 90° (see <a href="#">Chapter 3.1.1.3, "Quadrature Offset"</a> , on page 17).  |
| I/Q skew [s]  | Delay of the transmission of the data on the I path compared to the Q path (see <a href="#">Chapter 3.1.1.4, "I/Q Skew"</a> , on page 18)  |
| PPDU power [dBm]  | Mean PPDU power  |
| Crest factor [dB]   | The ratio of the peak power to the mean power of the signal (also called Peak to Average Power Ratio, PAPR).   |
| MIMO Cross Power [dB]   |  |
| Center frequency error [Hz]   | Frequency error between the signal and the current center frequency of the R&S FPS; the corresponding limits specified in the standard are also indicated*)<br><br>The absolute frequency error includes the frequency error of the R&S FPS and that of the DUT. If possible, the transmitter R&S FPS and the DUT should be synchronized (using an external reference).<br><br>See R&S FPS User Manual > Instrument setup > External reference |
| *) the limits can be changed via remote control (not manually, see <a href="#">Chapter 11.5.9, "Limits"</a> , on page 241); in this case, the currently defined limits are displayed here |  |

## WLAN I/Q Measurement (Modulation Accuracy, Flatness and Tolerance)

| Parameter   | Description  |
|---|--|
| Symbol clock error [ppm]  | Clock error between the signal and the sample clock of the R&S FPS in parts per million (ppm), i.e. the symbol timing error; the corresponding limits specified in the standard are also indicated *)<br><br>If possible, the transmitter R&S FPS and the DUT should be synchronized (using an external reference).<br><br>See R&S FPS User Manual > Instrument setup > External reference |
| CPE   | Common phase error   |
| <b>Stream parameters</b>  |  |
| Pilot bit error rate [%]  |  |
| EVM all carriers [%/dB]   | EVM (Error Vector Magnitude) of the payload symbols over all carriers; the corresponding limits specified in the standard are also indicated*)   |
| EVM data carriers [%/dB]  | EVM (Error Vector Magnitude) of the payload symbols over all data carriers; the corresponding limits specified in the standard are also indicated*)  |
| EVM pilot carriers [%/dB]   | EVM (Error Vector Magnitude) of the payload symbols over all pilot carriers; the corresponding limits specified in the standard are also indicated*)   |
| *) the limits can be changed via remote control (not manually, see <a href="#">Chapter 11.5.9, "Limits"</a> , on page 241); in this case, the currently defined limits are displayed here |  |

Table 3-2: WLAN I/Q parameters for IEEE 802.11b or g (DSSS)

| Parameter                                   | Description   |
|---|---|
| Sample Rate Fs                              | Input sample rate   |
| PPDU  | Type of the analyzed PPDU   |
| Data Rate                                   | Data rate used for analysis of the signal   |
| SGL   | Indicates single measurement mode (as opposed to continuous)  |
| Standard                                    | Selected WLAN measurement standard  |
| Meas Setup                                  | Number of Transmitter (Tx) and Receiver (Rx) channels used in the measurement   |
| Capture time                                | Duration of signal capture  |
| No. of Samples                              | Number of samples captured (= sample rate * capture time)   |
| No. of Data Symbols                         | The minimum and maximum number of data symbols that a PPDU may have if it is to be considered in results analysis   |
| Analyzed PPDU                               | For statistical evaluation of PPDU (see <a href="#">"PPDU Statistic Count / No of PPDU to Analyze"</a> on page 139): <x> PPDU of totally required <y> PPDU have been analyzed so far. <z> indicates the number of analyzed PPDU in the most recent sweep. |
| Number of recognized PPDU (global)          | Number of PPDU recognized in capture buffer   |
| Number of analyzed PPDU (global)            | Number of analyzed PPDU in capture buffer   |
| Number of analyzed PPDU in physical channel | Number of PPDU analyzed in entire signal (if available)   |

## WLAN I/Q Measurement (Modulation Accuracy, Flatness and Tolerance)

| Parameter                   | Description  |
|-----------------------------|--|
| Peak vector error           | Peak vector error (EVM) over the complete PPDU including the preamble in % and in dB; calculated according to the IEEE 802.11b or g (DSSS) definition of the normalized error vector magnitude (see <a href="#">"Peak Vector Error (IEEE method)"</a> on page 20);<br>The corresponding limits specified in the standard are also indicated *)   |
| PPDU EVM                    | EVM (Error Vector Magnitude) over the complete PPDU including the preamble in % and dB   |
| I/Q offset [dB]             | Transmitter center frequency leakage relative to the total Tx channel power (see <a href="#">Chapter 3.1.1.1, "I/Q Offset"</a> , on page 16)   |
| Gain imbalance [%/dB]       | Amplification of the quadrature phase component of the signal relative to the amplification of the in-phase component (see <a href="#">Chapter 3.1.1.2, "Gain Imbalance"</a> , on page 16)   |
| Quadrature error [°]        | Measure for the crosstalk of the Q-branch into the I-branch (see <a href="#">"Gain imbalance, I/Q offset, quadrature error"</a> on page 67).   |
| Center frequency error [Hz] | Frequency error between the signal and the current center frequency of the R&S FPS; the corresponding limits specified in the standard are also indicated*)<br><br>The absolute frequency error includes the frequency error of the R&S FPS and that of the DUT. If possible, the transmitter R&S FPS and the DUT should be synchronized (using an external reference).<br><br>See R&S FPS User Manual > Instrument setup > External reference |
| Chip clock error [ppm]      | Clock error between the signal and the chip clock of the R&S FPS in parts per million (ppm), i.e. the chip timing error; the corresponding limits specified in the standard are also indicated *)<br><br>If possible, the transmitter R&S FPS and the DUT should be synchronized (using an external reference).<br><br>See R&S FPS User Manual > Instrument setup > External reference   |
| Rise time                   | Time the signal needs to increase its power level from 10% to 90% of the maximum or the average power (depending on the reference power setting)<br>The corresponding limits specified in the standard are also indicated *)   |
| Fall time                   | Time the signal needs to decrease its power level from 90% to 10% of the maximum or the average power (depending on the reference power setting)<br>The corresponding limits specified in the standard are also indicated *)   |
| Mean power [dBm]            | Mean PPDU power  |
| Peak power [dBm]            | Peak PPDU power  |
| Crest factor [dB]           | The ratio of the peak power to the mean power of the PPDU (also called Peak to Average Power Ratio, PAPR).   |

The R&S FPS WLAN application also performs statistical evaluation over several PPDU's and displays one or more of the following results:

Table 3-3: Calculated summary results

| Result type | Description  |
|-------------|--|
| Min         | Minimum measured value                             |
| Mean/ Limit | Mean measured value / limit defined in standard    |
| Max/Limit   | Maximum measured value / limit defined in standard |

### 3.1.1.1 I/Q Offset

An I/Q offset indicates a carrier offset with fixed amplitude. This results in a constant shift of the I/Q axes. The offset is normalized by the mean symbol power and displayed in dB.

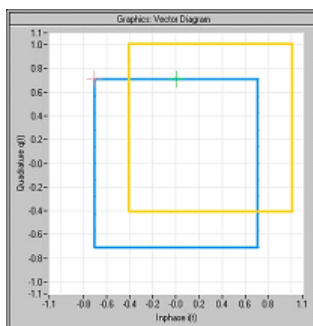


Figure 3-1: I/Q offset in a vector diagram

### 3.1.1.2 Gain Imbalance

An ideal I/Q modulator amplifies the I and Q signal path by exactly the same degree. The imbalance corresponds to the difference in amplification of the I and Q channel and therefore to the difference in amplitude of the signal components. In the vector diagram, the length of the I vector changes relative to the length of the Q vector.

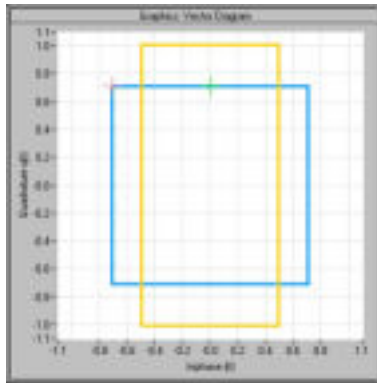
The result is displayed in dB and %, where 1 dB offset corresponds to roughly 12 % difference between the I and Q gain, according to the following equation:

$$\text{Imbalance [dB]} = 20 \log (| \text{Gain}_Q | / | \text{Gain}_I |)$$

Positive values mean that the Q vector is amplified more than the I vector by the corresponding percentage. For example using the figures mentioned above:

$$0.98 \approx 20 * \log_{10}(1.12/1)$$

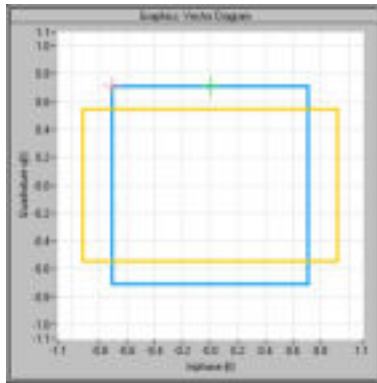




**Figure 3-2: Positive gain imbalance**

Negative values mean that the I vector is amplified more than the Q vector by the corresponding percentage. For example using the figures mentioned above:

$$-0.98 \approx 20 \cdot \log_{10}(1/1.12)$$



**Figure 3-3: Negative gain imbalance**

### 3.1.1.3 Quadrature Offset

An ideal I/Q modulator sets the phase angle between the I and Q path mixer to exactly 90 degrees. With a quadrature offset, the phase angle deviates from the ideal 90 degrees, the amplitudes of both components are of the same size. In the vector diagram, the quadrature offset causes the coordinate system to shift.

A positive quadrature offset means a phase angle greater than 90 degrees:

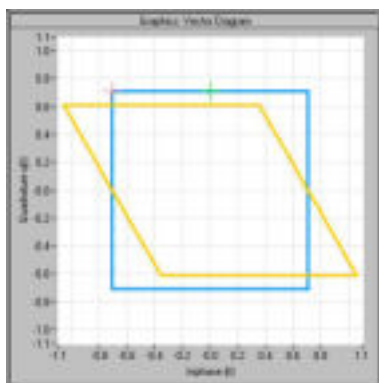


Figure 3-4: Positive quadrature offset

A negative quadrature offset means a phase angle less than 90 degrees:

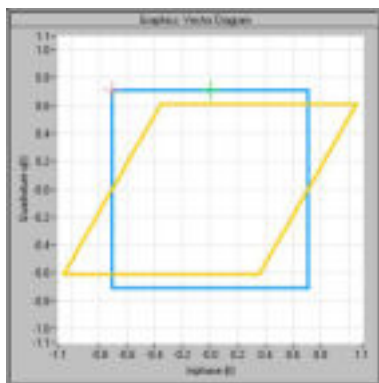


Figure 3-5: Negative quadrature offset

#### 3.1.1.4 I/Q Skew

If transmission of the data on the I path is delayed compared to the Q path, or vice versa, the I/Q data becomes *skewed*.

The I/Q skew results are currently not measured directly, but can be compensated for together with [Gain Imbalance](#) and [Quadrature Offset](#) (see "[I/Q Mismatch Compensation](#)" on page 121).

#### 3.1.1.5 I/Q Mismatch

I/Q mismatch is a comprehensive term for [Gain Imbalance](#), [Quadrature Offset](#), and [I/Q Skew](#).

Compensation for I/Q mismatch is useful, for example, if the device under test is known to be affected by these impairments but the EVM without these effects is of interest. Note, however, that measurements strictly according to IEEE 802.11-2012, IEEE 802.11ac-2013 WLAN standard may not use compensation.

### 3.1.1.6 RF Carrier Suppression (IEEE 802.11b, g (DSSS))

#### Standard definition

The RF carrier suppression, measured at the channel center frequency, shall be at least 15 dB below the peak SIN(x)/x power spectrum. The RF carrier suppression shall be measured while transmitting a repetitive 01 data sequence with the scrambler disabled using DQPSK modulation. A 100 kHz resolution bandwidth shall be used to perform this measurement.

#### Comparison to IQ offset measurement in the R&S FPS WLAN application

The IQ offset measurement in the R&S FPS WLAN application returns the current carrier feedthrough normalized to the mean power at the symbol timings. This measurement does not require a special test signal and is independent of the transmit filter shape.

The RF carrier suppression measured according to the standard is inversely proportional to the IQ offset measured in the R&S FPS WLAN application. The difference (in dB) between the two values depends on the transmit filter shape and should be determined with a reference measurement.

The following table lists the difference exemplarily for three transmit filter shapes ( $\pm 0.5$  dB):

| Transmit filter               | – IQ-Offset [dB] – RF-Carrier-Suppression [dB] |
|-------------------------------|--|
| Rectangular                   | 11 dB  |
| Root raised cosine, "α" = 0.3 | 10 dB  |
| Gaussian, "α" = 0.3           | 9 dB   |

### 3.1.1.7 EVM Measurement

The R&S FPS WLAN application provides two different types of EVM calculation.

#### PPDU EVM (Direct method)

The PPDU EVM (direct) method evaluates the root mean square EVM over one PPDU. That is the square root of the averaged error power normalized by the averaged reference power:

$$EVM = \sqrt{\frac{\sum_{n=0}^{N-1} |\mathbf{x}_{meas}(n) - \mathbf{x}_{ref}(n)|^2}{\sum_{n=0}^{N-1} |\mathbf{x}_{ref}(n)|^2}} = \sqrt{\frac{\sum_{n=0}^{N-1} |\mathbf{e}(n)|^2}{\sum_{n=0}^{N-1} |\mathbf{x}_{ref}(n)|^2}}$$

Before calculation of the EVM, tracking errors in the measured signal are compensated for if specified by the user. In the ideal reference signal, the tracking errors are always

compensated for. Tracking errors include phase (center frequency error + common phase error), timing (sampling frequency error) and gain errors. quadrature offset and gain imbalance errors, however, are not corrected.

The PPDU EVM is not part of the IEEE standard and no limit check is specified. Nevertheless, this commonly used EVM calculation can provide some insight in modulation quality and enables comparisons to other modulation standards.

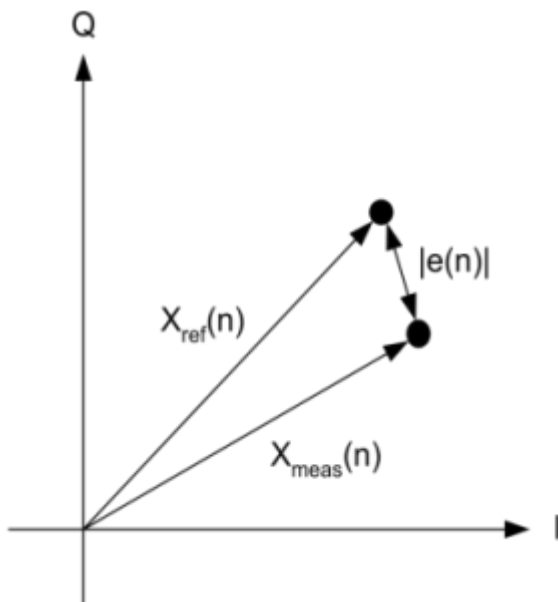


Figure 3-6: I/Q diagram for EVM calculation

#### Peak Vector Error (IEEE method)

The peak vector error (Peak EVM) is defined in section 18.4.7.8 "Transmit modulation accuracy" of the IEEE 802.11b standard. The phase, timing and gain tracking errors of the measurement signal (center frequency error, common phase error, sampling frequency error) are compensated for before EVM calculation.

The standard does not specify a normalization factor for the error vector magnitude. To get an EVM value that is independent of the level, the R&S FPS WLAN application normalizes the EVM values. Thus, an EVM of 100% indicates that the error power on the I- or Q-channels equals the mean power on the I- or Q-channels, respectively.

The peak vector error is the maximum EVM over all payload symbols and all active carriers for one PPDU. If more than one PPDU is analyzed (several analyzed PPDUs in the capture buffer or due to the [PPDU Statistic Count / No of PPDUs to Analyze](#) setting), the Min / Mean / Max columns show the minimum, mean or maximum Peak EVM of all analyzed PPDUs.

The IEEE 802.11b or g (DSSS) standards allow a peak vector error of less than 35%. In contrary to the specification, the R&S FPS WLAN application does not limit the measurement to 1000 chips length, but searches the maximum over the whole PPDU.

### 3.1.2 Evaluation Methods for WLAN IQ Measurements

The captured I/Q data from the WLAN signal can be evaluated using various different methods without having to start a new measurement or sweep. Which results are displayed depends on the selected evaluation.

The selected evaluation method not only affects the result display in a window, but also the results of the trace data query in remote control (see [TRACe<n> \[ :DATA\]](#) on page 289).


All evaluations available for the selected WLAN measurement are displayed in Smart-Grid mode.

To activate SmartGrid mode, do one of the following:

- 

Select the "SmartGrid" icon from the toolbar.

- Select the "Display Config" button in the configuration "Overview" (see [Chapter 5.2, "Display Configuration"](#), on page 90).
- Press the MEAS CONFIG hardkey and then select the "Display Config" softkey.

To close the SmartGrid mode and restore the previous softkey menu select the  "Close" icon in the righthand corner of the toolbar, or press any key.



#### MIMO measurements

When you capture more than one data stream (MIMO measurement setup, see [Chapter 4.3, "Signal Processing for MIMO Measurements \(IEEE 802.11ac, n\)"](#), on page 69), each result display contains several tabs. The results for each data stream are displayed in a separate tab. In addition, an overview tab is provided in which all data streams are displayed at once, in individual subwindows.

The WLAN measurements provide the following evaluation methods:

|  |    |
|--|----|
| <a href="#">AM/AM</a> .....                                | 22 |
| <a href="#">AM/PM</a> .....                                | 23 |
| <a href="#">AM/EVM</a> .....                               | 23 |
| <a href="#">Bitstream</a> .....                            | 24 |
| <a href="#">Constellation</a> .....                        | 26 |
| <a href="#">Constellation vs Carrier</a> .....             | 28 |
| <a href="#">EVM vs Carrier</a> .....                       | 29 |
| <a href="#">EVM vs Chip</a> .....                          | 30 |
| <a href="#">EVM vs Symbol</a> .....                        | 30 |
| <a href="#">FFT Spectrum</a> .....                         | 31 |
| <a href="#">Freq. Error vs Preamble</a> .....              | 33 |
| <a href="#">Gain Imbalance vs Carrier</a> .....            | 33 |
| <a href="#">Group Delay</a> .....                          | 34 |
| <a href="#">Magnitude Capture</a> .....                    | 35 |
| <a href="#">Phase Error vs Preamble</a> .....              | 36 |
| <a href="#">Phase Tracking</a> .....                       | 37 |
| <a href="#">PLCP Header (IEEE 802.11b, g (DSSS))</a> ..... | 37 |

|                              |    |
|------------------------------|----|
| PvT Full PPDU.....           | 38 |
| PvT Rising Edge.....         | 39 |
| PvT Falling Edge.....        | 40 |
| Quad Error vs Carrier.....   | 41 |
| Result Summary Detailed..... | 41 |
| Result Summary Global.....   | 43 |
| Signal Field.....            | 45 |
| Spectrum Flatness.....       | 48 |

### AM/AM

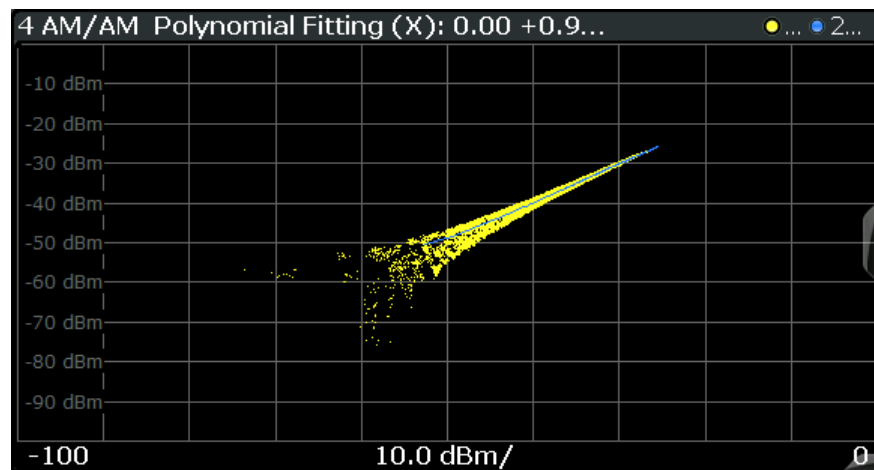
This result display shows the measured and the reference signal in the time domain. For each sample, the x-axis value represents the amplitude of the reference signal and the y-axis value represents the amplitude of the measured signal.

The reference signal is derived from the measured signal after frequency and time synchronisation, channel equalization and demodulation of the signal. The equivalent time domain representation of the reference signal is calculated by reapplying all the impairments that have been removed prior to demodulation.

The trace is determined by calculating a *polynomial regression model* of a specified degree (see [Chapter 5.3.10.3, "AM/AM Configuration"](#), on page 145) for the scattered measurement vs. reference signal data. The resulting regression polynomial is indicated in the window title of the result display.

Note: The measured signal and reference signal are complex signals.

This result display is **not** available for single-carrier measurements (**IEEE 802.11b, g (DSSS)**).



Remote command:

LAY:ADD? '1', RIGH, AMAM, see [LAYout:ADD\[:WINDow\]?](#) on page 251

or:

[CONFigure:BURSt:AM:AM\[:IMMediate\]](#) on page 185

Polynomial degree:

[CONFigure:BURSt:AM:AM:POLYnomial](#) on page 259

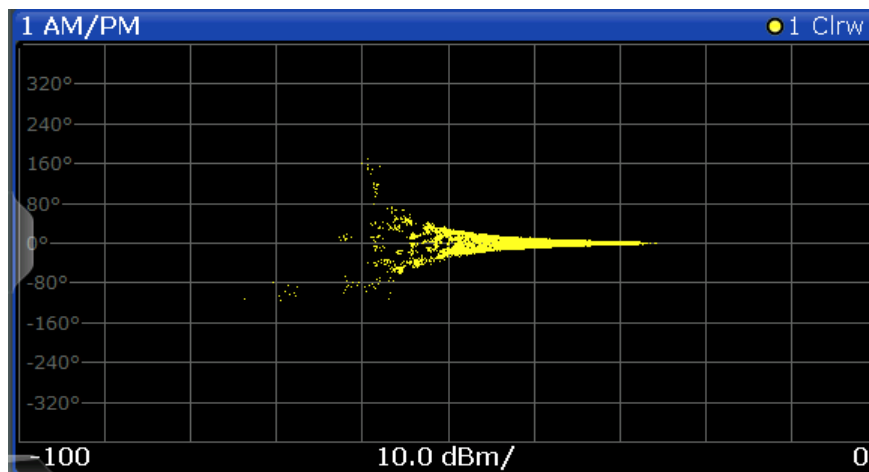
Results:

[TRACe<n>\[:DATA\]](#), see [Chapter 11.9.4.1, "AM/AM"](#), on page 295

**AM/PM**

This result display shows the measured and the reference signal in the time domain. For each sample, the x-axis value represents the amplitude of the reference signal. The y-axis value represents the angle difference of the measured signal minus the reference signal.

This result display is **not** available for single-carrier measurements (**IEEE 802.11b, g (DSSS)**).



Remote command:

LAY:ADD? '1', RIGH, AMPM, see [LAYout:ADD\[:WINDow\]?](#) on page 251

or:

[CONFigure:BURSt:AM:PM\[:IMMediate\]](#) on page 185

Querying results:

[TRACe<n>\[:DATA\]](#), see [Chapter 11.9.4.2, "AM/PM"](#), on page 295

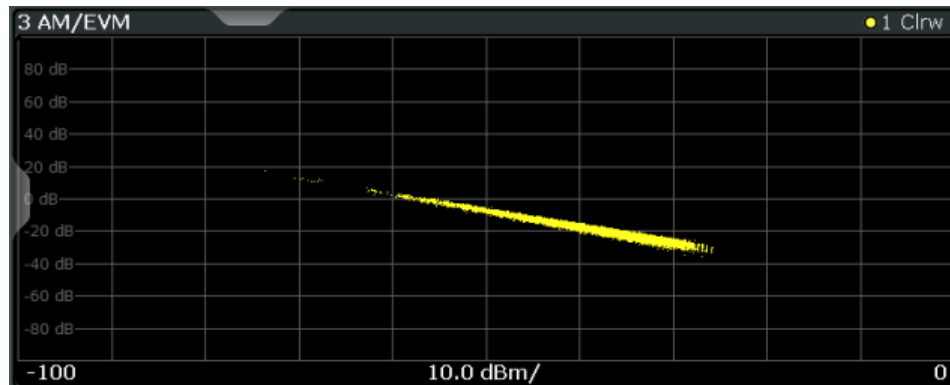
**AM/EVM**

This result display shows the measured and the reference signal in the time domain. For each sample, the x-axis value represents the amplitude of the reference signal. The y-axis value represents the length of the error vector between the measured signal and the reference signal.

The length of the error vector is normalised with the power of the corresponding reference signal sample.

This result display is **not** available for single-carrier measurements (**IEEE 802.11b, g (DSSS)**).

## WLAN I/Q Measurement (Modulation Accuracy, Flatness and Tolerance)



Remote command:

LAY:ADD? '1', RIGH, AMEV, see [LAYout:ADD\[:WINDOW\]?](#) on page 251

or:

CONFigure:BURSt:AM:EVM[:IMMediate] on page 185

Querying results:

TRACe<n>[:DATA], see [Chapter 11.9.4.3, "AM/EVM"](#), on page 295

### Bitstream

This result display shows a demodulated payload data stream for all analyzed PPDU's of the currently captured I/Q data as indicated in the "Magnitude Capture" display. The bitstream is derived from the constellation diagram points using the 'constellation bit encoding' from the corresponding WLAN standard. See for example *IEEE Std. 802.11-2012 'Fig. 18-10 BPSK, QPSK, 16-QAM and 64-QAM constellation bit encoding'*. Thus, the bitstream is *NOT* channel-decoded.

For multicarrier measurements (**IEEE 802.11a, g (OFDM), ac, j, n, p**) the results are grouped by symbol and carrier.



WLAN I/Q Measurement (Modulation Accuracy, Flatness and Tolerance)

| 1 Bitstream |          |        |        |
|-------------|----------|--------|--------|
| Carrier     | Symbol 1 |        |        |
| -26         | 000010   | 110111 | 111110 |
| -23         | 000001   | 010100 | 0      |
| -20         | 011001   | 101010 | 010101 |
| -17         | 001010   | 011100 | 101010 |
| -14         | 111100   | 001010 | 001101 |
| -11         | 011011   | 111110 | 010010 |
| -8          | 111100   | 0      | 001100 |
| -5          | 001101   | 111100 | 101100 |
| -2          | 101010   | 100011 | NULL   |
| 1           | 101010   | 101101 | 101010 |
| 4           | 011010   | 000101 | 010001 |
| 7           | 0        | 101101 | 001011 |
| 10          | 000110   | 100100 | 100101 |
| 13          | 101001   | 111101 | 101011 |
| 16          | 011100   | 111001 | 010010 |
| 19          | 110100   | 111001 | 0      |
| 22          | 000011   | 101111 | 101111 |
| 25          | 001111   | 111100 |        |
| Carrier     | Symbol 2 |        |        |

Figure 3-7: Bitstream result display for IEEE 802.11a, g (OFDM), ac, n, p standards

For MIMO measurements (IEEE 802.11ac, n) the results are grouped by stream, symbol and carrier.

Figure 3-8: Bitstream result display for IEEE 802.11n MIMO measurements

For single-carrier measurements (**IEEE 802.11b, g (DSSS)**) the results are grouped by PDU.

| 4 Bitstream   |          |          |          |
|---------------|----------|----------|----------|
| PPDU 1        |          |          |          |
| PLCP Preamble |          |          |          |
| 0             | 11111111 | 11111111 | 11111111 |
| 24            | 11111111 | 11111111 | 11111111 |
| 48            | 11111111 | 11111111 | 11111111 |
| 72            | 11111111 | 11111111 | 11111111 |
| 96            | 11111111 | 11111111 | 11111111 |
| 120           | 11111111 | 00000101 | 11001111 |
| PLCP Header   |          |          |          |
| 0             | 01010000 | 00100000 | 00000000 |
| 24            | 00000100 | 11001000 | 01000110 |
| PSDU          |          |          |          |
| 0             | 10000000 | 01000010 | 00110000 |
| 24            | 10011100 | 10101011 | 00001101 |
| 48            | 11101001 | 10111001 | 00010100 |

Figure 3-9: Bitstream result display for IEEE 802.11b, g (DSSS) standards

The numeric trace results for this evaluation method are described in [Chapter 11.9.4.4, "Bitstream"](#), on page 295.

Remote command:

LAY:ADD? '1',RIGH, BITS, see [LAYout:ADD\[:WINDow\]?](#) on page 251

or:

[CONFigure:BURSt:STATistics:BSTReam\[:IMMediate\]](#) on page 189

Querying results:

[TRACe<n>\[:DATA\]](#), see [Chapter 11.9.4.4, "Bitstream"](#), on page 295

### Constellation

This result display shows the in-phase and quadrature phase results for all payload symbols and all carriers for the analyzed PPDUs of the current capture buffer. The Tracking/Channel Estimation according to the user settings is applied.

The inphase results (I) are displayed on the x-axis, the quadrature phase (Q) results on the y-axis.

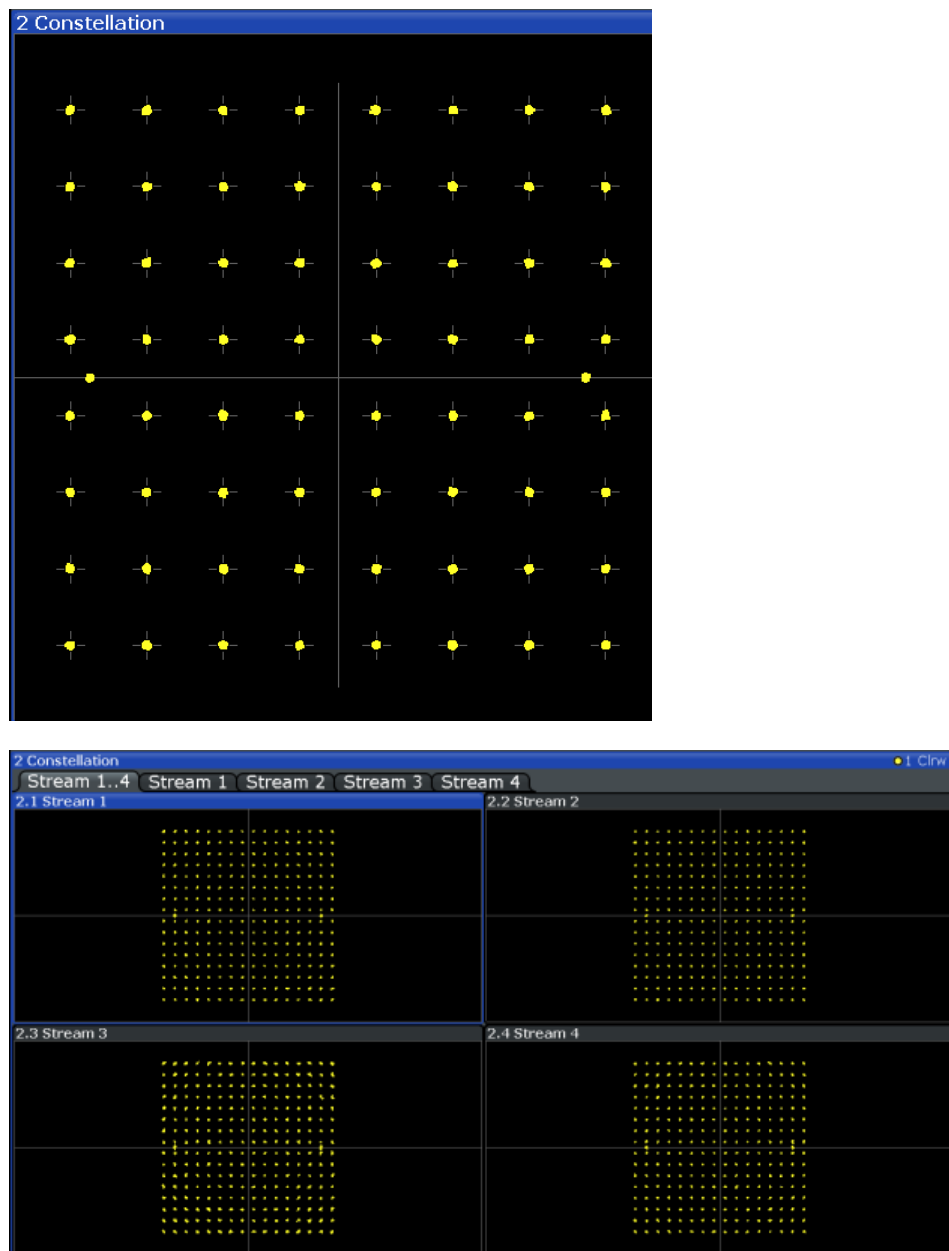


Figure 3-10: Constellation result display for IEEE 802.11n MIMO measurements

The numeric trace results for this evaluation method are described in [Chapter 11.9.4.6, "Constellation"](#), on page 297.

Remote command:

LAY:ADD? '1',RIGHT, CONS, see [LAYout:ADD\[:WINDow\]?](#) on page 251

or:

CONFigure:BURSt:CONSt:CSYMBOL[:IMMediate] on page 186

Querying results:

TRACe<n>[:DATA], see [Chapter 11.9.4.6, "Constellation"](#), on page 297

## WLAN I/Q Measurement (Modulation Accuracy, Flatness and Tolerance)

**Constellation vs Carrier**

This result display shows the in-phase and quadrature phase results for all payload symbols and all carriers for the analyzed PPDUs of the current capture buffer. The Tracking/Channel Estimation according to the user settings is applied.

This result display is **not** available for single-carrier measurements (IEEE 802.11b, g (DSSS)).

The x-axis represents the carriers. The magnitude of the in-phase and quadrature part is shown on the y-axis, both are displayed as separate traces (I-> trace 1, Q-> trace 2).

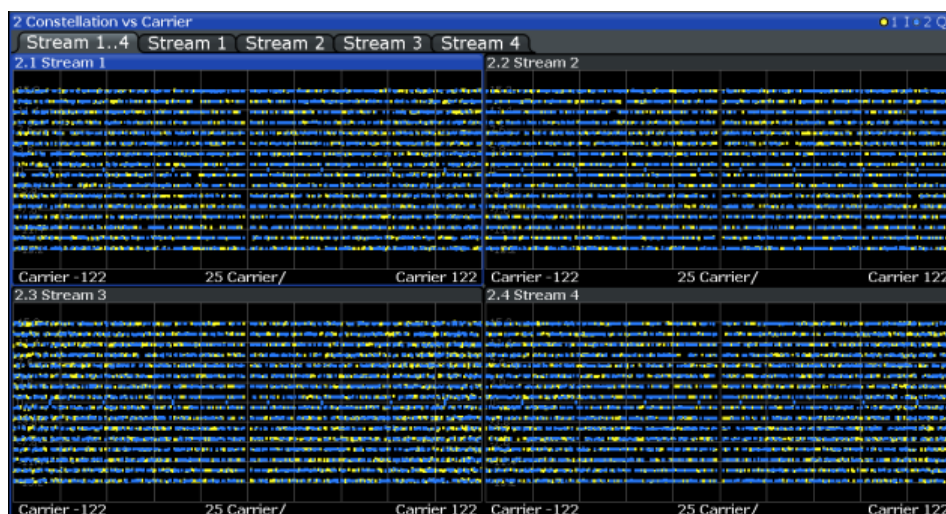
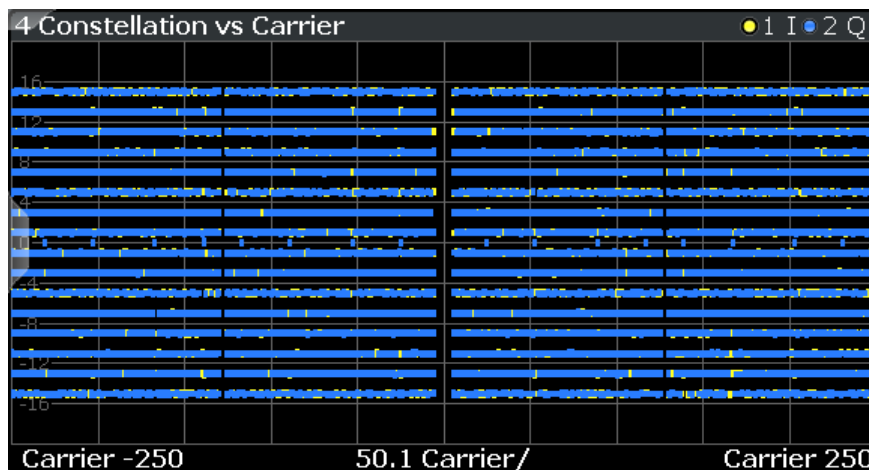


Figure 3-11: Constellation vs. carrier result display for IEEE 802.11n MIMO measurements

The numeric trace results for this evaluation method are described in [Chapter 11.9.4.7, "Constellation vs Carrier"](#), on page 298.

Remote command:

LAY:ADD? '1',RIGH, CVC, see [LAYout:ADD\[:WINDow\]?](#) on page 251

or:

[CONFigure:BURSt:CONST:CCARrier\[:IMMEdiate\]](#) on page 185

Querying results:

[TRACe<n>\[:DATA\]](#), see [Chapter 11.9.4.7, "Constellation vs Carrier"](#), on page 298

### EVM vs Carrier

This result display shows all EVM values recorded on a per-subcarrier basis over the number of analyzed PPDUs as defined by the "Evaluation Range > Statistics". The Tracking/Channel Estimation according to the user settings is applied (see [Chapter 5.3.7, "Tracking and Channel Estimation"](#), on page 119). The Minhold, Average and Maxhold traces are displayed.

This result display is **not** available for single-carrier measurements (**IEEE 802.11b, g (DSSS)**).

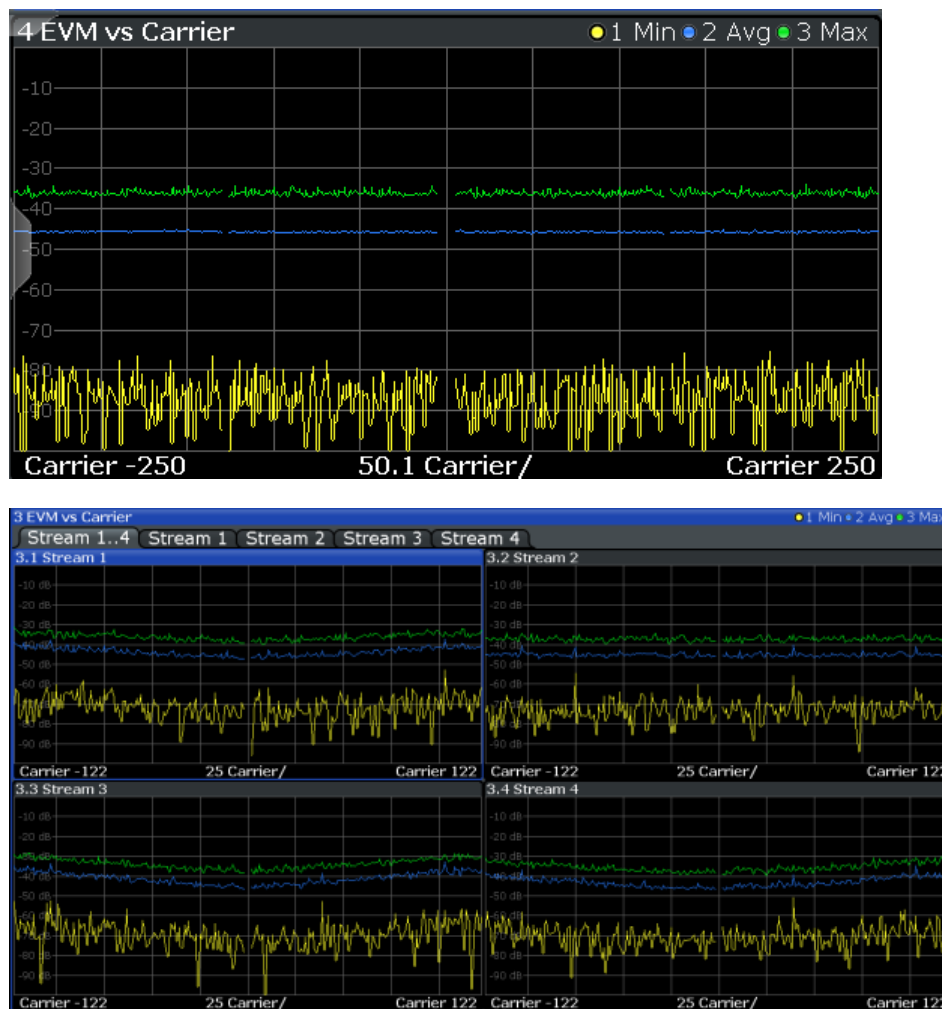


Figure 3-12: EVM vs carrier result display for IEEE 802.11n MIMO measurements

The numeric trace results for this evaluation method are described in [Chapter 11.9.4.10, "EVM vs Carrier"](#), on page 298.

Remote command:

LAY:ADD? '1', RIGH, EVC, see [LAYout:ADD\[:WINDow\]?](#) on page 251

or:

CONFigure:BURSt:EVM:ECARrier[:IMMediate] on page 186

Querying results:

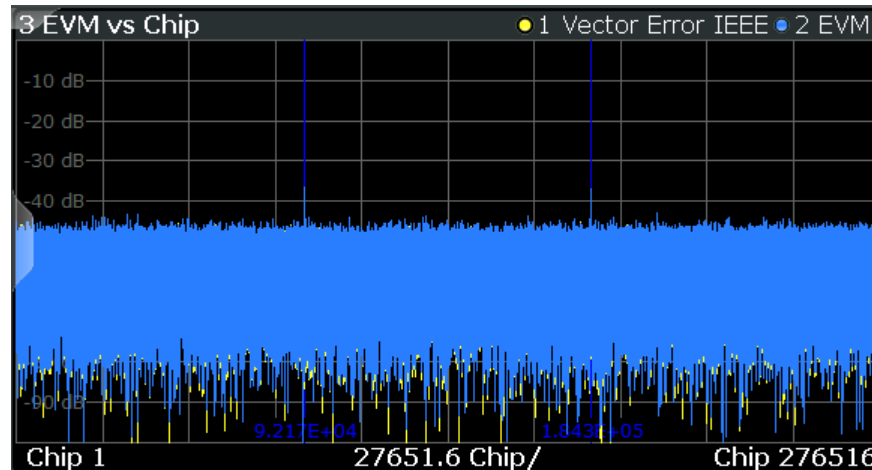
TRACe<n>[:DATA], see [Chapter 11.9.4.10, "EVM vs Carrier"](#), on page 298

### EVM vs Chip

This result display shows the error vector magnitude per chip.

This result display is **only** available for single-carrier measurements (**IEEE 802.11b, g (DSSS)**).

Since the R&S FPS WLAN application provides two different methods to calculate the EVM, two traces are displayed:



- "Vector Error IEEE" shows the error vector magnitude as defined in the IEEE 802.11b or g (DSSS) standards (see also ["Error vector magnitude \(EVM\) - IEEE 802.11b or g \(DSSS\) method"](#) on page 68)
- "EVM" shows the error vector magnitude calculated with an alternative method that provides higher accuracy of the estimations (see also ["Error vector magnitude \(EVM\) - R&S FPS method"](#) on page 67).

Remote command:

LAY:ADD? '1',RIGH, EVCH, see [LAYout:ADD\[:WINDow\]?](#) on page 251

or:

[CONFigure:BURSt:EVM:EChip\[:IMMediate\]](#) on page 186

[CONFigure:BURSt:EVM:ESYMBOL\[:IMMediate\]](#) on page 186

Querying results:

[TRACe<n>\[:DATA\]](#), see [Chapter 11.9.4.11, "EVM vs Chip"](#), on page 299

### EVM vs Symbol

This result display shows all EVM values calculated on a per-carrier basis over the number of analyzed PPDUs as defined by the "Evaluation Range > Statistics" settings (see ["PPDU Statistic Count / No of PPDUs to Analyze"](#) on page 139). The Tracking/Channel Estimation according to the user settings is applied (see [Chapter 5.3.7, "Tracking and Channel Estimation"](#), on page 119). The MinHold, Maxhold, and Average traces are displayed.

## WLAN I/Q Measurement (Modulation Accuracy, Flatness and Tolerance)



Figure 3-13: EVM vs symbol result display for IEEE 802.11n MIMO measurements

This result display is **not** available for single-carrier measurements (IEEE 802.11b, g (DSSS)).

Remote command:

LAY:ADD? '1',RIGH, EVSY, see LAYout:ADD[:WINDow]? on page 251

or:

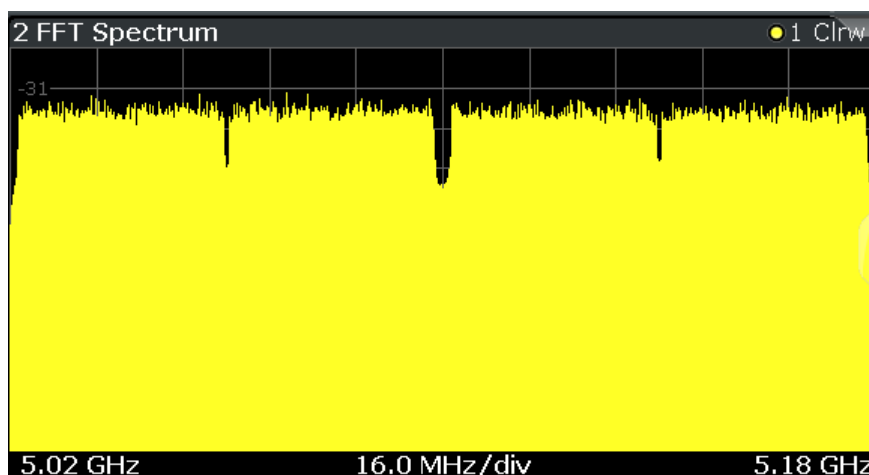
CONFigure:BURSt:EVM:ESYMBOL[:IMMediate] on page 186

Querying results:

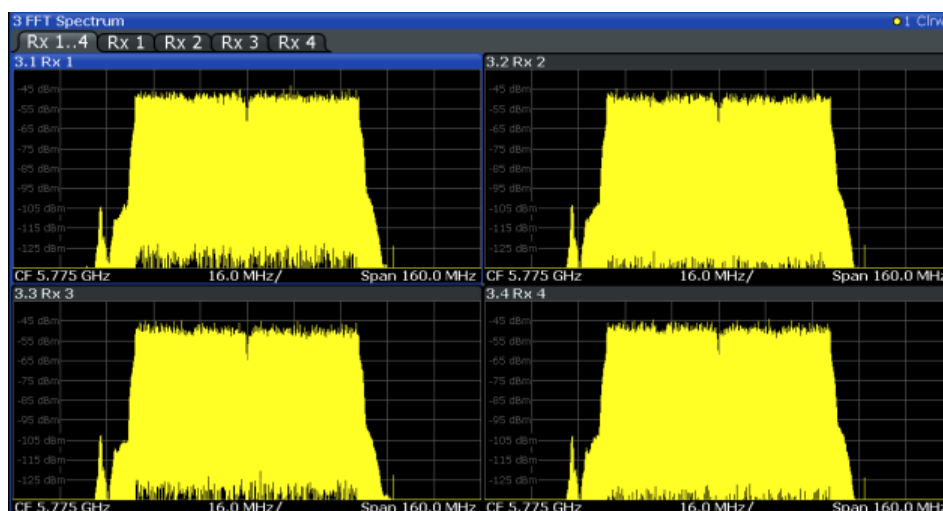
TRACe<n>[:DATA], see Chapter 11.9.4.12, "EVM vs Symbol", on page 299

### FFT Spectrum

This result display shows the power vs frequency values obtained from a FFT. The FFT is performed over the complete data in the current capture buffer, without any correction or compensation.



**Note:** MIMO measurements. When you capture more than one data stream (MIMO measurement setup, see [Chapter 4.3, "Signal Processing for MIMO Measurements \(IEEE 802.11ac, n\)"](#), on page 69), each result display contains several tabs. The results for each data stream are displayed in a separate tab. In addition, an overview tab is provided in which all data streams are displayed at once, in individual subwindows.



**Figure 3-14:** FFT spectrum result display for IEEE 802.11n MIMO measurements

The numeric trace results for this evaluation method are described in [Chapter 11.9.4.13, "FFT Spectrum"](#), on page 300.

Remote command:

LAY:ADD? '1',RIGH, FSP, see [LAYout:ADD\[:WINDow\]?](#) on page 251

or:

[CONFigure:BURSt:SPECTrum:FFT\[:IMMediate\]](#) on page 188

Querying results:

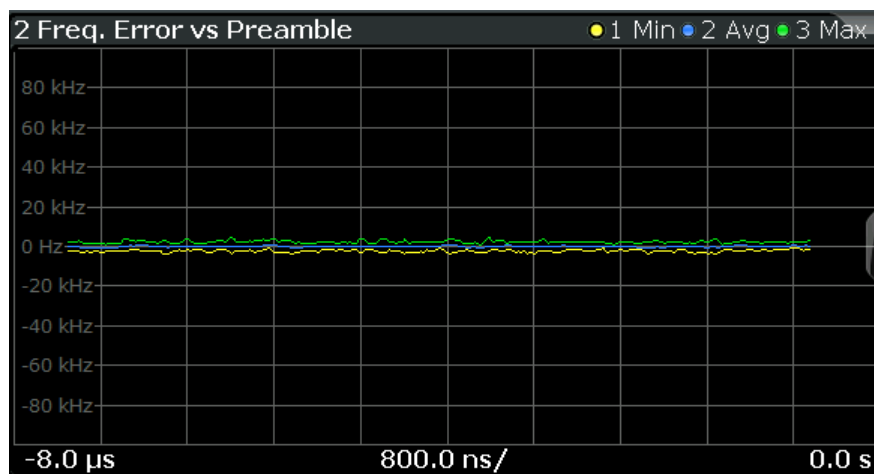
[TRACe<n>\[:DATA\]](#), see [Chapter 11.9.4.13, "FFT Spectrum"](#), on page 300



## WLAN I/Q Measurement (Modulation Accuracy, Flatness and Tolerance)

**Freq. Error vs Preamble**

Displays the frequency error values recorded over the preamble part of the PPDU. A minimum, average and maximum trace are displayed.



Remote command:

LAY:ADD? '1', RIGH, FEVP, see [LAYout:ADD\[:WINDow\]?](#) on page 251

or:

[CONFigure:BURSt:PREamble\[:IMMediate\]](#) on page 187

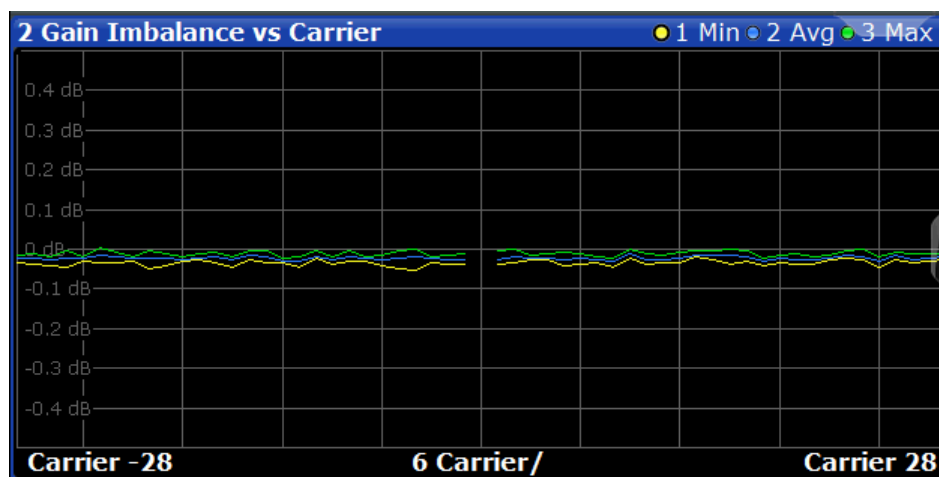
[CONFigure:BURSt:PREamble:SElect](#) on page 187

Querying results:

[TRACe<n>\[:DATA\]](#), see [Chapter 11.9.4.9, "Error vs Preamble"](#), on page 298

**Gain Imbalance vs Carrier**

Displays the minimum, average and maximum gain imbalance versus carrier in individual traces. For details on gain imbalance see [Chapter 3.1.1.2, "Gain Imbalance"](#), on page 16.



Remote command:

LAY:ADD? '1', RIGH, GAIN, see [LAYout:ADD\[:WINDow\]?](#) on page 251

or:

[CONFigure:BURSt:GAIN:GCARrier\[:IMMediate\]](#) on page 187

Querying results:

TRACe<n> [ : DATA ], see [Chapter 11.9.4.8, "Error vs Carrier"](#), on page 298

### Group Delay

Displays all Group Delay (GD) values recorded on a per-subcarrier basis - over the number of analyzed PPDU's as defined by the "Evaluation Range > Statistics" settings (see ["PPDU Statistic Count / No of PPDU's to Analyze"](#) on page 139).

All 57 carriers are shown, including the unused carrier 0.

This result display is **not** available for single-carrier measurements (**IEEE 802.11b, g (DSSS)**).

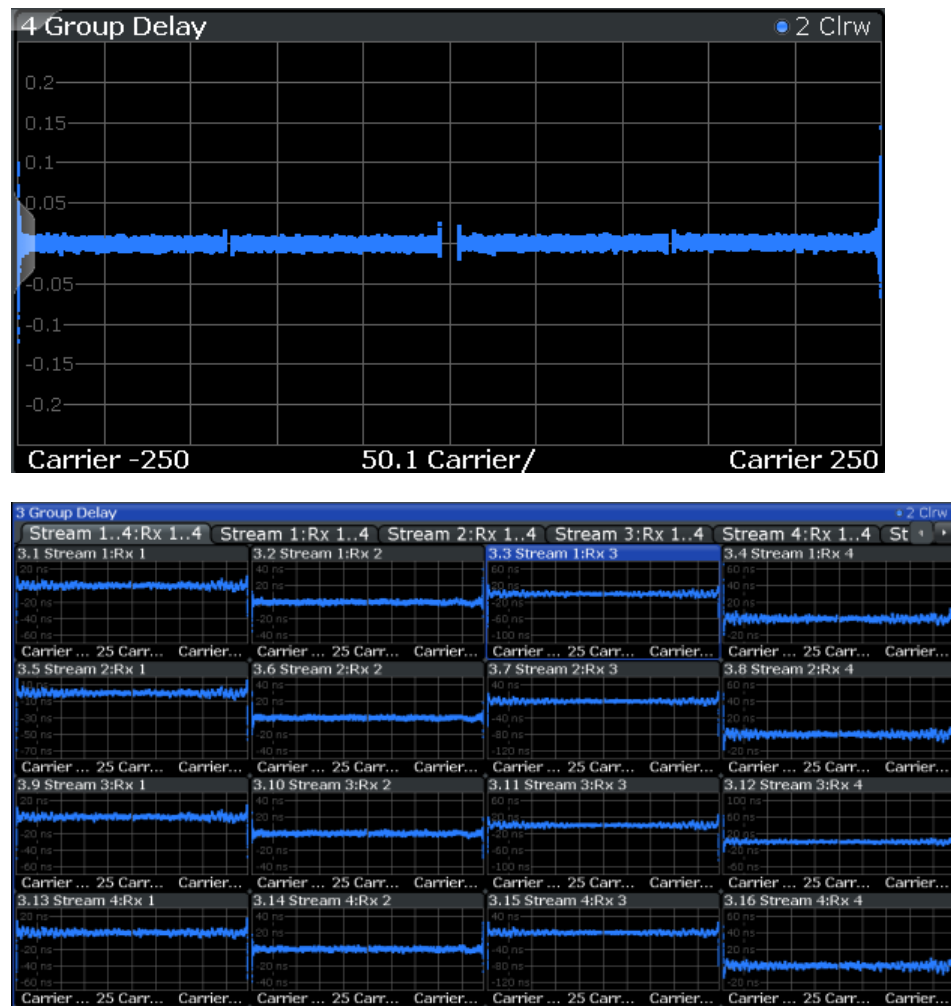


Figure 3-15: Group delay result display for IEEE 802.11n MIMO measurements

Group delay is a measure of phase distortion and defined as the derivation of phase over frequency.

To calculate the group delay, the estimated channel is upsampled, inactive carriers are interpolated and phases are unwrapped before they are differentiated over the carrier frequencies. Thus, the group delay indicates the time a pulse in the channel is delayed for each carrier frequency. However, not the absolute delay is of interest, but rather the deviation between carriers. Thus, the mean delay over all carriers is deducted.

For an ideal channel, the phase increases linearly, which causes a constant time delay over all carriers. In this case, a horizontal line at the zero value would be the result.

The numeric trace results for this evaluation method are described in [Chapter 11.9.4.14, "Group Delay"](#), on page 300.

Remote command:

LAY:ADD? '1',RIGH, GDEL, see [LAYout:ADD\[:WINDow\]?](#) on page 251

or:

CONF:BURS:SPEC:FLAT:SEL GRD, see [CONFigure:BURSt:SPECTrum:FLATness:SElect](#) on page 188 and

[CONFigure:BURSt:SPECTrum:FLATness\[:IMMediate\]](#) on page 189

Querying results:

TRACe<n>[:DATA], see [Chapter 11.9.4.14, "Group Delay"](#), on page 300

### Magnitude Capture

The Magnitude Capture Buffer display shows the complete range of captured data for the last sweep. Green bars at the bottom of the Magnitude Capture Buffer display indicate the positions of the analyzed PPDU's. A blue bar indicates the selected PPDU if the evaluation range is limited to a single PPDU (see ["Analyze this PPDU / PPDU to Analyze"](#) on page 138).

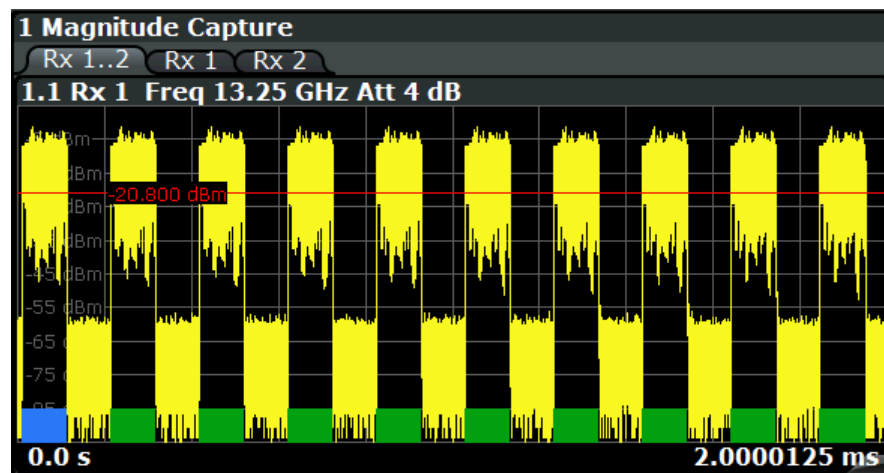


Figure 3-16: Magnitude capture display for single PPDU evaluation

**Note:** MIMO measurements. When you capture more than one data stream (MIMO measurement setup, see [Chapter 4.3, "Signal Processing for MIMO Measurements \(IEEE 802.11ac, n\)"](#), on page 69), each result display contains several tabs. The results for each data stream are displayed in a separate tab. In addition, an overview tab is provided in which all data streams are displayed at once, in individual subwindows.

## WLAN I/Q Measurement (Modulation Accuracy, Flatness and Tolerance)

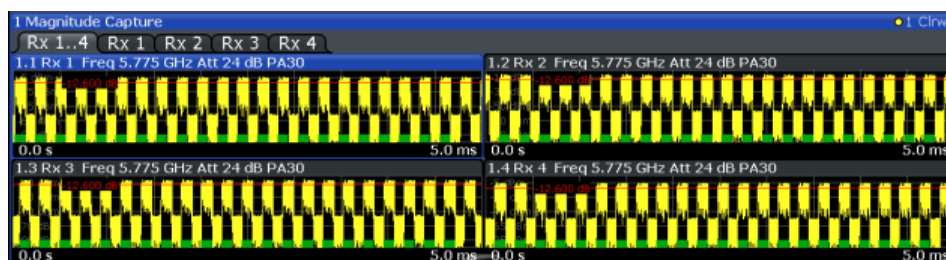


Figure 3-17: Magnitude Capture display for MIMO measurement with 4 Rx antennas

For the Magnitude Capture display, each subwindow contains additional information for each Rx antenna, namely:

- Antenna number
- Center frequency
- (Mechanical) attenuation (ATT) in dB
- Electronical attenuation (EL) in dB
- Reference offset (EXT) in dB
- Preamplification (PA) in dB

Numeric trace results are not available for this evaluation method.

Remote command:

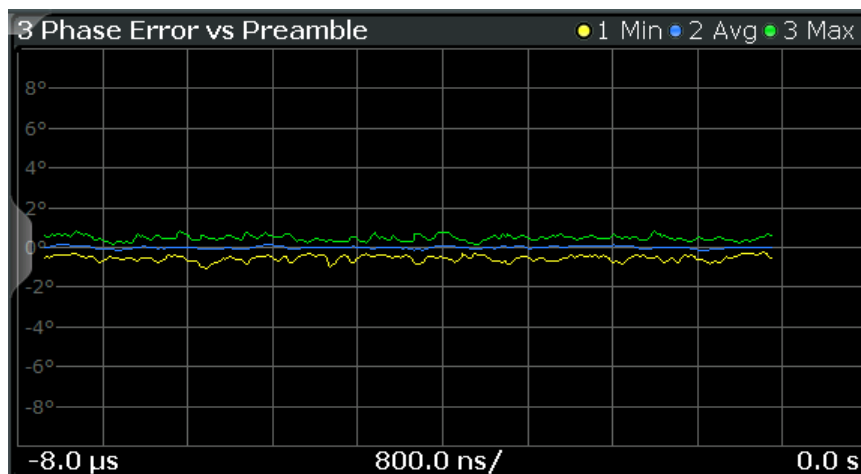
LAY:ADD? '1', RIGH, CMEM, see LAYout:ADD[:WINDow]? on page 251

Querying results:

TRACe<n>[:DATA], see Chapter 11.9.4.15, "Magnitude Capture", on page 301

### Phase Error vs Preamble

Displays the phase error values recorded over the preamble part of the PPDU. A minimum, average and maximum trace are displayed.



Remote command:

LAY:ADD? '1', RIGH, PEVP, see LAYout:ADD[:WINDow]? on page 251

or:

CONFigure:BURSt:PREamble[:IMMediate] on page 187

CONFigure:BURSt:PREamble:SElect on page 187

Querying results:

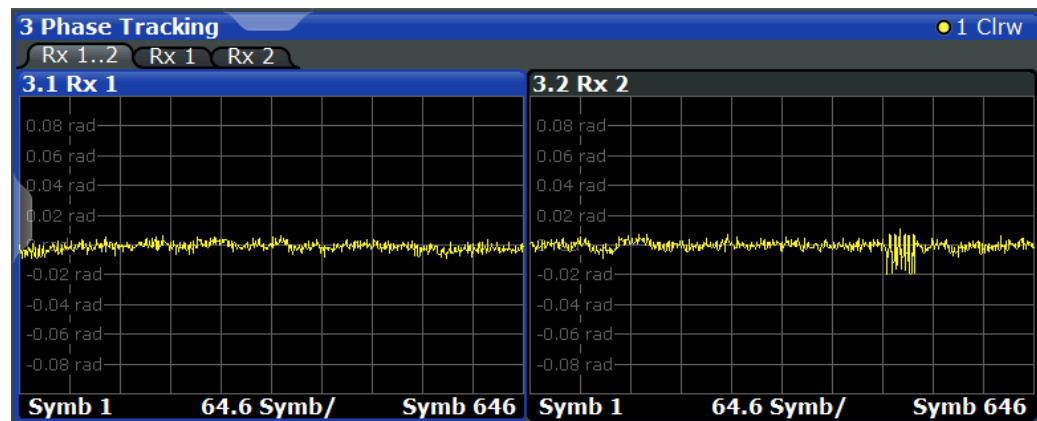
TRACe<n>[:DATA], see Chapter 11.9.4.9, "Error vs Preamble", on page 298

## WLAN I/Q Measurement (Modulation Accuracy, Flatness and Tolerance)

**Phase Tracking**

Displays the average phase tracking result per symbol (in Radians).

This result display is **not** available for single-carrier measurements (**IEEE 802.11b, g (DSSS)**).



Remote command:

LAY:ADD? '1', RIGH, PTR, see [LAYout:ADD\[:WINDow\]?](#) on page 251

or:

[CONFigure:BURSt:PTRacking\[:IMMediate\]](#) on page 187

Querying results:

[TRACe<n>\[:DATA\]](#), see [Chapter 11.9.4.16, "Phase Tracking"](#), on page 301

**PLCP Header (IEEE 802.11b, g (DSSS))**

This result display shows the decoded data from the PLCP header of the PPDU.

This result display is **only** available for single-carrier measurements (**IEEE 802.11b, g (DSSS)**); for other standards, use [Signal Field](#) instead.

| 1 PLCP Header |                        |                           |                            |                        |
|---------------|------------------------|---------------------------|----------------------------|------------------------|
|               | Signal                 | Service                   | PSDU Length                | CRC                    |
| Burst 1       | 01101110<br>11 Mbits/s | 00100000<br>Lock/CCK / -- | 0000001011101001<br>745 µs | 1011010110001010<br>OK |
| Burst 2       | 01101110<br>11 Mbits/s | 00100000<br>Lock/CCK / -- | 0000001011101001<br>745 µs | 1011010110001010<br>OK |
| Burst 3       | 01101110<br>11 Mbits/s | 00100000<br>Lock/CCK / -- | 0000001011101001<br>745 µs | 1011010110001010<br>OK |
| Burst 4       | 01101110<br>11 Mbits/s | 00100000<br>Lock/CCK / -- | 0000001011101001<br>745 µs | 1011010110001010<br>OK |
| Burst 5       | 01101110<br>11 Mbits/s | 00100000<br>Lock/CCK / -- | 0000001011101001<br>745 µs | 1011010110001010<br>OK |

Figure 3-18: PLCP Header result display for IEEE 802.11b, g (DSSS) standards

The following information is provided:

(The signal field information is provided as a decoded bit sequence and, where appropriate, also in human-readable form beneath the bit sequence for each PPDU.)

WLAN I/Q Measurement (Modulation Accuracy, Flatness and Tolerance)

**Table 3-4: Demodulation results in PLCP Header result display (IEEE 802.11b, g (DSSS))**

| Result      | Description   | Example                       |
|-------------|---|-------------------------------|
| PPDU        | Number of the decoded PPDU<br>A colored block indicates that the PPDU was successfully decoded.   | PPDU 1                        |
| Signal      | Information in "signal" field<br>The decoded data rate is shown below.  | 01101110<br>11 MBits/s        |
| Service     | Information in "service" field<br><Symbol clock state> /<Modulation format> / <Length extension bit state><br>where:<br><Symbol clock state>: Locked / - -<br><Modulation format>: see <a href="#">Table 4-1</a><br><Length extension bit state>: 1 (set) / - - (not set) | 00100000<br>Lock/CCK/- -      |
| PSDU Length | Information in "length" field<br>Time required to transmit the PSDU   | 00000000111100<br>0<br>120 µs |
| CRC         | Information in "CRC" field<br>Result of cyclic redundancy code check: "OK" or "Failed"  | 111010011100111<br>0<br>OK    |

Remote command:

LAY:ADD? '1',RIGH, SFI, see [LAYout:ADD\[:WINDow\]?](#) on page 251

or:

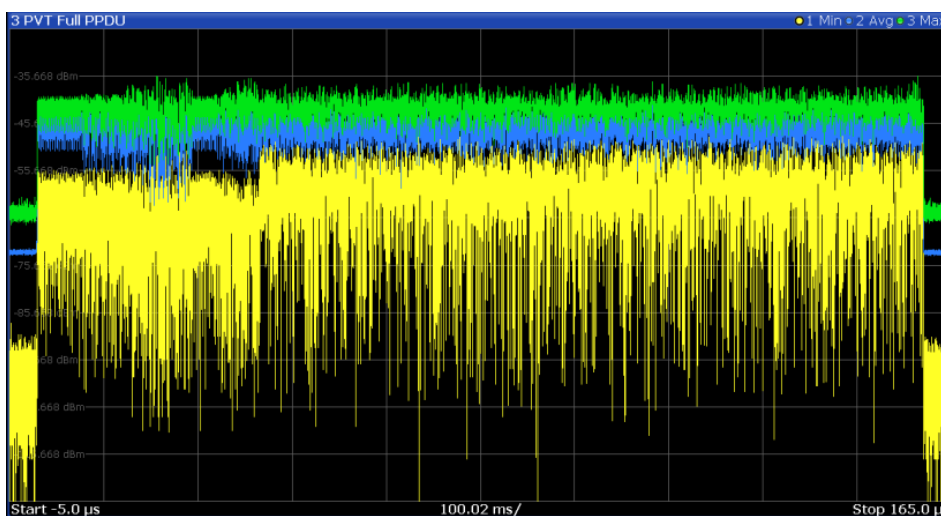
[CONFigure:BURSt:STATistics:SFIeld\[:IMMediate\]](#) on page 189

Querying results:

[TRACe<n>\[:DATA\]](#), see [Chapter 11.9.4.18, "Signal Field"](#), on page 302

**PvT Full PPDU**

Displays the minimum, average and maximum power vs time diagram for all PPDU's.



**Figure 3-19: PvT Full PPDU result display for IEEE 802.11a, g (OFDM), ac, n, p standards**

## WLAN I/Q Measurement (Modulation Accuracy, Flatness and Tolerance)



Figure 3-20: PVT Full PPDU result display for IEEE 802.11n MIMO measurements

For single-carrier measurements (**IEEE 802.11b, g (DSSS)**), the PVT results are displayed as percentage values of the reference power. The reference can be set to either the maximum or mean power of the PPDU.

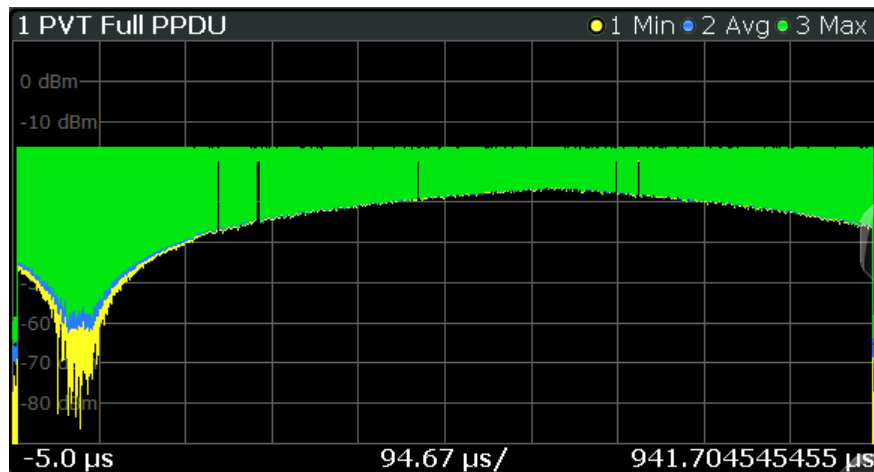


Figure 3-21: PVT Full PPDU result display for IEEE 802.11b, g (DSSS) standards

Remote command:

LAY:ADD:WIND '2', RIGH, PFPP see [LAYout:ADD\[:WINDow\]?](#) on page 251

or:

[CONFigure:BURSt:PVT:SElect](#) on page 188

[CONFigure:BURSt:PVT\[:IMMediate\]](#) on page 187

Querying results:

[TRACe<n>\[:DATA\]](#), see [Chapter 11.9.4.17, "Power vs Time \(PVT\)"](#), on page 301

### PvT Rising Edge

Displays the minimum, average and maximum power vs time diagram for the rising edge of all PPDU.

## WLAN I/Q Measurement (Modulation Accuracy, Flatness and Tolerance)



Figure 3-22: PVT Rising Edge result display

Remote command:

LAY:ADD:WIND '2', RIGH, PRIS see [LAYout:ADD\[:WINDow\]?](#) on page 251

or:

[CONFigure:BURSt:PVT:SElect](#) on page 188

[CONFigure:BURSt:PVT\[:IMMediate\]](#) on page 187

Querying results:

[TRACe<n>\[:DATA\]](#), see [Chapter 11.9.4.17, "Power vs Time \(PVT\)"](#), on page 301

### PvT Falling Edge

Displays the minimum, average and maximum power vs time diagram for the falling edge of all PPDU's.

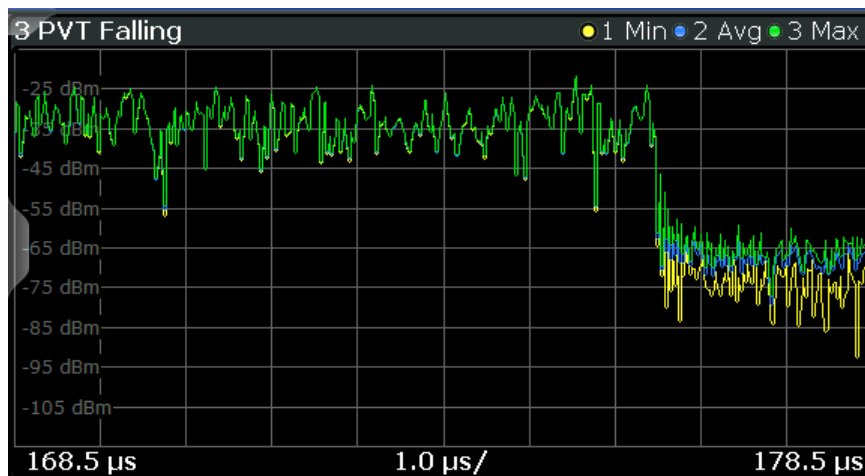


Figure 3-23: PVT Falling Edge result display

Remote command:

LAY:ADD:WIND '2', RIGH, PFAL see [LAYout:ADD\[:WINDow\]?](#) on page 251

or:

[CONFigure:BURSt:PVT:SElect](#) on page 188

[CONFigure:BURSt:PVT\[:IMMediate\]](#) on page 187

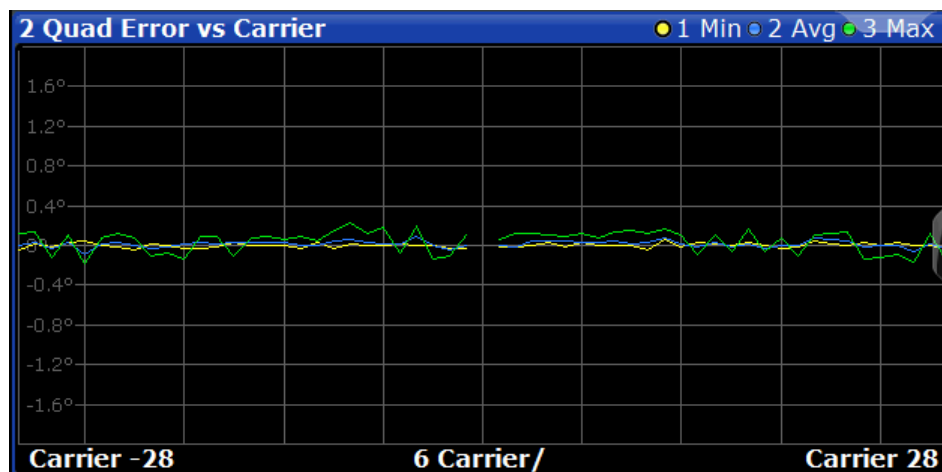


Querying results:

TRACe<n>[:DATA], see [Chapter 11.9.4.17, "Power vs Time \(PVT\)"](#), on page 301

### Quad Error vs Carrier

Displays the minimum, average and maximum quadrature offset (error) versus carrier in individual traces. For details on quadrature offset see [Chapter 3.1.1.3, "Quadrature Offset"](#), on page 17.



Remote command:

LAY:ADD? '1', RIGH, QUAD, see [LAYout:ADD\[:WINDow\]?](#) on page 251

or:

CONFigure:BURSt:QUAD:QCARrier[:IMMediate] on page 188

Querying results:

TRACe<n>[:DATA], see [Chapter 11.9.4.8, "Error vs Carrier"](#), on page 298

### Result Summary Detailed

The *detailed* result summary contains individual measurement results for the Transmitter and Receiver channels and for the bitstream.

This result display is **not** available for single-carrier measurements (**IEEE 802.11b, g (DSSS)**).

## WLAN I/Q Measurement (Modulation Accuracy, Flatness and Tolerance)

| 4 Result Summary Detailed |        |        |        |        |        | 4.2 Tx 2:Rx 2      |        |        |        |        |        |
|---------------------------|--------|--------|--------|--------|--------|--------------------|--------|--------|--------|--------|--------|
| 4.1 Tx 1:Rx 1             |        |        |        |        |        | 4.2 Tx 2:Rx 2      |        |        |        |        |        |
| Tx 1                      |        |        |        |        |        | Tx 2               |        |        |        |        |        |
|                           | Min    | Mean   | Limit  | Max    | Lir    |                    | Min    | Mean   | Limit  | Max    | Lir    |
| IQ Offset                 | -45.70 | -45.47 | -20.00 | -45.37 | -20.00 | IQ Offset          | -62.45 | -62.07 | -20.00 | -61.67 | -20.00 |
| Gain Imbalance            | -0.26  | -0.25  |        | -0.24  |        | Gain Imbalance     | -0.06  | -0.04  |        | -0.02  |        |
|                           | -0.02  | -0.02  |        | -0.02  |        |                    | -0.01  | -0.00  |        | -0.00  |        |
| Quad. Offset              | 0.03   | 0.04   |        | 0.05   |        | Quad. Offset       | -0.00  | 0.01   |        | 0.02   |        |
| IQ Skew                   | -1.03  | -0.41  |        | 0.92   |        | IQ Skew            | 0.88   | 2.48   |        | 3.56   |        |
| PPDU Power                | ---    | ---    |        | ---    |        | PPDU Power         | ---    | ---    |        | ---    |        |
| Crest Factor              | ---    | ---    |        | ---    |        | Crest Factor       | ---    | ---    |        | ---    |        |
| Rx 1                      |        |        |        |        |        | Rx 2               |        |        |        |        |        |
|                           | Min    | Mean   | Limit  | Max    | Lir    |                    | Min    | Mean   | Limit  | Max    | Lir    |
| PPDU Power                | -11.94 | -11.94 |        | -11.94 |        | PPDU Power         | -15.52 | -15.51 |        | -15.51 |        |
| Crest Factor              | 10.87  | 10.88  |        | 10.88  |        | Crest Factor       | 10.55  | 10.57  |        | 10.58  |        |
| MIMO Cross Power          | ---    | -6.60  |        | ---    |        | MIMO Cross Power   | ---    | -6.60  |        | ---    |        |
| Center Freq Error         | ---    | ---    |        | ---    |        | Center Freq Error  | ---    | ---    |        | ---    |        |
| Symbol Clock Error        | ---    | ---    |        | ---    |        | Symbol Clock Error | ---    | ---    |        | ---    |        |
| CPE                       | ---    | ---    |        | ---    |        | CPE                | ---    | ---    |        | ---    |        |
| Stream 1                  |        |        |        |        |        | Stream 2           |        |        |        |        |        |
|                           | Min    | Mean   | Limit  | Max    | Lir    |                    | Min    | Mean   | Limit  | Max    | Lir    |
| BER Pilot                 | ---    | ---    | 0.00   | ---    | 0.00   | BER Pilot          | ---    | ---    | 0.00   | ---    | 0.00   |
| EVM All Carrier           | -46.94 | -46.62 | -22.00 | -46.31 | -22.00 | EVM All Carrier    | -47.17 | -46.65 | -16.00 | -46.16 | -16.00 |
| EVM Data Carrier          | -46.89 | -46.55 | -22.00 | -46.23 | -22.00 | EVM Data Carrier   | -47.13 | -46.61 | -16.00 | -46.14 | -16.00 |
| EVM Pilot Carrier         | -49.34 | -48.28 | -5.00  | -47.53 | -5.00  | EVM Pilot Carrier  | -48.13 | -47.54 | -5.00  | -46.43 | -5.00  |

Figure 3-24: Detailed Result Summary result display for IEEE 802.11n MIMO measurements

The "Result Summary Detailed" contains the following information:

**Note:** You can configure which results are displayed (see [Chapter 5.3.10, "Result Configuration"](#), on page 143). However, the results are always calculated, regardless of their visibility.

Tx channel ("Tx All"):

- I/Q offset [dB]
- Gain imbalance [%/dB]
- Quadrature offset [°]
- I/Q skew [ps]
- PPDU power [dBm]
- Crest factor [dB]

Receive channel ("Rx All"):

- PPDU power [dBm]
- Crest factor [dB]
- MIMO cross power
- Center frequency error
- Symbol clock error
- CPE

Bitstream ("Stream All"):

- Pilot bit error rate [%]
- EVM all carriers [%/dB]
- EVM data carriers [%/dB]
- EVM pilot carriers [%/dB]

For details on the individual parameters and the summarized values see [Chapter 3.1.1, "Modulation Accuracy, Flatness and Tolerance Parameters"](#), on page 12.

## WLAN I/Q Measurement (Modulation Accuracy, Flatness and Tolerance)

Remote command:

LAY:ADD? '1',RIGH, RSD, see LAYout:ADD[:WINDow]? on page 251

Querying results:

FETCh:BURSt:ALL on page 273

### Result Summary Global

The *global* result summary provides measurement results based on the complete signal, consisting of all channels and streams. The observation length is the number of PPDU's to be analyzed as defined by the "Evaluation Range > Statistics" settings. In contrast, the *detailed* result summary provides results for each individual channel and stream.

| I Result Summary Global        |        |              |            |                               |            |      |
|--------------------------------|--------|--------------|------------|-------------------------------|------------|------|
| No. of PPDU's - Recognized: 19 |        | Analyzed: 18 |            | Analyzed Physical Channel: 18 |            |      |
| PPDU's:                        | Min    | Mean         | Limit      | Max                           | Limit      | Unit |
| Pilot Bit Error Rate           | 0.00   | 0.00         | 0.00       | 0.00                          | 0.00       | %    |
| EVM All Carriers               | 0.34   | 0.38         | 31.62      | 0.49                          | 31.62      | %    |
|                                | -49.25 | -48.46       | -10.00     | -46.15                        | -10.00     | dB   |
| EVM Data Carriers              | 0.34   | 0.38         | 31.62      | 0.50                          | 31.62      | %    |
|                                | -49.25 | -48.44       | -10.00     | -46.07                        | -10.00     | dB   |
| EVM Pilot Carriers             | 0.29   | 0.34         | 56.23      | 0.45                          | 56.23      | %    |
|                                | -50.62 | -49.31       | -5.00      | -46.99                        | -5.00      | dB   |
| Center Frequency Error         | -4.34  | -0.85        | ±100000.00 | 3.55                          | ±100000.00 | Hz   |
| Symbol Clock Error             | 0.02   | 0.09         | ±20.00     | 0.17                          | ±20.00     | ppm  |

Figure 3-25: Global result summary for IEEE 802.11a, g (OFDM), ac, n, p standards

## WLAN I/Q Measurement (Modulation Accuracy, Flatness and Tolerance)

| 1 Result Summary Global       |        |             |            |                              |            |      |
|-------------------------------|--------|-------------|------------|------------------------------|------------|------|
| No. of PPDU's - Recognized: 3 |        | Analyzed: 3 |            | Analyzed Physical Channel: 0 |            |      |
| PPDU's:                       | Min    | Mean        | Limit      | Max                          | Limit      | Unit |
| Peak Vector Error             | 1.18   | 1.37        | 35.00      | 1.47                         | 35.00      | %    |
| PPDU EVM                      | 0.19   | 0.19        |            | 0.19                         |            | %    |
|                               | -54.59 | -54.57      |            | -54.54                       |            | dB   |
| IQ Offset                     | -67.45 | -67.33      |            | -67.24                       |            | dB   |
|                               | 82.34  | 82.34       |            | 82.34                        |            | %    |
| Gain Imbalance                | -15.06 | -15.06      |            | -15.06                       |            | dB   |
|                               | 0.00   | 0.00        |            | 0.00                         |            | °    |
| Quadrature Error              | 0.00   | 0.00        |            | 0.00                         |            | °    |
| Center Freq Error             | 0.00   | 0.00        | ±331250.00 | 0.00                         | ±331250.00 | Hz   |
| Chip Clock Error              | -0.00  | -0.00       | ±25.00     | -0.00                        | ±25.00     | ppm  |
| Rise Time                     | 1.00   | 1.00        | 2.00       | 1.00                         | 2.00       | µs   |
| Fall Time                     | 3.18   | 3.18*       | 2.00       | 3.18*                        | 2.00       | µs   |
| Mean Power                    | -2.62  | -2.62       |            | -2.62                        |            | dBm  |
| Peak Power                    | -1.67  | -1.67       |            | -1.66                        |            | dBm  |
| Crest Factor                  | 0.94   | 0.95        |            | 0.95                         |            | dB   |

Figure 3-26: Global result summary for IEEE 802.11b, g (DSSS) standards

The "Result Summary Global" contains the following information:

**Note:** You can configure which results are displayed (see [Chapter 5.3.10, "Result Configuration"](#), on page 143). However, the results are always calculated, regardless of their visibility.

- Number of recognized PPDU's
- Number of analyzed PPDU's
- Number of analyzed PPDU's in entire physical channel (if available)

**IEEE 802.11a, g (OFDM), ac, j, n, p standards:**

- Pilot bit error rate [%]
- EVM all carriers [%/dB]
- EVM data carriers [%/dB]
- EVM pilot carriers [%/dB]
- Center frequency error [Hz]
- Symbol clock error [ppm]

**IEEE 802.11b, g (DSSS) standards:**

- Peak vector error
- PPDU EVM
- Quadrature offset
- Gain imbalance

## WLAN I/Q Measurement (Modulation Accuracy, Flatness and Tolerance)

- Quadrature error
- Center frequency error
- Chip cock error
- Rise time
- Fall time
- Mean power
- Peak power
- Crest power

For details on the individual results and the summarized values see [Chapter 3.1.1, "Modulation Accuracy, Flatness and Tolerance Parameters"](#), on page 12.

Remote command:

LAY:ADD? '1',RIGH, RSGL, see [LAYout:ADD\[:WINDow\]?](#) on page 251

Querying results:

[FETCh:BURSt:ALL](#) on page 273

### Signal Field

This result display shows the decoded data from the "Signal" field of each recognized PPDU. This field contains information on the modulation used for transmission.

This result display is **not** available for single-carrier measurements (**IEEE 802.11b, g (DSSS)**); use [PLCP Header \(IEEE 802.11b, g \(DSSS\)\)](#) instead.

| Format | MCS          | CBW     | HT-SIG Len / Sym Estimated         | SNRA | STBC    | GI     | Ness    | CRC                    | Tail   |
|--------|--------------|---------|------------------------------------|------|---------|--------|---------|------------------------|--------|
| HT-MF  | 0110000<br>6 | 1<br>40 | 000000000100000<br>Sig 17 / Est 17 | 1110 | 00<br>0 | 0<br>L | 00<br>0 | 10111001<br>0x10011101 | 000000 |
| HT-MF  | 0110000<br>6 | 1<br>40 | 000000000100000<br>Sig 17 / Est 17 | 1110 | 00<br>0 | 0<br>L | 00<br>0 | 10111001<br>0x10011101 | 000000 |
| HT-MF  | 0110000<br>6 | 1<br>40 | 000000000100000<br>Sig 17 / Est 17 | 1110 | 00<br>0 | 0<br>L | 00<br>0 | 10111001<br>0x10011101 | 000000 |
| HT-MF  | 0110000<br>6 | 1<br>40 | 000000000100000<br>Sig 17 / Est 17 | 1110 | 00<br>0 | 0<br>L | 00<br>0 | 10111001<br>0x10011101 | 000000 |
| HT-MF  | 0110000<br>6 | 1<br>40 | 000000000100000<br>Sig 17 / Est 17 | 1110 | 00<br>0 | 0<br>L | 00<br>0 | 10111001<br>0x10011101 | 000000 |

Figure 3-27: Signal Field display for IEEE 802.11n

The signal field information is provided as a decoded bit sequence and, where appropriate, also in human-readable form, beneath the bit sequence for each PPDU.

The currently applied demodulation settings (as defined by the user, see [Chapter 5.3.8, "Demodulation"](#), on page 122) are indicated beneath the table header for reference. Since the demodulation settings define which PPDU's are to be analyzed, this *logical filter* may be the reason if the "Signal Field" display is not as expected.

Table 3-5: Demodulation parameters and results for Signal Field result display (IEEE 802.11a, g (OFDM), j, p)

| Parameter     | Description  |
|---------------|--|
| Format        | PPDU format used for measurement (Not part of the IEEE 802.11a, g (OFDM), p signal field, displayed for convenience; see <a href="#">"PPDU Format to measure"</a> on page 124) |
| CBW           | Channel bandwidth to measure (Not part of the signal field, displayed for convenience)   |
| Rate / Mbit/s | Symbol rate per second   |
| R             | Reserved bit   |

## WLAN I/Q Measurement (Modulation Accuracy, Flatness and Tolerance)

| Parameter     | Description                                      |
|---------------|--|
| Length / Sym  | Human-readable length of payload in OFDM symbols |
| P             | Parity bit                                       |
| (Signal) Tail | Signal tail (preset to 0)                        |

**Table 3-6: Demodulation parameters and results for Signal Field result display (IEEE 802.11ac)**

| Parameter          | Description  |
|--------------------|--|
| Format             | PPDU format used for measurement (Not part of the IEEE 802.11ac signal field, displayed for convenience; see <a href="#">"PPDU Format to measure"</a> on page 124) |
| MCS                | Modulation and Coding Scheme (MCS) index of the PPDU as defined in IEEE Std 802.11-2012 section "20.6 Parameters for HT MCSs"                                      |
| BW                 | Channel bandwidth to measure<br>0: 20 MHz<br>1: 40 MHz<br>2: 80 MHz<br>3: 80+80 MHz and 160MHz   |
| L-SIG Length / Sym | Human-readable length of payload in OFDM symbols   |
| STBC               | Space-Time Block Coding<br>0: no spatial streams of any user has space time block coding<br>1: all spatial streams of all users have space time block coding       |
| GI                 | Guard interval length PPDU must have to be measured<br>1: short guard interval is used in the Data field<br>0: short guard interval is not used in the Data field  |
| Ness               | Number of extension spatial streams ( $N_{ESS}$ , see <a href="#">"Extension Spatial Streams (sounding)"</a> on page 135)  |
| CRC                | Cyclic redundancy code   |

**Table 3-7: Demodulation parameters and results for Signal Field result display (IEEE 802.11n)**

| Parameter           | Description   |
|---------------------|---|
| Format              | PPDU format used for measurement (Not part of the IEEE 802.11n signal field, displayed for convenience; see <a href="#">"PPDU Format to measure"</a> on page 124) |
| MCS                 | Modulation and Coding Scheme (MCS) index of the PPDU as defined in IEEE Std 802.11-2012 section "20.6 Parameters for HT MCSs"                                     |
| CBW                 | Channel bandwidth to measure<br>0: 20 MHz or 40 MHz upper/lower<br>1: 40 MHz  |
| HT-SIG Length / Sym | Human-readable length of payload in OFDM symbols<br>The number of octets of data in the PSDU in the range of 0 to 65 535  |

## WLAN I/Q Measurement (Modulation Accuracy, Flatness and Tolerance)

| Parameter | Description   |
|-----------|---|
| SNRA      | <b>Smoothing/Not Sounding/Reserved/Aggregation:</b><br><b>Smoothing:</b><br>1: channel estimate smoothing is recommended<br>0: only per-carrier independent (unsmoothed) channel estimate is recommended<br><b>Not Sounding:</b><br>1: PPDU is not a sounding PPDU<br>0: PPDU is a sounding PPDU<br><b>Reserved:</b> Set to 1<br><b>Aggregation:</b><br>1: PPDU in the data portion of the packet contains an AMPDU<br>0: otherwise |
| STBC      | Space-Time Block Coding<br>00: no STBC (NSTS = NSS)<br>≠0: the difference between the number of spacetime streams (NSTS) and the number of spatial streams (NSS) indicated by the MCS   |
| GI        | Guard interval length PPDU must have to be measured<br>1: short GI used after HT training<br>0: otherwise   |
| Ness      | Number of extension spatial streams ( $N_{ESS}$ , see <a href="#">"Extension Spatial Streams (sounding)"</a> on page 135)   |
| CRC       | Cyclic redundancy code of bits 0–23 in HT-SIG1 and bits 0–9 in HT-SIG2  |
| Tail Bits | Used to terminate the trellis of the convolution coder. Set to 0.   |

The values for the individual demodulation parameters are described in [Chapter 5.3.8, "Demodulation"](#), on page 122. The following abbreviations are used in the "Signal Field" table:

**Table 3-8: Abbreviations for demodulation parameters shown in "Signal Field" display**

| Abbreviation in "Signal Field" display | Parameter in "Demodulation" settings   |
|--|--|
| A1st                                   | Auto, same type as first PPDU          |
| AI                                     | Auto, individual for each PPDU         |
| M<x>                                   | Meas only the specified PPDUs (<x>)    |
| D<x>                                   | Demod all with specified parameter <y> |

The Signal Field measurement indicates certain inconsistencies in the signal or discrepancies between the demodulation settings and the signal to be analyzed. In both cases, an appropriate warning is displayed and the results for the PPDU are highlighted orange - both in the "Signal Field" display and the "Magnitude Capture" display. If the signal was analyzed with warnings the results – indicated by a message - also contribute to the overall analysis results.

PPDUs detected in the signal that do not pass the logical filter, i.e. are not to be included in analysis, are dismissed. An appropriate message is provided. The corresponding PPDU in the capture buffer is not highlighted.

The numeric trace results for this evaluation method are described in [Chapter 11.9.4.18, "Signal Field"](#), on page 302.

Remote command:

LAY:ADD? '1',RIGH, SFI, see LAYout:ADD[:WINDow]? on page 251

or:

CONFigure:BURSt:STATistics:SFIeld[:IMMediate] on page 189

Querying results:

TRACe<n>[:DATA], see [Chapter 11.9.4.18, "Signal Field"](#), on page 302

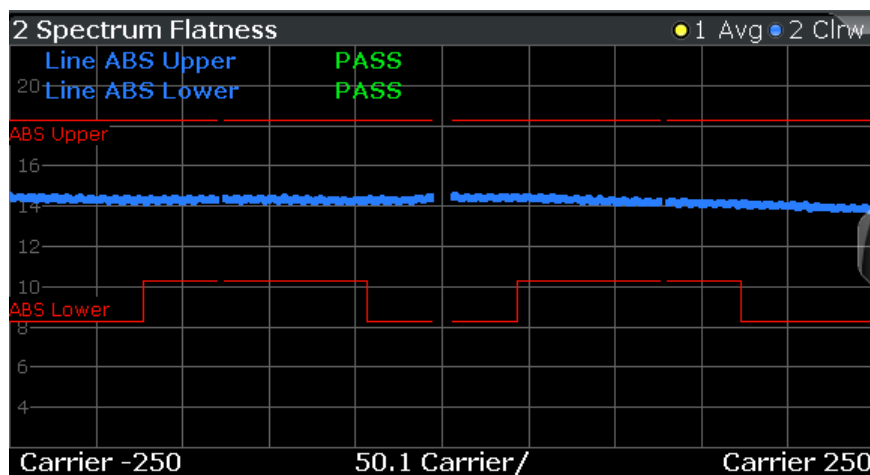
### Spectrum Flatness

The Spectrum Flatness trace is derived from the magnitude of the estimated channel transfer function. Since this estimated channel is calculated from all payload symbols of the PPDU, it represents a carrier-wise mean gain of the channel. Assuming that we have a cable connection between the DUT and the R&S FPS that adds no residual channel distortion, the "Spectrum Flatness" shows the spectral distortion caused by the DUT (for example the transmit filter).

This result display is **not** available for single-carrier measurements (**IEEE 802.11b, g (DSSS)**).

The diagram shows the relative power per carrier. All carriers are displayed, including the unused carrier(s).

In contrast to the SISO measurements in previous Rohde & Schwarz signal and spectrum analyzers, the trace is no longer normalized to 0 dB (scaled by the mean gain of all carriers).



For more information see [Chapter 4.3.6, "Crosstalk and Spectrum Flatness"](#), on page 77.



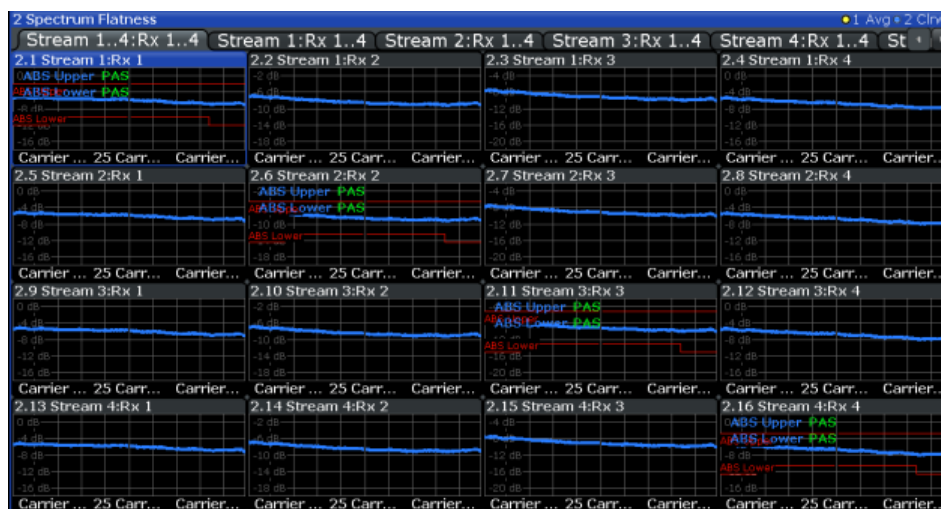


Figure 3-28: Spectrum flatness result display for IEEE 802.11n MIMO measurements

The numeric trace results for this evaluation method are described in [Chapter 11.9.4.19, "Spectrum Flatness"](#), on page 302.

Remote command:

LAY:ADD? '1',RIGHT, SFL, see [LAYout:ADD\[:WINDow\]?](#) on page 251

or:

CONF:BURS:SPEC:FLAT:SEL FLAT (see [CONFigure:BURSt:SPECTrum:FLATness:SElect](#) on page 188) and

[CONFigure:BURSt:SPECTrum:FLATness\[:IMMediate\]](#) on page 189

Querying results:

TRACe<n>[:DATA], see [Chapter 11.9.4.19, "Spectrum Flatness"](#), on page 302

## 3.2 Frequency Sweep Measurements

As described above, the WLAN IQ measurement captures the I/Q data from the WLAN signal using a (nearly rectangular) filter with a relatively large bandwidth. However, some parameters specified in the WLAN 802.11 standard require a better signal-to-noise level or a smaller bandwidth filter than the I/Q measurement provides and must be determined in separate measurements.

Parameters that are common to several digital standards and are often required in signal and spectrum test scenarios can be determined by the standard measurements provided in the R&S FPS base unit (Spectrum application). These measurements are performed using a much narrower bandwidth filter, and they capture only the power level (magnitude, which we refer to as *RF data*) of the signal, as opposed to the two components provided by I/Q data.

Frequency sweep measurements can tune on a constant frequency ("Zero span measurement") or sweep a frequency range ("Frequency sweep measurement")

The signal cannot be demodulated based on the captured RF data. However, the required power information can be determined much more precisely, as more noise is filtered out of the signal.

The Frequency sweep measurements provided by the R&S FPS WLAN application are identical to the corresponding measurements in the base unit, but are pre-configured according to the requirements of the selected WLAN 802.11 standard.

For details on these measurements see the R&S FPS User Manual.



#### MSRA operating mode

Frequency sweep measurements are not available in MSRA operating mode.

For details on the MSRA operating mode see the R&S FPS MSRA User Manual.

The R&S FPS WLAN application provides the following frequency sweep measurements:

### 3.2.1 Measurement Types and Results for Frequency Sweep Measurements

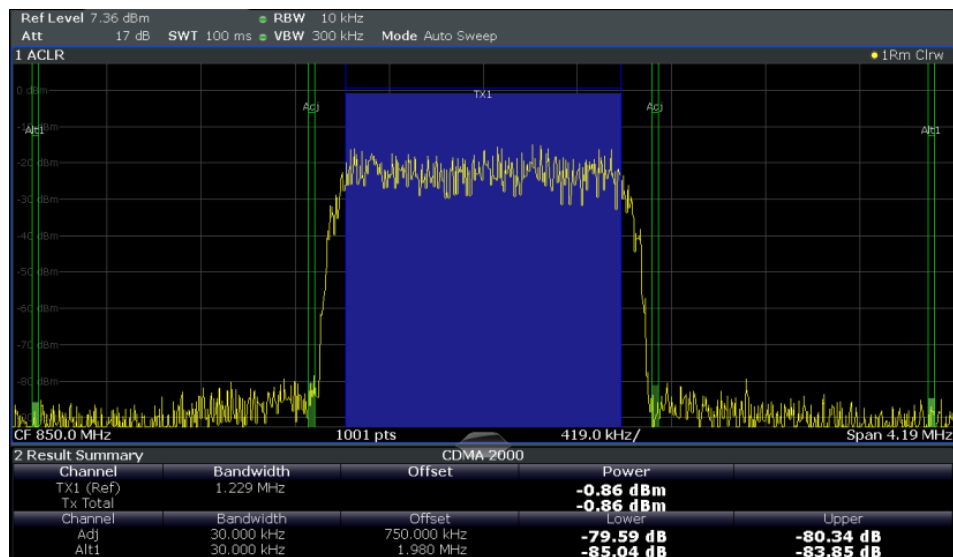
The R&S FPS WLAN application provides the following pre-configured frequency sweep measurements:

|                             |    |
|-----------------------------|----|
| Channel Power ACLR.....     | 50 |
| Spectrum Emission Mask..... | 51 |
| Occupied Bandwidth.....     | 52 |
| CCDF.....                   | 53 |

#### Channel Power ACLR

Channel Power ACLR performs an adjacent channel power (also known as adjacent channel leakage ratio) measurement according to WLAN 802.11 specifications.

The R&S FPS measures the channel power and the relative power of the adjacent channels and of the alternate channels. The results are displayed in the Result Summary.



For details see [Chapter 5.4.1, "Channel Power \(ACLR\) Measurements"](#), on page 152.

Remote command:

`CONFigure:BURSt:SPECTrum:ACPR[:IMMediate]` on page 190

Querying results:

`CALC:MARK:FUNC:POW:RES? ACP`, see `CALCulate<n>:MARKer<m>:FUNCtion:POWer<sb>:RESult?` on page 285

### Spectrum Emission Mask

**Access:** "Overview" > "Select Measurement" > "SEM"

**or:** MEAS > "Select Measurement" > "SEM"

The Spectrum Emission Mask (SEM) measurement determines the power of the WLAN 802.11 signal in defined offsets from the carrier and compares the power values with a spectral mask specified by the WLAN 802.11 specifications. The limits depend on the selected bandclass. Thus, the performance of the DUT can be tested and the emissions and their distance to the limit be identified.

**Note:** The WLAN 802.11 standard does not distinguish between spurious and spectral emissions.

For details see [Chapter 5.4.2, "Spectrum Emission Mask"](#), on page 153.

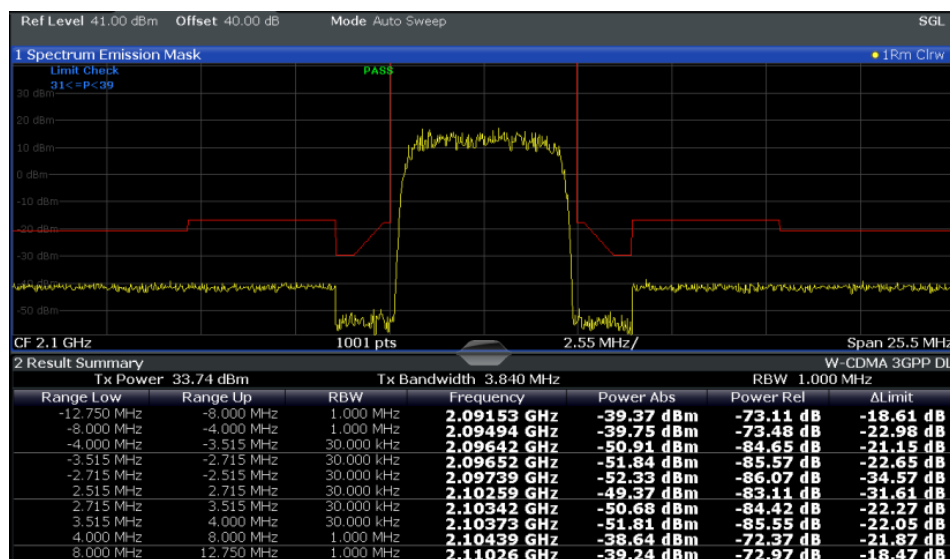


Figure 3-29: SEM measurement results

Remote command:

CONFigure:BURSt:SPECTrum:MASK[:IMMediate] on page 190

Querying results:

CALCulate<n>:LIMit<k>:FAIL? on page 284

TRAC:DATA? LIST, see TRACe<n>[:DATA] on page 289

### Occupied Bandwidth

The Occupied Bandwidth (OBW) measurement determines the bandwidth in which – in default settings - 99 % of the total signal power is to be found. The percentage of the signal power to be included in the bandwidth measurement can be changed.

The occupied bandwidth is indicated as the "Occ BW" function result in the marker table; the frequency markers used to determine it are also displayed.



For details see Chapter 5.4.3, "Occupied Bandwidth", on page 154.

Remote command:

`CONFigure:BURSt:SPECTrum:OBWidth[:IMMediate]` on page 191

Querying results:

`CALC:MARK:FUNC:POW:RES? OBW`, see `CALCulate<n>:MARKer<m>:FUNCTion:POWer<sb>:RESult?` on page 285

**CCDF**

The CCDF (complementary cumulative distribution function) measurement determines the distribution of the signal amplitudes. The measurement captures a user-definable amount of samples and calculates their mean power. As a result, the probability that a sample's power is higher than the calculated mean power + x dB is displayed. The crest factor is displayed in the Result Summary.

For details see [Chapter 5.4.4, "CCDF"](#), on page 155.



Figure 3-30: CCDF measurement results

Remote command:

`CONFigure:BURSt:STATistics:CCDF[:IMMediate]` on page 191

Querying results:

`CALCulate<n>:MARKer<m>:Y?` on page 304

`CALCulate<n>:STATistics:RESult<t>?` on page 287

**3.2.2 Evaluation Methods for Frequency Sweep Measurements**

The evaluation methods for frequency sweep measurements in the R&S FPS WLAN application are identical to those in the R&S FPS base unit (Spectrum application).

[Diagram](#)..... 54

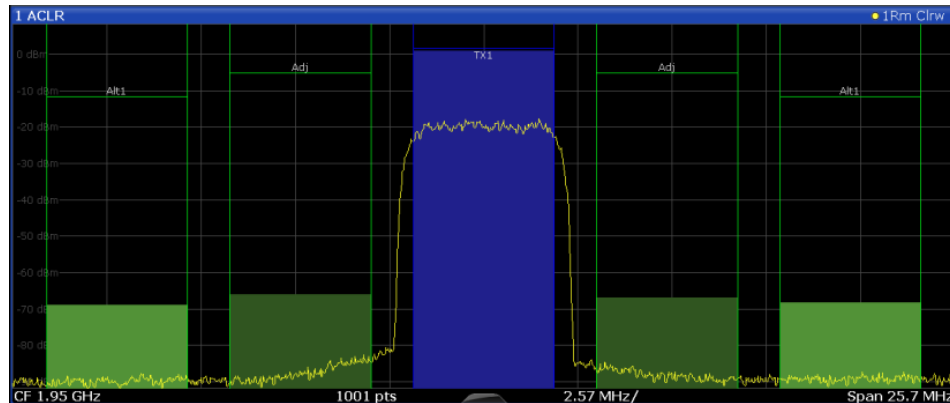
[Result Summary](#)..... 54

[Marker Table](#)..... 54

[Marker Peak List](#)..... 55

**Diagram**

Displays a basic level vs. frequency or level vs. time diagram of the measured data to evaluate the results graphically. This is the default evaluation method. Which data is displayed in the diagram depends on the "Trace" settings. Scaling for the y-axis can be configured.



Remote command:

LAY:ADD? '1',RIGHT, DIAG, see LAYout:ADD[:WINDow]? on page 251

**Result Summary**

Result summaries provide the results of specific measurement functions in a table for numerical evaluation. The contents of the result summary vary depending on the selected measurement function. See the description of the individual measurement functions for details.

| 2 Result Summary |            |             |                  |                  |
|------------------|------------|-------------|------------------|------------------|
| Channel          | Bandwidth  | Offset      | Power            |                  |
| TX1 (Ref)        | 1.229 MHz  |             | <b>-0.86 dBm</b> |                  |
| Tx Total         |            |             | <b>-0.86 dBm</b> |                  |
| Channel          | Bandwidth  | Offset      | Lower            | Upper            |
| Adj              | 30.000 kHz | 750.000 kHz | <b>-79.59 dB</b> | <b>-80.34 dB</b> |
| Alt1             | 30.000 kHz | 1.980 MHz   | <b>-85.04 dB</b> | <b>-83.85 dB</b> |

**Tip:** To navigate within long result summary tables, simply scroll through the entries with your finger on the touchscreen.

Remote command:

LAY:ADD? '1',RIGHT, RSUM, see LAYout:ADD[:WINDow]? on page 251

**Marker Table**

Displays a table with the current marker values for the active markers.

| 4 Marker Table |      |     |     |                   |  |                   |
|----------------|------|-----|-----|-------------------|--|-------------------|
| Wnd            | Type | Ref | Trc | X-value           |  | Y-value           |
| 1              | M1   |     | 1   | <b>13.25 GHz</b>  |  | <b>-200.0 dBm</b> |
| 1              | D2   | M1  | 1   | <b>-600.0 kHz</b> |  | <b>0.0 dB</b>     |
| 1              | D3   | M1  | 1   | <b>600.0 kHz</b>  |  | <b>0.0 dB</b>     |
| 1              | D4   | M1  | 1   | <b>-2.0 MHz</b>   |  | <b>0.0 dB</b>     |

Remote command:

LAY:ADD? '1',RIGHT, MTAB, see LAYout:ADD[:WINDow]? on page 251

Results:

CALCulate<n>:MARKer<m>:X on page 287

CALCulate<n>:MARKer<m>:Y? on page 304

### Marker Peak List

The marker peak list determines the frequencies and levels of peaks in the spectrum or time domain. How many peaks are displayed can be defined, as well as the sort order. In addition, the detected peaks can be indicated in the diagram. The peak list can also be exported to a file for analysis in an external application.

| 2 Marker Peak List |                |             |
|--------------------|----------------|-------------|
| No                 | Stimulus       | Response    |
| 1                  | 64.400000 MHz  | -30.352 dBm |
| 2                  | 128.400000 MHz | -51.896 dBm |
| 3                  | 192.300000 MHz | -40.227 dBm |
| 4                  | 257.200000 MHz | -60.699 dBm |
| 5                  | 320.200000 MHz | -44.273 dBm |
| 6                  | 384.100000 MHz | -53.494 dBm |
| 7                  | 448.100000 MHz | -47.460 dBm |
| 8                  | 513.000000 MHz | -55.603 dBm |

**Tip:** To navigate within long marker peak lists, simply scroll through the entries with your finger on the touchscreen.

Remote command:

LAY:ADD? '1',RIGH, PEAK, see [LAYout:ADD\[:WINDow\]?](#) on page 251

Results:

[CALCulate<n>:MARKer<m>:X](#) on page 287

[CALCulate<n>:MARKer<m>:Y?](#) on page 304

## 4 Measurement Basics

Some background knowledge on basic terms and principles used in WLAN measurements is provided here for a better understanding of the required configuration settings.

### 4.1 Signal Processing for Multicarrier Measurements (IEEE 802.11a, g (OFDM), j, p)

This description gives a rough view of the signal processing when using the R&S FPS WLAN application with the IEEE 802.11a, g (OFDM), j, p standards. Details are disregarded in order to provide a concept overview.

#### Abbreviations

|                  |  |
|------------------|--|
| $a_{l,k}$        | symbol at symbol $l$ of subcarrier $k$             |
| $EVM_k$          | error vector magnitude of subcarrier $k$           |
| EVM              | error vector magnitude of current packet           |
| $g$              | signal gain  |
| $\Delta f$       | frequency deviation between Tx and Rx              |
| $l$              | symbol index $l = \{1 \dots \text{nof\_Symbols}\}$ |
| nof_symbols      | number of symbols of payload                       |
| $H_k$            | channel transfer function of subcarrier $k$        |
| $k$              | channel index $k = \{-31 \dots 32\}$               |
| $K_{\text{mod}}$ | modulation-dependent normalization factor          |
| $\xi$            | relative clock error of reference oscillator       |
| $r_{l,k}$        | subcarrier of symbol $l$                           |

- [Block Diagram for Multicarrier Measurements](#)..... 56
- [Literature on the IEEE 802.11a Standard](#)..... 63

#### 4.1.1 Block Diagram for Multicarrier Measurements

A diagram of the significant blocks when using the IEEE 802.11a, g (OFDM), j, p standard in the R&S FPS WLAN application is shown in [Figure 4-1](#).

First the RF signal is downconverted to the IF frequency  $f_{\text{IF}}$ . The resulting IF signal  $r_{\text{IF}}(t)$  is shown on the left-hand side of the figure. After bandpass filtering, the signal is sampled by an analog to digital converter (ADC) at a sample rate of  $f_{\text{s1}}$ . This digital



sequence is resampled. Thus, the sample rate of the downsampled sequence  $r(i)$  is the Nyquist rate of  $f_{s3} = 20$  MHz. Up to this point the digital part is implemented in an ASIC.

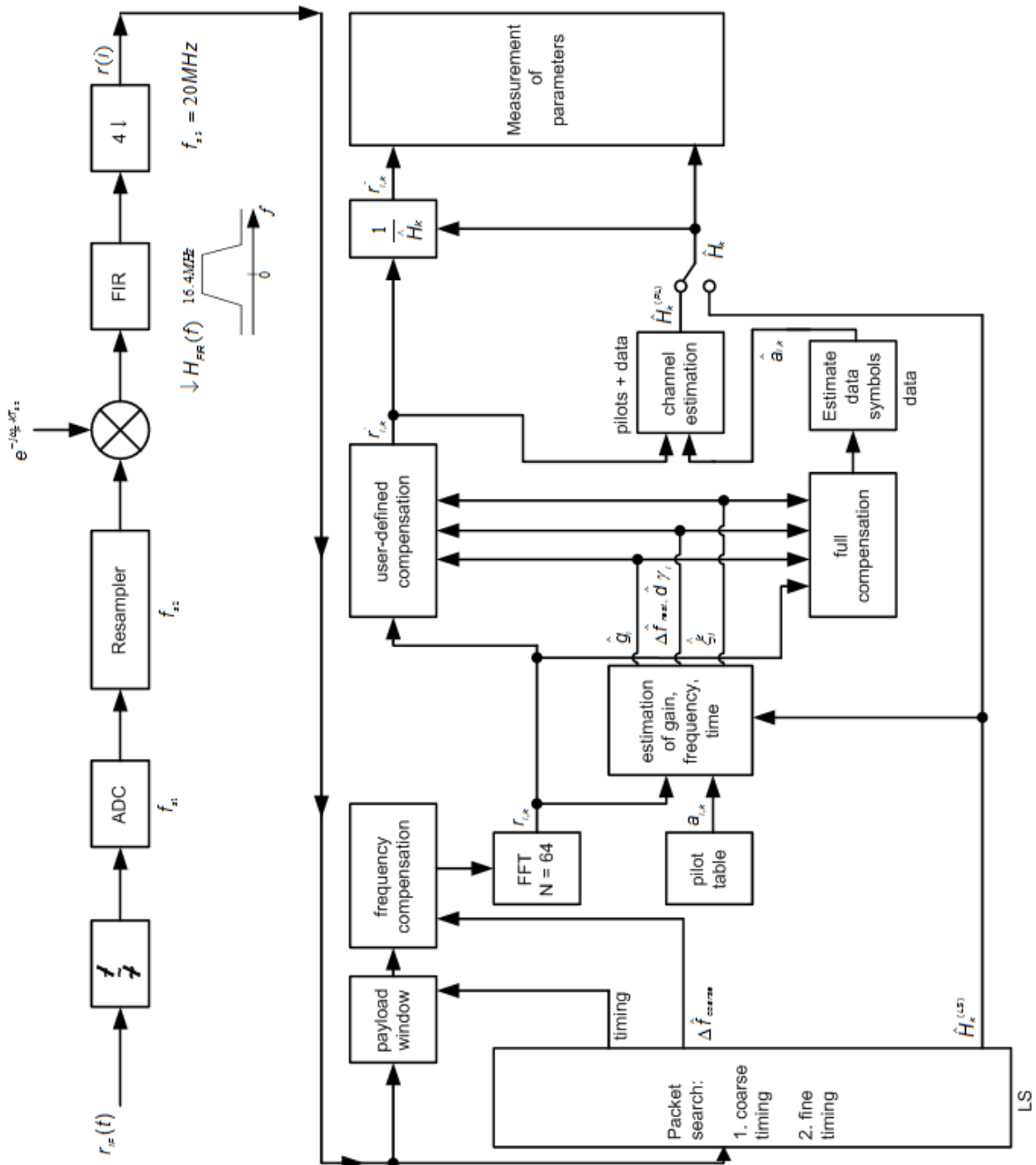


Figure 4-1: Block diagram for the R&S FPS WLAN application using the IEEE 802.11a, g (OFDM), j, p standard

In the lower part of the figure the subsequent digital signal processing is shown.

### Packet search and timing detection

In the first block the **packet search** is performed. This block detects the *long symbol* (LS) and recovers the timing. The **coarse timing** is detected first. This search is implemented in the time domain. The algorithm is based on cyclic repetition within the LS after  $N = 64$  samples. Numerous treatises exist on this subject, e.g. [1] to [3].

Furthermore, a coarse estimate  $\Delta f_{\text{coarse}}$  of the Rx-Tx frequency offset  $\Delta f$  is derived from the metric in [6]. (The hat generally indicates an estimate, e.g.  $\hat{x}$  is the estimate of  $x$ .) This can easily be understood because the phase of  $r(i) \cdot \Delta r^*(i + N)$  is determined by the frequency offset. As the frequency deviation  $\Delta f$  can exceed half a bin (distance between neighboring subcarriers) the preceding *short symbol* (SS) is also analyzed in order to detect the ambiguity.

After the coarse timing calculation the time estimate is improved by the **fine timing** calculation. This is achieved by first estimating the coarse frequency response  $\hat{H}_k^{(LS)}$ , where  $k = \{-26.. 26\}$  denotes the channel index of the *occupied* subcarriers. First the FFT of the LS is calculated. After the FFT calculation the known symbol information of the LS subcarriers is removed by dividing by the symbols. The result is a coarse estimate  $\hat{H}_k$  of the channel transfer function. In the next step, the complex channel impulse response is computed by an IFFT. Then the energy of the windowed impulse response (the window size is equal to the guard period) is calculated for each trial time. Afterwards the trial time of the maximum energy is detected. This trial time is used to adjust the timing.

### Determining the payload window

Now the position of the LS is known and the starting point of the useful part of the first payload symbol can be derived. In the next block this calculated time instant is used to position the **payload window**. Only the payload part is windowed. This is sufficient because the payload is the only subject of the subsequent measurements.

In the next block the windowed sequence is **compensated** by the coarse frequency estimate  $\Delta f_{\text{coarse}}$ . This is necessary because otherwise inter-channel interference (ICI) would occur in the frequency domain.

The transition to the frequency domain is achieved by an FFT of length 64. The FFT is performed symbol-wise for each symbol of the payload ("nof\_symbols"). The calculated FFTs are described by  $r_{l,k}$  with:

- $l = \{1 .. \text{nof\_symbols}\}$  as the symbol index
- $k = \{-31 .. 32\}$  as the channel index

In case of an additive white Gaussian noise (AWGN) channel, the FFT is described by [4], [5]

$$r_{l,k} = K_{\text{mod}} \times a_{l,k} \times g_l \times H_k \times e^{j(\text{phase}_l^{(\text{common})} + \text{phase}_{l,k}^{(\text{timing})})} + n_{l,k}$$

#### Equation 4-1: FFT

with:

- $K_{\text{mod}}$ : the modulation-dependant normalization factor

- $a_{l,k}$ : the symbol of subcarrier  $k$  at symbol  $l$
- $g_l$ : the gain at the symbol  $l$  in relation to the reference gain  $g = 1$  at the long symbol (LS)
- $H_k$ : the channel frequency response at the long symbol (LS)
- $phase_l^{(common)}$ : the common phase drift phase of all subcarriers at symbol  $l$  (see [Common phase drift](#))
- $phase_{l,k}^{(timing)}$ : the phase of subcarrier  $k$  at symbol  $l$  caused by the timing drift (see [Common phase drift](#))
- $n_{l,k}$ : the independent Gaussian distributed noise samples

### Phase drift and frequency deviation

The common phase drift in [FFT](#) is given by:

$$phase_l^{(common)} = 2\pi \times N_s / N \times \Delta f_{rest} T \times l + d\gamma_l$$

**Equation 4-2: Common phase drift**

with

- $N_s = 80$ : the number of Nyquist samples of the symbol period
- $N = 64$ : the number of Nyquist samples of the useful part of the symbol
- $\Delta f_{rest}$ : the (not yet compensated) frequency deviation
- $d\gamma_l$ : the phase jitter at the symbol  $l$

In general, the coarse frequency estimate  $\Delta \hat{f}_{coarse}$  (see [Figure 4-1](#)) is not error-free. Therefore the remaining frequency error  $\Delta f_{rest}$  represents the frequency deviation in  $r_{l,k}$  not yet compensated. Consequently, the overall frequency deviation of the device under test (DUT) is calculated by:

$$\Delta f = \Delta \hat{f}_{coarse} + \Delta f_{rest}$$



The common phase drift in [Common phase drift](#) is divided into two parts to calculate the overall frequency deviation of the DUT.

The reason for the phase jitter  $d\gamma_l$  in [Common phase drift](#) may be different. The nonlinear part of the phase jitter may be caused by the phase noise of the DUT oscillator. Another reason for nonlinear phase jitter may be the increase of the DUT amplifier temperature at the beginning of the PPDU. Note that besides the nonlinear part the phase jitter,  $d\gamma_l$  also contains a constant part. This constant part is caused by the frequency deviation  $\Delta f_{rest}$  not yet compensated. To understand this, keep in mind that the measurement of the phase starts at the first symbol  $l = 1$  of the payload. In contrast, the channel frequency response  $H_k$  in [FFT](#) represents the channel at the long symbol of the preamble. Consequently, the frequency deviation  $\Delta f_{rest}$  not yet compensated produces a phase drift between the long symbol and the first symbol of the payload. Therefore, this phase drift appears as a constant value ("DC value") in  $d\gamma_l$ .

### Tracking the phase drift, timing jitter and gain

Referring to the IEEE 802.11a, g (OFDM), j, p measurement standard, chapter 17.3.9.7 "Transmit modulation accuracy test" [6], the common phase drift phase<sub>l</sub> (common) must be estimated and compensated from the pilots. Therefore this "symbol-wise phase tracking" is activated as the default setting of the R&S FPS WLAN application (see "Phase Tracking" on page 121).

Furthermore, the timing drift in FFT is given by:

$$phase_{l,k}^{(timing)} = 2\pi \times N_s / N \times \xi \times k \times l$$

#### Equation 4-3: Timing drift

with  $\xi$ : the relative clock deviation of the reference oscillator

Normally, a symbol-wise timing jitter is negligible and thus not modeled in Timing drift. However, there may be situations where the timing drift has to be taken into account. This is illustrated by an example: In accordance to [6], the allowed clock deviation of the DUT is up to  $\xi_{max} = 20$  ppm. Furthermore, a long packet with 400 symbols is assumed. The result of FFT and Timing drift is that the phase drift of the highest sub-carrier  $k = 26$  in the last symbol  $l = \text{nof\_symbols}$  is 93 degrees. Even in the noise-free case, this would lead to symbol errors. The example shows that it is actually necessary to estimate and compensate the clock deviation, which is accomplished in the next block.

Referring to the IEEE 802.11a, g (OFDM), j, p measurement standard [6], the timing drift phase<sub>l,k</sub> (timing) is not part of the requirements. Therefore the "time tracking" is not activated as the default setting of the R&S FPS WLAN application (see "Timing Error Tracking" on page 121). The time tracking option should rather be seen as a powerful analyzing option.

In addition, the tracking of the gain  $g_l$  in FFT is supported for each symbol in relation to the reference gain  $g = 1$  at the time instant of the long symbol (LS). At this time the coarse channel transfer function  $\hat{H}^{(LS)}_k$  is calculated.

This makes sense since the sequence  $r'_{l,k}$  is compensated by the coarse channel transfer function  $\hat{H}^{(LS)}_k$  before estimating the symbols. Consequently, a potential change of the gain at the symbol  $l$  (caused, for example, by the increase of the DUT amplifier temperature) may lead to symbol errors especially for a large symbol alphabet  $M$  of the MQAM transmission. In this case, the estimation and the subsequent compensation of the gain are useful.

Referring to the IEEE 802.11a, g (OFDM), j, p measurement standard [6], the compensation of the gain  $g_l$  is not part of the requirements. Therefore the "gain tracking" is not activated as the default setting of the R&S FPS WLAN application (see "Level Error (Gain) Tracking" on page 121).

### Determining the error parameters (log likelihood function)

How can the parameters above be calculated? In this application the optimum maximum likelihood algorithm is used. In the first estimation step the symbol-independent parameters  $\Delta f_{rest}$  and  $\xi$  are estimated. The symbol dependent parameters can be

neglected in this step, i.e. the parameters are set to  $g_l = 1$  and  $d\tilde{\gamma} = 0$ . Referring to [FFT](#), the log likelihood function  $L$  must be calculated as a function of the trial parameters  $\Delta\tilde{f}_{rest}$  and  $\tilde{\xi}$ . (The tilde generally describes a trial parameter. Example:  $\tilde{x}$  is the trial parameter of  $x$ .)

$$L_1(\Delta\tilde{f}_{rest}, \tilde{\xi}) = \sum_{l=1}^{nof\_symbols} \sum_{k=-21,-7,7,21} \left| r_{l,k} - a_{l,k} \times \hat{H}_k^{(LS)} \times e^{j(\tilde{p}hase_l^{(common)} + \tilde{p}hase_l^{(ti\ min\ g)})} \right|^2$$

with

$$\tilde{p}hase_l^{(common)} = 2\pi \times N_s / N \times \Delta\tilde{f}_{rest} T \times l$$

$$\tilde{p}hase_l^{(ti\ min\ g)} = 2\pi \times N_s / N \times \tilde{\xi} \times k \times l$$

**Equation 4-4: Log likelihood function (step 1)**

The trial parameters leading to the minimum of the log likelihood function are used as estimates  $\Delta\hat{f}_{rest}$  and  $\hat{\xi}$ . In [Log likelihood function \(step 1\)](#) the known pilot symbols  $a_{l,k}$  are read from a table.

In the second step, the log likelihood function is calculated for every symbol  $l$  as a function of the trial parameters  $\tilde{g}_l$  and  $d\tilde{\gamma}_l$ :

$$L_2(\tilde{g}_l, d\tilde{\gamma}_l) = \sum_{k=-21,-7,7,21} \left| r_{l,k} - a_{l,k} \times \tilde{g}_l \times \hat{H}_k^{(LS)} \times e^{j(\tilde{p}hase_l^{(common)} + \tilde{p}hase_l^{(ti\ min\ g)})} \right|^2$$

with

$$\tilde{p}hase_l^{(common)} = 2\pi \times N_s / N \times \Delta\hat{f}_{rest} T \times l + d\tilde{\gamma}_l$$

$$\tilde{p}hase_l^{(ti\ min\ g)} = 2\pi \times N_s / N \times \hat{\xi} \times k \times l$$

**Equation 4-5: Log likelihood function (step 2)**

Finally, the trial parameters leading to the minimum of the log likelihood function are used as estimates  $\hat{g}_l$  and  $d\hat{\gamma}_l$ .

This robust algorithm works well even at low signal to noise ratios with the Cramer Rao Bound being reached.

### Compensation

After estimation of the parameters, the sequence  $r_{l,k}$  is compensated in the compensation blocks.

In the upper analyzing branch the compensation is user-defined i.e. the user determines which of the parameters are compensated. This is useful in order to extract the influence of these parameters. The resulting output sequence is described by:  $\hat{\gamma}'_{\delta,k}$ .

### Data symbol estimation

In the lower compensation branch the full compensation is always performed. This separate compensation is necessary in order to avoid symbol errors. After the full compensation the secure estimation of the data symbols  $\hat{a}_{l,k}$  is performed. From [FFT](#) it is clear that first the channel transfer function  $H_k$  must be removed. This is achieved by

dividing the known coarse channel estimate  $\hat{H}^{(LS)}_k$  calculated from the LS. Usually an error free estimation of the data symbols can be assumed.

### Improving the channel estimation

In the next block a better channel estimate  $\hat{H}^{(PL)}_k$  of the data and pilot subcarriers is calculated by using all "nof\_symbols" symbols of the payload (PL). This can be accomplished at this point because the phase is compensated and the data symbols are known. The long observation interval of nof\_symbols symbols (compared to the short interval of 2 symbols for the estimation of  $\hat{H}^{(LS)}_k$ ) leads to a nearly error-free channel estimate.

In the following equalizer block,  $\hat{H}^{(LS)}_k$  is compensated by the channel estimate. The resulting channel-compensated sequence is described by  $y_{\delta,k}$ . The user may either choose the coarse channel estimate  $\hat{H}^{(LS)}_k$  (from the long symbol) or the nearly error-free channel estimate  $\hat{H}^{(PL)}_k$  (from the payload) for equalization. If the improved estimate  $\hat{H}^{(LS)}_k$  is used, a 2 dB reduction of the subsequent EVM measurement can be expected.

According to the IEEE 802.11a measurement standard [6], the coarse channel estimation  $\hat{H}^{(LS)}_k$  (from the long symbol) has to be used for equalization. Therefore the default setting of the R&S FPS WLAN application is equalization from the coarse channel estimate derived from the long symbol.

### Calculating error parameters

In the last block the parameters of the demodulated signal are calculated. The most important parameter is the error vector magnitude of the subcarrier "k" of the current packet:

$$\overline{EVM} = \sqrt{\frac{1}{\text{nof\_packets}} \sum_{\text{counter}=1}^{\text{nof\_packets}} EVM^2(\text{counter})}$$

**Equation 4-6: Error vector magnitude of the subcarrier k in current packet**

Furthermore, the packet error vector magnitude is derived by averaging the squared  $EVM_k$  versus k:

$$EVM = \sqrt{\frac{1}{52} \sum_{k=-26(k \neq 0)}^{26} EVM_k^2}$$

**Equation 4-7: Error vector magnitude of the entire packet**

Finally, the average error vector magnitude is calculated by averaging the packet EVM of all nof\_symbols detected packets:

$$EVM_k = \sqrt{\frac{1}{\text{nof\_symbols}} \sum_{l=1}^{\text{nof\_symbols}} |r_{l,k}'' - K_{\text{mod}} \times a_{l,k}|^2}$$

**Equation 4-8: Average error vector magnitude**

This parameter is equivalent to the "RMS average of all errors":  $\text{Error}_{\text{RMS}}$  of the IEEE 802.11a measurement commandment (see [6]).

#### 4.1.2 Literature on the IEEE 802.11a Standard

|     |  |
|-----|--|
| [1] | Speth, Classen, Meyr: "Frame synchronization of OFDM systems in frequency selective fading channels", VTC '97, pp. 1807-1811                                       |
| [2] | Schmidl, Cox: "Robust Frequency and Timing Synchronization of OFDM", IEEE Trans. on Comm., Dec. 1997, pp. 1613-621   |
| [3] | Minn, Zeng, Bhargava: "On Timing Offset Estimation for OFDM", IEEE Communication Letters, July 2000, pp. 242-244   |
| [4] | Speth, Fechtel, Fock, Meyr: "Optimum receive antenna Design for Wireless Broad-Band Systems Using OFDM – Part I", IEEE Trans. On Comm. VOL. 47, NO 11, Nov. 1999   |
| [5] | Speth, Fechtel, Fock, Meyr: "Optimum receive antenna Design for Wireless Broad-Band Systems Using OFDM – Part II", IEEE Trans. On Comm. VOL. 49, NO 4, April. 2001 |
| [6] | IEEE 802.11a, Part 11: WLAN Medium Access Control (MAC) and Physical Layer (PHY) specifications  |

## 4.2 Signal Processing for Single-Carrier Measurements (IEEE 802.11b, g (DSSS))

This description gives a rough overview of the signal processing concept of the WLAN 802.11 application for IEEE 802.11b or g (DSSS) signals.

### Abbreviations

|                   |   |
|-------------------|---|
| $\varepsilon$     | timing offset   |
| $\Delta f$        | frequency offset  |
| $\Delta\Phi$      | phase offset  |
| $\hat{g}_I$       | estimate of the gain factor in the I-branch                               |
| $\hat{g}_Q$       | estimate of the gain factor in the Q-branch                               |
| $\Delta\hat{g}_Q$ | accurate estimate of the crosstalk factor of the Q-branch in the I-branch |
| $\hat{h}_s(v)$    | estimated baseband filter of the transmit antenna                         |
| $\hat{h}_r(v)$    | estimated baseband filter of the receive antenna                          |
| $\hat{\delta}_I$  | estimate of the IQ-offset in the I-branch                                 |
| $\hat{\delta}_Q$  | estimate of the IQ-offset in the I-branch                                 |
| $r(v)$            | measurement signal  |
| $\hat{s}(v)$      | estimate of the reference signal  |

|                |   |
|----------------|---|
| $\hat{s}_n(v)$ | estimate of the power-normalized and undisturbed reference signal         |
| ARG{...}       | calculation of the angle of a complex value                               |
| EVM            | error vector magnitude  |
| IMAG{...}      | calculation of the imaginary part of a complex value                      |
| PPDU           | protocol data unit - a burst in the signal containing transmission data   |
| PSDU           | protocol service data unit- a burst in the signal containing service data |
| REAL{...}      | calculation of the real part of a complex value                           |

- [Block Diagram for Single-Carrier Measurements](#).....64
- [Calculation of Signal Parameters](#).....66
- [Literature on the IEEE 802.11b Standard](#).....69

### 4.2.1 Block Diagram for Single-Carrier Measurements

A block diagram of the measurement application is shown below in [Figure 4-2](#). The baseband signal of an IEEE 802.11b or g (DSSS) wireless LAN system transmit antenna is sampled with a sample rate of 44 MHz.

The first task of the measurement application is to detect the position of the PPDU within the measurement signal  $r_1(v)$ . The detection algorithm is able to find the the beginning of short and long PPDU's and can distinguish between them. The algorithm also detects the initial state of the scrambler, which is not specified by the IEEE 802.11 standard.

If the start position of the PPDU is known, the header of the PPDU can be demodulated. The bits transmitted in the header provide information about the length of the PPDU and the modulation type used in the PSDU.

Once the start position and the PPDU length are fully known, better estimates of timing offset, timing drift, frequency offset and phase offset can be calculated using the entire data of the PPDU.

At this point of the signal processing, demodulation can be performed without decision error. After demodulation the normalized (in terms of power) and undisturbed reference signal  $s(v)$  is available.

If the frequency offset is not constant and varies with time, the frequency offset and phase offset in several partitions of the PPDU must be estimated and corrected. Additionally, timing offset, timing drift and gain factor can be estimated and corrected in several partitions of the PPDU. These corrections can be switched off individually in the demodulation settings of the application.



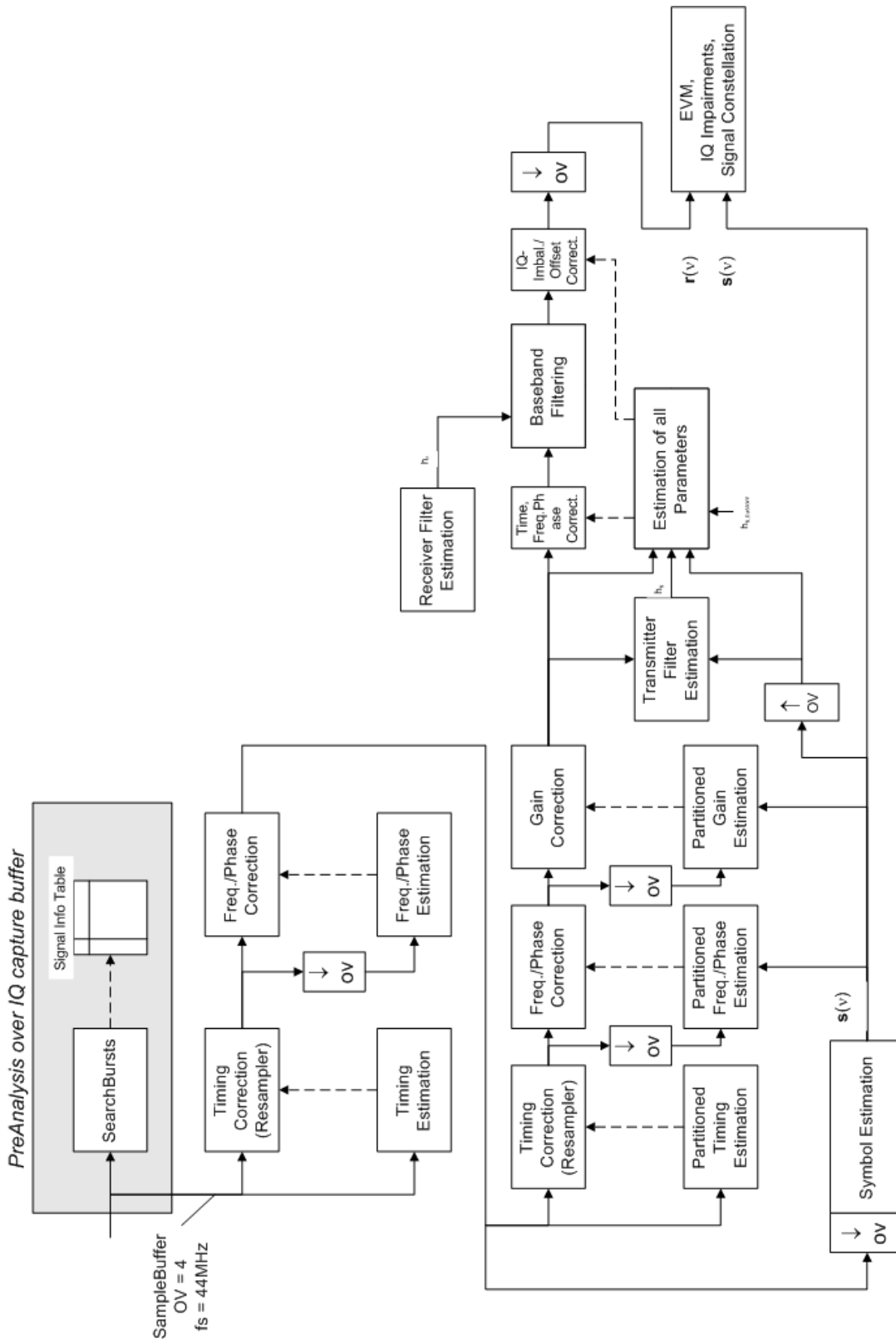


Figure 4-2: Signal processing for IEEE 802.11b or g (DSSS) signals

Once the the normalized and undisturbed reference signal is available, the transmit antenna baseband filter (Tx filter) is estimated by minimizing the cost function of a maximum-likelihood-based estimator:

$$L_1 = \sum_{\nu=0}^{N-1} \left| r(\nu) \times e^{-j2\pi\Delta\tilde{f}\nu} \times e^{-j\Delta\tilde{\phi}} - \sum_{i=-L}^{+L} \tilde{h}_s(i) \times \hat{s}_n(\nu - i) - \tilde{o}_I - j\tilde{o}_Q \right|^2$$

Equation 4-9: transmit antenna baseband filter (Tx filter) estimation

where:

$r(\nu)$  : the oversampled measurement signal

$\hat{s}_n(\nu)$  : the normalized oversampled power of the undisturbed reference signal

$N$  : the observation length

$L$  : the filter length

$\Delta\tilde{f}\nu$  : the variation parameters of the frequency offset

$\Delta\tilde{\phi}$  : the variation parameters of the phase offset

$\tilde{o}_I, \tilde{o}_Q$ : the variation parameters of the IQ-offset

$\tilde{h}_s(i)$ : the coefficients of the transmitter filter

#### 4.2.2 Calculation of Signal Parameters

The frequency offset, the phase offset and the IQ-offset are estimated jointly with the coefficients of the transmit filter to increase the estimation quality.

Once the transmit filter is known, all other unknown signal parameters are estimated with a maximum-likelihood-based estimation, which minimizes the cost function:

$$L_2 = \sum_{\nu=0}^{N-1} \left| r(\nu - \tilde{\varepsilon}) \times e^{-j2\pi\tilde{f}\nu} \times e^{-j\Delta\tilde{\phi}} - \tilde{g}_I \times s_I(\nu) - j\tilde{g}_Q \times s_Q(\nu) + \Delta\tilde{g}_Q \times s_Q(\nu) - \tilde{o}_I - j\tilde{o}_Q \right|^2$$

Equation 4-10: Cost function for signal parameters

where:

$\tilde{g}_I, \tilde{g}_Q$  : the variation parameters of the gain used in the I/Q-branch

$\Delta\tilde{g}_Q$  : the crosstalk factor of the Q-branch into the I-branch

$s_I(\nu), s_Q(\nu)$  : the filtered reference signal of the I/Q-branch

The unknown signal parameters are estimated in a joint estimation process to increase the accuracy of the estimates.

The accurate estimates of the frequency offset, the gain imbalance, the quadrature error and the normalized I/Q offset are displayed by the measurement software.

#### Gain imbalance, I/Q offset, quadrature error

The gain imbalance is the quotient of the estimates of the gain factor of the Q-branch, the crosstalk factor and the gain factor of the I-branch:

$$\mathbf{Gain - imbalance} = \left| \frac{\hat{\mathbf{g}}_Q + \Delta\hat{\mathbf{g}}_Q}{\hat{\mathbf{g}}_I} \right|$$

Equation 4-11: Gain imbalance

The quadrature error is a measure for the crosstalk of the Q-branch into the I-branch:

$$\mathbf{Quadrature - Error} = \mathbf{ARG} \{ \hat{\mathbf{g}}_Q + \mathbf{j} \times \Delta\hat{\mathbf{g}}_Q \}$$

Equation 4-12: Quadrature error (crosstalk)

The normalized I/Q offset is defined as the magnitude of the I/Q offset normalized by the magnitude of the reference signal:

$$\mathbf{IQ - Offset} = \frac{\sqrt{\hat{\sigma}_I^2 + \hat{\sigma}_Q^2}}{\sqrt{\frac{1}{2} \cdot [\hat{\mathbf{g}}_I^2 + \hat{\mathbf{g}}_Q^2]}}$$

Equation 4-13: I/Q offset

At this point of the signal processing all unknown signal parameters such as timing offset, frequency offset, phase offset, I/Q offset and gain imbalance have been evaluated and the measurement signal can be corrected accordingly.

#### Error vector magnitude (EVM) - R&S FPS method

Using the corrected measurement signal  $r(v)$  and the estimated reference signal  $\hat{s}(v)$ , the modulation quality parameters can be calculated. The mean error vector magnitude (EVM) is the quotient of the root-mean-square values of the error signal power and the reference signal power:

$$\mathbf{EVM} = \frac{\sqrt{\sum_{v=0}^{N-1} |r(v) - \hat{s}(v)|^2}}{\sqrt{\sum_{v=0}^{N-1} |\hat{s}(v)|^2}}$$

Equation 4-14: Mean error vector magnitude (EVM)

Whereas the symbol error vector magnitude is the momentary error signal magnitude normalized by the root mean square value of the reference signal power:

$$EVM(v) = \frac{|r(v) - \hat{s}(v)|}{\sqrt{\sum_{v=0}^{N-1} |\hat{s}(v)|^2}}$$

**Equation 4-15: Symbol error vector magnitude**

### Error vector magnitude (EVM) - IEEE 802.11b or g (DSSS) method

In [2] a different algorithm is proposed to calculate the error vector magnitude. In a first step the IQ-offset in the I-branch and the IQ-offset of the Q-branch are estimated separately:

$$\hat{o}_I = \frac{1}{N} \sum_{v=0}^{N-1} \text{REAL} \{r(v)\}$$

**Equation 4-16: I/Q offset I-branch**

$$\hat{o}_Q = \frac{1}{N} \sum_{v=0}^{N-1} \text{IMAG} \{r(v)\}$$

**Equation 4-17: I/Q offset Q-branch**

where  $r(v)$  is the measurement signal which has been corrected with the estimates of the timing offset, frequency offset and phase offset, but not with the estimates of the gain imbalance and I/Q offset

With these values the gain imbalance of the I-branch and the gain imbalance of the Q-branch are estimated in a non-linear estimation in a second step:

$$\hat{g}_I = \frac{1}{N} \sum_{v=0}^{N-1} |\text{REAL} \{r(v) - \hat{o}_I\}|$$

**Equation 4-18: Gain imbalance I-branch**

$$\hat{g}_Q = \frac{1}{N} \sum_{v=0}^{N-1} |\text{IMAG} \{r(v) - \hat{o}_Q\}|$$

**Equation 4-19: Gain imbalance Q-branch**

Finally, the mean error vector magnitude can be calculated with a non-data-aided calculation:

$$V_{\text{err}}(\mathbf{v}) = \frac{\sqrt{\frac{1}{2} \sum_{v=0}^{N-1} [|\text{REAL} \{r(v)\} - \hat{o}_I| - \hat{g}_I]^2 + \frac{1}{2} \sum_{v=0}^{N-1} [|\text{IMAG} \{r(v)\} - \hat{o}_Q| - \hat{g}_Q]^2}}{\sqrt{\frac{1}{2} \cdot [\hat{g}_I^2 + \hat{g}_Q^2]}}$$

**Equation 4-20: Mean error vector magnitude**

The symbol error vector magnitude is the error signal magnitude normalized by the root mean square value of the estimate of the measurement signal power:

$$V_{\text{err}}(\mathbf{v}) = \frac{\sqrt{\frac{1}{2} [\text{REAL}\{\mathbf{r}(\mathbf{v})\} - \hat{\mathbf{o}}_I - \hat{\mathbf{g}}_I]^2 + \frac{1}{2} [\text{MAG}\{\mathbf{r}(\mathbf{v})\} - \hat{\mathbf{o}}_Q - \hat{\mathbf{g}}_Q]^2}}{\sqrt{\frac{1}{2} \cdot [\hat{\mathbf{g}}_I^2 + \hat{\mathbf{g}}_Q^2]}}$$

*Equation 4-21: Symbol error vector magnitude*

The advantage of this method is that no estimate of the reference signal is needed, but the I/Q offset and gain imbalance values are not estimated in a joint estimation procedure. Therefore, each estimation parameter disturbs the estimation of the other parameter and the accuracy of the estimates is lower than the accuracy of the estimations achieved by [transmit antenna baseband filter \(Tx filter\) estimation](#). If the EVM value is dominated by Gaussian noise this method yields similar results as [Cost function for signal parameters](#).



The EVM vs Symbol result display shows two traces, each using a different calculation method, so you can easily compare the results (see "[EVM vs Symbol](#)" on page 30)

### 4.2.3 Literature on the IEEE 802.11b Standard

|     |   |
|-----|---|
| [1] | Institute of Electrical and Electronic Engineers, Part 11: Wireless LAN Medium Access Control (MAC) and Physical Layer (PHY) specifications, IEEE Std 802.11-1999, Institute of Electrical and Electronic Engineers, Inc., 1999.  |
| [2] | Institute of Electrical and Electronic Engineers, Part 11: Wireless LAN Medium Access Control (MAC) and Physical Layer (PHY) specifications: Higher-Speed Physical Layer Extensions in the 2.4 GHz Band, IEEE Std 802.11b-1999, Institute of Electrical and Electronic Engineers, Inc., 1999. |

## 4.3 Signal Processing for MIMO Measurements (IEEE 802.11ac, n)

For measurements according to the IEEE 802.11a, b, g standards, only a single transmit antenna and a single receive antenna are required (SISO = single in, single out). For measurements according to the IEEE 802.11ac or n standard, the R&S FPS can measure multiple data streams between multiple transmit antennas and multiple receive antennas (MIMO = multiple in, multiple out).



As opposed to other Rohde & Schwarz signal and spectrum analyzers, in the R&S FPS WLAN application, MIMO is not selected as a specific standard. Rather, when you select the IEEE 802.11ac or n standard, MIMO is automatically available. In the default configuration, a single transmit antenna and a single receive antenna are assumed, which corresponds to the common SISO setup.

## Basic technologies

Some basic technologies used in MIMO systems are introduced briefly here. For more detailed information, see the Rohde & Schwarz Application Note (1MA142: "Introduction to MIMO"), available for download from the Rohde & Schwarz website.

MIMO systems use *transmit diversity* or *space-division multiplexing*, or both. With **transmit diversity**, a bit stream is transmitted simultaneously via two antennas, but with different coding in each case. This improves the signal-to-noise ratio and the cell edge capacity.

For **space-division multiplexing**, multiple (different) data streams are sent simultaneously from the transmit antennas. Each receive antenna captures the superposition of all transmit antennas. In addition, channel effects caused by reflections and scattering etc., are added to the received signals. The receiver determines the originally sent symbols by multiplying the received symbols with the inverted channel matrix (that is, the mapping between the streams and the transmit antennas, see [Chapter 4.3.2, "Spatial Mapping"](#), on page 71).

Using space-division multiplexing, the transmitted data rates can be increased significantly by using additional antennas.

To reduce the correlation between the propagation paths, the transmit antenna can delay all of the transmission signals except one. This method is referred to as *cyclic delay diversity* or **cyclic delay shift**.

The basis of the majority of the applications for broadband transmission is the **OFDM method**. In contrast to single-carrier methods, an OFDM signal is a combination of many orthogonal, separately modulated carriers. Since the data is transmitted in parallel, the symbol length is significantly smaller than in single-carrier methods with identical transmission rates.

## Signal processing chain

In a test setup with multiple antennas, the R&S FPS is likely to receive multiple spatial streams, one from each antenna. Each stream has gone through a variety of transformations during transmission. The signal processing chain is displayed in [Figure 4-3](#), starting with the creation of the spatial streams in the transmitting device, through the wireless transmission and ending with the merging of the spatial streams in the receiving device. This processing chain has been defined by IEEE.

The following figure shows the basic processing steps performed by the transmit antenna and the complementary blocks in reverse order applied at the receive antenna:

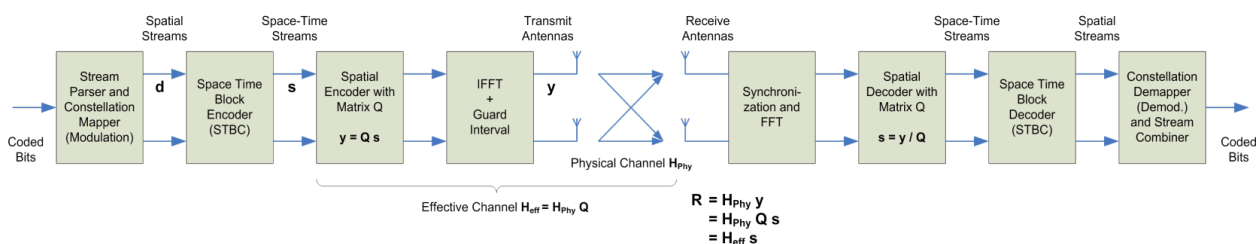


Figure 4-3: Data flow from the transmit antenna to the receive antenna

### 4.3.1 Space-Time Block Coding (STBC)

The coded bits to be transmitted are modulated to create a data stream, referred to as a *spatial stream*, by the stream parser in the transmitting device under test (see [Figure 4-3](#)).

The Space-Time Block Encoder (STBC) implements the transmit diversity technique (see "[Basic technologies](#)" on page 70). It creates multiple copies of the data streams, each encoded differently, which can then be transmitted by a number of antennas.

To do so, the STBC encodes only the *data* carriers in the spatial stream using a matrix. Each row in the matrix represents an OFDM symbol and each column represents one antenna's transmissions over time (thus the term *space-time encoder*). This means each block represents the same data, but with a different coding. The resulting blocks are referred to as *space-time streams* (STS). Each stream is sent to a different Tx antenna. This *diversity coding* increases the signal-to-noise ratio at the receive antenna. The *pilot* carriers are inserted after the data carriers went through the STBC. Thus, only the data carriers are decoded by the analyzer to determine characteristics of the demodulated data (see also [Figure 4-6](#)).

In order to transmit the space-time streams, two or more antennas are required by the sender, and one or more antennas are required by the receive antenna.

### 4.3.2 Spatial Mapping

The Spatial Encoder (see [Figure 4-3](#)) is responsible for the spatial multiplexing. It defines the mapping between the streams and the transmit antennas - referred to as *spatial mapping* - or as a matrix: the *spatial mapping matrix*.

In the R&S FPS WLAN application, the mapping can be defined using the following methods:

- **Direct mapping:** one single data stream is mapped to an exclusive Tx antenna (The spatial matrix contains "1" on the diagonal and otherwise zeros.)
- **Spatial Expansion:** multiple (different) data streams are assigned to each antenna in a defined pattern
- **User-defined mapping:** the data streams are mapped to the antennas by a user-defined matrix

#### User-defined spatial mapping

You can define your own spatial mapping between streams and Tx antennas.

For each antenna (Tx1..4), the complex element of each STS-stream is defined. The upper value is the real part part of the complex element. The lower value is the imaginary part of the complex element.

Additionally, a "Time Shift" can be defined for cyclic delay diversity (CSD).

The stream for each antenna is calculated as:

$$\begin{pmatrix} Tx_1 - Stream \\ \vdots \\ Tx_4 - Stream \end{pmatrix} = \begin{pmatrix} Tx_{1,STS.1} & \dots & Tx_{1,STS.4} \\ \vdots & & \vdots \\ Tx_{4,STS.1} & \dots & Tx_{4,STS.4} \end{pmatrix} \begin{pmatrix} STS - Stream_1 \\ \vdots \\ STS - Stream_4 \end{pmatrix}$$

### 4.3.3 Physical vs Effective Channels

The **effective channel** refers to the transmission path starting from the space-time stream and ending at the receive antenna. It is the product of the following components:

- the spatial mapping
- the crosstalk inside the device under test (DUT) transmission paths
- the crosstalk of the channel between the transmit antennas and the receive antennas

For each space-time stream, at least one training field (the (V)HT-LTF) is included in every PPDU preamble (see Figure 4-4). Each sender antenna transmits these training fields, which are known by the receive antenna. The effective channel can be calculated from the received (and known) (V)HT-LTF symbols of the preamble, without knowledge of the spatial mapping matrix or the physical channel. Thus, the effective channel can always be calculated.

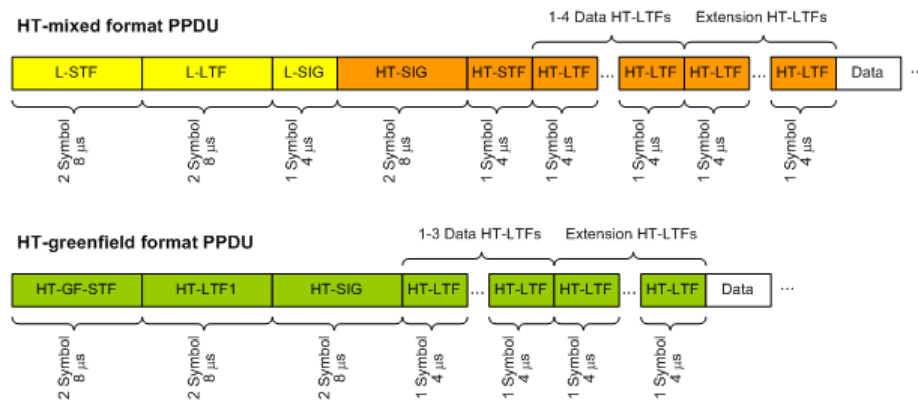


Figure 4-4: Training fields (TF) in the preamble of PPDU in IEEE 802.11n standard

The effective channel is sufficient to calculate the EVM, the constellation diagram and the bitstream results of the measured signal, so these results are always available.

The **physical channel** refers to the transmission path starting from the transmit antenna streams and ending at the receive antenna. It is the product of the following components:

- the crosstalk inside the device under test (DUT) transmission paths
- the crosstalk of the channel between the transmit antennas and the receive antennas



The physical channel is derived from the effective channel using the inverted spatial mapping matrix  $Q$ :

$$H_{\text{phy}} = H_{\text{eff}}Q^{-1}$$

Thus, if the spatial mapping matrix cannot be inverted, the physical channel cannot be calculated. This may be the case, for example, if the signal contains fewer streams than Rx antenna signals, or if the spatial matrix is close to numerical singularity.

In this case, results that are based on the transmit antenna such as I/Q offset, gain imbalance and quadrature offset are not available.



#### Crosstalk in estimated channels

Note that the estimated channel transfer function contains crosstalk from various sources, for example:

- from the transmission paths inside the DUT
- from the connection between the analyzer and the DUT
- from the analyzer itself

The crosstalk from the analyzer can be neglected. If the analyzer and DUT are connected by cable, this source of crosstalk can also be neglected. For further information on crosstalk see [Chapter 4.3.6, "Crosstalk and Spectrum Flatness"](#), on page 77.

### 4.3.4 Capturing Data from MIMO Antennas

The primary purpose of many test applications that verify design parameters, or are used in production, is to determine if the transmitted signals adhere to the relevant standards and whether the physical characteristics fall within the specified limits. In such cases there is no need to measure the various transmit paths simultaneously. Instead, they can either be tested as single antenna measurements, or sequentially (with restrictions, see also [Chapter 4.3.4.1, "Sequential MIMO Measurement"](#), on page 74). Then only one analyzer is needed to measure parameters such as error vector magnitude (EVM), power and I/Q imbalance.

Measurements that have to be carried out for development or certification testing are significantly more extensive. In order to fully reproduce the data in transmit signals or analyze the crosstalk between the antennas, for example, measurements must be performed simultaneously on all antennas. One analyzer is still sufficient if the system is using transmit diversity (multiple input single output – MISO). However, space-division multiplexing requires two or more analyzers to calculate the precoding matrix and demodulate the signals.

The R&S FPS WLAN application provides the following methods to capture data from the MIMO antennas:

- **Simultaneous MIMO operation**  
The data streams are measured simultaneously by multiple analyzers. One of the analyzers is defined as a *master*, which receives the I/Q data from the other analyzers (the *slaves*). The IP addresses of each slave analyzer must be provided to

the master. The only function of the slaves is to record the data that is then accumulated centrally by the master.

(Note that only the MIMO master analyzer requires the R&S FPS-K91n or ac option. The slave analyzers do not require a R&S FPS WLAN application.)

The number of Tx antennas on the DUT defines the number of analyzers required for this measurement setup.

Tip: Use the master's trigger output (see [Chapter 4.9.5, "Trigger Synchronization Using the Master's Trigger Output"](#), on page 85) or an R&S Z11 trigger box (see [Chapter 4.9.6, "Trigger Synchronization Using an R&S FS-Z11 Trigger Unit"](#), on page 85) to send the same trigger signal to all devices.

The master calculates the measurement results based on the I/Q data captured by *all* analyzers (master and slaves) and displays them in the selected result displays.

- **Sequential using open switch platform**

The data streams are measured sequentially by a single analyzer connected to an additional switch platform that switches between antenna signals. No manual interaction is necessary during the measurement. The R&S FPS WLAN application captures the I/Q data for all antennas sequentially and calculates and displays the results (individually for each data stream) in the selected result displays automatically.

A single analyzer and the Rohde & Schwarz OSP Switch Platform is required to measure the multiple DUT Tx antennas (the switch platform must be fitted with at least one R&S®OSP-B101 option; the number depends on the number of Tx antennas to measure). The IP address of the OSP and the used module (configuration bank) must be defined on the analyzer; the required connections between the DUT Tx antennas, the switch box and the analyzer are indicated in the MIMO "Signal Capture" dialog box.

For **important restrictions** concerning sequential measurement see [Chapter 4.3.4.1, "Sequential MIMO Measurement"](#), on page 74.

- **Sequential using manual operation**

The data streams are captured sequentially by a single analyzer. The antenna signals must be connected to the single analyzer input sequentially by the user.

In the R&S FPS WLAN application, individual capture buffers are provided (and displayed) for each antenna input source, so that results for the individual data streams can be calculated. The user must initiate data capturing for each antenna and result calculation for all data streams manually.

For **important restrictions** concerning sequential measurement see [Chapter 4.3.4.1, "Sequential MIMO Measurement"](#), on page 74.

- **Single antenna measurement**

The data from the Tx antenna is measured and evaluated as a single antenna (SISO) measurement ("DUT MIMO configuration" = "1 Tx antenna").

#### 4.3.4.1 Sequential MIMO Measurement

Sequential MIMO measurement allows for MIMO analysis with a single analyzer by capturing the receive antennas one after another (sequentially). However, sequential MIMO measurement requires each Tx antenna to transmit **the same PPDU over time**. (The PPDU *content* from different Tx antennas, on the other hand, may be different.) If this requirement can not be fulfilled, use the simultaneous MIMO capture method (see [Chapter 4.3.4, "Capturing Data from MIMO Antennas"](#), on page 73).

In addition, the following **PPDU attributes must be identical for ALL antennas**:

- PPDU length
- PPDU type
- Channel bandwidth
- MCS Index
- Guard Interval Length
- Number of STBC Streams
- Number of Extension Streams

Thus, for each PPDU the Signal Field bit vector has to be identical for ALL antennas!

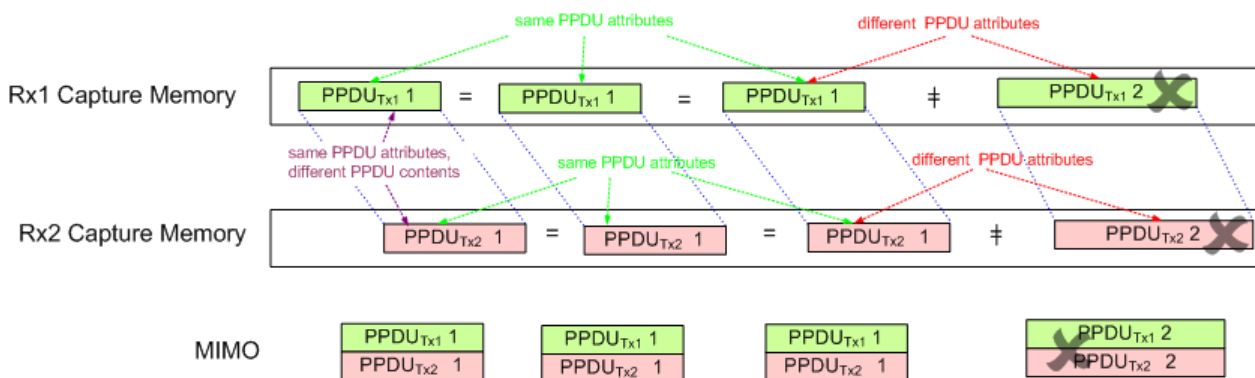


Figure 4-5: Basic principle of “Sequential MIMO Measurement” with 2 receive antennas

Note that, additionally, the data contents of the sent PPDU *payloads* must also be the same for each Tx antenna, but this is not checked. Thus, useless results are returned if different data was sent.



To provide identical PPDU content for each Tx antenna in the measurement, you can use the same pseudo-random bit sequence (PRBS) with the same PRBS seed (initial bit sequence), for example, when generating the useful data for the PPDU.

### 4.3.5 Calculating Results

When you analyze a WLAN signal in a MIMO setup, the R&S FPS acts as the receiving device. Since most measurement results have to be calculated at a particular stage in the processing chain, the R&S FPS WLAN application has to do the same decoding that the receive antenna does.

The following diagram takes a closer look at the processing chain and the results at its individual stages.

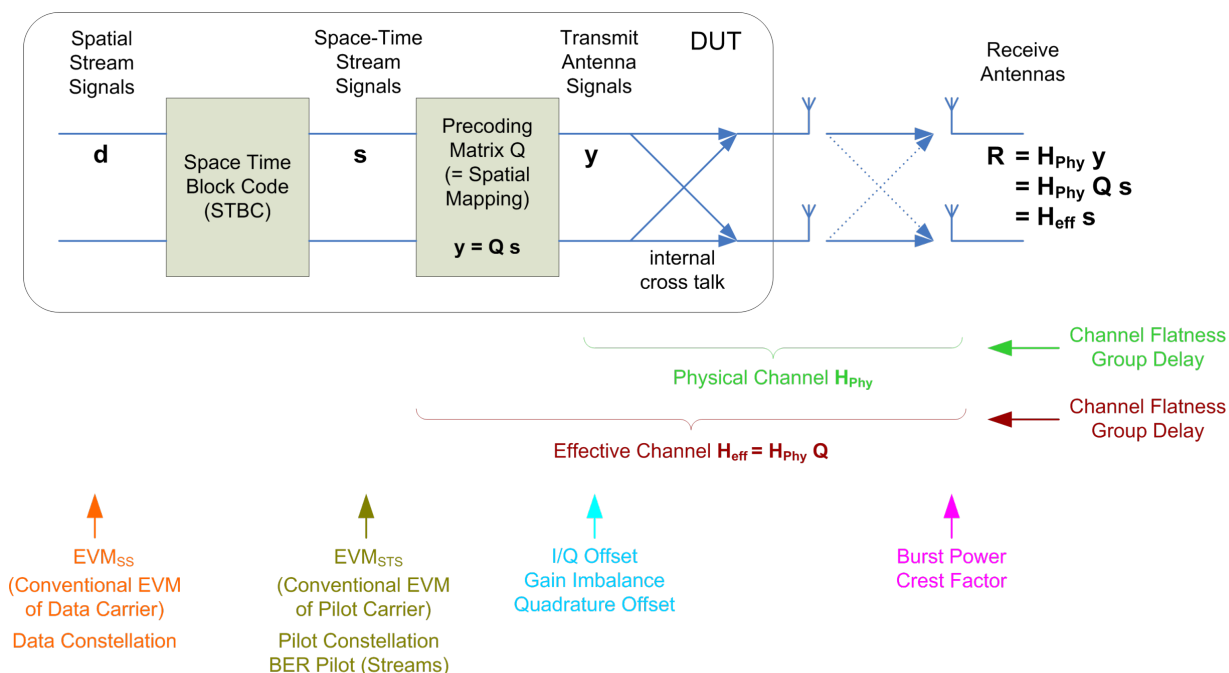


Figure 4-6: Results at individual processing stages

### Receive antenna results

The R&S FPS WLAN application can determine receive antenna results directly from the captured data at the receive antenna, namely:

- PPDU Power
- Crest factor

For all other results, the R&S FPS WLAN application has to revert the processing steps to determine the signal characteristics at those stages.

### Transmit antenna results (based on the physical channel)

If the R&S FPS WLAN application can determine the physical channel (see [Chapter 4.3.3, "Physical vs Effective Channels"](#), on page 72), it can evaluate the following results:

- Channel Flatness (based on the physical channel)
- Group Delay (based on the physical channel)
- I/Q Offset
- Quadrature Offset
- Gain Imbalance

### Space-time stream results (based on the effective channel)

If the application knows the effective channel (see [Chapter 4.3.3, "Physical vs Effective Channels"](#), on page 72), it can evaluate the following results:

- Channel Flatness (based on the effective channel)
- Group Delay (based on the effective channel)
- EVM of pilot carriers
- Constellation of pilot carriers
- Bitstream of pilot carriers

### Spatial stream results

If space-time encoding is implemented, the demodulated data must first be decoded to determine the following results:

- EVM of data carriers
- Constellation diagram
- Bitstream



The *pilot* carriers are inserted directly after the data carriers went through the STBC (see also [Chapter 4.3.1, "Space-Time Block Coding \(STBC\)"](#), on page 71). Thus, only the data carriers need to be decoded by the analyzer to determine characteristics of the demodulated data. Because of this approach to calculate the EVM, Constellation and Bitstream results, you might get results for a different number of streams for pilots and data carriers if STBC is applied.

## 4.3.6 Crosstalk and Spectrum Flatness

In contrast to the SISO measurements in previous Rohde & Schwarz signal and spectrum analyzers, the spectrum flatness trace is no longer normalized to 0 dB (scaled by the mean gain of all carriers).

For MIMO there may be different gains in the transmission paths and you do not want to lose the relation between these transmission paths. For example, in a MIMO transmission path matrix we have paths carrying power (usually the diagonal elements for the transmitted streams), but also elements with only residual crosstalk power. The power distribution of the transmission matrix depends on the spatial mapping of the transmitted streams. But even if all matrix elements carry power, the gains may be different. This is the reason why the traces are no longer scaled to 0 dB. Although the absolute gain of the Spectrum Flatness is not of interest, it is now maintained in order to show the different gains in the transmission matrix elements. Nevertheless, the limit lines are still symmetric to the mean trace, individually for each element of the transmission matrix.

By default, full MIMO equalizing is performed by the R&S FPS WLAN application. However, you can deactivate compensation for crosstalk (see ["Compensate Crosstalk \(MIMO only\)"](#) on page 122). In this case, simple main path equalizing is performed only for direct connections between Tx and Rx antennas, disregarding ancillary trans-

mission between the main paths (crosstalk). This is useful to investigate the effects of crosstalk on results such as EVM.

## 4.4 Channels and Carriers

In an OFDM system such as WLAN, the channel is divided into carriers using FFT / IFFT. Depending on the channel bandwidth, the FFT window varies between 64 and 512 (see also [Chapter 4.6, "Demodulation Parameters - Logical Filters"](#), on page 79). Some of these carriers can be used (active carriers), others are inactive (e.g. guard carriers at the edges). The channel can then be determined using the active carriers as known points; inactive carriers are interpolated.

## 4.5 Recognized vs. Analyzed PPDU

A PPDU in a WLAN signal consists of the following parts:

(For IEEE 802.11n see also [Figure 4-4](#))

- **Preamble**  
Information required to recognize the PPDU within the signal, for example training fields
- **Signal Field**  
Information on the modulation used for transmission of the useful data
- **Payload**  
The useful data

During signal processing, PPDU are recognized by their preamble symbols. The recognized PPDU and the information on the modulation used for transmission of the useful data are shown in the "Signal Field" result display

(see ["Signal Field"](#) on page 45)

Not all of the recognized PPDU are analyzed. Some are dismissed because the PPDU parameters do not match the user-defined demodulation settings, which act as a *logical filter* (see also [Chapter 4.6, "Demodulation Parameters - Logical Filters"](#), on page 79). Others may be dismissed because they contain too many or too few payload symbols (as defined by the user), or due to other irregularities or inconsistency.

Dismissed PPDU are indicated as such in the "Signal Field" result display (highlighted red, with a reason for dismissal).

PPDU with detected inconsistencies are indicated by orange highlighting and a warning in the "Signal Field" result display, but are nevertheless analyzed and included in statistical and global evaluations.

The remaining correct PPDU are highlighted green in the "Magnitude Capture" buffer and "Signal Field" result displays and analyzed according to the current user settings.

**Example:**

The evaluation range is configured to take the "Source of Payload Length" from the signal field. If the power period detected for a PPDU deviates from the PPDU length coded in the signal field, a warning is assigned to this PPDU. The decoded signal field length is used to analyze the PPDU. The decoded and measured PPDU length together with the appropriate information is shown in the "Signal Field" result display.

## 4.6 Demodulation Parameters - Logical Filters

The demodulation settings define which PPDUs are to be analyzed, thus they define a *logical filter*. They can either be defined using specific values or according to the first measured PPDU.

Which of the WLAN demodulation parameter values are supported depends on the selected digital standard, some are also interdependant.

**Table 4-1: Supported modulation formats, PPDU formats and channel bandwidths depending on standard**

| Standard   | Modulation formats   | PPDU formats                      | Channel bandwidths   |
|--|--|-----------------------------------|--|
| IEEE 802.11a,<br>g (OFDM), j, p  | BPSK (6 Mbps & 9 Mbps)<br>QPSK (12 Mbps & 18 Mbps)<br>16QAM (24 Mbps & 36 Mbps)<br>64QAM (48 Mbps & 54 Mbps) | Non-HT<br>Short PPDU<br>Long PPDU | 5 MHz, 10 MHz, 20 MHz <sup>*)</sup>  |
| IEEE 802.11ac  | 16QAM<br>64QAM<br>256QAM<br>1024QAM  | VHT                               | 20 MHz <sup>*)</sup> , 40 MHz <sup>*)</sup> , 80 MHz <sup>*)</sup> , 160 MHz <sup>*)</sup> |
| IEEE 802.11b,<br>g (DSSS)  | DBPSK (1 Mbps)<br>DQPSK (2 Mbps)<br>CCK (5.5 Mbps & 11 Mbps)<br>PBCC (5.5 Mbps & 11 Mbps)                    | Short PPDU<br>Long PPDU           | 22 MHz   |
| *) requires R&S FPS bandwidth extension option, see <a href="#">Chapter A.1, "Sample Rate and Maximum Usable I/Q Bandwidth for RF Input"</a> , on page 317 |  |                                   |  |

| Standard   | Modulation formats  | PPDU formats   | Channel bandwidths                          |
|--|---|--|---|
| IEEE 802.11n   | <p><b>SISO:</b></p> <p>BPSK (6.5, 7.2, 13.5 &amp; 15 Mbps)</p> <p>QPSK (13, 14.4, 19.5, 21.7, 27, 30, 40.5 &amp; 45 Mbps)</p> <p>16QAM (26, 28.9, 39, 43.3, 54, 60, 81 &amp; 90 Mbps)</p> <p>64QAM (52, 57.8, 58.5, 65, 72.2, 108, 121.5, 135, 120, 135 &amp; 150 Mbps)</p> <p><b>MIMO:</b></p> <p>depends on the MCS index</p> | <p>HT-MF (Mixed format)</p> <p>HT-GF (Greenfield format)</p> | 20 MHz <sup>*)</sup> , 40 MHz <sup>*)</sup> |
| <p><sup>*)</sup>: requires R&amp;S FPS bandwidth extension option, see <a href="#">Chapter A.1, "Sample Rate and Maximum Usable I/Q Bandwidth for RF Input"</a>, on page 317</p> |   |  |   |

## 4.7 Receiving Data Input and Providing Data Output

The R&S FPS can analyze signals from different input sources and provide various types of output (such as noise or trigger signals).

### 4.7.1 Input from Noise Sources

The R&S FPS provides an optional NOISE SOURCE CONTROL connector with a voltage supply for an external noise source. By switching the supply voltage for an external noise source on or off in the firmware, you can activate or deactivate the device as required.

External noise sources are useful when you are measuring power levels that fall below the noise floor of the R&S FPS itself, for example when measuring the noise level of an amplifier.

In this case, you can first connect an external noise source (whose noise power level is known in advance) to the R&S FPS and measure the total noise power. From this value you can determine the noise power of the R&S FPS. Then when you measure the power level of the actual DUT, you can deduct the known noise level from the total power to obtain the power level of the DUT.

The noise source is controlled in the "Output" settings, see ["Noise Source"](#) on page 96

### 4.7.2 Receiving and Providing Trigger Signals

Using one of the TRG IN / AUX connectors of the R&S FPS, the R&S FPS can use a signal from an external device as a trigger to capture data. Alternatively, the internal



trigger signal used by the R&S FPS can be output for use by other connected devices. Using the same trigger on several devices is useful to synchronize the transmitted and received signals within a measurement.

For details on the connectors see the R&S FPS "Getting Started" manual.

#### External trigger as input

If the trigger signal for the R&S FPS is provided by an external device, the trigger signal source must be connected to the R&S FPS and the trigger source must be defined as "External" for the R&S FPS.

#### Trigger output

The R&S FPS can provide output to another device either to pass on the internal trigger signal, or to indicate that the R&S FPS itself is ready to trigger.

The trigger signal can be output by the R&S FPS automatically, or manually by the user. If it is provided automatically, a high signal is output when the R&S FPS has triggered due to a measurement start ("Device Triggered"), or when the R&S FPS is ready to receive a trigger signal after a measurement start ("Trigger Armed").

#### Manual triggering

If the trigger output signal is initiated manually, the length and level (high/low) of the trigger pulse is also user-definable. Note, however, that the trigger pulse level is always opposite to the constant signal level defined by the output "Level" setting, e.g. for "Level = High", a constant high signal is output to the connector until the "Send Trigger" button is selected. Then, a low pulse is provided.



Providing trigger signals as output is described in detail in the R&S FPS User Manual.

---

## 4.8 Preparing the R&S FPS for the Expected Input Signal - Frontend Parameters

On the R&S FPS, the input data can only be processed optimally if the hardware settings match the signal characteristics as closely as possible. On the other hand, the hardware must be protected from powers or frequencies that exceed the allowed limits. Therefore, you must set the hardware so that it is optimally prepared for the expected input signal, without being overloaded. You do this using the *frontend* parameters. Consider the following recommendations:

#### Reference level

Adapt the R&S FPS's hardware to the expected maximum signal level by setting the "Reference Level" to this maximum. Compensate for any external attenuation or gain by defining a "Reference Level" offset.

**Attenuation**

To optimize the signal-to-noise ratio of the measurement for high signal levels and to protect the R&S FPS from hardware damage, provide for a high attenuation. Use AC coupling for DC input voltage.

**Amplification**

To optimize the signal-to-noise ratio of the measurement for low signal levels, the signal level in the R&S FPS should be as high as possible but without introducing compression, clipping, or overload. Provide for early amplification by the preamplifier and a low attenuation.

**Impedance**

When measuring in a 75  $\Omega$  system, connect an external matching pad to the RF input and adapt the reference impedance for power results. The insertion loss is compensated for numerically.

## 4.9 Triggered Measurements

In a basic measurement with default settings, the measurement is started immediately. However, sometimes you want the measurement to start only when a specific condition is fulfilled, for example a signal level is exceeded, or in certain time intervals. For these cases you can define a trigger for the measurement. In FFT sweep mode, the trigger defines when the data acquisition starts for the FFT conversion.

An "Offset" can be defined to delay the measurement after the trigger event, or to include data before the actual trigger event in time domain measurements (pre-trigger offset).

For complex tasks, advanced trigger settings are available:

- Hysteresis to avoid unwanted trigger events caused by noise
- Holdoff to define exactly which trigger event will cause the trigger in a jittering signal
- [Trigger Offset](#)..... 82
- [Trigger Hysteresis](#)..... 83
- [Trigger Drop-Out Time](#)..... 83
- [Trigger Holdoff](#)..... 84
- [Trigger Synchronization Using the Master's Trigger Output](#)..... 85
- [Trigger Synchronization Using an R&S FS-Z11 Trigger Unit](#)..... 85

### 4.9.1 Trigger Offset

An offset can be defined to delay the measurement after the trigger event, or to include data before the actual trigger event in time domain measurements (pre-trigger offset). Pre-trigger offsets are possible because the R&S FPS captures data continuously in the time domain, even before the trigger occurs.

See ["Trigger Offset"](#) on page 108.

### 4.9.2 Trigger Hysteresis

Setting a hysteresis for the trigger helps avoid unwanted trigger events caused by noise, for example. The hysteresis is a threshold to the trigger level that the signal must fall below on a rising slope or rise above on a falling slope before another trigger event occurs.

#### Example:

In the following example, the second possible trigger event is ignored as the signal does not exceed the hysteresis (threshold) before it reaches the trigger level again on the rising edge. On the falling edge, however, two trigger events occur as the signal exceeds the hysteresis before it falls to the trigger level the second time.

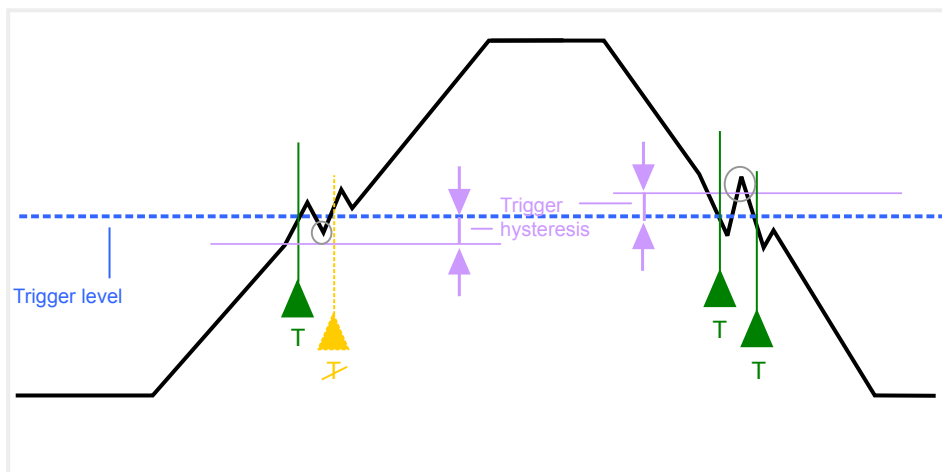


Figure 4-7: Effects of the trigger hysteresis

See ["Hysteresis"](#) on page 109

### 4.9.3 Trigger Drop-Out Time

If a modulated signal is instable and produces occasional "drop-outs" during a burst, you can define a minimum duration that the input signal must stay below the trigger level before triggering again. This is called the "drop-out" time. Defining a dropout time helps you stabilize triggering when the analyzer is triggering on undesired events.

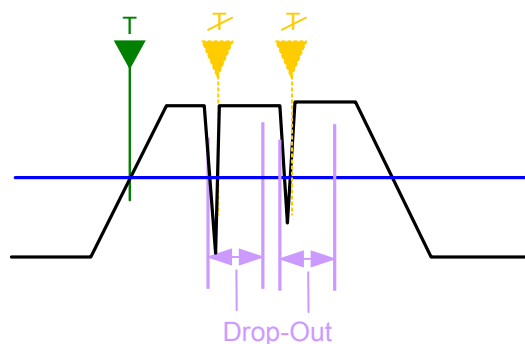


Figure 4-8: Effect of the trigger drop-out time

See "Drop-Out Time" on page 108.



#### Drop-out times for falling edge triggers

If a trigger is set to a falling edge ("Slope" = "Falling", see "Slope" on page 109) the measurement is to start when the power level falls below a certain level. This is useful, for example, to trigger at the end of a burst, similar to triggering on the rising edge for the beginning of a burst.

If a drop-out time is defined, the power level must remain below the trigger level at least for the duration of the drop-out time (as defined above). However, if a drop-out time is defined that is longer than the pulse width, this condition cannot be met before the final pulse, so a trigger event will not occur until the pulsed signal is over!

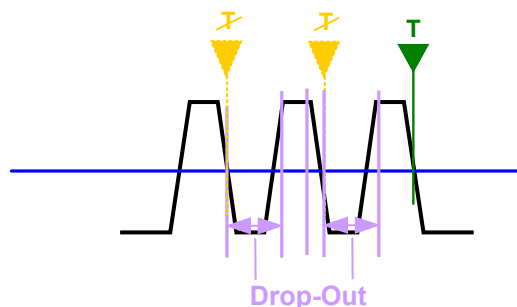


Figure 4-9: Trigger drop-out time for falling edge trigger

For gated measurements, a combination of a falling edge trigger and a drop-out time is generally not allowed.

#### 4.9.4 Trigger Holdoff

The trigger holdoff defines a waiting period before the next trigger after the current one will be recognized.

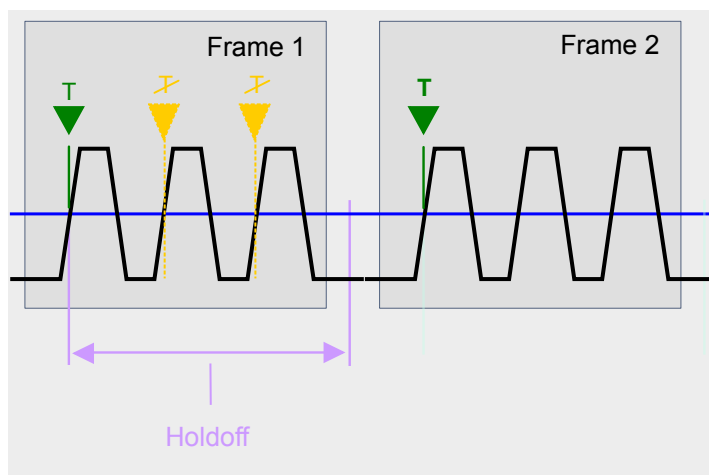


Figure 4-10: Effect of the trigger holdoff

See ["Trigger Holdoff"](#) on page 109.

#### 4.9.5 Trigger Synchronization Using the Master's Trigger Output

For MIMO measurements in which the data from the multiple antennas is captured simultaneously by multiple analyzers (see ["Simultaneous Signal Capture Setup"](#) on page 112, the data streams to be analyzed must be synchronized in time. One possibility to ensure that all analyzers start capturing I/Q data at the same time is using the master's trigger output functionality.

The R&S FPS has variable input/output connectors for trigger signals. If you set the master's TRIGGER 2 INPUT/OUTPUT connector to "device-triggered" output, and connect it to the slaves' trigger input connectors, the master R&S FPS sends its trigger event signal to any connected slaves. The slaves are automatically configured to use the trigger source "External". The master itself can be configured to use any of the following trigger sources:

- External
- I/Q Power
- IF Power
- RF Power
- Power Sensor

#### 4.9.6 Trigger Synchronization Using an R&S FS-Z11 Trigger Unit

For MIMO measurements in which the data from the multiple antennas is captured simultaneously by multiple analyzers (see ["Simultaneous Signal Capture Setup"](#) on page 112, the data streams to be analyzed must be synchronized in time. The R&S FS-Z11 Trigger Unit can ensure that all analyzers start capturing I/Q data at the same time. Compared to using the master's trigger out function, using the Trigger Unit pro-

vides a more accurate synchronisation of the slaves. However, it requires the additional hardware.

The Trigger Unit is connected to the DUT and all involved analyzers. Then the Trigger Unit can be used in the following operating modes:

- **External mode:** If the DUT has a trigger output, the trigger signal from the DUT triggers all analyzers simultaneously.  
The DUT's TRIGGER OUTPUT is connected to the Trigger Unit's TRIG INPUT connector. Each of the Trigger Unit's TRIG OUT connectors is connected to one of the analyzer's TRIGGER INPUT connectors.
- **Free Run mode:** This mode is used if no trigger signal is available. The master analyzer sends a trigger impulse to the Trigger Unit to start the measurement as soon as all slave analyzers are ready to measure.  
The NOISE SOURCE output of the master analyzer is connected to the Trigger Unit's NOISE SOURCE input. Each of the Trigger Unit's TRIG OUT connectors is connected to one of the analyzer's TRIGGER INPUT connectors. When the master analyzer sends a signal to the Trigger Unit via its NOISE SOURCE output, the Trigger Unit triggers all analyzers simultaneously via its TRIGGER OUTPUT.
- **Manual mode:** a trigger is generated by the Trigger Unit and triggers all analyzers simultaneously. No connection to the DUT is required.  
Each of the Trigger Unit's TRIG OUT connectors is connected to one of the analyzer's TRIGGER INPUT connectors. A trigger signal is generated when you press (release) the "TRIG MANUAL" button on the Trigger unit.  
**Note:** In manual mode you must *turn on the NOISE SOURCE output* of the master analyzer manually (see the manual of the analyzer)!

A Trigger Unit is activated in the [Trigger Source Settings](#). The required connections between the analyzers, the trigger unit, and the DUT are visualized in the dialog box.



The NOISE SOURCE output of the master analyzer must be connected to the Trigger Unit's NOISE SOURCE input for all operating modes to supply the power for the Trigger Unit.

---

For more detailed information on the R&S FS-Z11 Trigger Unit and the required connections, see the "R&S FS-Z11 Trigger Unit Manual".

## 4.10 WLAN I/Q Measurements in MSRA Operating Mode

The R&S FPS WLAN application can also be used to analyze I/Q data in MSRA operating mode.



In MSRA operating mode, the **IEEE 802.11b and g (DSSS)** standards are not supported.

---

In MSRA operating mode, only the MSRA Master actually captures data; the MSRA applications receive an extract of the captured data for analysis, referred to as the

**application data.** For the R&S FPS WLAN application in MSRA operating mode, the application data range is defined by the same settings used to define the signal capture in Signal and Spectrum Analyzer mode. In addition, a capture offset can be defined, i.e. an offset from the start of the captured data to the start of the analysis interval for the WLAN I/Q measurement.

### Data coverage for each active application

Generally, if a signal contains multiple data channels for multiple standards, separate applications are used to analyze each data channel. Thus, it is of interest to know which application is analyzing which data channel. The MSRA Master display indicates the data covered by each application, restricted to the channel bandwidth used by the corresponding standard, by vertical blue lines labeled with the application name.

### Analysis interval

However, the individual result displays of the application need not analyze the complete data range. The data range that is actually analyzed by the individual result display is referred to as the **analysis interval**.

In the R&S FPS WLAN application the analysis interval is automatically determined according to the selected channel, carrier or PPDU to analyze which is defined for the evaluation range, depending on the result display. The analysis interval can not be edited directly in the R&S FPS WLAN application, but is changed automatically when you change the evaluation range.

### Analysis line

A frequent question when analyzing multi-standard signals is how each data channel is correlated (in time) to others. Thus, an analysis line has been introduced. The analysis line is a common time marker for all MSRA applications. It can be positioned in any MSRA application or the MSRA Master and is then adjusted in all other applications. Thus, you can easily analyze the results at a specific time in the measurement in all applications and determine correlations.

If the marked point in time is contained in the analysis interval of the application, the line is indicated in all time-based result displays, such as time, symbol, slot or bit diagrams. By default, the analysis line is displayed, however, it can be hidden from view manually. In all result displays, the "AL" label in the window title bar indicates whether or not the analysis line lies within the analysis interval or not:

- **orange "AL"**: the line lies within the interval
- **white "AL"**: the line lies within the interval, but is not displayed (hidden)
- **no "AL"**: the line lies outside the interval

The analysis line is displayed in the following result displays.

- Magnitude Capture
- Power vs Time
- EVM vs Symbol

For details on the MSRA operating mode see the R&S FPS MSRA User Manual.

## 5 Configuration

The default WLAN I/Q measurement captures the I/Q data from the WLAN signal and determines various characteristic signal parameters such as the modulation accuracy, spectrum flatness, center frequency tolerance and symbol clock tolerance in just one measurement (see [Chapter 3.1, "WLAN I/Q Measurement \(Modulation Accuracy, Flatness and Tolerance\)"](#), on page 12)

Other parameters specified in the WLAN 802.11 standard must be determined in separate measurements (see [Chapter 5.4, "Frequency Sweep Measurements"](#), on page 151).

The settings required to configure each of these measurements are described here.

### Selecting the measurement type

- ▶ To select a different measurement type, do one of the following:
  - Select the "Overview" softkey. In the "Overview", select the "Select Measurement" button. Select the required measurement.
  - Press the MEAS key. In the "Select Measurement" dialog box, select the required measurement.

|   |     |
|---|-----|
| • <a href="#">Multiple Measurement Channels and Sequencer Function</a> .....              | 88  |
| • <a href="#">Display Configuration</a> .....   | 90  |
| • <a href="#">WLAN IQ Measurement (Modulation Accuracy, Flatness, Tolerance...)</a> ..... | 90  |
| • <a href="#">Frequency Sweep Measurements</a> .....                                      | 151 |

### 5.1 Multiple Measurement Channels and Sequencer Function

When you activate an application, a new measurement channel is created which determines the measurement settings for that application. These settings include the input source, the type of data to be processed (I/Q or RF data), frequency and level settings, measurement functions etc. If you want to perform the same measurement but with different center frequencies, for instance, or process the same input data with different measurement functions, there are two ways to do so:


- Change the settings in the measurement channel for each measurement scenario. In this case the results of each measurement are updated each time you change the settings and you cannot compare them or analyze them together without storing them on an external medium.
- Activate a new measurement channel for the same application. In the latter case, the two measurement scenarios with their different settings are displayed simultaneously in separate tabs, and you can switch between the tabs to compare the results. For example, you can activate one WLAN measurement channel to perform a WLAN modulation accuracy measurement, and a second channel to perform an



SEM measurement using the same WLAN input source. Then you can monitor all results at the same time in the "MultiView" tab.

The number of channels that can be configured at the same time depends on the available memory on the instrument.

Only one measurement can be performed on the R&S FPS at any time. If one measurement is running and you start another, or switch to another channel, the first measurement is stopped. In order to perform the different measurements you configured in multiple channels, you must switch from one tab to another.

However, you can enable a Sequencer function that automatically calls up each activated measurement channel in turn. This means the measurements configured in the channels are performed one after the other in the order of the tabs. The currently active measurement is indicated by a  symbol in the tab label. The result displays of the individual channels are updated in the corresponding tab (as well as the "Multi-View") as the measurements are performed. Sequencer operation is independent of the currently *displayed* tab; for example, you can analyze the SEM measurement while the modulation accuracy measurement is being performed by the Sequencer.

For details on the Sequencer function see the R&S FPS User Manual.

The Sequencer functions are only available in the "MultiView" tab.

|                      |    |
|----------------------|----|
| Sequencer State..... | 89 |
| Sequencer Mode.....  | 89 |

### Sequencer State

Activates or deactivates the Sequencer. If activated, sequential operation according to the selected Sequencer mode is started immediately.

Remote command:

`SYSTEM:SEQuencer` on page 269

`INITiate<n>:SEQuencer:IMMediate` on page 267

`INITiate<n>:SEQuencer:ABORt` on page 267

### Sequencer Mode

Defines how often which measurements are performed. The currently selected mode softkey is highlighted blue. During an active Sequencer process, the selected mode softkey is highlighted orange.

"Single Sequence"

Each measurement is performed once, until all measurements in all active channels have been performed.

"Continuous Sequence"

The measurements in each active channel are performed one after the other, repeatedly, in the same order, until sequential operation is stopped.


This is the default Sequencer mode.

Remote command:

`INITiate<n>:SEQuencer:MODE` on page 268


## 5.2 Display Configuration

The measurement results can be displayed using various evaluation methods. All evaluation methods available for the R&S FPS WLAN application are displayed in the evaluation bar in SmartGrid mode when you do one of the following:

- Select the  "SmartGrid" icon from the toolbar.
- Select the "Display Config" button in the "Overview".
- Select the "Display Config" softkey in any WLAN menu.

Then you can drag one or more evaluations to the display area and configure the layout as required.

Up to 16 evaluation methods can be displayed simultaneously in separate windows. The WLAN evaluation methods are described in [Chapter 3, "Measurements and Result Displays"](#), on page 12.

To close the SmartGrid mode and restore the previous softkey menu select the  "Close" icon in the righthand corner of the toolbar, or press any key.



For details on working with the SmartGrid see the R&S FPS Getting Started manual.

## 5.3 WLAN IQ Measurement (Modulation Accuracy, Flatness, Tolerance...)

When you activate the WLAN application, an I/Q measurement of the input signal is started automatically with the default configuration. The "WLAN" menu is displayed and provides access to the most important configuration functions. This menu is also displayed when you press the MEAS CONFIG key.



The "Span", "Bandwidth", "Lines", and "Marker Functions" menus are not available for WLAN IQ measurements.

WLAN measurements can be configured easily in the "Overview" dialog box, which is displayed when you select the "Overview" softkey from any menu.

- [Configuration Overview](#).....91
- [Signal Description](#).....92
- [Input and Frontend Settings](#).....94
- [Signal Capture \(Data Acquisition\)](#).....103
- [Application Data \(MSRA\)](#) .....118
- [Synchronization and OFDM Demodulation](#).....118
- [Tracking and Channel Estimation](#).....119
- [Demodulation](#).....122
- [Evaluation Range](#).....137

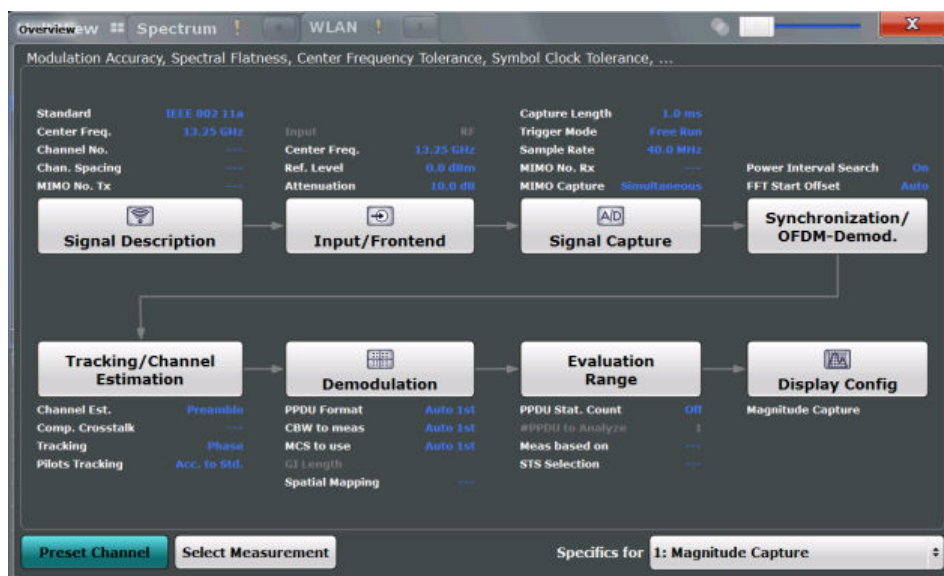
## WLAN IQ Measurement (Modulation Accuracy, Flatness, Tolerance...)

- [Result Configuration](#).....143
- [Automatic Settings](#)..... 150
- [Sweep Settings](#)..... 150

### 5.3.1 Configuration Overview



Throughout the measurement channel configuration, an overview of the most important currently defined settings is provided in the "Overview". The "Overview" is displayed when you select the "Overview" icon, which is available at the bottom of all softkey menus.



The "Overview" not only shows the main measurement settings, it also provides quick access to the main settings dialog boxes. The indicated signal flow shows which parameters affect which processing stage in the measurement. Thus, you can easily configure an entire measurement channel from input over processing to output and analysis by stepping through the dialog boxes as indicated in the "Overview".



The available settings and functions in the "Overview" vary depending on the currently selected measurement. For frequency sweep measurements see [Chapter 5.4, "Frequency Sweep Measurements"](#), on page 151.

For the WLAN IQ measurement, the "Overview" provides quick access to the following configuration dialog boxes (listed in the recommended order of processing):

1. "Select Measurement"  
See ["Selecting the measurement type"](#) on page 88
2. "Signal Description"  
See [Chapter 5.3.2, "Signal Description"](#), on page 92
3. "Input/ Frontend"

See and [Chapter 5.3.3, "Input and Frontend Settings"](#), on page 94

4. "Signal Capture"  
See [Chapter 5.3.4, "Signal Capture \(Data Acquisition\)"](#), on page 103
5. "Synchronization / OFDM demodulation"  
See [Chapter 5.3.6, "Synchronization and OFDM Demodulation"](#), on page 118
6. "Tracking / Channel Estimation"  
See [Chapter 5.3.7, "Tracking and Channel Estimation"](#), on page 119
7. "Demodulation"  
See [Chapter 5.3.8, "Demodulation"](#), on page 122
8. "Evaluation Range"  
See [Chapter 5.3.9, "Evaluation Range"](#), on page 137
9. "Display Configuration"  
See [Chapter 5.2, "Display Configuration"](#), on page 90

#### To configure settings

- ▶ Select any button in the "Overview" to open the corresponding dialog box.

#### Preset Channel

Select the "Preset Channel" button in the lower lefthand corner of the "Overview" to restore all measurement settings **in the current channel** to their default values.

Note that the PRESET key restores the entire instrument to its default values and thus closes **all measurement channels** on the R&S FPS (except for the default Spectrum application channel)!

Remote command:

`SYSTem:PRESet:CHANnel [:EXECute]` on page 183

#### Select Measurement

Selects a measurement to be performed.

See ["Selecting the measurement type"](#) on page 88.

#### Specifics for

The measurement channel may contain several windows for different results. Thus, the settings indicated in the "Overview" and configured in the dialog boxes vary depending on the selected window.

Select an active window from the "Specifics for" selection list that is displayed in the "Overview" and in all window-specific configuration dialog boxes.

The "Overview" and dialog boxes are updated to indicate the settings for the selected window.

## 5.3.2 Signal Description

The signal description provides information on the expected input signal.

|                      |    |
|----------------------|----|
| Standard.....        | 93 |
| Frequency.....       | 93 |
| Tolerance Limit..... | 93 |

### Standard

Defines the WLAN standard (depending on which WLAN options are installed). The measurements are performed according to the specified standard with the correct limit values and limit lines.

Many other WLAN measurement settings depend on the selected standard (see [Chapter 4.6, "Demodulation Parameters - Logical Filters"](#), on page 79).

**Note:** In MSRA operating mode, the **IEEE 802.11b and g (DSSS)** standards are not supported.

Remote command:

`CONFigure:STANdard` on page 192

### Frequency

Specifies the center frequency of the signal to be measured.

Remote command:

`[SENSe:]FREQuency:CENTer` on page 196

### Tolerance Limit

Defines the tolerance limit to be used for the measurement. The required tolerance limit depends on the used standard:

"Prior IEEE 802.11-2012 Standard"

Tolerance limits are based on the IEEE 802.11 specification **prior to 2012**.

Default for OFDM standards (except 802.11ac).

"In line with IEEE 802.11-2012 Standard"

Tolerance limits are based on the IEEE 802.11 specification from **2012**.

Required for DSSS standards. Also possible for OFDM standards (except 802.11ac).

"In line with IEEE 802.11ac standard"

Tolerance limits are based on the **IEEE 802.11ac** specification. Required by IEEE 802.11ac standard.

Remote command:

[CALCulate:LIMit:TOLerance](#) on page 192

### 5.3.3 Input and Frontend Settings

The R&S FPS can analyze signals from different input sources and provide various types of output (such as noise or trigger signals).



#### Importing and Exporting I/Q Data

The I/Q data to be analyzed for WLAN 802.11 can not only be measured by the WLAN application itself, it can also be imported to the application, provided it has the correct format. Furthermore, the analyzed I/Q data from the WLAN application can be exported for further analysis in external applications.

See [Chapter 7.1, "Import/Export Functions"](#), on page 157.

Frequency, amplitude and y-axis scaling settings represent the "frontend" of the measurement setup.

For more information on the use and effects of these settings, see [Chapter 4.8, "Preparing the R&S FPS for the Expected Input Signal - Frontend Parameters"](#), on page 81.

- [Input Source Settings](#).....94
- [Output Settings](#)..... 96
- [Frequency Settings](#)..... 98
- [Amplitude Settings](#)..... 99

#### 5.3.3.1 Input Source Settings

**Access:** "Overview" > "Input/Frontend" > "Input Source"

**or:** INPUT/OUTPUT > "Input Source Config"

The input source determines which data the R&S FPS will analyze.



The Digital I/Q input source is currently not available in the R&S FPS WLAN application.

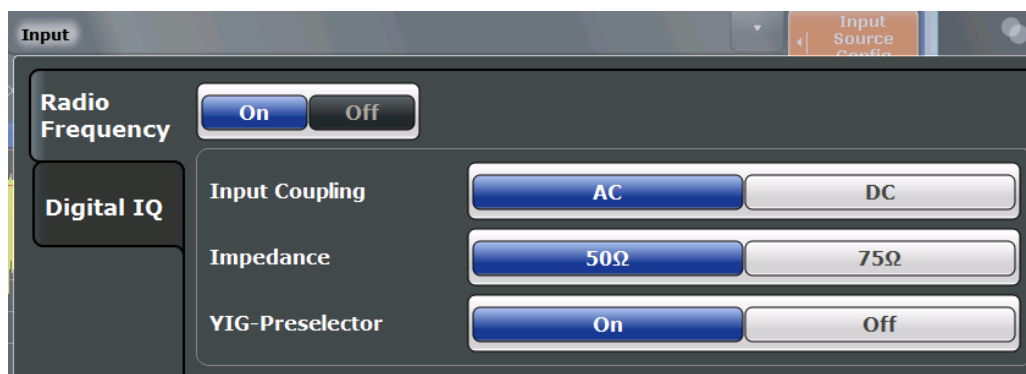
- [Radio Frequency Input](#).....94

#### Radio Frequency Input

**Access:** "Overview" > "Input/Frontend" > "Input Source" > "Radio Frequency"

**or:** INPUT/OUTPUT > "Input Source Config" > "Radio Frequency"

The default input source for the R&S FPS is "Radio Frequency", i.e. the signal at the RF INPUT connector of the R&S FPS. If no additional options are installed, this is the only available input source.



|                            |    |
|----------------------------|----|
| Radio Frequency State..... | 95 |
| Input Coupling.....        | 95 |
| Impedance.....             | 95 |
| YIG-Preselector.....       | 95 |

### Radio Frequency State

Activates input from the RF INPUT connector.

Remote command:

[INPut:SElect](#) on page 195

### Input Coupling

The RF input of the R&S FPS can be coupled by alternating current (AC) or direct current (DC).

AC coupling blocks any DC voltage from the input signal. This is the default setting to prevent damage to the instrument. Very low frequencies in the input signal may be distorted.

However, some specifications require DC coupling. In this case, you must protect the instrument from damaging DC input voltages manually. For details, refer to the data sheet.

Remote command:

[INPut:COUpling](#) on page 193

### Impedance

For some measurements, the reference impedance for the measured levels of the R&S FPS can be set to 50 Ω or 75 Ω.

75 Ω should be selected if the 50 Ω input impedance is transformed to a higher impedance using a 75 Ω adapter of the RAZ type (= 25 Ω in series to the input impedance of the instrument). The correction value in this case is 1.76 dB = 10 log (75Ω/50Ω).

Remote command:

[INPut:IMPedance](#) on page 194

### YIG-Preselector

Activates or deactivates the YIG-preselector, if available on the R&S FPS.

An internal YIG-preselector at the input of the R&S FPS ensures that image frequencies are rejected. However, the YIG filter may limit the bandwidth of the I/Q data and will add some magnitude and phase distortions. You can check the impact in the Spectrum Flatness and Group Delay result displays.

Note that the YIG-preselector is active only on frequencies greater than 8 GHz. Therefore, switching the YIG-preselector on or off has no effect if the frequency is below that value.

Remote command:

`INPut:FILTer:YIG[:STATe]` on page 194

### 5.3.3.2 Output Settings

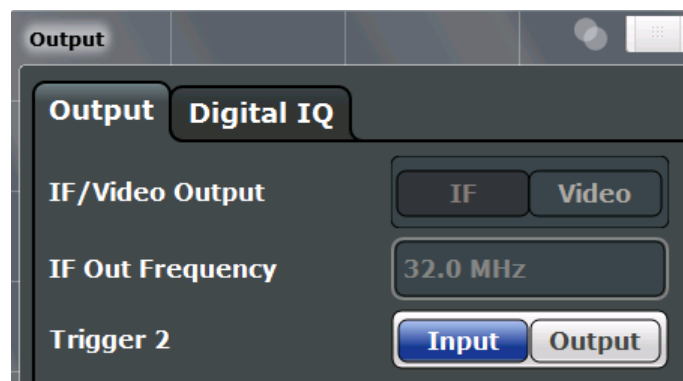
**Access:** INPUT/OUTPUT > "Output"

The R&S FPS can provide output to special connectors for other devices.

For details on connectors refer to the R&S FPS Getting Started manual, "Front / Rear Panel View" chapters.



How to provide trigger signals as output is described in detail in the R&S FPS User Manual.



|                     |    |
|---------------------|----|
| Noise Source.....   | 96 |
| Trigger 2.....      | 97 |
| L Output Type.....  | 97 |
| L Level.....        | 97 |
| L Pulse Length..... | 97 |
| L Send Trigger..... | 98 |

#### Noise Source

Switches the supply voltage for an external noise source on the R&S FPS on or off, if available.

External noise sources are useful when you are measuring power levels that fall below the noise floor of the R&S FPS itself, for example when measuring the noise level of a DUT.

For details see [Chapter 4.7.1, "Input from Noise Sources"](#), on page 80



Remote command:

[DIAGnostic:SERvice:NSource](#) on page 195

### Trigger 2

Defines the usage of the variable TRIGGER AUX connector on the rear panel.

(Trigger 1 is INPUT only.)

**Note:** Providing trigger signals as output is described in detail in the R&S FPS User Manual.

|          |   |
|----------|---|
| "Input"  | The signal at the connector is used as an external trigger source by the R&S FPS. Trigger input parameters are available in the "Trigger" dialog box.   |
| "Output" | The R&S FPS sends a trigger signal to the output connector to be used by connected devices. Further trigger parameters are available for the connector. |

**Note:** For simultaneous MIMO measurements (see ["Simultaneous Signal Capture Setup"](#) on page 112), if you set the master's TRIGGER 2 INPUT/OUTPUT connector to "device-triggered" output, the master R&S FPS sends its trigger event signal to any connected slaves. See also [Chapter 4.9.5, "Trigger Synchronization Using the Master's Trigger Output"](#), on page 85.

Remote command:

[OUTPut:TRIGger<port>:LEVel](#) on page 209

[OUTPut:TRIGger<port>:DIRection](#) on page 208

### Output Type ← Trigger 2

Type of signal to be sent to the output

|                    |   |
|--------------------|---|
| "Device Triggered" | (Default) Sends a trigger when the R&S FPS triggers.  |
| "Trigger Armed"    | Sends a (high level) trigger when the R&S FPS is in "Ready for trigger" state. This state is indicated by a status bit in the <code>STATUS:OPERation</code> register (bit 5). |
| "User Defined"     | Sends a trigger when user selects "Send Trigger" button. In this case, further parameters are available for the output signal.  |

Remote command:

[OUTPut:TRIGger<port>:OTYPe](#) on page 209

### Level ← Output Type ← Trigger 2

Defines whether a constant high (1) or low (0) signal is sent to the output connector.

Remote command:

[OUTPut:TRIGger<port>:LEVel](#) on page 209

### Pulse Length ← Output Type ← Trigger 2

Defines the length of the pulse sent as a trigger to the output connector.

Remote command:

[OUTPut:TRIGger<port>:PULSe:LENGth](#) on page 210

**Send Trigger ← Output Type ← Trigger 2**

Sends a user-defined trigger to the output connector immediately. Note that the trigger pulse level is always opposite to the constant signal level defined by the output "Level" setting, e.g. for "Level = High", a constant high signal is output to the connector until the "Send Trigger" button is selected. Then, a low pulse is sent.

Which pulse level will be sent is indicated by a graphic on the button.

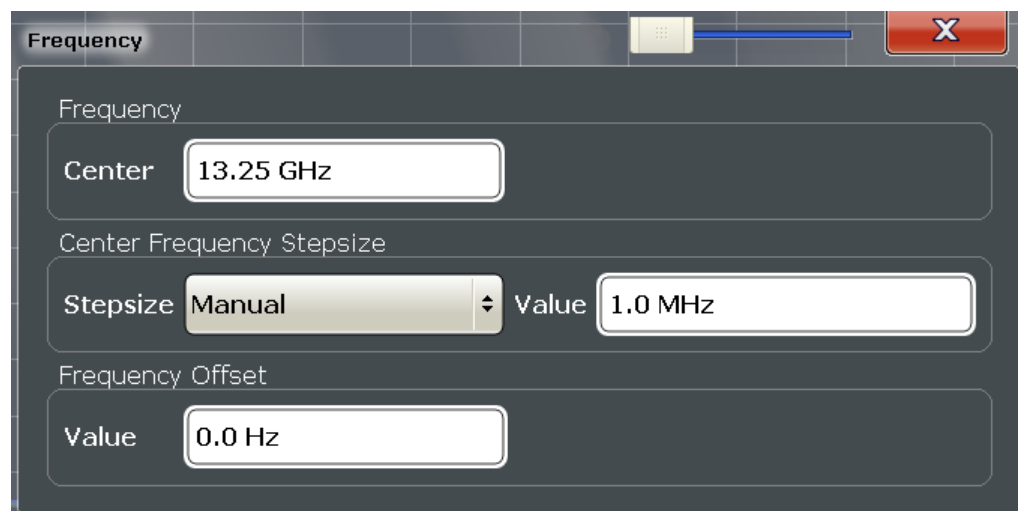
Remote command:

[OUTPut:TRIGger<port>:PULSe:IMMediate](#) on page 210

**5.3.3.3 Frequency Settings**

**Access:** "Overview" > "Input/Frontend" > "Frequency"

**or:** FREQ > "Frequency Config"



[Center frequency](#).....98  
[Center Frequency Stepsize](#).....98  
[Frequency Offset](#).....99

**Center frequency**

Defines the center frequency of the signal in Hertz.

Remote command:

[\[SENSe:\] FREQuency:CENTer](#) on page 196

**Center Frequency Stepsize**

Defines the step size by which the center frequency is increased or decreased using the arrow keys.

When you use the rotary knob the center frequency changes in steps of only 1/10 of the "Center Frequency Stepsize".

The step size can be coupled to another value or it can be manually set to a fixed value.

"= Center"      Sets the step size to the value of the center frequency. The used value is indicated in the "Value" field.

## WLAN IQ Measurement (Modulation Accuracy, Flatness, Tolerance...)

"Manual" Defines a fixed step size for the center frequency. Enter the step size in the "Value" field.

Remote command:

[SENSe:] FREQuency:CENTer:STEP on page 196

**Frequency Offset**

Shifts the displayed frequency range along the x-axis by the defined offset.

This parameter has no effect on the instrument's hardware, or on the captured data or on data processing. It is simply a manipulation of the final results in which absolute frequency values are displayed. Thus, the x-axis of a spectrum display is shifted by a constant offset if it shows absolute frequencies, but not if it shows frequencies relative to the signal's center frequency.

A frequency offset can be used to correct the display of a signal that is slightly distorted by the measurement setup, for example.

The allowed values range from -100 GHz to 100 GHz. The default setting is 0 Hz.

**Note:** In MSRA mode, this function is only available for the MSRA Master.

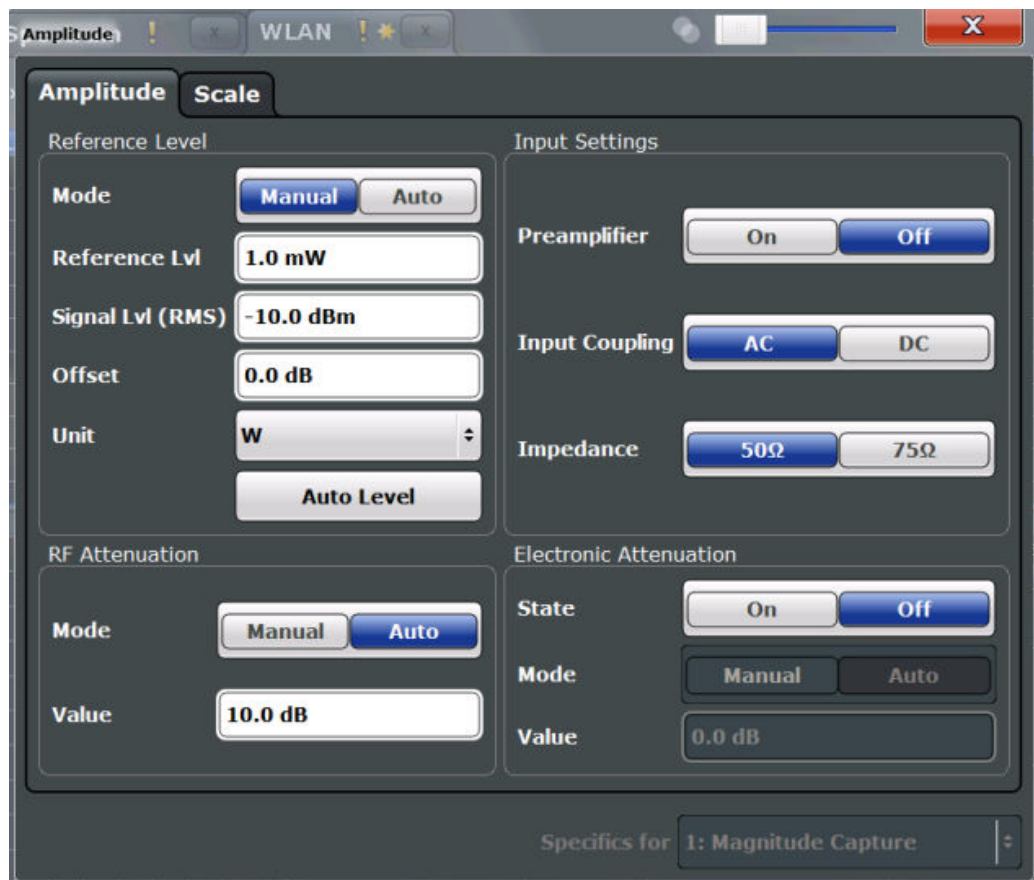
Remote command:

[SENSe:] FREQuency:OFFSet on page 197

**5.3.3.4 Amplitude Settings**

**Access:** "Overview" > "Input/Frontend" > "Amplitude"

Amplitude settings determine how the R&S FPS must process or display the expected input power levels.



Reference Level Settings..... 100

- └ Reference Level Mode..... 100
- └ Reference Level..... 101
- └ Signal Level (RMS)..... 101
- └ Shifting the Display (Offset)..... 101
- └ Unit..... 101
- └ Setting the Reference Level Automatically (Auto Level)..... 102

RF Attenuation..... 102

- └ Attenuation Mode / Value..... 102

Using Electronic Attenuation..... 102

Input Settings..... 103

- └ Preamplifier (option B22/B24)..... 103

**Reference Level Settings**

The reference level defines the expected maximum signal level. Signal levels above this value may not be measured correctly, which is indicated by the "IF OVLD" status display.

**Reference Level Mode ← Reference Level Settings**

By default, the reference level is automatically adapted to its optimal value for the current input data (continuously). At the same time, the internal attenuators and the pre-amplifier are adjusted so the signal-to-noise ratio is optimized, while signal compression, clipping and overload conditions are minimized.

In order to define the reference level manually, switch to "Manual" mode. In this case you must define the following reference level parameters.

Remote command:

`CONF:POW:AUTO ON`, see [CONFigure:POWer:AUTO](#) on page 198

#### Reference Level ← Reference Level Settings

Defines the expected maximum signal level. Signal levels above this value may not be measured correctly, which is indicated by the "IF OVLD" status display.

This value is overwritten if "Auto Level" mode is turned on.

Remote command:

`DISPlay[:WINDow<n>]:TRACe<t>:Y[:SCALe]:RLEVel` on page 199

#### Signal Level (RMS) ← Reference Level Settings

Specifies the mean power level of the source signal as supplied to the instrument's RF input. This value is overwritten if "Auto Level" mode is turned on.

Remote command:

`CONFigure:POWer:EXPEcted:RF` on page 199

#### Shifting the Display (Offset) ← Reference Level Settings

Defines an arithmetic level offset. This offset is added to the measured level irrespective of the selected unit. The scaling of the y-axis is changed accordingly.

Define an offset if the signal is attenuated or amplified before it is fed into the R&S FPS so the application shows correct power results. All displayed power level results will be shifted by this value.

Note, however, that the [Reference Level](#) value ignores the "Reference Level Offset". It is important to know the actual power level the R&S FPS must handle.

To determine the required offset, consider the external attenuation or gain applied to the input signal. A positive value indicates that an attenuation took place (R&S FPS increases the displayed power values), a negative value indicates an external gain (R&S FPS decreases the displayed power values).

The setting range is  $\pm 200$  dB in 0.01 dB steps.

Remote command:

`DISPlay[:WINDow<n>]:TRACe<t>:Y[:SCALe]:RLEVel:OFFSet` on page 199

#### Unit ← Reference Level Settings

The R&S FPS measures the signal voltage at the RF input.

The following units are available and directly convertible:

- dBm
- dBmV
- dB $\mu$ V

Remote command:

`CALCulate<n>:UNIT:POWer` on page 198

### Setting the Reference Level Automatically (Auto Level) ← Reference Level Settings

Automatically determines the optimal reference level for the current input data. At the same time, the internal attenuators and the preamplifier are adjusted so the signal-to-noise ratio is optimized, while signal compression, clipping and overload conditions are minimized.

In order to do so, a level measurement is performed to determine the optimal reference level.

This function is only available for the MSRA Master, not for the applications.

Remote command:

`CONFigure:POWer:AUTO` on page 198

### RF Attenuation

Defines the attenuation applied to the RF input.

#### Attenuation Mode / Value ← RF Attenuation

The RF attenuation can be set automatically as a function of the selected reference level (Auto mode). This ensures that no overload occurs at the RF INPUT connector for the current reference level. It is the default setting.

By default and when [electronic attenuation](#) is not available, mechanical attenuation is applied.

In "Manual" mode, you can set the RF attenuation in 1 dB steps (down to 0 dB). Other entries are rounded to the next integer value. The range is specified in the data sheet. If the defined reference level cannot be set for the defined RF attenuation, the reference level is adjusted accordingly and the warning "Limit reached" is displayed.

**NOTICE!** Risk of hardware damage due to high power levels. When decreasing the attenuation manually, ensure that the power level does not exceed the maximum level allowed at the RF input, as an overload may lead to hardware damage.

Remote command:

`INPut:ATTenuation` on page 199

`INPut:ATTenuation:AUTO` on page 200

### Using Electronic Attenuation

If the (optional) Electronic Attenuation hardware is installed on the R&S FPS, you can also activate an electronic attenuator.

In "Auto" mode, the settings are defined automatically; in "Manual" mode, you can define the mechanical and electronic attenuation separately.

**Note:** Electronic attenuation is not available for stop frequencies (or center frequencies in zero span) >7 GHz.

In "Auto" mode, RF attenuation is provided by the electronic attenuator as much as possible to reduce the amount of mechanical switching required. Mechanical attenuation may provide a better signal-to-noise ratio, however.

When you switch off electronic attenuation, the RF attenuation is automatically set to the same mode (auto/manual) as the electronic attenuation was set to. Thus, the RF attenuation may be set to automatic mode, and the full attenuation is provided by the mechanical attenuator, if possible.

Both the electronic and the mechanical attenuation can be varied in 1 dB steps. Other entries are rounded to the next lower integer value.

If the defined reference level cannot be set for the given attenuation, the reference level is adjusted accordingly and the warning "Limit reached" is displayed in the status bar.

Remote command:

`INPut:EATT:STATe` on page 201

`INPut:EATT:AUTO` on page 200

`INPut:EATT` on page 200

### Input Settings

Some input settings affect the measured amplitude of the signal, as well.

The parameters "Input Coupling" and "Impedance" are identical to those in the "Input" settings, see [Chapter 5.3.3.1, "Input Source Settings"](#), on page 94.

### Preamplifier (option B22/B24) ← Input Settings

Switches the preamplifier on and off. If activated, the input signal is amplified by 20 dB.

If option R&S FPS-B22 is installed, the preamplifier is only active below 7 GHz.

If option R&S FPS-B24 is installed, the preamplifier is active for all frequencies.

Remote command:

`INPut:GAIN:STATe` on page 201

## 5.3.4 Signal Capture (Data Acquisition)

You can define how much and how data is captured from the input signal.



### MSRA operating mode

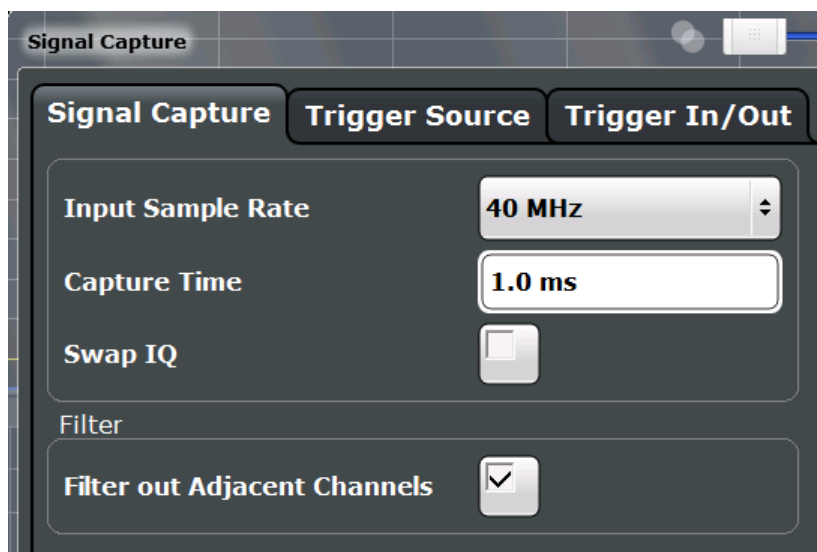
In MSRA operating mode, only the MSRA Master channel actually captures data from the input signal. The data acquisition settings for the R&S FPS WLAN application in MSRA mode define the **application data extract**. See [Chapter 5.3.5, "Application Data \(MSRA\)"](#), on page 118.

For details on the MSRA operating mode see the R&S FPS MSRA User Manual.

- [General Capture Settings](#)..... 103
- [Trigger Settings](#)..... 105
- [MIMO Capture Settings](#)..... 111

### 5.3.4.1 General Capture Settings

The general capture settings define how much and which data is to be captured during the WLAN IQ measurement.



|   |     |
|---|-----|
| Input Sample Rate.....  | 104 |
| Capture Time.....   | 104 |
| Capture Offset.....   | 104 |
| Swap I/Q.....   | 105 |
| Suppressing (Filter out) Adjacent Channels (IEEE 802.11a, g (OFDM), ac, j, n, p)... | 105 |

### Input Sample Rate

This is the sample rate the R&S FPS WLAN application expects the I/Q input data to have. If necessary, the R&S FPS has to resample the data.

During data processing in the R&S FPS, the sample rate usually changes (decreases). The RF input is captured by the R&S FPS using a high sample rate, and is resampled before it is processed by the R&S FPS WLAN application.

Remote command:

[TRACe: IQ: SRATe](#) on page 203

### Capture Time

Specifies the duration (and therefore the amount of data) to be captured in the capture buffer. If the capture time is too short, demodulation will fail.

Remote command:

[\[SENSe:\] SWEEp: TIME](#) on page 203

### Capture Offset

This setting is only available for applications in **MSRA operating mode**. It has a similar effect as the trigger offset in other measurements: it defines the time offset between the capture buffer start and the start of the extracted application data.

In MSRA mode, the offset must be a positive value, as the capture buffer starts at the trigger time = 0.

For details on the MSRA operating mode see the R&S FPS MSRA User Manual.

Remote command:

[\[SENSe:\] MSRA: CAPTure: OFFSet](#) on page 247



**Swap I/Q**

Activates or deactivates the inverted I/Q modulation. If the I and Q parts of the signal from the DUT are interchanged, the R&S FPS can do the same to compensate for it.

|     |   |
|-----|---|
| On  | I and Q signals are interchanged<br>Inverted sideband, $Q+jI$   |
| Off | I and Q signals are not interchanged<br>Normal sideband, $I+jQ$ |

Remote command:

`[SENSe:]SWAPiq` on page 202

**Suppressing (Filter out) Adjacent Channels (IEEE 802.11a, g (OFDM), ac, j, n, p)**

If activated (default), only the useful signal is analyzed, all signal data in adjacent channels is removed by the filter.

This setting improves the signal to noise ratio and thus the EVM results for signals with strong or a large number of adjacent channels. However, for some measurements information on the effects of adjacent channels on the measured signal may be of interest.

Remote command:

`[SENSe:]BANDwidth[:RESolution]:FILTer[:STATe]` on page 202

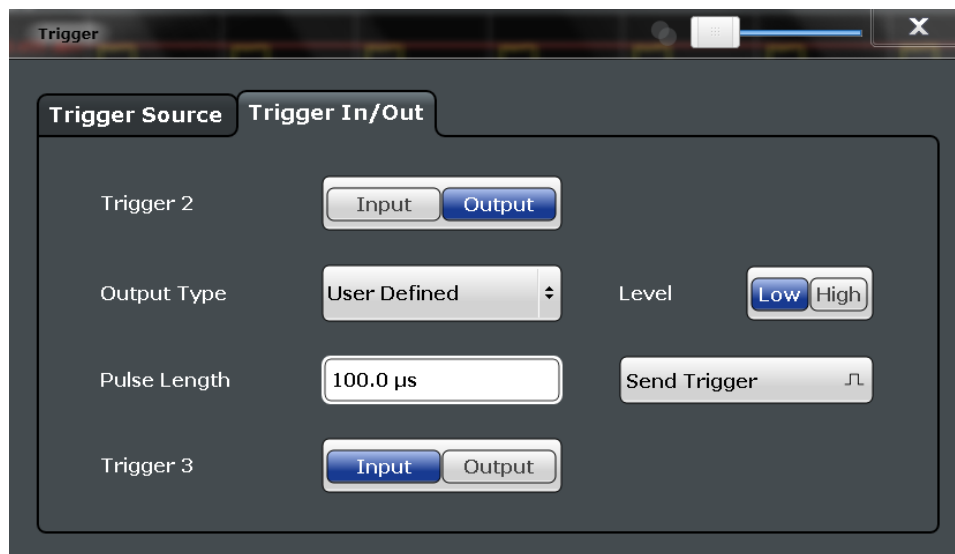
**5.3.4.2 Trigger Settings**

**Access:** "Overview" > "Signal Capture" > "Trigger Source"

Trigger settings determine when the R&S FPS starts to capture the input signal.

The screenshot shows the 'Trigger Source' configuration window. It includes a 'Trigger Source' dropdown set to 'Free Run', an 'FS-Z11 Trigger' toggle set to 'Off', and various trigger parameters like 'Level Mode', 'Trigger Level', 'Trigger Offset' (-10.0 µs), 'Drop-Out Time' (0.0 s), 'Slope' (Rising/Falling), 'Holdoff' (0.0 s), and 'Hysteresis' (3.0 dB). A 'Connection Guideline for Trigger Unit FS-Z11' diagram illustrates the connections between the DUT's RF outputs, the FS-Z11 Trigger Unit's TRIG INPUT/OUTPUT, and the Master Analyzer and three Slave Analyzers.

External triggers from one of the TRIGGER INPUT/OUTPUT connectors on the R&S FPS are configured in a separate tab of the dialog box.



For more information on trigger settings see [Chapter 4.9, "Triggered Measurements"](#), on page 82.

|                              |     |
|------------------------------|-----|
| Trigger Source Settings..... | 106 |
| L Trigger Source.....        | 106 |
| L Free Run.....              | 107 |
| L External Trigger 1/2.....  | 107 |
| L RF Power.....              | 107 |
| L I/Q Power.....             | 107 |
| L Time.....                  | 108 |
| L Trigger Level Mode.....    | 108 |
| L Trigger Level.....         | 108 |
| L Drop-Out Time.....         | 108 |
| L Trigger Offset.....        | 108 |
| L Hysteresis.....            | 109 |
| L Trigger Holdoff.....       | 109 |
| L Slope.....                 | 109 |
| L FS-Z11 Trigger.....        | 109 |
| L Capture Offset.....        | 109 |
| Trigger 2.....               | 110 |
| L Output Type.....           | 110 |
| L Level.....                 | 110 |
| L Pulse Length.....          | 110 |
| L Send Trigger.....          | 111 |

**Trigger Source Settings**

The Trigger Source settings define when data is captured.

**Trigger Source ← Trigger Source Settings**

Defines the trigger source. If a trigger source other than "Free Run" is set, "TRG" is displayed in the channel bar and the trigger source is indicated.

Remote command:

`TRIGger [:SEquence] :SOURce` on page 207

**Free Run ← Trigger Source ← Trigger Source Settings**

No trigger source is considered. Data acquisition is started manually or automatically and continues until stopped explicitly.

Remote command:

TRIG:SOUR IMM, see TRIGger[:SEquence]:SOURce on page 207

**External Trigger 1/2 ← Trigger Source ← Trigger Source Settings**

Data acquisition starts when the TTL signal fed into the specified input connector meets or exceeds the specified trigger level.

(See "Trigger Level" on page 108).

**Note:** The "External Trigger 1" softkey automatically selects the trigger signal from the TRG IN connector.

For details see the "Instrument Tour" chapter in the R&S FPS Getting Started manual.

"External Trigger 1"

Trigger signal from the TRG IN connector.

"External Trigger 2"

Trigger signal from the TRG AUX connector.

Note: Connector must be configured for "Input" in the "Outputs" configuration (see "Trigger 2" on page 97).

Remote command:

TRIG:SOUR EXT, TRIG:SOUR EXT2

See TRIGger[:SEquence]:SOURce on page 207

**RF Power ← Trigger Source ← Trigger Source Settings**

Defines triggering of the measurement via signals which are outside the displayed measurement range.

For this purpose the instrument uses a level detector at the first intermediate frequency.

The input signal must be in the frequency range between 500 MHz and 7 GHz.

The resulting trigger level at the RF input depends on the RF attenuation and preamplification. For details on available trigger levels see the instrument's data sheet.

**Note:** If the input signal contains frequencies outside of this range (e.g. for fullspan measurements), the measurement may be aborted and a message indicating the allowed input frequencies is displayed in the status bar.

A "Trigger Offset", "Trigger Polarity" and "Trigger Holdoff" (to improve the trigger stability) can be defined for the RF trigger, but no "Hysteresis".

Remote command:

TRIG:SOUR RFP, see TRIGger[:SEquence]:SOURce on page 207

**I/Q Power ← Trigger Source ← Trigger Source Settings**

Triggers the measurement when the magnitude of the sampled I/Q data exceeds the trigger threshold.

The trigger bandwidth corresponds to the "Usable I/Q Bandwidth", which depends on the sample rate of the captured I/Q data (see ["Input Sample Rate"](#) on page 104 and [Chapter A.1, "Sample Rate and Maximum Usable I/Q Bandwidth for RF Input"](#), on page 317).

Remote command:

TRIG:SOUR IQP, see [TRIGger\[:SEQuence\]:SOURce](#) on page 207

#### Time ← Trigger Source ← Trigger Source Settings

Triggers in a specified repetition interval.

Remote command:

TRIG:SOUR TIME, see [TRIGger\[:SEQuence\]:SOURce](#) on page 207

#### Trigger Level Mode ← Trigger Source Settings

By default, the optimum trigger level for power triggers is automatically measured and determined at the start of each sweep (for Modulation Accuracy, Flatness, Tolerance... measurements).

In order to define the trigger level manually, switch to "Manual" mode.

Remote command:

TRIG:SEQ:LEV:POW:AUTO ON, see [TRIGger:SEQuence:LEVel:POWer:AUTO](#) on page 206

#### Trigger Level ← Trigger Source Settings

Defines the trigger level for the specified trigger source.

For details on supported trigger levels, see the data sheet.

Remote command:

[TRIGger\[:SEQuence\]:LEVel:IFPower](#) on page 206

[TRIGger\[:SEQuence\]:LEVel:IQPower](#) on page 206

[TRIGger\[:SEQuence\]:LEVel\[:EXTernal<port>\]](#) on page 205

[TRIGger\[:SEQuence\]:LEVel:RFPower](#) on page 207

#### Drop-Out Time ← Trigger Source Settings

Defines the time the input signal must stay below the trigger level before triggering again.

For more information on the drop-out time see [Chapter 4.9.3, "Trigger Drop-Out Time"](#), on page 83.

Remote command:

[TRIGger\[:SEQuence\]:DTIME](#) on page 204

#### Trigger Offset ← Trigger Source Settings

Defines the time offset between the trigger event and the start of the measurement.

For more information see [Chapter 4.9.1, "Trigger Offset"](#), on page 82.

|             |  |
|-------------|--|
| offset > 0: | Start of the measurement is delayed      |
| offset < 0: | Measurement starts earlier (pre-trigger) |

Remote command:

[TRIGger\[:SEquence\]:HOLDoff\[:TIME\]](#) on page 204

#### **Hysteresis** ← Trigger Source Settings

Defines the distance in dB to the trigger level that the trigger source must exceed before a trigger event occurs. Setting a hysteresis avoids unwanted trigger events caused by noise oscillation around the trigger level.

This setting is only available for "IF Power" trigger sources. The range of the value is between 3 dB and 50 dB with a step width of 1 dB.

For more information see [Chapter 4.9.2, "Trigger Hysteresis"](#), on page 83.

Remote command:

[TRIGger\[:SEquence\]:IFPower:HYSteresis](#) on page 205

#### **Trigger Holdoff** ← Trigger Source Settings

Defines the minimum time (in seconds) that must pass between two trigger events. Trigger events that occur during the holdoff time are ignored.

For more information see [Chapter 4.9.4, "Trigger Holdoff"](#), on page 84.

Remote command:

[TRIGger\[:SEquence\]:IFPower:HOLDoff](#) on page 204

#### **Slope** ← Trigger Source Settings

For all trigger sources except time you can define whether triggering occurs when the signal rises to the trigger level or falls down to it.

Remote command:

[TRIGger\[:SEquence\]:SLOPe](#) on page 207

#### **FS-Z11 Trigger** ← Trigger Source Settings

If activated, the measurement is triggered by a connected R&S FS-Z11 trigger unit, simultaneously for all connected analyzers. This is useful for MIMO measurements in simultaneous measurement mode (see ["Simultaneous Signal Capture Setup"](#) on page 112).

The [Trigger Source](#) is automatically set to ["External Trigger 1/2"](#) on page 107. The required connections between the analyzers, the trigger unit, and the DUT are indicated in the graphic.

For details see [Chapter 4.9.6, "Trigger Synchronization Using an R&S FS-Z11 Trigger Unit"](#), on page 85.

Remote command:

[TRIGger\[:SEquence\]:SOURce](#) on page 207

#### **Capture Offset** ← Trigger Source Settings

This setting is only available for applications in **MSRA operating mode**. It has a similar effect as the trigger offset in other measurements: it defines the time offset between the capture buffer start and the start of the extracted application data.

In MSRA mode, the offset must be a positive value, as the capture buffer starts at the trigger time = 0.

For details on the MSRA operating mode see the R&S FPS MSRA User Manual.

Remote command:

[\[SENSe:\]MSRA:CAPTURE:OFFSet](#) on page 247

### Trigger 2

Defines the usage of the variable TRIGGER AUX connector on the rear panel.

(Trigger 1 is INPUT only.)

**Note:** Providing trigger signals as output is described in detail in the R&S FPS User Manual.

|          |   |
|----------|---|
| "Input"  | The signal at the connector is used as an external trigger source by the R&S FPS. Trigger input parameters are available in the "Trigger" dialog box.   |
| "Output" | The R&S FPS sends a trigger signal to the output connector to be used by connected devices. Further trigger parameters are available for the connector. |

**Note:** For simultaneous MIMO measurements (see ["Simultaneous Signal Capture Setup"](#) on page 112), if you set the master's TRIGGER 2 INPUT/OUTPUT connector to "device-triggered" output, the master R&S FPS sends its trigger event signal to any connected slaves. See also [Chapter 4.9.5, "Trigger Synchronization Using the Master's Trigger Output"](#), on page 85.

Remote command:

[OUTPut:TRIGger<port>:LEVel](#) on page 209

[OUTPut:TRIGger<port>:DIRection](#) on page 208

### Output Type ← Trigger 2

Type of signal to be sent to the output

|                    |   |
|--------------------|---|
| "Device Triggered" | (Default) Sends a trigger when the R&S FPS triggers.  |
| "Trigger Armed"    | Sends a (high level) trigger when the R&S FPS is in "Ready for trigger" state. This state is indicated by a status bit in the <code>STATUS:OPERation</code> register (bit 5). |
| "User Defined"     | Sends a trigger when user selects "Send Trigger" button. In this case, further parameters are available for the output signal.  |

Remote command:

[OUTPut:TRIGger<port>:OTYPe](#) on page 209

### Level ← Output Type ← Trigger 2

Defines whether a constant high (1) or low (0) signal is sent to the output connector.

Remote command:

[OUTPut:TRIGger<port>:LEVel](#) on page 209

### Pulse Length ← Output Type ← Trigger 2

Defines the length of the pulse sent as a trigger to the output connector.

Remote command:

[OUTPut:TRIGger<port>:PULSe:LENGth](#) on page 210

### Send Trigger ← Output Type ← Trigger 2

Sends a user-defined trigger to the output connector immediately. Note that the trigger pulse level is always opposite to the constant signal level defined by the output "Level" setting, e.g. for "Level = High", a constant high signal is output to the connector until the "Send Trigger" button is selected. Then, a low pulse is sent.

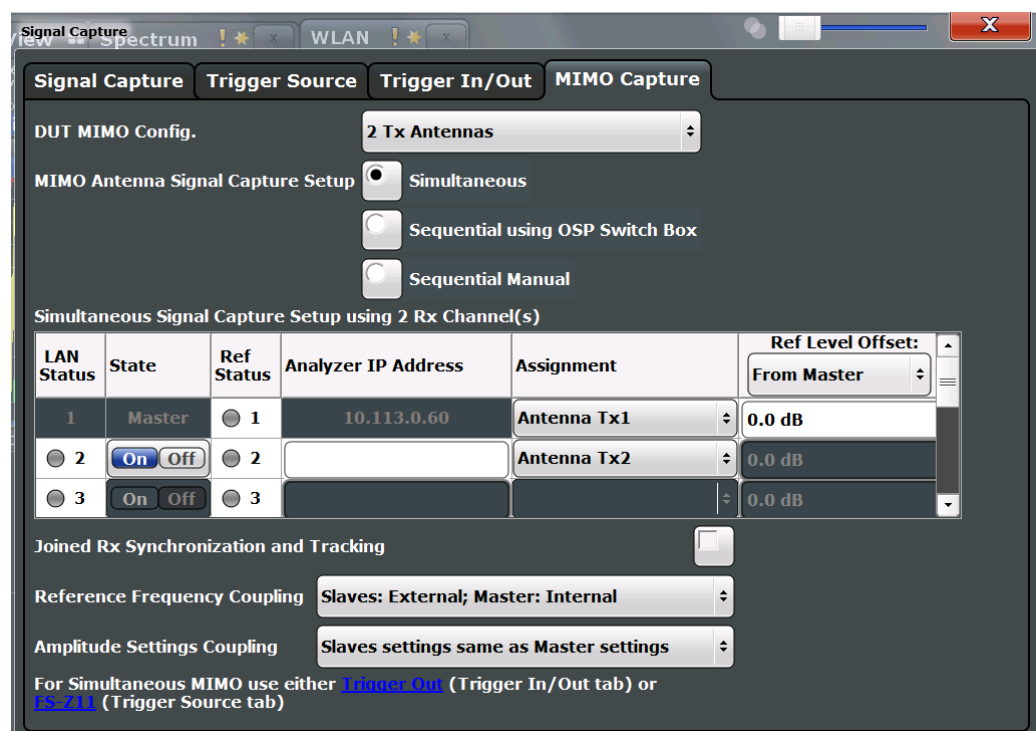
Which pulse level will be sent is indicated by a graphic on the button.

Remote command:

`OUTPut:TRIGger<port>:PULSe:IMMediate` on page 210

### 5.3.4.3 MIMO Capture Settings

The following settings are **only available for the IEEE 802.11ac and n standards.**



- DUT MIMO Configuration..... 112
- MIMO Antenna Signal Capture Setup..... 112
- Simultaneous Signal Capture Setup..... 112
  - └ LAN Status..... 112
  - └ State..... 113
  - └ Reference Status..... 113
  - └ Analyzer IP Address..... 113
  - └ Assignment..... 113
  - └ Reference Level Offset..... 113
  - └ Joined RX Sync and Tracking..... 113
  - └ Reference Frequency Coupling..... 114
  - └ Amplitude Settings Coupling..... 114
- Sequential Using OSP Switch Setup..... 114
  - └ OSP IP Address..... 115

|  |     |
|--|-----|
| L OSP Switch Bank Configuration.....       | 116 |
| Manual Sequential MIMO Data Capture.....   | 116 |
| L Single / Cont.....                       | 117 |
| L Calc Results.....                        | 117 |
| L Clear All Magnitude Capture Buffers..... | 117 |
| L RUN SGL / RUN CONT updates.....          | 117 |

### DUT MIMO Configuration

Defines the number of Tx antennas of the device under test (DUT). Currently up to eight Tx antennas are supported.

Remote command:

[CONFigure:WLAN:DUTConfig](#) on page 213

### MIMO Antenna Signal Capture Setup

Defines the MIMO method used by the R&S FPS(s) to capture data from multiple Tx antennas sent by one device under test (DUT).

|                               |   |
|-------------------------------|---|
| "Simultaneous"                | Simultaneous normal MIMO operation<br>The number of Tx antennas set in <a href="#">DUT MIMO Configuration</a> defines the number of analyzers required for this measurement setup.  |
| "Sequential using OSP switch" | Sequential using open switch platform<br>A single analyzer and the Rohde & Schwarz OSP Switch Platform (with at least one fitted R&S®OSP-B101 option) is required to measure the number of DUT Tx Antennas as defined in <a href="#">DUT MIMO Configuration</a> . |
| "Sequential manual"           | Sequential using manual operation<br>A single analyzer is required to measure the number of DUT Tx Antennas as defined in <a href="#">DUT MIMO Configuration</a> . Data capturing is performed manually via the analyzer's user interface.                        |

Remote command:

[CONFigure:WLAN:MIMO:CAPture:TYPE](#) on page 214

### Simultaneous Signal Capture Setup

For each RX antenna from which data is to be captured simultaneously, the settings are configured here.

### LAN Status ← Simultaneous Signal Capture Setup

The LED symbol indicates the LAN connection state for each individual antenna (except for the master):

*Table 5-1: Meaning of LED colors*

| Color | State   |
|-------|---|
| gray  | antenna off or IP address not available/valid       |
| red   | antenna on and IP address valid, but not accessible |
| green | antenna on and IP address accessible                |



**State ← Simultaneous Signal Capture Setup**

Switches the corresponding slave analyzer on or off. In "On" state the slave analyzer captures data. This data is transferred via LAN to the master for analysis of the MIMO system.

Remote command:

[CONFigure:WLAN:ANTMatrix:STATe<antenna>](#) on page 213

**Reference Status ← Simultaneous Signal Capture Setup**

LEDs indicate the connection state of the device providing the individual reference frequency for each channel (for ["Reference Frequency Coupling"](#) on page 114).

*Table 5-2: Meaning of LED colors*

| Color | State  |
|-------|--|
| gray  | external reference off or IP address not available/valid       |
| red   | external reference on and IP address valid, but not accessible |
| green | external reference on and IP address accessible                |

**Analyzer IP Address ← Simultaneous Signal Capture Setup**

Defines the IP addresses of the slaves connected via LAN to the master.

Remote command:

[CONFigure:WLAN:ANTMatrix:ADDRes<add>](#) on page 210

**Assignment ← Simultaneous Signal Capture Setup**

Assignment of the expected antenna to an analyzer. For a wired connection the assignment of the Tx antenna connected to the analyzer is a possibility. For a wired connection and Direct Spatial Mapping the Spectrum Flatness traces in the diagonal contain the useful information, in case the signal transmitted from the antennas matches with the expected antennas. Otherwise the secondary diagonal will contain the useful traces.

Remote command:

[CONFigure:WLAN:ANTMatrix:ANTenna<Analyzer>](#) on page 211

**Reference Level Offset ← Simultaneous Signal Capture Setup**

For simultaneous MIMO setups, you can set the reference level for all slave devices to the same setting as the master device, or define individual offsets.

"From Master" The slave analyzers' reference levels are set to match that of the master.

"Manual" The slave analyzers' reference levels are specified individually and are not coupled to the reference level offset of the master analyzer.

Remote command:

[CONFigure:WLAN:ANTMatrix:SOURce:RLEVel:OFFSet](#) on page 212

[CONFigure:WLAN:ANTMatrix:RLEVel<antenna>:OFFSet](#) on page 211

**Joined RX Sync and Tracking ← Simultaneous Signal Capture Setup**

This command configures how PPDU synchronization and tracking is performed for multiple captured antenna signals.

## WLAN IQ Measurement (Modulation Accuracy, Flatness, Tolerance...)

- "ON" RX antennas are synchronized and tracked together.  
 "OFF" RX antennas are synchronized and tracked separately.

Remote command:

[CONFigure:WLAN:RSYNc:JOINed](#) on page 215

**Reference Frequency Coupling ← Simultaneous Signal Capture Setup**

For simultaneous MIMO setups, you can set the reference frequency source for all slave devices to the same setting as the master device.

- "Slaves Reference same as Master setting" Both the master and all slaves use the same reference, according to the setting at the master.
- "Slaves: External; Master: Internal" The slave devices are set to use the external reference from the master. The master device uses its internal reference. Configure the master to send its reference frequency to all slave devices via one of its REF OUTPUT connectors. (See the R&S FPS User Manual for details.)
- "Off" Both the master and slave devices use their own internal references; the frequencies are not coupled.

Remote command:

[CONFigure:WLAN:ANTMatrix:SOURce:ROSCillator:SOURce](#) on page 213

**Amplitude Settings Coupling ← Simultaneous Signal Capture Setup**

For simultaneous MIMO setups, you can set the amplitude settings for all slave devices to the same setting as the master device. Thus, for example, you can force the slave devices to auto-level in order to achieve better results. This feature requires that the WLAN 802.11 application R&S FPS-K91 is installed on the slave device.

- "Slaves settings same as Master settings" Both the master and all slaves use the same amplitude settings, according to the settings at the master. All settings on the slave are ignored (including "Reference Level Auto"). Note: if "Reference Level Auto" is set at the master, the master channel performs an auto-level measurement and the resulting amplitude settings are transferred to the slaves.
- "Slaves auto-level same as master" The slave devices perform an auto-level at the same time as the master. The amplitude settings are then determined automatically by each device according to the measured values. This feature requires that the WLAN 802.11 application R&S FPS-K91 (version 1.31 or higher) is installed on the slave devices.
- "Off" Both the master and slave devices use their own amplitude settings as defined prior to the measurement; the settings are not coupled.

Remote command:

[CONFigure:WLAN:ANTMatrix:SOURce:AMPLitude:SOURce](#) on page 211

**Sequential Using OSP Switch Setup**

A single analyzer and the Rohde & Schwarz OSP Switch Platform (with at least one fitted R&S@OSP-B101 option) is required to measure the DUT Tx Antennas.

**Note:** For sequential MIMO measurements the DUT has to transmit identical PPDU's over time! The signal field, for example, has to be identical for all PPDU's. For details see [Chapter 4.3.4.1, "Sequential MIMO Measurement"](#), on page 74.

This setup requires the analyzer and the OSP switch platform to be connected via LAN. A connection diagram is shown to assist you in connecting the specified number of DUT Tx antennas with the analyzer via the Rohde & Schwarz OSP switch platform.

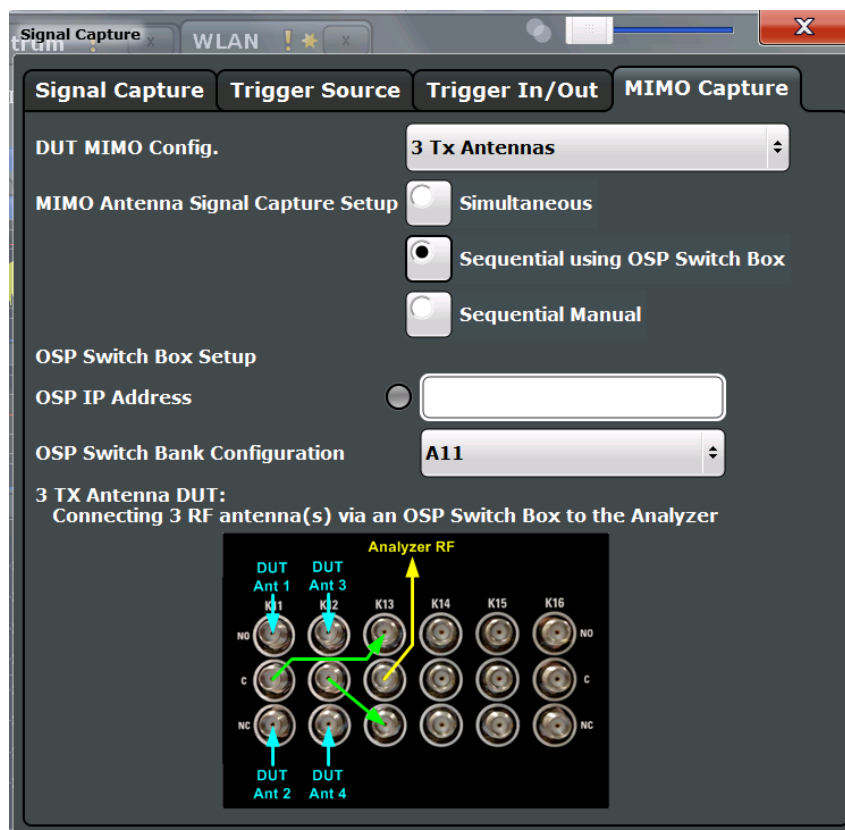


Figure 5-1: Connection instructions for sequential MIMO using an OSP switch

The diagram shows an R&S®OSP-B101 option fitted in one of the three module slots at the rear of the OSP switch platform. The DUT Tx antennas, the OSP switching box and the analyzer have to be connected as indicated in the diagram.

- **Blue** colored arrows represent the RF connections between the Tx antennas of the DUT and the corresponding SMA plugs of the R&S®OSP-B101 option.
- **Green** colored arrows represent auxiliary connections of SMA plugs of the R&S®OSP-B101 option.
- **Yellow** colored arrows represent the connection between the SMA plug of the R&S®OSP-B101 option with the RF or analog baseband input of the analyzer.

#### OSP IP Address ← Sequential Using OSP Switch Setup

The analyzer and the R&S OSP switch platform have to be connected via LAN. Enter the IP address of the OSP switch platform.

When using an R&S®OSP130 switch platform, the IP address is shown in the front display.

When using a R&S®OSP120 switch platform, connect an external monitor to get the IP address or use the default IP address of the OSP switch platform. For details read the OSP operation manual.

An online keyboard is displayed to enter the address in dotted IPV4 format.

**Tip:** the LED symbol indicates the state of the OSP switch box:

| Color | State  |
|-------|--|
| gray  | OSP switch box off or IP address not available/valid       |
| red   | OSP switch box on and IP address valid, but not accessible |
| green | OSP switch box on and IP address accessible                |

Remote command:

[CONFigure:WLAN:MIMO:OSP:ADDRes](#) on page 215

### OSP Switch Bank Configuration ← Sequential Using OSP Switch Setup

The R&S®OSP-B101 option is fitted in one of the three module slots (*switch banks*) at the rear of the OSP switch platform. The DUT Tx antennas are connected with the analyzer via the R&S®OSP-B101 module fitted in the OSP switch platform. Select the R&S®OSP-B101 module that is used for this connection.

Remote command:

[CONFigure:WLAN:MIMO:OSP:MODule](#) on page 215

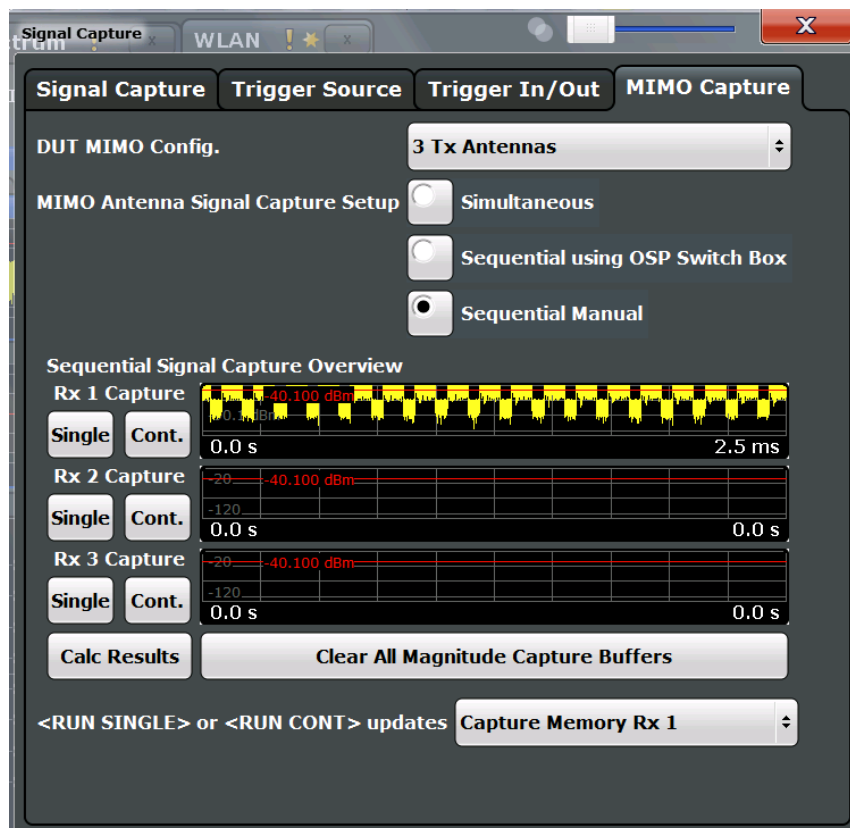
### Manual Sequential MIMO Data Capture

**Note:** For sequential MIMO measurements the DUT has to transmit identical PPDUs over time! The signal field, for example, has to be identical for all PPDUs. For details see [Chapter 4.3.4.1, "Sequential MIMO Measurement"](#), on page 74.

For this MIMO method you must connect each Tx antenna of the WLAN DUT with the analyzer and start data capturing manually (see [Chapter 5.3.12, "Sweep Settings"](#), on page 150).

The dialog box shows a preview of the capture memories (one for each RX antenna). The PPDUs detected by the application are highlighted by the green bars.

## WLAN IQ Measurement (Modulation Accuracy, Flatness, Tolerance...)



Remote command:

CONF:WLAN:MIMO:CAPT:TYP MAN, see [CONFigure:WLAN:MIMO:CAPTure:TYPE](#) on page 214

#### Single / Cont. ← Manual Sequential MIMO Data Capture

Starts a single or continuous new measurement for the corresponding antenna.

Remote command:

CONF:WLAN:MIMO:CAPT RX1, see [CONFigure:WLAN:MIMO:CAPTure](#) on page 214  
[INITiate<n>\[:IMMediate\]](#) on page 267

#### Calc Results ← Manual Sequential MIMO Data Capture

Calculates the results for the captured antenna signals.

Remote command:

[CALCulate<n>:BURSt\[:IMMediate\]](#) on page 266

#### Clear All Magnitude Capture Buffers ← Manual Sequential MIMO Data Capture

Clears all the capture buffers and previews.

#### RUN SGL / RUN CONT updates ← Manual Sequential MIMO Data Capture

Determines which capture buffer is used to store data if a measurement is started via the global RUN SGL / RUN CONT keys.

### 5.3.5 Application Data (MSRA)

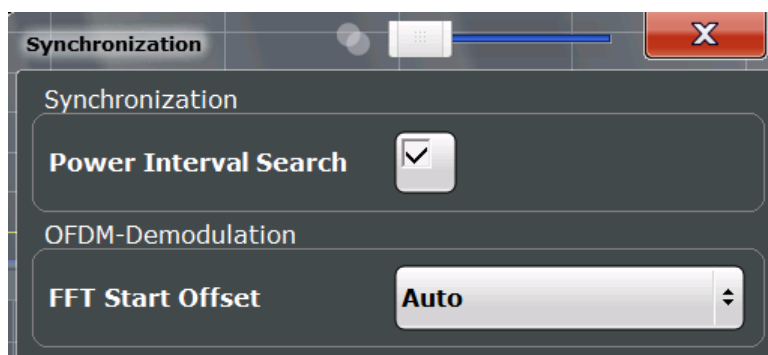
For the R&S FPS WLAN application in MSRA operating mode, the application data range is defined by the same settings used to define the signal capturing in Signal and Spectrum Analyzer mode (see [Chapter 5.3.4, "Signal Capture \(Data Acquisition\)"](#), on page 103).

In addition, a capture offset can be defined, i.e. an offset from the start of the captured data to the start of the analysis interval for the WLAN 802.11 I/Q measurement (see ["Capture Offset"](#) on page 104).

The **analysis interval** cannot be edited manually, but is determined automatically according to the selected channel, carrier or PPDU to analyze which is defined for the evaluation range, depending on the result display. Note that the channel/carrier/PPDU is analyzed *within the application data*.

### 5.3.6 Synchronization and OFDM Demodulation

Synchronization settings have an effect on which parts of the input signal are processed during the WLAN measurement.



|   |     |
|---|-----|
| <a href="#">Power Interval Search</a> ..... | 118 |
| <a href="#">FFT Start Offset</a> .....      | 118 |

#### Power Interval Search

If enabled, the R&S FPS WLAN application initially performs a coarse burst search on the input signal in which increases in the power vs time trace are detected. Further time-consuming processing is then only performed where bursts are assumed. This improves the measurement speed for signals with low duty cycle rates.

However, for signals in which the PPDU power levels differ significantly, this option should be disabled as otherwise some PDUs may not be detected.

Remote command:

[\[SENSe:\] DEMod:TXARea](#) on page 216

#### FFT Start Offset

This command specifies the start offset of the FFT for OFDM demodulation (not for the FFT Spectrum display).

## WLAN IQ Measurement (Modulation Accuracy, Flatness, Tolerance...)

"AUTO"

The FFT start offset is automatically chosen to minimize the intersymbol interference.

"Guard Interval Cntr"

Guard Interval Center: The FFT start offset is placed to the center of the guard interval.

"Peak"

The peak of the fine timing metric is used to determine the FFT start offset.

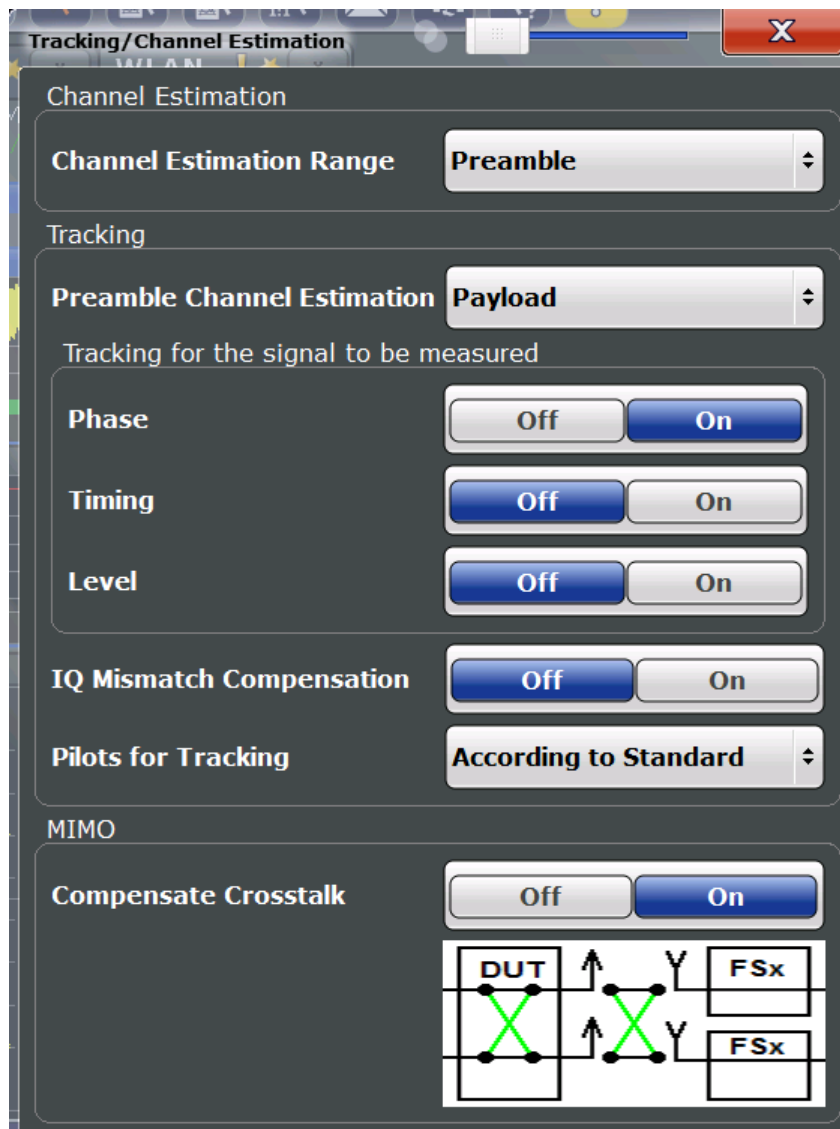
Remote command:

[SENSe:]DEMod:FFT:OFFSet on page 215

### 5.3.7 Tracking and Channel Estimation

**Access:** "Overview" > "Tracking/Channel Estimation"

The channel estimation settings determine which channels are assumed in the input signal. Tracking settings allow for compensation of some transmission effects in the signal (see "[Tracking the phase drift, timing jitter and gain](#)" on page 60).



Channel Estimation Range..... 120  
 Preamble Channel Estimation..... 121  
 Phase Tracking..... 121  
 Timing Error Tracking..... 121  
 Level Error (Gain) Tracking..... 121  
 I/Q Mismatch Compensation..... 121  
 Pilots for Tracking..... 122  
 Compensate Crosstalk (MIMO only)..... 122

**Channel Estimation Range**

Specifies the signal range used to estimate the channels.

This function is **not** available for IEEE 802.11b or g (DSSS).

- "Preamble"      The channel estimation is performed in the preamble as required in the standard.



## WLAN IQ Measurement (Modulation Accuracy, Flatness, Tolerance...)

"Payload" The channel estimation is performed in the preamble and the payload. The EVM results can be calculated more accurately.

Remote command:

[\[SENSe:\]DEMod:CESTimation](#) on page 217

### Preamble Channel Estimation

Defines which results are used for preamble tracking prior to the preamble channel estimation.

"Payload" Payload tracking results are used for preamble tracking prior to the preamble channel estimation

"(V)HT-LTF Symbols + Payload" (V)HT-LTF Symbols and Payload tracking results are used for preamble tracking prior to the preamble channel estimation.

Remote command:

[SENSe:TRACking:PREamble](#) on page 219

### Phase Tracking

Activates or deactivates the compensation for phase drifts. If activated, the measurement results are compensated for phase drifts on a per-symbol basis.

Remote command:

[SENSe:TRACking:PHASe](#) on page 218

### Timing Error Tracking

Activates or deactivates the compensation for timing drift. If activated, the measurement results are compensated for timing error on a per-symbol basis.

Remote command:

[SENSe:TRACking:TIME](#) on page 219

### Level Error (Gain) Tracking

Activates or deactivates the compensation for level drifts within a single PPDU. If activated, the measurement results are compensated for level error on a per-symbol basis.

Remote command:

[SENSe:TRACking:LEVel](#) on page 218

### I/Q Mismatch Compensation

Activates or deactivates the compensation for I/Q mismatch.

If activated, the measurement results are compensated for gain imbalance and quadrature offset. Since the quadrature offset is compensated carrier-wise, I/Q skew impairments are compensated as well.

This setting is **not available for standards IEEE 802.11b and g (DSSS)**.

For details see [Chapter 3.1.1.5, "I/Q Mismatch"](#), on page 18.

**Note:** For EVM measurements according to the IEEE 802.11-2012, IEEE 802.11ac-2013 WLAN standard, I/Q mismatch compensation must be deactivated.

Remote command:

[SENSe:TRACking:IQMComp](#) on page 217

### Pilots for Tracking

In case tracking is used, the used pilot sequence has an effect on the measurement results.

This function is **not** available for **IEEE 802.11b or g (DSSS)**.

"According to standard"

The pilot sequence is determined according to the corresponding WLAN standard. In case the pilot generation algorithm of the device under test (DUT) has a problem, the non-standard-conform pilot sequence might affect the measurement results, or the WLAN application might not synchronize at all onto the signal generated by the DUT.

"Detected"

The pilot sequence detected in the WLAN signal to be analyzed is used by the WLAN application. In case the pilot generation algorithm of the device under test (DUT) has a problem, the non-standard-conform pilot sequence will not affect the measurement results. In case the pilot sequence generated by the DUT is correct, it is recommended that you use the "According to Standard" setting because it generates more accurate measurement results.

Remote command:

[SENSe:TRACking:PILots](#) on page 218

### Compensate Crosstalk (MIMO only)

Activates or deactivates the compensation for crosstalk in MIMO measurement setups.

This setting is **only available for standard IEEE 802.11ac or n (MIMO)**.

By default, full MIMO equalizing is performed by the R&S FPS WLAN application. However, you can deactivate compensation for crosstalk. In this case, simple main path equalizing is performed only for direct connections between Tx and Rx antennas, disregarding ancillary transmission between the main paths (crosstalk). This is useful to investigate the effects of crosstalk on results such as EVM.

On the other hand, for cable connections, which have practically no crosstalk, you may get better EVM results if crosstalk is compensated for.

For details see [Chapter 4.3.6, "Crosstalk and Spectrum Flatness"](#), on page 77.

Remote command:

[SENSe:TRACking:CROSstalk](#) on page 217

## 5.3.8 Demodulation

The demodulation settings define which PPDU's are to be analyzed, thus they define a *logical filter*.

The available demodulation settings vary depending on the selected digital standard in the "Signal Description" (see ["Standard"](#) on page 93).

- Demodulation - IEEE 802.11a, g (OFDM), j, p..... 123
- Demodulation - IEEE 802.11ac..... 125
- Demodulation - IEEE 802.11b, g (DSSS)..... 130
- Demodulation - IEEE 802.11n..... 131
- Demodulation - MIMO (IEEE 802.11ac, n)..... 136

**5.3.8.1 Demodulation - IEEE 802.11a, g (OFDM), j, p**

The following settings are available for demodulation of IEEE 802.11a, g (OFDM), j, p signals.

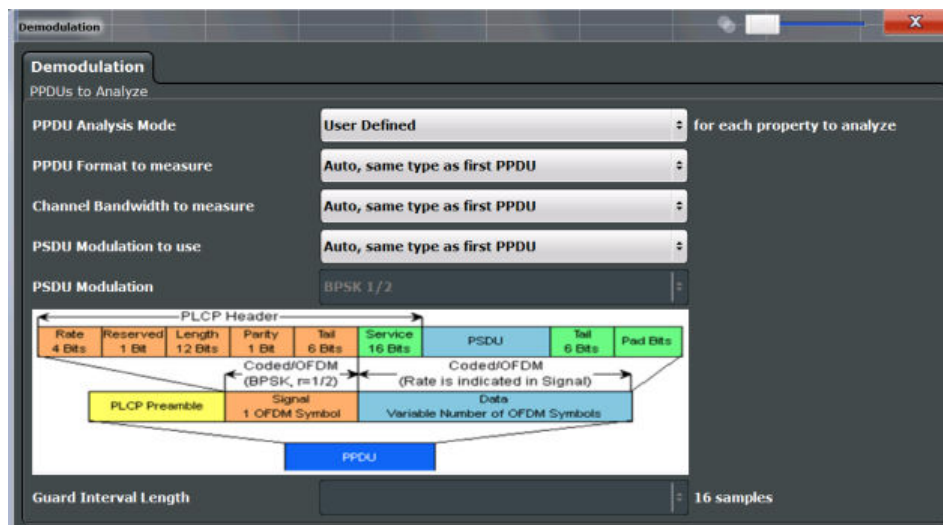


Figure 5-2: Demodulation settings for IEEE 802.11a, g (OFDM), j, or p standard

- PPDU Analysis Mode..... 123
- PPDU Format to measure..... 124
- Channel Bandwidth to measure (CBW)..... 124
- PSDU Modulation to use..... 125
- PSDU Modulation..... 125

**PPDU Analysis Mode**

Defines whether all or only specific PPDU are to be analyzed.

"Auto, same type as first PPDU"

The signal symbol field, i.e. the PLCP header field, of the first recognized PPDU is analyzed to determine the details of the PPDU. All PPDU identical to the first recognized PPDU are analyzed. All subsequent settings are set to "Auto" mode.

"Auto, individually for each PPDU"

All PPDU are analyzed

"User-defined"

User-defined settings define which PPDU are analyzed. This setting is automatically selected when any of the subsequent settings are changed to a value other than "Auto".

Remote command:

[SENSe:] DEMod: FORMat [: BCONtent] : AUTO on page 231

#### PPDU Format to measure

Defines which PPDU formats are to be included in the analysis. Depending on which standards the communicating devices are using, different formats of PDUs are available. Thus you can restrict analysis to the supported formats.

**Note:** The PPDU format determines the available channel bandwidths.

For details on supported PPDU formats and channel bandwidths depending on the standard see [Table 4-1](#).

**Note:** The terms in brackets in the following description indicate how the setting is referred to in the Signal Field result display ("Format" column, see ["Signal Field"](#) on page 45).

"Auto, same type as first PPDU(A1st)"

The format of the first valid PPDU is detected and subsequent PDUs are analyzed only if they have the same format.

"Auto, individually for each PPDU(AI)"

All PDUs are analyzed regardless of their format

"Meas only ...(M ...)"

Only PDUs with the specified format are analyzed

"Demod all as ...(D ...)"

All PDUs are assumed to have the specified PPDU format

Remote command:

[SENSe:] DEMod: FORMat: BANalyze: BType: AUTO: TYPE on page 229

[SENSe:] DEMod: FORMat: BANalyze on page 227

#### Channel Bandwidth to measure (CBW)

Defines the channel bandwidth of the PDUs taking part in the analysis. Depending on which standards the communicating devices are using, different PDU formats and channel bandwidths are supported.

For details on supported PDU formats and channel bandwidths depending on the standard see [Table 4-1](#).

**Note:** The terms in brackets in the following description indicate how the setting is referred to in the Signal Field result display ("Format" column, see ["Signal Field"](#) on page 45).

"Auto, same type as first PDU""(A1st)"

The channel bandwidth of the first valid PDU is detected and subsequent PDUs are analyzed only if they have the same channel bandwidth.

"Auto, individually for each PDU""(AI)"

All PDUs are analyzed regardless of their channel bandwidth

"Meas only ... signal""(M ...)"

Only PDUs with the specified channel bandwidth are analyzed

"Demod all as ... signal""(D ...)"

All PDUs are assumed to have the specified channel bandwidth

Remote command:

[\[SENSe:\] BANDwidth:CHANnel:AUTO:TYPE](#) on page 225

#### **PSDU Modulation to use**

Specifies which PSDUs are to be analyzed depending on their modulation. Only PSDUs using the selected modulation are considered in measurement analysis.

For details on supported modulation depending on the standard see [Table 4-1](#).

"Auto, same type as first PPDU""(A1st)"

All PSDUs using the same modulation as the first recognized PPDU are analyzed.

"Auto, individually for each PPDU""(AI)"

All PSDUs are analyzed

"Meas only the specified PSDU Modulation""(M ...)"

Only PSDUs with the modulation specified by the [PSDU Modulation](#) setting are analyzed

"Demod all with specified PSDU modulation""(D ...)"

The PSDU modulation of the [PSDU Modulation](#) setting is used for all PSDUs.

Remote command:

[\[SENSe:\] DEMod:FORMat:BANalyze:BTYPe:AUTO:TYPE](#) on page 229

[\[SENSe:\] DEMod:FORMat:BANalyze](#) on page 227

#### **PSDU Modulation**

If analysis is restricted to PSDU with a particular modulation type, this setting defines which type.

For details on supported modulation depending on the standard see [Table 4-1](#).

Remote command:

[\[SENSe:\] DEMod:FORMat:BANalyze](#) on page 227

### **5.3.8.2 Demodulation - IEEE 802.11ac**

The following settings are available for demodulation of IEEE 802.11ac signals.

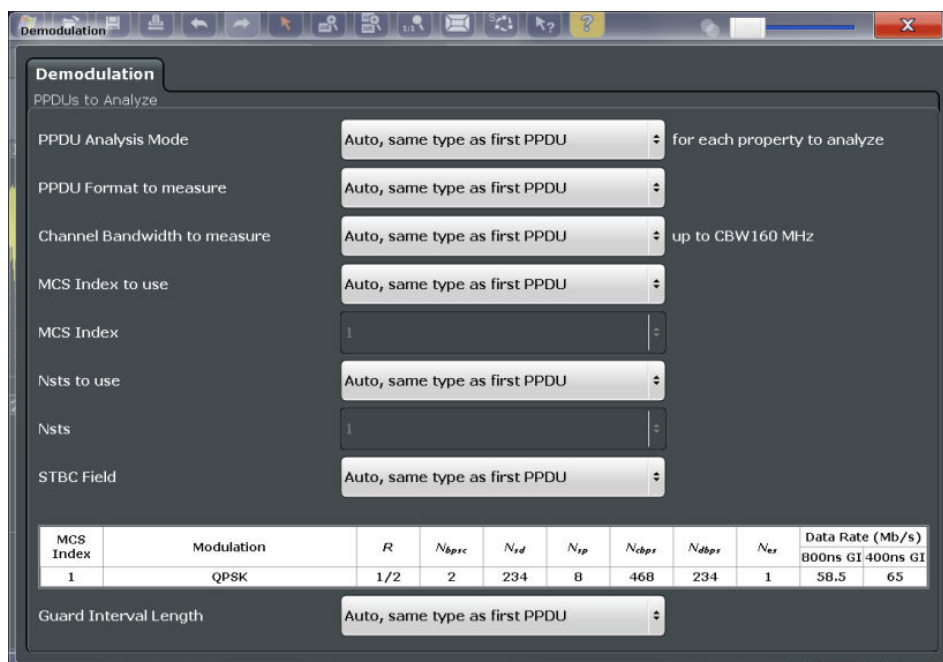


Figure 5-3: Demodulation settings for IEEE 802.11ac standard

PPDU Analysis Mode..... 126

PPDU Format to measure..... 127

Channel Bandwidth to measure (CBW)..... 127

MCS Index to use..... 128

MCS Index..... 128

Nsts to use..... 128

Nsts..... 129

STBC Field..... 129

Table info overview..... 129

Guard Interval Length..... 129

**PPDU Analysis Mode**

Defines whether all or only specific PPDU are to be analyzed.

"Auto, same type as first PPDU"

The signal symbol field, i.e. the PLCP header field, of the first recognized PPDU is analyzed to determine the details of the PPDU. All PPDU identical to the first recognized PPDU are analyzed. All subsequent settings are set to "Auto" mode.

"Auto, individually for each PPDU"

All PPDU are analyzed

"User-defined"

User-defined settings define which PPDU are analyzed. This setting is automatically selected when any of the subsequent settings are changed to a value other than "Auto".

Remote command:

[SENSe:] DEMod:FORMat [:BCONtent] :AUTO on page 231

**PPDU Format to measure**

Defines which PPDU formats are to be included in the analysis. Depending on which standards the communicating devices are using, different formats of PDUs are available. Thus you can restrict analysis to the supported formats.

**Note:** The PDU format determines the available channel bandwidths.

For details on supported PDU formats and channel bandwidths depending on the standard see [Table 4-1](#).

**Note:** The terms in brackets in the following description indicate how the setting is referred to in the Signal Field result display ("Format" column, see "[Signal Field](#)" on page 45).

"Auto, same type as first PDU(A1st)"

The format of the first valid PDU is detected and subsequent PDUs are analyzed only if they have the same format.

"Auto, individually for each PDU(AI)"

All PDUs are analyzed regardless of their format

"Meas only ...(M ...)"

Only PDUs with the specified format are analyzed

"Demod all as ...(D ...)"

All PDUs are assumed to have the specified PDU format

Remote command:

[SENSe:] DEMod: FORMat: BANalyze: BTYPE: AUTO: TYPE on page 229

[SENSe:] DEMod: FORMat: BANalyze on page 227

**Channel Bandwidth to measure (CBW)**

Defines the channel bandwidth of the PDUs taking part in the analysis. Depending on which standards the communicating devices are using, different PDU formats and channel bandwidths are supported.

For details on supported PDU formats and channel bandwidths depending on the standard see [Table 4-1](#).

**Note:** The terms in brackets in the following description indicate how the setting is referred to in the Signal Field result display ("Format" column, see "[Signal Field](#)" on page 45).

"Auto, same type as first PDU"(A1st)"

The channel bandwidth of the first valid PDU is detected and subsequent PDUs are analyzed only if they have the same channel bandwidth.

"Auto, individually for each PDU"(AI)"

All PDUs are analyzed regardless of their channel bandwidth

"Meas only ... signal"(M ...)"

Only PDUs with the specified channel bandwidth are analyzed

"Demod all as ... signal"(D ...)"

All PDUs are assumed to have the specified channel bandwidth

Remote command:

[SENSe:] BANDwidth: CHANnel: AUTO: TYPE on page 225

**MCS Index to use**

Defines the PPDU's taking part in the analysis depending on their Modulation and Coding Scheme (MCS) index.

**Note:** The terms in brackets in the following description indicate how the setting is referred to in the Signal Field result display ("Format" column, see "Signal Field" on page 45).

"Auto, same type as first PPDU:"(A1st)"

All PPDU's using the MCS index identical to the first recognized PPDU are analyzed.

" Auto, individually for each PPDU"(AI)"

All PPDU's are analyzed

"Meas only the specified MCS"(M ...)"

Only PPDU's with the MCS index specified for the [MCS Index](#) setting are analyzed

"Demod all with specified MCS"(D ...)"

The [MCS Index](#) setting is used for all PPDU's.

Remote command:

[\[SENSe:\] DEMod:FORMat:MCSindex:MODE](#) on page 231

**MCS Index**

Defines the MCS index of the PPDU's taking part in the analysis manually. This field is enabled for "MCS index to use" = "Meas only the specified MCS" or "Demod all with specified MCS".

Remote command:

[\[SENSe:\] DEMod:FORMat:MCSindex](#) on page 231

**Nsts to use**

Defines the the PPDU's taking part in the analysis depending on their Nsts.

**Note:** The terms in brackets in the following description indicate how the setting is referred to in the "Signal Field" result display ("NSTS" column, see "Signal Field" on page 45).

"Auto, same type as first PPDU:"(A1st)"

All PPDU's using the Nsts identical to the first recognized PPDU are analyzed.

" Auto, individually for each PPDU"(AI)"

All PPDU's are analyzed

"Meas only the specified Nsts"(M ...)"

Only PPDU's with the Nsts specified for the "[Nsts](#)" on page 129 setting are analyzed

"Demod all with specified Nsts"(D ...)"

The "[Nsts](#)" on page 129 setting is used for all PPDU's.

Remote command:

[\[SENSe:\] DEMod:FORMat:NSTSindex:MODE](#) on page 232



**Nsts**

Defines the Nsts of the PPDU taking part in the analysis. This field is enabled for **Nsts to use** = "Meas only the specified Nsts" or "Demod all with specified Nsts".

Remote command:

[\[SENSe:\]DEMod:FORMat:NSTSiNdex](#) on page 232

**STBC Field**

Defines the PPDU taking part in the analysis according to the Space-Time Block Coding (STBC) field content.

**Note:** The terms in brackets in the following description indicate how the setting is referred to in the Signal Field result display ("Format" column, see **"Signal Field"** on page 45).

"Auto, same type as first PPDU""(A1st)"

All PPDU using a STBC field content identical to the first recognized PPDU are analyzed.

"Auto, individually for each PPDU""(AI)"

All PPDU are analyzed.

"Meas only if STBC field = 1 (+1 Stream)""(M1)"(IEEE 802.11N)

Only PPDU with the specified STBC field content are analyzed.

"Meas only if STBC field = 2 (+2 Stream)""(M2)"(IEEE 802.11N)

Only PPDU with the specified STBC field content are analyzed.

"Demod all as STBC field = 1""(D1)"(IEEE 802.11N)

All PPDU are analyzed assuming the specified STBC field content.

"Demod all as STBC field = 2""(D2)"(IEEE 802.11N)

All PPDU are analyzed assuming the specified STBC field content.

"Meas only if STBC = 1 (Nsts = 2Nss)""(M1)"(IEEE 802.11AC)

Only PPDU with the specified STBC field content are analyzed.

"Demod all as STBC = 1 (Nsts = 2Nss)""(D1)"(IEEE 802.11AC)

All PPDU are analyzed assuming the specified STBC field content.

Remote command:

[CONFigure:WLAN:STBC:AUTO:TYPE](#) on page 224

**Table info overview**

Depending on the selected channel bandwidth, MCS index or NSS (STBC), the relevant information from the modulation and coding scheme (MCS) as defined in the WLAN 802.11 standard is displayed here. This information is for reference only, for example so you can determine the required data rate.

**Guard Interval Length**

Defines the PPDU taking part in the analysis depending on the guard interval length.

**Note:** The terms in brackets in the following description indicate how the setting is referred to in the Signal Field result display ("Format" column, see **"Signal Field"** on page 45).

"Auto, same type as first PPDU""(A1st)"

All PPDU using the guard interval length identical to the first recognized PPDU are analyzed.

- "Auto, individually for each PPDU"(AI)"  
All PPDUs are analyzed.
- "Meas only Short"(MS)"  
Only PPDUs with short guard interval length are analyzed.
- "Meas only Long"(ML)"  
Only PPDUs with long guard interval length are analyzed.
- "Demod all as short"(DS)"  
All PPDUs are demodulated assuming short guard interval length.
- "Demod all as long "(DL)"  
All PPDUs are demodulated assuming long guard interval length.

Remote command:

- CONFigure:WLAN:GTIME:AUTO on page 221
- CONFigure:WLAN:GTIME:AUTO:TYPE on page 221
- CONFigure:WLAN:GTIME:SElect on page 222

### 5.3.8.3 Demodulation - IEEE 802.11b, g (DSSS)

The following settings are available for demodulation of IEEE 802.11b or g (DSSS) signals.

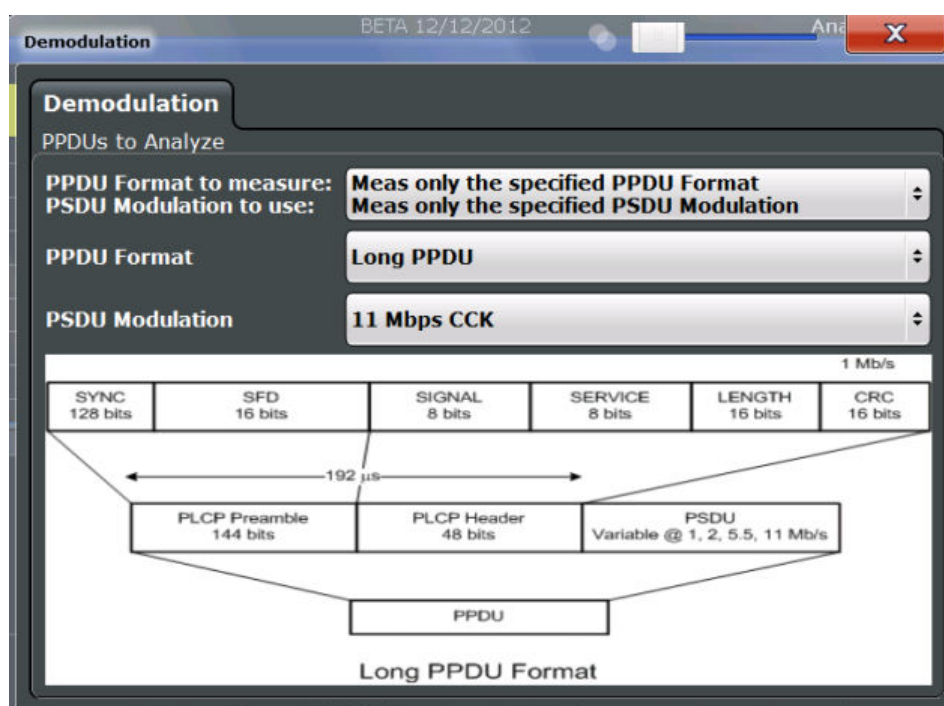


Figure 5-4: Demodulation settings for IEEE 802.11b, g (DSSS) signals

- PPDU Format to measure / PSDU Modulation to use..... 131
- PPDU Format..... 131
- PSDU Modulation..... 131

**PPDU Format to measure / PSDU Modulation to use**

Defines which PPDU formats/modulations are to be included in the analysis. Depending on which standards the communicating devices are using, different formats of PPDUs are available. Thus you can restrict analysis to the supported formats.

**Note:** The PPDU format determines the available channel bandwidths.

For details on supported PPDU formats, modulations, and channel bandwidths depending on the standard see [Table 4-1](#).

"Auto, same type as first PPDU"

The format/modulation of the first valid PPDU is detected and subsequent PPDUs are analyzed only if they have the same format.

"Auto, individually for each PPDU"

All PPDUs are analyzed regardless of their format/modulation

"Meas only ..."

Only PPDUs with the specified format or PSDUs with the specified modulation are analyzed

"Demod all as ..."

All PPDUs are assumed to have the specified PPDU format/ PSDU modulation

Remote command:

[\[SENSe:\] DEMod:FORMat:BANalyze:BTYPe:AUTO:TYPE](#) on page 229

[\[SENSe:\] DEMod:FORMat:BANalyze](#) on page 227

[\[SENSe:\] DEMod:FORMat:SIGSymbol](#) on page 233

**PPDU Format**

If analysis is restricted to PPDUs with a particular format (see [PPDU Format to measure / PSDU Modulation to use](#)), this setting defines which type.

For details on supported modulation depending on the standard see [Table 4-1](#).

Remote command:

[\[SENSe:\] DEMod:FORMat:BANalyze](#) on page 227

[\[SENSe:\] DEMod:FORMat:BANalyze:BTYPe](#) on page 228

**PSDU Modulation**

If analysis is restricted to PSDU with a particular modulation type, this setting defines which type.

For details on supported modulation depending on the standard see [Table 4-1](#).

Remote command:

[\[SENSe:\] DEMod:FORMat:BANalyze](#) on page 227

**5.3.8.4 Demodulation - IEEE 802.11n**

The following settings are available for demodulation of IEEE 802.11n signals.

WLAN IQ Measurement (Modulation Accuracy, Flatness, Tolerance...)

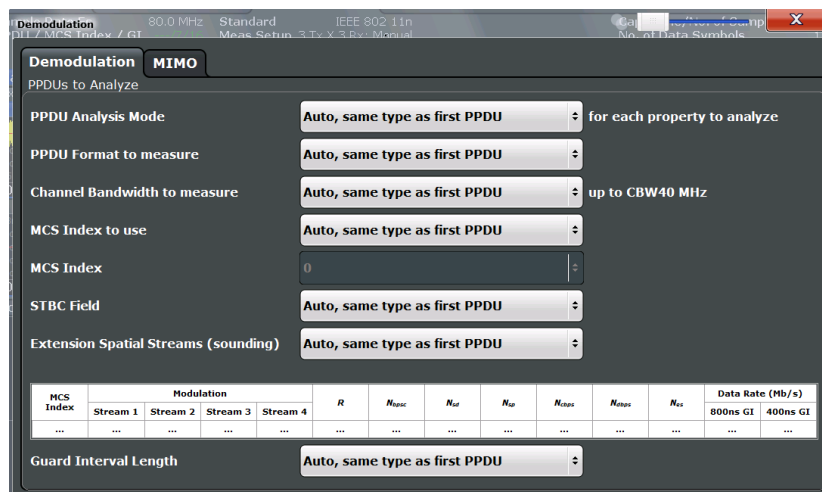


Figure 5-5: Demodulation settings for IEEE 802.11n standard

PPDU Analysis Mode..... 132

PPDU Format to measure..... 132

Channel Bandwidth to measure (CBW)..... 133

MCS Index to use..... 133

MCS Index..... 134

STBC Field..... 134

Extension Spatial Streams (sounding)..... 135

Table info overview..... 135

Guard Interval Length..... 135

**PPDU Analysis Mode**

Defines whether all or only specific PPDUs are to be analyzed.

"Auto, same type as first PPDU"

The signal symbol field, i.e. the PLCP header field, of the first recognized PPDU is analyzed to determine the details of the PPDU. All PPDUs identical to the first recognized PPDU are analyzed. All subsequent settings are set to "Auto" mode.

"Auto, individually for each PPDU"

All PPDUs are analyzed

"User-defined"

User-defined settings define which PPDUs are analyzed. This setting is automatically selected when any of the subsequent settings are changed to a value other than "Auto".

Remote command:

[SENSe:] DEMod:FORMat [:BContent] :AUTO on page 231

**PPDU Format to measure**

Defines which PPDU formats are to be included in the analysis. Depending on which standards the communicating devices are using, different formats of PPDUs are available. Thus you can restrict analysis to the supported formats.

**Note:** The PPDU format determines the available channel bandwidths.

## WLAN IQ Measurement (Modulation Accuracy, Flatness, Tolerance...)

For details on supported PPDU formats and channel bandwidths depending on the standard see [Table 4-1](#).

**Note:** The terms in brackets in the following description indicate how the setting is referred to in the Signal Field result display ("Format" column, see "[Signal Field](#)" on page 45).

"Auto, same type as first PPDU(A1st)"

The format of the first valid PPDU is detected and subsequent PDUs are analyzed only if they have the same format.

"Auto, individually for each PPDU(AI)"

All PDUs are analyzed regardless of their format

"Meas only ...(M ...)"

Only PDUs with the specified format are analyzed

"Demod all as ...(D ...)"

All PDUs are assumed to have the specified PPDU format

Remote command:

[\[SENSe:\] DEMod:FORMat:BANalyze:BTYPe:AUTO:TYPE](#) on page 229

[\[SENSe:\] DEMod:FORMat:BANalyze](#) on page 227

### Channel Bandwidth to measure (CBW)

Defines the channel bandwidth of the PDUs taking part in the analysis. Depending on which standards the communicating devices are using, different PPDU formats and channel bandwidths are supported.

For details on supported PPDU formats and channel bandwidths depending on the standard see [Table 4-1](#).

**Note:** The terms in brackets in the following description indicate how the setting is referred to in the Signal Field result display ("Format" column, see "[Signal Field](#)" on page 45).

"Auto, same type as first PPDU"(A1st)"

The channel bandwidth of the first valid PPDU is detected and subsequent PDUs are analyzed only if they have the same channel bandwidth.

"Auto, individually for each PPDU"(AI)"

All PDUs are analyzed regardless of their channel bandwidth

"Meas only ... signal"(M ...)"

Only PDUs with the specified channel bandwidth are analyzed

"Demod all as ... signal"(D ...)"

All PDUs are assumed to have the specified channel bandwidth

Remote command:

[\[SENSe:\] BANDwidth:CHANnel:AUTO:TYPE](#) on page 225

### MCS Index to use

Defines the PDUs taking part in the analysis depending on their Modulation and Coding Scheme (MCS) index.

**Note:** The terms in brackets in the following description indicate how the setting is referred to in the Signal Field result display ("Format" column, see "Signal Field" on page 45).

"Auto, same type as first PPDU""(A1st)"

All PDUs using the MCS index identical to the first recognized PDU are analyzed.

" Auto, individually for each PPDU""(AI)"

All PDUs are analyzed

"Meas only the specified MCS""(M ...)"

Only PDUs with the MCS index specified for the [MCS Index](#) setting are analyzed

"Demod all with specified MCS""(D ...)"

The [MCS Index](#) setting is used for all PDUs.

Remote command:

[\[SENSe:\]DEMod:FORMat:MCSindex:MODE](#) on page 231

### MCS Index

Defines the MCS index of the PDUs taking part in the analysis manually. This field is enabled for "MCS index to use" = "Meas only the specified MCS" or "Demod all with specified MCS".

Remote command:

[\[SENSe:\]DEMod:FORMat:MCSindex](#) on page 231

### STBC Field

Defines the PDUs taking part in the analysis according to the Space-Time Block Coding (STBC) field content.

**Note:** The terms in brackets in the following description indicate how the setting is referred to in the Signal Field result display ("Format" column, see "Signal Field" on page 45).

"Auto, same type as first PPDU""(A1st)"

All PDUs using a STBC field content identical to the first recognized PDU are analyzed.

"Auto, individually for each PPDU""(AI)"

All PDUs are analyzed.

"Meas only if STBC field = 1 (+1 Stream)""(M1)"(IEEE 802.11N)

Only PDUs with the specified STBC field content are analyzed.

"Meas only if STBC field = 2 (+2 Stream)""(M2)"(IEEE 802.11N)

Only PDUs with the specified STBC field content are analyzed.

"Demod all as STBC field = 1""(D1)"(IEEE 802.11N)

All PDUs are analyzed assuming the specified STBC field content.

"Demod all as STBC field = 2""(D2)"(IEEE 802.11N)

All PDUs are analyzed assuming the specified STBC field content.

"Meas only if STBC = 1 (Nsts = 2Nss)""(M1)"(IEEE 802.11AC)

Only PDUs with the specified STBC field content are analyzed.

## WLAN IQ Measurement (Modulation Accuracy, Flatness, Tolerance...)

"Demod all as STBC = 1 (Nsts = 2Nss)""(D1)""(IEEE 802.11AC)

All PPDU are analyzed assuming the specified STBC field content.

Remote command:

[CONFigure:WLAN:STBC:AUTO:TYPE](#) on page 224

### Extension Spatial Streams (sounding)

Defines the PPDU taking part in the analysis according to the Ness field content.

**Note:** The terms in brackets in the following description indicate how the setting is referred to in the Signal Field result display ("NESS" column, see ["Signal Field"](#) on page 45).

"Auto, same type as first PDU""(A1st)" All PPDU using a Ness value identical to the first recognized PDU are analyzed.

"Auto, individually for each PDU""(AI)" All PPDU are analyzed.

"Meas only if Ness = <x>""(M ...)" Only PPDU with the specified Ness value are analyzed.

"Demod all as Ness = <x>" All PPDU are analyzed assuming the specified Ness value.

Remote command:

[CONFigure:WLAN:EXTension:AUTO:TYPE](#) on page 220

### Table info overview

Depending on the selected channel bandwidth, MCS index or NSS (STBC), the relevant information from the modulation and coding scheme (MCS) as defined in the WLAN 802.11 standard is displayed here. This information is for reference only, for example so you can determine the required data rate.

### Guard Interval Length

Defines the PPDU taking part in the analysis depending on the guard interval length.

**Note:** The terms in brackets in the following description indicate how the setting is referred to in the Signal Field result display ("Format" column, see ["Signal Field"](#) on page 45).

"Auto, same type as first PDU""(A1st)" All PPDU using the guard interval length identical to the first recognized PDU are analyzed.

"Auto, individually for each PDU""(AI)" All PPDU are analyzed.

"Meas only Short""(MS)" Only PPDU with short guard interval length are analyzed.

"Meas only Long""(ML)" Only PPDU with long guard interval length are analyzed.

"Demod all as short""(DS)" All PPDU are demodulated assuming short guard interval length.

"Demod all as long ""(DL)"

All PPDU's are demodulated assuming long guard interval length.

Remote command:

CONFigure:WLAN:GTIME:AUTO on page 221

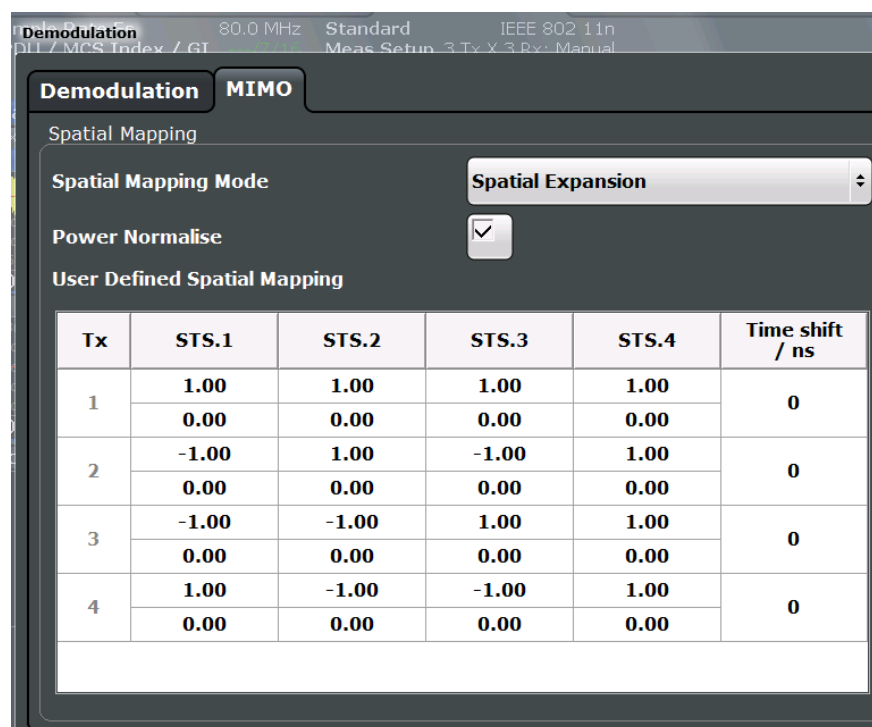
CONFigure:WLAN:GTIME:AUTO:TYPE on page 221

CONFigure:WLAN:GTIME:SElect on page 222

### 5.3.8.5 Demodulation - MIMO (IEEE 802.11ac, n)

The MIMO settings define the mapping between streams and antennas.

This tab is **only available for the standard IEEE 802.11ac or n (MIMO)**.



Spatial Mapping Mode..... 136  
 Power Normalise..... 137  
 User Defined Spatial Mapping..... 137

#### Spatial Mapping Mode

Defines the mapping between streams and antennas.

For details see [Chapter 4.3.2, "Spatial Mapping"](#), on page 71.

- "Direct" The mapping between streams and antennas is the identity matrix. See also section "20.3.11.10.1 Spatial Mapping" of the IEEE 802.11n WLAN standard.
- "Spatial Expansion:" For this mode all streams contribute to all antennas. See also section "20.3.11.10.1 Spatial Mapping" of the IEEE 802.11n WLAN standard.
- "User defined" The mapping between streams and antennas is defined by the [User Defined Spatial Mapping](#) table.



Remote command:

[CONFigure:WLAN:SMAPping:MODE](#) on page 223

#### Power Normalise

Specifies whether an amplification of the signal power due to the spatial mapping is performed according to the matrix entries.

"On"                    Spatial mapping matrix is scaled by a constant factor to obtain a passive spatial mapping matrix which does not increase the total transmitted power.

"Off"                    Normalization step is omitted

Remote command:

[CONFigure:WLAN:SMAPping:NORMAlise](#) on page 223

#### User Defined Spatial Mapping

Define your own spatial mapping between streams and antennas.

For each antenna (Tx1..4), the complex element of each STS-Stream is defined. The upper value is the real part part of the complex element. The lower value is the imaginary part of the complex element.

Additionally, a "Time Shift" can be defined for cyclic delay diversity (CSD).

Remote command:

[CONFigure:WLAN:SMAPping:TX<ch>](#) on page 223

[CONFigure:WLAN:SMAPping:TX<ch>:STReam<stream>](#) on page 224

[CONFigure:WLAN:SMAPping:TX<ch>:TIMeshift](#) on page 224

### 5.3.9 Evaluation Range

The evaluation range defines which objects the result displays are based on. The available settings depend on the selected standard.

- [Evaluation Range Settings for IEEE 802.11a, g \(OFDM\), ac, j, n, p](#)..... 137
- [Evaluation Range Settings for IEEE 802.11b, g \(DSSS\)](#)..... 140

#### 5.3.9.1 Evaluation Range Settings for IEEE 802.11a, g (OFDM), ac, j, n, p

The following settings are available to configure the evaluation range for standards IEEE 802.11a, g (OFDM), ac, j, n, p.

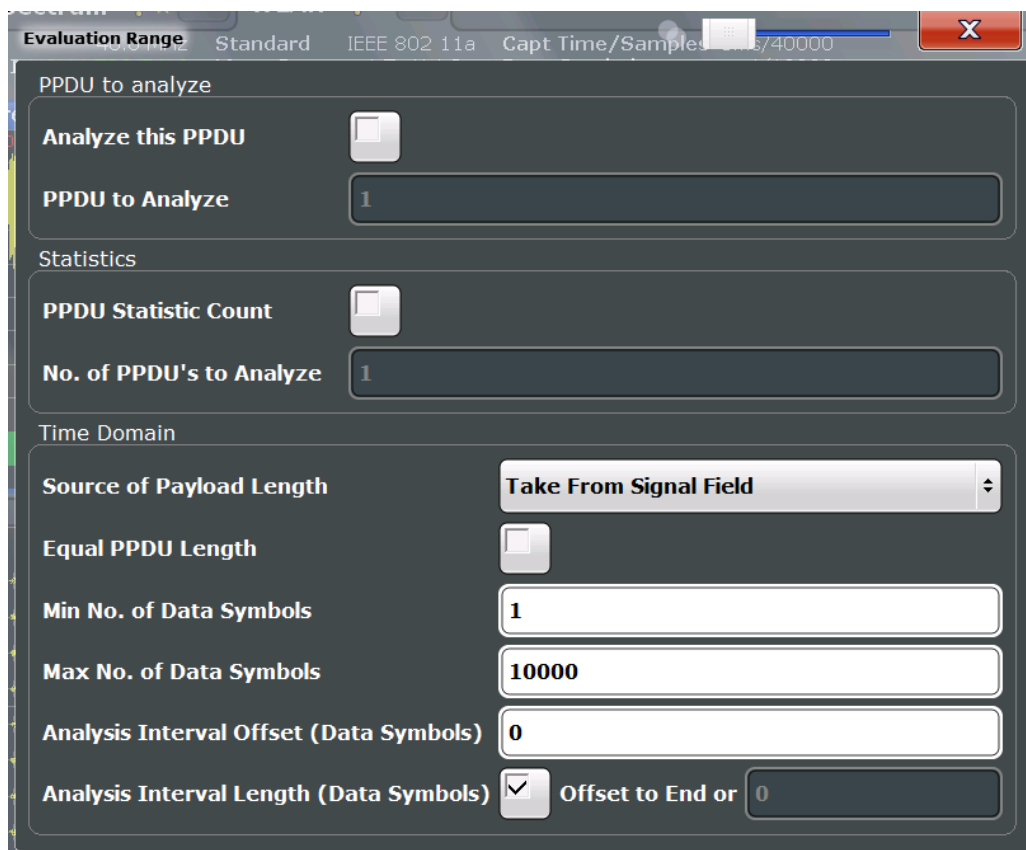


Figure 5-6: Evaluation range settings for IEEE 802.11a, ac, g (OFDM), j, n, p standards

Analyze this PPDU / PPDU to Analyze..... 138  
 PPDU Statistic Count / No of PPDU's to Analyze..... 139  
 Source of Payload Length..... 139  
 Equal PPDU Length..... 139  
 (Min./Max.) No. of Data Symbols..... 139  
 Analysis Interval Offset / Analysis Interval Length..... 140

**Analyze this PPDU / PPDU to Analyze**

If enabled, the WLAN I/Q results are based on one individual PPDU only, namely the defined "PPDU to Analyze". The result displays are updated to show the results for the the new evaluation range. The selected PPDU is marked by a blue bar in PPDU-based results (see "Magnitude Capture" on page 35).

**Note:** AM/AM, AM/EVM and AM/PM results are not updated when single PPDU analysis is selected.

In MSRA mode, single PPDU analysis is not available.

Remote command:

- [SENSe:] BURSt: SElect: STATe on page 236
- [SENSe:] BURSt: SElect on page 236

**PPDU Statistic Count / No of PDUs to Analyze**

If the statistic count is enabled, the specified number of PDUs is taken into consideration for the statistical evaluation. Sweeps are performed continuously until the required number of PDUs are available. The number of captured and required PDUs, as well as the number of PDUs detected in the current sweep, are indicated as "Analyzed PDUs" in the channel bar.

(See ["Channel bar information"](#) on page 10).

If disabled, all valid PDUs in the current capture buffer are considered. Note that in this case, the number of PDUs contributing to the current results may vary extremely.

Remote command:

[\[SENSe:\]BURSt:COUNT:STATe](#) on page 236

[\[SENSe:\]BURSt:COUNT](#) on page 235

**Source of Payload Length**

Defines which signal source is used to determine the payload length of a PDU.

"Take from Signal Field" (IEEE 802.11 A, J, P)

Uses the length defined by the signal field

"L-Signal" (IEEE 802.11 AC)

Determines the length of the L signal

"HT-Signal" (IEEE 802.11 N)

Determines the length of the HT signal

"Estimate from signal"

Uses an estimated length

Remote command:

[CONFigure:WLAN:PAYLoad:LENGTH:SRC](#) on page 235

**Equal PDU Length**

If enabled, only PDUs with the specified [\(Min./Max.\) Payload Length](#) are considered for measurement analysis.

If disabled, a maximum and minimum [\(Min./Max.\) Payload Length](#) can be defined and all PDUs whose length is within this range are considered.

Remote command:

**IEEE 802.11a, ac, g (OFDM), j, n, p**

[\[SENSe:\]DEMod:FORMat:BANalyze:SYMBOLs:EQUal](#) on page 239

**IEEE 802.11 b, g (DSSS):**

[\[SENSe:\]DEMod:FORMat:BANalyze:DURation:EQUal](#) on page 238

[\[SENSe:\]DEMod:FORMat:BANalyze:DBYTes:EQUal](#) on page 237

**(Min./Max.) No. of Data Symbols**

If the [Equal PDU Length](#) setting is enabled, the number of data symbols defines the exact length a PDU must have to be considered for analysis.

If the [Equal PDU Length](#) setting is disabled, you can define the minimum and maximum number of data symbols a PDU must contain to be considered in measurement analysis.

Remote command:

[SENSe:]DEMod:FORMat:BANalyze:SYMBOLs:MIN on page 241

[SENSe:]DEMod:FORMat:BANalyze:SYMBOLs:MAX on page 240

#### **Analysis Interval Offset / Analysis Interval Length**

The analysis interval defines the symbol range that is actually evaluated by the individual result display. By default it is defined as the length of the detected PPDU, possibly restricted by the minimum or maximum number of data symbols. However, it can be restricted further.

The "Analysis Interval Offset" specifies the number of data symbols from the start of each PPDU that are to be skipped before symbols take part in analysis.

If "Analysis Interval Length" is enabled, then the number of PPDU data symbols after the "Analysis Interval Offset" which are to be analyzed can be specified.

If "Analysis Interval Length" is disabled, then all PPDU data symbols after the "Analysis Interval Offset" are evaluated.

Remote command:

[SENSe:]DEMod:FORMat:BANalyze:SYMBOLs:OFFSet on page 241

[SENSe:]DEMod:FORMat:BANalyze:SYMBOLs:LENGTH:STATE on page 239

[SENSe:]DEMod:FORMat:BANalyze:SYMBOLs:LENGTH on page 240

#### **5.3.9.2 Evaluation Range Settings for IEEE 802.11b, g (DSSS)**

The following settings are available to configure the evaluation range for standards IEEE 802.11b, g (DSSS).

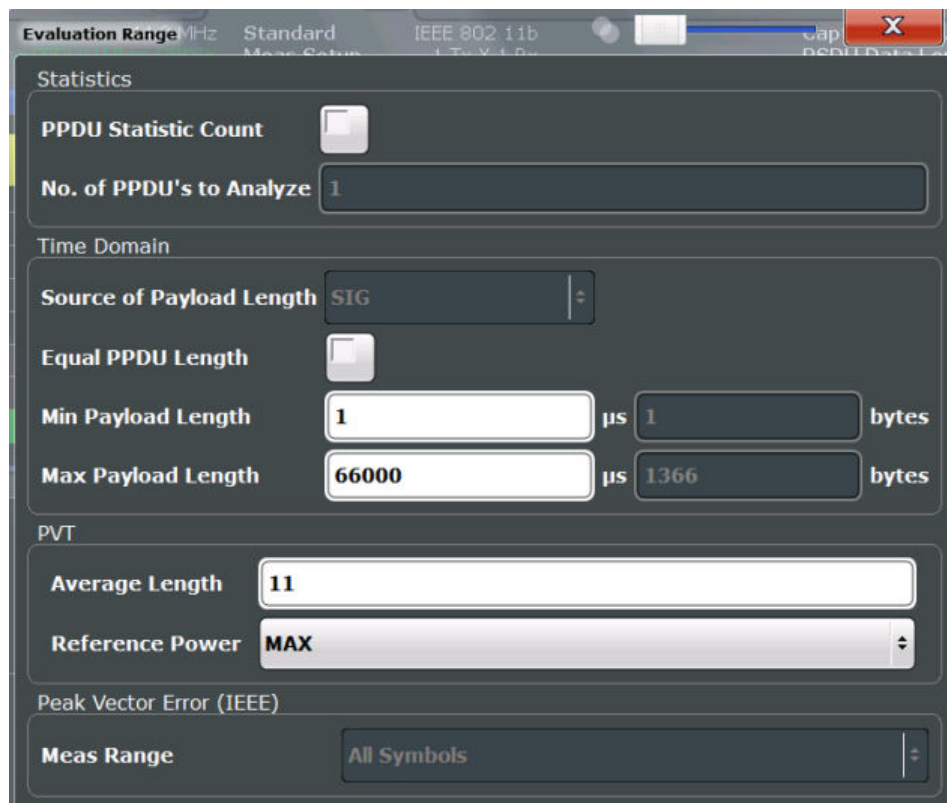


Figure 5-7: Evaluation range settings for IEEE 802.11b and g (DSSS) standards

PPDU Statistic Count / No of PPDU's to Analyze..... 141  
 Equal PPDU Length..... 141  
 (Min./Max.) Payload Length..... 142  
 PVT : Average Length..... 142  
 PVT : Reference Power..... 142  
 Peak Vector Error : Meas Range..... 142

**PPDU Statistic Count / No of PPDU's to Analyze**

If the statistic count is enabled, the specified number of PPDU's is taken into consideration for the statistical evaluation. Sweeps are performed continuously until the required number of PPDU's are available. The number of captured and required PPDU's, as well as the number of PPDU's detected in the current sweep, are indicated as "Analyzed PPDU's" in the channel bar.

(See "Channel bar information" on page 10).

If disabled, all valid PPDU's in the current capture buffer are considered. Note that in this case, the number of PPDU's contributing to the current results may vary extremely.

Remote command:

- [SENSE:] BURSt: COUNT: STATE on page 236
- [SENSE:] BURSt: COUNT on page 235

**Equal PPDU Length**

If enabled, only PPDU's with the specified (Min./Max.) Payload Length are considered for measurement analysis.

If disabled, a maximum and minimum (**Min./Max.**) **Payload Length** can be defined and all PPDU's whose length is within this range are considered.

Remote command:

**IEEE 802.11a, ac, g (OFDM), j, n, p**

[SENSe:]DEMod:FORMat:BANalyze:SYMBOLs:EQUal on page 239

**IEEE 802.11 b, g (DSSS):**

[SENSe:]DEMod:FORMat:BANalyze:DURation:EQUal on page 238

[SENSe:]DEMod:FORMat:BANalyze:DBYTes:EQUal on page 237

**(Min./Max.) Payload Length**

If the **Equal PPDU Length** setting is enabled, the payload length defines the exact length a PPDU must have to be considered for analysis.

If the **Equal PPDU Length** setting is disabled, you can define the minimum and maximum payload length a PPDU must contain to be considered in measurement analysis.

The payload length can be defined as a duration in  $\mu$ s or a number of bytes (only if specific PPDU modulation and format are defined for analysis, see "**PPDU Format to measure**" on page 124).

Remote command:

[SENSe:]DEMod:FORMat:BANalyze:DBYTes:MIN on page 237

[SENSe:]DEMod:FORMat:BANalyze:DURation:MIN on page 238

[SENSe:]DEMod:FORMat:BANalyze:DBYTes:MAX on page 237

[SENSe:]DEMod:FORMat:BANalyze:DURation:MAX on page 238

**PVT : Average Length**

Defines the number of samples used to adjust the length of the smoothing filter for PVT measurement.

For details see "**PvT Full PPDU**" on page 38.

Remote command:

CONFigure:BURSt:PVT:AVERage on page 234

**PVT : Reference Power**

Sets the reference for the rise and fall time in PVT calculation to the maximum or mean PPDU power.

For details see "**PvT Full PPDU**" on page 38.

Remote command:

CONFigure:BURSt:PVT:RPOWer on page 234

**Peak Vector Error : Meas Range**

Displays the used measurement range for peak vector error measurement (for reference only).

"All Symbols"    Peak Vector Error results are calculated over the complete PPDU

"PSDU only"    Peak Vector Error results are calculated over the PSDU only

Remote command:

CONFigure:WLAN:PVERror:MRANge? on page 235

### 5.3.10 Result Configuration

For some result displays, additional settings are available.

The "Result Configuration" softkey in the main "WLAN" menu opens the "Result Configuration" dialog box. This softkey is only available if a window with additional settings is currently selected.

Alternatively, select a window from the "Specifics for" selection list in the "Overview", then select the "Result Configuration" button to display the "Result Configuration" dialog box.

Depending on the selected result display, different settings are available.

- [Result Summary Configuration](#)..... 143
- [Spectrum Flatness and Group Delay Configuration](#)..... 144
- [AM/AM Configuration](#)..... 145

#### 5.3.10.1 Result Summary Configuration

You can configure which results are displayed in Result Summary displays (see "[Result Summary Detailed](#)" on page 41 and "[Result Summary Global](#)" on page 43). However, the results are always *calculated*, regardless of their visibility on the screen.

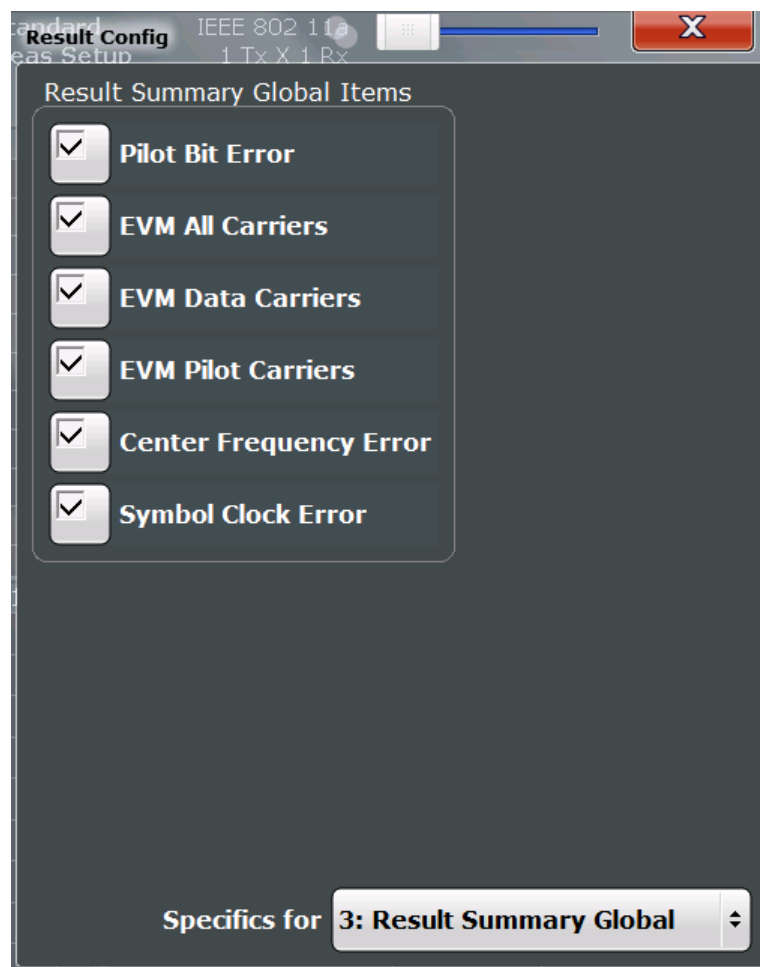


Figure 5-8: Result Summary Global configuration for IEEE 802.11a, ac, g (OFDM), j, n, p standards

**Remote command:**

`DISPlay[:WINDow<n>]:TABLE:ITEM` on page 257

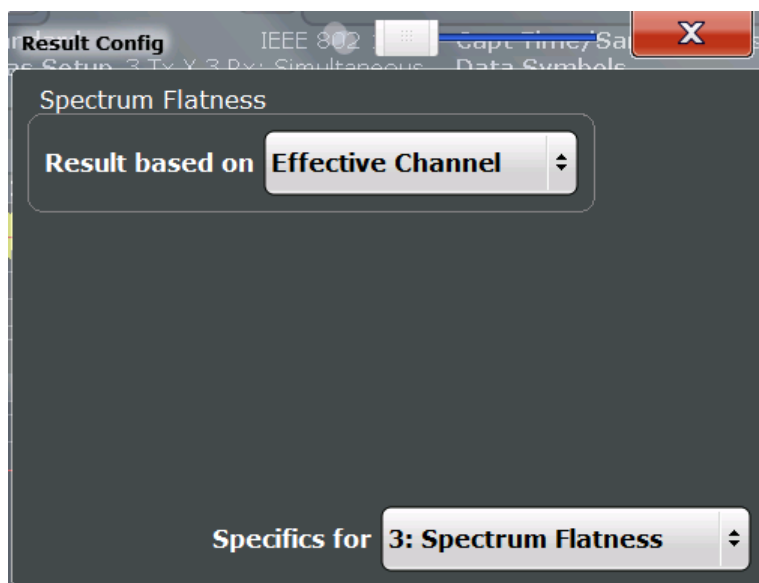
### 5.3.10.2 Spectrum Flatness and Group Delay Configuration

For MIMO measurements, Spectrum Flatness and Group Delay results can be based on either the effective channels or the physical channels.

While the physical channels cannot always be determined, the effective channel can always be estimated from the known training fields. Thus, for some PPDU or measurement scenarios, only the results based on the mapping of the space-time stream to the Rx antenna (effective channel) are available, as the mapping of the Rx antennas to the Tx antennas (physical channel) could not be determined.

For more information see [Chapter 4.3.3, "Physical vs Effective Channels"](#), on page 72.





Remote command:

[CONFigure:BURSt:SPECTrum:FLATness:CSElect](#) on page 259

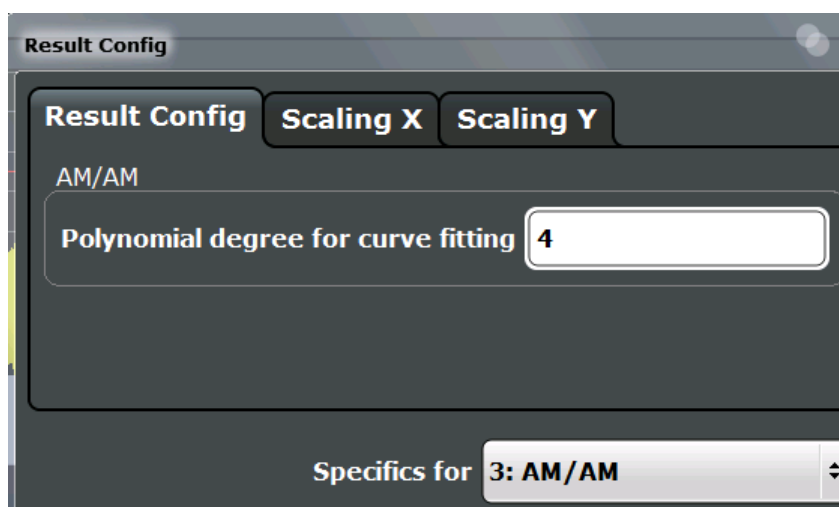
### 5.3.10.3 AM/AM Configuration

For AM result displays some additional configuration settings are available.

- [General AM/AM Settings](#).....145
- [Scaling AM Result Displays](#)..... 146

#### General AM/AM Settings

For AM/AM result displays, the trace is determined by calculating a polynomial regression model for the scattered measurement vs. reference signal data (see "AM/AM" on page 22). The degree of this model can be specified in the "Result Config" dialog box for this result display.



The resulting regression polynomial is indicated in the window title of the result display.

#### Remote command:

[CONFigure:BURSt:AM:AM:POLYnomial](#) on page 259

Resulting coefficients:

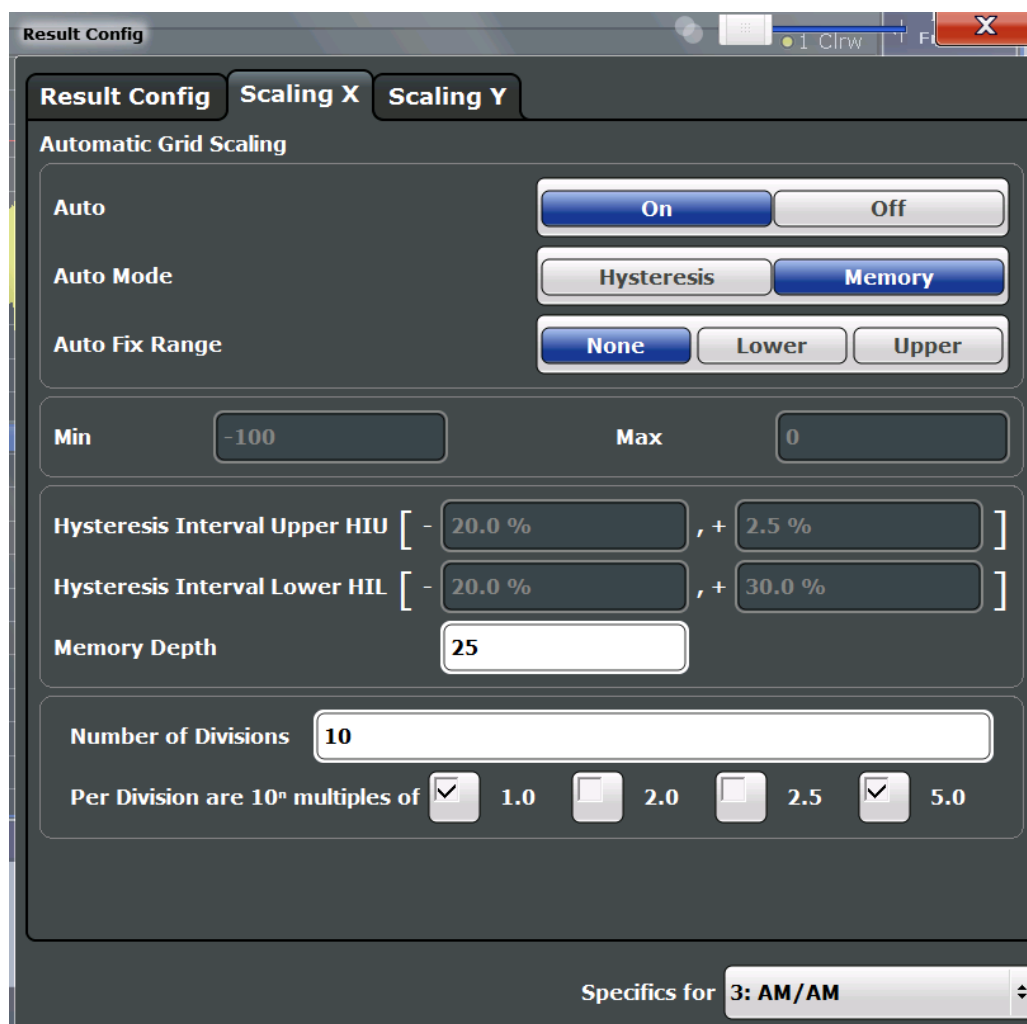
[FETCh:BURSt:AM:AM:COEFficients?](#) on page 274

#### Scaling AM Result Displays

Scaling settings are available for the x-axis or y-axis of the following result displays:

- [AM/AM](#)
- [AM/PM](#)
- [AM/EVM](#)

The available scaling settings and functions are identical for both axes, but can be configured separately.



|                                      |     |
|--------------------------------------|-----|
| Automatic Grid Scaling.....          | 147 |
| Auto Mode.....                       | 147 |
| Auto Fix Range.....                  | 147 |
| Hysteresis Interval Upper/Lower..... | 148 |
| Minimum / Maximum.....               | 148 |
| Memory Depth.....                    | 149 |
| Number of Divisions.....             | 149 |
| Scaling per division.....            | 149 |

### Automatic Grid Scaling

Activates or deactivates automatic scaling of the x-axis or y-axis for the specified trace display. If enabled, the R&S FPS WLAN application automatically scales the x-axis or y-axis to best fit the measurement results.

If disabled, the x-axis or y-axis is scaled according to the specified [Minimum / Maximum](#) and [Number of Divisions](#).

Remote command:

`DISPlay[:WINDow<n>]:TRACe<t>:Y[:SCALe]:AUTO` on page 260

### Auto Mode

Determines which algorithm is used to determine whether the x-axis or y-axis requires automatic rescaling.

|              |   |
|--------------|---|
| "Hysteresis" | If the minimum and/or maximum values of the current measurement exceed a specific value range (hysteresis interval), the axis is rescaled. The hysteresis interval is defined as a percentage of the currently displayed value range on the x-axis or y-axis. An upper hysteresis interval is defined for the maximum value, a lower hysteresis interval is defined for the minimum value.<br>(See <a href="#">Hysteresis Interval Upper/Lower</a> )        |
| "Memory"     | If the minimum or maximum values of the current measurement exceed the minimum or maximum of the <x> previous results, respectively, the axis is rescaled.<br>The minimum and maximum value of each measurement are added to the memory. After <x> measurements, the oldest results in the memory are overwritten by each new measurement.<br>The number <x> of results in the memory to be considered is configurable (see <a href="#">Memory Depth</a> ). |

Remote command:

`DISPlay[:WINDow<n>]:TRACe<t>:Y[:SCALe]:AUTO:MODE` on page 262

### Auto Fix Range

This command defines the use of fixed value limits.

|         |   |
|---------|---|
| "None"  | Both the upper and lower limits are determined by automatic scaling of the x-axis or y-axis.  |
| "Lower" | The lower limit is fixed (defined by the <a href="#">Minimum / Maximum</a> settings), while the upper limit is determined by automatic scaling of the x-axis or y-axis. |

## WLAN IQ Measurement (Modulation Accuracy, Flatness, Tolerance...)

"Upper" The upper limit is fixed (defined by the [Minimum / Maximum](#) settings), while the lower limit is determined by automatic scaling of the x-axis or y-axis.

Remote command:

`DISPlay[:WINDow<n>]:TRACe<t>:Y[:SCALe]:AUTO:FIXed:RANGe`  
on page 260

**Hysteresis Interval Upper/Lower**

For automatic scaling based on hysteresis, the hysteresis intervals are defined here. Depending on whether either of the limits are fixed or not (see [Auto Fix Range](#)), one or both limits are defined by a hysteresis value range.

The hysteresis range is defined as a percentage of the currently displayed value range on the x-axis or y-axis.

**Example:**

The currently displayed value range on the y-axis is 0 to 100. The upper limit is fixed by a maximum of 100. The lower hysteresis range is defined as -10% to +10%. If the minimum value in the current measurement drops below -10 or exceeds +10, the y-axis will be rescaled automatically, for example to [-10..+100] or [+10..+100], respectively.

"Upper"(HIU) If the maximum value in the current measurement exceeds the specified range, the x-axis or y-axis is rescaled automatically.

"Lower"(HIL) If the minimum value in the current measurement exceeds the specified range, the x-axis or y-axis is rescaled automatically.

Remote command:

`DISPlay[:WINDow<N>]:TRACe<t>:Y[:SCALe]:AUTO:HYSTeresis:LOWer:UPPer` on page 261

`DISPlay[:WINDow<N>]:TRACe<t>:Y[:SCALe]:AUTO:HYSTeresis:LOWer:LOWer` on page 261

`DISPlay[:WINDow<N>]:TRACe<t>:Y[:SCALe]:AUTO:HYSTeresis:UPPer:LOWer` on page 261

`DISPlay[:WINDow<N>]:TRACe<t>:Y[:SCALe]:AUTO:HYSTeresis:UPPer:UPPer` on page 262

**Minimum / Maximum**

Defines the minimum and maximum value to be displayed on the x-axis or y-axis of the specified evaluation diagram.

For automatic scaling with a fixed range (see [Auto Fix Range](#)), the minimum defines the fixed lower limit, the maximum defines the fixed upper limit.

Remote command:

`DISPlay[:WINDow<n>]:TRACe<t>:Y[:SCALe]:MAXimum` on page 263

`DISPlay[:WINDow<n>]:TRACe<t>:Y[:SCALe]:MINimum` on page 264

**Memory Depth**

For automatic scaling based on memory (see "Auto Mode" on page 147), this value defines the number <x> of previous results to be considered when determining if rescaling is required.

The minimum and maximum value of each measurement are added to the memory. After <x> measurements, the oldest results in the memory are overwritten by each new measurement.

If the maximum value in the current measurement exceeds the maximum of the <x>previous results, and the upper limit is not fixed, the x-axis or y-axis is rescaled.

If the minimum value in the current measurement drops below the minimum of the <x>previous results, and the lower limit is not fixed, the x-axis or y-axis is rescaled.

Remote command:

`DISPlay[:WINDow<n>]:TRACe<t>:Y[:SCALe]:AUTO:MEMory:DEPTH`  
on page 262

**Number of Divisions**

Defines the number of divisions to be used for the x-axis or y-axis. By default, the x-axis or y-axis is divided into 10 divisions.

Remote command:

`DISPlay[:WINDow<n>]:TRACe<t>:Y[:SCALe]:DIVisions` on page 263

**Scaling per division**

Determines the values shown for each division on the x-axis or y-axis.

One or more multiples of  $10^n$  can be selected. The R&S FPS WLAN application then selects the optimal scaling from the selected values.

**Example:**

- Multiples of "2.0" and "2.5" selected; division range = [-80..-130]; number of divisions: 10;  
Possible scaling (n=1):  
[-80;-85;-90;-95;-100;-105;-110;-115;-130;]
- Multiples of "2.0" selected; division range = [-80..-130]; number of divisions: 10;  
Possible scaling (n=1):  
[0;-20;-40;-60;-80;-100;-120;-140;-160;-180;]

|       |   |
|-------|---|
| "1.0" | Each division on the x-axis or y-axis displays multiples of $1 \cdot 10^n$ :<br>For example for n= -1; division range = [0..1]; number of divisions: 10;<br>[0, 0.1, 0.2, 0.3, 0.4, 0.5, 0.6, 0.7, 0.8, 0.9, 1.0] |
| "2.0" | Each division on the x-axis or y-axis displays multiples of $2 \cdot 10^n$ :<br>For example for n= -1; division range = [0..1]; number of divisions: 5;<br>[0, 0.2, 0.4, 0.6, 0.8, 1.0]                           |
| "2.5" | Each division on the x-axis or y-axis displays multiples of $2.5 \cdot 10^n$ :<br>For example for n= -1; division range = [0..1]; number of divisions: 5;<br>[0, 0.25, 0.5, 0.75, 1.0]                            |

"5.0" Each division on the x-axis or y-axis displays multiples of  $5 \cdot 10^n$ :  
For example for  $n = -1$ ; division range = [0..1]; number of divisions: 5,  
[-0.5, 0, 0.5, 1.0, 1.5]

Remote command:

`DISPlay[:WINDow<n>]:TRACe<t>:Y[:SCALe]:PDIVision` on page 264

### 5.3.11 Automatic Settings

Some settings can be adjusted by the R&S FPS automatically according to the current measurement settings and signal characteristics.

To activate the automatic adjustment of a setting, select the corresponding function in the AUTO SET menu or in the configuration dialog box for the setting, where available.



#### MSRA operating mode

In MSRA operating mode, the following automatic settings are not available, as they require a new data acquisition. However, the R&S FPS WLAN application cannot perform data acquisition in MSRA operating mode.

[Setting the Reference Level Automatically \(Auto Level\).....](#) 150

#### Setting the Reference Level Automatically (Auto Level)

Automatically determines a reference level which ensures that no overload occurs at the R&S FPS for the current input data. At the same time, the internal attenuators are adjusted so the signal-to-noise ratio is optimized, while signal compression and clipping are minimized.

To determine the required reference level, a level measurement is performed on the R&S FPS.

If necessary, you can optimize the reference level further by manually decreasing the attenuation level to the lowest possible value before an overload occurs, then decreasing the reference level in the same way.

Remote command:

`[SENSe:]ADJust:LEVel` on page 244

### 5.3.12 Sweep Settings

The sweep settings define how the data is measured.

[Continuous Sweep/RUN CONT.....](#) 150  
[Single Sweep/ RUN SINGLE.....](#) 151  
[Continue Single Sweep.....](#) 151  
[Refresh \( MSRA only\).....](#) 151

#### Continuous Sweep/RUN CONT

After triggering, starts the measurement and repeats it continuously until stopped.

While the measurement is running, the "Continuous Sweep" softkey and the RUN CONT key are highlighted. The running measurement can be aborted by selecting the highlighted softkey or key again. The results are not deleted until a new measurement is started.

**Note:** Sequencer. Furthermore, the RUN CONT key controls the Sequencer, not individual sweeps. RUN CONT starts the Sequencer in continuous mode.

Remote command:

`INITiate<n>:CONTinuous` on page 266

#### Single Sweep/ RUN SINGLE

While the measurement is running, the "Single Sweep" softkey and the RUN SINGLE key are highlighted. The running measurement can be aborted by selecting the highlighted softkey or key again.

Remote command:

`INITiate<n>[:IMMediate]` on page 267

#### Continue Single Sweep

After triggering, repeats the number of sweeps set in "Sweep Count", without deleting the trace of the last measurement.

While the measurement is running, the "Continue Single Sweep" softkey and the RUN SINGLE key are highlighted. The running measurement can be aborted by selecting the highlighted softkey or key again.

#### Refresh ( MSRA only)

This function is only available if the Sequencer is deactivated and only for **MSRA applications**.

The data in the capture buffer is re-evaluated by the currently active application only. The results for any other applications remain unchanged.

This is useful, for example, after evaluation changes have been made or if a new sweep was performed from another application; in this case, only that application is updated automatically after data acquisition.

**Note:** To update all active applications at once, use the "Refresh all" function in the "Sequencer" menu.

Remote command:

`INITiate<n>:REFresh` on page 246

## 5.4 Frequency Sweep Measurements

When you activate a measurement channel in WLAN mode, an IQ measurement of the input signal is started automatically (see [Chapter 3.1, "WLAN I/Q Measurement \(Modulation Accuracy, Flatness and Tolerance\)"](#), on page 12). However, some parameters specified in the WLAN 802.11 standard require a better signal-to-noise level or a smaller bandwidth filter than the default measurement on I/Q data provides and must be determined in separate measurements based on RF data (see [Chapter 3.2, "Fre-](#)

quency Sweep Measurements", on page 49). In these measurements, demodulation is not performed.

### Selecting the measurement type

WLAN measurements require a special operating mode on the R&S FPS, which you activate using the MODE key.

- ▶ To select a frequency sweep measurement type, do one of the following:
  - Select the "Overview" softkey. In the "Overview", select the "Select Measurement" button. Select the required measurement.
  - Press the MEAS key. In the "Select Measurement" dialog box, select the required measurement.

The R&S FPS WLAN application uses the functionality of the R&S FPS base system (Spectrum application) to perform the WLAN frequency sweep measurements. Some parameters are set automatically according to the WLAN 802.11 standard the first time a measurement is selected (since the last PRESET operation). These parameters can be changed, but are not reset automatically the next time you re-enter the measurement. Refer to the description of each measurement type for details.

The main measurement configuration menus for the WLAN frequency sweep measurements are identical to the Spectrum application.

For details refer to "Measurements" in the R&S FPS User Manual.

The measurement-specific settings for the following measurements are available via the "Overview".

- [Channel Power \(ACLR\) Measurements](#)..... 152
- [Spectrum Emission Mask](#)..... 153
- [Occupied Bandwidth](#)..... 154
- [CCDF](#)..... 155

#### 5.4.1 Channel Power (ACLR) Measurements

The Adjacent Channel Power measurement analyzes the power of the TX channel and the power of adjacent and alternate channels on the left and right side of the TX channel. The number of TX channels and adjacent channels can be modified as well as the band class. The bandwidth and power of the TX channel and the bandwidth, spacing and power of the adjacent and alternate channels are displayed in the Result Summary.

Channel Power ACLR measurements are performed as in the Spectrum application with the following predefined settings according to WLAN specifications (adjacent channel leakage ratio).



**Table 5-3: Predefined settings for WLAN ACLR Channel Power measurements**

| Setting                     | Default value  |
|-----------------------------|--|
| ACLR Standard               | same as defined in WLAN signal description (see "Standard" on page 93) |
| Number of adjacent channels | 3  |
| Reference channel           | Max power Tx channel   |
| Channel bandwidth           | 20 MHz   |

For further details about the ACLR measurements refer to "Measuring Channel Power and Adjacent-Channel Power" in the R&S FPS User Manual.

To restore adapted measurement parameters, the following parameters are saved on exiting and are restored on re-entering this measurement:

- Reference level and reference level offset
- RBW, VBW
- Sweep time
- Span
- Number of adjacent channels
- Fast ACLR mode

The main measurement menus for the frequency sweep measurements are identical to the Spectrum application.

## 5.4.2 Spectrum Emission Mask

The Spectrum Emission Mask measurement shows the quality of the measured signal by comparing the power values in the frequency range near the carrier against a spectral mask that is defined by the WLAN 802.11 specifications. The limits depend on the selected power class. Thus, the performance of the DUT can be tested and the emissions and their distance to the limit are identified.



Note that the WLAN standard does not distinguish between spurious and spectral emissions.

The Result Summary contains a peak list with the values for the largest spectral emissions including their frequency and power.

The WLAN application performs the SEM measurement as in the Spectrum application with the following settings:

**Table 5-4: Predefined settings for WLAN SEM measurements**

| Setting          | Default value |
|------------------|---------------|
| Number of ranges | 3             |
| Frequency Span   | +/- 12.75 MHz |

| Setting                 | Default value |
|-------------------------|---------------|
| Fast SEM                | OFF           |
| Sweep time              | 140 µs        |
| RBW                     | 30 kHz        |
| Power reference type    | Channel Power |
| Tx Bandwidth            | 3.84 MHz      |
| Number of power classes | 1             |



You must select the SEM file with the pre-defined settings required by the standard manually (using the "Standard Files" softkey in the main "SEMask" menu). The subdirectory displayed in the SEM standard file selection dialog box depends on the standard you selected previously for the WLAN Modulation Accuracy, Flatness,... measurement (see "Standard" on page 93).

For further details about the Spectrum Emission Mask measurements refer to "Spectrum Emission Mask Measurement" in the R&S FPS User Manual.

To restore adapted measurement parameters, the following parameters are saved on exiting and are restored on re-entering this measurement:

- Reference level and reference level offset
- Sweep time
- Span

The main measurement menus for the frequency sweep measurements are identical to the Spectrum application.

### 5.4.3 Occupied Bandwidth

**Access:** "Overview" > "Select Measurement" > "OBW"

**or:** MEAS > "Select Measurement" > "OBW"

The Occupied Bandwidth measurement is performed as in the Spectrum application with default settings.

*Table 5-5: Predefined settings for WLAN 802.11 OBW measurements*

| Setting           | Default value |
|-------------------|---------------|
| % Power Bandwidth | 99 %          |
| Channel bandwidth | 3.84 MHz      |

The Occupied Bandwidth measurement determines the bandwidth that the signal occupies. The occupied bandwidth is defined as the bandwidth in which – in default settings – 99 % of the total signal power is to be found. The percentage of the signal power to be included in the bandwidth measurement can be changed.

For further details about the Occupied Bandwidth measurements refer to "Measuring the Occupied Bandwidth" in the R&S FPS User Manual.

To restore adapted measurement parameters, the following parameters are saved on exiting and are restored on re-entering this measurement:

- Reference level and reference level offset
- RBW, VBW
- Sweep time
- Span

#### 5.4.4 CCDF

**Access:** "Overview" > "Select Measurement" > "CCDF"

**or:** MEAS > "Select Measurement" > "CCDF"

The CCDF measurement determines the distribution of the signal amplitudes (complementary cumulative distribution function). The CCDF and the Crest factor are displayed. For the purposes of this measurement, a signal section of user-definable length is recorded continuously in zero span, and the distribution of the signal amplitudes is evaluated.

The measurement is useful to determine errors of linear amplifiers. The crest factor is defined as the ratio of the peak power and the mean power. The Result Summary displays the number of included samples, the mean and peak power and the crest factor.

The CCDF measurement is performed as in the Spectrum application with the following settings:

*Table 5-6: Predefined settings for WLAN 802.11 CCDF measurements*

| Setting            | Default value     |
|--------------------|-------------------|
| CCDF               | Active on trace 1 |
| Analysis bandwidth | 10 MHz            |
| Number of samples  | 62500             |
| Detector           | Sample            |

For further details about the CCDF measurements refer to "Statistical Measurements" in the R&S FPS User Manual.

To restore adapted measurement parameters, the following parameters are saved on exiting and are restored on re-entering this measurement:

- Reference level and reference level offset
- Analysis bandwidth
- Number of samples

## 6 Analysis

General result analysis settings concerning the trace and markers etc. are currently not available for the standard WLAN measurements. Only one (Clear/Write) trace and one marker are available for these measurements.



### **Analysis of frequency sweep measurements**

General result analysis settings concerning the trace, markers, lines etc. for RF measurements are identical to the analysis functions in the Spectrum application except for some special marker functions and spectrograms, which are not available in the WLAN application.

For details see the "Common Analysis and Display Functions" chapter in the R&S FPS User Manual.

---

The remote commands required to perform these tasks are described in [Chapter 11.10, "Analysis"](#), on page 303.

## 7 I/Q Data Import and Export

Baseband signals mostly occur as so-called complex baseband signals, i.e. a signal representation that consists of two channels; the in phase (I) and the quadrature (Q) channel. Such signals are referred to as I/Q signals. The complete modulation information and even distortion that originates from the RF, IF or baseband domains can be analyzed in the I/Q baseband.

Importing and exporting I/Q signals is useful for various applications:

- Generating and saving I/Q signals in an RF or baseband signal generator or in external software tools to analyze them with the R&S FPS later
- Capturing and saving I/Q signals with an RF or baseband signal analyzer to analyze them with the R&S FPS or an external software tool later

As opposed to storing trace data, which may be averaged or restricted to peak values, I/Q data is stored as it was captured, without further processing. The data is stored as complex values in 32-bit floating-point format. Multi-channel data is not supported. The I/Q data is stored in a format with the file extension `.iq.tar`.

For a detailed description see the R&S FPS I/Q Analyzer and I/Q Input User Manual.



### Export only in MSRA mode

In MSRA mode, I/Q data can only be exported to other applications; I/Q data cannot be imported to the MSRA Master or any MSRA applications.

- [Import/Export Functions](#)..... 157
- [How to Export and Import I/Q Data](#)..... 158

### 7.1 Import/Export Functions



The following import and export functions are available via softkeys in the "Save/Recall" menu which is displayed when you select the "Save" or "Open" icon in the toolbar.



These functions are only available if no measurement is running.

In particular, if [Continuous Sweep/RUN CONT](#) is active, the import/export functions are not available.



For a description of the other functions in the "Save/Recall" menu see the R&S FPS User Manual.

|                                    |     |
|------------------------------------|-----|
| <a href="#">Import</a> .....       | 158 |
| L <a href="#">I/Q Import</a> ..... | 158 |
| <a href="#">Export</a> .....       | 158 |
| L <a href="#">I/Q Export</a> ..... | 158 |

### Import

Provides functions to import data.

#### I/Q Import ← Import

Opens a file selection dialog box to select an import file that contains IQ data. This function is only available in single sweep mode and only in applications that process I/Q data, such as the I/Q Analyzer or optional applications.

Note that the I/Q data must have a specific format as described in the R&S FPS I/Q Analyzer and I/Q Input User Manual.

Remote command:

[MMEMory:LOAD:IQ:STATe](#) on page 302

### Export

Opens a submenu to configure data export.

#### I/Q Export ← Export

Opens a file selection dialog box to select an export file to which the IQ data will be stored. This function is only available in single sweep mode, and only in applications that process I/Q data, such as the I/Q Analyzer or optional applications.

**Note:** Secure user mode.

In secure user mode, settings that are to be stored on the instrument are stored to volatile memory, which is restricted to 256 MB. Thus, a "Memory full" error may occur although the hard disk indicates that storage space is still available.

To store data permanently, select an external storage location such as a USB memory device.

For details see "Protecting Data Using the Secure User Mode" in the "Data Management" section of the R&S FPS User Manual.

Remote command:

[MMEMory:STORe<n>:IQ:STATe](#) on page 303


## 7.2 How to Export and Import I/Q Data



I/Q data can only be exported in applications that process I/Q data, such as the I/Q Analyzer or optional applications.


### Capturing and exporting I/Q data

1. Press the PRESET key.
2. Press the MODE key and select the R&S FPS WLAN application or any other application that supports I/Q data.
3. Configure the data acquisition.
4. Press the RUN SINGLE key to perform a single sweep measurement.

5. Select the  "Save" icon in the toolbar.
6. Select the "I/Q Export" softkey.
7. In the file selection dialog box, select a storage location and enter a file name.
8. Select "Save".

The captured data is stored to a file with the extension `.iq.tar`.

#### Importing I/Q data

1. Press the MODE key and select the "IQ Analyzer" or any other application that supports I/Q data.
2. If necessary, switch to single sweep mode by pressing the RUN SINGLE key.
3. Select the  "Open" icon in the toolbar.
4. Select the "I/Q Import" softkey.
5. Select the storage location and the file name with the `.iq.tar` file extension.
6. Select "Open".

The stored data is loaded from the file and displayed in the current application.

#### Previewing the I/Q data in a web browser

The `iq-tar` file format allows you to preview the I/Q data in a web browser.

1. Use an archive tool (e.g. WinZip® or PowerArchiver®) to unpack the `iq-tar` file into a folder.
2. Locate the folder using Windows Explorer.
3. Open your web browser.

4. Drag the I/Q parameter XML file, e.g. `example.xml`, into your web browser.

**xzy.xml (of .iq.tar file)**

| Description        |                         |
|--------------------|-------------------------|
| Saved by           | FSV IQ Analyzer         |
| Comment            | Here is a comment       |
| Date & Time        | 2011-03-03 14:33:05     |
| Sample rate        | 6.5 MHz                 |
| Number of samples  | 65000                   |
| Duration of signal | 10 ms                   |
| Data format        | complex, float32        |
| Data filename      | xzy.complex.1ch.float32 |
| Scaling factor     | 1 V                     |

| Channel 1   |                |
|---|----------------|
| Comment   | Channel 1 of 1 |
| <b>Power vs time</b><br>y-axis: 10 dB /div<br>x-axis: 1 ms /div |                |
| <b>Spectrum</b><br>y-axis: 20 dB /div<br>x-axis: 500 kHz /div   |                |

E-mail: [info@rohde-schwarz.com](mailto:info@rohde-schwarz.com)  
 Internet: <http://www.rohde-schwarz.com>  
 Fileformat version: 1



## 8 How to Perform Measurements in the WLAN Application

The following step-by-step instructions demonstrate how to perform measurements in the R&S FPS WLAN application. The following tasks are described:

- [How to Determine Modulation Accuracy, Flatness and Tolerance Parameters for WLAN Signals](#)..... 161
- [How to Determine the OBW, SEM, ACLR or CCDF for WLAN Signals](#)..... 163

### 8.1 How to Determine Modulation Accuracy, Flatness and Tolerance Parameters for WLAN Signals

1. Press the MODE key.

A dialog box opens that contains all operating modes and applications currently available on your R&S FPS.

2. Select the "WLAN" item.



The R&S FPS opens a new measurement channel for the WLAN application.

3. Select the "Overview" softkey to display the "Overview" for a WLAN measurement.
4. Select the "Signal Description" button to define the digital standard to be used.
5. Select the "Input/Frontend" button and then the "Frequency" tab to define the input signal's center frequency.
6. Select the "Signal Capture" button to define how much and which data to capture from the input signal.
7. To define a particular starting point for the FFT or to improve the measurement speed for signals with a low duty cycle, select the "Synchronization/OFDM-Demod." button and set the required parameters.
8. Select the "Tracking/Channel Estimation" button to define how the data channels are to be estimated and which distortions will be compensated for.
9. Select the "Demod" button to provide information on the modulated signal and how the PPDU's detected in the capture buffer are to be demodulated.
10. Select the "Evaluation Range" button to define which data in the capture buffer you want to analyze.


11. Select the "Display Config" button and select the displays that are of interest to you (up to 16).  
Arrange them on the display to suit your preferences.

12. Exit the SmartGrid mode.

13. Start a new sweep with the defined settings.

- To perform a single sweep measurement, press the RUN SINGLE hardkey.
- To perform a continuous sweep measurement, press the RUN CONT hardkey.

In MSRA mode you may want to stop the continuous measurement mode by the Sequencer and perform a single data acquisition:

- a) Select the Sequencer icon (  ) from the toolbar.
- b) Set the Sequencer state to "OFF".
- c) Press the RUN SINGLE key.

Measurement results are updated once the measurement has completed.

#### To select the application data for MSRA measurements

In multi-standard radio analysis you can analyze the data captured by the MSRA Master in the R&S FPS WLAN application. Assuming you have detected a suspect area of the captured data in another application, you would now like to analyze the same data in the R&S FPS WLAN application.

1. Select the "Overview" softkey to display the "Overview" for WLAN I/Q measurements.
2. Select the "Signal Capture" button.
3. Define the application data range as the "Capture Time".
4. Define the starting point of the application data as the "Capture offset". The offset is calculated according to the following formula:  
$$\text{<capture offset>} = \text{<starting point for application>} - \text{<starting point in capture buffer>}$$
5. The analysis interval is automatically determined according to the selected channel, carrier or PPDU to analyze (defined for the evaluation range), depending on the result display. Note that the channel/carrier/PPDU is analyzed *within the application data*. If the analysis interval does not yet show the required area of the capture buffer, move through the channels/carriers/PPDUs in the evaluation range or correct the application data range.
6. If the Sequencer is off, select the "Refresh" softkey in the "Sweep" menu to update the result displays for the changed application data.

## 8.2 How to Determine the OBW, SEM, ACLR or CCDF for WLAN Signals

1. Press the MODE key and select the "WLAN" application.  
The R&S FPS opens a new measurement channel for the WLAN application. I/Q data acquisition is performed by default.
2. Select the "Signal Description" button to define the digital standard to be used.
3. Select the required measurement:
  - a) Press the MEAS key.
  - b) In the "Select Measurement" dialog box, select the required measurement.  
The selected measurement is activated with the default settings for WLAN immediately.
4. For SEM measurements, select the required standard settings file:
  - a) In the SEMask menu, select the "Standard Files" softkey.
  - b) Select the required settings file. The subdirectory displayed in the file selection dialog box depends on the standard you selected in [step 2](#).
5. If necessary, adapt the settings as described for the individual measurements in the R&S FPS User Manual.
6. Select the "Display Config" button and select the evaluation methods that are of interest to you.  
Arrange them on the display to suit your preferences.
7. Exit the SmartGrid mode and select the "Overview" softkey to display the "Overview" again.
8. Select the "Analysis" button in the "Overview" to make use of the advanced analysis functions in the result displays.
  - Configure a trace to display the average over a series of sweeps; if necessary, increase the "Sweep Count" in the "Sweep" settings.
  - Configure markers and delta markers to determine deviations and offsets within the evaluated signal.
  - Use special marker functions to calculate noise or a peak list.
  - Configure a limit check to detect excessive deviations.
9. Optionally, export the trace data of the graphical evaluation results to a file.
  - a) In the "Traces" tab of the "Analysis" dialog box, switch to the "Trace Export" tab.
  - b) Select "Export Trace to ASCII File".
  - c) Define a file name and storage location and select "OK".

## 9 Basic Measurement Examples

This section provides step-by-step instructions for working through an ordinary measurement.

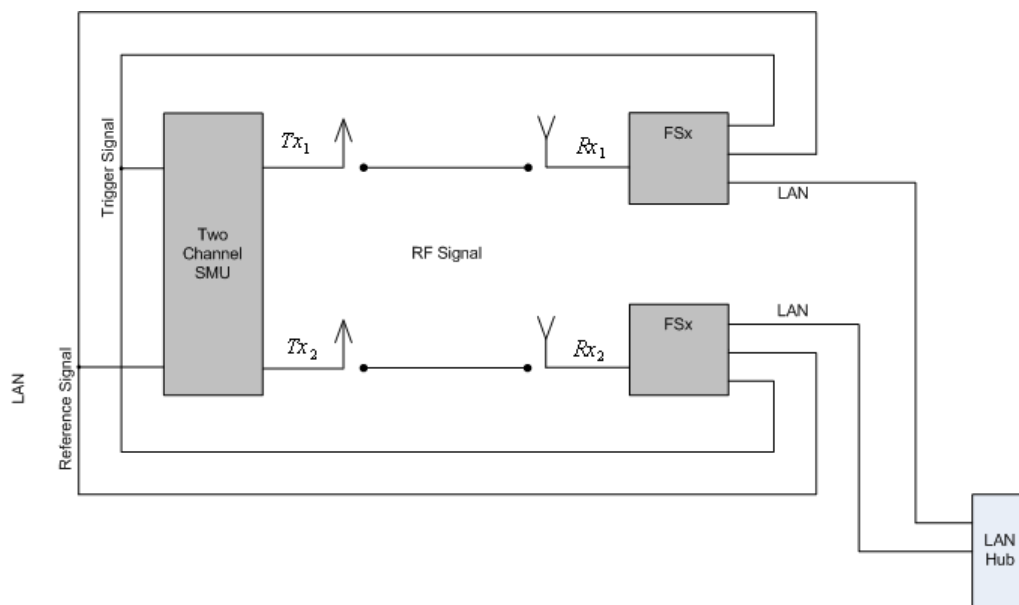
In this example, a DUT using IEEE 802.11a is used. The DUT is connected to the R&S FPS using the RF input of the R&S FPS. The DUT generates a signal modulated using 16QAM.

- [Measurement Example: Setting up a MIMO measurement](#)..... 164

### 9.1 Measurement Example: Setting up a MIMO measurement

For this example a 2 Tx MIMO DUT according to IEEE 802.11n is used.

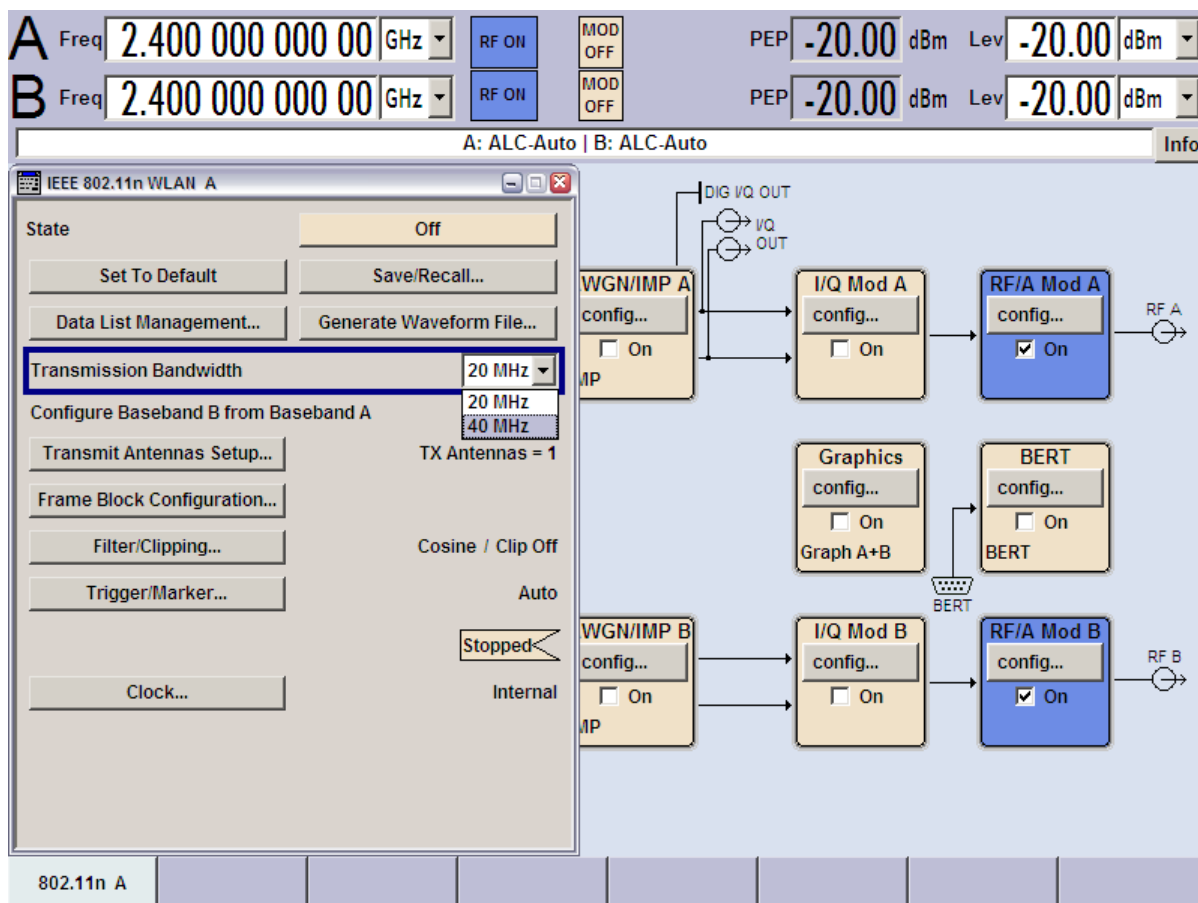
1. The MIMO DUT is connected to the analyzers according to the following setup:



2. Connect the external reference REF OUT of the SMU with the external reference REF IN of the analyzers. Switch on the external reference for both analyzers in the spectrum analyzer base system.
3. Connect the marker output of the SMU with the EXT TRIGGER input of the analyzers.
4. Either connect the "Path A RF/Baseband" connector with one analyzer and the "Path B RF/Baseband" connector with the other analyzer, or use the air interface with appropriate antennas.

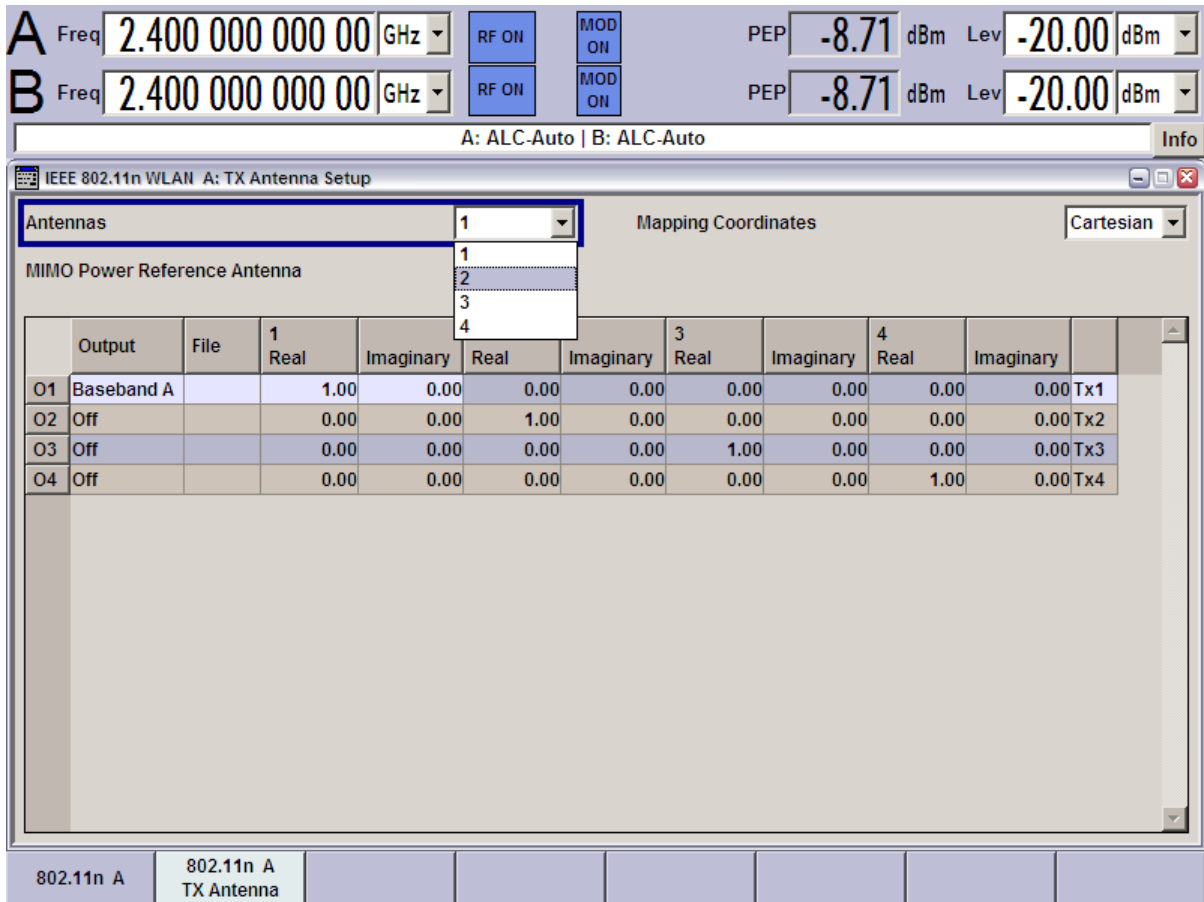
## Measurement Example: Setting up a MIMO measurement

5. Connect the master and the slave analyzer via LAN according to the figure above. As an alternative, it is sufficient to connect master and slave with a cross LAN cable. The analyzer with the R&S FPS-K91n option can be used as master. The slave analyzer does not require a WLAN option.
6. Setup the SMU to generate a 2 Tx IEEE 802.11n (MIMO) signal. For the SMU "Baseband A" select the "IEEE 802.11n ..." option. This opens the "IEEE 802.11n WLAN A" dialog.



7. Select the "Transmission Bandwidth" 40MHz. In the "IEEE 802.11n WLAN A" dialog, press the "Frame Block Configuration ..." button to open the "IEEE 802.11n WLAN A: Frame Blocks Configuration" dialog.

Measurement Example: Setting up a MIMO measurement



8. Select "Antennas" 2.  
 In the "IEEE 802.11n WLAN A" dialog, press the "Frame Block Configuration ..." button to open the "IEEE 802.11n WLAN A: Frame Blocks Configuration" dialog.

## Measurement Example: Setting up a MIMO measurement

IEEE 802.11n WLAN A: Frame Blocks Configuration

| Type | Physical Mode | Tx Mode    | Frames   | Idle Time /ms | Data  | DList / Pattern | Boost /dB | PPDU      | Data Rate /Mbps | State |
|------|---------------|------------|----------|---------------|-------|-----------------|-----------|-----------|-----------------|-------|
| 1 >  | Data          | Mixed Mode | HT-20MHz | 1             | 0.100 | PN 9            | 0.00      | Config... | 13.00           | On    |

Legend:

- Legacy
- Mixed Mode
- Green Field
- Sounding

Buttons: Append, Insert, Delete, Copy, Paste

- Select "Tx Mode" *HT-40MHz*.  
Press the "PPDU Config ..." button to open the "IEEE 802.11n WLAN A: PPDU Configuration for Frame Block 1" dialog.

## Measurement Example: Setting up a MIMO measurement

The screenshot displays the configuration for a MIMO measurement. At the top, two channels (A and B) are configured with a frequency of 2.400 GHz, PEP of -8.71 dBm, and a level of -20.00 dBm. The main dialog, titled "IEEE 802.11n WLAN A: PPDU Configuration for Frame Block 1", shows the following settings:

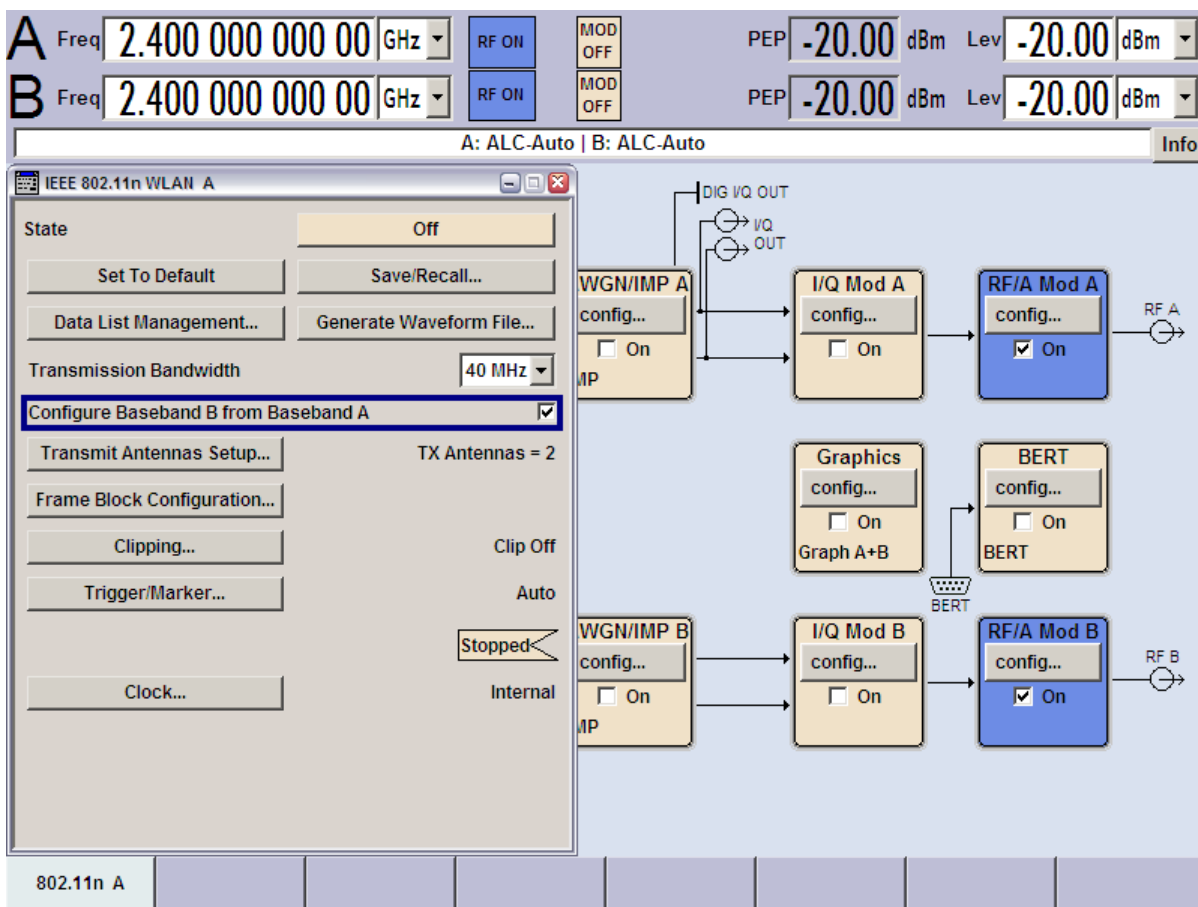
- Stream Settings:**
  - Spatial Streams: 2
  - Extended Spatial Streams: 0
  - Space Time Streams: 2
  - Space Time Block Coding: inactive
- Spatial Stream Modulation:**
  - Stream 1: QPSK
  - Stream 2: QPSK
  - Stream 3: QPSK
  - Stream 4: QPSK
- Data Settings:**
  - Data Bits Per Symbol: 216
  - Data Rate (Mbps): 54.00
  - Data Length: 1024 bytes
  - Number Of Data Symbols: 39
  - Preamble/Header Active:  On
  - Guard: Long
  - Scrambler: On (User Init)
  - Scrambler Init (hex): 01
  - Channel Coding: BCC
  - Encoders: 1
  - Rate: 1/2
  - Interleaver Active:  On
  - Service Field (hex): 0000

Buttons at the bottom include Append, Insert, Delete, Copy, and Paste.

10. Select "Spatial Streams" 2 and "Space Time Streams" 2.  
Return to the "IEEE 802.11n WLAN A" dialog.

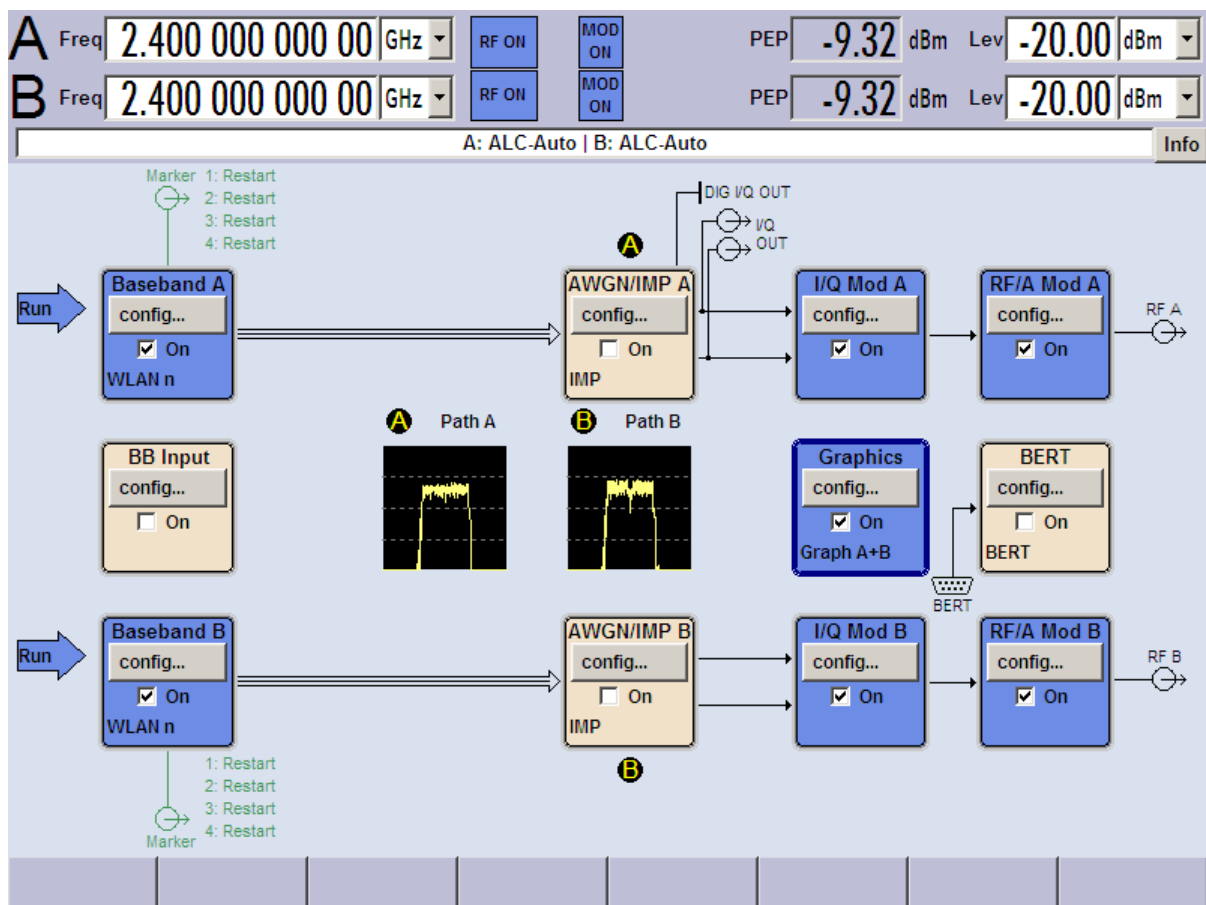


Measurement Example: Setting up a MIMO measurement



11. Check "Configure Baseband B from Baseband A". This will generate a IEEE 802.11n conform Tx 2 signal for path B of the SMU.
12. Toggle the "State" to *On* and make sure "RF/A Mod A" and "RF/B Mod B" are switched on.

## Measurement Example: Setting up a MIMO measurement



13. Using the "Graphics | Power Spectrum" display shows the power spectrum for both antennas.
14. Now set up the spectrum analyzer with the R&S FPS-K91n option to perform the WLAN MIMO measurements. Start the R&S FPS-K91n application.
15. Select "Standard" *IEEE 802.11n (MIMO)*.  
Set the "RF Frequency" the DUT is transmitting.
16. Set "Trigger Mode" to "External".  
Select the "STC/MIMO" tab in the "General Settings" dialog box.
17. Select "DUT MIMO configuration" *2 Tx Antennas*.
18. Set the "IP Address" of the slave in the "MIMO Measurement Setup" table and turn the "State" of the slave to *ON*.

# 10 Optimizing and Troubleshooting the Measurement

- [Optimizing the Measurement Results](#)..... 171
- [Error Messages and Warnings](#)..... 172

## 10.1 Optimizing the Measurement Results

If the results do not meet your expectations, try the following methods to optimize the measurement.

- [Improving Performance](#) ..... 171
- [Improving Channel Estimation and EVM Accuracy](#)..... 171

### 10.1.1 Improving Performance

#### Performing a coarse burst search

For signals with **low duty cycle rates**, enable the "Power Interval Search" for synchronization (see "[Power Interval Search](#)" on page 118). In this case, the R&S FPS WLAN application initially performs a coarse burst search on the input signal in which increases in the power vs time trace are detected. Further time-consuming processing is then only performed where bursts are assumed. This improves the measurement speed.

However, for signals in which the PPDU power levels differ significantly, this option should be disabled as otherwise some PPDUs may not be detected.

### 10.1.2 Improving Channel Estimation and EVM Accuracy

The channels in the WLAN signal are estimated based on the expected input signal description and the information provided by the PPDUs themselves. The more accurate the channel estimation, the more accurate the EVM based on these channels can be calculated.

#### Increasing the basis for channel estimation

The more information that can be used to estimate the channels, the more accurate the results. For measurements that need not be performed strictly according to the WLAN 802.11 standard, set the "Channel Estimation Range" to "Payload" (see "[Channel Estimation Range](#)" on page 120).

The channel estimation is performed in the preamble and the payload. The EVM results can be calculated more accurately.

### Accounting for phase drift in the EVM

According to the WLAN 802.11 standards, the common phase drift must be estimated and compensated from the pilots. Thus, these deviations are not included in the EVM. To include the phase drift, disable "Phase Tracking" (see ["Phase Tracking"](#) on page 121).

### Analyzing time jitter

Normally, a symbol-wise timing jitter is negligible and not required by the IEEE 802.11a measurement standard [6], and thus not considered in channel estimation. However, there may be situations where the timing drift has to be taken into account.

However, to analyze the time jitter per symbol, enable "Timing Tracking" (see ["Timing Error Tracking"](#) on page 121).

### Compensating for non-standard-conform pilot sequences

In case the pilot generation algorithm of the device under test (DUT) has a problem, the non-standard-conform pilot sequence might affect the measurement results, or the WLAN application might not synchronize at all onto the signal generated by the DUT.

In this case, set the "Pilots for Tracking" to "Detected" (see ["Pilots for Tracking"](#) on page 122), so that the pilot sequence detected in the signal is used instead of the sequence defined by the standard.

However, if the pilot sequence generated by the DUT is correct, it is recommended that you use the "According to Standard" setting because it generates more accurate measurement results.

## 10.2 Error Messages and Warnings

The following messages are displayed in the status bar in case of errors.

### Results contribute to overall results despite inconsistencies:

#### **"Info: Comparison between HT-SIG Payload Length and Estimated Payload Length not performed due to insufficient SNR"**

The R&S FPS WLAN application compares the HT-SIG length against the length estimated from the PPDU power profile. If the two values do not match, the corresponding entry is highlighted orange. If the signal quality is very bad, this comparison is suppressed and the message above is shown.

#### **"Warning: HT-SIG of PPDU was not evaluated"**

Decoding of the HT-SIG was not possible because there was not enough data in the Capture Memory (potential PPDU truncation).

#### **"Warning: Mismatch between HT-SIG and estimated (SNR+Power) PPDU length"**

The HT-SIG length and the length estimated by the R&S FPS WLAN application (from the PPDU power profile) are different.

**"Warning: Physical Channel estimation impossible / Phy Chan results not available Possible reasons: channel matrix not square or singular to working precision"**

The Physical Channel results could not be calculated for one or both of the following reasons:

- The spatial mapping can not be applied due to a rectangular mapping matrix (the number of space time streams is not equal to the number of transmit antennas).
- The spatial mapping matrices are singular to working precision.

**PPDUs are dismissed due to inconsistencies****"Hint: PPDU requires at least one payload symbol"**

Currently at least one payload symbol is required in order to successfully analyze the PPDU. Null data packet (NDP) sounding PPDUs will generate this message.

**"Hint: PPDU dismissed due to a mismatch with the PPDU format to be analyzed"**

The properties causing the mismatches for this PPDU are highlighted.

**"Hint: PPDU dismissed due to truncation"**

The first or the last PPDU was truncated during the signal capture process, for example.

**"Hint: PPDU dismissed due to HT-SIG inconsistencies"**

One or more of the following HT-SIG decoding results are outside of specified range: MCS index, Number of additional STBC streams, Number of space time streams (derived from MCS and STBC), CRC Check failed, Non zero tail bits.

**"Hint: PPDU dismissed because payload channel estimation was not possible"**

The payload based channel estimation was not possible because the channel matrix is singular to working precision.

**"Hint: Channel matrix singular to working precision"**

Channel equalizing (for PPDU Length Detection, fully and user compensated measurement signal) is not possible because the estimated channel matrix is singular to working precision.

# 11 Remote Commands for WLAN Measurements

The following commands are required to perform measurements in the R&S FPS WLAN application in a remote environment.

It is assumed that the R&S FPS has already been set up for remote control in a network as described in the R&S FPS User Manual.



Note that basic tasks that are independent of the application are not described here. For a description of such tasks, see the R&S FPS User Manual.

In particular, this includes:

- Managing Settings and Results, i.e. storing and loading settings and result data
- Basic instrument configuration, e.g. checking the system configuration, customizing the screen layout, or configuring networks and remote operation
- Using the common status registers

After an introduction to SCPI commands, the following tasks specific to the WLAN application are described here:

|   |     |
|---|-----|
| • <a href="#">Common Suffixes</a> .....   | 174 |
| • <a href="#">Introduction</a> .....  | 175 |
| • <a href="#">Activating WLAN Measurements</a> .....  | 180 |
| • <a href="#">Selecting a Measurement</a> .....   | 184 |
| • <a href="#">Configuring the WLAN IQ Measurement (Modulation Accuracy, Flatness and Tolerance)</a> ..... | 191 |
| • <a href="#">Configuring Frequency Sweep Measurements on WLAN Signals</a> .....                          | 247 |
| • <a href="#">Configuring the Result Display</a> .....  | 249 |
| • <a href="#">Starting a Measurement</a> .....  | 265 |
| • <a href="#">Retrieving Results</a> .....  | 269 |
| • <a href="#">Analysis</a> .....  | 303 |
| • <a href="#">Status Registers</a> .....  | 306 |
| • <a href="#">Commands for Compatibility</a> .....  | 311 |
| • <a href="#">Programming Examples (R&amp;S FPS WLAN application)</a> .....                               | 312 |

## 11.1 Common Suffixes

For the description of the remote commands in the WLAN application, the following common suffixes are used:

*Table 11-1: Common suffixes for WLAN measurements on I/Q data*

| Suffix | Value range | Description |
|--------|-------------|-------------|
| <n>    | 1..16       | Window      |
| <k>    | 1..8        | Limit       |

| Suffix | Value range | Description |
|--------|-------------|-------------|
| <t>    | 1           | Trace       |
| <m>    | 1..4        | Marker      |

**Table 11-2: Common suffixes for frequency sweep measurements**

| Suffix | Value range   | Description |
|--------|---|-------------|
| <n>    | 1..16   | Window      |
| <t>    | 1..6  | Trace       |
| <m>    | 1..16   | Marker      |
| <ch>   | 1..18 (Tx channel)<br>1..11 (ALternate or ADJacent channel) | Channel     |
| <k>    | 1..8  | Limit line  |

## 11.2 Introduction

Commands are program messages that a controller (e.g. a PC) sends to the instrument or software. They operate its functions ('setting commands' or 'events') and request information ('query commands'). Some commands can only be used in one way, others work in two ways (setting and query). If not indicated otherwise, the commands can be used for settings and queries.

The syntax of a SCPI command consists of a header and, in most cases, one or more parameters. To use a command as a query, you have to append a question mark after the last header element, even if the command contains a parameter.

A header contains one or more keywords, separated by a colon. Header and parameters are separated by a "white space" (ASCII code 0 to 9, 11 to 32 decimal, e.g. blank). If there is more than one parameter for a command, these are separated by a comma from one another.

Only the most important characteristics that you need to know when working with SCPI commands are described here. For a more complete description, refer to the User Manual of the R&S FPS.



### Remote command examples

Note that some remote command examples mentioned in this general introduction may not be supported by this particular application.

### 11.2.1 Conventions used in Descriptions

Note the following conventions used in the remote command descriptions:

- **Command usage**

If not specified otherwise, commands can be used both for setting and for querying parameters.

If a command can be used for setting or querying only, or if it initiates an event, the usage is stated explicitly.

- **Parameter usage**

If not specified otherwise, a parameter can be used to set a value and it is the result of a query.

Parameters required only for setting are indicated as **Setting parameters**.

Parameters required only to refine a query are indicated as **Query parameters**.

Parameters that are only returned as the result of a query are indicated as **Return values**.

- **Conformity**

Commands that are taken from the SCPI standard are indicated as **SCPI confirmed**. All commands used by the R&S FPS follow the SCPI syntax rules.

- **Asynchronous commands**

A command which does not automatically finish executing before the next command starts executing (overlapping command) is indicated as an **Asynchronous command**.

- **Reset values (\*RST)**

Default parameter values that are used directly after resetting the instrument (\*RST command) are indicated as **\*RST** values, if available.

- **Default unit**

This is the unit used for numeric values if no other unit is provided with the parameter.

- **Manual operation**

If the result of a remote command can also be achieved in manual operation, a link to the description is inserted.

## 11.2.2 Long and Short Form

The keywords have a long and a short form. You can use either the long or the short form, but no other abbreviations of the keywords.

The short form is emphasized in upper case letters. Note however, that this emphasis only serves the purpose to distinguish the short from the long form in the manual. For the instrument, the case does not matter.

**Example:**

SENSe:FREQuency:CENTer is the same as SENS:FREQ:CENT.

## 11.2.3 Numeric Suffixes

Some keywords have a numeric suffix if the command can be applied to multiple instances of an object. In that case, the suffix selects a particular instance (e.g. a measurement window).

Numeric suffixes are indicated by angular brackets (<n>) next to the keyword.



If you don't quote a suffix for keywords that support one, a 1 is assumed.

**Example:**

`DISPlay[:WINDow<1...4>]:ZOOM:STATe` enables the zoom in a particular measurement window, selected by the suffix at `WINDow`.

`DISPlay:WINDow4:ZOOM:STATe ON` refers to window 4.

## 11.2.4 Optional Keywords

Some keywords are optional and are only part of the syntax because of SCPI compliance. You can include them in the header or not.

Note that if an optional keyword has a numeric suffix and you need to use the suffix, you have to include the optional keyword. Otherwise, the suffix of the missing keyword is assumed to be the value 1.

Optional keywords are emphasized with square brackets.

**Example:**

Without a numeric suffix in the optional keyword:

`[SENSe:]FREQuency:CENTer` is the same as `FREQuency:CENTer`

With a numeric suffix in the optional keyword:

`DISPlay[:WINDow<1...4>]:ZOOM:STATe`

`DISPlay:ZOOM:STATe ON` enables the zoom in window 1 (no suffix).

`DISPlay:WINDow4:ZOOM:STATe ON` enables the zoom in window 4.

## 11.2.5 Alternative Keywords

A vertical stroke indicates alternatives for a specific keyword. You can use both keywords to the same effect.

**Example:**

`[SENSe:]BANDwidth|BWIDth[:RESolution]`

In the short form without optional keywords, `BAND 1MHZ` would have the same effect as `BWID 1MHZ`.

## 11.2.6 SCPI Parameters

Many commands feature one or more parameters.

If a command supports more than one parameter, these are separated by a comma.

**Example:**

`LAYout:ADD:WINDow Spectrum,LEFT,MTABLE`

Parameters may have different forms of values.

- [Numeric Values](#).....178
- [Boolean](#).....179
- [Character Data](#).....179
- [Character Strings](#).....179
- [Block Data](#).....179

### 11.2.6.1 Numeric Values

Numeric values can be entered in any form, i.e. with sign, decimal point or exponent. In case of physical quantities, you can also add the unit. If the unit is missing, the command uses the basic unit.

#### Example:

with unit: `SENSe:FREQuency:CENTer 1GHZ`

without unit: `SENSe:FREQuency:CENTer 1E9` would also set a frequency of 1 GHz.

Values exceeding the resolution of the instrument are rounded up or down.

If the number you have entered is not supported (e.g. in case of discrete steps), the command returns an error.

Instead of a number, you can also set numeric values with a text parameter in special cases.

- **MIN/MAX**  
Defines the minimum or maximum numeric value that is supported.
- **DEF**  
Defines the default value.
- **UP/DOWN**  
Increases or decreases the numeric value by one step. The step size depends on the setting. In some cases you can customize the step size with a corresponding command.

#### Querying numeric values

When you query numeric values, the system returns a number. In case of physical quantities, it applies the basic unit (e.g. Hz in case of frequencies). The number of digits after the decimal point depends on the type of numeric value.

#### Example:

Setting: `SENSe:FREQuency:CENTer 1GHZ`

Query: `SENSe:FREQuency:CENTer?` would return `1E9`

In some cases, numeric values may be returned as text.

- **INF/NINF**  
Infinity or negative infinity. Represents the numeric values 9.9E37 or -9.9E37.
- **NAN**

Not a number. Represents the numeric value 9.91E37. NAN is returned in case of errors.

### 11.2.6.2 Boolean

Boolean parameters represent two states. The "ON" state (logically true) is represented by "ON" or a numeric value 1. The "OFF" state (logically untrue) is represented by "OFF" or the numeric value 0.

#### Querying boolean parameters

When you query boolean parameters, the system returns either the value 1 ("ON") or the value 0 ("OFF").

#### Example:

Setting: `DISPlay:WINDow:ZOOM:STATe ON`

Query: `DISPlay:WINDow:ZOOM:STATe?` would return 1

### 11.2.6.3 Character Data

Character data follows the syntactic rules of keywords. You can enter text using a short or a long form. For more information see [Chapter 11.2.2, "Long and Short Form"](#), on page 176.

#### Querying text parameters

When you query text parameters, the system returns its short form.

#### Example:

Setting: `SENSe:BANDwidth:RESolution:TYPE NORMal`

Query: `SENSe:BANDwidth:RESolution:TYPE?` would return NORM

### 11.2.6.4 Character Strings

Strings are alphanumeric characters. They have to be in straight quotation marks. You can use a single quotation mark ( ' ) or a double quotation mark ( " ).

#### Example:

`INSTRument:DELeTe 'Spectrum'`

### 11.2.6.5 Block Data

Block data is a format which is suitable for the transmission of large amounts of data.

The ASCII character # introduces the data block. The next number indicates how many of the following digits describe the length of the data block. In the example the 4 following digits indicate the length to be 5168 bytes. The data bytes follow. During the transmission of these data bytes all end or other control signs are ignored until all bytes are

transmitted. #0 specifies a data block of indefinite length. The use of the indefinite format requires a NL^END message to terminate the data block. This format is useful when the length of the transmission is not known or if speed or other considerations prevent segmentation of the data into blocks of definite length.

## 11.3 Activating WLAN Measurements

WLAN measurements require a special application on the R&S FPS (R&S FPS-K91). The measurement is started immediately with the default settings.



These are basic R&S FPS commands, listed here for your convenience.

|   |     |
|---|-----|
| <a href="#">INSTrument:CREate:DUPLicate</a> .....     | 180 |
| <a href="#">INSTrument:CREate[:NEW]</a> .....         | 180 |
| <a href="#">INSTrument:CREate:REPLace</a> .....       | 181 |
| <a href="#">INSTrument:DELeTe</a> .....               | 181 |
| <a href="#">INSTrument:LIST?</a> .....                | 181 |
| <a href="#">INSTrument:REName</a> .....               | 182 |
| <a href="#">INSTrument[:SELeCt]</a> .....             | 183 |
| <a href="#">SYSTem:PRESet:CHANnel[:EXECute]</a> ..... | 183 |

### **INSTrument:CREate:DUPLicate**

This command duplicates the currently selected measurement channel, i.e. creates a new measurement channel of the same type and with the identical measurement settings. The name of the new channel is the same as the copied channel, extended by a consecutive number (e.g. "IQAnalyzer" -> "IQAnalyzer2").

The channel to be duplicated must be selected first using the `INST:SEL` command.

**Example:**

```
INST:SEL 'IQAnalyzer'
```

```
INST:CRE:DUPL
```

Duplicates the channel named 'IQAnalyzer' and creates a new measurement channel named 'IQAnalyzer2'.

**Usage:** Event

### **INSTrument:CREate[:NEW] <ChannelType>, <ChannelName>**

This command adds an additional measurement channel.

The number of measurement channels you can configure at the same time depends on available memory.

**Parameters:**

<ChannelType> Channel type of the new channel.  
For a list of available channel types see [INSTrument:LIST?](#) on page 181.

<ChannelName> String containing the name of the channel. The channel name is displayed as the tab label for the measurement channel.  
 Note: If the specified name for a new channel already exists, the default name, extended by a sequential number, is used for the new channel (see [INSTrument:LIST?](#) on page 181).

**Example:** `INST:CRE IQ, 'IQAnalyzer2'`  
 Adds an additional I/Q Analyzer channel named "IQAnalyzer2".

### **INSTrument:CREate:REPLace** <ChannelName1>,<ChannelType>,<ChannelName2>

This command replaces a measurement channel with another one.

#### **Setting parameters:**

<ChannelName1> String containing the name of the measurement channel you want to replace.

<ChannelType> Channel type of the new channel.  
 For a list of available channel types see [INSTrument:LIST?](#) on page 181.

<ChannelName2> String containing the name of the new channel.  
 Note: If the specified name for a new channel already exists, the default name, extended by a sequential number, is used for the new channel (see [INSTrument:LIST?](#) on page 181).

**Example:** `INST:CRE:REPL 'IQAnalyzer2',IQ, 'IQAnalyzer'`  
 Replaces the channel named 'IQAnalyzer2' by a new measurement channel of type 'IQ Analyzer' named 'IQAnalyzer'.

**Usage:** Setting only

### **INSTrument:DELeTe** <ChannelName>

This command deletes a measurement channel.

If you delete the last measurement channel, the default "Spectrum" channel is activated.

#### **Parameters:**

<ChannelName> String containing the name of the channel you want to delete.  
 A measurement channel must exist in order to be able delete it.

**Example:** `INST:DEL 'IQAnalyzer4'`  
 Deletes the channel with the name 'IQAnalyzer4'.

**Usage:** Event

### **INSTrument:LIST?**

This command queries all active measurement channels. This is useful in order to obtain the names of the existing measurement channels, which are required in order to replace or delete the channels.

**Return values:**

<ChannelType>  
<ChannelName>

For each channel, the command returns the channel type and channel name (see tables below).

Tip: to change the channel name, use the `INSTrument:REName` command.

**Example:**

```
INST:LIST?
```

Result for 3 measurement channels:

```
'ADEM', 'Analog Demod', 'IQ', 'IQ Analyzer', 'IQ', 'IQ Analyzer2'
```

**Usage:**

Query only

**Table 11-3: Available measurement channel types and default channel names in Signal and Spectrum Analyzer mode**

| Application                      | <ChannelType> Parameter | Default Channel Name*) |
|----------------------------------|-------------------------|------------------------|
| Spectrum                         | SANALYZER               | Spectrum               |
| I/Q Analyzer                     | IQ                      | IQ Analyzer            |
| Analog Demodulation (R&S FPS-K7) | ADEM                    | Analog Demod           |
| GSM (R&S FPS-K10)                | GSM                     | GSM                    |
| Noise (R&S FPS-K30)              | NOISE                   | Noise                  |
| Phase Noise (R&S FPS-K40)        | PNOISE                  | Phase Noise            |
| VSA (R&S FPS-K70)                | DDEM                    | VSA                    |
| 3GPP FDD BTS (R&S FPS-K72)       | BWCD                    | 3G FDD BTS             |
| 3GPP FDD UE (R&S FPS-K73)        | MWCD                    | 3G FDD UE              |
| TD-SCDMA BTS (R&S FPS-K76)       | BTDS                    | TD-SCDMA BTS           |
| TD-SCDMA UE (R&S FPS-K77)        | MTDS                    | TD-SCDMA UE            |
| cdma2000 BTS (R&S FPS-K82)       | BC2K                    | CDMA2000 BTS           |
| cdma2000 MS (R&S FPS-K83)        | MC2K                    | CDMA2000 MS            |
| 1xEV-DO BTS (R&S FPS-K84)        | BDO                     | 1xEV-DO BTS            |
| 1xEV-DO MS (R&S FPS-K85)         | MDO                     | 1xEV-DO MS             |
| WLAN (R&S FPS-K91)               | WLAN                    | WLAN                   |
| LTE (R&S FPS-K10x)               | LTE                     | LTE                    |

\*) the default channel name is also listed in the table. If the specified name for a new channel already exists, the default name, extended by a sequential number, is used for the new channel.

**INSTrument:REName** <ChannelName1>, <ChannelName2>

This command renames a measurement channel.

**Parameters:**

<ChannelName1> String containing the name of the channel you want to rename.

<ChannelName2> String containing the new channel name.  
Note that you can not assign an existing channel name to a new channel; this will cause an error.

**Example:** `INST:REN 'IQAnalyzer2','IQAnalyzer3'`  
Renames the channel with the name 'IQAnalyzer2' to 'IQAnalyzer3'.

**Usage:** Setting only

#### **INSTrument[:SElect] <ChannelType> | <ChannelName>**

This command activates a new measurement channel with the defined channel type, or selects an existing measurement channel with the specified name.

See also `INSTrument:CREate[:NEW]` on page 180.

For a list of available channel types see `INSTrument:LIST?` on page 181.

#### **Parameters:**

<ChannelType> Channel type of the new channel.  
For a list of available channel types see [Table 11-3](#).

#### **WLAN**

WLAN option, R&S FPS–K91

<ChannelName> String containing the name of the channel.

**Example:** `INST WLAN`  
Activates a measurement channel for the WLAN application.  
`INST 'WLAN'`  
Selects the measurement channel named 'WLAN' (for example before executing further commands for that channel).

#### **SYSTem:PRESet:CHANnel[:EXECute]**

This command restores the default instrument settings in the current channel.

Use `INST:SEL` to select the channel.

**Example:** `INST 'Spectrum2'`  
Selects the channel for "Spectrum2".  
`SYST:PRESet:CHAN:EXEC`  
Restores the factory default settings to the "Spectrum2" channel.

**Usage:** Event

**Manual operation:** See "[Preset Channel](#)" on page 92

## 11.4 Selecting a Measurement

The following commands are required to define the measurement type in a remote environment. The selected measurement must be started explicitly (see [Chapter 11.8, "Starting a Measurement"](#), on page 265)!

For details on available measurements see [Chapter 3, "Measurements and Result Displays"](#), on page 12.



The WLAN IQ measurement captures the I/Q data from the WLAN signal using a (nearly rectangular) filter with a relatively large bandwidth. This measurement is selected when the WLAN measurement channel is activated. The commands to select a different measurement or return to the WLAN IQ measurement are described here.

Note that the `CONF:BURSt:<ResultType>:IMM` commands change the screen layout to display the Magnitude Capture buffer in window 1 at the top of the screen and the selected result type in window 2 below that. Any other active windows are closed.

Use the `LAYOut` commands to change the display (see [Chapter 11.7, "Configuring the Result Display"](#), on page 249).

- [Selecting the WLAN IQ Measurement \(Modulation Accuracy, Flatness and Tolerance\)](#)..... 184
- [Selecting a Common RF Measurement for WLAN Signals](#)..... 190

### 11.4.1 Selecting the WLAN IQ Measurement (Modulation Accuracy, Flatness and Tolerance)

Any of the following commands can be used to return to the WLAN IQ measurement. Each of these results are automatically determined when the WLAN IQ measurement is performed.



The selected measurement must be started explicitly (see [Chapter 11.8, "Starting a Measurement"](#), on page 265)!

|  |     |
|--|-----|
| <code>CONFigure:BURSt:AM:AM[:IMMEDIATE]</code> .....                                   | 185 |
| <code>CONFigure:BURSt:AM:EVM[:IMMEDIATE]</code> .....                                  | 185 |
| <code>CONFigure:BURSt:AM:PM[:IMMEDIATE]</code> .....                                   | 185 |
| <code>CONFigure:BURSt:CONST:CCARrier[:IMMEDIATE]</code> .....                          | 185 |
| <code>CONFigure:BURSt:CONST:CSYMBOL[:IMMEDIATE]</code> .....                           | 186 |
| <code>CONFigure:BURSt:EVM:ECARrier[:IMMEDIATE]</code> .....                            | 186 |
| <code>CONFigure:BURSt:EVM:ESYMBOL[:IMMEDIATE] (IEEE 802.11b and g (DSSS))</code> ..... | 186 |
| <code>CONFigure:BURSt:EVM:ECHIP[:IMMEDIATE]</code> .....                               | 186 |
| <code>CONFigure:BURSt:EVM:ESYMBOL[:IMMEDIATE]</code> .....                             | 186 |
| <code>CONFigure:BURSt:GAIN:GCARrier[:IMMEDIATE]</code> .....                           | 187 |
| <code>CONFigure:BURSt:PREamble[:IMMEDIATE]</code> .....                                | 187 |
| <code>CONFigure:BURSt:PREamble:SElect</code> .....                                     | 187 |
| <code>CONFigure:BURSt:PTRacking[:IMMEDIATE]</code> .....                               | 187 |



|   |     |
|---|-----|
| CONFigure:BURSt:PVT[:IMMEDIATE].....                | 187 |
| CONFigure:BURSt:PVT:SElect.....                     | 188 |
| CONFigure:BURSt:QUAD:QCARrier[:IMMEDIATE].....      | 188 |
| CONFigure:BURSt:SPECTrum:FFT[:IMMEDIATE].....       | 188 |
| CONFigure:BURSt:SPECTrum:FLATness:SElect.....       | 188 |
| CONFigure:BURSt:SPECTrum:FLATness[:IMMEDIATE].....  | 189 |
| CONFigure:BURSt:STATistics:BSTReam[:IMMEDIATE]..... | 189 |
| CONFigure:BURSt:STATistics:SFeld[:IMMEDIATE].....   | 189 |
| DISPlay[:WINDow<n>]:SElect.....                     | 190 |

---

#### CONFigure:BURSt:AM:AM[:IMMEDIATE]

This remote control command configures the result display type of window 2 to be AM vs AM. Results are only displayed after a measurement is executed, e.g. using the `INITiate<n>[:IMMEDIATE]` command.

**Usage:** Event

**Manual operation:** See "[AM/AM](#)" on page 22

---

#### CONFigure:BURSt:AM:EVM[:IMMEDIATE]

This remote control command configures the result display type of window 2 to be AM vs. EVM. Results are only displayed after a measurement is executed, e.g. using the `INITiate<n>[:IMMEDIATE]` command.

**Usage:** Event

**Manual operation:** See "[AM/EVM](#)" on page 23

---

#### CONFigure:BURSt:AM:PM[:IMMEDIATE]

This remote control command configures the result display type of window 2 to be AM vs PM. Results are only displayed after a measurement is executed, e.g. using the `INITiate<n>[:IMMEDIATE]` command.

**Usage:** Event

**Manual operation:** See "[AM/PM](#)" on page 23

---

#### CONFigure:BURSt:CONSt:CCARrier[:IMMEDIATE]

This remote control command configures the result display type of window 2 to be Constellation vs Carrier.

Results are only displayed after a measurement is executed, e.g. using the `INITiate<n>[:IMMEDIATE]` command.

**Usage:** Event

**Manual operation:** See "[Constellation vs Carrier](#)" on page 28

---

**CONFigure:BURSt:CONSt:CSYMBOL[:IMMEDIATE]**

This remote control command configures the result display type of window 2 to be Constellation (vs Symbol).

Results are only displayed after a measurement has been executed, e.g. using the `INITiate<n>[:IMMEDIATE]` command.

**Usage:** Event

**Manual operation:** See "Constellation" on page 26

---

**CONFigure:BURSt:EVM:ECARrier[:IMMEDIATE]**

This remote control command configures the result display type of window 2 to be EVM vs Carrier.

Results are only displayed after a measurement is executed, e.g. using the `INITiate<n>[:IMMEDIATE]` command.

**Usage:** Event

**Manual operation:** See "EVM vs Carrier" on page 29

---

**CONFigure:BURSt:EVM:ESYMBOL[:IMMEDIATE] (IEEE 802.11b and g (DSSS))**  
**CONFigure:BURSt:EVM:ECHIP[:IMMEDIATE]**

Both of these commands configure the measurement type to be EVM vs Chip for **IEEE 802.11b and g (DSSS)** standards. For compatibility reasons, the `CONFigure:BURSt:EVM:ESYMBOL[:IMMEDIATE]` command is also supported for the IEEE 802.11b and g (DSSS) standards. However, for new remote control programs use the `LAYout` commands (see [Chapter 11.7.2, "Working with Windows in the Display"](#), on page 250).

Results are only displayed after a measurement is executed, e.g. using the `INITiate<n>[:IMMEDIATE]` command.

**Manual operation:** See "EVM vs Chip" on page 30

---

**CONFigure:BURSt:EVM:ESYMBOL[:IMMEDIATE]**

This remote control command configures the measurement type to be EVM vs Symbol.

For **IEEE 802.11b and g (DSSS)** standards, this command selects the EVM vs Chip result display.

Results are only displayed after a measurement is executed, e.g. using the `INITiate<n>[:IMMEDIATE]` command.

**Usage:** Event

**Manual operation:** See "EVM vs Chip" on page 30  
See "EVM vs Symbol" on page 30

**CONFigure:BURSt:GAIN:GCARrier[:IMMEDIATE]**

This remote control command configures the result display type of window 2 to be Gain Imbalance vs Carrier. Results are only displayed after a measurement is executed, e.g. using the `INITiate<n>[:IMMEDIATE]` command.

**Usage:** Event

**Manual operation:** See "Gain Imbalance vs Carrier" on page 33

**CONFigure:BURSt:PREamble[:IMMEDIATE]**

This remote control command configures the measurement type to be Frequency Error vs Preamble or Phase Error vs Preamble. Which of the two is determined by `CONFigure:BURSt:PREamble:SElect`.

**Manual operation:** See "Freq. Error vs Preamble" on page 33  
See "Phase Error vs Preamble" on page 36

**CONFigure:BURSt:PREamble:SElect <ErrType>**

This remote control command specifies whether frequency or phase results are displayed when the measurement type is set to Error Vs Preamble (`CONFigure:BURSt:PREamble[:IMMEDIATE]` on page 187).

**Parameters:**

<ErrType>

**FREQUENCY**

Displays frequency error results for the preamble of the measured PPDU's only

**PHASE**

Displays phase error results for the preamble of the measured PPDU's only

**Example:** `CONF:BURS:PRE:SEL PHAS`

**Manual operation:** See "Freq. Error vs Preamble" on page 33  
See "Phase Error vs Preamble" on page 36

**CONFigure:BURSt:PTRacking[:IMMEDIATE]**

This remote control command configures the measurement type to be Phase Tracking vs Symbol.

**Manual operation:** See "Phase Tracking" on page 37

**CONFigure:BURSt:PVT[:IMMEDIATE]**

This remote control command configures the measurement type to be Power vs Time.

**Manual operation:** See "PvT Full PPDU" on page 38  
See "PvT Rising Edge" on page 39  
See "PvT Falling Edge" on page 40

**CONFigure:BURSt:PVT:SElect** <Mode>

This remote command determines how to interpret the Power vs Time measurement results.

**Parameters:**

|        |   |
|--------|---|
| <Mode> | <b>EDGE</b><br>Displays rising and falling edges only |
|        | <b>FALL</b><br>Displays falling edge only             |
|        | <b>FULL</b><br>Displays the full PPDU                 |
|        | <b>RISE</b><br>Displays the rising edge only          |

**Example:**

```
CONF:BURS:PVT:SEL FULL
```

Interprets the measurement results as full PPDU

**Manual operation:** See "[PvT Full PPDU](#)" on page 38  
 See "[PvT Rising Edge](#)" on page 39  
 See "[PvT Falling Edge](#)" on page 40

**CONFigure:BURSt:QUAD:QCARrier[:IMMEDIATE]**

This remote control command configures the result display type in window 2 to be Quadrature Error vs Carrier. Results are only displayed after a measurement is executed, e.g. using the [INITiate<n>\[:IMMEDIATE\]](#) command.

**Usage:** Event

**Manual operation:** See "[Quad Error vs Carrier](#)" on page 41

**CONFigure:BURSt:SPECTrum:FFT[:IMMEDIATE]**

This remote control command configures the result display type of window 2 to be FFT Spectrum.

Results are only displayed after a measurement is executed, e.g. using the [INITiate<n>\[:IMMEDIATE\]](#) command.

**Usage:** Event

**Manual operation:** See "[FFT Spectrum](#)" on page 31

**CONFigure:BURSt:SPECTrum:FLATness:SElect** <MeasType>

This remote control command configures result display type of window 2 to be either Spectrum Flatness or Group Delay.

Results are only displayed after a measurement is executed, e.g. using the [INITiate<n>\[:IMMEDIATE\]](#) command.

**Parameters:****<MeasType>** FLATness | GRDelay**Example:**`CONF:BURSt:SPECtrum:FLAT:SEL FLAT`

Configures the result display of window 2 to be Spectrum Flatness.

`CONF:BURSt:SPECtrum:FLAT:IMM`

Performs a default WLAN measurement. When the measurement is completed, the Spectrum Flatness results are displayed.

**Usage:**

Event

**Manual operation:**See "[Group Delay](#)" on page 34See "[Spectrum Flatness](#)" on page 48**CONFigure:BURSt:SPECtrum:FLATness[:IMMEDIATE]**

This remote control command configures the result display in window 2 to be Spectrum Flatness or Group Delay, depending on which result display was selected last using `CONFigure:BURSt:SPECtrum:FLATness:SElect` on page 188.

Results are only displayed after a measurement is executed, e.g. using the `INITiate<n>[:IMMEDIATE]` command.

**Example:**`CONF:BURSt:SPECtrum:FLAT:SEL FLAT`

Configures the result display of window 2 to be Spectrum Flatness.

`CONF:BURSt:SPECtrum:FLAT:IMM`

Performs a default WLAN measurement. When the measurement is completed, the Spectrum Flatness results are displayed.

**Usage:**

Event

**Manual operation:**See "[Group Delay](#)" on page 34See "[Spectrum Flatness](#)" on page 48**CONFigure:BURSt:STATistics:BSTReam[:IMMEDIATE]**

This remote control command configures the result display type of window 2 to be Bitstream.

Results are only displayed after a measurement is executed, e.g. using the `INITiate<n>[:IMMEDIATE]` command.

**Usage:**

Event

**Manual operation:**See "[Bitstream](#)" on page 24**CONFigure:BURSt:STATistics:SFIeld[:IMMEDIATE]**

This remote control command configures the result display type of window 2 to be Signal Field.

Results are only displayed after a measurement is executed, e.g. using the `INITiate<n>[:IMMEDIATE]` command.

**Usage:** Event

**Manual operation:** See "PLCP Header (IEEE 802.11b, g (DSSS))" on page 37  
See "Signal Field" on page 45

#### **DISPlay[:WINDow<n>]:SElect**

This command sets the focus on the selected result display window.

This window is then the active window.

**Example:** `DISP:WIND1:SEL`  
Sets the window 1 active.

**Usage:** Setting only

### 11.4.2 Selecting a Common RF Measurement for WLAN Signals

The following commands are required to select a common RF measurement for WLAN signals in a remote environment.

For details on available measurements see [Chapter 3.2, "Frequency Sweep Measurements"](#), on page 49.



The selected measurement must be started explicitly (see [Chapter 11.8, "Starting a Measurement"](#), on page 265)!

|   |     |
|---|-----|
| <code>CONFigure:BURSt:SPECTrum:ACPR[:IMMEDIATE]</code> .....    | 190 |
| <code>CONFigure:BURSt:SPECTrum:MASK[:IMMEDIATE]</code> .....    | 190 |
| <code>CONFigure:BURSt:SPECTrum:OBWidth[:IMMEDIATE]</code> ..... | 191 |
| <code>CONFigure:BURSt:STATistics:CCDF[:IMMEDIATE]</code> .....  | 191 |

#### **CONFigure:BURSt:SPECTrum:ACPR[:IMMEDIATE]**

This remote control command configures the result display in window 2 to be ACPR (adjacent channel power relative). Results are only displayed after a measurement is executed, e.g. using the `INITiate<n>[:IMMEDIATE]` command.

**Usage:** Event

**Manual operation:** See "Channel Power ACLR" on page 50

#### **CONFigure:BURSt:SPECTrum:MASK[:IMMEDIATE]**

This remote control command configures the result display in window 2 to be Spectrum Mask. Results are only displayed after a measurement is executed, e.g. using the `INITiate<n>[:IMMEDIATE]` command

Configuring the WLAN IQ Measurement (Modulation Accuracy, Flatness and Tolerance)

**Usage:** Event

**Manual operation:** See "[Spectrum Emission Mask](#)" on page 51

---

#### **CONFigure:BURSt:SPECtrum:OBWidth[:IMMEDIATE]**

This remote control command configures the result display in window 2 to be ACPR (adjacent channel power relative). Results are only displayed after a measurement is executed, e.g. using the `INITiate<n>[:IMMEDIATE]` command.

**Usage:** Event

**Manual operation:** See "[Occupied Bandwidth](#)" on page 52

---

#### **CONFigure:BURSt:STATistics:CCDF[:IMMEDIATE]**

This remote control command configures the result display in window 2 to be CCDF (conditional cumulative distribution function). Results are only displayed after a measurement is executed, e.g. using the `INITiate<n>[:IMMEDIATE]` command.

**Usage:** Event

**Manual operation:** See "[CCDF](#)" on page 53

## 11.5 Configuring the WLAN IQ Measurement (Modulation Accuracy, Flatness and Tolerance)

The following commands are required to configure the WLAN IQ measurement described in [Chapter 3.1, "WLAN I/Q Measurement \(Modulation Accuracy, Flatness and Tolerance\)"](#), on page 12.

- [Signal Description](#)..... 191
- [Configuring the Data Input and Output](#)..... 193
- [Frontend Configuration](#)..... 195
- [Signal Capturing](#).....202
- [Synchronization and OFDM Demodulation](#).....215
- [Tracking and Channel Estimation](#)..... 216
- [Demodulation](#).....220
- [Evaluation Range](#).....234
- [Limits](#).....241
- [Automatic Settings](#)..... 244
- [Configuring the Application Data Range \(MSRA mode only\)](#)..... 245

### 11.5.1 Signal Description

The signal description provides information on the expected input signal.

Useful commands for describing the WLAN signal described elsewhere:

- `[SENSe:]FREQuency:CENTer` on page 196

Configuring the WLAN IQ Measurement (Modulation Accuracy, Flatness and Tolerance)

### Remote commands exclusive to describing the WLAN signal:

|   |     |
|---|-----|
| <a href="#">CONFigure:STANdard</a> .....        | 192 |
| <a href="#">CALCulate:LIMit:TOLerance</a> ..... | 192 |

---

#### CONFigure:STANdard <Standard>

This remote control command specifies which WLAN standard the option is configured to measure.

The availability of many commands depends on the selected standard!

#### Parameters:

|            |          |   |
|------------|----------|---|
| <Standard> | <b>0</b> | IEEE 802.11a  |
|            | <b>1</b> | IEEE 802.11b  |
|            | <b>2</b> | IEEE 802.11j (10 MHz)   |
|            | <b>3</b> | IEEE 802.11j (20 MHz)   |
|            | <b>4</b> | IEEE 802.11g  |
|            |          | To distinguish between OFDM and DSSS use the command <a href="#">[SENSe:]DEMod:FORMat:BANalyze:BTYPe</a> on page 228. |
|            |          | By default, the R&S FPS WLAN application selects the most recently defined PPDU type.                                 |
|            | <b>6</b> | IEEE 802.11n  |
|            | <b>7</b> | IEEE 802.11n (MIMO)   |
|            | <b>8</b> | IEEE 802.11ac   |
|            | <b>9</b> | IEEE 802.11p  |
|            | *RST:    | 0   |

**Example:** Select IEEE 802.11g OFDM standard:  
`CONF:STAN 4`  
`SENS:DEMOD:FORM:BAN:BTYP 'OFDM'`

**Manual operation:** See "[Standard](#)" on page 93

---

#### CALCulate:LIMit:TOLerance <Limit>

This command defines or queries the tolerance limit to be used for the measurement. The required tolerance limit depends on the used standard.



## Configuring the WLAN IQ Measurement (Modulation Accuracy, Flatness and Tolerance)

**Parameters:**

|         |   |
|---------|---|
| <Limit> | PRIOR11_2012   STD11_2012   P11ACD5_1   |
|         | <b>PRIOR11_2012</b><br>Tolerance limits are based on the IEEE 802.11 specification <b>prior to 2012</b> .<br>Default for OFDM standards (except 802.11ac).                              |
|         | <b>STD11_2012</b><br>Tolerance limits are based on the IEEE 802.11 specification from <b>2012</b> .<br>Required for DSSS standards. Also possible for OFDM standards (except 802.11ac). |
|         | <b>P11ACD5_1</b><br>Tolerance limits are based on the <b>IEEE 802.11ac</b> specification.<br>Required by IEEE 802.11ac standard.  |
| *RST:   | STD11_2012  |

**Manual operation:** See "[Tolerance Limit](#)" on page 93

## 11.5.2 Configuring the Data Input and Output

- [RF Input](#)..... 193
- [Configuring the Outputs](#)..... 195

### 11.5.2.1 RF Input

|  |     |
|--|-----|
| <a href="#">INPut:COUPling</a> .....           | 193 |
| <a href="#">INPut:DPATH</a> .....              | 194 |
| <a href="#">INPut:FILTer:YIG[:STATe]</a> ..... | 194 |
| <a href="#">INPut:IMPedance</a> .....          | 194 |
| <a href="#">INPut:SElect</a> .....             | 195 |

---

#### **INPut:COUPling** <CouplingType>

This command selects the coupling type of the RF input.

**Parameters:**

|                |                          |
|----------------|--------------------------|
| <CouplingType> | <b>AC</b><br>AC coupling |
|                | <b>DC</b><br>DC coupling |
| *RST:          | AC                       |

**Example:** INP:COUP DC

**Usage:** SCPI confirmed

**Manual operation:** See "[Input Coupling](#)" on page 95

## Configuring the WLAN IQ Measurement (Modulation Accuracy, Flatness and Tolerance)

**INPut:DPATH** <State>

Enables or disables the use of the direct path for frequencies close to 0 Hz.

**Parameters:**

<State>                   **AUTO | 1**  
 (Default) the direct path is used automatically for frequencies close to 0 Hz.

**OFF | 0**  
 The analog mixer path is always used.

\*RST:                    1

**Example:**               INP:DPAT OFF

**Usage:**                 SCPI confirmed

**INPut:FILTer:YIG[:STATe]** <State>

This command turns the YIG-preselector on and off.

Note the special conditions and restrictions for the YIG filter described in "[YIG-Preselector](#)" on page 95.

**Parameters:**

<State>                   ON | OFF | 0 | 1

\*RST:                    1 (0 for I/Q Analyzer, GSM, VSA, Pulse, Amplifier measurements)

**Example:**               INP:FILT:YIG OFF  
 Deactivates the YIG-preselector.

**Manual operation:**   See "[YIG-Preselector](#)" on page 95

**INPut:IMPedance** <Impedance>

This command selects the nominal input impedance of the RF input. In some applications, only 50 Ω are supported.

75 Ω should be selected if the 50 Ω input impedance is transformed to a higher impedance using a matching pad of the RAZ type (= 25 Ω in series to the input impedance of the instrument). The power loss correction value in this case is 1.76 dB = 10 log (75Ω/50Ω).

**Parameters:**

<Impedance>             50 | 75

\*RST:                    50 Ω

**Example:**               INP:IMP 75

**Usage:**                 SCPI confirmed

**Manual operation:**   See "[Impedance](#)" on page 95

## Configuring the WLAN IQ Measurement (Modulation Accuracy, Flatness and Tolerance)

**INPut:SElect** <Source>

This command selects the signal source for measurements, i.e. it defines which connector is used to input data to the R&S FPS.

If no additional input options are installed, only RF input is supported.

Tip: The I/Q data to be analyzed for WLAN 802.11 can not only be measured by the WLAN application itself, it can also be imported to the application, provided it has the correct format. Furthermore, the analyzed I/Q data from the WLAN application can be exported for further analysis in external applications. See [Chapter 7.1, "Import/Export Functions"](#), on page 157.

**Parameters:**

<Source>                      **RF**  
Radio Frequency ("RF INPUT" connector)  
\*RST:                      RF

**Manual operation:**    See "[Radio Frequency State](#)" on page 95

**11.5.2.2 Configuring the Outputs**

Configuring trigger input/output is described in "[Configuring the Trigger Output](#)" on page 208.

[DIAGnostic:SERVice:NSOource](#)..... 195

**DIAGnostic:SERVice:NSOource** <State>

This command turns the 28 V supply of the BNC connector labeled NOISE SOURCE CONTROL on the R&S FPS on and off.

For details see [Chapter 4.7.1, "Input from Noise Sources"](#), on page 80.

**Parameters:**

<State>                      ON | OFF  
\*RST:                      OFF

**Example:**                      DIAG:SERV:NSO ON

**Manual operation:**    See "[Noise Source](#)" on page 96

**11.5.3 Frontend Configuration**

The following commands configure frequency, amplitude and y-axis scaling settings, which represent the "frontend" of the measurement setup.

- [Frequency](#)..... 196
- [Amplitude Settings](#)..... 197

### 11.5.3.1 Frequency

|   |     |
|---|-----|
| [SENSe:]FREQUENCY:CENTer.....           | 196 |
| [SENSe:]FREQUENCY:CENTer:STEP.....      | 196 |
| [SENSe:]FREQUENCY:CENTer:STEP:AUTO..... | 197 |
| [SENSe:]FREQUENCY:OFFSet.....           | 197 |

---

#### [SENSe:]FREQUENCY:CENTer <Frequency>

This command defines the center frequency.

##### Parameters:

<Frequency> The allowed range and  $f_{\max}$  is specified in the data sheet.

##### UP

Increases the center frequency by the step defined using the [SENSe:]FREQUENCY:CENTer:STEP command.

##### DOWN

Decreases the center frequency by the step defined using the [SENSe:]FREQUENCY:CENTer:STEP command.

\*RST:  $f_{\max}/2$

Default unit: Hz

##### Example:

```
FREQ:CENT 100 MHz
FREQ:CENT:STEP 10 MHz
FREQ:CENT UP
Sets the center frequency to 110 MHz.
```

**Usage:** SCPI confirmed

**Manual operation:** See "Frequency" on page 93  
See "Center frequency" on page 98

---

#### [SENSe:]FREQUENCY:CENTer:STEP <StepSize>

This command defines the center frequency step size.

You can increase or decrease the center frequency quickly in fixed steps using the SENS:FREQ UP AND SENS:FREQ DOWN commands, see [SENSe:]FREQUENCY:CENTer on page 196.

##### Parameters:

<StepSize>  $f_{\max}$  is specified in the data sheet.

Range: 1 to  $f_{\max}$

\*RST: 0.1 x span

Default unit: Hz

##### Example:

```
FREQ:CENT 100 MHz
FREQ:CENT:STEP 10 MHz
FREQ:CENT UP
Sets the center frequency to 110 MHz.
```

**Manual operation:** See "Center Frequency Stepsize" on page 98

## Configuring the WLAN IQ Measurement (Modulation Accuracy, Flatness and Tolerance)

**[SENSe:]FREQuency:CENTer:STEP:AUTO <State>**

This command couples or decouples the center frequency step size to the span.

In time domain (zero span) measurements, the center frequency is coupled to the RBW.

**Parameters:**

<State> ON | OFF | 0 | 1  
\*RST: 1

**Example:**

FREQ:CENT:STEP:AUTO ON  
Activates the coupling of the step size to the span.

**[SENSe:]FREQuency:OFFSet <Offset>**

This command defines a frequency offset.

If this value is not 0 Hz, the application assumes that the input signal was frequency shifted outside the application. All results of type "frequency" will be corrected for this shift numerically by the application.

See also "[Frequency Offset](#)" on page 99.

**Note:** In MSRA mode, the setting command is only available for the MSRA Master. For MSRA applications, only the query command is available.

**Parameters:**

<Offset> Range: -100 GHz to 100 GHz  
\*RST: 0 Hz

**Example:**

FREQ:OFFS 1GHZ

**Usage:** SCPI confirmed

**Manual operation:** See "[Frequency Offset](#)" on page 99

**11.5.3.2 Amplitude Settings**

The following commands are required to configure the amplitude settings in a remote environment.

Useful commands for amplitude settings described elsewhere:

- [INPut:COUPling](#) on page 193
- [INPut:IMPedance](#) on page 194
- [\[SENSe:\]ADJust:LEVel](#) on page 244

**Remote commands exclusive to amplitude settings:**

|   |     |
|---|-----|
| <a href="#">CALCulate&lt;n&gt;:UNIT:POWer</a> .....                             | 198 |
| <a href="#">CONFigure:POWer:AUTO</a> .....                                      | 198 |
| <a href="#">CONFigure:POWer:AUTO:SWEp:TIME</a> .....                            | 198 |
| <a href="#">CONFigure:POWer:EXPEcted:RF</a> .....                               | 199 |
| <a href="#">DISPlay[:WINDow&lt;n&gt;]:TRACe&lt;t&gt;:Y[:SCALE]:RLEVel</a> ..... | 199 |

Configuring the WLAN IQ Measurement (Modulation Accuracy, Flatness and Tolerance)

|   |     |
|---|-----|
| DISPlay[:WINDow<n>]:TRACe<t>:Y[:SCALe]:RLEVel:OFFSet..... | 199 |
| INPut:ATTenuation.....                                    | 199 |
| INPut:ATTenuation:AUTO.....                               | 200 |
| INPut:EATT.....   | 200 |
| INPut:EATT:AUTO.....                                      | 200 |
| INPut:EATT:STATe.....                                     | 201 |
| INPut:GAIN:STATe.....                                     | 201 |

---

### CALCulate<n>:UNIT:POWer <Unit>

This command selects the unit of the y-axis.

The unit applies to all power-based measurement windows (regardless of the <n> suffix).

#### Parameters:

<Unit>                    \*RST:        dBm

#### Example:

CALC:UNIT:POW DBM  
Sets the power unit to dBm.

**Manual operation:** See "Unit" on page 101

---

### CONFigure:POWer:AUTO <Mode>

This command is used to switch on or off automatic power level detection.

#### Parameters for setting and query:

<Mode>                    **ON**  
Automatic power level detection is performed at the start of each measurement sweep, and the reference level is adapted accordingly.

**OFF**  
The reference level must be defined manually (see [DISPlay\[:WINDow<n>\]:TRACe<t>:Y\[:SCALe\]:RLEVel](#) on page 199)

**ONCE**  
Automatic power level detection is performed once at the start of the next measurement sweep, and the reference level is adapted accordingly.

\*RST:                    ON

**Manual operation:** See "Reference Level Mode" on page 100  
See "Setting the Reference Level Automatically (Auto Level)" on page 102

---

### CONFigure:POWer:AUTO:SWEep:TIME <Value>

This command is used to specify the auto track time, i.e. the sweep time for auto level detection.

This setting can currently only be defined in remote control, not in manual operation.

## Configuring the WLAN IQ Measurement (Modulation Accuracy, Flatness and Tolerance)

**Parameters for setting and query:**

<Value>                    numeric value  
                               Auto level measurement sweep time  
                               Range:        0.01 to 1  
                               \*RST:        0.1 s  
                               Default unit: S

**Example:**                    `CONF:POW:AUTO:SWE:TIME 0.01 MS`

**CONFigure:POWer:EXPeCted:RF <Value>**

This command specifies the mean power level of the source signal as supplied to the instrument's RF input. This value is overwritten if "Auto Level" mode is turned on.

**Parameters:**

<Value>                    Default unit: DBM

**Manual operation:**    See "[Signal Level \(RMS\)](#)" on page 101

**DISPlay[:WINDow<n>]:TRACe<t>:Y[:SCALe]:RLEVel <ReferenceLevel>**

This command defines the reference level (for all traces, <t> is irrelevant).

**Example:**                    `DISP:TRAC:Y:RLEV -60dBm`

**Usage:**                    SCPI confirmed

**Manual operation:**    See "[Reference Level](#)" on page 101

**DISPlay[:WINDow<n>]:TRACe<t>:Y[:SCALe]:RLEVel:OFFSet <Offset>**

This command defines a reference level offset (for all traces, <t> is irrelevant).

**Parameters:**

<Offset>                    Range:        -200 dB to 200 dB  
                               \*RST:        0dB

**Example:**                    `DISP:TRAC:Y:RLEV:OFFS -10dB`

**Manual operation:**    See "[Shifting the Display \(Offset\)](#)" on page 101

**INPut:ATTenuation <Attenuation>**

This command defines the total attenuation for RF input.

If an electronic attenuator is available and active, the command defines a mechanical attenuation (see [INPut:EATT:STATe](#) on page 201).

If you set the attenuation manually, it is no longer coupled to the reference level, but the reference level is coupled to the attenuation. Thus, if the current reference level is not compatible with an attenuation that has been set manually, the command also adjusts the reference level.

## Configuring the WLAN IQ Measurement (Modulation Accuracy, Flatness and Tolerance)

**Parameters:**

<Attenuation>            Range:     see data sheet  
                               Increment:  5 dB  
                               \*RST:     10 dB (AUTO is set to ON)

**Example:**

INP:ATT 30dB  
 Defines a 30 dB attenuation and decouples the attenuation from the reference level.

**Usage:**

SCPI confirmed

**Manual operation:** See "[Attenuation Mode / Value](#)" on page 102

**INPut:ATTenuation:AUTO <State>**

This command couples or decouples the attenuation to the reference level. Thus, when the reference level is changed, the R&S FPS determines the signal level for optimal internal data processing and sets the required attenuation accordingly.

**Parameters:**

<State>                    ON | OFF | 0 | 1  
                               \*RST:     1

**Example:**

INP:ATT:AUTO ON  
 Couples the attenuation to the reference level.

**Usage:**

SCPI confirmed

**Manual operation:** See "[Attenuation Mode / Value](#)" on page 102

**INPut:EATT <Attenuation>**

This command defines an electronic attenuation manually. Automatic mode must be switched off (INP:EATT:AUTO OFF, see [INPut:EATT:AUTO](#) on page 200).

If the current reference level is not compatible with an attenuation that has been set manually, the command also adjusts the reference level.

This command requires the electronic attenuation hardware option.

**Parameters:**

<Attenuation>            attenuation in dB  
                               Range:     see data sheet  
                               Increment:  1 dB  
                               \*RST:     0 dB (OFF)

**Example:**

INP:EATT:AUTO OFF  
 INP:EATT 10 dB

**Manual operation:** See "[Using Electronic Attenuation](#)" on page 102

**INPut:EATT:AUTO <State>**

This command turns automatic selection of the electronic attenuation on and off.



## Configuring the WLAN IQ Measurement (Modulation Accuracy, Flatness and Tolerance)

If on, electronic attenuation reduces the mechanical attenuation whenever possible.

This command requires the electronic attenuation hardware option.

**Parameters:**

<State>            1 | 0 | ON | OFF  
                       **1 | ON**  
                       **0 | OFF**  
 \*RST:            1

**Example:**            INP:EATT:AUTO OFF

**Manual operation:** See "[Using Electronic Attenuation](#)" on page 102

**INPut:EATT:STATe** <State>

This command turns the electronic attenuator on and off.

This command requires the electronic attenuation hardware option.

**Parameters:**

<State>            1 | 0 | ON | OFF  
                       **1 | ON**  
                       **0 | OFF**  
 \*RST:            0

**Example:**            INP:EATT:STAT ON  
 Switches the electronic attenuator into the signal path.

**Manual operation:** See "[Using Electronic Attenuation](#)" on page 102

**INPut:GAIN:STATe** <State>

This command turns the preamplifier on and off.

If activated, the input signal is amplified by 20 dB.

If option R&S FPS-B22 is installed, the preamplifier is only active below 7 GHz.

If option R&S FPS-B24 is installed, the preamplifier is active for all frequencies.

**Parameters:**

<State>            ON | OFF  
 \*RST:            OFF

**Example:**            INP:GAIN:STAT ON  
 Switches on 20 dB preamplification.

**Usage:**            SCPI confirmed

**Manual operation:** See "[Preamplifier \(option B22/B24\)](#)" on page 103

## 11.5.4 Signal Capturing

The following commands are required to configure how much and how data is captured from the input signal.



### MSRA operating mode

In MSRA operating mode, only the MSRA Master channel actually captures data from the input signal. The data acquisition settings for the R&S FPS WLAN application in MSRA mode define the **application data extract**.

For details on the MSRA operating mode see the R&S FPS MSRA User Manual.

- [General Capture Settings](#).....202
- [Configuring Triggered Measurements](#).....203
- [MIMO Capture Settings](#).....210

### 11.5.4.1 General Capture Settings

|   |     |
|---|-----|
| <a href="#">[SENSe:]BANDwidth[:RESolution]:FILTer[:STATe]</a> ..... | 202 |
| <a href="#">[SENSe:]SWAPiq</a> .....                                | 202 |
| <a href="#">[SENSe:]SWEep:TIME</a> .....                            | 203 |
| <a href="#">TRACe:IQ:SRATe</a> .....                                | 203 |

#### **[SENSe:]BANDwidth[:RESolution]:FILTer[:STATe] <State>**

This remote control command enables or disables use of the adjacent channel filter.

If activated, only the useful signal is analyzed, all signal data in adjacent channels is removed by the filter. This setting improves the signal to noise ratio and thus the EVM results for signals with strong or a large number of adjacent channels. However, for some measurements information on the effects of adjacent channels on the measured signal may be of interest.

#### **Parameters:**

<State>                    ON | OFF | 0 | 1  
 \*RST:                    1

**Manual operation:** See "[Suppressing \(Filter out\) Adjacent Channels \(IEEE 802.11a, g \(OFDM\), ac, j, n, p\)](#)" on page 105

#### **[SENSe:]SWAPiq <State>**

This command defines whether or not the recorded I/Q pairs should be swapped (I<->Q) before being processed. Swapping I and Q inverts the sideband.

This is useful if the DUT interchanged the I and Q parts of the signal; then the R&S FPS can do the same to compensate for it.

## Configuring the WLAN IQ Measurement (Modulation Accuracy, Flatness and Tolerance)

**Parameters:**

<State>                   **ON**  
 I and Q signals are interchanged  
 Inverted sideband,  $Q+j*I$

**OFF**  
 I and Q signals are not interchanged  
 Normal sideband,  $I+j*Q$

\*RST:           OFF

**Manual operation:** See "[Swap I/Q](#)" on page 105

**[SENSe:]SWEep:TIME <Time>**

This command defines the measurement time.

**Parameters:**

<Time>                   refer to data sheet

\*RST:           depends on current settings (determined automatically)

**Example:**           SWE:TIME 10s

**Usage:**               SCPI confirmed

**Manual operation:** See "[Capture Time](#)" on page 104

**TRACe:IQ:SRATe <SampleRate>**

This command sets the final user sample rate for the acquired I/Q data. Thus, the user sample rate can be modified without affecting the actual data capturing settings on the R&S FPS.

**Parameters:**

<SampleRate>           The valid sample rates are described in [Chapter A.1, "Sample Rate and Maximum Usable I/Q Bandwidth for RF Input"](#), on page 317.

\*RST:           32 MHz

**Manual operation:** See "[Input Sample Rate](#)" on page 104

**11.5.4.2 Configuring Triggered Measurements**

The following commands are required to configure a triggered measurement in a remote environment. The tasks for manual operation are described in [Chapter 5.3.4.2, "Trigger Settings"](#), on page 105.



The \*OPC command should be used after commands that retrieve data so that subsequent commands to change the selected trigger source are held off until after the sweep is completed and the data has been returned.

- [Configuring the Triggering Conditions](#).....204
- [Configuring the Trigger Output](#).....208

### Configuring the Triggering Conditions

The following commands are required to configure a triggered measurement.

|   |     |
|---|-----|
| <a href="#">TRIGger[:SEQuence]:DTIME</a> .....                        | 204 |
| <a href="#">TRIGger[:SEQuence]:HOLDoff[:TIME]</a> .....               | 204 |
| <a href="#">TRIGger[:SEQuence]:IFPower:HOLDoff</a> .....              | 204 |
| <a href="#">TRIGger[:SEQuence]:IFPower:HYSteresis</a> .....           | 205 |
| <a href="#">TRIGger[:SEQuence]:LEVel[:EXternal&lt;port&gt;]</a> ..... | 205 |
| <a href="#">TRIGger[:SEQuence]:LEVel:IFPower</a> .....                | 206 |
| <a href="#">TRIGger[:SEQuence]:LEVel:IQPower</a> .....                | 206 |
| <a href="#">TRIGger:SEQuence:LEVel:POWer:AUTO</a> .....               | 206 |
| <a href="#">TRIGger[:SEQuence]:LEVel:RFPower</a> .....                | 207 |
| <a href="#">TRIGger[:SEQuence]:SLOPe</a> .....                        | 207 |
| <a href="#">TRIGger[:SEQuence]:SOURce</a> .....                       | 207 |

#### TRIGger[:SEQuence]:DTIME <DropoutTime>

Defines the time the input signal must stay below the trigger level before a trigger is detected again.

##### Parameters:

<DropoutTime> Dropout time of the trigger.  
 Range: 0 s to 10.0 s  
 \*RST: 0 s

**Manual operation:** See "[Drop-Out Time](#)" on page 108

#### TRIGger[:SEQuence]:HOLDoff[:TIME] <Offset>

Defines the time offset between the trigger event and the start of the measurement.

##### Parameters:

<Offset> \*RST: 0 s

**Example:** TRIG:HOLD 500us

**Manual operation:** See "[Trigger Offset](#)" on page 108

#### TRIGger[:SEQuence]:IFPower:HOLDoff <Period>

This command defines the holding time before the next trigger event.

Note that this command can be used for **any trigger source**, not just IF Power (despite the legacy keyword).

## Configuring the WLAN IQ Measurement (Modulation Accuracy, Flatness and Tolerance)

**Parameters:**

<Period>                   Range:     0 s to 10 s  
                               \*RST:     0 s

**Example:**

TRIG:SOUR EXT  
 Sets an external trigger source.  
 TRIG:IFP:HOLD 200 ns  
 Sets the holding time to 200 ns.

**Manual operation:** See "[Trigger Holdoff](#)" on page 109

**TRIGger[:SEQuence]:IFPower:HYSTeresis <Hysteresis>**

This command defines the trigger hysteresis, which is only available for "IF Power" trigger sources.

**Parameters:**

<Hysteresis>               Range:     3 dB to 50 dB  
                               \*RST:     3 dB

**Example:**

TRIG:SOUR IFP  
 Sets the IF power trigger source.  
 TRIG:IFP:HYST 10DB  
 Sets the hysteresis limit value.

**Manual operation:** See "[Hysteresis](#)" on page 109

**TRIGger[:SEQuence]:LEVel[:EXTernal<port>] <TriggerLevel>**

This command defines the level the external signal must exceed to cause a trigger event.

Note that the variable INPUT/OUTPUT connectors (ports 2+3) must be set for use as input using the [OUTPut:TRIGger<port>:DIRection](#) command.

For details on the trigger source see "[Trigger Source Settings](#)" on page 106.

**Suffix:**

<port>                      Selects the trigger port.  
                               1 = trigger port 1 (TRIG IN connector on rear panel)  
                               2 = trigger port 2 (TRIG AUX connector on rear panel)

**Parameters:**

<TriggerLevel>             Range:     0.5 V to 3.5 V  
                               \*RST:     1.4 V

**Example:**

TRIG:LEV 2V

**Manual operation:** See "[Trigger Level](#)" on page 108

## Configuring the WLAN IQ Measurement (Modulation Accuracy, Flatness and Tolerance)

**TRIGger[:SEQuence]:LEVel:IFPower** <TriggerLevel>

This command defines the power level at the third intermediate frequency that must be exceeded to cause a trigger event. Note that any RF attenuation or preamplification is considered when the trigger level is analyzed. If defined, a reference level offset is also considered.

For details on the trigger settings see ["Trigger Source Settings"](#) on page 106.

**Parameters:**

<TriggerLevel> For details on available trigger levels and trigger bandwidths see the data sheet.

\*RST: -10 dBm

**Example:**

TRIG:LEV:IFP -30DBM

**Manual operation:** See ["Trigger Level"](#) on page 108

**TRIGger[:SEQuence]:LEVel:IQPower** <TriggerLevel>

This command defines the magnitude the I/Q data must exceed to cause a trigger event. Note that any RF attenuation or preamplification is considered when the trigger level is analyzed.

For details on the trigger source see ["Trigger Source Settings"](#) on page 106.

**Parameters:**

<TriggerLevel> Range: -130 dBm to 30 dBm

\*RST: -20 dBm

**Example:**

TRIG:LEV:IQP -30DBM

**Manual operation:** See ["Trigger Level"](#) on page 108

**TRIGger:SEQuence:LEVel:POWer:AUTO** <State>

By default, the optimum trigger level for power triggers is automatically measured and determined at the start of each sweep (for Modulation Accuracy, Flatness, Tolerance... measurements).

This function is only considered for TRIG:SEQ:SOUR IFP and TRIG:SEQ:SOUR RFP, see [TRIGger\[:SEQuence\]:SOURce](#) on page 207

In order to define the trigger level manually, switch this function off and define the level using [TRIGger\[:SEQuence\]:LEVel:IFPower](#) on page 206 or [TRIGger\[:SEQuence\]:LEVel:RFPower](#) on page 207.

**Parameters for setting and query:**

<State>

**OFF**

Switches the auto level detection function off

**ON**

Switches the auto level detection function on

\*RST: ON

## Configuring the WLAN IQ Measurement (Modulation Accuracy, Flatness and Tolerance)

**Manual operation:** See ["Trigger Level Mode"](#) on page 108

---

**TRIGger[:SEQuence]:LEVel:RFPower** <TriggerLevel>

This command defines the power level the RF input must exceed to cause a trigger event. Note that any RF attenuation or preamplification is considered when the trigger level is analyzed. If defined, a reference level offset is also considered.

The input signal must be between 500 MHz and 8 GHz.

For details on the trigger source see ["Trigger Source Settings"](#) on page 106.

**Parameters:**

<TriggerLevel> For details on available trigger levels and trigger bandwidths see the data sheet.

\*RST: -20 dBm

**Example:** TRIG:LEV:RFP -30dBm

**Manual operation:** See ["Trigger Level"](#) on page 108

---

**TRIGger[:SEQuence]:SLOPe** <Type>

For external and time domain trigger sources you can define whether triggering occurs when the signal rises to the trigger level or falls down to it.

**Parameters:**

<Type> POSitive | NEGative

**POSitive**

Triggers when the signal rises to the trigger level (rising edge).

**NEGative**

Triggers when the signal drops to the trigger level (falling edge).

\*RST: POSitive

**Example:** TRIG:SLOP NEG

**Manual operation:** See ["Slope"](#) on page 109

---

**TRIGger[:SEQuence]:SOURce** <Source>

This command selects the trigger source.

For details on the available trigger sources see ["Trigger Source Settings"](#) on page 106.

**Note on external triggers:**

If a measurement is configured to wait for an external trigger signal in a remote control program, remote control is blocked until the trigger is received and the program can continue. Make sure this situation is avoided in your remote control programs.

## Configuring the WLAN IQ Measurement (Modulation Accuracy, Flatness and Tolerance)

**Parameters:**

|          |  |
|----------|--|
| <Source> | <b>IMMediate</b><br>Free Run   |
|          | <b>EXTernal</b><br>Trigger signal from the TRIGGER IN connector.   |
|          | <b>EXT2</b><br>Trigger signal from the TRIGGER AUX connector.  |
|          | <b>RFPower</b><br>First intermediate frequency   |
|          | <b>IFPower</b><br>Second intermediate frequency  |
|          | <b>IQPower</b><br>Magnitude of sampled I/Q data<br>For applications that process I/Q data, such as the I/Q Analyzer<br>or optional applications. |
|          | *RST: IMMediate  |

**Example:**

TRIG:SOUR EXT  
Selects the external trigger input as source of the trigger signal

**Manual operation:**

See "Trigger Source" on page 106  
See "Free Run" on page 107  
See "External Trigger 1/2" on page 107  
See "RF Power" on page 107  
See "I/Q Power" on page 107  
See "Time" on page 108  
See "FS-Z11 Trigger" on page 109

**Configuring the Trigger Output**

The following commands are required to send the trigger signal to one of the variable TRIGGER INPUT/OUTPUT connectors on the R&S FPS.

|   |     |
|---|-----|
| OUTPut:TRIGger<port>:DIRection.....       | 208 |
| OUTPut:TRIGger<port>:LEVel.....           | 209 |
| OUTPut:TRIGger<port>:OTYPe.....           | 209 |
| OUTPut:TRIGger<port>:PULSe:IMMediate..... | 210 |
| OUTPut:TRIGger<port>:PULSe:LENGth.....    | 210 |

**OUTPut:TRIGger<port>:DIRection <Direction>**

This command selects the trigger direction for trigger ports that serve as an input as well as an output.

**Suffix:**

<port> Selects the used trigger port.  
2 = TRG AUX



## Configuring the WLAN IQ Measurement (Modulation Accuracy, Flatness and Tolerance)

**Parameters:**

<Direction>           **INPut**  
Port works as an input.

**OUTPut**  
Port works as an output.

\*RST:           INPut

**Manual operation:** See "[Trigger 2](#)" on page 97

**OUTPut:TRIGger<port>:LEVel <Level>**

This command defines the level of the signal generated at the trigger output.

This command works only if you have selected a user defined output with [OUTPut:TRIGger<port>:OTYPe](#).

**Suffix:**

<port>               Selects the trigger port to which the output is sent.  
2 = TRG AUX

**Parameters:**

<Level>             **HIGH**  
TTL signal.

**LOW**  
0 V

\*RST:           LOW

**Manual operation:** See "[Trigger 2](#)" on page 97  
See "[Level](#)" on page 97

**OUTPut:TRIGger<port>:OTYPe <OutputType>**

This command selects the type of signal generated at the trigger output.

**Suffix:**

<port>               Selects the trigger port to which the output is sent.  
2 = TRG AUX

**Parameters:**

<OutputType>       **DEVice**  
Sends a trigger signal when the R&S FPS has triggered internally.

**TARMed**  
Sends a trigger signal when the trigger is armed and ready for an external trigger event.

**UDEFineD**  
Sends a user defined trigger signal. For more information see [OUTPut:TRIGger<port>:LEVel](#).

\*RST:           DEVice

**Manual operation:** See "[Output Type](#)" on page 97

Configuring the WLAN IQ Measurement (Modulation Accuracy, Flatness and Tolerance)

---

### OUTPut:TRIGger<port>:PULSe:IMMediate

This command generates a pulse at the trigger output.

#### Suffix:

<port>                      Selects the trigger port to which the output is sent.  
2 = TRG AUX

**Usage:**                      Event

**Manual operation:**    See "Send Trigger" on page 98

---

### OUTPut:TRIGger<port>:PULSe:LENGth <Length>

This command defines the length of the pulse generated at the trigger output.

#### Suffix:

<port>                      Selects the trigger port to which the output is sent.  
2 = TRG AUX

#### Parameters:

<Length>                    Pulse length in seconds.

**Manual operation:**    See "Pulse Length" on page 97

#### 11.5.4.3 MIMO Capture Settings

The following commands are **only available for IEEE 802.11ac, n standards**.

Useful commands for defining MIMO capture settings described elsewhere:

- `CALCulate<n>:BURSt[:IMMediate]` on page 266

#### Remote commands exclusive to defining MIMO capture settings:

|  |     |
|--|-----|
| <code>CONFigure:WLAN:ANTMatrix:ADDRess&lt;add&gt;</code> .....           | 210 |
| <code>CONFigure:WLAN:ANTMatrix:ANTenna&lt;Analyzer&gt;</code> .....      | 211 |
| <code>CONFigure:WLAN:ANTMatrix:RLEVel&lt;antenna&gt;:OFFSet</code> ..... | 211 |
| <code>CONFigure:WLAN:ANTMatrix:SOURce:AMPLitude:SOURce</code> .....      | 211 |
| <code>CONFigure:WLAN:ANTMatrix:SOURce:RLEVel:OFFSet</code> .....         | 212 |
| <code>CONFigure:WLAN:ANTMatrix:SOURce:ROSCillator:SOURce</code> .....    | 213 |
| <code>CONFigure:WLAN:ANTMatrix:STATe&lt;antenna&gt;</code> .....         | 213 |
| <code>CONFigure:WLAN:DUTConfig</code> .....                              | 213 |
| <code>CONFigure:WLAN:MIMO:CAPTure</code> .....                           | 214 |
| <code>CONFigure:WLAN:MIMO:CAPTure:BUFFer</code> .....                    | 214 |
| <code>CONFigure:WLAN:MIMO:CAPTure:TYPE</code> .....                      | 214 |
| <code>CONFigure:WLAN:MIMO:OSP:ADDRess</code> .....                       | 215 |
| <code>CONFigure:WLAN:MIMO:OSP:MODule</code> .....                        | 215 |
| <code>CONFigure:WLAN:RSYNc:JOINed</code> .....                           | 215 |

---

### CONFigure:WLAN:ANTMatrix:ADDRess<add> <Address>

This remote control command specifies the TCP/IP address for each receiver path in IPV4 format. Note, it is not possible to set the IP address of ANTMATRIX1 (Master)

## Configuring the WLAN IQ Measurement (Modulation Accuracy, Flatness and Tolerance)

**Parameters:**

<Address> TCP/IP address in IPV4 format

**Manual operation:** See ["Analyzer IP Address"](#) on page 113

**CONFigure:WLAN:ANTMatrix:ANTenna<Analyzer> <Antenna>**

This remote control command specifies the antenna assignment of the receive path.

**Parameters:**

<Antenna> ANTenna1 | ANTenna2 | ANTenna3 | ANTenna4  
Antenna assignment of the receiver path

**Example:**

```
CONF:WLAN:ANTM:ANT2 ANT1
Analyzer number 2 measures antenna no. 1
CONF:WLAN:ANTM;ANT4 ANT2
Analyzer number 42 measures antenna no. 2
```

**Manual operation:** See ["Assignment"](#) on page 113

**CONFigure:WLAN:ANTMatrix:RLEVel<antenna>:OFFSet <OffLevel>**

This remote control command determines whether the reference value offset for the specified antenna if the master and slave devices in a simultaneous MIMO setup are not coupled (see [CONFigure:WLAN:ANTMatrix:SOURce:RLEVel:OFFSet](#) on page 212).

**Suffix:**

<antenna> 1..8  
antenna index as specified by [CONFigure:WLAN:ANTMatrix:STATE<antenna>](#) on page 213

**Parameters:**

<OffLevel> level offset in dB  
\*RST: 0

**Example:**

```
CONF:WLAN:ANTM:SOUR:RLEV:OFFS MAN
CONF:WLAN:ANTM:RLEV2:OFFS 10
Sets the reference level offset for the second antenna in the
antenna matrix to 10 dB.
```

**Manual operation:** See ["Reference Level Offset"](#) on page 113

**CONFigure:WLAN:ANTMatrix:SOURce:AMPLitude:SOURce <Coupling>**

This remote control command determines whether the amplitude settings for the master and slave devices in a simultaneous MIMO setup are coupled or not.

## Configuring the WLAN IQ Measurement (Modulation Accuracy, Flatness and Tolerance)

**Parameters:**

&lt;Coupling&gt;

Coupling mode

**AUTO**

The slave devices perform an auto-level at the same time as the master. The amplitude settings are then determined automatically by each device according to the measured values. This feature requires that the WLAN 802.11 application R&S FPS-K91 (version 1.31 or higher) is installed on the slave device.

**MASTer**

Both the master and all slaves use the same amplitude settings, according to the settings at the master. All settings on the slave are ignored (including "Reference Level Auto").

Note: if "Reference Level Auto" is set at the master, the master channel performs an auto-level measurement and the resulting amplitude settings are transferred to the slaves.

**OFF**

Both the master and slave devices use their own amplitude settings as defined prior to the measurement; the settings are not coupled.

\*RST: MASTer

**Example:**

CONF:WLAN:ANTM:SOUR:AMPL:SOUR AUTO

**Manual operation:** See ["Amplitude Settings Coupling"](#) on page 114**CONFigure:WLAN:ANTMatrix:SOURce:RLEVel:OFFSet** <Coupling>

This remote control command determines whether the reference level for the master and slave devices in a simultaneous MIMO setup are coupled or not.

**Parameters:**

&lt;Coupling&gt;

Coupling mode

**MASTer**

The slave analyzers' reference levels are set to match that of the master.

**MANual**

The slave analyzers' reference levels are specified individually (see [CONFigure:WLAN:ANTMatrix:RLEVel<antenna>:OFFSet](#) on page 211) and are not coupled to the reference level offset of the master analyzer.

\*RST: MASTer

**Example:**

CONF:WLAN:ANTM:SOUR:RLEV:OFFS MAN

CONF:WLAN:ANTM:RLEV2:OFFS 10

Sets the reference level offset for the second antenna in the antenna matrix to 10 dB.

**Manual operation:** See ["Reference Level Offset"](#) on page 113

## Configuring the WLAN IQ Measurement (Modulation Accuracy, Flatness and Tolerance)

**CONFigure:WLAN:ANTMatrix:SOURce:ROSCillator:SOURce** <Coupling>

This remote control command determines whether the reference frequency for the master and slave devices in a simultaneous MIMO setup are coupled or not.

**Parameters:**

|            |   |
|------------|---|
| <Coupling> | Coupling mode   |
|            | <b>AUTO</b>   |
|            | Slaves set to the same external reference source as master. Use an R&S Z11 trigger box to send to the same trigger to all devices (see <a href="#">TRIG:SEQ:SOUR TUN</a> ). |
|            | <b>EXternal</b>   |
|            | Slaves' reference source is set to external. Configure a trigger output from the master (see <a href="#">OUTPut:TRIGger&lt;port&gt;:OTYPe</a> on page 209).                 |
|            | <b>OFF</b>  |
|            | Slaves' reference source is set to internal.  |
|            | *RST: EXT   |

**Example:** CONF:WLAN:ANTM:SOUR:ROSC:SOUR AUTO

**Manual operation:** See "[Reference Frequency Coupling](#)" on page 114

**CONFigure:WLAN:ANTMatrix:STATe<antenna>** <State>

This remote control command specifies the state of the specified antenna. Note, it is not possible to change the state of the first antenna (Master).

**Parameters:**

|         |                      |
|---------|----------------------|
| <State> | ON   OFF             |
|         | State of the antenna |

**Manual operation:** See "[State](#)" on page 113

**CONFigure:WLAN:DUTConfig** <NoOfAnt>

This remote control command specifies the number of antennas used for MIMO measurement.

**Parameters:**

|           |   |
|-----------|---|
| <NoOfAnt> | TX1   TX2   TX3   TX4   TX5   TX6   TX7   TX8 |
|           | TX1: one antenna,<br>TX2: two antennas etc.   |
|           | *RST: TX1                                     |

**Example:** CONF:WLAN:DUTC TX1

**Manual operation:** See "[DUT MIMO Configuration](#)" on page 112

## Configuring the WLAN IQ Measurement (Modulation Accuracy, Flatness and Tolerance)

**CONFigure:WLAN:MIMO:CAPTURE** <SignalPath>

Specifies the signal path to be captured in MIMO sequential manual measurements. Subsequently, use the `INITiate<n>[:IMMEDIATE]` command to start capturing data.

**Parameters:**

<SignalPath> RX1 | RX2 | RX3 | RX4 | RX5 | RX6 | RX7 | RX8  
 For details see "[Manual Sequential MIMO Data Capture](#)" on page 116.  
 \*RST: RX1

**Example:**

```
CONFigure:WLAN:MIMO:CAPTURE RX2
INIT:IMM
Starts capturing data from the receive antenna number 2.
```

**Manual operation:** See "[Single / Cont.](#)" on page 117

**CONFigure:WLAN:MIMO:CAPTURE:BUFFER** <SignalPath>

Specifies the signal path to be captured in MIMO sequential manual measurements and immediately starts capturing data.

**Parameters:**

<SignalPath> RX1 | RX2 | RX3 | RX4 | RX5 | RX6 | RX7 | RX8  
 For details see "[Manual Sequential MIMO Data Capture](#)" on page 116.  
 \*RST: RX1

**Example:**

```
CONFigure:WLAN:MIMO:CAPTURE:BUFFER RX2
Starts capturing data from the receive antenna number 2.
```

**CONFigure:WLAN:MIMO:CAPTURE:TYPE** <Method>

Specifies the method used to analyze MIMO signals.

**Parameters:**

<Method> SIMultaneous | OSP | MANual  
**SIMultaneous**  
 Simultaneous normal MIMO operation  
**OSP**  
 Sequential using open switch platform  
**MANual**  
 Sequential using manual operation  
 \*RST: SIM

**Manual operation:** See "[MIMO Antenna Signal Capture Setup](#)" on page 112  
 See "[Manual Sequential MIMO Data Capture](#)" on page 116

## Configuring the WLAN IQ Measurement (Modulation Accuracy, Flatness and Tolerance)

**CONFigure:WLAN:MIMO:OSP:ADDRes** <Address>

Specifies the TCP/IP address of the switch unit to be used for automated sequential MIMO measurements. The supported unit is Rohde & Schwarz OSP 1505.3009.03 with module option 1505.5101.02

**Parameters:**

<Address>

**Manual operation:** See ["OSP IP Address"](#) on page 115

**CONFigure:WLAN:MIMO:OSP:MODule** <ID>

Specifies the module of the switch unit to be used for automated sequential MIMO measurements. The supported unit is Rohde & Schwarz OSP 1505.3009.03 with module option 1505.5101.02

**Parameters:**

<ID> A11 | A12 | A13

**Manual operation:** See ["OSP Switch Bank Configuration"](#) on page 116

**CONFigure:WLAN:RSYNc:JOINed** <State>

This command configures how PPDU synchronization and tracking is performed for multiple antennas.

**Parameters:**

<State> ON | OFF

**ON**  
RX antennas are synchronized and tracked together.

**OFF**  
RX antennas are synchronized and tracked separately.

\*RST: OFF

**Manual operation:** See ["Joined RX Sync and Tracking"](#) on page 113

## 11.5.5 Synchronization and OFDM Demodulation

|  |     |
|--|-----|
| <a href="#">[SENSe:]DEMod:FFT:OFFSet</a> ..... | 215 |
| <a href="#">[SENSe:]DEMod:TXARea</a> .....     | 216 |

**[SENSe:]DEMod:FFT:OFFSet** <Mode>

This command specifies the start offset of the FFT for OFDM demodulation (not for the FFT Spectrum display).

## Configuring the WLAN IQ Measurement (Modulation Accuracy, Flatness and Tolerance)

**Parameters:**

&lt;Mode&gt; AUTO | GICenter | PEAK

**AUTO**

The FFT start offset is automatically chosen to minimize the intersymbol interference.

**GICenter**

Guard Interval Center: The FFT start offset is placed to the center of the guard interval.

**PEAK**

The peak of the fine timing metric is used to determine the FFT start offset.

\*RST: AUTO

**Manual operation:** See "[FFT Start Offset](#)" on page 118**[SENSe:]DEMod:TXARea <State>**

If enabled, the R&S FPS WLAN application initially performs a coarse burst search on the input signal in which increases in the power vs time trace are detected. Further time-consuming processing is then only performed where bursts are assumed. This improves the measurement speed for signals with low duty cycle rates.

However, for signals in which the PPDU power levels differ significantly, this option should be disabled as otherwise some PPDUs may not be detected.

**Parameters:**

&lt;State&gt; ON | OFF | 0 | 1

**ON | 1**

A coarse burst search is performed based on the power levels of the input signal.

**OFF | 0**

No pre-evaluation is performed, the entire signal is processed.

\*RST: 1

**Manual operation:** See "[Power Interval Search](#)" on page 118

## 11.5.6 Tracking and Channel Estimation

|   |     |
|---|-----|
| <a href="#">[SENSe:]DEMod:CESTimation</a> .....           | 217 |
| <a href="#">SENSe:TRACking:CROStalk</a> .....             | 217 |
| <a href="#">SENSe:TRACking:IQMComp</a> .....              | 217 |
| <a href="#">SENSe:TRACking:LEVel</a> .....                | 218 |
| <a href="#">SENSe:TRACking:PHASe</a> .....                | 218 |
| <a href="#">SENSe:TRACking:PILots</a> .....               | 218 |
| <a href="#">SENSe:TRACking:PREamble</a> .....             | 219 |
| <a href="#">SENSe:TRACking:TIME</a> .....                 | 219 |
| <a href="#">[SENSe] (see also SENSe: commands!)</a> ..... | 220 |



**[SENSe:]DEMod:CEStimation <State>**

This command defines whether channel estimation will be done in preamble and payload or only in preamble. The effect of this is most noticeable for the EVM measurement results, where the results will be improved when this feature is enabled.

However, this functionality is not supported by the IEEE 802.11 standard and must be disabled if the results are to be measured strictly according to the standard.

**Parameters:**

&lt;State&gt;

ON | OFF

**ON**

The channel estimation is performed in the preamble and the payload. The EVM results can be calculated more accurately.

**OFF**

The channel estimation is performed in the preamble as required in the standard.

\*RST: OFF

**Manual operation:** See "[Channel Estimation Range](#)" on page 120

**SENSe:TRACking:CROStalk <State>**

Activates or deactivates the compensation for crosstalk between MIMO carriers.

This command is **only available for standard IEEE 802.11ac or n (MIMO)**.

**Parameters:**

&lt;State&gt;

ON | OFF

\*RST: OFF

**Example:**

SENSe:TRAC:CROStalk ON

**Manual operation:** See "[Compensate Crosstalk \(MIMO only\)](#)" on page 122

**SENSe:TRACking:IQMComp <State>**

Activates or deactivates the compensation for I/Q mismatch (gain imbalance, quadrature offset, I/Q skew, see [Chapter 3.1.1.5, "I/Q Mismatch"](#), on page 18).

This setting is **not available for standards IEEE 802.11b and g (DSSS)**.

**Parameters:**

&lt;State&gt;

ON | OFF

**ON**

Compensation for gain imbalance, quadrature offset, and I/Q skew impairments is applied.

**OFF**

Compensation is not applied; this setting is required for measurements strictly according to the IEEE 802.11-2012, IEEE 802.11ac-2013 WLAN standard

\*RST: OFF

## Configuring the WLAN IQ Measurement (Modulation Accuracy, Flatness and Tolerance)

**Example:** `SENS:TRAC:IQMC ON`

**Manual operation:** See "[I/Q Mismatch Compensation](#)" on page 121

**SENSe:TRACking:LEVel** <State>

Activates or deactivates the compensation for level variations within a single PPDU. If activated, the measurement results are compensated for level error on a per-symbol basis.

**Parameters:**

<State>                    ON | OFF  
 \*RST:                    OFF

**Example:** `SENS:TRAC:LEV ON`

**Manual operation:** See "[Level Error \(Gain\) Tracking](#)" on page 121

**SENSe:TRACking:PHASe** <State>

Activates or deactivates the compensation for phase drifts. If activated, the measurement results are compensated for phase drifts on a per-symbol basis.

**Parameters:**

<State>                    ON | OFF | 0 | 1  
 \*RST:                    1

**Example:** `SENS:TRAC:PHAS ON`

**Manual operation:** See "[Phase Tracking](#)" on page 121

**SENSe:TRACking:PILOts** <Mode>

In case tracking is used, the used pilot sequence has an effect on the measurement results.

## Configuring the WLAN IQ Measurement (Modulation Accuracy, Flatness and Tolerance)

**Parameters:**

&lt;Mode&gt; STANdard | DETected

**STANdard**

The pilot sequence is determined according to the corresponding WLAN standard. In case the pilot generation algorithm of the device under test (DUT) has a problem, the non-standard-conform pilot sequence might affect the measurement results, or the WLAN application might not synchronize at all onto the signal generated by the DUT.

**DETeCted**

The pilot sequence detected in the WLAN signal to be analyzed is used by the WLAN application. In case the pilot generation algorithm of the device under test (DUT) has a problem, the non-standard-conform pilot sequence will not affect the measurement results. In case the pilot sequence generated by the DUT is correct, it is recommended that you use the "According to Standard" setting because it generates more accurate measurement results.

\*RST: STANdard

**Example:**

SENS:TRAC:PIL DET

**Manual operation:** See "[Pilots for Tracking](#)" on page 122**SENSe:TRACking:PREamble** <Mode>

Defines which results are used for preamble tracking prior to the preamble channel estimation.

**Parameters:**

&lt;Mode&gt;

**PAYLoad**

Payload tracking results are used for preamble tracking prior to the preamble channel estimation

**VHT**

(V)HT-LTF Symbols and Payload tracking results are used for preamble tracking prior to the preamble channel estimation.

\*RST: PAYLoad

**Example:**

SENS:TRAC:PRE VHT

**Manual operation:** See "[Preamble Channel Estimation](#)" on page 121**SENSe:TRACking:TIME** <State>

Activates or deactivates the compensation for timing drift. If activated, the measurement results are compensated for timing error on a per-symbol basis.

**Parameters:**

&lt;State&gt; ON | OFF | 0 | 1

\*RST: 0

Configuring the WLAN IQ Measurement (Modulation Accuracy, Flatness and Tolerance)

**Example:**                   SENS:TRAC:TIME ON

**Manual operation:**   See "Timing Error Tracking" on page 121

---

[SENSe] (see also SENSe: commands!)

### 11.5.7 Demodulation

The demodulation settings define which PPDU's are to be analyzed, thus they define a *logical filter*.

The available demodulation settings vary depending on the selected digital standard (see [CONFigure:STANdard](#) on page 192).

Manual configuration is described in [Chapter 5.3.8, "Demodulation"](#), on page 122.

|   |     |
|---|-----|
| <a href="#">CONFigure:WLAN:EXTension:AUTO:TYPE</a> .....                        | 220 |
| <a href="#">CONFigure:WLAN:GTIme:AUTO</a> .....                                 | 221 |
| <a href="#">CONFigure:WLAN:GTIme:AUTO:TYPE</a> .....                            | 221 |
| <a href="#">CONFigure:WLAN:GTIme:SElect</a> .....                               | 222 |
| <a href="#">CONFigure:WLAN:SMAPping:MODE</a> .....                              | 223 |
| <a href="#">CONFigure:WLAN:SMAPping:NORMalise</a> .....                         | 223 |
| <a href="#">CONFigure:WLAN:SMAPping:TX&lt;ch&gt;</a> .....                      | 223 |
| <a href="#">CONFigure:WLAN:SMAPping:TX&lt;ch&gt;:STReam&lt;stream&gt;</a> ..... | 224 |
| <a href="#">CONFigure:WLAN:SMAPping:TX&lt;ch&gt;:TIMeshift</a> .....            | 224 |
| <a href="#">CONFigure:WLAN:STBC:AUTO:TYPE</a> .....                             | 224 |
| <a href="#">[SENSe:]BANDwidth:CHANnel:AUTO:TYPE</a> .....                       | 225 |
| <a href="#">[SENSe:]DEMod:FORMat:BANalyze</a> .....                             | 227 |
| <a href="#">[SENSe:]DEMod:FORMat:BANalyze:BTYPe</a> .....                       | 228 |
| <a href="#">[SENSe:]DEMod:FORMat:BANalyze:BTYPe:AUTO:TYPE</a> .....             | 229 |
| <a href="#">[SENSe:]DEMod:FORMat[:BContent]:AUTO</a> .....                      | 231 |
| <a href="#">[SENSe:]DEMod:FORMat:MCSindex</a> .....                             | 231 |
| <a href="#">[SENSe:]DEMod:FORMat:MCSindex:MODE</a> .....                        | 231 |
| <a href="#">[SENSe:]DEMod:FORMat:NSTindex</a> .....                             | 232 |
| <a href="#">[SENSe:]DEMod:FORMat:NSTindex:MODE</a> .....                        | 232 |
| <a href="#">[SENSe:]DEMod:FORMat:SIGSymbol</a> .....                            | 233 |

---

**CONFigure:WLAN:EXTension:AUTO:TYPE** <PPDUType>

Defines the PPDU's taking part in the analysis according to the Ness (Extension Spatial Streams) field content (for **IEEE 802.11n** standard only).

## Configuring the WLAN IQ Measurement (Modulation Accuracy, Flatness and Tolerance)

**Parameters:**

&lt;PPDUType&gt;

FBURst | ALL | M0 | M1 | M2 | M3 | D0 | D1 | D2 | D3

The first PPDU is analyzed and subsequent PPDU are analyzed only if they match

**FBURst**

The Ness field contents of the first PPDU is detected and subsequent PPDU are analyzed only if they have the same Ness field contents (corresponds to "Auto, same type as first PPDU")

**ALL**

All recognized PPDU are analyzed according to their individual Ness field contents (corresponds to "Auto, individually for each PPDU")

**M0 | M1 | M2 | M3**

Only PPDU with the specified Ness value are analyzed.

**D0 | D1 | D2 | D3**

All PPDU are analyzed assuming the specified Ness value.

\*RST: FBURst

**Example:**

```
CONF:WLAN:EXT:AUTO:TYPE M0
```

**Manual operation:** See ["Extension Spatial Streams \(sounding\)"](#) on page 135

**CONFigure:WLAN:GTIMe:AUTO <State>**

This remote control command specifies whether the guard time of the input signal is automatically detected or specified manually (**IEEE 802.11n or ac** only).

**Parameters:**

&lt;State&gt;

**ON**

The guard time is detected automatically according to [CONFigure:WLAN:GTIMe:AUTO:TYPE](#) on page 221.

**OFF**

The guard time is defined by the [CONFigure:WLAN:GTIMe:SElect](#) command.

\*RST: ON

**Manual operation:** See ["Guard Interval Length"](#) on page 129

**CONFigure:WLAN:GTIMe:AUTO:TYPE <Type>**

This remote control command specifies which PPDU are analyzed depending on their guard length if automatic detection is used (`CONF:WLAN:GTIM:AUTO ON`, see [CONFigure:WLAN:GTIMe:AUTO](#) on page 221).

This command is available for **IEEE 802.11 n, ac** standards only.

## Configuring the WLAN IQ Measurement (Modulation Accuracy, Flatness and Tolerance)

**Note:** On previous Rohde & Schwarz signal and spectrum analyzers, this command configured both the guard interval type and the channel bandwidth. On the R&S FPS, this command only configures the guard type. The channel bandwidth of the PPDU to be measured must be configured separately using the `[SENSe:]BANDwidth:CHANnel:AUTO:TYPE` command.

**Parameters:**

&lt;Type&gt;

**FBURst**

The Guard interval length of the first PPDU is detected and subsequent PDUs are analyzed only if they have the same length (corresponds to "Auto, same type as first PPDU")

**ALL**

All PDUs are analyzed regardless of their guard length (corresponds to "Auto, individually for each PPDU").

**MS**

Only PDUs with short guard interval length are analyzed. (corresponds to "Meas only Short" in manual operation; MN8 | MN16 parameters in previous Rohde & Schwarz signal and spectrum analyzers)

**ML**

Only PDUs with long guard interval length are analyzed. (corresponds to "Meas only Long" in manual operation; ML16 | ML32 parameters in previous Rohde & Schwarz signal and spectrum analyzers)

**DS**

All PDUs are demodulated assuming short guard interval length. (corresponds to "Demod all as short" in manual operation; DN8 | DN16 parameters in previous Rohde & Schwarz signal and spectrum analyzers)

**DL**

All PDUs are demodulated assuming long guard interval length. (corresponds to "Demod all as long" in manual operation; DL16 | DL32 parameters in previous Rohde & Schwarz signal and spectrum analyzers)

\*RST: 'ALL'

**Example:**

```
CONF:WLAN:GTIM:AUTO:TYPE DL
```

**Manual operation:** See "[Guard Interval Length](#)" on page 129

**CONFigure:WLAN:GTIMe:SElect <GuardTime>**

This remote control command specifies the guard time the PDUs in the **IEEE 802.11n** or **ac** input signal should have. If the guard time is specified to be detected from the input signal using the `CONFigure:WLAN:GTIMe:AUTO` command then this command is query only and allows the detected guard time to be obtained.

## Configuring the WLAN IQ Measurement (Modulation Accuracy, Flatness and Tolerance)

**Parameters:**

&lt;GuardTime&gt; SHORT | NORMAl

**SHORT**

Only the PPDUs with short guard interval are analyzed.

**NORMAl**Only the PPDUs with long guard interval are analyzed.  
("Long" in manual operation)

\*RST: NORMAl

**Example:**

CONF:WLAN:GTIM:SEL SHOR

**Manual operation:** See "[Guard Interval Length](#)" on page 129**CONFigure:WLAN:SMAPPing:MODE <Mode>**

This remote control command specifies the special mapping mode.

**Parameters:**

&lt;Mode&gt; DIRect | SEXPansion | USER

**DIRect**

direct

**SEXPansion**

expansion

**USER**

user defined

**Manual operation:** See "[Spatial Mapping Mode](#)" on page 136**CONFigure:WLAN:SMAPPing:NORMalise <State>**

This remote control command specifies whether an amplification of the signal power due to the spatial mapping is performed according to the matrix entries. If this command is set to ON then the spatial mapping matrix is scaled by a constant factor to obtain a passive spatial mapping matrix which does not increase the total transmitted power. If this command is set to OFF the normalization step is omitted.

**Parameters:**

&lt;State&gt;

**Manual operation:** See "[Power Normalise](#)" on page 137**CONFigure:WLAN:SMAPPing:TX<ch> <STS I>, <STS Q>{<STS I>,<STS Q>},<TimeShift>**

This remote control command specifies the mapping for all streams (real &amp; imaginary data pairs) and timeshift for a specified antenna.

**Parameters:**

&lt;STS I&gt; Imag part of the complex element of the STS-Stream

&lt;STS Q&gt; Real part of the complex element of the STS-Stream

## Configuring the WLAN IQ Measurement (Modulation Accuracy, Flatness and Tolerance)

<TimeShift> Time shift for specification of user defined CSD (cyclic delay diversity) for the Spatial Mapping.

Range: -32 ns to 32 ns

Default unit: ns

**Example:** `CONF:WLAN:SMAP:TX  
1.0,1.0,2.0,2.0,3.0,3.0,4.0,4.0,1e-9`

**Manual operation:** See "[User Defined Spatial Mapping](#)" on page 137

### CONFigure:WLAN:SMAPping:TX<ch>:STReam<stream> <STS I>, <STS Q>

This remote control command specifies the mapping for a specific stream and antenna.

**Parameters:**

<STS I> Imag part of the complex element of the STS-Stream

<STS Q> Real part of the complex element of the STS-Stream

**Example:** `CONF:WLAN:SMAP:TX4:STR1 1.0,1.0`

**Manual operation:** See "[User Defined Spatial Mapping](#)" on page 137

### CONFigure:WLAN:SMAPping:TX<ch>:TIMeshift <TimeShift>

This remote control command specifies the timeshift for a specific antenna.

**Parameters:**

<TimeShift> Time shift (in s) for specification of user defined CSD (cyclic delay diversity) for the Spatial Mapping.

Range: -32 ns to 32 ns

**Manual operation:** See "[User Defined Spatial Mapping](#)" on page 137

### CONFigure:WLAN:STBC:AUTO:TYPE <PPDUType>

This remote control command specifies which PPDU's are analyzed according to STBC streams (for **IEEE 802.11n, ac** standards only).



Configuring the WLAN IQ Measurement (Modulation Accuracy, Flatness and Tolerance)

**Parameters:**

<PPDUType> FBURst | ALL | M0 | M1 | M2 | D0 | D1 | D2

**FBURst**

The STBC of the first PPDU is detected and subsequent PPDU are analyzed only if they have the same STBC (corresponds to "Auto, same type as first PPDU")

**ALL**

All recognized PPDU are analyzed according to their individual STBC (corresponds to "Auto, individually for each PPDU")

**M0 | M1 | M2**

Measure only if STBC field = 0 | 1 | 2

For details see "[STBC Field](#)" on page 129

**D0 | D1 | D2**

Demod all as STBC field = 0 | 1 | 2

For details see "[STBC Field](#)" on page 129

**Example:**

CONF:WLAN:STBC:AUTO:TYPE M0

**Manual operation:** See "[STBC Field](#)" on page 129

---

**[SENSe:]BANDwidth:CHANnel:AUTO:TYPE <Bandwidth>**

This remote control command specifies the bandwidth in which the PPDU are analyzed.

This command is only available for standards **IEEE 802.11a, ac, n**.

Note that channel bandwidths larger than 10 MHz require a bandwidth extension option on the R&S FPS, see [Chapter A.1, "Sample Rate and Maximum Usable I/Q Bandwidth for RF Input"](#), on page 317.

## Configuring the WLAN IQ Measurement (Modulation Accuracy, Flatness and Tolerance)

**Parameters:**

&lt;Bandwidth&gt;

FBURst | ALL | MB5 | MB10 | MB20 | MB40 | MB80 | MB160 |  
DB5 | DB10 | DB20 | DB40 | DB80 | DB160**FBURst**

The channel bandwidth of the first valid PPDU is detected and subsequent PDUs are analyzed only if they have the same channel bandwidth (corresponds to "Auto, same type as first PPDU")

**ALL**

All PDUs are analyzed regardless of the channel bandwidth (corresponds to "Auto, individually for each PPDU")

**MB5**

Only PDUs within a channel bandwidth of 5MHz are analyzed  
(IEEE 802.11 a, p only)

**MB10**

Only PDUs within a channel bandwidth of 10MHz are analyzed  
(IEEE 802.11 a, p only)

**MB20**

Only PDUs within a channel bandwidth of 20MHz are analyzed

**MB40**

Only PDUs within a channel bandwidth of 40MHz are analyzed  
(IEEE 802.11 n, ac only)

**MB80**

Only PDUs within a channel bandwidth of 80MHz are analyzed  
(IEEE 802.11 ac only)

**MB160**

Only PDUs within a channel bandwidth of 160MHz are analyzed  
(IEEE 802.11 ac only)

**DB5**

All PDUs are analyzed within a channel bandwidth of 5MHz  
(IEEE 802.11 a, p only)

**DB10**

All PDUs are analyzed within a channel bandwidth of 10MHz  
(IEEE 802.11 a, p only)

**DB20**

All PDUs are analyzed within a channel bandwidth of 20MHz

**DB40**

All PDUs are analyzed within a channel bandwidth of 40MHz  
(IEEE 802.11 n, ac only)

**DB80**

All PDUs are analyzed within a channel bandwidth of 80MHz  
(IEEE 802.11 n, ac only)

**DB160**

All PDUs are analyzed within a channel bandwidth of 160MHz

## Configuring the WLAN IQ Measurement (Modulation Accuracy, Flatness and Tolerance)

(IEEE 802.11 n, ac only)

\*RST: FBURst

**Example:** SENS:BAND:CHAN:AUTO:TYPE MB20**Manual operation:** See "[Channel Bandwidth to measure \(CBW\)](#)" on page 124**[SENSe:]DEMod:FORMat:BANalyze** <Format>

Specifies which PSDUs are to be analyzed depending on their modulation. Only PSDUs using the selected modulation are considered in result analysis.

Note: to analyze all PPDU that are identical to the first detected PPDU (corresponds to "Auto, same type as first PPDU"), use the command:

SENS:DEMO:FORM:BANA:BTYP:AUTO:TYPE FBUR.

To analyze all PPDU regardless of their format and modulation (corresponds to "Auto, individually for each PPDU"), use the command:

SENS:DEMO:FORM:BANA:BTYP:AUTO:TYPE ALL.

See [\[SENSe:\]DEMod:FORMat:BANalyze:BTYPe:AUTO:TYPE](#) on page 229.**Parameters:**

&lt;Format&gt; \*RST: QAM64

**Example:** SENS:DEMO:FORM:BAN 'BPSK6'

**Manual operation:** See "[PPDU Format to measure](#)" on page 124  
 See "[PSDU Modulation to use](#)" on page 125  
 See "[PSDU Modulation](#)" on page 125  
 See "[PPDU Format to measure / PSDU Modulation to use](#)" on page 131  
 See "[PPDU Format](#)" on page 131

**Table 11-4: Modulation format parameters for IEEE 802.11a, g (OFDM), j, p standard**

| SCPI parameter | Dialog parameter |
|----------------|------------------|
| BPSK6          | BPSK 1/2         |
| BPSK9          | BPSK 3/4         |
| QPSK12         | QPSK 1/2         |
| QPSK18         | QPSK 3/4         |
| QAM1624        | 16-QAM 1/2       |
| QAM1636        | 16-QAM 3/4       |
| QAM6448        | 64-QAM 2/3       |
| QAM6454        | 64-QAM 3/4       |

## Configuring the WLAN IQ Measurement (Modulation Accuracy, Flatness and Tolerance)

**Table 11-5: Modulation format parameters for IEEE 802.11b or g (DSSS) standard**

| SCPI parameter | Dialog parameter                           |
|----------------|--|
| CCK11          | Complementary Code Keying at 11 Mbps       |
| CCK55          | Complementary Code Keying at 5.5 Mbps      |
| DBPSK1         | Differential BI-Phase shift keying         |
| DQPSK2         | Differential Quadrature phase shift keying |
| PBCC11         | PBCC at 11 Mbps                            |
| PBCC22         | PBCC at 11 Mbps                            |
| PBCC55         | PBCC at 5.5 Mbps                           |

**Table 11-6: Modulation format parameters for IEEE 802.11n standard**

| SCPI parameter | Dialog parameter                             |
|----------------|--|
| BPSK65         | BI-Phase shift keying at 6.5 Mbps            |
| BPSK72         | BI-Phase shift keying at 7.2 Mbps            |
| QAM1626        | Quadrature Amplitude Modulation at 26 Mbps   |
| QAM1639        | Quadrature Amplitude Modulation at 39 Mbps   |
| QAM16289       | Quadrature Amplitude Modulation at 28.9 Mbps |
| QAM16433       | Quadrature Amplitude Modulation at 43.3 Mbps |
| QAM6452        | Quadrature Amplitude Modulation at 52 Mbps   |
| QAM6465        | Quadrature Amplitude Modulation at 65 Mbps   |
| QAM16289       | Quadrature Amplitude Modulation at 28.9 Mbps |
| QAM16433       | Quadrature Amplitude Modulation at 43.3 Mbps |
| QAM64578       | Quadrature Amplitude Modulation at 57.8 Mbps |
| QAM64585       | Quadrature Amplitude Modulation at 58.5 Mbps |
| QAM64722       | Quadrature Amplitude Modulation at 72.2 Mbps |
| QPSK13         | Quadrature phase shift keying at 13 Mbps     |
| QPSK144        | Quadrature phase shift keying at 14.4 Mbps   |
| QPSK195        | Quadrature phase shift keying at 19.5 Mbps   |
| QPSK217        | Quadrature phase shift keying at 21.7 Mbps   |

---

**[SENSe:]DEMod:FORMat:BAalyze:BTYPe <PPDUType>**

This remote control command specifies the type of PPDU to be analyzed. Only PPDUs of the specified type take part in measurement analysis.

## Configuring the WLAN IQ Measurement (Modulation Accuracy, Flatness and Tolerance)

**Parameters:**

&lt;PPDUType&gt;

**'LONG'**

Only long (DSSS) PLCP PPDU's are analyzed.  
Available for IEEE 802.11b, g.

**'SHORT'**

Only short (DSSS) PLCP PPDU's are analyzed.  
Available for IEEE 802.11b, g.

**'OFDM'**

Only OFDM PPDU's are analyzed.  
Available for IEEE 802.11g.

**'MM20'**

IEEE 802.11n, Mixed Mode, 20 MHz sample rate  
Note that this setting is maintained for compatibility reasons only. Use the specified commands for new remote control programs (see [SENSe:]DEMod:FORMat:BANalyze:BTYPe:AUTO:TYPE on page 229 and [SENSe:]BANDwidth:CHANnel:AUTO:TYPE on page 225).

For new programs use:

```
[SENSe:]DEMod:FORMat:BANalyze:BTYPe:AUTO:TYPE
MMIX
[SENSe:]BANDwidth:CHANnel:AUTO:TYPE MB20
```

**'GFM20'**

IEEE 802.11n Green Field Mode, 20 MHz sample rate  
Note that this setting is maintained for compatibility reasons only. Use the specified commands for new remote control programs (see [SENSe:]DEMod:FORMat:BANalyze:BTYPe:AUTO:TYPE on page 229 and [SENSe:]BANDwidth:CHANnel:AUTO:TYPE on page 225).

For new programs use:

```
[SENSe:]DEMod:FORMat:BANalyze:BTYPe:AUTO:TYPE
MGRF
[SENSe:]BANDwidth:CHANnel:AUTO:TYPE MB20
```

**Example:**

Select IEEE 802.11g OFDM standard:

```
CONF:STAN 4
SENS:DEM:FORM:BAN:BTYP 'OFDM'
```

**Manual operation:** See "PPDU Format" on page 131

---

**[SENSe:]DEMod:FORMat:BANalyze:BTYPe:AUTO:TYPE <Analysis>**

This remote control command specifies how signals are analyzed.

## Configuring the WLAN IQ Measurement (Modulation Accuracy, Flatness and Tolerance)

**Parameters:**

&lt;Analysis&gt;

FBURst | ALL | MMIX | MGRF | DMIX | DGRF | MVHT | DVHT | MNHT | DNHT

**FBURst**

The format of the first valid PPDU is detected and subsequent PDUs are analyzed only if they have the same format (corresponds to "Auto, same type as first PDU")

**ALL**

All PDUs are analyzed regardless of their format (corresponds to "Auto, individually for each PDU")

**MNHT**

Only PDUs with format "Non-HT" are analyzed

**IEEE 802.11a, g (OFDM), p****DNHT**

All PDUs are assumed to have the PDU format "Non-HT"

**IEEE 802.11a, g (OFDM), p****MMIX**

Only PDUs with format "HT-MF" (Mixed) are analyzed

**(IEEE 802.11 n)****MGRF**

Only PDUs with format "HT-GF" (Greenfield) are analyzed

**(IEEE 802.11 n)****DMIX**

All PDUs are assumed to have the PDU format "HT-MF"

**(IEEE 802.11 n)****DGRF**

All PDUs are assumed to have the PDU format "HT-GF"

**(IEEE 802.11 n)****MVHT**

Only PDUs with format "VHT" are analyzed

**(IEEE 802.11 ac)****DVHT**

All PDUs are assumed to have the PDU format "VHT"

**(IEEE 802.11 ac)****FMMM**

Only PDUs with specified format are analyzed (see [\[SENSe: \] DEMod: FORMat: BANalyze](#) on page 227)

**(IEEE 802.11 b, g (DSSS))****FMMD**

All PDUs are assumed to have the specified PDU format (see [\[SENSe: \] DEMod: FORMat: BANalyze](#) on page 227)

**(IEEE 802.11 b, g (DSSS))**

\*RST: FBURst

**Example:**

SENS: DEM: FORM: BAN: BTYP: AUTO: TYPE FBUR

## Configuring the WLAN IQ Measurement (Modulation Accuracy, Flatness and Tolerance)

**Manual operation:** See ["PPDU Format to measure"](#) on page 124  
 See ["PSDU Modulation to use"](#) on page 125  
 See ["PPDU Format to measure / PSDU Modulation to use"](#)  
 on page 131

**[SENSe:]DEMod:FORMat:BCONtent]:AUTO <State>**

This command determines whether the PPDU to be analyzed are determined automatically or by the user.

**Parameters:**

&lt;State&gt;

**ON**

The signal field, i.e. the PLCP header field, of the first recognized PPDU is analyzed to determine the details of the PPDU. All PPDU identical to the first recognized PPDU are analyzed.

**OFF**

Only PPDU that match the user-defined PPDU type and modulation are considered in results analysis (see [\[SENSe:\]DEMod:FORMat:BANalyze:BTYPe:AUTO:TYPE](#) on page 229 and [\[SENSe:\]DEMod:FORMat:BANalyze](#) on page 227).

**Manual operation:** See ["PPDU Analysis Mode"](#) on page 123

**[SENSe:]DEMod:FORMat:MCSindex <Index>**

This command specifies the MCS index which controls the data rate, modulation and streams (for **IEEE 802.11n, ac** standards only, see document: IEEE 802.11n/D11.0 June 2009).

This command is required if [\[SENSe:\]DEMod:FORMat:MCSindex:MODE](#) is set to MEAS or DEM.

**Parameters:**

&lt;Index&gt;

\*RST: 1

**Example:**

SENS:DEMod:FORM:MCS:MODE MEAS

SENS:DEMod:FORM:MCS 1

**Manual operation:** See ["MCS Index"](#) on page 128

**[SENSe:]DEMod:FORMat:MCSindex:MODE <Mode>**

This command defines the PPDU taking part in the analysis depending on their Modulation and Coding Scheme (MCS) index (for **IEEE 802.11n, ac** standards only).

## Configuring the WLAN IQ Measurement (Modulation Accuracy, Flatness and Tolerance)

**Parameters:**

&lt;Mode&gt;

FBURst | ALL | MEASure | DEMod

**FBURst**

The MCS index of the first PPDU is detected and subsequent PDUs are analyzed only if they have the same MCS index (corresponds to "Auto, same type as first PDU")

**ALL**

All recognized PDUs are analyzed according to their individual MCS indexes (corresponds to "Auto, individually for each PDU")

**MEASure**

Only PDUs with an MCS index which matches that specified by `[SENSe:]DEMod:FORMat:MCSindex` are analyzed

**DEMod**

All PDUs will be analyzed according to the MCS index specified by `[SENSe:]DEMod:FORMat:MCSindex`.

\*RST: FBURst

**Example:**

SENS:DEMod:FORMat:MCS:MODE MEAS

SENS:DEMod:FORMat:MCS 1

**Manual operation:** See "[MCS Index to use](#)" on page 128**[SENSe:]DEMod:FORMat:NSTSindex <Index>**

Defines the the PDUs taking part in the analysis depending on their Nsts.

This command is only available for the **IEEE 802.11 ac** standard.

This command is available for `DEMod:FORMat:NSTS:MODE MEAS` or `DEMod:FORMat:NSTS:MODE DEM` (see `[SENSe:]DEMod:FORMat:NSTSindex:MODE` on page 232).

**Parameters:**

&lt;Index&gt;

**Example:**

SENS:DEMod:FORMat:NSTS:MODE MEAS

SENS:DEMod:FORMat:NSTS 1

**Manual operation:** See "[Nsts](#)" on page 129**[SENSe:]DEMod:FORMat:NSTSindex:MODE <Mode>**

Defines the the PDUs taking part in the analysis depending on their Nsts.

This command is only available for the **IEEE 802.11 ac** standard.



## Configuring the WLAN IQ Measurement (Modulation Accuracy, Flatness and Tolerance)

**Parameters:**

<Mode> FBURst | ALL | MEASure | DEMod

**FBURst**

The Nsts of the first PPDU is detected and subsequent PDUs are analyzed only if they have the same Nsts (corresponds to "Auto, same type as first PPDU")

**ALL**

All recognized PDUs are analyzed according to their individual Nsts (corresponds to "Auto, individually for each PDU")

**MEASure**

Only PDUs with the Nsts specified by [SENSe:]DEMod:FORMat:NSTSiNdex are analyzed

**DEMod**

The "Nsts" index specified by [SENSe:]DEMod:FORMat:NSTSiNdex is used for all PDUs.

\*RST: FBURst

**Example:**

```
SENS:DEM:FORM:NSTS:MODE MEAS
SENS:DEM:FORM:NSTS 1
```

**Manual operation:** See "Nsts to use" on page 128

**[SENSe:]DEMod:FORMat:SIGSymbol <State>**

Activates and deactivates signal symbol field decoding.

For IEEE 802.11b this command can only be queried as the decoding of the signal field is always performed for this standard.

**Parameters for setting and query:**

<State>

**OFF**

Deactivates signal symbol field decoding. All PDUs are assumed to have the specified PDU format / PSDU modulation, regardless of the actual format or modulation.

**ON**

If activated, the signal symbol field of the PDU is analyzed to determine the details of the PDU. Only PDUs which match the PDU type/ PSDU modulation defined by [SENSe:]DEMod:FORMat:BANalyze and [SENSe:]DEMod:FORMat:BANalyze:BTYPe are considered in results analysis.

\*RST: OFF

**Example:**

```
DEM:FORM:SIGS ON
```

**Manual operation:** See "PDU Format to measure / PSDU Modulation to use" on page 131

## 11.5.8 Evaluation Range

The evaluation range defines which data is evaluated in the result display.

Note that, as opposed to manual operation, the PPDUs to be analyzed can be defined either by the number of data symbols, the number of data bytes, or the measurement duration.

|   |     |
|---|-----|
| CONFigure:BURSt:PVT:AVERAge.....                        | 234 |
| CONFigure:BURSt:PVT:RPOWer.....                         | 234 |
| CONFigure:WLAN:PAYLoad:LENGth:SRC.....                  | 235 |
| CONFigure:WLAN:PVERror:MRANge?.....                     | 235 |
| [SENSe:]BURSt:COUNt.....                                | 235 |
| [SENSe:]BURSt:COUNt:STATe.....                          | 236 |
| [SENSe:]BURSt:SELEct.....                               | 236 |
| [SENSe:]BURSt:SELEct:STATe.....                         | 236 |
| [SENSe:]DEMod:FORMat:BANalyze:DBYTes:EQUal.....         | 237 |
| [SENSe:]DEMod:FORMat:BANalyze:DBYTes:MAX.....           | 237 |
| [SENSe:]DEMod:FORMat:BANalyze:DBYTes:MIN.....           | 237 |
| [SENSe:]DEMod:FORMat:BANalyze:DURation:EQUal.....       | 238 |
| [SENSe:]DEMod:FORMat:BANalyze:DURation:MAX.....         | 238 |
| [SENSe:]DEMod:FORMat:BANalyze:DURation:MIN.....         | 238 |
| [SENSe:]DEMod:FORMat:BANalyze:SYMBols:EQUal.....        | 239 |
| [SENSe:]DEMod:FORMat:BANalyze:SYMBols:LENGth:STATe..... | 239 |
| [SENSe:]DEMod:FORMat:BANalyze:SYMBols:LENGth.....       | 240 |
| [SENSe:]DEMod:FORMat:BANalyze:SYMBols:MAX.....          | 240 |
| [SENSe:]DEMod:FORMat:BANalyze:SYMBols:MIN.....          | 241 |
| [SENSe:]DEMod:FORMat:BANalyze:SYMBols:OFFSet.....       | 241 |

---

### CONFigure:BURSt:PVT:AVERAge <Value>

Defines the number of samples used to adjust the length of the smoothing filter for PVT measurement.

This command is **only** available for **IEEE 802.11b, g (DSSS)** standards.

#### Parameters:

<Value>

**Manual operation:** See "[PVT : Average Length](#)" on page 142

---

### CONFigure:BURSt:PVT:RPOWer <Mode>

This remote control command configures the use of either mean or maximum PPDU power as a reference power for the 802.11b, g (DSSS) PVT measurement.

#### Parameters:

<Mode>                    MEAN | MAXimum

**Manual operation:** See "[PVT : Reference Power](#)" on page 142

**CONFigure:WLAN:PAYLoad:LENGth:SRC** <Source>

Defines which payload length is used to determine the minimum or maximum number of required data symbols (**IEEE 802.11n, ac**).

**Parameters:**

|          |  |
|----------|--|
| <Source> | ESTimate   HTSignal  |
|          | <b>ESTimate</b>  |
|          | Uses a length estimated from the input signal                  |
|          | <b>HTSignal</b>  |
|          | ( <b>IEEE811.02 n</b> )  |
|          | Determines the length of the HT signal (from the signal field) |
|          | <b>LSIGNAL</b>   |
|          | ( <b>IEEE811.02 ac</b> )                                       |
|          | Determines the length of the L signal (from the signal field)  |

**Manual operation:** See "[Source of Payload Length](#)" on page 139

**CONFigure:WLAN:PVERror:MRANge?** <Range>

This remote control command queries whether the Peak Vector Error results are calculated over the complete PPDU or just over the PSDU.

This command is supported for **802.11b** and **802.11g (DSSS)** only.

**Return values:**

|         |   |
|---------|---|
| <Range> | ALL   PSDU  |
|         | <b>ALL</b>  |
|         | Peak Vector Error results are calculated over the complete PPDU |
|         | <b>PSDU</b>   |
|         | Peak Vector Error results are calculated over the PSDU only     |

**Usage:** Query only

**Manual operation:** See "[Peak Vector Error : Meas Range](#)" on page 142

**[SENSe:]BURSt:COUNt** <Value>

If the statistic count is enabled (see [[SENSe](#) : ] [BURSt](#) : [COUNt](#) : [STATe](#) on page 236), the specified number of PPDU is taken into consideration for the statistical evaluation (maximally the number of PPDU detected in the current capture buffer).

If disabled, all detected PPDU in the current capture buffer are considered.

**Parameters:**

<Value> \*RST: 1

**Example:**

```
SENS:BURS:COUN:STAT ON
SENS:BURS:COUN 10
```

**Manual operation:** See "[PPDU Statistic Count / No of PPDU to Analyze](#)" on page 139

## Configuring the WLAN IQ Measurement (Modulation Accuracy, Flatness and Tolerance)

**[SENSe:]BURSt:COUNT:STATe <State>**

If the statistic count is enabled, the specified number of PPDU is taken into consideration for the statistical evaluation (maximally the number of PPDU detected in the current capture buffer).

If disabled, all detected PPDU in the current capture buffer are considered.

**Parameters:**

<State> ON | OFF  
\*RST: OFF

**Example:**

```
SENS:BURS:COUN:STAT ON
SENS:BURS:COUN 10
```

**Manual operation:** See ["PPDU Statistic Count / No of PPDU to Analyze"](#) on page 139

**[SENSe:]BURSt:SELEct <Value>**

If single PPDU analysis is enabled (see [\[SENSe:\]BURSt:SELEct:STATe](#) on page 236), the WLAN 802.11 I/Q results are based on the specified PPDU.

If disabled, all detected PPDU in the current capture buffer are evaluated.

**Parameters:**

<Value> \*RST: 1

**Example:**

```
SENS:BURS:SEL:STAT ON
SENS:BURS:SEL 2
```

Results are based on the PPDU number 2 only.

**Manual operation:** See ["Analyze this PPDU / PPDU to Analyze"](#) on page 138

**[SENSe:]BURSt:SELEct:STATe <State>**

Defines the evaluation basis for result displays.

Note that this setting is only applicable *after* a measurement has been performed.

**Parameters:**

<State> ON | OFF | 0 | 1

**OFF | 0**

All detected PPDU in the current capture buffer are evaluated.

**ON | 1**

The WLAN 802.11 I/Q results are based on one individual PPDU only, namely the defined using [\[SENSe:\]BURSt:SELEct](#) on page 236. As soon as a new measurement is started, the evaluation range is reset to all PPDU in the current capture buffer.

\*RST: 0

## Configuring the WLAN IQ Measurement (Modulation Accuracy, Flatness and Tolerance)

**Example:**                   SENS: BURS: SEL: STAT ON  
                                   SENS: BURS: SEL 2  
                                   Results are based on the PPDU number 2 only.

**Manual operation:** See ["Analyze this PPDU / PPDU to Analyze"](#) on page 138

**[SENSe:]DEMod:FORMat:BANalyze:DBYTes:EQual <State>**

For IEEE 802.11b and g (DSSS) signals only:

If **enabled**, only PPDU with a **specific** payload length are considered for measurement analysis.

If **disabled**, only PPDU whose length is within a specified **range** are considered.

The payload length is specified by the [\[SENSe:\]DEMod:FORMat:BANalyze:DBYTes:MIN](#) command.

A payload length **range** is defined as a minimum and maximum number of symbols the payload may contain (see [\[SENSe:\]DEMod:FORMat:BANalyze:DBYTes:MAX](#) on page 237 and [\[SENSe:\]DEMod:FORMat:BANalyze:DBYTes:MIN](#)).

**Parameters:**

<State>                   ON | OFF  
                                   \*RST:       OFF

**Manual operation:** See ["Equal PPDU Length"](#) on page 139

**[SENSe:]DEMod:FORMat:BANalyze:DBYTes:MAX <NumDataBytes>**

If the [\[SENSe:\]DEMod:FORMat:BANalyze:DBYTes:EQual](#) command is set to **false**, this command specifies the maximum number of data bytes allowed for a PPDU to take part in measurement analysis.

If the [\[SENSe:\]DEMod:FORMat:BANalyze:DBYTes:EQual](#) command is set to **true**, then this command has no effect.

**Parameters:**

<NumDataBytes>       \*RST:       64  
                                   Default unit: bytes

**Manual operation:** See ["\(Min./Max.\) Payload Length"](#) on page 142

**[SENSe:]DEMod:FORMat:BANalyze:DBYTes:MIN <NumDataBytes>**

For IEEE 802.11b and g (DSSS) signals only:

If the [\[SENSe:\]DEMod:FORMat:BANalyze:DBYTes:EQual](#) command is set to **true**, then this command specifies the exact number of data bytes a PPDU must have to take part in measurement analysis.

If the [\[SENSe:\]DEMod:FORMat:BANalyze:DBYTes:EQual](#) command is set to **false**, this command specifies the minimum number of data bytes required for a PPDU to take part in measurement analysis.

## Configuring the WLAN IQ Measurement (Modulation Accuracy, Flatness and Tolerance)

**Parameters:**

<NumDataBytes> \*RST: 1  
Default unit: bytes

**Manual operation:** See "(Min./Max.) Payload Length" on page 142

**[SENSe:]DEMod:FORMat:BANalyze:DURation:EQUal <State>**

For IEEE 802.11b and g (DSSS) signals only:

If **enabled**, only PPDU's with a **specific** duration are considered for measurement analysis.

If **disabled**, only PPDU's whose duration is within a specified **range** are considered.

The duration is specified by the [SENSe:]DEMod:FORMat:BANalyze:DURation:MIN command.

A duration **range** is defined as a minimum and maximum duration the PPDU may have (see [SENSe:]DEMod:FORMat:BANalyze:DURation:MAX and [SENSe:]DEMod:FORMat:BANalyze:DURation:MIN).

**Parameters:**

<State> ON | OFF  
\*RST: OFF

**Manual operation:** See "Equal PPDU Length" on page 139

**[SENSe:]DEMod:FORMat:BANalyze:DURation:MAX <Duration>**

For IEEE 802.11b and g (DSSS) signals only:

If the [SENSe:]DEMod:FORMat:BANalyze:DURation:EQUal command is set to **false**, this command specifies the maximum number of symbols allowed for a PPDU to take part in measurement analysis.

If the [SENSe:]DEMod:FORMat:BANalyze:DURation:EQUal command is set to **true**, then this command has no effect.

**Parameters:**

<Duration> \*RST: 5464  
Default unit: us

**Manual operation:** See "(Min./Max.) Payload Length" on page 142

**[SENSe:]DEMod:FORMat:BANalyze:DURation:MIN <Duration>**

For IEEE 802.11b and g (DSSS) signals only:

If the [SENSe:]DEMod:FORMat:BANalyze:DURation:EQUal command is set to **true** then this command specifies the **exact** duration required for a PPDU to take part in measurement analysis.



## Configuring the WLAN IQ Measurement (Modulation Accuracy, Flatness and Tolerance)

**Example:**                   SENS:DEM:FORM:BAN:SYMB:OFFS 10  
 PPDUs are analyzed after the 10th symbol in the PPDU.  
 SENS:DEM:FORM:BAN:SYMB:LENG:STAT OFF  
 PPDUs are analyzed after the symbol offset (10) until the end of each PPDU.  
 SENS:DEM:FORM:BAN:SYMB:LENG 100  
 100 symbols after the symbol offset (10-110) are analyzed in each PPDU.

**Manual operation:** See ["Analysis Interval Offset / Analysis Interval Length"](#) on page 140

**[SENSe:]DEMod:FORMat:BANalyze:SYMBols:LENGth <NumDataSymbols>**

For IEEE 802.11a, ac, g (OFDM), j, n, p signals only:

If the [\[SENSe:\]DEMod:FORMat:BANalyze:SYMBols:LENGth:STATe](#) command is set to **false**, this command specifies the number of PPDU data symbols after the Analysis Interval Offset (see [\[SENSe:\]DEMod:FORMat:BANalyze:SYMBols:OFFSet](#) on page 241) which are to be analyzed.

If the [\[SENSe:\]DEMod:FORMat:BANalyze:SYMBols:LENGth:STATe](#) command is set to **true**, then this command has no effect.

**Parameters:**

<NumDataSymbols> Range:       0 to 10000  
 \*RST:            0

**Example:**                   SENS:DEM:FORM:BAN:SYMB:OFFS 10  
 SENS:DEM:FORM:BAN:SYMB:LENG:STAT OFF  
 SENS:DEM:FORM:BAN:SYMB:LENG 100

**Manual operation:** See ["Analysis Interval Offset / Analysis Interval Length"](#) on page 140

**[SENSe:]DEMod:FORMat:BANalyze:SYMBols:MAX <NumDataSymbols>**

For IEEE 802.11a, ac, g (OFDM), j, n, p signals only:

If the [\[SENSe:\]DEMod:FORMat:BANalyze:SYMBols:EQUal](#) command is set to **false**, this command specifies the maximum number of payload symbols allowed for a PPDU to take part in measurement analysis.

The number of payload symbols is defined as the uncoded bits including service and tail bits.

If the [\[SENSe:\]DEMod:FORMat:BANalyze:SYMBols:EQUal](#) command has been set to **true**, then this command has no effect.

**Parameters:**

<NumDataSymbols> \*RST:       64

**Manual operation:** See ["\(Min./Max.\) No. of Data Symbols"](#) on page 139



---

**[SENSe:]DEMod:FORMat:BANalyze:SYMBols:MIN** <NumDataSymbols>

For IEEE 802.11a, ac, g (OFDM), j, n, p signals only:

If the `[SENSe:]DEMod:FORMat:BANalyze:SYMBols:EQUal` command has been set to **true**, then this command specifies the exact number of payload symbols a PPDU must have to take part in measurement analysis.

If the `[SENSe:]DEMod:FORMat:BANalyze:SYMBols:EQUal` command is set to **false**, this command specifies the minimum number of payload symbols required for a PPDU to take part in measurement analysis.

The number of payload symbols is defined as the uncoded bits including service and tail bits.

**Parameters:**

<NumDataSymbols> \*RST: 1

**Example:**

```
SENS:DEM:FORM:BAN:SYMB:EQU ON
SENS:DEMO:FORM:BANA:SYMB:MIN
```

**Manual operation:** See "[\(Min./Max.\) No. of Data Symbols](#)" on page 139

---

**[SENSe:]DEMod:FORMat:BANalyze:SYMBols:OFFSet** <NumDataSymbols>

For IEEE 802.11a, ac, g (OFDM), j, n, p signals only:

This command specifies the number of data symbols from the start of each PPDU that are to be skipped before symbols take part in analysis.

**Parameters:**

<NumDataSymbols> Range: 0 to 10000  
\*RST: 0

**Example:**

```
SENS:DEM:FORM:BAN:SYMB:OFFS 10
PPDUs are analyzed after the 10th symbol in the PPDU.
SENS:DEM:FORM:BAN:SYMB:OFFS 0
PPDUs are analyzed with a symbol offset of 0, i.e. starting with
the first symbol
```

**Manual operation:** See "[Analysis Interval Offset / Analysis Interval Length](#)" on page 140

---

## 11.5.9 Limits

The following commands are required to define the limits against which the individual parameter results are checked. Principally, the limits are defined in the WLAN 802.11 standards. However, you can change the limits for your own test cases and reset the limits to the standard values later. Note that changing limits is currently only possible via remote control, not manually via the user interface.

The commands required to retrieve the limit check results are described in [Chapter 11.9.1.3, "Limit Check Results"](#), on page 280.

## Configuring the WLAN IQ Measurement (Modulation Accuracy, Flatness and Tolerance)

Useful commands for defining limits described elsewhere:

- [UNIT:EVM](#) on page 280
- [UNIT:GIMBalance](#) on page 280

**Remote commands exclusive to defining limits:**

|   |     |
|---|-----|
| <a href="#">CALCulate:LIMit:BURSt:ALL</a> .....                   | 242 |
| <a href="#">CALCulate:LIMit:BURSt:EVM:ALL[:AVERAge]</a> .....     | 242 |
| <a href="#">CALCulate:LIMit:BURSt:EVM:ALL:MAXimum</a> .....       | 242 |
| <a href="#">CALCulate:LIMit:BURSt:EVM:DATA[:AVERAge]</a> .....    | 243 |
| <a href="#">CALCulate:LIMit:BURSt:EVM:DATA:MAXimum</a> .....      | 243 |
| <a href="#">CALCulate:LIMit:BURSt:EVM:PILot[:AVERAge]</a> .....   | 243 |
| <a href="#">CALCulate:LIMit:BURSt:EVM:PILot:MAXimum</a> .....     | 243 |
| <a href="#">CALCulate:LIMit:BURSt:FERRor[:AVERAge]</a> .....      | 243 |
| <a href="#">CALCulate:LIMit:BURSt:FERRor:MAXimum</a> .....        | 243 |
| <a href="#">CALCulate:LIMit:BURSt:IQOFfset[:AVERAge]</a> .....    | 244 |
| <a href="#">CALCulate:LIMit:BURSt:IQOFfset:MAXimum</a> .....      | 244 |
| <a href="#">CALCulate:LIMit:BURSt:SYMBolerror[:AVERAge]</a> ..... | 244 |
| <a href="#">CALCulate:LIMit:BURSt:SYMBolerror:MAXimum</a> .....   | 244 |

**CALCulate:LIMit:BURSt:ALL** <Limits>

This command sets or returns the limit values for the parameters determined by the default WLAN measurement all in one step.

(see [Chapter 3.1.1, "Modulation Accuracy, Flatness and Tolerance Parameters"](#), on page 12).

To define individual limit values use the individual  
CALCulate<n>:LIMit<k>:BURSt... commands.

Note that the units for the EVM and gain imbalance parameters must be defined in advance using the following commands:

- [UNIT:EVM](#) on page 280
- [UNIT:GIMBalance](#) on page 280

**Parameters:**

<Limits>

The parameters are input or output as a list of (ASCII) values separated by ',' in the following order:

<average CF error>, <max CF error>, <average symbol clock error>, <max symbol clock error>, <average I/Q offset>, <maximum I/Q offset>, <average EVM all carriers>, <max EVM all carriers>, <average EVM data carriers>, <max EVM data carriers>  
<average EVM pilots>, <max EVM pilots>

**CALCulate:LIMit:BURSt:EVM:ALL[:AVERAge]** <Limit>**CALCulate:LIMit:BURSt:EVM:ALL:MAXimum** <Limit>

This command sets or queries the average or maximum error vector magnitude limit for all carriers as determined by the default WLAN measurement.

## Configuring the WLAN IQ Measurement (Modulation Accuracy, Flatness and Tolerance)

For details see [Chapter 3.1.1, "Modulation Accuracy, Flatness and Tolerance Parameters"](#), on page 12.

**Parameters:**

<Limit> numeric value in dB  
 The unit for the EVM parameters can be changed in advance using `UNIT:EVM` on page 280.  
 Default unit: DB

**CALCulate:LIMit:BURSt:EVM:DATA[:AVERAge] <Limit>**

**CALCulate:LIMit:BURSt:EVM:DATA:MAXimum <Limit>**

This command sets or queries the average or maximum error vector magnitude limit for the data carrier determined by the default WLAN measurement.

For details see [Chapter 3.1.1, "Modulation Accuracy, Flatness and Tolerance Parameters"](#), on page 12.

**Parameters:**

<Limit> numeric value in dB  
 The unit for the EVM parameters can be changed in advance using `UNIT:EVM` on page 280.  
 Default unit: DB

**CALCulate:LIMit:BURSt:EVM:PILOt[:AVERAge] <Limit>**

**CALCulate:LIMit:BURSt:EVM:PILOt:MAXimum <Limit>**

This command sets or queries the average or maximum error vector magnitude limit for the pilot carriers determined by the default WLAN measurement.

For details see [Chapter 3.1.1, "Modulation Accuracy, Flatness and Tolerance Parameters"](#), on page 12.

**Parameters:**

<Limit> numeric value in dB  
 The unit for the EVM parameters can be changed in advance using `UNIT:EVM` on page 280.  
 Default unit: DB

**CALCulate:LIMit:BURSt:FERRor[:AVERAge] <Limit>**

**CALCulate:LIMit:BURSt:FERRor:MAXimum <Limit>**

This command sets or queries the average or maximum center frequency error limit determined by the default WLAN measurement.

For details see [Chapter 3.1.1, "Modulation Accuracy, Flatness and Tolerance Parameters"](#), on page 12.

**Parameters:**

<Limit> numeric value in Hertz  
 Default unit: HZ



Configuring the WLAN IQ Measurement (Modulation Accuracy, Flatness and Tolerance)

|                          |  |
|--------------------------|--|
| <b>Example:</b>          | ADJ:LEV  |
| <b>Usage:</b>            | Event  |
| <b>Manual operation:</b> | See " <a href="#">Setting the Reference Level Automatically (Auto Level)</a> " on page 150 |

### 11.5.11 Configuring the Application Data Range (MSRA mode only)

In MSRA operating mode, only the MSRA Master actually captures data; the MSRA applications define an extract of the captured data for analysis, referred to as the **application data**.

For the R&S FPS WLAN application, the application data range is defined by the same commands used to define the signal capture in Signal and Spectrum Analyzer mode (see [Chapter 11.5.4, "Signal Capturing"](#), on page 202). Be sure to select the correct measurement channel before executing this command.

In addition, a capture offset can be defined, i.e. an offset from the start of the captured data to the start of the application data for the WLAN I/Q measurement.

The **analysis interval** used by the individual result displays cannot be edited, but is determined automatically. However, you can query the currently used analysis interval for a specific window.

The **analysis line** is displayed by default but can be hidden or re-positioned.

#### Remote commands exclusive to MSRA applications

The following commands are only available for MSRA application channels:

|   |     |
|---|-----|
| <a href="#">CALCulate&lt;n&gt;:MSRA:ALINe:SHOW</a> .....            | 245 |
| <a href="#">CALCulate&lt;n&gt;:MSRA:ALINe[:VALue]</a> .....         | 246 |
| <a href="#">CALCulate&lt;n&gt;:MSRA:WINDow&lt;n&gt;:IVAL?</a> ..... | 246 |
| <a href="#">INITiate&lt;n&gt;:REFresh</a> .....                     | 246 |
| <a href="#">[SENSe:]MSRA:CAPTure:OFFSet</a> .....                   | 247 |

---

#### **CALCulate<n>:MSRA:ALINe:SHOW**

This command defines whether or not the analysis line is displayed in all time-based windows in all MSRA applications and the MSRA Master.

(<n> is irrelevant.)

**Note:** even if the analysis line display is off, the indication whether or not the currently defined line position lies within the analysis interval of the active application remains in the window title bars.

#### **Parameters:**

|         |          |
|---------|----------|
| <State> | ON   OFF |
| *RST:   | ON       |

## Configuring the WLAN IQ Measurement (Modulation Accuracy, Flatness and Tolerance)

**CALCulate<n>:MSRA:ALINe[:VALue] <Position>**

This command defines the position of the analysis line for all time-based windows in all MSRA applications and the MSRA Master.

(<n> is irrelevant.)

**Parameters:**

<Position> Position of the analysis line in seconds. The position must lie within the measurement time of the MSRA measurement.  
Default unit: s

**CALCulate<n>:MSRA:WINDow<n>:IVAL?**

This command queries the analysis interval for the window specified by the WINDow suffix <n> (the CALC suffix is irrelevant). This command is only available in application measurement channels, not the MSRA View or MSRA Master.

**Return values:**

<IntStart> Start value of the analysis interval in seconds  
Default unit: s

<IntStop> Stop value of the analysis interval in seconds

**Usage:** Query only

**INITiate<n>:REFResh**

This function is only available if the Sequencer is deactivated (`SYSTem:SEQuencer SYST:SEQ:OFF`) and only for applications in MSRA mode, not the MSRA Master.

The data in the capture buffer is re-evaluated by the currently active application only. The results for any other applications remain unchanged.

(The suffix <n> is irrelevant.)

**Example:**

```
SYST:SEQ:OFF
Deactivates the scheduler
INIT:CONT OFF
Switches to single sweep mode.
INIT;*WAI
Starts a new data measurement and waits for the end of the
sweep.
INST:SEL 'IQ ANALYZER'
Selects the IQ Analyzer channel.
INIT:REFR
Refreshes the display for the I/Q Analyzer channel.
```

**Usage:** Event

**Manual operation:** See "[Refresh \( MSRA only\)](#)" on page 151

**[SENSe:]MSRA:CAPTure:OFFSet <Offset>**

This setting is only available for applications in MSRA mode, not for the MSRA Master. It has a similar effect as the trigger offset in other measurements.

**Parameters:**

&lt;Offset&gt;

This parameter defines the time offset between the capture buffer start and the start of the extracted application data. The offset must be a positive value, as the application can only analyze data that is contained in the capture buffer.

Range: 0 to &lt;Record length&gt;

\*RST: 0

**Manual operation:** See "[Capture Offset](#)" on page 104

## 11.6 Configuring Frequency Sweep Measurements on WLAN Signals

The R&S FPS WLAN application uses the functionality of the R&S FPS base system (Spectrum application, see the R&S FPS User Manual) to perform the WLAN frequency sweep measurements. The R&S FPS WLAN application automatically sets the parameters to predefined settings as described in [Chapter 5.4, "Frequency Sweep Measurements"](#), on page 151.

The WLAN RF measurements must be activated for a measurement channel in the WLAN application, see [Chapter 11.3, "Activating WLAN Measurements"](#), on page 180.

For details on configuring these RF measurements in a remote environment, see the Remote Commands chapter of the R&S FPS User Manual.

**Remote commands exclusive to SEM measurements in the WLAN application:**

|  |     |
|--|-----|
| <a href="#">[SENSe:]POWer:SEM.....</a>       | 247 |
| <a href="#">[SENSe:]POWer:SEM:CLASs.....</a> | 249 |

**[SENSe:]POWer:SEM <Type>**

This command sets the Spectrum Emission Mask (SEM) measurement type.

## Configuring Frequency Sweep Measurements on WLAN Signals

**Parameters:**

&lt;Type&gt; IEEE | ETSI | User

**User**

Settings and limits are configured via a user-defined XML file. Load the file using `MMEMory:LOAD:SEM:STATE` on page 311.

**IEEE**

Settings and limits are as specified in the IEEE Std 802.11n™-2009 Figure 20-17—Transmit spectral mask for 20 MHz transmission. For other IEEE standards see the parameter values in the table below.

After a query, `IEEE` is returned for all IEEE standards.

**ETSI**

Settings and limits are as specified in the ETSI standard.

\*RST: IEEE

**Example:**

```
POW:SEM ETSI
```

**Table 11-7: Supported IEEE standards**

| Manual operation              | The spectrum emission mask measurement is performed according to the standard  | Parameter value                  |
|-------------------------------|--|----------------------------------|
| IEEE 802.11n-2009<br>20M@2.4G | IEEE Std 802.11n™-2009<br>Figure 20-17—Transmit spectral mask for 20 MHz transmission  | IEEE<br>or<br>'IEEE_2009_20_2_4' |
| IEEE 802.11n-2009<br>40M@2.4G | IEEE Std 802.11n™-2009<br>Figure 20-18—Transmit spectral mask for a 40 MHz channel   | 'IEEE_2009_40_2_4'               |
| IEEE 802.11n-2009 20M@5G      | IEEE Std 802.11n™-2009<br>Figure 20-17—Transmit spectral mask for 20 MHz transmission  | 'IEEE_2009_20_5'                 |
| IEEE 802.11n-2009 40M@5G      | IEEE Std 802.11n™-2009<br>Figure 20-18—Transmit spectral mask for a 40 MHz channel   | 'IEEE_2009_40_5'                 |
| IEEE 802.11mb/D08<br>20M@2.4G | IEEE Std 802.11n™-2009<br>Figure 20-17—Transmit spectral mask for 20 MHz transmission<br>IEEE Draft P802.11-REVmb™/D8.0, March 2011<br>Figure 19-17—Transmit spectral mask for 20 MHz transmission in the 2.4 GHz band | 'IEEE_D08_20_2_4'                |
| IEEE 802.11mb/D08<br>40M@2.4G | IEEE Std 802.11n™-2009<br>Figure 20-18—Transmit spectral mask for a 40 MHz channel<br>IEEE Draft P802.11-REVmb™/D8.0, March 2011<br>Figure 19-18—Transmit spectral mask for a 40 MHz channel in the 2.4 GHz band       | 'IEEE_D08_40_2_4'                |
| IEEE 802.11mb/D08 20M@5G      | IEEE Draft P802.11-REVmb™/D8.0, March 2011<br>Figure 19-19—Transmit spectral mask for 20 MHz transmission in the 5 GHz band  | 'IEEE_D08_20_5'                  |



| Manual operation          | The spectrum emission mask measurement is performed according to the standard  | Parameter value     |
|---------------------------|--|---------------------|
| IEEE 802.11mb/D08 40M@5G  | IEEE Draft P802.11-REVmb™/D8.0, March 2011<br>Figure 19-20—Transmit spectral mask for a 40 MHz channel in the 5 GHz band | 'IEEE_D08_40_5'     |
| IEEE 802.11ac/D1.1 20M@5G | IEEE P802.11ac™/D1.1, August 2011<br>Figure 22-17—Transmit spectral mask for a 20 MHz channel                            | 'IEEE_AC_D1_1_20_5' |
| IEEE 802.11ac/D1.1 40M@5G | IEEE P802.11ac™/D1.1, August 2011<br>Figure 22-18—Transmit spectral mask for a 40 MHz channel                            | 'IEEE_AC_D1_1_40_5' |
| IEEE 802.11ac/D1.1 80M@5G | IEEE P802.11ac™/D1.1, August 2011<br>Figure 22-19—Transmit spectral mask for a 80 MHz channel                            | 'IEEE_AC_D1_1_80_5' |

### [SENSe:]POWER:SEM:CLASs <Index>

This command sets the Spectrum Emission Mask (SEM) power class index. The index represents the power classes to be applied. The index is directly related to the entries displayed in the power class drop down combo box, within the SEM settings configuration page.

#### Parameters:

<Index>                      \*RST:        0

## 11.7 Configuring the Result Display

The following commands are required to configure the screen display in a remote environment. The corresponding tasks for manual operation are described in [Chapter 5.2, "Display Configuration"](#), on page 90.



The suffix <n> in the following remote commands represents the window (1..16) in the currently selected measurement channel.

- [General Window Commands](#)..... 249
- [Working with Windows in the Display](#)..... 250
- [Selecting Items to Display in Result Summary](#)..... 257
- [Configuring the Spectrum Flatness and Group Delay Result Displays](#)..... 259
- [Configuring the AM/AM Result Display](#)..... 259

### 11.7.1 General Window Commands

The following commands are required to configure general window layout, independent of the application.

Note that the suffix <n> always refers to the window *in the currently selected measurement channel* (see [INSTrument\[:SElect\]](#) on page 183).

|  |     |
|--|-----|
| <a href="#">DISPlay:FORMat</a> .....                 | 250 |
| <a href="#">DISPlay[:WINDow&lt;n&gt;]:SIZE</a> ..... | 250 |

---

### DISPlay:FORMat <Format>

This command determines which tab is displayed.

#### Parameters:

|          |  |
|----------|--|
| <Format> | <b>SPLit</b><br>Displays the MultiView tab with an overview of all active channels |
|          | <b>SINGle</b><br>Displays the measurement channel that was previously focused.     |
| *RST:    | SING   |

**Example:**           DISP:FORM SPL

---

### DISPlay[:WINDow<n>]:SIZE <Size>

This command maximizes the size of the selected result display window *temporarily*. To change the size of several windows on the screen permanently, use the [LAY:SPLe](#) command (see [LAYout:SPLe](#) on page 255).

#### Parameters:

|        |   |
|--------|---|
| <Size> | <b>LARGe</b><br>Maximizes the selected window to full screen.<br>Other windows are still active in the background.  |
|        | <b>SMALI</b><br>Reduces the size of the selected window to its original size.<br>If more than one measurement window was displayed originally, these are visible again. |
| *RST:  | SMALI   |

**Example:**           DISP:WIND2:LARG

## 11.7.2 Working with Windows in the Display

The following commands are required to change the evaluation type and rearrange the screen layout for a measurement channel as you do using the SmartGrid in manual operation. Since the available evaluation types depend on the selected application, some parameters for the following commands also depend on the selected measurement channel.

Note that the suffix <n> always refers to the window *in the currently selected measurement channel* (see [INSTrument\[:SElect\]](#) on page 183).

|                            |     |
|----------------------------|-----|
| LAYout:ADD[:WINDow]?       | 251 |
| LAYout:CATalog[:WINDow]?   | 253 |
| LAYout:IDENtify[:WINDow]?  | 254 |
| LAYout:REMove[:WINDow]     | 254 |
| LAYout:REPLace[:WINDow]    | 254 |
| LAYout:SPLitter            | 255 |
| LAYout:WINDow<n>:ADD?      | 256 |
| LAYout:WINDow<n>:IDENtify? | 256 |
| LAYout:WINDow<n>:REMove    | 257 |
| LAYout:WINDow<n>:REPLace   | 257 |

---

### LAYout:ADD[:WINDow]? <WindowName>,<Direction>,<WindowType>

This command adds a window to the display in the active measurement channel.

This command is always used as a query so that you immediately obtain the name of the new window as a result.

To replace an existing window, use the `LAYout:REPLace[:WINDow]` command.

#### Parameters:

|              |   |
|--------------|---|
| <WindowName> | String containing the name of the existing window the new window is inserted next to.<br>By default, the name of a window is the same as its index. To determine the name and index of all active windows, use the <code>LAYout:CATalog[:WINDow]?</code> query. |
| <Direction>  | LEFT   RIGHT   ABOVE   BELOW<br>Direction the new window is added relative to the existing window.  |
| <WindowType> | text value<br>Type of result display (evaluation method) you want to add. See the table below for available parameter values.   |

#### Return values:

|                 |   |
|-----------------|---|
| <NewWindowName> | When adding a new window, the command returns its name (by default the same as its number) as a result. |
|-----------------|---|

#### Example:

```
LAY:ADD? '1', LEFT, MTAB
```

Result:

```
'2'
```

Adds a new window named '2' with a marker table to the left of window 1.

#### Usage:

Query only

- Manual operation:**
- See "AM/AM" on page 22
  - See "AM/PM" on page 23
  - See "AM/EVM" on page 23
  - See "Bitstream" on page 24
  - See "Constellation" on page 26
  - See "Constellation vs Carrier" on page 28
  - See "EVM vs Carrier" on page 29
  - See "EVM vs Chip" on page 30
  - See "EVM vs Symbol" on page 30
  - See "FFT Spectrum" on page 31
  - See "Freq. Error vs Preamble" on page 33
  - See "Gain Imbalance vs Carrier" on page 33
  - See "Group Delay" on page 34
  - See "Magnitude Capture" on page 35
  - See "Phase Error vs Preamble" on page 36
  - See "Phase Tracking" on page 37
  - See "PLCP Header (IEEE 802.11b, g (DSSS))" on page 37
  - See "PvT Full PPDU" on page 38
  - See "PvT Rising Edge" on page 39
  - See "PvT Falling Edge" on page 40
  - See "Quad Error vs Carrier" on page 41
  - See "Result Summary Detailed" on page 41
  - See "Result Summary Global" on page 43
  - See "Signal Field" on page 45
  - See "Spectrum Flatness" on page 48
  - See "Diagram" on page 54
  - See "Result Summary" on page 54
  - See "Marker Table" on page 54
  - See "Marker Peak List" on page 55

**Table 11-8: <WindowType> parameter values for WLAN application**

| Parameter value                  | Window type   |
|----------------------------------|---|
| <b>Window types for I/Q data</b> |   |
| AMAM                             | AM/AM (IEEE 802.11a, g (OFDM), ac, n, p only)                       |
| AMEV                             | AM/EVM (IEEE 802.11a, g (OFDM), ac, n, p only)                      |
| AMPM                             | AM/PM (IEEE 802.11a, g (OFDM), ac, n, p only)                       |
| BITStream                        | Bitstream   |
| CMEMory                          | Magnitude Capture   |
| CONStellation                    | Constellation   |
| CVCarrier                        | Constellation vs Carrier (IEEE 802.11a, ac, g (OFDM), j, n, p only) |
| EVCARRIER                        | EVM vs Carrier (IEEE 802.11a, ac, g (OFDM), j, n, p only)           |
| EVCHip                           | EVM vs Chip (IEEE 802.11b and g (DSSS) only)                        |
| EVSYMBOL                         | EVM vs Symbol (IEEE 802.11a, ac, g (OFDM), j, n, p only)            |
| FEVPreamble                      | Frequency Error vs. Preamble  |

| Parameter value                 | Window type   |
|---------------------------------|---|
| FSPpectrum                      | FFT Spectrum  |
| GAIN                            | Gain Imbalance vs. carrier  |
| GDElay                          | Group Delay (IEEE 802.11a, ac, g (OFDM), j, n, p only)  |
| PEVPreamble                     | Phase Error vs. Preamble  |
| PFALing                         | PvT Falling Edge  |
| PFPPdu                          | PvT Full PDU  |
| PRISing                         | PvT Rising Edge   |
| PTRacking                       | Phase tracking vs. symbol   |
| QUAD                            | Quadrature error vs. carrier  |
| RSDetailed                      | Result Summary Detailed (IEEE 802.11a, ac, g (OFDM), j, n, p only)                            |
| RSGlobal                        | Result Summary Global   |
| SFfield                         | Signal Field (IEEE 802.11a, ac, g (OFDM), j, n, p)<br>PLCP Header (IEEE 802.11b and g (DSSS)) |
| SFLatness                       | Spectrum Flatness (IEEE 802.11a, ac, g (OFDM), j, n, p only)                                  |
| <b>Window types for RF data</b> |   |
| DIAGram                         | Diagram (SEM, ACLR)   |
| MTABLE                          | Marker table (SEM, ACLR)  |
| PEAKlist                        | Marker peak list (SEM, ACLR)  |
| RSUMmary                        | Result summary (SEM, ACLR)  |

### LAYout:CATalog[:WINDow]?

This command queries the name and index of all active windows in the active measurement channel from top left to bottom right. The result is a comma-separated list of values for each window, with the syntax:

```
<WindowName_1>,<WindowIndex_1>..<WindowName_n>,<WindowIndex_n>
```

#### Return values:

<WindowName>      string  
Name of the window.  
In the default state, the name of the window is its index.

<WindowIndex>    **numeric value**  
Index of the window.

#### Example:

```
LAY:CAT?
```

Result:

```
'2',2,'1',1
```

Two windows are displayed, named '2' (at the top or left), and '1' (at the bottom or right).

**Usage:** Query only

---

**LAYout:IDENTify[:WINDow]? <WindowName>**

This command queries the **index** of a particular display window in the active measurement channel.

**Note:** to query the **name** of a particular window, use the `LAYout:WINDow<n>:IDENTify?` query.

**Query parameters:**

<WindowName> String containing the name of a window.

**Return values:**

<WindowIndex> Index number of the window.

**Example:**

```
LAY:WIND:IDEN? '2'
```

Queries the index of the result display named '2'.

Response:

```
2
```

**Usage:** Query only

---

**LAYout:REMOve[:WINDow] <WindowName>**

This command removes a window from the display in the active measurement channel.

**Parameters:**

<WindowName> String containing the name of the window.  
In the default state, the name of the window is its index.

**Example:**

```
LAY:REM '2'
```

Removes the result display in the window named '2'.

**Usage:** Event

---

**LAYout:REPLace[:WINDow] <WindowName>,<WindowType>**

This command replaces the window type (for example from "Diagram" to "Result Summary") of an already existing window in the active measurement channel while keeping its position, index and window name.

To add a new window, use the `LAYout:ADD[:WINDow]?` command.

**Parameters:**

<WindowName> String containing the name of the existing window.  
By default, the name of a window is the same as its index. To determine the name and index of all active windows in the active measurement channel, use the `LAYout:CATalog[:WINDow]?` query.

<WindowType> Type of result display you want to use in the existing window.  
See `LAYout:ADD[:WINDow]?` on page 251 for a list of available window types.

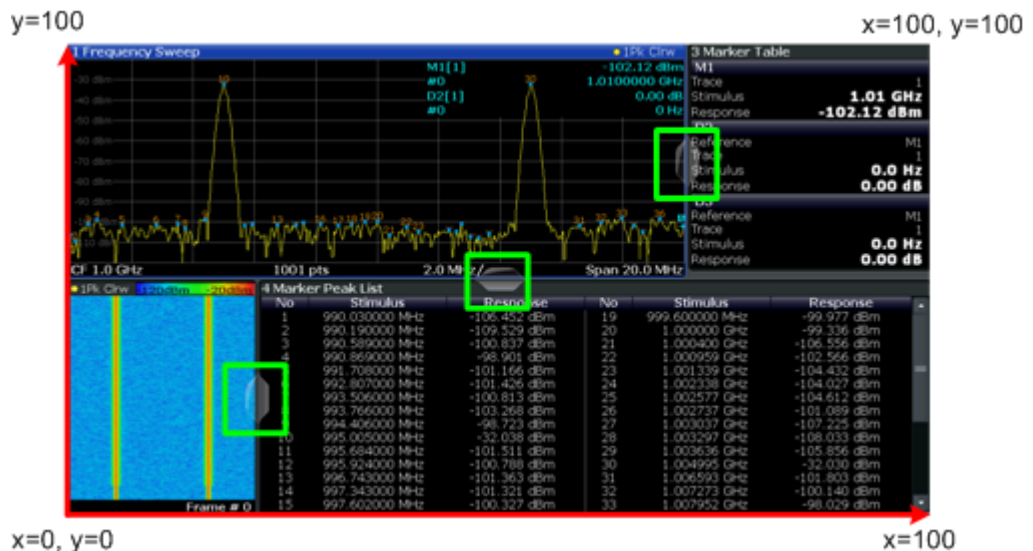
**Example:** `LAY:REPL:WIND '1',MTAB`  
Replaces the result display in window 1 with a marker table.

**LAYout:SPLitter** <Index1>,<Index2>,<Position>

This command changes the position of a splitter and thus controls the size of the windows on each side of the splitter.

Compared to the `DISPlay[:WINDow<n>]:SIZE` on page 250 command, the `LAYout:SPLitter` changes the size of all windows to either side of the splitter permanently, it does not just maximize a single window temporarily.

Note that windows must have a certain minimum size. If the position you define conflicts with the minimum size of any of the affected windows, the command will not work, but does not return an error.



**Figure 11-1:** SmartGrid coordinates for remote control of the splitters

**Parameters:**

- <Index1> The index of one window the splitter controls.
- <Index2> The index of a window on the other side of the splitter.
- <Position> New vertical or horizontal position of the splitter as a fraction of the screen area (without channel and status bar and softkey menu).  
The point of origin ( $x = 0$ ,  $y = 0$ ) is in the lower left corner of the screen. The end point ( $x = 100$ ,  $y = 100$ ) is in the upper right corner of the screen. (See [Figure 11-1](#).)  
The direction in which the splitter is moved depends on the screen layout. If the windows are positioned horizontally, the splitter also moves horizontally. If the windows are positioned vertically, the splitter also moves vertically.

Range: 0 to 100

**Example:** `LAY:SPL 1,3,50`  
 Moves the splitter between window 1 ('Frequency Sweep') and 3 ('Marker Table') to the center (50%) of the screen, i.e. in the figure above, to the left.

**Example:** `LAY:SPL 1,4,70`  
 Moves the splitter between window 1 ('Frequency Sweep') and 3 ('Marker Peak List') towards the top (70%) of the screen. The following commands have the exact same effect, as any combination of windows above and below the splitter moves the splitter vertically.

`LAY:SPL 3,2,70`

`LAY:SPL 4,1,70`

`LAY:SPL 2,1,70`

---

### LAYout:WINDow<n>:ADD? <Direction>,<WindowType>

This command adds a measurement window to the display. Note that with this command, the suffix <n> determines the existing window next to which the new window is added, as opposed to `LAYout:ADD[:WINDow]?`, for which the existing window is defined by a parameter.

To replace an existing window, use the `LAYout:WINDow<n>:REPLace` command.

This command is always used as a query so that you immediately obtain the name of the new window as a result.

#### Parameters:

<Direction> LEFT | RIGHT | ABOVE | BELOW

<WindowType> Type of measurement window you want to add.  
 See `LAYout:ADD[:WINDow]?` on page 251 for a list of available window types.

#### Return values:

<NewWindowName> When adding a new window, the command returns its name (by default the same as its number) as a result.

**Example:** `LAY:WIND1:ADD? LEFT,MTAB`  
 Result:  
 '2'  
 Adds a new window named '2' with a marker table to the left of window 1.

**Usage:** Query only

---

### LAYout:WINDow<n>:IDENTify?

This command queries the **name** of a particular display window (indicated by the <n> suffix) in the active measurement channel.

**Note:** to query the **index** of a particular window, use the `LAYout:IDENTify[:WINDow]?` command.



**Return values:**

<WindowName> String containing the name of a window.  
In the default state, the name of the window is its index.

**Example:**

```
LAY:WIND2:IDEN?
Queries the name of the result display in window 2.
Response:
'2'
```

**Usage:** Query only

**LAYout:WINDow<n>:REMOve**

This command removes the window specified by the suffix <n> from the display in the active measurement channel.

The result of this command is identical to the [LAYout:REMOve\[:WINDow\]](#) command.

**Example:**

```
LAY:WIND2:REM
Removes the result display in window 2.
```

**Usage:** Event

**LAYout:WINDow<n>:REPLace <WindowType>**

This command changes the window type of an existing window (specified by the suffix <n>) in the active measurement channel.

The result of this command is identical to the [LAYout:REPLace\[:WINDow\]](#) command.

To add a new window, use the [LAYout:WINDow<n>:ADD?](#) command.

**Parameters:**

<WindowType> Type of measurement window you want to replace another one with.  
See [LAYout:ADD\[:WINDow\]?](#) on page 251 for a list of available window types.

**Example:**

```
LAY:WIND2:REPL MTAB
Replaces the result display in window 2 with a marker table.
```

### 11.7.3 Selecting Items to Display in Result Summary

The following command defines which items are displayed in the Result Summary.

**DISPlay[:WINDow<n>]:TABLe:ITEM <Item>,<State>**

Defines which items are *displayed* in the Result Summary

(see ["Result Summary Detailed"](#) on page 41 and ["Result Summary Global"](#) on page 43).

Note that the results are always *calculated*, regardless of their visibility in the Result Summary.

**Parameters:**

<Item> Item to be included in Result Summary. For an overview of possible results and the required parameters see the tables below.

<State> ON | OFF

**ON**  
Item is displayed in Result Summary.

**OFF**  
Item is not displayed in Result Summary.

\*RST: ON

**Table 11-9: Parameters for the items of the "Result Summary Detailed"**

| Result in table                   | SCPI parameter |
|-----------------------------------|----------------|
| <b>TX channel ("Tx All")</b>      | TALL           |
| I/Q offset                        | IOFSset        |
| Gain imbalance                    | GIMBalance     |
| Quadrature offset                 | QOFFset        |
| PPDU power                        | TPPower        |
| Crest factor                      | TCFactor       |
| <b>Receive channel ("Rx All")</b> | RALL           |
| PPDU power                        | RPPower        |
| Crest factor                      | RCFactor       |
| <b>Bitstream ("Stream All")</b>   | SALL           |
| Pilot bit error rate              | BPILot         |
| EVM all carriers                  | SEACarriers    |
| EVM data carriers                 | SEDCarriers    |
| EVM pilot carriers                | SEPCarriers    |

**Table 11-10: Parameters for the items of the "Result Summary Global"**

| Result in table        | SCPI parameter |
|------------------------|----------------|
| Pilot bit error rate   | PBERate        |
| EVM all carriers       | EACarriers     |
| EVM data carriers      | EDCarriers     |
| EVM pilot carriers     | EPCarriers     |
| Center frequency error | CFERror        |
| Symbol clock error     | SCERror        |

### 11.7.4 Configuring the Spectrum Flatness and Group Delay Result Displays

The following command is only relevant for the Spectrum Flatness and Group Delay result displays.

---

**CONFigure:BURSt:SPECTrum:FLATness:CSElect** <ChannelType>

This remote control command configures the Spectrum Flatness and Group Delay results to be based on either effective or physical channels. This command is only valid for IEEE 802.11n and IEEE 802.11ac standards.

While the physical channels cannot always be determined, the effective channel can always be estimated from the known training fields. Thus, for some PPDU or measurement scenarios, only the results based on the mapping of the space-time stream to the Rx antenna (effective channel) are available, as the mapping of the Rx antennas to the Tx antennas (physical channel) could not be determined.

**Parameters:**

<ChannelType>      EFFective | PHYSical  
 \*RST:              EFF

**Example:**

CONF:BURS:SPEC:FLAT:CSEL PHYS

Configures the Spectrum Flatness and Group Delay result displays to calculate the results based on the physical channel.

**Usage:**              Event

### 11.7.5 Configuring the AM/AM Result Display

The following commands are only relevant for the AM/AM result display.

---

**CONFigure:BURSt:AM:AM:POLYnomial** <Degree>

This remote control command specifies the degree of the polynomial regression model used to determine the AM/AM result display.

The resulting coefficients of the regression polynomial can be queried using the [FETCh:BURSt:AM:AM:COEFFicients?](#) command.

**Parameters:**

<Degree>            integer  
 Range:              1 to 20  
 \*RST:                4

**Example:**

CONF:BURS:AM:AM:POLY 3

**Manual operation:** See "[AM/AM](#)" on page 22

---

**DISPlay[:WINDow<n>]:TRACe<t>:X[:SCALe]:AUTO <State>**

**DISPlay[:WINDow<n>]:TRACe<t>:Y[:SCALe]:AUTO <State>**

This command activates or deactivates automatic scaling of the x-axis or y-axis for the specified trace display. If enabled, the R&S FPS WLAN application automatically scales the x-axis or y-axis to best fit the measurement results.

If disabled, the x-axis or y-axis is scaled according to the specified minimum/maximum values (see `DISPlay[:WINDow<n>]:TRACe<t>:Y[:SCALe]:MINimum/`  
`DISPlay[:WINDow<n>]:TRACe<t>:Y[:SCALe]:MAXimum`) and number of divisions (see `DISPlay[:WINDow<n>]:TRACe<t>:Y[:SCALe]:DIVisions`).

**Parameters:**

<State>                    ON | OFF | 0 | 1  
                               **OFF | 0**  
                               Switches the function off  
                               **ON | 1**  
                               Switches the function on

\*RST:                    1

**Example:**                    DISP:WIND2:TRAC:Y:SCAL:AUTO ON

**Manual operation:**    See "[Automatic Grid Scaling](#)" on page 147

---

**DISPlay[:WINDow<n>]:TRACe<t>:X[:SCALe]:AUTO:FIXed:RANGe**  
                               <AutoFixRange>

**DISPlay[:WINDow<n>]:TRACe<t>:Y[:SCALe]:AUTO:FIXed:RANGe**  
                               <AutoFixRange>

This command defines the use of fixed value limits.

**Parameters:**

<AutoFixRange>            NONE | LOWer | UPPer  
                               **NONE**  
                               Both the upper and lower limits are determined by automatic scaling of the x-axis or y-axis.  
                               **LOWer**  
                               The lower limit is fixed (defined by `DISPlay[:WINDow<n>]:TRACe<t>:Y[:SCALe]:MINimum/`  
`DISPlay[:WINDow<n>]:TRACe<t>:Y[:SCALe]:MAXimum`), while the upper limit is determined by automatic scaling of the x-axis or y-axis.  
                               **UPPer**  
                               The upper limit is fixed, while the lower limit is determined by automatic scaling of the x-axis or y-axis.

**Example:**                    DISP:WIND1:TRAC:Y:AUTO:FIX:RANG LOW  
                                   DISP:WIND1:TRAC:Y:MIN 0dBm  
                                   Sets the lower limit of the y-axis to a fixed value of 0 dBm.

**Manual operation:**    See "[Auto Fix Range](#)" on page 147

---

**DISPlay[:WINDow<N>]:TRACe<t>:X[:SCALe]:AUTO:HYSTeresis:LOWer:UPPer**  
<Value>

**DISPlay[:WINDow<N>]:TRACe<t>:Y[:SCALe]:AUTO:HYSTeresis:LOWer:UPPer**  
<Value>

For automatic scaling based on hysteresis, this command defines the upper limit of the lower hysteresis interval.

If the minimum value in the current measurement exceeds this limit, the x-axis or y-axis is rescaled automatically.

For details see "[Hysteresis Interval Upper/Lower](#)" on page 148.

**Parameters:**

<Value> Percentage of the currently displayed value range on the x-axis or y-axis.

**Example:** `DISP:WIND2:TRAC:Y:SCAL:AUTO:HYST:LOW:UPP 5`

**Manual operation:** See "[Hysteresis Interval Upper/Lower](#)" on page 148

---

**DISPlay[:WINDow<N>]:TRACe<t>:X[:SCALe]:AUTO:HYSTeresis:LOWer:LOWer**  
<Value>

**DISPlay[:WINDow<N>]:TRACe<t>:Y[:SCALe]:AUTO:HYSTeresis:LOWer:LOWer**  
<Value>

For automatic scaling based on hysteresis, this command defines the lower limit of the lower hysteresis interval.

If the minimum value in the current measurement drops below this limit, the x-axis or y-axis is rescaled automatically.

For details see "[Hysteresis Interval Upper/Lower](#)" on page 148.

**Parameters:**

<Value> Percentage of the currently displayed value range on the x-axis or y-axis.

**Example:** `DISP:WIND2:TRAC:Y:SCAL:AUTO:HYST:LOW:LOW 5`

**Manual operation:** See "[Hysteresis Interval Upper/Lower](#)" on page 148

---

**DISPlay[:WINDow<N>]:TRACe<t>:X[:SCALe]:AUTO:HYSTeresis:UPPer:LOWer**  
<Value>

**DISPlay[:WINDow<N>]:TRACe<t>:Y[:SCALe]:AUTO:HYSTeresis:UPPer:LOWer**  
<Value>

For automatic scaling based on hysteresis, this command defines the lower limit of the upper hysteresis interval.

If the maximum value in the current measurement drops below this limit, the x-axis or y-axis is rescaled automatically.

For details see "[Hysteresis Interval Upper/Lower](#)" on page 148.

**Parameters:**

<Value> Percentage of the currently displayed value range on the x-axis or y-axis.

**Example:**

DISP:WIND2:TRAC:Y:AUTO:HYST:UPP:LOW 25

**Manual operation:** See "[Hysteresis Interval Upper/Lower](#)" on page 148

**DISPlay[:WINDow<N>]:TRACe<t>:X[:SCALe]:AUTO:HYSTeresis:UPPer:UPPer**  
<Value>

**DISPlay[:WINDow<N>]:TRACe<t>:Y[:SCALe]:AUTO:HYSTeresis:UPPer:UPPer**  
<Value>

For automatic scaling based on hysteresis, this command defines the upper limit of the upper hysteresis interval.

If the maximum value in the current measurement exceeds this limit, the x-axis or y-axis is rescaled automatically.

For details see "[Hysteresis Interval Upper/Lower](#)" on page 148.

**Parameters:**

<Value> Percentage of the currently displayed value range on the x-axis or y-axis.

**Example:**

DISP:WIND2:TRAC:Y:AUTO:HYST:UPP:UPP 20

**Manual operation:** See "[Hysteresis Interval Upper/Lower](#)" on page 148

**DISPlay[:WINDow<n>]:TRACe<t>:X[:SCALe]:AUTO:MEMory:DEPTh <NoMeas>**  
**DISPlay[:WINDow<n>]:TRACe<t>:Y[:SCALe]:AUTO:MEMory:DEPTh <NoMeas>**

For automatic scaling based on memory, this value defines the number <x> of previous results to be considered when determining if rescaling is required.

The minimum and maximum value of each measurement are added to the memory. After <x> measurements, the oldest results in the memory are overwritten by each new measurement.

For details see "[Auto Mode](#)" on page 147.

**Parameters:**

<NoMeas> integer value  
Number of measurement results to be stored for autoscaling

**Example:**

DISP:WIND2:TRAC:Y:AUTO:MEM:DEPT 16

**Manual operation:** See "[Memory Depth](#)" on page 149

**DISPlay[:WINDow<n>]:TRACe<t>:X[:SCALe]:AUTO:MODE <AutoMode>**  
**DISPlay[:WINDow<n>]:TRACe<t>:Y[:SCALe]:AUTO:MODE <AutoMode>**

This command determines which algorithm is used to determine whether the x-axis or y-axis requires automatic rescaling.

**Parameters:**

&lt;AutoMode&gt;

**HYSTeresis**

If the minimum and/or maximum values of the current measurement exceed a specific value range (hysteresis interval), the axis is rescaled. The hysteresis interval is defined as a percentage of the currently displayed value range on the x-axis or y-axis. An upper hysteresis interval is defined for the maximum value, a lower hysteresis interval is defined for the minimum value.

**MEMory**

If the minimum and/or maximum values of the current measurement exceed the minimum and/or maximum of the <x> previous results, the axis is rescaled.

The minimum and maximum value of each measurement are added to the memory. After <x> measurements, the oldest results in the memory are overwritten by each new measurement.

The number of results in the memory to be considered is configurable (see `DISPlay[:WINDow<n>]:TRACe<t>:Y[:SCALe]:AUTO:MEMory:DEPTh`).

\*RST:       HYSTeresis

**Example:**

DISP:WIND2:TRAC:Y:AUTO:MODE MEM

**Manual operation:** See "[Auto Mode](#)" on page 147

**DISPlay[:WINDow<n>]:TRACe<t>:X[:SCALe]:DIVisions <NoDivisions>**

**DISPlay[:WINDow<n>]:TRACe<t>:Y[:SCALe]:DIVisions <NoDivisions>**

Defines the number of divisions to be used for the x-axis or y-axis in the specified window.

Separate division settings can be configured for individual result displays.

**Parameters:**

&lt;NoDivisions&gt;

**Example:**

DISP:WIND2:TRAC:Y:SCAL:DIV 10

**Manual operation:** See "[Number of Divisions](#)" on page 149

**DISPlay[:WINDow<n>]:TRACe<t>:X[:SCALe]:MAXimum <Max>**

**DISPlay[:WINDow<n>]:TRACe<t>:Y[:SCALe]:MAXimum <Max>**

Defines the maximum value to be displayed on the x-axis or y-axis of the specified evaluation diagram.

For automatic scaling with a fixed range (see `DISPlay[:WINDow<n>]:TRACe<t>:Y[:SCALe]:AUTO:FIXed:RANGe` on page 260), the maximum defines the fixed upper limit.

**Suffix:**

&lt;n&gt;

1..n

<t> 1..n

**Parameters:**

<Max>

**Example:** DISP:WIND2:TRAC:Y:SCAL:MAX 100

**Manual operation:** See "[Minimum / Maximum](#)" on page 148

**DISPlay[:WINDow<n>]:TRACe<t>:X[:SCALe]:MINimum <Min>**

**DISPlay[:WINDow<n>]:TRACe<t>:Y[:SCALe]:MINimum <Min>**

Defines the minimum value to be displayed on the x-axis or y-axis of the specified evaluation diagram.

For automatic scaling with a fixed range (see [DISPlay\[:WINDow<n>\]:TRACe<t>:Y\[:SCALe\]:AUTO:FIXed:RANGe](#) on page 260), the minimum defines the fixed lower limit.

**Suffix:**

<n> 1..n

<t> 1..n

**Parameters:**

<Min>

**Example:** DISP:WIND2:TRAC:Y:SCAL:MIN -20

**Manual operation:** See "[Minimum / Maximum](#)" on page 148

**DISPlay[:WINDow<n>]:TRACe<t>:X[:SCALe]:PDIVision**

<State\_1>,<State\_2>,<State\_2\_5>,<State\_5>

**DISPlay[:WINDow<n>]:TRACe<t>:Y[:SCALe]:PDIVision <Multiple>[,<Multiple>]**

Determines the values shown for each division on the x-axis or y-axis in the specified window.

One or more multiples of  $10^n$  can be selected. The R&S FPS WLAN application then selects the optimal scaling from the selected values.

For details see "[Scaling per division](#)" on page 149.

**Parameters:**

<Multiple> 1.0 | 2.0 | 2.5 | 5.0

If enabled, each division on the x-axis or y-axis displays the selected multiple of  $10^n$ .

\*RST: 1.0,5.0

**Example:** DISP:WIND:TRAC:Y:SCAL:PDIV 2.0,2.5

Multiples of  $2.0 \cdot 10^n$  or multiples of  $2.5 \cdot 10^n$  are displayed on the x-axis or y-axis.

**Manual operation:** See "[Scaling per division](#)" on page 149



## 11.8 Starting a Measurement

When a WLAN measurement channel is activated on the R&S FPS, a WLAN IQ measurement (Modulation Accuracy, Flatness and Tolerance, see [Chapter 3.1, "WLAN I/Q Measurement \(Modulation Accuracy, Flatness and Tolerance\)"](#), on page 12), is started immediately. However, you can stop and start a new measurement any time.

Furthermore, you can perform a sequence of measurements using the Sequencer (see [Chapter 5.1, "Multiple Measurement Channels and Sequencer Function"](#), on page 88).

|  |     |
|--|-----|
| ABORt.....                               | 265 |
| CALCulate<n>:BURSt[:IMMEDIATE].....      | 266 |
| INITiate<n>:CONTinuous.....              | 266 |
| INITiate<n>[:IMMEDIATE].....             | 267 |
| INITiate<n>:SEQuencer:ABORt.....         | 267 |
| INITiate<n>:SEQuencer:IMMEDIATE.....     | 267 |
| INITiate<n>:SEQuencer:MODE.....          | 268 |
| INITiate<n>:SEQuencer:REFResh[:ALL]..... | 268 |
| SYSTem:SEQuencer.....                    | 269 |

### ABORt

This command aborts the measurement in the current measurement channel and resets the trigger system.

To prevent overlapping execution of the subsequent command before the measurement has been aborted successfully, use the `*OPC?` or `*WAI` command after `ABOR` and before the next command.

For details see the "Remote Basics" chapter in the R&S FPS User Manual.

To abort a sequence of measurements by the Sequencer, use the `INITiate<n>:SEQuencer:ABORt` command.

#### Note on blocked remote control programs:

If a sequential command cannot be completed, for example because a triggered sweep never receives a trigger, the remote control program will never finish and the remote channel to the R&S FPS is blocked for further commands. In this case, you must interrupt processing on the remote channel first in order to abort the measurement.

To do so, send a "Device Clear" command from the control instrument to the R&S FPS on a parallel channel to clear all currently active remote channels. Depending on the used interface and protocol, send the following commands:

- **Visa:** `viClear()`

Now you can send the `ABORt` command on the remote channel performing the measurement.

#### Example:

```
ABOR; :INIT:IMM
```

Aborts the current measurement and immediately starts a new one.

|                 |  |
|-----------------|--|
| <b>Example:</b> | ABOR; *WAI<br>INIT: IMM<br>Aborts the current measurement and starts a new one once abortion has been completed. |
| <b>Usage:</b>   | Event<br>SCPI confirmed  |

**CALCulate<n>:BURSt[:IMMEDIATE]**

This command forces the IQ measurement results to be recalculated according to the current settings.

**Manual operation:** See "[Calc Results](#)" on page 117

**INITiate<n>:CONTInuous <State>**

This command controls the measurement mode for an individual measurement channel.

Note that in single measurement mode, you can synchronize to the end of the measurement with \*OPC, \*OPC? or \*WAI. In continuous measurement mode, synchronization to the end of the measurement is not possible. Thus, it is not recommended that you use continuous measurement mode in remote control, as results like trace data or markers are only valid after a single measurement end synchronization.

For details on synchronization see the "Remote Basics" chapter in the R&S FPS User Manual.

If the measurement mode is changed for a measurement channel while the Sequencer is active (see [INITiate<n>:SEQuencer:IMMEDIATE](#) on page 267) the mode is only considered the next time the measurement in that channel is activated by the Sequencer.

|                    |  |
|--------------------|--|
| <b>Suffix:</b>     |  |
| <n>                | irrelevant   |
| <b>Parameters:</b> |  |
| <State>            | ON   OFF   0   1<br><b>ON   1</b><br>Continuous measurement<br><b>OFF   0</b><br>Single measurement<br>*RST: 0 |

|                 |   |
|-----------------|---|
| <b>Example:</b> | INIT:CONT OFF<br>Switches the measurement mode to single measurement.<br>INIT:CONT ON<br>Switches the measurement mode to continuous measurement. |
|-----------------|---|

**Manual operation:** See "[Continuous Sweep/RUN CONT](#)" on page 150

**INITiate<n>[:IMMEDIATE]**

This command starts a (single) new measurement.

You can synchronize to the end of the measurement with \*OPC, \*OPC? or \*WAI.

For details on synchronization see the "Remote Basics" chapter in the R&S FPS User Manual.

**Suffix:**

<n> irrelevant

**Usage:**

Event

**Manual operation:**

See "Single / Cont." on page 117

See "Single Sweep/ RUN SINGLE" on page 151

**INITiate<n>:SEQuencer:ABORT**

This command stops the currently active sequence of measurements. The Sequencer itself is not deactivated, so you can start a new sequence immediately using [INITiate<n>:SEQuencer:IMMEDIATE](#) on page 267.

To deactivate the Sequencer use [SYSTem:SEQuencer](#) on page 269.

**Suffix:**

<n> irrelevant

**Usage:**

Event

**Manual operation:**

See "Sequencer State" on page 89

**INITiate<n>:SEQuencer:IMMEDIATE**

This command starts a new sequence of measurements by the Sequencer.

Its effect is similar to the [INITiate<n>\[:IMMEDIATE\]](#) command used for a single measurement.

Before this command can be executed, the Sequencer must be activated (see [SYSTem:SEQuencer](#) on page 269).

**Suffix:**

<n> irrelevant

**Example:**

```
SYST:SEQ ON
```

Activates the Sequencer.

```
INIT:SEQ:MODE SING
```

Sets single sequence mode so each active measurement will be performed once.

```
INIT:SEQ:IMM
```

Starts the sequential measurements.

**Usage:**

Event

**Manual operation:**

See "Sequencer State" on page 89

**INITiate<n>:SEQuencer:MODE <Mode>**

This command selects the way the R&S FPS application performs measurements sequentially.

Before this command can be executed, the Sequencer must be activated (see [SYSTem:SEQuencer](#) on page 269).

A detailed programming example is provided in the "Operating Modes" chapter in the R&S FPS User Manual.

**Note:** In order to synchronize to the end of a sequential measurement using \*OPC, \*OPC? or \*WAI you must use `SINGle` Sequence mode.

For details on synchronization see the "Remote Basics" chapter in the R&S FPS User Manual.

**Suffix:**

<n> irrelevant

**Parameters:**

<Mode>

**SINGle**

Each measurement is performed once (regardless of the channel's sweep mode), considering each channels' sweep count, until all measurements in all active channels have been performed.

**CONTInuous**

The measurements in each active channel are performed one after the other, repeatedly (regardless of the channel's sweep mode), in the same order, until the Sequencer is stopped.

**CDEFined**

First, a single sequence is performed. Then, only those channels in continuous sweep mode (`INIT:CONT ON`) are repeated.

\*RST: CONTInuous

**Example:**

```
SYST:SEQ ON
```

Activates the Sequencer.

```
INIT:SEQ:MODE SING
```

Sets single sequence mode so each active measurement will be performed once.

```
INIT:SEQ:IMM
```

Starts the sequential measurements.

**Manual operation:** See "[Sequencer Mode](#)" on page 89

**INITiate<n>:SEQuencer:REFResh[:ALL]**

This function is only available if the Sequencer is deactivated ([SYSTem:SEQuencer](#) `SYST:SEQ:OFF`) and only in MSRA mode.

The data in the capture buffer is re-evaluated by all active MSRA applications.

(The suffix <n> is irrelevant.)

|                 |   |
|-----------------|---|
| <b>Example:</b> | <pre>SYST:SEQ:OFF</pre> <p>Deactivates the scheduler</p> <pre>INIT:CONT OFF</pre> <p>Switches to single sweep mode.</p> <pre>INIT;*WAI</pre> <p>Starts a new data measurement and waits for the end of the sweep.</p> <pre>INIT:SEQ:REFR</pre> <p>Refreshes the display for all channels.</p> |
| <b>Usage:</b>   | Event   |

---

### SYSTem:SEQuencer <State>

This command turns the Sequencer on and off. The Sequencer must be active before any other Sequencer commands (`INIT:SEQ...`) are executed, otherwise an error will occur.

A detailed programming example is provided in the "Operating Modes" chapter in the R&S FPS User Manual.

#### Parameters:

|         |   |
|---------|---|
| <State> | ON   OFF   0   1  |
|         | <b>ON   1</b>   |
|         | The Sequencer is activated and a sequential measurement is started immediately.   |
|         | <b>OFF   0</b>  |
|         | The Sequencer is deactivated. Any running sequential measurements are stopped. Further Sequencer commands ( <code>INIT:SEQ...</code> ) are not available. |
|         | *RST: 0   |

|                 |  |
|-----------------|--|
| <b>Example:</b> | <pre>SYST:SEQ ON</pre> <p>Activates the Sequencer.</p> <pre>INIT:SEQ:MODE SING</pre> <p>Sets single Sequencer mode so each active measurement will be performed once.</p> <pre>INIT:SEQ:IMM</pre> <p>Starts the sequential measurements.</p> <pre>SYST:SEQ OFF</pre> |
|-----------------|--|

**Manual operation:** See "[Sequencer State](#)" on page 89

## 11.9 Retrieving Results

The following commands are required to retrieve the results from a WLAN measurement in a remote environment.



Before retrieving measurement results, check if PPDU synchronization was successful or not by checking the status register (see [Chapter 11.11.1, "The STATus:QUESTIONable:SYNC Register"](#), on page 307). If no PDUs were found, STAT:QUES:SYNC:COND? returns 0 (see [STATus:QUESTIONable:SYNC:CONDition?](#) on page 309).



The \*OPC command should be used after commands that retrieve data so that subsequent commands to change the trigger or data capturing settings are held off until after the data capture is completed and the data has been returned.

- [Numeric Modulation Accuracy, Flatness and Tolerance Results](#).....270
- [Numeric Results for Frequency Sweep Measurements](#).....283
- [Retrieving Trace Results](#).....288
- [Measurement Results for TRACe<n>\[:DATA\]? TRACE<n>](#).....292
- [Importing and Exporting I/Q Data and Results](#).....302

## 11.9.1 Numeric Modulation Accuracy, Flatness and Tolerance Results

The following commands describe how to retrieve the numeric results from the standard WLAN measurements.



The commands to retrieve results from frequency sweep measurements for WLAN signals are described in [Chapter 11.9.2, "Numeric Results for Frequency Sweep Measurements"](#), on page 283.

- [PPDU and Symbol Count Results](#).....270
- [Error Parameter Results](#)..... 272
- [Limit Check Results](#)..... 280

### 11.9.1.1 PPDU and Symbol Count Results

The following commands are required to retrieve PPDU and symbol count results from the WLAN IQ measurement on the captured I/Q data (see [Chapter 3.1.1, "Modulation Accuracy, Flatness and Tolerance Parameters"](#), on page 12).

|  |     |
|--|-----|
| <a href="#">FETCh:BURSt:COUNt?</a> .....     | 271 |
| <a href="#">FETCh:BURSt:COUNt:ALL?</a> ..... | 271 |
| <a href="#">FETCh:SYMBol:COUNt?</a> .....    | 271 |
| <a href="#">FETCh:BURSt:LENGthS?</a> .....   | 271 |
| <a href="#">FETCh:BURSt:STARtS?</a> .....    | 271 |
| <a href="#">UNIT:BURSt</a> .....             | 272 |

---

**FETCh:BURSt:COUnT?**

This command returns the number of analyzed PPDU's from the current capture buffer. If multiple measurements are required because the number of PPDU's to analyze is greater than the number of PPDU's that can be captured in one buffer, this command only returns the number of captured PPDU's *in the current capture buffer* (as opposed to [FETCh:BURSt:COUnT:ALL?](#)).

**Usage:** Query only

---

**FETCh:BURSt:COUnT:ALL?**

This command returns the number of analyzed PPDU's for the entire measurement. If multiple measurements are required because the number of PPDU's to analyze is greater than the number of PPDU's that can be captured in one buffer, this command returns the number of analyzed PPDU's in *all* measurements (as opposed to [FETCh:BURSt:COUnT?](#)).

**Usage:** Query only

---

**FETCh:SYMBol:COUnT?**

This command returns the number of symbols in each analyzed PPDU as a comma separated list. The length of the list corresponds to the number of PPDU's, i.e. the result of [FETCh:BURSt:COUnT:ALL?](#).

**Usage:** Query only

---

**FETCh:BURSt:LENGthS?**

This command returns the length of the analyzed PPDU's from the current measurement. If the number of PPDU's to analyze is greater than the number of PPDU's that can be captured in one buffer, this command only returns the lengths of the PPDU's *in the current capture buffer*.

The result is a comma-separated list of lengths, one for each PPDU.

**Return values:**

<PPDULength> Length of the PPDU in the unit specified by the [UNIT:BURSt](#) command.

**Usage:** Query only

---

**FETCh:BURSt:STARtS?**

This command returns the start position of each analyzed PPDU in the current capture buffer.

**Return values:**

<Position> Comma-separated list of samples or symbols (depending on the `UNIT:BURSt` command) indicating the start position of each PDU.

**Usage:**

Query only

**UNIT:BURSt <Unit>**

This command specifies the units for PDU length results (see `FEtCh:BURSt:LENGthS?` on page 271).

**Parameters:**

<Unit> SYMBol | SAMPlE  
\*RST: SYMBol

**11.9.1.2 Error Parameter Results**

The following commands are required to retrieve individual results from the WLAN IQ measurement on the captured I/Q data (see [Chapter 3.1.1, "Modulation Accuracy, Flatness and Tolerance Parameters"](#), on page 12).

|  |     |
|--|-----|
| <code>FEtCh:BURSt:ALL</code> .....                 | 273 |
| <code>FEtCh:BURSt:AM:AM:COEFficients?</code> ..... | 274 |
| <code>FEtCh:BURSt:BERPilot:AVERAge?</code> .....   | 275 |
| <code>FEtCh:BURSt:BERPilot:MAXimum?</code> .....   | 275 |
| <code>FEtCh:BURSt:BERPilot:MINimum?</code> .....   | 275 |
| <code>FEtCh:BURSt:CPERror:AVERAge</code> .....     | 275 |
| <code>FEtCh:BURSt:CPERror:MAXimum</code> .....     | 275 |
| <code>FEtCh:BURSt:CPERror:MINimum</code> .....     | 275 |
| <code>FEtCh:BURSt:CRESt[:AVERAge]?</code> .....    | 275 |
| <code>FEtCh:BURSt:CRESt:MAXimum?</code> .....      | 275 |
| <code>FEtCh:BURSt:CRESt:MINimum?</code> .....      | 275 |
| <code>FEtCh:BURSt:EVM:ALL:AVERAge?</code> .....    | 275 |
| <code>FEtCh:BURSt:EVM:ALL:MAXimum?</code> .....    | 275 |
| <code>FEtCh:BURSt:EVM:ALL:MINimum?</code> .....    | 275 |
| <code>FEtCh:BURSt:EVM:DATA:AVERAge?</code> .....   | 276 |
| <code>FEtCh:BURSt:EVM:DATA:MAXimum?</code> .....   | 276 |
| <code>FEtCh:BURSt:EVM:DATA:MINimum?</code> .....   | 276 |
| <code>FEtCh:BURSt:EVM:DIRect:AVERAge?</code> ..... | 276 |
| <code>FEtCh:BURSt:EVM:DIRect:MAXimum?</code> ..... | 276 |
| <code>FEtCh:BURSt:EVM:DIRect:MINimum?</code> ..... | 276 |
| <code>FEtCh:BURSt:EVM:PILot:AVERAge?</code> .....  | 276 |
| <code>FEtCh:BURSt:EVM:PILot:MAXimum?</code> .....  | 276 |
| <code>FEtCh:BURSt:EVM:PILot:MINimum?</code> .....  | 276 |
| <code>FEtCh:BURSt:EVM[:IEEE]:AVERAge?</code> ..... | 277 |
| <code>FEtCh:BURSt:EVM[:IEEE]:MAXimum?</code> ..... | 277 |
| <code>FEtCh:BURSt:EVM[:IEEE]:MINimum?</code> ..... | 277 |
| <code>FEtCh:BURSt:CFERror:AVERAge</code> .....     | 277 |
| <code>FEtCh:BURSt:CFERror:MAXimum</code> .....     | 277 |



|                                       |     |
|---------------------------------------|-----|
| FETCh:BURSt:CFERror:MINimum.....      | 277 |
| FETCh:BURSt:FERRor:AVERage?.....      | 277 |
| FETCh:BURSt:FERRor:MAXimum?.....      | 277 |
| FETCh:BURSt:FERRor:MINimum?.....      | 277 |
| FETCh:BURSt:GIMBalance:AVERage?.....  | 277 |
| FETCh:BURSt:GIMBalance:MAXimum?.....  | 277 |
| FETCh:BURSt:GIMBalance:MINimum?.....  | 277 |
| FETCh:BURSt:IQOFfset:AVERage?.....    | 277 |
| FETCh:BURSt:IQOFfset:MAXimum?.....    | 277 |
| FETCh:BURSt:IQOFfset:MINimum?.....    | 277 |
| FETCh:BURSt:EVM:ALL:AVERage?.....     | 278 |
| FETCh:BURSt:EVM:ALL:MAXimum?.....     | 278 |
| FETCh:BURSt:EVM:ALL:MINimum?.....     | 278 |
| FETCh:BURSt:MCPower:AVERage.....      | 278 |
| FETCh:BURSt:MCPower:MAXimum.....      | 278 |
| FETCh:BURSt:MCPower:MINimum.....      | 278 |
| FETCh:BURSt:PAYLoad[:AVERage]?.....   | 278 |
| FETCh:BURSt:PAYLoad:MINimum?.....     | 278 |
| FETCh:BURSt:PAYLoad:MAXimum?.....     | 278 |
| FETCh:BURSt:PEAK[:AVERage]?.....      | 278 |
| FETCh:BURSt:PEAK:MINimum?.....        | 278 |
| FETCh:BURSt:PEAK:MAXimum?.....        | 278 |
| FETCh:BURSt:PREamble[:AVERage]?.....  | 278 |
| FETCh:BURSt:PREamble:MINimum?.....    | 278 |
| FETCh:BURSt:PREamble:MAXimum?.....    | 278 |
| FETCh:BURSt:QUADoffset:AVERage?.....  | 279 |
| FETCh:BURSt:QUADoffset:MAXimum?.....  | 279 |
| FETCh:BURSt:QUADoffset:MINimum?.....  | 279 |
| FETCh:BURSt:RMS[:AVERage]?.....       | 279 |
| FETCh:BURSt:RMS:MAXimum?.....         | 279 |
| FETCh:BURSt:RMS:MINimum?.....         | 279 |
| FETCh:BURSt:SYMBOLerror:AVERage?..... | 279 |
| FETCh:BURSt:SYMBOLerror:MAXimum?..... | 279 |
| FETCh:BURSt:SYMBOLerror:MINimum?..... | 279 |
| FETCh:BURSt:TFALI:AVERage?.....       | 279 |
| FETCh:BURSt:TFALI:MAXimum?.....       | 279 |
| FETCh:BURSt:TFALI:MINimum?.....       | 279 |
| FETCh:BURSt:TRISe:AVERage?.....       | 280 |
| FETCh:BURSt:TRISe:MAXimum?.....       | 280 |
| FETCh:BURSt:TRISe:MINimum?.....       | 280 |
| UNIT:EVM.....                         | 280 |
| UNIT:GIMBalance.....                  | 280 |
| UNIT:PREamble.....                    | 280 |

---

### FETCh:BURSt:ALL

This command returns all results from the default WLAN measurement (Modulation Accuracy, Flatness and Tolerance)

(see [Chapter 3.1.1, "Modulation Accuracy, Flatness and Tolerance Parameters"](#), on page 12).

The results are output as a list of result strings separated by commas in ASCII format. The results are output in the following order:

<Global Result>, <Stream 1 result> ... <Stream n result>

**Return values:**

<Global Result>      <preamble power>, <payload power>, <peak power>, <min rms power>, <avg rms power>, <max rms power>, 'nan','nan','nan', <min freq error>, <avg freq error>, <max freq error>, <min symbol error>, <avg symbol error>, <max symbol error>, 'nan','nan','nan', 'nan','nan','nan', 'nan','nan','nan', <min EVM all>, <avg EVM all>, <max EVM all>, <min EVM data>, <avg EVM data >, <max EVM data> <min EVM pilots>, <avg EVM pilots >, <max EVM pilots> 'nan','nan','nan', 'nan','nan','nan', 'nan','nan','nan', 'nan','nan','nan',

<Stream Results>    'nan','nan','nan', 'nan','nan','nan', <peak power>, <min rms power>, <avg rms power>, <max rms power>, <min crest factor>, <avg crest factor>, <max crest factor>, <min freq error>, <avg freq error>, <max freq error>, <min symbol error>, <avg symbol error>, <max symbol error>, <min IQ offset>, <avg IQ offset>, <max IQ offset>, <min gain imb>, <avg gain imb>, <max gain imb>, <min quad offset>, <avg quad offset>, <max quad offset>, <min EVM all>, <avg EVM all>, <max EVM all>, <min EVM data>, <avg EVM data >, <max EVM data> <min EVM pilots>, <avg EVM pilots >, <max EVM pilots> <min BER>, <avg BER >, <max BER> <min IQ skew>, <avg IQ skew>, <max IQ skew> <min MIMO CP>, <avg MIMO CP>, <max MIMO CP> <min CPE>, <avg CPE>, <max CPE>

**Manual operation:**    See ["Result Summary Detailed"](#) on page 41  
                               See ["Result Summary Global"](#) on page 43

---

**FETCh:BURSt:AM:AM:COEFFicients?**

This remote control returns the coefficients of the polynomial regression model used to determine the AM/AM result display.

See ["AM/AM"](#) on page 22 for details.

**Return values:**

<Coefficients>            comma-separated list of numeric values  
 The coefficients are listed in ascending order of degree (as displayed in the result display title bar).

**Example:**

FETCH:BURSt:AM:AM:COEF?

**Usage:**

Query only

**FETCH:BURSt:BERPilot:AVERAge?****FETCH:BURSt:BERPilot:MAXimum?****FETCH:BURSt:BERPilot:MINimum?**

This command returns the Bit Error Rate (BER) for Pilots (average, maximum or minimum value) in % for the IEEE 802.11n (MIMO) standard. For details see [Chapter 3.1.1, "Modulation Accuracy, Flatness and Tolerance Parameters"](#), on page 12.

**Return values:**

<Result>                    <Global Result>, <Stream 1 result> ... <Stream n result>

**Usage:**

Query only

**FETCH:BURSt:CPERror:AVERAge****FETCH:BURSt:CPERror:MAXimum****FETCH:BURSt:CPERror:MINimum**

This command returns the common phase error (average, maximum or minimum value) in degrees for the IEEE 802.11n (MIMO) standard. For details see [Chapter 3.1.1, "Modulation Accuracy, Flatness and Tolerance Parameters"](#), on page 12.

**Parameters:**

<Result>                    <Stream 1 result> ... <Stream n result>

**FETCH:BURSt:CRESt[:AVERAge]?****FETCH:BURSt:CRESt:MAXimum?****FETCH:BURSt:CRESt:MINimum?**

This command returns the average, maximum or minimum determined CREST factor (= ratio of peak power to average power) in dB.

For details see [Chapter 3.1.1, "Modulation Accuracy, Flatness and Tolerance Parameters"](#), on page 12.

**Usage:**

Query only

**FETCH:BURSt:EVM:ALL:AVERAge?****FETCH:BURSt:EVM:ALL:MAXimum?****FETCH:BURSt:EVM:ALL:MINimum?**

This command returns the average, maximum or minimum EVM in dB. This is a combined figure that represents the pilot, data and the free carrier.

For details see [Chapter 3.1.1, "Modulation Accuracy, Flatness and Tolerance Parameters"](#), on page 12.

**Return values:**

<Result>                    <Global Result>, <Stream 1 result> ... <Stream n result>

**Usage:**                    Query only

**FETCh:BURSt:EVM:DATA:AVERage?**

**FETCh:BURSt:EVM:DATA:MAXimum?**

**FETCh:BURSt:EVM:DATA:MINimum?**

This command returns the average, maximum or minimum EVM for the data carrier in dB.

For details see [Chapter 3.1.1, "Modulation Accuracy, Flatness and Tolerance Parameters"](#), on page 12.

**Return values:**

<Result>                    <Global Result>, <Stream 1 result> ... <Stream n result>

**Usage:**                    Query only

**FETCh:BURSt:EVM:DIRect:AVERage?**

**FETCh:BURSt:EVM:DIRect:MAXimum?**

**FETCh:BURSt:EVM:DIRect:MINimum?**

This command returns the average, maximum or minimum EVM in dB for the IEEE 802.11b standard. This result is the value after filtering.

For details see [Chapter 3.1.1, "Modulation Accuracy, Flatness and Tolerance Parameters"](#), on page 12.

**Usage:**                    Query only

**FETCh:BURSt:EVM:PILot:AVERage?**

**FETCh:BURSt:EVM:PILot:MAXimum?**

**FETCh:BURSt:EVM:PILot:MINimum?**

This command returns the average, maximum or minimum EVM in dB for the pilot carrier.

For details see [Chapter 3.1.1, "Modulation Accuracy, Flatness and Tolerance Parameters"](#), on page 12.

**Return values:**

<Result>                    <Global Result>, <Stream 1 result> ... <Stream n result>

**Usage:**                    Query only

---

**FETCh:BURSt:EVM[:IEEE]:AVERAge?**  
**FETCh:BURSt:EVM[:IEEE]:MAXimum?**  
**FETCh:BURSt:EVM[:IEEE]:MINimum?**

This command returns the average, maximum or minimum EVM in dB for the IEEE 802.11b standard. This result is the value before filtering.

For details see [Chapter 3.1.1, "Modulation Accuracy, Flatness and Tolerance Parameters"](#), on page 12.

**Usage:** Query only

---

**FETCh:BURSt:CFERror:AVERAge**  
**FETCh:BURSt:CFERror:MAXimum**  
**FETCh:BURSt:CFERror:MINimum**  
**FETCh:BURSt:FERRor:AVERAge?**  
**FETCh:BURSt:FERRor:MAXimum?**  
**FETCh:BURSt:FERRor:MINimum?**

This command returns the average, maximum or minimum center frequency errors in Hertz.

For details see [Chapter 3.1.1, "Modulation Accuracy, Flatness and Tolerance Parameters"](#), on page 12.

**Return values:**

<Result> <Global Result>, <Stream 1 result> ... <Stream n result>

**Usage:** Query only

---

**FETCh:BURSt:GIMBalance:AVERAge?**  
**FETCh:BURSt:GIMBalance:MAXimum?**  
**FETCh:BURSt:GIMBalance:MINimum?**

This command returns the average, maximum or minimum I/Q imbalance in dB.

For details see [Chapter 3.1.1, "Modulation Accuracy, Flatness and Tolerance Parameters"](#), on page 12.

**Usage:** Query only

---

**FETCh:BURSt:IQOFfset:AVERAge?**  
**FETCh:BURSt:IQOFfset:MAXimum?**  
**FETCh:BURSt:IQOFfset:MINimum?**

This command returns the average, maximum or minimum I/Q offset in dB.

For details see [Chapter 3.1.1, "Modulation Accuracy, Flatness and Tolerance Parameters"](#), on page 12.

**Usage:** Query only

---

**FETCh:BURSt:EVM:ALL:AVERage?**  
**FETCh:BURSt:EVM:ALL:MAXimum?**  
**FETCh:BURSt:EVM:ALL:MINimum?**

This command returns the average, maximum or minimum I/Q skew in picoseconds.

For details see [Chapter 3.1.1, "Modulation Accuracy, Flatness and Tolerance Parameters"](#), on page 12.

**Usage:** Query only

---

**FETCh:BURSt:MCPower:AVERage**  
**FETCh:BURSt:MCPower:MAXimum**  
**FETCh:BURSt:MCPower:MINimum**

This command returns the MIMO cross power (average, maximum or minimum value) in dB for the IEEE 802.11n (MIMO) standard. For details see [Chapter 3.1.1, "Modulation Accuracy, Flatness and Tolerance Parameters"](#), on page 12.

**Parameters:**

<Result> <Stream 1 result> ... <Stream n result>

---

**FETCh:BURSt:PAYLoad[:AVERage]?**  
**FETCh:BURSt:PAYLoad:MINimum?**  
**FETCh:BURSt:PAYLoad:MAXimum?**

This command returns the average, maximum or minimum of the "Payload Power per PDU" (in dBm). All analyzed PDUs, up to the statistic length, take part in the statistical evaluation.

**Usage:** Query only

---

**FETCh:BURSt:PEAK[:AVERage]?**  
**FETCh:BURSt:PEAK:MINimum?**  
**FETCh:BURSt:PEAK:MAXimum?**

This command returns the average, maximum or minimum of the "Peak Power per PDU" (in dBm). All analyzed PDUs, up to the statistic length, take part in the statistical evaluation.

**Usage:** Query only

---

**FETCh:BURSt:PREamble[:AVERage]?**  
**FETCh:BURSt:PREamble:MINimum?**  
**FETCh:BURSt:PREamble:MAXimum?**

This command returns the average, maximum or minimum of the "Preamble Power per PDU" (in dBm). All analyzed PDUs, up to the statistic length, take part in the statistical evaluation.

**Usage:** Query only

---

---

**FETCH:BURSt:QUADoffset:AVERage?**  
**FETCH:BURSt:QUADoffset:MAXimum?**  
**FETCH:BURSt:QUADoffset:MINimum?**

This command returns the average, maximum or minimum quadrature offset of symbols within a PPDU. This value indicates the phase accuracy.

For details see [Chapter 3.1.1, "Modulation Accuracy, Flatness and Tolerance Parameters"](#), on page 12.

**Usage:** Query only

---

**FETCH:BURSt:RMS[:AVERage]?**  
**FETCH:BURSt:RMS:MAXimum?**  
**FETCH:BURSt:RMS:MINimum?**

This command returns the average, maximum or minimum RMS power in dBm for all analyzed PPDUs.

For details see [Chapter 3.1.1, "Modulation Accuracy, Flatness and Tolerance Parameters"](#), on page 12.

**Return values:**

<Result> <Global Result>, <Stream 1 result> ... <Stream n result>

**Usage:** Query only

---

**FETCH:BURSt:SYMBOLerror:AVERage?**  
**FETCH:BURSt:SYMBOLerror:MAXimum?**  
**FETCH:BURSt:SYMBOLerror:MINimum?**

This command returns the average, maximum or minimum percentage of symbols that were outside the allowed demodulation range within a PPDU (as defined by the standard).

For details see [Chapter 3.1.1, "Modulation Accuracy, Flatness and Tolerance Parameters"](#), on page 12.

**Return values:**

<Result> <Global Result>, <Stream 1 result> ... <Stream n result>

**Usage:** Query only

---

**FETCH:BURSt:TFALI:AVERage?**  
**FETCH:BURSt:TFALI:MAXimum?**  
**FETCH:BURSt:TFALI:MINimum?**

This command returns the average, maximum or minimum PPDU fall time in seconds.

This command is only applicable to IEEE802.11b & IEEE802.11g (DSSS) signals.

For details see [Chapter 3.1.1, "Modulation Accuracy, Flatness and Tolerance Parameters"](#), on page 12.

**Usage:** Query only

---

**FETCH:BURSt:TRISe:AVERAge?**  
**FETCH:BURSt:TRISe:MAXimum?**  
**FETCH:BURSt:TRISe:MINimum?**

This command returns the average, maximum or minimum burst rise time in seconds.

This command is only applicable to IEEE802.11b & IEEE802.11g (DSSS) signals.

For details see [Chapter 3.1.1, "Modulation Accuracy, Flatness and Tolerance Parameters"](#), on page 12.

**Usage:** Query only

---

**UNIT:EVM** <Unit>

This command specifies the units for EVM limits and results

(see [Chapter 3.1.1, "Modulation Accuracy, Flatness and Tolerance Parameters"](#), on page 12).

**Parameters:**

<Unit> DB | PCT  
 \*RST: DB

---

**UNIT:GIMBalance** <Unit>

This command specifies the units for gain imbalance results

(see [Chapter 3.1.1, "Modulation Accuracy, Flatness and Tolerance Parameters"](#), on page 12).

**Parameters:**

<Unit> DB | PCT  
 \*RST: DB

---

**UNIT:PREamble** <Unit>

This command specifies the units for preamble error results.

**Parameters:**

<Unit> HZ | PCT

---

### 11.9.1.3 Limit Check Results

The following commands are required to query the results of the limit checks.

Useful commands for retrieving results described elsewhere:

- [UNIT:EVM](#) on page 280
- [UNIT:GIMBalance](#) on page 280



**Remote commands exclusive to retrieving limit check results**

|   |     |
|---|-----|
| <a href="#">CALCulate:LIMit:BURSt:ALL:RESult?</a> .....                   | 281 |
| <a href="#">CALCulate:LIMit:BURSt:EVM:ALL[:AVERAge]:RESult?</a> .....     | 281 |
| <a href="#">CALCulate:LIMit:BURSt:EVM:ALL:MAXimum:RESult?</a> .....       | 281 |
| <a href="#">CALCulate:LIMit:BURSt:EVM:DATA[:AVERAge]:RESult?</a> .....    | 281 |
| <a href="#">CALCulate:LIMit:BURSt:EVM:DATA:MAXimum:RESult?</a> .....      | 281 |
| <a href="#">CALCulate:LIMit:BURSt:EVM:PILot[:AVERAge]:RESult?</a> .....   | 282 |
| <a href="#">CALCulate:LIMit:BURSt:EVM:PILot:MAXimum:RESult?</a> .....     | 282 |
| <a href="#">CALCulate:LIMit:BURSt:FERRor[:AVERAge]:RESult?</a> .....      | 282 |
| <a href="#">CALCulate:LIMit:BURSt:FERRor:MAXimum:RESult?</a> .....        | 282 |
| <a href="#">CALCulate:LIMit:BURSt:IQOFfset[:AVERAge]:RESult?</a> .....    | 282 |
| <a href="#">CALCulate:LIMit:BURSt:IQOFfset:MAXimum:RESult?</a> .....      | 282 |
| <a href="#">CALCulate:LIMit:BURSt:SYMBolerror[:AVERAge]:RESult?</a> ..... | 283 |
| <a href="#">CALCulate:LIMit:BURSt:SYMBolerror:MAXimum:RESult?</a> .....   | 283 |

**CALCulate:LIMit:BURSt:ALL:RESult?**

This command returns the result of the EVM limit check for all carriers. The limit value is defined by the standard or the user (see [CALCulate:LIMit:BURSt:ALL](#) on page 242).

**Return values:**

|              |  |
|--------------|--|
| <LimitCheck> | <b>PASS</b><br>The defined limit for the parameter was not exceeded. |
|              | <b>FAILED</b><br>The defined limit for the parameter was exceeded.   |

**Usage:** Query only

**CALCulate:LIMit:BURSt:EVM:ALL[:AVERAge]:RESult?****CALCulate:LIMit:BURSt:EVM:ALL:MAXimum:RESult?**

This command returns the result of the average or maximum EVM limit check. The limit value is defined by the standard or the user (see [CALCulate:LIMit:BURSt:EVM:ALL:MAXimum](#) on page 242).

**Return values:**

|              |  |
|--------------|--|
| <LimitCheck> | <b>PASS</b><br>The defined limit for the parameter was not exceeded. |
|              | <b>FAILED</b><br>The defined limit for the parameter was exceeded.   |

**Usage:** Query only

**CALCulate:LIMit:BURSt:EVM:DATA[:AVERAge]:RESult?****CALCulate:LIMit:BURSt:EVM:DATA:MAXimum:RESult?**

This command returns the result of the average or maximum EVM limit check for data carriers. The limit value is defined by the standard or the user (see [CALCulate:LIMit:BURSt:EVM:DATA:MAXimum](#) on page 243).

**Return values:**

<LimitCheck>      **PASS**  
The defined limit for the parameter was not exceeded.

**FAILED**  
The defined limit for the parameter was exceeded.

**Usage:**                      Query only

**CALCulate:LIMit:BURSt:EVM:PILot[:AVERage]:RESult?****CALCulate:LIMit:BURSt:EVM:PILot:MAXimum:RESult?**

This command returns the result of the average or maximum EVM limit check for pilot carriers. The limit value is defined by the standard or the user (see [CALCulate:LIMit:BURSt:EVM:PILot:MAXimum](#) on page 243).

**Return values:**

<LimitCheck>      **PASS**  
The defined limit for the parameter was not exceeded.

**FAILED**  
The defined limit for the parameter was exceeded.

**Usage:**                      Query only

**CALCulate:LIMit:BURSt:FERRor[:AVERage]:RESult?****CALCulate:LIMit:BURSt:FERRor:MAXimum:RESult?**

This command returns the result of the average or maximum center frequency error limit check. The limit value is defined by the standard or the user (see [CALCulate:LIMit:BURSt:FERRor:MAXimum](#) on page 243).

**Return values:**

<LimitCheck>      **PASS**  
The defined limit for the parameter was not exceeded.

**FAILED**  
The defined limit for the parameter was exceeded.

**Usage:**                      Query only

**CALCulate:LIMit:BURSt:IQOFFset[:AVERage]:RESult?****CALCulate:LIMit:BURSt:IQOFFset:MAXimum:RESult?**

This command returns the result of the average or maximum I/Q offset limit check. The limit value is defined by the standard or the user (see [CALCulate:LIMit:BURSt:IQOFFset:MAXimum](#) on page 244).

**Return values:**

<LimitCheck>      **PASS**  
The defined limit for the parameter was not exceeded.

**FAILED**  
The defined limit for the parameter was exceeded.

**Usage:** Query only

---

**CALCulate:LIMit:BURSt:SYMBolerror[:AVERage]:RESult?**

**CALCulate:LIMit:BURSt:SYMBolerror:MAXimum:RESult?**

This command returns the result of the average or maximum symbol clock error limit check. The limit value is defined by the standard or the user (see [CALCulate:LIMit:BURSt:SYMBolerror:MAXimum](#) on page 244).

**Return values:**

<LimitCheck>           **PASS**  
The defined limit for the parameter was not exceeded.

**FAILED**  
The defined limit for the parameter was exceeded.

**Usage:** Query only

## 11.9.2 Numeric Results for Frequency Sweep Measurements

The following commands are required to retrieve the numeric results of the WLAN frequency sweep measurements (see [Chapter 3.2, "Frequency Sweep Measurements"](#), on page 49).



In the following commands used to retrieve the numeric results for RF data, the suffixes <n> for CALCulate and <k> for LIMit are irrelevant.

---

|   |     |
|---|-----|
| <a href="#">CALCulate&lt;n&gt;:LIMit&lt;k&gt;:ACPower:ACHannel:RESult?</a> .....            | 283 |
| <a href="#">CALCulate&lt;n&gt;:LIMit&lt;k&gt;:ACPower:ALternate&lt;ch&gt;:RESult?</a> ..... | 283 |
| <a href="#">CALCulate&lt;n&gt;:LIMit&lt;k&gt;:FAIL?</a> .....                               | 284 |
| <a href="#">CALCulate&lt;n&gt;:MARKer&lt;m&gt;:FUNction:POWer&lt;sb&gt;:RESult?</a> .....   | 285 |
| <a href="#">CALCulate&lt;n&gt;:MARKer&lt;m&gt;:X</a> .....                                  | 287 |
| <a href="#">CALCulate&lt;n&gt;:STATistics:RESult&lt;t&gt;?</a> .....                        | 287 |

---

**CALCulate<n>:LIMit<k>:ACPower:ACHannel:RESult?**

**CALCulate<n>:LIMit<k>:ACPower:ALternate<ch>:RESult?**

This command queries the state of the limit check for the adjacent or alternate channels in an ACLR measurement.

(<n>, <k> are irrelevant.)

To get a valid result, you have to perform a complete measurement with synchronization to the end of the measurement before reading out the result. This is only possible for single measurement mode.

See also [INITiate<n>:CONTinuous](#) on page 266.

**Suffix:**

<ch>                       1 to 11  
Alternate channel number

**Return values:**

<LowerChan>, text value  
 <UpperChan> The command returns two results. The first is the result for the lower, the second for the upper adjacent or alternate channel.

**PASSED**

Limit check has passed.

**FAIL**

Limit check has failed.

**Example:**

```
INIT:IMM;*WAI;
CALC:LIM:ACP:ACH:RES?
PASSED,PASSED
```

**Usage:**

Query only

**CALCulate<n>:LIMit<k>:FAIL?**

This command queries the result of a limit check.

For measurements in the R&S FPS WLAN application, the numeric suffix <k> specifies the limit line according to [Table 11-11](#).

To get a valid result, you have to perform a complete measurement with synchronization to the end of the measurement before reading out the result. This is only possible for single measurement mode.

See also [INITiate<n>:CONTinuous](#) on page 266.

**Return values:**

<Result>           **0**  
                           PASS  
                           **1**  
                           FAIL

**Example:**

```
INIT;*WAI
Starts a new sweep and waits for its end.
CALC:LIM3:FAIL?
Queries the result of the check for limit line 3.
```

**Usage:**

Query only  
 SCPI confirmed

**Manual operation:** See "[Spectrum Emission Mask](#)" on page 51

**Table 11-11: Limit line suffix <k> for WLAN application**

| Suffix | Limit  |
|--------|--|
| 1 to 2 | These indexes are not used                               |
| 3      | Limit line for Spectrum Emission Mask as defined by ETSI |
| 4      | Spectrum Flatness (Upper) limit line                     |
| 5      | Spectrum Flatness (Lower) limit line                     |
| 6      | Limit line for Spectrum Emission Mask as defined by IEEE |

|    |                             |
|----|-----------------------------|
| 7  | PVT Rising Edge max limit   |
| 8  | PVT Rising Edge mean limit  |
| 9  | PVT Falling Edge max limit  |
| 10 | PVT Falling Edge mean limit |

---

**CALCulate<n>:MARKer<m>:FUNCtion:POWer<sb>:RESult? <Measurement>**

This command queries the results of power measurements (<n>, <m> are irrelevant).

This command is only available for measurements on RF data (see [Chapter 3.2, "Frequency Sweep Measurements"](#), on page 49).

To get a valid result, you have to perform a complete measurement with synchronization to the end of the measurement before reading out the result. This is only possible for single measurement mode.

See also [INITiate<n>:CONTinuous](#) on page 266.

**Suffix:**

<sb>                    1 | 2 | 3 (4 | 5)  
                          irrelevant

**Query parameters:**

&lt;Measurement&gt;

**ACPower | MCACpower**

ACLR measurements (also known as adjacent channel power or multicarrier adjacent channel measurements).

Returns the power for every active transmission and adjacent channel. The order is:

- power of the transmission channels
- power of adjacent channel (lower,upper)
- power of alternate channels (lower,upper)

**MSR ACLR results:**

For MSR ACLR measurements, the order of the returned results is slightly different:

- power of the transmission channels
- total power of the transmission channels for each sub block
- power of adjacent channels (lower, upper)
- power of alternate channels (lower, upper)
- power of gap channels (lower1, upper1, lower2, upper2)

The unit of the return values depends on the scaling of the y-axis:

- logarithmic scaling returns the power in the current unit
- linear scaling returns the power in W

**CN**

Carrier-to-noise measurements.

Returns the C/N ratio in dB.

**CNO**

Carrier-to-noise measurements.

Returns the C/N ratio referenced to a 1 Hz bandwidth in dBm/Hz.

**CPOWer**

Channel power measurements.

Returns the channel power. The unit of the return values depends on the scaling of the y-axis:

- logarithmic scaling returns the power in the current unit
- linear scaling returns the power in W

For SEM measurements, the return value is the channel power of the reference range (in the specified sub block).

**PPOWer**

Peak power measurements.

Returns the peak power. The unit of the return values depends on the scaling of the y-axis:

- logarithmic scaling returns the power in the current unit
- linear scaling returns the power in W

For SEM measurements, the return value is the peak power of the reference range (in the specified sub block).

**OBANdwidth | OBWidth**

Occupied bandwidth.

Returns the occupied bandwidth in Hz.

**Usage:**

Query only

**Manual operation:** See "Channel Power ACLR" on page 50  
See "Occupied Bandwidth" on page 52

---

#### **CALCulate<n>:MARKer<m>:X <Position>**

This command moves a marker to a particular coordinate on the x-axis.

If necessary, the command activates the marker.

If the marker has been used as a delta marker, the command turns it into a normal marker.

#### **Parameters:**

<Position>                      Numeric value that defines the marker position on the x-axis.  
Range:                      The range depends on the current x-axis range.

#### **Example:**

`CALC:MARK2:X 1.7MHz`  
Positions marker 2 to frequency 1.7 MHz.

**Manual operation:** See "Marker Table" on page 54  
See "Marker Peak List" on page 55

---

#### **CALCulate<n>:STATistics:RESult<t>? <ResultType>**

This command queries the results of a CCDF or ADP measurement for a specific trace.

(<n> is irrelevant.)

#### **Parameters:**

<ResultType>                      **MEAN**  
Average (=RMS) power in dBm measured during the measurement time.

**PEAK**  
Peak power in dBm measured during the measurement time.

**CFACTOR**  
Determined crest factor (= ratio of peak power to average power) in dB.

**ALL**  
Results of all three measurements mentioned before, separated by commas: <mean power>,<peak power>,<crest factor>

#### **Example:**

`CALC:STAT:RES2? ALL`  
Reads out the three measurement results of trace 2. Example of answer string: 5.56,19.25,13.69 i.e. mean power: 5.56 dBm, peak power 19.25 dBm, crest factor 13.69 dB

**Usage:** Query only

**Manual operation:** See "CCDF" on page 53

### 11.9.3 Retrieving Trace Results

The following commands describe how to retrieve the trace data from the WLAN IQ measurement (Modulation Accuracy, Flatness and Tolerance). Note that for these measurements, only 1 trace per window can be configured.

The traces for frequency sweep measurements are identical to those in the Spectrum application.

Useful commands for retrieving results described elsewhere:

- `DISPlay[:WINDow<n>]:SElect` on page 190

#### Remote commands exclusive to retrieving trace results:

|   |     |
|---|-----|
| <code>FORMat[:DATA]</code> .....              | 288 |
| <code>[SENSe:]BURSt:SElect</code> .....       | 289 |
| <code>[SENSe:]BURSt:SElect:STATe</code> ..... | 289 |
| <code>TRACe&lt;n&gt;[:DATA]</code> .....      | 289 |
| <code>TRACe&lt;n&gt;[:DATA]:X?</code> .....   | 291 |
| <code>TRACe:IQ:DATA:MEMory</code> .....       | 291 |

---

#### `FORMat[:DATA]` <Format>

This command selects the data format that is used for transmission of trace data from the R&S FPS to the controlling computer.

Note that the command has no effect for data that you send to the R&S FPS. The R&S FPS automatically recognizes the data it receives, regardless of the format.

#### Parameters:

<Format>

##### **AScii**

AScii format, separated by commas.

This format is almost always suitable, regardless of the actual data format. However, the data is not as compact as other formats may be.

##### **REAL,32**

32-bit IEEE 754 floating-point numbers in the "definite length block format".

In the Spectrum application, the format setting `REAL` is used for the binary transmission of trace data.

For I/Q data, 8 bytes per sample are returned for this format setting.

##### **UINT**

In the R&S FPS WLAN application, bitstream data can be sent as unsigned integers format to improve the data transfer speed (compared to AScii format).

\*RST: AScii

**Example:** `FORM REAL,32`

**Usage:** SCPI confirmed



**[SENSe:]BURSt:SElect <Value>**

This command selects the PPDU for which the trace data is queried (using `TRACe<n>[:DATA]`) for the "EVM vs Symbol" and "EVM vs Carrier" result displays if `[SENSe:]BURSt:SElect:STATe` is ON.

The selected PPDU does not affect the corresponding graphical trace displays.

**Parameters:**

<Value>                   Range:       1 to <statistic count>  
\*RST:                    1

**Example:**

```
LAY:WIND2:REPL EVSY
SENS:BURS:SEL:STAT ON
SENS:BURS:SEL 10
TRAC2:DATA? TRACE1
```

Returns the trace results for the PPDU number 10 in window 2 ("EVM vs Symbol").

**[SENSe:]BURSt:SElect:STATe <State>**

Determines whether a selected PPDU (using `[SENSe:]BURSt:SElect`) is considered or ignored.

**Parameters:**

<State>                   ON | OFF

**ON**

Only the results for the selected PPDU are considered by a subsequent `TRACe<n>[:DATA]` query for "EVM vs Symbol" and "EVM vs Carrier" result displays.

**OFF**

**"EVM vs Symbol"** result display: query returns all detected PPDUs in the current capture buffer

**"EVM vs Carrier"** result display: query returns the statistical results for all analyzed PPDUs

\*RST:                    OFF

**Example:**

```
LAY:WIND2:REPL EVSY
SENS:BURS:SEL:STAT ON
SENS:BURS:SEL 10
TRAC2:DATA? TRACE1
```

Returns the trace results for the PPDU number 10 in window 2 ("EVM vs Symbol").

**TRACe<n>[:DATA] <ResultType>**

This command queries current trace data and measurement results from the window previously selected using `DISPlay[:WINDow<n>]:SElect`.

As opposed to the R&S FPS base unit, the window suffix <n> is not considered in the R&S FPS WLAN application! Use the `DISP:WIND<n>:SELect` to select the window before you query trace results!

For details see [Chapter 11.9.4, "Measurement Results for TRACE<n>\[:DATA\]? TRACE<n>"](#), on page 292.

**Suffix:**

<n> irrelevant

**Parameters:**

<ResultType> Selects the type of result to be returned.

**TRACE1 | ... | TRACE6**

Returns the trace data for the corresponding trace.

Note that for the default WLAN I/Q measurement (Modulation Accuracy, Flatness and Tolerance), only 1 trace per window (TRACE1) is available.

**LIST**

Returns the results of the peak list evaluation for Spectrum Emission Mask measurements.

**Return values:**

<TraceData> For more information see tables below.

**Example:**

```
DISP:WIND2:SEL
```

```
TRAC? TRACE3
```

Queries the data of trace 3 in window 2.

**Manual operation:**

See ["AM/AM"](#) on page 22

See ["AM/PM"](#) on page 23

See ["AM/EVM"](#) on page 23

See ["Bitstream"](#) on page 24

See ["Constellation"](#) on page 26

See ["Constellation vs Carrier"](#) on page 28

See ["EVM vs Carrier"](#) on page 29

See ["EVM vs Chip"](#) on page 30

See ["EVM vs Symbol"](#) on page 30

See ["FFT Spectrum"](#) on page 31

See ["Freq. Error vs Preamble"](#) on page 33

See ["Gain Imbalance vs Carrier"](#) on page 33

See ["Group Delay"](#) on page 34

See ["Magnitude Capture"](#) on page 35

See ["Phase Error vs Preamble"](#) on page 36

See ["Phase Tracking"](#) on page 37

See ["PLCP Header \(IEEE 802.11b, g \(DSSS\)\)"](#) on page 37

See ["PvT Full PPDU"](#) on page 38

See ["PvT Rising Edge"](#) on page 39

See ["PvT Falling Edge"](#) on page 40

See ["Quad Error vs Carrier"](#) on page 41

See ["Signal Field"](#) on page 45

See ["Spectrum Flatness"](#) on page 48

See ["Spectrum Emission Mask"](#) on page 51

**Table 11-12: Return values for TRACE1 to TRACE6 parameter**

For I/Q data traces, the results depend on the evaluation method (window type) selected for the current window (see `LAYout:ADD[:WINDow]?` on page 251). The results for the various window types are described in [Chapter 11.9.4, "Measurement Results for TRACe<n>\[:DATA\]? TRACE<n>"](#), on page 292.

For RF data traces, the trace data consists of a list of 1001 power levels that have been measured. The unit depends on the measurement and on the unit you have currently set.

For SEM measurements, the x-values should be queried as well, as they are not equi-distant (see `TRACe<n>[:DATA]:X?` on page 291).

**Table 11-13: Return values for LIST parameter**

This parameter is only available for SEM measurements.

For each sweep list range you have defined (range 1...n), the command returns eight values in the following order.

<No>,<StartFreq>,<StopFreq>,<RBW>,<PeakFreq>,<PowerAbs>,<PowerRel>,<PowerDelta>,<LimitCheck>,<Unused1>,<Unused2>

- <No>: range number
- <StartFreq>,<StopFreq>: start and stop frequency of the range
- <RBW>: resolution bandwidth
- <PeakFreq>: frequency of the peak in a range
- <PowerAbs>: absolute power of the peak in dBm
- <PowerRel>: power of the peak in relation to the channel power in dBc
- <PowerDelta>: distance from the peak to the limit line in dB, positive values indicate a failed limit check
- <LimitCheck>: state of the limit check (0 = PASS, 1 = FAIL)
- <Unused1>,<Unused2>: reserved (0.0)

### TRACe<n>[:DATA]:X? <TraceNumber>

This command queries the horizontal trace data for each sweep point in the specified window, for example the frequency in frequency domain or the time in time domain measurements.

This is especially useful for traces with non-equidistant x-values, e.g. for SEM or Spurious Emissions measurements.

#### Query parameters:

<TraceNumber> Trace number.

**TRACE1 | ... | TRACE6**

#### Example:

`TRAC3:X? TRACE1`

Returns the x-values for trace 1 in window 3.

#### Usage:

Query only

### TRACe:IQ:DATA:MEMory <OffsetSamp>, <NumSamples>

Returns all the I/Q trace data in the capture buffer. The result values are scaled in Volts. The command returns a comma-separated list of the measured voltage values in floating point format (Comma Separated Values = CSV). The number of values returned is 2 \* the number of complex samples, the first half being the I values, the second half the Q values.

**Parameters:**

|              |   |
|--------------|---|
| <OffsetSamp> | Offset of the values to be read related to the start of the capture buffer.<br>Range: 0 to (<NumSamples>-1) |
| <NumSamples> | Number of measurement values to be read.<br>Range: 1 to (<NumSamples>-<OffsetSa>)                           |

**11.9.4 Measurement Results for TRACe<n>[:DATA]? TRACE<n>**

The evaluation method selected by the `LAY:ADD:WIND` command also affects the results of the trace data query (see `TRACe<n>[:DATA]? TRACE<n>`).

Details on the returned trace data depending on the evaluation method are provided here.



No trace data is available for the following evaluation methods:

- Magnitude Capture
- Result Summary (Global/Detailed)

As opposed to the R&S FPS base unit, the window suffix <n> is not considered in the R&S FPS WLAN application! Use the `DISPlay[:WINDow<n>]:SElect` to select the window before you query trace results!

---

For details on the graphical results of these evaluation methods, see [Chapter 3.1.2, "Evaluation Methods for WLAN IQ Measurements"](#), on page 21.

The following table provides an overview of the main characteristics of the WLAN OFDM symbol structure in the frequency domain for various standards. The description of the TRACe results refers to these values to simplify the description.

Table 11-14: WLAN OFDM symbol structure in the frequency domain

| Standard            | CBW / MHz | $N_{\text{FFT}}$ | $N_{\text{SD}}$<br>No. of data sc | $N_{\text{SP}}$<br>No. of pilot sc | Pilot subcarrier (sc)                     | $N_{\text{ST}}$<br>No. of sc total:<br>$=N_{\text{SD}}+N_{\text{SP}}$ | $N_{\text{Null}}$<br>No. of DC/Null sc | DC / Null subcarrier   | $N_{\text{used}}$<br>No. of used sc := $N_{\text{ST}} + N_{\text{Null}}$ | $N_{\text{guard}}$<br>:= $N_{\text{FFT}} - N_{\text{used}}$ | Comment   |
|---------------------|-----------|------------------|-----------------------------------|------------------------------------|---|---|--|------------------------|--|---|---|
| IEEE 802.11 a, j, p | 5         | 64               | 48                                | 4                                  | {-21,-7,7,21}                             | 52  | 1                                      | {0}                    | 53   | 11  | IEEE Std 802.11-2012 Tab Table 18-5—Timing-related parameters       |
|                     | 10        | 64               | 48                                | 4                                  | {-21,-7,7,21}                             | 52  | 1                                      | {0}                    | 53   | 11  | IEEE Std 802.11-2012 Tab Table 18-5—Timing-related parameters       |
|                     | 20        | 64               | 48                                | 4                                  | {-21,-7,7,21}                             | 52  | 1                                      | {0}                    | 53   | 11  | IEEE Std 802.11-2012 Tab Table 18-5—Timing-related parameters       |
| 11n                 | 20        | 64               | 52                                | 4                                  | {-21,-7,7,21} <sup>1)</sup>               | 56  | 1                                      | {0}                    | 57   | 7   | IEEE Std 802.11-2012 Tab Table 20-6—Timing-related constants        |
|                     | 40        | 128              | 108                               | 6                                  | {-53, -25, -11, 11, 25, 53} <sup>1)</sup> | 114   | 3                                      | {-1,0,1} <sup>3)</sup> | 117  | 11  | IEEE Std 802.11-2012 Tab Table 20-6—Timing-related constants        |
| 11ac                | 20        | 64               | 52                                | 4                                  | {-21,-7,7,21} <sup>2)</sup>               | 56  | 1                                      | {0}                    | 57   | 7   | IEEE P802.11ac/D2.1, March 2012 Table 22-5—Timing-related constants |
|                     | 40        | 128              | 108                               | 6                                  | {-53, -25, -11, 11, 25, 53} <sup>2)</sup> | 114   | 3                                      | {-1,0,1} <sup>4)</sup> | 117  | 11  | IEEE P802.11ac/D2.1, March 2012 Table 22-5—Timing-related constants |
|                     | 40        | 128              | 108                               | 6                                  | {-53, -25, -11, 11, 25, 53} <sup>2)</sup> | 114   | 3                                      | {-1,0,1} <sup>4)</sup> | 117  | 11  | IEEE P802.11ac/D2.1, March 2012 Table 22-5—Timing-related constants |

1) IEEE Std 802.11-2012 Section 20.3.11.10 Pilot subcarriers

2) IEEE P802.11ac/D2.1, March 2012 Section 22.3.10.10 Pilot subcarriers

3) IEEE Std 802.11-2012 equation (20-59)

4) IEEE P802.11ac/D2.1, March 2012 equation (22-94)

5) IEEE P802.11ac/D2.1, March 2012 equation (22-95)

6) IEEE P802.11ac/D2.1, March 2012 equation (22-96)

| Standard   | CBW / MHz | $N_{FFT}$ | $N_{SD}$<br>No. of data sc | $N_{SP}$<br>No. of pilot sc | Pilot subcarrier (sc)  | $N_{ST}$<br>No. of sc total:<br>$=N_{SD}+N_{SP}$ | $N_{Null}$<br>No. of DC/Null sc | DC / Null subcarrier                                    | $N_{used}$<br>No. of used sc:<br>$=N_{ST}+N_{Null}$ | $N_{guard} := N_{FFT} - N_{used}$ | Comment   |
|--|-----------|-----------|----------------------------|-----------------------------|--|--|---------------------------------|---|---|-----------------------------------|---|
|  | 80        | 256       | 234                        | 8                           | {-103, -75, -39, -11, 11, 39, 75, 103} <sup>2)</sup>   | 242  | 3                               | {-1, 0, 1} <sup>5)</sup>                                | 245   | 11                                | IEEE P802.11ac/D2.1, March 2012 Table 22-5—Timing-related constants |
|  | 160       | 512       | 468                        | 16                          | {-231, -203, -167, -139, -117, -89, -53, -25, 25, 53, 89, 117, 139, 167, 203, 231} <sup>2)</sup> | 484  | 17                              | {-129, -128, -127, -5:1.5, 127, 128, 129} <sup>6)</sup> | 501   | 11                                | IEEE P802.11ac/D2.1, March 2012 Table 22-5—Timing-related constants |
| 1) IEEE Std 802.11-2012 Section 20.3.11.10 Pilot subcarriers<br>2) IEEE P802.11ac/D2.1, March 2012 Section 22.3.10.10 Pilot subcarriers<br>3) IEEE Std 802.11-2012 equation (20-59)<br>4) IEEE P802.11ac/D2.1, March 2012 equation (22-94)<br>5) IEEE P802.11ac/D2.1, March 2012 equation (22-95)<br>6) IEEE P802.11ac/D2.1, March 2012 equation (22-96) |           |           |                            |                             |  |  |                                 |   |   |                                   |   |

|   |   |     |
|---|---|-----|
| • | <a href="#">AM/AM</a> .....   | 295 |
| • | <a href="#">AM/PM</a> .....   | 295 |
| • | <a href="#">AM/EVM</a> .....  | 295 |
| • | <a href="#">Bitstream</a> .....   | 295 |
| • | <a href="#">CCDF – Complementary Cumulative Distribution Function</a> ..... | 296 |
| • | <a href="#">Constellation</a> .....   | 297 |
| • | <a href="#">Constellation vs Carrier</a> .....                              | 298 |
| • | <a href="#">Error vs Carrier</a> .....                                      | 298 |
| • | <a href="#">Error vs Preamble</a> .....                                     | 298 |
| • | <a href="#">EVM vs Carrier</a> .....  | 298 |
| • | <a href="#">EVM vs Chip</a> .....   | 299 |
| • | <a href="#">EVM vs Symbol</a> .....   | 299 |
| • | <a href="#">FFT Spectrum</a> .....  | 300 |
| • | <a href="#">Group Delay</a> .....   | 300 |
| • | <a href="#">Magnitude Capture</a> .....                                     | 301 |
| • | <a href="#">Phase Tracking</a> .....  | 301 |
| • | <a href="#">Power vs Time (PVT)</a> .....                                   | 301 |
| • | <a href="#">Signal Field</a> .....  | 302 |
| • | <a href="#">Spectrum Flatness</a> .....                                     | 302 |

#### 11.9.4.1 [AM/AM](#)

For each sample, the x-axis value represents the amplitude of the reference-signal and the y-axis value represents the amplitude of the measured-signal.

Note: The measured signal and reference signal are complex signals.

#### 11.9.4.2 [AM/PM](#)

For each sample, the x-axis value represents the amplitude of the reference signal. The y-axis value represents the angle difference of the measured signal minus the reference signal.

Note: The measured signal and reference signal are complex signals.

#### 11.9.4.3 [AM/EVM](#)

For each sample, the x-axis value represents the amplitude of the reference-signal. The y-axis value represents the length of the error vector between the measured signal and the reference signal.

Note: The measured signal and reference signal are complex signals.

#### 11.9.4.4 [Bitstream](#)

Data is returned depending on the selected standard for which the measurement was executed (see [CONFigure:STANdard](#) on page 192):

**IEEE 802.11a, ac, g (OFDM), j, n, p standard (OFDM physical layers)**

For a given OFDM symbol and a given subcarrier, the bitstream result is derived from the corresponding complex constellation point according to *Std IEEE802.11-2012 "Figure 18-10—BPSK, QPSK, 16-QAM, and 64-QAM constellation bit encoding"*. The bit pattern (binary representation) is converted to its equivalent integer value as the final measurement result. The number of values returned for each analyzed OFDM symbol corresponds to the number of data subcarriers plus the number of pilot subcarriers ( $N_{SD} + N_{SP}$ ) in remote mode.



As opposed to the graphical Bitstream results, the DC and NULL carriers are not available in remote mode.

| Standard            | CBW in MHz | $N_{SD}$<br>(Number of data subcarriers) | $N_{SP}$<br>(Number of pilot subcarriers) | $N_{ST}$<br>(Total number of subcarriers: $N_{SD} + N_{SP}$ ) |
|---------------------|------------|--|---|---|
| IEEE 802.11 a, p    | 5          | 48                                       | 4   | 52  |
| IEEE 802.11 a, j, p | 10         | 48                                       | 4   | 52  |
| IEEE 802.11 a, j, p | 20         | 48                                       | 4   | 52  |
| IEEE 802.11n        | 20         | 52                                       | 4   | 56  |
| IEEE 802.11n        | 40         | 108                                      | 6   | 114   |
| IEEE 802.11ac       | 20         | 52                                       | 4   | 56  |
| IEEE 802.11ac       | 40         | 108                                      | 6   | 114   |
| IEEE 802.11ac       | 80         | 234                                      | 8   | 242   |
| IEEE 802.11ac       | 160        | 468                                      | 16  | 484   |

**IEEE 802.11b and g (DSSS) standard (DSSS physical layers)**

For the IEEE 802.11b and g (DSSS) standard, the data is returned in PPDU order. Each PPDU is represented as a series of bytes. For each PPDU, the first 9 or 18 bytes represent the PLCP preamble for short and long PPDU types, respectively. The next 6 bytes represent the PLCP header. The remaining bytes represent the PSDU. Data is returned in ASCII printable hexadecimal character format.

TRACE1 is used for these measurement results.

**11.9.4.5 CCDF – Complementary Cumulative Distribution Function**

The length of the results varies; up to a maximum of 201 data points is returned, following a data count value. The first value in the return data represents the quantity of probability values that follow. Each of the potential 201 data points is returned as a probability value and represents the total number of samples that are equal to or exceed the current mean power level.



Probability data is returned up to the power level that contains at least one sample. It is highly unlikely that the full 201 data values will ever be returned.

Each probability value is returned as a floating point number, with a value between 0 and 1.

The syntax of the result is thus:

N, CCDF(0), CCDF(1/10), CCDF(2/10), ..., CCDF((N-1)/10)

#### 11.9.4.6 Constellation

This measurement represents the complex constellation points as I and Q data. See for example IEEE Std. 802.11-2012 'Fig. 18-10 BPSK, QPSK, 16-QAM and 64-QAM constellation bit encoding'. Each I and Q point is returned in floating point format.

Data is returned as a repeating array of interleaved I and Q data in groups of selected carriers per OFDM-Symbol, until all the I and Q data for the analyzed OFDM-Symbols is exhausted.

The following carrier selections are possible:

- "All Carriers": `CONFigure:BURSt:CONStellation:CARRier:SElect ALL`  
 $N_{ST}$  pairs of I and Q data per OFDM-Symbol  
 OFDM-Symbol 1:  $(I_{1,1}, Q_{1,1}), (I_{1,2}, Q_{1,2}), \dots, (I_{1,Nst}, Q_{1,Nst})$   
 OFDM-Symbol 2:  $(I_{2,1}, Q_{2,1}), (I_{2,2}, Q_{2,2}), \dots, (I_{2,Nst}, Q_{2,Nst})$   
 ...  
 OFDM-Symbol N:  
 $(I_{N,1}, Q_{N,1}), (I_{N,2}, Q_{N,2}), \dots, (I_{N,Nst}, Q_{N,Nst})$
- "Pilots Only": `CONFigure:BURSt:CONStellation:CARRier:SElect PILOTS`  
 $N_{SP}$  pairs of I and Q data per OFDM-Symbol in the natural number order.  
 OFDM-Symbol 1:  $(I_{1,1}, Q_{1,1}), (I_{1,2}, Q_{1,2}), \dots, (I_{1,Nsp}, Q_{1,Nsp})$   
 OFDM-Symbol 2:  $(I_{2,1}, Q_{2,1}), (I_{2,2}, Q_{2,2}), \dots, (I_{2,Nsp}, Q_{2,Nsp})$   
 ...  
 OFDM-Symbol N:  
 $(I_{N,1}, Q_{N,1}), (I_{N,2}, Q_{N,2}), \dots, (I_{N,Nsp}, Q_{N,Nsp})$
- Single carrier:  
 1 pair of I and Q data per OFDM-Symbol for the selected carrier  
`CONFigure:BURSt:CONStellation:CARRier:SElect k`  
 with  
 $k \in \left\{ -\frac{(N_{used} - 1)}{2}, -\frac{(N_{used} - 1)}{2} + 1, \dots, \frac{(N_{used} - 1)}{2} \right\}$   
 OFDM-Symbol 1:  $(I_{1,1}, Q_{1,1})$   
 OFDM-Symbol 2:  $(I_{2,1}, Q_{2,1})$   
 ...  
 OFDM-Symbol N:  $(I_{N,1}, Q_{N,1})$

#### 11.9.4.7 Constellation vs Carrier

This measurement represents the complex constellation points as I and Q data. See for example IEEE Std. 802.11-2012 'Fig. 18-10 BPSK, QPSK, 16-QAM and 64-QAM constellation bit encoding'. Each I and Q point is returned in floating point format. Data is returned as a repeating array of interleaved I and Q data in groups of  $N_{\text{used}}$  subcarriers per OFDM-Symbol, until all the I and Q data for the analyzed OFDM-Symbols is exhausted.

Note that as opposed to the Constellation results, the DC/null subcarriers are included as NaNs.

$N_{\text{used}}$  pairs of I and Q data per OFDM-Symbol

OFDM-Symbol 1:  $(I_{1,1}, Q_{1,1}), (I_{1,2}, Q_{1,2}), \dots, (I_{1,N_{\text{used}}}, Q_{1,N_{\text{used}}})$

OFDM-Symbol 2:  $(I_{2,1}, Q_{2,1}), (I_{2,2}, Q_{2,2}), \dots, (I_{2,N_{\text{used}}}, Q_{2,N_{\text{used}}})$

...

OFDM-Symbol N:

$(I_{N,1}, Q_{N,1}), (I_{N,2}, Q_{N,2}), \dots, (I_{N,N_{\text{used}}}, Q_{N,N_{\text{used}}})$

#### 11.9.4.8 Error vs Carrier

Three trace types are provided for gain imbalance/quadrature error evaluation:

|        |  |
|--------|--|
| TRACE1 | The minimum gain imbalance/quadrature error value - over the analyzed PPDU's - for each of the $N_{\text{used}}$ subcarriers |
| TRACE2 | The average gain imbalance/quadrature error value - over the analyzed PPDU's - for each of the $N_{\text{used}}$ subcarriers |
| TRACE3 | The maximum gain imbalance/quadrature error value - over the analyzed PPDU's - for each of the $N_{\text{used}}$ subcarriers |

Each gain imbalance/quadrature error value is returned as a floating point number, expressed in units of dB.

Supported data formats (see [FORMat \[ :DATA \]](#) on page 288): ASCii|UINT

#### 11.9.4.9 Error vs Preamble

Three traces types are available for frequency or phase error measurement. The basic trace types show either the minimum, mean or maximum frequency or phase value as measured over the preamble part of the PPDU.

Supported data formats (see [FORMat \[ :DATA \]](#) on page 288): ASCii|REAL

#### 11.9.4.10 EVM vs Carrier

Three trace types are provided for this evaluation:

**Table 11-15: Query parameter and results for EVM vs Carrier**

|        |   |
|--------|---|
| TRACE1 | The minimum EVM value - over the analyzed PPDUs - for each of the $N_{\text{used}}$ subcarriers |
| TRACE2 | The average EVM value - over the analyzed PPDUs - for each of the $N_{\text{used}}$ subcarriers |
| TRACE3 | The maximum EVM value - over the analyzed PPDUs - for each of the $N_{\text{used}}$ subcarriers |

Each EVM value is returned as a floating point number, expressed in units of dB.

Supported data formats (see [FORMat \[:DATA\]](#) on page 288): ASCii|UINt

**Example:**

For  $EVM_{m,n}$ : the EVM of the m-th analyzed PPDU for the subcarrier  $n = \{1, 2, \dots, N_{\text{used}}\}$

TRACE1: Minimum EVM value per subcarrier

Minimum( $EVM_{1,1}$ ,  $EVM_{2,1}$ , ...,  $EVM_{\text{Statistic Length},1}$ ),

//Minimum EVM value for subcarrier  $-(N_{\text{used}}-1)/2$

Minimum( $EVM_{1,2}$ ,  $EVM_{2,2}$ , ...,  $EVM_{\text{Statistic Length},2}$ ),

// Minimum EVM value for subcarrier  $-(N_{\text{used}}-1)/2 + 1$

...

Minimum( $EVM_{1,N_{\text{used}}}$ ,  $EVM_{2,N_{\text{used}}}$ , ...,  $EVM_{\text{Statistic Length},N_{\text{used}}}$ )

// Minimum EVM value for subcarrier  $+(N_{\text{used}}-1)/2$

**11.9.4.11 EVM vs Chip**

These results are **only** available for single-carrier measurements (**IEEE 802.11b, g (DSSS)**).

Since the R&S FPS WLAN application provides two different methods to calculate the EVM, two traces are available:

|        |                   |
|--------|-------------------|
| TRACE1 | EVM IEEE values   |
| TRACE2 | EVM Direct values |

Each trace shows the EVM value as measured over the complete capture period.

The number of repeating groups that are returned is equal to the number of measured chips.

Each EVM value is returned as a floating point number, expressed in units of dBm.

Supported data formats (see [FORMat \[:DATA\]](#) on page 288): ASCii|REAL

**11.9.4.12 EVM vs Symbol**

Three traces types are available with this measurement. The basic trace types show either the minimum, mean or maximum EVM value, as measured over the complete capture period.

The number of repeating groups that are returned is equal to the number of measured symbols.

Each EVM value is returned as a floating point number, expressed in units of dBm.

Supported data formats (see [FORMat \[ :DATA \]](#) on page 288): ASCii|REAL

|        |                    |
|--------|--------------------|
| TRACE1 | Minimum EVM values |
| TRACE2 | Mean EVM values    |
| TRACE3 | Maximum EVM values |

These results are **not** available for single-carrier measurements (**IEEE 802.11b, g (DSSS)**).

#### 11.9.4.13 FFT Spectrum

Returns the power vs frequency values obtained from the FFT. This is an exhaustive call, due to the fact that there are nearly always more FFT points than I/Q samples. The number of FFT points is a power of 2 that is higher than the total number of I/Q samples, i.e.; number of FFT points := round number of I/Q-samples to next power of 2.

E.g. if there were 20000 samples, then 32768 FFT points are returned.

Data is returned in floating point format in dBm.

#### 11.9.4.14 Group Delay

Currently the following trace types are provided with this measurement:

- **TRACE1**  
A repeating list of group delay values for each subcarrier. The number of repeating lists corresponds to the number of fully analyzed PPDU as displayed in the current Magnitude Capture. Each group delay value is returned as a floating point number, expressed in units of seconds.
- **TRACE**  
All group delay values per subcarrier for each analyzed PDU of the capture period

**Example:**

For  $GD_{m,n}$ : the group delay of the m-th analyzed PPDU for the subcarrier corresponding to  $n = \{1, 2, \dots, N_{used}\}$ ;

```
TRACE:DATA? TRACE2
```

Analyzed PPDU 1:

$GD_{1,1}, GD_{1,2}, \dots,$

Analyzed PPDU 2:

$GD_{2,1}, GD_{2,2}, \dots,$

...

Analyzed PPDU N :

$GD_{N,1}, GD_{N,2}, \dots,$

**11.9.4.15 Magnitude Capture**

Returns the magnitude for each measurement point as measured over the complete capture period. The number of measurement points depends on the input sample rate and the capture time (see "[Input Sample Rate](#)" on page 104 and "[Capture Time](#)" on page 104).

**11.9.4.16 Phase Tracking**

Returns the average phase tracking result per symbol (in Radians).

These results are **not** available for single-carrier measurements (**IEEE 802.11b, g (DSSS)**).

**11.9.4.17 Power vs Time (PVT)**

All complete PDUs within the capture time are analyzed in three master PDUs. The three master PDUs relate to the minimum, maximum and average values across all complete PDUs. This data is returned in dBm values on a per sample basis. Each sample relates to an analysis of each corresponding sample within each processed PDU.

For PVT Rising and PVT Falling displays, the results are restricted to the rising or falling edge of the analyzed PDUs.

The type of PVT data returned is determined by the TRACE number passed as an argument to the SCPI command:

|        |                         |
|--------|-------------------------|
| TRACE1 | minimum PDU data values |
| TRACE2 | mean PDU data values    |
| TRACE3 | maximum PDU data values |

Supported data formats (see [FORMat \[:DATA\]](#) on page 288): ASCii|REAL

#### 11.9.4.18 Signal Field

The bits are returned as read from the corresponding signal field parts in transmit order. I.e. the first transmitted bit has the highest significance and the last transmitted bit has the lowest significance.

See also "Signal Field" on page 45.

The `TRAC:DATA?` command returns the information as read from the signal field for each analyzed PPDU. The signal field bit sequence is converted to an equivalent sequence of hexadecimal digits for each analyzed PPDU in transmit order.

#### 11.9.4.19 Spectrum Flatness

The spectrum flatness evaluation returns the relative power values per carrier (in dB).

Two trace types are provided for this evaluation:

**Table 11-16: Query parameter and results for Spectrum Flatness**

|        |  |
|--------|--|
| TRACE1 | All spectrum flatness values per channel   |
| TRACE2 | An average spectrum flatness value for each of the 53 (or 57/117 within the IEEE 802.11 n standard) carriers |

Supported data formats (`FORMat:DATA`): `ASCIi|REAL`

### 11.9.5 Importing and Exporting I/Q Data and Results

The I/Q data to be evaluated in the WLAN application can not only be measured by the WLAN application itself, it can also be imported to the application, provided it has the correct format. Furthermore, the evaluated I/Q data from the WLAN application can be exported for further analysis in external applications.

For details on importing and exporting I/Q data see the R&S FPS User Manual.

|  |     |
|--|-----|
| <code>MMEMory:LOAD:IQ:STATe</code> .....           | 302 |
| <code>MMEMory:STORe&lt;n&gt;:IQ:STATe</code> ..... | 303 |

---

#### **MMEMory:LOAD:IQ:STATe 1,<FileName>**

This command restores I/Q data from a file.

The file extension is \*.iqw.

#### **Parameters:**

<FileName> String containing the path and name of the source file.

#### **Example:**

```
MMEM:LOAD:IQ:STAT 1, 'C:\R_S\Instr\user\data.iqw'
```

Loads IQ data from the specified file.

**Usage:** Setting only

**Manual operation:** See "I/Q Import" on page 158

---

**MMEMory:STORe<n>:IQ:STATe 1, <FileName>**

This command writes the captured I/Q data to a file.

The suffix <n> is irrelevant.

The file extension is \*.iq.tar. By default, the contents of the file are in 32-bit floating point format.

#### Secure User Mode

In secure user mode, settings that are to be stored on the instrument are stored to volatile memory, which is restricted to 256 MB. Thus, a "Memory full" error may occur although the hard disk indicates that storage space is still available.

To store data permanently, select an external storage location such as a USB memory device.

For details see "Protecting Data Using the Secure User Mode" in the "Data Management" section of the R&S FPS User Manual.

#### Parameters:

1

<FileName>                      String containing the path and name of the target file.

**Example:**                      MMEM:STOR:IQ:STAT 1, 'C:  
   \R\_S\Instr\user\data.iq.tar'  
   Stores the captured I/Q data to the specified file.

**Manual operation:**    See "[I/Q Export](#)" on page 158

## 11.10 Analysis

The following commands define general result analysis settings concerning the traces and markers in standard WLAN measurements. Currently, only one (Clear/Write) trace and one marker are available for standard WLAN measurements.



#### Analysis for RF measurements

General result analysis settings concerning the trace, markers, lines etc. for RF measurements are identical to the analysis functions in the Spectrum application except for some special marker functions and spectrograms, which are not available in the WLAN application.

For details see the "General Measurement Analysis and Display" chapter in the R&S FPS User Manual.

---

- [Markers](#)..... 304
- [Zooming into the Display](#).....305

### 11.10.1 Markers

Markers help you analyze your measurement results by determining particular values in the diagram. Currently, only 1 marker per window can be configured for standard WLAN measurements.

|  |     |
|--|-----|
| <a href="#">CALCulate&lt;n&gt;:MARKer&lt;m&gt;[:STATe]</a> ..... | 304 |
| <a href="#">CALCulate&lt;n&gt;:MARKer&lt;m&gt;:Y?</a> .....      | 304 |

---

#### **CALCulate<n>:MARKer<m>[:STATe]** <State>

This command turns markers on and off. If the corresponding marker number is currently active as a deltamarker, it is turned into a normal marker.

##### **Parameters:**

<State>                    ON | OFF  
                              \*RST:        OFF

**Example:**                CALC:MARK3 ON  
                              Switches on marker 3.

---

#### **CALCulate<n>:MARKer<m>:Y?**

This command queries the position of a marker on the y-axis.

If necessary, the command activates the marker first.

To get a valid result, you have to perform a complete measurement with synchronization to the end of the measurement before reading out the result. This is only possible for single measurement mode.

See also [INITiate<n>:CONTinuous](#) on page 266.

##### **Return values:**

<Result>                    Result at the marker position.

**Example:**                INIT:CONT OFF  
                              Switches to single measurement mode.  
                              CALC:MARK2 ON  
                              Switches marker 2.  
                              INIT;\*WAI  
                              Starts a measurement and waits for the end.  
                              CALC:MARK2:Y?  
                              Outputs the measured value of marker 2.

**Usage:**                    Query only

**Manual operation:**    See "[CCDF](#)" on page 53  
                              See "[Marker Table](#)" on page 54  
                              See "[Marker Peak List](#)" on page 55



## 11.10.2 Zooming into the Display

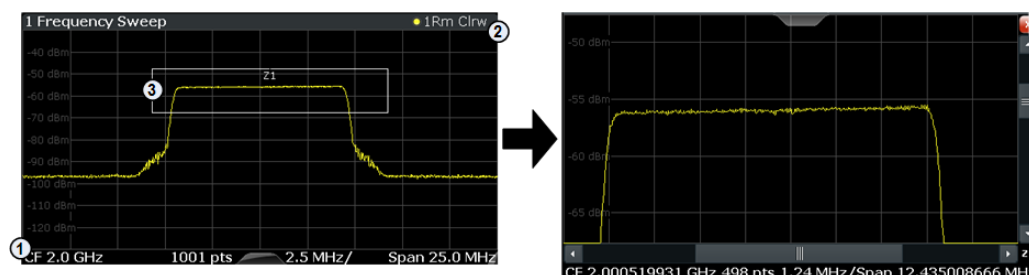
### 11.10.2.1 Using the Single Zoom

DISPlay[:WINDow<n>]:ZOOM:AREA..... 305  
 DISPlay[:WINDow<n>]:ZOOM:STATE..... 305

**DISPlay[:WINDow<n>]:ZOOM:AREA <x1>,<y1>,<x2>,<y2>**

This command defines the zoom area.

To define a zoom area, you first have to turn the zoom on.



- 1 = origin of coordinate system (x1 = 0, y1 = 0)
- 2 = end point of system (x2 = 100, y2= 100)
- 3 = zoom area (e.g. x1 = 60, y1 = 30, x2 = 80, y2 = 75)

**Parameters:**

<x1>,<y1>,  
<x2>,<y2>

Diagram coordinates in % of the complete diagram that define the zoom area.

The lower left corner is the origin of coordinate system. The upper right corner is the end point of the system.

Range: 0 to 100

Default unit: PCT

**DISPlay[:WINDow<n>]:ZOOM:STATE <State>**

This command turns the zoom on and off.

**Parameters:**

<State> ON | OFF  
 \*RST: OFF

**Example:**

DISP:ZOOM ON  
 Activates the zoom mode.

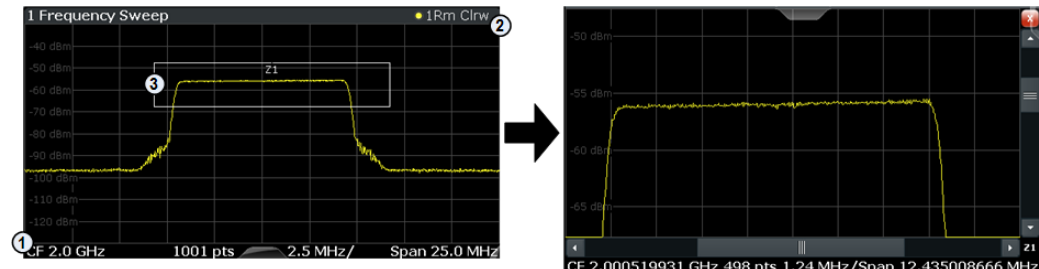
### 11.10.2.2 Using the Multiple Zoom

DISPlay[:WINDow<n>]:ZOOM:MULTiple<zoom>:AREA..... 306  
 DISPlay[:WINDow<n>]:ZOOM:MULTiple<zoom>:STATE..... 306

**DISPlay[:WINDow<n>]:ZOOM:MULTiple<zoom>:AREA <x1>,<y1>,<x2>,<y2>**

This command defines the zoom area for a multiple zoom.

To define a zoom area, you first have to turn the zoom on.



1 = origin of coordinate system (x1 = 0, y1 = 0)

2 = end point of system (x2 = 100, y2 = 100)

3 = zoom area (e.g. x1 = 60, y1 = 30, x2 = 80, y2 = 75)

**Suffix:**

<zoom> 1...4  
Selects the zoom window.

**Parameters:**

<x1>,<y1>,  
<x2>,<y2> Diagram coordinates in % of the complete diagram that define the zoom area.

The lower left corner is the origin of coordinate system. The upper right corner is the end point of the system.

Range: 0 to 100

Default unit: PCT

**DISPlay[:WINDow<n>]:ZOOM:MULTiple<zoom>:STATE <State>**

This command turns the multiple zoom on and off.

**Suffix:**

<zoom> 1...4  
Selects the zoom window.  
If you turn off one of the zoom windows, all subsequent zoom windows move up one position.

**Parameters:**

<State> ON | OFF  
\*RST: OFF

## 11.11 Status Registers

The WLAN application uses the standard status registers of the R&S FPS (depending on the measurement type). However, some registers are used differently. Only those differences are described in the following sections.

For details on the common R&S FPS status registers refer to the description of remote control basics in the R&S FPS User Manual.



\*RST does not influence the status registers.

- [The STATUS:QUESTIONABLE:SYNC Register](#).....307
- [Querying the Status Registers](#)..... 308

### 11.11.1 The STATUS:QUESTIONABLE:SYNC Register

The STATUS:QUESTIONABLE:SYNC register contains application-specific information about synchronization errors or errors during pilot symbol detection. If any errors occur in this register, the status bit #11 in the STATUS:QUESTIONABLE register is set to 1.



Each active channel uses a separate STATUS:QUESTIONABLE:SYNC register. Thus, if the status bit #11 in the STATUS:QUESTIONABLE register indicates an error, the error may have occurred in any of the channel-specific STATUS:QUESTIONABLE:SYNC registers. In this case, you must check the register of each channel to determine which channel caused the error. By default, querying the status of a register always returns the result for the currently selected channel. However, you can specify any other channel name as a query parameter.

**Table 11-17: Meaning of the bits used in the STATUS:QUESTIONABLE:SYNC register**

| Bit No. | Meaning   |
|---------|---|
| 0       | PPDU not found<br>This bit is set if an IQ measurement is performed and no PPDU are detected  |
| 1       | This bit is not used  |
| 2       | No PPDU of REQuired type<br>This bit is set if an IQ measurement is performed and no PPDU of the specified type are detected                        |
| 3       | GATE length too small<br>This bit is set if gating is used in a measurement and the gate length is not set sufficiently large enough                |
| 4       | PPDU count too small<br>This bit is set if a PVT measurement is performed with gating active and there is not at least 1 PPDU within the gate lines |
| 5       | Auto level OVERload<br>This bit is set if a signal overload is detected when an auto-level measurement is performed                                 |
| 6       | Auto level NoSIGnal<br>This bit is set if no signal is detected by the auto-level measurement   |

| Bit No. | Meaning                  |
|---------|--------------------------|
| 7 - 14  | These bits are not used. |
| 15      | This bit is always 0.    |

### 11.11.2 Querying the Status Registers

The following commands are required to query the status of the R&S FPS and the WLAN application.

For details on the common R&S FPS status registers refer to the description of remote control basics in the R&S FPS User Manual.

- [General Status Register Commands](#)..... 308
- [Reading Out the EVENT Part](#).....309
- [Reading Out the CONDition Part](#)..... 309
- [Controlling the ENABLE Part](#).....309
- [Controlling the Negative Transition Part](#)..... 310
- [Controlling the Positive Transition Part](#)..... 310

#### 11.11.2.1 General Status Register Commands

|  |     |
|--|-----|
| <a href="#">STATus:PRESet</a> .....        | 308 |
| <a href="#">STATus:QUEue[:NEXT]?</a> ..... | 308 |

---

#### STATus:PRESet

This command resets the edge detectors and `ENABLE` parts of all registers to a defined value. All `PTRansition` parts are set to `FFFFh`, i.e. all transitions from 0 to 1 are detected. All `NTRansition` parts are set to 0, i.e. a transition from 1 to 0 in a `CONDition` bit is not detected. The `ENABLE` part of the `STATus:OPERation` and `STATus:QUESTionable` registers are set to 0, i.e. all events in these registers are not passed on.

**Usage:**                      Event

---

#### STATus:QUEue[:NEXT]?

This command queries the most recent error queue entry and deletes it.

Positive error numbers indicate device-specific errors, negative error numbers are error messages defined by SCPI. If the error queue is empty, the error number 0, "No error", is returned.

**Usage:**                      Query only

### 11.11.2.2 Reading Out the EVENT Part

---

```

STATus:OPERation[:EVENT]?
STATus:QUESTionable[:EVENT]?
STATus:QUESTionable:ACPLimit[:EVENT]? <ChannelName>
STATus:QUESTionable:LIMit<n>[:EVENT]? <ChannelName>
STATus:QUESTionable:SYNC[:EVENT]? <ChannelName>

```

This command reads out the EVENT section of the status register.

The command also deletes the contents of the EVENT section.

**Query parameters:**

<ChannelName> String containing the name of the channel.  
The parameter is optional. If you omit it, the command works for the currently active channel.

**Usage:** Query only

### 11.11.2.3 Reading Out the CONDition Part

---

```

STATus:OPERation:CONDition?
STATus:QUESTionable:CONDition?
STATus:QUESTionable:ACPLimit:CONDition? <ChannelName>
STATus:QUESTionable:LIMit<n>:CONDition? <ChannelName>
STATus:QUESTionable:SYNC:CONDition? <ChannelName>

```

This command reads out the CONDition section of the status register.

The command does not delete the contents of the EVENT section.

**Query parameters:**

<ChannelName> String containing the name of the channel.  
The parameter is optional. If you omit it, the command works for the currently active channel.

**Usage:** Query only

### 11.11.2.4 Controlling the ENABLE Part

---

```

STATus:OPERation:ENABLE <SumBit>
STATus:QUESTionable:ENABLE <SumBit>
STATus:QUESTionable:ACPLimit:ENABLE <SumBit>,<ChannelName>
STATus:QUESTionable:LIMit<n>:ENABLE <SumBit>,<ChannelName>
STATus:QUESTionable:SYNC:ENABLE <BitDefinition>,<ChannelName>

```

This command controls the ENABLE part of a register.

The ENABLE part allows true conditions in the EVENT part of the status register to be reported in the summary bit. If a bit is 1 in the enable register and its associated event bit transitions to true, a positive transition will occur in the summary bit reported to the next higher level.

**Parameters:**

- <BitDefinition> Range: 0 to 65535
- <ChannelName> String containing the name of the channel.  
The parameter is optional. If you omit it, the command works for the currently active channel.

**11.11.2.5 Controlling the Negative Transition Part**


---

**STATus:OPERation:NTRansition** <SumBit>  
**STATus:QUESTionable:NTRansition** <SumBit>  
**STATus:QUESTionable:ACPLimit:NTRansition** <SumBit>,<ChannelName>  
**STATus:QUESTionable:LIMit<n>:NTRansition** <SumBit>,<ChannelName>  
**STATus:QUESTionable:SYNC:NTRansition** <BitDefinition>,<ChannelName>

This command controls the Negative TRansition part of a register.

Setting a bit causes a 1 to 0 transition in the corresponding bit of the associated register. The transition also writes a 1 into the associated bit of the corresponding EVENT register.

**Parameters:**

- <BitDefinition> Range: 0 to 65535
- <ChannelName> String containing the name of the channel.  
The parameter is optional. If you omit it, the command works for the currently active channel.

**11.11.2.6 Controlling the Positive Transition Part**


---

**STATus:OPERation:PTRansition** <SumBit>  
**STATus:QUESTionable:PTRansition** <SumBit>  
**STATus:QUESTionable:ACPLimit:PTRansition** <SumBit>,<ChannelName>  
**STATus:QUESTionable:LIMit<n>:PTRansition** <SumBit>,<ChannelName>  
**STATus:QUESTionable:SYNC:PTRansition** <BitDefinition>,<ChannelName>

These commands control the Positive TRansition part of a register.

Setting a bit causes a 0 to 1 transition in the corresponding bit of the associated register. The transition also writes a 1 into the associated bit of the corresponding EVENT register.

**Parameters:**

- <BitDefinition> Range: 0 to 65535
- <ChannelName> String containing the name of the channel.  
The parameter is optional. If you omit it, the command works for the currently active channel.

## 11.12 Commands for Compatibility

The following commands are provided only for compatibility to remote control programs from WLAN applications on previous signal analyzers. For new remote control programs use the specified alternative commands.



The `CONF:BURS:<ResultType>:IMM` commands used in former R&S Signal and Spectrum Analyzers to change the result display are still supported for compatibility reasons; however they have been replaced by the `LAY:ADD:WIND` commands in the R&S FPS (see [Chapter 11.7, "Configuring the Result Display"](#), on page 249). Note that the `CONF:BURS:<ResultType>:IMM` commands change the screen layout to display the Magnitude Capture buffer in window 1 at the top of the screen and the selected result type in window 2 below that.

|   |     |
|---|-----|
| <code>MMEMemory:LOAD:SEM:STATE</code> ..... | 311 |
| <code>TRIGger[:SEquence]:MODE</code> .....  | 311 |

### **MMEMemory:LOAD:SEM:STATE** <1>, <Filename>

This command loads a spectrum emission mask setup from an xml file.

Note that this command is maintained for compatibility reasons only. Use the `SENS:ESP:PRES` command for new remote control programs.

See the R&S FPS User Manual, "Remote commands for SEM measurements" chapter.

#### **Parameters:**

<1>

<Filename>                      string  
 Path and name of the .xml file that contains the SEM setup information.

#### **Example:**

```
MMEMemory:LOAD:SEM:STAT 1,
'..\sem_std\WLAN\802_11a\802_11a_10MHz_5GHz_band.XML'
```

### **TRIGger[:SEquence]:MODE** <Source>

Defines the trigger source.

Note that this command is maintained for compatibility reasons only. Use the `TRIGger[:SEquence]:SOURCE` on page 207 commands for new remote control programs.

This command configures how triggering is to be performed.

**Parameters:**

<Source> IMMEDIATE | EXTERNAL | VIDEO | RFPower | IFPower | TV | AF | AM | FM | PM | AMRelative | LXI | TIME | SLEFt | SRIGHt | SMPX | SMONo | SSTereo | SRDS | SPILot | BBPower | MASK | PSEnSor | TDTRigger | IQPower | EXT2 | EXT3

## 11.13 Programming Examples (R&S FPS WLAN application)

This example demonstrates how to configure a WLAN 802.11 measurement in a remote environment.

- [Measurement 1: Measuring Modulation Accuracy for WLAN 802.11n Standard..312](#)
- [Measurement 2: Determining the Spectrum Emission Mask..... 315](#)

### 11.13.1 Measurement 1: Measuring Modulation Accuracy for WLAN 802.11n Standard

This example demonstrates how to configure a WLAN IQ measurement for a signal according to WLAN 802.11n standard in a remote environment.

```
//----- Preparing the application -----
// Preset the instrument
*RST
// Enter the WLAN option K91n
INSTRUMENT:SElect WLAN
// Switch to single sweep mode and stop sweep
INITiate:CONTinuous OFF;:ABORT

//----- Configuring the result display -----
// Activate following result displays:
// 1: Magnitude Capture (default, upper left)
// 2: Result Summary Detailed (below Mag Capt)
// 3: Result Summary Global (default, lower right)
// 4: EVM vs Carrier (next to Mag Capt)

LAY:REPL '2',RSD
LAY:ADD:WIND? '1',RIGH,EVC
//Result: '4'

//----- Signal description -----
//Use measurement standard IEEE 802 11n
CONF:STAN 6
//Center frequency is 13.25 GHz
FREQ:CENT 13.25GHZ

//----- Configuring Data Acquisition -----
//Each measurement captures data for 10 ms.
SWE:TIME 10ms
```



## Programming Examples (R&amp;S FPS WLAN application)

```

//Set the input sample rate for the captured I/Q data to 20MHz
TRAC:IQ:SRAT 20MHZ
// Number of samples captured per measurement: 0.01s * 20e6 samples per second
// = 200 000 samples
//Include effects from adjacent channels - switch off filter
BAND:FILT OFF

//----- Synchronization -----
//Improve performance - perform coarse burst search initially
SENS:DEM:TXAR ON
//Minimize the intersymbol interference - FFT start offset determined automatically
SENS:DEM:FFT:OFFS AUTO

//----- Tracking and channel estimation -----
//Improve EVM accuracy - estimate channel from preamble and payload
SENS:DEM:CEST ON
//Use pilot sequence as defined in standard
SENS:TRAC:PIL STAN
//Disable all tracking and compensation functions
SENS:TRAC:LEV OFF
SENS:TRAC:PHAS OFF
SENS:TRAC:TIME OFF

//----- Demodulation -----
//Define a user-defined logical filter to analyze:
SENS:DEM:FORM:BCON:AUTO OFF
//all PPDU formats
SENS:DEM:FORM:BAN:BTYP:AUTO:TYPE ALL
//20MHZ channel bandwidth
SENS:BAND:CHAN:AUTO:TYPE MB20
//an MCS Index '1'
SENS:DEM:FORM:MCS:MODE MEAS
SENS:DEM:FORM:MCS 1
//STBC field = '1'
CONF:WLAN:STBC:AUTO:TYPE M1
//Ness = 1
CONF:WLAN:EXT:AUTO:TYPE M1
//short guard interval length (8 samples)
CONF:WLAN:GTIM:AUTO ON
CONF:WLAN:GTIM:AUTO:TYPE MS

//----- Evaluation range settings -----
//Calculate statistics over 10 PPDU
SENS:BURS:COUN:STAT ON
SENS:BURS:COUN 10
//Determine payload length from HT signal
CONF:WLAN:PAYL:LENG:SRC HTS
//Payload length: 8-16 symbols
SENS:DEM:FORM:BAN:SYMB:EQU OFF
SENS:DEM:FORM:BAN:SYMB:MIN 8

```

## Programming Examples (R&amp;S FPS WLAN application)

```

SENS:DEM:FORM:BAN:SYMB:MAX 16

//----- Measurement settings -----
//Define units for EVM and Gain imbalance results
UNIT:EVM PCT
UNIT:GIMB PCT

//----- Defining Limits -----
//Define non-standard limits for demonstration purposes
//and return to standard limits later.
//Query current limit settings:
CALC:LIM:BURS:ALL?
//Set new limits:
//Average CF error: 5HZ
//max CF error: 10HZ
//average symbol clock error: 5
//max symbol clock error: 10
//average I/Q offset: 5
//maximum I/Q offset: 10
//average EVM all carriers: 0.1%
//max EVM all carriers: 0.5%
//average EVM data carriers: 0.1%
//max EVM data carriers: 0.5%
//average EVM pilots: 0.1%
//max EVM pilots: 0.5%
CALC:LIM:BURS:ALL 5,10,5,10,5,10,0.1,0.5,0.1,0.5,0.1,0.5

//----- Performing the Measurements -----
// Run 10 (blocking) single measurements
INITiate:IMMEDIATE;*WAI

//----- Retrieving Results -----
//Query the I/Q data from magnitude capture buffer for first ms
// 200 000 samples per second -> 200 samples
TRACel:IQ:DATA:MEMory? 0,200
//Note: result will be too long to display in IECWIN, but is stored in log file
//Query the I/Q data from magnitude capture buffer for second ms
TRACel:IQ:DATA:MEMory? 201,400
//Note: result will be too long to display in IECWIN, but is stored in log file

//Select window 4 (EVM vs carrier)
DISP:WIND4:SEL
//Query the current EVM vs carrier trace
TRAC:DATA? TRACE1
//Note: result will be too long to display in IECWIN, but is stored in log file
//Query the result of the average EVM for all carriers
FETC:BURS:EVM:ALL:AVER?
//Query the result of the EVM limit check for all carriers
CALC:LIM:BURS:ALL:RES?

```

```
//Return to standard-defined limits
CALC:LIM:BURS:ALL
//Query the result of the EVM limit check for all carriers again
CALC:LIM:BURS:ALL:RES?
```

```
//----- Exporting Captured I/Q Data-----
//Store the captured I/Q data to a file.
MMEM:STOR:IQ:STAT 1, 'C:\R_S\Instr\user\data.iq.tar'
```

### 11.13.2 Measurement 2: Determining the Spectrum Emission Mask

```
//----- Preparing the application -----
*RST
//Reset the instrument
INST:CRE:NEW WLAN, 'SEMMeasurement'
//Activate a WLAN measurement channel named "SEMMeasurement"

//----- Configuring the measurement -----
DISP:TRAC:Y:SCAL:RLEV 0
//Set the reference level to 0 dBm
FREQ:CENT 2.1175 GHz
//Set the center frequency to 2.1175 GHz
CONF:BURS:SPEC:MASK
//Select the spectrum emission mask measurement

//----- Performing the Measurement-----
INIT:CONT OFF
//Stops continuous sweep
SWE:COUN 100
//Sets the number of sweeps to be performed to 100
INIT;*WAI
//Start a new measurement with 100 sweeps and wait for the end

//----- Retrieving Results-----
CALC:LIM:FAIL?
//Queries the result of the limit check
//Result: 0 [passed]
TRAC:DATA? LIST
//Retrieves the peak list of the spectrum emission mask measurement
//Result:
//+1.000000000,-1.275000000E+007,-8.500000000E+006,+1.000000000E+006,
//+2.108782336E+009,-8.057177734E+001,-7.882799530E+001,-2.982799530E+001,
//+0.000000000,+0.000000000,+0.000000000,

//+2.000000000,-8.500000000E+006,-7.500000000E+006,+1.000000000E+006,
//+2.109000064E+009,-8.158547211E+001,-7.984169006E+001,-3.084169006E+001,
//+0.000000000,+0.000000000,+0.000000000,
```

## Programming Examples (R&amp;S FPS WLAN application)

```
//+3.000000000,-7.500000000E+006,-3.500000000E+006,+1.000000000E+006,
//+2.113987200E+009,-4.202708435E+001,-4.028330231E+001,-5.270565033,
//+0.000000000,+0.000000000,+0.000000000,
```

[...]

**Table 11-18: Trace results for SEM measurement**

| Range No. | Start freq. [Hz] | Stop freq. [Hz]  | RBW [Hz]         | Freq. peak power [Hz] | Abs. peak power [dBm] | Rel. peak power [%] | Delta to margin [dB] | Limit check result | -           | -           | -           |
|-----------|------------------|------------------|------------------|-----------------------|-----------------------|---------------------|----------------------|--------------------|-------------|-------------|-------------|
| 1         | +1.00000000      | -1.27500000E+007 | -8.50000000E+006 | +1.00000000E+006      | +2.108782336E+009     | -8.057177734E+001   | -7.882799530E+001    | -2.982799530E+001  | +0.00000000 | +0.00000000 | +0.00000000 |
| 2         | +2.00000000      | -8.50000000E+006 | -7.50000000E+006 | +1.00000000E+006      | +2.109000064E+009     | -8.158547211E+001   | -7.984169006E+001    | -3.084169006E+001  | +0.00000000 | +0.00000000 | +0.00000000 |
| 3         | +3.00000000      | -7.50000000E+006 | -3.50000000E+006 | +1.00000000E+006      | +2.113987200E+009     | -4.202708435E+001   | -4.028330231E+001    | -5.270565033       | +0.00000000 | +0.00000000 | +0.00000000 |
| ...       | ...              |                  |                  |                       |                       |                     |                      |                    |             |             |             |

# Annex

## A Annex: Reference

### A.1 Sample Rate and Maximum Usable I/Q Bandwidth for RF Input

#### Definitions

- **Input sample rate (ISR):** the sample rate of the useful data provided by the device connected to the input of the R&S FPS
- (User, Output) **Sample rate (SR):** the sample rate that is defined by the user (e.g. in the "Data Acquisition" dialog box in the "I/Q Analyzer" application) and which is used as the basis for analysis or output
- **Usable I/Q (Analysis) bandwidth:** the bandwidth range in which the signal remains undistorted in regard to amplitude characteristic and group delay; this range can be used for accurate analysis by the R&S FPS
- **Record length:** Number of I/Q samples to capture during the specified measurement time; calculated as the measurement time multiplied by the sample rate

For the I/Q data acquisition, digital decimation filters are used internally in the R&S FPS. The passband of these digital filters determines the *maximum usable I/Q bandwidth*. In consequence, signals within the usable I/Q bandwidth (passband) remain unchanged, while signals outside the usable I/Q bandwidth (passband) are suppressed. Usually, the suppressed signals are noise, artifacts, and the second IF side band. If frequencies of interest to you are also suppressed, you should try to increase the output sample rate, since this increases the maximum usable I/Q bandwidth.



#### Bandwidth extension options

The maximum usable I/Q bandwidth provided by the R&S FPS in the basic installation can be extended by additional options. These options can either be included in the initial installation (B-options) or updated later (U-options). The maximum bandwidth provided by the individual option is indicated by its number, for example, B40 extends the bandwidth to 40 MHz.

As a rule, the usable I/Q bandwidth is proportional to the output sample rate. Yet, when the I/Q bandwidth reaches the bandwidth of the analog IF filter (at very high output sample rates), the curve breaks.

- [Bandwidth Extension Options](#)..... 318
- [Relationship Between Sample Rate and Usable I/Q Bandwidth](#).....318
- [Relationship Between Sample Rate, Record Length and Usable I/Q Bandwidth](#). 318

- R&S FPS without additional bandwidth extension options..... 319
- R&S FPS with option B40 (I/Q Bandwidth Extension):..... 320
- R&S FPS with activated option B160 (I/Q Bandwidth Extension):..... 320

### A.1.1 Bandwidth Extension Options

| Max. usable I/Q BW | Required B-option |
|--------------------|-------------------|
| 40 MHz             | B40               |
| 160 MHz            | B160              |

### A.1.2 Relationship Between Sample Rate and Usable I/Q Bandwidth

Up to the maximum bandwidth, the following rule applies:

$$\text{Usable I/Q bandwidth} = 0.8 * \text{Output sample rate}$$



#### MSRA operating mode

In MSRA operating mode, the MSRA Master is restricted to a sample rate of 600 MHz.

The [Figure A-1](#) shows the maximum usable I/Q bandwidths depending on the output sample rates.

### A.1.3 Relationship Between Sample Rate, Record Length and Usable I/Q Bandwidth

Up to the maximum bandwidth, the following rule applies:

$$\text{Usable I/Q bandwidth} = 0.8 * \text{Output sample rate}$$

Regarding the record length, the following rule applies:

$$\text{Record length} = \text{Measurement time} * \text{sample rate}$$

#### Maximum record length for RF input

The maximum record length, that is, the maximum number of samples that can be captured, depends on the sample rate.

**Table A-1: Maximum record length**

| Sample rate   | Maximum record length   |
|---|---|
| 100 Hz to 128 MHz   | 440 MSamples (precisely: 461373440 (= 440*1024*1024) samples) |
| 128 MHz to 10 GHz<br>(upsampling)<br>MSRA master:<br>128 MHz to 600 MHz | 220 MSamples  |

The Figure A-1 shows the maximum usable I/Q bandwidths depending on the output sample rates.

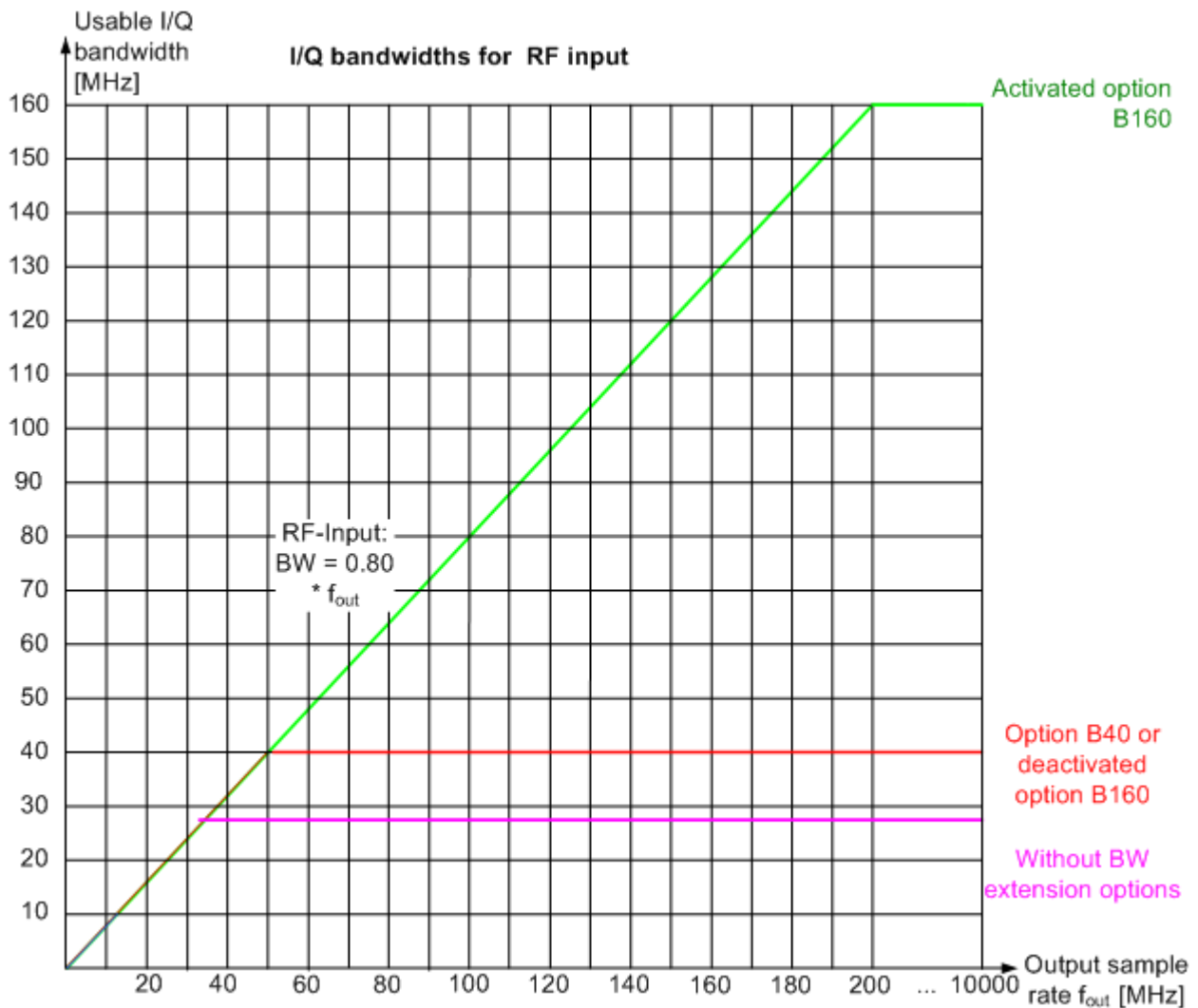


Figure A-1: Relationship between maximum usable I/Q bandwidth and output sample rate with and without bandwidth extensions

### A.1.4 R&S FPS without additional bandwidth extension options

sample rate: 100 Hz - 10 GHz

maximum bandwidth: 28 MHz



#### MSRA operating mode

In MSRA operating mode, the MSRA Master is restricted to a sample rate of 600 MHz.

## Sample Rate and Maximum Usable I/Q Bandwidth for RF Input

| Sample rate   | Maximum I/Q bandwidth             |
|---|-----------------------------------|
| 100 Hz to 35 MHz                                      | proportional up to maximum 28 MHz |
| 35 MHz to 10 GHz<br>MSRA master:<br>35 MHz to 600 MHz | 28 MHz                            |

**A.1.5 R&S FPS with option B40 (I/Q Bandwidth Extension):**

sample rate: 100 Hz - 10 GHz

maximum bandwidth: 40 MHz

**MSRA operating mode**

In MSRA operating mode, the MSRA Master is restricted to a sample rate of 600 MHz.

| Sample rate   | Maximum I/Q bandwidth             |
|---|-----------------------------------|
| 100 Hz to 50 MHz                                      | proportional up to maximum 40 MHz |
| 50 MHz to 10 GHz<br>MSRA master:<br>50 MHz to 600 MHz | 40 MHz                            |

**A.1.6 R&S FPS with activated option B160 (I/Q Bandwidth Extension):**

sample rate: 100 Hz - 10 GHz

maximum bandwidth: 160 MHz

**MSRA operating mode**

In MSRA operating mode, the MSRA Master is restricted to a sample rate of 600 MHz.

| Sample rate   | Maximum I/Q bandwidth              |
|---|------------------------------------|
| 100 Hz to 128 MHz                                       | proportional up to maximum 160 MHz |
| 128 MHz to 10 GHz<br>MSRA master:<br>128 MHz to 600 MHz | 160 MHz                            |





### Restrictions

The optional bandwidth extension R&S FPS-B160 can not be activated if any of the following conditions apply:

- For center frequencies larger than 7 GHz  
(Unless optional YIG preselector bypass is installed, see "YIG-Preselector" on page 95.)
- With any trigger except for an external trigger

## A.2 I/Q Data File Format (iq-tar)

I/Q data is packed in a file with the extension `.iq.tar`. An iq-tar file contains I/Q data in binary format together with meta information that describes the nature and the source of data, e.g. the sample rate. The objective of the iq-tar file format is to separate I/Q data from the meta information while still having both inside one file. In addition, the file format allows you to preview the I/Q data in a web browser, and allows you to include user-specific data.

The iq-tar container packs several files into a single `.tar` archive file. Files in `.tar` format can be unpacked using standard archive tools (see [http://en.wikipedia.org/wiki/Comparison\\_of\\_file\\_archivers](http://en.wikipedia.org/wiki/Comparison_of_file_archivers)) available for most operating systems. The advantage of `.tar` files is that the archived files inside the `.tar` file are not changed (not compressed) and thus it is possible to read the I/Q data directly within the archive without the need to unpack (untar) the `.tar` file first.



### Sample iq-tar files

If you have the optional R&S FPS VSA application (R&S FPS-K70), some sample iq-tar files are provided in the `C:/R_S/Instr/user/vsa/DemoSignals` directory on the R&S FPS.

### Contained files

An iq-tar file must contain the following files:

- **I/Q parameter XML file**, e.g. `xyz.xml`  
Contains meta information about the I/Q data (e.g. sample rate). The filename can be defined freely, but there must be only one single I/Q parameter XML file inside an iq-tar file.
- **I/Q data binary file**, e.g. `xyz.complex.float32`  
Contains the binary I/Q data of all channels. There must be only one single I/Q data binary file inside an iq-tar file.

Optionally, an iq-tar file can contain the following file:

- **I/Q preview XSLT file**, e.g. `open_IqTar_xml_file_in_web_browser.xslt`  
Contains a stylesheet to display the I/Q parameter XML file and a preview of the I/Q data in a web browser.

A sample stylesheet is available at [http://www.rohde-schwarz.com/file/open\\_IqTar\\_xml\\_file\\_in\\_web\\_browser.xslt](http://www.rohde-schwarz.com/file/open_IqTar_xml_file_in_web_browser.xslt).

## A.2.1 I/Q Parameter XML File Specification



The content of the I/Q parameter XML file must comply with the XML schema `RsIqTar.xsd` available at: <http://www.rohde-schwarz.com/file/RsIqTar.xsd>.

In particular, the order of the XML elements must be respected, i.e. iq-tar uses an "ordered XML schema". For your own implementation of the iq-tar file format make sure to validate your XML file against the given schema.

The following example shows an I/Q parameter XML file. The XML elements and attributes are explained in the following sections.

### Sample I/Q parameter XML file: xyz.xml

```
<?xml version="1.0" encoding="UTF-8"?>
<?xml-stylesheet type="text/xsl"
href="open_IqTar_xml_file_in_web_browser.xslt"?>
<RS_IQ_TAR_FileFormat fileFormatVersion="1"
xsi:noNamespaceSchemaLocation="RsIqTar.xsd"
xmlns:xsi="http://www.w3.org/2001/XMLSchema-instance">
  <Name>FSV-K10</Name>
  <Comment>Here is a comment</Comment>
  <DateTime>2011-01-24T14:02:49</DateTime>
  <Samples>68751</Samples>
  <Clock unit="Hz">6.5e+006</Clock>
  <Format>complex</Format>
  <DataType>float32</DataType>
  <ScalingFactor unit="V">1</ScalingFactor>
  <NumberOfChannels>1</NumberOfChannels>
  <DataFilename>xyz.complex.float32</DataFilename>
  <UserData>
    <UserDefinedElement>Example</UserDefinedElement>
  </UserData>
  <PreviewData>...</PreviewData>
</RS_IQ_TAR_FileFormat>
```

| Element              | Description   |
|----------------------|---|
| RS_IQ_TAR_FileFormat | The root element of the XML file. It must contain the attribute <code>fileFormatVersion</code> that contains the number of the file format definition. Currently, <code>fileFormatVersion "2"</code> is used. |
| Name                 | Optional: describes the device or application that created the file.  |
| Comment              | Optional: contains text that further describes the contents of the file.  |
| DateTime             | Contains the date and time of the creation of the file. Its type is <code>xs:dateTime</code> (see <code>RsIqTar.xsd</code> ).   |

## I/Q Data File Format (iq-tar)

| Element          | Description   |
|------------------|---|
| Samples          | <p>Contains the number of samples of the I/Q data. For multi-channel signals all channels have the same number of samples. One sample can be:</p> <ul style="list-style-type: none"> <li>• A complex number represented as a pair of I and Q values</li> <li>• A complex number represented as a pair of magnitude and phase values</li> <li>• A real number represented as a single real value</li> </ul> <p>See also <code>Format</code> element.</p>   |
| Clock            | <p>Contains the clock frequency in Hz, i.e. the sample rate of the I/Q data. A signal generator typically outputs the I/Q data at a rate that equals the clock frequency. If the I/Q data was captured with a signal analyzer, the signal analyzer used the clock frequency as the sample rate. The attribute <code>unit</code> must be set to "Hz".</p>  |
| Format           | <p>Specifies how the binary data is saved in the I/Q data binary file (see <code>DataFilename</code> element). Every sample must be in the same format. The format can be one of the following:</p> <ul style="list-style-type: none"> <li>• <code>complex</code>: Complex number in cartesian format, i.e. I and Q values interleaved. I and Q are unitless</li> <li>• <code>real</code>: Real number (unitless)</li> <li>• <code>polar</code>: Complex number in polar format, i.e. magnitude (unitless) and phase (rad) values interleaved. Requires <code>DataType = float32</code> or <code>float64</code></li> </ul>  |
| DataType         | <p>Specifies the binary format used for samples in the I/Q data binary file (see <code>DataFilename</code> element and <a href="#">Chapter A.2.2, "I/Q Data Binary File"</a>, on page 325). The following data types are allowed:</p> <ul style="list-style-type: none"> <li>• <code>int8</code>: 8 bit signed integer data</li> <li>• <code>int16</code>: 16 bit signed integer data</li> <li>• <code>int32</code>: 32 bit signed integer data</li> <li>• <code>float32</code>: 32 bit floating point data (IEEE 754)</li> <li>• <code>float64</code>: 64 bit floating point data (IEEE 754)</li> </ul>  |
| ScalingFactor    | <p>Optional: describes how the binary data can be transformed into values in the unit Volt. The binary I/Q data itself has no unit. To get an I/Q sample in the unit Volt the saved samples have to be multiplied by the value of the <code>ScalingFactor</code>. For polar data only the magnitude value has to be multiplied. For multi-channel signals the <code>ScalingFactor</code> must be applied to all channels.</p> <p>The attribute <code>unit</code> must be set to "V".</p> <p>The <code>ScalingFactor</code> must be &gt; 0. If the <code>ScalingFactor</code> element is not defined, a value of 1 V is assumed.</p>   |
| NumberOfChannels | <p>Optional: specifies the number of channels, e.g. of a MIMO signal, contained in the I/Q data binary file. For multi-channels, the I/Q samples of the channels are expected to be interleaved within the I/Q data file (see <a href="#">Chapter A.2.2, "I/Q Data Binary File"</a>, on page 325). If the <code>NumberOfChannels</code> element is not defined, one channel is assumed.</p>   |
| DataFilename     | <p>Contains the filename of the I/Q data binary file that is part of the iq-tar file.</p> <p>It is recommended that the filename uses the following convention:<br/> <code>&lt;xyz&gt;.&lt;Format&gt;.&lt;Channels&gt;ch.&lt;Type&gt;</code></p> <ul style="list-style-type: none"> <li>• <code>&lt;xyz&gt;</code> = a valid Windows file name</li> <li>• <code>&lt;Format&gt;</code> = complex, polar or real (see <code>Format</code> element)</li> <li>• <code>&lt;Channels&gt;</code> = Number of channels (see <code>NumberOfChannels</code> element)</li> <li>• <code>&lt;Type&gt;</code> = float32, float64, int8, int16, int32 or int64 (see <code>DataType</code> element)</li> </ul> <p>Examples:</p> <ul style="list-style-type: none"> <li>• xyz.complex.1ch.float32</li> <li>• xyz.polar.1ch.float64</li> <li>• xyz.real.1ch.int16</li> <li>• xyz.complex.16ch.int8</li> </ul> |

| Element     | Description   |
|-------------|---|
| UserData    | Optional: contains user, application or device-specific XML data which is not part of the iq-tar specification. This element can be used to store additional information, e.g. the hardware configuration. User data must be valid XML content.   |
| PreviewData | Optional: contains further XML elements that provide a preview of the I/Q data. The preview data is determined by the routine that saves an iq-tar file (e.g. R&S FPS). For the definition of this element refer to the <code>RsIqTar.xsd</code> schema. Note that the preview can be only displayed by current web browsers that have JavaScript enabled and if the XSLT stylesheet <code>open_IqTar_xml_file_in_web_browser.xslt</code> is available. |

### Example: ScalingFactor

Data stored as `int16` and a desired full scale voltage of 1 V

$$\text{ScalingFactor} = 1 \text{ V} / \text{maximum int16 value} = 1 \text{ V} / 2^{15} = 3.0517578125\text{e-}5 \text{ V}$$

| Scaling Factor                 | Numerical value    | Numerical value x ScalingFactor |
|--------------------------------|--------------------|---------------------------------|
| Minimum (negative) int16 value | $-2^{15} = -32768$ | -1 V                            |
| Maximum (positive) int16 value | $2^{15}-1 = 32767$ | 0.999969482421875 V             |

### Example: PreviewData in XML

```
<PreviewData>
  <ArrayOfChannel length="1">
    <Channel>
      <PowerVsTime>
        <Min>
          <ArrayOfFloat length="256">
            <float>-134</float>
            <float>-142</float>
            ...
            <float>-140</float>
          </ArrayOfFloat>
        </Min>
        <Max>
          <ArrayOfFloat length="256">
            <float>-70</float>
            <float>-71</float>
            ...
            <float>-69</float>
          </ArrayOfFloat>
        </Max>
      </PowerVsTime>
      <Spectrum>
        <Min>
          <ArrayOfFloat length="256">
            <float>-133</float>
            <float>-111</float>
            ...
```

```

        <float>-111</float>
    </ArrayOfFloat>
</Min>
<Max>
    <ArrayOfFloat length="256">
        <float>-67</float>
        <float>-69</float>
        ...
        <float>-70</float>
        <float>-69</float>
    </ArrayOfFloat>
</Max>
</Spectrum>
<IQ>
    <Histogram width="64" height="64">0123456789...0</Histogram>
</IQ>
</Channel>
</ArrayOfChannel>
</PreviewData>

```

## A.2.2 I/Q Data Binary File

The I/Q data is saved in binary format according to the format and data type specified in the XML file (see `Format` element and `DataType` element). To allow reading and writing of streamed I/Q data, all data is interleaved, i.e. complex values are interleaved pairs of I and Q values and multi-channel signals contain interleaved (complex) samples for channel 0, channel 1, channel 2 etc. If the `NumberOfChannels` element is not defined, one channel is presumed.

### Example: Element order for real data (1 channel)

```

I[0],           // Real sample 0
I[1],           // Real sample 1
I[2],           // Real sample 2
...

```

### Example: Element order for complex cartesian data (1 channel)

```

I[0], Q[0],     // Real and imaginary part of complex sample 0
I[1], Q[1],     // Real and imaginary part of complex sample 1
I[2], Q[2],     // Real and imaginary part of complex sample 2
...

```

### Example: Element order for complex polar data (1 channel)

```

Mag[0], Phi[0], // Magnitude and phase part of complex sample 0
Mag[1], Phi[1], // Magnitude and phase part of complex sample 1
Mag[2], Phi[2], // Magnitude and phase part of complex sample 2
...

```

**Example: Element order for complex cartesian data (3 channels)**

Complex data: I[channel no][time index], Q[channel no][time index]

```
I[0][0], Q[0][0],           // Channel 0, Complex sample 0
I[1][0], Q[1][0],           // Channel 1, Complex sample 0
I[2][0], Q[2][0],           // Channel 2, Complex sample 0

I[0][1], Q[0][1],           // Channel 0, Complex sample 1
I[1][1], Q[1][1],           // Channel 1, Complex sample 1
I[2][1], Q[2][1],           // Channel 2, Complex sample 1

I[0][2], Q[0][2],           // Channel 0, Complex sample 2
I[1][2], Q[1][2],           // Channel 1, Complex sample 2
I[2][2], Q[2][2],           // Channel 2, Complex sample 2
...
```

**Example: Element order for complex cartesian data (1 channel)**

This example demonstrates how to store complex cartesian data in float32 format using MATLAB®.

```
% Save vector of complex cartesian I/Q data, i.e. iqiqliq...
N = 100
iq = randn(1,N)+1j*randn(1,N)
fid = fopen('xyz.complex.float32','w');
for k=1:length(iq)
    fwrite(fid, single(real(iq(k))), 'float32');
    fwrite(fid, single(imag(iq(k))), 'float32');
end
fclose(fid)
```

## List of Remote Commands (WLAN)

|   |     |
|---|-----|
| [SENSe:]ADJust:LEVel.....                               | 244 |
| [SENSe:]BANDwidth:CHANnel:AUTO:TYPE.....                | 225 |
| [SENSe:]BANDwidth[:RESolution]:FILTer[:STATe].....      | 202 |
| [SENSe:]BURSt:COUNT.....                                | 235 |
| [SENSe:]BURSt:COUNT:STATe.....                          | 236 |
| [SENSe:]BURSt:SElect.....                               | 236 |
| [SENSe:]BURSt:SElect.....                               | 289 |
| [SENSe:]BURSt:SElect:STATe.....                         | 236 |
| [SENSe:]BURSt:SElect:STATe.....                         | 289 |
| [SENSe:]DEMod:CEStimation.....                          | 217 |
| [SENSe:]DEMod:FFT:OFFSet.....                           | 215 |
| [SENSe:]DEMod:FORMat:BANalyze.....                      | 227 |
| [SENSe:]DEMod:FORMat:BANalyze:BTYPe.....                | 228 |
| [SENSe:]DEMod:FORMat:BANalyze:BTYPe:AUTO:TYPE.....      | 229 |
| [SENSe:]DEMod:FORMat:BANalyze:DBYTes:EQUal.....         | 237 |
| [SENSe:]DEMod:FORMat:BANalyze:DBYTes:MAX.....           | 237 |
| [SENSe:]DEMod:FORMat:BANalyze:DBYTes:MIN.....           | 237 |
| [SENSe:]DEMod:FORMat:BANalyze:DURation:EQUal.....       | 238 |
| [SENSe:]DEMod:FORMat:BANalyze:DURation:MAX.....         | 238 |
| [SENSe:]DEMod:FORMat:BANalyze:DURation:MIN.....         | 238 |
| [SENSe:]DEMod:FORMat:BANalyze:SYMBols:EQUal.....        | 239 |
| [SENSe:]DEMod:FORMat:BANalyze:SYMBols:LENGth.....       | 240 |
| [SENSe:]DEMod:FORMat:BANalyze:SYMBols:LENGth:STATe..... | 239 |
| [SENSe:]DEMod:FORMat:BANalyze:SYMBols:MAX.....          | 240 |
| [SENSe:]DEMod:FORMat:BANalyze:SYMBols:MIN.....          | 241 |
| [SENSe:]DEMod:FORMat:BANalyze:SYMBols:OFFSet.....       | 241 |
| [SENSe:]DEMod:FORMat:MCSindex.....                      | 231 |
| [SENSe:]DEMod:FORMat:MCSindex:MODE.....                 | 231 |
| [SENSe:]DEMod:FORMat:NSTSinDex.....                     | 232 |
| [SENSe:]DEMod:FORMat:NSTSinDex:MODE.....                | 232 |
| [SENSe:]DEMod:FORMat:SIGSymbol.....                     | 233 |
| [SENSe:]DEMod:FORMat[:BContent]:AUTO.....               | 231 |
| [SENSe:]DEMod:TXARea.....                               | 216 |
| [SENSe:]FREQuency:CENTer.....                           | 196 |
| [SENSe:]FREQuency:CENTer:STEP.....                      | 196 |
| [SENSe:]FREQuency:CENTer:STEP:AUTO.....                 | 197 |
| [SENSe:]FREQuency:OFFSet.....                           | 197 |
| [SENSe:]MSRA:CAPTure:OFFSet.....                        | 247 |
| [SENSe:]POWer:SEM.....                                  | 247 |
| [SENSe:]POWer:SEM:CLASs.....                            | 249 |
| [SENSe:]SWAPiq.....                                     | 202 |
| [SENSe:]SWEp:TIME.....                                  | 203 |
| [SENSe] (see also SENSe: commands!).....                | 220 |
| ABORt.....  | 265 |
| CALCulate:LIMit:BURSt:ALL.....                          | 242 |
| CALCulate:LIMit:BURSt:ALL:RESult?.....                  | 281 |
| CALCulate:LIMit:BURSt:EVM:ALL:MAXimum.....              | 242 |

|   |     |
|---|-----|
| CALCulate:LIMit:BURSt:EVM:ALL:MAXimum:RESult?                       | 281 |
| CALCulate:LIMit:BURSt:EVM:ALL[:AVERAge]                             | 242 |
| CALCulate:LIMit:BURSt:EVM:ALL[:AVERAge]:RESult?                     | 281 |
| CALCulate:LIMit:BURSt:EVM:DATA:MAXimum                              | 243 |
| CALCulate:LIMit:BURSt:EVM:DATA:MAXimum:RESult?                      | 281 |
| CALCulate:LIMit:BURSt:EVM:DATA[:AVERAge]                            | 243 |
| CALCulate:LIMit:BURSt:EVM:DATA[:AVERAge]:RESult?                    | 281 |
| CALCulate:LIMit:BURSt:EVM:PILot:MAXimum                             | 243 |
| CALCulate:LIMit:BURSt:EVM:PILot:MAXimum:RESult?                     | 282 |
| CALCulate:LIMit:BURSt:EVM:PILot[:AVERAge]                           | 243 |
| CALCulate:LIMit:BURSt:EVM:PILot[:AVERAge]:RESult?                   | 282 |
| CALCulate:LIMit:BURSt:FERRor:MAXimum                                | 243 |
| CALCulate:LIMit:BURSt:FERRor:MAXimum:RESult?                        | 282 |
| CALCulate:LIMit:BURSt:FERRor[:AVERAge]                              | 243 |
| CALCulate:LIMit:BURSt:FERRor[:AVERAge]:RESult?                      | 282 |
| CALCulate:LIMit:BURSt:IQOFset:MAXimum                               | 244 |
| CALCulate:LIMit:BURSt:IQOFset:MAXimum:RESult?                       | 282 |
| CALCulate:LIMit:BURSt:IQOFset[:AVERAge]                             | 244 |
| CALCulate:LIMit:BURSt:IQOFset[:AVERAge]:RESult?                     | 282 |
| CALCulate:LIMit:BURSt:SYMBolerror:MAXimum                           | 244 |
| CALCulate:LIMit:BURSt:SYMBolerror:MAXimum:RESult?                   | 283 |
| CALCulate:LIMit:BURSt:SYMBolerror[:AVERAge]                         | 244 |
| CALCulate:LIMit:BURSt:SYMBolerror[:AVERAge]:RESult?                 | 283 |
| CALCulate:LIMit:TOLerance   | 192 |
| CALCulate<n>:BURSt[:IMMediate]                                      | 266 |
| CALCulate<n>:LIMit<k>:ACPowEr:ACHannel:RESult?                      | 283 |
| CALCulate<n>:LIMit<k>:ACPowEr:ALTerNate<ch>:RESult?                 | 283 |
| CALCulate<n>:LIMit<k>:FAIL?   | 284 |
| CALCulate<n>:MARKer<m>:FUNctIon:POWer<sb>:RESult?                   | 285 |
| CALCulate<n>:MARKer<m>:X  | 287 |
| CALCulate<n>:MARKer<m>:Y?   | 304 |
| CALCulate<n>:MARKer<m>[:STATe]                                      | 304 |
| CALCulate<n>:MSRA:ALINe:SHOW  | 245 |
| CALCulate<n>:MSRA:ALINe[:VALue]                                     | 246 |
| CALCulate<n>:MSRA:WINDow<n>:IVAL?                                   | 246 |
| CALCulate<n>:STATistics:RESult<t>?                                  | 287 |
| CALCulate<n>:UNIT:POWer   | 198 |
| CONFigure:BURSt:AM:AM:POLYnomial                                    | 259 |
| CONFigure:BURSt:AM:AM[:IMMediate]                                   | 185 |
| CONFigure:BURSt:AM:EVM[:IMMediate]                                  | 185 |
| CONFigure:BURSt:AM:PM[:IMMediate]                                   | 185 |
| CONFigure:BURSt:CONSt:CCARrier[:IMMediate]                          | 185 |
| CONFigure:BURSt:CONSt:CSYMBOL[:IMMediate]                           | 186 |
| CONFigure:BURSt:EVM:ECARrier[:IMMediate]                            | 186 |
| CONFigure:BURSt:EVM:ECHip[:IMMediate]                               | 186 |
| CONFigure:BURSt:EVM:ESYMBOL[:IMMediate]                             | 186 |
| CONFigure:BURSt:EVM:ESYMBOL[:IMMediate] (IEEE 802.11b and g (DSSS)) | 186 |
| CONFigure:BURSt:GAIN:GCARrier[:IMMediate]                           | 187 |
| CONFigure:BURSt:PREAmble:SElect                                     | 187 |
| CONFigure:BURSt:PREAmble[:IMMediate]                                | 187 |



|   |     |
|---|-----|
| CONFigure:BURSt:PTRacking[:IMMediate].....              | 187 |
| CONFigure:BURSt:PVT:AVERAge.....                        | 234 |
| CONFigure:BURSt:PVT:RPOWer.....                         | 234 |
| CONFigure:BURSt:PVT:SElect.....                         | 188 |
| CONFigure:BURSt:PVT[:IMMediate].....                    | 187 |
| CONFigure:BURSt:QUAD:QCARrier[:IMMediate].....          | 188 |
| CONFigure:BURSt:SPECtrum:ACPR[:IMMediate].....          | 190 |
| CONFigure:BURSt:SPECtrum:FFT[:IMMediate].....           | 188 |
| CONFigure:BURSt:SPECtrum:FLATness:CSElect.....          | 259 |
| CONFigure:BURSt:SPECtrum:FLATness:SElect.....           | 188 |
| CONFigure:BURSt:SPECtrum:FLATness[:IMMediate].....      | 189 |
| CONFigure:BURSt:SPECtrum:MASK[:IMMediate].....          | 190 |
| CONFigure:BURSt:SPECtrum:OBWidth[:IMMediate].....       | 191 |
| CONFigure:BURSt:STATistics:BSTReam[:IMMediate].....     | 189 |
| CONFigure:BURSt:STATistics:CCDF[:IMMediate].....        | 191 |
| CONFigure:BURSt:STATistics:SField[:IMMediate].....      | 189 |
| CONFigure:POWer:AUTO.....                               | 198 |
| CONFigure:POWer:AUTO:SWEEp:TIME.....                    | 198 |
| CONFigure:POWer:EXPEcted:RF.....                        | 199 |
| CONFigure:STANdard.....                                 | 192 |
| CONFigure:WLAN:ANTMatrix:ADDRes<add>.....               | 210 |
| CONFigure:WLAN:ANTMatrix:ANTenna<Analyzer>.....         | 211 |
| CONFigure:WLAN:ANTMatrix:RLEVel<antenna>:OFFSet.....    | 211 |
| CONFigure:WLAN:ANTMatrix:SOURce:AMPLitude:SOURce.....   | 211 |
| CONFigure:WLAN:ANTMatrix:SOURce:RLEVel:OFFSet.....      | 212 |
| CONFigure:WLAN:ANTMatrix:SOURce:ROSCillator:SOURce..... | 213 |
| CONFigure:WLAN:ANTMatrix:STATe<antenna>.....            | 213 |
| CONFigure:WLAN:DUTConfig.....                           | 213 |
| CONFigure:WLAN:EXTension:AUTO:TYPE.....                 | 220 |
| CONFigure:WLAN:GTIME:AUTO.....                          | 221 |
| CONFigure:WLAN:GTIME:AUTO:TYPE.....                     | 221 |
| CONFigure:WLAN:GTIME:SElect.....                        | 222 |
| CONFigure:WLAN:MIMO:CAPTure.....                        | 214 |
| CONFigure:WLAN:MIMO:CAPTure:BUFFer.....                 | 214 |
| CONFigure:WLAN:MIMO:CAPTure:TYPE.....                   | 214 |
| CONFigure:WLAN:MIMO:OSP:ADDRes.....                     | 215 |
| CONFigure:WLAN:MIMO:OSP:MODule.....                     | 215 |
| CONFigure:WLAN:PAYLoad:LENGth:SRC.....                  | 235 |
| CONFigure:WLAN:PVERror:MRANge?.....                     | 235 |
| CONFigure:WLAN:RSYNc:JOINed.....                        | 215 |
| CONFigure:WLAN:SMAPping:MODE.....                       | 223 |
| CONFigure:WLAN:SMAPping:NORMalise.....                  | 223 |
| CONFigure:WLAN:SMAPping:TX<ch>.....                     | 223 |
| CONFigure:WLAN:SMAPping:TX<ch>:STReam<stream>.....      | 224 |
| CONFigure:WLAN:SMAPping:TX<ch>:TIMeshift.....           | 224 |
| CONFigure:WLAN:STBC:AUTO:TYPE.....                      | 224 |
| DIAGnostic:SERVice:NSOURce.....                         | 195 |
| DISPlay:FORMat.....                                     | 250 |
| DISPlay[:WINDow<n>]:SElect.....                         | 190 |
| DISPlay[:WINDow<n>]:SIZE.....                           | 250 |

|   |     |
|---|-----|
| DISPlay[:WINDow<n>]:TABLe:ITEM.....                                     | 257 |
| DISPlay[:WINDow<n>]:TRACe<t>:X[:SCALe]:AUTO.....                        | 260 |
| DISPlay[:WINDow<n>]:TRACe<t>:X[:SCALe]:AUTO:FIXed:RANGe.....            | 260 |
| DISPlay[:WINDow<N>]:TRACe<t>:X[:SCALe]:AUTO:HYSTeresis:LOWer:LOWer..... | 261 |
| DISPlay[:WINDow<N>]:TRACe<t>:X[:SCALe]:AUTO:HYSTeresis:LOWer:UPPer..... | 261 |
| DISPlay[:WINDow<N>]:TRACe<t>:X[:SCALe]:AUTO:HYSTeresis:UPPer:LOWer..... | 261 |
| DISPlay[:WINDow<N>]:TRACe<t>:X[:SCALe]:AUTO:HYSTeresis:UPPer:UPPer..... | 262 |
| DISPlay[:WINDow<n>]:TRACe<t>:X[:SCALe]:AUTO:MEMory:DEPTH.....           | 262 |
| DISPlay[:WINDow<n>]:TRACe<t>:X[:SCALe]:AUTO:MODE.....                   | 262 |
| DISPlay[:WINDow<n>]:TRACe<t>:X[:SCALe]:DIVisions.....                   | 263 |
| DISPlay[:WINDow<n>]:TRACe<t>:X[:SCALe]:MAXimum.....                     | 263 |
| DISPlay[:WINDow<n>]:TRACe<t>:X[:SCALe]:MINimum.....                     | 264 |
| DISPlay[:WINDow<n>]:TRACe<t>:X[:SCALe]:PDIVision.....                   | 264 |
| DISPlay[:WINDow<n>]:TRACe<t>:Y[:SCALe]:AUTO.....                        | 260 |
| DISPlay[:WINDow<n>]:TRACe<t>:Y[:SCALe]:AUTO:FIXed:RANGe.....            | 260 |
| DISPlay[:WINDow<N>]:TRACe<t>:Y[:SCALe]:AUTO:HYSTeresis:LOWer:LOWer..... | 261 |
| DISPlay[:WINDow<N>]:TRACe<t>:Y[:SCALe]:AUTO:HYSTeresis:LOWer:UPPer..... | 261 |
| DISPlay[:WINDow<N>]:TRACe<t>:Y[:SCALe]:AUTO:HYSTeresis:UPPer:LOWer..... | 261 |
| DISPlay[:WINDow<N>]:TRACe<t>:Y[:SCALe]:AUTO:HYSTeresis:UPPer:UPPer..... | 262 |
| DISPlay[:WINDow<n>]:TRACe<t>:Y[:SCALe]:AUTO:MEMory:DEPTH.....           | 262 |
| DISPlay[:WINDow<n>]:TRACe<t>:Y[:SCALe]:AUTO:MODE.....                   | 262 |
| DISPlay[:WINDow<n>]:TRACe<t>:Y[:SCALe]:DIVisions.....                   | 263 |
| DISPlay[:WINDow<n>]:TRACe<t>:Y[:SCALe]:MAXimum.....                     | 263 |
| DISPlay[:WINDow<n>]:TRACe<t>:Y[:SCALe]:MINimum.....                     | 264 |
| DISPlay[:WINDow<n>]:TRACe<t>:Y[:SCALe]:PDIVision.....                   | 264 |
| DISPlay[:WINDow<n>]:TRACe<t>:Y[:SCALe]:RLEVel.....                      | 199 |
| DISPlay[:WINDow<n>]:TRACe<t>:Y[:SCALe]:RLEVel:OFFSet.....               | 199 |
| DISPlay[:WINDow<n>]:ZOOM:AREA.....                                      | 305 |
| DISPlay[:WINDow<n>]:ZOOM:MULTiple<zoom>:AREA.....                       | 306 |
| DISPlay[:WINDow<n>]:ZOOM:MULTiple<zoom>:STATe.....                      | 306 |
| DISPlay[:WINDow<n>]:ZOOM:STATe.....                                     | 305 |
| FETCh:BURSt:ALL.....  | 273 |
| FETCh:BURSt:AM:AM:COEFFicients?.....                                    | 274 |
| FETCh:BURSt:BERPilot:AVERAge?.....                                      | 275 |
| FETCh:BURSt:BERPilot:MAXimum?.....                                      | 275 |
| FETCh:BURSt:BERPilot:MINimum?.....                                      | 275 |
| FETCh:BURSt:CFERror:AVERAge.....  | 277 |
| FETCh:BURSt:CFERror:MAXimum.....  | 277 |
| FETCh:BURSt:CFERror:MINimum.....  | 277 |
| FETCh:BURSt:COUNt:ALL?.....   | 271 |
| FETCh:BURSt:COUNt?.....   | 271 |
| FETCh:BURSt:CPErRor:AVERAge.....  | 275 |
| FETCh:BURSt:CPErRor:MAXimum.....  | 275 |
| FETCh:BURSt:CPErRor:MINimum.....  | 275 |
| FETCh:BURSt:CRESt:MAXimum?.....   | 275 |
| FETCh:BURSt:CRESt:MINimum?.....   | 275 |
| FETCh:BURSt:CRESt:AVERAge?.....   | 275 |
| FETCh:BURSt:EVM:ALL:AVERAge?.....                                       | 275 |
| FETCh:BURSt:EVM:ALL:AVERAge?.....                                       | 278 |
| FETCh:BURSt:EVM:ALL:MAXimum?.....                                       | 275 |

|                                  |     |
|----------------------------------|-----|
| FETCh:BURSt:EVM:ALL:MAXimum?     | 278 |
| FETCh:BURSt:EVM:ALL:MINimum?     | 275 |
| FETCh:BURSt:EVM:ALL:MINimum?     | 278 |
| FETCh:BURSt:EVM:DATA:AVERage?    | 276 |
| FETCh:BURSt:EVM:DATA:MAXimum?    | 276 |
| FETCh:BURSt:EVM:DATA:MINimum?    | 276 |
| FETCh:BURSt:EVM:DIRect:AVERage?  | 276 |
| FETCh:BURSt:EVM:DIRect:MAXimum?  | 276 |
| FETCh:BURSt:EVM:DIRect:MINimum?  | 276 |
| FETCh:BURSt:EVM:PILot:AVERage?   | 276 |
| FETCh:BURSt:EVM:PILot:MAXimum?   | 276 |
| FETCh:BURSt:EVM:PILot:MINimum?   | 276 |
| FETCh:BURSt:EVM[:IEEE]:AVERage?  | 277 |
| FETCh:BURSt:EVM[:IEEE]:MAXimum?  | 277 |
| FETCh:BURSt:EVM[:IEEE]:MINimum?  | 277 |
| FETCh:BURSt:FERRor:AVERage?      | 277 |
| FETCh:BURSt:FERRor:MAXimum?      | 277 |
| FETCh:BURSt:FERRor:MINimum?      | 277 |
| FETCh:BURSt:GIMBalance:AVERage?  | 277 |
| FETCh:BURSt:GIMBalance:MAXimum?  | 277 |
| FETCh:BURSt:GIMBalance:MINimum?  | 277 |
| FETCh:BURSt:IQOffset:AVERage?    | 277 |
| FETCh:BURSt:IQOffset:MAXimum?    | 277 |
| FETCh:BURSt:IQOffset:MINimum?    | 277 |
| FETCh:BURSt:LENGths?             | 271 |
| FETCh:BURSt:MCPower:AVERage      | 278 |
| FETCh:BURSt:MCPower:MAXimum      | 278 |
| FETCh:BURSt:MCPower:MINimum      | 278 |
| FETCh:BURSt:PAYLoad:MAXimum?     | 278 |
| FETCh:BURSt:PAYLoad:MINimum?     | 278 |
| FETCh:BURSt:PAYLoad[:AVERage]?   | 278 |
| FETCh:BURSt:PEAK:MAXimum?        | 278 |
| FETCh:BURSt:PEAK:MINimum?        | 278 |
| FETCh:BURSt:PEAK[:AVERage]?      | 278 |
| FETCh:BURSt:PREamble:MAXimum?    | 278 |
| FETCh:BURSt:PREamble:MINimum?    | 278 |
| FETCh:BURSt:PREamble[:AVERage]?  | 278 |
| FETCh:BURSt:QUADoffset:AVERage?  | 279 |
| FETCh:BURSt:QUADoffset:MAXimum?  | 279 |
| FETCh:BURSt:QUADoffset:MINimum?  | 279 |
| FETCh:BURSt:RMS:MAXimum?         | 279 |
| FETCh:BURSt:RMS:MINimum?         | 279 |
| FETCh:BURSt:RMS[:AVERage]?       | 279 |
| FETCh:BURSt:STARts?              | 271 |
| FETCh:BURSt:SYMBolerror:AVERage? | 279 |
| FETCh:BURSt:SYMBolerror:MAXimum? | 279 |
| FETCh:BURSt:SYMBolerror:MINimum? | 279 |
| FETCh:BURSt:TFALI:AVERage?       | 279 |
| FETCh:BURSt:TFALI:MAXimum?       | 279 |
| FETCh:BURSt:TFALI:MINimum?       | 279 |

|                                      |     |
|--------------------------------------|-----|
| FETCh:BURSt:TRISe:AVERAge?           | 280 |
| FETCh:BURSt:TRISe:MAXimum?           | 280 |
| FETCh:BURSt:TRISe:MINimum?           | 280 |
| FETCh:SYMBol:COUNT?                  | 271 |
| FORMat[:DATA]                        | 288 |
| INITiate<n>:CONTinuous               | 266 |
| INITiate<n>:REFResh                  | 246 |
| INITiate<n>:SEQuencer:ABORt          | 267 |
| INITiate<n>:SEQuencer:IMMediate      | 267 |
| INITiate<n>:SEQuencer:MODE           | 268 |
| INITiate<n>:SEQuencer:REFResh[:ALL]  | 268 |
| INITiate<n>[:IMMediate]              | 267 |
| INPut:ATTenuation                    | 199 |
| INPut:ATTenuation:AUTO               | 200 |
| INPut:COUPling                       | 193 |
| INPut:DPATH                          | 194 |
| INPut:EATT                           | 200 |
| INPut:EATT:AUTO                      | 200 |
| INPut:EATT:STATe                     | 201 |
| INPut:FILTer:YIG[:STATe]             | 194 |
| INPut:GAIN:STATe                     | 201 |
| INPut:IMPedance                      | 194 |
| INPut:SElect                         | 195 |
| INSTrument:CREate:DUPLicate          | 180 |
| INSTrument:CREate:REPLace            | 181 |
| INSTrument:CREate[:NEW]              | 180 |
| INSTrument:DELeTe                    | 181 |
| INSTrument:LIST?                     | 181 |
| INSTrument:REName                    | 182 |
| INSTrument[:SElect]                  | 183 |
| LAYout:ADD[:WINDow]?                 | 251 |
| LAYout:CATalog[:WINDow]?             | 253 |
| LAYout:IDENtify[:WINDow]?            | 254 |
| LAYout:REMOve[:WINDow]               | 254 |
| LAYout:REPLace[:WINDow]              | 254 |
| LAYout:SPLitter                      | 255 |
| LAYout:WINDow<n>:ADD?                | 256 |
| LAYout:WINDow<n>:IDENtify?           | 256 |
| LAYout:WINDow<n>:REMOve              | 257 |
| LAYout:WINDow<n>:REPLace             | 257 |
| MMEMory:LOAD:IQ:STATe                | 302 |
| MMEMory:LOAD:SEM:STATe               | 311 |
| MMEMory:STORE<n>:IQ:STATe            | 303 |
| OUTPut:TRIGger<port>:DIRection       | 208 |
| OUTPut:TRIGger<port>:LEVel           | 209 |
| OUTPut:TRIGger<port>:OTYPe           | 209 |
| OUTPut:TRIGger<port>:PULSe:IMMediate | 210 |
| OUTPut:TRIGger<port>:PULSe:LENGth    | 210 |
| SENSe:TRACking:CROStalk              | 217 |
| SENSe:TRACking:IQMComp               | 217 |

|  |     |
|--|-----|
| SENSe:TRACking:LEVel.....                      | 218 |
| SENSe:TRACking:PHASe.....                      | 218 |
| SENSe:TRACking:PILots.....                     | 218 |
| SENSe:TRACking:PREamble.....                   | 219 |
| SENSe:TRACking:TIME.....                       | 219 |
| STATus:OPERation:CONDition?.....               | 309 |
| STATus:OPERation:ENABle.....                   | 309 |
| STATus:OPERation:NTRansition.....              | 310 |
| STATus:OPERation:PTRansition.....              | 310 |
| STATus:OPERation[:EVENT]?.....                 | 309 |
| STATus:PRESet.....                             | 308 |
| STATus:QUEStionable:ACPLimit:CONDition?.....   | 309 |
| STATus:QUEStionable:ACPLimit:ENABle.....       | 309 |
| STATus:QUEStionable:ACPLimit:NTRansition.....  | 310 |
| STATus:QUEStionable:ACPLimit:PTRansition.....  | 310 |
| STATus:QUEStionable:ACPLimit[:EVENT]?.....     | 309 |
| STATus:QUEStionable:CONDition?.....            | 309 |
| STATus:QUEStionable:ENABle.....                | 309 |
| STATus:QUEStionable:LIMit<n>:CONDition?.....   | 309 |
| STATus:QUEStionable:LIMit<n>:ENABle.....       | 309 |
| STATus:QUEStionable:LIMit<n>:NTRansition.....  | 310 |
| STATus:QUEStionable:LIMit<n>:PTRansition.....  | 310 |
| STATus:QUEStionable:LIMit<n>[:EVENT]?.....     | 309 |
| STATus:QUEStionable:NTRansition.....           | 310 |
| STATus:QUEStionable:PTRansition.....           | 310 |
| STATus:QUEStionable:SYNC:CONDition?.....       | 309 |
| STATus:QUEStionable:SYNC:ENABle.....           | 309 |
| STATus:QUEStionable:SYNC:NTRansition.....      | 310 |
| STATus:QUEStionable:SYNC:PTRansition.....      | 310 |
| STATus:QUEStionable:SYNC[:EVENT]?.....         | 309 |
| STATus:QUEStionable[:EVENT]?.....              | 309 |
| STATus:QUEue[:NEXT]?.....                      | 308 |
| SYSTem:PRESet:CHANnel[:EXECute].....           | 183 |
| SYSTem:SEQuencer.....                          | 269 |
| TRACe:IQ:DATA:MEMory.....                      | 291 |
| TRACe:IQ:SRATe.....                            | 203 |
| TRACe<n>[:DATA].....                           | 289 |
| TRACe<n>[:DATA]:X?.....                        | 291 |
| TRIGger:SEQuence:LEVel:POWER:AUTO.....         | 206 |
| TRIGger[:SEQuence]:DTIME.....                  | 204 |
| TRIGger[:SEQuence]:HOLDoff[:TIME].....         | 204 |
| TRIGger[:SEQuence]:IFPower:HOLDoff.....        | 204 |
| TRIGger[:SEQuence]:IFPower:HYSTeresis.....     | 205 |
| TRIGger[:SEQuence]:LEVel:IFPower.....          | 206 |
| TRIGger[:SEQuence]:LEVel:IQPower.....          | 206 |
| TRIGger[:SEQuence]:LEVel:RFPower.....          | 207 |
| TRIGger[:SEQuence]:LEVel[:EXTernal<port>]..... | 205 |
| TRIGger[:SEQuence]:MODE.....                   | 311 |
| TRIGger[:SEQuence]:SLOPe.....                  | 207 |
| TRIGger[:SEQuence]:SOURce.....                 | 207 |

|                      |     |
|----------------------|-----|
| UNIT:BURSt.....      | 272 |
| UNIT:EVM.....        | 280 |
| UNIT:GIMBalance..... | 280 |
| UNIT:PREamble.....   | 280 |

# Index

## A

|  |               |
|--|---------------|
| Abbreviations                                  |               |
| Signal processing IEEE 802.11a, g (OFDM), j, p | 56            |
| Aborting                                       |               |
| Sweep  | 150, 151      |
| AC/DC coupling                                 | 95            |
| ACLR   |               |
| Configuring (cdma2000)                         | 152           |
| Results  | 50            |
| Results (remote)                               | 285           |
| Activating                                     |               |
| WLAN measurements (remote)                     | 180           |
| Additive white Gaussian noise (AWGN)           | 58            |
| Adjacent channel leakage ratio                 |               |
| see ACLR                                       | 50            |
| Adjacent channels                              |               |
| Filtering out                                  | 105, 202      |
| AM/AM  |               |
| Polynomial degree                              | 145           |
| Result displays                                | 22            |
| Trace data                                     | 295           |
| AM/EVM   |               |
| Result displays                                | 23            |
| Trace data                                     | 295           |
| AM/PM  |               |
| Result displays                                | 23            |
| Trace data                                     | 295           |
| Amplitude                                      |               |
| Configuration (remote)                         | 197           |
| Configuration (softkey)                        | 99            |
| Settings                                       | 99            |
| Analysis                                       |               |
| Bandwidth, definition                          | 317           |
| Remote control                                 | 303           |
| RF measurements                                | 156           |
| Settings                                       | 156           |
| Analysis interval                              |               |
| MSRA   | 103, 118, 202 |
| Analysis line                                  | 87            |
| Antennas                                       |               |
| Assignment (MIMO)                              | 113           |
| Mapping (MIMO)                                 | 137           |
| MIMO settings                                  | 112           |
| OSP switch box                                 | 116           |
| State (MIMO)                                   | 112           |
| Application cards                              | 7             |
| Application notes                              | 7             |
| Applications                                   |               |
| Adopted parameters                             | 90            |
| Switching                                      | 90            |
| Attenuation                                    | 102           |
| Auto   | 102           |
| Electronic                                     | 102           |
| Manual   | 102           |
| Option   | 102           |
| Auto level                                     |               |
| Reference level                                | 102, 150      |
| Softkey  | 102, 150      |
| Auto settings                                  | 150           |
| Remote control                                 | 244           |
| Auto track time                                |               |
| Remote control                                 | 198           |

## B

|                              |          |
|------------------------------|----------|
| Bandwidth                    |          |
| Coverage, MSRA mode          | 87       |
| Extension options            | 317, 318 |
| Maximum usable               | 317      |
| Menu                         | 90       |
| Relationship to sample rate  | 318      |
| Bit error rate (BER)         |          |
| Pilot                        | 12       |
| Bitstream                    |          |
| Result display               | 24       |
| Trace data                   | 295      |
| Block diagram                |          |
| IEEE 802.11a, g (OFDM), j, p | 56       |
| Brochures                    | 7        |

## C

|   |                              |
|---|------------------------------|
| Capture buffer                            |                              |
| Results                                   | 35                           |
| Capture buffers                           |                              |
| Clearing (MIMO)                           | 117                          |
| Used (MIMO)                               | 117                          |
| Capture offset                            |                              |
| MSRA applications                         | 104, 109, 118                |
| Remote                                    | 247                          |
| Softkey                                   | 104, 109                     |
| Capture time                              | 12, 14, 104                  |
| Displayed                                 | 10                           |
| see also Measurement time                 | 203                          |
| Carriers                                  |                              |
| Active                                    | 78                           |
| CCDF                                      |                              |
| Configuring (applications)                | 155                          |
| Results                                   | 53                           |
| Trace data                                | 296                          |
| Center frequency                          | 98                           |
| Error                                     | 12                           |
| Softkey                                   | 98                           |
| Step size                                 | 98                           |
| Channel                                   |                              |
| Estimating                                | 120, 217                     |
| Estimating (IEEE 802.11a, g (OFDM), j, p) | 62                           |
| Channel bandwidth                         |                              |
| MSRA mode                                 | 87                           |
| Channel bandwidth (CBW)                   |                              |
| PPDU                                      | 124, 127, 131, 132, 133, 225 |
| Channel bar                               |                              |
| Displayed information                     | 10                           |
| Channel estimation                        |                              |
| Remote control                            | 216                          |
| Channel power                             |                              |
| ACLR, see ACLR                            | 50                           |
| Channels                                  |                              |
| Active carriers                           | 78                           |
| AWGN (IEEE 802.11a, g (OFDM), j, p)       | 58                           |
| Effective                                 | 72                           |
| Physical                                  | 72                           |
| Closing                                   |                              |
| Channels (remote)                         | 181                          |
| Windows (remote)                          | 254, 257                     |

- Compensating
  - IEEE 802.11a, g (OFDM), j, p ..... 61
  - Payload window (IEEE 802.11a, g (OFDM), j, p) ..... 58
- Compensation
  - I/Q Mismatch ..... 121
- Complementary cumulative distribution function
  - see CCDF ..... 53
- Constellation
  - Result display ..... 26
  - vs carrier (result display) ..... 28
  - vs carrier (trace data) ..... 298
  - vs symbol (trace data) ..... 297
- Continue single sweep
  - Softkey ..... 151
- Continuous Sequencer
  - Softkey ..... 89
- Continuous sweep
  - Softkey ..... 150
- Conventions
  - SCPI commands ..... 175
- Copying
  - Measurement channel (remote) ..... 180
- Coupling
  - Input (remote) ..... 193
- Crest Factor ..... 12
- Crosstalk
  - MIMO ..... 217
- D**
- Data acquisition
  - Manual (MIMO) ..... 116, 117
  - MIMO capture method ..... 112
  - MIMO settings ..... 111
  - MSRA ..... 103, 118, 202
  - see Signal capturing ..... 103
- Data format
  - Remote ..... 288
- Data input ..... 94
- Data output ..... 94
- Data sheet ..... 7
- Data streams
  - Mapping (MIMO) ..... 137
- Data symbols
  - Estimating (IEEE 802.11a, g (OFDM), j, p) ..... 61
  - Number ..... 12
  - Number of; displayed ..... 10
  - Required ..... 139, 235
- Demodulation
  - Basics ..... 79
  - Configuring ..... 122
  - Configuring (remote) ..... 220
  - Dependencies ..... 79
  - Parameters ..... 79
  - Settings (MIMO) ..... 136
- Diagram footer ..... 11
- Diagrams
  - Evaluation method ..... 54
- Digital standard ..... 12, 14
  - Channel bandwidths ..... 124, 127, 133
  - Displayed ..... 10
  - Selecting ..... 93
  - Selecting (remote) ..... 192
- Direct path
  - Remote ..... 194
- Display
  - Configuration (softkey) ..... 90
  - Understanding ..... 9
- Drop-out time
  - Trigger ..... 83, 108
- Duplicating
  - Measurement channel (remote) ..... 180
- E**
- Electronic input attenuation ..... 102
- Errors
  - Calculating parameters ..... 60
  - Calculating parameters (IEEE 802.11a, g (OFDM), j, p) ..... 62
  - Center frequency ..... 12
  - crosstalk ..... 217
  - EVM ..... 19
  - Gain imbalance ..... 12, 16, 18
  - I/Q offset ..... 12, 16
  - I/Q skew ..... 18
  - Messages ..... 172
  - Phase drift ..... 121, 218
  - Pilots ..... 122, 218
  - PPDU levels ..... 121, 217, 218
  - PPDU timing ..... 121, 219
  - Quadrature (phase angle I, Q) ..... 17, 18
  - Quadrature offset ..... 12
  - Status bits ..... 307
  - Symbol timing ..... 12
- Estimates
  - Signal processing (IEEE 802.11a, g (OFDM), j, p) ..... 58
- Estimating
  - Channels (IEEE 802.11a, g (OFDM), j, p) ..... 62
- Evaluation methods
  - Frequency sweep measurement ..... 53
  - Remote ..... 251
  - Trace data ..... 292
  - WLAN ..... 21
- Evaluation range
  - Remote ..... 234
  - Result displays ..... 137
  - Settings ..... 156
- EVM
  - All carriers ..... 12
  - Calculating (IEEE 802.11a, g (OFDM), j, p) ..... 62
  - Calculating (WLAN) ..... 19
  - Data carriers ..... 12
  - Data carriers, limit check result (remote) ..... 281
  - I/Q diagram ..... 20
  - IEEE 802.11b, g (DSSS) ..... 20
  - Limit check result (remote) ..... 281
  - Limits (remote) ..... 242, 243
  - Optimizing ..... 120, 217
  - Pilot carriers ..... 12
  - Pilot carriers, limit check result (remote) ..... 282
  - PPDU (direct) ..... 19
  - Units ..... 280
  - vs carrier (result display) ..... 29
  - vs carrier (trace data) ..... 298
  - vs chip (result display) ..... 30
  - vs symbol (result display) ..... 30
- Exporting
  - I/Q data ..... 94, 157, 158, 321, 325
  - I/Q data (remote) ..... 302
  - Softkey ..... 158



- Extension Spatial Streams
  - PPDUs ..... 135, 220
- External trigger ..... 107
  - Level (remote) ..... 205
- F**
- FFT
  - AWGN channel (IEEE 802.11a, g (OFDM), j, p) ..... 58
  - Carriers ..... 78
  - Signal processing (IEEE 802.11a, g (OFDM), j, p) ..... 58
  - Spectrum (result display) ..... 31
  - Spectrum (trace data) ..... 300
  - Start offset ..... 118
  - Start offset (remote) ..... 215
- Files
  - Format, I/Q data ..... 321
  - I/Q data binary XML ..... 325
  - I/Q parameter XML ..... 322
- Filters
  - Adjacent channels ..... 202
  - YIG (remote) ..... 194
- Format
  - Data (remote) ..... 288
  - PPDU (remote) ..... 229
- Free Run
  - Trigger ..... 107
- Freq. Error vs Preamble
  - Result displays ..... 33
- Frequency
  - Configuration ..... 98
  - Configuration (remote) ..... 196
  - Deviation ..... 59
  - Error limit (remote) ..... 243
  - Offset ..... 99
- Frequency offset
  - Error, limit check result (remote) ..... 282
  - Rx-Tx ..... 58
- Frequency sweep measurements
  - Configuring ..... 151
  - Selecting ..... 152
  - WLAN ..... 49
- Frontend
  - Configuration (remote) ..... 195
  - Parameters ..... 81
- G**
- Gain
  - Tracking (IEEE 802.11a, g (OFDM), j, p) ..... 60
- Gain imbalance ..... 12, 16, 18
  - Units ..... 280
- Group delay
  - Result display ..... 34
  - Trace data ..... 300
- Guard interval ..... 12
  - Displayed ..... 10
  - Length (PPDUs) ..... 129, 135, 221, 222
- H**
- Hysteresis
  - Trigger ..... 109
- I**
- I/Q data
  - Export file binary data description ..... 325
  - Export file parameter description ..... 322
  - Exporting ..... 94, 158
  - Exporting (remote) ..... 302
  - Exporting/Importing ..... 158
  - Importing ..... 94, 158
  - Importing (remote) ..... 302
  - Importing/Exporting ..... 157
  - Maximum bandwidth ..... 317
  - Sample rate ..... 317
- I/Q measurements
  - Configuring (remote) ..... 191
- I/Q mismatch ..... 18
- I/Q Mismatch
  - Compensation ..... 121
- I/Q offset ..... 12, 16
  - Limit check result (remote) ..... 282
  - Limits (remote) ..... 244
- I/Q Power
  - Trigger ..... 107
  - Trigger level (remote) ..... 206
- I/Q skew ..... 18
- IEEE 802.11a
  - Signal processing ..... 56
- IEEE 802.11a, g (OFDM), j, p
  - Literature ..... 63
  - Modulation formats ..... 79
- IEEE 802.11g (OFDM)
  - Signal processing ..... 56
- IEEE 802.11n
  - Modulation formats ..... 79
- IF Power
  - Trigger level (remote) ..... 206
- Impedance
  - Remote ..... 194
  - Setting ..... 95
- Importing
  - I/Q data ..... 94, 157, 158, 322
  - I/Q data (remote) ..... 302
  - Softkey ..... 158
- Input
  - Coupling ..... 95
  - Coupling (remote) ..... 193
  - RF ..... 95
  - Settings ..... 94, 103
  - Signal, parameters ..... 80
  - Source Configuration (softkey) ..... 94
  - Source, Radio frequency (RF) ..... 94
- Input sample rate ..... 104
  - Displayed ..... 10
  - Remote ..... 203
- Input sample rate (ISR)
  - Definition ..... 317
- Installation ..... 8
- Inter-channel interference (ICI) ..... 58
- IP address
  - OSP switchbox (MIMO) ..... 115
- J**
- Joined RX Sync and Tracking
  - MIMO ..... 113

**K**

|            |     |
|------------|-----|
| Keys       |     |
| BW         | 90  |
| LINES      | 90  |
| MKR FUNCT  | 90  |
| RUN CONT   | 150 |
| RUN SINGLE | 151 |
| SPAN       | 90  |

**L**

|   |          |
|---|----------|
| Level                                   |          |
| Tracking                                | 121      |
| Tracking (IEEE 802.11a, g (OFDM), j, p) | 60       |
| Level error tracking                    | 217, 218 |
| Limits                                  |          |
| Defining (remote)                       | 241      |
| EVM                                     | 242, 243 |
| EVM pilot carriers, result              | 282      |
| EVM, result                             | 281      |
| Frequency error, result                 | 282      |
| Frequency error                         | 243      |
| I/Q offset                              | 244      |
| I/Q offset, result                      | 282      |
| Symbol clock error                      | 244      |
| Symbol clock error, result              | 283      |
| Lines                                   |          |
| Menu                                    | 90       |
| Literature                              |          |
| IEEE 802.11a, g (OFDM), j, p            | 63       |
| Log likelihood function                 |          |
| IEEE 802.11a, g (OFDM), j, p            | 60       |
| Logical filter                          | 79       |
| Long symbol (LS)                        |          |
| IEEE 802.11a, g (OFDM), j, p            | 58       |

**M**

|                            |                   |
|----------------------------|-------------------|
| Magnitude Capture          |                   |
| Result display             | 35                |
| Trace data                 | 292               |
| Marker Functions           |                   |
| Menu                       | 90                |
| Marker table               |                   |
| Evaluation method          | 54                |
| Markers                    |                   |
| Configuration (remote)     | 304               |
| Querying position (remote) | 304               |
| Table (evaluation method)  | 54                |
| Maximizing                 |                   |
| Windows (remote)           | 250               |
| Maximum                    |                   |
| Y-axis                     | 148               |
| MCS index                  | 12, 128, 133, 134 |
| Displayed                  | 10                |
| Displayed information      | 129, 135          |
| Remote                     | 231               |
| Measurement channel        |                   |
| Creating (remote)          | 180, 181, 183     |
| Deleting (remote)          | 181               |
| Duplicating (remote)       | 180               |
| Querying (remote)          | 181               |
| Renaming (remote)          | 182               |
| Replacing (remote)         | 181               |
| Selecting (remote)         | 183               |

|                               |               |
|-------------------------------|---------------|
| Measurement examples          |               |
| WLAN                          | 164           |
| Measurement time              |               |
| Remote                        | 203           |
| Measurements                  |               |
| Frequency sweep               | 49            |
| RF, results                   | 50            |
| RF, types                     | 50            |
| Selecting                     | 88, 92        |
| Selecting (remote)            | 184           |
| Setup, displayed              | 10            |
| Starting (remote)             | 265           |
| Types                         | 12            |
| Messages                      |               |
| Signal Field                  | 172           |
| MIMO                          | 69            |
| Antenna assignment            | 113           |
| Calculating results           | 117           |
| Capture buffers               | 117           |
| Capture method                | 112           |
| Capture settings              | 111           |
| Crosstalk                     | 217           |
| Demodulation settings         | 136           |
| DUT configuration             | 112           |
| Joined RX Sync and Tracking   | 113           |
| Manual data capture           | 117           |
| Manual sequential capture     | 116           |
| Normalizing power             | 137           |
| OSP IP address                | 115           |
| PPDU synchronization          | 113           |
| Reference frequency coupling  | 114           |
| Sequential capture using OSP  | 114           |
| Simultaneous capture settings | 112           |
| Slave analyzers               | 113           |
| Spatial mapping mode          | 136           |
| User-defined spatial mapping  | 137           |
| Minimum                       |               |
| Y-axis                        | 148           |
| Modulation                    |               |
| Formats                       | 79            |
| Inverted (I/Q, remote)        | 202           |
| Inverted (I/Q)                | 105           |
| PPDU                          | 125, 131, 229 |
| PPDU (remote)                 | 228           |
| PPDUs                         | 128, 133      |
| Modulation Accuracy           |               |
| Parameters                    | 12            |
| Modulation and Coding Scheme  |               |
| see MCS                       | 128, 133      |
| MSR ACLR                      |               |
| Results (remote)              | 285           |
| MSRA                          |               |
| Analysis interval             | 103, 118, 202 |
| Operating mode                | 86            |
| RF measurements               | 50            |
| MSRA applications             |               |
| Capture offset                | 118           |
| Capture offset (remote)       | 247           |
| MSRA Master                   |               |
| Data coverage                 | 87            |
| Multiple                      |               |
| Measurement channels          | 88            |
| <b>N</b>                      |               |
| Ness                          |               |
| PPDUs                         | 135, 220      |

- Nof\_symbols ..... 58
- Noise
  - Additive white Gaussian (AWG) ..... 58
  - Source ..... 80, 96
- Normalizing
  - Power (MIMO) ..... 137
- Nsts
  - PPDUs ..... 128, 129, 232
- Number of samples
  - Displayed ..... 10
- O**
- OBW
  - Configuring (applications) ..... 154
  - Results ..... 52
- Occupied bandwidth
  - see OBW ..... 52
- Offset
  - Amplification I, Q ..... 16, 18
  - Analysis interval ..... 104, 109
  - Carriers ..... 16
  - Frequency ..... 99
  - Phase angle I, Q ..... 17, 18
  - Quadrature ..... 17, 18
  - Reference level ..... 101
- Online help ..... 6
- Options
  - Bandwidth extension ..... 317, 318
  - Electronic attenuation ..... 102
  - Preamplifier (B24) ..... 103
- OSP switch box
  - Antenna connection (MIMO) ..... 116
  - IP address ..... 115
  - Setup ..... 114
  - State (MIMO) ..... 115
- Output
  - Configuration ..... 96
  - Configuration (remote) ..... 195
  - Noise source ..... 80, 96
  - Parameters ..... 80
  - Sample rate, definition ..... 317
  - Settings ..... 96
  - Trigger ..... 97, 110
- Overview
  - Configuring WLAN measurements ..... 91
- P**
- Packet search
  - IEEE 802.11a, g (OFDM), j, p ..... 58
- Parameters
  - Frontend ..... 81
  - Input signal ..... 80
  - Output ..... 80
  - WLAN ..... 12
- Payload
  - Channel estimation ..... 120, 217
  - Length ..... 139, 141, 142, 235
  - Length (source, remote) ..... 235
  - Length (source) ..... 139
  - Window ..... 58
- Peak list
  - Evaluation method ..... 55
- Peak vector error
  - Measurement range ..... 142
- Peak Vector Error ..... 20
- Phase drift ..... 59
  - Tracking ..... 121
  - Tracking (IEEE 802.11a, g (OFDM), j, p) ..... 60
- Phase Error vs Preamble
  - Result displays ..... 36
- Phase tracking ..... 218
- Phase Tracking
  - Result displays ..... 37
- Pilot bit error rate ..... 12
- Pilots
  - for tracking ..... 122, 218
- Polynomial degree
  - AM/AM ..... 145
- Power
  - Interval search ..... 118
  - PPDU ..... 12
  - vs frequency ..... 31
  - vs time, see PvT ..... 38, 39, 40
- Power interval search ..... 216
- Power normalize
  - MIMO ..... 137
- PPDU
  - Abbreviation ..... 64
  - Amount to analyze ..... 139, 141, 236
  - Amount to analyze (remote) ..... 235
  - Analysis mode ..... 123, 126, 132
  - Analyzed ..... 10, 78
  - Channel bandwidth ..... 124, 127, 131, 132, 133, 225
  - Count (remote) ..... 270
  - Currently analyzed ..... 12, 14
  - Demodulation ..... 122
  - Displayed ..... 10
  - EVM (Direct) ..... 19
  - Extension Spatial Streams (IEEE 802.11 n) ..... 135, 220
  - Format ..... 124, 127, 131, 132
  - Format (remote) ..... 227, 229
  - Guard interval length (IEEE 802.11 n, ac) ..... 129, 135, 221, 222
  - Length ..... 272
  - Level errors ..... 121, 217, 218
  - Maximum length (remote) ..... 240
  - Minimum length (remote) ..... 241
  - Modulation ..... 125, 229
  - Modulation (IEEE 802.11 a) ..... 125, 131
  - Modulation (IEEE 802.11 n, ac) ..... 128, 133
  - Modulation (remote) ..... 228
  - Ness (IEEE 802.11 n) ..... 135, 220
  - Nsts ..... 128
  - Nsts (IEEE 802.11 ac) ..... 129, 232
  - Number to analyze ..... 236
  - Number to analyze (remote) ..... 236
  - Payload length ..... 139, 141, 142
  - Payload length (remote) ..... 235
  - Phase drift ..... 121, 218
  - Physical channel ..... 12, 14
  - Pilots ..... 122, 218
  - Power ..... 12
  - Power search ..... 118, 216
  - Recognized ..... 12, 14, 78
  - Selecting ..... 289
  - Selecting (remote) ..... 289
  - Signal field ..... 45, 123, 126, 132, 231
  - Start position ..... 271
  - STBC (IEEE 802.11 ac,n) ..... 129, 134, 224
  - Synchronization (MIMO) ..... 113
  - Timing errors ..... 121, 219

- Total analyzed ..... 12, 14
- Valid ..... 78
- PPDUs
  - Evaluation range ..... 138
  - PvT ..... 187, 188
- Preamble
  - Channel estimation ..... 120, 217, 219
  - Units ..... 280
- Preamplifier
  - Setting ..... 103
  - Softkey ..... 103
- Presetting
  - Channels ..... 92
- Pretrigger ..... 108
- Programming examples
  - SEM ..... 315
  - Statistics ..... 312
  - WLAN ..... 312
- PSDU
  - Abbreviation ..... 64
- PvT
  - Falling edge, result display ..... 40
  - Full PPDU ..... 187, 188
  - Full PPDU, result display ..... 38
  - Rising & Falling ..... 187, 188
  - Rising edge, result display ..... 39
- PvT Full Burst
  - Trace data ..... 301
- Q**
- Quadrature offset ..... 17, 18
  - Error ..... 12
- R**
- Record length
  - Definition ..... 317
  - Relationship to sample rate ..... 318
- Reference frequency
  - Coupling (MIMO) ..... 114
- Reference level
  - Auto level ..... 102, 150
  - Auto level (continuous) ..... 100
  - Offset ..... 101
  - Offset (softkey) ..... 101
  - Unit ..... 101
  - Value ..... 101
- Refreshing
  - MSRA applications ..... 151
  - MSRA applications (remote) ..... 246
  - Softkey ..... 151
- Release notes ..... 7
- Remote commands
  - Basics on syntax ..... 175
  - Boolean values ..... 179
  - Capitalization ..... 176
  - Character data ..... 179
  - Data blocks ..... 179
  - Numeric values ..... 178
  - Obsolete ..... 311
  - Optional keywords ..... 177
  - Parameters ..... 177
  - Strings ..... 179
  - Suffixes ..... 176
- Restoring
  - Channel settings ..... 92
- Result configuration
  - Softkey ..... 143
- Result displays
  - AM/AM ..... 22
  - AM/EVM ..... 23
  - AM/PM ..... 23
  - Bitstream ..... 24
  - Configuration (remote) ..... 249
  - Configuring ..... 90
  - Constellation ..... 26
  - Constellation vs carrier ..... 28
  - Diagram ..... 54
  - Evaluated data ..... 137
  - EVM vs carrier ..... 29
  - EVM vs chip ..... 30
  - EVM vs Symbol ..... 30
  - FFT spectrum ..... 31
  - Freq. Error vs Preamble ..... 33
  - Gain Imbalance vs Carrier ..... 33
  - Group Delay ..... 34
  - Magnitude Capture ..... 35
  - Marker table ..... 54
  - Peak list ..... 55
  - Phase Error vs Preamble ..... 36
  - Phase Tracking ..... 37
  - PvT Falling Edge ..... 40
  - PvT Full PPDU ..... 38
  - PvT Rising Edge ..... 39
  - Quad Error vs Carrier ..... 41
  - Result Summary ..... 54
  - Result Summary Detailed ..... 41
  - Result Summary Global ..... 43
  - Result Summary, items ..... 143
  - Result Summary, items (remote) ..... 257
  - see also Evaluation methods ..... 12
  - Signal Field ..... 45
  - Signal Field (K91/91n) ..... 37
  - Spectrum Flatness ..... 48
  - WLAN ..... 21
- Result Summary
  - Detailed (result display) ..... 41
  - Evaluation method ..... 54
  - Global (result display) ..... 43
  - Items to display ..... 143
  - Items to display (remote) ..... 257
  - Result display ..... 54
  - Trace data ..... 292
- Results
  - AM/AM ..... 295
  - AM/EVM ..... 295
  - AM/PM ..... 295
  - Bitstream ..... 295
  - CCDF ..... 296
  - Constellation vs carrier ..... 298
  - Constellation vs symbol ..... 297
  - Data format (remote) ..... 288
  - Evaluating ..... 156
  - EVM vs Carrier ..... 298
  - FFT Spectrum ..... 300
  - Group delay ..... 300
  - Magnitude Capture ..... 292
  - Numeric (remote) ..... 270
  - PvT Full Burst ..... 301
  - Result summary ..... 292
  - Retrieving (remote) ..... 269
  - RF (remote) ..... 283
  - Signal field ..... 302

- Spectrum Flatness ..... 302
- Trace (remote) ..... 288
- Trace data query (remote) ..... 292
- Updating the display ..... 151
- Updating the display (remote) ..... 246
- Retrieving
  - Numeric results (remote) ..... 270
  - Results (remote) ..... 269
  - RF Results (remote) ..... 283
  - Trace results (remote) ..... 288
- RF attenuation
  - Auto ..... 102
  - Manual ..... 102
- RF input
  - Remote ..... 193, 195
- RF measurements
  - Analysis ..... 156
  - Configuration (remote) ..... 247
  - MSRA ..... 50
  - Results (remote) ..... 283
  - Step by step ..... 163
- RF Power
  - Trigger ..... 107
  - Trigger level (remote) ..... 207
- RUN CONT
  - Key ..... 150
- RUN SINGLE
  - Key ..... 151
- S**
- Sample rate ..... 12, 14
  - Definition ..... 317
  - Displayed ..... 10
  - Maximum ..... 317
  - Relationship to bandwidth ..... 318
  - Remote ..... 203
- Samples
  - Number ..... 12, 14
- Scaling
  - Y-axis ..... 148
- Select meas ..... 88
- SEM
  - Configuring (cdma2000) ..... 153
  - Programming example ..... 315
  - Results ..... 51
- Sequencer ..... 88
  - Aborting (remote) ..... 267
  - Activating (remote) ..... 267
  - Mode ..... 89
  - Mode (remote) ..... 268
  - Remote ..... 266
  - Softkey ..... 89
  - State ..... 89
- Sequential
  - MIMO capture method ..... 114
- Sequential (manual)
  - MIMO capture method ..... 116
- Settings
  - Overview ..... 91
- Short symbol (SS)
  - IEEE 802.11a, g (OFDM), j, p ..... 58
- Signal capturing
  - Duration ..... 104
  - Remote control ..... 202
  - Softkey ..... 103
- Signal description
  - Configuring ..... 92
  - Remote control ..... 191
  - Softkey ..... 92
- Signal field ..... 231
- Signal Field
  - PPDU analysis ..... 123, 126, 132
  - Result display ..... 45
  - Trace data ..... 302
- Signal level ..... 101
- Signal processing
  - IEEE 802.11a, g (OFDM), j, p ..... 56
  - IEEE 802.11b, g (DSSS) ..... 63
- Signal source
  - Remote ..... 195
- Simultaneous
  - MIMO capture method ..... 112
- Single Sequencer
  - Softkey ..... 89
- Single sweep
  - Softkey ..... 151
- SISO ..... 69
- Skew ..... 18
- Slave analyzers
  - IP address (MIMO) ..... 113
  - State (MIMO) ..... 113
- Slope
  - Trigger ..... 109, 207
- SmartGrid ..... 21, 90
- softkey
  - Average Length (K91/91n) ..... 142
  - Ref Pow Max/Mean (K91/91n) ..... 142
- Softkeys
  - Amplitude Config ..... 99
  - Auto Level ..... 102, 150
  - Capture Offset ..... 104, 109
  - Center ..... 98
  - Continue Single Sweep ..... 151
  - Continuous Sequencer ..... 89
  - Continuous Sweep ..... 150
  - Display Config ..... 90
  - Export ..... 158
  - External ..... 107
  - Free Run ..... 107
  - Frequency Config ..... 98
  - I/Q Power ..... 107
  - Import ..... 158
  - Input Source Config ..... 94
  - IQ Export ..... 158
  - IQ Import ..... 158
  - Outputs Config ..... 96
  - Preamp ..... 103
  - Ref Level Offset ..... 101
  - Refresh ..... 151
  - Result Config ..... 143
  - RF Atten Auto ..... 102
  - RF Atten Manual ..... 102
  - RF Power ..... 107
  - Sequencer ..... 89
  - Signal Capture ..... 103
  - Signal Description ..... 92
  - Single Sequencer ..... 89
  - Single Sweep ..... 151
  - Sweep Config ..... 150
  - Time ..... 108
  - Trigger Config ..... 105
  - Trigger Offset ..... 108

- Space-Time Block Coding
    - see STBC ..... 129, 134
  - Space-time stream ..... 72
  - Span
    - Menu ..... 90
  - Spatial mapping mode
    - MIMO ..... 136
    - User-defined (MIMO) ..... 137
  - Specifics for
    - Configuration ..... 92
  - Spectrum Emission Mask
    - see SEM ..... 51
  - Spectrum Flatness
    - Parameters ..... 12
    - Result display ..... 48
    - Trace data ..... 302
  - Standard
    - see Digital standard ..... 10
  - Standard WLAN measurements ..... 12
  - Starting
    - WLAN application ..... 9
  - Statistic count ..... 139, 141, 236
    - Remote ..... 235
  - Statistics
    - PPDUs ..... 16
    - Programming example ..... 312
  - Status bar ..... 11
    - Error messages ..... 172
  - Status registers
    - Contents ..... 307
    - Querying ..... 307, 308
    - STATus:QUEStionable:SYNC ..... 307
    - WLAN ..... 307
  - STBC
    - PPDUs ..... 129, 134
    - PPDUs (remote) ..... 224
  - Suffixes
    - Common ..... 174
    - Remote commands ..... 176
  - Swap I/Q
    - Remote ..... 202
  - Swap IQ ..... 105
  - Sweep
    - Aborting ..... 150, 151
    - Configuration (softkey) ..... 150
    - Time (remote) ..... 203
  - Symbol clock
    - Error ..... 12
    - error limit (remote) ..... 244
    - Error, limit check result (remote) ..... 283
  - Symbols
    - Count (remote) ..... 270
    - Data ..... 61
    - Long (IEEE 802.11a, g (OFDM), j, p) ..... 58
    - Short (IEEE 802.11a, g (OFDM), j, p) ..... 58
  - Synchronization ..... 118
    - Remote control ..... 215
- T**
- Time trigger
    - Softkey ..... 108
  - Timing
    - Coarse ..... 58
    - Detection (IEEE 802.11a, g (OFDM), j, p) ..... 58
    - Deviations ..... 34
    - Fine ..... 58
    - Tracking ..... 121
    - Tracking (IEEE 802.11a, g (OFDM), j, p) ..... 60
    - Timing error tracking ..... 219
    - Tolerance
      - Parameters ..... 12
    - Traces
      - Querying results ..... 21
      - Results (remote) ..... 288
    - Tracking ..... 60
      - crosstalk ..... 217
      - Level errors ..... 121, 217, 218
      - Phase drift ..... 121, 218
      - Pilots ..... 122, 218
      - Remote control ..... 216
      - Timing errors ..... 121, 219
    - Trigger
      - Configuration (remote) ..... 203
      - Configuration (softkey) ..... 105
      - Drop-out time ..... 108
      - Drop-Out Time ..... 83
      - External (remote) ..... 207
      - Holdoff ..... 84, 109
      - Hysteresis ..... 83, 109
      - Measurements ..... 82
      - Offset ..... 82, 108
      - Output ..... 97, 110
      - Slope ..... 109, 207
      - Synchronization ..... 85
    - Trigger level ..... 108
      - Auto ..... 108
      - Auto (remote) ..... 206
      - External trigger (remote) ..... 205
      - I/Q Power (remote) ..... 206
      - IF Power (remote) ..... 206
      - RF Power (remote) ..... 207
    - Trigger source ..... 106
      - External ..... 107
      - Free Run ..... 107
      - I/Q Power ..... 107
      - RF Power ..... 107
      - Time ..... 108
    - Troubleshooting ..... 171

**U**

    - Units
      - EVM results ..... 280
      - Gain imbalance results ..... 280
      - PPDU length results ..... 272
      - Preamble results ..... 280
      - Reference level ..... 101
    - Updating
      - Result display ..... 151
      - Result display (remote) ..... 246
    - Usable I/Q bandwidth
      - Definition ..... 317
    - User sample rate
      - Definition ..... 317

**W**

    - White papers ..... 7
    - Window title bar ..... 11
    - Windows
      - Adding (remote) ..... 251
      - Closing (remote) ..... 254, 257
      - Configuring ..... 92

|  |          |
|--|----------|
| Layout (remote) .....                  | 255      |
| Maximizing (remote) .....              | 250      |
| Querying (remote) .....                | 253, 254 |
| Replacing (remote) .....               | 254      |
| Splitting (remote) .....               | 250      |
| Types (remote) .....                   | 251      |
| <b>WLAN</b>                            |          |
| Measurements .....                     | 12       |
| Measurements, step by step .....       | 161      |
| Parameters .....                       | 12       |
| Programming examples .....             | 312      |
| Remote control .....                   | 174      |
| Results .....                          | 12       |
| <b>Y</b>                               |          |
| Y-maximum, Y-minimum                   |          |
| Scaling .....                          | 148      |
| YIG-preselector                        |          |
| Activating/Deactivating .....          | 95       |
| Activating/Deactivating (remote) ..... | 194      |
| <b>Z</b>                               |          |
| Zooming                                |          |
| Activating (remote) .....              | 305      |
| Area (Multiple mode, remote) .....     | 306      |
| Area (remote) .....                    | 305      |
| Multiple mode (remote) .....           | 305, 306 |
| Remote .....                           | 305      |
| Single mode (remote) .....             | 305      |