



INSTRUCTION MANUAL

drift convertible booster seat

FROM
6 TO **8**^{**}
MONTHS YEARS



Illustrations and designs may vary.

IMPORTANT: KEEP THIS BOOKLET IN THE PLACE PROVIDED ON THE CHILD RESTRAINT.



[motherschoice.com.au](https://www.motherschoice.com.au)







*Harness mode #Unharnessed mode Service Australian Standard AS/NZS 1754.24:2001 SAT design

HARNESSED MODE:
6 MONTHS TO 4 YEARS APPROXIMATELY

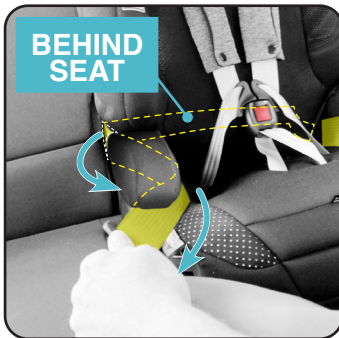

HARNESSED MODE:
6 MONTHS TO 4 YEARS APPROXIMATELY

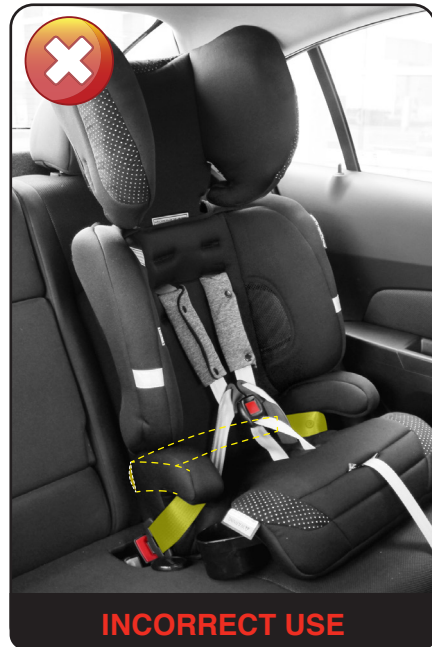
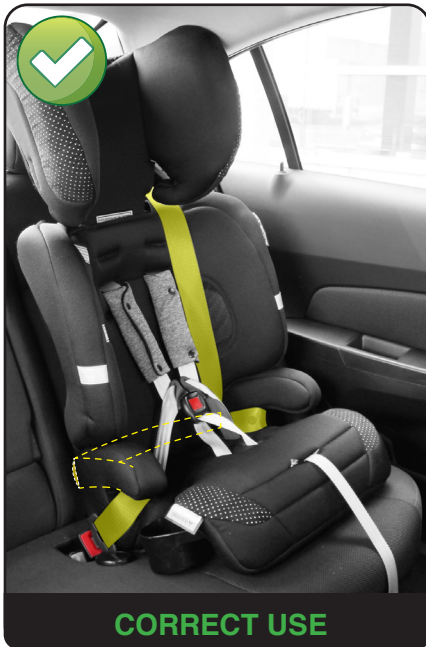

For detailed step by step installation instructions, please refer to **page 23**.

TRANSITIONING TO BOOSTER MODE: REMOVING HARNESS

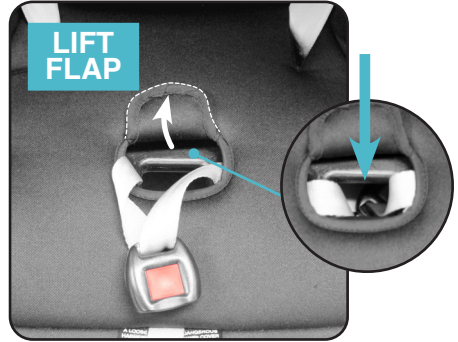
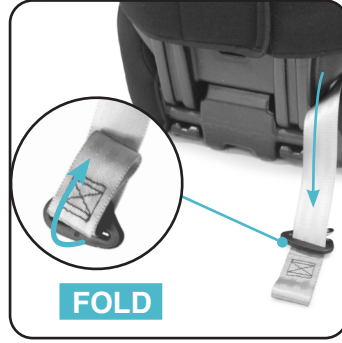

For detailed step by step installation instructions, please refer to **page 25**.

BOOSTER MODE:
4 YEARS TO 8 YEARS APPROXIMATELY

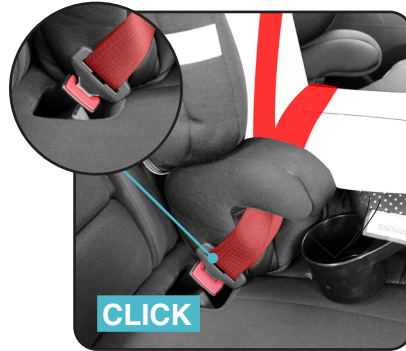
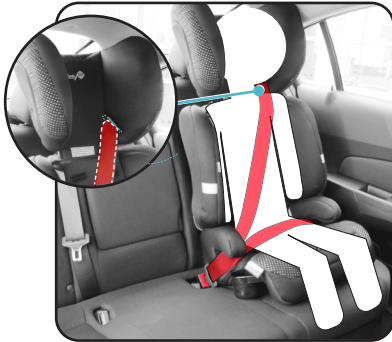

For detailed step by step installation instructions, please refer to **page 29**.

contents

Quick start guide	2-5
Before you start	7
Warnings	8-9
PREPARING SEAT AND VEHICLE	
Next seat for your child	10
Harnesses shoulder height markers	11
Components list for harnessed use	12
Anchor fitting locations	13
Anchor installation	14-16
Correct forward-facing operation	17
SEAT OPERATION AND ADJUSTMENT	
Adjusting top tether strap	18
Adjusting harness and seat configuration	19
Loosening and fastening harness straps	20
Adjusting the headrest, recline and cup holders	21
Buckle fastening and operation	22
HARNES MODE	
Forward-facing harness installation	23-24
BOOSTER MODE	
Removing the harness for booster use	25
Booster shoulder height markers	26
Components list for booster use	27
Correct positioning of booster seat	28
Securing child and booster seat to vehicle	29
CARE AND MAINTENANCE	
Buckle maintenance	30-31
Fabric cleaning and care instructions	32
Removing and fitting accessories	33
Hardware cleaning and care instructions	34
CONTACTS	
Warranty	35
Notes	36-38
Product Registration	39
Customer service	40



Before you start:

Thank you for purchasing this child seat. This product is suitable for children approximately 6 months old, to approximately 6 to 8 years old. We welcome you as a valued customer, and trust that your child will enjoy many years of comfort and safety.

No child restraint can guarantee absolute protection from a crash. However proper use of this restraint may reduce the risk of injury or death!

need assistance?

Call our Customer Service Team: 1300 809 526
Monday to Friday (8:30am - 5:00pm AEST)
or send an email: customerservice@dorel.com.au

www.motherschoice.com.au  **mother's choice**

before you start...

Please read and follow all of the instructions outlined in this manual for maximum protection.

If you have any questions regarding the installation or use of this child restraint in Australia or New Zealand, please contact our customer service numbers provided. An alternative option is to also contact any registered child fitting station authorised by your local transport authority.

No child restraint can guarantee absolute protection from a crash. However proper use of this restraint may reduce the risk of injury or death.

WARNINGS

IMPORTANT: RETAIN FOR FUTURE REFERENCE

THESE INSTRUCTIONS DETAIL THE SAFE USE, FITMENT AND MAINTENANCE OF THE SEAT.

PLEASE READ THESE INSTRUCTIONS CAREFULLY AND ENSURE THAT THEY ARE FOLLOWED AT ALL TIMES.

NO SAFETY SEAT CAN GUARANTEE PROTECTION FROM INJURY HOWEVER, PROPER USE OF THIS SEAT REDUCES THE RISK OF SERIOUS INJURY OR DEATH TO YOUR CHILD.

THIS RESTRAINT MUST BE ATTACHED TO A CHILD RESTRAINT UPPER ANCHORAGE POINT IN THE CAR. REFER TO CAR OWNER'S HANDBOOK FOR LOCATION OF UPPER ANCHORAGE POINTS. REFER TO A CHILD RESTRAINT FITTING STATION IF NO UPPER ANCHORAGE POINTS ARE IN THE MOTOR CAR.

Follow the manufacturer's instructions at all times.

- To be used in a forward-facing position with built-in harness by a child whose shoulders are above the lower shoulder height marker (approximately 6 months of age) until their shoulders reach the middle shoulder height marker (approximately 4 years of age). Then to be used with a lap-sash seatbelt until the child's shoulders reach the upper shoulder height marker (approximately 6-8 years of age).
- Continue to use this child restraint until the child reaches this limit. Children are safest in a booster seat until their shoulders reach the upper shoulder height marker of the booster seat.
- Do not use this child restraint until child's shoulders are above the lower shoulder height marker.
- THIS RESTRAINT MUST BE USED IN CARS WITH FORWARD-FACING SEATS WITH A LAP-SASH SEATBELT. THIS BOOSTER SEAT IS NOT SUITABLE FOR USE WITH A CHILD HARNESS.
- If the knees do not bend in front of the vehicle seat cushion continue to use a booster seat.

WARNINGS

- Just using a seatbelt is not recommended for children that have outgrown this seat. Use a larger booster seat.
- Use the restraint exactly as shown in the instructions.
- Supervision of children is needed because they may be able to undo the buckles.
- **DO NOT LEAVE CHILDREN UNATTENDED IN THE CAR.**
- Do not alter or modify this restraint.
- Repairs must only be done by the manufacturers or agent.
- Do not allow the restraint to come into contact with polishes, oils, bleach and other chemicals.
- Destroy the restraint if it has been in a severe crash, even if no damage is visible.
- **DO NOT USE THIS RESTRAINT WITHOUT THE COVER.**
- **DO NOT USE WITH JUST A LAP BELT.** You must use with a lap-sash seatbelt.
- The lap part of the seatbelt must be firmly across the thighs and the sash belt fitted diagonally across the chest and on the shoulder.
- Fit the restraint firmly to the car seat.
- Fit the harness firmly to the child.
- A loose restraint or harness is dangerous.
- Always secure the loose end of the top tether strap. Do not use the child restraint where this strap may fall into a split in the seat back or off the side of the seat.
- **ALWAYS ATTACH HOOK AND REMOVE SLACK.**
- Seatbelt extenders are not recommended to be used if the seatbelt is not long enough to secure the child restraint. If seatbelts are too short then advice should be sought from a child restraint fitter and their recommendation be considered before using a seatbelt extender.
- This child restraint is not approved for use with any connectors that connect to the car's ISOFIX low anchorages.
- The use of child restraints in the front seat may be restricted for children of specific ages by local legislation. Please check with your local legislation regarding any restriction for child restraint.
- Care and attention should always be given to ventilation and shading of the occupant.
- Use of aftermarket accessories (i.e. items not provided in the box with the child restraint), can reduce the safety provided by child restraint and may cause injury or death. For approved aftermarket accessories please refer to **page 13**.
- Ensure the belt webbing is not twisted.
- **TO BE USED WITH A LAP-SASH SEATBELT IN THE FRONT/BACK OF MOST CARS WITH FORWARD FACING SEATS.**

THE NEXT SEAT FOR YOUR CHILD

When your child has outgrown the seat, you can either use:

A booster seat suitable for children up to 4-10 years of age until their shoulders reach the upper height marker of the booster seat. **NOTE:** This illustration is representative only.

Or, follow the steps below to see if your child is ready to use a vehicle seat belt.

If your child is transitioning out of a booster, try this simple **three point test**. You may find that your child is not yet ready to use an adult seatbelt without the booster.

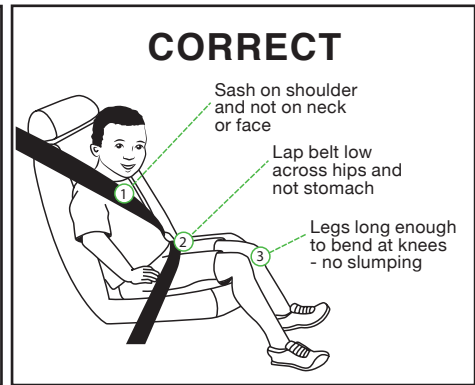
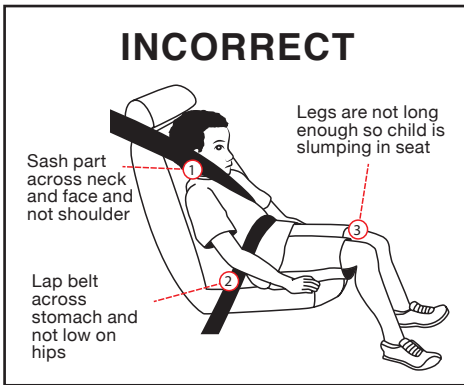

3 POINT TEST

1. Does the sash part of the seatbelt sit on the middle of the shoulder and not touch the neck or face?
2. Does the lap part of the seatbelt sit low down on the hips and not on the abdomen?
3. When you sit the child on the seat with their bottom all the way back, are their thighs long enough for their knees to bend allowing the legs to hang over the front of the seat?

If you answered “no” to any of these questions, your child needs to be in a booster seat to make both the sash and the lap part of the seatbelt fit right to ensure maximum crash protection.

SHOULDER HEIGHT MARKERS - HARNESSED



IMPORTANT: FOLLOW THIS ADVICE

MARKER B: MIDDLE HEIGHT MARKER



Harnessed Mode

Convert to **Booster Mode** when the child's shoulders reach this middle height marker. If the child's shoulders are below, then continue to use the harness.

MARKER A: LOWER HEIGHT MARKER



Harnessed Mode

The child's shoulders must be in-line or above this marker. If the child's shoulders are below then the child should remain in their previous child restraint.

The child restraint is unsuitable for the occupant when the shoulders are below the lower marker (Marker A) or above the upper marker (Marker C, refer to page 26). The child needs to be moved into the next form of restraint when they reach the top shoulder height marker. For more information, refer to page 10.

COMPONENTS LIST FOR HARNESSSED USE



- 1. Adjustable Headrest
- 2. Shoulder Height Markers
- 3. Harness Slots
- 4. Belt Mates (x2)
- 5. Harness
- 6. Buckle
- 7. Harness Release Lever (under trim)
- 8. Forward-Facing Belt Path Markers
- 9. Cup Holder (both sides)
- 10. Adjuster Strap



- 11. Headrest Lever
- 12. Top Tether Strap
- 13. Top Tether Adjuster
- 14. Top Tether / Instruction Manual Storage Pocket
- 15. Top Tether Hook
- 16. Anchor Fitting
- 17. Forward-Facing Belt Path Markers
- 18. Splitter Plate

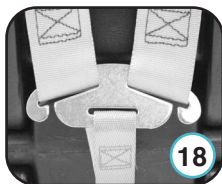

Forward-Facing Belt Path Markers

ANCHOR FITTING LOCATIONS

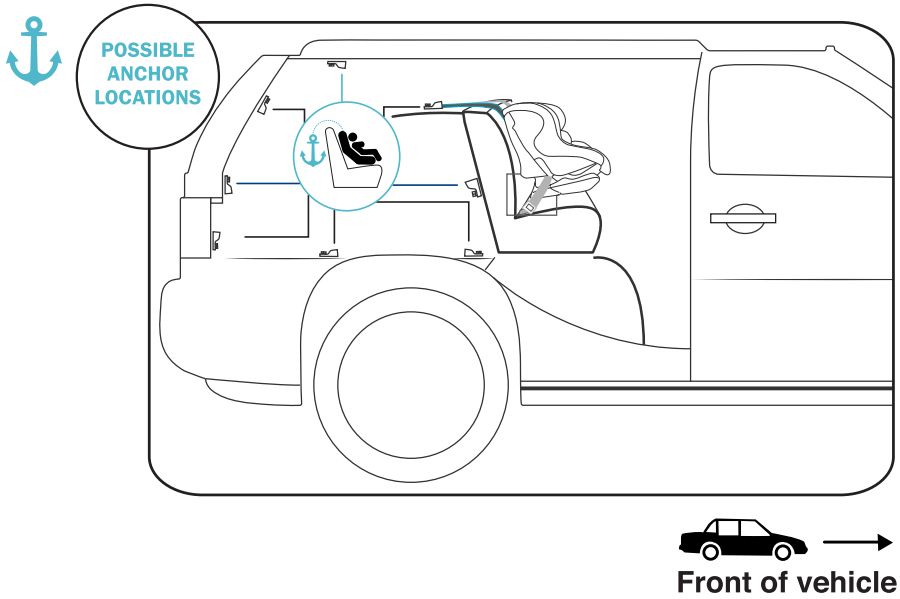

- The anchor point can be found in different locations in different cars. The illustration above shows possible locations of anchor points. Sometimes it is on the parcel shelf in sedans, and on the floor area in station wagons, vans and hatchbacks. Make sure that you do not confuse the luggage hook in the back of a station wagon with anchor points. Refer to your owner's manual.
- An extension strap may be needed for vehicles without a fixed parcel shelf. Extension straps and extra fittings are available from various stores.

Extension straps 300mm ref no. 015057

Extension straps 600mm ref no. 015058

Belt converter ref no. 015059

- Use of aftermarket accessories (i.e. items not provided in the box with the child restraint), can reduce the safety provided by the child restraint and may cause injury or death.

ANCHOR INSTALLATION

Child restraints must be used correctly to provide proper protection for your child. The anchorage system on child restraint must be used in the correct way.

CORRECT

Make sure there is no slack in the top strap and the attachment clip is upright in the anchorage fitting.

INCORRECT

The clip must not lie flat on the anchorage fitting.

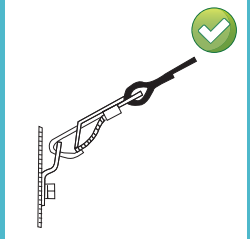
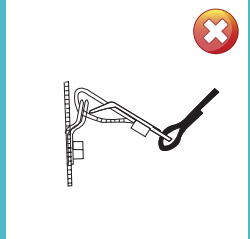
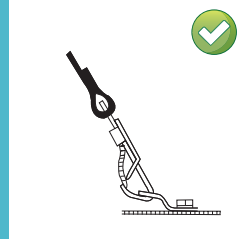
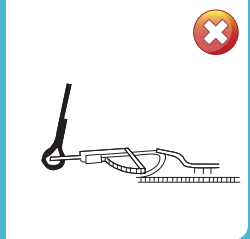
INSTALLATION	CORRECT	INCORRECT
<p>FIGURE 1</p> <p>ANCHORAGES IN VERTICAL PANEL AT REAR OF VEHICLE</p>		
<p>FIGURE 1</p> <p>FLOOR MOUNTED ANCHORAGES</p>		

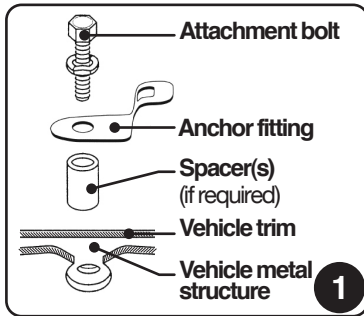

For cars fitted with a child restraint upper anchorage point:

Locate the upper anchorage point behind the rear seating position (consult the car owner's handbook for the location of the upper anchorage point). Remove the thread plug from the parcel shelf/floor/roof and install the attachment bolt as shown in Figure 1.

CAUTION: DO NOT OVERTIGHTEN THE ATTACHMENT BOLT. OVERTIGHTENING MAY FRACTURE OR BREAK BOLT. MAXIMUM TORQUE IS 20 Nm.

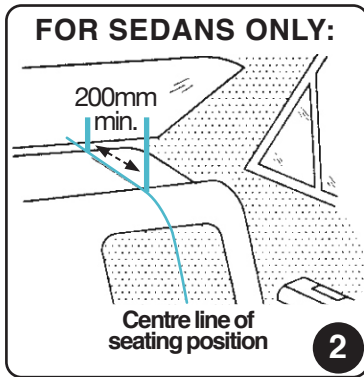

For cars not fitted with a child restraint upper anchorage point:

For sedans only:

Drill a 9mm diameter hole in the parcel shelf on the centre-line of the seating position as shown in Figure 2. Install the anchor bolt as shown in Figure 3. It is recommended that this installation be carried out by a child restraint fitting station or licenced motor mechanic.

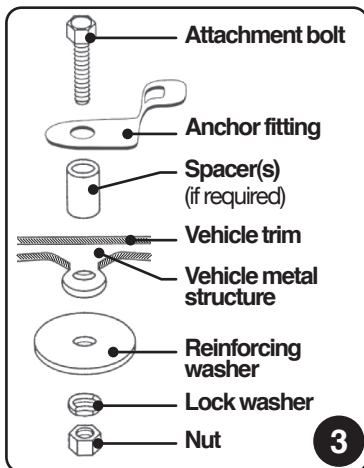

For vehicles other than sedans:

In Australia, consult your nearest child restraint fitting station or traffic authority for vehicle inspection to find the best, correct position for the placement of the upper anchorage point, and for the correct attachment bolt length and use of spacers. In New Zealand, consult the agent for the vehicle.



WARNINGS

CHILD RESTRAINTS MUST NOT BE ATTACHED TO UNSOUND METAL OR TO WOOD OR SYNTHETIC STRUCTURES. WHEN DRILLING THE 9mm HOLE DO NOT DRILL THROUGH FUEL LINES, FUEL TANKS, ELECTRICAL WIRING, OR RADIO SPEAKERS. WEBBING STRAPS MUST BE PROTECTED FROM SHARP CORNERS AND EDGES.

THE ANCHOR FITTING MUST BE USED ONLY AS DESCRIBED ABOVE. IT MUST NOT BE HOOKED ONTO ANY OTHER OBJECT.

IMPROPER PLACEMENT OF THE SAFETY SEAT INCREASES THE RISK OF SERIOUS INJURY OR DEATH.

Some seating positions in your vehicle may NOT be safe for this safety seat. Some vehicles do not have any seating positions that can be used safely with the seat. If you are not sure where to place the booster seat in your vehicle, consult your vehicle's owner's handbook.

CORRECT FORWARD-FACING VEHICLE POSITION

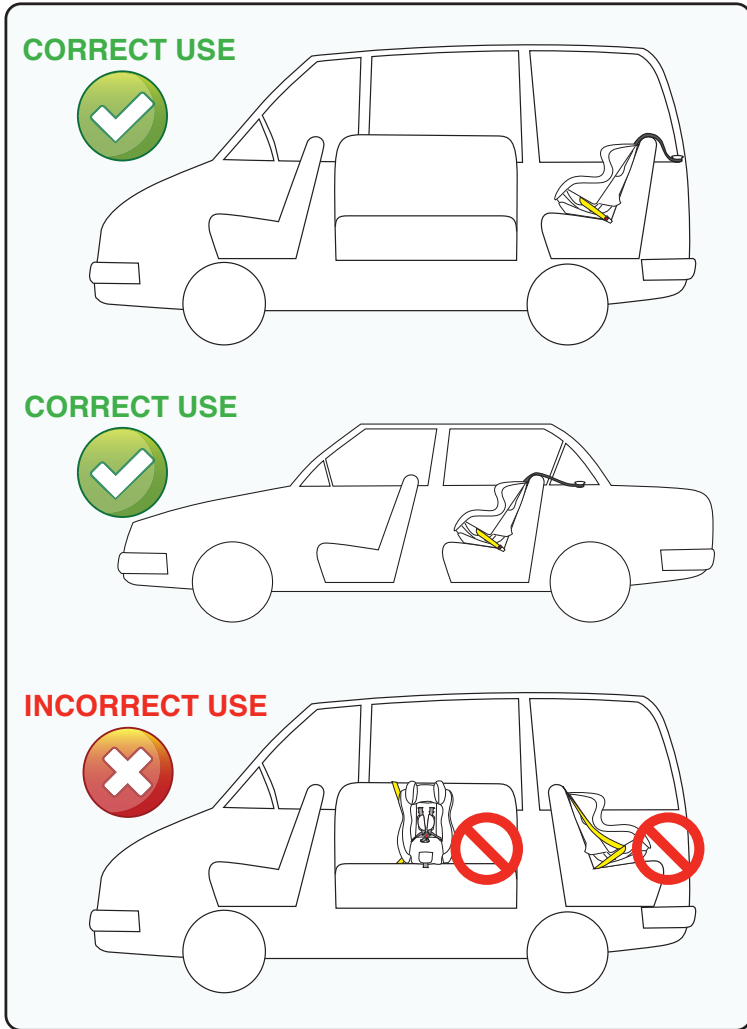

⚠ WARNING

- **IMPROPER PLACEMENT OF THE SAFETY SEAT INCREASES THE RISK OF SERIOUS INJURY OR DEATH.**

ADJUSTING TOP TETHER STRAP

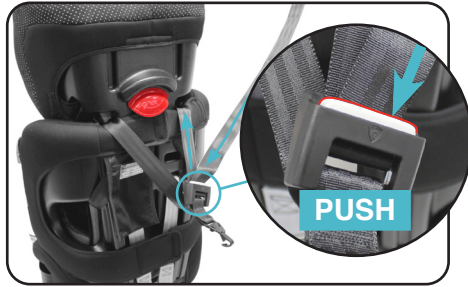

- Press on the adjuster button and pull strap to loosen.

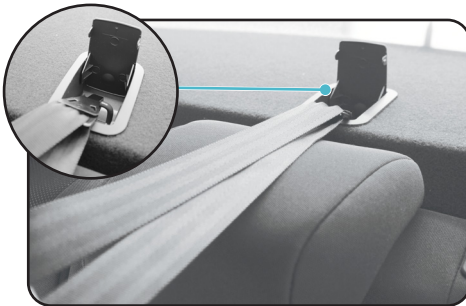

- Attach top tether strap to vehicle anchor point.



- Place one knee on child restraint, push down firmly and tighten top anchorage strap by pulling free end of

NOTE: Ensure the base of the seat is not lifted from the car seat.

Always secure the loose end of the top tether strap to prevent it hanging out of the car or being accessible by the child. Please store excess webbing in the rear pocket at the rear of the restraint.

CAUTION: CHILDREN CAN BE INJURED OR RESTRAINTS AND TOP TETHER STRAP DAMAGED BY UNSECURED CARGO IN A COLLISION. SECURE OR REMOVE HAZARDOUS CARGO BEFORE USING THIS CHILD RESTRAINT.

THIS RESTRAINT IS NOT SUITABLE FOR USE WHERE THE TOP TETHER STRAP MAY FALL INTO A SPLIT IN THE SEAT BACK OR OFF THE SIDE OF THE SEAT.

ADJUSTING HARNESS AND SEAT CONFIGURATIONS

You **MUST** make these adjustments to your child restraint before you install the seat in the vehicle. Please adjust harness according to the infants shoulder height marker prior to installation.

Strap can be next slot above

Child shoulders

Strap cannot be more than 25mm below

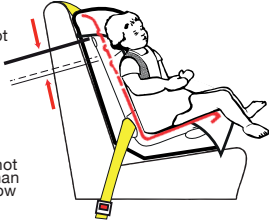

FORWARD-FACING

(6 months to 4 years)



The shoulder straps must be in the slots which are nearest to the child's shoulders, but not more than 25 mm below the child's shoulders.

To adjust shoulder strap height:

1. Place thumb or finger through cover opening and press the harness release lever at the front of seat.
2. Pull both shoulder straps simultaneously to loosen.
3. Undo the straps from the splitter plate located on the back of the child restraint.
4. Re-thread the shoulder straps through the desired slots. Reconnect the straps to the splitter plate.

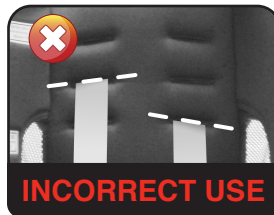
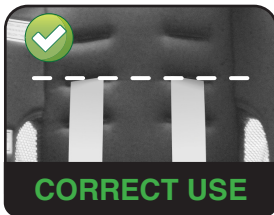
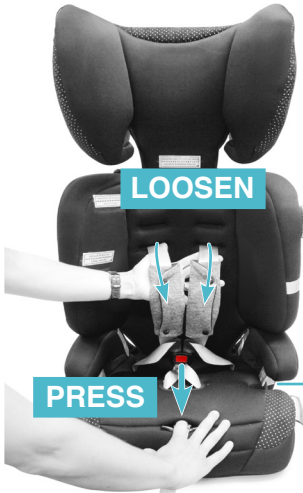

NOTE: Ensure the harness heights are of equal length.



WARNING

- Always adjust the height of the shoulder straps as the child grows.

LOOSENING AND FASTENING HARNESS STRAPS

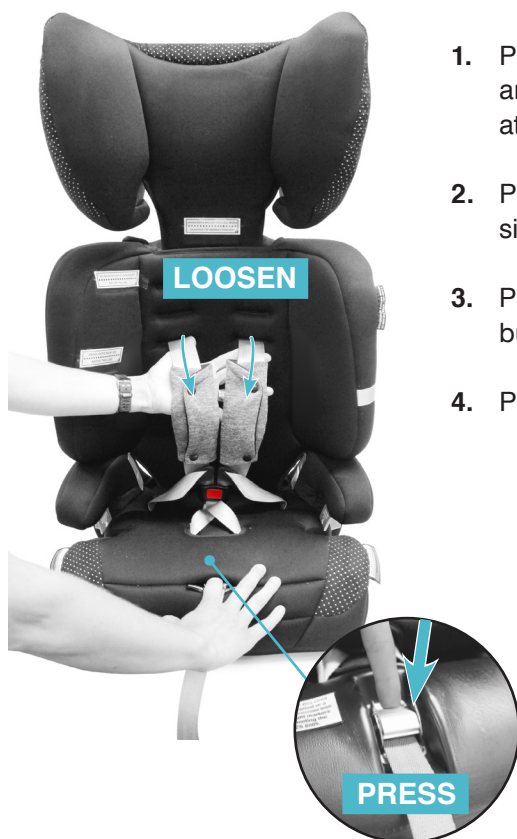

1. Place thumb through cover opening and press the harness release lever at the front of seat.
2. Pull both shoulder straps simultaneously to loosen.
3. Press the red button to release the buckle.
4. Place child into the child restraint.



5. Fasten buckle (see page 22).
6. Pull the adjuster strap at the front of the seat until the harness straps lay firmly against the child.

WARNING

- **DO NOT LEAVE CHILDREN UNATTENDED IN THE CAR.**

ADJUSTING THE HEADREST



- The booster seat is fitted with 6 height positions.
- Lift **RED** lever to raise or lower the headrest to the desired position.

Adjusting the Installation Recline



To recline backrest:

Push the backrest of the seat to recline it backward for vehicle fitment if needed.

To adjust back to upright position:

Pull the backrest of the seat forward in the upright position.

Cup Holders

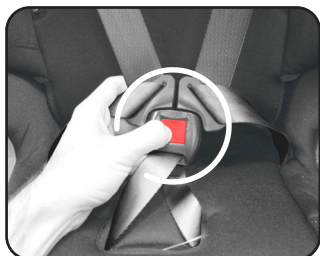

- To use cup holders, simply swing outwards on either side.
- Push back when not in use.

BUCKLE FASTENING AND OPERATION

Release: Press the red button to release the buckle.

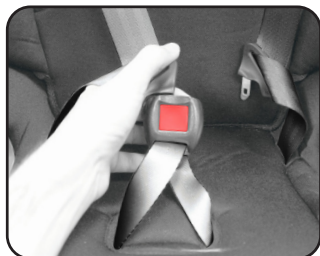

1. Insert one buckle tongue as shown in image. You will not hear a click.

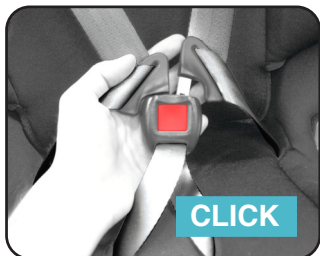

2. Insert the second buckle tongue as shown. Now listen for a “**click!**”.

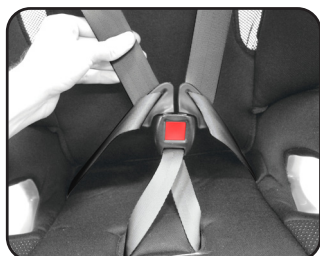

3. Remember to always pull up on the harness straps to make sure buckle is locked tightly.

INSTALLATION - HARNESS MODE

NOTE: Before you start installation, adjust the shoulder straps to fit your child. Refer to **page 19**.

1. Loosen the top tether strap. Place restraint on back seat of vehicle in line with a top tether strap anchorage point.



2. Hold the lap-sash belt together and start under the armrest. Feed the lap-sash belt through the front of the seat, through the **YELLOW** forward-facing belt path.



3. Place your hand behind the seat and pull the belt across the back.

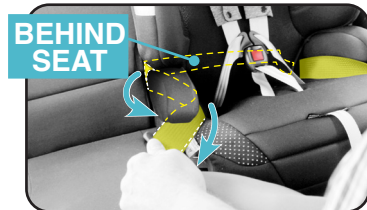

4. Feed the lap-sash belt through the opening in the back of the seat, marked as the **YELLOW** forward-facing belt path.

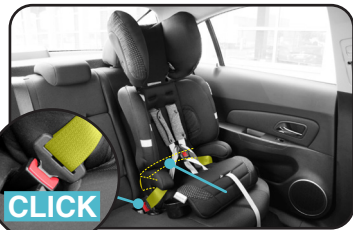

5. Fasten the seatbelt, ensuring you hear a “click!”

6. Reposition the sash-belt from the outside of the seat to the inside. The sash-belt should lay as shown as pictured.



7. Place one hand on seat and firmly press the child restraint down into the vehicle seat and pull on seatbelt to remove slack.



8. Continue to remove slack, placing one hand on seat and firmly pressing the child restraint down into the vehicle seat and pull on seatbelt to remove slack.



9. Attach the top tether strap to the anchorage point. Adjust until all the slack is removed. Ensure base of seat is not lifted.

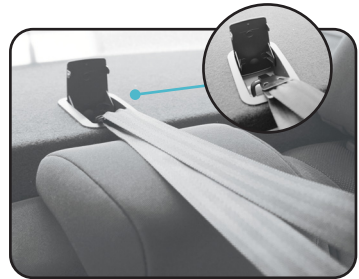

NOTE: If the car seatbelt is not long enough to secure the child restraint, **DO NOT USE SEAT BELT EXTENDERS.**

NOTE: There is an option to install seat using seat belt with accessory Belt Converter. Please see instructions provided with Belt Converter for installation.

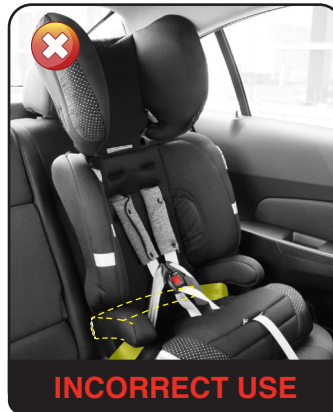
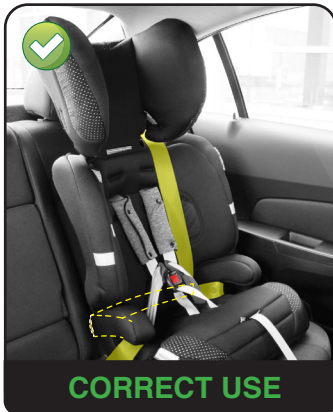

REMOVING THE HARNESS FOR BOOSTER USE

1. Loosen the harness to gain easy access to the splitter plate located on the back of the child restraint. Undo the harness straps from the splitter plate, and pull the straps out through the harness slots.
2. Slide the straps to the back of the child restraint (between the seat back and armrest opening), and pull the buckle tongues to the end of the straps. Fold the free end of the harness over.
3. Continue to roll the harness strap with the buckle tongue contained. Tuck the rolled strap into the seat trim for storage.
4. To store the harness buckle, lift the flap to reveal a storage space in the base of the seat. Simply push the buckle down into the gap, and place the flap back into position to cover.
5. Lift the trim up to expose the adjuster strap. Pull the adjuster strap to full length, then roll the strap tightly until it reaches the harness release lever. Pull cover over, back into place.

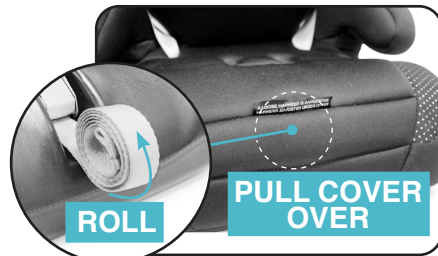
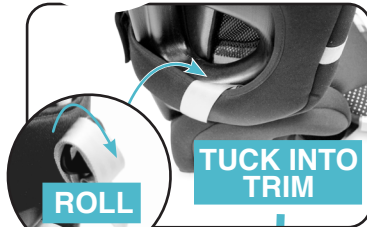
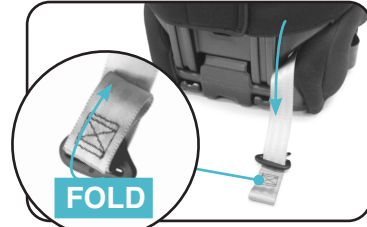

SHOULDER HEIGHT MARKER FOR BOOSTER USE



IMPORTANT: FOLLOW THIS ADVICE

MARKER C: OLDER CHILD



Upper Shoulder Height Marker

When the child's shoulders reach this upper marker, or the child no longer fits in the child restraint (approximately 6 to 8 years of age), then the child must be moved to the next form of child restraint.

The child needs to be moved into the next form of restraint when they reach the top shoulder height marker. For more information, refer to page 10.

COMPONENTS LIST FOR BOOSTER USE



- 1. **Sash Guide** (both sides)
- 2. **Shoulder Height Marker**
- 3. **Seat Back**
- 4. **Booster Seat Belt Path Markers** (both sides)
- 5. **Armrests** (x2)
- 6. **Seat Base**



- 7. **BOOSTER SEAT BELT PATH**
Booster Seat Belt Path Markers (both sides)



- 8. **Headrest Lever**
- 9. **Top Tether Strap**
- 10. **Top Tether Adjuster**
- 11. **Top Tether / Instruction Manual Pocket**
- 12. **Top Tether Hook**
- 13. **Anchor Fitting**
- 14. **Harness Strap Storage Location**

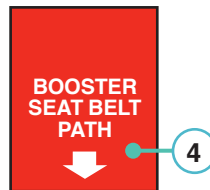

Booster Seat Belt Path Markers

CORRECT POSITIONING OF BOOSTER SEAT

Correct and Safe Positioning

Use only the vehicle's lap-sash seat belt when restraining the child in the booster seat.

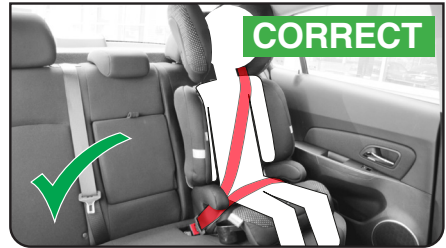

Incorrect Positioning

NEVER use a vehicle's lap-only belt across front of the child and booster seat. It **WILL NOT** restrain your child's shoulders in the event of an accident and could result in serious injury.



Correct Shoulder Position

To ensure the correct head support is obtained, the bottom of the headrest **MUST** be even or slightly higher with the top of child's shoulders.

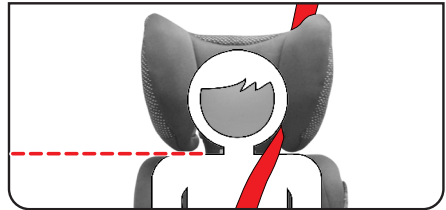

NOTE: If the vehicle seat belt lays across the child's neck or face, then read just the headrest height.

CAUTION: In the event of a crash, a seat belt across the child's throat could cause a strangulation hazard.



WARNING: A SASH BELT UNDER THE ARM OR BEHIND THE BACK IS DANGEROUS.

SECURING CHILD AND BOOSTER SEAT TO VEHICLE

Place the booster seat firmly against the back of a forward facing vehicle seat equipped with a lap and shoulder belt only.

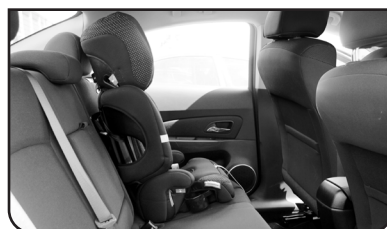

DO NOT place the booster seat in a vehicle without the tether strap attached to the vehicle's anchor fitting. Refer to page 18.

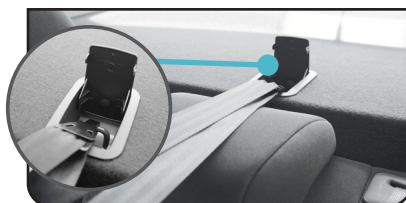

Have your child sit in the booster seat with their back flat against its back.

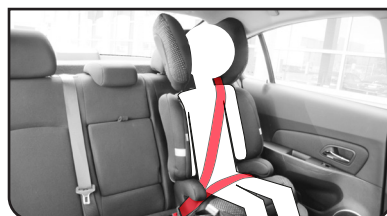

Position the sash belt through the sash guide in the headrest. The lap belt portion **MUST** be positioned low on the hips.

ALWAYS USE THE SASH GUIDE.

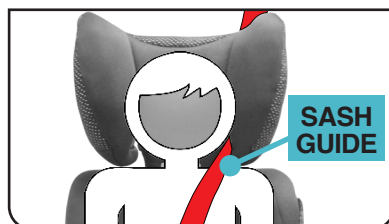

NOTE: The vehicle's seatbelt **MUST NOT** be twisted.

Fasten buckle and pull up on the shoulder belt to tighten.

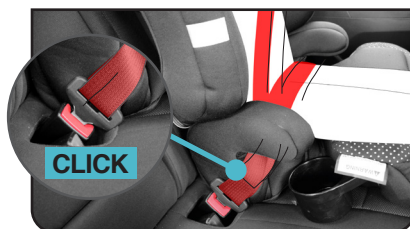

 **WARNING**

DO NOT LEAVE CHILDREN UNATTENDED IN THE CAR.

BUCKLE MAINTENANCE

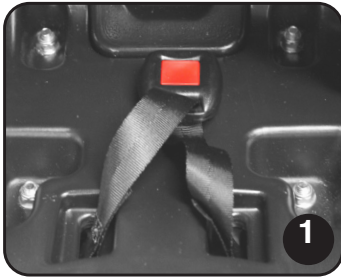

Follow the manufacturer's instructions at all times. Before removal, ensure you have carefully noted the way which the various parts are attached to the seat so as to facilitate reassembly.

Your child car seat is equipped with a buckle designed to give your child maximum protection during proper use (**Figure 1**). When working properly, your buckle should always fasten with an audible '**CLICK**'.

If sticky liquids (such as baby food, fruit juice, etc.) get into the buckle it may become sluggish and you will not hear a '**CLICK**'.



Removing buckle:

1. Lay seat on back to allow easy access for buckle removal (**Figure 1a**).
2. Using a flat object (such as a flat-head screw-driver, not included) gently slide the Metal Plate (**Figure 1b**) into a loosened position, repeat on the other side.
3. Turn each metal plate and push through the top opening to release crotch buckle for cleaning (**Figure 1c**).

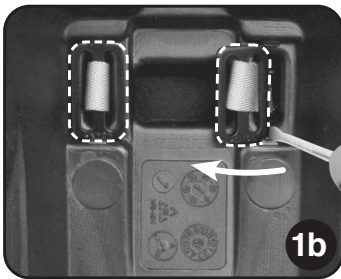

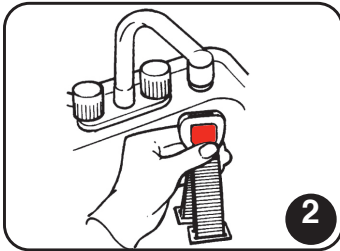

2

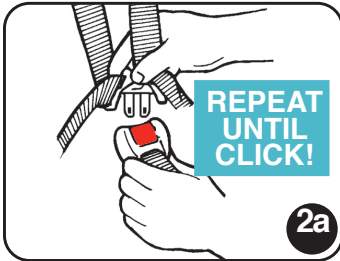

2a

Cleaning buckle:

1. Place the buckle unit under running water (40 degrees Celsius), (**Figure 2**). Let the water flow through the mouth of the buckle for one minute.
2. Simultaneously latch and unlatch the tongues into the buckle several times until a strong audible click is heard (**Figure 2a**).
3. If you still cannot hear a strong audible click after latching the buckle several times. Repeat steps above.
4. DO NOT oil any part of the buckle.
5. Allow buckle to completely dry.

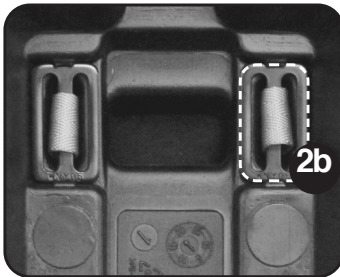

2b

Refitting buckle:

1. Refit crotch buckle ensuring **RED** button is facing out.
2. Place the two metal plates back and slide them back into position (**Figure 2b**).
3. Pull the buckle up to make sure that it is fitted properly and that the metal plates are secure.

- If the buckle does not return to original working order, contact Dorel Australia Customer Service on **1300 809 526**.
- If you are a New Zealand customer, please contact IGC Dorel New Zealand Customer Service on **0800 628 000**.

CLEANING COVERS AND HEADREST

HEADREST COVER: Adjust the booster seat headrest to its highest position. Separate velcro from around sash guides and back of headrest to remove cover.

MAIN BODY COVER: Separate velcro at the back of the seat. Pull around the armrest and remove cover off the seat. Ensure you free the elastic under seat and that it is not caught on cup holders.

- The seat covers can be machine washed in lukewarm water on the 'delicate' cycle.
- Tumble dry for 10 - 15 minutes on low heat.
- **DO NOT BLEACH**
- **DO NOT DRY CLEAN**
- **DO NOT IRON**
- Once they are fully dry, they should be refitted in the following sequence:



FITTING THE HEADREST COVER

Extend the booster seat headrest to its highest position then fit the headrest cover by stretching it over the headrest and securing velcro tabs around the sash guide.

FITTING THE MAIN BODY COVER

Start by fitting on the armrest, then place the trim on the back. Pull elastic under the base and over the cup holders, then fasten the velcro under the base and on the back of the trim.

REMOVING AND FITTING ACCESSORIES



TO REMOVE BELT MATES

To remove the belt mates, undo the shoulder straps from the splitter plate and pull the straps to the front of the seat. Slide the belt mates free.

TO REPLACE BELT MATES

Fit belt mates to harness straps by feeding the straps through the belt mates, then thread the straps through the harness slots and attach to the splitter plate.



TO REMOVE HEADREST

To remove the headrest, simply undo the velcro tabs from the sash guide and pull the insert out.

TO REPLACE HEADREST

Fit headrest inserts to seat by stretching it over the headrest and securing velcro tabs around the sash guide.

CLEANING SHELL

- CLEANING PLASTIC PARTS - Sponge clean with mild soap and cool water. NEVER clean with ammonia or bleach based, or spirit-type cleaners.
- DO NOT USE THIS SAFETY SEAT WITHOUT ITS COVER.
- FROM TIME TO TIME CHECK THE SEAT for worn parts, torn material and stitching. If damage is found, DO NOT try to modify the safety seat. Replace the safety seat.
- IMPORTANT - Only genuine replacement parts supplied by Dorel Australia Pty Ltd can be used on the booster seat.
- Use of aftermarket accessories (i.e. items not provided in the box with the child restraint) can reduce the safety provided by child restraint and may cause injury or death. For approved aftermarket accessories please refer to **page 13**.

VERY IMPORTANT: Only replace the cover with a manufacturer's supplied replacement cover with identical shoulder height markers or a replacement cover meeting AS/NZS 8005.

WARRANTY

Dorel Australia Pty Ltd warrants your new product to be free from defects in materials and workmanship for 6 years on the seat and 2 years on the trim, from the date of purchase, provided that the product is used in accordance with accompanying recommendations or instructions where provided. The benefit of this warranty is in addition to your rights under the Australian consumer law and to other rights and remedies of the consumer under a law in relation to the goods or services to which the warranty relates.

Dorel Australia Pty Ltd will provide you with your choice of a refund, repair or exchange (where possible) for this product if it becomes defective within the warranty period. Dorel Australia Pty Ltd will bear the reasonable expense of claiming the warranty. This warranty will no longer apply where the defect is a result of alteration, accident, misuse, abuse or neglect.

Please retain your receipt as proof of purchase and contact our Customer Service Team on ph: 1300 809 526 or alternatively, via our website at www.dorel.com.au for any difficulties with your product. Warranty claims and claims for expense incurred in returning this product can be addressed to our Customer Service Team at 655-685 Somerville Road, West Sunshine, Vic, 3020.

For New Zealand please contact Customer Service Centre, 14 Sir William Avenue, East Tamaki, Auckland, 2013. Auckland: (09) 274 1040 NZ wide: 0800 628 000 (toll free). Hours: 8:00am - 4:00pm, Monday to Friday.

Our goods come with guarantees that cannot be excluded under the Australian consumer law. You are entitled to a replacement or refund for a major failure and compensation for any other reasonably foreseeable loss or damage. You are also entitled to have the goods repaired or replaced if the goods fail to be of acceptable quality and the failure does not amount to a major failure.



**IMPORTANT:
KEEP THIS INSTRUCTION MANUAL IN THE POCKET
PROVIDED AT THE REAR OF THE SEAT.**

Notes

Notes

Notes



motherschoice.com.au

mother's choice tip...

Visit us online to register your new Mother's Choice product.

www.motherschoice.com.au/product-registration

benefits of registration

- Your safety - allows us to contact you with important product notifications.
- Confirmation of ownership - provides a record in case of product loss or theft.
- Improved product development - helps us continue to design products that meet your needs.

**to prevent loss or fading,
please attach your receipt here:**



DOREL AUSTRALIA PTY LTD

655-685 Somerville Road
Sunshine West Victoria 3020
Hours: 8:30 am - 5:00 pm Mon-Fri

Email: customerservice@dorel.com.au

Phone: 1300 809 526 (toll free)

IGC DOREL NEW ZEALAND LTD

14 Sir William Avenue
East Tamaki Auckland 2013
Hours: 8:00 am - 5:00 pm Mon-Fri

Email: customerservice@dorel.co.nz

Phone: 0800 628 000 (toll free)



Specifications are subject to change without notice. Copy or reproduction without permission is prohibited. © 2020 Dorel Australia Pty Ltd. All Rights Reserved.

www.dorel.com.au

GMBE 2013 10/2020