

Dell™ PowerEdge™ 1750 Systems Installation and Troubleshooting Guide

[Introduction](#)

[Indicators, Messages, and Codes](#)

[Finding Software Solutions](#)

[Running the System Diagnostics](#)

[Troubleshooting Your System](#)

[Installing System Options](#)

[Installing Drives](#)

[Getting Help](#)

[Jumpers and Connectors](#)

[I/O Connectors](#)

[Abbreviations and Acronyms](#)



NOTE: A NOTE indicates important information that helps you make better use of your computer.



NOTICE: A NOTICE indicates either potential damage to hardware or loss of data and tells you how to avoid the problem.



CAUTION: A CAUTION indicates a potential for property damage, personal injury, or death.

Information in this document is subject to change without notice.
© 2002 Dell Computer Corporation. All rights reserved.

Reproduction in any manner whatsoever without the written permission of Dell Computer Corporation is strictly forbidden.

Trademarks used in this text: *Dell*, the *DELL* logo, *PowerEdge*, *DellNet*, *Dell OpenManage*, *Dimension*, *Inspiron*, *Dell Precision*, *OptiPlex*, and *Latitude* are trademarks of Dell Computer Corporation; *Xeon* is a trademark and *Intel* is a registered trademark of Intel Corporation; *Microsoft* and *Windows* are registered trademarks of Microsoft Corporation.

Other trademarks and trade names may be used in this document to refer to either the entities claiming the marks and names or their products. Dell Computer Corporation disclaims any proprietary interest in trademarks and trade names other than its own.

Initial release: 17 Dec 2002

Jumpers and Connectors

Dell™ PowerEdge™ 1750 Systems Installation and Troubleshooting Guide

- [Jumpers—A General Explanation](#)
- [System Board Jumpers](#)
- [System Board Connectors](#)
- [SCSI Backplane Board Connectors](#)
- [Disabling a Forgotten Password](#)

This section provides specific information about the jumpers on the system board. It also provides some basic information on jumpers and switches and describes the connectors and sockets on the various boards in the system.

Jumpers—A General Explanation

Jumpers provide a convenient and reversible way of reconfiguring the circuitry on a printed circuit board. When reconfiguring the system, you may need to change jumper settings on the system board. You may also need to change jumper settings on expansion cards or drives.

Jumpers

Jumpers are small blocks on a circuit board with two or more pins emerging from them. Plastic plugs containing a wire fit down over the pins. The wire connects the pins and creates a circuit. To change a jumper setting, pull the plug off its pin(s) and carefully fit it down onto the pin(s) indicated. [Figure A-1](#) shows an example of a jumper.

Figure A-1. Example Jumper

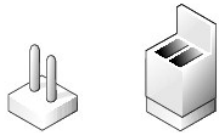

⚠ CAUTION: Make sure the system is turned off before you change a jumper setting. Otherwise, damage to the system or unpredictable results may occur.

A jumper is referred to as open or unjumped when the plug is pushed down over only one pin or if there is no plug at all. When the plug is pushed down over two pins, the jumper is referred to as jumped. The jumper setting is often shown in text as two numbers, such as 1-2. The number 1 is printed on the circuit board so that you can identify each pin number based on the location of pin 1.

System Board Jumpers

[Figure A-2](#) shows the location and default settings of the jumper blocks on the system board. See [Table A-1](#) for the designations, default settings, and functions of the system's jumpers.

Figure A-2. System Board Jumpers

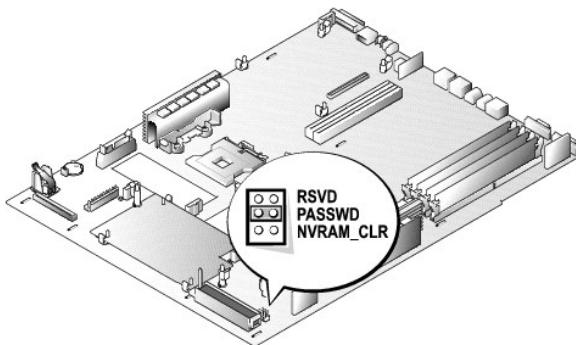







Table A-1. System Board Jumper Settings

Jumper	Setting	Description
PASSWD	 (default)	The password feature is enabled. The password feature is disabled.
NVRAM_CLR	 (default)	The configuration settings are retained at system boot. The configuration settings are cleared at next system boot. (If the configuration settings become corrupted to the point where the system will not boot, install the jumper plug and boot the system. Remove the jumper before restoring the configuration information.)
RSVD		Reserved (<i>do not change</i>).
jumpered  unjumpered 		

System Board Connectors

See [Figure A-3](#) and [Table A-2](#) for the descriptions and locations of the system board connectors.

Figure A-3. System Board Connectors and Sockets

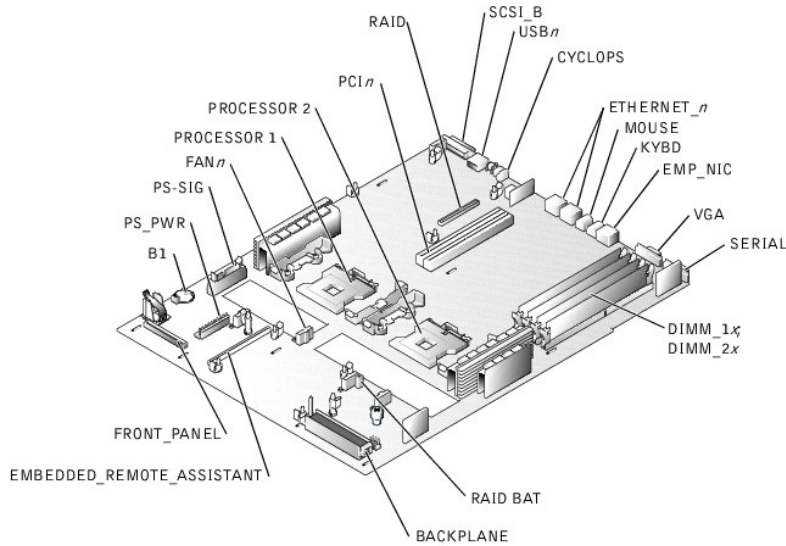

Table A-2. System Board Connectors and Sockets

Connector or Socket	Description
BACKPLANE	SCSI backplane board connector
B1	System battery connector
CYCLOPS	Cable-management arm system status connector
DIMM_1x; DIMM_2x	Memory module sockets
EMBEDDED_REMOTE_ASSISTANT	Connector for optional RAC
EMP_NIC	RAC Ethernet port connector
ETHERNET_n	NIC connectors (2)
FAN_n	Cooling fan power connectors (six on system board; one on control panel assembly)
FRONT_PANEL	System control panel connector
KYBD	Keyboard connectors
MOUSE	Mouse connector
PCI_n	PCI riser board connector
PROCESSOR 1	Microprocessor socket 1
PROCESSOR 2	Microprocessor socket 2
PS_PWR	System board power connector

PS_SIG	Power supply signal connector
RAID	Socket for optional ROMB card
RAID BAT	Backup battery connector for ROMB card
SCSI_B	External SCSI connector
SERIAL	Serial port connector
USB n	USB connector
VGA	VGA connector

SCSI Backplane Board Connectors

[Figure A-4](#) shows the location of the connectors on the top of the SCSI backplane board.

Figure A-4. Connectors on the SCSI Backplane Board

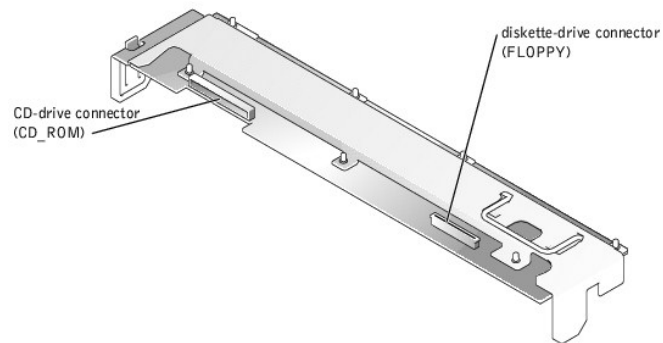

Disabling a Forgotten Password

The system's software security features include a system password and a setup password, which are discussed in detail in "Using the System Setup Program" in the *User's Guide*. A password jumper on the system board enables these password features or disables them and clears any password(s) currently in use.

To disable a forgotten system password or setup password, perform the following steps.

⚠ CAUTION: Only trained service technicians are authorized to remove the system cover and access any of the components inside the system. See your *System Information Guide* for complete information about safety precautions, working inside the computer, and protecting against electrostatic discharge.

1. Open the system covers. See "[Opening the System Covers](#)" in "Troubleshooting Your System."
2. See [Figure A-2](#) for the location of the password jumper (labeled "PASSWD") on the system board.
3. Remove the jumper plug from the PASSWD jumper.
4. Close the system covers. See "[Closing the System Covers](#)" in "Troubleshooting Your System."
5. Reconnect the system to an electrical outlet and turn it on.

The existing passwords are not disabled (erased) until the system boots with the PASSWD jumper plug removed. However, before you assign a new system and/or setup password, you must reinstall the jumper plug.

🔧 NOTE: If you assign a new system and/or setup password with the jumper plug still removed, the system disables the new password(s) the next time it boots.

6. Repeat step 1.
7. Install the jumper plug on the PASSWD jumper.
8. Close the system covers, and then reconnect the system and peripherals to their electrical outlets and turn them on.
9. Assign a new system and/or setup password.

To assign a new passwords using the System Setup program, see "Assigning a System Password" in the *User's Guide*.

[Back to Contents Page](#)

I/O Connectors

Dell™ PowerEdge™ 1750 Systems Installation and Troubleshooting Guide

- [I/O Connectors](#)
- [Serial Connector](#)
- [PS/2-Compatible Keyboard and Mouse Connectors](#)
- [Video Connector](#)
- [USB Connector](#)
- [RAC Ethernet Connector](#)
- [Integrated NIC Connector](#)
- [Network Cable Requirements](#)

I/O Connectors

I/O connectors are the gateways that the system uses to communicate with external devices, such as a keyboard, mouse, printer, or monitor. This section describes the various connectors on your system. If you reconfigure the hardware connected to the system, you may also need the pin number and signal information for these connectors. [Figure B-1](#) illustrates the I/O connectors on the system back panel; [Figure B-2](#) identifies the I/O connectors on the front panel.

Figure B-1. I/O Connectors on Back Panel

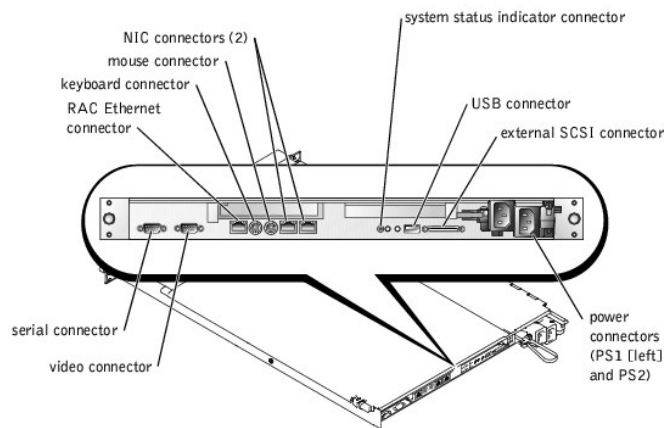
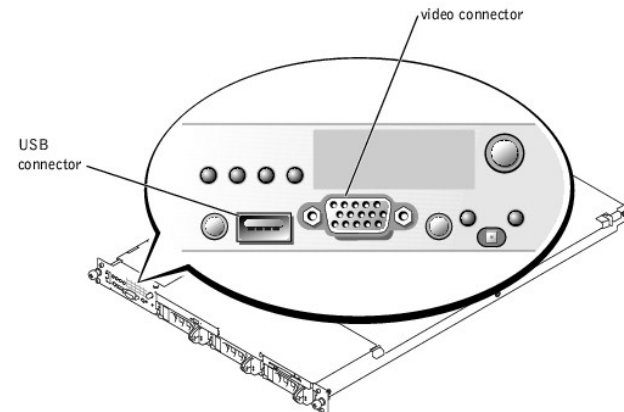









Figure B-2. I/O Connectors on Front Panel



[Table B-1](#) shows the icons used to label the connectors on the system.

Table B-1. I/O Connector Icon

Icon	Connector
	Serial connector
	Mouse connector
	Keyboard connector
	Video connector
	USB connector
	NIC connector
	RAC Ethernet connector

Serial Connector

Serial connectors support devices such as external modems, printers, and mice that require serial data transmission. The serial connector uses a 9-pin D-subminiature connector.

Serial Connector Autoconfiguration

The default designation of the integrated serial connector is COM1. When you add an expansion card containing a serial connector that has the same designation as the integrated connector, the system's autoconfiguration feature remaps (reassigns) the integrated serial connector to the next available designation. Both the new and the remapped COM connectors share the same IRQ setting. COM1 and COM3 share IRQ4, while COM2 and COM4 share IRQ3.

 **NOTE:** If two COM connectors share an IRQ setting, you may not be able to use them both at the same time. In addition, if you install one or more expansion cards with serial connectors designated as COM1 and COM3, the integrated serial connector is disabled.

Before adding a card that remaps the COM connectors, check the documentation that came with the software to make sure that the software can accommodate the new COM connector designation.

[Figure B-3](#) illustrates the pin numbers for the serial connector and [Table B-2](#) defines the pin assignments for the connector.

Figure B-3. Serial Connector Pin Numbers

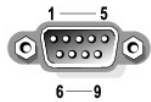

Table B-2. Serial Connector Pin Assignments

Pin	Signal	I/O	Definition
1	DCD	I	Data carrier detect
2	SIN	I	Serial input
3	SOUT	O	Serial output
4	DTR	O	Data terminal ready
5	GND	N/A	Signal ground
6	DSR	I	Data set ready
7	RTS	O	Request to send
8	CTS	I	Clear to send
9	RI	I	Ring indicator
Shell	N/A	N/A	Chassis ground

PS/2-Compatible Keyboard and Mouse Connectors

The PS/2-compatible keyboard and mouse cables attach to 6-pin, miniature DIN connectors. [Figure B-4](#) illustrates the pin numbers for these connectors and [Table B-3](#) defines the pin assignments for these connectors.

Figure B-4. PS/2-Compatible Keyboard and Mouse Connector Pin Numbers



Table B-3. Keyboard and Mouse Connector Pin Assignments

Pin	Signal	I/O	Definition
1	KBDATA or MSDATA	I/O	Keyboard data or mouse data
2	NC	N/A	No connection
3	GND	N/A	Signal ground
4	FVcc	N/A	Fused supply voltage
5	KBCLK or MSCLK	I/O	Keyboard clock or mouse clock
6	NC	N/A	No connection
Shell	N/A	N/A	Chassis ground

Video Connector

You can attach a VGA-compatible monitor to the system's integrated video controller using a 15-pin high-density D-subminiature connector. [Figure B-5](#) illustrates the pin numbers for the video connector and [Table B-4](#) defines the pin assignments for the connector.

NOTE: Installing a video card automatically disables the system's integrated video controller.

Figure B-5. Video Connector Pin Numbers

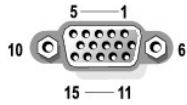

Table B-4. Video Connector Pin Assignments

Pin	Signal	I/O	Definition
1	RED	O	Red video
2	GREEN	O	Green video
3	BLUE	O	Blue video
4	NC	N/A	No connection
5-8, 10	GND	N/A	Signal ground
9	VCC	N/A	Vcc
11	NC	N/A	No connection
12	DDC data out	O	Monitor detect data
13	HSYNC	O	Horizontal synchronization
14	VSYSNC	O	Vertical synchronization
15	DDC clock out	O	Monitor detect clock

USB Connector

The system's USB connector supports USB-compliant peripherals such as keyboards, mice, and printers and may also support USB-compliant devices such as diskette drives and CD drives. [Figure B-6](#) illustrates the pin numbers for the USB connector and [Table B-5](#) defines the pin assignments for the connector.

NOTE: Do not attach a USB device or a combination of USB devices that draw a maximum current of more than 500 mA per channel or +5 V. Attaching devices that exceed this threshold may cause the USB connectors to shut down. See the documentation that accompanied the USB devices for their maximum current ratings.

Figure B-6. USB Connector Pin Numbers



Table B-5. USB Connector Pin Assignments

Pin	Signal	I/O	Definition
1	Vcc	N/A	Supply voltage
2	DATA-	I/O	Data (-)
3	DATA+	I/O	Data (+)
4	GND	N/A	Signal ground

RAC Ethernet Connector

The system's optional RAC circuitry is designed to provide remote access capabilities for the system. It is designed specifically to work with systems management software. [Figure B-7](#) illustrates the pin numbers for the RAC Ethernet connector and [Table B-6](#) defines the pin assignments for the connector.

Figure B-7. RAC Ethernet Connector

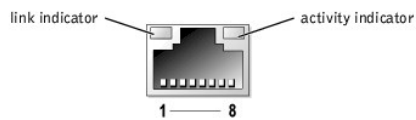

Table B-6. RAC Ethernet Connector Pin Assignments

Pin	Signal	I/O	Definition
1	TD+	O	Data out (+)
2	TD-	O	Data out (-)
3	RD+	I	Data in (+)
4	NC	N/A	No connection
5	NC	N/A	No connection
6	RD-	I	Data in (-)
7	NC	N/A	No connection
8	NC	N/A	No connection

Integrated NIC Connector

The system's integrated NIC functions as a separate network expansion card while providing fast communication between servers and workstations. [Figure B-8](#) illustrates the pin numbers for the NIC connector and [Table B-7](#) defines the pin assignments for the connector.

Figure B-8. NIC Connector

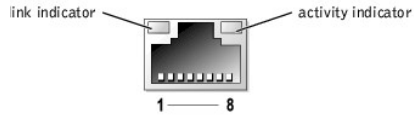

Table B-7. NIC Connector Pin Assignments

Pin	Signal	I/O	Definition
1	TP0+	I/O	Data0 (+)
2	TP0-	I/O	Data0 (-)
3	TP1+	I/O	Data1 (+)
4	TP2+	I/O	Data2 (+)
5	TP2-	I/O	Data2 (-)
6	TP1-	I/O	Data1 (-)
7	TP3+	I/O	Data3 (+)
8	TP3-	I/O	Data3 (-)

Network Cable Requirements

The NIC supports a UTP Ethernet cable equipped with a standard RJ45-compatible plug. Observe the following cabling restrictions.

🔔 **NOTICE:** To avoid line interference, voice and data lines must be in separate sheaths.

- 1 Use Category 5 or greater wiring and connectors.
- 1 Do not exceed a cable run length (from a workstation to a hub) of 100 m (328 ft).

For detailed guidelines on operation of a network, see "Systems Considerations of Multi-Segment Networks" in the IEEE 802.3 standard.

[Back to Contents Page](#)

[Back to Contents Page](#)

Abbreviations and Acronyms

Dell™ PowerEdge™ 1750 Systems Installation and Troubleshooting Guide

The following list defines or identifies technical terms, abbreviations, and acronyms used in your user documents.

A

ampere(s)

AC

alternating current

ACPI

Advanced Configuration and Power Interface

ADC

analog-to-digital converter

ANSI

American National Standards Institute

APIC

Advanced Peripheral Interrupt Controller

ASIC

application-specific integrated circuit

BIOS

basic input/output system

bpi

bits per inch

bps

bits per second

BTU

British thermal unit

C

Celsius

CD

compact disc

CD

compact disc

CGA

color graphics adapter

cm

centimeter(s)

cpi

characters per inch

cpl

characters per line

CPU

central processing unit

DAC

digital-to-analog converter

DAT

digital audio tape

dB

decibel(s)

dBA

adjusted decibel(s)

DC

direct current

DDR

dual data rate

DIMM

dual in-line memory module

DIN

Deutsche Industrie Norm

DIP

dual in-line package

DMA

direct memory access

DOC

Department of Communications (in Canada)

dpi

dots per inch

DRAC

Dell remote access card

DRAM

dynamic random-access memory

DS/DD

double-sided double-density

DS/HD

double-sided high-density

DSA

Dell SCSI Array

ECC

error checking and correction

EDO

extended-data out

EGA

enhanced graphics adapter

EIDE

enhanced integrated drive electronics

EMI

electromagnetic interference

EMM

expanded memory manager

EMS

Expanded Memory Specification

EPP

Enhanced Parallel Port

EPROM

erasable programmable read-only memory

ESD

electrostatic discharge

ESDI

enhanced small-device interface

ESM

embedded server management

F

Fahrenheit

FAT

file allocation table

FCC

Federal Communications Commission

ft

feet

g

gram(s)

G

gravities

GB

gigabyte(s)

GUI

graphical user interface

h**Hz**

hertz

I/O

input/output

ID

identification

IDE

integrated drive electronics

IRQ

interrupt request

K

kilo- (1024)

KB

kilobyte(s)

KB/sec

kilobyte(s) per second

Kb

kilobit(s)

Kbps

kilobit(s) per second

kg

kilogram(s)

KHz

kilohertz

LAN

local area network

lb

pound(s)

LCD

liquid crystal display

LED

light-emitting diode

LIF

low insertion force

LN

load number

lpi

lines per inch

LVD

low voltage differential

m

meter(s)

mA

milliamper(s)

mAh

milliampere-hour(s)

MB

megabyte(s)

Mb

megabit(s)

Mbps

megabit(s) per second

MBR

master boot record

MDA

monochrome display adapter

MGA

monochrome graphics adapter

MHz

megahertz

mm

millimeter(s)

ms

millisecond(s)

MTBF

mean time between failures

mV

millivolt(s)

NIC

network interface controller

NiCad

nickel cadmium

NiMH

nickel-metal hydride

NMI

nonmaskable interrupt

ns

nanosecond(s)

NTFS

NT File System

NVRAM

nonvolatile random-access memory

OTP

one-time programmable

PAL

programmable array logic

PCI

Peripheral Component Interconnect

PCMCIA

Personal Computer Memory Card International Association

PDB

power distribution board

PGA

pin grid array

POST

power-on self-test

ppm

pages per minute

PQFP

plastic quad flat pack

PS/2

Personal System/2

PXE

preboot execution environment

RAC

remote access controller

RAID

redundant arrays of independent disks

RAM

random-access memory

REN

ringer equivalence number

RFI

radio frequency interference

RGB

red/green/blue

ROM

read-only memory

ROMB

RAID on motherboard

rpm

revolutions per minute

RTC

real-time clock

SCSI

small computer system interface

sec

second(s)

SEC

single-edge contact

SDRAM

synchronous dynamic random-access memory

SIMM

single in-line memory module

SMB

server management bus

SNMP

Simple Network Management Protocol

SRAM

static random-access memory

SVGA

super video graphics array

TFT

thin film transistor

tpi

tracks per inch

UMB

upper memory block

UPS

uninterruptible power supply

USB

universal serial bus

V

volt(s)

VAC

volt(s) alternating current

VDC

volt(s) direct current

VGA

video graphics array

VLSI

very-large-scale integration

VRAM

video random-access memory

VRM

voltage regulator module

W

watt(s)

WH

watt-hour(s)

X**XMM**

extended memory manager

XMS

eXtended Memory Specification

Z**ZIF**

zero insertion force

[Back to Contents Page](#)

[Back to Contents Page](#)

Introduction

Dell™ PowerEdge™ 1750 Systems Installation and Troubleshooting Guide

[Other Documents You May Need](#)

Your system is a rack-dense, full-featured, highly available, rack-mount system equipped with one or two Intel® Xeon™ microprocessors. This system includes the following service features to make troubleshooting and repair easy and effective:

- 1 Systems management hardware, which monitors temperatures and voltages throughout the system and notifies you if the system overheats, if a system cooling fan malfunctions, or if a power supply fails
- 1 A comprehensive system diagnostics program, which checks for hardware problems (if the system can boot)

The following system upgrade options are offered:

- 1 An additional Intel Xeon microprocessor
- 1 A second, hot-pluggable 320-W power supply
- 1 Additional memory up to 8 GB, by installing combinations of 128-MB, 256-MB, 512-MB, 1-GB, and 2-GB DDR SDRAM memory modules
- 1 Up to two additional 1-inch, internal U320 SCSI hard drives (for a total of three)
- 1 An optional ROMB through a separate RAID controller that incorporates 128 MB of cache memory and a RAID battery
- 1 Up to two PCI expansion cards: two 3.3-V, 64-bit, 133-MHz PCI-X cards or one 3.3-V, 64-bit, 133-MHz PCI-X card and one 5-V, 64-bit, 33-MHz PCI card
- 1 Optional remote access controller (RAC) card for remote systems management

Other Documents You May Need

 The *System Information Guide* provides important safety and regulatory information. Warranty information may be included within this document or as a separate document.

- 1 The *Rack Installation Guide* included with your rack solution describes how to install your system into a rack.
- 1 The *Setting Up Your System* document provides an overview of initially setting up your system.
- 1 The *User's Guide* provides information about system features and technical specifications
- 1 The *Dell Remote Access Controller Installation and Setup Guide* provides complete information about installing, configuring, and using a RAC to remotely access a system.
- 1 Systems management software documentation describes the features, requirements, installation, and basic operation of the software.
- 1 Operating system documentation describes how to install (if necessary), configure, and use the operating system software.
- 1 Documentation for any components you purchased separately provides information to configure and install these options.
- 1 Updates are sometimes included with the system to describe changes to the system, software, and/or documentation.

 **NOTE:** Always read the updates first because they often supersede information in other documents.

- 1 Release notes or readme files may be included to provide last-minute updates to the system or documentation or advanced technical reference material intended for experienced users or technicians.

[Back to Contents Page](#)

Indicators, Messages, and Codes

Dell™ PowerEdge™ 1750 Systems Installation and Troubleshooting Guide

- [Indicators on the Optional Bezel](#)
- [Front-Panel Features](#)
- [Back-Panel Features](#)
- [Power Supply Features](#)
- [System Messages](#)
- [System Beep Codes](#)
- [Warning Messages](#)
- [Diagnostics Messages](#)
- [Alert Messages](#)

Applications, operating systems, and the system itself are capable of identifying problems and alerting you to them. When a problem occurs, a message may appear on the monitor screen or a beep code may sound.

Several different types of messages can indicate when the system is not functioning properly:

- 1 Indicators on the front bezel
- 1 Front-panel indicators
- 1 SCSI hard drive indicators
- 1 Power supply indicators
- 1 System messages
- 1 System beep codes
- 1 Warning messages
- 1 Diagnostics messages
- 1 Alert messages

The system indicators and the front and back panel features are illustrated in the following figures. This section also describes each type of message and lists the possible causes and actions you can take to resolve any problems indicated by a message. To determine what type of message you have received, read the following sections.

Indicators on the Optional Bezel

The optional system bezel incorporates a system status indicator divided into blue and amber system status indicators. See [Figure 2-1](#). The blue indicator lights up when the system is operating correctly. The amber caution indicator lights up when the system needs attention due to a problem with power supplies, fans, system temperature, system memory, or hard drives.

[Table 2-1](#) lists the system's indicator patterns. Different patterns are displayed as events occur in the system.

Figure 2-1. System Status Indicators

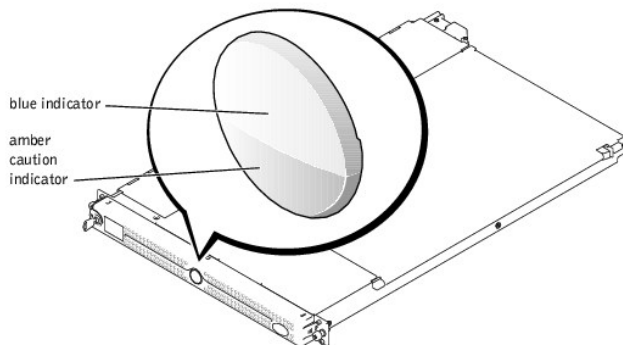

Table 2-1. System Status Indicator Patterns

Blue Indicator	Amber Caution Indicator	Description
----------------	-------------------------	-------------

Off	Off	Power is not available to the system, or power is available to the system, but the system is not powered on.
Off	Blinking	The system has detected an error.
On	Off	Power is on, and the system is operational.
Blinking	Off	The indicator has been activated to identify the system in a rack.
NOTE: While the system is being identified, the blue indicator blinks even though an error has been detected. After the system is identified, the blue indicator stops blinking and the amber indicator resumes blinking.		

Front-Panel Features

Figure 2-2 shows the controls, indicators, and connectors located behind the optional bezel on the system's front panel. Table 2-2 provides a description of each feature.

Figure 2-2. Front-Panel Features

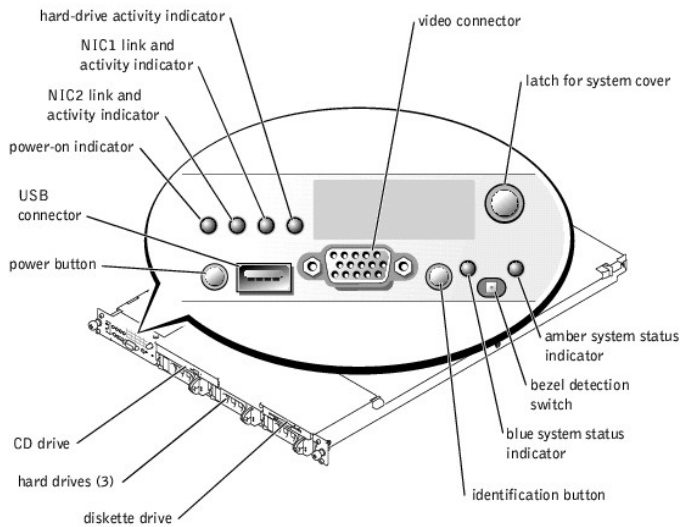





Table 2-2. Front-Panel LED Indicators, Buttons, and Connectors

Indicator, Button, or Connector	Icon	Description
Blue system status indicator		The blue system status indicator lights up during normal system operation. Both the systems management software and the identification buttons located on the front and back of the system can cause the blue system status indicator to flash to identify a particular system.
Amber system status indicator		The amber system status indicator flashes when the system needs attention. Check for a problem with the power supplies, fans, system temperature, or hard drives. NOTE: If the system is connected to AC power and an error has been detected, the amber system status indicator flashes regardless of whether the system has been powered on.
NIC1 and NIC2 link and activity indicators		The link and activity indicators for the two integrated NICs light intermittently when the NICs are in use.
Hard-drive activity indicator		The green hard-drive activity indicator flashes when the hard drives are in use. See Figure 2-3 for more information on hard-drive indicators.
Power-on indicator, power button		The power-on indicator lights when the system power is on. The power button controls the DC power supply output to the system.

		NOTE: If you turn off the system using the power button and the system is running an ACPI-compliant operating system, the system performs a graceful shutdown before the power is turned off. If the system is not running an ACPI-compliant operating system, the power is turned off immediately after the power button is pressed.
Identification button		The identification buttons on the front and back panels can be used to locate a particular system within a rack. When one of these buttons is pushed, the blue system status indicator on the front and back blinks until one of the buttons is pushed again.
USB connector		Connects a USB 1.1-compliant device to the system.
Video connector		Connects a monitor to the system.

SCSI Hard-Drive Indicator Codes

If the optional ROMB card is activated, two indicators on each of the hard-drive carriers provide information about the status of the hard drives. See [Figure 2-3](#) and [Table 2-3](#). The SCSI backplane firmware controls the drive power-on/fault indicator.

Figure 2-3. SCSI Hard-Drive Indicators

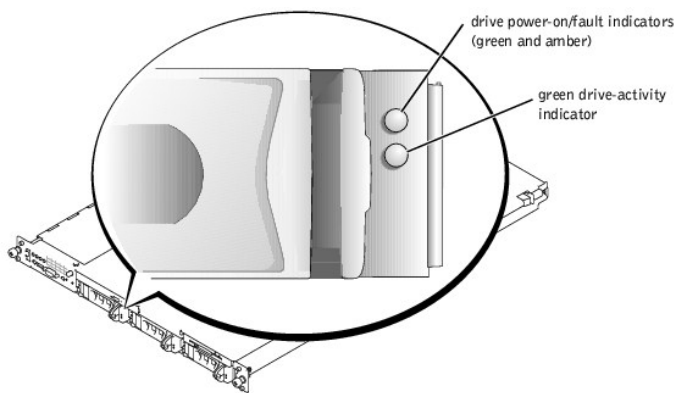

[Table 2-3](#) lists the drive indicator patterns. Different patterns are displayed as drive events occur in the system. For example, if a hard drive fails, the "drive failed" pattern appears. After the drive is selected for removal, the "drive being prepared for removal" pattern appears, followed by the "drive ready for insertion or removal" pattern. After the replacement drive is installed, the "drive being prepared for operation" pattern appears, followed by the "drive online" pattern.

 **NOTE:** If the optional ROMB card is not installed, only the "drive online" indicator pattern appears. The drive-activity indicator also blinks when the drive is being accessed.

Table 2-3. SCSI Hard-Drive Indicator Patterns

Condition	Indicator Pattern
Identify drive	The green power-on/fault indicator blinks four times per second.
Drive being prepared for removal	The green power-on/fault indicator blinks two times per second.
Drive ready for insertion or removal	Both drive indicators are off.
Drive being prepared for operation	The green power-on/fault indicator is on.
Drive predicted failure	The power-on/fault indicator slowly blinks green, amber, and off.
Drive failed	The amber power-on/fault indicator blinks four times per second.
Drive rebuilding	The green power-on/fault indicator blinks slowly.
Drive online	The green power-on/fault indicator is on.

Back-Panel Features

[Figure 2-4](#) shows the controls, indicators, connectors, and expansion slots located on the system's back panel.

- For information about the connectors, see "[System Board Connectors](#)" in "Jumpers and Connectors."
- The blue and amber system status indicator combines the functions of the separate blue and amber system status indicators on the front panel. For more information, see [Table 2-2](#).
- For information about the identification buttons located on the front and back of the system, see "[Front-Panel Features](#)."

1 For PCI card information, see "[Installing Expansion Cards](#)" in "Installing System Options."

NOTE: Connect the power cable to connector PS1 if your system only has one power supply. See [Figure 2-4](#).

Figure 2-4. Back-Panel Features and Indicators

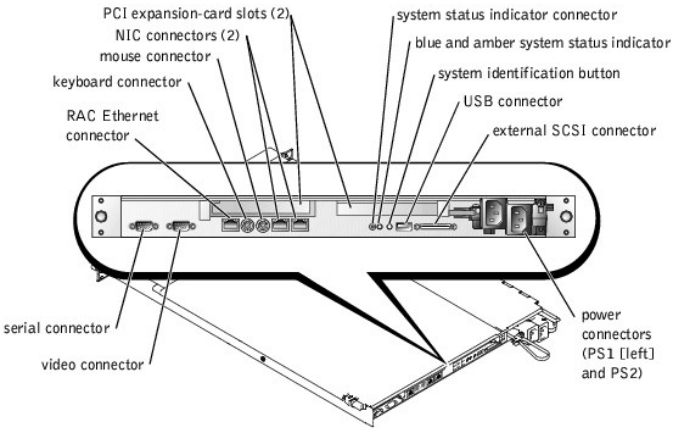

Power Supply Features

Each hot-pluggable power supply has three indicators, visible when the system covers are open, that indicate whether power is present or whether a power fault has occurred. See [Table 2-4](#) for more information about the indicators. See "[Opening the System Covers](#)" in "Troubleshooting Your System" for information about accessing the inside of the system.

Figure 2-5. Power Supply Features

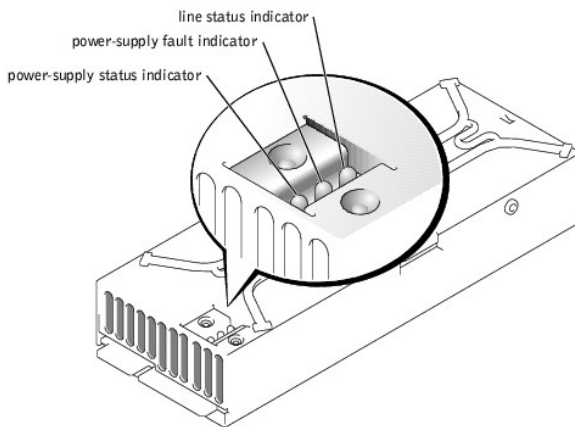

Table 2-4. Power-Supply Indicator Patterns

Indicator	Indicator Code
Line status	Green indicates that a valid power source is connected to the system.
Power-supply fault	Red indicates a problem with the power supply.
Power-supply status	Green indicates that the power supply is operational.

System Messages

System messages alert you to a possible operating system problem or to a conflict between the software and hardware. [Table 2-5](#) lists the system error messages that can occur and the probable cause for each message.

 **NOTE:** If you receive a system message that is not listed in [Table 2-5](#), check the documentation for the application that is running when the message appears or the operating system's documentation for an explanation of the message and recommended action.

Table 2-5. System Messages

Message	Causes	Corrective Actions
Address mark not found	Faulty diskette/CD drive subsystem or hard-drive subsystem (defective system board).	See "Getting Help."
Amount of available memory limited to 256 MB!	OS Install Mode is enabled in the System Setup program.	Disable the OS Install Mode in the System Setup program. See "Using the System Setup program" in the <i>User's Guide</i> .
Alert! One or more of the memory DIMMs are out of rev.	One or more of the installed DIMMs are not supported by the system. DIMMs must be registered DDR SDRAM rated for 266-MHz operation.	Ensure that all installed memory meets the system specifications. See "Installing Memory Modules" in "Installing System Options."
Alert! Redundant memory disabled! Memory configuration does not support redundant memory.	One memory bank is not populated, or memory banks are different sizes. To support redundant memory, both banks must be populated, and all four DIMMs must be the same size.	Install identical DIMMs in all four memory banks. See "Installing Memory Modules" in "Installing System Options."
Alert! Unsupported memory, incomplete sets, or unmatched sets. The following memory DIMM(s) have been disabled: DIMM_xx	DIMMs are installed in a mismatched pair, or one memory slot in a bank is empty. Memory must be installed in matched pairs. In a mismatched memory bank, neither DIMM is used.	Ensure that memory is installed in matched pairs. See "Installing Memory Modules" in "Installing System Options."
Auxiliary device failure	Mouse or keyboard cable connector loose or improperly connected; defective mouse or keyboard.	Check the mouse and keyboard cable connections. See "Troubleshooting External Connections" in "Troubleshooting Your System." If the problem persists, replace the mouse. If the problem persists, replace the keyboard. See "Getting Help."
Attachment failed to respond.	Diskette drive or hard-drive controller cannot send data to associated drive.	Reboot the system. If you receive an error message from the SCSI, RAID, or diskette controller, see "Getting Help." If no error message appears at system boot, reseal all drives. If the problem persists, see "Getting Help."
Bad error-correction code (ECC) on disk read. Controller has failed.	Faulty diskette drive, tape drive, or hard-drive subsystem (defective backplane board).	Reseat all drives and reboot the system. If the error message reappears, see "Getting Help."
BIOS Update Attempt Failed!	Remote BIOS update attempt failed.	Retry the BIOS update. If the problem persists, see "Getting Help."
Caution! NVRAM_CLR jumper is installed on system board - please run SETUP program.	Incorrect configuration settings in System Setup program, NVRAM_CLR jumper is installed, or faulty system battery.	Check the System Setup configuration settings. See "Using the System Setup Program" in the <i>User's Guide</i> . Remove the NVRAM_CLR jumper. See Figure A-2 for jumper location. Replace the battery. See "Replacing the System Battery" in "Installing System Options."
CPUs with different cache sizes detected.	Two different types of microprocessors are installed.	Install a correct version of the microprocessor so that both microprocessors have the same level 2 cache size. See "Installing Microprocessors" in "Installing System Options."
Data error	Faulty diskette, diskette drive, or hard drive.	Replace the diskette. Reseat all drives and reboot the system. If the error message reappears, see "Getting Help."
Decreasing available memory	One or more memory modules improperly seated or faulty.	Remove and reseat the memory modules. See "Installing Memory Modules" in "Installing System Options." If the problem persists, replace the memory modules. If the problem persists, see "Getting Help."
Diskette drive 0 seek failure Diskette drive 1 seek failure	Faulty or improperly inserted diskette or incorrect configuration settings in System Setup program.	Reseat the diskette drive and replace the diskette. See "Installing a Diskette Drive" in "Installing Drives." Run the System Setup program to correct the diskette drive type. See "Using the System Setup Program" in the <i>User's Guide</i> .
Diskette read failure	Faulty diskette, or faulty or improperly connected diskette drive.	Reseat the diskette drive and replace the diskette. See "Installing a Diskette Drive" in "Installing Drives."
Diskette subsystem reset failed	Faulty diskette/CD drive controller (defective system board).	Replace the system board. See "Getting Help."
Diskette write protected	Diskette write-protect feature is enabled.	Disable the write-protect feature on the diskette.
Drive not ready	Diskette missing from or improperly inserted into the diskette drive.	Reinsert the diskette into the drive.
ECC memory error	Improperly seated or faulty memory modules.	Remove and reseat the memory modules. See "Installing Memory Modules" in "Installing System Options." If the problem persists, replace the memory modules. If the problem persists, see "Getting Help."
Embedded server management error Embedded server management is not present	Embedded server management memory may be temporarily corrupted.	To clear the embedded server management memory, shut down the system, disconnect the power cord(s), wait approximately 30 seconds, and then reconnect the power cord(s) and restart the system. If the problem persists, see "Getting Help."
Error: Dell Remote Access Controller	Defective RAC or system board.	Replace the RAC. See the documentation that came with the

initialization failure		RAC. If the problem persists, you may need to replace the system board. See " Getting Help ."
Gate A20 failure	Faulty keyboard controller (defective system board).	Replace the system board. See " Getting Help ."
General failure	Application program or operating system failure.	Reboot. If the message reappears, see your software documentation.
Hard disk controller failure Hard disk read failure	Incorrect configuration settings in the System Setup program, improperly connected hard drive, or faulty hard-drive controller subsystem (defective system board).	Check the hard-drive configuration settings in the System Setup program. See "Using the System Setup Program" in the <i>User's Guide</i> . Reinstall the hard drive. See " Installing SCSI Hard Drives " in "Installing Drives."
Invalid configuration information - please run SETUP program.	Incorrect configuration settings in the System Setup program, the NVRAM_CLR jumper is installed, or the system battery is faulty.	Check the System Setup configuration settings. See "Using the System Setup Program" in the <i>User's Guide</i> . Remove the NVRAM_CLR jumper. See Figure A-2 for jumper location. Replace the battery. See " Replacing the System Battery " in "Installing System Options."
Invalid memory configuration detected. Potential for data corruption exists!	Memory modules are not installed in matched pairs.	Install memory modules in matched pairs. See " Installing Memory Modules " in "Installing System Options."
Invalid NVRAM configuration, resource re-allocated	System configuration data has been ignored.	Check the System Setup configuration settings. See "Using the System Setup Program" in the <i>User's Guide</i> .
I/O card parity interrupt at address	Expansion card(s) is improperly installed or faulty.	Reinstall the expansion card(s). See " Installing Expansion Cards " in "Installing System Options." If the problem persists, replace the expansion card(s).
Keyboard controller failure	Defective keyboard/mouse controller (defective system board).	Replace the system board. See " Getting Help ."
Keyboard data line failure Keyboard stuck key failure Keyboard clock line failure Keyboard failure	Keyboard cable connector is loose or improperly connected; defective keyboard; defective keyboard/mouse controller (defective system board).	Check the keyboard cable connection. Replace the keyboard. If the problem persists, replace the system board. See " Getting Help ."
Memory allocation error	Memory module(s) is not connected properly, or an application program or the operating system failed.	Reseat the modules. See " Installing Memory Modules " in "Installing System Options." Reboot the system. If the message reappears, see your software documentation.
Memory address line failure at address, read value expecting value Memory high data line failure at start address to end address Memory high address line failure at start address to end address Memory double word logic failure at start address to end address Memory double word logic failure at address, read value expecting value Memory odd/even logic failure at start address to end address Memory odd/even logic failure at address, read value expecting value Memory write/read failure at address, read value expecting value Memory write/read failure at start address to end address	Faulty or improperly seated memory modules or defective system board.	Remove and reseat the memory modules. See " Installing Memory Modules " in "Installing System Options." If the problem persists, replace the memory modules. If the problem persists, see " Getting Help ."
Memory parity failure at start address to end address Memory parity error at address	Improperly seated or faulty memory modules.	Remove and reseat the memory modules. See " Installing Memory Modules " in "Installing System Options." If the problem persists, replace the memory modules. If the problem persists, see " Getting Help ."
No boot device available	Faulty diskette, diskette/CD drive subsystem, hard drive, or hard-drive subsystem; no boot disk in drive A.	Replace the diskette or the hard drive. See " Installing Drives ." If the problem persists, replace the system board. See " Getting Help ."
No boot sector on hard- disk	No operating system on the hard drive.	Check the hard-drive configuration settings in the System Setup program. See "Using the System Setup Program" in the <i>User's Guide</i> .
No timer tick interrupt	Defective system board.	Replace the system board. See " Getting Help ."
No PXE-capable device available	<F12> was pressed during POST and no PXE devices are detected.	Check the cables connected to the NICs. Check the configuration settings in the System Setup program for the NICs. See "Using the System Setup Program" in the <i>User's Guide</i> .
Non-system disk or disk error	Faulty diskette, diskette drive subsystem, or hard-drive subsystem.	Replace the diskette. Reseat all drives and reboot the system. If the error message reappears, see " Getting Help ."
Not a boot diskette	No operating system on diskette.	Use a bootable diskette.

PCI BIOS failed to install	PCI device (option ROM) checksum failure is detected during shadowing.	Contact the PCI device manufacturer to obtain a suitable replacement PCI option ROM. Follow the manufacturer's instructions to install the option ROM.
Plug & Play Configuration Error	Error encountered when initializing the PCI device, or the system board is defective.	Install the NVRAM_CLR jumper and reboot the system. If the problem persists, replace the system board. See " Getting Help ."
Plug & Play Configuration Error PCI_n	Error encountered when initializing the PCI adapter.	Install the NVRAM_CLR jumper and reboot the system. If the problem persists, replace the specified expansion-card. See " Installing Expansion Cards " in "Installing System Options." If the problem persists, replace the system board. See " Getting Help ."
Primary backplane error	Improperly attached or missing backplane.	Ensure that the SCSI backplane board is fully seated. See " Troubleshooting SCSI Hard Drives " in "Troubleshooting Your System."
Primary IDE device 0 not found Primary IDE device 1 not found	Improperly connected or missing IDE device.	Ensure that the device's interface cable is securely connected to the SCSI backplane board. Replace the device. If the problem persists, see " Getting Help ."
Processor 1 internal error Processor 2 internal error	Defective microprocessor or system board (reported by the NMI handler).	Replace the specified microprocessor. See " Installing Microprocessors " in "Installing System Options." If the problem persists, replace the system board. See " Getting Help ."
Processor bus error PCI bus error IMB bus error	Defective system board (reported by the NMI handler).	Replace the system board. See " Getting Help ."
Processor x is not a 533-MHz system bus processor This system bus speed is not supported on this system board.	This system supports only Intel® Xeon™ 533-MHz front-side-bus (system bus) processors.	Reboot the system. If you receive beep code 4-4-3 (processor frequency mismatch), replace processor x with a supported processor. See " Installing Microprocessors " in "Installing System Options." If a beep code does not occur at system boot, turn off the system, install the NVRAM_CLR jumper, and reboot the system. If the message reappears, see " Getting Help ."
Read fault Requested sector not found	Faulty diskette, diskette-drive subsystem, or hard-drive subsystem.	Replace the diskette, or reseal all drives and reboot the system. If the message reappears, see " Getting Help ."
Reset failed	Improperly connected diskette/tape drive, hard drive, or power cable.	Check the drive and cable connections, and reset the system again. If the message reappears, see " Getting Help ."
ROM bad checksum = address	Expansion card improperly installed or faulty.	Reinstall the expansion card. See " Installing Expansion Cards " in "Installing System Options."
Sector not found Seek error Seek operation failed	Defective sectors on diskette or hard drive. Faulty diskette, diskette-drive subsystem, or hard-drive subsystem.	Replace the diskette, or reseal all drives and reboot the system. If the message reappears, see " Getting Help ."
Shutdown failure	Defective system board.	Replace the system board. See " Getting Help ."
System backplane error	Improperly attached or missing SCSI backplane.	Check that the SCSI backplane board is fully seated. See " Troubleshooting SCSI Hard Drives " in "Troubleshooting Your System."
System halted! Must power down.	Wrong password entered too many times.	Reboot the system and enter the correct password. If the problem persists, see " Disabling a Forgotten Password " in "Jumpers and Connectors."
System parity error	Defective expansion card(s) or improperly seated or faulty memory modules (reported by the NMI handler).	Replace the expansion cards one at a time until the error is corrected. See " Installing Expansion Cards " in "Installing System Options." Remove and reseal the memory modules. See " Installing Memory Modules " in "Installing System Options." If the problem persists, replace the memory modules. If the problem persists, see " Getting Help ."
The following memory DIMMs are unsupported: DIMM_xx. This system only supports 266 MHz DIMMs.	One or more of the installed DIMMs has a frequency less than 266 MHz. System memory must be rated for 266 MHz.	Replace lower-speed DIMM(s) with modules rated for 266-MHz operation. See " Installing Memory Modules " in "Installing System Options."
Time-of-day clock stopped	Defective battery or faulty chip (defective system board).	Replace the system battery. See " Replacing the System Battery " in "Installing System Options." If the problem persists, replace the system board. See " Getting Help ."
Time-of-day not set - please run SETUP program	Incorrect Time or Date settings or defective system battery.	Check the Time and Date settings. See "Using the System Setup Program" in the <i>User's Guide</i> . If the problem persists, replace the system battery. See " Replacing the System Battery " in "Installing System Options." If the problem persists, replace the system board. See " Getting Help ."
Timer chip counter 2 failed	Defective system board.	Replace the system board. See " Getting Help ."
Unsupported CPU combination	Microprocessor combination is not supported by the system.	Install a supported microprocessor combination. See " Installing Microprocessors " in "Installing System Options."
Unsupported CPU stepping detected.	Microprocessor is not supported by the system.	Install the correct version of the microprocessor in the specified microprocessor socket. See " Installing Microprocessors " in "Installing System Options."
Utility partition not available	<F10> key was pressed during POST.	Create a utility partition on the boot hard drive. See "Using

	but no utility partition exists on the boot hard drive.	the Dell OpenManage Server Assistant CD" in your <i>User's Guide</i> .
Warning: Detected mode change from SCSI to RAID on channel x of the embedded RAID subsystem. Warning: Detected missing RAID hardware for the embedded RAID subsystem. Data loss will occur! Press Y to switch mode to SCSI, press any other key to disable both channels. Press Y to confirm the change; press any other key to cancel.	Type of controller has changed since previous system boot.	Back up information on the hard drives before changing the type of controller used with the drives.
Warning: Detected mode change from RAID to SCSI on channel x of the embedded RAID subsystem. Warning: Detected missing RAID hardware for the embedded RAID subsystem. Data loss will occur! Press Y to switch mode to SCSI, press any other key to disable both channels. Press Y to confirm the change; press any other key to cancel.	Type of controller has changed since previous system boot.	Back up information on the hard drives before changing the type of controller used with the drives.
Warning! Embedded SCSI- RAID error	Faulty RAID adapter, or ROMB card firmware is either corrupted or is the wrong version.	Reseat the ROMB card. See " Installing a ROMB Card " in "Installing System Options." Reboot the system. If the message reappears, see " Getting Help ."
Warning! Embedded SCSI- RAID firmware is not present!	ROMB card firmware is either corrupted or is the wrong version.	Reseat the ROMB card. See " Installing a ROMB Card " in "Installing System Options." Reboot the system. If the message reappears, see " Getting Help ."
Warning! Firmware is out-of-date, please update	Out-of-date firmware.	Update the system firmware. See "Using the <i>Dell OpenManage Server Assistant</i> CD" in your <i>User's Guide</i> for information about updating the system firmware.
Warning! No microcode update loaded for processor x	BIOS is not current.	Update the BIOS, but do not turn the system off before the update. See "Using the System Setup Program" in the <i>User's Guide</i> .
Warning! Remote Access Controller command failure	Command protocol failure between the RAC and ESM3.	Reseat the RAC in its system board connector. See " Removing and Replacing the Optional Front Bezel " (if necessary) and " Opening the System Covers " in "Troubleshooting Your System." See Figure A-3 in "Jumpers and Connectors" for the location of the RAC Ethernet connector. If the message reappears, see " Getting Help ."
Warning! Unsupported Remote Access Controller firmware version detected	RAC firmware is corrupted or is the wrong version.	Reseat the RAC in its system board connector. See " Removing and Replacing the Optional Front Bezel " (if necessary) and " Opening the System Covers " in "Troubleshooting Your System." See Figure A-3 in "Jumpers and Connectors" for the location of the RAC connector. If the message reappears, see " Getting Help ."
Write fault Write fault on selected drive	Faulty diskette or hard drive.	Replace the diskette or hard drive. See " Installing Drives ."

System Beep Codes

When an error that cannot be reported on the monitor occurs during a boot routine, the system may emit a series of beeps that identify the problem.

 **NOTE:** If the system boots without a keyboard, mouse, or monitor attached, the system will not issue beep codes related to these peripherals.

When a beep code is emitted, record it on a copy of the Diagnostics Checklist in "[Getting Help](#)," and then look it up in [Table 2-6](#). If you are unable to resolve the problem by looking up the meaning of the beep code, use the system diagnostics to identify a more serious cause. If you are still unable to resolve the problem, see "[Getting Help](#)."

Table 2-6. System Beep Codes

Code	Cause	Corrective Action
1-1-2	Microprocessor register test failure	Replace microprocessor 1. See " Installing Microprocessors " in "Installing System Options." If the problem persists, replace microprocessor 2.
1-1-3	CMOS write/read failure	Replace the system board. See " Getting Help ."
1-1-4	BIOS checksum failure	This fatal error usually requires replacement of the BIOS firmware. See " Getting Help ."
1-2-1	Programmable interval-timer failure	Replace the system board. See " Getting Help ."
1-2-2	DMA initialization failure	Remove and reseat the memory modules. See " Installing Memory Modules " in "Installing System Options." If the problem persists, replace the memory modules. If the problem persists, see " Getting Help ."
1-2-3	DMA page register write/read failure	
1-3-1	Main-memory refresh verification failure	
1-3-2	No memory installed	
1-3-3	Chip or data line failure in the first 64 KB of main memory	

1-3-4	Odd/even logic failure in the first 64 KB of main memory	
1-4-1	Address line failure in the first 64 KB of main memory	
1-4-2	Parity failure in the first 64 KB of main memory	
2-1-1 through 2-4-4	Bit failure in the first 64 KB of main memory	
3-1-1	Slave DMA-register failure	Replace the system board. See " Getting Help ."
3-1-2	Master DMA-register failure	
3-1-3	Master interrupt-mask register failure	
3-1-4	Slave interrupt-mask register failure	
3-2-4	Keyboard-controller test failure	Check the keyboard cable and connector for proper connection. If the problem persists, replace the keyboard. If the problem persists, replace the system board. See " Getting Help ."
3-3-1	CMOS failure	Replace the system board. See " Getting Help ."
3-3-2	System configuration check failure	
3-3-3	Keyboard controller not detected	
3-3-4	Screen initialization failure	
3-4-2	Screen-retrace test failure	
3-4-3	Search for video ROM failure	
4-2-1	No timer tick	
4-2-2	Shutdown failure	
4-2-3	Gate A20 failure	
4-2-4	Unexpected interrupt in protected mode	Ensure that all expansion cards are properly seated, and then reboot the system.
4-3-1	Improperly seated or faulty memory modules	Remove and reseat the memory modules. See " Installing Memory Modules " in "Installing System Options." If the problem persists, replace the memory modules. If the problem persists, see " Getting Help ."
4-3-3	Defective system board	Replace the system board. See " Getting Help ."
4-3-4	Time-of-day clock stopped	Replace the battery. See " Replacing the System Battery " in "Installing System Options." If the problem persists, replace the system board. See " Getting Help ."
4-4-1	Super I/O chip failure (defective system board)	Replace the system board. See " Getting Help ."
4-4-3	Microprocessor frequency mismatch. Occurs when the front-side (external) bus speed of a microprocessor is not 533 MHz.	If video is available, a screen message identifies the faulty microprocessor. Replace the microprocessor. If video is not available, replace microprocessor 1 and then, if the problem persists, replace microprocessor 2. See " Installing Microprocessors " in "Installing System Options."
4-4-4	Cache test failure (defective microprocessor)	Remove and reseat the specified microprocessor. See " Installing Microprocessors " in "Installing System Options." If the problem persists, replace the microprocessor. If the problem persists, see " Getting Help ."

Warning Messages

A warning message alerts you to a possible problem and asks you to take corrective action before the system continues a task. For example, before you format a diskette, a message may warn you that you may lose all data on the diskette, as a way to protect against inadvertently erasing or writing over the data. These warning messages usually interrupt the procedure and require you to respond by typing y (yes) or n (no).

 **NOTE:** Warning messages are generated by either the application program or the operating system. See "[Finding Software Solutions](#)" and the documentation that accompanied the operating system or application program for more information on warning messages.

Diagnostics Messages

When you run a test group or subtest in the system diagnostics, an error message may result. These particular error messages are not covered in this section. Record the message on a copy of the Diagnostics Checklist (see "[Getting Help](#)"), and then follow the instructions in that section for obtaining technical assistance.

Alert Messages

The optional system management software generates alert messages for your system. For example, the server agent software generates messages that appear in the SNMP trap log file. Alert messages consist of information, status, warning, and failure messages for drive, temperature, fan, and power conditions. More information about alert messages is provided in the system management software documentation found on the documentation CD that shipped with your system.

[Back to Contents Page](#)

[Back to Contents Page](#)

Finding Software Solutions

Dell™ PowerEdge™ 1750 Systems Installation and Troubleshooting Guide

- [Before You Begin](#)
- [Troubleshooting Errors and Conflicts](#)

Software problems can be caused by:

- 1 Improper installation or configuration of an application
- 1 Application conflicts
- 1 Input errors
- 1 Interrupt assignment conflicts

Ensure that you are installing the software application according to the software manufacturer's recommended procedures. If a problem occurs after you install the software, you might need to troubleshoot your software application and your system.

See the documentation that accompanied the software or contact the software manufacturer for detailed troubleshooting information.

 **NOTE:** If all of the system diagnostic tests complete successfully, then the problem is most likely caused by the software and not the hardware.

Before You Begin

- 1 Scan the software media with antivirus software.
- 1 Read the software documentation before you run the installation utility.
- 1 Be prepared to respond to prompts from the installation utility.

The installation utility may require you to enter information about your system, such as how the operating system is configured, and the type of peripherals that are connected to the system. Have this information available before running the installation utility.

Troubleshooting Errors and Conflicts

While configuring and running software, problems might occur that are caused by input errors, application conflicts, and/or IRQ assignment conflicts. The problems are sometimes indicated by error messages.

Error messages are generated by system hardware or software. "[Indicators, Messages, and Codes](#)" provides information about error messages that are hardware-based. If you receive an error message that is not listed, see your operating system or software program documentation for troubleshooting information.

Input Errors

Pressing a specific key or set of keys at the wrong time may produce unexpected results. See the documentation that came with the software application to ensure that the values or characters you are entering are valid.

Ensure that your operating system is configured properly to run the application. Remember that whenever you change the parameters of the operating system, the changes can conflict with an application's operating requirements. After you configure the operating system, you may need to reinstall or reconfigure a software application so that it can run properly in its new environment.

Application Conflicts

Some applications can leave unnecessary files or data behind after they are deleted from your system. Device drivers can also create application errors. If application errors occur, see your application device driver or operating system documentation for troubleshooting information.

IRQ Assignment Conflicts

Most PCI devices can share an IRQ with another device, but they cannot use an IRQ simultaneously. To avoid this type of conflict, see the documentation for each PCI device for specific IRQ requirements.

Table 3-1. IRQ Assignments

IRQ Line	Assignment
IRQ0	System timer
IRQ1	Keyboard controller
IRQ2	Interrupt controller 1 to enable IRQ8 through IRQ15
IRQ3	Reserved for system use
IRQ4	Serial port 1 (COM1 and COM3)

IRQ5	<i>Available</i>
IRQ6	Diskette drive controller
IRQ7	<i>Available</i>
IRQ8	Real-time clock/system CMOS
IRQ9	ACPI functions (used for power management)
IRQ10	Used by ESM hardware
IRQ11	<i>Available</i>
IRQ12	PS/2 mouse port unless the mouse is disabled through the System Setup program
IRQ13	Math coprocessor
IRQ14	RAC, if installed; <i>available</i> if a RAC is not installed
IRQ15	Secondary IDE controller

[Back to Contents Page](#)

[Back to Contents Page](#)

Running the System Diagnostics

Dell™ PowerEdge™ 1750 Systems Installation and Troubleshooting Guide

- [Using Server Administrator Diagnostics](#)
- [System Diagnostics Features](#)
- [When to Use the System Diagnostics](#)
- [Running the System Diagnostics](#)
- [System Diagnostics Testing Options](#)
- [Using the Advanced Testing Options](#)
- [Error Messages](#)

If you experience a problem with your system, run the diagnostics before calling for technical assistance. The purpose of the diagnostics is to test your system's hardware without requiring additional equipment or risking data loss. If you are unable to fix the problem yourself, service and support personnel can use diagnostics test results to help you solve the problem.

Using Server Administrator Diagnostics

To assess a system problem, first use the online Server Administrator diagnostics. If you are unable to identify the problem, then use the system diagnostics.

To access the online diagnostics, log into the Server Administrator home page, and then click the **Diagnostics** tab. For information about using diagnostics, see the online help. For additional information, see the *Server Administrator User's Guide*.

System Diagnostics Features

The system diagnostics provides a series of menus and options for particular device groups or devices. The system diagnostics menus and options allow you to:

- 1 Run tests individually or collectively.
 - 1 Control the sequence of tests.
 - 1 Repeat tests.
 - 1 Display, print, or save test results.
 - 1 Temporarily suspend testing if an error is detected or terminate testing when a user-defined error limit is reached.
 - 1 View help messages that briefly describe each test and its parameters.
 - 1 View status messages that inform you if tests are completed successfully.
 - 1 View error messages that inform you of problems encountered during testing.
-

When to Use the System Diagnostics

If a major component or device in the system does not operate properly, component failure may be indicated. As long as the microprocessor and the system's input/output devices (monitor, keyboard, and diskette drive) are functioning, you can use the system diagnostics to help identify the problem.

Running the System Diagnostics

The system diagnostics can be run either from the utility partition on your hard drive or from a set of diskettes that you create using the *Dell OpenManage Server Assistant* CD.



NOTICE: Use the system diagnostics to test only your system. Using this program with other systems may cause invalid results or error messages. In addition, use only the program that came with your system (or an updated version of that program).

From the Utility Partition

1. As the system boots, press <F10> during POST.
2. From the utility partition main menu under **Run System Utilities**, select **Run System Diagnostics**.

From the Diagnostics Diskettes

1. Create a set of diagnostics diskettes from the *Dell OpenManage Server Assistant* CD. See "Using the Dell OpenManage Server Assistant CD" in your *User's Guide* for information on creating the diskettes.
2. Insert the first diagnostics diskette.

3. Reboot the system.

If the system fails to boot, see "[Getting Help.](#)"

When you start the system diagnostics, a message is displayed stating that the diagnostics are initializing. Next, the **Diagnostics** menu appears. The menu allows you to run all or specific diagnostics tests or to exit the system diagnostics.

 **NOTE:** Before you read the rest of this section, start the system diagnostics so that you can see the utility on your screen.

System Diagnostics Testing Options

To select an option from the **Diagnostics** menu, highlight the option and press <Enter>, or press the key that corresponds to the highlighted letter in the option.

[Table 4-1](#) provides a brief explanation of testing options.

Table 4-1. System Diagnostics Testing Options

Testing Option	Function
Quick Tests	Performs a quick check of the system. Select Test All Devices and then select Quick Tests . This option runs device tests that do not require user interaction. Use this option to quickly identify the source of your problem.
Test One Device	Tests a particular device.
Extended Tests	Performs a more thorough check of the system. Select Test All Devices and then select Extended Tests .
Advanced Testing	Checks a particular area of the system.
Information and Results	Displays test results.
Program Options	Sets various test parameters.
Device Configuration	Displays an overview of the devices in the system.
Exit to MS-DOS	Exits the diagnostics and returns to the System Utilities menu.

Using the Advanced Testing Options

When you select **Advanced Testing** from the **Diagnostics** menu, the main screen of the diagnostics appears and displays the following information:

- 1 Two lines at the top of the screen identify the diagnostics utility, the version number, and the system's service tag number.
- 1 The left side of the screen under **Device Groups** lists the diagnostic device groups in the order that they are tested if you select **All** under the **Run Tests** submenu. Press the up- or down-arrow keys to highlight a particular device group. Press the left- or right-arrow keys to select the options on the menu. As you move from one menu option to another, a brief explanation of the highlighted option appears at the bottom of the screen.
- 1 The right side of the screen under **Devices for Highlighted Group** lists the specific devices within a particular test group.
- 1 The menu area consists of two lines at the bottom of the screen. The first line lists the menu options that you can select; press the left- or right-arrow key to highlight an option. The second line provides information about the highlighted option.

For more information about a device group or device, highlight the Help option and press <Enter>. Press <Esc> to return to the previous screen.

Error Messages

When you run a system diagnostics test, you may receive an error message during testing. Record the message on a copy of the Diagnostics Checklist. For a copy of the Diagnostics Checklist and instructions for obtaining technical assistance, see "[Getting Help.](#)"

[Back to Contents Page](#)

Troubleshooting Your System

Dell™ PowerEdge™ 1750 Systems Installation and Troubleshooting Guide

- [Safety First—For You and Your System](#)
- [Checking the Equipment](#)
- [Start-Up Routine](#)
- [Troubleshooting External Connections](#)
- [Responding to a Systems Management Software Alert Message](#)
- [Inside the System](#)
- [Removing and Replacing the Optional Front Bezel](#)
- [Opening the System Covers](#)
- [Closing the System Covers](#)
- [Troubleshooting a Wet System](#)
- [Troubleshooting a Damaged System](#)
- [Troubleshooting the System Battery](#)
- [Troubleshooting Power Supplies](#)
- [Troubleshooting System Cooling Problems](#)
- [Troubleshooting System Memory](#)
- [Troubleshooting a Diskette Drive](#)
- [Troubleshooting a CD Drive](#)
- [Troubleshooting SCSI Hard Drives](#)
- [Troubleshooting an Optional Integrated RAID Controller \(ROMB Card\)](#)
- [Troubleshooting a RAID Controller Card](#)
- [Troubleshooting Expansion Cards](#)
- [Troubleshooting the Microprocessors](#)

Safety First—For You and Your System

To perform certain procedures in this document, you must remove the system cover and work inside the system. While working inside the system, do not attempt to service the system except as explained in this guide and elsewhere in your system documentation.

- ⚠ Always follow the instructions closely, and ensure that you review all information in "Safety Instructions" in the *System Information Guide*.
- ⚠ **CAUTION:** Only trained service technicians are authorized to remove the system cover and access any of the components inside the system. See your *System Information Guide* for complete information about safety precautions, working inside the computer, and protecting against electrostatic discharge.

Checking the Equipment

This section provides troubleshooting procedures for external devices attached to the system, such as the monitor, keyboard, or mouse. Before you perform any of the procedures, see "[Troubleshooting External Connections](#)."

Start-Up Routine

Look and listen during the system's start-up routine for the indications described in [Table 5-1](#).

Table 5-1. Start-Up Routine Indications

Look/listen for:	Action
System status indicator activity (on the optional front bezel or on the front panel) that indicates a system component problem.	See " Indicators on the Optional Bezel " or " Front-Panel Features " in "Indicators, Messages, and Codes."
An error message displayed on the monitor.	See " System Messages " in "Indicators, Codes, and Messages."
A series of beeps emitted by the system.	See " System Beep Codes " in "Indicators, Codes, and Messages."
Alert messages from the systems management software.	See the systems management software documentation.
The monitor's power indicator.	See " Troubleshooting the Video Subsystem ."
The keyboard indicators.	See " Troubleshooting the Keyboard ."
The USB diskette drive activity indicator.	See " Troubleshooting a USB Device ."
The USB CD drive activity indicator.	See " Troubleshooting a USB Device ."
The diskette drive activity indicator.	See " Troubleshooting a Diskette Drive ."
The CD drive activity indicator.	See " Troubleshooting a CD Drive ."
The hard-drive activity indicator.	See " Troubleshooting SCSI Hard Drives ."
An unfamiliar constant scraping or grinding sound when you access a drive.	See " Getting Help ."

Troubleshooting External Connections

Loose or improperly connected cables are the most likely source of problems for the system, monitor, and other peripherals (such as a printer, keyboard, mouse, or other external device). Ensure that all external cables are securely attached to the external connectors on your system. See [Figure 2-4](#) for the back-panel connectors on your system; see [Figure 2-2](#) for the front-panel connectors.

Troubleshooting the Video Subsystem

Problem

- 1 Monitor is not working properly.
- 1 Video memory is faulty.

Action

1. Check the system and power connections to the monitor.
2. Determine whether the system has monitors attached to both the front and rear video connectors.

The system supports only one monitor attached to either the front or rear video connector. When a monitor is connected to the front panel, the back-panel video and PS/2 keyboard and mouse connectors are disabled.

If two monitors are attached to the system, disconnect one monitor. If the problem is not resolved, continue to the next step.

3. Check the system and power connections to the monitor.
4. Run the appropriate online diagnostic test. See "[Using Server Administrator Diagnostics](#)" in "Running System Diagnostics."

If the tests run successfully, the problem is not related to video hardware. See "[Finding Software Solutions](#)."

If the tests fail, see "[Getting Help](#)."

Troubleshooting the Keyboard

Problem

- 1 System message indicates a problem with the keyboard.
- 1 Keyboard is not functioning properly.

Action

1. Ensure that the keyboard is properly connected to the system.
2. Run the appropriate online diagnostic test. See "[Using Server Administrator Diagnostics](#)" in "Running System Diagnostics."

If the test fails, continue to the next step.

3. Press each key on the keyboard, and examine the keyboard, cable, and cable connector for signs of damage, including bent pins.

If the keyboard is not damaged, go to [step 5](#).

If the keyboard is damaged, continue to the next step.

4. Swap the faulty keyboard with a working keyboard.

If the problem is resolved, replace the faulty keyboard. See "[Getting Help](#)."

5. Run the keyboard test in the system diagnostics. See "[Running the System Diagnostics](#)."

If the test fails, see "[Getting Help](#)."

Troubleshooting the Mouse

Problem

- 1 System message indicates a problem with the mouse.
- 1 Mouse is not functioning properly.

Action

1. Run the appropriate online diagnostic test. See "[Using Server Administrator Diagnostics](#)" in "Running System Diagnostics."

If the test fails, continue to the next step.

2. Examine the mouse and its cable for signs of damage.

If the mouse is not damaged, go to [step 4](#).

If the mouse is damaged, continue to the next step.

3. Swap the faulty mouse with a working mouse.

If the problem is resolved, replace the faulty mouse. See "[Getting Help](#)."

4. Enter the System Setup program and ensure that the mouse controller is enabled. See "Using the System Setup Program" in your *User's Guide*.

If the problem is not resolved, continue to the next step.

5. Run the pointing devices test in the system diagnostics. See "[Running the System Diagnostics](#)."

If the test fails, see "[Getting Help](#)."

Troubleshooting Basic I/O Functions

Problem

1. Error message indicates a problem with a serial port.
1. Device connected to a serial port is not operating properly.

Action

1. Enter the System Setup program and ensure that the serial port(s) are enabled. See "Using the System Setup Program" in the *User's Guide*.
2. If the problem is confined to a particular application, see the application documentation for specific port configuration requirements that the program may require.
3. Run the appropriate online diagnostic test. See "[Running the System Diagnostics](#)" in "Running System Diagnostics."

If the tests run successfully but the problem persists, see "[Troubleshooting a Serial I/O Device](#)."

Troubleshooting a Serial I/O Device

Problem

1. Device connected to the serial port is not operating properly.

Action

1. Turn off the system and any peripheral devices connected to the serial port.
2. Swap the serial interface cable with a working cable, and turn on the system and the serial device.

If the problem is resolved, replace the interface cable. See "[Getting Help](#)."

3. Turn off the system and the serial device, and swap the device with a comparable device.
4. Turn on the system and the serial device.

If the problem is resolved, replace the serial device. See "[Getting Help](#)."

If the problem persists, see "[Getting Help](#)."

Troubleshooting a USB Device

Problem

1. System message indicates a problem with a USB device.
1. Device connected to a USB port is not operating properly.

Action

1. Enter the System Setup program, and ensure that the USB ports are enabled. See "Using the System Setup Program" in your *User's Guide*.
2. Turn off the system and any USB devices.
3. Disconnect the USB devices, and connect the malfunctioning device to the other USB connector.
4. Turn on the system and the reconnected device.

If the problem is resolved, the USB connector might be defective. See "[Getting Help](#)."

5. If possible, swap the interface cable with a working cable.

If the problem is resolved, replace the interface cable. See "[Getting Help](#)."

6. Turn off the system and the USB device, and swap the device with a comparable device.
7. Turn on the system and the USB device.

If the problem is resolved, replace the USB device. See "[Getting Help](#)."

If the problem persists, see "[Getting Help](#)."

Troubleshooting an Integrated NIC

Problem

- 1 NIC cannot communicate with network.

Action

1. Run the appropriate online diagnostic test. See "[Using Server Administrator Diagnostics](#)" in "Running System Diagnostics."

If the tests fail, continue to the next step.

2. Check the appropriate indicator on the NIC connector. See [Table 2-2](#) in "Indicators, Messages, and Codes."

- 1 If the link indicator does not light, check all cable connections.
- 1 If the activity indicator does not light, the network driver files might be damaged or missing.

Remove and reinstall the drivers if applicable. See the NIC's documentation.

- 1 Change the autonegotiation setting, if possible.
- 1 Use another connector on the switch or hub.

If you are using a NIC card instead of an integrated NIC, see the documentation for the NIC card.

3. Ensure that the appropriate drivers are installed and the protocols are bound. See the NIC's documentation.
4. Enter the System Setup program and confirm that the NICs are enabled. See "Using the System Setup Program" in your User's Guide.
5. Ensure that the NICs, hubs, and switches on the network are all set to the same data transmission speed. See the network equipment documentation.
6. Ensure that all network cables are of the proper type and do not exceed the maximum length. See "Network Cable Requirements" in your *User's Guide*.

Responding to a Systems Management Software Alert Message

Systems management software monitors critical system voltages and temperatures, fans, and hard drives in the system. Alert messages appear in the **Alert Log** window. For information about the **Alert Log** window, see the systems management software documentation.

Inside the System

In [Figure 5-1](#), the system covers are open and the bezel is removed to provide an interior view of the system.

Figure 5-1. Inside the System

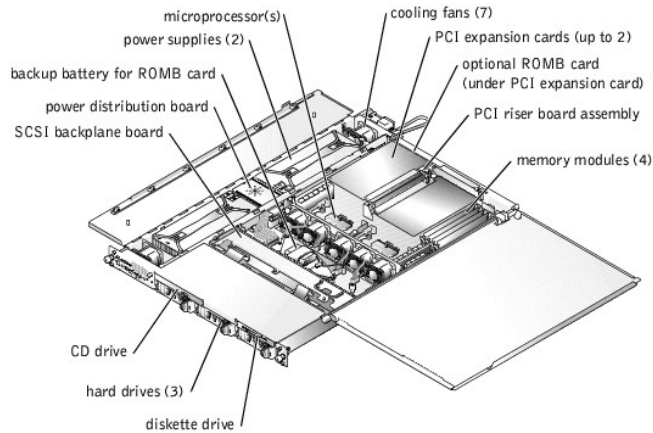

The system board can accommodate one or two microprocessors. The PCI riser board assembly accommodates up to two PCI expansion cards. Up to four memory modules may be installed on the system board.

The hard-drive bays provide space for up to three 1-inch SCSI hard drives. SCSI hard drives are connected to a SCSI controller on the system board through the SCSI backplane board.

The peripheral bays provide space for an optional 3.5-inch diskette drive and a CD drive.

The power distribution board (PDB) provides hot-plug logic and power distribution for the system. Two hot-pluggable, redundant power supplies provide power to the system board and internal peripherals.

During an installation or troubleshooting procedure, you may be required to change a jumper. For information about the system board jumpers, see "[Jumpers and Connectors](#)."

Removing and Replacing the Optional Front Bezel

The front bezel has system status indicators. A lock on the bezel restricts access to the power button, diskette drive, CD drive, hard drive(s), and the interior of the system.

- 1 To remove the bezel, use the system key to unlock the keylock on the bezel, press the tab at each end of the bezel, and then pull the bezel away from the system. See [Figure 5-2](#).
- 1 To replace the front bezel, fit the tabs on the bezel into the corresponding slots in the front panel and lock the keylock.

Figure 5-2. Removing and Replacing the Optional Front Bezel

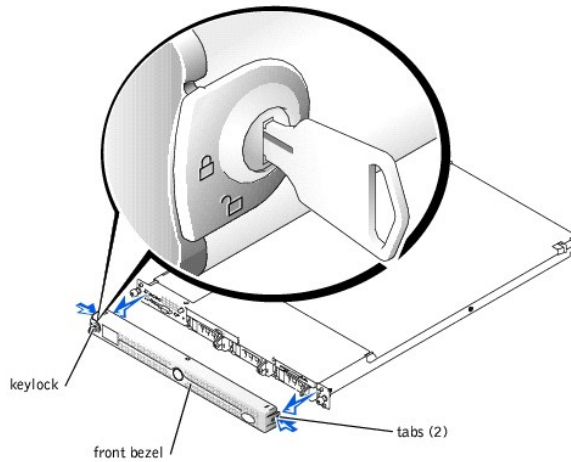

Opening the System Covers

Two covers on the top of the system provide access to the system board and other internal components.

To open the system covers, perform the following steps:

1. Observe the precautions in "[Safety First—For You and Your System](#)." Also observe the safety instructions in the *System Information Guide*.
2. Slide the system out of the rack.
3. If the front bezel is installed, remove the front bezel. See "[Removing and Replacing the Optional Front Bezel](#)."
4. If the optional security screw is installed on the system cover (see [Figure 5-3](#)), remove it now.

Figure 5-3. Opening the System Covers

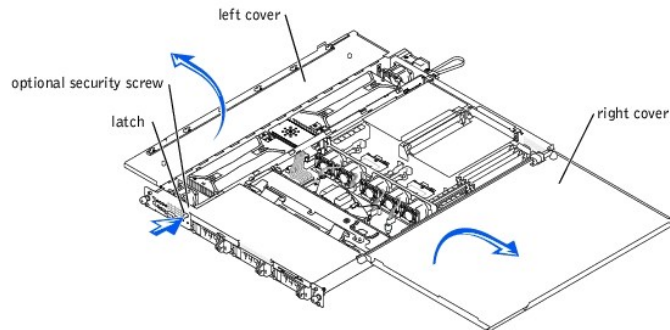

5. Press the latch on the system front panel and lift the left cover.
 6. Lift the right cover.
-

Closing the System Covers

When closing the covers, close the right (larger) cover first and then close the left cover. Press firmly on the left cover to snap the securing latch into place.

Troubleshooting a Wet System

Problem

- 1 Liquid spilled on the system.
- 1 Excessive humidity.

Action

⚠ CAUTION: Only trained service technicians are authorized to remove the system cover and access any of the components inside the system. See your *System Information Guide* for complete information about safety precautions, working inside the computer, and protecting against electrostatic discharge.

1. Turn off the system and attached peripherals, and disconnect the system from the electrical outlet.
2. Open the system. See "[Opening the System Covers](#)."
3. Remove all expansion cards installed in the system. See "[Removing an Expansion Card](#)" in "Installing System Options."
4. Let the system dry thoroughly for at least 24 hours.
5. Close the system. See "[Closing the System Covers](#)."
6. Reconnect the system to the electrical outlet, and turn on the system and attached peripherals.

If the system does not start properly, see "[Getting Help](#)."

7. If the system starts properly, shut down the system and reinstall all of the expansion cards that you removed. See "[Installing an Expansion Card](#)" in "Installing System Options."
8. Run the system board tests in the system diagnostics to confirm that the system is working properly. See "[Running the System Diagnostics](#)."

If the tests fail, see "[Getting Help](#)."

Troubleshooting a Damaged System

Problem

- 1 System was dropped or damaged.

Action

⚠ CAUTION: Only trained service technicians are authorized to remove the system cover and access any of the components inside the system. See your *System Information Guide* for complete information about safety precautions, working inside the computer, and protecting against electrostatic discharge.

1. Open the system covers. See "[Opening the System Covers](#)."
2. Ensure that the following components are properly installed:
 - 1 Expansion cards
 - 1 Power supplies
 - 1 Fans
 - 1 Drive-carrier connections to the SCSI backplane board, if applicable
3. Ensure that all cables are properly connected.
4. Close the cover. See "[Closing the System Covers](#)."
5. Run the system board tests in the system diagnostics. See "[Running the System Diagnostics](#)."

If the tests fail, see "[Getting Help](#)."

Troubleshooting the System Battery

Problem

- 1 System message indicates a problem with the battery.

- 1 System Setup program loses system configuration information.
- 1 System date and time do not remain current.

Action

1. Re-enter the time and date through the System Setup program. See "Using the System Setup Program" in your *User's Guide*.
2. Turn off the system and disconnect it from the electrical outlet for at least one hour.
3. Reconnect the system to the electrical outlet and turn on the system.
4. Enter the System Setup program.

If the date and time are not correct in the System Setup program, replace the battery. See "[Replacing the System Battery](#)" in "Installing System Options."

If the problem is not resolved by replacing the battery, see "[Getting Help](#)."

 **NOTE:** Some software may cause the system time to speed up or slow down. If the system seems to operate normally except for the time kept in the System Setup program, the problem may be caused by software rather than by a defective battery.

 **NOTE:** If the system is turned off for long periods of time (for weeks or months), the NVRAM may lose its system configuration information. This situation is caused by a defective battery.

Troubleshooting Power Supplies

Problem

- 1 System-status indicators are amber.
- 1 Power-supply fault indicators are amber.

Action

 **CAUTION:** Only trained service technicians are authorized to remove the system cover and access any of the components inside the system. See your *System Information Guide* for complete information about safety precautions, working inside the computer, and protecting against electrostatic discharge.

1. Run the appropriate online diagnostics test. See "[Using Server Administrator Diagnostics](#)" in "Running the System Diagnostics."
2. Turn off the system and attached peripherals, and disconnect the system from the electrical outlet.
3. Open the system. See "[Opening the System Covers](#)."
4. Locate the faulty power supply.

The power supply's fault indicator is lit. See [Table 2-4](#) in "Indicators, Messages, and Codes."

 **NOTICE:** The power supplies are hot-pluggable. One power supply must be installed for the system to operate. The system is in the redundant mode when two power supplies are installed. Remove and install only one power supply at a time in a system that is powered on.

5. Ensure that the power supply is properly installed by removing and reinstalling it. See "[Removing and Replacing Power Supplies](#)" in "Installing System Options."

 **NOTE:** After installing a power supply, allow several seconds for the system to recognize the power supply and to determine if it is working properly. The power indicator turns green to signify that the power supply is functioning properly. See [Table 2-4](#) in "Indicators, Messages, and Codes."

6. If the problem is resolved, close the system covers. See "[Closing the System Covers](#)."

If the problem persists, remove the faulty power supply. See "[Removing a Power Supply](#)" in "Installing System Options."

7. Install a new power supply. See "[Installing a Power Supply](#)" in "Installing System Options."

If the problem persists, see "[Getting Help](#)."

Troubleshooting System Cooling Problems

Problem

- 1 Systems management software issues a fan-related error message.

Action

Ensure that none of the following conditions exist:

- 1 Ambient temperature is too high.
- 1 External airflow is obstructed.
- 1 An individual cooling fan has failed. See "[Troubleshooting a Fan](#)."

Troubleshooting a Fan

Problem

- 1 System-status indicator is amber.
- 1 Systems management software issues a fan-related error message.
- 1 Fan status indicator indicates a problem with the fan.

Action

1. Run the appropriate diagnostic test. See "[Using Server Administrator Diagnostics](#)" in "Running System Diagnostics."

 **CAUTION:** Only trained service technicians are authorized to remove the system cover and access any of the components inside the system. See your *System Information Guide* for complete information about safety precautions, working inside the computer, and protecting against electrostatic discharge.

 **CAUTION:** Redundant cooling is not supported. Replace a failed fan as soon as possible.

2. Open the system. See "[Opening the System Covers](#)."

 **CAUTION:** The cooling fans are hot-pluggable. To maintain proper cooling while the system is on, replace only one fan at a time.

3. Locate the fan indicator that is blinking amber.

 **NOTE:** The fan indicators are small LEDs located next to each fan power connector. A solid green LED means that the fan is operating correctly; a blinking amber LED indicates a problem.

4. Ensure that the faulty fan's power cable is firmly attached to the fan power connector. See "[Removing and Replacing System Fans](#)" in "Installing System Options."

 **NOTE:** Wait 30 seconds for the system to recognize the fan and determine whether it is working properly.

5. If the problem is not resolved, install a new fan. See "[Removing and Replacing System Fans](#)" in "Installing System Options."

If the replacement fan is working properly, close the system. See "[Closing the System Covers](#)."

If the replacement fan does not operate, see "[Getting Help](#)."

Troubleshooting System Memory

Problem

- 1 Faulty memory module.
- 1 Faulty system board.
- 1 Amber system status indicators may indicate a problem with system memory.

Action

 **CAUTION:** Only trained service technicians are authorized to remove the system cover and access any of the components inside the system. See your *System Information Guide* for complete information about safety precautions, working inside the computer, and protecting against electrostatic discharge.

1. Run the appropriate online diagnostic test. See "[Using Server Administrator Diagnostics](#)" in "Running System Diagnostics."

If the test fails, continue to the next step.

2. Turn on the system and attached peripherals.

If an error messages does not appear, go to [step 12](#).

3. Enter the System Setup program and check the system memory setting. See "Using the System Setup Program" in your *User's Guide*.

If the amount of memory installed matches the system memory setting, go to [step 12](#).

4. Remove the bezel if a bezel is attached. See "[Removing and Replacing the Optional Front Bezel](#)."
5. Turn off the system and attached peripherals, and disconnect the system from the electrical outlet.
6. Open the system. See "[Opening the System Covers](#)."
7. Ensure that the memory banks are populated correctly. See "[Memory Module Installation Guidelines](#)" in "Installing System Options."

If the memory modules are populated correctly, continue to the next step.

8. Reseat the memory modules in their sockets. See "[Installing Memory Modules](#)" in "Installing System Options."
9. Close the system. See "[Closing the System Covers](#)."
10. Reconnect the system to the electrical outlet, and turn on the system and attached peripherals.
11. Enter the System Setup program and check the system memory setting. See "Using the System Setup Program" in your *User's Guide*.

If the amount of memory installed does not match the system memory setting, then perform the following steps:

- a. Turn off the system and attached peripherals, and disconnect the system from its electrical outlet.
- b. Open the system. See "[Opening the System Covers](#)."

 **NOTE:** Several configurations for the memory modules exist; see "[Memory Module Installation Guidelines](#)" in "Installing System Options."

- c. Swap the memory modules in bank 1 with a working pair of DIMMs of the same capacity. See "[Installing Memory Modules](#)" in "Installing System Options."
 - d. Close the system. See "[Closing the System Covers](#)."
 - e. Reconnect the system to its electrical outlet, and turn on the system and attached peripherals.
 - f. As the system boots, observe the monitor screen and the indicators on the keyboard.
12. Perform the following steps:
 - a. Turn off the system and attached peripherals, and disconnect the system from its electrical outlet.
 - b. Open the system. See "[Opening the System Covers](#)."
 - c. Repeat [step c](#) through [step f](#) in [step 11](#) for each memory module installed.

If the problem persists, see "[Getting Help](#)."

13. Run the system memory test in the system diagnostics. See "[Running the System Diagnostics](#)."

If the test fails, see "[Getting Help](#)."

Troubleshooting a Diskette Drive

Problem

1. Error message indicates a diskette drive problem.

Action

1. Enter the System Setup program and verify that the diskette drive is configured correctly. See "Using the System Setup Program" in the User's Guide.
2. Run the appropriate online diagnostic test. See "[Using Server Administrator Diagnostics](#)" in "Running System Diagnostics."
3. Run the diskette drive tests to check whether the diskette drive works correctly. See "[Running the System Diagnostics](#)."

If the tests fail, continue to the next step.

4. Turn off the system and attached peripherals, and disconnect the system from the electrical outlet.
5. Open or remove the bezel, if one is present. See "[Removing and Replacing the Optional Front Bezel](#)."

 **CAUTION:** Only trained service technicians are authorized to remove the system cover and access any of the components inside the system. See your *System Information Guide* for complete information about safety precautions, working inside the computer, and protecting against electrostatic discharge.

6. Open the system. See "[Opening the System Covers](#)."
7. Ensure that the diskette drive interface cable is securely connected to the diskette drive and the system board.
8. Close the system. See "[Closing the System Covers](#)."
9. Reconnect the system to the electrical outlet, and turn on the system and attached peripherals.
10. Run the diskette drive tests to see whether the diskette drive works correctly.
11. If the tests complete successfully but the error message reappears, continue to the next step.
12. Turn off the system and attached peripherals, and disconnect the system from its electrical outlet.

13. Open the system. See "[Opening the System Covers.](#)"
 14. Remove all expansion cards installed in the system. See "[Removing an Expansion Card](#)" in "Installing System Options."
 15. Close the system. See "[Closing the System Covers.](#)"
 16. Reconnect the system to the electrical outlet, and turn on the system and attached peripherals.
 17. Run the diskette drive tests to see whether the diskette drive works correctly.

If the tests run successfully, an expansion card may be conflicting with the diskette drive logic, or an expansion card may be faulty. Continue to the next step.

If the tests fail, see "[Getting Help.](#)"
 18. Turn off the system and attached peripherals, and disconnect the system from the electrical outlet.
 19. Open the system. See "[Opening the System Covers.](#)"
 20. Reinstall one of the expansion cards you removed in [step 14](#). See "[Installing an Expansion Card](#)" in "Installing System Options."
 21. Close the system. See "[Closing the System Covers.](#)"
 22. Reconnect the system to the electrical outlet, and turn on the system and attached peripherals.
 23. Run the diskette drive tests to see whether the diskette drive works correctly.
 24. Repeat [step 18](#) through [step 23](#) until all expansion cards are reinstalled or one of the expansion cards causes the tests to fail.

If the problem is not resolved, see "[Getting Help.](#)"
-

Troubleshooting a CD Drive

Problem

1. System cannot read data from a CD.
1. CD drive indicator does not blink during boot.

Action

1. Try using a different CD that you know works properly.
2. Enter the System Setup program and ensure that the drive's IDE or SCSI controller is enabled. See "Using the System Setup Program" in the *User's Guide*.
3. Run the appropriate online diagnostic test. See "[Using Server Administrator Diagnostics](#)" in "[Running the System Diagnostics.](#)"
4. Run the IDE or SCSI devices tests in the system diagnostics to determine whether the drive works correctly. See "[Running the System Diagnostics.](#)"

If the tests fail, continue to the next step.

5. Turn off the system and attached peripherals, and disconnect the system from the electrical outlet.
6. Remove the bezel, if present. See "[Removing and Replacing the Optional Front Bezel.](#)"
7. Turn off the system and attached peripherals, and disconnect the system from the electrical outlet.

 **CAUTION:** Only trained service technicians are authorized to remove the system cover and access any of the components inside the system. See your *System Information Guide* for complete information about safety precautions, working inside the computer, and protecting against electrostatic discharge.

8. Open the system. See "[Opening the System Covers.](#)"
9. Ensure that the CD interface cable is securely connected to the CD drive and to the controller.
10. Close the system. See "[Closing the System Covers.](#)"
11. Reconnect the system to the electrical outlet, and turn on the system and attached peripherals.
12. Run the IDE devices tests in the system diagnostics to determine whether the CD drive works correctly.

If the problem is not resolved, see "[Getting Help.](#)"

Troubleshooting SCSI Hard Drives

Problem

1. Device driver error.
1. Hard drive not recognized by the system.

Action

 **CAUTION:** Only trained service technicians are authorized to remove the system cover and access any of the components inside the system. See your *System Information Guide* for complete information about safety precautions, working inside the computer, and protecting against electrostatic discharge.

 **NOTICE:** This procedure can destroy data stored on the hard drive. Before you continue, back up all files on the hard drive.

1. Run the appropriate online diagnostic test. See "[Using Server Administrator Diagnostics](#)" in "Running System Diagnostics."
If the test fails, continue to the next step.
2. Run the SCSI controllers test and the hard drive tests in the system diagnostics. See "[Running the System Diagnostics](#)."
For information about testing the controller, see the SCSI or RAID controller's documentation.
If the tests fail, continue to the next step.
3. If the integrated SCSI host adapter controls the SCSI hard drives, restart the system and press <Ctrl><a> to enter the SCSI configuration utility program.

 **NOTE:** If your system has an optional RAID controller card installed, restart the system and press <Ctrl><h>, <Ctrl><a>, or <Ctrl><m>, depending on the utility. See the documentation supplied with the controller for information about the configuration utility.

4. Ensure that the primary SCSI channel is enabled, and restart the system.
5. Verify that the device drivers are installed and configured correctly. See the operating system documentation.
6. Remove the hard drive and install it in another drive bay.
7. If the problem is resolved, reinstall the hard drive in the original bay. See "[Installing SCSI Hard Drives](#)" in "Installing Drives."
If the hard drive functions properly in the original bay, the drive carrier could have intermittent problems. Replace the drive carrier. See "[Installing SCSI Hard Drives](#)" in "Installing Drives."
If the problem persists, the SCSI backplane board has a defective connector. See "[Getting Help](#)."
8. Format and partition the hard drive. See the operating system documentation.
9. If possible, restore the files to the drive.
If the problem persists, see "[Getting Help](#)."

Troubleshooting an Optional Integrated RAID Controller (ROMB Card)

Problem

1. Error message indicates an integrated RAID controller problem.

Action

 **CAUTION:** Only trained service technicians are authorized to remove the system cover and access any of the components inside the system. See your *System Information Guide* for complete information about safety precautions, working inside the computer, and protecting against electrostatic discharge.

1. Run the appropriate online diagnostic test. See "[Using Server Administrator Diagnostics](#)" in "Running System Diagnostics."
If the test fails, continue to the next step.
2. Enter the System Setup program and ensure that the integrated RAID controller is enabled. See "Using the System Setup Program" in your *User's Guide*.
3. Ensure that the RAID controller is configured properly. See the RAID controller's documentation for information about configuration settings.
If the problem is not resolved, continue to the next step.
4. Remove the bezel, if present. See "[Removing and Replacing the Optional Front Bezel](#)."
5. Turn off the system and attached peripherals, and disconnect the system from its electrical outlet.
6. Open the system. See "[Opening the System Covers](#)."
7. Ensure that the ROMB card is properly installed.
See "[Installing a ROMB Card](#)" in "Installing System Options."
8. Close the system. See "[Closing the System Covers](#)."
9. Reconnect the system to its electrical outlet, and turn on the system and attached peripherals.
If the problem is not resolved, continue to the next step.

10. Turn off the system and attached peripherals, and disconnect the system from its electrical outlet.
11. Open the system. See "[Opening the System Covers](#)."

 **CAUTION:** Replace the battery only with the same or equivalent type recommended by the manufacturer. Discard used batteries according to the manufacturer's instructions. See the *System Information Guide* for more information.

12. Replace the ROMB battery. See "[Installing a ROMB Card](#)" in "Installing System Options."
13. Close the system. See "[Closing the System Covers](#)."
14. Reconnect the system to its electrical outlet, and turn on the system and attached peripherals.

If the problem persists, see "[Getting Help](#)."

Troubleshooting a RAID Controller Card

 **NOTE:** When troubleshooting a RAID controller card, also see the documentation for your operating system and the RAID controller.

Problem

- 1 Error message indicates a RAID controller problem.
- 1 RAID controller performs incorrectly or not at all.

Action

 **CAUTION:** Only trained service technicians are authorized to remove the system cover and access any of the components inside the system. See your *System Information Guide* for complete information about safety precautions, working inside the computer, and protecting against electrostatic discharge.

1. Run the appropriate online diagnostic test. See "[Using Server Administrator Diagnostics](#)" in "Running the System Diagnostics."
If the test fails, continue to the next step.
 2. Remove the bezel, if present. See "[Removing and Replacing the Optional Front Bezel](#)."
 3. Turn off the system and attached peripherals, and disconnect the system from the electrical outlet.
 4. Open the system. See "[Opening the System Covers](#)."
 5. Ensure that the controller card is firmly seated in its connector. See "[Installing Expansion Cards](#)" in "Installing System Options."
 6. Ensure that the appropriate cables are firmly connected to their corresponding connectors on the controller card.
 7. Close the system. See "[Closing the System Covers](#)."
 8. Reconnect the system to the electrical outlet, and turn on the system and attached peripherals.
If the problem persists, see the RAID controller's documentation for more information on troubleshooting.
-

Troubleshooting Expansion Cards

 **NOTE:** When troubleshooting an expansion card, see the documentation for your operating system and the expansion card.

Problem

- 1 Error message indicates a problem with an expansion card.
- 1 Expansion card performs incorrectly or not at all.

Action

1. Run the appropriate online diagnostic test. See "[Using Server Administrator Diagnostics](#)" in "Running System Diagnostics."
2. Remove the bezel, if present. See "[Removing and Replacing the Optional Front Bezel](#)."
3. Turn off the system and attached peripherals, and disconnect the system from the electrical outlet.

 **CAUTION:** Only trained service technicians are authorized to remove the system cover and access any of the components inside the system. See your *System Information Guide* for complete information about safety precautions, working inside the computer, and protecting against electrostatic discharge.

4. Open the system. See "[Opening the System Covers](#)."

5. Ensure that each expansion card is firmly seated in its connector. See "[Installing Expansion Cards](#)" in "Installing System Options."
6. Close the system. See "[Closing the System Covers](#)."
7. Reconnect the system to the electrical outlet, and turn on the system and attached peripherals.
8. Run the appropriate tests in the system diagnostics. See "[Running the System Diagnostics](#)."

If the problem persists, continue to the next step.

9. Turn off the system and attached peripherals, and disconnect the system from the electrical outlet.
10. Open the system. See "[Opening the System Covers](#)."
11. Remove all expansion cards installed in the system. See "[Removing an Expansion Card](#)" in "Installing System Options."
12. Close the system. See "[Closing the System Covers](#)."
13. Reconnect the system to the electrical outlet, and turn on the system and attached peripherals.
14. Run **Quick Tests** in the system diagnostics.

If the tests fail, see "[Getting Help](#)."

15. For each expansion card you removed in [step 11](#), perform the following steps:
 - a. Turn off the system and attached peripherals, and disconnect the system from the electrical outlet.
 - b. Open the system. See "[Opening the System Covers](#)."
 - c. Reinstall one of the expansion cards.
 - d. Close the system. See "[Closing the System Covers](#)."
 - e. Run the appropriate tests in the system diagnostics.

If the tests fail, see "[Getting Help](#)."

If you reinstall all of the expansion cards and the tests fail, see "[Getting Help](#)."

Troubleshooting the Microprocessors

Problem

1. Error message indicates a processor problem.
1. A heat sink is not installed for each processor.

Action

 **CAUTION:** Only trained service technicians are authorized to remove the system cover and access any of the components inside the system. See your *System Information Guide* for complete information about safety precautions, working inside the computer, and protecting against electrostatic discharge.

1. Run the appropriate online diagnostics test. See "[Using Server Administrator Diagnostics](#)" in "Running the System Diagnostics."
2. Turn off the system and attached peripherals, and disconnect the system from the electrical outlet.
3. Open the system. See "[Opening the System Covers](#)."
4. Ensure that each processor and heat sink are properly installed. See "[Installing Microprocessors](#)" in "Installing System Options."
5. Close the system. See "[Closing the System Covers](#)."
6. Reconnect the system to the electrical outlet, and turn on the system and attached peripherals.
7. Run **Quick Tests** in the system diagnostics. See "[Running the System Diagnostics](#)."

If the tests fail or the problem persists, continue to the next step.

8. Turn off the system and attached peripherals, and disconnect the system from the electrical outlet.
9. Open the system. See "[Opening the System Covers](#)."
10. Remove processor 2. See "[Installing Microprocessors](#)" in "Installing System Options."

To locate the processor 1 and processor 2 sockets, see [Figure A-3](#).

If only one processor is installed, see "[Getting Help](#)."

11. Close the system. See "[Closing the System Covers](#)."
12. Reconnect the system to the electrical outlet, and turn on the system and attached peripherals.
13. Run **Quick Tests** in the system diagnostics. See "[Running the System Diagnostics](#)."

If the tests complete successfully, go to [step 19](#).

14. Turn off the system and attached peripherals, and disconnect the system from the electrical outlet.
 15. Open the system. See "[Opening the System Covers](#)."
 16. Replace processor 1 with another processor of the same capacity. See "[Installing Microprocessors](#)" in "Installing System Options."
 17. Close the system. See "[Closing the System Covers](#)."
 18. Run **Quick Tests** in the system diagnostics. See "[Running the System Diagnostics](#)."

If the tests complete successfully, replace processor 1. See "[Getting Help](#)."
 19. Turn off the system and attached peripherals, and disconnect the system from the electrical outlet.
 20. Open the system. See "[Opening the System Covers](#)."
 21. Reinstall processor 2. See "[Installing Microprocessors](#)" in "Installing System Options."
 22. Close the system. See "[Closing the System Covers](#)."
 23. Reconnect the system to the electrical outlet, and turn on the system and attached peripherals.
 24. Run **Quick Tests** in the system diagnostics. See "[Running the System Diagnostics](#)."

If the tests fail or the problem persists, see "[Getting Help](#)."
-

[Back to Contents Page](#)

Installing System Options

Dell™ PowerEdge™ 1750 Systems Installation and Troubleshooting Guide

- [Installing Expansion Cards](#)
- [Installing Memory Modules](#)
- [Installing Microprocessors](#)
- [Installing a ROMB Card](#)
- [Removing and Replacing System Fans](#)
- [Removing and Replacing Power Supplies](#)
- [Replacing the System Battery](#)

This section describes how to install the following options:

- 1 Expansion cards
- 1 Memory modules
- 1 Microprocessors
- 1 ROMB card

This section also includes instructions for replacing system fans and power supplies, as well as the system battery.

Installing Expansion Cards

Up to two half-length, PCI-X expansion cards can be installed in the system, one on each side of the riser board assembly. See [Figure 6-1](#). The riser board assembly consists of two riser boards permanently attached to each other with plastic standoffs. It plugs into twin riser connectors on the system board and is considered an extension of the system board. See [Figure A-3](#).

The PCI slot locations are marked on the system board as PCI 1 and PCI 2. The PCI 1 connector on the riser board assembly is higher than the PCI 2 connector, because the PCI 1 card installs above the optional ROMB card.

Two different PCI card configurations are available:

- 1 Two PCI-X, 64-bit, 133-MHz, 3.3-V expansion cards
- 1 One PCI-X, 64-bit, 133-MHz, 3.3-V expansion card in PCI 2, and one PCI, 64-bit, 33-MHz, 5-V expansion card in PCI 1.

Figure 6-1. Riser-Board Expansion-Card Connectors

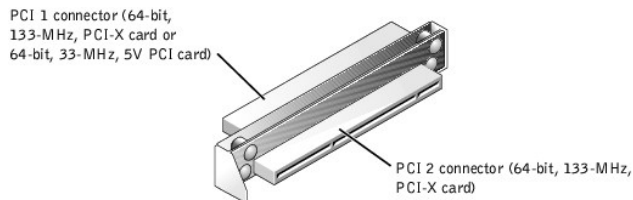

Installing an Expansion Card

To install an expansion card, perform the following steps.

⚠ CAUTION: Before you perform this procedure, you must turn off the system and disconnect it from its power source. For more information, see "[Safety First—For You and Your System](#)" in "Troubleshooting Your System."

1. Turn off the system, including any attached peripherals, and disconnect the system from its electrical outlet.
2. Prepare the expansion card for installation, and open the system covers. See "[Opening the System Covers](#)" in "Troubleshooting Your System."

See the documentation that came with the expansion card for information about configuring the card, making internal connections, or otherwise customizing the card for your system.

3. Remove the filler bracket from the expansion slot.

Figure 6-2. Installing an Expansion Card

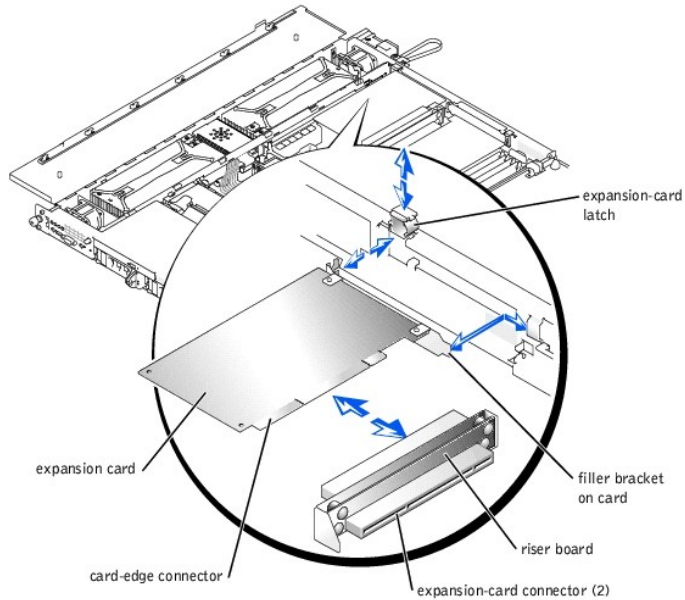

4. Slide the plastic expansion-card latch in the chassis wall up to the release position.
5. Install the new expansion card:
 - a. Lower the card into the system.
 - b. Insert the card-edge connector firmly into the expansion-card connector on the riser board. Press in until the card is fully seated, ensuring that the card's filler bracket also fits correctly into the expansion-slot opening. See [Figure 6-2](#).
6. When the card is seated in the connector, press the expansion-card latch down firmly.
7. Connect any cables that should be attached to the card.

See the documentation supplied with the card for information about its cable connections.
8. Close the system covers. See "[Closing the System Covers](#)" in "Troubleshooting Your System."
9. Reconnect the system and peripherals to their electrical outlets, and turn them on.

Removing an Expansion Card

To remove an expansion card, perform the following steps.

⚠ CAUTION: Before you perform this procedure, you must turn off the system and disconnect it from its power source. For more information, see "[Safety First—For You and Your System](#)" in "Troubleshooting Your System."

1. Turn off the system, including any attached peripherals, and disconnect the system from its electrical outlet.
2. Open the system covers. See "[Opening the System Covers](#)" in "Troubleshooting Your System."
3. Disconnect any cables connected to the card.
4. Slide the plastic expansion-card latch in the chassis wall up to the release position. See [Figure 6-2](#).
5. Grasp the expansion card by its edges, and remove it from the expansion-card connector.
6. If you are removing the card permanently, install a metal filler bracket over the empty card-slot opening.

🔧 NOTE: Installing a filler bracket over an empty expansion slot is necessary to maintain Federal Communications Commission (FCC) certification of the system. The brackets also keep dust and dirt out of the system and aid in proper cooling and airflow inside the system.

7. Press the expansion-card latch down firmly.
8. Close the system covers. See "[Closing the System Covers](#)" in "Troubleshooting Your System."
9. Reconnect the system and peripherals to their electrical outlets, and turn them on.

Installing Memory Modules

The four memory module sockets on the system board can accommodate from 256 MB to 8 GB of registered DDR SDRAM. See [Figure 5-1](#).

Memory Module Upgrade Kits

The system is upgradable to 8 GB by installing combinations of 128-, 256-, 512-MB, 1-GB, or 2-GB registered memory modules. You can purchase memory upgrade kits as needed.

NOTE: The memory modules must be rated for 266-MHz operation.

Memory Module Installation Guidelines

Starting with the socket closest to the edge of the system board, the memory module sockets are labeled DIMM_1A and DIMM_1B (bank 1) and DIMM_2A and DIMM_2B (bank 2). See [Figure 6-3](#). When you install memory modules, follow these guidelines:

- 1 You must install memory modules in matched pairs (bank 1 DIMMs must match; bank 2 DIMMs must match).
- 1 Install a pair of memory modules in bank 1 before installing a second pair in bank 2.

Figure 6-3. Memory Module Sockets

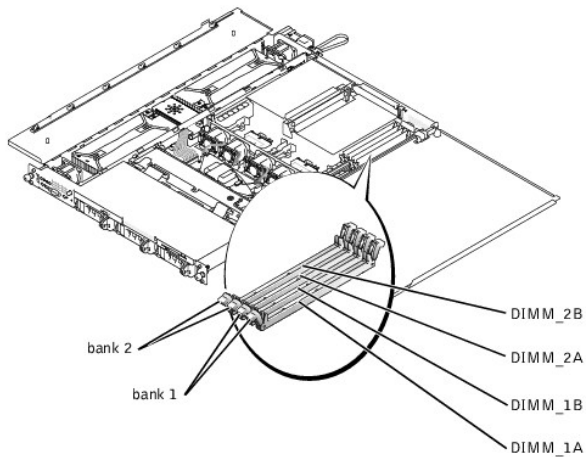

[Table 6-1](#) illustrates several sample memory configurations based on these guidelines.

Table 6-1. Sample Memory Configurations

Total Desired Memory	BANK1		BANK2	
	DIMM_1A	DIMM_1B	DIMM_2A	DIMM_2B
256 MB	128 MB	128 MB	none	none
512 MB	256 MB	256 MB	none	none
1 GB	256 MB	256 MB	256 MB	256 MB
4 GB	1 GB	1 GB	1 GB	1 GB
8 GB	2 GB	2 GB	2 GB	2 GB

Performing a Memory Module Upgrade

To perform a memory module upgrade to the system board, perform the following steps.

CAUTION: Before you perform this procedure, you must turn off the system and disconnect it from its power source. For more information, see "[Safety First—For You and Your System](#)" in "Troubleshooting Your System."

1. Open the system covers. See "[Opening the System Covers](#)" in "Troubleshooting Your System."
2. Locate the memory module sockets in which you will install or replace memory modules.

[Figure 6-3](#) identifies the memory module banks on the system board and shows the order of the socket designations.

3. Install or replace the memory modules as necessary to reach the desired memory total. See "[Installing Memory Modules](#)" or "[Removing Memory Modules](#)."
4. Close the system covers. See "[Closing the System Covers](#)" in "Troubleshooting Your System."
5. Reconnect the system to the electrical outlet, and turn on the system.

After the system completes the POST routine, it runs a memory test. The system detects that the new memory does not match the system configuration information and displays an error message.

6. Press <F2> to enter the System Setup program, and check the **System Memory** setting on the System Setup screens.

The system should have already changed the value in the **System Memory** setting to reflect the newly installed memory.

7. If the **System Memory** value is incorrect, one or more of the memory modules may not be installed properly. Repeat step 1 through step 6, checking to make sure that the memory modules are firmly seated in their sockets.
8. Run the system memory test in the system diagnostics.

Installing Memory Modules

To install a memory module, perform the following steps:

1. To open the memory module socket, press down and outward on the socket latches. See [Figure 6-4](#).

Figure 6-4. Installing a Memory Module

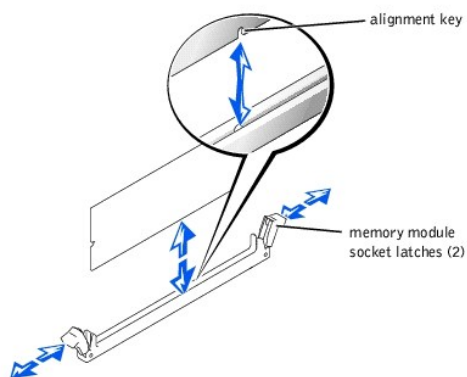

2. Align the memory module's edge connector with the slot in the center of the memory module socket, and insert the memory module straight down into the socket. See [Figure 6-4](#).

The module and the socket are keyed to prevent misalignment.

3. Press down on the memory module with your thumbs until the latches snap up around the module, securing it. See [Figure 6-4](#).

When the memory module is properly seated in the socket, the latches on the memory module socket should align with the latches on the other sockets with memory modules installed.

4. Repeat step 1 through step 3 of this procedure to install the remaining memory modules.
5. Perform step 4 through step 8 of "[Performing a Memory Module Upgrade](#)."

Removing Memory Modules

To remove a memory module, press down and outward on the socket latches on each end of the socket until the memory module pops out of the socket. See [Figure 6-5](#).

Figure 6-5. Removing Memory Modules

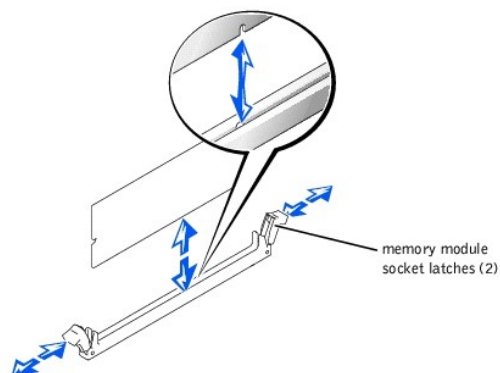

Installing Microprocessors

To take advantage of future options in speed and functionality, you can add a second microprocessor or replace either the primary or secondary microprocessor.

➡ **NOTICE:** The second microprocessor must be of the same type and speed as the first microprocessor.

⚠ **CAUTION:** Ensure that you install only microprocessors purchased from Dell and intended for this system. Using a different microprocessor could cause data loss, system damage, or personal injury.

Each microprocessor and its associated level 2 (L2) cache memory are contained in an FC-PGA2 package that is installed in a ZIF socket on the system board. The secondary microprocessor must have the same operating frequency and cache size as the primary microprocessor.

The following items are included in the microprocessor upgrade kit:

- 1 A microprocessor
- 1 A heat sink
- 1 Two retention clips

The following subsections describes how to remove and install a microprocessor in either the primary or secondary microprocessor connector.

Removing a Microprocessor

⚠ **CAUTION:** Before you perform this procedure, you must turn off the system and disconnect it from its electrical outlet. For more information, see "[Safety First—For You and Your System](#)" in "Troubleshooting Your System."

1. Turn off the system, including any attached peripherals, and disconnect the system from its electrical outlet.
2. Open the system covers. See "[Opening the System Covers](#)" in "Troubleshooting Your System."
3. To remove the two retention clips that secure the heat sink to the microprocessor socket at both ends, press down firmly on the release tab of each retention clip until it disengages from the socket. See [Figure 6-6](#).

➡ **NOTICE:** Never remove the heat sink from a microprocessor unless you intend to remove the microprocessor. The heat sink is necessary to maintain proper thermal conditions.

⚠ **CAUTION:** The microprocessor chip and heat sink can become extremely hot. Be sure that the microprocessor has had sufficient time to cool before handling.

Figure 6-6. Retention Clip

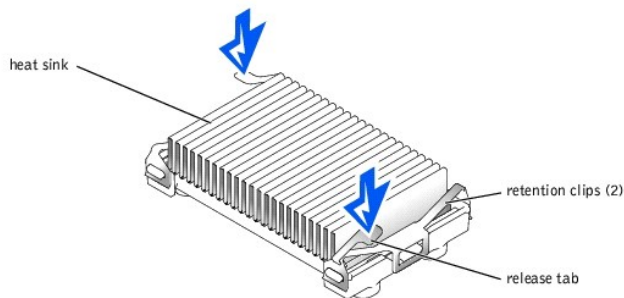

4. Remove the heat sink.

➡ **NOTICE:** Be careful not to bend any of the pins when removing the microprocessor. Bending the pins can permanently damage the microprocessor.

5. Remove the microprocessor from the socket by pulling the socket release lever straight up until the processor is released, and then lift the processor out of the socket. See [Figure 6-7](#).

If you are installing a new microprocessor, leave the release lever up so that the socket is ready for the new microprocessor.

Figure 6-7. Removing the Microprocessor

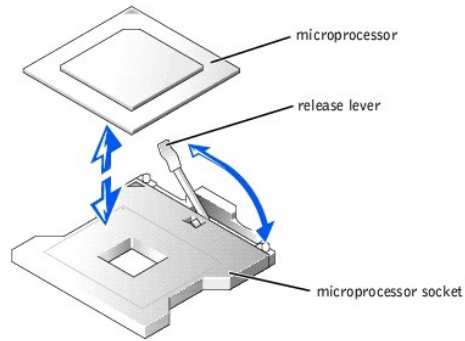

Installing a Microprocessor

⚠ CAUTION: Before you perform this procedure, you must turn off the system and disconnect it from its electrical outlet. For more information, see "[Safety First—For You and Your System](#)" in "Troubleshooting Your System."

1. Turn off the system, including any attached peripherals, and disconnect the system from its electrical outlet.
2. Open the system covers. See "[Opening the System Covers](#)" in "Troubleshooting Your System."

➡ NOTICE: Be careful not to bend any of the pins when unpacking the microprocessor. Bending the pins can permanently damage the microprocessor.

3. Unpack the new microprocessor.

If any of the pins on the microprocessor appear bent, see "[Getting Help](#)."

➡ NOTICE: Identifying the pin-1 corners is critical to positioning the processor correctly.

4. Identify the pin-1 corner of the microprocessor, indicated by a tiny gold triangle on the top of the microprocessor. See [Figure 6-8](#).

Figure 6-8. Pin-1 Identification

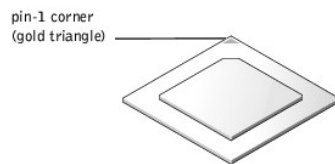

➡ NOTICE: Positioning the microprocessor incorrectly can permanently damage the processor and the system when you turn on the system.

5. Align the pin-1 corner of the microprocessor with the pin-1 corner of the microprocessor socket, which is also identified by a small triangle. See [Figure 6-9](#).

Figure 6-9. Installing the Microprocessor

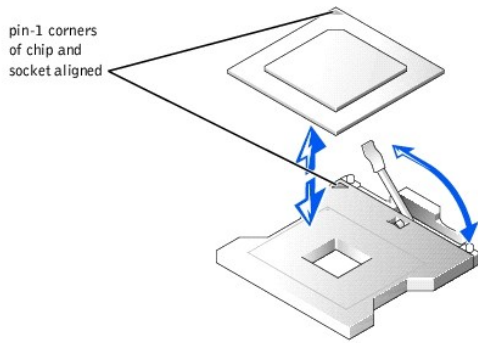

6. Install the microprocessor in the socket. See [Figure 6-9](#).

- a. If the release lever on the microprocessor socket is not all the way up, move it to that position now. See [Figure 6-9](#).

NOTICE: When placing the microprocessor in the socket, be sure that all of the pins on the processor go into the corresponding holes of the socket. Be careful not to bend the pins.

- b. With the pin-1 corners of the processor and socket aligned, set the processor lightly in the socket and make sure that all pins are matched with the correct holes in the socket.

Because the system uses a ZIF microprocessor socket, *you do not need to use force* (which could bend the pins if the microprocessor is misaligned). When the microprocessor is positioned correctly, it should drop down into the socket with minimal pressure.

- c. When the processor is fully seated in the socket, rotate the socket release lever back down until it snaps into place, securing the processor.

7. Place the new heat sink on top of the microprocessor. See [Figure 6-10](#).

8. Replace the two retention clips:

- a. Orient the retention clips. The clips are designed in pairs so that each clip fits only one end of the socket; when installed, the clips face opposite ways.
 - 1 For processor 1, the outer retention clip's release tab faces the back of the system; the inner retention clip faces the opposite way.
 - 1 For processor 2, the outer retention clip's release tab faces the front of the system; the inner retention clip faces the opposite way.
- b. Hook the end of the clip that is opposite the release tab over the retaining tab on the edge of the socket.
- c. Press the clip down so that the hole in the middle of the clip engages the tab in the side of the socket.
- d. Continue pressing down on the release tab while pressing in on the free end of the clip until the end of the clip snaps over the tab on the corner of the socket. See [Figure 6-10](#).

Figure 6-10. Installing the Heat Sink



9. Close the system covers. See "[Closing the System Covers](#)" in "Troubleshooting Your System."
10. Reconnect your system and peripherals to their electrical outlets, and turn them on.

As the system boots, it detects the presence of the new microprocessor and automatically changes the system configuration information in the System Setup program.
11. Press <F2> to enter the System Setup program, and check that the microprocessor categories match the new system configuration. See the system's *User's Guide* for instructions.
12. Run the system diagnostics to verify that the new microprocessor is operating correctly.

See "[Running the System Diagnostics](#)" for information on running the diagnostics and troubleshooting any problems that may occur.

Installing a ROMB Card

- CAUTION:** Before you perform this procedure, you must turn off the system and disconnect it from its power source. For more information, see "[Safety First—For You and Your System](#)" in "Troubleshooting Your System."
 - CAUTION:** Only trained service technicians are authorized to remove the system cover and access any of the components inside the system. See your *System Information Guide* for complete information about safety precautions, working inside the computer, and protecting against electrostatic discharge.
 - NOTICE:** To avoid possible data loss, back up all data on the hard drives before changing the mode of operation of the integrated SCSI controller from SCSI to RAID.
1. Turn off the system, including any attached peripherals, and disconnect the system from the electrical outlet.
 2. Open the system covers. See "[Opening the System Covers](#)" in "Troubleshooting Your System."
 3. Locate the ROMB card connector on the system board. See [Figure A-3](#).
 4. If a PCI card is installed over the ROMB card connector, remove it. See "[Removing an Expansion Card](#)."
 5. Position the ROMB card with the notch in its plastic cover facing the redundant power supply bay, and align the edges of the card with the four plastic standoffs on the system board.
 6. Press down on the three "bulls eyes" on the ROMB card cover until the four plastic standoffs snap over the edge of the card. See [Figure 6-11](#).

Figure 6-11. Installing the ROMB Card and Backup Battery

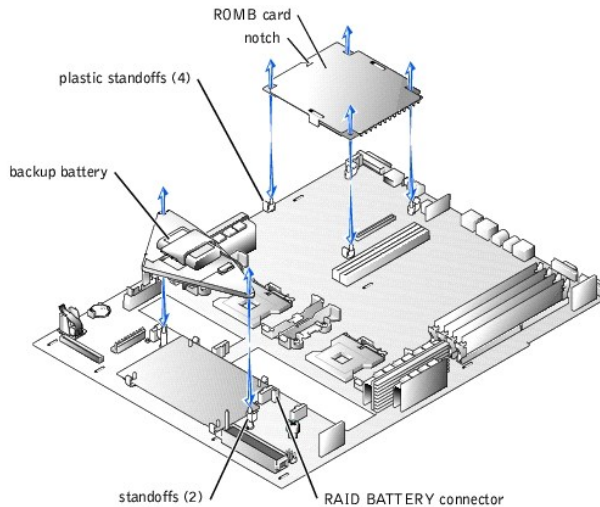

7. Install the ROMB backup battery:
 - a. Position the battery board as shown in [Figure 6-11](#), and press it down into the two standoffs until it snaps into place.
 - b. Plug the battery cable into the RAID BATTERY connector on the system board.
8. If you removed a PCI card in [step 4](#), replace it. See "[Installing an Expansion Card](#)."
9. Close the system covers. See "[Closing the System Covers](#)" in "Troubleshooting Your System."
10. Reconnect the system and peripherals to their power sources, and turn them on.
11. Enter the System Setup program and verify that the setting for the SCSI controller has changed to reflect the presence of the RAID hardware. See "Using the System Setup Program" in your User's Guide.
12. Install the RAID software. See the ROMB card software documentation for more information.

Removing a ROMB Card

CAUTION: Before you perform this procedure, you must turn off the system and disconnect it from its power source. For more information, see "[Safety First—For You and Your System](#)" in "Troubleshooting Your System."

CAUTION: Only trained service technicians are authorized to remove the system cover and access any of the components inside the system. See your *System Information Guide* for complete information about safety precautions, working inside the computer, and protecting against electrostatic discharge.

NOTICE: To avoid possible data loss, back up all data on the hard drives before changing the mode of operation of the integrated SCSI controller from SCSI to RAID.

1. Turn off the system, including any attached peripherals, and disconnect the system from the electrical outlet.
2. Open the system covers. See "[Opening the System Covers](#)" in "Troubleshooting Your System."
3. If a PCI card is installed over the ROMB card, remove the PCI card. See "[Removing an Expansion Card](#)."
4. Pull the ROMB card up out of the four standoffs. See [Figure 6-11](#).
5. Disconnect the ROMB backup battery from the backup battery connector, and pull the battery assembly up out of the two standoffs. See [Figure 6-11](#).
6. Close the system covers. See "[Closing the System Covers](#)" in "Troubleshooting Your System."

Removing and Replacing System Fans

The five system-board cooling fans and two power-supply cooling fans must be installed and operational at all times. See [Figure 6-12](#). A blinking amber LED next to a fan power connector indicates a faulty fan that needs to be replaced.

CAUTION: Only trained service technicians are authorized to remove the system cover and access any of the components inside the system. See your *System Information Guide* for complete information about safety precautions, working inside the computer, and protecting against electrostatic discharge.

NOTICE: The fans are hot-pluggable. If a fan fails, replace it as soon as possible. Operating the system with a failed fan may cause the system to overheat and lock up.

1. Open the system covers. See "[Opening the System Covers](#)" in "Troubleshooting Your System."
2. Locate the faulty cooling fan(s) with the blinking amber LEDs.

3. Before replacing a fan, check the fan's power cable connection to verify that a loose connection is not the problem. If the problem is not resolved, continue with this procedure.

Figure 6-12. Cooling Fan

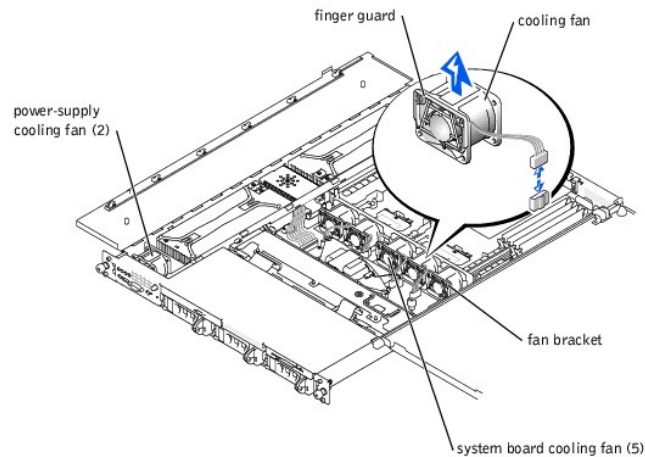



4. Disconnect the fan power cable from the system board or control panel board.
5. Lift the defective fan straight up out of the power-supply bay or fan bracket. See [Figure 6-12](#).
6. Insert the new fan straight down into the power-supply bay or fan bracket. The fans are keyed for correct orientation:
 - 1 For fans installed in the fan bracket, the finger guard on the fan faces the front of the system.
 - 1 For the two fans installed in the power-supply bays, the finger guards face the rear of the system.
7. Connect the fan power cable to the associated power connector on the system board or control panel board.
8. If the replacement fan does not operate, the control panel, control panel cable, or system board is faulty. See "[Getting Help](#)."

 **NOTE:** After installing a new fan, allow up to 30 seconds for the system to recognize the fan and determine whether it is working properly.

Removing and Replacing Power Supplies

 **CAUTION:** Only trained service technicians are authorized to remove the system cover and access any of the components inside the system. See your *System Information Guide* for complete information about safety precautions, working inside the computer, and protecting against electrostatic discharge.

 **CAUTION:** The connectors on the PDB contain high voltage. Do not remove the metal cover from the PDB or touch the connectors on the PDB or power supply.

 **NOTICE:** The power supplies are hot-pluggable. Remove and replace only one power supply at a time.

Removing a Power Supply

1. Open the system covers. See "[Opening the System Covers](#)" in "Troubleshooting Your System."
2. Identify the failed supply using the red fault indicator on the top of the supply. See [Figure 2-5](#) in "[Indicators, Messages, and Codes](#)."

 **CAUTION:** Disconnect the AC cord for the failed power supply before removing the power supply.

3. Disconnect the AC cord for the power supply. To identify the correct power connector, see [Figure 2-4](#) in "[Indicators, Messages, and Codes](#)."
4. Grasp the power supply handle and slide the power supply away from the power distribution board approximately 0.75 inch (2 cm), and then lift the power supply out of the chassis. See [Figure 6-13](#).

Figure 6-13. Removing a Power Supply

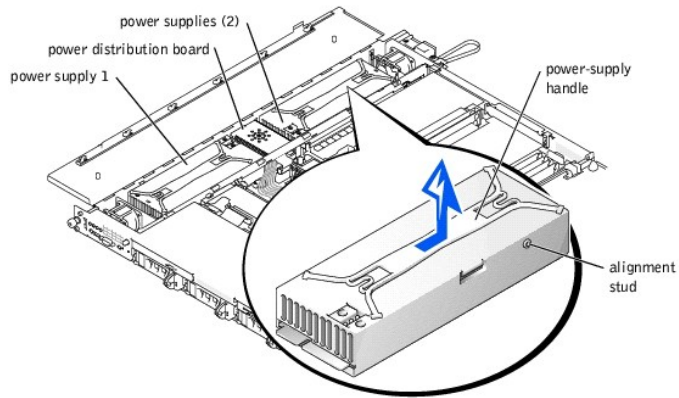

Installing a Power Supply

1. To install the replacement power supply, align the stud on the side of the power supply with the corresponding notch in the chassis wall, and then lower the power supply into the chassis. See [Figure 6-13](#).
2. Slide the power supply toward the PDB until the power supply connector is fully seated in the PDB connector.

Replacing the System Battery

The system battery is a 3.0-V, coin-cell battery that maintains system configuration, date, and time information in a special section of memory when you turn off the system. The operating life of the battery ranges from 2 to 5 years, depending on how you use the system (for example, if you keep the system on most of the time, the battery gets little use and thus lasts longer). You may need to replace the battery if an incorrect time or date is displayed during the boot routine.

You can operate the system without a battery; however, the system configuration information maintained by the battery in NVRAM is erased each time you remove power from the system. Therefore, you must re-enter the system configuration information and reset the options each time the system boots until you replace the battery.

To replace the battery, perform the following steps.

⚠ CAUTION: Only trained service technicians are authorized to remove the system cover and access any of the components inside the system. See your *System Information Guide* for complete information about safety precautions, working inside the computer, and protecting against electrostatic discharge.

⚠ CAUTION: There is a danger of a new battery exploding if it is incorrectly installed. Replace the battery only with the same or equivalent type recommended by the manufacturer. Discard used batteries according to the manufacturer's instructions.

1. Enter the System Setup program and, if possible, make a printed copy of the System Setup screens. See "Using the System Setup Program" in the *User's Guide*.
2. Turn off the system, including any attached peripherals, and disconnect the system from the electrical outlet.
3. Open the system covers. See "[Opening the System Covers](#)" in "Troubleshooting Your System."

🔧 NOTICE: To avoid damage to the battery connector, you must firmly support the connector while installing or removing a battery.

4. Remove the system battery. See [Figure A-3](#) for the battery connector location.
 - a. Support the battery connector by pressing down firmly on the positive side of the connector. See [Figure 6-14](#).
 - b. While supporting the battery connector, press the battery toward the positive side of the connector and pry it up out of the securing tabs at the negative side of the connector.

Figure 6-14. Installing the System Battery

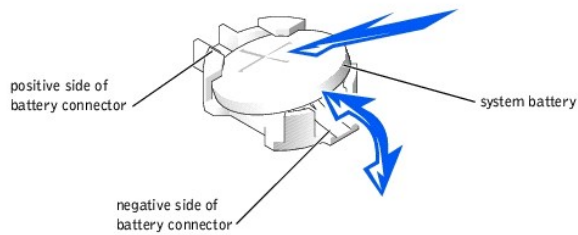

NOTICE: To avoid damage to the battery connector, you must firmly support the connector while installing or removing a battery.

5. Install the new system battery. See [Figure 6-14](#).
 - a. Support the battery connector by pressing down firmly on the positive side of the connector.
 - b. Hold the battery with the "+" facing up, and slide it under the securing tabs at the positive side of the connector.
 - c. Press the battery straight down into the connector until it snaps into place.
6. Close the system covers. See "[Closing the System Covers](#)" in "Troubleshooting Your System."
7. Reconnect the system and any attached peripherals to their electrical outlets, and turn them on.
8. Enter the System Setup program to confirm that the battery is operating properly. See "Using the System Setup Program" in the *User's Guide*.
9. Enter the correct time and date in the System Setup program's **Time** and **Date** settings.
10. Re-enter any system configuration information that is no longer displayed on the System Setup screens, and then exit the System Setup program.
11. To test the newly installed battery, power down and disconnect the system from its electrical source for at least an hour.
12. After an hour, connect the system to its electrical source and turn on the power.
13. Enter the System Setup program and if the time and date are still incorrect, see "[Getting Help](#)."

[Back to Contents Page](#)

[Back to Contents Page](#)

Installing Drives

Dell™ PowerEdge™ 1750 Systems Installation and Troubleshooting Guide

- [Installing SCSI Hard Drives](#)
- [Installing a CD Drive](#)
- [Installing a Diskette Drive](#)
- [Connecting External SCSI Hard Drives](#)
- [Connecting an External SCSI Tape Drive](#)
- [Configuring the Boot Device](#)

Your system features three internal hard-drive bays to accommodate up to three SCSI hard drives. Your system also features two peripheral bays that can be used for an optional CD drive and a 3.5-inch diskette drive. This section contains instructions for replacing these devices as well as upgrading the system by installing a host adapter card.

Installing SCSI Hard Drives

This subsection describes how to install and configure SCSI hard drives in the system's internal hard-drive bays and how to upgrade the system by installing a host adapter expansion card.

The internal hard-drive bays provide space for up to three 1-inch SCSI hard drives. These drives connect to the system board through the SCSI backplane board.

Before You Begin

SCSI hard drives are supplied in special drive carriers that fit in the hard-drive bays.

- ➡ **NOTICE:** Before attempting to remove or install a drive while the system is running, see the documentation for the host adapter to ensure that the host adapter is configured correctly to support hot-pluggable drive removal and insertion.

- 📌 **NOTE:** It is recommended that you use only drives that have been tested and approved for use with the SCSI backplane board.

You may need to use different programs than those provided with the operating system to partition and format SCSI hard drives.

- ➡ **NOTICE:** Do not turn off or reboot your system while the drive is being formatted. Doing so can cause a drive failure.

When you format a high-capacity SCSI hard drive, allow enough time for the formatting to be completed. Long format times for these drives are normal. A 9-GB hard drive, for example, can take up to 2.5 hours to format.

Installing a SCSI Hard Drive

- ➡ **NOTICE:** Hot-plug drive installation is not supported for systems without the optional ROMB card.

1. If the system does not have a ROMB card installed, shut down the system.
2. Remove the front bezel, if attached. See "[Removing and Replacing the Optional Front Bezel](#)" in "Troubleshooting Your System."
3. Open the hard-drive handle. See [Figure 7-1](#).

Figure 7-1. Installing a SCSI Hard Drive

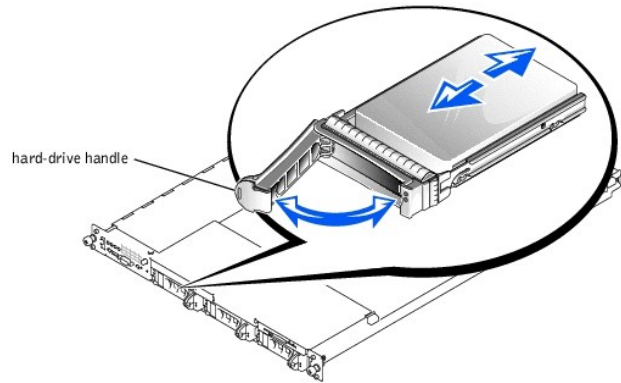

4. Insert the hard drive into the drive bay. See [Figure 7-1](#).
5. Close the hard-drive handle to lock the drive in place.
6. Replace the front bezel, if it was removed in step 3.
7. If the hard drive is a new drive, run the **SCSI Controllers** test in the system diagnostics.

Removing a SCSI Hard Drive

NOTICE: Hot-plug drive installation is not supported for systems without the optional ROMB card.

1. If the system does not have a ROMB installed, shut down the system.
2. Remove the front bezel, if attached. See "[Removing and Replacing the Optional Front Bezel](#)" in "Troubleshooting Your System."
3. For systems with a ROMB card, power down the hard-drive bay and wait until the SCSI hard-drive indicators on the drive carrier signal that the drive can be removed safely.

If the drive has been online, the green power on/fault indicator will flash as the drive is powered down. When both drive indicators are off, the drive is ready for removal.

4. Open the hard-drive handle to release the drive.
5. Slide the hard drive out until it is free of the drive bay.
6. Replace the front bezel, if it was removed in step 2.

Installing a CD Drive

The optional CD drive is contained in a carrier that slides into the peripheral bay.

CAUTION: Only trained service technicians are authorized to remove the system cover and access any of the components inside the system. See your *System Information Guide* for complete information about safety precautions, working inside the computer, and protecting against electrostatic discharge.

1. Turn off the system, including any attached peripherals, and disconnect the system from the electrical outlet.
2. Remove the front bezel, if attached. See "[Removing and Replacing the Optional Front Bezel](#)" in "Troubleshooting Your System."
3. Open the system covers. See "[Opening the System Covers](#)" in "Troubleshooting Your System."
4. If a filler plate is installed in the drive bay, remove it now.
5. If the drive carrier and the drive were supplied separately, install the drive in the carrier. See [Figure 7-2](#).

Figure 7-2. Installing a CD Drive in a Drive Carrier

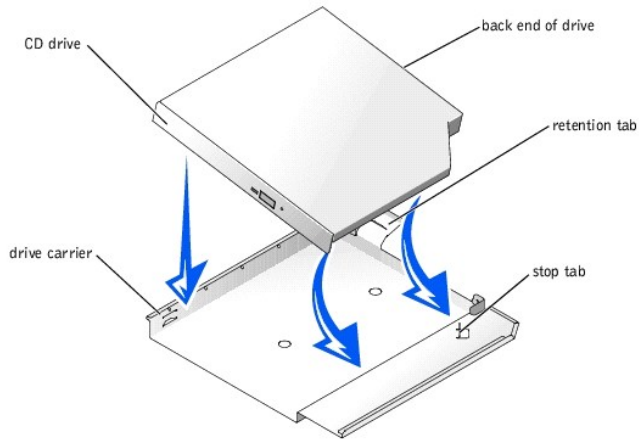

- a. Match the back end of the drive with the back end of the carrier, which has a retention tab.
 - b. Fit the right edge of the CD drive into the carrier tray, pressing the drive firmly backward against the stop tab near the right rear corner of the carrier.
 - c. Lower the left side of the drive into the carrier until the drive snaps into place.
6. Slide the drive into the peripheral bay until it is fully inserted. See [Figure 7-3](#).

Figure 7-3. Installing a CD Drive

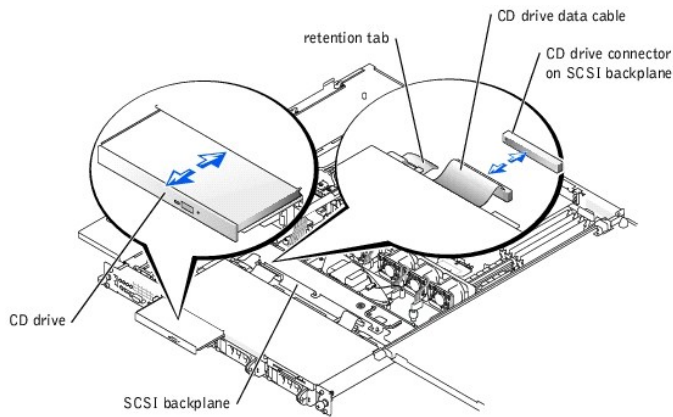

7. Connect the CD drive data cable to the CD drive and to the CD drive connector on the SCSI backplane. See [Figure A-4](#).
8. Close the system covers. See "[Closing the System Covers](#)" in "Troubleshooting Your System."
9. Replace the front bezel, if it was removed in step 2. See "[Removing and Replacing the Optional Front Bezel](#)" in "Troubleshooting Your System."
10. Reconnect the system and peripherals to their electrical outlets.

Installing a Diskette Drive

The optional diskette drive is contained in a carrier that slides into the peripheral bay. Perform the following steps to install a diskette drive.

⚠ CAUTION: Only trained service technicians are authorized to remove the system cover and access any of the components inside the system. See your *System Information Guide* for complete information about safety precautions, working inside the computer, and protecting against electrostatic discharge.

1. Turn off the system, including any attached peripherals, and disconnect the system from the electrical outlet.
2. Remove the front bezel, if attached. See "[Removing and Replacing the Optional Front Bezel](#)" in "Troubleshooting Your System."
3. Open the system covers. See "[Opening the System Covers](#)" in "Troubleshooting Your System."
4. If a filler plate is installed in the drive bay, remove it now.
5. If the carrier and the drive were supplied separately, install the drive in the carrier. See [Figure 7-4](#).

Figure 7-4. Installing a Diskette Drive in a Carrier

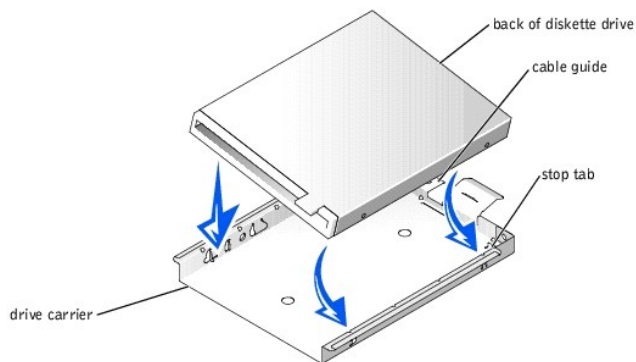

- a. Fit the right edge of the diskette drive into the carrier tray, pressing the drive against the stop tab at the back of the carrier.
 - b. Lower the left edge of the drive into the carrier until the drive snaps into place.
 - c. Attach the end of the ribbon cable labeled "FLOPPY" to the back of the diskette drive, and then insert the cable through the slot in the cable guide at the back of the carrier.
6. Slide the drive into the peripheral bay until it is fully seated. See [Figure 7-5](#).

Ensure that you do not damage the ribbon cable at the back of the drive.

Figure 7-5. Installing a Diskette Drive

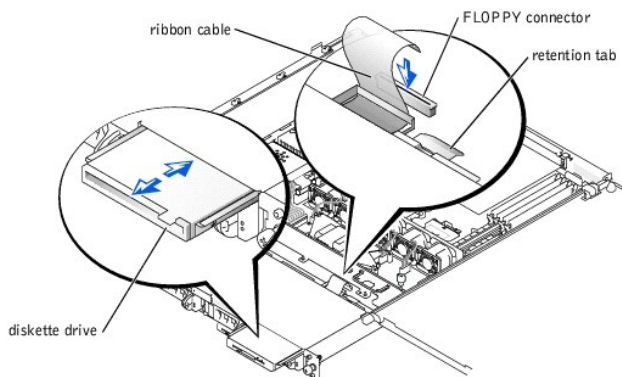

7. Connect the other end of the ribbon cable to the diskette drive connector on the SCSI backplane. See [Figure A-4](#).
8. Close the system covers. See "[Closing the System Covers](#)" in "Troubleshooting Your System."
9. Replace the front bezel, if it was removed in step 2. See "[Removing and Replacing the Optional Front Bezel](#)" in "Troubleshooting Your System."
10. Reconnect the system and peripherals to their electrical outlets.

Connecting External SCSI Hard Drives

Follow these general guidelines when connecting external SCSI hard drives to the external SCSI connector on the system's back panel or to a SCSI controller card.

CAUTION: Before you perform this procedure, you must turn off the system and disconnect it from its power source. For more information, see "[Safety First—For You and Your System](#)" in "Troubleshooting Your System."

CAUTION: Only trained service technicians are authorized to remove the system cover and access any of the components inside the system. See your *System Information Guide* for complete information about safety precautions, working inside the computer, and protecting against electrostatic discharge.

1. Turn off the system, including any attached peripherals, and disconnect the system from the electrical outlet.
2. If you are installing a SCSI controller card, install the card now. See "[Installing Expansion Cards](#)" in "Installing System Options."
3. Connect the external SCSI devices to the external SCSI connector on the system's back panel.

If you are attaching multiple external SCSI devices, daisy-chain the devices using the cables shipped with each device.

4. Reconnect the system to an electrical outlet and turn it on.
5. Connect the external device(s) to electrical outlet(s) and turn them on.
6. Install any required SCSI device drivers. See "Installing and Configuring SCSI Drivers" in the User's Guide.
7. Test the SCSI devices.

Connecting an External SCSI Tape Drive

This subsection describes how to configure and install an external SCSI tape drive with an add-in PCI controller card.

 **NOTE:** The integrated SCSI controller does not support mixed mode (one channel SCSI and one channel RAID). For this reason, in a system with RAID, Dell does not support an external tape drive connected to the external SCSI controller.

 **CAUTION:** Only trained service technicians are authorized to remove the system cover and access any of the components inside the system. See your *System Information Guide* for complete information about safety precautions, working inside the computer, and protecting against electrostatic discharge.

1. Turn off the system, including any attached peripherals, and disconnect the system from the electrical outlet.
2. Ground yourself by touching an unpainted metal surface on the back of the system, unpack the drive, and compare the jumper and switch settings with those in the documentation that came with the drive.
3. Unpack the tape drive and controller card and configure the tape drive according to the documentation that came with the tape drive, based on the following guidelines:
 - a. Each device attached to a SCSI host adapter must have a unique SCSI ID number. (Narrow SCSI devices use IDs 0 to 7; wide SCSI devices use IDs from 0 to 15).

A SCSI tape drive is typically configured as SCSI ID 6.

 **NOTE:** There is no requirement that SCSI ID numbers be assigned sequentially or that devices be attached to the cable in order by ID number.

- b. SCSI logic requires that the two devices at opposite ends of a SCSI chain be terminated and that all devices in between be unterminated. Therefore, you enable the tape drive's termination if it is the last device in a chain of devices (or sole device) connected to the SCSI controller.
4. Install the controller card in an expansion slot. See "[Installing Expansion Cards](#)" in "Installing System Options."
 5. Connect the tape drive's interface/DC power cable to the connector on the controller card supplied with the tape drive.
 6. Reconnect the system and peripherals to their electrical outlets, and turn them on.
 7. Perform a tape backup and verification test with the drive as instructed in the software documentation that came with the drive.

Configuring the Boot Device

If you plan to boot the system from a hard drive, the drive must be attached to the primary (or boot) controller. The device that the system boots from is determined by the boot order specified in the System Setup program.

The System Setup program provides options that the system uses to scan for installed boot devices. See your system's User's Guide for information about the System Setup program.

[Back to Contents Page](#)

[Back to Contents Page](#)

Getting Help

Dell™ PowerEdge™ 1750 Systems Installation and Troubleshooting Guide

- [Technical Assistance](#)
 - [Dell Enterprise Training and Certification](#)
 - [Problems With Your Order](#)
 - [Product Information](#)
 - [Returning Items for Warranty Repair or Credit](#)
 - [Before You Call](#)
 - [Contacting Dell](#)
-

Technical Assistance

If you need assistance with a technical problem, perform the following steps:

1. Complete the procedures in "[Troubleshooting Your System](#)."
2. Run the system diagnostics and record any information provided.
3. Make a copy of the [Diagnostics Checklist](#), and fill it out.
4. Use Dell's extensive suite of online services available at Dell Support at support.dell.com for help with installation and troubleshooting procedures.

For more information, see "[Online Services](#)."

5. If the preceding steps have not resolved the problem, call Dell for technical assistance.

 **NOTE:** Call technical support from a phone near or at the system so that technical support can assist you with any necessary procedures.

 **NOTE:** Dell's Express Service Code system may not be available in all countries.

When prompted by Dell's automated telephone system, enter your Express Service Code to route the call directly to the proper support personnel. If you do not have an Express Service Code, open the **Dell Accessories** folder, double-click the **Express Service Code** icon, and follow the directions.

For instructions on using the technical support service, see "[Technical Support Service](#)" and "[Before You Call](#)."

 **NOTE:** Some of the following services are not always available in all locations outside the continental U.S. Call your local Dell representative for information on availability.

Online Services

You can access Dell Support at support.dell.com. Select your region on the **WELCOME TO DELL SUPPORT** page, and fill in the requested details to access help tools and information.

You can contact Dell electronically using the following addresses:

- 1 World Wide Web

www.dell.com/

www.dell.com/ap/ (for Asian/Pacific countries only)

www.euro.dell.com (for Europe only)

www.dell.com/la (for Latin American countries)

- 1 Anonymous file transfer protocol (FTP)

[ftp.dell.com/](ftp://ftp.dell.com/)

Log in as user: `anonymous`, and use your e-mail address as your password.

- 1 Electronic Support Service

support@us.dell.com

apsupport@dell.com (for Asian/Pacific countries only)

support.euro.dell.com (for Europe only)

- 1 Electronic Quote Service

sales@dell.com

apmarketing@dell.com (for Asian/Pacific countries only)

1 Electronic Information Service

info@dell.com

AutoTech Service

Dell's automated technical support service—AutoTech—provides recorded answers to the questions most frequently asked by Dell customers about their portable and desktop computer systems.

When you call AutoTech, use your touch-tone telephone to select the subjects that correspond to your questions.

The AutoTech service is available 24 hours a day, 7 days a week. You can also access this service through the technical support service. See the contact information for your region.

Automated Order-Status Service

To check on the status of any Dell products that you have ordered, you can go to support.dell.com, or you can call the automated order-status service. A recording prompts you for the information needed to locate and report on your order. See the contact information for your region.

Technical Support Service

Dell's technical support service is available 24 hours a day, 7 days a week, to answer your questions about Dell hardware. Our technical support staff use computer-based diagnostics to provide fast, accurate answers.

To contact Dell's technical support service, see "[Before You Call](#)" and then see the contact information for your region.

Dell Enterprise Training and Certification

Dell Enterprise Training and Certification is available; see www.dell.com/training for more information. This service may not be offered in all locations.

Problems With Your Order

If you have a problem with your order, such as missing parts, wrong parts, or incorrect billing, contact Dell for customer assistance. Have your invoice or packing slip available when you call. See the contact information for your region.

Product Information

If you need information about additional products available from Dell, or if you would like to place an order, visit the Dell website at www.dell.com. For the telephone number to call to speak to a sales specialist, see the contact information for your region.

Returning Items for Warranty Repair or Credit

Prepare all items being returned, whether for repair or credit, as follows:

1. Call Dell to obtain a Return Material Authorization Number, and write it clearly and prominently on the outside of the box.
For the telephone number to call, see the contact information for your region.
2. Include a copy of the invoice and a letter describing the reason for the return.
3. Include a copy of any diagnostic information (including the Diagnostics Checklist) indicating the tests you have run and any error messages reported by the system diagnostics.
4. Include any accessories that belong with the item(s) being returned (such as power cables, media such as CDs and diskettes, and guides) if the return is for credit.
5. Pack the equipment to be returned in the original (or equivalent) packing materials.

You are responsible for paying shipping expenses. You are also responsible for insuring any product returned, and you assume the risk of loss during shipment to Dell. Collect-on-delivery (C.O.D.) packages are not accepted.

Returns that are missing any of the preceding requirements will be refused at our receiving dock and returned to you.

Before You Call

 **NOTE:** Have your Express Service Code ready when you call. The code helps Dell's automated-support telephone system direct your call more efficiently.

Remember to fill out the [Diagnostics Checklist](#). If possible, turn on your system before you call Dell for technical assistance and call from a telephone at or near the computer. You may be asked to type some commands at the keyboard, relay detailed information during operations, or try other troubleshooting steps possible only at the computer system itself. Ensure that the system documentation is available.

⚠ CAUTION: Only trained service technicians are authorized to remove the system cover and access any of the components inside the system. See your *System Information Guide* for complete information about safety precautions, working inside the computer, and protecting against electrostatic discharge.

Diagnostics Checklist
Name:
Date:
Address:
Phone number:
Service tag (bar code on the back of the computer):
Express Service Code:
Return Material Authorization Number (if provided by Dell support technician):
Operating system and version:
Peripherals:
Expansion cards:
Are you connected to a network? Yes No
Network, version, and network card:
Programs and versions:
See your operating system documentation to determine the contents of the system's start-up files. If possible, print each file. Otherwise, record the contents of each file before calling Dell.
Error message, beep code, or diagnostic code:
Description of problem and troubleshooting procedures you performed:

Contacting Dell

To contact Dell electronically, you can access the following websites:

- 1 www.dell.com
- 1 support.dell.com (technical support)
- 1 premiersupport.dell.com (technical support for educational, government, healthcare, and medium/large business customers, including Premier, Platinum, and Gold customers)

For specific web addresses for your country, find the appropriate country section in the table below.

NOTE: Toll-free numbers are for use within the country for which they are listed.

When you need to contact Dell, use the electronic addresses, telephone numbers, and codes provided in the following table. If you need assistance in determining which codes to use, contact a local or an international operator.

Country (City) International Access Code Country Code City Code	Department Name or Service Area, Website and E-Mail Address	Area Codes, Local Numbers, and Toll-Free Numbers
Anguilla	General Support	toll-free: 800-335-0031
Antigua and Barbuda	General Support	1-800-805-5924
Argentina (Buenos Aires)	Website: www.dell.com.ar	
International Access Code: 00	Tech Support and Customer Care	toll-free: 0-800-444-0733
Country Code: 54	Sales	0-810-444-3355
City Code: 11	Tech Support Fax	11 4515 7139
	Customer Care Fax	11 4515 7138
Aruba	General Support	toll-free: 800-1578
Australia (Sydney)	E-mail (Australia): au_tech_support@dell.com	
International Access Code: 0011	E-mail (New Zealand): nz_tech_support@dell.com	
	Home and Small Business	1-300-65-55-33

Country Code: 61 City Code: 2	Government and Business	toll-free: 1-800-633-559
	Preferred Accounts Division (PAD)	toll-free: 1-800-060-889
	Customer Care	toll-free: 1-800-819-339
	Corporate Sales	toll-free: 1-800-808-385
	Transaction Sales	toll-free: 1-800-808-312
	Fax	toll-free: 1-800-818-341
Austria (Vienna) International Access Code: 900 Country Code: 43 City Code: 1	Website: support.euro.dell.com	
	E-mail: tech_support_central_europe@dell.com	
	Home/Small Business Sales	01 795 67602
	Home/Small Business Fax	01 795 67605
	Home/Small Business Customer Care	01 795 67603
	Preferred Accounts/Corporate Customer Care	0660 8056
	Home/Small Business Technical Support	01 795 67604
	Preferred Accounts/Corporate Technical Support	0660 8779
	Switchboard	01 491 04 0
Bahamas	General Support	toll-free: 1-866-278-6818
Barbados	General Support	1-800-534-3066
Belgium (Brussels) International Access Code: 00 Country Code: 32 City Code: 2	Website: support.euro.dell.com	
	E-mail: tech_be@dell.com	
	E-mail for French Speaking Customers: support.euro.dell.com/be/fr/emaildell/	
	Technical Support	02 481 92 88
	Customer Care	02 481 91 19
	Home/Small Business Sales	toll-free: 0800 16884
	Corporate Sales	02 481 91 00
	Fax	02 481 92 99
	Switchboard	02 481 91 00
Bermuda	General Support	1-800-342-0671
Bolivia	General Support	toll-free: 800-10-0238
Brazil International Access Code: 00 Country Code: 55 City Code: 51	Website: www.dell.com/br	
	Customer Support, Technical Support	0800 90 3355
	Tech Support Fax	51 481 5470
	Customer Care Fax	51 481 5480
	Sales	0800 90 3390
British Virgin Islands	General Support	toll-free: 1-866-278-6820
Brunei Country Code: 673	Customer Technical Support (Penang, Malaysia)	604 633 4966
	Customer Service (Penang, Malaysia)	604 633 4949
	Transaction Sales (Penang, Malaysia)	604 633 4955
Canada (North York, Ontario) International Access Code: 011	Automated Order-Status System	toll-free: 1-800-433-9014
	AutoTech (automated technical support)	toll-free: 1-800-247-9362
	TechFax	toll-free: 1-800-950-1329
	Customer Care (home/small business)	toll-free: 1-800-847-4096
	Customer Care (med./large business, government)	toll-free: 1-800-326-9463
	Technical Support (home/small business)	toll-free: 1-800-847-4096
	Technical Support (med./large bus., government)	toll-free: 1-800-847-4096
	Sales (direct sales—from outside Toronto)	toll-free: 1-800-387-5752
	Sales (direct sales—from within Toronto)	416 758-2200
	Sales (federal government, education, and medical)	toll-free: 1-800-567-7542
Cayman Islands	General Support	1-800-805-7541
Chile (Santiago) Country Code: 56 City Code: 2	Sales, Customer Support, and Technical Support	toll-free: 1230-020-4823
China (Xiamen) Country Code: 86 City Code: 592	Tech Support website: support.ap.dell.com/china	
	Tech Support E-mail: cn_support@dell.com	
	Tech Support Fax	818 1350
	Home and Small Business Technical Support	toll-free: 800 858 2437
	Corporate Accounts Technical Support	toll-free: 800 858 2333
	Customer Experience	toll-free: 800 858 2060

	Home and Small Business	toll-free: 800 858 2222
	Preferred Accounts Division	toll-free: 800 858 2062
	Large Corporate Accounts GCP	toll-free: 800 858 2055
	Large Corporate Accounts Key Accounts	toll-free: 800 858 2628
	Large Corporate Accounts North	toll-free: 800 858 2999
	Large Corporate Accounts North Government and Education	toll-free: 800 858 2955
	Large Corporate Accounts East	toll-free: 800 858 2020
	Large Corporate Accounts East Government and Education	toll-free: 800 858 2669
	Large Corporate Accounts Queue Team	toll-free: 800 858 2572
	Large Corporate Accounts South	toll-free: 800 858 2355
	Large Corporate Accounts West	toll-free: 800 858 2811
	Large Corporate Accounts Spare Parts	toll-free: 800 858 2621
Colombia	General Support	980-9-15-3978
Costa Rica	General Support	0800-012-0435
Czech Republic (Prague)	Website: support.euro.dell.com	
International Access Code: 00	E-mail: czech_dell@dell.com	
Country Code: 420	Technical Support	02 22 83 27 27
City Code: 2	Customer Care	02 22 83 27 11
	Fax	02 22 83 27 14
	TechFax	02 22 83 27 28
	Switchboard	02 22 83 27 11
Denmark (Copenhagen)	Website: support.euro.dell.com	
International Access Code: 00	E-mail Support (portable computers): den_nbk_support@dell.com	
Country Code: 45	E-mail Support (desktop computers): den_support@dell.com	
	E-mail Support (servers): Nordic_server_support@dell.com	
	Technical Support	7023 0182
	Customer Care (Relational)	7023 0184
	Home/Small Business Customer Care	3287 5505
	Switchboard (Relational)	3287 1200
	Fax Switchboard (Relational)	3287 1201
	Switchboard (Home/Small Business)	3287 5000
	Fax Switchboard (Home/Small Business)	3287 5001
Dominica	General Support	toll-free: 1-866-278-6821
Dominican Republic	General Support	1-800-148-0530
Ecuador	General Support	toll-free: 999-119
El Salvador	General Support	01-899-753-0777
Finland (Helsinki)	Website: support.euro.dell.com	
International Access Code: 990	E-mail: fin_support@dell.com	
Country Code: 358	E-mail Support (servers): Nordic_support@dell.com	
City Code: 9	Technical Support	09 253 313 60
	Technical Support Fax	09 253 313 81
	Relational Customer Care	09 253 313 38
	Home/Small Business Customer Care	09 693 791 94
	Fax	09 253 313 99
	Switchboard	09 253 313 00
France (Paris) (Montpellier)	Website: support.euro.dell.com	
International Access Code: 00	E-mail: support.euro.dell.com/fr/fr/emaildell/	
Country Code: 33	Home and Small Business	
City Codes: (1) (4)	Technical Support	0825 387 270
	Customer Care	0825 823 833
	Switchboard	0825 004 700
	Switchboard (calls from outside of France)	04 99 75 40 00
	Sales	0825 004 700
	Fax	0825 004 701
	Fax (calls from outside of France)	04 99 75 40 01
	Corporate	
	Technical Support	0825 004 719
	Customer Care	0825 338 339
	Switchboard	01 55 94 71 00

	Sales	01 55 94 71 00
	Fax	01 55 94 71 01
Germany (Langen)	Website: support.euro.dell.com	
International Access Code: 00	E-mail: tech_support_central_europe@dell.com	
Country Code: 49	Technical Support	06103 766-7200
City Code: 6103	Home/Small Business Customer Care	0180-5-224400
	Global Segment Customer Care	06103 766-9570
	Preferred Accounts Customer Care	06103 766-9420
	Large Accounts Customer Care	06103 766-9560
	Public Accounts Customer Care	06103 766-9555
	Switchboard	06103 766-7000
Grenada	General Support	toll-free: 1-866-540-3355
Guatemala	General Support	1-800-999-0136
Guyana	General Support	toll-free: 1-877-270-4609
Hong Kong	Technical Support (Dimension™ and Inspiron™)	296 93188
International Access Code: 001	Technical Support (OptiPlex™, Latitude™, and Dell Precision™)	296 93191
Country Code: 852	Customer Service (non-technical, post-sales issues)	800 93 8291
	Transaction Sales	toll-free: 800 96 4109
	Large Corporate Accounts HK	toll-free: 800 96 4108
	Large Corporate Accounts GCP HK	toll-free: 800 90 3708
India	Technical Support	1600 33 8045
	Sales	1600 33 8044
Ireland (Cherrywood)	Website: support.euro.dell.com	
International Access Code: 16	E-mail: dell_direct_support@dell.com	
Country Code: 353	Ireland Technical Support	1850 543 543
City Code: 1	U.K. Technical Support (dial within U.K. only)	0870 908 0800
	Home User Customer Care	01 204 4095
	Small Business Customer Care	01 204 4444
	U.K. Customer Care (dial within U.K. only)	0870 906 0010
	Corporate Customer Care	01 204 4003
	Ireland Sales	01 204 4444
	U.K. Sales (dial within U.K. only)	0870 907 4000
	SalesFax	01 204 0144
	Fax	01 204 5960
	Switchboard	01 204 4444
Italy (Milan)	Website: support.euro.dell.com	
International Access Code: 00	E-mail: support.euro.dell.com/it/it/emaildell/	
Country Code: 39	Home and Small Business	
City Code: 02	Technical Support	02 577 826 90
	Customer Care	02 696 821 14
	Fax	02 696 821 13
	Switchboard	02 696 821 12
	Corporate	
	Technical Support	02 577 826 90
	Customer Care	02 577 825 55
	Fax	02 575 035 30
	Switchboard	02 577 821
Jamaica	General Support (dial from within Jamaica only)	1-800-682-3639
Japan (Kawasaki)	Website: support.jp.dell.com	
International Access Code: 001	Technical Support (servers)	toll-free: 0120-198-498
Country Code: 81	Technical Support outside of Japan (servers)	81-44-556-4162
City Code: 44	Technical Support (Dimension™ and Inspiron™)	toll-free: 0120-198-226
	Technical Support outside of Japan (Dimension and Inspiron)	81-44-520-1435
	Technical Support (Dell Precision™, OptiPlex™, and Latitude™)	toll-free: 0120-198-433
	Technical Support outside of Japan (Dell Precision, OptiPlex, and Latitude)	81-44-556-3894
	24-Hour Automated Order Service	044-556-3801
	Customer Care	044-556-4240
	Business Sales Division (up to 400 employees)	044-556-1465
	Preferred Accounts Division Sales (over 400 employees)	044-556-3433

	Large Corporate Accounts Sales (over 3500 employees)	044-556-3430
	Public Sales (government agencies, educational institutions, and medical institutions)	044-556-1469
	Global Segment Japan	044-556-3469
	Individual User	044-556-1760
	Faxbox Service	044-556-3490
	Switchboard	044-556-4300
Korea (Seoul) International Access Code: 001 Country Code: 82 City Code: 2	Technical Support	toll-free: 080-200-3800
	Sales	toll-free: 080-200-3600
	Customer Service (Seoul, Korea)	toll-free: 080-200-3800
	Customer Service (Penang, Malaysia)	604 633 4949
	Fax	2194-6202
	Switchboard	2194-6000
Latin America	Customer Technical Support (Austin, Texas, U.S.A.)	512 728-4093
	Customer Service (Austin, Texas, U.S.A.)	512 728-3619
	Fax (Technical Support and Customer Service) (Austin, Texas, U.S.A.)	512 728-3883
	Sales (Austin, Texas, U.S.A.)	512 728-4397
	SalesFax (Austin, Texas, U.S.A.)	512 728-4600 or 512 728-3772
Luxembourg International Access Code: 00 Country Code: 352	Website: support.euro.dell.com	
	E-mail: tech_be@dell.com	
	Technical Support (Brussels, Belgium)	02 481 92 88
	Home/Small Business Sales (Brussels, Belgium)	toll-free: 080016884
	Corporate Sales (Brussels, Belgium)	02 481 91 00
	Customer Care (Brussels, Belgium)	02 481 91 19
	Fax (Brussels, Belgium)	02 481 92 99
	Switchboard (Brussels, Belgium)	02 481 91 00
Macao Country Code: 853	Technical Support	toll-free: 0800 582
	Customer Service (Penang, Malaysia)	604 633 4949
	Transaction Sales	toll-free: 0800 581
Malaysia (Penang) International Access Code: 00 Country Code: 60 City Code: 4	Technical Support	toll-free: 1 800 888 298
	Customer Service	04 633 4949
	Transaction Sales	toll-free: 1 800 888 202
	Corporate Sales	toll-free: 1 800 888 213
Mexico International Access Code: 00 Country Code: 52	Customer Technical Support	001-877-384-8979 or 001-877-269-3383
	Sales	50-81-8800 or 01-800-888-3355
	Customer Service	001-877-384-8979 or 001-877-269-3383
	Main	50-81-8800 or 01-800-888-3355
		General Support
Montserrat	General Support	001-800-882-1519
Netherlands Antilles	General Support	
Netherlands (Amsterdam) International Access Code: 00 Country Code: 31 City Code: 20	Website: support.euro.dell.com	
	E-mail (Technical Support):	
	(Enterprise): nl_server_support@dell.com	
	(Latitude): nl_latitude_support@dell.com	
	(Inspiron): nl_inspiron_support@dell.com	
	(Dimension): nl_dimension_support@dell.com	
	(OptiPlex): nl_optiplex_support@dell.com	
	(Dell Precision): nl_workstation_support@dell.com	
	Technical Support	020 674 45 00
	Technical Support Fax	020 674 47 66

	Home/Small Business Customer Care	020 674 42 00
	Relational Customer Care	020 674 4325
	Home/Small Business Sales	020 674 55 00
	Relational Sales	020 674 50 00
	Home/Small Business Sales Fax	020 674 47 75
	Relational Sales Fax	020 674 47 50
	Switchboard	020 674 50 00
	Switchboard Fax	020 674 47 50
New Zealand	E-mail (New Zealand): nz_tech_support@dell.com	
International Access Code: 00	E-mail (Australia): au_tech_support@dell.com	
Country Code: 64	Home and Small Business	0800 446 255
	Government and Business	0800 444 617
	Sales	0800 441 567
	Fax	0800 441 566
Nicaragua	General Support	001-800-220-1006
Norway (Lysaker)	Website: support.euro.dell.com	
International Access Code: 00	E-mail Support (portable computers):	
Country Code: 47	nor_nbk_support@dell.com	
	E-mail Support (desktop computers):	
	nor_support@dell.com	
	E-mail Support (servers):	
	nordic_server_support@dell.com	
	Technical Support	671 16882
	Relational Customer Care	671 17514
	Home/Small Business Customer Care	23162298
	Switchboard	671 16800
	Fax Switchboard	671 16865
Panama	General Support	001-800-507-0962
Peru	General Support	0800-50-669
Poland (Warsaw)	Website: support.euro.dell.com	
International Access Code: 011	E-mail: pl_support@dell.com	
Country Code: 48	Customer Service Phone	57 95 700
City Code: 22	Customer Care	57 95 999
	Sales	57 95 999
	Customer Service Fax	57 95 806
	Reception Desk Fax	57 95 998
	Switchboard	57 95 999
Portugal	E-mail: support.euro.dell.com/es/es/emaildell/	
International Access Code: 00	Technical Support	800 834 077
Country Code: 35	Customer Care	800 300 415 or 800 834 075
	Sales	800 300 410 or 800 300 411 or 800 300 412 or 121 422 07 10
	Fax	121 424 01 12
Puerto Rico	General Support	1-800-805-7545
St. Kitts and Nevis	General Support	toll-free: 1-877-441-4731
St. Lucia	General Support	1-800-882-1521
St. Vincent and the Grenadines	General Support	toll-free: 1-877-270-4609
Singapore (Singapore)	Technical Support	toll-free: 800 6011 051
International Access Code: 005	Customer Service (Penang, Malaysia)	604 633 4949
Country Code: 65	Transaction Sales	toll-free: 800 6011 054
	Corporate Sales	toll-free: 800 6011 053
South Africa (Johannesburg)	Website: support.euro.dell.com	
International Access Code: 09/091	E-mail: dell_za_support@dell.com	
Country Code: 27	Technical Support	011 709 7710
	Customer Care	011 709 7707
	Sales	011 709 7700

City Code: 11	Fax	011 706 0495	
	Switchboard	011 709 7700	
Southeast Asian and Pacific Countries	Customer Technical Support, Customer Service, and Sales (Penang, Malaysia)	604 633 4810	
Spain (Madrid)	Website: support.euro.dell.com		
International Access Code: 00	E-mail: support.euro.dell.com/es/es/emaildell/		
	Home and Small Business		
Country Code: 34	Technical Support	902 100 130	
	Customer Care	902 118 540	
City Code: 91	Sales	902 118 541	
	Switchboard	902 118 541	
	Fax	902 118 539	
	Corporate		
	Technical Support	902 100 130	
	Customer Care	902 118 546	
	Switchboard	91 722 92 00	
	Fax	91 722 95 83	
	Sweden (Upplands Vasby)	Website: support.euro.dell.com	
	International Access Code: 00	E-mail: swe_support@dell.com	
E-mail Support for Latitude and Inspiron: Swe-nbk_kats@dell.com			
Country Code: 46	E-mail Support for OptiPlex: Swe_kats@dell.com		
	E-mail Support for Servers: Nordic_server_support@dell.com		
City Code: 8	Technical Support	08 590 05 199	
	Relational Customer Care	08 590 05 642	
	Home/Small Business Customer Care	08 587 70 527	
	Employee Purchase Program (EPP) Support	20 140 14 44	
	Fax Technical Support	08 590 05 594	
	Sales	08 590 05 185	
	Switzerland (Geneva)	Website: support.euro.dell.com	
	International Access Code: 00	E-mail: swisstech@dell.com	
		E-mail for French-speaking HSB and Corporate Customers: support.euro.dell.com/ch/fr/emaildell/	
	Country Code: 41	Technical Support (Home and Small Business)	0844 811 411
Technical Support (Corporate)		0844 822 844	
City Code: 22	Customer Care (Home and Small Business)	0848 802 202	
	Customer Care (Corporate)	0848 821 721	
	Fax	022 799 01 90	
	Switchboard	022 799 01 01	
	Taiwan	Technical Support (portable and desktop computers)	toll-free: 00801 86 1011
International Access Code: 002	Technical Support (servers)	toll-free: 0080 60 1256	
	Transaction Sales	toll-free: 0080 651 228	
Country Code: 886		or 0800 33 556	
	Corporate Sales	toll-free: 0080 651 227	
		or 0800 33 555	
Thailand	Technical Support	toll-free: 0880 060 07	
International Access Code: 001	Customer Service (Penang, Malaysia)	604 633 4949	
	Sales	toll-free: 0880 060 09	
Trinidad/Tobago	General Support	1-800-805-8035	
Turks and Caicos Islands	General Support	toll-free: 1-866-540-3355	
U.K. (Bracknell)	Website: support.euro.dell.com		
International Access Code: 00	Customer Care website: dell.co.uk/lca/customerservices		
	E-mail: dell_direct_support@dell.com		
Country Code: 44	Technical Support (Corporate/Preferred Accounts/PAD [1000+ employees])	0870 908 0500	
	Technical Support (direct/PAD and general)	0870 908 0800	
City Code: 1344	Global Accounts Customer Care	01344 373 185	
		or 01344 373 186	
	Home and Small Business Customer Care	0870 906 0010	

	Corporate Customer Care	0870 908 0500
	Preferred Accounts (500-5000 employees) Customer Care	01344 373 196
	Central Government Customer Care	01344 373 193
	Local Government & Education Customer Care	01344 373 199
	Health Customer Care	01344 373 194
	Home and Small Business Sales	0870 907 4000
	Corporate/Public Sector Sales	01344 860 456
Uruguay	General Support	toll-free: 000-413-598-2521
U.S.A. (Austin, Texas) International Access Code: 011 Country Code: 1	Automated Order-Status Service	toll-free: 1-800-433-9014
	AutoTech (portable and desktop computers)	toll-free: 1-800-247-9362
	Consumer (Home and Home Office)	
	Technical Support	toll-free: 1-800-624-9896
	Customer Service	toll-free: 1-800-624-9897
	DellNet™ Service and Support	toll-free: 1-877-Dellnet (1-877-335-5638)
	Employee Purchase Program (EPP) Customers	toll-free: 1-800-695-8133
	Financial Services website: www.dellfinancialservices.com	
	Financial Services (lease/loans)	toll-free: 1-877-577-3355
	Financial Services (Dell Preferred Accounts [DPA])	toll-free: 1-800-283-2210
	Business	
	Customer Service and Technical Support	toll-free: 1-800-822-8965
	Employee Purchase Program (EPP) Customers	toll-free: 1-800-695-8133
	Projectors Technical Support	toll-free: 1-877-459-7298
	Public (government, education, and healthcare)	
	Customer Service and Technical Support	toll-free: 1-800-456-3355
	Employee Purchase Program (EPP) Customers	toll-free: 1-800-234-1490
	Dell Sales	toll-free: 1-800-289-3355 or toll-free: 1-800-879-3355
	Dell Outlet Store (Dell refurbished computers)	toll-free: 1-888-798-7561
	Software and Peripherals Sales	toll-free: 1-800-671-3355
	Spare Parts Sales	toll-free: 1-800-357-3355
	Extended Service and Warranty Sales	toll-free: 1-800-247-4618
	Fax	toll-free: 1-800-727-8320
Dell Services for the Deaf, Hard-of-Hearing, or Speech-Impaired	toll-free: 1-877-DELLTTY (1-877-335-5889)	
U.S. Virgin Islands	General Support	1-877-673-3355
Venezuela	General Support	8001-3605



[Back to Contents Page](#)

[Back to Contents Page](#)

Dell™ PowerEdge™ 1750 Systems Installation and Troubleshooting Guide

- [Notes, Notices, and Cautions](#)
 - [Abbreviations and Acronyms](#)
-

Notes, Notices, and Cautions

-  **NOTE:** A NOTE indicates important information that helps you make better use of your computer.
 -  **NOTICE:** A NOTICE indicates either potential damage to hardware or loss of data and tells you how to avoid the problem.
 -  **CAUTION:** A CAUTION indicates a potential for property damage, personal injury, or death.
-

Abbreviations and Acronyms

For a complete list of abbreviations and acronyms, see "Abbreviations and Acronyms."

Information in this document is subject to change without notice.
© 2002 Dell Computer Corporation. All rights reserved.

Reproduction in any manner whatsoever without the written permission of Dell Computer Corporation is strictly forbidden.

Trademarks used in this text: *Dell*, the *DELL* logo, *PowerEdge*, *DellNet*, *Dell OpenManage*, *Dimension*, *Inspiron*, *Dell Precision*, *OptiPlex*, and *Latitude* are trademarks of Dell Computer Corporation; *Xeon* is a trademark and *Intel* is a registered trademark of Intel Corporation; *Microsoft* and *Windows* are registered trademarks of Microsoft Corporation.

Other trademarks and trade names may be used in this document to refer to either the entities claiming the marks and names or their products. Dell Computer Corporation disclaims any proprietary interest in trademarks and trade names other than its own.

[Back to Contents Page](#)