

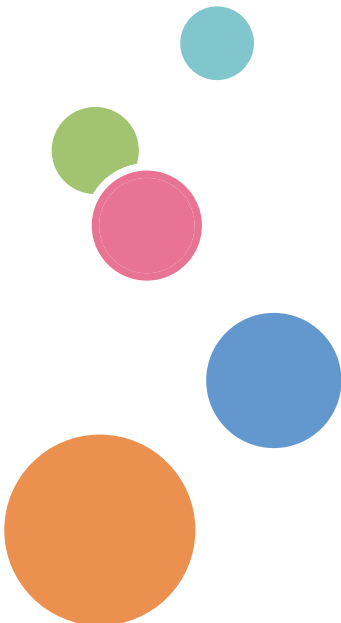

# User's Guide

Guide to the Machine	1
Paper Specifications and Adding Paper	2
Printing Documents	3
Copying Originals	4
Scanning Originals	5
Sending and Receiving a Fax	6
Configuring the Machine Using the Control Panel	7
Configuring the Machine Using Utilities	8
Maintaining the Machine	9
Troubleshooting	10
Configuring Network Settings Using OS X	11
Appendix	12





# TABLE OF CONTENTS

---

How to Find Information about Operations and Troubleshooting.....	10
Operating Manual (Printed).....	10
Operating Manual (Digital Format).....	10
Help.....	11
How to Read This Manual.....	13
Introduction.....	13
Symbols Used in This Manual.....	13
Model-Specific Information.....	13
Disclaimer.....	14
Notes.....	14
Note to Administrator.....	15
About IP Address.....	15

## 1. Guide to the Machine

---

Guide to Components.....	17
Exterior.....	17
Interior.....	19
Control Panel (When Using SP 320SN or SP 325SNw).....	20
Control Panel (When Using SP 320SFN or SP 325SFNw).....	21
Changing Operation Modes.....	24
Multi-access.....	25
About Operation Tools.....	28
Assigning a Setting to the Shortcut Key.....	30
Assigning a Setting Using the Control Panel.....	30
Assigning a Setting Using Web Image Monitor.....	30
Accessing the Function Assigned to the Shortcut Key.....	31
Entering Characters.....	32

## 2. Paper Specifications and Adding Paper

---

Workflow for Loading Paper and Configuring Paper Sizes and Types.....	35
Loading Paper.....	36
Loading Paper into Tray 1.....	36
Loading Paper into Bypass Tray.....	40
Loading Envelopes.....	41
Specifying Paper Type and Paper Size Using the Control Panel.....	45

---

Specifying the Paper Type.....	45
Specifying the Standard Paper Size.....	46
Specifying a Custom Paper Size.....	46
Specifying Paper Type and Paper Size Using Smart Organizing Monitor.....	48
Specifying a Custom Paper Size.....	48
Specifying Paper Type and Paper Size Using Web Image Monitor.....	50
Specifying a Custom Paper Size.....	50
Specifying Paper Type and Paper Size Using the Printer Driver.....	51
When Using Windows.....	51
When Using OS X.....	52
Supported Paper.....	53
Specifications of Paper Types.....	55
Non-Recommended Paper Types.....	61
Paper Storage.....	62
Print Area.....	62
Placing Originals.....	65
Placing Originals on the Exposure Glass.....	65
Placing Originals in the Auto Document Feeder (only SP 320SFN, SP 325SNw, and SP 325SFNw)...	65
About Originals.....	66

### **3. Printing Documents**

---

What You Can Do with the Printer Function.....	69
Displaying the Printing Preferences Dialog Box.....	70
Displaying the Printing Preferences Dialog Box from the [Start] Menu.....	70
Displaying the Printing Preferences Dialog Box in an Application.....	70
Basic Operation of Printing.....	72
If a Paper Mismatch Occurs.....	73
Canceling a Print Job.....	73

### **4. Copying Originals**

---

What You Can Do with the Copier Function.....	75
Copier Mode Screen.....	76
Basic Operation of Copying.....	77
Canceling a Copy.....	78

---

Making Enlarged or Reduced Copies.....	80
Specifying Reduce/Enlarge.....	80
Copying Single-Sided Originals with 2-Sided and Combined Printing.....	82
Specifying Combined and 2-sided Copies.....	85
Copying 2-Sided Originals with 2-Sided and Combined Printing.....	86
Duplex Copying Manually Using the ADF (for SP 320SFN).....	87
Duplex Copying Manually Using the Exposure Glass (for SP 320SN).....	87
Copying an ID Card.....	89
Specifying Scan Settings for Copying.....	91
Adjusting Image Density.....	91
Selecting the Document Type According to Original.....	91

## 5. Scanning Originals

---

What You Can Do with the Scanner Function.....	93
Scanner Mode Screen.....	94
Registering Scan Destinations.....	95
Modifying Scan Destinations.....	100
Deleting Scan Destinations.....	101
Testing Transmission.....	101
Basic Operation of Scan to Folder.....	103
<b>1</b> Printing the Check Sheet.....	103
<b>2</b> Confirming the User Name and Computer Name.....	104
<b>3</b> Creating a Shared Folder on a Computer.....	106
<b>4</b> Specifying Access Privileges for the Created Shared Folder.....	107
<b>5</b> Registering a Shared Folder in the Machine's Address Book.....	108
<b>6</b> Send Scanned Files to a Shared Folder.....	109
Basic Operation of Scan to E-mail.....	112
<b>1</b> Configuring SMTP and DNS Settings.....	112
<b>2</b> Registering Destination E-mail Addresses to the Address Book.....	113
<b>3</b> Sending Scanned Files by E-mail.....	113
Basic Operation of Scan to FTP.....	116
<b>1</b> Configuring FTP Server Settings.....	116
<b>2</b> Sending Scanned Files to an FTP Server.....	116

---

Specifying the Scan Destination Using the One Touch Buttons or [Pause/Redial] Key (only SP 320SFN and SP 325SFNw).....	119
Basic Procedures for Saving Scan Files on a USB Flash Memory Device.....	121
Scanning from Smart Organizing Monitor.....	123
Scanner Settings You Can Configure for Smart Organizing Monitor.....	124
Basic Operation for TWAIN Scanning.....	127
Using TWAIN scanner.....	127
TWAIN scanning.....	127
Settings you can configure in the TWAIN dialog box.....	128
Basic Operation for WIA Scanning.....	130
Using SANE scanning.....	131
Specifying Scan Settings for Scanning.....	132
Specifying the Scanning Size According to the Size of the Original.....	132
Adjusting Image Density.....	132
Specifying Resolution.....	133

## **6. Sending and Receiving a Fax**

---

What You Can Do with the Fax Function.....	135
Fax Setting Workflows.....	137
Fax Mode Screen.....	138
Setting the Date and Time.....	139
Registering Fax Destinations.....	140
Registering Fax Destinations Using the Control Panel.....	140
Registering Fax Destinations Using Web Image Monitor.....	142
Sending a Fax.....	145
Selecting Transmission Mode.....	145
Basic Operation for Sending a Fax.....	146
Specifying the Fax Destination.....	149
Useful Sending Functions.....	153
Specifying Scan Settings for Faxing.....	156
Using the Fax Function from a Computer (LAN-Fax).....	158
Basic Operation for Sending Faxes from a Computer.....	158
Configuring Transmission Settings.....	160
Configuring the LAN-Fax Address Book.....	160

Editing a Fax Cover Sheet.....	163
Receiving a Fax.....	164
Selecting Reception Mode.....	164
Forwarding or Storing Faxes in Memory.....	168
Lists/Reports Related to Fax.....	172

## **7. Configuring the Machine Using the Control Panel**

Basic Operation.....	173
Menu Chart.....	175
Copier Features Settings.....	176
Scan Settings.....	181
Fax Features Settings.....	184
Address Book Settings.....	192
System Settings.....	193
Printer Features Settings.....	198
Tray Paper Settings.....	202
Administrator Settings.....	206
Printing Lists/Reports.....	213
Printing the Configuration Page.....	213
Types of Lists/Reports.....	213
Network Settings.....	215
Wi-Fi Setup Wizard.....	219

## **8. Configuring the Machine Using Utilities**

Available Setting Functions Using Web Image Monitor and Smart Organizing Monitor.....	221
Using Web Image Monitor.....	222
Displaying Top Page.....	223
Changing the Interface Language.....	224
Checking the System Information.....	225
Status Tab.....	225
Counter Tab.....	226
Machine Information Tab.....	227
Configuring the System Settings.....	228
Sound Volume Adjustment Tab (only SP 320SFN and SP 325SFNw).....	228
Tray Paper Settings Tab.....	228

---

Copier Tab.....	231
Fax Tab (only SP 320SFN and SP 325SFNw).....	231
Priority Tray Tab.....	233
Toner Management Tab.....	233
Interface Tab.....	234
Shortcut to Function Tab.....	234
Registering Destinations.....	235
Configuring the Network Settings.....	236
Network Status Tab.....	236
IPv6 Configuration Tab.....	237
Network Application Tab.....	237
DNS Tab.....	238
Auto E-mail Notification Tab.....	239
SNMP Tab.....	240
SMTP Tab.....	241
POP3 Tab.....	242
Wireless Tab (only SP 325SNw and SP 325SFNw).....	242
Google Cloud Tab.....	244
Configuring the IPsec Settings.....	245
IPsec Global Settings Tab.....	245
IPsec Policy List Tab.....	245
Printing Lists/Reports.....	249
Configuring the Administrator Settings.....	250
Administrator Tab.....	250
Rest Settings Tab.....	250
Backup Setting Tab.....	251
Restore Setting Tab.....	252
Set Date/Time Tab.....	253
Energy Saver Mode Tab.....	254
Using Smart Organizing Monitor.....	255
Displaying the Smart Organizing Monitor Dialog.....	255
Checking the Status Information.....	255
Configuring the Machine Settings.....	256



Printing the Configuration Page.....	258
Scanning Documents.....	258

## 9. Maintaining the Machine

Replacing the Print Cartridge.....	259
Cautions When Cleaning.....	263
Cleaning the Friction Pad and Paper Feed Roller.....	264
Cleaning the Exposure Glass.....	266
Cleaning the Auto Document Feeder (When Using SP 320SFN).....	267
Cleaning the Auto Document Feeder (When Using SP 325SNw or SP 325SFNw).....	268
Moving and Transporting the Machine.....	269
Disposal.....	270
Where to Inquire.....	270

## 10. Troubleshooting

Error and Status Messages on the Screen.....	271
Error and Status Messages Appear on Smart Organizing Monitor.....	279
Clearing Misfeeds.....	281
Removing Jammed Paper from Tray 1.....	281
Removing Jammed Paper from the Bypass Tray.....	283
Removing Jammed Paper from the Standard Tray or Duplex Unit.....	285
Removing Jammed Paper from the Auto Document Feeder.....	290
When You Cannot Print Test Page.....	292
Paper Feed Problems.....	293
Print Quality Problems.....	295
Checking the Condition of the Machine.....	295
Checking the Printer Driver Settings.....	295
Printer Problems.....	297
When You Cannot Print Properly.....	297
When You Cannot Print Clearly.....	299
When Paper is Not Fed or Ejected Properly.....	300
Copier Problems.....	301
When You Cannot Make Clear Copies.....	301
When You Cannot Make Copies as Wanted.....	302
Scanner Problems.....	303

When You Cannot Browse the Network to Send a Scan File.....	303
When Scanning Is Not Done As Expected.....	303
Fax Problems.....	304
Common Problems.....	307

## 11. Configuring Network Settings Using OS X

Connecting the Machine to a Wired Network.....	309
Using a USB Cable.....	309
Using an Ethernet Cable.....	310
Connecting the Machine to a Wireless Network.....	312
Installing the Printer Driver.....	312
Installing Smart Organizing Monitor.....	312
Using the Wi-Fi Setup Wizard.....	313
Using the WPS Button.....	314
Using a PIN Code.....	316

## 12. Appendix

Transmission Using IPsec.....	319
Encryption and Authentication by IPsec.....	319
Security Association.....	320
Encryption Key Exchange Settings Configuration Flow.....	321
Specifying Encryption Key Exchange Settings.....	321
Specifying IPsec Settings on the Computer.....	322
Enabling and Disabling IPsec Using the Control Panel.....	324
Notes About the Toner.....	325
Specifications of the Machine.....	326
General Function Specifications.....	326
Printer Function Specifications.....	329
Copier Function Specifications.....	330
Scanner Function Specifications.....	331
Fax Function Specifications.....	331
Consumables.....	333
Print Cartridge.....	333
Information for This Machine.....	334
User Information on Electrical & Electronic Equipment  Region A (mainly Europe and Asia).....	334

---

Note for the Battery and/or Accumulator Symbol (For EU countries only).....	335
Environmental Advice for Users  Region <b>A</b> (mainly Europe).....	335
Notice To Wireless LAN Interface Users  Region <b>A</b> (mainly Europe).....	336
NOTICE TO USERS (NEW ZEALAND).....	337
Notes to users in the state of California (Notes to Users in USA).....	337
Notes to users in the United States of America.....	337
Notes to Canadian Users of Wireless Devices.....	340
Notes to Canadian Users.....	341
Remarques à l'attention des utilisateurs canadiens.....	341
ENERGY STAR Program.....	342
Saving Energy.....	342
Copyright Information about Installed Applications.....	346
Apache License.....	346
dnsmasq.....	348
GPL Version 2.....	349
iperf.....	357
libHaru.....	359
Libsasl.....	359
mDNSResponder.....	361
OpenCV.....	362
Open SSL.....	363
WPA Supplicant.....	366
Trademarks.....	368
<b>INDEX</b> .....	371

---

# How to Find Information about Operations and Troubleshooting

You can find support information about operating the machine and troubleshooting in the Operating Manual (printed), Operating Manual (digital format), and Help (online).

---

## Operating Manual (Printed)

---

The following manuals are provided with this machine.

### Safety Information

This manual explains the safety precautions that should be followed when using the machine. Be sure to read this manual before using the machine.

### Setup Guide

This manual explains how to set up the machine. It also explains how to remove the machine from the packaging and how to connect it to a computer.

### Initial Guide for FAX (only SP 320SFN and SP 325SFNw)

This manual explains the preparations for using the fax function. Be sure to read this manual before using the fax function.

---

## Operating Manual (Digital Format)

---

Operating manuals can be viewed from Ricoh's website or from the provided CD-ROM.

### Viewing from a web browser

Access the Internet from a web browser.

Confirm that the computer or the machine is connected to the network.

Download the operating manuals from <http://www.ricoh.com/>.

### Viewing from the provided CD-ROM

Operating manuals can also be viewed from the provided CD-ROM.

- When using Windows
  1. Insert the CD-ROM into the CD-ROM drive.
  2. Click [Read Manual] and follow the instructions on the screen.

The PDF file manual opens.

- When using OS X
  1. Insert the CD-ROM into the CD-ROM drive.

2. Double-click **Manuals.htm** file, located on the CD-ROM root directory.
  3. Select the language.
  4. Click **[Read PDF manuals]**.
  5. Click the manual you want to refer to.
- The PDF file manual opens.

---

## Help

---

Use the following procedure to open the Help files learn about the printer driver and Smart Organizing Monitor functions.

For details about using Smart Organizing Monitor, see page 255 "Using Smart Organizing Monitor".

### Printer driver

1. Click **[Help]** on the printing preferences dialog box.

For the procedure on how to open the printing preferences dialog box, see page 70 "Displaying the Printing Preferences Dialog Box".

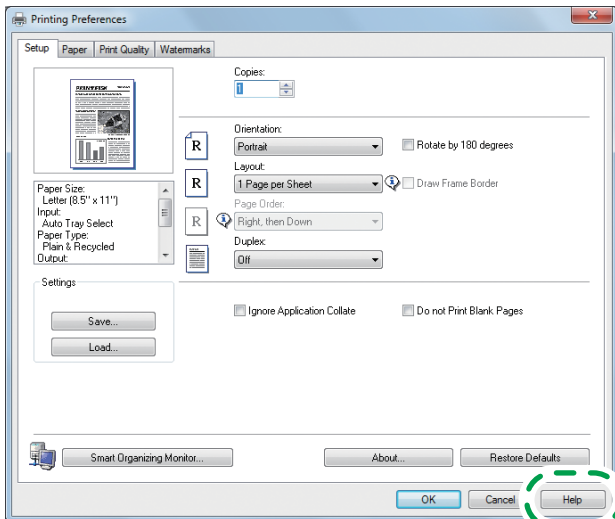

DSG250

## Smart Organizing Monitor

1. Click [Help] on the [Printer Configuration] screen.

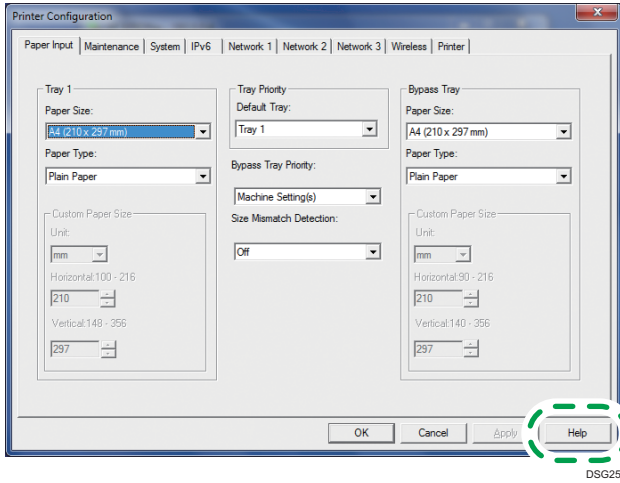

---

# How to Read This Manual

---

## Introduction

---

This manual contains detailed instructions and notes on the operation and use of this machine. For your safety and benefit, read this manual carefully before using the machine. Keep this manual in a handy place for quick reference.

---

## Symbols Used in This Manual

---

This manual uses the following symbols:

**★ Important**

Indicates points to pay attention to when using the machine, and explanations of likely causes of paper misfeeds, damage to originals, or loss of data. Be sure to read these explanations.

**↓ Note**

Indicates supplementary explanations of the machine's functions, and instructions on resolving user errors.

[ ]

Indicates the names of keys on the machine's display or control panels.

---

## Model-Specific Information

---

This section explains how you can identify the region your machine belongs to.

There is a label on the rear of the machine, located in the position shown below. The label contains details that identify the region your machine belongs to. Read the label.

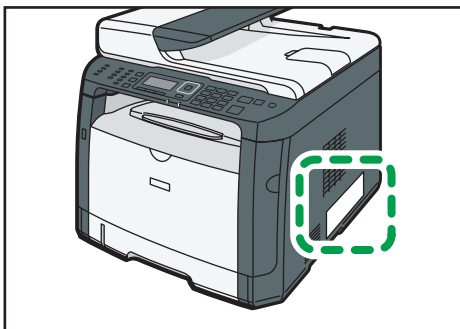

DSG200

---

The following information is region-specific. Read the information under the symbol that corresponds to the region of your machine.

 **Region A** (mainly Europe and Asia)

If the label contains the following, your machine is a region A model:

- CODE XXXX -27
- 220–240 V

 **Region B** (mainly North America)

If the label contains the following, your machine is a region B model:

- CODE XXXX -17
- 120–127 V

 **Note**

- Dimensions in this manual are given in two units of measure: metric and inch. If your machine is a Region A model, refer to the metric units. If your machine is a Region B model, refer to the inch units.

---

## Disclaimer

---

To the maximum extent permitted by applicable laws, in no event will the manufacturer be liable for any damages whatsoever arising out of failures of this machine, losses of the registered data, or the use or non-use of this product and operation manuals provided with it.

Make sure that you always copy or have backups of the data registered in this machine. Documents or data might be erased due to your operational errors or malfunctions of the machine.

In no event will the manufacturer be responsible for any documents created by you using this machine or any results from the data executed by you.

For good output quality, the manufacturer recommends that you use genuine toner from the manufacturer.

---

## Notes

---

Contents of this manual are subject to change without prior notice.

The manufacturer shall not be responsible for any damage or expense that might result from the use of parts other than genuine parts from the manufacturer with your office products.

Some illustrations in this manual might be slightly different from the machine.

The illustrations of the control panel and the machine in this manual are for the SP 325SFNw.



---

## Note to Administrator

---

### Password

---

Certain configurations of this machine can be password-protected to prevent unauthorized modifications by others. We strongly recommend you to create your own password immediately.

The following are the operations that can be password-protected:

- Entering the [Address Book], [Network Settings], [Wi-Fi Setup Wizard], or [Admin. Tools] menu using the control panel

You can access these menus without a password by factory default.

The setting for creating a password can be found in [Admin. Tools].

- Configuring the machine using Web Image Monitor

You can configure the machine using Web Image Monitor without a password by factory default.

The setting for creating a password can be found in [Administrator Settings].

For details about creating passwords, see page 250 "Configuring the Administrator Settings".

---

## About IP Address

---

In this manual, "IP address" covers both IPv4 and IPv6 environments. Read the instructions that are relevant to the environment you are using.



# 1. Guide to the Machine

This chapter describes preparations for using the machine and its operating instructions.

## Guide to Components

This section introduces the names of the various parts on the front and rear side of the machine and outlines their functions.

### Exterior

**★ Important**

- SP 320SN is not equipped with an Auto Document Feeder (ADF).

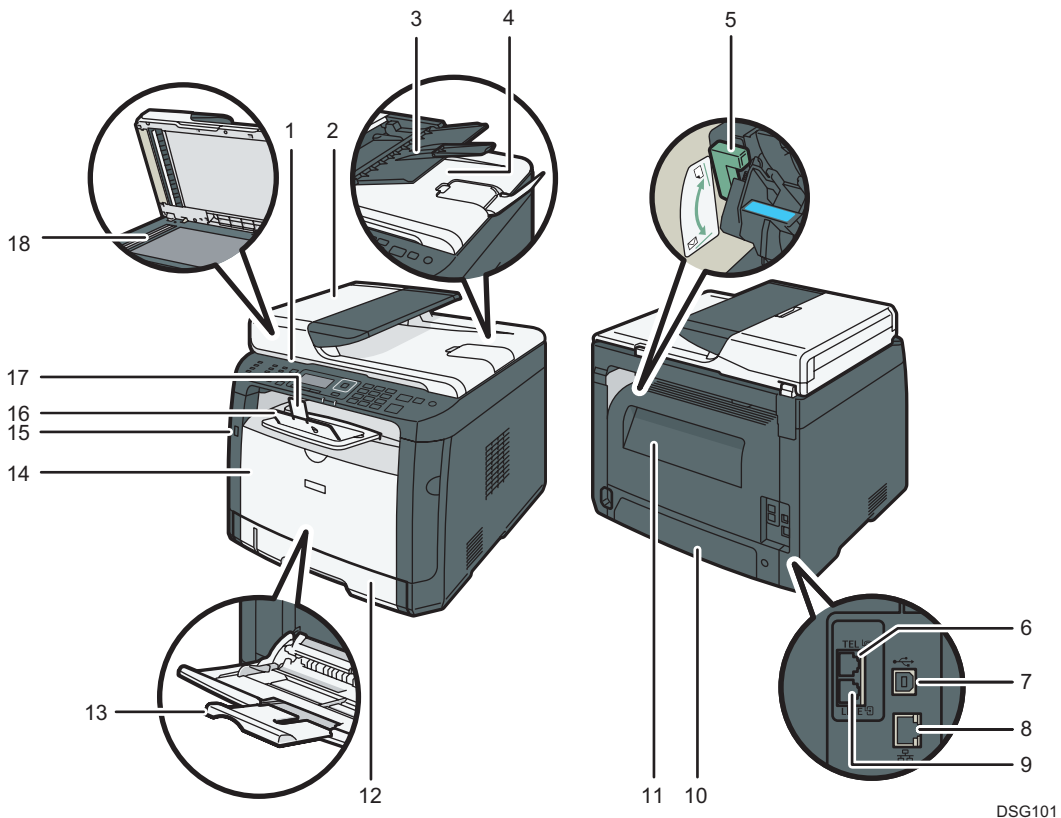

DSG101

No.	Name	Description
1	Control Panel	Contains a screen and keys for machine control.

No.	Name	Description
2	ADF Cover	Open this cover to remove originals jammed in the ADF.
3	Input Tray for the ADF	Place stacks of originals here. They will feed in automatically. This tray can hold up to 35 sheets of plain paper.
4	Auto Document Feeder (Exposure Glass Cover)	The ADF is integrated with the exposure glass cover. Open this cover to place originals on the exposure glass.
5	Envelope Levers	Lower these levers when copying or printing on envelopes. Pull up these levers back when copying or printing on paper other than envelopes.
6	External Telephone Connector	For connecting an external telephone.
7	USB Port	For connecting the machine to a computer using a USB cable.
8	Ethernet Port	For connecting the machine to the network using a network interface cable.
9	G3 (analog) Line Interface Connector	For connecting a telephone line.
10	Tray 1 Rear Cover	Remove this cover when loading paper longer than A4 in Tray 1.
11	Rear Cover	Open this cover to remove jammed paper or to lower the levers inside before printing on envelopes.
12	Tray 1	This tray can hold up to 250 sheets of plain paper.
13	Bypass Tray	This tray can hold up to 50 sheets of plain paper.
14	Front Cover	Open this cover to replace the print cartridge or remove jammed paper.
15	USB Flash Disk Port	Insert a USB flash memory device to store scanned files using the Scan to USB function.
16	Standard Tray	Printed paper is output here. Up to 50 sheets of plain paper can be stacked here.
17	Stop Fence	Raise this fence to prevent paper from falling off.
18	Exposure Glass	Place originals here sheet by sheet.

**Note**

- If it is difficult to take printed paper out of the output tray, you can lift the control panel and make it easier to take the printed paper out.

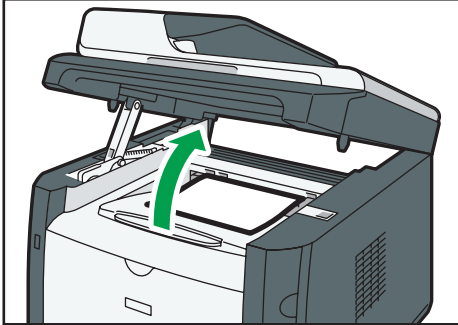

DSG102

**Interior**

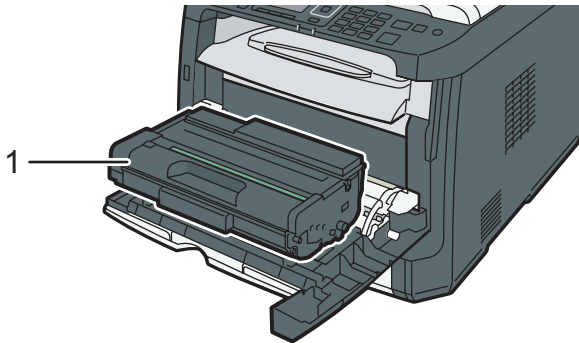

DSG104

No.	Name	Description
1	Print Cartridge	A replacement consumable that is required to make prints on paper. It needs to be replaced when the alert indicator flashes red. For details about replacing the cartridge, see page 259 "Replacing the Print Cartridge".

## Control Panel (When Using SP 320SN or SP 325SNw)

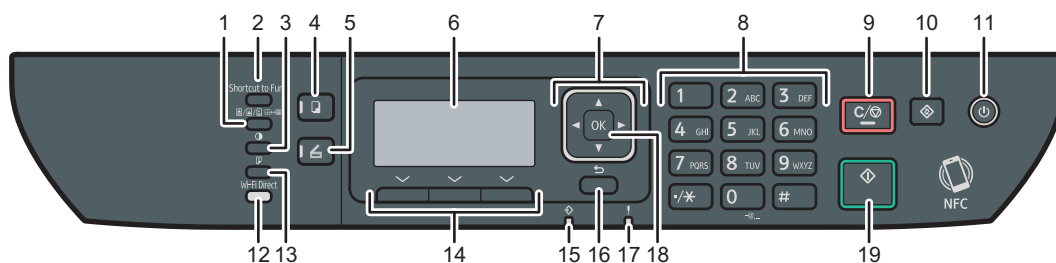

DSG105

No.	Name	Description
1	[Image Quality] key	Press to select the scan quality for the current job.
2	[Shortcut to Func.] key	Press to use the function pre-assigned to this key.
3	[Density] key	Press to adjust the image density for the current job.
4	[Copy] key	Press to switch the machine to copier mode.
5	[Scanner] key	Press to switch the machine to scanner mode.
6	Screen	Displays the current status and messages.
7	Scroll Keys	Press to move the cursor in the direction indicated by the key.
8	Number Keys	Press to enter numerical values when specifying settings such as fax numbers and copy quantities or to enter letters when specifying names.
9	[Clear/Stop] key	Press to cancel or stop print jobs, document copying, scanning, fax transmission/reception, and other actions in progress.
10	[User Tools] key	Press to display the menu for configuring the machine's system settings.
11	[Power] key	This indicator lights up blue when the machine is turned on.
12	[Wi-Fi Direct] key (only SP 325SNw)	Pressing this key while Wi-Fi is disabled activates Wi-Fi and reboots the machine automatically. Press this key while Wi-Fi is enabled to activate or deactivate the Wi-Fi Direct function. This indicator lights blue when the Wi-Fi Direct function is active.
13	[Duplex] key	Press to print on both sides of paper.

No.	Name	Description
14	Selection keys	Press the key underneath an item shown on the bottom line of the screen to select it.
15	Data In Indicator	This indicator flashes blue when the machine receives print data from the host device.
16	[Back] key	Press to cancel the last operation or to return to the previous level of the menu tree.
17	Alert Indicator	This indicator lights up red when the machine runs out of paper or consumables, when the paper settings do not match the settings specified by the driver, or when other errors occur. It flashes when the toner is nearly empty.
18	[OK] Key	Press to confirm settings and specified values, or to move to the next menu level.
19	[Start] key	Press to start fax transmission/reception, scanning, or copying.

### Control Panel (When Using SP 320SFN or SP 325SFNw)

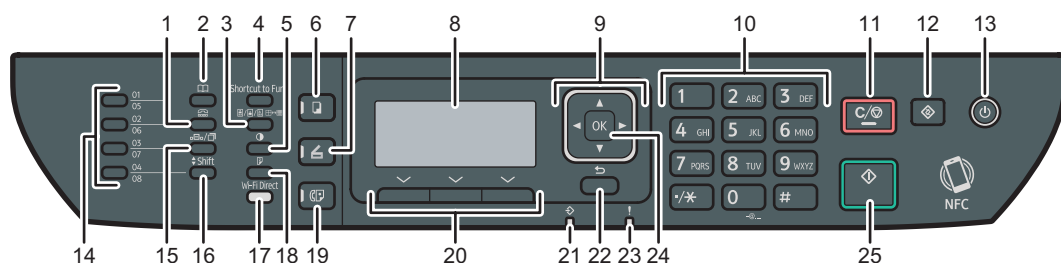

DSG106

No.	Name	Description
1	[On Hook Dial] key	Press to use on-hook dialing to check the destination's status when sending a fax.
2	[Address Book] key	Press to select a scan or fax destination from the Address Book.
3	[Image Quality] key	Press to select the scan quality for the current job.
4	[Shortcut to Func.] key	Press to use the function pre-assigned to this key.
5	[Density] key	Press to adjust the image density for the current job.

No.	Name	Description
6	[Copy] key	Press to switch the machine to copier mode.
7	[Scanner] key	Press to switch the machine to scanner mode.
8	Screen	Displays the current status and messages.
9	Scroll Keys	Press to move the cursor in the direction indicated by the key.
10	Number Keys	Press to enter numerical values when specifying settings such as fax numbers and copy quantities or to enter letters when specifying names.
11	[Clear/Stop] key	Press to cancel or stop print jobs, document copying, scanning, fax transmission/reception, and other actions in progress.
12	[User Tools] key	Press to display the menu for configuring the machine's system settings.
13	[Power] key	This indicator lights up blue when the machine is turned on.
14	One Touch buttons	Press to select a scan or fax Quick Dial destination.
15	[Pause/Redial] key	Press to insert a pause in a fax number or to display the last used scan or fax destination.
16	[Shift] key	Press to use the Quick Dial numbers 5 to 8 when specifying a scan or fax destination using the One Touch buttons.
17	[Wi-Fi Direct] key (only SP 325SFNw)	Pressing this key while Wi-Fi is disabled activates Wi-Fi and reboots the machine automatically. Press this key while Wi-Fi is enabled to activate or deactivate the Wi-Fi Direct function. This indicator lights blue when the Wi-Fi Direct function is active.
18	[Duplex] key	Press to print on both sides of paper.
19	[Facsimile] key	Press to switch the machine to fax mode.
20	Selection keys	Press the key underneath an item shown on the bottom line of the screen to select it.
21	Data In Indicator	This indicator flashes blue when the machine receives print data from the host device.
22	[Back] key	Press to cancel the last operation or to return to the previous level of the menu tree.



No.	Name	Description
23	Alert Indicator	This indicator lights up red when the machine runs out of paper or consumables, when the paper settings do not match the settings specified by the driver, or when other errors occur. It flashes when the toner is nearly empty.
24	[OK] Key	Press to confirm settings and specified values, or to move to the next menu level.
25	[Start] key	Press to start fax transmission/reception, scanning, or copying.

# Changing Operation Modes

You can switch between copier, scanner, and fax modes by pressing the corresponding keys.

Press the [Copy], [Scanner], or [Facsimile] (only SP 320SFN and SP 325SFNw) key to activate each mode. While in each mode, the corresponding key lights up.

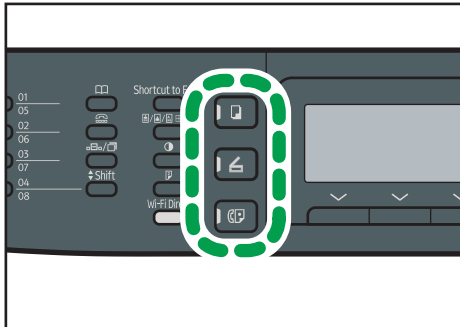

DSG108

## Function Priority

By default, copy mode is selected when the machine is turned on, or if the preset [System Auto Reset Timer] time passes with no operation while the initial screen of the current mode is displayed. You can change the selected mode using [Function Priority] under [Admin. Tools].

For details about [System Auto Reset Timer] or [Function Priority], see page 206 "Administrator Settings".

## Multi-access

This machine can perform multiple jobs using different functions, such as copying and faxing, at the same time. Performing multiple functions simultaneously is called "Multi-access".

The following table shows the functions that can be performed simultaneously.

Current job	Job that you want to execute simultaneously
Copying	<ul style="list-style-type: none"> <li>• Fax memory transmission</li> <li>• Fax memory reception</li> <li>• Receiving a print job from a computer (the actual printing starts after copying is finished)</li> <li>• Receiving a LAN-Fax job from a computer</li> <li>• LAN-Fax transmission</li> </ul>
Scanning	<ul style="list-style-type: none"> <li>• Fax memory transmission</li> <li>• Fax immediate printing</li> <li>• Fax memory reception</li> <li>• Printing a fax received in the machine's memory</li> <li>• Printing</li> <li>• Receiving a LAN-Fax job from a computer</li> <li>• LAN-Fax transmission</li> </ul>
Scanning a fax into the machine's memory before transmission	<ul style="list-style-type: none"> <li>• Fax memory transmission</li> <li>• Fax immediate printing</li> <li>• Fax memory reception</li> <li>• Printing a fax received in the machine's memory</li> <li>• Printing</li> <li>• Receiving a LAN-Fax job from a computer</li> </ul>
Fax immediate transmission (scanning an original and sending it simultaneously)	<ul style="list-style-type: none"> <li>• Printing a fax received in the machine's memory</li> <li>• Printing</li> <li>• Receiving a LAN-Fax job from a computer</li> </ul>

Current job	Job that you want to execute simultaneously
Fax memory transmission (sending a fax that has already been stored in the machine's memory)	<ul style="list-style-type: none"> <li>• Copying</li> <li>• Scanning</li> <li>• Scanning a fax into the machine's memory before transmission</li> <li>• Printing a fax received in the machine's memory</li> <li>• Printing</li> <li>• Receiving a LAN-Fax job from a computer</li> </ul>
Fax immediate printing (receiving a fax and printing it simultaneously)	<ul style="list-style-type: none"> <li>• Scanning * 1</li> <li>• Scanning a fax into the machine's memory before transmission</li> <li>• Receiving a LAN-Fax job from a computer</li> </ul>
Fax memory reception (storing a received fax into the machine's memory)	<ul style="list-style-type: none"> <li>• Copying</li> <li>• Scanning</li> <li>• Scanning a fax into the machine's memory before transmission</li> <li>• Receiving a LAN-Fax job from a computer</li> </ul>
Printing a fax received in the machine's memory	<ul style="list-style-type: none"> <li>• Scanning * 1</li> <li>• Scanning a fax into the machine's memory before transmission</li> <li>• Fax immediate transmission</li> <li>• Fax memory transmission</li> <li>• Receiving a LAN-Fax job from a computer</li> <li>• LAN-Fax transmission</li> </ul>
Printing	<ul style="list-style-type: none"> <li>• Scanning</li> <li>• Scanning a fax into the machine's memory before transmission</li> <li>• Fax immediate transmission</li> <li>• Fax memory transmission</li> <li>• LAN-Fax transmission</li> </ul>
Receiving a LAN-Fax job from a computer	<ul style="list-style-type: none"> <li>• Copying</li> <li>• Scanning</li> <li>• Fax immediate printing</li> <li>• Fax memory reception</li> <li>• Printing a fax received in the machine's memory</li> <li>• LAN-Fax transmission</li> </ul>

Current job	Job that you want to execute simultaneously
LAN-Fax transmission	<ul style="list-style-type: none"><li>• Copying</li><li>• Scanning</li><li>• Scanning a fax into the machine's memory before transmission</li><li>• Printing a fax received in the machine's memory</li><li>• Printing</li><li>• Receiving a LAN-Fax job from a computer</li></ul>

\* 1 Fax printing may take longer than normal if you scan using the control panel at the same time, especially when scanning multiple pages using the exposure glass.

**Note**

- If you try to use a function that cannot be performed simultaneously, you will hear a beep sound from the machine or see a failure message pop up on your computer screen. In this case, try again after the current job is finished.

# About Operation Tools

This section explains the operation tools of this machine.

## Control Panel

The control panel contains a screen and keys for controlling the machine. They allow you to configure the machine's various settings.

For details about how to use the control panel, see page 173 "Configuring the Machine Using the Control Panel".

## Smart Organizing Monitor

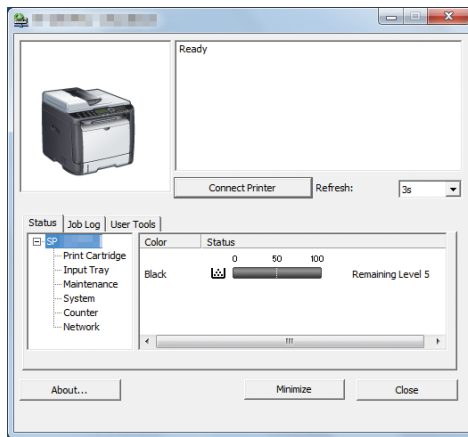

Install this utility on your computer from the included CD-ROM before using it.

Using Smart Organizing Monitor, you can check the machine's status, configure its settings, and use other functions.

For details about how to use Smart Organizing Monitor, see page 255 "Using Smart Organizing Monitor".

## Web Image Monitor

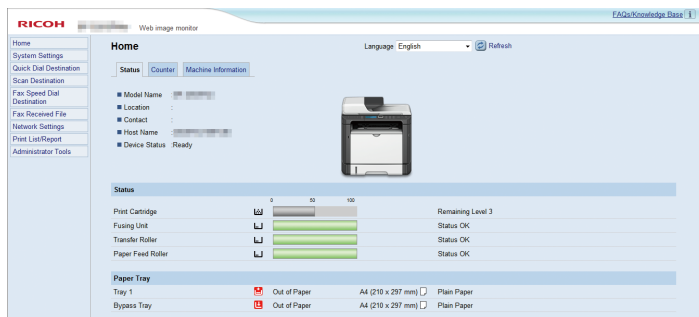

You can check the machine's status and configure its settings by accessing the machine directly using Web Image Monitor.

For details about how to use Web Image Monitor, see page 221 "Configuring the Machine Using Utilities".

## Assigning a Setting to the Shortcut Key

You can access a frequently-used setting with a single keystroke by assigning the setting to the [Shortcut to Func.] key.

You can configure settings for the following 3 function:

- ID Card Copy Mode
- Direct Transmission
- Select Scanner Address

---

### Assigning a Setting Using the Control Panel

---

1. Press the [User Tools] key.
2. Press the [▲] or [▼] key to select [Admin. Tools], and then press the [OK] key.
3. If you are requested to enter a password, enter the password using the number keys, and then press the [OK] key.
4. Press the [▲] or [▼] key to select [Shortcut to Function], and then press the [OK] key.
5. Press the [▲] or [▼] key to select the setting you want to configure, and then press the [OK] key.
6. Press the [User Tools] key to return to the initial screen.

#### ↓ Note

- A password for accessing the [Admin. Tools] menu can be specified in [Admin. Tools Lock].

---

### Assigning a Setting Using Web Image Monitor

---

1. Start the web browser and enter "http://(the machine's IP address)/" in the address bar.
2. Click [System Settings].
3. Click the [Shortcut to Function] tab.
4. Specify the setting you want to configure from [Shortcut to Function Settings].
5. Enter the administrator password if required.
6. Click [OK].
7. Close the web browser.

#### ↓ Note

- For details about passwords, see page 250 "Configuring the Administrator Settings".



## Accessing the Function Assigned to the Shortcut Key

1. Press the [Shortcut to Func.] key.

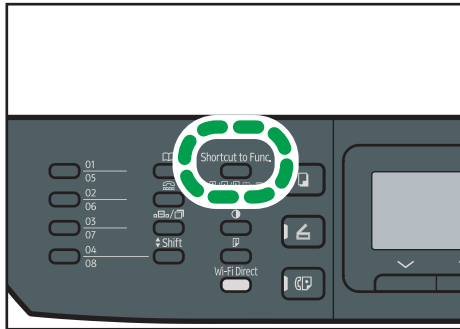

The function assigned to the [Shortcut to Func.] key is displayed.

# Entering Characters

To enter characters, use keys as follows:

## To enter a digit

Press a number key.

## To delete a character

Press the [◀] key.

## To enter a fax number

- To enter a number  
Use the number keys.
- To enter characters other than digits

"\*": Press [✳].

"#": Press [#].

"+": Press [✳].

Pause: Press the [Pause/Redial] key. "P" appears on the screen.

Space: Press the [▶] key.

## To enter a name

Letters, numbers, and symbols can be entered using the number keys.

To enter two characters consecutively that use the same number key, press the [▶] key to move the cursor before entering the second character.

Number key	Number of key press																															
	1	2	3	4	5	6	7	8	9	10	11	12	13	14	15	16	17	18	19	20	21	22	23	24	25	26	27	28	29	30	31	
1	1																															
2	A	Ã	Ä	Å	Æ	B	C	Ç	a	à	á	â	ã	ä	æ	b	c	ç	2													
3	D	E	É	F	d	e	è	é	ê	ë	f	3																				
4	G	H	I	g	h	i	ì	í	î	ï	4																					
5	J	K	L	j	k	l	5																									
6	M	N	Ñ	O	Õ	Ö	Ø	Œ	m	n	ñ	o	ò	ó	ô	õ	ø	œ	6													
7	P	Q	R	S	ß	p	q	r	s	7																						
8	T	U	Ü	V	t	u	ù	ú	û	ü	v	8																				
9	W	X	Y	Z	w	x	y	ÿ	z	9																						
0	0	-	.	!	"	,	;	:	^	'	_	=	/		'	?	\$	@	%	&	+	(	)	[	]	{	}	<	>	~	\	
✳	✳																															
#	#																															

DSG155

### Note

- Characters you can enter depend on the setting you are configuring.

- If the number you entered is too large or too small for the setting, it will not be accepted. If you press the [OK] key, the machine will increase or decrease the number to the minimum or maximum value for the setting.



# 2. Paper Specifications and Adding Paper

This chapter describes how to load paper and originals and about their specifications.

## Workflow for Loading Paper and Configuring Paper Sizes and Types

This section explains how to load paper and operations required after paper is loaded. After following the procedures below, you can copy or print on the paper that is loaded in the machine.

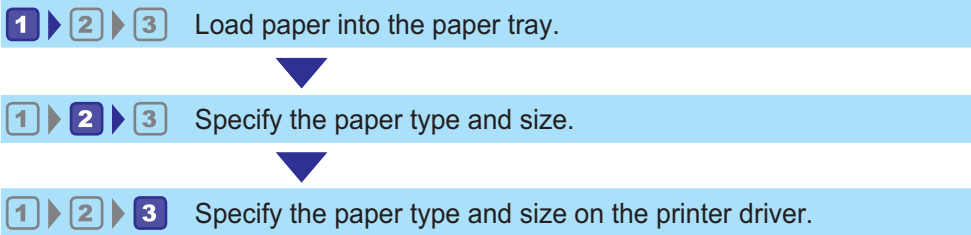

DSC260

For details about the procedures, refer to the next page.

Procedure	Reference
1	See page 36 "Loading Paper".
2	There are three ways to specify the paper type and size. <ul style="list-style-type: none"><li>• When using the control panel See page 45 "Specifying Paper Type and Paper Size Using the Control Panel".</li><li>• When using Web Image Monitor See page 50 "Specifying Paper Type and Paper Size Using Web Image Monitor".</li><li>• When using Smart Organizing Monitor See page 48 "Specifying Paper Type and Paper Size Using Smart Organizing Monitor".</li></ul>
3	See page 51 "Specifying Paper Type and Paper Size Using the Printer Driver".

For details about supported paper, see page 53 "Supported Paper".

# Loading Paper

This section explains how to load paper into the paper tray and the bypass tray.

## ⚠ CAUTION

- When loading paper, take care not to trap or injure your fingers.

For information about supported paper, precautions for storing paper and print areas, see page 53 "Supported Paper".

## Loading Paper into Tray 1

The following example explains how to load paper in the standard paper tray (Tray 1) of SP 325SNw and SP 325SFNw.

All models are loaded in the same way.

### ★ Important

- Before printing on paper other than envelopes, make sure to pull up the levers on the machine rear, inside the rear cover. Leaving the levers lowered can cause print quality problems when printing on paper other than envelopes.

1. Pull out tray 1 carefully with both hands.

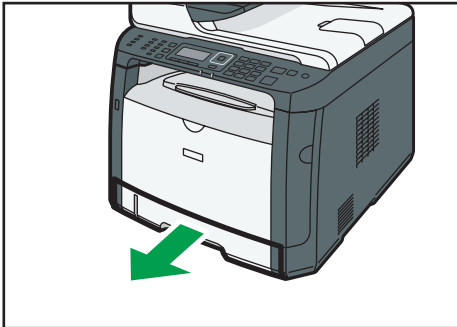

DSG110

Place the tray on a flat surface.

2. Slide the side and end paper guides outward.

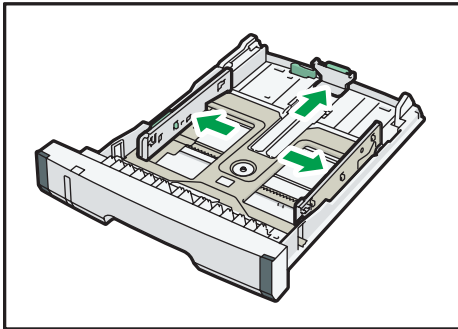

DSG111

3. Fan the paper and load it in the tray with the print side faced down.

Make sure paper is not stacked higher than the upper limit marked inside the side paper guide.

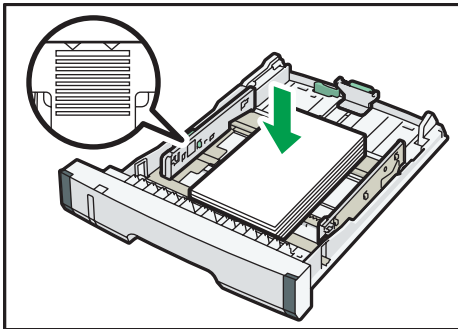

DSG113

4. Slide the guides inward until they are flush against the sides of the paper.

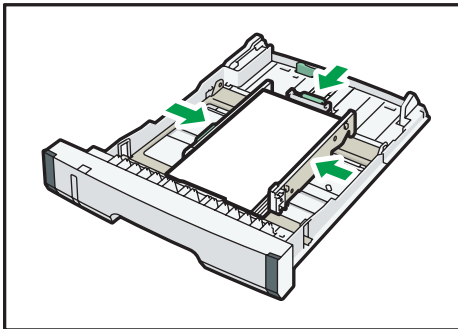

DSG112

When loading custom size paper, set the paper guide slightly wider than the actual paper size.

5. Check there are no gaps between the paper and the paper guides; both side and end paper guides.

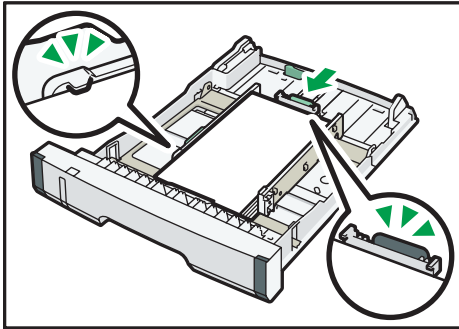

DSG115

6. Carefully push tray 1 straight into the machine.

To avoid paper jams, make sure the tray is securely inserted.

**Note**

- The remaining paper indicator on the left front side of the paper tray shows approximately how much paper is remaining.

### Extending the Tray 1 to load paper (When Using SP 325SNw or SP 325SFNw)

This section explains how to load paper longer than A4 (297 mm) into the machine.

1. Pull out tray 1 carefully with both hands.  
Place the tray on a flat surface.
2. Remove the tray 1 rear cover by pushing its center.

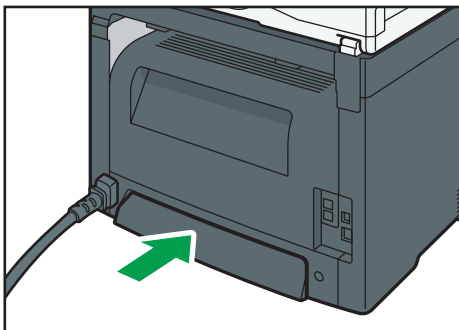

DSG116

3. Release the extender lock on the left rear of the tray, and then pull out the extender until it clicks.

Make sure the extender's inner surface and the scale are aligned.



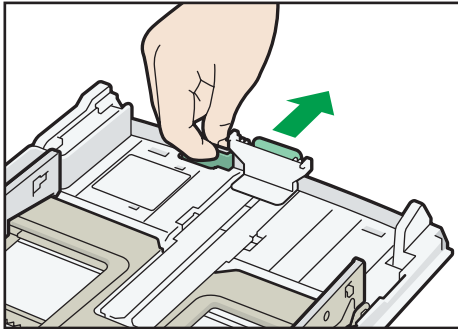

DSG117

#### 4. Follow Steps 2 to 6 in "Loading Paper into Tray 1".

##### ↓ Note

- To reinsert the extender, you might have to push it with moderate force.
- The remaining paper indicator on the left front side of the paper tray shows approximately how much paper is remaining.

### Extending the Tray 1 to load paper (When using SP 320SN or SP 320SFN)

This section explains how to load paper longer than A4 (297 mm) into the machine.

1. Pull out tray 1 carefully with both hands.  
Place the tray on a flat surface.
2. Remove the tray 1 rear cover by pushing its center.

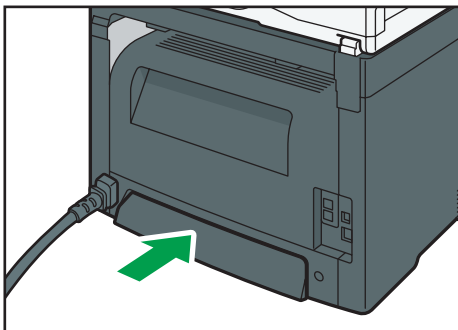

DSG116

3. Release the extender locks on both sides of the tray, and then pull out the extender until it clicks.

Make sure the extender's inner surface and the scale are aligned.

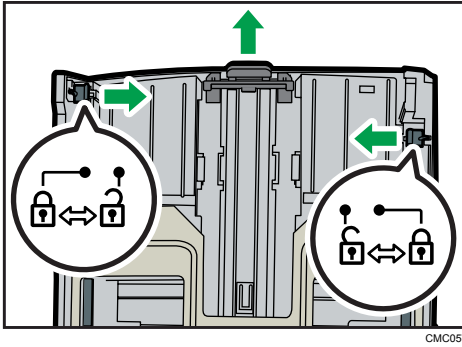

4. Lock the extender in the extended position.

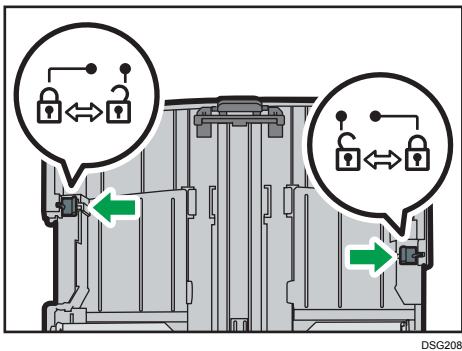

5. Follow Steps 2 to 6 in "Loading Paper into Tray 1".

**Note**

- To reinsert the extender, you might have to push it with moderate force.
- The remaining paper indicator on the left front side of the paper tray shows approximately how much paper is remaining.

## Loading Paper into Bypass Tray

**Important**

- Before printing on paper other than envelopes, make sure to pull up the levers on the machine rear, inside the rear cover. Leaving the levers lowered can cause print quality problems when printing on paper other than envelopes.
- Do not load paper while the machine is printing.

1. Open the bypass tray.

If you load A4 (297 mm) or larger size paper, pull out the bypass tray extension.

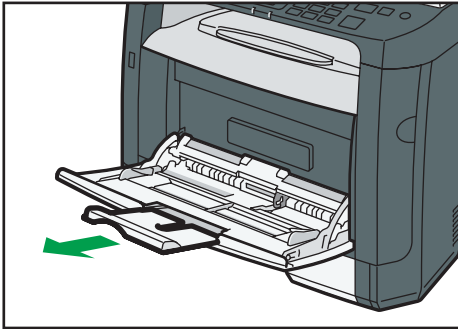

DSG118

2. Slide the side guides outward, then load paper with the print side up, and push in until it stops against the machine.

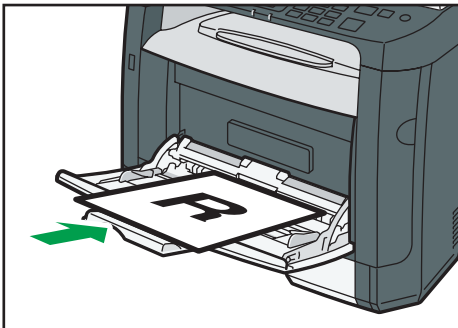

DSG119

3. Adjust the side guides to the paper width.

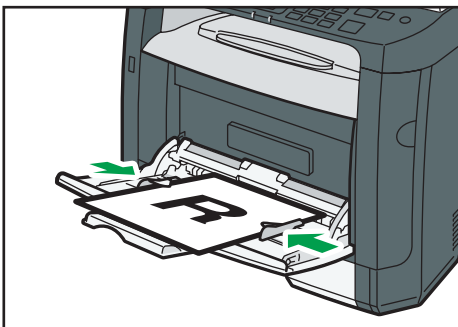

DSG120

---

## Loading Envelopes

---

### ★ Important

- Before printing on envelopes, make sure to lower the levers on the machine rear, inside the rear cover, to avoid envelopes coming out creased. Also, pull up the levers back to their original

positions after printing. Leaving the levers lowered can cause print quality problems when printing on paper other than envelopes.

- Avoid using self-adhesive envelopes. They may cause machine malfunctions.
- Check there is no air in the envelopes before loading.
- Load only one size and type of envelope at a time.
- Before loading envelopes, flatten their leading edges (the edge going into the machine) by running a pencil or ruler across them.
- Some kinds of envelope might cause misfeeds, wrinkles or print poorly.
- Print quality on envelopes may be uneven if parts of an envelope have different thicknesses. Print one or two envelopes to check print quality.
- In a hot and humid environment, the envelope might be output creased or improper printing quality.

1. Open the bypass tray.

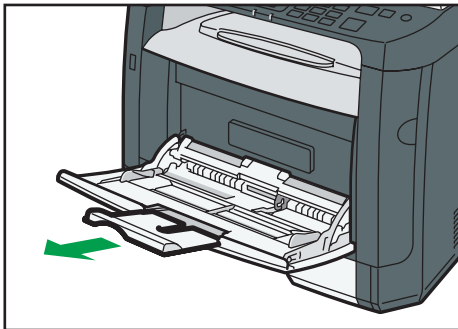

DSG118

2. Slide the side guides outward, then load envelopes with the print side up, and push in until it stops against the machine.

Envelopes whose flaps are open must be printed with the flaps open, and envelopes whose flaps are closed must be printed with the flaps closed. Before loading envelopes, make sure they are as flat as possible.

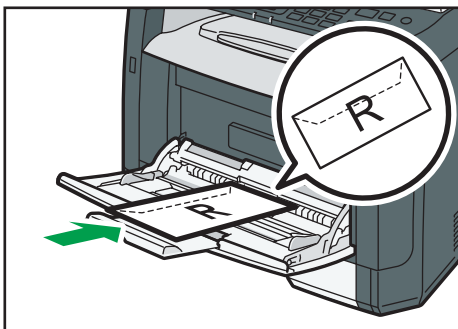

DSG122

### 3. Adjust the side guides to the envelope width.

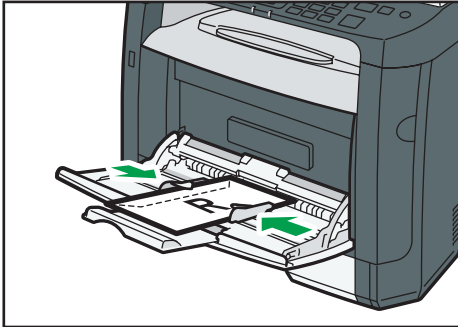

DSG123

### 4. Open the rear cover.

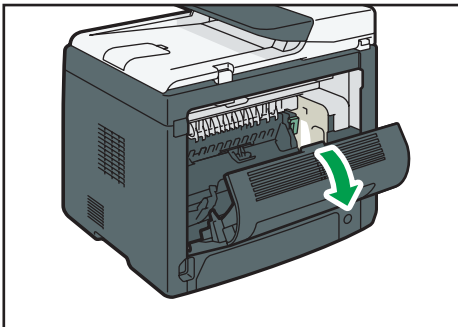

DSG124

### 5. Lower the levers for printing envelopes on both sides to the position indicated with an envelope mark.

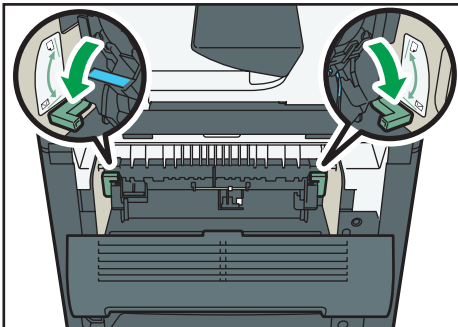

DSG125

Make sure to pull up the levers back to their original positions after printing.

### 6. Close the rear cover.

#### ↓ Note

- Be sure to load envelopes so that their flaps are on the left. If you do not, the envelopes will become creased.

- If printed envelopes come out badly creased, load the envelopes in the opposite direction, and then rotate the print object by 180 degrees using the printer driver before printing. For details, see the printer driver Help.

# Specifying Paper Type and Paper Size Using the Control Panel

This section describes how to specify the paper size and paper type using the control panel.

## Note

- Paper type and size can also be specified using the printer driver. For details, see the printer driver Help.
- For prints from the bypass tray, you can select to print according to either the printer driver settings or the control panel settings with [Bypass Tray Priority] under [Tray Paper Settings]. For details about [Bypass Tray Priority], see page 202 "Tray Paper Settings".
- If [Auto Continue] under [System Settings] is enabled, printing stops temporarily if a paper type/size error is detected. The printing restarts automatically with the settings made with the control panel after about ten seconds. For details about [Auto Continue], see page 193 "System Settings".

2

## Specifying the Paper Type

This section describes how to specify the paper type.

1. Press the [User Tools] key.

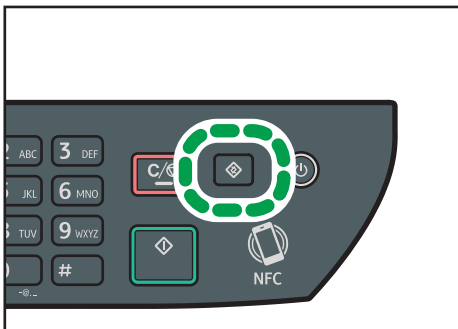

2. Press the [▲] or [▼] key to select [Tray Paper Settings], and then press the [OK] key.
3. Press the [▲] or [▼] key to select the paper type setting for the desired tray, and then press the [OK] key.
4. Press the [▲] or [▼] key to select the desired paper type, and then press the [OK] key.
5. Press the [User Tools] key to return to the initial screen.

## Note

- You can press the [Back] key to exit to the previous level of the menu tree.

---

## Specifying the Standard Paper Size

---

This section describes how to specify the standard paper size.

1. Press the [User Tools] key.

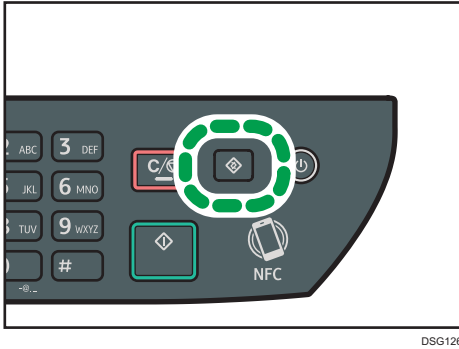

2. Press the [▲] or [▼] key to select [Tray Paper Settings], and then press the [OK] key.
3. Press the [▲] or [▼] key to select the paper size setting for the desired tray, and then press the [OK] key.
4. Press the [▲], [▼], [◀], or [▶] key to select the desired paper size, and then press the [OK] key.
5. Press the [User Tools] key to return to the initial screen.

**Note**

- You can press the [Back] key to exit to the previous level of the menu tree.

---

## Specifying a Custom Paper Size

---

This section describes how to specify a custom paper size.

**Important**

- When you perform printing, make sure that the paper size specified with the printer driver matches the paper size specified with the control panel. If a paper size mismatch occurs, a message appears on the display. To ignore the error and print using mismatched paper, see page 73 "If a Paper Mismatch Occurs".

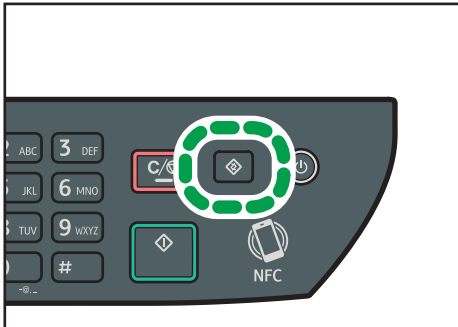

**1. Press the [User Tools] key.**

2. Press the [▲] or [▼] key to select [Tray Paper Settings], and then press the [OK] key.
3. Press the [▲] or [▼] key to select the paper size setting for the desired tray, and then press the [OK] key.
4. Press the [▲], [▼], [◀], or [▶] key to select [Custom Size], and then press the [OK] key.
5. Press the [▲] or [▼] key to select [mm] or [inch], and then press the [OK] key.
6. Enter the width using number keys, and then press the [OK] key.  
To enter a decimal point, press [✱].
7. Enter the length using number keys, and then press the [OK] key.  
To enter a decimal point, press [✱].
8. Press the [User Tools] key to return to the initial screen.

**Note**

- You can press the [Back] key to exit to the previous level of the menu tree.

# Specifying Paper Type and Paper Size Using Smart Organizing Monitor

The procedure in this section is an example based on Windows 7. The actual procedure may vary depending on the operating system you are using.

1. On the [Start] menu, click [All Programs].
2. Click [SP 320 Series Software Utilities].
3. Click [Smart Organizing Monitor].

Smart Organizing Monitor starts.

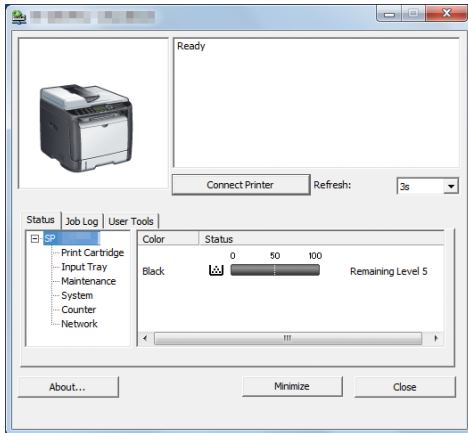

4. If the machine you are using is not selected, click [Connect Printer], and then do one of the following:
  - Select the machine's model.
  - Enter the IP address of the machine manually.
  - Click [Search Network Printer] to search the machine via the network.
5. Click [OK].
6. On the [User Tools] tab, click [Printer Configuration].

If you are requested to enter an access code, enter the access code and then click [OK].  
The default access code is "Admin".
7. On the [Paper Input] tab, select the paper type and paper size, and then click [OK].
8. Click [Close].

---

## Specifying a Custom Paper Size

---

1. On the [Start] menu, click [All Programs].

2. Click [SP 320 Series Software Utilities].
3. Click [Smart Organizing Monitor].
4. If the machine you are using is not selected, click [Connect Printer], and then do one of the following:
  - Select the machine's model.
  - Enter the IP address of the machine manually.
  - Click [Search Network Printer] to search the machine via the network.
5. Click [OK].
6. On the [User Tools] tab, click [Printer Configuration].

If you are requested to enter an access code, enter the access code and then click [OK].  
The default access code is "Admin".
7. On the [Paper Input] tab, select [Custom Paper Size] in the [Paper Size] list.
8. In the [Unit:] list, select [mm:] or [inch:].
9. In the [Horizontal] box and [Vertical] box, specify the width and length.
10. Click [OK].
11. Click [Close].

# Specifying Paper Type and Paper Size Using Web Image Monitor

This section describes how to specify paper sizes and types using Web Image Monitor.

2

1. Start the web browser and access the machine by entering its IP address.

The top page of Web Image Monitor appears.

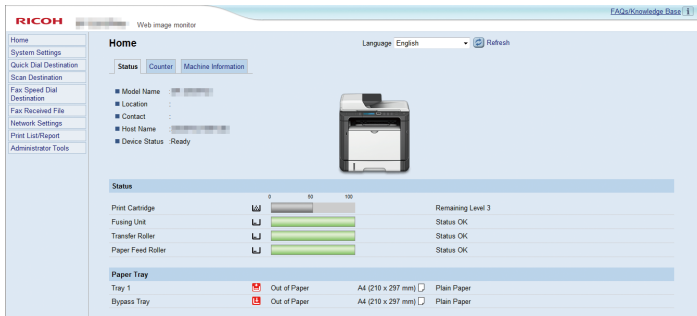

2. Click [System Settings].
3. Click [Tray Paper Settings].
4. Select the paper type and paper size for the tray you want to use.
5. Enter the administrator password if required.
6. Click [OK].
7. Close the web browser.

---

## Specifying a Custom Paper Size

---

1. Start the web browser and access the machine by entering the IP address.
2. Click [System Settings].
3. Click [Tray Paper Settings].
4. Select [Custom Size] in the [Paper Size] list.
5. Select [mm] or [inch] and specify the width and length.
6. Enter the administrator password if required.
7. Click [OK].
8. Close the web browser.

# Specifying Paper Type and Paper Size Using the Printer Driver

## ★ Important

- Make sure that the paper type and size specified with the printer driver matches the type and size of the paper loaded in the tray. Since this machine does not detect paper sizes automatically, the type or size of the paper may be mismatched and the print job may not print correctly.

2

## When Using Windows

The procedure in this section is an example based on Windows 7. The actual procedure may vary depending on the operating system you are using.

### 1. Open the [Printing Preferences] dialog box from the printer driver.

For information of how to open the printer driver properties from [Devices and Printers], see page 70 "Displaying the Printing Preferences Dialog Box".

The [Printing Preferences] dialog box appears.

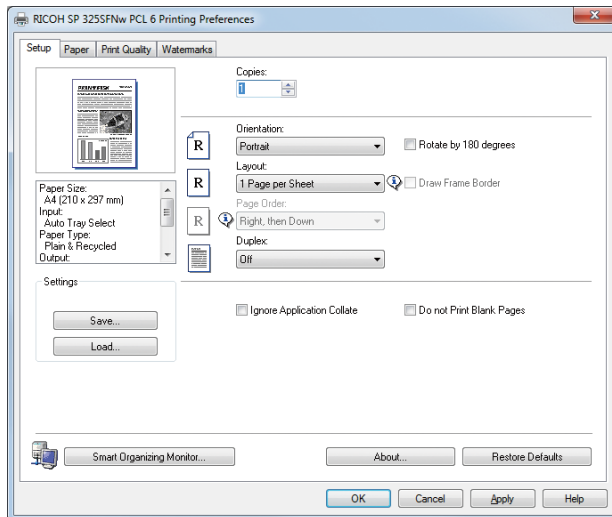

2. Click the [Paper] tab.
3. In the [Input Tray:] list, select the paper tray you want to use for printing.
4. In the [Paper Type:] list, select the type of paper that is loaded in the paper tray.
5. Select the [Print On] check box and select the size of the paper that is loaded in the paper tray.

Clear the [Fit to Print Size] check box as necessary.

6. Click [OK].

---

## When Using OS X

---

The procedure in this section is an example based on OS X 10.11. The actual procedure may vary depending on the operating system you are using.

2

1. Start System Preferences.
2. Click [Printers & Scanners].
3. Select the printer you are using.
4. In the [Paper Size:] list, select the size of the document to be printed.
5. Select [Printer Features] in the pop-up menu.
6. In the [Media Type:] list, select the type of paper that is loaded in the paper tray.

# Supported Paper

## ★ Important

- After loading paper in the tray, specify the paper type and size using the control panel or using Smart Organizing Monitor and printer driver. This machine does not detect the paper size automatically.
- When loading custom size paper, specify the width and length using the control panel and the printer driver.

2

### Tray 1

Type	Size	Weight	Capacity
Plain Paper	A4, 8 <sup>1</sup> / <sub>2</sub> × 11, B5 JIS, B6 JIS,	52 to 162 g/m <sup>2</sup>	250
Recycled Paper	A5 LEF, A5 SEF, A6, 8 <sup>1</sup> / <sub>2</sub> ×	(14 to 43 lb.)	(80 g/m <sup>2</sup> , 20 lb.)
Thick Paper 1	14, 8 <sup>1</sup> / <sub>2</sub> × 13, 8.5 × 13.4, 8.5		
Thick Paper 2	× 13.6, 16K, 8.11 × 13.3,		
Thin Paper	5 <sup>1</sup> / <sub>2</sub> × 8 <sup>1</sup> / <sub>2</sub>		
Letterhead			
Preprinted Paper			
Label Paper			
Prepunched Paper			
Bond Paper			
Cardstock			
Color Paper			

Type	Size	Weight	Capacity
Plain Paper	Custom size:	52 to 162 g/m <sup>2</sup>	250
Recycled Paper	100 to 216 mm in width,	(14 to 43 lb.)	(80 g/m <sup>2</sup> , 20 lb.)
Thick Paper 1	148 to 356 mm in length		
Thick Paper 2	(3.94 to 8.50 inches in width,		
Thin Paper	5.83 to 14.02 inches in length)		
Letterhead			
Preprinted Paper			
Label Paper			
Prepunched Paper			
Bond Paper			
Cardstock			
Color Paper			

**Bypass tray**

Type	Size	Weight	Capacity <sup>*1</sup>
Plain Paper	A4, 8 1/2 × 11, B5 JIS, B6 JIS,	52 to 162 g/m <sup>2</sup>	50
Recycled Paper	A5 LEF, A5 SEF, A6, 8 1/2 ×	(14 to 43 lb.)	(80 g/m <sup>2</sup> , 20 lb.)
Thick Paper 1	14, 8 1/2 × 13, 8.5 × 13.4, 8.5		
Thick Paper 2	× 13.6, 16K, 8.11 × 13.3,		
Thin Paper	5 1/2 × 8 1/2, 4 1/8 × 9 1/2,		
Letterhead	3 7/8 × 7 1/2, DL Env, C6 Env,		
Preprinted Paper	C5 Env		
Envelope			
Label Paper			
Prepunched Paper			
Bond Paper			
Cardstock			
Color Paper			



Type	Size	Weight	Capacity <sup>*1</sup>
Plain Paper	Custom size:	52 to 162 g/m <sup>2</sup>	50
Recycled Paper	90 to 216 mm in width,	(14 to 43 lb.)	(80 g/m <sup>2</sup> , 20 lb.)
Thick Paper 1	140 to 356 mm in length		
Thick Paper 2	(3.54 to 8.50 inches in width,		
Thin Paper	5.51 to 14.02 inches in length)		
Letterhead			
Preprinted Paper			
Envelope			
Label Paper			
Prepunched Paper			
Bond Paper			
Cardstock			
Color Paper			

\*1 The number of envelopes that can be loaded is up to 8.

#### ↓ Note

- Always set the paper vertically regardless of the size.

## Specifications of Paper Types

The following tables describe the types of paper that can be used with this machine.

#### ★ Important

- Depending on the paper type, the toner may take a while to dry. Before handling printed sheets, make sure that they have fully dried. Otherwise, the toner may smudge.
- Print quality can be guaranteed only if recommended paper is used. For more information about the recommended paper, contact your sales or service representative.

### Plain Paper

Item	Description
Paper thickness	65 to 99 g/m <sup>2</sup> (17 to 27 lb.)
Supported paper tray	Tray 1 and bypass tray

Item	Description
Duplex supported size	A4, 8 <sup>1</sup> / <sub>2</sub> × 11, 8 <sup>1</sup> / <sub>2</sub> × 14, 8 <sup>1</sup> / <sub>2</sub> × 13, 8.5 × 13.4, 8.5 × 13.6, 8.11 × 13.3

### Thick Paper 1

Item	Description
Paper thickness	100 to 130 g/m <sup>2</sup> (27 to 35 lb.)
Supported paper tray	Tray 1 and bypass tray
Duplex supported size	A4, 8 <sup>1</sup> / <sub>2</sub> × 11, 8 <sup>1</sup> / <sub>2</sub> × 14, 8 <sup>1</sup> / <sub>2</sub> × 13, 8.5 × 13.4, 8.5 × 13.6, 8.11 × 13.3

### Thick Paper 2

Item	Description
Paper thickness	131 to 162 g/m <sup>2</sup> (35 to 43 lb.)
Supported paper tray	Tray 1 and bypass tray
Duplex supported size	None

### Thin Paper

Item	Description
Paper thickness	52 to 64 g/m <sup>2</sup> (14 to 16 lb.)
Supported paper tray	Tray 1 and bypass tray
Duplex supported size	A4, 8 <sup>1</sup> / <sub>2</sub> × 11, 8 <sup>1</sup> / <sub>2</sub> × 14, 8 <sup>1</sup> / <sub>2</sub> × 13, 8.5 × 13.4, 8.5 × 13.6, 8.11 × 13.3

## Recycled Paper

Item	Description
Paper thickness	75 to 90 g/m <sup>2</sup> (20 to 24 lb.)
Supported paper tray	Tray 1 and bypass tray
Duplex supported size	A4, 8 <sup>1</sup> / <sub>2</sub> × 11, 8 <sup>1</sup> / <sub>2</sub> × 14, 8 <sup>1</sup> / <sub>2</sub> × 13, 8.5 × 13.4, 8.5 × 13.6, 8.11 × 13.3
Notes	If the paper thickness is outside the specified range, select [Thin Paper], [Plain Paper], [Thick Paper 1], or [Thick Paper 2].

## Color Paper

Item	Description
Paper thickness	75 to 90 g/m <sup>2</sup> (20 to 24 lb.)
Supported paper tray	Tray 1 and bypass tray
Duplex supported size	A4, 8 <sup>1</sup> / <sub>2</sub> × 11, 8 <sup>1</sup> / <sub>2</sub> × 14, 8 <sup>1</sup> / <sub>2</sub> × 13, 8.5 × 13.4, 8.5 × 13.6, 8.11 × 13.3
Notes	If the paper thickness is outside the specified range, select [Thin Paper], [Plain Paper], [Thick Paper 1], or [Thick Paper 2].

## Preprinted Paper

Item	Description
Paper thickness	75 to 90 g/m <sup>2</sup> (20 to 24 lb.)
Supported paper tray	Tray 1 and bypass tray
Duplex supported size	A4, 8 <sup>1</sup> / <sub>2</sub> × 11, 8 <sup>1</sup> / <sub>2</sub> × 14, 8 <sup>1</sup> / <sub>2</sub> × 13, 8.5 × 13.4, 8.5 × 13.6, 8.11 × 13.3
Notes	If the paper thickness is outside the specified range, select [Thin Paper], [Plain Paper], [Thick Paper 1], or [Thick Paper 2].

## Prepunched Paper

Item	Description
Paper thickness	75 to 90 g/m <sup>2</sup> (20 to 24 lb.)
Supported paper tray	Tray 1 and bypass tray
Duplex supported size	A4, 8 <sup>1</sup> / <sub>2</sub> × 11, 8 <sup>1</sup> / <sub>2</sub> × 14, 8 <sup>1</sup> / <sub>2</sub> × 13, 8.5 × 13.4, 8.5 × 13.6, 8.11 × 13.3
Notes	If the paper thickness is outside the specified range, select [Thin Paper], [Plain Paper], [Thick Paper 1], or [Thick Paper 2].

## Letterhead

Item	Description
Paper thickness	100 to 130 g/m <sup>2</sup> (27 to 35 lb.)
Supported paper tray	Tray 1 and bypass tray
Duplex supported size	A4, 8 <sup>1</sup> / <sub>2</sub> × 11, 8 <sup>1</sup> / <sub>2</sub> × 14, 8 <sup>1</sup> / <sub>2</sub> × 13, 8.5 × 13.4, 8.5 × 13.6, 8.11 × 13.3
Notes	Paper that has a thickness outside the specified range cannot be printed onto.

## Bond Paper

Item	Description
Paper thickness	105 to 160 g/m <sup>2</sup> (28 to 43 lb.)
Supported paper tray	Tray 1 and bypass tray
Duplex supported size	None
Notes	If the paper thickness is outside the specified range, select [Thin Paper], [Plain Paper], [Thick Paper 1], or [Thick Paper 2].

## Cardstock

Item	Description
Paper thickness	105 to 160 g/m <sup>2</sup> (28 to 43 lb.)
Supported paper tray	Tray 1 and bypass tray
Duplex supported size	None
Notes	If the paper thickness is outside the specified range, select [Thin Paper], [Plain Paper], [Thick Paper 1], or [Thick Paper 2].

## Label Paper

Item	Description
Paper thickness	105 to 160 g/m <sup>2</sup> (28 to 43 lb.)
Supported paper tray	Tray 1 and bypass tray
Duplex supported size	None
Notes	Avoid using adhesive label paper on which glue is exposed. Glue may stick to the inner parts of the machine, which can cause paper feed problems, deterioration in print quality, or premature wear of the print cartridge's photo conductor unit.

## Envelope

Item	Description
Supported paper tray	Bypass tray
Duplex supported size	None

### Notes

- Avoid using self-adhesive envelopes. They may cause machine malfunctions.
- The number of envelopes that can be printed per minute is approximately half that of middle thick paper.
- Paper can be loaded only up to the lower of the two paper limit marks of the tray.

- If printed envelopes come out badly creased, load the envelopes in the opposite direction. Also, configure the printer driver to rotate the print object 180 degrees. For details about changing the orientation see the printer driver Help.
- Environmental factors can degrade the print quality on both recommended and non-recommended envelopes.
- If envelopes are severely curled after printing, flatten them by bending them back against the curl.
- After printing, envelopes sometimes have creases along their long edges and toner smear on their unprinted sides. Print images might also be blurred. When printing large, black-solid areas, striping can occur as a result of the envelopes overlapping.
- To correctly specify the length of an envelope whose flap opens along its short edge, be sure to include the open flap when measuring.

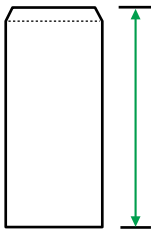

CER112

- Fan envelopes, and then align their edges before loading.

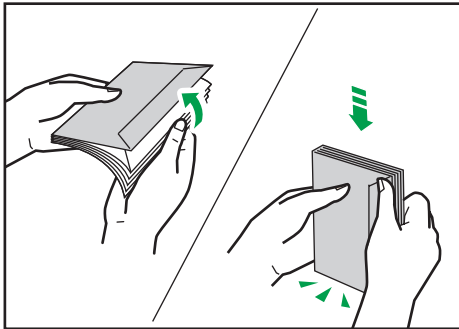

DAC573

- When fanning envelopes, make sure they are not stuck together. If they are stuck together, separate them.
- When fanning envelopes, make sure the envelope flaps are not stuck. If they are stuck, separate them.
- Before loading envelopes, flatten them out so that their curl does not exceed that shown as shown below.

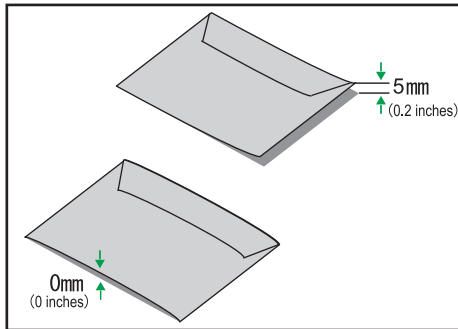

DAC574

- If the curl is severe, flatten out the envelopes using your fingers, as shown below.

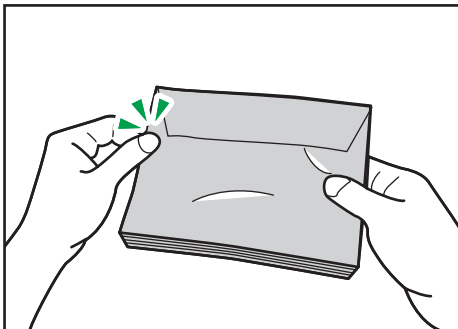

DAC575

## Non-Recommended Paper Types

Do not use the following types of paper:

- Ink-jet printer paper
- Bent, folded, or creased paper
- Curled or twisted paper
- Torn paper
- Wrinkled paper
- Damp paper
- Dirty or damaged paper
- Paper that is dry enough to emit static electricity
- Paper that has already been printed onto, except a preprinted letterhead paper.

Malfunctions are especially likely when using paper printed on by other than a laser printer (e.g. monochrome and color copiers, ink-jet printers, etc.)

- Special paper, such as thermal paper and carbon paper
- Paper weighing heavier or lighter than the limit

- Paper with windows, holes, perforations, cutouts, or embossing
- Adhesive label paper on which glue or base paper is exposed
- Paper with clips or staples

**Note**

- When loading paper, take care not to touch the surface of the paper.
- Even if paper is adequate for the machine, poorly stored paper can cause paper misfeeds, print quality degradation, or malfunctions.

## Paper Storage

**Important**

- **Store paper appropriately. If the paper is stored incorrectly, misfeeds, lower printing quality, or malfunctions may result.**

When storing paper:

- Do not store paper in a humid place.
- Do not store paper in direct sunlight.
- Do not stand paper on its edge.
- Store any leftover paper in a wrapping or box supplied with the paper.

## Print Area

The diagram below shows the area of the paper that the machine can print on.

**From the printer driver**

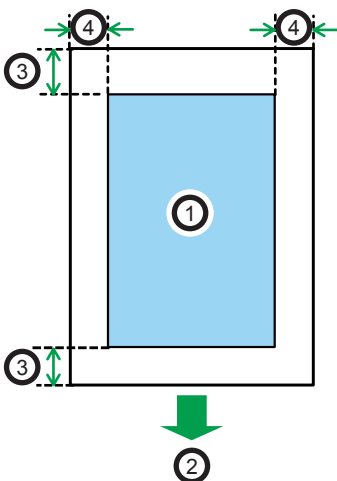

CH2904



1. Print area
2. Feed direction
3. Approx. 4.2 mm (0.2 inches)
4. Approx. 4.2 mm (0.2 inches)

### Envelope

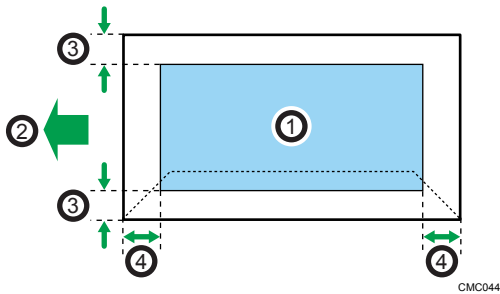

1. Print area
2. Feed direction
3. Approximately 4.2 mm (0.2 inches)
4. Approximately 4.2 mm (0.2 inches)

### Copier function

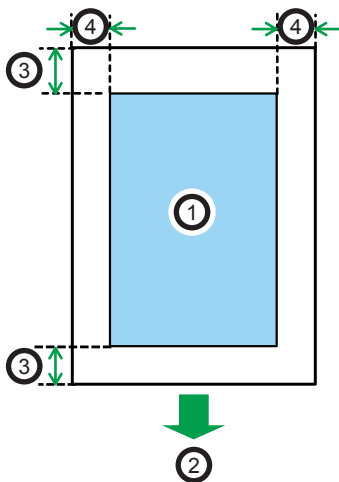

1. Print area
2. Feed direction
3. Approx. 4 mm (0.2 inches)
4. Approx. 2.8 mm (0.1 inches)

### Fax function

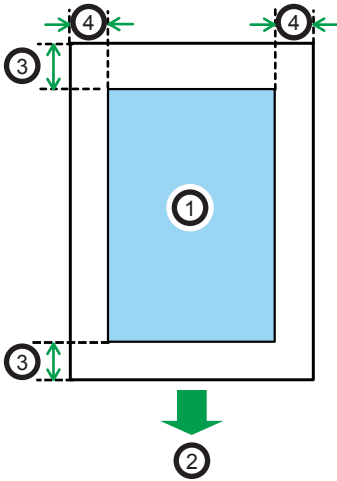

CH2904

1. Print area
2. Feed direction
3. Approx. 4.2 mm (0.2 inches)
4. Approx. 2 mm (0.08 inches)

#### ↓ Note

- The print area may vary depending on the paper size, printer language and printer driver settings.
- For better envelope printing, we recommend you set the right, left, top, and bottom print margins to at least 15 mm (0.6 inches) each.

# Placing Originals

This section describes the types of originals you can set and how to place them.

## Placing Originals on the Exposure Glass

This section describes the procedure for placing originals on the exposure glass.

### ★ Important

- Do not place originals before any correction fluid and toner has completely dried. Doing so may make marks on the exposure glass that will appear on copies.
- The original in the ADF takes precedence over the original on the exposure glass if you place originals both in the ADF and on the exposure glass.

### ↓ Note

- Because colors made by marker or highlighter pen on originals are difficult to reproduce, they might not appear on copies.

#### 1. Lift the ADF or the exposure glass cover.

Be careful not to hold the input tray when lifting the ADF, for the tray might be damaged.

#### 2. Place the original face down on the exposure glass. The original should be aligned to the rear left corner.



DSG127

#### 3. Lower the ADF or the exposure glass cover.

Hold down the ADF or the exposure glass cover with your hands when using thick, folded, or bound originals and when the ADF or the exposure glass cover cannot be lowered completely.

## Placing Originals in the Auto Document Feeder (only SP 320SFN, SP 325SNw, and SP 325SFNw)

By using the ADF, you can scan multiple pages at once.

**★ Important**

- Do not place different size originals in the ADF at once.
- Straighten curls in the originals before placing them in the ADF.
- To prevent multiple sheets from being fed at once, fan the pages of your original before placing them in the ADF.
- Place the original squarely.

1. Open the cover of the input tray for the ADF and adjust the guides according to the size of the original.

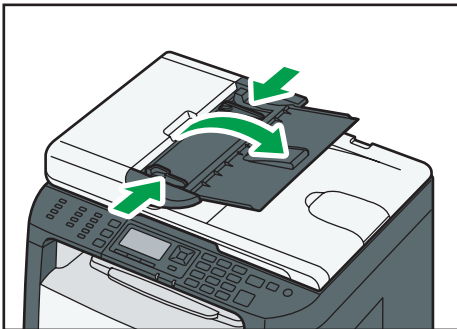

DSG128

2. Place the aligned originals face up in the ADF. The last page should be on the bottom.

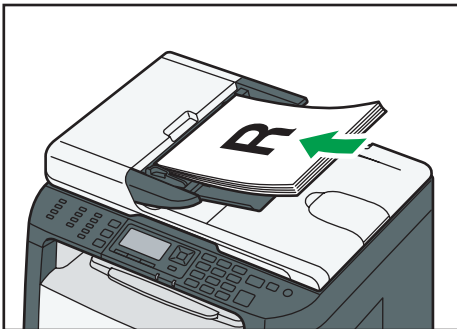

DSG129

**↓ Note**

- When placing originals longer than A4, pull out the ADF tray's extenders.

---

## About Originals

---

This section describes the types of originals that can be placed and the parts of the original that are unscannable.

## Recommended size of originals

---

This section describes the recommended size of the original.

### Exposure glass

Up to 216 mm (8.5 inches) in width, up to 297 mm (11.7 inches) in length

### ADF (only SP 320SFN, SP 325SNw, and SP 325SFNw)

- Paper size: 140 to 216 mm (5<sup>1</sup>/<sub>2</sub> to 8<sup>1</sup>/<sub>2</sub> inches) in width, 140 to 356 mm (5<sup>1</sup>/<sub>2</sub> to 14 inches) in length
- Paper weight: 52 to 120 g/m<sup>2</sup> (13.8 to 28.0 lb.)

#### Note

- Only 1 sheet of an original can be placed on the exposure glass at a time.
- In the ADF, up to 35 sheets of originals can be placed at once (when using paper weighing 80 g/m<sup>2</sup>, 20 lb.).

### Types of originals not supported by the Auto Document Feeder (only SP 320SFN, SP 325SNw, and SP 325SFNw)

---

If placed in the ADF, the following types of original might be damaged or become jammed, or result in gray or black lines appearing on prints:

- Originals larger or heavier than recommended
- Stapled or clipped originals
- Perforated or torn originals
- Curled, folded, or creased originals
- Pasted originals
- Originals with any kind of coating, such as thermal fax paper, art paper, aluminum foil, carbon paper, or conductive paper
- Originals with perforated lines
- Originals with indexes, tags, or other projecting parts
- Sticky originals such as translucent paper
- Thin, highly flexible originals
- Thick originals such as postcards
- Bound originals such as books
- Transparent originals such as OHP transparencies or translucent paper
- Originals that are wet with toner or white out

## Unscannable image area

Even if you correctly place originals in the ADF or on the exposure glass, margins of a few millimeters on all four sides of the original might not be scanned.

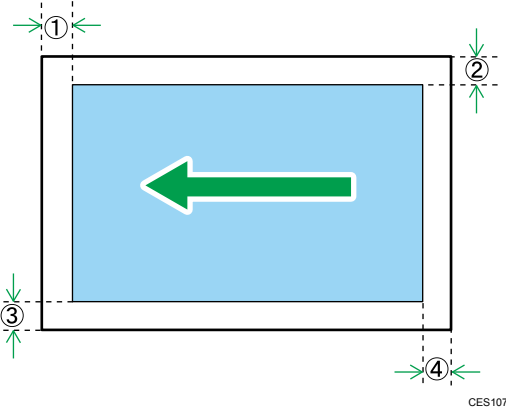

2

### Margins when using exposure glass

	In copier mode	In scanner mode	In fax mode
① Top	4 mm	0 mm	0 mm
② Right	3 mm	0 mm	0 mm
③ Left	3 mm	0 mm	0 mm
④ Bottom	3 mm	0 mm	0 mm

### Margins when using ADF (only SP 320SFN, SP 325SNw, and SP 325SFNw)

	In copier mode	In scanner mode	In fax mode
① Top	4 mm	0 mm	0 mm
② Right	3 mm	0 mm	0 mm
③ Left	3 mm	0 mm	0 mm
④ Bottom	3 mm	2 mm	0 mm

# 3. Printing Documents

This chapter describes how to configure settings on the printer driver and print documents.

## What You Can Do with the Printer Function

### Duplex printing

You can print on both sides of a sheet of paper. For details, see the printer driver Help.



DSG261

### Combined printing

You can combine multiple pages and print them on a single sheet of paper. For details, see the printer driver Help.



DSG262

## Displaying the Printing Preferences Dialog Box

To change the default settings of the printer driver, configure settings in the [Printing Preferences] dialog box.

To change the default settings of all applications, open the [Printing Preferences] dialog box from the OS. For details, see page 70 "Displaying the Printing Preferences Dialog Box from the [Start] Menu".

To change the default settings of a specific application, open the [Printing Preferences] dialog box from that application. For details, see page 70 "Displaying the Printing Preferences Dialog Box in an Application".

3

---

### Displaying the Printing Preferences Dialog Box from the [Start] Menu

---

This section explains how to open the [Printing Preferences] dialog box from [Devices and Printers].

 **Important**

- When the printer driver is distributed from the print server, the setting values specified by the server are displayed as the default for [Printing Defaults...].
  - You cannot configure different print settings for each user. The settings configured in this dialog box are used as the default.
1. On the [Start] menu, click [Devices and Printers].
  2. Right-click the icon of the printer you want to use.
  3. Click [Printing Preferences].

---

### Displaying the Printing Preferences Dialog Box in an Application

---

You can make printer settings for a specific application. To make printer settings for a specific application, open the [Printing Preferences] dialog box from that application.

The settings displayed in the [Printing Preferences] dialog box opened from the [Devices and Printers] window are applied as the default in the [Printing Preferences] dialog box opened in an application. When printing from an application, modify the settings as required.

The screens displayed may differ depending on the application. The following procedure explains how to print documents from an application using WordPad in Windows 7 as an example.

#### Displaying the Printing Preferences Dialog Box in an Application When Using Windows

---

1. Click the WordPad menu button in the upper left corner of the window, and then click [Print].



2. In the [Select Printer] list, select the printer you want to use.
3. Click [Preferences].

**Note**

- Procedures for opening the [Printing Preferences] dialog box vary depending on the application. For details, see the printer driver Help or the manuals provided with the application.

## Displaying the Printing Preferences Dialog Box in an Application When Using OS X

The following procedure is explained using OS X 10.11 as an example.

1. Open the document to print.
2. Select [Print...] on the [File] menu.
3. Check that the machine name or IP address you are using is selected in the [Printer:] popup menu.

If the machine name or IP address you are using is not selected in the [Printer:] list, click the list, and then select the machine.

# Basic Operation of Printing

The following procedure explains how to perform basic printing.

The procedure in this section is an example based on Windows 7. The actual procedure may vary depending on the operating system you are using.

For details of printing options, see the printer driver Help.

## 1. Open the printer properties dialog box in your document's application.

3

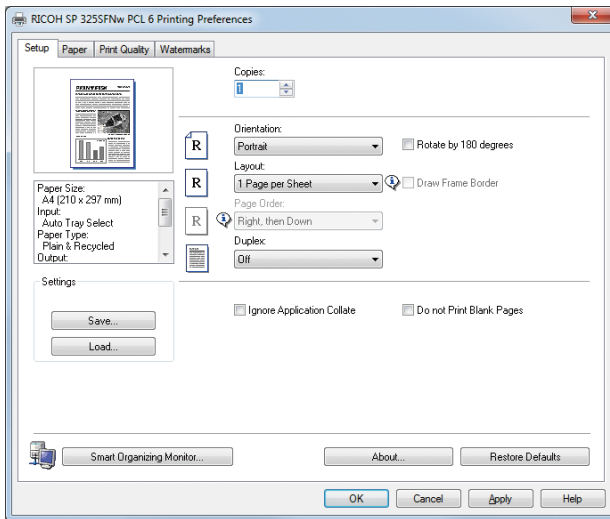

For details about each setting, click [Help]. You can also click the information icons to show configuration information.

## 2. Set printing options as necessary, and then click [OK].

The printer properties dialog box closes.

## 3. Click [Print].

### Note

- If a paper jam occurs, printing stops after the current page has been printed out. After the jammed paper is removed, printing restarts from the jammed page automatically. For details about how to remove the jammed paper, see page 281 "Clearing Misfeeds".
- After printing on envelopes, make sure to pull up the levers for printing on envelopes back to their original positions. Leaving the levers lowered can cause print quality problems when printing on paper other than envelopes. For details about the levers for printing on envelopes, see page 36 "Loading Paper".

---

## If a Paper Mismatch Occurs

---

The machine reports an error if:

- The paper type does not match the print job's settings when [Input Tray:] is set to [Auto Tray Select].
- The paper size does not match the print job's settings when [Size Mismatch Detection] under [Tray Paper Settings] is enabled.

There are two ways to resolve these errors:

### Continue printing using mismatched paper

Ignore the error and print using mismatched paper.

### Cancel the print job

Cancel printing.

#### Note

- For details about [Size Mismatch Detection], see page 202 "Tray Paper Settings".
- If [Auto Continue] under [System Settings] is enabled, the machine ignores the paper type and size settings and prints on whatever paper is loaded. Printing stops temporarily when the error is detected, and restarts automatically after about ten seconds using the settings made on the control panel. For details about [Auto Continue], see page 193 "System Settings".

### Continuing printing using mismatched paper

---

If the paper is too small for the print job, the printed image will be cropped.

1. If the error message is displayed, press the [OK] key.

---

## Canceling a Print Job

---

You can cancel print jobs using either the machine's control panel or your computer, depending on the status of the job.

### Canceling a print job before printing has started

---

- Windows
  1. Double-click the printer icon on the task tray of your computer.
  2. Select the print job you want to cancel, click the [Document] menu, and then click [Cancel].
  3. Click [Yes].

**Note**

- If you cancel a print job that has already been processed, printing may continue for a few pages before being canceled.
- It may take a while to cancel a large print job.

## Canceling a print job while printing

---

1. Press the [Clear/Stop] key.

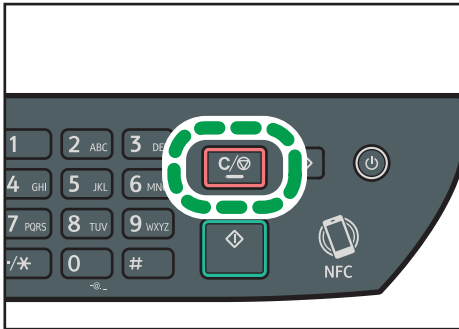

DSG129

# 4. Copying Originals

This chapter describes the basic and advanced procedures for making copies and how to specify settings.

## What You Can Do with the Copier Function

### Duplex copying

You can copy two pages onto both sides of a single sheet of paper. For details about the settings, see page 82 "Copying Single-Sided Originals with 2-Sided and Combined Printing" and page 86 "Copying 2-Sided Originals with 2-Sided and Combined Printing".

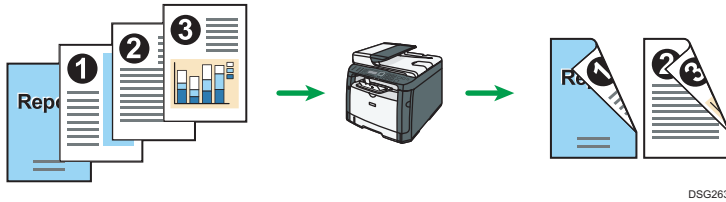

### Combined copying (only SP 320SFN, SP 325SNw, and SP 325SFNw are available)

You can copy multiple pages onto a single sheet of paper. For details about the settings, see page 82 "Copying Single-Sided Originals with 2-Sided and Combined Printing" and page 86 "Copying 2-Sided Originals with 2-Sided and Combined Printing".

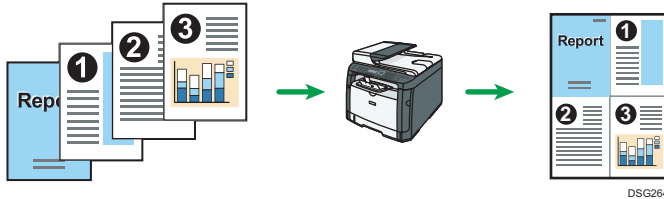

### ID card copying

ID card copying allows you to copy the front and back sides of an ID card or passport onto one side of a sheet of paper. For details, see page 89 "Copying an ID Card".

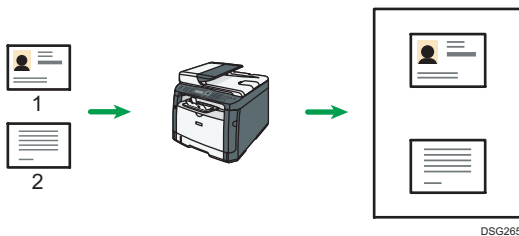

# Copier Mode Screen

This section provides information about the screen when the machine is in copier mode.

By default, the display shows the copier screen when the machine is turned on.

If the scanner or fax screen is shown on the display, press the [Copy] key on the control panel to switch to the copier screen.

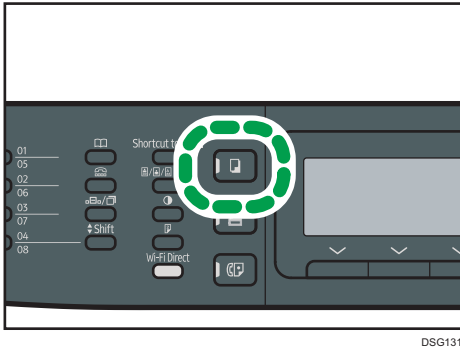

DSG131

## Screen in standby mode

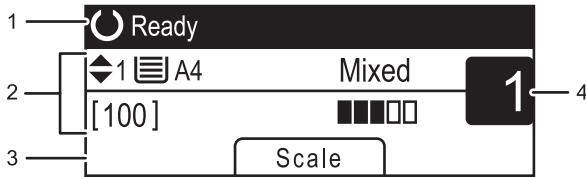

DSG132

### 1. Current status or messages

Displays the current status or messages.

### 2. Current settings

Displays the current tray, reproduction ratio, and scan settings.

### 3. Selection key items

Displays the functions you can use by pressing the corresponding selection keys.

### 4. Copy quantity

Displays the current copy quantity. You can change the copy quantity using the number keys.

## ↓ Note

- The start-up mode can be specified in the [Function Priority] setting under [Admin. Tools]. For details, see page 206 "Administrator Settings".

# Basic Operation of Copying

## ★ Important

- The original in the ADF takes precedence over the original on the exposure glass if you place originals both in the ADF and on the exposure glass.

### 1. Press the [Copy] key.

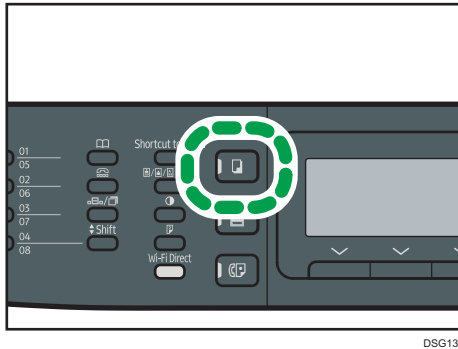

### 2. Place the original on the exposure glass or in the ADF.

To place the original, see page 65 "Placing Originals". If necessary, configure advanced photocopy settings.

### 3. To make multiple copies, enter the number of copies using the number keys.

### 4. Press the [Start] key.

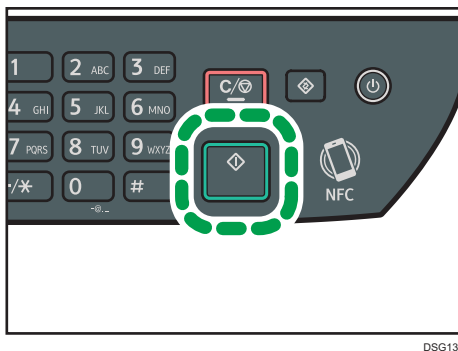

## ↓ Note

- The maximum number of copies is 99.
- You can change the paper tray for the current job by pressing the [▲] or [▼] key. You can also select to change the paper tray automatically according to the paper size (A4, Letter, or 16K).
- You can select the paper tray for printing out copies in [Select Paper] under [Copier Features]. If you set the machine to switch between tray 1 and the bypass tray automatically depending on the paper size in this setting, you can also specify the tray the machine uses first in [Paper Tray Priority]

under [Tray Paper Settings]. For [Select Paper], see page 176 "Copier Features Settings". For [Paper Tray Priority], see page 202 "Tray Paper Settings".

- When making multiple copies of a multi-page document, you can select whether copies are output in collated sets, or in page batches in the [Sort] setting under [Copier Features]. For [Sort], see page 176 "Copier Features Settings".
- If a paper jam occurs, printing stops after the current page has been printed out. After the jammed paper is removed, printing restarts from the jammed page automatically.
- If a scanning jam occurs in the ADF, copying is canceled immediately. In this case, copy the originals again starting from the jammed page. For the direction to remove the jammed paper, see page 281 "Clearing Misfeeds".

4

## Canceling a Copy

### While scanning the original

If copying is canceled while the machine is scanning the original, copying is cancelled immediately and there is no printout.

When the original is set in the ADF, scanning stops immediately but pages that have already been scanned completely will be copied.

### While printing

If copying is canceled during printing, the photocopy process is canceled after the current page has been printed out.

Follow the procedure below to cancel copying.

1. Press the [Copy] key.

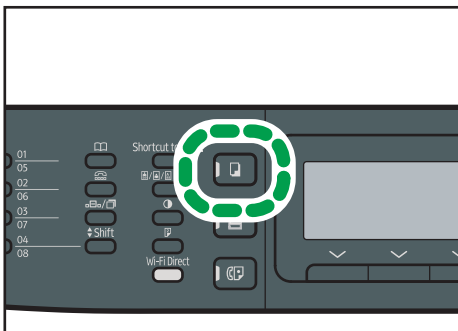



2. Press the [Clear/Stop] key.

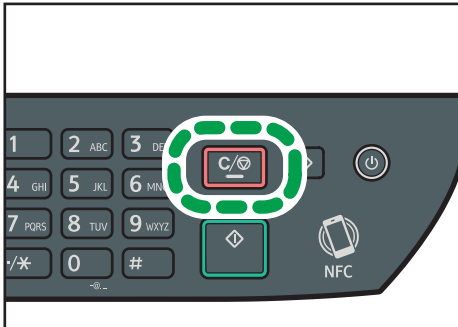

DSG129

# Making Enlarged or Reduced Copies

There are two ways to set the scaling ratio: using a preset ratio or manually specifying a customized ratio.

## Preset ratio

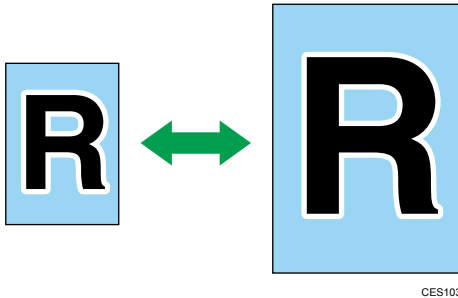

- **Region A** (mainly Europe and Asia)  
50%, 71%, 82%, 93%, 122%, 141%, 200%, 400%
- **Region B** (mainly North America)  
50%, 65%, 78%, 93%, 129%, 155%, 200%, 400%

## Custom ratio



25% to 400% in 1% increments.

---

## Specifying Reduce/Enlarge

---

1. Press [Scale].

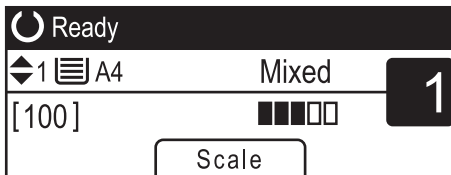

**2. Press [Reduce], [Enlarge], or [Zoom].**

For [Reduce] or [Enlarge], press the [▲], [▼], [◀], or [▶] key to select the desired ratio. For [Zoom], specify the desired ratio using the number keys.

**3. Press the [OK] key.**

# Copying Single-Sided Originals with 2-Sided and Combined Printing

This section explains how to combine and print a multiple pages (two or four pages) on one side or both sides of paper. (only SP 320SFN, SP 325SNw, and SP 325SFNw are available)

**★ Important**





- This function is only available when the original is set in the ADF, not when it is set on the exposure glass.
- To use this function, the paper size used for printing copies must be set to A4, Letter or Legal.
- Paper between 64 and 105 g/m<sup>2</sup> can be used for duplex printing.
- The types of paper that can be used for 2-sided copy are plain, thin, thick 1, recycled, color, letterhead, preprinted, and prepunched.

There are following copy modes. Select a copy mode according to your original and how you want the copy outputs to appear.

**Combined copy on one side**

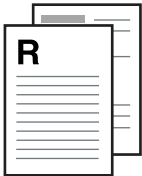





In this mode, a two or four-page original is combined and printed on one side of paper.

- 1Sd 2Orig->Comb 2on1 1Sd

	Original	Copy
Portrait		
Landscape		

CMF250

- 1Sd 4Orig->Comb 4on1 1Sd







	Original	Copy	
Portrait		Left to Right 	Top to Bottom 
Landscape		Left to Right 	Top to Bottom 

CMF251

**Combined copy on both sides**

In this mode, a multiple-page original is combined and printed on both sides of paper.

- 1Sd 1Orig->Comb 2on1 2Sd

	Original	Copy	
Portrait		Top to Top 	Top to Bottom 
Landscape		Top to Top 	Top to Bottom 

CMF254

- 1Sd 8Orig->Comb 4on1 2Sd

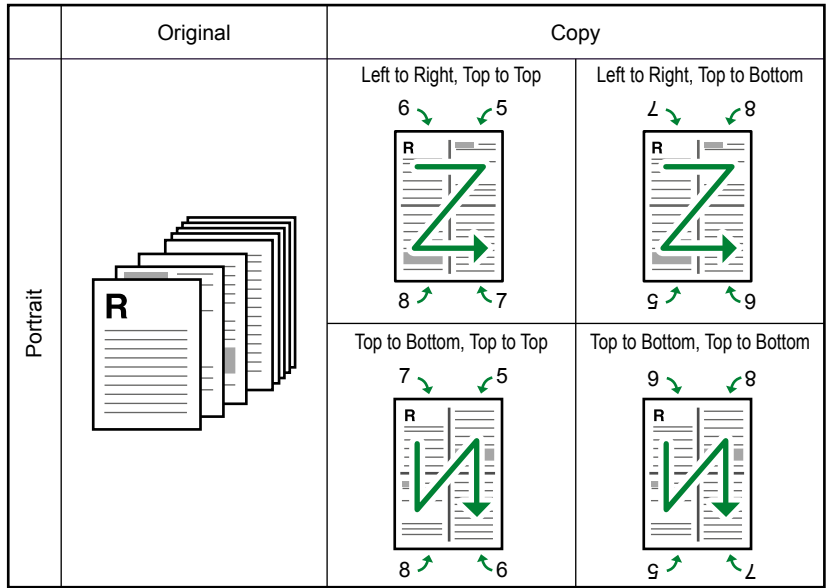



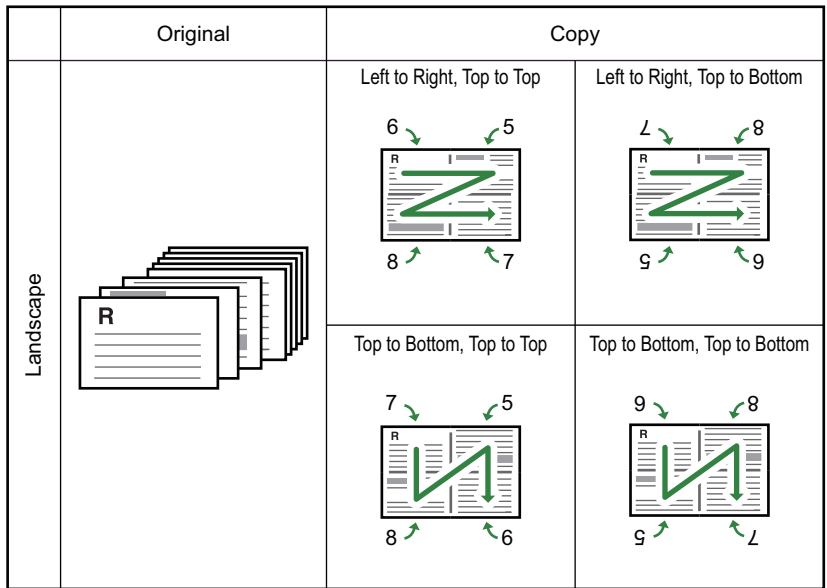

CMF255

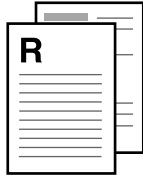

DC7004

**1 Sided Orig->2 Sided Copy**

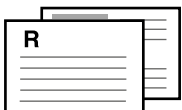
In this mode, one-sided pages are printed on the front and back sides of paper without being combined.

	Original	Copy	
Portrait		Top to Top 	Top to Bottom 
Landscape		Top to Top 	Top to Bottom 

CMF260

## Specifying Combined and 2-sided Copies

1. Press the [Duplex] key.

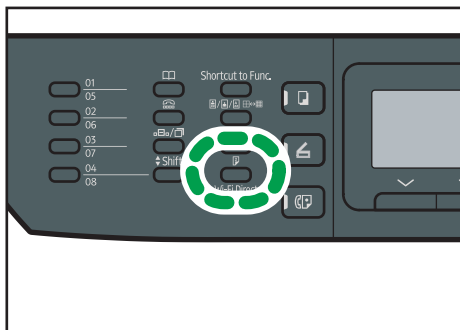

DSG135

2. Press the [▲] or [▼] key to select the desired copy mode, and then press the [OK] key.
3. Press the [▲] or [▼] key to select paper orientation and page order, and then press the [OK] key.

### ↓ Note

- You can change the machine's default [Duplex/Combine] setting to always make photocopies in combine mode. For details, see page 176 "Copier Features Settings".

# Copying 2-Sided Originals with 2-Sided and Combined Printing

This section explains how to make 2-sided copies of 2-sided originals, or copy two original pages to one sheet, or copy four original pages to one sheet with two pages per side. (only SP 325SNw and SP 325SFNw are available)

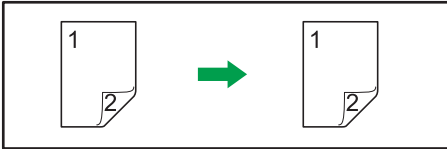

DAC602



DAC603

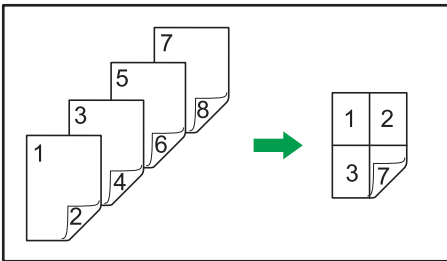

DAC603

## ★ Important

- Make sure the same number of pages will be printed on the front and back of all sheets. Otherwise, the job will be reset.

The following five types of manual 2-sided copying are available.

### 2Sd 1Orig->Comb 2on1 1Sd

Copies one 2-sided original to one side of a sheet.

### 2Sd 2Orig->Comb 4on1 1Sd

Copies two 2-sided originals to one side of a sheet.

### 2 Sided Orig->2 Sided Copy

Makes 2-sided copies of 2-sided originals.

### 2Sd 2Orig->Comb 2on1 2Sd

Copies both sides of one 2-sided original to one side of a sheet, and both sides of another 2-sided original to the other side of the sheet.



**2Sd 4Orig->Comb 4on1 2Sd**

Copies four 2-sided originals to one sheet with four pages per side.

**Duplex Copying Manually Using the ADF (for SP 320SFN)**

1. Press the [Duplex] key.

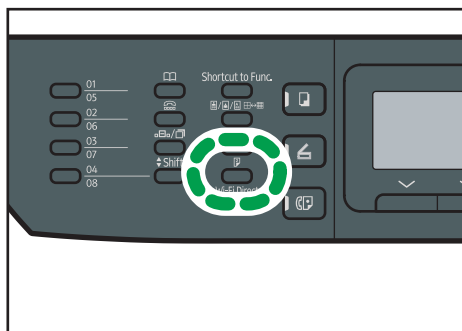

DSG135

2. Press the [▲] or [▼] key to select the desired copy mode, and then press the [OK] key.
3. Press the [▲] or [▼] key to select paper orientation and page order, and then press the [OK] key.
4. Press the [Back] key.
5. Place all 2-sided originals into the ADF with their fronts facing up.
6. Press the [▲] or [▼] key to select a paper tray.
7. Press the [Start] key.

**Note**

- After you place the originals, press the [Start] key within the time specified in [System Auto Reset Timer]. Otherwise, the job is canceled. For details, see page 206 "Administrator Settings".
- If the memory becomes full while originals are being scanned, the job is canceled.

**Duplex Copying Manually Using the Exposure Glass (for SP 320SN)****★ Important**

- When printing odd pages in [Manual 2 Sided Scan Mode], the last page cannot be printed. Before printing the last page, set the [Duplex/Combine] to [Off].

1. Press the [Duplex] key.
2. Press the [▲] key or [▼] key to select [Manual 2 Sided Scan Mode], and then press the [OK] key.

- 3. Place the original on the exposure glass front side down and with the top to the rear of the machine.**

Place the originals one by one.

- 4. Press the [Start] key.**

A message prompting you to place the original back side down on the exposure glass appears on the display.

- 5. Place the original on the exposure glass with the back side faced down and with the top to the rear of the machine.**

- 6. Press the [Start] key again.**

When all originals have been scanned, press the [Clear/Stop] key.

4

 **Note**

- After you load the original, press the [Start] key within the time specified in [System Auto Reset Timer]. Otherwise, the job is canceled. For details, see page 206 "Administrator Settings".
- Sort is not available.

# Copying an ID Card

This section describes how to copy the front and back sides of an ID card or other small documents onto one side of a sheet of paper.

## ★ Important

- This function is available only when the original is set on the exposure glass, not when it is set in the ADF.
- To use this function, the paper size used for printing copies must be set to A6, A5, A4, Half Letter or Letter.

Printed paper size	Scanned paper size
A4	A5 (148×210 mm)
Letter	Half Letter (140×216 mm)
A5	A6 (105×148 mm)
Half Letter	Quarter Letter (108×140 mm)
A6	A7 (74×105 mm)

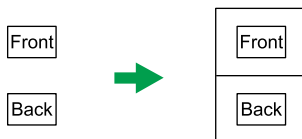

CES165

### 1. Press the [Shortcut to Func.] key.

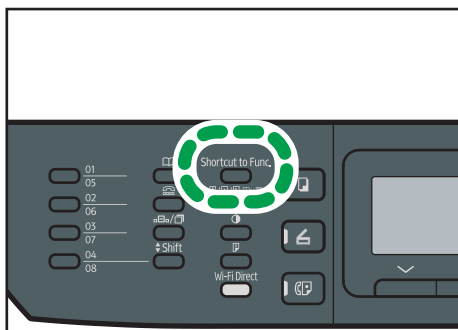

DSG139

To make the [Shortcut to Func.] key enable ID card copy mode for the current job, [Shortcut to Function] under [Admin. Tools] must be set to [ID Card Copy Mode]. You can also assign the setting using Web Image Monitor.

For [Shortcut to Function], see page 206 "Administrator Settings".

- 2. To make multiple copies, enter the number of copies using the number keys.**
- 3. Place the original in the upper-left corner of the exposure glass.**

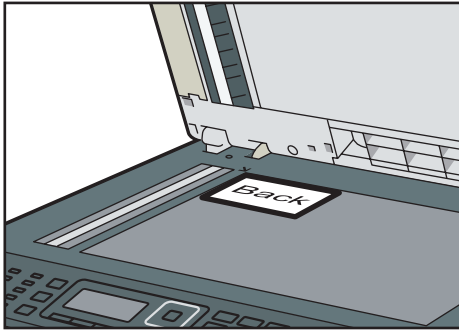

DSG140

- 4. Press the [Start] key.**

A message prompting you to place the original back side down on the exposure glass appears on the display.

- 5. Place the original on the exposure glass with the back side faced down and with the top to the rear of the machine within the time specified in [System Auto Reset Timer], and then press the [Start] key again.**

**Note**

- For the ID card copy function, you can set the machine to print a line in the middle of the printed paper. Specify [ID Card Center Line] under [Copier Features].
- You can change the scanning size for the ID card function. Specify [ID Card Size] under [Copier Features].

# Specifying Scan Settings for Copying

This section describes how to specify image density and scan quality for the current job.

## Adjusting Image Density

There are five image density levels. The higher the density level, the darker the printout.

1. Press the [Density] key.

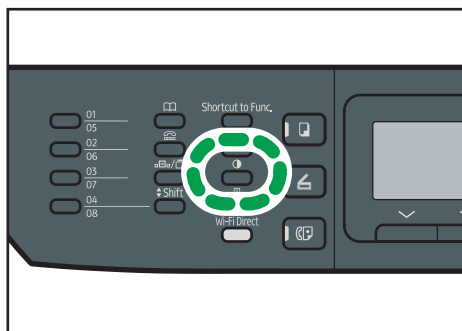

DSG142

2. Press the [◀] or [▶] key to select the desired density level, and then press the [OK] key.

### Note

- You can change the machine's default [Density] setting to always make copies with a specific density level. For details, see page 176 "Copier Features Settings".

## Selecting the Document Type According to Original

There are three document types:

### Mixed

Select this when the original contains both text and photographs or pictures.

### Text

Select this when the original contains only text and no photographs or pictures.

### Photo

Select this when the original contains only photographs or pictures. Use this mode for the following types of original:

- Photographs
- Pages that are entirely or mainly photographs or pictures, such as magazine pages.

1. Press the [Image Quality] key.

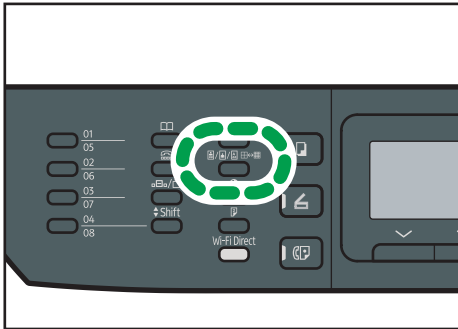

DSG143

4

2. Press the [▲] or [▼] key to select the desired document type, and then press the [OK] key.

↓ Note

- You can change the machine's default [Original Type] setting to always make copies with a specific document type. For details, see page 176 "Copier Features Settings".

# 5. Scanning Originals

This chapter describes how to specify settings and use the scanner function.

## What You Can Do with the Scanner Function

### Send Scanned Documents to a Folder on a Client Computer

For details, see "Basic Operation of Scan to Folder".



### Send Scanned Documents by E-mail

For details, see "Basic Operation of Scan to E-mail".

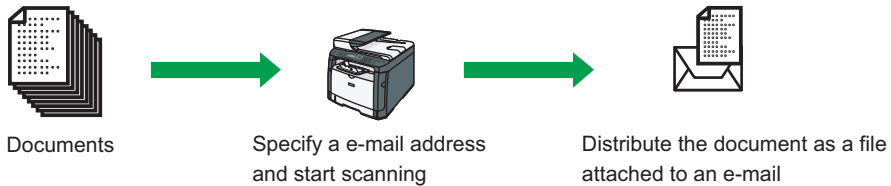

### Scanning Documents from a Client Computer

For details, see "Basic Operation for TWAIN Scanning".

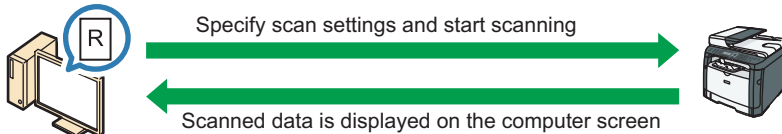

### Saving Scan Files on a USB Flash Memory Device

For details, see "Basic Procedures for Saving Scan Files on a USB Flash Memory Device".

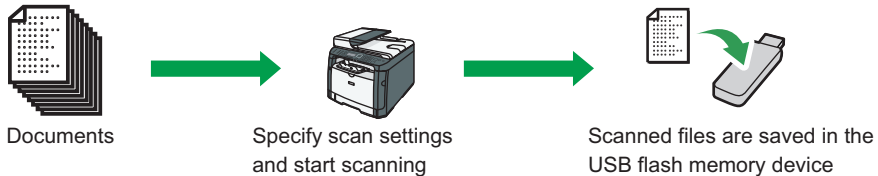

DSG266

# Scanner Mode Screen

This section provides information about the screen in scanner mode.

By default, the display shows the copier screen when the machine is turned on. If the copier or fax screen is shown on the display, press the [Scanner] key on the control panel to switch to the scanner screen.

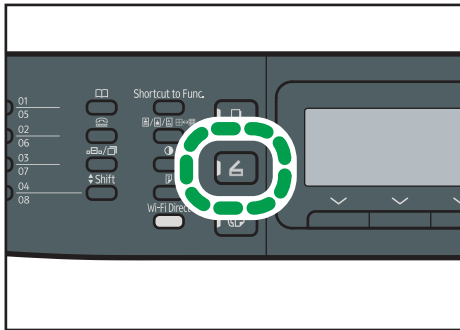

DSG144

5

## Screen in standby mode

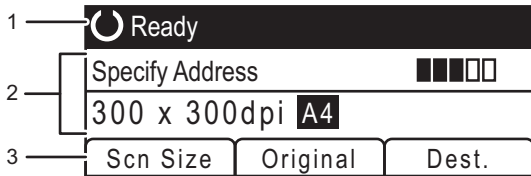

DSG145

### 1. Current status or messages

Displays the current status or messages.

### 2. Current settings

Displays the current scanning mode and scan settings.

- When "Specify Address" is displayed:
  - Scan to E-mail, Scan to FTP, or Scan to Folder functions can be used.

### 3. Selection key items

Displays the functions you can use by pressing the corresponding selection keys.

#### ↓ Note

- The machine's default mode at power on can be specified in the [Function Priority] setting under [Admin. Tools]. For [Function Priority], see page 206 "Administrator Settings".



# Registering Scan Destinations

This section describes how to register scan destinations in the Address Book. To send scanned files to an e-mail address (Scan to E-mail), FTP server (Scan to FTP), or a shared folder on a network computer (Scan to Folder), you must first register the destination in the Address Book using Web Image Monitor.

## ★ Important

- **The Address Book data could be damaged or lost unexpectedly. The manufacturer shall not be responsible for any damages resulting from such data loss. Be sure to create backup files of the Address Book data periodically.**
- **Depending on your network environment, the Scan to FTP and Scan to Folder functions may require a user name and password to be correctly entered in the destination information. In such cases, after registering destinations, check that the user name and password are correctly entered by sending test documents to those destinations.**

The Address Book can contain up to 100 entries, including 8 Quick Dial entries.

Destinations registered as Quick Dial entries can be selected by pressing the corresponding One Touch button (only SP 320SFN and SP 325SFNw).

1. **Start the web browser and access the machine by entering its IP address.**
2. **Click [Quick Dial Destination] or [Scan Destination].**
3. **From the [Destination Type] list, select [E-mail Address], [FTP], or [Folder].**
4. **Register information as necessary.**

The information you must register varies depending on the destination type. For details, see the tables below.

5. **Enter the administrator password if required.**
6. **Click [Apply].**
7. **Close the web browser.**

### Scan to E-mail Settings

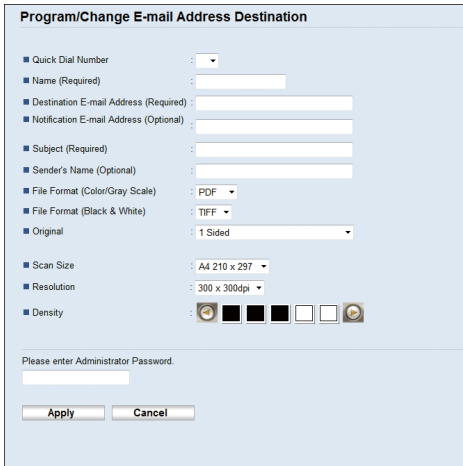

5



Item	Setting	Description
Quick Dial Number	Optional	Select when setting the destination as a Quick Dial entry.
Name	Required	Name of the destination. The name specified here will be shown on the screen when selecting a scan destination. Can contain up to 16 characters.
Destination E-mail Address	Required	E-mail address of the destination. Can contain up to 64 characters.
Notification E-mail Address	Optional	E-mail address to which a notification is sent after transmission. Can contain up to 64 characters.
Subject	Required	Subject of the e-mail. Can contain up to 64 characters.
Sender's Name	Optional	Name of e-mail sender. The name specified here will be shown under "From" or a similar field of the recipient's email application. Can contain up to 32 characters.
File Format (Color/Gray Scale)	Required	File format of the scanned file when scanning in color. PDF or JPEG can be selected. PDF supports multiple pages in a document, but JPEG does not.
File Format (Black & White)	Required	File format of the scanned file when scanning in black and white. PDF or TIFF can be selected. Both formats support multiple pages in a document.

Item	Setting	Description
Original (only SP 325SNw and SP 325SFNw)	Optional	Select the sides of the original (1 side or 2-sides) to scan according to the page and binding orientation.
Scan Size	Optional	Select the scanning size for the original from A5, B5, A4, 7 <sup>1</sup> / <sub>4</sub> × 10 <sup>1</sup> / <sub>2</sub> , 8 <sup>1</sup> / <sub>2</sub> × 5 <sup>1</sup> / <sub>2</sub> , 8 <sup>1</sup> / <sub>2</sub> × 11, 8 <sup>1</sup> / <sub>2</sub> × 14, 16K, or custom size.  If you select custom size, select [mm] or [Inch], and then specify the width and length.
Resolution	Optional	Select the scan resolution from 100×100, 150×150, 200×200, 300×300, 400×400, or 600×600 dpi.
Density	Optional	Specify the image density by clicking the right or left button.  is the lightest, and  is the darkest.

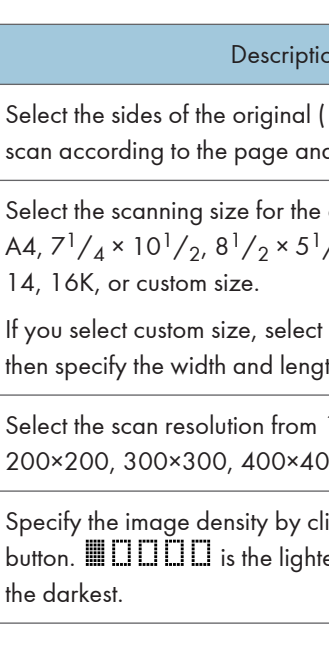
### Scan to FTP Settings



Item	Setting	Description
Quick Dial Number	Optional	Select when setting the destination as a Quick Dial entry.
Name	Required	Name of the destination. The name specified here will be shown on the screen when selecting a scan destination. Can contain up to 16 characters.
Hostname or IP Address	Required	Name or IP address of the FTP server. Can contain up to 64 characters.

Item	Setting	Description
File Format (Color/Gray Scale)	Required	File format of the scanned file when scanning in color. PDF or JPEG can be selected. PDF supports multiple pages in a document, but JPEG does not.
File Format (Black & White)	Required	File format of the scanned file when scanning in black and white. PDF or TIFF can be selected. Both formats support multiple pages in a document.
FTP User Name	Optional	User name for logging in to the FTP server. Can contain up to 32 characters.
FTP Password	Optional	Password for logging in to the FTP server. Can contain up to 32 characters.
Directory	Optional	Name of the FTP server directory where scanned files are stored. Can contain up to 64 characters.
Notification E-mail Address	Optional	E-mail address to which a notification is sent after transmission. Can contain up to 64 characters.
Original (only SP 325SNw and SP 325SFNw)	Optional	Select the sides of the original (1 side or 2-sides) to scan according to the page and binding orientation.
Scan Size	Optional	Select the scanning size for the original from A5, B5, A4, 7 <sup>1</sup> / <sub>4</sub> × 10 <sup>1</sup> / <sub>2</sub> , 8 <sup>1</sup> / <sub>2</sub> × 5 <sup>1</sup> / <sub>2</sub> , 8 <sup>1</sup> / <sub>2</sub> × 11, 8 <sup>1</sup> / <sub>2</sub> × 14, 16K, or custom size.  If you select custom size, select [mm] or [Inch], and then specify the width and length.
Resolution	Optional	Select the scan resolution from 100×100, 150×150, 200×200, 300×300, 400×400, or 600×600 dpi.
Density	Optional	Specify the image density by clicking the right or left button.  is the lightest, and  is the darkest.

## Scan to Folder Settings



**Program/Change Folder Destination**

- Quick Dial Number: [Dropdown]
- Name (Required): [Text Field]
- Service Name (Required): [Text Field] (Example: \\Computer\_name\_or\_IP\Share\_Folder)
- Domain (Optional): [Text Field]
- Login User Name (Optional): [Text Field]
- Login Password (Optional): [Password Field]
- Directory (Optional): [Text Field]
- Notification E-mail Address (Optional): [Text Field]
- File Format (Color/Gray Scale): PDF [Dropdown]
- File Format (Black & White): TIFF [Dropdown]
- Original: 1 Sided [Dropdown]
- Scan Size: A4 210 x 297 [Dropdown]
- Resolution: 300 x 300dpi [Dropdown]
- Density: [Color Selection Icons]

Please enter Administrator Password: [Text Field]

[Apply] [Cancel]

Item	Setting	Description
Quick Dial Number	Optional	Select when setting the destination as a Quick Dial entry.
Name	Required	Name of the destination. The name specified here will be shown on the screen when selecting a scan destination. Can contain up to 16 characters.
Service Name	Required	Path to the directory where scanned files will be stored. Consists of the IP address or name of the destination computer (can contain up to 64 characters), and name of the shared folder (can contain up to 32 characters).
Domain	Optional	Specify the name of the domain to which the computer belongs. Can contain up to 15 characters.
Login User Name	Optional	User name for logging in to the destination computer. Can contain up to 32 characters.
Login Password	Optional	Password for logging in to the destination computer. Can contain up to 32 characters.
Directory	Optional	Directory within the shared folder for storing scanned files. Can contain up to 64 characters.
Notification E-mail Address	Optional	E-mail address to which a notification is sent after transmission. Can contain up to 64 characters.

Item	Setting	Description
File Format (Color/Gray Scale)	Required	File format of the scanned file when scanning in color. PDF or JPEG can be selected. PDF supports multiple pages in a document, but JPEG does not.
File Format (Black & White)	Required	File format of the scanned file when scanning in black and white. PDF or TIFF can be selected. Both formats support multiple pages in a document.
Original (only SP 325SNw and SP 325SFNw)	Optional	Select the sides of the original (1 side or 2-sides) to scan according to the page and binding orientation.
Scan Size	Optional	Select the scanning size for the original from A5, B5, A4, $7\frac{1}{4} \times 10\frac{1}{2}$ , $8\frac{1}{2} \times 5\frac{1}{2}$ , $8\frac{1}{2} \times 11$ , $8\frac{1}{2} \times 14$ , 16K, or custom size. If you select custom size, select [mm] or [Inch], and then specify the width and length.
Resolution	Optional	Select the scan resolution from 100×100, 150×150, 200×200, 300×300, 400×400, or 600×600 dpi.
Density	Optional	Specify the image density by clicking the right or left button.  is the lightest, and  is the darkest.

#### ↓ Note

- To send files via e-mail, SMTP and DNS settings must be configured properly.
- If you are using the Scan to E-mail function, select a time zone according to your geographic location to send email with correct transmission date and time.
- To send files to an FTP server or computer, the user name, password, and directory must be configured properly.
- On a network that uses a DNS server, specify a computer name in [Service Name] and the name of the domain to which the computer belongs in [Domain]. In this case, also configure the DNS related settings using Web Image Monitor.
- Scan destinations cannot be registered using the control panel.

## Modifying Scan Destinations

This section describes how to modify the information of registered destinations.

1. Start the web browser and access the machine by entering its IP address.

2. Click [Scan Destination].
3. Click the [E-mail Address], [FTP], or [Folder] tab.
4. Select the entry to modify, and then click [Change].
5. Modify settings as necessary.
6. Enter the administrator password if required.
7. Click [Apply].
8. Close the web browser.

**Note**

- You can unassign a Quick Dial entry from a One-touch button from the [Quick Dial Destination] page. (only SP 320SFN and SP 325SFNw) To do this, select the desired entry, click [Delete], and then click [Apply] again on a confirmation page.

---

## Deleting Scan Destinations

---

5

This section describes how to delete registered destinations.

1. Start the web browser and access the machine by entering its IP address.
2. Click [Scan Destination].
3. Click the [E-mail Address], [FTP], or [Folder] tab.
4. Select the entry to delete, and then click [Delete].
5. Confirm that the entry you have selected is the entry that you want to delete.
6. Enter the administrator password if required.
7. Click [Apply].
8. Close the web browser.

---

## Testing Transmission

---

**★ Important**

- When a USB flash memory device is inserted into the machine, scanned documents will be stored in the USB flash memory device. Confirm that there are no USB flash memory devices inserted into the machine.

1. Place the original on the exposure glass or in the ADF.

**2. Press the [Scanner] key, and then press the [Address Book] key.**

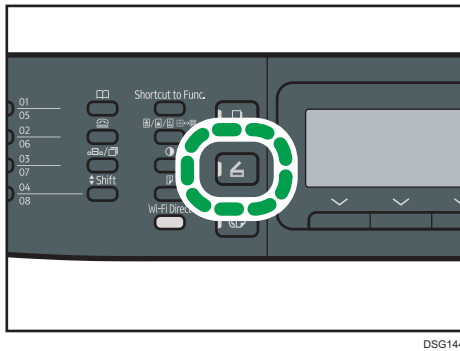

DSG144

Alternatively, you can press the [Shortcut to Func.] key if [Shortcut to Function] under [Admin. Tools] is set to [Select Scanner Address]. For [Shortcut to Function], see page 206 "Administrator Settings".

5

**3. Make sure [Search Address Book] is selected, and then press the [OK] key.**

If you want to search for a specific entry by its name, enter the first letters of the name using the number keys, and then press the [OK] key. Each time you enter a character, the display changes to show the matching name.

**4. Search for the desired destination by pressing the [▲] or [▼] key to scroll the Address Book, and then press the [OK] key.**

When you specify a scan destination, the machine's scan settings change automatically according to the information registered for that destination in the Address Book. If necessary, you can change the scan settings using the control panel. For scan settings, see page 132 "Specifying Scan Settings for Scanning".

**5. Press the [Start] key.**

Scanning starts and scanned documents will be stored in a shared folder.

**Note**

- If the machine fails to transmit the file, confirm the following items.
  - The destination is registered to the Address Book correctly.
  - Disable the security software or firewall of the destination computer and try the job again. For details about security software or the firewall settings, contact your network administrator.
  - If there are several destination computers, test the job with other computers. Compare the settings with the computer the file was transmitted from. For details, contact your network administrator.
  - There is enough disk space on the destination computer.



# Basic Operation of Scan to Folder

This section explains the preparations and procedures to send scanned documents to a folder on a client computer.

After following the procedures below, you can send scanned documents from the machine to a shared folder on a client computer.

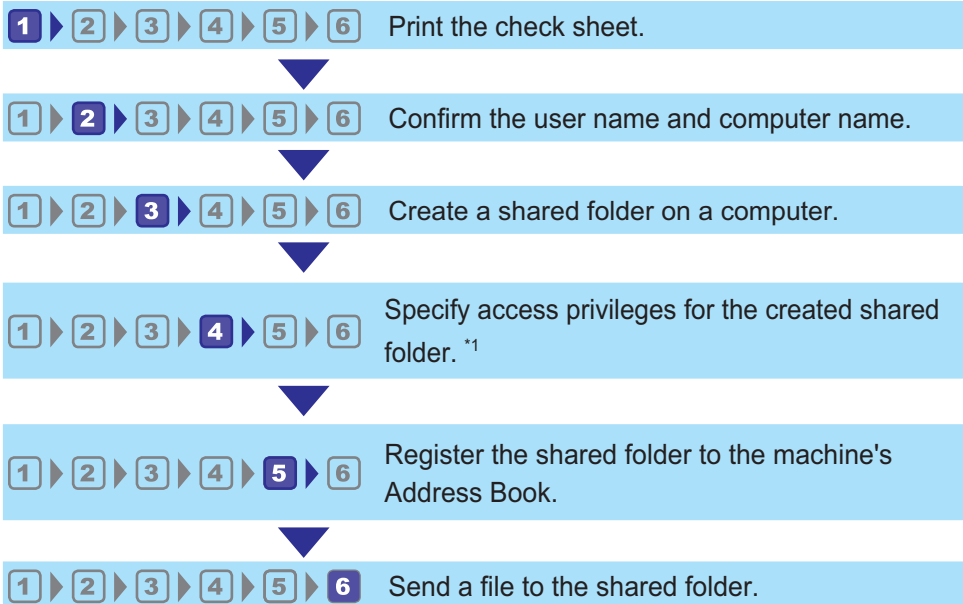

DSG267

\* 1 only Windows

## ↓ Note

- You can create the shared folder under Windows Vista or later, Windows Server 2003 or later, and OS X 10.7 or later.
- Files can be sent via SMB using the SMB (139/TCP, 137/UDP) or CIFS (445/TCP) protocol.
- Files can be sent via SMB (139/TCP, 137/UDP) in a NetBIOS over TCP/IP environment only.
- Files cannot be sent via SMB in a NetBEUI environment.

## 1 Printing the Check Sheet

Print out the following check sheet. Write on the check sheet the settings for the computer to which you will send documents.

For details about how to use the check sheet to make a list of the setting values, see page 104 "2 Confirming the User Name and Computer Name" and page 106 "3 Creating a Shared Folder on a Computer".

**★ Important**

- After registering scan destinations to the Address Book, discard the completed check sheet to prevent leakage of personal information.

**Check Sheet**

No.	Check Item (Entry Example)	Entry Column
[1]	Computer name (ex. YamadaPC)	
	Active settings of DHCP server ([Yes] or [No])	
	Computer's IP address (ex. 192.168.0.152)	
[2]	Domain Name/Working Group Name (ex. ABCD-NET)	USERDNSDOMAIN
		USERDOMAIN
	Computer's user name (ex. TYamada)	
[3]	Computer's login password (ex. Administrator)	
[4]	Computer's shared folder name (ex. scan)	

**↓ Note**

- Depending on the network environment, USERDNSDOMAIN or USERDOMAIN may not be displayed. Write the domain name or working group name in the check sheet.

**2 Confirming the User Name and Computer Name****Confirming the User Name and Computer Name When Running Microsoft Windows**

Confirm the user name and the name of the computer you will send scanned documents to.

1. On the [Start] menu, point to [All Programs], click [Accessories], and then click [Command Prompt].
2. Enter the command "ipconfig /all", and then press the [Enter] key.
3. Confirm the name of the computer, the active settings of the DHCP server, and the IPv4 address, and then write them in [1] on the check sheet.

The computer's name is displayed under [Host Name].

The address displayed under [IPv4 Address] is the IPv4 address of the computer.

Active settings of DHCP server are displayed under [Enabled DHCP].

4. Next, enter the command "set user", and then press the [Enter] key.

Be sure to put a space between "set" and "user".

5. Confirm the domain name/working group name and the user name, and then write them in [2] on the check sheet.

The user name is displayed under [USERNAME].

Confirm the computer's login password and write it in [3] on the check sheet.

Next, create a shared folder on a computer. For details about creating a shared folder, see page 106 "3 Creating a Shared Folder on a Computer".

#### Note

- Depending on the operating system or security settings, it might be possible to specify a user name that does not have a password assigned. However, we recommend that for greater security you select a user name that has a password.

## Confirming the User Name and Computer Name When Running OS X

Confirm the user name and the name of the computer you will send scanned documents to. Confirm the values, and then write them on the check sheet.

1. On the Apple menu, click [About This Mac].

The computer's information screen appears.

2. Click [System Report...].

3. In the left pane, click [Software], and then confirm the computer name and user name under "System Software Overview:".

The computer name is displayed next to [Computer Name].

The user name is displayed next to [User Name].

On the check sheet, write the computer name in [1] and the user name in [2].

Next, create a shared folder on a computer. For details about creating a shared folder, see page 106 "3 Creating a Shared Folder on a Computer".

**Note**

- Depending on the operating system or security settings, you might be able to specify a user name that does not have a password assigned. However, we recommend that you select a user name that has a password.
- To confirm the IP address on the Apple menu, click [System Preferences...], and then click [Network] on the System Preferences window. Then click [Ethernet]. The address displayed in the IP address field is the IP address of the computer.

**3 Creating a Shared Folder on a Computer****Creating a Shared Folder on a Computer Running Microsoft Windows**

Create a shared destination folder in Windows and enable sharing. In the following procedure, a computer which is running under Windows 7 Ultimate and participating in a domain is used as an example.

**★ Important**

- You must log in as an Administrators group member to create a shared folder.
- If "Everyone" is left selected in Step 6, the created shared folder will be accessible by all users. This is a security risk, so we recommend that you give access rights only to specific users. Use the following procedure to remove "Everyone" and specify user access rights.

1. Create a folder, just as you would create a normal folder, in a location of your choice on the computer. Write the folder name in [4] on the check sheet.
2. Right-click the folder, and then click [Properties].
3. On the [Sharing] tab, select [Advanced Sharing...].
4. Select the [Share this folder] check box.
5. Click [Permissions].
6. In the [Group or user names:] list, select "Everyone", and then click [Remove].
7. Click [Add...].

In the [Select Users or Groups] window, add groups or users to whom you want to grant access. In the following procedure, the procedure to give access privileges to users that you wrote on the check sheet is used as an example.

8. In the [Select Users of Groups] window, click [Advanced...].
9. Specify one or more object types, select a location, and then click [Find Now].
10. From the list of results, select the groups and users you want to grant access to (the name you wrote in [2] on the check sheet), and then click [OK].
11. In the [Select Users of Groups] window, click [OK].

12. In the [Group or user names:] list, select a group or user (the name you wrote in [2] on the check sheet), and then, in the [Allow] column of the permissions list, select either the [Full Control] or [Change] check box.

Configure the access permissions for each group and user.

13. Click [OK] 3 times.

If you want to specify access privileges for the created folder to allow other users or groups to access it, proceed to page 107 "[4](#) Specifying Access Privileges for the Created Shared Folder".

If not, proceed to page 108 "[5](#) Registering a Shared Folder in the Machine's Address Book".

## Creating a Shared Folder on a Computer Running OS X

The following procedures explain how to create a shared folder on a computer running OS X, and how to confirm the computer's information. OS X 10.11 is used in these examples.

### ★ Important

- You must log in as an administrator to create a shared folder.
1. Create the folder that you want to send scan files to.  
Write the folder name into [4] in the check sheet.
  2. On the Apple menu, click [System Preferences...].
  3. Click [Sharing].
  4. Select the [File Sharing] check box.
  5. Click [Options...].
  6. Select the [Share files and folders using SMB] check box.
  7. Select the account that will be used to access the shared folder.
  8. If the [Authenticate] screen appears, enter the password for the account, click [OK], and then click [Done].
  9. Under the [Shared Folders:] list, click [+].
  10. Select the folder you have created, and then click [Add].
  11. Make sure that the permissions for the user who will access this folder are set to [Read & Write].

Next, register scan destinations. For details about registering scan destinations, see page 108 "[5](#) Registering a Shared Folder in the Machine's Address Book".

## [4](#) Specifying Access Privileges for the Created Shared Folder

If you want to specify access privileges for the created folder to allow other users or groups to access the folder, configure the folder as follows:

1. Right-click the folder created in Step 3, and then click [Properties].
2. On the [Security] tab, click [Edit...].
3. Click [Add...].
4. In the [Select Users of Groups] window, click [Advanced...].
5. Specify one or more object types, select a location, and then click [Find Now].
6. From the list of results, select the groups and users you want to grant access to, and then click [OK].
7. In the [Select Users of Groups] window, click [OK].
8. In the [Groups or user names:] list, select a group or user, and then, in the [Allow] column of the permissions list, select either the [Full control] or [Modify] check box.
9. Click [OK] twice.

Next, register scan destinations. For details about registering scan destinations, see page 108 "5 Registering a Shared Folder in the Machine's Address Book".

**Note**

- If you are creating a shared folder for the first time on this computer, you must enable the file sharing function. For details, see Windows Help.

---

## 5 Registering a Shared Folder in the Machine's Address Book

---

Register scan destinations using Web Image Monitor.

1. Start the web browser and access the machine by entering its IP address.
2. Click [Quick Dial Destination] or [Scan Destination].
3. From the [Destination Type] list, select [Folder].
4. Register information as necessary.

The information you must register are the following items. For details, see page 95 "Registering Scan Destinations".

- Name
- Service Name

5. Enter the administrator password if required.
6. Click [Apply].
7. Close the web browser.

Preparations for Scan to Folder are complete.

For details about sending scanned files to the destination you registered to the Address Book, see page 109 "6 Send Scanned Files to a Shared Folder".

### ↓ Note

- If the machine fails to transfer the file, confirm the following items.
  - Destination is registered to the Address Book correctly.
  - Set the security software or firewall of the destination computer to off and try the job again. For details about security software or the firewall settings, contact your network administrator.
  - If there is more than one destination computer, test the job with other computers. Compare the settings with the computer which succeeded to transfer the file. For details, contact your network administrator.
  - When there is not enough disk space on the destination computer, the machine may fail to transfer the file.

## 6 Send Scanned Files to a Shared Folder

Send scanned files to the shared folder registered in Step 5.

### ★ Important

- The original in the ADF takes precedence over the original on the exposure glass if you place originals both in the ADF and on the exposure glass.
- Register the scan destination in the Address Book using Web Image Monitor. For details, see page 95 "Registering Scan Destinations".
- When a USB flash memory device is inserted into the machine, scanned documents will be stored in the USB flash memory device. Confirm that there are no USB flash memory devices inserted into the machine.

#### 1. Place the original on the exposure glass or in the ADF.

To place the original, see page 65 "Placing Originals".

#### 2. Press the [Scanner] key, and then press the [Address Book] key.

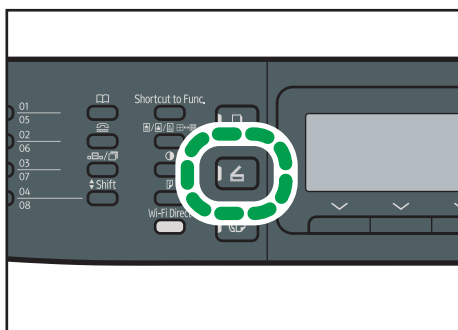

DSG144

Alternatively, you can press the [Shortcut to Func.] key if [Shortcut to Function] under [Admin. Tools] is set to [Select Scanner Address]. For [Shortcut to Function], see page 206 "Administrator Settings".

**3. Make sure [Search Address Book] is selected, and then press the [OK] key.**

If you want to search for a specific entry by its name, enter the first letters of the name using the number keys, and then press the [OK] key. Each time you enter a character, the display changes to show the matching name.

**4. Search for the desired destination by pressing the [▲] or [▼] key to scroll the Address Book, and then press the [OK] key.**

When you specify a scan destination, the machine's scan settings change automatically according to the information registered for that destination in the Address Book. If necessary, you can change the scan settings using the control panel. For scan settings, see page 132 "Specifying Scan Settings for Scanning".

**5. Press the [Start] key.**



DSG133

Depending on the machine's settings, you may see the following screen on the display when scanning from the exposure glass.



If you see this screen, proceed to the next step.

- 6. If you have more originals to scan, place the next original on the exposure glass, and then press [Yes]. Repeat this step until all originals are scanned.**
- 7. When all originals have been scanned, press [No] to start sending the scanned file.**

**↓ Note**

- To cancel scanning, press the [Scanner] key, and then press the [Clear/Stop] key. The scan files are discarded.



- You can also specify a destination using the One Touch buttons, [Pause/Redial] key (only SP 320SFN and SP 325SFNw). For details, see page 119 "Specifying the Scan Destination Using the One Touch Buttons or [Pause/Redial] Key (only SP 320SFN and SP 325SFNw)".

# Basic Operation of Scan to E-mail

This section explains the preparations and procedures to send scanned documents as a file attached to an e-mail.

After following the procedures below, you can send scanned documents to the specified e-mail address.

**1** ▶ **2** ▶ **3** Configure SMTP server and DNS settings.

**1** ▶ **2** ▶ **3** Register the destination e-mail address in the Address Book.

**1** ▶ **2** ▶ **3** Send scanned files by e-mail.

DSG268

## 5

## 1 Configuring SMTP and DNS Settings

To send files via e-mail, SMTP and DNS settings must be configured properly.

For details about SMTP server information, contact the network administrator of your Internet service provider.

Configure SMTP and DNS information using Web Image Monitor.

1. Start the web browser and access the machine by entering its IP address.
2. Click [Network Settings].
3. Click the [DNS] tab.
4. Register information as necessary.  
For details, see page 236 "Configuring the Network Settings".
5. Click [OK].
6. Click the [SMTP] tab.
7. Register information as necessary.  
For details, see page 236 "Configuring the Network Settings".
8. Click [OK].
9. Close the web browser.

Next, register the destination e-mail address to the Address Book. For details, see page 113 "2 Registering Destination E-mail Addresses to the Address Book".

## 2 Registering Destination E-mail Addresses to the Address Book

Configure the destination information using Web Image Monitor.

1. Start the web browser and access the machine by entering its IP address.
2. Click [Quick Dial Destination] or [Scan Destination].
3. From the [Destination Type] list, select [E-mail Address].
4. Register information as necessary.

The information you must register are the following items. For details, see page 95 "Registering Scan Destinations".

- Name
- Destination E-mail Address
- Subject

5. Enter the administrator password if required.
6. Click [Apply].
7. Close the web browser.

Preparations for Scan to E-mail are complete.

For details about sending files to the registered destinations, see page 113 "3 Sending Scanned Files by E-mail".

## 3 Sending Scanned Files by E-mail

This section explains how to send scanned files to the destinations registered in Step 2.

### ★ Important

- The original in the ADF takes precedence over the original on the exposure glass if you place originals both in the ADF and on the exposure glass.
- Register the scan destination in the Address Book using Web Image Monitor. For details, see page 95 "Registering Scan Destinations".
- When a USB flash memory device is inserted into the machine, scanned documents will be stored in the USB flash memory device. Confirm that there are no USB flash memory devices inserted into the machine.

1. Place the original on the exposure glass or in the ADF.

To place the original, see page 65 "Placing Originals".

2. Press the [Scanner] key, and then press the [Address Book] key.

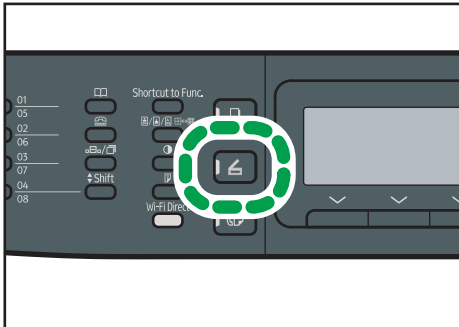

DSG144

Alternatively, you can press the [Shortcut to Func.] key if [Shortcut to Function] under [Admin. Tools] is set to [Select Scanner Address]. For [Shortcut to Function], see page 206 "Administrator Settings".

5

3. Make sure [Search Address Book] is selected, and then press the [OK] key.

If you want to search for a specific entry by its name, enter the first letters of the name using the number keys, and then press the [OK] key. Each time you enter a character, the display changes to show the matching name.

4. Search for the desired destination by pressing the [▲] or [▼] key to scroll the Address Book, and then press the [OK] key.

When you specify a scan destination, the machine's scan settings change automatically according to the information registered for that destination in the Address Book. If necessary, you can change the scan settings using the control panel. For scan settings, see page 132 "Specifying Scan Settings for Scanning".

5. Press the [Start] key.



DSG133

Depending on the machine's settings, you may see the following screen on the display when scanning from the exposure glass.

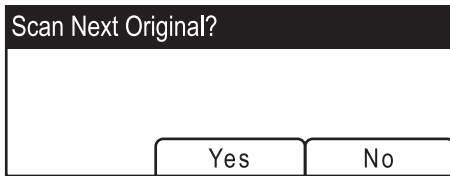

If you see this screen, proceed to the next step.

6. If you have more originals to scan, place the next original on the exposure glass, and then press [Yes]. Repeat this step until all originals are scanned.
7. When all originals have been scanned, press [No] to start sending the scanned file.

**Note**

- To cancel scanning, press the [Scanner] key, and then press the [Clear/Stop] key. The scan files are discarded.
- You can also specify a destination using the One Touch buttons, [Pause/Redial] key (only SP 320SFN and SP 325SFNw). For details, see page 119 "Specifying the Scan Destination Using the One Touch Buttons or [Pause/Redial] Key (only SP 320SFN and SP 325SFNw)".

# Basic Operation of Scan to FTP

This section explains the preparations and instructions to send scanned documents to an FTP server. After following the procedures below, you can send scanned documents to an FTP server.

**1** ▶ **2** Configure FTP server settings.



**1** ▶ **2** Send scanned files to the FTP server.

DSG269

---

## **1** Configuring FTP Server Settings

---

5

To send files to an FTP server, configure FTP server settings properly. For details about FTP servers, contact your network administrator.

Configure FTP server settings using Web Image Monitor.

- 1. Start the web browser and access the machine by entering its IP address.**
- 2. Click [Quick Dial Destination] or [Scan Destination].**
- 3. From the [Destination Type] list, select [FTP].**
- 4. Register information as necessary.**

The information you must register are the following items. For details, see page 95 "Registering Scan Destinations".

- Name
- Hostname or IP Address

- 5. Enter the administrator password if required.**
- 6. Click [Apply].**
- 7. Close the web browser.**

Preparations for Scan to FTP are complete.

For details about sending files to the registered destinations, see page 116 "**2** Sending Scanned Files to an FTP Server".

---

## **2** Sending Scanned Files to an FTP Server

---

This section explains how to send scanned files to the destinations registered in Step 1.

### ★ Important

- The original in the ADF takes precedence over the original on the exposure glass if you place originals both in the ADF and on the exposure glass.
- Register the scan destination in the Address Book using Web Image Monitor. For details, see page 95 "Registering Scan Destinations".
- When a USB flash memory device is inserted into the machine, scanned documents will be stored in the USB flash memory device. Confirm that there are no USB flash memory devices inserted into the machine.

#### 1. Place the original on the exposure glass or in the ADF.

To place the original, see page 65 "Placing Originals".

#### 2. Press the [Scanner] key, and then press the [Address Book] key.

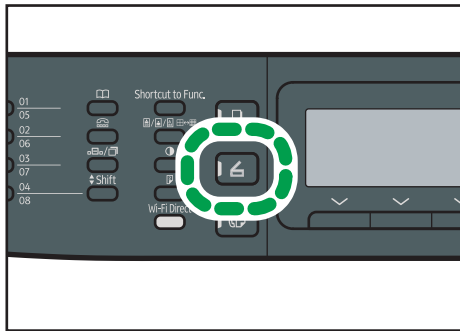

DSG144

Alternatively, you can press the [Shortcut to Func.] key if [Shortcut to Function] under [Admin. Tools] is set to [Select Scanner Address]. For [Shortcut to Function], see page 206 "Administrator Settings".

#### 3. Make sure [Search Address Book] is selected, and then press the [OK] key.

If you want to search for a specific entry by its name, enter the first letters of the name using the number keys, and then press the [OK] key. Each time you enter a character, the display changes to show the matching name.

#### 4. Search for the desired destination by pressing the [▲] or [▼] key to scroll the Address Book, and then press the [OK] key.

When you specify a scan destination, the machine's scan settings change automatically according to the information registered for that destination in the Address Book. If necessary, you can change the scan settings using the control panel. For scan settings, see page 132 "Specifying Scan Settings for Scanning".

5. Press the [Start] key.



DSG133

Depending on the machine's settings, you may see the following screen on the display when scanning from the exposure glass.

5

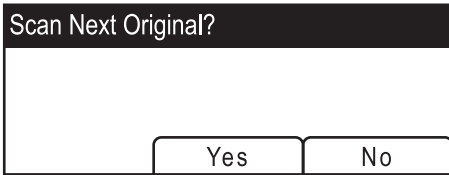

If you see this screen, proceed to the next step.

6. If you have more originals to scan, place the next original on the exposure glass, and then press [Yes]. Repeat this step until all originals are scanned.
7. When all originals have been scanned, press [No] to start sending the scanned file.

**Note**

- To cancel scanning, press the [Scanner] key, and then press the [Clear/Stop] key. The scan files are discarded.
- You can also specify a destination using the One Touch buttons, [Pause/Redial] key (only SP 320SFN and SP 325SFNw). For details, see page 119 "Specifying the Scan Destination Using the One Touch Buttons or [Pause/Redial] Key (only SP 320SFN and SP 325SFNw)".



# Specifying the Scan Destination Using the One Touch Buttons or [Pause/Redial] Key (only SP 320SFN and SP 325SFNw)

This section describes how to specify a destination using the following keys:

- One Touch buttons  
Use these to specify destinations registered as Quick Dial entries.
- [Pause/Redial] key  
Press this to specify the last used destination as the destination for the current job.

## Using the One Touch buttons

Press the One Touch button to which the desired Quick Dial entry is registered.

Press the [Shift] key to use the Quick Dial entries Nos. 5 to 8.

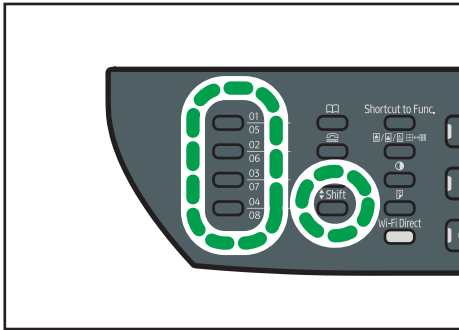

DSG147

## Using the [Pause/Redial] key

Press the [Pause/Redial] key to select the last used destination.

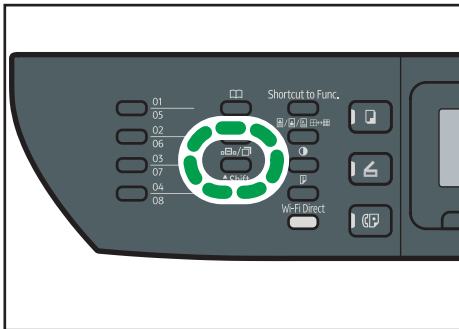

DSG148

 **Note**

- When you specify a scan destination, the machine's scan settings change automatically according to the information registered for that destination in the Address Book. If necessary, you can change the scan settings using the control panel. For details, see page 132 "Specifying Scan Settings for Scanning".
- The [Pause/Redial] key is not effective for the first scan job after the machine is turned on.
- To select destinations not registered as Quick Dial entries, use the [Address Book] key. For specifying destinations using the [Address Book] key, see page 103 "Basic Operation of Scan to Folder".

# Basic Procedures for Saving Scan Files on a USB Flash Memory Device

This section explains basic operations of Scan to USB. Files are saved to the USB flash memory device inserted into the machine.

## ★ Important

- The original in the ADF takes precedence over the original on the exposure glass if you place originals both in the ADF and on the exposure glass.
- This machine does not support the use of external USB hubs.
- Not all types of USB flash memory devices are supported.
- When using Scan to USB, set [Save Scn Data to USB] to [Active]. For details, see page 206 "Administrator Settings".

### 1. Insert the USB flash memory device into the USB port.

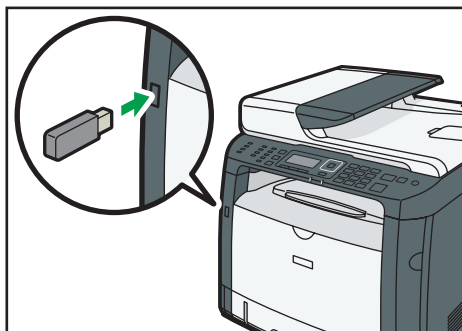

DSG149

The scanner screen appears on the display.

A message indicating the machine is reading the device appears. Wait until [Save Scn Data to USB] appears on the display. The time before the message appears differs depending on the type of USB flash memory device.

### 2. Place the original on the exposure glass or in the ADF.

To place the original, see page 65 "Placing Originals".

Specify the scanning settings as necessary. For details of specifying the scanning settings, see page 132 "Specifying Scan Settings for Scanning".

**3. Press the [Start] key.**



DSG133

**4. Select the file format from [TIFF] or [PDF] by pressing the corresponding selection key.**

If the [Limitless Scan] setting under [Scan Settings] is enabled, you may see the following screen on the display when scanning from the exposure glass.

5



If you see this screen, proceed to the next step.

- 5. If you have more originals to scan, place the next original on the exposure glass, and then press [Yes]. Repeat this step until all originals are scanned.**
- 6. When all originals have been scanned, press [No] to start sending the scanned file.**
- 7. Wait until "Completed the Process" is displayed on the screen.**

Scanned files are saved in the root directory of the USB flash memory device.

**8. Remove the USB flash memory device from the machine.**

**↓ Note**

- To cancel scanning, press the [Scanner] key, and then press the [Clear/Stop] key. The scan files are discarded.

# Scanning from Smart Organizing Monitor

The procedure in this section is an example based on Windows 7. The actual procedure may vary depending on the operating system you are using.

1. Place originals.
2. On the [Start] menu, click [All Programs].
3. Click [SP 320 Series Software Utilities].
4. Click [Smart Organizing Monitor].

Smart Organizing Monitor starts.

5. Click the [User Tools] tab.
6. Click [Scan].

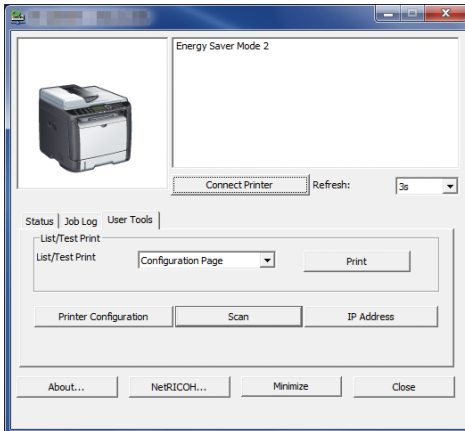

The dialog box appears.

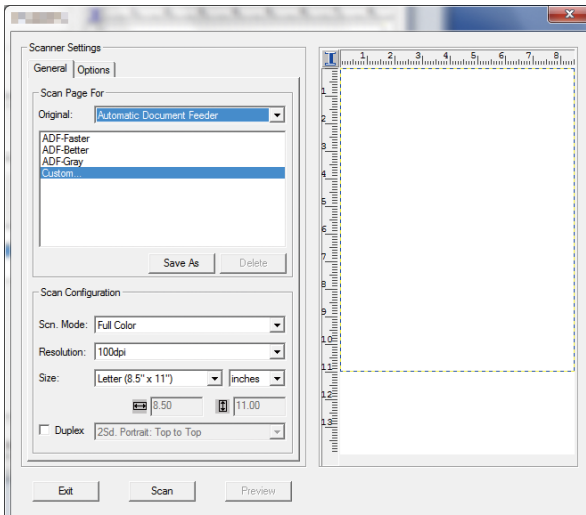

7. On the [General] tab, specify settings according to the types of originals and scanning, and the orientation of the original.
8. On the [Options] tab, specify the file format and the directory to save the file.
9. Click [Scan].
10. After all originals are scanned, click [Exit].

## Scanner Settings You Can Configure for Smart Organizing Monitor

The following explains the setting options you can configure when Smart Organizing Monitor is used for scanning.

### [General] tab

5

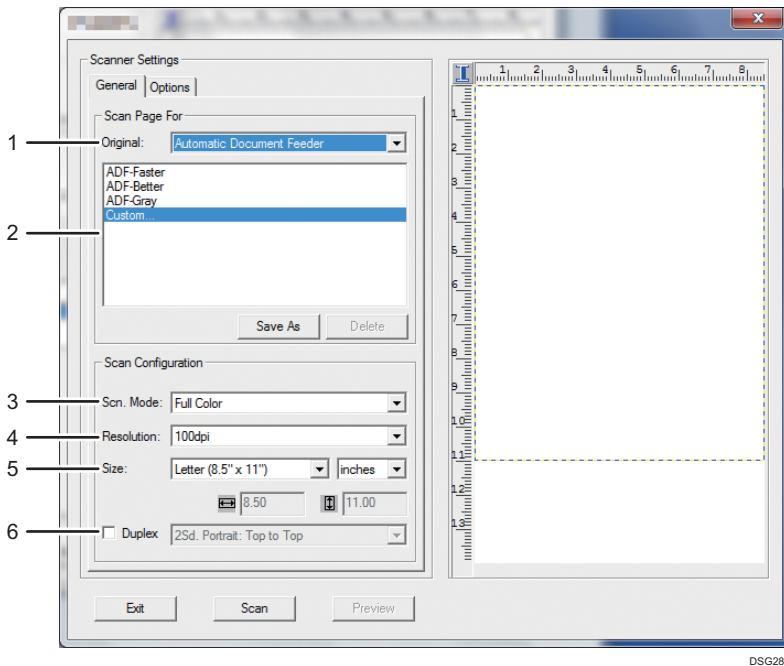

DSG280

#### 1. Original: (only SP 320SFN, SP 325SNw, and SP 325SFNw)

Select [Exposure Glass] to scan from the exposure glass or [Automatic Document Feeder] to scan from the ADF.

#### 2. Original type

According to your original, select a setting from the list of options detailed below, or select [Custom...] to configure your own scan settings. [Scn. Mode], [Resolution], and [Size] under [Scan Configuration] will change according to the original type setting you selected here.

- When using the exposure glass:

[Editing Text (OCR)]

[Faxing, Filing, or Copying]

[Black and White Photo]  
 [Color Document-Faster]  
 [Color Document-Better Quality]  
 [Custom...]

- When using the ADF (only SP 320SFN, SP 325SNw, and SP 325SFNw):

[ADF-Faster]  
 [ADF-Better]  
 [ADF-Gray]  
 [Custom...]

### 3. Scn. Mode:

Select from full color, grayscale, or black-and-white.

### 4. Resolution:

Select a resolution from the list. Note that increasing the resolution also increases the file size and scanning time.

Select from 100, 200, 300, or 600 dpi.

### 5. Size:

Select the scanning size.

When [Exposure Glass] is selected in [Original:], you can change the scanning size with your mouse in the preview area. Also, after selecting [User defined], you can select the unit of measure from [cm], [inches], or [pixels].

### 6. Duplex (only SP 320SFN, SP 325SNw, and SP 325SFNw)

Appears only when [Automatic Document Feeder] is selected in [Original:]. Select the check box when scanning both sides of the original, and then specify the orientation.

[Options] tab

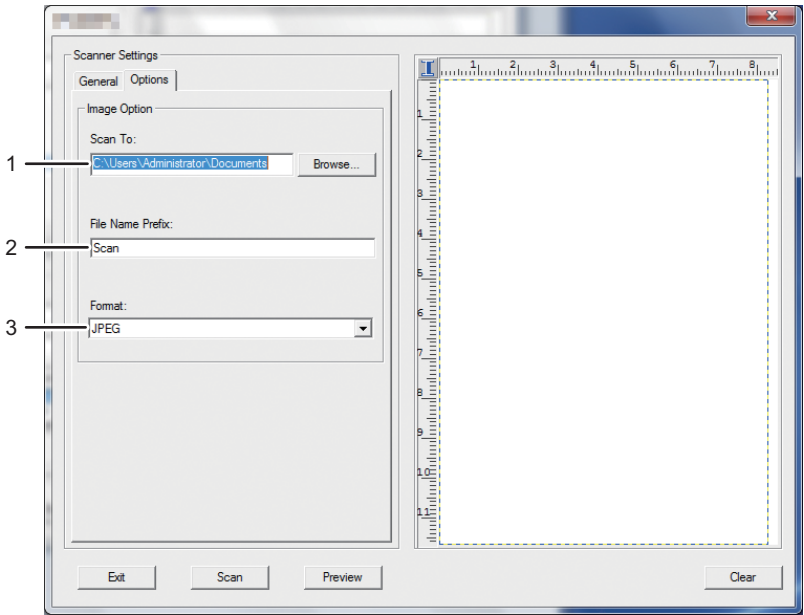

DSG281

**1. Scan To:**

Specify the directory to save the file.

**2. File Name Prefix:**

Specify the file name prefix. Numbers are consecutively assigned after the prefix.

For example, if [File Name Prefix] is "Scan", file names will be "Scan001", "Scan002", and so on.

**3. Format:**

Select the file format of the scanned document from JPEG, TIFF, or PDF.



# Basic Operation for TWAIN Scanning

This section describes the basic TWAIN scanning operation.

TWAIN scanning is possible if a TWAIN-compatible application is running on your computer.



DSG270

## 1. Your Computer (TWAIN driver already installed)

Instruct the machine to start scanning the original that is set on the machine.

## 2. This Machine

The original that is set on the machine is scanned, and its data is sent to a client computer.

5

## Using TWAIN scanner

This section describes the preparations for using the TWAIN scanner.

### ★ Important

- To use the TWAIN scanner, you must install the TWAIN driver, which is on the supplied CD-ROM.
- To use the TWAIN scanner, a TWAIN-compliant application must be installed.

To use the machine as a TWAIN scanner, first do the following:

- Install the TWAIN driver.
- Install a TWAIN-compliant application.

## TWAIN scanning

TWAIN scanning is possible if your computer is running a TWAIN-compatible application.

The following is a general scan procedure with the TWAIN driver, so the actual operation may differ depending on the applications you use. For details, see the application's Help.

1. Start a TWAIN-compliant application.
2. Place originals.

### 3. Open the Scanner Control dialog box.

The Scanner Control dialog box is used to control the scanner using the TWAIN driver. To open the Scanner Control dialog box, select the correct TWAIN scanner using the TWAIN-compliant application. For details, see the application's Help.

### 4. Make settings according to such factors as the type of original, type of scanning, and orientation of the original.

For details, see the TWAIN driver Help.

### 5. In the Scanner Control dialog box, click [Scan].

Depending on the security setting, if you press [Scan], a dialog box for entering the user name and password may appear.

If there are more originals to be scanned, place the next original, and then click [Continue].

If there are no more originals to be scanned, click [Complete].

## Settings you can configure in the TWAIN dialog box

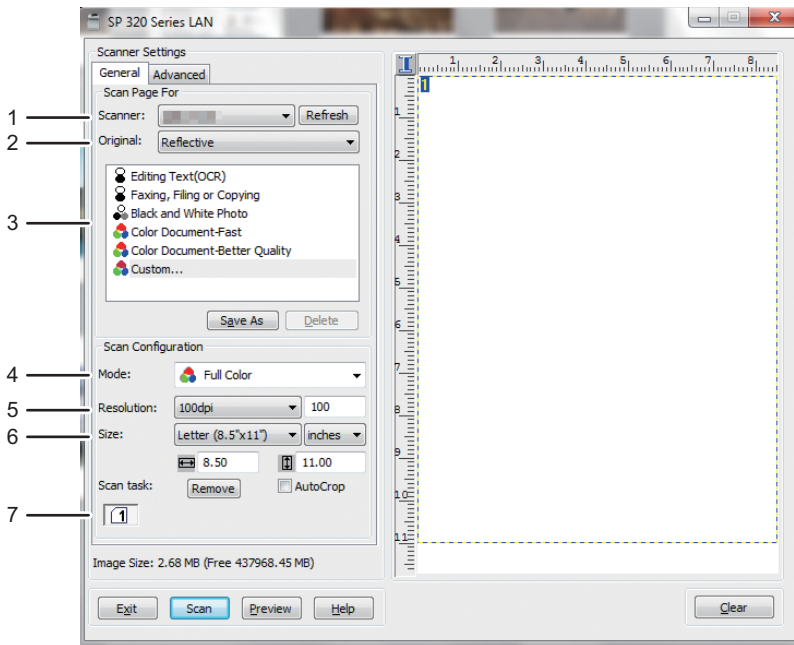

DSG150

#### 1. Scanner:

Select the scanner you want to use. The scanner you select becomes the default scanner. Click [Refresh] to discover all available scanners connected via USB or the network.

#### 2. Original: (only SP 320SFN, SP 325SNw, and SP 325SFNw)

Select [Reflective] to scan from the exposure glass, or [Automatic Document Feeder] to scan from the ADF.

### 3. Original type

According to your original, select a setting from the list of options detailed below, or select [Custom...] to configure your own scan settings. [Mode], [Resolution], and [Size] under [Scan Configuration] will change according to the original type setting you selected here.

- When using the exposure glass:
  - [Editing Text(OCR)]
  - [Faxing, Filing or Copying]
  - [Black and White Photo]
  - [Color Document-Fast]
  - [Color Document-Better Quality]
  - [Custom...]
- When using the ADF (only SP 320SFN, SP 325SNw, and SP 325SFNw):
  - [ADF-Faster]
  - [ADF-Better]
  - [ADF - Gray]
  - [Custom...]

### 4. Mode:

Select from color, grayscale, or black-and-white.

### 5. Resolution:

Select a resolution from the list. If you select [User defined], enter a resolution value directly in the edit box. Note that increasing the resolution also increases the file size and scanning time.

Selectable resolutions vary depending on where the original is set.

- When using the exposure glass:
  - 75, 100, 150, 200, 300, 400, 500, 600, 1200, 2400, 4800, 9600, 19200 dpi, User defined
- When using the ADF (only SP 320SFN, SP 325SNw, and SP 325SFNw):
  - 75, 100, 150, 200, 300, 400, 500, 600 dpi, User defined

### 6. Size:

Select the scanning size. If you select [User defined], enter the scanning size directly in the edit box. Also, you can change the scanning size with your mouse in the preview area. You can select the unit of measure from [cm], [inches], or [pixels]. Selectable resolutions vary depending on where the original is set. For details, see the TWAIN Help.

### 7. Scan task: (when using the exposure glass)

Displays up to 10 previously used scan areas. To remove a scan task, select the number of the task, and then click [Remove]. You can select [AutoCrop] to let the scanner automatically detect the size of your original.

#### Note

- If the scan data is larger than the memory capacity, an error message appears and scanning is canceled. If this happens, specify a lower resolution and scan the original again.

## Basic Operation for WIA Scanning

1. Place the original on the exposure glass or in the ADF.
2. On the [Start] menu on your computer, click [Devices and Printers].
3. Right-click the icon of the printer model you want to use, and then click [Start scan] to open the dialog box for the scan settings.
4. In the dialog box, configure the scan settings as required, and then click [Scan].
5. Click [Import].

## Using SANE scanning

This driver allows you to scan images and edit them using SANE compatible software.

## Specifying Scan Settings for Scanning

When you specify a scan destination, the machine's scan settings change automatically according to the information registered for that destination in the Address Book. If necessary, you can change the scan settings for the current job using the control panel.

### Specifying the Scanning Size According to the Size of the Original

This section describes how to specify the scanning size according to the size of the current original.

1. Press [Scn Size].

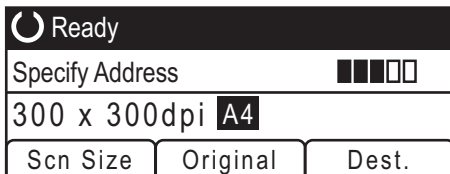

2. Press the [▲] or [▼] key to select the size of the original, and then press the [OK] key.

If you selected anything other than [Custom Size], you do not need to perform the remaining steps of the procedure.

3. Press the [▲] or [▼] key to select [mm] or [inch], and then press the [OK] key.
4. Enter the width using the number keys, and then press the [OK] key.

To enter a decimal point, press [✱].

5. Enter the length using the number keys, and then press the [OK] key.

To enter a decimal point, press [✱].

#### ↓ Note

- You can change the machine's default [Scan Size] setting to always scan originals with a specific scanning size. For details, see page 181 "Scan Settings".

### Adjusting Image Density

This section describes how to adjust image density for the current job.

There are five image density levels. The higher the density level, the darker the scanned image.

### 1. Press the [Density] key.

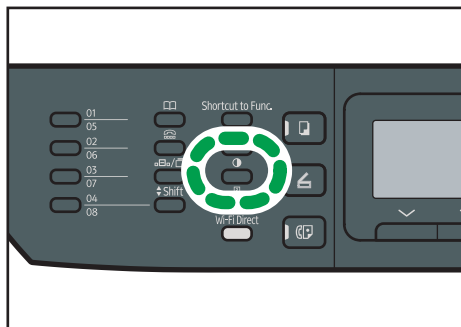

DSG142

### 2. Press the [◀] or [▶] key to select the desired density level, and then press the [OK] key.

#### ↓ Note

- You can change the machine's default [Density] setting to always scan with a specific density level. For details, see page 181 "Scan Settings".

5

## Specifying Resolution

This section describes how to specify the scan resolution for the current job.

There are six resolution settings. The higher the resolution, the higher the quality but greater the file size.

### 1. Press the [Image Quality] key.

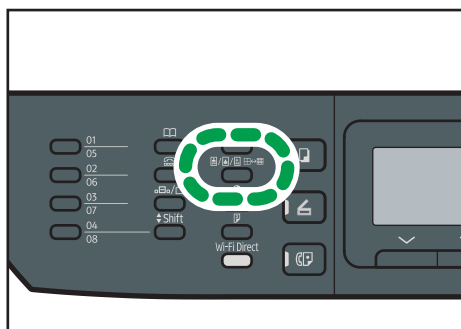

DSG143

### 2. Press the [▲], [▼], [◀], or [▶] key to select the desired resolution, and then press the [OK] key.

#### ↓ Note

- You can change the machine's default [Resolution] setting to always scan with a specific resolution level. For details, see page 181 "Scan Settings".





# 6. Sending and Receiving a Fax

This chapter describes how to use the fax function and specify the settings.

This function is available for SP 320SFN or SP 325SFNw.

## What You Can Do with the Fax Function

### Send faxes easily with one touch buttons

By registering destinations, you can specify destinations easily by pressing a one touch button.

For details, see page 140 "Registering Fax Destinations".

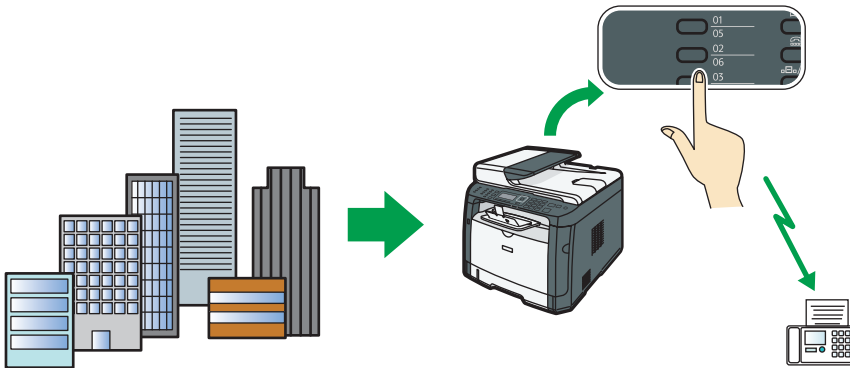

DSG271

### Forward received faxes to receive them wherever you are

By forwarding received faxes to an e-mail address or a folder, you can receive them anytime, anywhere you are.

For details, see page 168 "Forwarding or Storing Faxes in Memory".

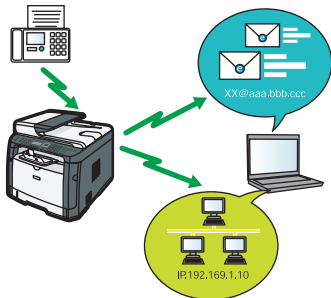

DSG272

### Send faxes by data to save paper

By using a LAN-Fax Driver, you can send documents from your computer without printing them.

For details, see page 158 "Using the Fax Function from a Computer (LAN-Fax)".

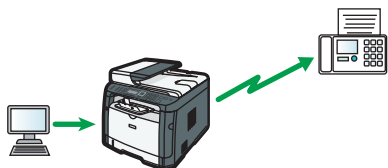

DSG273

# Fax Setting Workflows

This section explains the preparations and procedures to send fax documents to a folder on a client computer.

After following the procedures below, you can send fax documents from the machine to a shared folder on a client computer.

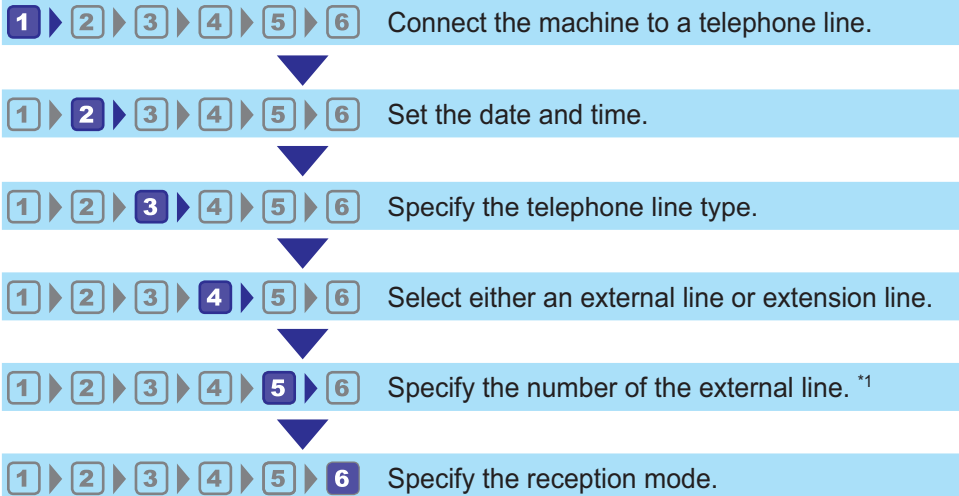

DSG290

\*1 Specify when using an extension line or a PBX.

Procedure	Reference
<b>1</b>	See Initial Guide for FAX.
<b>2</b>	
<b>3</b>	
<b>4</b>	
<b>5</b>	
<b>6</b>	For details about selecting reception modes, see page 164 "Selecting Reception Mode".

## Fax Mode Screen

This section provides information about the screen in fax mode.

By default, the display shows the copier screen when the machine is turned on.

If the copy or scanner screen is shown on the display, press the [Facsimile] key on the control panel to switch to the fax screen.

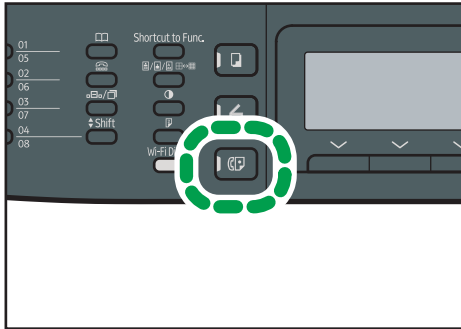

DSG153

## 6

### Screen in standby mode

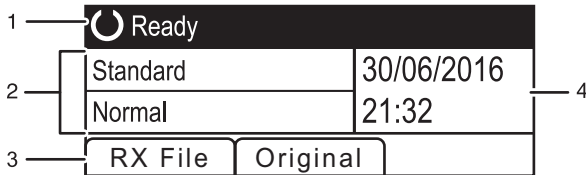

DSG154

#### 1. Current status or messages

Displays the current status or messages.

#### 2. Current settings

Displays the current resolution and density settings.

#### 3. Selection key items

Displays the functions you can use by pressing the corresponding selection keys.

#### 4. Current date and time

Shows the current date and time.

#### ↓ Note

- The machine's default mode at power on can be specified in the [Function Priority] setting under [Admin. Tools]. For [Function Priority], see page 206 "Administrator Settings".
- The display format for time and date can be specified in [Set Date/Time] under [Admin. Tools]. For setting the date and time, see page 139 "Setting the Date and Time".

# Setting the Date and Time

1. Press the [User Tools] key.

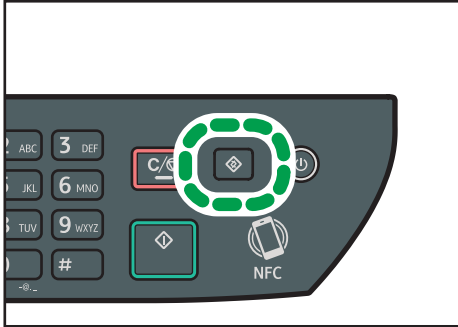

DSG126

2. Press the [▲] or [▼] key to select [Admin. Tools], and then press the [OK] key.
3. If you are requested to enter a password, enter the password using the number keys, and then press the [OK] key.
4. Press the [▲] or [▼] key to select [Set Date/Time], and then press the [OK] key.
5. Press the [▲] or [▼] key to select [Set Date], and then press the [OK] key.
6. Press the [▲] or [▼] key to select the desired date format, and then press the [OK] key.  
For the date and time display format, see page 206 "Administrator Settings".
7. Enter the current date using the number keys, and then press the [OK] key.  
You can press the [◀] or [▶] key to move between fields.
8. Press the [▲] or [▼] key to select [Set Time], and then press the [OK] key.
9. Press the [▲] or [▼] key to select the desired time format, and then press the [OK] key.
10. Enter the current time using the number keys, and then press the [OK] key.  
If you selected [12-hour Format], press the [▲] or [▼] key to select [AM] or [PM].  
You can press the [◀] or [▶] key to move between fields.
11. Press the [User Tools] key to return to the initial screen.

## ↓ Note

- A password for accessing the [Admin. Tools] menu can be specified in [Admin. Tools Lock]. For [Admin. Tools Lock], see page 206 "Administrator Settings".

## Registering Fax Destinations

This section describes how to register fax destinations in the Address Book using the control panel. For entering characters, see page 32 "Entering Characters".

The Address Book can also be edited using Web Image Monitor.

### ★ Important

- The Address Book data could be damaged or lost unexpectedly. The manufacturer shall not be responsible for any damages resulting from such data loss. Be sure to create backup files of the Address Book data periodically. For details about creating backup files, see page 250 "Configuring the Administrator Settings".

The Address Book can contain up to 108 entries (8 Quick Dial entries and 100 Speed Dial entries).

### Quick Dial entries

Destinations registered as Quick Dial entries can be selected by pressing the corresponding One Touch button.

### Speed Dial entries

Destinations registered as Speed Dial entries can be selected from the Address Book. Press the [Address Book] key, select [Search Address Book], and then select the desired entry using the [▲] or [▼] key.

## Registering Fax Destinations Using the Control Panel

1. Press the [User Tools] key.

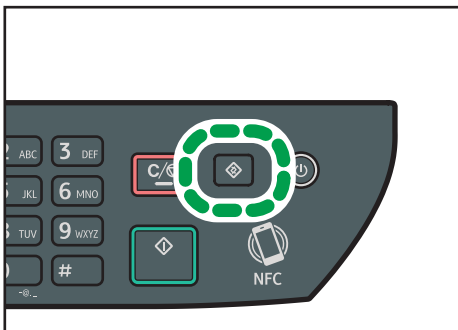

DSG126

2. Press the [▲] or [▼] key to select [Address Book], and then press the [OK] key.
3. If you are requested to enter a password, enter the password using the number keys, and then press the [OK] key.
4. Press the [▲] or [▼] key to select [Quick Dial No.] or [Fax Speed Dial No.], and then press the [OK] key.

5. Press the [▲] or [▼] key to select [No.], and then enter the desired Quick Dial number (1 to 8) or Speed Dial number (1 to 100) using the number keys.  
If a destination is already registered for the input number, the fax number and fax name registered for that number appear.
6. Press the [▲] or [▼] key to select [Fax No.], and then enter the fax number (up to 40 characters).
7. Press the [▲] or [▼] key to select [Name], and then enter the fax name (up to 20 characters).
8. Confirm the setting, and then press the [OK] key.
9. Press the [User Tools] key to return to the initial screen.

#### ↓ Note

- For details about entering characters, see page 32 "Entering Characters".
- A fax number can contain 0 to 9, pause, "\*#", and space.
- If necessary, insert a pause in the fax number. The machine pauses briefly before it dials the digits following the pause. You can specify the length of the pause time in the [Pause Time] setting under [Fax TX Settings]. For [Pause Time], see page 184 "Fax Features Settings".
- To use tone services on a pulse-dialing line, insert "\*" in the fax number. "\*" switches the dialing mode from pulse to tone temporarily.
- If the machine is connected to the telephone network through a PBX, make sure to enter the outside line access number specified in [PBX Access Number] before the fax number. For [PBX Access Number], see page 206 "Administrator Settings".
- A password for accessing the [Address Book] menu can be specified in [Admin. Tools Lock]. For [Admin. Tools Lock], see page 206 "Administrator Settings".

## Modifying or deleting fax destinations

1. Press the [User Tools] key.

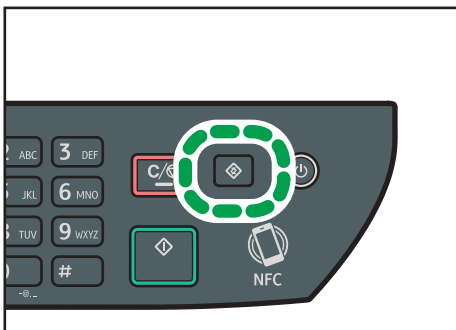

DSG126

2. Press the [▲] or [▼] key to select [Address Book], and then press the [OK] key.

3. If you are requested to enter a password, enter the password using the number keys, and then press the [OK] key.

A password for accessing the [Address Book] menu can be specified in [Admin. Tools Lock]. For details about [Admin. Tools Lock], see page 206 "Administrator Settings".

4. Press the [▲] or [▼] key to select [Quick Dial No.] or [Fax Speed Dial No.], and then press the [OK] key.
5. Press the [▲] or [▼] key to select [No.], and then enter the desired Quick Dial number (1 to 8) or Speed Dial number (1 to 100) using the number keys.

The fax number and fax name registered for that number appear.

6. Press the [▲] or [▼] key to select [Fax No.], and then modify the fax number (up to 40 characters).

If you want to delete the fax number, press the [◀] key until the current number is deleted.

7. Press the [▲] or [▼] key to select [Name], and then modify the fax name (up to 20 characters).

If you want to delete the fax name, press the [◀] key until the current name is deleted.

8. Confirm the setting, and then press the [OK] key.
9. Press the [User Tools] key to return to the initial screen.

 **Note**

- For details about entering characters, see page 32 "Entering Characters".

---

## Registering Fax Destinations Using Web Image Monitor

---

1. Start the web browser and access the machine by entering its IP address.
2. Click [Quick Dial Destination] or [Fax Speed Dial Destination].
3. From the [Destination Type] list, select [Fax].
4. Select [Quick Dial Number] or [Speed Dial Number], and then select the registration number from the list.
5. Register information as necessary.
6. Enter the administrator password if required.
7. Click [Apply].
8. Close the web browser.



## Fax destination settings

Item	Setting	Description
Quick Dial Number / Speed Dial Number	Required	Select the number to which you want to register Quick Dial or Speed Dial destination.
Name	Optional	Name of the destination. The name specified here will be shown on the screen when selecting a fax destination. Can contain up to 20 characters.
Fax Number	Required	Fax number of the destination. Can contain up to 40 characters.  If the machine is connected to the telephone network through a PBX, make sure to enter the outside line access number specified in [PBX Access Number] before the fax number. For [PBX Access Number], see page 206 "Administrator Settings".

### Note

- A fax number can contain 0 to 9, "P" (pause), "\*", "#", "-", and space.
- If necessary, insert a pause in the fax number. The machine pauses briefly before it dials the digits following the pause. You can specify the length of the pause time in the [Pause Time] setting under [Fax TX Settings]. For [Pause Time], see page 184 "Fax Features Settings".
- For details about using Web Image Monitor, see page 221 "Configuring the Machine Using Utilities".
- To use tone services on a pulse-dialing line, insert "\*" in the fax number. "\*" switches the dialing mode from pulse to tone temporarily.

## Modifying fax destinations

1. Start the web browser and access the machine by entering its IP address.

**2. Click [Quick Dial Destination] or [Fax Speed Dial Destination].**

If you modify the Speed Dial entry, proceed to Step 4.

**3. Click [Fax Quick Dial Destination].**

**4. Select the entry to modify, and then click [Change].**

If you want to delete the entry, click [Delete].

**5. Modify settings as necessary.**

To delete the entry, confirm the entry you have selected.

**6. Enter the administrator password if required.**

**7. Click [Apply].**

**8. Close the web browser.**

# Sending a Fax

## ★ Important

- It is recommended that you call the receiver and confirm with them when sending important documents.

## Selecting Transmission Mode

The following explains the transmission modes of the fax function and how to select them.

### Types of transmission modes

There are two types of transmission:

- Memory transmission
- Immediate transmission

### Selecting the transmission mode

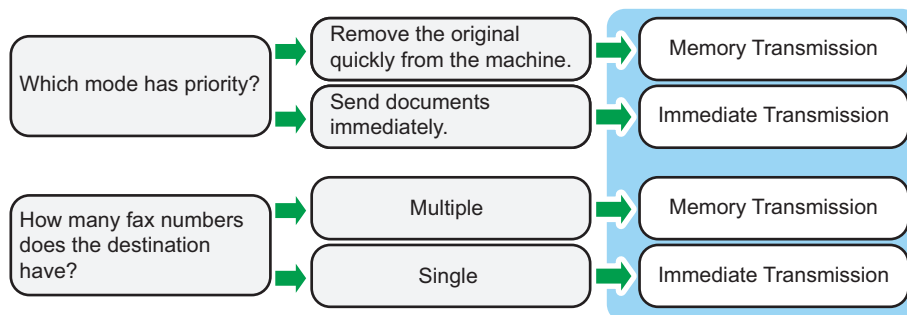

DSG274

### Description of transmission modes

- Memory transmission
- Immediate transmission

In this mode, the machine scans several originals into memory and sends them all at once. This is convenient when you are in a hurry and want to remove the document from the machine. In this mode, you can send a fax to multiple destinations. If the Auto Redial under Fax TX Settings is enabled, the machine redials the fax destination automatically when the line is busy or a transmission error occurs. The number of redial attempts is set to two or three in five-minute intervals, depending on the Country setting under Admin. Tools. You can disable Auto Redial under Fax Features. For details, see page 184 "Fax Features Settings".

- Immediate transmission

In this mode, the machine scans the original and faxes it simultaneously. This is convenient when you want to send an original quickly or when you want to check the destination you are

sending to. The original is not stored in memory. You can only specify one destination. If fax is not received normally, an error message appears on the control panel.

### Configuring the transmission mode

1. Press the [Facsimile] key, and then press the [◀] or [▶] key.

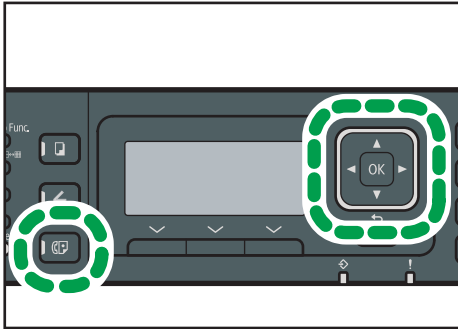

DSG275

Alternatively, you can press the [Shortcut to Func.] key if [Shortcut to Function] under [Admin. Tools] is set to [Direct Transmission]. For [Shortcut to Function], see page 206 "Administrator Settings".

2. Press the [▲] or [▼] key to select [Direct Transmission], and then press the [OK] key.
3. Press the [▲] or [▼] key to select [Off], [On], or [Next Fax Only], and then press the [OK] key.

For Memory Transmission, select [Off].

For Immediate Transmission, select [On] or [Next Fax Only].

4. Press the [User Tools] key to return to the initial screen.

## Basic Operation for Sending a Fax

### ★ Important

- The original in the ADF takes precedence over the original on the exposure glass if you place originals both in the ADF and on the exposure glass.
- If you are using the SP 325SFNw and the setting for [Original] is either [Dup.Portrait:T To T], [Dup.Portrait:T To B], [Dup.Landscape:T To T], or [Dup.Landscape:T To B], load the originals into the ADF. No data is transmitted if you place the originals on the exposure glass. For details about the [Original] setting, see page 184 "Fax Features Settings".

### 1. Press the [Facsimile] key.

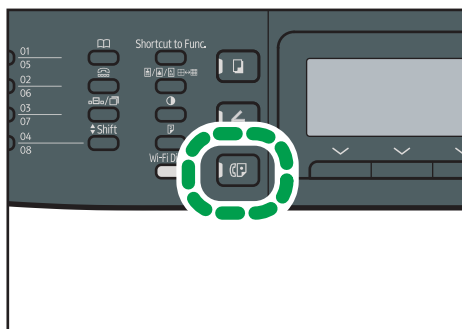

DSG153

### 2. Place the original on the exposure glass or in the ADF.

To place the originals, see page 65 "Placing Originals".

### 3. Enter the fax number (up to 40 characters) using the number keys, or specify a destination using the One Touch buttons or Speed Dial function.

For details about entering characters, see page 32 "Entering Characters".

For details about specifying destinations using the One Touch buttons or Speed Dial function, see page 149 "Specifying the Fax Destination".

If the machine is connected to the telephone network through a PBX, make sure to enter the outside line access number specified in [PBX Access Number] before the fax number. For [PBX Access Number], see page 206 "Administrator Settings".

### 4. Press the [Start] key.



DSG133

- Depending on the machine's settings, you may be prompted to enter the fax number again if you manually entered the destination fax number. In this case, re-enter the number within 60 seconds, and then press the [Start] key. If the fax numbers do not match, go back to Step 3. For [Fax Number Confirmation], see page 206 "Administrator Settings".
- When using the exposure glass in Memory Transmission mode, you will be prompted to place another original. In this case, proceed to the next step.

5. If you have more originals to scan, press [Yes] within 60 seconds, place the next original on the exposure glass, and then press [OK]. Repeat this step until all originals are scanned.

If you do not press [Yes] within 60 seconds, the machine will start to dial the destination.

6. When all originals have been scanned, press [No] or the [Start] key to start sending the fax.

 **Note**

- A fax number can contain 0 to 9, pause, "\*", "#", and space.
- If necessary, insert a pause in a fax number. The machine pauses briefly before it dials the digits following the pause. You can specify the length of the pause time in the [Pause Time] setting under [Fax TX Settings]. For [Pause Time], see page 184 "Fax Features Settings".
- To use tone services on a pulse-dialing line, insert "\*" in a fax number. "\*" switches the dialing mode from pulse to tone temporarily.
- You can specify multiple destinations and broadcast the fax you are sending. For sending a fax using the broadcast function, see page 149 "Specifying the Fax Destination".
- The machine prompts you to enter the fax number twice only when you dial the destination manually. Destinations specified using the One Touch buttons, Speed Dial function, or [Pause/Redial] key need not be confirmed.
- When in Memory Transmission mode, you can enable the [Auto Redial] setting under [Fax TX Settings] to set the machine to automatically redial the destination if the line is busy or an error occurs during transmission. For [Auto Redial], see page 184 "Fax Features Settings".
- When in Memory Transmission mode, the machine's memory may become full while scanning the originals. In this case, the screen prompts you to cancel the transmission or to send only the pages that have been scanned successfully.
- When using SP 325SFNw, you can scan 2-sided originals from the ADF in Memory Transmission mode. Specify how to scan 2-sided originals in the [Original] setting under [Fax TX Settings]. For [Original], see page 184 "Fax Features Settings".
- If paper is jammed in the ADF, the jammed page has not been scanned properly. When the machine is in Immediate Transmission mode, resend the fax starting from the jammed page. When in Memory Transmission mode, scan the entire originals again. For details about removing paper jammed in the ADF, see page 281 "Clearing Misfeeds".

## Canceling a fax

---

Follow the procedure below to cancel sending a fax.

### When in Immediate Transmission mode

If you cancel sending a fax while the machine is scanning the original, the fax transmission process is canceled immediately. In this case, an error is displayed on the other party's machine.

## When in Memory Transmission mode

If you cancel sending a fax while the machine is scanning the original, the machine will not send the document.

If you cancel sending a fax during transmission, the fax transmission process is canceled immediately. In this case, an error is displayed on the other party's machine.

### 1. Press the [Facsimile] key.

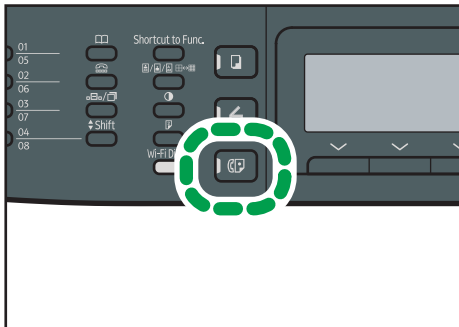

DSG153

### 2. Press the [Clear/Stop] key.

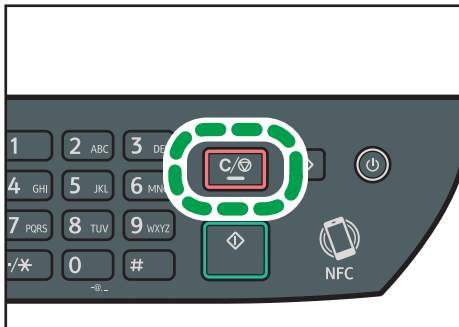

DSG129

#### Note

- If you cancel sending a fax while broadcasting, only the fax to the current destination is canceled. The fax will be sent to the subsequent destinations as normal. For details about sending a fax using the broadcast function, see page 149 "Specifying the Fax Destination".

## Specifying the Fax Destination

Other than entering the destination fax number using the number keys, you can specify destinations using the following functions:

- One Touch buttons

- Speed Dial
- Broadcast function
- Redial function

### Specifying the destination using the One Touch buttons

1. Press the [Facsimile] key.

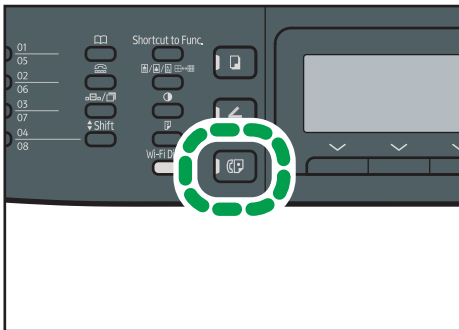

DSG153

2. Press the One Touch button to which the desired Quick Dial entry is registered.

Press the [Shift] key if you want to use Quick Dial entries Nos. 5 to 8 before pressing a One Touch button. For registering the Quick Dial entries, see page 140 "Registering Fax Destinations".

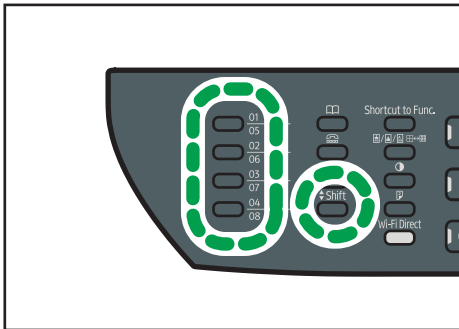

DSG147

**Note**

- You can check the registered names and fax numbers by printing a report. For printing the Quick Dial list, see page 213 "Printing Lists/Reports".



## Specifying the destination using Speed Dial

### 1. Press the [Facsimile] key.

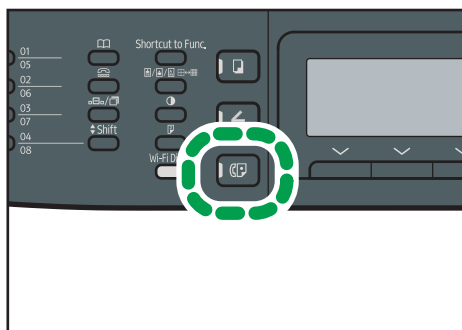

DSG153

### 2. Press the [Address Book] key.

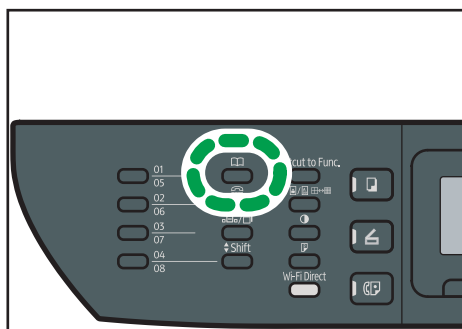

DSG158

### 3. Make sure [Search Address Book] is selected, and then press the [OK] key.

If you want to search for a specific entry by its registration number or name, use the following procedure:

- Searching by the registration number  
Press the [Address Book] key again, enter the number using the number keys, and then press the [OK] key.
- Searching by the name  
Enter the first letters of the name using the number keys, and then press the [OK] key. Each time you enter a character, the display changes to show the matching name.

### 4. Press the [▲] or [▼] key to select the desired Speed Dial entry, and then press the [OK] key.

For registering the Speed Dial entries, see page 140 "Registering Fax Destinations".

#### ↓ Note

- The Address Book shows only the Speed Dial entries. Use the One Touch buttons to specify Quick Dial destinations.

- You can check the registered names and fax numbers by printing a report. For printing the Speed Dial list, see page 213 "Printing Lists/Reports".

## Specifying the destination using the broadcast function

You can send a fax to multiple destinations (up to 100 destinations) simultaneously.

Faxes are sent to destinations in the order they were specified.

### 1. Press the [Facsimile] key.

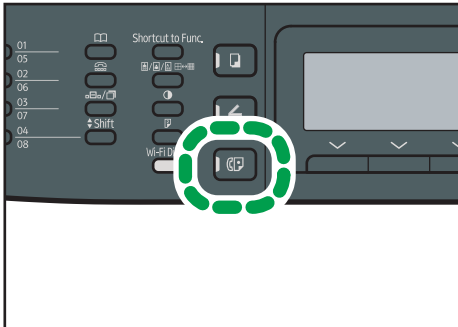

DSG153

### 2. Add a destination by using one of the following methods:

- To add a Quick Dial destination: press a corresponding One Touch button.
- To add a Speed Dial destination: press the [Address Book] key, select [Search Address Book], select a destination, and then press the [OK] key.
- To add a manually-specified destination: confirm that [No.key] is pressed, and then enter the destination fax number using the number keys.

### 3. Press the [OK] key.

Press [List] to see the list of destinations that have been added so far.

Go back to Step 2 to add further destinations.

#### ↓ Note

- While specifying multiple destinations, you can press the [Clear/Stop] key to clear all destinations.
- If you specify multiple destinations in Immediate Transmission mode, the mode switches to Memory Transmission mode temporarily.
- While broadcasting, pressing the [Clear/Stop] key cancels the fax to the current destination only.

## Specifying the destination using the redial function

You can specify the last used destination as the destination for the current job.

This function saves time when you are sending to the same destination repeatedly, as you do not have to enter the destination each time.

### 1. Press the [Facsimile] key.

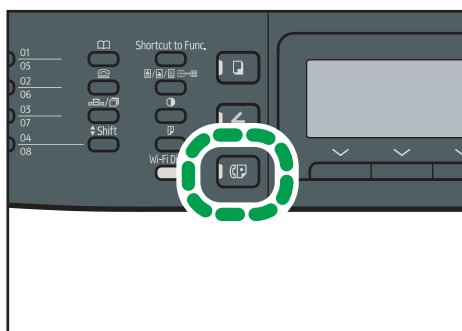

DSG153

### 2. Press the [Pause/Redial] key.

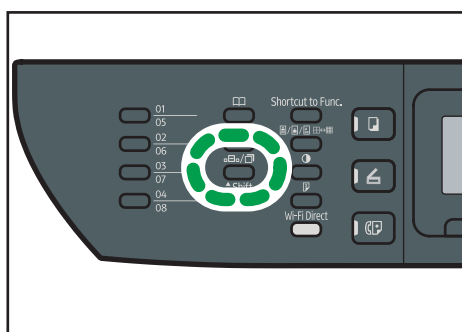

DSG148

## Useful Sending Functions

You can check the status of the other party's machine easily before sending a fax by using the On Hook Dial function. Using an external telephone, you can talk and send a fax in one call.

### ★ Important

- This function is available in Immediate Transmission mode only.

The procedure differs depending on whether [Operation] is set to [Easy Mode] or [Advanced Mode] in [Fax Features].

## Sending a fax using On Hook Dial

The On Hook Dial function allows you to check the destination's status while listening to the tone from the internal speaker. This function is useful when you want to ensure that the fax will be received.

**★ Important**

- The On Hook Dial function cannot be used when [Fax Number Confirmation] under [Admin. Tools] is enabled.

**1. Place the original.**

If [Operation] is set to [Easy Mode], you cannot send faxes using the exposure glass.

**2. Press the [Facsimile] key.**

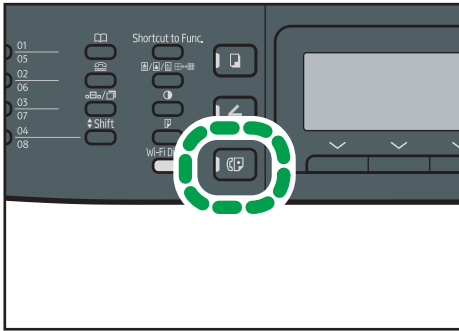

6

**3. Press the [On Hook Dial] key.**

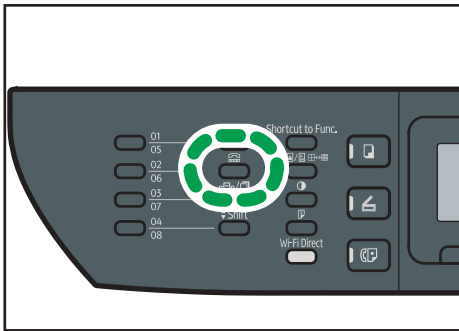

"On Hook" appears on the screen.

**4. Specify the destination using the number keys.**

5. If you hear a high pitched tone, press the [Start] key.

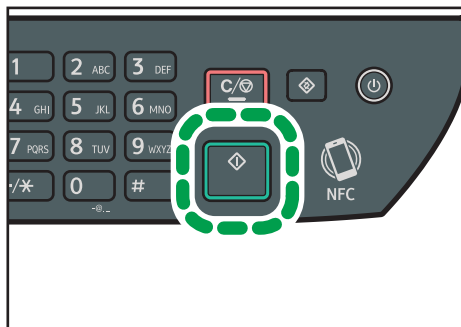

DSG133

If [Operation] is set to [Easy Mode], Step 6 does not apply.

6. If the original is placed on the exposure glass, press [TX], and then press the [Start] key.

**Note**

- For details about selecting the transmission mode, see page 145 "Selecting Transmission Mode".
- For details about [Fax Number Confirmation], see page 206 "Administrator Settings".
- For details about [Operation], see page 184 "Fax Features Settings"

6

## Sending a fax after a conversation

An external telephone allows you to send a fax after finishing your conversation without having to disconnect and redial. This function is useful when you want to ensure that the fax has been received.

1. Place the original.

If [Operation] is set to [Easy Mode], you cannot send faxes using the exposure glass.

2. Press the [Facsimile] key.

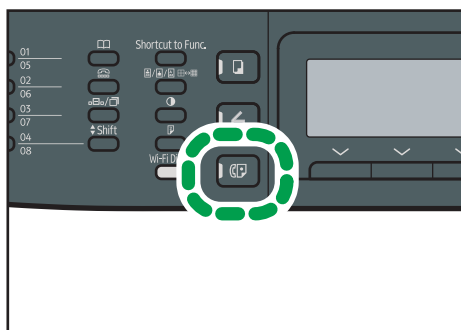

DSG153

3. Pick up the handset.

4. Specify the destination using the external telephone.

5. When the other party answers, ask them to press their fax start button.

6. If you hear a high pitched tone, press the [Start] key.



DSG133

If [Operation] is set to [Easy Mode], Step 8 does not apply.

7. If the original is placed on the exposure glass, press [TX], and then press the [Start] key.

8. Replace the handset.

**Note**

- For details about [Operation], see page 184 "Fax Features Settings".

## Specifying Scan Settings for Faxing

### Adjusting image density

This section describes how to adjust image density for the current job.

There are three image density levels. The darker the density level, the darker the printout.

1. Press the [Density] key.

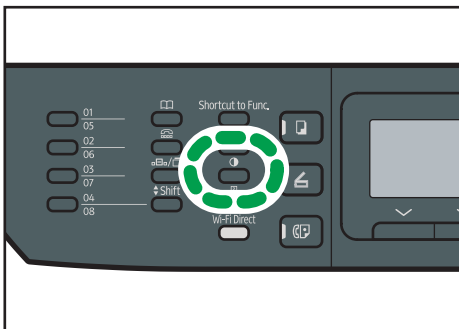

DSG142

2. Press the [▲] or [▼] key to select the desired density level, and then press the [OK] key.

### ↓ Note

- You can change the machine's default [Density] setting to always scan with a specific density level. For [Density], see page 184 "Fax Features Settings".

## Specifying the resolution

This section describes how to specify the scan resolution for the current job.

There are three resolution settings:

### Standard

Select this when the original is a printed or typewritten document with normal-sized characters.

### Detail

Select this when the original is a document with small print.

### Photo

Select this when the original contains images such as photographs or shaded drawings.

#### 1. Press the [Image Quality] key.

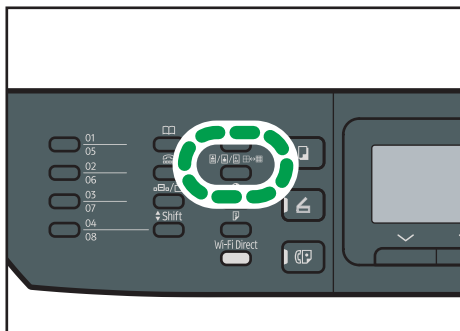

DSG143

#### 1. Press the [▲] or [▼] key to select the desired resolution setting, and then press the [OK] key.

### ↓ Note

- You can change the machine's default [Resolution] setting to always scan with a specific resolution level. For [Resolution], see page 184 "Fax Features Settings".

# Using the Fax Function from a Computer (LAN-Fax)

This section describes how to use the fax function of the machine from a computer.

You can send a document directly from a computer through this machine to another fax machine, without printing the document.

---

## Basic Operation for Sending Faxes from a Computer

---

This section describes the basic operation for sending faxes from a computer.

You can select a destination from the LAN-Fax address book or enter a fax number manually. You can send faxes to up to 100 destinations at one time.

The procedure in this section is an example based on Windows 7.

### ★ Important

- Using LAN-Fax, you can send up to 10 pages (including the cover sheet) at a time.
- Before sending a fax, the machine stores all the fax data in memory. If the machine's memory becomes full while storing this data, the fax transmission will be canceled. If this happens, lower the resolution or reduce the number of pages and try again.

1. Open the file you want to send.
2. On the [File] menu, click [Print...].
3. Select the LAN-Fax driver as the printer, and then click [Print].
4. Specify a destination.
  - To specify a destination from the LAN-Fax address book:  
Select a destination from [User List:], and then click [Add to List].  
Repeat this step to add more destinations.
  - To enter a fax number directly:  
Click the [Specify Destination] tab, and enter a fax number (up to 40 digits) in [Fax Number:], and then click [Add to List].  
Repeat this step to add more destinations.
5. To attach a cover sheet, click [Edit Cover Sheet] on the [Specify Destination] tab, and then select the [Attach a Cover Sheet] check box.  
Edit the cover sheet as necessary, and then click [OK].  
For details about editing a fax cover sheet, see page 163 "Editing a Fax Cover Sheet".
6. Click [Send].



### ↓ Note

- For details, see the LAN-Fax driver help.
- A fax number can contain 0 to 9, "P" (pause), "\*#", "-", and space.
- If necessary, insert a pause in a fax number. The machine pauses briefly before it dials the digits following the pause. You can specify the length of the pause time in the [Pause Time] setting under [Fax TX Settings]. For [Pause Time], see page 184 "Fax Features Settings".
- To use tone services on a pulse-dialing line, insert "\*" in a fax number. "\*" switches the dialing mode from pulse to tone temporarily.
- To delete an entered destination, select the destination in the [Destination List:], and then click [Delete from List].
- You can register the fax number you entered in the [Specify Destination] tab in the LAN-Fax Address Book. Click [Save to Address Book] to open the dialog box for registering a destination.

## Canceling a fax

You can cancel sending a fax using either the machine's control panel or your computer, depending on the status of the job.

6

### Canceling while the machine is receiving a fax from the computer

If the machine is shared by multiple computers, be careful not to cancel the fax of another user.

1. Double-click the printer icon on the task bar of your computer.
2. Select the print job you want to cancel, click the [Document] menu, and then click [Cancel].
3. Click [Yes].

### Canceling while sending a fax

Cancel the fax using the control panel.

1. Press the [Facsimile] key.

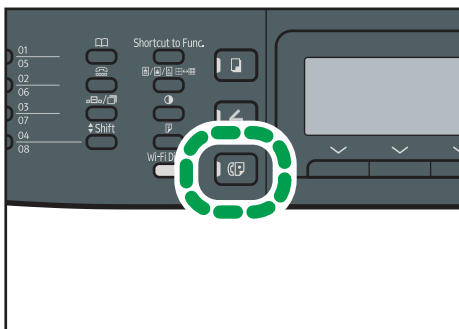

DSG153

2. Press the [Clear/Stop] key.

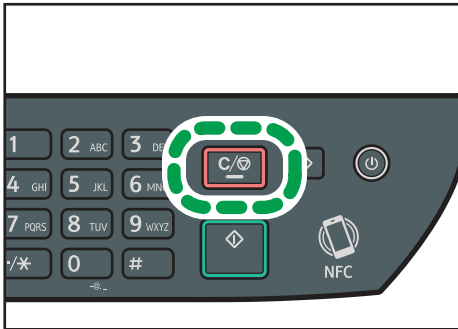

---

## Configuring Transmission Settings

---

This section describes how to configure transmission settings in the LAN-Fax driver's properties.

Properties are set separately for each application.

6

1. On the [File] menu, click [Print...].
2. Select the LAN-Fax driver as the printer, and then click a button such as [Preferences].  
LAN-Fax driver properties dialog box appears.
3. Click the [Setup] tab.
4. Configure settings as necessary, and then click [OK].

For details about the settings, see the LAN-Fax driver help.

---

## Configuring the LAN-Fax Address Book

---

This section describes the LAN-Fax address book. Configure the LAN-Fax address book on the computer. The LAN-Fax address book allows you to specify LAN-Fax destinations quickly and easily.

The LAN-Fax address book can contain up to 1000 entries, including individual destinations and groups of destinations.

---

### Opening the LAN-Fax address book

---

1. On the [Start] menu, click [Devices and Printers].
2. Right-click the LAN-Fax driver icon, and then click [Printing preferences].
3. Click the [Address Book] tab.

## Registering destinations

---

1. Open the LAN-Fax address book, and then click [Add User].
2. Enter the destination information.  
You must enter a contact name and fax number.
3. Click [OK].

## Modifying destinations

---

1. Open the LAN-Fax address Book, select the destination you want to modify from the [User List:], and then click [Edit].
2. Modify information as necessary, and then click [OK].  
Click [Save as new User] if you want to register a new destination with similar information. This is useful when you want to register a series of destinations that contain similar information. To close the dialog box without modifying the original destination, click [Cancel].

## Registering groups

---

1. Open the LAN-Fax address Book, and then click [Add Group].
2. Enter the group name in [Group Name].
3. Select the destination you want to include in the group from [User List:], and then click [Add].  
To delete a destination from a group, select the destination you want to delete from [List of Group Members:], and then click [Delete from List].
4. Click [OK].

## Modifying groups

---

1. Open the LAN-Fax address Book, select the group you want to modify from the [User List:], and then click [Edit].
2. To add a destination to the group, select the destination you want to add from [User List:] and click [Add].
3. To delete a destination from the group, select the destination you want to delete from [List of Group Members:], and then click [Delete from List].
4. Click [OK].

## Deleting individual destinations or groups

---

1. Open the LAN-Fax Address Book, select the destination you want to delete from [User List:], and then click [Delete].

A confirmation message appears.

2. Click [Yes].

## Exporting/Importing LAN-Fax Address Book data

---

### ★ Important

- The following procedure is based on Windows 7 as an example. If you are using another operating system, the procedure might vary slightly.

### Exporting LAN-Fax Address Book data

LAN-Fax Address Book data can be exported to a file in CSV (Comma Separated Values) format. Follow this procedure to export LAN-Fax Address Book data.

1. Open the LAN-Fax Address Book, and then click [Export].
2. Navigate to the location to save the LAN-Fax Address Book data, specify a name for the file, and then click [Save].

### Importing LAN-Fax Address Book data

LAN-Fax Address Book data can be imported from files in CSV format. You can import address book data from other applications if the data is saved as a CSV file.

1. Open the LAN-Fax Address Book, and then click [Import].
2. Select the file containing the address book data, and then click [Open].

A dialog box for selecting the items to import appears.

3. For each field, select an appropriate item from the list.

Select [\*empty\*] for fields for which there is no data to import. Note that [\*empty\*] cannot be selected for [Name] and [Fax].

4. Click [OK].

For details about the settings, see the LAN-Fax driver help.

### ↓ Note

- CSV files are exported using Unicode encoding.
- LAN-Fax Address Book data can be imported from CSV files whose character encoding is Unicode or ASCII.
- Group data cannot be exported or imported.

- Up to 1000 destinations can be registered in the LAN-Fax Address Book. If this limit is exceeded during importing, the remaining destinations will not be imported.

---

## Editing a Fax Cover Sheet

---

1. On the [File] menu, click [Print...].
2. Select the LAN-Fax driver as the printer, and then click [Print].
3. Click the [Specify Destination] tab, and then click [Edit Cover Sheet].
4. Configure settings as necessary, and then click [OK].

For details about the settings, see the LAN-Fax driver help.

## Receiving a Fax

### ★ Important

- When receiving an important fax, we recommend you confirm the contents of the received fax with the sender.
- The machine may not be able to receive faxes when the amount of free memory space is low.

### ↓ Note

- You can use an external telephone to use this machine as a telephone.
- Only A4, Letter, or Legal size paper can be used for printing faxes.

---

## Selecting Reception Mode

---

The following explains the reception modes of the fax function and how to select them.

### ★ Important

- In FAX/TAD mode, the machine receives the fax automatically after the external telephone answering device rings the number of times specified in [Total No. of Rings (TAD)]. Set the external telephone answering device to ring before receiving a fax. For details about [Total No. of Rings (TAD)], see page 184 "Fax Features Settings".

### Types of reception mode

There are four types of reception:

- Fax Only mode
- FAX/TEL Manual mode
- FAX/TEL Auto mode
- FAX/TAD mode

## Selecting the reception modes

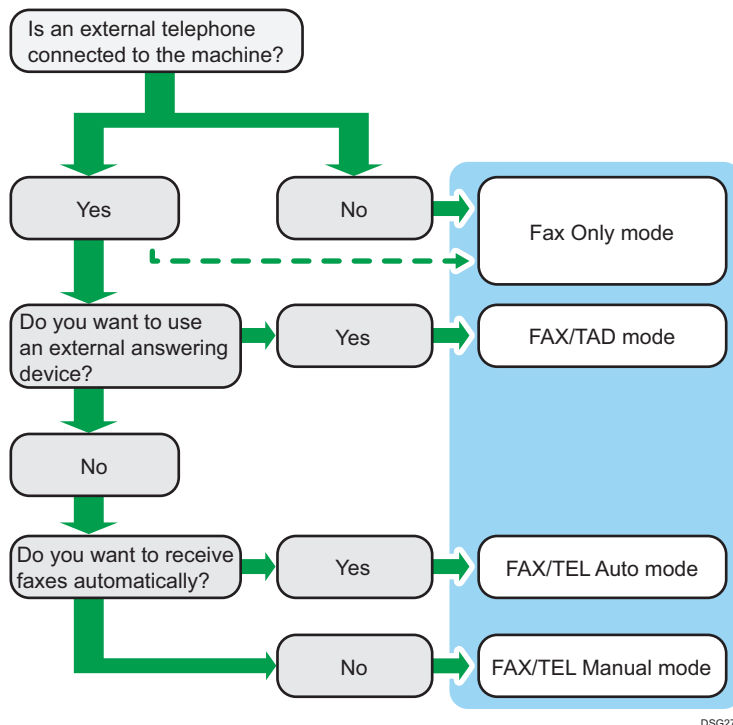

## Description of reception modes

- Fax Only mode (auto reception)
  - When an external telephone is not connected
 

The machine automatically answers all incoming calls in fax reception mode.
  - When an external telephone is connected
 

The machine automatically answers all incoming calls in fax reception mode after the external telephone rings the number of times specified. It is convenient for those who only use telephones for outgoing calls.
- FAX/TAD mode (auto reception)
 

In this mode, the external telephone answering device answers and records messages when the machine receives telephone calls. If the incoming call is a fax call, the machine receives the fax automatically. For details, see page 168 "Receiving a fax in FAX/TAD mode".
- FAX/TEL Auto mode (auto reception)
 

In this mode, the machine receives faxes automatically if a fax calling tone is detected from an incoming call. For details, see page 167 "Receiving a fax in FAX/TEL Auto mode".
- FAX/TEL Manual mode (manual reception)

In this mode, you must answer calls with the handset or an external telephone. If a call is a fax call, you must start the fax reception manually. For details, see page 166 "Receiving a fax in FAX/TEL Manual mode".

### Configuring the reception mode

1. Press the [User Tools] key.

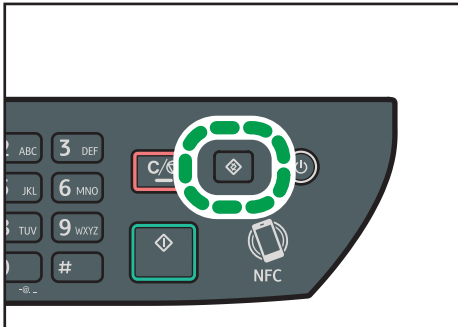

DSG126

2. Press the [▲] or [▼] key to select [Fax Features], and then press the [OK] key.
3. Press the [▲] or [▼] key to select [Reception Settings], and then press the [OK] key.
4. Press the [▲] or [▼] key to select [Switch Reception Mode], and then press the [OK] key.
5. Press the [▲], [▼], [◀], or [▶] key to select the desired reception mode, and then press the [OK] key.
6. Press the [User Tools] key to return to the initial screen.

#### ↓ Note

- In FAX/TAD mode, the machine automatically starts to receive faxes after the external telephone answering device rings the number of times specified in [Total No. of Rings (TAD)] under [Fax Features]. Make sure to set the external telephone answering device to answer calls before the machine starts to receive faxes. For [Total No. of Rings (TAD)], see page 184 "Fax Features Settings".
- An external telephone is required to use this machine as a telephone. For details about connecting an external telephone to the machine, see Initial Guide for FAX.

### Receiving a fax in FAX/TEL Manual mode

#### ★ Important

- The procedure differs depending on whether [Operation] is set to [Easy Mode] or [Advanced Mode] in [Fax Features].
- To receive faxes, be sure to first remove any originals loaded in the ADF.



### 1. Pick up the handset to answer the call.

A normal telephone call starts.

### 2. When you hear a fax calling tone or no sound, press the [Facsimile] key, and then press the [Start] key.

If [Operation] is set to [Easy Mode], proceed to Step 5.

### 3. Press [RX].

### 4. Press the [Start] key.

### 5. Replace the handset.

#### ↓ Note

- For details about [Operation], see page 184 "Fax Features Settings".

## Receiving a fax in Fax Only mode

When the reception mode is set to Fax Only mode, the machine automatically answers all incoming calls in fax reception mode.

#### ↓ Note

- You can specify the number of times the machine rings before answering a call in the [Number of Rings] setting under [Fax Features]. For [Number of Rings], see page 184 "Fax Features Settings".
- If you answer a call with the external telephone while the machine is ringing, a normal telephone call starts. If you hear a fax calling tone or no sound, receive the fax manually. To receive the fax manually, see page 166 "Receiving a fax in FAX/TEL Manual mode".

## Receiving a fax in FAX/TEL Auto mode

When the reception mode is set to FAX/TEL Auto mode, the machine receives faxes automatically if a fax calling tone is detected from an incoming call.

If you answer a call with the external telephone while the machine is ringing, a normal telephone call starts. If you hear a fax calling tone, receive the fax manually. To receive the fax manually, see page 166 "Receiving a fax in FAX/TEL Manual mode".

#### ↓ Note

- You can specify how long the machine rings before it receives faxes in the [RX Mode Auto Switch Time] setting under [Fax Features]. For [RX Mode Auto Switch Time], see page 184 "Fax Features Settings".

## Receiving a fax in FAX/TAD mode

When the reception mode is set to FAX/TAD mode, the external telephone answering device answers and records messages when the machine receives telephone calls. If the incoming call is a fax call, the machine receives the fax automatically.

**1. When there is an incoming call, the external telephone answering device rings the number of times specified in [Total No. of Rings (TAD)] under [Fax Features].**

For [Total No. of Rings (TAD)], see page 184 "Fax Features Settings".

If the external telephone answering device does not answer, the machine starts to receive the fax automatically.

**2. If the external telephone answering device answers, the machine monitors silence on the line for 30 seconds (silence detection).**

- If a fax calling tone or no sound is detected, the machine starts to receive the fax automatically.
- If a voice is detected, a normal telephone call starts. The external telephone answering device records messages.

### ↓ Note

- You can manually receive a fax during silence detection. To receive the fax manually, see page 166 "Receiving a fax in FAX/TEL Manual mode".
- Silence detection does not terminate for 30 seconds even if the external telephone answering device goes on-hook, unless you press the [Clear/Stop] key and disconnect the call.

## Forwarding or Storing Faxes in Memory

To prevent unauthorized users from seeing sensitive faxes, you can set the machine to forward received faxes to a preset destination, or store them in memory without printing them out.

### ↓ Note

- The table below shows what happens after forwarding succeeds or fails depending on the machine's configuration.

Forwarding	[Print Received File]	Results
Success	Automatic	The machine prints out the fax and deletes it from memory.
Success	Manual	The machine stores the fax in memory for later manual printing.

Forwarding	[Print Received File]	Results
Failure	Automatic	The machine prints out a forwarding failure report, prints out the fax, and then deletes it from memory.
Failure	Manual	The machine prints out a forwarding failure report and stores the fax in memory for later manual printing.

- If the machine is unable to print out a fax due to machine errors such as an empty paper tray or a paper jam, the fax will remain in memory. The remaining pages will start printing as soon as the problem is resolved.
- The number of forwarding attempts and the attempt interval time can be specified using Web Image Monitor. For details about the forwarding destination, forwarding trials and interval settings, see page 228 "Configuring the System Settings".

## Forwarding settings

6

To specify the forwarding conditions for received faxes, configure the machine as follows:

1. Press the [User Tools] key.

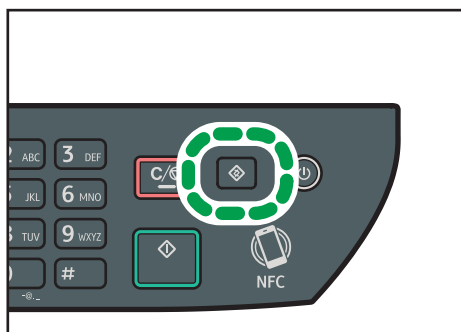

DSG126

2. Press the [▲] or [▼] key to select [Fax Features], and then press the [OK] key.
3. Press the [▲] or [▼] key to select [Reception Settings], and then press the [OK] key.
4. Press the [▲] or [▼] key to select [Reception File Setting], and then press the [OK] key.
5. Press the [▲] or [▼] key to select [Forward & Print], and then press the [OK] key.  
To send e-mail notifications after faxes are forwarded, proceed to Step 6.
6. Press the [▲] or [▼] key to select [Notify Forward Status], and then press the [OK] key.

**7. Press the [▲] or [▼] key to select [Active], and then press the [OK] key.**

- [Active]: Send an e-mail notification after forwarding. E-mail notification destination depends on how the forwarding destination is configured.
- [Inactive]: An e-mail notification is not sent.

## Specifying the forwarding destination using Web Image Monitor

---

1. Start the web browser and access the machine by entering its IP address.
2. Click [System Settings].
3. Click the [Fax] tab.
4. Specify the forwarding destination in [Forwarding Destination].
  - [E-mail Address]: Enter a destination e-mail address.
  - [Scan Destination]: Select a scan destination as a forwarding destination.
5. Enter the administrator password if required.
6. Click [OK].
7. Close the web browser.

For details about using Web Image Monitor, see page 222 "Using Web Image Monitor".

## Configuring the storing conditions

---

To specify the storing conditions for received faxes, configure the machine as follows:

1. Press the [User Tools] key.
2. Press the [▲] or [▼] key to select [Fax Features], and then press the [OK] key.
3. Press the [▲] or [▼] key to select [Reception Settings], and then press the [OK] key.
4. Press the [▲] or [▼] key to select [Reception File Setting], and then press the [OK] key.
5. Press the [▲] or [▼] key to select [Print] or [Forward & Print], and then press the [OK] key.
6. Press the [▲] or [▼] key to select [Print Received File], and then press the [OK] key.
7. Press the [▲] or [▼] key to select [Automatic] or [Manual], and then press the [OK] key.
  - [Automatic]: Automatically print out the received faxes and delete from memory.
  - [Manual]: Store the received faxes in memory for later manual printing.
8. Press the [User Tools] key to return to the initial screen.

When the fax is successfully printed out, it will be deleted from memory.

If the machine is unable to print out a fax due to machine errors such as an empty paper tray or a paper jam, the fax will remain in memory. The remaining pages will start printing as soon as the problem is resolved.

## Printing Out Faxes Stored in Memory

This section explains how to print out received faxes stored in the machine's memory.

If the Data-In indicator is flashing, there is a fax in machine's memory. Follow the procedure below to print the fax.

1. Press the [User Tools] key.

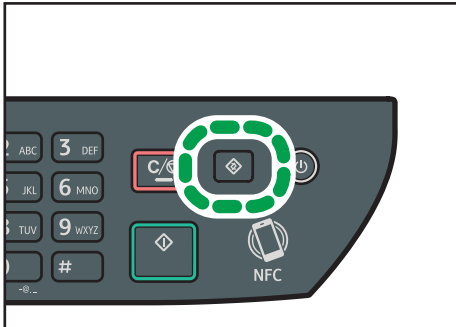

2. Press the [▲] or [▼] key to select [Fax Features], and then press the [OK] key.
3. Press the [▲] or [▼] key to select [Reception Settings], and then press the [OK] key.
4. Press the [▲] or [▼] key to select [RX Store File], and then press the [OK] key.
5. Press the [▲] or [▼] key to select [Print Selected File], and then press the [OK] key.
6. Press the [▲] or [▼] key to select the print job, and then press the [OK] key.
7. Press the [OK] key.
8. Press the [User Tools] key to return to the initial screen.

## Lists/Reports Related to Fax

The lists and reports related to the fax function are as follow:

- Fax Journal  
Prints a fax transmission and reception journal for the last 50 jobs.
- Print Status Report  
Prints out the latest transmission result.
- Standby File List  
Prints a list of pending fax jobs remaining in the machine's memory.
- Power Failure Report  
Prints a report when the machine's power has been interrupted while sending or receiving a fax, or images stored in the machine's memory have been lost due to the machine being turned off for a prolonged period of time.
- Fax Speed Dial List  
Prints a list of Speed Dial entries.
- Quick Dial No. List  
Prints a list of Quick Dial entries.

### Note

- For more information on Fax Journal and Print Status Report, see page 184 "Fax Features Settings".

# 7. Configuring the Machine Using the Control Panel

This chapter describes how to configure the machine using the control panel.

## Basic Operation

There are two main ways to access the machine settings:

- Press the [User Tools] key to access the system or network settings.
- Press the [◀] or [▶] key while in standby mode of each function to access the Copy, Scan, or Fax settings.

To check which category the function you want to configure belongs to, see page 175 "Menu Chart".

1. If you want to configure the machine's system settings, press the [User Tools] key.

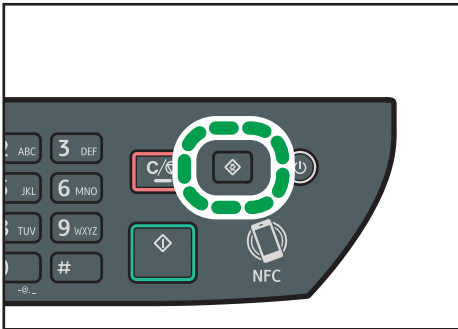

DSG126

Otherwise, press the [◀] or [▶] key while "Ready" is displayed on the initial screen of the Copy, Scan, and Fax settings.

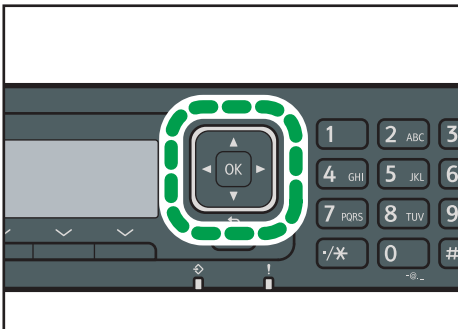

DSG156

2. Press the [▼] or [▲] key to select the settings you want to use.

For a list of available items, see page 175 "Menu Chart".

If you select [Address Book], [Network Settings], or [Admin. Tools] menu, you might be requested to enter a password. Enter the four-digit password, and then press the [OK] key. For details about the password, see [Admin. Tools Lock] on page 206 "Administrator Settings".

3. To confirm setting items and values displayed, press the [OK] key.
4. To go back to the previous item, press the [Back] key.

 **Note**

- To return to the initial screen, press the [Back] key the same amount of times as the number of selected items, or press the [User Tools] key once.



# Menu Chart

This section lists the parameters included in each menu.

For details about configuring the machine using Web Image Monitor, see page 221 "Configuring the Machine Using Utilities".

## ★ Important

- Some items can also be configured using Web Image Monitor.

### **Copier Features ([◀] [▶] key setting)**

For details, see page 176 "Copier Features Settings".

### **Scan Settings ([◀] [▶] key setting)**

For details, see page 181 "Scan Settings".

### **Fax Features ([User Tools] key setting)**

For details, see page 184 "Fax Features Settings".

### **Address Book ([User Tools] key setting)**

For details, see page 192 "Address Book Settings".

### **System Settings ([User Tools] key setting)**

For details, see page 193 "System Settings".

### **Tray Paper Settings**

For details, see page 202 "Tray Paper Settings".

### **Wi-Fi Setup Wizard**

For details, see Setup Guide.

### **Network Settings ([User Tools] key setting)**

For details, see page 215 "Network Settings".

### **Print List/Report ([User Tools] key setting)**

For details, see page 213 "Printing Lists/Reports".

### **Admin. Tools ([User Tools] key setting)**

























For details, see page 206 "Administrator Settings".



### **Printer Features ([User Tools] key setting)**

For details, see page 198 "Printer Features Settings".

## Copier Features Settings

Item	Description	Value
Select Paper	<p>Specifies the paper size used for printing copies.</p> <p>When a tray is selected, the machine prints from that tray only.</p> <p>When a paper size is selected, the machine checks the trays for the paper of the specified size in the order of priority as set in [Paper Tray Priority] under [Tray Paper Settings].</p> <p>If multiple trays contain valid paper, the first tray the machine finds will be used for printing; when that tray runs out of paper, the machine automatically switches to the next tray to continue printing.</p>	<ul style="list-style-type: none"> <li>• Tray 1</li> <li>• Bypass Tray</li> <li>• A4</li> <li>• 8 1/2 × 11</li> <li>• 16K</li> </ul> <p>Default: [Tray 1]</p>
Sort	<p>Configures the machine to sort the output pages into sets when making multiple copies of a multi-page document (P1, P2, P1, P2...).</p>	<ul style="list-style-type: none"> <li>• Off</li> <li>• On</li> </ul> <p>Default: [Off]</p>



Item	Description	Value
Original Type	Specifies the content of originals, to optimize copy quality.	<ul style="list-style-type: none"> <li>• Mixed Select this when the original contains both text and photographs or pictures.</li> <li>• Text Select this when the original contains only text and no photographs or pictures.</li> <li>• Photo Select this when the original contains photographs or pictures. Use this mode for the following types of original: <ul style="list-style-type: none"> <li>• Photographs</li> <li>• Pages that are entirely or mainly photographs or pictures, such as magazine pages.</li> </ul> </li> </ul> <p>Default: [Mixed]</p>
Density	Specifies the image density for photocopying.	<ul style="list-style-type: none"> <li>•     (Lightest)</li> <li>•    </li> <li>•    </li> <li>•    </li> <li>•     (Darkest)</li> </ul> <p>Default:    </p>







Item	Description	Value
Reduce/Enlarge	Specifies the percentage by which copies are enlarged or reduced.	<p> <b>Region A</b></p> <ul style="list-style-type: none"> <li>• 50%</li> <li>• 71% (A4-&gt;A5)</li> <li>• 82% (B5J-&gt;A5)</li> <li>• 93%</li> <li>• 100%</li> <li>• 122% (A5-&gt;B5J)</li> <li>• 141% (A5-&gt;A4)</li> <li>• 200%</li> <li>• 400%</li> </ul> <p> <b>Region B</b></p> <ul style="list-style-type: none"> <li>• 50%</li> <li>• 65% LT-&gt;HLT</li> <li>• 78% LG-&gt;LT</li> <li>• 93%</li> <li>• 129% HLT-&gt;LT</li> <li>• 155% HLT-&gt;LG</li> <li>• 200%</li> <li>• 400%</li> <li>• Zoom 25-400%</li> </ul> <p>Default: [100%]</p>

Item	Description	Value
Duplex/Combine	<p>Specifies combined copying. Select a copy mode according to your original and how you want the copy outputs to appear. For more details, see page 82 "Copying Single-Sided Originals with 2-Sided and Combined Printing" and page 86 "Copying 2-Sided Originals with 2-Sided and Combined Printing".</p> <p>Note that enabling combined copying automatically disables ID card copying.</p> <p>Some items might not appear, depending on the model type you are using.</p>	<ul style="list-style-type: none"> <li>• Off</li> <li>• 1Sd 2Orig-&gt;Comb 2on1 1Sd</li> <li>• 1Sd 4Orig-&gt;Comb 4on1 1Sd</li> <li>• 1 Sided Orig-&gt;2 Sided Copy</li> <li>• 1Sd 4Orig-&gt;Comb 2on1 2Sd</li> <li>• 1Sd 8Orig-&gt;Comb 4on1 2Sd</li> <li>• 2Sd 1Orig-&gt;Comb 2on1 1Sd</li> <li>• 2Sd 2Orig-&gt;Comb 4on1 1Sd</li> <li>• 2 Sided Orig-&gt;2 Sided Copy</li> <li>• 2Sd 2Orig-&gt;Comb 2on1 2Sd</li> <li>• 2Sd 4Orig-&gt;Comb 4on1 2Sd</li> <li>• Manual 2 Sided Scan Mode</li> </ul> <p>Default: [Off]</p>

Item	Description	Value
ID Card Settings	Specifies the ID Card Copy setting.	<ul style="list-style-type: none"> <li>• ID Card Copy                             <ul style="list-style-type: none"> <li>• Off</li> <li>• On</li> </ul> </li> </ul> Default: [Off] <ul style="list-style-type: none"> <li>• ID Card Center Line                             <p>Specify whether to draw a center line when making ID card copy.</p> <ul style="list-style-type: none"> <li>• Print</li> <li>• Do not Print</li> </ul> </li> </ul> Default: [Do not Print] <ul style="list-style-type: none"> <li>• ID Card Size                             <p>You can change the ID card copy scanning size.</p> <ul style="list-style-type: none"> <li>• Horizontal: 50 to 148mm (1.90 to 5.83 inches)</li> <li>• Vertical: 50 to 216mm (1.90 to 8.50 inches)</li> </ul> </li> </ul> Default(horizontal × vertical): 57×88mm (2.24×3.46inches)

## Scan Settings

Item	Description	Value
Scan Size	Specifies the scanning size according to the size of the original.	<p>8 1/2 × 14, 8 1/2 × 11, 8 1/2 × 5 1/2, 7 1/4 × 10 1/2, A4, B5, A5, 16K, Custom Size</p> <p> <b>Region A</b></p> <p>Default: [A4]</p> <p> <b>Region B</b></p> <p>Default: [8 1/2 × 11]</p>
Scanning Mode	Specifies the scanning mode using the control panel.	<ul style="list-style-type: none"> <li>• <b>B&amp;W</b> The machine creates 1-bit black-and-white images. Images contain only black and white colors.</li> <li>• <b>Color</b> The machine creates 8-bit color images. Images are full color.</li> <li>• <b>Gray Scale</b> The machine creates 8-bit black-and-white images. Images contain black and white, and intermediate gray colors.</li> </ul> <p>Default: [B&amp;W]</p>
Max. E-mail Size	Specifies the maximum size of a file that can be sent by e-mail.	<ul style="list-style-type: none"> <li>• 1 MB</li> <li>• 2 MB</li> <li>• 3 MB</li> <li>• 4 MB</li> <li>• 5 MB</li> <li>• No Limit</li> </ul> <p>Default: [1 MB]</p>

Item	Description	Value
Density	Specifies the image density for scanning originals.	<ul style="list-style-type: none"> <li>•  (Lightest)</li> <li>• </li> <li>• </li> <li>• </li> <li>•  (Darkest)</li> </ul> Default: 
Resolution	Specifies the resolution for scanning the original.	<ul style="list-style-type: none"> <li>• 100 × 100dpi</li> <li>• 150 × 150dpi</li> <li>• 200 × 200dpi</li> <li>• 300 × 300dpi</li> <li>• 400 × 400dpi</li> <li>• 600 × 600dpi</li> </ul> Default: [300 × 300dpi]
Compression (Color)	Specifies the color compression ratio for JPEG files. The lower the compression ratio, the higher the quality but greater the file size.	<ul style="list-style-type: none"> <li>• Low</li> <li>• Medium</li> <li>• High</li> </ul> Default: [Medium]
Limitless Scan	Sets the machine to request next originals when scanning with the exposure glass.	<ul style="list-style-type: none"> <li>• Off</li> <li>• On</li> </ul> Default: [Off]
File Type	Specifies whether to create a multi-page file containing all pages or separate single-page files when scanning multiple pages.  Note that a scanned file can contain multiple pages only when the file format is PDF or TIFF. If the file format is JPEG, a single-page file is created for each scanned page.	<ul style="list-style-type: none"> <li>• Multi-page</li> <li>• Single Page</li> </ul> Default: [Multi-page]



Item	Description	Value
Original (only SP 325SNw and SP 325SFNw)	Specifies the orientation to scan and whether to have scanned in double side.	<ul style="list-style-type: none"><li>• Sim.Portrait</li><li>• Dup.Portrait: T To T</li><li>• Dup.Portrait: T To B</li><li>• Dup.Landscape: T To T</li><li>• Dup.Landscape: T To B</li></ul> Default: [Sim.Portrait]

# Fax Features Settings

## Fax TX Settings

Item	Description	Value
Direct Transmission	Sets the machine to send a fax immediately when the original is scanned.	<ul style="list-style-type: none"> <li>• Off Select this when using Memory Transmission.</li> <li>• On Select this when using Immediate Transmission.</li> <li>• Next Fax Only Select this when using Immediate Transmission for the next transmission only.</li> </ul> Default: Off
Resolution	Specifies the resolution to use for scanning originals.	<ul style="list-style-type: none"> <li>• Standard Select this when the original is a printed or typewritten document with normal-sized characters.</li> <li>• Detail Select this when the original is a document with small print.</li> <li>• Photo Select this when the original contains images such as photographs or shaded drawings.</li> </ul> Default: Standard
Density	Specifies the image density to use for scanning originals.	<ul style="list-style-type: none"> <li>• Light</li> <li>• Normal</li> <li>• Dark</li> </ul> Default: Normal

Item	Description	Value
Pause Time	Specifies the length of pause time when a pause is inserted between the digits of a fax number.	1 to 15 seconds Default: <b>3</b> seconds
Auto Redial	Sets the machine to redial the fax destination automatically when the line is busy or a transmission error occurs, if the machine is in Memory Transmission mode. The number of redial attempts is preset to two or three times, depending on the Country setting under Admin. Tools, in five-minute intervals.	<ul style="list-style-type: none"> <li>• Off</li> <li>• On</li> </ul> Default: On
Print Fax Header	Sets the machine to add a header to every fax you send. The header includes the current date and time, user fax name and fax number of the machine, job ID, and page information.	<ul style="list-style-type: none"> <li>• Off</li> <li>• On</li> </ul> Default: On
Original (only SP 325SFNw)	Specifies the orientation to fax and whether to have faxes printed in both sides.	<ul style="list-style-type: none"> <li>• Sim.Portrait</li> <li>• Dup.Portrait: T To T</li> <li>• Dup.Portrait: T To B</li> <li>• Dup.Landscape: T To T</li> <li>• Dup.Landscape: T To B</li> </ul> Default: Sim.Portrait

### Reception Settings

Specifies the settings for receiving a fax.

Item	Description	Value
Switch Reception Mode	Specifies the reception mode.	<ul style="list-style-type: none"> <li>• Fax Only The machine automatically answers all incoming calls in fax reception mode.</li> <li>• FAX/TEL(Mnl.) The machine rings when it receives incoming calls. The machine receives faxes only when you manually receive faxes.</li> <li>• FAX/TAD The machine receives faxes automatically when a fax call is received. Otherwise, the connected telephone answering device answers the call.</li> <li>• FAX/TEL(Auto) The machine receives faxes automatically if a fax calling tone is detected from an incoming call.  If you answer the call with the external telephone while the machine is ringing, a normal telephone call starts. If you hear a fax calling tone, receive the fax manually.</li> </ul> <p>Default: [Fax Only]</p>
Auto Reduction	<p>Sets the machine to reduce the size of a received fax if it is too large to print on a single sheet of paper.</p> <p>Note that the machine only reduces the size down to 74%. If further reduction is required to fit the fax on a single sheet, it will be printed on separate sheets without being reduced.</p>	<ul style="list-style-type: none"> <li>• Off</li> <li>• On</li> </ul> <p>Default: [On]</p> <p>Default may be [Off] depending on the [Country] setting under [Admin. Tools].</p>

Item	Description	Value
Total No. of Rings (TAD)	Specifies the number of times the external telephone answering device rings before the machine starts to receive faxes in FAX/TAD mode.	3 to 20 times, in increments of 1 Default: <b>3</b> times
Number of Rings	Specifies the number of times the machine rings before it starts to receive faxes in Fax Only mode.	3 to 5 times Default: <b>3</b> times
RX Mode Auto Switch Time	Specifies how long the machine rings before it starts to receive faxes in FAX/TEL (Auto) mode.	5 to 99 seconds Default: 15 seconds
2 Sided Print	Specify whether or not received fax documents are to be printed on both sides of the paper.	<ul style="list-style-type: none"> <li>• Off</li> <li>• 2 Sided Portrait: T to T</li> <li>• 2 Sided Portrait: T to B</li> </ul> Default: [Off]
RX Store File	You can print or delete received faxes.	<ul style="list-style-type: none"> <li>• Print Selected File You can select and print received faxes.</li> <li>• Delete Selected File You can select and delete received faxes.</li> <li>• Delete All Files</li> </ul>
Reception File Setting	Sets the machine to store received faxes into memory for printing or forward them to a preset destination. Use Web Image Monitor to specify the forwarding destination (for details, see page 228 "Configuring the System Settings").	<ul style="list-style-type: none"> <li>• Print</li> <li>• Forward &amp; Print</li> </ul> Default: [Print]
Print Received File	Sets the machine to automatically print the faxes received into memory or store them for later manual printing.	<ul style="list-style-type: none"> <li>• Manual</li> <li>• Automatic</li> </ul> Default: [Automatic]

Item	Description	Value
Notify Forward Status	Sets the machine to send e-mail notifications after faxes are forwarded. The e-mail notification destination depends on how the forwarding destination is configured using Web Image Monitor (for details, see page 228 "Configuring the System Settings").	<ul style="list-style-type: none"> <li>• Inactive</li> <li>• Active</li> </ul> Default: [Inactive]

**Delete Standby File**

Deletes unsent fax jobs remaining in the machine's memory. The machine can store up to 5 unsent fax jobs. This function is only performed when selected.

Item	Description	Value
Delete Selected File	To delete a fax job, select the desired job, and then press the [OK] key. Pressing the [Back] key exits to the previous level of the menu tree without deleting the fax job.	-
Delete All Files	To delete the fax jobs, press the [OK] key. Pressing the [Back] key exits to the previous level of the menu tree without deleting the fax jobs.	-

**Communication Settings**

Item	Description	Value
ECM Transmission	Sets the machine to automatically resend parts of the data that are lost during transmission.	<ul style="list-style-type: none"> <li>• Off</li> <li>• On</li> </ul> Default: [On]
ECM Reception	Sets the machine to automatically receive parts of the data that are lost during reception.	<ul style="list-style-type: none"> <li>• Off</li> <li>• On</li> </ul> Default: [On]

Item	Description	Value
Dial Tone Detect	Sets the machine to detect a dial tone before the machine begins to dial the destination automatically.  (Default may be [Not Detect] depending on the [Country] setting under [Admin. Tools].)	<ul style="list-style-type: none"> <li>• Detect</li> <li>• Not Detect</li> </ul> Default: [Detect]
Transmission Speed	Specifies the transmission speed for the fax modem.	<ul style="list-style-type: none"> <li>• 33.6 Kbps</li> <li>• 14.4 Kbps</li> <li>• 9.6 Kbps</li> <li>• 7.2 Kbps</li> <li>• 4.8 Kbps</li> <li>• 2.4 Kbps</li> </ul> Default: [33.6 Kbps]
Reception Speed	Specifies the reception speed for the fax modem.	<ul style="list-style-type: none"> <li>• 33.6 Kbps</li> <li>• 14.4 Kbps</li> <li>• 9.6 Kbps</li> <li>• 7.2 Kbps</li> <li>• 4.8 Kbps</li> <li>• 2.4 Kbps</li> </ul> Default: [33.6 Kbps]

**Report Print Settings**

Item	Description	Value
<p>Print Status Report</p>	<p>Sets the machine to print a transmission report automatically after a fax transmission.</p> <p>When the machine is in Immediate Transmission mode, the image of the original will not be reproduced on the report, even if [Error Only (Image Attached)] or [Every Time (With Image)] is selected.</p> <p>Note that if a memory error occurs for LAN-Fax transmission, a transmission report will always be printed regardless of this setting.</p> <p>The transmission report will be printed on A4 or Letter size paper.</p>	<ul style="list-style-type: none"> <li>• Error Only Prints a report when a transmission error occurs.</li> <li>• Error Only (Image Attached) Prints a report with an image of the original when transmission error occurs.</li> <li>• Print Every Time Prints a report for every fax transmission.</li> <li>• Every Time (With Image) Prints a report with an image of the original for every fax transmission.</li> <li>• Do not Print</li> </ul> <p>Default: [Every Time (With Image)]</p>
<p>Print Fax Journal</p>	<p>Sets the machine to print a fax journal automatically for every 50 fax jobs (both sent and received).</p> <p>The fax journal will be printed on A4 or Letter size paper.</p>	<ul style="list-style-type: none"> <li>• Auto Print</li> <li>• Do not Auto Print</li> </ul> <p>Default: [Auto Print]</p>



## Operation

Item	Description	Value
Operation	<p>You can simplify the procedure for sending and receiving faxes by disabling the use of the exposure glass. If originals are loaded in the ADF, you can fax them using the ADF in either mode by pressing the [Start] key.</p>	<ul style="list-style-type: none"> <li>• Easy Mode           <p>If you select [Easy Mode], you can receive faxes by pressing the [Start] key. The exposure glass cannot be used in this mode.</p> </li> <li>• Advanced Mode           <p>If you select [Advanced Mode], you can specify whether to send or receive faxes after pressing the [Start] key.</p> </li> </ul> <p>Default: [Advanced Mode]</p>

# Address Book Settings

Item	Description	Value
Quick Dial No.	Specifies the fax number and name for Quick Dial entries. You can register up to 8 Quick Dial entries.	<ul style="list-style-type: none"> <li>• No. Specifies the Quick Dial number.</li> <li>• Fax No. Specifies the fax number for Quick Dial entries. The fax number can contain up to 40 characters, including 0 to 9, pause, "✳", "#", and space.</li> <li>• Name Specifies the name for Quick Dial entries. The name can contain up to 20 characters.</li> </ul>
Fax Speed Dial No.	Specifies the fax number and name for Speed Dial entries. You can register up to 100 Speed Dial entries.	<ul style="list-style-type: none"> <li>• No. Specifies the Speed Dial number.</li> <li>• Fax No. Specifies the fax number for Speed Dial entries. The fax number can contain up to 40 characters, including 0 to 9, pause, "✳", "#", and space.</li> <li>• Name Specifies the name for Speed Dial entries. The name can contain up to 20 characters.</li> </ul>

# System Settings

## Adjust Sound Volume

Specifies the volume of the sounds produced by the machine.

Item	Description	Value
Panel Key Sound	Specifies the volume of the beep that sounds when a key is pressed.	<ul style="list-style-type: none"> <li>• Off</li> <li>• Low</li> <li>• Middle</li> <li>• High</li> </ul> Default: [Low]
Ring Volume	Specifies the volume of the ringing tone.	<ul style="list-style-type: none"> <li>• Off</li> <li>• Low</li> <li>• Middle</li> <li>• High</li> </ul> Default: [Middle]
On Hook Mode	Specifies the volume of the sound from the speaker during on hook mode.	<ul style="list-style-type: none"> <li>• Off</li> <li>• Low</li> <li>• Middle</li> <li>• High</li> </ul> Default: [Middle]
Job End Tone	Specifies the volume of the beep that sounds when a job is complete.	<ul style="list-style-type: none"> <li>• Off</li> <li>• Low</li> <li>• Middle</li> <li>• High</li> </ul> Default: [Middle]
Job Error Tone	Specifies the volume of the beep that sounds when a fax transmission error occurs.	<ul style="list-style-type: none"> <li>• Off</li> <li>• Low</li> <li>• Middle</li> <li>• High</li> </ul> Default: [Middle]

Item	Description	Value
Alarm Volume	Specifies the volume of the alarm that sounds when an operation error occurs.	<ul style="list-style-type: none"> <li>• Off</li> <li>• Low</li> <li>• Middle</li> <li>• High</li> </ul> Default: [Middle]

**I/O Timeout**

Item	Description	Value
USB	Specifies how many seconds the machine waits for print data, if the data is interrupted while it is being sent from the computer via USB. If the machine does not receive any more data within the time specified here, the machine only prints the data it has received. If printing is frequently interrupted by data from other ports, increase the timeout period.	<ul style="list-style-type: none"> <li>• 15 sec.</li> <li>• 60 sec.</li> <li>• 300 sec.</li> </ul> Default: [60 sec.]
Network	Specifies how many seconds the machine waits for print data, if the data is interrupted while it is being sent from the computer via network. If the machine does not receive any more data within the time specified here, the machine only prints the data it has received. If printing is frequently interrupted by data from other ports, increase the timeout period.	<ul style="list-style-type: none"> <li>• 15 sec.</li> <li>• 60 sec.</li> <li>• 300 sec.</li> </ul> Default: [15 sec.]

Item	Description	Value
Fixed USB Port	Specifies whether the same printer/ LAN-Fax driver can be used for multiple machines or not under USB connection.	<ul style="list-style-type: none"> <li>• Off You must install the printer/ LAN-Fax driver separately for individual machines, because the machine other than the original will be recognized as a new device upon USB connection.</li> <li>• On The same printer/LAN-Fax driver you have installed in your computer can be used with any machine other than the one originally used for installation, if the machine is of the same model.</li> </ul> Default: [Off]

### Auto Continue



Item	Description	Value
Auto Continue	Sets the machine to ignore an error with paper size or type and continue printing. The printing stops temporarily when an error is detected, and restarts automatically after about ten seconds using the settings made on the control panel.	<ul style="list-style-type: none"> <li>• Off</li> <li>• On</li> </ul> Default: [Off]

### Toner Saving

Item	Description	Value
Toner Saving	Sets the machine to print using a reduced amount of toner (for prints made by the copier function only).	<ul style="list-style-type: none"> <li>• Off</li> <li>• On</li> </ul> Default: [Off]

### Supplies Status

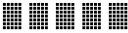
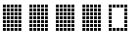
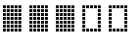
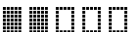
Displays information about consumables. To replace the print cartridge, fusing unit, transfer roller, or paper feed roller, contact your sales or service representative.

Item	Description	Value
<ul style="list-style-type: none"> <li>• Print Cart.</li> <li>• Fusing Unit</li> <li>• Transfer Roller</li> <li>• Paper Feed Roller</li> </ul>	Displays the remaining amount of supplies.	<ul style="list-style-type: none"> <li>•  (New)</li> <li>• </li> <li>• </li> <li>• </li> <li>• </li> <li>•  (Needs replacing)</li> </ul>

### Printer Registration

Adjust the registration of each tray if necessary. You can adjust the registration value between -15 and +15 (that is, -1.5 and +1.5 mm, in 0.1 mm increments).

Default: 0 for all parameters

7

Item	Description
Horiz.: Tray 1	Select this to adjust the tray 1 registration horizontally.
Vert.: Tray 1	Select this to adjust the tray 1 registration vertically.
Horiz.: Bypass Tray	Select this to adjust the bypass tray registration horizontally.
Vert.: Bypass Tray	Select this to adjust the bypass tray registration vertically.
Horiz.: Duplex: Back	Select this to adjust the registration of the back of duplex printing horizontally.
Vert.: Duplex: Back	Select this to adjust the registration of the back of duplex printing vertically.

## Low Humidity Mode

Item	Description	Value
Low Humidity Mode	<p>If the machine is used in a room where humidity level is low, black lines of a few millimeters thick may appear on printouts with 75-millimeter spaces in between. Selecting [On] for this setting may prevent these lines from appearing (wait for about one day until this setting becomes effective).</p> <p>Note that when this setting is enabled, the machine automatically performs self-maintenance in every 10 minutes.</p>	<ul style="list-style-type: none"> <li>• Off</li> <li>• On</li> </ul> <p>Default: [Off]</p>

## Image Density

Item	Description	Value
Image Density	Adjusts the density of images on prints.	-3 to +3 Default: 0

# Printer Features Settings

## List/Test Print

Prints lists showing configurations on the machine.

The lists will be printed on A4 or Letter size paper.



Item	Description
Config. Page	Prints general information and the current configurations of the machine.
Menu List	Prints the machine's function menus.
Test Page	Prints a test page for checking the single-sided printing condition. The test page contains network settings.
PCL Font List	Prints installed PCL font list.
Duplex Test Page	Prints a test page for checking the duplex printing condition.

## System

7

Item	Description	Value
Copies	Sets the machine to print the specified number of sets.  This setting is disabled if the number of pages to print is specified by the printer driver.	1 to 999 Default: 1
Sub Paper Size	Sets the machine to print onto paper of another size if the specified paper is not loaded in any tray. Alternative sizes are preset to A4 and Letter.	<ul style="list-style-type: none"> <li>• Auto</li> <li>• Off</li> </ul> Default: [Off]





Item	Description	Value
Default Page Size	Specifies the paper size to be used when the paper size is not specified in the print job.	A4, 8 1/2 × 11, B5 JIS, B6 JIS, A5 LEF, A5 SEF, A6, 8 1/2 × 14, 8 1/2 × 13, 8.5 × 13.4, 8.5 × 13.6, 16K, 8.11 × 13.3, 5 1/2 × 8 1/2, 4 1/8 × 9 1/2, 3 7/8 × 7 1/2, DL Env, C6 Env, C5 Env  Region <b>A</b> Default: A4  Region <b>B</b> Default: [8 1/2 × 11]
Duplex	Sets the machine to print on both sides of paper according to the specified binding method.	<ul style="list-style-type: none"> <li>• None</li> <li>• Long Edge Bind</li> <li>• Short Edge Bind</li> </ul> Default: [None]
Blank Page Print	Sets the machine to print blank pages. When cover sheet printing is enabled from the printer driver, cover sheets are inserted even if you select [Off]. Note that this setting has lower priority than the printer driver's blank page setting.	<ul style="list-style-type: none"> <li>• On</li> <li>• Off</li> </ul> Default: [On]
Print Error Report	Sets the machine to print an error page when the machine detects a printer or memory error.	<ul style="list-style-type: none"> <li>• On</li> <li>• Off</li> </ul> Default: [Off]

### PCL Menu

Specifies conditions when using PCL for printing.





Item	Description	Value
Orientation	Specifies the page orientation.	<ul style="list-style-type: none"> <li>• Portrait</li> <li>• Landscape</li> </ul> Default: [Portrait]

Item	Description	Value
Form Lines	Specifies the number of lines per page.	5 to 128  Region <b>A</b> Default: <b>64</b>  Region <b>B</b> Default: <b>60</b>
Font Number	Specifies the ID of the default font you want to use.	0 to 89 Default: <b>0</b>
Point Size	Specifies the point size for the default font. This setting is effective only for a variable-space font.	4.00 to 999.75 Default: <b>12.00</b> points You can use the [▼] or [▲] key to change the value in 0.25 increments.
Font Pitch	Specifies the number of characters per inch for the default font. This setting is effective only for fixed-space fonts.	0.44 to 99.99 Default: <b>10.00</b> pitch
Symbol Set	Specifies the character set for the default font. The following sets are available:	Roman-8, Roman-9, ISO L1, ISO L2, ISO L5, PC-8, PC-8 D/N, PC-850, PC-852, PC-858, PC8-TK, Win L1, Win L2, Win L5, Desktop, PS Text, VN Intl, VN US, MS Publ, Math-8, PS Math, VN Math, Pifont, Legal, ISO 4, ISO 6, ISO 11, ISO 15, ISO 17, ISO 21, ISO 60, ISO 69, Win 3.0, MC Text, ISO L6, ISO L9, PC-775, PC-1004, Win Baltic Default: [PC-8]
Courier Font	Specifies a courier-type font.	<ul style="list-style-type: none"> <li>• Regular</li> <li>• Dark</li> </ul> Default: [Regular]
Ext. A4 Width	Sets the machine to extend the width of the printable area of A4 size paper, reducing side margin width.	<ul style="list-style-type: none"> <li>• On</li> <li>• Off</li> </ul> Default: [Off]

Item	Description	Value
Append CR to LF	Sets the machine to append a CR code to each LF code to print text data clearly.	<ul style="list-style-type: none"><li>• On</li><li>• Off</li></ul> Default: [Off]
Resolution	Specifies the print resolution in dots per inch.	600 × 600 dpi Default: [600 × 600 dpi]

# Tray Paper Settings

Item	Description	Value
Paper Type: Tray 1	Specifies the paper type for tray 1.	<ul style="list-style-type: none"> <li>• Plain Paper</li> <li>• Recycled Paper</li> <li>• Thick Paper 1</li> <li>• Thick Paper 2</li> <li>• Thin Paper</li> <li>• Letterhead</li> <li>• Preprinted Paper</li> <li>• Label Paper</li> <li>• Prepunched Paper</li> <li>• Bond Paper</li> <li>• Cardstock</li> <li>• Color Paper</li> </ul> Default: [Plain Paper]
Paper Type: Bypass Tray	Specifies the paper type for bypass tray.	<ul style="list-style-type: none"> <li>• Plain Paper</li> <li>• Recycled Paper</li> <li>• Thick Paper 1</li> <li>• Thick Paper 2</li> <li>• Thin Paper</li> <li>• Letterhead</li> <li>• Preprinted Paper</li> <li>• Envelope</li> <li>• Label Paper</li> <li>• Prepunched Paper</li> <li>• Bond Paper</li> <li>• Cardstock</li> <li>• Color Paper</li> </ul> Default: [Plain Paper]

Item	Description	Value
Paper Size: Tray 1		<p>A4, 8 1/2 × 11, B5 JIS, B6 JIS, A5 LEF, A5 SEF, A6, 8 1/2 × 14, 8 1/2 × 13, 8.5 × 13.4, 8.5 × 13.6, 16K, 8.11 × 13.3, 5 1/2 × 8 1/2, Custom Size</p> <p> <b>Region A</b></p> <p>Default: A4</p> <p> <b>Region B</b></p> <p>Default: [8 1/2 × 11]</p>
Paper Size: Bypass Tray		<p>A4, 8 1/2 × 11, B5 JIS, B6 JIS, A5 LEF, A5 SEF, A6, 8 1/2 × 14, 8 1/2 × 13, 8.5 × 13.4, 8.5 × 13.6, 16K, 8.11 × 13.3, 5 1/2 × 8 1/2, 4 1/8 × 9 1/2, 3 7/8 × 7 1/2, DL Env, C6 Env, C5 Env, Custom Size</p> <p> <b>Region A</b></p> <p>Default: [A4]</p> <p> <b>Region B</b></p> <p>Default: [8 1/2 × 11]</p>

Item	Description	Value
Bypass Tray Priority	Specifies how print jobs using the bypass tray are handled.	<ul style="list-style-type: none"> <li data-bbox="820 309 1215 578"> <p>• Machine Setting(s)</p> <p>The machine prints all print jobs according to the machine's settings.</p> <p>An error will occur if the paper size/type settings of the machine and printer driver do not match.</p> </li> <li data-bbox="820 597 1215 970"> <p>• Any Size/Type</p> <p>The machine prints all print jobs according to the printer driver's settings.</p> <p>Printing proceeds even if the paper size/type settings of the machine and printer driver do not match. However, if the paper is too small for the print job, the printed image will be cropped.</p> </li> <li data-bbox="820 989 1215 1617"> <p>• Any Custom Size/Type</p> <p>The machine prints custom size print jobs according to the printer driver's settings and prints standard size print jobs according to the machine's settings.</p> <p>For custom size print jobs, printing proceeds even if the paper size/type settings of the machine and printer driver do not match. However, if the paper is too small for the print job, the printed image will be cropped.</p> <p>For standard size print jobs, an error will occur if the paper size/type settings of the machine and printer driver do not match.</p> </li> </ul> <p data-bbox="797 1636 1215 1675">Default: [Machine Setting(s)]</p>

Item	Description	Value
Paper Tray Priority	<p>Specifies the tray that the machine checks first for paper that can be used for the job when a tray is set to be selected automatically.</p> <p>If multiple trays contain valid paper, the first tray the machine finds will be used for printing; when that tray runs out of paper, the machine automatically switches to the next tray to continue printing.</p>	<ul style="list-style-type: none"> <li>• Printer           <p>Select a tray to check first when automatic tray selection is specified for the print job.</p> <ul style="list-style-type: none"> <li>• Tray 1</li> <li>• Bypass Tray</li> </ul> <p>Default: [Tray 1]</p> </li> <li>• Copier           <p>Select a tray to check first when [A4], [8 1/2 × 11], or [16K] is selected for [Select Paper] under [Copier Features].</p> <ul style="list-style-type: none"> <li>• Tray 1</li> <li>• Bypass Tray</li> </ul> <p>Default: [Tray 1]</p> </li> </ul>
Size Mismatch Detection	Sets the machine to report an error if the paper size does not match the print job's settings.	<ul style="list-style-type: none"> <li>• On</li> <li>• Off</li> </ul> <p>Default: [Off]</p>

# Administrator Settings

Item	Description	Value
Set Date/Time	Sets the date and time of the machine's internal clock. (Default may differ depending on the [Country] setting under [Admin. Tools].)	<ul style="list-style-type: none"> <li>• Set Date Specifies the date of the machine's internal clock. Only dates that correspond with the year and month can be set. Incompatible dates will be refused. Default date format: [Year/Month/Day]                             <ul style="list-style-type: none"> <li>• Date format: Month/Day/Year, Day/Month/Year, or Year/Month/Day</li> <li>Year: 2000 to 2099</li> <li>Month: 1 to 12</li> <li>Day: 1 to 31</li> </ul> </li> <li>• Set Time Sets the time of the machine's internal clock. Default time format: [24-hour Format]                             <ul style="list-style-type: none"> <li>• Time format: 12-hour Format, 24-hour Format</li> <li>AM/PM stamp: AM, PM (for 12-hour Format)</li> <li>Hour: 0 to 23 (for 24-hour Format), or 1 to 12 (for 12-hour Format)</li> <li>Minute: 0 to 59</li> </ul> </li> </ul>
Program Fax Information	Specifies the fax name and fax number of the machine.	<ul style="list-style-type: none"> <li>• No.: Specifies the fax number of the machine using up to 20 characters, including 0 to 9, space, and "+".</li> <li>• Name: Specifies the fax name of the machine using up to 20 alphanumeric characters and symbols.</li> </ul>



Item	Description	Value
Dial/Push Phone	<p>Specifies the line type of the telephone line.</p> <p>To configure this setting, contact your telephone company and select the setting based on your telephone line. Selecting a wrong setting may cause failures in fax transmissions.</p> <p>[Dial Phone (20PPS)] may not appear depending on the country setting of the machine.</p>	<ul style="list-style-type: none"> <li>• Push Phone</li> <li>• Dial Phone (10PPS)</li> <li>• Dial Phone (20PPS)</li> </ul> <p>Default: [Push Phone]</p>
PSTN / PBX	<p>Sets the machine to connect to the public switched telephone network (PSTN) or a private branch exchange (PBX).</p>	<ul style="list-style-type: none"> <li>• PSTN</li> <li>• PBX</li> </ul> <p>Default: [PSTN]</p>
PBX Access Number	<p>Specifies the dial number to access the outside line when the machine is connected to a PBX.</p> <p>Make sure that this setting matches the setting of your PBX. Otherwise, you may not be able to send faxes to outside destinations.</p>	<p>0 to 999</p> <p>Default: 9</p>
Function Priority	<p>Specifies the mode that is activated when the power is turned on, or if the time specified for [System Auto Reset Timer] elapses without activity while the initial screen of the current mode is displayed.</p>	<ul style="list-style-type: none"> <li>• Copier</li> <li>• Facsimile</li> <li>• Scanner</li> </ul> <p>Default: [Copier]</p>

Item	Description	Value
System Auto Reset Timer	Sets the machine to return to the mode specified in [Function Priority].	<ul style="list-style-type: none"> <li>• On (30 sec., 1 min., 2 min., 3 min., 5 min., 10 min.)</li> <li>• Off</li> </ul> Default: [On] (1 minute)
Energy Saver Mode	Sets the machine to enter Energy Saver mode, Energy Saver mode 1 or Energy Saver mode 2, to reduce power consumption. The machine recovers from Energy Saver mode when it receives a print job, prints a received fax, or when any key is pressed.	<ul style="list-style-type: none"> <li>• EnergySaverMode 1                             <p>The machine enters Energy Saver mode 1 if the machine has been idle for about 30 seconds. It takes less time to recover from Energy Saver mode 1 than from power-off state or Energy Saver mode 2, but power consumption is higher in Energy Saver mode 1 than in Energy Saver mode 2.</p>                             Default: [Off]                             <ul style="list-style-type: none"> <li>• Off</li> <li>• On</li> </ul> </li> <li>• EnergySaverMode 2                             <p>The machine enters Energy Saver mode 2 after the period of time specified for this setting is passed. The machine consumes less power in Energy Saver mode 2 than in Energy Saver mode 1, but it takes longer to recover from Energy Saver mode 2 than from Energy Saver mode 1.</p> <ul style="list-style-type: none"> <li>• Europe                                     <ul style="list-style-type: none"> <li>• On (1 to 20 minutes)</li> <li>• 30sec</li> <li>• Off</li> </ul>                                     Default: [30sec]                                 </li> <li>• Countries other than European countries                                     <ul style="list-style-type: none"> <li>• On (1 to 240 minutes)</li> <li>• 30sec</li> <li>• Off</li> </ul> </li> </ul> </li> </ul>

Item	Description	Value
Language	<p>Specifies the language used on the screen and in reports.</p> <p>The default value for this setting is the language you have specified during the Initial Setup, which is required after turning on the machine for the first time.</p>	<ul style="list-style-type: none"> <li>• English</li> <li>• German</li> <li>• French</li> <li>• Italian</li> <li>• Spanish</li> <li>• Dutch</li> <li>• Swedish</li> <li>• Norwegian</li> <li>• Danish</li> <li>• Finnish</li> <li>• Portuguese</li> <li>• Czech</li> <li>• Hungarian</li> <li>• Polish</li> <li>• Simplified Chinese</li> <li>• Russian</li> <li>• Brazilian Portuguese</li> <li>• Turkish</li> <li>• Arabic</li> <li>• Kazakhstan</li> </ul>
Area (only SP 320SN and SP 325SNw for Europe)	<p>By selecting the area in which the machine is being used, you can narrow down the choice of display language and other settings.</p> <p>You can also specify this setting during the initial setup after turning the power on for the first time.</p>	<ul style="list-style-type: none"> <li>• Europe</li> <li>• Asia</li> <li>• Oceania</li> <li>• Americas</li> <li>• Africa</li> </ul> <p>Default: [Europe]</p>

Item	Description	Value
Country	<p>Selects the country in which the machine is used. The country code you specify determines the time and date display format and the default values of the fax transmission-related settings.</p> <p>Make sure to select the country code correctly. Selecting a wrong country code may cause failures in fax transmissions.</p> <p>The default value for this setting is the country code you have specified during the Initial Setup, which is required after turning on the machine for the first time.</p>	<p>Algeria, Argentina, Australia, Austria, Belgium, Bolivia, Brazil, Bulgaria, Canada, Chile, China, Colombia, Costa Rica, Croatia, Cyprus, Czech Republic, Denmark, Dominican Republic, Ecuador, Egypt, El Salvador, Estonia, Finland, France, Germany, Greece, Guam, Guatemala, Honduras, Hong Kong, Hungary, Iceland, India, Ireland, Israel, Italy, Japan, Jordan, Kazakhstan, Kuwait, Latvia, Lebanon, Liechtenstein, Lithuania, Luxembourg, Malaysia, Malta, Mexico, Montenegro, Morocco, Netherlands, New Zealand, Nicaragua, Nigeria, Norway, Oman, Panama, Paraguay, Peru, Philippines, Poland, Portugal, Puerto Rico, Romania, Russia, Saudi Arabia, Senegal, Serbia, Singapore, Slovakia, Slovenia, South Africa, Spain, Sri Lanka, Sweden, Switzerland, Taiwan, Thailand, Trinidad and Tobago, Tunisia, Turkey, UAE, UK, Uruguay, USA, Venezuela, Vietnam, Virgin Islands, Yemen</p>

Item	Description	Value
Reset Settings	Be sure not to clear the settings by mistake.	<ul style="list-style-type: none"> <li>• Reset All Settings Resets the machine's settings to their defaults except the following:               <ul style="list-style-type: none"> <li>• Language settings</li> <li>• Country settings</li> <li>• Network settings</li> <li>• Fax destinations</li> </ul>               Press the [OK] key to execute. Press the [Back] key to exit to the previous level of the menu tree without clearing the settings.             </li> <li>• Reset Network Settings Resets the network settings to their defaults. Press the [OK] key to execute. Press the [Back] key to exit to the previous level of the menu tree without clearing the settings.</li> <li>• Clear Address Book Clears the fax Quick Dial/Speed Dial destinations. Press the [OK] key to execute. Press the [Back] key to exit to the previous level of the menu tree without clearing the destinations.</li> </ul>
Shortcut to Function	Assigns one of the following functions to the [Shortcut to Func.] key on the control panel.	<ul style="list-style-type: none"> <li>• ID Card Copy Mode</li> <li>• Direct Transmission</li> <li>• Select Scanner Address</li> </ul> Default: [ID Card Copy Mode]
Admin. Tools Lock	Specifies a four-digit password for accessing the [Address Book], [Network Settings], [Wi-Fi Setup Wizard], and [Admin. Tools] menus.  Do not forget this password.	<ul style="list-style-type: none"> <li>• On (0000 to 9999)</li> <li>• Off</li> </ul> Default: [Off]

Item	Description	Value
IPsec	<p>Selects whether to enable or disable IPsec.</p> <p>This function appears only when a password is specified under [Admin. Tools Lock].</p>	<ul style="list-style-type: none"> <li>• Inactive</li> <li>• Active</li> </ul> <p>Default: [Inactive]</p>
Fax Number Confirmation	<p>Sets the machine to require a fax number to be entered twice when specifying a destination manually.</p> <p>When this function is enabled, you cannot use the On Hook Dial function.</p> <p>This function appears only when a password is specified under [Admin. Tools Lock].</p>	<ul style="list-style-type: none"> <li>• On</li> <li>• Off</li> </ul> <p>Default: [Off]</p>
Save Scn Data to USB	<p>Specify whether to enable or disable Scan to USB.</p> <p>This function appears only when a password is specified under [Admin. Tools Lock].</p>	<ul style="list-style-type: none"> <li>• Inactive</li> <li>• Active</li> </ul> <p>Default: [Active]</p>

# Printing Lists/Reports

## Printing the Configuration Page

1. Press the [User Tools] key.

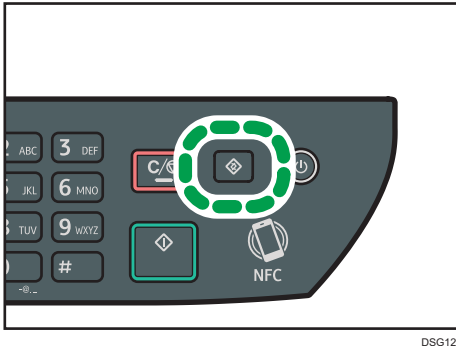

2. Press the [▲] or [▼] key to select [Print List/Report], and then press the [OK] key.
3. Press the [▲] or [▼] key to select [Configuration Page], and then press the [OK] key.
4. Press [OK] in the confirmation screen.

7

## Types of Lists/Reports

### Note

- Reports will be printed on A4 or Letter size paper. Load one of these sizes of paper into the tray before printing reports.

### Configuration Page

Prints general information and the current configurations of the machine.

### Fax Journal

Prints a fax transmission and reception journal for the last 50 jobs.

### Standby File List

Prints a list of fax jobs remaining in the machine's memory to be printed, sent, or forwarded.

### Quick Dial No. List

Prints a list of scan and fax Quick Dial entries.

### Fax Speed Dial List

Prints a list of Speed Dial entries.

- Sort by Speed Dial No.

Prints the list with the entries sorted by Speed Dial registration number.

- Sort by Name

Prints the list with the entries sorted by name.

### **Scanner Address List**

Prints a list of scan destinations.

### **Scanner Journal**

Prints a scanner journal for the last 100 Scan to E-mail, Scan to FTP, and Scan to Folder transmissions.

### **Maintenance Page**

Prints the maintenance page.



# Network Settings

## ★ Important

- Depending on the settings you change, the machine might need to be restarted.
- Depending on the model you are using, some items might not appear.

### Ethernet

Item	Description	Value
MAC Address	Displays the machine's MAC address.	–
Ethernet Speed	Displays the current Ethernet speed setting.	<ul style="list-style-type: none"> <li>• 100Mbps Full Duplex</li> <li>• 100Mbps Half Duplex</li> <li>• 10Mbps Full Duplex</li> <li>• 10Mbps Half Duplex</li> <li>• Ethernet Unavailable</li> </ul> <p>Appears when a network cable is not connected.</p>
Set Ethernet Speed	<p>Specifies the speed for Ethernet communication. Select a speed that matches your network environment.</p> <p>For most networks, the default setting is the optimum setting.</p>	<ul style="list-style-type: none"> <li>• Auto Select</li> <li>• 100Mbps Full Duplex</li> <li>• 100Mbps Half Duplex</li> <li>• 10Mbps Full Duplex</li> <li>• 10Mbps Half Duplex</li> </ul> <p>Default: [Auto Select]</p>

7

### Wi-Fi

Item	Description	Value
Wi-Fi Enable	<p>Select whether to enable or disable Wireless LAN.</p> <p>If [Disable] is set, [Wi-Fi Status], [MAC Address], [Current Connection], [Input SSID], [WPS] and [Wi-Fi Direct] are not displayed.</p>	<ul style="list-style-type: none"> <li>• Disable</li> <li>• Enable</li> </ul> <p>Default: [Disable]</p>
Wi-Fi Status	Displays the current connection status.	–
MAC Address	Displays the machine's MAC address.	–

Item	Description	Value
Current Connection	Displays detailed information about the connection, such as the SSID and the wireless signal strength.	–
Input SSID	Displays the procedure for manually connecting to a wireless LAN. It leads you step-by-step through configuring the settings for connecting with a wireless LAN.	–
WPS	Connects with one touch using WPS (Wi-Fi Protected Setup). For details, see Setup Guide.	<ul style="list-style-type: none"> <li>• PBC</li> <li>• PIN</li> </ul>
Wi-Fi Direct	Enables devices to communicate directly with each other without using a central access point.	–

### IPv4 Configuration

7

Item	Description	Value
DHCP	Sets the machine to receive its IPv4 address, subnet mask, and default gateway address automatically from a DHCP server.	<ul style="list-style-type: none"> <li>• Inactive</li> <li>• Active</li> </ul> Default: [Active]
IP Address	Specifies the machine's IPv4 address when DHCP is not used. Use this menu to check the current IP address when DHCP is used.	Default: <b>XXX.XXX.XXX.XXX</b> The numbers represented by "X" vary according to your network environment.
Subnet Mask	Specifies the machine's subnet mask when DHCP is not used. Use this menu to check the current subnet mask when DHCP is used.	Default: <b>XXX.XXX.XXX.XXX</b> The numbers represented by "X" vary according to your network environment.

Item	Description	Value
Gateway Address	Specifies the machine's default gateway address when DHCP is not used.  Use this menu to check the current default gateway address when DHCP is used.	Default: <b>XXX.XXX.XXX.XXX</b>  The numbers represented by "X" vary according to your network environment.
IP Address Method	Displays the IP address acquisition method.	<ul style="list-style-type: none"> <li>• IP Not Ready</li> <li>• DHCP</li> <li>• Manual Config.</li> <li>• Default IP</li> </ul>
Wi-Fi Direct IP Address	Displays the IP address of Wi-Fi Direct.	–

### IPv6 Configuration

Item	Description	Value
IPv6	Select whether to enable or disable IPv6.	<ul style="list-style-type: none"> <li>• Inactive</li> <li>• Active</li> </ul> Default: [Inactive]
DHCP	Sets the machine to receive its IPv6 address from a DHCP server.	<ul style="list-style-type: none"> <li>• Inactive</li> <li>• Active</li> </ul> Default: [Active]
IP Address (DHCP)	Displays the IPv6 address obtained from a DHCP server.	–

Item	Description	Value
Manual Config. Address	Specifies the machine's IPv6 settings.	<ul style="list-style-type: none"> <li data-bbox="842 315 1215 619">• Manual Config. Address Specifies the machine's IPv6 address when DHCP is not used. Can contain up to 46 characters.  For details about entering characters, see page 32 "Entering Characters".</li> <li data-bbox="842 635 1215 746">• Prefix Length Specifies the prefix length, using a value between 0 and 128.</li> <li data-bbox="842 766 1215 1030">• Gateway Address Specifies the IPv6 address of the default gateway. Can contain up to 46 characters.  For details about entering characters, see page 32 "Entering Characters".</li> </ul>
Stateless Address	Displays the IPv6 stateless addresses obtained from a Router Advertisement.	<ul style="list-style-type: none"> <li data-bbox="842 1060 1071 1089">• Stateless Address 1</li> <li data-bbox="842 1105 1071 1134">• Stateless Address 2</li> <li data-bbox="842 1150 1071 1179">• Stateless Address 3</li> <li data-bbox="842 1195 1071 1225">• Stateless Address 4</li> </ul>
Link-local Address	Displays the IPv6 link local address.	–

**Note**

- Contact your network administrator for information about the network configuration.

# Wi-Fi Setup Wizard

You can enable wireless connections by following the wizard's instructions. For details, see Setup Guide. If [Wi-Fi Enable] in [Wi-Fi] under [Network Settings] is set to [Disable], the Wi-Fi Setup Wizard does not appear.



# 8. Configuring the Machine Using Utilities

This chapter describes how to configure the machine using utilities.

## Available Setting Functions Using Web Image Monitor and Smart Organizing Monitor

Use Web Image Monitor or Smart Organizing Monitor to change the configuration of the machine from a computer.

Available operations for Web Image Monitor and Smart Organizing Monitor are as follows:

Available operations	Web Image Monitor	Smart Organizing Monitor
Checking the system settings	Available	Available
Configuring paper settings	Available	Available
Adjusting the sound volume	Available	Unavailable
Configuring paper settings for copying	Available	Unavailable
Configuring fax settings	Available	Unavailable
Configuring the priority tray	Available	Available
Configuring toner saving	Available	Unavailable
Configuring interface settings	Available	Available
Configuring the shortcut to function settings	Available	Unavailable
Registering destinations	Available	Unavailable
Checking the network settings	Available	Available
Configuring IPsec settings	Available	Available
Configuring Energy Saver Mode	Available	Available
Configuring administrator settings	Available	Unavailable
Printing lists/reports	Available	Available

# Using Web Image Monitor

## ★ Important

- Some items might not appear, depending on the model type you are using.
- Some items can also be configured using the control panel.

### Supported web browsers

- Internet Explorer 6 or later
- Firefox 3.0 or later
- Safari 4.0 or later

## ↓ Note

- To operate the machine via Web Image Monitor, you must first configure the machine's TCP/IP or wireless LAN settings. For details, see page 215 "Network Settings" or page 236 "Configuring the Network Settings".



# Displaying Top Page

When you access the machine using Web Image Monitor, the top page appears in your browser's window.

1. Launch the web browser.
2. In the web browser's address bar, enter "http://(machine's IP address)/" to access the machine.

If a DNS or WINS server is used and the machine's host name has been specified, you can enter the host name instead of the IP address.

The top page of Web Image Monitor appears.

## Top page

Every Web Image Monitor page is divided into the following areas:

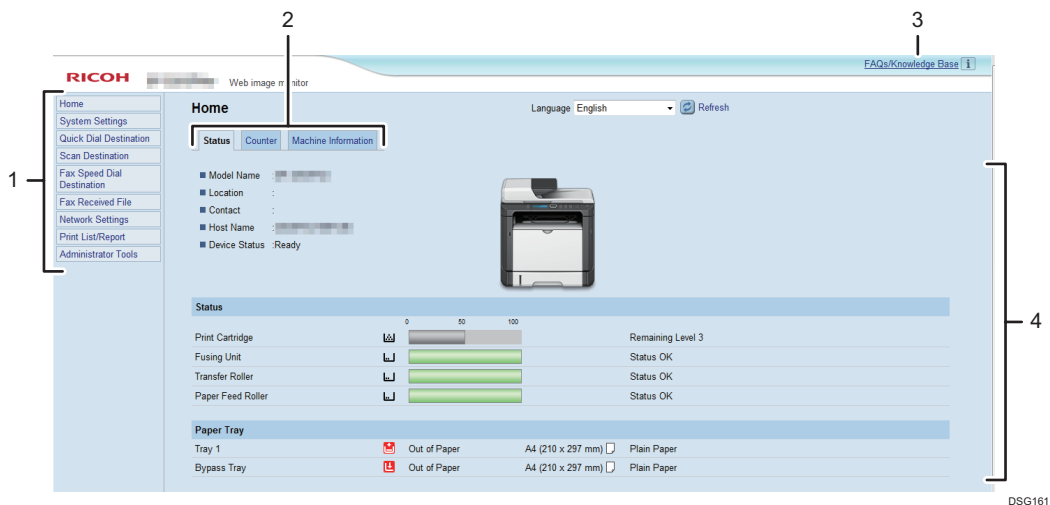

### 1. Menu area

Clicking a menu shows its contents in the main area.

### 2. Tab area

Contains tabs for switching between information and settings you want to see or configure.

### 3. FAQs/Knowledge Base

Provides answers to frequently asked questions and other useful information about using this machine.

An Internet connection is required to view this information.

### 4. Main area

Displays the contents of the item selected in the menu area.

Information in the main area is not automatically updated. Click [Refresh] at the upper-right in the main area to update the information. Click the refresh button of the web browser to refresh the entire browser screen.

**Note**

- If you use an older version of a supported web browser or the web browser has JavaScript and cookies disabled, display and operation problems may occur.
- If you are using a proxy server, configure the web browser settings as necessary. For details about the settings, contact your network administrator.
- The previous page may not appear even if the back button of the web browser is clicked. If this happens, click the refresh button of the web browser.
- The FAQs (Frequently Asked Questions)/Knowledge Base are not available in certain languages.

---

## Changing the Interface Language

---

Select the desired interface language from the [Language] list.

# Checking the System Information

Click [Home] to display the main page of Web Image Monitor. You can check the current system information on this page.

This page contains three tabs: [Status], [Counter], and [Machine Information].

## Status Tab

Item	Description
Model Name	Shows the name of the machine.
Location	Shows the location of the machine as registered on the [SNMP] page.
Contact	Shows the contact information of the machine as registered on the [SNMP] page.
Host Name	Shows the host name specified in [Host Name] on the [DNS] page.
Device Status	Shows the current messages on the machine's display.

## Status

Item	Description
Print Cartridge	Shows the amount of toner remaining.
Fusing Unit	Shows the remaining life of the fusing unit, as "Status OK", "Replacement Required Soon" or "Replacement Required". For replacing, contact your sales or service representative.
Transfer Roller	Shows the remaining life of the transfer roller, as "Status OK", "Replacement Required Soon" or "Replacement Required". For replacing, contact your sales or service representative.
Paper Feed Roller	Shows the remaining life of the paper feed roller, as "Status OK", "Replacement Required Soon" or "Replacement Required". For replacing, contact your sales or service representative.

## Paper Tray

Item	Description
Tray 1	Shows the current state and paper size/type setting of tray 1.

Item	Description
Bypass Tray	Shows the current state and paper size/type setting of the bypass tray.

**Note**

- If a non-genuine print cartridge is installed, toner life cannot be reliably indicated.

## Counter Tab

### Page Counter

Item	Description
Printer	Shows the following for pages printed using the printer function: <ul style="list-style-type: none"> <li>• Total number of pages printed using the printer function, and lists/reports printed from the [List/Test Print] menu under [Printer Features]</li> <li>• Number of color pages (always shows 0)</li> <li>• Number of black-and-white pages</li> </ul>
Scanner	Shows the following for pages scanned using the scanner function: <ul style="list-style-type: none"> <li>• Total number of pages</li> <li>• Number of color pages</li> <li>• Number of black-and-white pages</li> </ul>
Copier	Shows the following for pages printed using the copier function: <ul style="list-style-type: none"> <li>• Total number of pages</li> <li>• Number of color pages (always shows 0)</li> <li>• Number of black-and-white pages</li> </ul>
Fax (only SP 320SFN and SP 325SFNw)	Shows the following for public telephone line faxes: <ul style="list-style-type: none"> <li>• Total number of pages sent and received</li> <li>• Number of pages received</li> <li>• Number of pages sent</li> </ul>

**Print Counter**

Item	Description
Page Total	Shows the total number of all prints from the machine: <ul style="list-style-type: none"> <li>• Pages printed using the printer, copy, and fax functions</li> <li>• Lists/Reports printed from the [Print List/Report] menu</li> <li>• Lists/Reports printed from the [List/Test Print] menu under [Printer Features]</li> </ul>

**Duplex**

Item	Description
Duplex Total Page	Shows the total number of sheets printed on both sides.

**Machine Information Tab****Machine Information**

Item	Description
Firmware Version	Shows the version of firmware installed on the machine.
Engine FW Version	Shows the version of firmware for the machine engine.
Machine ID	Shows the identification number of the machine.
Fax Card (only SP 320SFN and SP 325SFNw)	Shows that a fax card is installed.
Total Memory	Shows the total memory installed on the machine.

## Configuring the System Settings

Click [System Settings] to display the page for configuring the system settings.

This page contains the following tabs: [Sound Volume Adjustment] (only SP 320SFN and SP 325SFNw), [Tray Paper Settings], [Copier], [Fax], [Priority Tray], [Toner Management], [Interface], and [Shortcut to Function].

### Sound Volume Adjustment Tab (only SP 320SFN and SP 325SFNw)

#### Sound Volume Adjustment

Item	Description
Panel Key Sound	Select the volume of the beep that sounds when a key is pressed from [Off], [Low], [Middle], or [High].
Ring Volume	Select the volume of the sound when the machine is set to ring from [Off], [Low], [Middle], or [High].
On Hook Mode	Select the volume of the sound from the speaker during on hook mode from [Off], [Low], [Middle], or [High].
Job End Tone	Select the volume of the beep that sounds when a job is complete from [Off], [Low], [Middle], or [High].
Job Error Tone	Select the volume of the beep that sounds when a fax transmission error occurs from [Off], [Low], [Middle], or [High].
Alarm Volume	Select the volume of the alarm that sounds when an operation error occurs from [Off], [Low], [Middle], or [High].

### Tray Paper Settings Tab

#### Tray 1

Item	Description
Paper Size	Select the paper size for tray 1 from the following: A4 (210 × 297 mm), Letter (8.5 × 11), B5 (182 × 257 mm), B6 (128 × 182 mm), A5 (210 × 148 mm), A5 (148 × 210 mm), A6 (105 × 148 mm), Legal (8.5 × 14), 8.5 × 13, 8.5 × 13.4, 8.5 × 13.6, 16K, 8.11 × 13.3, 5.5 × 8.5, Custom Size

Item	Description
Paper Type	Select the paper type for tray 1 from the following: Plain Paper, Recycled Paper, Thick Paper 1 (100 to 130g/m <sup>2</sup> ), Thick Paper 2 (131 to 162g/m <sup>2</sup> ), Thin Paper (52 to 64g/m <sup>2</sup> ), Letterhead, Preprinted Paper, Label Paper, Prepunched Paper, Bond Paper, Cardstock, Color Paper

### Bypass Tray

Item	Description
Paper Size	Select the paper size for the bypass tray from the following: A4 (210 × 297 mm), Letter (8.5 × 11), B5 (182 × 257 mm), B6 (128 × 182 mm), A5 (210 × 148 mm), A5 (148 × 210 mm), A6 (105 × 148 mm), Legal (8.5 × 14), 8.5 × 13, 8.5 × 13.4, 8.5 × 13.6, 16K, 8.11 × 13.3, 5.5 × 8.5, Com10 (104.8 × 241.3 mm), Monarch (98.4 × 190.5 mm), DL Env (110 × 220 mm), C6 Env (114 × 162 mm), C5 Env (162 × 229 mm), Custom Size
Paper Type	Select the paper type for the bypass tray from the following: Plain Paper, Recycled Paper, Thick Paper 1 (100 to 130g/m <sup>2</sup> ), Thick Paper 2 (131 to 162g/m <sup>2</sup> ), Thin Paper (52 to 64g/m <sup>2</sup> ), Letterhead, Preprinted Paper, Envelope, Label Paper, Prepunched Paper, Bond Paper, Cardstock, Color Paper

**Bypass Tray Setting Priority**

Item	Description
Bypass Tray Setting Priority	<p>Select how print jobs using the bypass tray are handled.</p> <ul style="list-style-type: none"> <li>• System Settings The machine prints all print jobs according to the machine's settings. An error will occur if the paper size/type settings of the machine and printer driver do not match.</li> <li>• Any Size/Type The machine prints all print jobs according to the printer driver's settings. Printing proceeds even if the paper size/type settings of the machine and printer driver do not match, but if the paper is too small for the print job, the printed image will be cropped.</li> <li>• Any Custom Size/Type The machine prints custom size print jobs according to the printer driver's settings and prints standard size print jobs according to the machine's settings. For custom size print jobs, printing proceeds even if the paper size/type settings of the machine and printer driver do not match, but if the paper is too small for the print job, the printed image will be cropped. For standard size print jobs, an error will occur if the paper size/type settings of the machine and printer driver do not match.</li> </ul>

**Size mismatch detection**

Item	Description
Size mismatch detection	Select whether to set the machine to report an error if the paper size does not match the print job's settings.



## Copier Tab

### Select Paper

Item	Description
Select Paper	<p>Select the paper size used for printing copies from the following: [Tray 1], [Bypass Tray], [A4 (210 × 297 mm)], [Letter (8.5 × 11)], or [16K (195 × 267 mm)].</p> <p>When a tray is selected, the machine prints from that tray only. When a paper size is selected, the machine checks the trays for the paper of the specified size in the order of priority as set in [Copier] in the [Priority Tray] page.</p> <p>If multiple trays contain valid paper, the first tray the machine finds will be used for printing; when that tray runs out of paper, the machine automatically switches to the next tray to continue printing.</p>

### Separation Line

Item	Description
Separation Line	Specify whether to print a line in the middle of the printed paper when making ID card copy or combined copy.

## Fax Tab (only SP 320SFN and SP 325SFNw)

### Fax Number Confirmation

Item	Description
Fax Number Confirmation	<p>Enable this setting to configure the machine to require a fax number to be entered twice when specifying a destination manually.</p> <p>This setting appears only when the administrator password is set in the [Administrator] page.</p>

### Fax Received File Processing

Item	Description
Received File Processing	Select whether received faxes are stored into the machine's memory for printing or forwarded to a destination specified for [Forwarding Destination].

Item	Description
Print Automatically	Select whether the faxes received into the machine's memory are printed automatically or stored for later manual printing.
Notify Forward Status	Select whether e-mail notifications are sent after forwarding faxes or not. Email notification destination depends on how [Forwarding Destination] is specified. <ul style="list-style-type: none"> <li>• If specified with [E-mail Address]: the notification will be sent to the administrator e-mail address specified in [Administrator E-mail Address] in the [Administrator] page.</li> <li>• If specified with [Scan Destination]: the notification will be sent to the notification destination specified for the selected scan destination.</li> </ul> <p>Note that if a destination e-mail address is not specified, no notification will be sent even if this setting is enabled.</p>
Forwarding Destination	Specifies the forwarding destination. <ul style="list-style-type: none"> <li>• [E-mail Address]: Enter a destination e-mail address. Can contain up to 64 characters.</li> <li>• [Scan Destination]: Select a scan destination as a forwarding destination.</li> </ul>
Number of Trials of Forwarding (time)	Specifies how many times the machine attempts to forward a fax (1 to 255 times).
Interval of Forwarding Trial (min.)	Specifies how many minutes the machine waits between forwarding attempts (1 to 255 minutes).

## 2 Sided Print

Item	Description
2 Sided Print	Specify whether to print received faxes on both sides of paper.

## Priority Tray Tab

### Priority Tray

Item	Description
Printer	<p>Select the tray that the machine checks first for paper that can be used for the job from [Tray 1] or [Bypass Tray].</p> <p>If automatic tray selection is specified for the print job and multiple trays contain valid paper, the first tray the machine finds will be used for printing; when that tray runs out of paper, the machine automatically switches to the next tray to continue printing.</p>
Copier	<p>Select the tray that the machine checks first for paper that can be used for the job from [Tray 1] or [Bypass Tray].</p> <p>If [A4 (210 × 297 mm)], [Letter (8.5 × 11)], or [16K (195 × 267 mm)] is selected for [Select Paper] in the [Copier] page and multiple trays contain valid paper, the first tray the machine finds will be used for printing; when that tray runs out of paper, the machine automatically switches to the next tray to continue printing.</p>

## Toner Management Tab

### Toner Saving

Item	Description
Toner Saving	Enable this setting to print using a reduced amount of toner when printing out copies.

### Supply End Option

Item	Description
Supply End Option	If [Continue Printing] is selected, refill toner will be available.

---

## Interface Tab

---

### Interface

Item	Description
Fixed USB Port	<p>Specifies whether the same printer/LAN-Fax driver can be used for multiple machines or not under USB connection.</p> <p>If this setting is enabled, the same printer/LAN-Fax driver you have installed in your computer can be used with any machine other than the one originally used for installation, if the machine is of the same model.</p> <p>If disabled, you must install the printer/LAN-Fax driver separately for individual machines, because the machine other than the original will be recognized as a new device upon USB connection.</p>

---

## Shortcut to Function Tab

---

### Shortcut to Function

Item	Description
Shortcut to Function Settings	<p>Assigns one of the following functions to the [Shortcut to Func.] key on the control panel.</p> <ul style="list-style-type: none"> <li>• [ID Card Copy Mode]</li> <li>• [Fax Immediate TX]</li> <li>• [Select Scanner Destination]</li> </ul>

# Registering Destinations

Scan and fax destinations can be registered using Web Image Monitor.

A maximum of 100 scan destinations and 108 fax destinations (8 Quick Dial and 100 Speed Dial destinations) can be registered. See the scan and fax sections for more information on registering destinations.

For details about registering scan destinations, see page 95 "Registering Scan Destinations".

For details about registering fax destinations using Web Image Monitor, see page 140 "Registering Fax Destinations".

# Configuring the Network Settings

Click [Network Settings] to display the page for configuring the network settings.

This page contains the following tabs: [Network Status], [IPv6 Configuration], [Network Application], [DNS], [Auto E-mail Notification], [SNMP], [SMTP], [POP3], [Wireless], and [Google Cloud Print].

## ★ Important

- Depending on the settings you change, the machine might need to be restarted.
- Depending on the model you are using, some items might not appear.

## Network Status Tab

### General Status

Item	Description
Ethernet Speed	Shows the type and speed of the network connection.
IPP Printer Name	Shows the name used to identify the machine on the network.
Network Version	Shows the version of the machine's network module (a part of the machine firmware).
Ethernet MAC Address	Shows the Ethernet MAC address of the machine.
Active Interface	Shows the active communication method.
Wi-Fi Direct IP Address (only SP 325SNw and SP 325SFNw)	Shows the IP address of Wi-Fi Direct.

### TCP/IP Status

Item	Description
DHCP	Select whether the machine should receive a dynamic IPv4 address automatically using DHCP. To use DHCP, select [Active]. When enabled, the items below cannot be configured.
IP Address	Enter the IPv4 address for the machine.
Subnet Mask	Enter the subnet mask of the network.
Gateway	Enter the IPv4 address of the network gateway.

## IPv6 Configuration Tab

### IPv6

Item	Description
IPv6	<p>Select whether to enable or disable IPv6. You cannot disable IPv6 using Web Image Monitor if the machine is currently in use in an IPv6 environment. In this case, use the control panel to disable [IPv6] under [Network Settings].</p> <p>When disabled, [DHCP], [Manual Configuration Address], [Prefix Length], and [Gateway Address] below cannot be configured.</p>

### IPv6 Address

Item	Description
DHCP	Select whether or not the machine obtains its IPv6 address from a DHCP server.
IP Address (DHCP)	Displays the IPv6 address obtained from the DHCP server when [DHCP] is set to [Active].
Stateless Address	Displays up to four stateless auto addresses.
Gateway Address	Displays the machine's default gateway address.
Link-local Address	Displays the link local address of the machine. The link local address is an address that is valid only inside the local network (local segment).
Manual Configuration Address	Enter the machine's IPv6 address. Can contain up to 39 characters.
Prefix Length	Enter the prefix length, using a value between 0 and 128.
Gateway Address	Enter the default gateway's IPv6 address. Can contain up to 39 characters.

## Network Application Tab

### Scanner Send Setting

Item	Description
E-mail	Select to enable the Scan to E-mail feature.

Item	Description
Max. E-mail Size	Select the maximum size of scan files that can be attached to an e-mail message (1 to 5 MB, or no limit).
FTP	Select to enable the Scan to FTP feature.
Folder	Select to enable the Scan to Folder feature.

### Network Print Setting

Item	Description
IPP	Select to enable network printing using Internet Print Protocol (via TCP port 631/80).
FTP	Select to enable network printing using an embedded FTP server in the machine (via TCP port 20/21).
RAW	Select to enable network raw printing.
Port No.	Enter the TCP port number to use for raw printing. The valid range is 1024 to 65535, except 5222, 5353, 6006, 28900, 29102, 53550 and 49999 (default is 9100).
LPR	Select to enable network printing using LPR/LPD (via TCP port 515).

### mDNS Setting

Item	Description
mDNS	Select to enable Multicast DNS (via UDP port 5353). If disabled, the item below cannot be configured.
Printer Name	Enter the name of the machine. Can contain up to 32 characters.

## DNS Tab

### DNS

Item	Description
DNS Method	Select whether to specify domain name servers manually or receive DNS information from the network automatically. When set to [Auto-Obtain (DHCP)], [Primary DNS Server], [Secondary DNS Server], and [Domain Name] below become unavailable.



Item	Description
Primary DNS Server	Enter the IPv4 address of the primary DNS.
Secondary DNS Server	Enter the IPv4 address of the secondary DNS.
Domain Name	Enter the IPv4 domain name for the machine. Can contain up to 32 characters.
IPv6 DNS Method	Select whether to specify the domain server manually or have the machine obtain its DNS information automatically.  When set to [Auto-Obtain (DHCP)], [Primary IPv6 DNS Server], [Secondary IPv6 DNS Server], and [IPv6 Domain Name] below become unavailable.
Primary IPv6 DNS Server	Enter the IPv6 address of the primary IPv6 DNS server. Can contain up to 39 characters.
Secondary IPv6 DNS Server	Enter the IPv6 address of the secondary IPv6 DNS server. Can contain up to 39 characters.
IPv6 Domain Name	Enter the IPv6 domain name of the machine. Can contain up to 32 characters.
DNS Resolve Priority	Select whether to give priority to IPv4 or IPv6 for DNS name resolution.
DNS Timeout (seconds)	Enter the number of seconds the machine waits before considering a DNS request to have timed out (1 to 999 seconds).
Host Name	Enter a host name for the machine. Can contain up to 15 characters.

## Auto E-mail Notification Tab

### E-mail Notification 1/E-mail Notification 2

Item	Description
Display Name	Enter a sender name for notification e-mail. Can contain up to 32 characters.
E-mail Address	Enter the address of the recipient of the alert email. Can contain up to 64 characters.
Paper Misfeed	Select to send an alert e-mail to the specified address if a paper jam occurs.
Out of Paper	Select to send an alert e-mail to the specified address if paper runs out.

Item	Description
Replace Print Cartridge Soon	Select to send an alert e-mail to the specified address if toner becomes low.
Call Service	Select to send an alert e-mail to the specified address if the machine requires servicing.
Replace Print Cartridge	Select to send an alert e-mail to the specified address if toner runs out.
Cover Open	Select to send an alert e-mail to the specified address if a cover is open.

## SNMP Tab

### SNMP

Item	Description
SNMP	Select whether to enable the machine to use SNMP services.

### Trap

Item	Description
Target Trap	Select whether to enable the machine to send traps to the management host (NMS). When disabled, [SNMP Management Host 1] and [SNMP Management Host 2] below become unavailable.
SNMP Management Host 1	Enter the IP address or host name of a management host. Can contain up to 64 characters.
SNMP Management Host 2	Enter the IP address or host name of a management host. Can contain up to 64 characters.

### Community

Item	Description
Get Community	Enter the community name to use for authentication of Get requests. Can contain up to 32 characters.
Trap Community	Enter the community name to use for authentication of Trap requests. Can contain up to 32 characters.

**System**

Item	Description
Location	Enter the location of the machine. The location entered here is displayed on the main page. Can contain up to 64 characters.
Contact	Enter the contact information of the machine. The contact information entered here is displayed on the main page. Can contain up to 64 characters.

**SMTP Tab****SMTP**

Item	Description
Primary SMTP Server	Enter the IP address or host name of the SMTP/POP3 server. Can contain up to 64 characters.
Port No.	Enter the port number for SMTP (1 to 65535).
Authentication Method	Select an authentication method from the following: [Anonymous]: The user name and password are not necessary. [SMTP]: The machine supports NTLM and LOGIN authentication. [POP before SMTP]: The POP3 server is used for authentication. When sending e-mails to an SMTP server, you can enhance the SMTP server security level by connecting to the POP server for authentication.
User Name	Enter the user name for logging in to the SMTP server. Can contain up to 32 characters.
Password	Enter the password for logging in to the SMTP server. Can contain up to 32 characters.
Device E-mail Address	Enter the machine's e-mail address.  This address is used as the sender's address of e-mail messages sent from this machine, such as notification e-mails. Can contain up to 64 characters.
Server Timeout (seconds)	Enter the number of seconds the machine waits before considering an SMTP operation to have timed out (1 to 999).

Item	Description
Time Zone	Select a time zone according to your geographic location. Selecting a different time zone may cause transmission date and time to be incorrect for email sent by the Scan to E-mail function, even when the machine's clock is set correctly.

## POP3 Tab

### POP3 Settings

Item	Description
POP3 Server	Enter the IP address or host name of the POP3 server for e-mail reception. The POP3 server specified here will be used for [POP before SMTP]. Can contain up to 64 characters.
User Account	Enter the user name for logging in to the POP3 server. Can contain up to 32 characters.
User Password	Enter the password for logging in to the POP3 server. Can contain up to 32 characters.
Authentication	Select an authentication method from the following: [None]: Password will not be encrypted. [APOP Authentication]: Password will be encrypted. [Auto]: Password will be encrypted or not be encrypted according to the POP3 server's settings.

## Wireless Tab (only SP 325SNw and SP 325SFNw)

### Wireless LAN Status

Item	Description
Wireless LAN Status	Displays the status of the connection to the wireless LAN.
MAC Address	Displays the MAC address.
Communication Mode	Displays the communication mode that the machine is connecting in.
SSID	Displays the SSID of the access point that the machine is connected to.
Wireless Signal Status	Displays the strength of the wireless signal that is being received.

Item	Description
Wireless	Specifies whether or not to use the wireless LAN. When [Active] is selected, [Wireless LAN Settings] below become available.

### Wireless LAN Settings

Item	Description
SSID	Enter the SSID of the access point. The SSID can contain up to 32 characters. When you click [Scan List], a list of available access points is displayed. You can select the SSID from the list.
Communication Mode	[Infrastructure] is selected by default. Therefore, connect the machine to a wireless router or access point.
Authentication	Select an authentication method.
Encryption	Select an encryption method.
WPA Passphrase	If [WPA2-PSK] or [Mixed Mode WPA/WPA2] is selected for [Authentication], enter the WPA encryption key.
WEP Key Length	If [WEP] is selected for [Encryption], select 64 bits or 128 bits for the length of the encryption key.
WEP Transmit Key ID	Select an ID number to identify each WEP key in case multiple WEP connections are configured.
WEP Key Format	Select a format for entering the WEP key.
WEP Key	Enter the WEP key. The number and type of characters you can enter vary depending on the length and format selected for the key. See the following: <ul style="list-style-type: none"> <li>WEP key length: [64bit], Format: [Hexadecimal] WEP key max length: 10 characters (0-9, A-F, a-f)</li> <li>WEP key length: [64bit], Format: [ASCII] WEP key max length: 5 characters (ASCII characters)</li> <li>WEP key length: [128bit], Format: [Hexadecimal] WEP key max length: 26 characters (0-9, A-F, a-f)</li> <li>WEP key length: [128bit], Format: [ASCII] WEP key max length: 13 characters (ASCII characters)</li> </ul>

**Note**

- If you are configuring the connection settings manually, check the SSID, authentication method, or encryption key of the access point or wireless router in advance.

**Wi-Fi Direct Settings**

Item	Description
SSID	Enter the SSID name. The SSID can contain up to 32 characters.

**Google Cloud Tab****Google Cloud**

Item	Description
Google Cloud Print	Specify whether to enable Google Cloud Print. When Google Cloud Print is disabled, [Local Discovery] and [Timeout (seconds)] below cannot be configured.
Registration Status	Displays the status of Google Cloud Print registration.
Registration Account	Displays the Account (e-mail address) of Google Cloud Print registration.
Local Discovery	Specify whether to enable local discovery.
Timeout (seconds)	Enter the number of seconds the machine waits before an XMPP connection times out.

# Configuring the IPsec Settings

Click [IPsec Settings] to display the page for configuring the IPsec settings.

This page contains the following tabs: [IPsec Global Settings] and [IPsec Policy List].

## ★ Important

- This function is available only when an administrator password is specified.

### IPsec Global Settings Tab

Item	Description
IPsec Function	Select whether to enable or disable IPsec.
Default Policy	Select whether to allow for the default IPsec policy.
Broadcast and Multicast Bypass	Select the services that you do not want to apply IPsec from the following: [DHCPv4], [DHCPv6], [SNMP], [mDNS], [NetBIOS], [UDP Port 53550]
All ICMP Bypass	Select whether to apply IPsec to ICMP packets (IPv4 and IPv6) from the following: [Active]: All ICMP packets will be bypassed without IPsec protection. "ping" command (echo request and echo reply) is not encapsulated by IPsec. [Inactive]: Some ICMP message types will be bypassed without IPsec protection.

### IPsec Policy List Tab

Item	Description
Name	Displays the name of the IPsec policy.
Address Settings	Displays the IP address filter of the IPsec policy as below: Remote address/Prefix length
Action	Displays the action of the IPsec policy as "Allow", "Drop", or "Require Security".
Status	Displays the status of the IPsec policy as "Active" or "Inactive".

To configure IPsec policies, select the desired IPsec policy, and then click [Change] to open the "IPsec Policy Settings" page. The following settings can be made on the "IPsec Policy Settings" page.

### IP Policy Settings

Item	Description
No.	Specify a number between 1 and 10 for the IPsec policy. The number you specify will determine the position of the policy in the IPsec Policy List. Policy searching is performed according to the order of the list. If the number you specify is already assigned to another policy, the policy you are configuring will take the number of the earlier policy, and the earlier policy and any subsequent policies will be renumbered accordingly.
Activity	Select whether to enable or disable the policy.
Name	Enter the name of the policy. Can contain up to 16 characters.
Address Type	Select IPv4 or IPv6 as the type of IP address to be used in IPsec communication.
Local Address	Displays the IP address of this printer.
Remote Address	Enter the IPv4 or IPv6 address of the device with which to communicate. Can contain up to 39 characters.
Prefix Length	Enter the prefix length of the Remote Address, using a value between 1 and 128. If this setting is left blank, "32" (IPv4) or "128" (IPv6) will be automatically selected.
Action	Specify how the IP packets are processed from the following: <ul style="list-style-type: none"> <li>• [Allow]: IP packets are both sent and received without IPsec applied to them.</li> <li>• [Drop]: IP packets are discarded.</li> <li>• [Require Security]: IPsec is applied to IP packets that are both sent and received.</li> </ul> <p>If you have selected [Require Security], you must configure [IPsec Settings] and [IKE Settings].</p>



**IPsec Settings**

Item	Description
Encapsulation Type	Specify the encapsulation type from the following: <ul style="list-style-type: none"> <li>• [Transport]: Select this mode to secure only the payload section of each IP packet when communicating with IPsec compliant devices.</li> <li>• [Tunnel]: Select this mode to secure every section of each IP packet. We recommend this type for communication between security gateways (such as VPN devices).</li> </ul>
Security Protocol	Select the security protocol from the following: <ul style="list-style-type: none"> <li>• [AH]: Establishes secure communication that supports authentication only.</li> <li>• [ESP]: Establishes secure communication that supports both authentication and data encryption.</li> <li>• [ESP&amp;AH]: Establishes secure communication that supports both data encryption and authentication of packets, including packet headers. Note that you cannot specify this protocol when [Tunnel] is selected for [Encapsulation Type].</li> </ul>
Authentication Algorithm for AH	Specify the authentication algorithm to be applied when [AH] or [ESP&AH] is selected for [Security Protocol] from the following: [MD5], [SHA1]
Encryption Algorithm for ESP	Specify the encryption algorithm to be applied when [ESP] or [ESP&AH] is selected for [Security Protocol] from the following: [None], [DES], [3DES], [AES-128], [AES-192], [AES-256]
Authentication Algorithm for ESP	Specify the authentication algorithm to be applied when [ESP] is selected for [Security Protocol] from the following: [MD5], [SHA1]
Life Time	Specify the life time of the IPsec SA (Security Association) as a time period or data volume. The SA will expire when the time period you specify elapses or the volume of data you specify reaches the volume carried.  If you specify both a time period and a data volume, the SA will expire as soon as either is reached, and a new SA will then be obtained by negotiation.  To specify the life time of the SA as a time period, enter a number of seconds.  To specify the life time of the SA as a data volume, enter a number of KBs.

Item	Description
Key Perfect Forward Secrecy	Select whether to enable or disable PFS (Perfect Forward Secrecy).

**IKE Settings**

Item	Description
IKE Version	Displays the IKE version.
Encryption Algorithm	Specify the encryption algorithm from the following: [DES], [3DES], [AES-128], [AES-192], [AES-256]
Authentication Algorithm	Specify the authentication algorithm from the following: [MD5], [SHA1]
IKE Life Time	Specify the life time of the ISAKMP SA as a time period. Enter a number of seconds.
IKE Diffie-Hellman Group	Select the IKE Diffie-Hellman Group to be used in the generation of the IKE encryption key from the following: [DH1], [DH2]
Pre-Shared Key	Specify the PSK (Pre-Shared Key) to be used for authentication of a communicating device. Can contain up to 32 characters.
Key Perfect Forward Secrecy	Select whether to enable or disable PFS (Perfect Forward Secrecy).

## Printing Lists/Reports

Click [Print List/Report] to display the page for printing reports. Then, select an item and click [Print] to print out information for that item.

### Print List/Report

Item	Description
Configuration Page	Prints general information about the machine and its current configuration.
Fax Journal	Prints a fax transmission and reception journal for the last 50 jobs. For details about automatic fax journal printing, see page 184 "Fax Features Settings".
Fax TX/RX Standby File List	Prints a list of fax jobs remaining in the machine's memory to be printed, sent, or forwarded.
Quick Dial Destination List	Prints a list of Quick Dial entries.
Fax Speed Dial Destination List	Prints a list of Speed Dial entries.
Scanner Destination List	Prints a list of scan destinations.
Scanner Journal	Prints a scanner journal for the last 100 Scan to E-mail, Scan to FTP, and Scan to Folder transmissions.
Maintenance Page	Prints the maintenance page.

#### Note

- Reports cannot be printed via Web Image Monitor if other jobs are printing. Before printing reports, confirm that machine is not printing.
- Reports will be printed on A4 or Letter size paper. Load one of these sizes of paper into the tray before printing reports.

## Configuring the Administrator Settings

Click [Administrator Tools] to display the page for configuring the administrator settings.

This page contains the following tabs: [Administrator], [Reset Settings], [Backup Setting], [Restore Setting], [Set Date/Time], and [Energy Saver Mode].

### Administrator Tab

#### Administrator Settings

Item	Description
Change Password (only SP 320SFN and SP 325SFNw)	Check this to configure the administrator password.
New Password	Enter the new administrator password. Can contain up to 16 characters.
Confirm New Password	Enter the same password again, to confirm.
Change E-mail Address (only SP 320SFN and SP 325SFNw)	Check this to configure the administrator e-mail address.
Administrator E-mail Address (only SP 320SFN and SP 325SFNw)	Enter the administrator e-mail address. If the machine's e-mail address is not configured in the [SMTP] page, this address will be used as the sender's address of e-mails sent from this machine, such as notification e-mails. Can contain up to 64 characters.

### Rest Settings Tab

#### Reset Settings

Item	Description
Reset Network Settings	Select to restore the following settings to their defaults: <ul style="list-style-type: none"> <li>• Settings under [Network Settings]</li> <li>• Settings under the [Administrator] tab of [Administrator Tools]</li> </ul>

Item	Description
Reset Menu Settings	Select to restore the settings other than the following to their defaults: <ul style="list-style-type: none"> <li>• Network settings</li> <li>• Scan destinations</li> <li>• User restriction settings</li> <li>• Fax destinations</li> <li>• IPsec settings</li> <li>• [Printer Registration], [Low Humidity Mode], and [Image Density] settings under [System Settings] of the control panel setting menu</li> </ul>
Clear Scan Destination	Select to clear the scan destinations.
Clear Address Book (only SP 320SFN and SP 325SFNw)	Select to clear the fax destinations.
Reset IPsec Settings	Select to clear the IPsec settings.

#### ↓ Note

- [Reset IPsec Settings] appears only when the administrator password is specified.

## Backup Setting Tab

#### ★ Important

- When sending the machine for repair, it is important that you create backup files in advance. The machine's settings are returned to the default after repair.

#### Backup Setting

Item	Description
Back up Network Settings	Backs up the following settings to a file: <ul style="list-style-type: none"> <li>• Settings under [Network Settings]</li> <li>• Settings under the [Administrator] tab of [Administrator Tools]</li> </ul> <p>Note that, however, [Max. E-mail Size] setting under [Network Application] will not be backed up here; it will be backed up by [Back up Menu Settings] instead.</p>

Item	Description
Back up Menu Settings	Backs up the settings other than the following to a file: <ul style="list-style-type: none"> <li>• Network settings</li> <li>• Scan destinations</li> <li>• User restriction settings</li> <li>• Fax destinations</li> <li>• IPsec settings</li> <li>• [Printer Registration], [Low Humidity Mode], and [Image Density] settings under [System Settings] of the control panel setting menu</li> </ul>
Back up Scan Destination	Backs up scan destinations to a file.
Back up Address Book (only SP 320SFN and SP 325SFNw)	Backs up fax destinations to a file.
Back up IPsec Settings	Backs up the IPsec settings to a file.

Follow the procedure below to create configuration backup files.

8

1. Select the option button for the type of data you wish to back up.
2. Enter the administrator password if required.
3. Click [OK].
4. Click [Save] in the confirmation dialog box.
5. Navigate to the location to save the backup file.
6. Specify a name for the file, and click [Save].

 **Note**

- [Back up IPsec Settings] appears only when the administrator password is specified.

---

## Restore Setting Tab

---

 **Important**

- When the machine is returned from repair, it is important that you restore the machine's settings from the backup files. The machine's settings are returned to the default after repair.

**Restore Setting**

Item	Description
File to Restore	Enter the path and name of the file to restore, or click [Browse...] to select the file.

Follow the procedure below to restore configuration backup files.

1. Click [Browse...].
2. Navigate to the directory containing the backup file to restore.
3. Select the backup file, and click [Open].
4. Enter the administrator password if required.
5. Click [OK].

**Note**

- If the settings are not restored successfully, an error message appears. Try again to restore the file completely.

**Set Date/Time Tab****Set Date**

Item	Description
Year	Enter the current year (2000 to 2099).
Month	Enter the current month (1 to 12).
Day	Enter the current day (1 to 31).
Date Format	Select the date format from [MM/DD/YYYY], [DD/MM/YYYY], or [YYYY/MM/DD].

**Set Time**

Item	Description
Time Format	Select 24- or 12-hour time format.
Time (AM/PM)	Select [AM] or [PM] if 12-hour time format is selected.
hour (0-23)	Enter the current hour if 24-hour time format is selected (0-23).
hour (1-12)	Enter the current hour if 12-hour time format is selected (1-12).

Item	Description
min. (0-59)	Enter the current minute (0-59).

## Energy Saver Mode Tab

### Energy Saver Mode

Item	Description
Energy Saver Mode 1	<p>Select [Active] to set the machine to enter Energy Saver mode 1 if the machine has been idle for about 30 seconds.</p> <p>It takes less time to recover from Energy Saver mode 1 than from power-off state or Energy Saver mode 2, but power consumption is higher in Energy Saver mode 1 than in Energy Saver mode 2.</p>
Energy Saver Mode 2	<ul style="list-style-type: none"> <li>• Europe Select [30sec] or specify the period of time (1-20min) for the machine to enter Energy Saver mode 2.</li> <li>• Countries other than European countries Select [30sec] or specify the period of time (1-240min) for the machine to enter Energy Saver mode 2.</li> </ul> <p>The machine consumes less power in Energy Saver mode 2 than in Energy Saver mode 1, but it takes longer to recover from Energy Saver mode 2 than from Energy Saver mode 1.</p>

**Note**

- The machine recovers from Energy Saver mode when it receives a print job, prints a received fax, or when any key is pressed.



# Using Smart Organizing Monitor

The state and status information of the machine can be checked using Smart Organizing Monitor.

## Displaying the Smart Organizing Monitor Dialog

1. On the [Start] menu, click [All Programs].
2. Click [SP 320 Series Software Utilities].
3. Click [Smart Organizing Monitor].
4. If the machine you are using is not selected, click [Connect Printer], and then do one of the following:
  - Select the machine's model.
  - Enter the IP address of the machine manually.
  - Click [Search Network Printer] to search the machine via the network.
5. Click [OK].

## Checking the Status Information

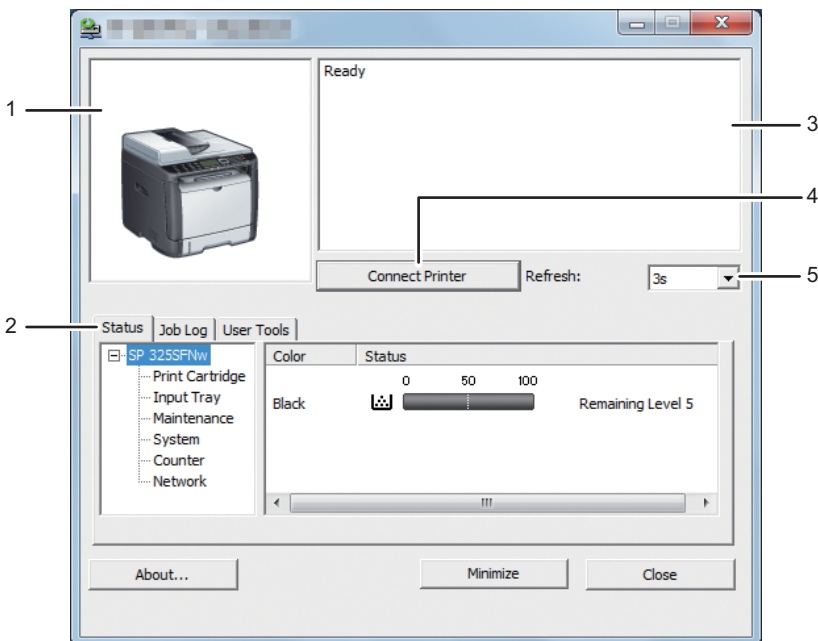

DSG164

### 1. Image area

Displays the status of this machine with an icon.

## 2. Tab area

- Status tab
  - Printer Name
  - Print Cartridge  
Displays the following messages to indicate remaining toner levels: Remaining Level 1 to 5, "Almost Empty" and "Empty".
  - Input Tray  
You can check the following information about the input trays.  
[Input Tray], [Status], [Paper Size], [Paper Type]  
Displays the type of the paper loaded into each input tray.
  - Maintenance  
Displays the consumables statuses.
  - System  
Displays the system information about the printer, such as the model name, system version, and memory size.
  - Counter  
Displays information about the counters.
  - Network  
Displays network details such as the printer's IP address and network-related information.
- Job Log tab  
Displays the job log information.
- User Tools tab  
Click to print lists or configuration pages, or to configure settings of the machine.

## 3. Message area

Displays the status of this machine with a message.

For details about error messages, see page 279 "Error and Status Messages Appear on Smart Organizing Monitor".

## 4. [Connect Printer] button

Click to select a printer driver.

## 5. [Refresh:]

Specify the automatic update of the display.

---

# Configuring the Machine Settings

---

Smart Organizing Monitor is used to modify the machine's settings.

1. On the [Start] menu, click [All Programs].
2. Click [SP 320 Series Software Utilities].
3. Click [Smart Organizing Monitor].

**4. If the machine you are using is not selected, click [Connect Printer], and then do one of the following:**

- Select the machine's model.
- Enter the IP address of the machine manually.
- Click [Search Network Printer] to search the machine via the network.

**5. Click [OK].**

**6. On the [User Tools] tab, click [Printer Configuration].**

**7. Enter the access code, and then click [OK].**

The default access code is "Admin".

**8. Change the settings if necessary.**

**9. Click [OK].**

**10. Click [Close].**

### Access Code

The configurable functions depend on the authority of the access code you enter.

- Administrator  
All tabs in the [Printer Configuration] dialog box are available.
- General users  
Only the [Paper Input] tab is available.

## Tab Settings

This section provides a tab-by-tab overview of the machine settings that can be modified using Smart Organizing Monitor. For more information on each setting item, see the Smart Organizing Monitor Help.

### Paper Input tab

- You can change paper size and other paper settings.

### Maintenance tab

- You can adjust print starting positions.

### System tab

- You can set basic functions required to use the printer. The printer can be used on factory-set defaults, but the configuration can be changed depending on the condition of the user.
- The changed condition holds even if the printer is turned off.
- The access code can be changed on this tab.

### IPv6, Network 1, Network 2 and Network 3 tabs

- You can set configurations about network connection and communication.

- The following operations are possible on these tabs:
  - Checking the printer name, active protocol, and other printer information
  - Making interface settings, including the timeout setting and protocol settings
  - Checking or making TCP/IP settings
  - Checking or making SMTP, SNMP and IPsec settings
  - Checking or making Alert settings

#### **Wireless tab**

- You can set configurations about wireless LAN network connection and communication.
- The following operations are possible on the tab:
  - Checking the wireless LAN status
  - Connecting wireless LAN manually

#### **Printer tab**

- You can set configurations about the printer.

---

## **Printing the Configuration Page**

---

1. On the [Start] menu, click [All Programs].
2. Click [SP 320 Series Software Utilities].
3. Click [Smart Organizing Monitor].
4. If the machine you are using is not selected, click [Connect Printer], and then do one of the following:
  - Select the machine's model.
  - Enter the IP address of the machine manually.
  - Click [Search Network Printer] to search the machine via the network.
5. Click [OK].
6. On the [User Tools] tab, select [Configuration Page] in the [List/Test Print] list.
7. Click [Print].

---

## **Scanning Documents**

---

On the [Scan] dialog box, specify scan settings and scan documents.

For details about how to scan or specify scan settings, see page 123 "Scanning from Smart Organizing Monitor".

# 9. Maintaining the Machine

This chapter describes how to replace supplies and how to clean the machine.

## Replacing the Print Cartridge

### ★ Important

- Store print cartridge in a cool dark place.
- Actual printable numbers vary depending on image volume and density, number of pages printed at a time, paper type and size, and environmental conditions such as temperature and humidity. Toner quality degrades over time. Early replacement of the print cartridge might be necessary. Therefore, we recommend you always keep a new print cartridge ready.
- For good print quality, the manufacturer recommends that you use genuine toner from the manufacturer.
- The manufacturer shall not be responsible for any damage or expense that might result from the use of parts other than genuine parts from the manufacturer with your office products.
- Do not allow paper clips, staples, or other small objects to fall inside the machine.
- Do not expose the print cartridge without its cover to direct sunlight for a long time.
- Do not touch the print cartridge's photo conductor unit.

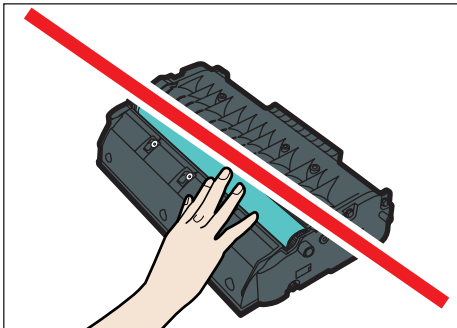

CMC013

- Do not touch the ID chip on the side of the print cartridge as indicated in the illustration below.

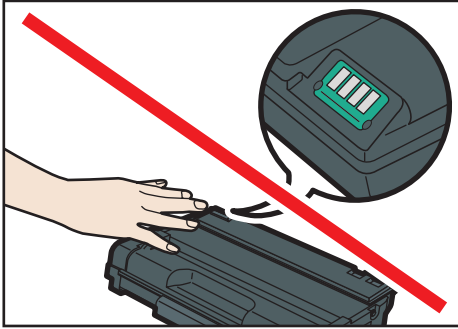

- If toner runs out, you cannot print until the print cartridge is replaced.

**Messages on the screen**

- Replace the print cartridge when "Replacement Required: Print Cartridge" appears on the screen.
- Prepare a new print cartridge when "Replace Required Soon: Print Cartridge" appears on the screen.

1. If paper is loaded in the bypass tray, remove the paper and close the bypass tray.
2. Push the side button to open the front cover, and then carefully lower it.

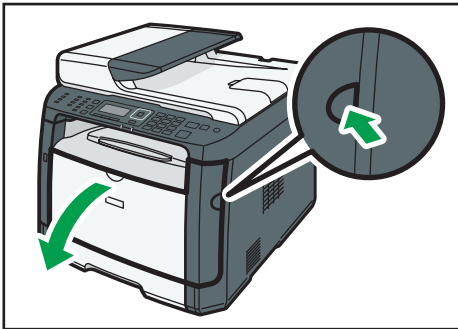

3. Hold the center of the print cartridge and carefully raise it slightly and then pull it out horizontally.

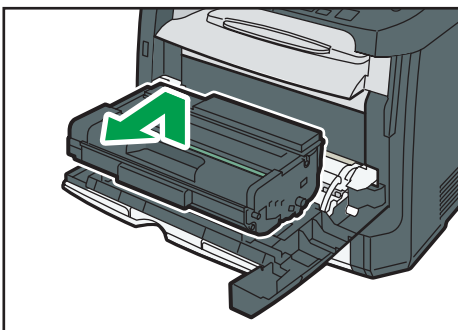

- Do not shake the removed print cartridge. Doing so can cause remaining toner to leak.
- Place the old print cartridge on paper or similar material to avoid dirtying your workspace.

4. Take the new print cartridge out of the box, and then take it out of the plastic bag.

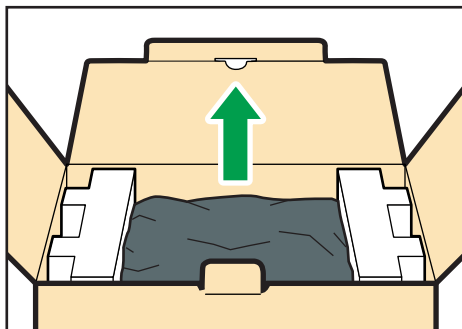

CMC081

5. Place the print cartridge on a flat surface, and then remove the protection sheet.

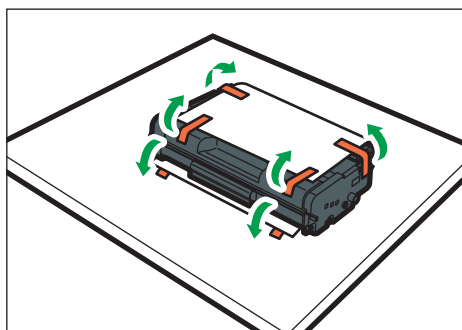

CMC019

6. Hold the print cartridge and shake it from side to side five or six times.

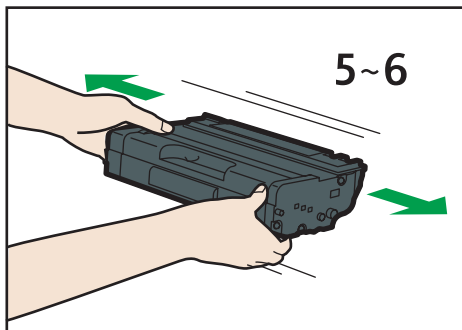

DPH045

Even distribution of toner within the bottle improves print quality.

7. Slide the print cartridge in horizontally. When the cartridge can go no further, raise it slightly and push it fully in. Then push down on the cartridge until it clicks into place.

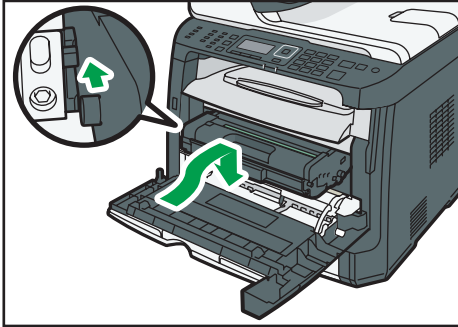

DSG171

8. Carefully push up the front cover until it closes. Be careful not to trap your fingers.

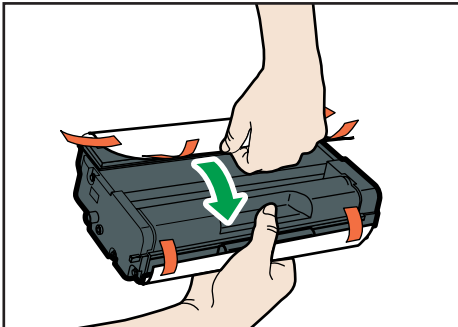

After closing the front cover, wait until the initial screen is displayed.

9. Put the protective sheet you removed in Step 5 on the old print cartridge. Then, put the old print cartridge into the bag, and then put it into the box.



CMC083

**Note**

- Make sure to cover the old print cartridge with the protective cover for recycling and environmental purposes.
-  **Region A** (mainly Europe and Asia)  
If you want to discard your used toner container, please contact your local sales office. If you discard it by yourself, treat it as general plastic waste material.
-  **Region B** (mainly North America)  
Please see our local company website for information on the recycling of supply products, or you can recycle items according to the requirements of your local municipalities or private recyclers.



## Cautions When Cleaning

Clean the machine periodically to maintain high print quality.

Dry wipe the exterior with a soft cloth. If dry wiping is not sufficient, wipe with a soft, damp cloth that has been wrung out thoroughly. If you still cannot remove the stain or grime, use a neutral detergent, wipe over the area with a thoroughly-wrung damp cloth, and then dry wipe the area and allow it to dry.

### ★ Important

- To avoid deformation, discoloration, or cracking, do not use volatile chemicals, such as benzine and thinner, or spray insecticide on the machine.
- If there is dust or grime inside the machine, wipe with a clean, dry cloth.
- You must disconnect the plug from the wall outlet at least once a year. Clean away any dust and grime from the plug and outlet before reconnecting. Accumulated dust and grime pose a fire hazard.
- Do not allow paper clips, staples, or other small objects to fall inside the machine.

## Cleaning the Friction Pad and Paper Feed Roller

1. Turn off the power.
2. Unplug the power cord from the wall outlet. Remove all the cables from the machine.
3. Pull out tray 1 carefully with both hands.

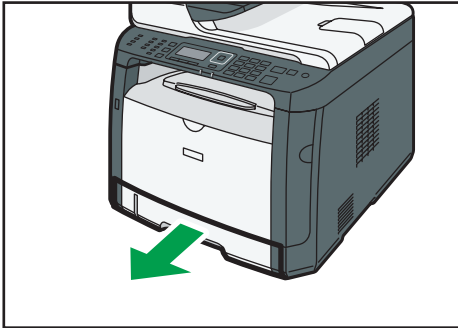

DSG110

Place the tray on a flat surface. If there is paper in the tray, remove it.

4. Wipe the friction pads with a damp cloth.

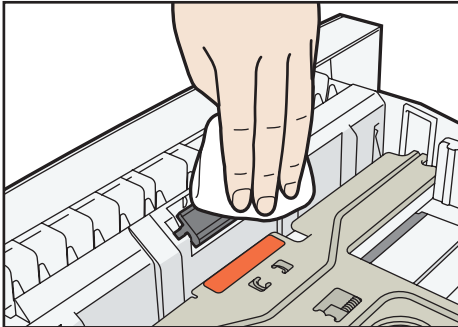

DSG172

5. Wipe the rubber part of the roller with a soft damp cloth. After that, wipe it with a dry cloth to remove the moisture.

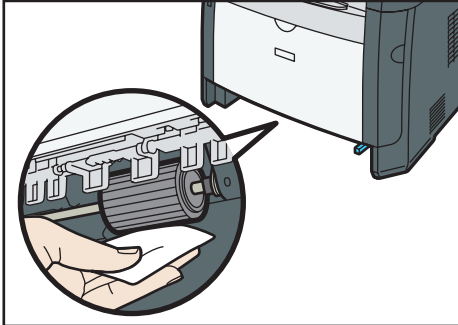

DSG173

6. Reload the removed paper into the tray, and then push the tray carefully into the machine until it clicks into place.

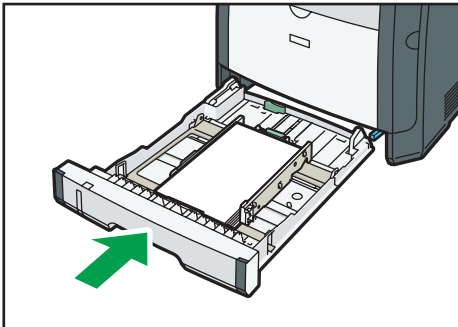

DSG174

7. Insert the plug of the power cord into the wall socket securely. Connect all the interface cables that were removed.
8. Turn on the power.

**Note**

- If jams or multi-sheet feeds occur after cleaning the friction pad, contact your sales or service representative.

## Cleaning the Exposure Glass

### 1. Lift the exposure glass cover.

When using SP 320SFN, SP 325SNw or SP 325SFNw, be careful not to hold the input tray when lifting the exposure glass cover, for the tray might be damaged.

### 2. Clean the parts indicated with arrows with a soft damp cloth and then wipe the same parts with a dry cloth to remove any remaining moisture.

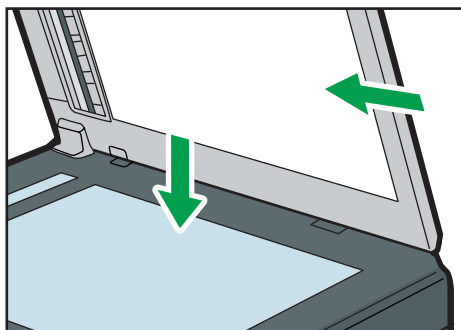

CVW041

# Cleaning the Auto Document Feeder (When Using SP 320SFN)

**1. Lift the ADF.**

Be careful not to hold the input tray when lifting the ADF, for the tray might be damaged.

**2. Clean the parts indicated with arrows with a soft damp cloth and then wipe the same parts with a dry cloth to remove any remaining moisture.**

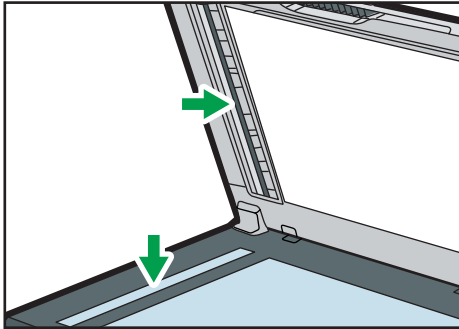

CVW042

## Cleaning the Auto Document Feeder (When Using SP 325SNw or SP 325SFNw)

**1. Lift the ADF.**

Be careful not to hold the input tray when lifting the ADF, for the tray might be damaged.

- 2. Clean the parts indicated with arrows with a soft damp cloth and then wipe the same parts with a dry cloth to remove any remaining moisture.**

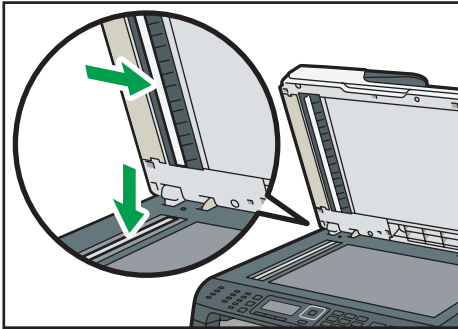

DSG175

# Moving and Transporting the Machine

This section provides cautions that you must follow when moving the machine both short and long distances.

Repack the machine in its original packing materials when moving it over a long distance.

## ★ Important

- **Be sure to disconnect all cables from the machine before transporting it.**
- **The machine is a precision piece of machinery. Be sure to handle it carefully when moving it.**
- **Make sure to move the machine horizontally. Take extra caution when carrying the machine up or down stairs.**
- **Do not remove the print cartridge when moving the machine.**
- **Be sure to hold the machine level while carrying it. To prevent toner from spilling, move the machine carefully.**
- Keep the machine away from salt-bearing air and corrosive gases. Also, do not install the machine in places where chemical reactions are likely (laboratories, etc.), as doing so will cause the machine to malfunction.

## Ventilation

When you use this machine in a confined space without good ventilation for a long time or print large quantities, you might detect an odd smell.

This might cause the output paper to also have an odd smell.

When you detect an odd smell, regularly ventilate in order to keep the workplace comfortable.

- Set up the machine so that it does not directly ventilate towards people.
- Ventilation should be more than 30 m<sup>3</sup>/hr/person.

## New machine smell

When a machine is new, it might have a unique smell. This smell will subside in about one week.

When you detect an odd smell, sufficiently ventilate and circulate the air in the room.

### 1. Be sure to check the following points:

- The power switch is turned off.
- The power cord is unplugged from the wall outlet.
- All other cables are unplugged from the machine.

### 2. Lift the machine using the inset grips on both sides of the machine, and then move it horizontally to the place where you want to use it.

## ↓ Note

- To move the machine over a long distance, pack it well and empty all the paper trays. Take care not to tip or tilt the machine during transit.

- Toner might spill inside the machine if the machine is not kept level during transit.
- For more information about moving the machine, contact your sales or service representative.

---

## **Disposal**

---

Ask your sales or service representative for information about correct disposal of this machine.

---

## **Where to Inquire**

---

Contact your sales or service representative for further information about the topics included in this manual or to inquire about other topics not included in this manual.



# 10. Troubleshooting

This chapter provides solutions for error messages and other problems.

## Error and Status Messages on the Screen

Messages are listed in alphabetical order in the table below.

"X" indicates a number in an error code that appear differently depending on a specific situation.

### ★ Important

- If the alert indicator lights up continuously or flashes, switch to copier mode and check the displayed message.

Message	Causes	Solutions
2XXX14	The machine was not able to print the received fax, or the machine's memory reached capacity while receiving a fax because the document was too large.	<ul style="list-style-type: none"><li>• The paper tray was empty. Load paper in the paper tray. See page 36 "Loading Paper".</li><li>• The paper tray did not contain A4, Letter, or Legal size paper. Load valid size paper in the tray, and configure the paper size settings under [Tray Paper Settings] accordingly.</li><li>• A cover or tray was open. Close the cover or tray.</li><li>• There was a paper jam. Remove the jammed paper. See page 281 "Clearing Misfeeds".</li><li>• A print cartridge was empty. Replace the print cartridge. See page 259 "Replacing the Print Cartridge".</li><li>• The received fax was too large. Ask the sender to resend the document in parts as several smaller individual faxes, or to send at a lower resolution.</li></ul>
ADF Cover Open Close ADF Cover	The ADF cover is open.	<ul style="list-style-type: none"><li>• Close the cover completely.</li></ul>

Message	Causes	Solutions
ADF Orig. Misfeed Open ADF Cover and remove paper.	An original has been jammed inside the ADF.	<ul style="list-style-type: none"> <li>Remove jammed originals, and then place them again. See page 281 "Clearing Misfeeds" and page 293 "Paper Feed Problems".</li> <li>Check the originals are suitable for scanning. See page 65 "Placing Originals".</li> </ul>
Available: IDCard Copy A4 or 8 1/2 x 11	ID card copy could not be performed because the tray does not contain the valid size paper, which are A4 or Letter size.	<ul style="list-style-type: none"> <li>Set the machine to print copies using the A4 or Letter size paper in the [Select Paper] setting. See page 176 "Copier Features Settings".</li> <li>Specify the A4 or Letter size paper for the tray selected for printing copies. See page 202 "Tray Paper Settings".</li> </ul>
Busy	Fax transmission could not be completed because the destination's line was busy.	Wait for a while and send the fax again.
Cannot Copy This Setting Comb.: 2 on 1 / 4 on 1	Combined copying could not be performed because the tray does not contain the valid size paper, which are A4, Letter, or Legal size.	<ul style="list-style-type: none"> <li>Set the machine to print copies using the A4, Letter, or Legal size paper in the [Select Paper] setting. See page 176 "Copier Features Settings".</li> <li>Specify the A4, Letter, or Legal size paper for the tray selected for printing copies. See page 202 "Tray Paper Settings".</li> </ul>
Cannot copy. Set original to ADF.	Combined copying could not be performed because the originals were not placed in the ADF.	<ul style="list-style-type: none"> <li>Use the ADF, even when copying a single sheet.</li> <li>If you need to use the exposure glass, turn off combined copying in [Duplex/Combine] under [Copier Features], and then try again. See page 176 "Copier Features Settings".</li> </ul>
Check Paper Size	The paper size set for the document differs from the size of the paper in the indicated tray.	Press the [OK] key to begin printing, or press the [Back] key to cancel the job.

Message	Causes	Solutions
Check Paper Type	The paper type set for the document differs from the type of the paper in the indicated tray.	Press the [OK] key to begin printing, or press the [Back] key to cancel the job.
Connection Failed	The line could not be connected correctly.	<ul style="list-style-type: none"> <li>• Confirm that the telephone line is properly connected to the machine.</li> <li>• Disconnect the telephone line from the machine, and connect a standard telephone in its place. Confirm that you can make calls using the telephone. If you cannot make calls this way, contact your telephone company.</li> </ul>
Cover open	A cover is open.	Close the cover completely.
Dest. is not Programmed	No Quick Dial entry is associated with the One Touch button you pressed.	<ul style="list-style-type: none"> <li>• Press a different One Touch button.</li> <li>• Assign a registered destination to the One Touch button. See page 95 "Registering Scan Destinations".</li> </ul>
Dial Failed	The fax could not be sent.	<ul style="list-style-type: none"> <li>• Confirm that the fax number you dialed is correct.</li> <li>• Confirm that the destination is a fax machine.</li> <li>• Confirm that the line is not busy.</li> <li>• You may need to insert a pause between dial digits. Press the [Pause/Redial] key after, for example, the area code.</li> </ul>
Exceeded Max.E-mail Size	The scan file exceeds the size limit for files that can be sent through e-mail.	<ul style="list-style-type: none"> <li>• Configure [Resolution] under [Scan Settings] to reduce the scanning resolution. See page 181 "Scan Settings".</li> <li>• Configure [Max. E-mail Size] under [Scan Settings] to increase the allowed size. See page 181 "Scan Settings".</li> </ul>

Message	Causes	Solutions
Fax Job Memory Overflow	The number of fax jobs in memory (unsent or unprinted faxes) has reached maximum, so new jobs cannot be stored.	Wait until pending jobs have been transmitted or printed.
I-Fax POP3 fails	Connection to the POP3 server failed.	<ul style="list-style-type: none"> <li>• Confirm that the network cable is properly connected to the machine.</li> <li>• Confirm that the network settings such as IP address, DNS, and POP3 settings have been configured properly (make sure that no double-byte character is used). See page 236 "Configuring the Network Settings".</li> </ul>
Indep.Sply.Prt.Cart.	A non-supported print cartridge is installed.	Remove and replace it with a print cartridge specified by an authorized dealer.
Internal Misfeed	Paper has been jammed in the machine.	Remove the jammed paper. See page 281 "Clearing Misfeeds".
Memory Almost Full	Memory has almost reached capacity during sort copy.	If several originals are still to be scanned, it is recommended to start printing now, and copy the remaining originals separately. If originals are being scanned from the ADF, remove any remaining pages from the ADF.
Memory Overflow	The data is too large or complex to print.	<ul style="list-style-type: none"> <li>• Select [600 × 600 dpi] in [Resolution] under [Printer Features] to reduce the size of data. See page 198 "Printer Features Settings".</li> <li>• If using the PCL6 printer driver, set [Resolution] in the [Print Quality] tab to [600 × 600 dpi].</li> </ul>

Message	Causes	Solutions
Memory Overflow	<ul style="list-style-type: none"> <li>The machine's memory reached capacity while scanning the first page of the original to store a fax job in memory before transmission.</li> <li>The machine's memory reached capacity while storing a fax in memory in Memory Transmission mode.</li> </ul>	Resend the fax in parts as several smaller individual faxes, or send at a lower resolution.
Memory Overflow TX Cancel	Memory has reached capacity while scanning the second or later pages of the original when trying to send a fax in Memory Transmission mode.	Press [TX] to send only the pages that have been scanned in memory, or press [Cancel] to cancel.
Misfeed: BypassTray	Paper has been jammed in the bypass tray.	Remove the jammed paper. See page 281 "Clearing Misfeeds".
Misfeed: Dup. Unit Remove Paper	Paper has been jammed in the duplex unit.	Remove the jammed paper. See page 281 "Clearing Misfeeds".
Misfeed: Stnd. Tray	Paper has been jammed in the paper exit area.	Remove the jammed paper. See page 281 "Clearing Misfeeds".
Misfeed: Tray 1	Paper has been jammed in the tray 1 paper input area.	Remove the jammed paper. See page 281 "Clearing Misfeeds".
Net Communication Error	Connection with the server was lost while sending or receiving data.	Contact the network administrator.
Network is not Ready	A scanned file could not be sent because the machine has not received IP address information from the DHCP server completely.	Wait until the machine receives the IP address information completely, and then try the operation again.
On Hook or Stop key	The machine has been off-hook for an extended period of time.	Put down the handset phone or press the [Clear/Stop] key.

Message	Causes	Solutions
Out of Paper: X	The indicated tray has run out of paper.	Load paper to the indicated tray. See page 36 "Loading Paper".
Please Restart Machine	The machine needs to be restarted.	Turn off the power, and then turn it back on.
Print Cart. Set Error	The print cartridge has not been installed or has not been installed correctly.	Reinstall the print cartridge. See page 259 "Replacing the Print Cartridge".
Remove Paper: Bypass Tray	The machine failed to proceed with the print job, because tray 1 was specified as the input tray but paper was set in the bypass tray.	Remove paper from the bypass tray.
Replace Required Soon: Print Cartridge	The print cartridge is almost empty.	Prepare a new print cartridge.
Replacement Required: Fusing Unit	The fusing unit is no longer usable, and must be replaced.	Contact your sales or service representative.
Replacement Required: Paper Feed Roller	The paper feed roller is no longer usable, and must be replaced.	Contact your sales or service representative.
Replacement Required: Print Cartridge	The machine has run out of toner.	Replace the print cartridge. See page 259 "Replacing the Print Cartridge".
Replacement Required: Transfer Roller	The transfer roller is no longer usable, and must be replaced.	Contact your sales or service representative.
RX Comm. Error	A reception error occurred, and the fax could not be received correctly.	If possible, contact the sender of the fax and ask them to resend it.

Message	Causes	Solutions
Scan (NW) Disconnected	A scanned file could not be sent because the Ethernet cable was not connected properly.	Reconnect the Ethernet cable properly, and then try the operation again.
Scan (USB) Disconnected	The USB cable was disconnected while scanning from a computer.	Reconnect the USB cable properly, and then try the operation again.
Server Connection Failed	A scanned file could not be sent because the destination could not be reached.	Confirm that the destination is registered correctly, and then try the operation again.
Server Response Error	An error occurred in communication with the server before beginning transmission.	Confirm that the destination is registered correctly, and then try the operation again. If the problem could not be solved, contact the network administrator.
Service call - X	A fatal hardware error has occurred, and the machine cannot function.	Contact your sales or service representative.
Set Correct Paper	The paper tray does not contain A4, Letter, or Legal size paper.	While the message is displayed, press the [OK] key. A menu for changing the paper size of the current tray appears. Load A4/Letter/ Legal size paper in the tray, and then select the corresponding paper size using [▲] or [▼] key and press the [OK] key. The machine will then print out the fax. Note that the paper size setting for the tray under [Tray Paper Settings] will be changed. See page 202 "Tray Paper Settings".
Set Original to ADF Cannot use exposure glass with set. in [Scan Size].	Scanning could not be performed because the originals were not placed in the ADF, even though the machine is set to scan originals larger than A4/Letter size.	<ul style="list-style-type: none"> <li>• Use the ADF, even when scanning A4/Letter or smaller size originals.</li> <li>• If you need to use the exposure glass, set A4/Letter or smaller size in [Scan Size] under [Scan Settings], and then try again. See page 132 "Specifying Scan Settings for Scanning".</li> </ul>

Message	Causes	Solutions
Sort Copy was Cancelled	The machine's memory reached capacity while originals were being scanned from the ADF to perform sort copying.	Press [Exit] to print the originals that were successfully scanned into memory. Then, copy again the originals left in the ADF.
TX Comm. Error	A transmission error occurred, and the fax could not be transmitted correctly.	If the [Auto Redial] setting is enabled, the machine will redial the number and try again. If all attempts fail, or if the machine is in Immediate Transmission mode, the fax will not be transmitted. Try the operation again.



## Error and Status Messages Appear on Smart Organizing Monitor

Message	Causes	Solutions
<p>No Response from I/O Device</p> <p>Check the cable, power cord, and main switch.</p>	<ul style="list-style-type: none"> <li>• The power cable of the machine is not plugged in.</li> <li>• The power of the machine is not turned ON.</li> <li>• The USB cable is not connected.</li> </ul>	<ul style="list-style-type: none"> <li>• Check the printer power cord.</li> <li>• Check the printer power switch is on.</li> <li>• Check the USB cable is properly connected.</li> </ul>
<p>Tray Not Detected or No Paper</p> <p>The indicated paper source tray is not set properly, or no paper loaded.</p> <p>Check the indicated tray.</p>	<ul style="list-style-type: none"> <li>• Tray 1 has run out of paper.</li> <li>• The bypass tray has run out of paper.</li> </ul>	<ul style="list-style-type: none"> <li>• Load paper into Tray 1. See page 36 "Loading Paper".</li> <li>• Load paper into the bypass tray. See page 36 "Loading Paper".</li> </ul>
<p>Tray 1 Jam</p> <p>Bypass Tray Jam</p> <p>Duplex Jam</p> <p>Inner Jam</p> <p>Outer Jam</p> <p>Total Jam</p>	<p>A paper jam has occurred in the machine.</p>	<p>Remove the jammed paper. See page 281 "Clearing Misfeeds" and page 293 "Paper Feed Problems".</p>
<p>Paper Size Mismatch</p> <p>Paper of the selected paper size is not loaded in the indicated paper source tray.</p> <p>Check the indicated tray.</p>	<p>The paper size specified on the machine and the size specified in the printer driver do not match.</p>	<p>For details about specifying the paper size setting on the machine, see page 35 "Paper Specifications and Adding Paper". For details about changing the paper size setting in the printer driver, see the printer driver Help.</p>

Message	Causes	Solutions
<p>Paper Type Mismatch</p> <p>Paper of the selected paper type is not loaded in the indicated paper source tray.</p> <p>Check the indicated tray.</p>	<p>The paper type specified on the machine and the type specified in the printer driver do not match.</p>	<p>For details about changing the paper type setting of the machine, see page 35 "Paper Specifications and Adding Paper".</p> <p>For details about changing the paper type setting in the printer driver, see the printer driver Help.</p>
<p>Print Cartridge is near empty.</p>	<p>The print cartridge is almost empty.</p>	<p>Prepare a new print cartridge.</p>
<p>Shortly printing becomes not available. Please keep Print Cartridge handy.</p>	<p>The machine has run out of the toner.</p>	<p>Replace the print cartridge. See page 259 "Replacing the Print Cartridge".</p>
<p>Printing has been interrupted because of the memory overflow.</p>	<p>The data is too large or complex to print.</p>	<p>Select [600 x 600 dpi] in [Resolution] to reduce the size of data. For details, see the printer driver Help.</p>
<p>Waste Toner full</p> <p>No printing is available.</p> <p>Open the indicated cover, and then replace Print Cartridge.</p>	<p>The waste toner bottle is full.</p>	<p>Replace the print cartridge.</p>
<p>No Toner or Waste Toner full</p> <p>No printing is available.</p> <p>Open the indicated cover, and then replace Print Cartridge.</p>	<p>The print cartridge has not been installed.</p>	<p>Replace the print cartridge. See page 259 "Replacing the Print Cartridge".</p>

# Clearing Misfeeds

## ★ Important

- Jammed paper may be covered in toner. Be careful not to get toner on your hands or clothes.
- Toner on prints made immediately after clearing a paper jam may be insufficiently fused and can smudge. Make test prints until smudges no longer appear.
- Do not forcefully remove jammed paper, as it may tear. Torn pieces remaining inside the machine will cause further jams and possibly damage the machine.
- Paper jams can cause pages to be lost. Check your print job for missing pages and reprint any pages that did not print out.
- If the alert indicator lights up continuously or flashes, switch to copier mode and check the displayed message.

## Removing Jammed Paper from Tray 1

If "Internal Misfeed" or "Misfeed: Tray 1" appears on the display, follow the procedure below to remove it.

1. Pull tray 1 halfway out, and check for jammed paper. If there is jammed paper, remove it carefully.

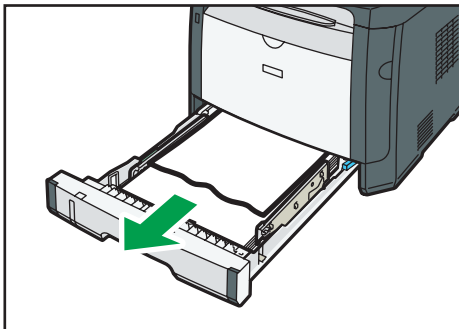

DSG176

2. Carefully slide tray 1 back in until it stops.
3. If paper is loaded in the bypass tray, remove the paper.
4. Close the bypass tray.

5. Push the side button to open the front cover, and then carefully lower it.

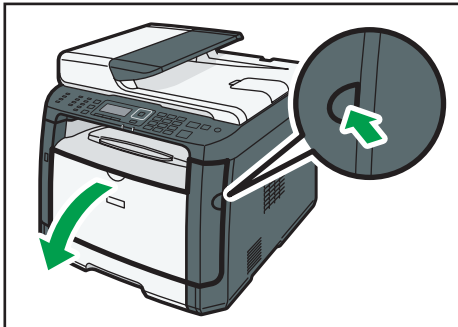

DSG168

6. Hold the center of the print cartridge and carefully raise it slightly and then pull it out horizontally.

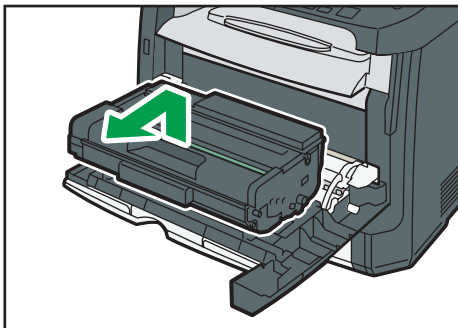

DSG169

- Do not shake the removed print cartridge. Doing so can cause remaining toner to leak.
- Place the print cartridge on paper or similar material to avoid dirtying your workspace.

7. Lifting the guide plate, remove the jammed paper carefully.

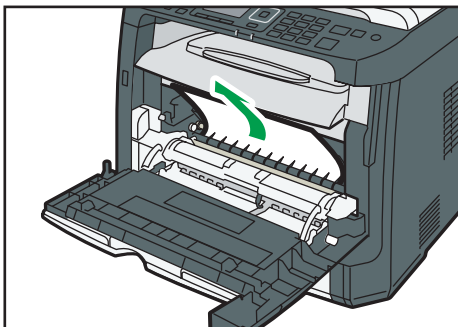

DSG178

- Slide the print cartridge horizontally. When the cartridge can go no further, raise it slightly and push it fully in. Then push down on the cartridge until it clicks into place.

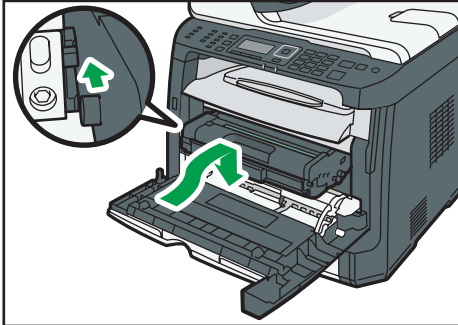

DSG171

- Using both hands, carefully push up the front cover until it closes.

**Note**

- When closing the front cover, push the upper area of the cover firmly. After closing the cover, check that the error is cleared.

## Removing Jammed Paper from the Bypass Tray

If "Misfeed: BypassTray" appears on the display, follow the procedure below to remove it.

- If paper is jammed in the bypass tray input area, remove the jammed paper carefully.

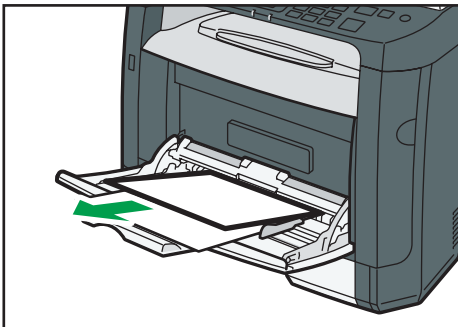

DSG179

- Close the bypass tray.

3. Push the side button to open the front cover, and then carefully lower it.

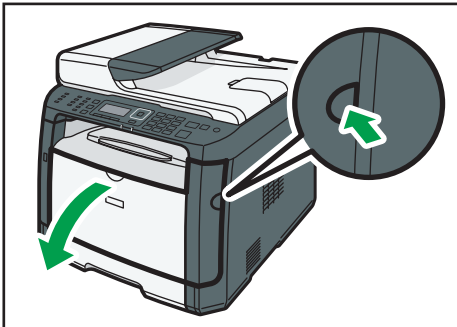

DSG168

4. Hold the center of the print cartridge and carefully raise it slightly and then pull it out horizontally.

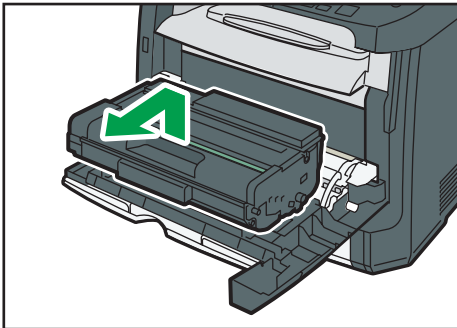

DSG169

- Do not shake the removed print cartridge. Doing so can cause remaining toner to leak.
- Place the print cartridge on paper or similar material to avoid dirtying your workspace.

5. Lifting the guide plate, remove the jammed paper carefully.

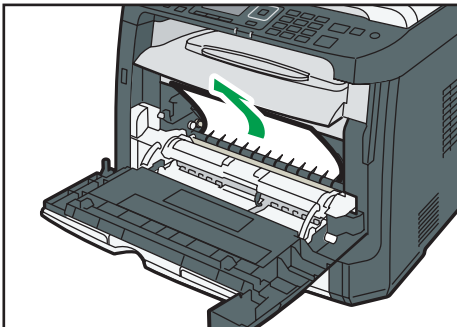

DSG178

- Slide the print cartridge in horizontally. When the cartridge can go no further, raise it slightly and push it fully in. Then push down on the cartridge until it clicks into place.

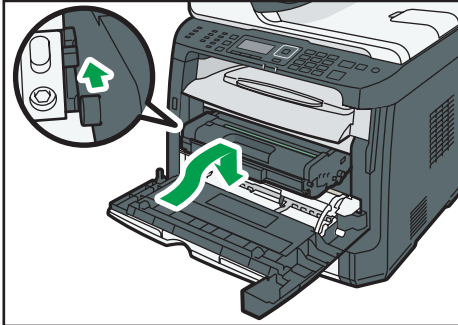

DSG171

- Using both hands, carefully push up the front cover until it closes.

**Note**

- When closing the front cover, push the upper area of the cover firmly. After closing the cover, check that the error is cleared.

## Removing Jammed Paper from the Standard Tray or Duplex Unit

If "Misfeed: Stnd. Tray" or "Misfeed: Dup. Unit Remove Paper" appears on the display, follow the procedure below to remove it.

- Open the rear cover.

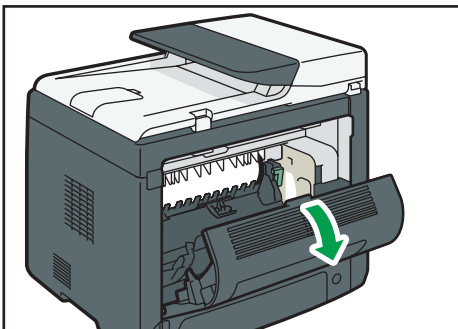

DSG188

**2. Hold down the B lever.**

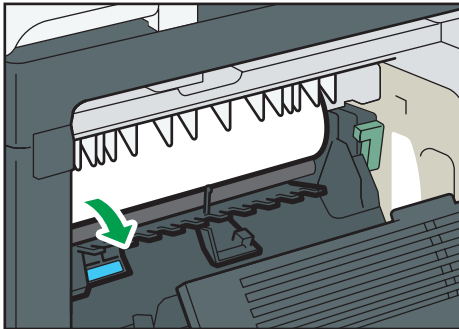

DSG181

**3. Remove the jammed paper carefully.**

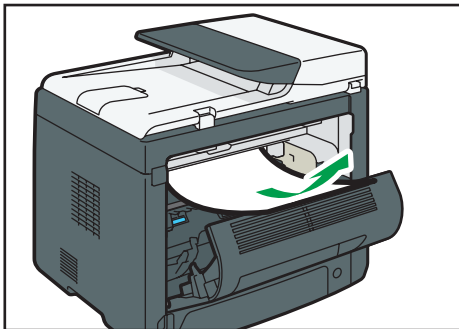

DSG190

**4. Close the rear cover.**

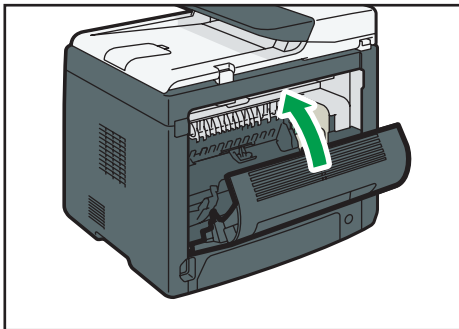

DSG182



5. Pull tray 1 halfway out, and check for jammed paper. If there is jammed paper, remove it carefully.

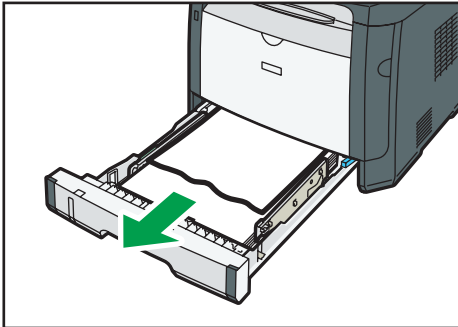

DSG176

6. Pull tray 1 out completely with both hands.

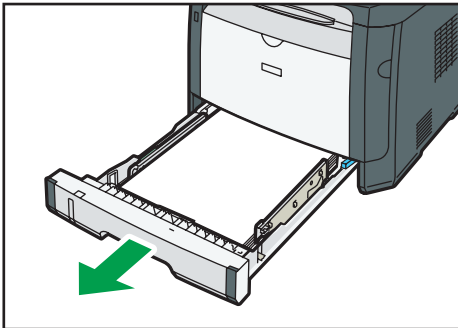

DSG232

Place the tray on a flat surface.

7. Push the lever.

Pushing the lever lowers the duplex transport unit.



DSG183

8. If there is jammed paper, carefully remove it.

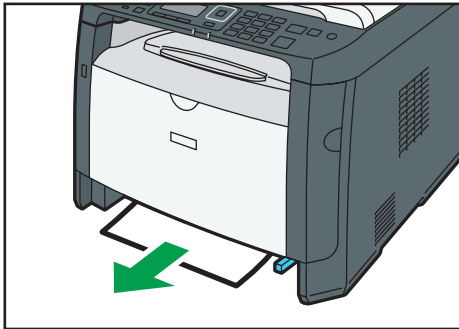

DSG184

9. With the duplex transport unit still lowered, carefully slide tray 1 back in until it stops.

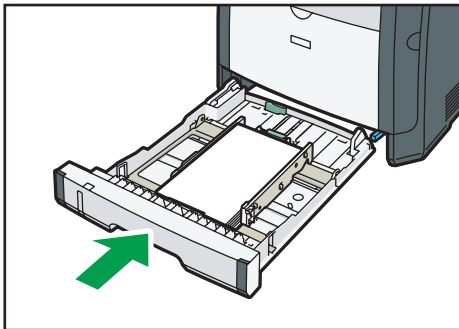

DSG174

10. If paper is loaded in the bypass tray, remove the paper and close the bypass tray.

11. Push the side button to open the front cover, and then carefully lower it.

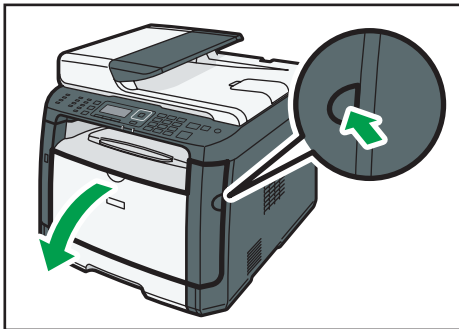

DSG168

12. Hold the center of the print cartridge and carefully raise it slightly and then pull it out horizontally.

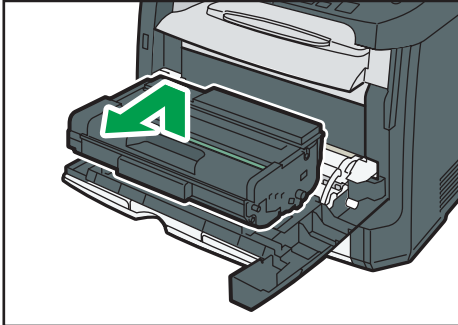

DSG169

- Do not shake the removed print cartridge. Doing so can cause remaining toner to leak.
- Place the print cartridge on paper or similar material to avoid dirtying your workspace.

13. Lifting the guide plate, remove the jammed paper carefully.

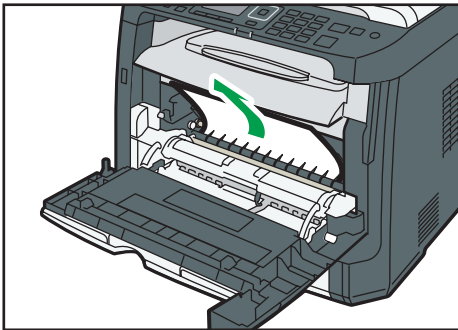

DSG178

14. Slide the print cartridge in horizontally. When the cartridge can go no further, raise it slightly and push it fully in. Then push down on the cartridge until it clicks into place.

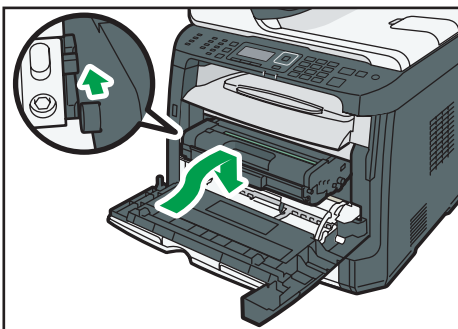

DSG171

15. Using both hands, carefully push up the front cover until it closes.

**Note**

- When closing the covers, push the covers firmly. After closing the covers, check that the error is cleared.

## Removing Jammed Paper from the Auto Document Feeder

When the following message appears on the screen, follow the procedure below to remove the original jammed in the ADF:

- "ADF Orig. Misfeed Open ADF Cover and remove paper."

### 1. Open the ADF cover.

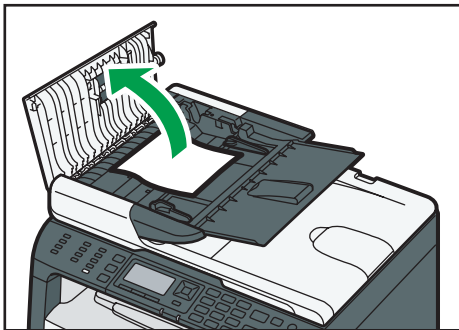

DSG185

### 2. Gently pull the jammed original to remove it. Be careful not to pull the original too hard, as it may rip.

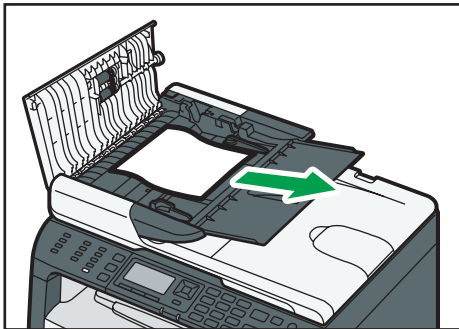

DSG186

### 3. Close the ADF cover.

### 4. Lift the ADF, and if there is original remaining in the ADF, gently pull the jammed original to remove it.

Be careful not to hold the input tray when lifting the ADF, for the tray might be damaged.

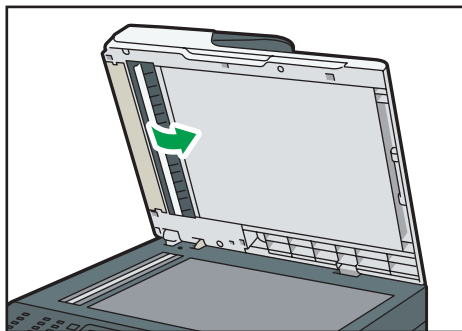

DSG187

5. Lower the ADF.

## When You Cannot Print Test Page

Possible cause	Solution
The power cord, a USB cable, or a network cable is not connected correctly.	Make sure that the power cord, USB cable, and network cable are connected correctly. Also confirm that they are not damaged.
The port connection is not established correctly.	<ol style="list-style-type: none"><li>1. On the [Start] menu, click [Devices and Printers].</li><li>2. Right-click the icon of the machine, and then click [Printer properties].</li><li>3. Click the [Ports] tab, and then make sure that the port is set as a USB or network printer.</li></ol>

## Paper Feed Problems

If the machine is operating but paper will not feed or paper jams occur frequently, check the condition of the machine and paper.

Problem	Solution
Paper does not feed smoothly.	<ul style="list-style-type: none"> <li>• Use supported types of paper. See page 53 "Supported Paper".</li> <li>• Load paper correctly, making sure that the paper guides are properly adjusted. See page 36 "Loading Paper".</li> <li>• If the paper is curled, straighten the paper.</li> <li>• Take out the paper from tray and fan it well. Then, reverse the top and bottom of the paper, and put it back in the tray.</li> </ul>
Paper jams occur frequently.	<ul style="list-style-type: none"> <li>• If there are gaps between the paper and the paper guides, adjust the paper guides to remove the gaps.</li> <li>• Avoid printing on both sides of paper when printing images that contain large solid areas, which consume a lot of toner.</li> <li>• Use supported types of paper. See page 53 "Supported Paper".</li> <li>• Load paper only as high as the upper limit markings on the paper guide.</li> <li>• Make sure that the friction pads and paper feed rollers are clean. See page 264 "Cleaning the Friction Pad and Paper Feed Roller".</li> </ul>

Problem	Solution
<p>Multiple sheets of paper are fed at one time.</p>	<ul style="list-style-type: none"> <li>• Fan the paper well before loading. Also make sure that the edges are even by tapping the stack on a flat surface such as a desk.</li> <li>• Make sure that the paper guides are in the right position.</li> <li>• Use supported types of paper. See page 53 "Supported Paper".</li> <li>• Load paper only as high as the upper limit markings on the paper guide.</li> <li>• Make sure that the friction pads and paper feed rollers are clean.</li> <li>• Check that paper was not added while there was still some left in the tray. Only add paper when there is none left in the tray.</li> </ul>
<p>Paper gets wrinkles.</p>	<ul style="list-style-type: none"> <li>• Paper is damp. Use paper that has been stored properly. See page 53 "Supported Paper".</li> <li>• Paper is too thin. See page 53 "Supported Paper".</li> <li>• If there are gaps between the paper and the paper guides, adjust the paper guides to remove the gaps.</li> </ul>
<p>The printed paper is curled.</p>	<ul style="list-style-type: none"> <li>• Load the paper upside down in the paper tray.</li> <li>• If the paper curl is severe, take prints from the output tray more frequently.</li> <li>• Paper is damp. Use paper that has been stored properly. See page 53 "Supported Paper".</li> </ul>
<p>Images are printed diagonally to the pages.</p> 	<p>If there are gaps between the paper and the paper guides, adjust the paper guides to remove the gaps.</p>



# Print Quality Problems

## Checking the Condition of the Machine

If there is a problem with the quality of printing, first check the condition of the machine.

Possible Cause	Solution
There is a problem with the machine's location.	Make sure that the machine is on a level surface. Place the machine where it will not be subject to vibration or shock.
Unsupported types of paper is used.	Make sure that the paper being used is supported by the machine. See page 53 "Supported Paper".
The paper type setting is incorrect.	Make sure that the paper type setting of the printer driver matches the type of paper loaded. See page 51 "Specifying Paper Type and Paper Size Using the Printer Driver".
A non-genuine print cartridge is being used.	Refilled or non-genuine print cartridge reduces print quality and can cause malfunctions. Use genuine print cartridge only.
An old print cartridge is being used.	Print cartridge should be opened before their expiration date and used within six months of being opened.
The machine is dirty.	See page 259 "Maintaining the Machine", and clean the machine as required.
Humidity level surrounding the machine may be too low.	Using the machine in a room where humidity level is too low may cause black lines of a few millimeters thick to appear on printouts with 75-millimeter spaces in between. In this case, set [Low Humidity Mode] to [On].  For details about how to configure the settings, see page 193 "System Settings".

## Checking the Printer Driver Settings

Problem	Solution
The printed image is smudged.	On the printer driver's [Paper] tab, select [Bypass Tray] in the [Input Tray:] list. In the [Paper Type:] list, select a proper paper type.

Problem	Solution
Images smudge when rubbed. (Toner is not fixed.)	On the printer driver's [Paper] tab, select a proper paper type in the [Paper Type:] list.
When printing graphics, the output and the screen are different.	To print accurately, specify the printer driver setting to print without using the graphics command. For details about specifying the printer driver setting, see the printer driver Help.
Images are cut off, or excess is printed.	Use the same size paper selected in the application. If you cannot load paper of the correct size, use the reduction function to reduce the image, and then print. For details about the reduction function, see the printer driver Help.
Photo images are coarse.	Use the application's or printer driver's settings to specify a higher resolution.  For details about the printer driver's settings, see the printer driver Help.
A solid line is printed as a dashed line or appears blurred.	Change the dithering settings on the printer driver. For details about the dithering settings, see the printer driver Help.
Fine lines are fuzzy, of inconsistent thickness, or do not appear.	Change the dithering settings on the printer driver. For details about the dithering settings, see the printer driver Help.  If the problem persists, specify the settings of the application in which the image was created to change the thickness of the lines.

# Printer Problems

This section describes printing problems and possible solutions.

## When You Cannot Print Properly

Problem	Solution
An error occurs.	<p>If an error occurs when printing, change the computer or printer driver settings.</p> <ul style="list-style-type: none"> <li>• Check the printer icon name does not exceed 32 alphanumeric characters. If it does, shorten it.</li> <li>• Check whether other applications are operating. Close any other applications, as they may be interfering with printing. If the problem is not resolved, close unneeded processes too.</li> <li>• Check that the latest printer driver is being used.</li> </ul>
A print job is canceled.	Set I/O Timeout to a larger value than the current settings.
There is a considerable delay between the print start command and actual printing.	<ul style="list-style-type: none"> <li>• Processing time depends on data volume. High volume data, such as graphics-heavy documents, take longer to be processed.</li> <li>• To speed up printing, reduce the printing resolution using the printer driver. For details, see the printer driver Help.</li> <li>• The machine is calibrating color. Wait for a while.</li> </ul>
Documents are not printed properly when using a certain application, or image data is not printed properly. Some characters are printed faintly or not printed.	Change the print quality settings.

Problem	Solution
It takes too long to complete the print job.	<ul style="list-style-type: none"> <li>• Photographs and other data intensive pages take a long time to be processed so simply wait when printing such data.</li> <li>• Changing the settings with printer driver may help to speed up printing. See the printer driver Help.</li> <li>• The data is so large or complex that it takes a long time to be processed.</li> <li>• If "Processing..." is displayed on the screen, the machine is receiving data. Wait for a while.</li> <li>• The printer is adjusting the color registration. Wait for a while.</li> </ul>
A printed image is different from the image on the computer's display.	<ul style="list-style-type: none"> <li>• When you use some functions, such as enlargement and reduction, the layout of the image might be different from that displayed in the computer display.</li> <li>• Check that the page layout settings are properly configured in the application.</li> <li>• Make sure the paper size selected in the printer properties dialog box matches the size of the paper loaded. For details, see the printer driver Help.</li> </ul>
Images are cut off, or excess pages are printed.	<p>If you are using paper whose size is smaller than the paper size selected in the application, use the same size paper selected in the application. If you cannot load paper of the correct size, use the reduction function to reduce the image, and then print.</p> <p>See the printer driver Help.</p>

## When You Cannot Print Clearly

Problem	Solution
The whole printout is blurred.	<ul style="list-style-type: none"> <li>• The paper being used may be damp. Use paper that has been stored properly. See page 53 "Supported Paper".</li> <li>• If you enable [Toner Saving] under [System Settings], printing is generally less dense.</li> <li>• The print cartridge is almost empty. If "Replacement Required: Print Cartridge" appears on the screen, replace the indicated print cartridge.</li> <li>• Condensation may have occurred. If rapid change in temperature or humidity occurs, use this machine only after it has acclimatized.</li> </ul>
Toner smears appear on the print side of the page.	<ul style="list-style-type: none"> <li>• The paper setting may not be correct. For example, although you are using thick paper, the setting for thick paper may not be specified. Check the printer driver's paper settings. See the printer driver Help.</li> <li>• Check that the paper is not curled or bent. Envelopes can be curled easily. Flatten out the paper before loading it. See page 36 "Loading Paper".</li> </ul>
Horizontal lines appear on the printed paper.	<ul style="list-style-type: none"> <li>• Impact can cause lines to appear on printed paper and other malfunctions. Protect the printer from impact at all times, especially while it is printing.</li> <li>• If lines appear on prints, turn the printer off, wait a few moments, and then turn it back on again. Then, perform the print job again.</li> </ul>
Photo images are coarse.	Some applications lower the resolution for making prints.
The backs of printed sheets are blemished.	<ul style="list-style-type: none"> <li>• When removing a jammed sheet, the inside of the printer may have become dirty. Print several sheets until they come out clean.</li> <li>• If document size is larger than paper size, e.g. A4 document on B5 paper, the back of the next printed sheet may become dirty.</li> </ul>

Problem	Solution
Fine dot patterns do not print.	Change the [Dithering] setting in the printer driver's dialog box. See the printer driver Help.
If rubbed with your finger, the print smears.	The setting of the paper may not be correct. For example, although thick paper is used, the setting for thick paper may not be specified. <ul style="list-style-type: none"> <li>• Check the paper settings of this printer. See page 35 "Paper Specifications and Adding Paper".</li> <li>• Check the paper settings of the printer driver. See the printer driver Help.</li> </ul>

### When Paper is Not Fed or Ejected Properly

Problem	Solution
Prints do not stack properly.	The paper being used may be damp. Use paper that has been stored properly. See page 53 "Supported Paper".
The printed paper is curled.	If you enable [Toner Saving] under [System Settings], printing is generally less dense.
Printed envelopes come out creased.	Check if the fusing unit levers are properly set. Lower the fusing unit levers.
Prints fall in front of the machine when they are output.	Raise the stop fence. See Setup Guide.
Prints do not stack properly.	<ul style="list-style-type: none"> <li>• Paper is damp. Use paper that has been stored properly. See page 53 "Supported Paper".</li> <li>• Raise the stop fence. See Setup Guide.</li> </ul>

# Copier Problems

## When You Cannot Make Clear Copies

Problem	Solution
The printed copy is blank.	The original is not placed correctly. When using the exposure glass, place originals copy side down. When using the ADF, place them copy side up. See page 65 "Placing Originals".
The wrong original was copied.	If copying from the exposure glass, make sure that there are no originals in the ADF.
Copied pages do not look the same as the originals.	Select the correct scan mode according to the type of original. See page 91 "Specifying Scan Settings for Copying".
Black spots appear when photocopying a photographic print.	The original may have stuck to the exposure glass due to high humidity. Place the original on the exposure glass, and then place two or three sheets of white paper on top of it. Leave the ADF open when copying.
A moire pattern is produced. 	The original probably has heavily lined or dotted areas. Switching the setting for image quality between [Photo] and [Mixed] may eliminate the moire pattern. See page 176 "Copier Features Settings".
The printed copy is dirty.	<ul style="list-style-type: none"> <li>Image density is too high.</li> <li>Adjust the image density. See page 91 "Specifying Scan Settings for Copying".</li> <li>Toner on the printed surface is not dry.</li> <li>Do not touch printed surfaces immediately after copying. Remove freshly printed sheets one by one, taking care not to touch printed areas.</li> <li>The exposure glass or ADF is dirty. See page 259 "Maintaining the Machine".</li> <li>Before placing originals on the exposure glass, make sure that toner or correction fluid is dry.</li> </ul>

---

Problem	Solution
When copying from the exposure glass, the print area of the copy is out of alignment with the original.	Place the original copy side down, making sure that it is aligned to the rear left corner and pressed flat against the exposure glass.

---

### When You Cannot Make Copies as Wanted

---

Problem	Solution
Photocopied pages are not in correct order.	On the control panel, change the [Sort] setting under [Copier Features] to collate pages as you require. For details about [Sort], see page 176 "Copier Features Settings".
Copied pages are too dark or too light.	Adjust the image density. See page 91 "Specifying Scan Settings for Copying".



# Scanner Problems

## When You Cannot Browse the Network to Send a Scan File

Problem	Solution
<p>The following machine settings may not be correct:</p> <ul style="list-style-type: none"> <li>• IP address</li> <li>• Subnet Mask</li> </ul>	<p>Check the settings. See page 215 "Network Settings".</p>

## When Scanning Is Not Done As Expected

Problem	Solution
<p>The machine does not start scanning.</p>	<p>The ADF or its cover is open. Close the ADF or its cover.</p>
<p>The scanned image is dirty.</p>	<ul style="list-style-type: none"> <li>• The exposure glass or ADF is dirty. See page 259 "Maintaining the Machine".</li> <li>• Before placing originals on the exposure glass, make sure that toner or correction fluid is dry.</li> </ul>
<p>The scanned image is distorted or out of position.</p>	<p>The original was moved during scanning. Do not move the original during scanning.</p>
<p>The scanned image is upside down.</p>	<p>The original was placed upside down. Place the original in the correct orientation. See page 65 "Placing Originals".</p>
<p>The scanned image is blank.</p>	<p>The original was placed with the front and back reversed. When using the exposure glass, place originals copy side down. When using the ADF, place originals copy side up. See page 65 "Placing Originals".</p>
<p>The scanned image is too dark or too light.</p>	<p>Adjust the image density. See page 132 "Specifying Scan Settings for Scanning".</p>

## Fax Problems

### When an error code appears on the fax journal or transmission status report

The table below describes the meaning of error codes that appear under "Results" on the fax journal or transmission status report, and what to do when a particular error code appears.

"X" indicates a number in an error code that appear differently depending on a specific situation.

Error Code	Solution
1XXX11	<p>An original has been jammed inside the ADF while sending a fax in Immediate Transmission mode.</p> <ul style="list-style-type: none"> <li>Remove jammed originals, and then place them again. See page 281 "Clearing Misfeeds".</li> <li>Check the originals are suitable for scanning. See page 65 "Placing Originals".</li> </ul>
1XXX21	<p>The line could not be connected correctly.</p> <ul style="list-style-type: none"> <li>Confirm that the telephone line is properly connected to the machine.</li> <li>Disconnect the telephone line from the machine, and connect a standard telephone in its place. Confirm that you can make calls using the telephone. If you cannot make calls this way, contact your telephone company.</li> <li>If the problem persists, contact your sales or service representative.</li> </ul>
1XXX22 to 1XXX23	<p>Dial fails when trying to send faxes.</p> <ul style="list-style-type: none"> <li>Confirm that the fax number you dialed is correct.</li> <li>Confirm that the destination is a fax machine.</li> <li>Confirm that the line is not busy.</li> <li>You may need to insert a pause between dial digits. Press the [Pause/Redial] key after, for example, the area code.</li> <li>Confirm that [PSTN / PBX] under [Admin. Tools] is set properly for your connection method to the telephone network. See page 206 "Administrator Settings".</li> </ul>

Error Code	Solution
1XXX32 to 1XXX84	<p>An error occurred while sending a fax.</p> <ul style="list-style-type: none"> <li>• Confirm that the telephone line is properly connected to the machine.</li> <li>• Disconnect the telephone line from the machine, and connect a standard telephone in its place. Confirm that you can make calls using the telephone. If you cannot make calls this way, contact your telephone company.</li> <li>• If the problem persists, contact your sales or service representative.</li> </ul>
2XXX14	<p>The machine was not able to print the received fax, or the machine's memory reached capacity while receiving a fax because the document was too large.</p> <ul style="list-style-type: none"> <li>• The paper tray was empty. Load paper in the paper tray. See page 36 "Loading Paper".</li> <li>• The paper tray did not contain A4, Letter, or Legal size paper. Load valid size paper in the tray, and configure the paper size settings under [Tray Paper Settings] accordingly.</li> <li>• A cover or tray was open. Close the cover or tray.</li> <li>• There was a paper jam. Remove the jammed paper. See page 281 "Clearing Misfeeds".</li> <li>• A print cartridge was empty. Replace the print cartridge. See page 259 "Replacing the Print Cartridge".</li> <li>• The received fax was too large. Ask the sender to re-send the document in parts as several smaller individual faxes, or to send at a lower resolution.</li> </ul>
2XXX32 to 2XXX84	<p>An error occurred while receiving a fax.</p> <ul style="list-style-type: none"> <li>• Confirm that the telephone line is properly connected to the machine.</li> <li>• Disconnect the telephone line from the machine, and connect a standard telephone in its place. Confirm that you can make calls using the telephone. If you cannot make calls this way, contact your telephone company.</li> <li>• If the problem persists, contact your sales or service representative.</li> </ul>

## When other problems occur

The table below describes how to troubleshoot problems that do not produce an error code.

Problem	Solution
Cannot send faxes.	<ul style="list-style-type: none"> <li>• See the solutions provided for errors 1XXX32 to 1XXX84 in the above table.</li> <li>• The machine cannot accept a new fax job because there are 5 unsent faxes in memory already. Wait until any of those faxes is transmitted completely, or use the [Delete Standby File] function to delete unnecessary faxes. For details, see page 184 "Fax Features Settings".</li> </ul>
Cannot receive faxes.	See the solutions provided for errors 2XXX32 to 2XXX84 in the above table.
Cannot receive faxes even when sending them is possible.	<ul style="list-style-type: none"> <li>• A print cartridge is empty. Replace the print cartridge. See page 259 "Replacing the Print Cartridge".</li> <li>• The paper tray is empty. Load paper in the paper tray. See page 36 "Loading Paper".</li> <li>• If fax reception mode is FAX/TEL Manual mode, you must receive the fax manually. See page 164 "Receiving a Fax".</li> </ul>
Cannot print received faxes.	<ul style="list-style-type: none"> <li>• The paper tray is empty. Load paper in the paper tray. See page 36 "Loading Paper".</li> <li>• The paper tray does not contain paper of the right size. Load paper of the right size in the paper tray.</li> </ul>
Faxes you sent appear spotty or dirty when received.	<ul style="list-style-type: none"> <li>• The exposure glass or ADF is dirty. See page 259 "Maintaining the Machine".</li> <li>• Before placing originals on the exposure glass, make sure that ink or correction fluid is dry.</li> </ul>
A fax you sent appears blank when received.	The original was placed upside down. Place the original in the correct orientation. See page 65 "Placing Originals".
The background of received images is dirty, or images from the rear side of the originals are visible.	Image density is too high. Adjust the image density.
Dial fails when trying to send faxes.	See the solutions provided for errors 1XXX22 to 1XXX23 in the above table.

## Common Problems

This section describes how to troubleshoot common problems that may occur while operating the machine.

Problem	Possible cause	Solution
The machine does not turn on.	The power cord is not connected properly.	<ul style="list-style-type: none"> <li>Make sure that the power plug is firmly inserted into the wall outlet.</li> <li>Make sure that the wall outlet is not defective by connecting another working device.</li> </ul>
An error message is shown on the machine's screen.	An error has occurred.	See page 271 "Error and Status Messages on the Screen".
Pages do not print.	The machine is warming up or receiving data.	Wait until "Printing..." appears on the screen. If "Processing..." is displayed on the screen, the machine is receiving data.
Pages are not printed.	The interface cable is not connected correctly.	<ul style="list-style-type: none"> <li>Reconnect the cable.</li> <li>Check that the interface cable is the correct type.</li> </ul>
Strange noise is heard.	The supplies are not properly installed.	Confirm that the supplies are properly installed.
The volume of the sounds produced by the machine is too loud.	The volume is set to the high level.	Adjust the volume of the beep, ring, speaker, and alarm sounds. For details, see page 193 "System Settings".
The volume of the sounds produced by the machine is too quiet.	The volume is muted or set to the low level.	Adjust the volume of the beep, ring, speaker, and alarm sounds. For details, see page 193 "System Settings".
The network setting may not have been configured properly or the 3G dongle may not be connected properly.	Using Web Image Monitor, check the setting and check whether printing can be performed.	If the problem persists, contact your service representative.

 **Note**

- If any of these problems persist, turn off the power, pull out the power cord, and contact your sales or service representative.

# 11. Configuring Network Settings Using OS X

---

This chapter describes how to connect the machine to the network and specify the network settings using OS X.

Configurations differ according to the communication environment of your system.

## Connecting the Machine to a Wired Network

The following procedure is explained using OS X 10.11 as an example.

---

### Using a USB Cable

---

1. Turn on your computer.
2. Insert the provided CD-ROM into the CD-ROM drive of the computer.  
If your computer does not have a CD-ROM drive, download a setup file from our website (<http://www.ricoh.com/printers/sp310/support/gateway/>).
3. Double-click the CD-ROM drive icon.
4. Double-click the [Mac OS X] folder.
5. Double-click the folder of driver you want to install.
6. Follow the instructions in the setup wizard.
7. Click [Close] in the [Summary] dialog box.
8. Start System Preferences.
9. Click [Printers & Scanners].

Check that the machine automatically recognized by plug-and-play appears in the printers list.

10. Click the [+] button.  
If [Add Printer or Scanner...] appears, click it.
11. Click [Default].
12. Select the printer that has "USB" indicated in the [Kind] column.
13. Select the printer you are using from the [Use:] pop-up menu.
14. Click [Add].
15. Click [Duplexer] on the [Setting up] screen, and then click [OK].
16. Quit System Preferences.

Setup is completed.

**Note**

- If you want to install Smart Organizing Monitor, see page 312 "Installing Smart Organizing Monitor".

---

## Using an Ethernet Cable

---

1. Turn on your computer.
2. Insert the provided CD-ROM into the CD-ROM drive of the computer.  
If your computer does not have a CD-ROM drive, download a setup file from our website (<http://www.ricoh.com/printers/sp310/support/gateway/>).
3. Double-click the CD-ROM drive icon.
4. Double-click the [Mac OS X] folder.
5. Double-click the folder of driver you want to install.
6. Follow the instructions in the setup wizard.
7. Click [Close] in the [Summary] dialog box.
8. Start System Preferences.
9. Click [Printers & Scanners].
10. Click the [+] button.  
If [Add Printer or Scanner...] appears, click it.
11. Click [Default].
12. Select the printer that has "Bonjour" indicated in the [Kind] column.  
If the printer name is not displayed, select the icon that corresponds to your network environment (TCP/IP, etc.).
13. Select the printer you are using from the [Use:] pop-up menu.
14. Click [Add].
15. Click [Duplexer] on the [Setting up] screen, and then click [OK].
16. Quit System Preferences.
17. On the [Application] menu, double-click [Smart Organizing Monitor].  
For details about how to install Smart Organizing Monitor, see page 312 "Installing Smart Organizing Monitor".
18. Click [User Tools] tab.
19. Click [Printer Configuration].
20. Enter the access code, and then click [OK].  
The default access code is "Admin".



21. On the [Network 1] tab, select [On] for [DHCP] to automatically obtain the IP address or [Off] to specify the IP address manually.

If you have selected [On], proceed to Step 25.

22. Enter the machine's IPv4 address in [IP Address].
23. Enter the subnet mask in [Subnet Mask].
24. Enter the gateway address in [Default Gateway Address].
25. Click [OK].
26. Wait until the machine restarts.

Setup is completed.

## Connecting the Machine to a Wireless Network

You can use this function on SP 325SNw and SP 325SFNw only.

There are four methods for connecting the machine to a wireless network:

- Using the Wi-Fi Setup Wizard  
See page 313 "Using the Wi-Fi Setup Wizard".
- Using the WPS button  
See page 314 "Using the WPS Button".
- Using a PIN code  
See page 316 "Using a PIN Code".

---

### Installing the Printer Driver

---

The following procedure is explained using OS X 10.11 as an example.

1. **Turn on your computer.**
2. **Insert the provided CD-ROM into the CD-ROM drive of the computer.**  
If your computer does not have a CD-ROM drive, download a setup file from our website (<http://www.ricoh.com/printers/sp310/support/gateway/>).
3. **Double-click the CD-ROM drive icon.**
4. **Double-click the [Mac OS X] folder.**
5. **Double-click the folder of driver you want to install.**
6. **Follow the instructions in the setup wizard.**
7. **Click [Close] in the [Summary] dialog box.**

---

### Installing Smart Organizing Monitor

---

The following procedure is explained using OS X 10.11 as an example.

1. **Turn on your computer.**
2. **Insert the provided CD-ROM into the CD-ROM drive of the computer.**  
If your computer does not have a CD-ROM drive, download a setup file from our website (<http://www.ricoh.com/printers/sp310/support/gateway/>).
3. **Double-click the CD-ROM drive icon.**
4. **Double-click the [Mac OS X] folder.**
5. **Double-click the [Utility] folder.**

6. Double-click the package file icon.
7. Follow the instructions in the setup wizard.
8. If the [Printer Driver Selection] dialog box appears, do one of the following:
  - Select the machine's model.
  - Enter the IP address of the machine manually.
  - Click [Search Network Printer] to search the machine via the network.
9. Click [OK].
10. Click [Close] in the [Summary] dialog box.

## Using the Wi-Fi Setup Wizard

A router (access point) is needed to set up a connection.

### Checking the SSID and encryption key

The SSID and Encryption key for the router (access point) may be printed on a label affixed to the router (access point). For details about the SSID and Encryption key, refer to the router (access point) manual.

### Configuring settings using the control panel

Before doing the following procedure, install the printer driver according to the procedure on page 312 "Installing the Printer Driver".

Make sure the Ethernet cable is not connected to the machine.

1. Check that the router (access point) is working correctly.
2. Press the [User Tools] key.

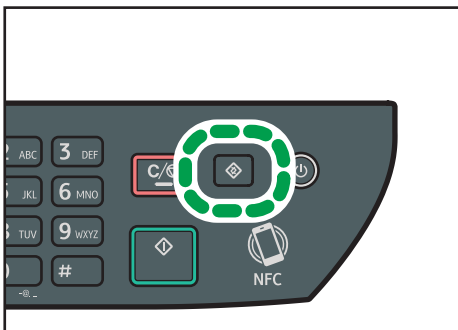

DSG126

3. Press the [▼] or [▲] key to select [Network Settings], and then press the [OK] key.

4. If you are requested to enter a password, enter the password using the number keys, and then press the [OK] key.

A password for accessing the [Network Settings] menu can be specified in [Admin. Tools Lock] under [Admin. Tools] menu.

5. Press the [▼] or [▲] key to select [Wi-Fi], and then press the [OK] key.
6. Select [Wi-Fi Enable], and then press the [OK] key.
7. Press the [▼] or [▲] key to select [Enable], and then press the [OK] key.
8. Press the [User Tools] key to return to the Initial screen.
9. Wait until the machine restarts.
10. Press the [User Tools] key.
11. Press the [▼] or [▲] key to select [Wi-Fi Setup Wizard], and then press the [OK] key.
12. If you are requested to enter a password, enter the password using the number keys, and then press the [OK] key.  
A password for accessing the [Wi-Fi Setup Wizard] menu can be specified in [Admin. Tools Lock] under [Admin. Tools] menu.
13. Press the [▼] or [▲] key to select SSID of the router (access point) from the searched SSID list, and then press the [OK] key.
14. Enter the encryption key using the number keys, and then press the [OK] key.  
As the passphrase, you can enter either 8 to 63 ASCII characters (0x20-0x7e) or 64 hexadecimal digits (0-9, A-F, a-f).
15. Press the [OK] key.
16. Check the result.

- Connection has succeeded:  
Configuring the Wi-Fi settings is complete.
- Connection has failed:  
Check the configuration for the router (access point), and then try the connection again.

---

## Using the WPS Button

---

A router (access point) is needed to set up a connection.

Before doing the following procedure, install the printer driver according to the procedure on page 312 "Installing the Printer Driver".

Make sure the Ethernet cable is not connected to the machine.

1. Check that the router (access point) is working correctly.

2. Press the [User Tools] key.

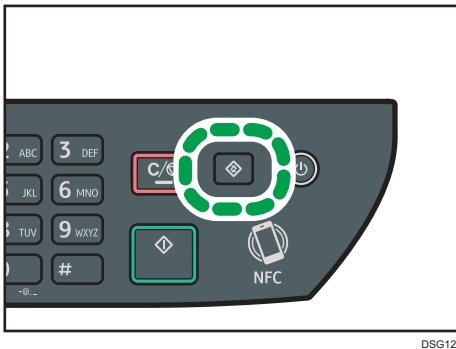

DSG126

3. Press the [▼] or [▲] key to select [Network Settings], and then press the [OK] key.

4. If you are requested to enter a password, enter the password using the number keys, and then press the [OK] key.

A password for accessing the [Network Settings] menu can be specified in [Admin. Tools Lock] under [Admin. Tools] menu.

5. Press the [▼] or [▲] key to select [Wi-Fi], and then press the [OK] key.

6. Select [Wi-Fi Enable], and then press the [OK] key.

7. Press the [▼] or [▲] key to select [Enable], and then press the [OK] key.

8. Press the [User Tools] key to return to the Initial screen.

9. Wait until the machine restarts.

10. Press the [User Tools] key.

11. Press the [▼] or [▲] key to select [Network Settings], and then press the [OK] key.

12. If you are requested to enter a password, enter the password using the number keys, and then press the [OK] key.

A password for accessing the [Network Settings] menu can be specified in [Admin. Tools Lock] under [Admin. Tools] menu.

13. Press the [▼] or [▲] key to select [Wi-Fi], and then press the [OK] key.

14. Press the [▼] or [▲] key to select [WPS], and then press the [OK] key.

15. Press the [▼] or [▲] key to select [PBC], and then press the [OK] key.

16. Press [Yes].

"Please push the [AP] within 2 minutes" appears, and the machine starts to connect in PBC method.

17. Press the WPS button on the router (access point) within two minutes.

For details about how to use the WPS button, refer to the manuals for the router (access point).

18. Check the result.

- Connection has succeeded:

Press [EXIT] to return to the screen displayed in Step 15, and then press the [User Tools] key to return to the initial screen.

Configuring the Wi-Fi settings is complete.

- Connection has failed:

Press [EXIT] to return to the screen displayed in Step 15. Check the configuration for the router (access point), then try the connection again.

## Using a PIN Code

A router (access point) is needed to set up a connection. To establish a connection using the PIN code, use a computer that is connected to the router (access point).

Before doing the following procedure, install the printer driver according to the procedure on page 312 "Installing the Printer Driver".

Make sure the Ethernet cable is not connected to the machine.

1. Check that the router (access point) is working correctly.
2. Open the PIN code configuration window (web page) for the router (access point) on your computer.
3. Press the [User Tools] key.

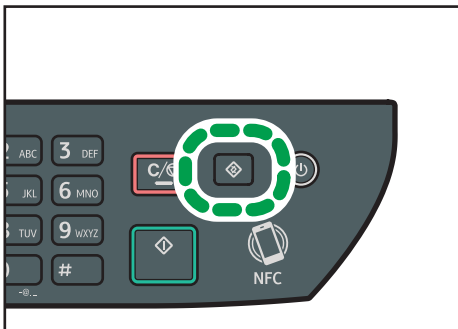

DSG126

4. Press the [▼] or [▲] key to select [Network Settings], and then press the [OK] key.
5. If you are requested to enter a password, enter the password using the number keys, and then press the [OK] key.

A password for accessing the [Network Settings] menu can be specified in [Admin. Tools Lock] under [Admin. Tools] menu.

6. Press the [▼] or [▲] key to select [Wi-Fi], and then press the [OK] key.
7. Select [Wi-Fi Enable], and then press the [OK] key.
8. Press the [▼] or [▲] key to select [Enable], and then press the [OK] key.
9. Press the [User Tools] key to return to the Initial screen.

10. Wait until the machine restarts.
11. Press the [User Tools] key.
12. Press the [▼] or [▲] key to select [Network Settings], and then press the [OK] key.
13. If you are requested to enter a password, enter the password using the number keys, and then press the [OK] key.

A password for accessing the [Network Settings] menu can be specified in [Admin. Tools Lock] under [Admin. Tools] menu.

14. Press the [▼] or [▲] key to select [Wi-Fi], and then press the [OK] key.
15. Press the [▼] or [▲] key to select [WPS], and then press the [OK] key.
16. Press the [▼] or [▲] key to select [PIN], and then press the [OK] key.
17. Check the PIN code.

Write down the PIN code in case you might forget it.

18. Enter the machine's PIN code (8 digits) on the router (access point)'s web page.(The web page accessed in Step 2)
19. Execute WPS (PIN system) from the router (access point)'s web page.
20. Press [Connect].

"Please wait for 2 minutes" and connecting with PIN method starts.

**21. Check the result.**

- Connection has succeeded:

Press [EXIT] to return to the screen displayed in Step 16, and then press the [User Tools] key to return to the initial screen.

Configuring the Wi-Fi settings is complete.

- Connection has failed:

Press [EXIT] to return to the screen displayed in Step 16. Check the configuration for the router (access point), then try the connection again.





# 12. Appendix

This chapter describes the machine specifications and consumables.

## Transmission Using IPsec

For securer communications, this machine supports the IPsec protocol. When applied, IPsec encrypts data packets at the network layer using shared key encryption. The machine uses encryption key exchange to create a shared key for both sender and receiver. To achieve even higher security, you can also renew the shared key on a validity period basis.

### ★ Important

- IPsec is not applied to data obtained through DHCP, DNS, or WINS.
- IPsec compatible operating systems are Windows 7 or later, Windows Server 2003 or later, OS X 10.7 or later, Red Hat Enterprise Linux 6 or later. However, some setting items are not supported depending on the operating system. Make sure the IPsec settings you specify are consistent with the operating system's IPsec settings.
- If you cannot access Web Image Monitor due to IPsec configuration problems, disable IPsec under [Admin. Tools] on the control panel, and then access Web Image Monitor.
- For details about specifying the IPsec settings using Web Image Monitor, see page 245 "Configuring the IPsec Settings".
- For details about enabling and disabling IPsec using the control panel, see page 206 "Administrator Settings".

## Encryption and Authentication by IPsec

IPsec consists of two main functions: the encryption function, which ensures the confidentiality of data, and the authentication function, which verifies the sender of the data and the data's integrity. This machine's IPsec function supports two security protocols: the ESP protocol, which enables both of the IPsec functions at the same time, and the AH protocol, which enables only the authentication function.

### ESP Protocol

The ESP protocol provides secure transmission through both encryption and authentication. This protocol does not provide header authentication.

- For successful encryption, both the sender and receiver must specify the same encryption algorithm and encryption key. The encryption algorithm and encryption key are specified automatically.
- For successful authentication, the sender and receiver must specify the same authentication algorithm and authentication key. The authentication algorithm and authentication key are specified automatically.

### AH Protocol

The AH protocol provides secure transmission through authentication of packets only, including headers.

- For successful authentication, the sender and receiver must specify the same authentication algorithm and authentication key. The authentication algorithm and authentication key are specified automatically.

### AH Protocol + ESP Protocol

When combined, the ESP and AH protocols provide secure transmission through both encryption and authentication. These protocols provide header authentication.

- For successful encryption, both the sender and receiver must specify the same encryption algorithm and encryption key. The encryption algorithm and encryption key are specified automatically.
- For successful authentication, the sender and receiver must specify the same authentication algorithm and authentication key. The authentication algorithm and authentication key are specified automatically.

#### Note

- Some operating systems use the term "Compliance" in place of "Authentication".

---

## Security Association

---

This machine uses encryption key exchange as the key setting method. With this method, agreements such as the IPsec algorithm and key must be specified for both sender and receiver. Such agreements form what is known as an SA (Security Association). IPsec communication is possible only if the receiver's and sender's SA settings are identical.

The SA settings are auto configured on both parties' machines. However, before the IPsec SA can be established, the ISAKMP SA (Phase 1) settings must be auto configured. When this is done, the IPsec SA (Phase 2) settings, which allow actual IPsec transmission, will be auto configured.

Also, for further security, the SA can be periodically auto updated by applying a validity period (time limit) for its settings. This machine only supports IKEv1 for encryption key exchange.

Multiple settings can be configured in the SA.

### Settings 1-10

You can configure ten separate sets of SA details (such as different shared keys and IPsec algorithms).

IPsec policies are searched through one by one, starting at [No.1].

## Encryption Key Exchange Settings Configuration Flow

This section explains the procedure for specifying encryption key exchange settings.

Machine	PC
1. Set the IPsec settings on Web Image Monitor.	1. Set the same IPsec settings as the machine on PC.
2. Enable IPsec settings.	2. Enable IPsec settings.
3. Confirm IPsec transmission.	

### Note

- After configuring IPsec, you can use "ping" command to check if the connection is established correctly. Because the response is slow during initial key exchange, it may take some time to confirm that transmission has been established.
- If you cannot access Web Image Monitor due to IPsec configuration problems, disable IPsec under [Admin. Tools] on the control panel, and then access Web Image Monitor.
- For details about disabling IPsec using the control panel, see page 206 "Administrator Settings".

## Specifying Encryption Key Exchange Settings

### Important

- This function is available only when an administrator password is specified.
1. Start the web browser and access the machine by entering its IP address.
  2. Click [IPsec Settings].
  3. Click the [IPsec Policy List] tab.
  4. Select the number of the setting you want to modify in the list, and then click [Change].
  5. Modify the IPsec related settings as necessary.
  6. Enter the administrator password, and then click [Apply].
  7. Click the [IPsec Global Settings] tab, and then select [Active] in [IPsec Function].
  8. If necessary, specify [Default Policy], [Broadcast and Multicast Bypass], and [All ICMP Bypass] also.
  9. Enter the administrator password, and then click [Apply].

### Note

- An administrator password can be specified in the [Administrator] tab.

---

## Specifying IPsec Settings on the Computer

---

Specify exactly the same settings for IPsec SA settings on your computer as are specified for the IPsec Settings on the machine. Setting methods differ according to the computer's operating system. The following procedure is based on Windows 7 in an IPv4 environment as an example.

1. On the [Start] menu, click [Control Panel], [System and Security], and then click [Administrative Tools].
2. Double-click [Local Security Policy], and then click [IP Security Policies on Local Computer].
3. In the "Action" menu, click [Create IP Security Policy...].

The IP Security Policy Wizard appears.

4. Click [Next].
5. Enter a security policy name in "Name", and then click [Next].
6. Clear the "Activate the default response rule" check box, and then click [Next].
7. Select "Edit properties", and then click [Finish].
8. In the "General" tab, click [Settings...].
9. In "Authenticate and generate a new key after every", enter the same validity period (in minutes) that is specified on the machine in [IKE Life Time], and then click [Methods...].
10. Confirm that the Encryption Algorithm ("Encryption"), Hash Algorithm ("Integrity"), and IKE Diffie-Hellman Group ("Diffie-Hellman Group") settings in "Security method preference order" all match those specified on the machine in [IKE Settings].

If the settings are not displayed, click [Add...].

11. Click [OK] twice.
12. Click [Add...] in the "Rules" tab.
13. Click [Next].
14. Select "This rule does not specify a tunnel", and then click [Next].
15. Select the type of network for IPsec, and then click [Next].
16. Click [Add...] in the IP Filter List.
17. In [Name], enter an IP Filter name, and then click [Add...].

The IP Filter Wizard appears.

18. Click [Next].
19. In [Description:], enter a name or a detailed explanation of the IP filter, and then click [Next].

You may click [Next] and proceed to the next step without entering any information in this field.

20. Select "My IP Address" in "Source address", and then click [Next].
21. Select "A specific IP Address or Subnet" in "Destination address", enter the machine's IP address, and then click [Next].
22. For the IPsec protocol type, select "Any", and then click [Next].
23. Click [Finish], and then click [OK].
24. Select the IP filter that you have just created, and then click [Next].
25. Click [Add...] in the Filter Action.  
The Filter Action Wizard appears.
26. Click [Next].
27. In [Name], enter a Filter Action name, and then click [Next].
28. Select "Negotiate security", and then click [Next].
29. Select one of options for computers allowed to communicate with, and then click [Next].
30. Select "Custom" and click [Settings...].
31. When [ESP] is selected for the machine in [Security Protocol] under [IPsec Settings], select [Data integrity and encryption (ESP)], and configure the following settings:  
Set the value of [Integrity algorithm] to the same value as the [Authentication Algorithm for ESP] specified on the machine.  
Set the value of [Encryption algorithm] to the same value as the [Encryption Algorithm for ESP] specified on the machine.
32. When [AH] is selected for the machine in [Security Protocol] under [IPsec Settings], select [Data and address integrity without encryption (AH)], and configure the following settings:  
Set the value of [Integrity algorithm] to the same value as the [Authentication Algorithm for AH] specified on the machine.  
Clear the [Data integrity and encryption (ESP)] check box.
33. When [ESP&AH] is selected for the machine in [Security Protocol] under [IPsec Settings], select [Data and address integrity without encryption (AH)], and configure the following settings:  
Set the value of [Integrity algorithm] under [Data and address integrity without encryption (AH)] to the same value as [Authentication Algorithm for AH] specified on the machine.  
Set the value of [Encryption algorithm] under [Data integrity and encryption (ESP)] to the same value as [Encryption Algorithm for ESP] specified on the machine.
34. In the Session key settings, select "Generate a new key every", and enter the same validity period (in [Seconds] or [Kbytes]) as that specified for [Life Time] on the machine.
35. Click [OK], and then click [Next].

**36. Click [Finish].**

If you are using IPv6, you must repeat this procedure from Step 12 and specify ICMPv6 as an exception. When you reach Step 22, select [58] as the protocol number for the "Other" target protocol type, and then set [Negotiate security] to [Permit].

**37. Select the filter action that you have just created, and then click [Next].****38. Select one of options for an authentication method, and then click [Next].****39. Click [Finish], and then click [OK] twice.**

The new IP security policy (IPsec settings) is specified.

**40. Select the security policy that you have just created, right click on it, and then click [Assign].**

IPsec settings on the computer are enabled.

**↓ Note**

- To disable the computer's IPsec settings, select the security policy, right click, and then click [Unassign].

---

## Enabling and Disabling IPsec Using the Control Panel

---

**★ Important**

- This function is available only when an administrator password is specified.
1. Press the [User Tools] key.
  2. Press the [▲] or [▼] key to select [Admin. Tools].
  3. Enter a password using the number keys, and then press the [OK] key.
  4. Press the [▲] or [▼] key to select [IPsec], and then press the [OK] key.
  5. Press the [▲] or [▼] key to select [Active] or [Inactive], and then press the [OK] key.
  6. Press the [User Tools] key to return to the initial screen.

**↓ Note**

- A password for accessing the [Admin. Tools] menu can be specified in [Admin. Tools Lock]. For details about [Admin. Tools Lock], see page 206 "Administrator Settings".
- You can press the [Back] key to exit to the previous level of the menu tree.



## Notes About the Toner

- Proper operation cannot be guaranteed if any third-party toner is used.
- Depending on printing conditions, there are cases where the printer cannot print the number of sheets indicated in the specifications.
- Replace the print cartridge if the printed image suddenly becomes pale or blurred.
- When operating the machine for the first time, use the print cartridge supplied with this machine. If this cartridge is not initially used, the following problems may occur:
  - "Replace Required Soon:" "Print Cartridge" will be displayed before the toner runs out.
  - "Replacement Required:" "Print Cartridge" will be displayed when the toner runs out, but instead the printed image suddenly becomes pale or blurred.
- The lifetime of the photo conductor, which is built into the print cartridge, is taken into account in displaying "Replace Required Soon:" "Print Cartridge". If the photo conductor stops working before the toner runs out, "Replace Required Soon:" "Print Cartridge" may be displayed.





# Specifications of the Machine

This section lists the machine's specifications.

## General Function Specifications

Item	Description
Configuration	Desktop
Print process	Laser electrostatic transfer
Maximum paper size for scanning using the exposure glass	216 mm × 297 mm (8.5 × 11.7 inches)
Maximum paper size for scanning using the ADF (only SP 320SFN, SP 325SNw, and SP 325SFNw)	216 mm × 356 mm (8.5 × 14 inches)
Maximum paper size for printing	216 mm × 356 mm (8.5 × 14 inches)
Warm-up time (23 °C, 71.6 °F)	<ul style="list-style-type: none"> <li>SP 320SN/SP 325SNw 28 seconds</li> <li>SP 320SFN/SP 325SFNw               <ul style="list-style-type: none"> <li> <b>Region A</b> 28 seconds</li> <li> <b>Region B</b> 29 seconds</li> </ul> </li> </ul>
Paper sizes	For details, see page 53 "Supported Paper".
Paper type	For details, see page 53 "Supported Paper".
Paper output capacity (80 g/m <sup>2</sup> , 20 lb)	50 sheets
Paper input capacity (80 g/m <sup>2</sup> , 20 lb)	<ul style="list-style-type: none"> <li>Tray 1 250 sheets</li> <li>Bypass tray 50 sheets</li> </ul>



Item	Description
ADF capacity (80 g/m <sup>2</sup> , 20 lb) (only SP 320SFN, SP 325SNw, and SP 325SFNw)	35 sheets
Memory	128 MB
Power requirements	<p> <b>Region A</b></p> <p>220-240 V, 4 A, 50/60 Hz</p> <p> <b>Region B</b></p> <p>120 V, 7 A, 60 Hz</p> <p>If the voltage supplied to the machine is outside the guaranteed operating range, "SC560" appears on the screen. If this happens, turn the power off and then back on. If the message does not disappear, contact your service representative.</p>
Power consumption  <b>Region A</b>	<ul style="list-style-type: none"> <li>• Maximum <ul style="list-style-type: none"> <li>• SP 320SN/SP 325SNw: 866 W</li> <li>• SP 320SFN/SP 325SFNw: 873 W</li> </ul> </li> <li>• Ready <ul style="list-style-type: none"> <li>• SP 320SN/SP 325SNw: 71.4 W</li> <li>• SP 320SFN/SP 325SFNw: 71.2 W</li> </ul> </li> <li>• During printing <ul style="list-style-type: none"> <li>• SP 320SN/SP 325SNw: 463 W</li> <li>• SP 320SFN/SP 325SFNw: 481 W</li> </ul> </li> </ul>
Power consumption  <b>Region B</b>	<ul style="list-style-type: none"> <li>• Maximum <ul style="list-style-type: none"> <li>• SP 320SN/SP 325SNw: 757 W</li> <li>• SP 320SFN/SP 325SFNw: 757 W</li> </ul> </li> <li>• Ready <ul style="list-style-type: none"> <li>• SP 320SN/SP 325SNw: 68.6 W</li> <li>• SP 320SFN/SP 325SFNw: 68.9 W</li> </ul> </li> <li>• During printing <ul style="list-style-type: none"> <li>• SP 320SN/SP 325SNw: 498 W</li> <li>• SP 320SFN/SP 325SFNw: 470 W</li> </ul> </li> </ul>

Item	Description
Noise emission (SP 320SN)	<ul style="list-style-type: none"> <li>• Sound power level Stand-by: 27.0 dB (A) During printing: 64.8 dB (A)</li> <li>• Sound pressure level Stand-by: 18.4 dB (A) During printing: 54.5 dB (A)</li> </ul>
Noise emission (SP 325SNw)	<ul style="list-style-type: none"> <li>• Sound power level Stand-by: 27.0 dB (A) During printing: 65.0 dB (A)</li> <li>• Sound pressure level Stand-by: 18.5 dB (A) During printing: 54.1 dB (A)</li> </ul>
Noise emission (SP 320SFN)	<ul style="list-style-type: none"> <li>• Sound power level Stand-by: 27.0 dB (A) During printing: 64.7 dB (A)</li> <li>• Sound pressure level Stand-by: 18.4 dB (A) During printing: 54.8 dB (A)</li> </ul>
Noise emission (SP 325SFNw)	<ul style="list-style-type: none"> <li>• Sound power level Stand-by: 27.0 dB (A) During printing: 65.0 dB (A)</li> <li>• Sound pressure level Stand-by: 18.5 dB (A) During printing: 54.1 dB (A)</li> </ul>
Machine dimensions (Width × Depth × Height)	<ul style="list-style-type: none"> <li>• SP 320SFN 405 × 392 × 395 mm (15.9 × 15.4 × 15.5 inches)</li> <li>• SP 320SN 405 × 392 × 346 mm (15.9 × 15.4 × 13.6 inches)</li> <li>• SP 325SNw and SP 325SFNw 405 × 392 × 405 mm (15.9 × 15.4 × 15.9 inches)</li> </ul>

Item	Description
Weight (machine body with consumables)	<ul style="list-style-type: none"> <li>• SP 320SN 18.0 kg (40 lb.) or less</li> <li>• SP 320SFN, SP 325SNw, SP 325SFNw 20.0 kg (45 lb.) or less</li> </ul>



**Note**

- Sound power level and sound pressure level are actual values measured in accordance with ISO 7779.
- Sound pressure level is measured from the position of the bystander.

## Printer Function Specifications

Item	Description
Printing speed	<ul style="list-style-type: none"> <li>• SP 320SN and SP 320SFN 26 pages per minute (A4)</li> <li>• SP 325SNw and SP 325SFNw 28 pages per minute (A4)</li> </ul>
Resolution	600 × 600 dpi (maximum: 1200 × 1200 dpi)
First print speed	8 seconds or less
Interface	<ul style="list-style-type: none"> <li>• Ethernet (10BASE-T, 100BASE-TX)</li> <li>• USB 2.0</li> <li>• Wi-Fi (only SP 325SNw and SP 325SFNw)</li> </ul>
Printer language	<ul style="list-style-type: none"> <li>• PCL XL for Windows and the Linux operating system</li> <li>• PCL5e for OS X</li> </ul>
Fonts	80 fonts

## Copier Function Specifications

Item	Description
Maximum resolution (scanning and printing)	<ul style="list-style-type: none"> <li>• Exposure glass Scanning: 600 × 600 dpi Printing: 600 × 600 dpi</li> <li>• ADF (only SP 320SFN, SP 325SNw, and SP 325SFNw) Scanning: 600 × 300 dpi Printing: 600 × 600 dpi</li> </ul>
First copy speed (A4, at 23 °C, 71.6 °F)	13 seconds or less
Multiple copy speed (Countries other than European countries)	<ul style="list-style-type: none"> <li>• SP 320SN, SP 320SFN 26 pages per minute</li> <li>• SP 325SNw, SP 325SFNw 28 pages per minute</li> </ul>
Reproduction ratio	<ul style="list-style-type: none"> <li>• Fixed ratio               <ul style="list-style-type: none"> <li> <b>Region A</b> 50%, 71%, 82%, 93%, 122%, 141%, 200%, 400%</li> <li> <b>Region B</b> 50%, 65%, 78%, 93%, 129%, 155%, 200%, 400%</li> </ul> </li> <li>• Zoom ratio 25% to 400%</li> </ul>
Copy quantity	99

## Scanner Function Specifications

Item	Description
Maximum scanning area (horizontal × vertical)	<ul style="list-style-type: none"> <li>Exposure glass 216 × 297 mm (8.5 × 11.7 inches)</li> <li>ADF (only SP 320SFN, SP 325SNw, and SP 325SFNw) 216 × 356 mm (8.5 × 14 inches)</li> </ul>
Maximum resolution when scanning from the control panel (Scan to E-mail, Scan to FTP, Scan to Folder, Scan to USB)	600 × 600 dpi
Maximum resolution when scanning from a computer (TWAIN)	<ul style="list-style-type: none"> <li>Exposure glass 600 × 600 dpi</li> <li>ADF (only SP 320SFN, SP 325SNw, and SP 325SFNw) 600 × 300 dpi</li> </ul>
Maximum resolution when scanning from a computer (WIA)	600 × 600 dpi
ADF throughput (only SP 320SFN, SP 325SNw, and SP 325SFNw)	<ul style="list-style-type: none"> <li>Black and white: 13 images per minute</li> <li>Full Color: 4 images per minute</li> </ul>
Interface	Ethernet (10BASE-T, 100BASE-TX), USB 2.0, Wi-Fi (only SP 325SNw and SP 325SFNw)

## Fax Function Specifications

Item	Description
Access line	<ul style="list-style-type: none"> <li>Public switched telephone networks (PSTN)</li> <li>Private branch exchange (PBX)</li> </ul>
Transmission mode	ITU-T Group 3 (G3)

Item	Description
Scan line density	<ul style="list-style-type: none"><li>• 8 dots per mm × 3.85 line per mm (200 × 100 dpi)</li><li>• 8 dots per mm × 7.7 line per mm (200 × 200 dpi)</li></ul>
Transmission time	3 seconds (8 dots per mm × 3.85 line per mm, 33.6 kbps, MMR, ITU-T # 1 chart)
Transfer rate	33.6 kbps to 2400 bps (auto shift down system)
Data compression methods	MH, MR, MMR
Memory capacity	100 sheets (8 dots per mm × 3.85 line per mm, MMR, ITU-T # 1 chart)
Address book	<ul style="list-style-type: none"><li>• Speed dial 100 items</li><li>• Quick dial 8 items</li><li>• Number of redials for Fax 1</li></ul>

# Consumables

## CAUTION

- Our products are engineered to meet high standards of quality and functionality, and we recommend that you use only the expendable supplies available at an authorized dealer.

## Print Cartridge

### Note

- For information about consumables, see our website (<http://www.ricoh.com/printers/sp310/support/gateway/>).
- If print cartridges are not changed when necessary, printing will become impossible. For easy replacement, we recommend you purchase and store extra print cartridges.
- Print cartridges (consumables) are not covered by warranty. However, if there is a problem, contact the store where they were purchased.
- When you first use this machine, use the print cartridges packaged with the machine.
- The supplied print cartridges are good for approximately 1,000 pages.
- This machine routinely performs cleaning and uses toner during this operation to maintain quality.
- To prevent a cleaning malfunction, you may need to replace a print cartridge even if it is not empty.

# Information for This Machine

---

## User Information on Electrical & Electronic Equipment Region **A** (mainly Europe and Asia)

---

### Users in the countries where this symbol shown in this section has been specified in national law on collection and treatment of E-waste

---

Our Products contain high quality components and are designed to facilitate recycling.

Our products or product packaging are marked with the symbol below.



The symbol indicates that the product must not be treated as municipal waste. It must be disposed of separately via the appropriate return and collection systems available. By following these instructions you ensure that this product is treated correctly and help to reduce potential impacts on the environment and human health, which could otherwise result from inappropriate handling. Recycling of products helps to conserve natural resources and protect the environment.

For more detailed information on collection and recycling systems for this product, please contact the shop where you purchased it, your local dealer or sales/service representatives.

### All Other Users

---

If you wish to discard this product, please contact your local authorities, the shop where you bought this product, your local dealer or sales/service representatives.

### For Users in India

---

This product complies with the "India E-waste Rule 2011" and prohibits use of lead, mercury, hexavalent chromium, polybrominated biphenyls or polybrominated diphenyl ethers in concentrations exceeding 0.1 weight % and 0.01 weight % for cadmium, except for the exemptions set in Schedule 2 of the Rule.



## For Turkey only

EEE Yönetmeliğine Uygundur.

Bu sistem sarf malzemeleri ve yedek parçaları da dahil olmak üzere EEE Yönetmeliğine Uygundur.

### Üretici:

Ricoh Company, Ltd.

8-13-1 Ginza,

Chuo-ku, Tokyo 104-8222 Japan

+81-36278-2111 (English only/Sadece İngilizce)

## Note for the Battery and/or Accumulator Symbol (For EU countries only)



In accordance with the Battery Directive 2006/66/EC Article 20 Information for end-users Annex II, the above symbol is printed on batteries and accumulators.

This symbol means that in the European Union, used batteries and accumulators should be disposed of separately from your household waste.

In the EU, there are separate collection systems for not only used electrical and electronic products but also batteries and accumulators.

Please dispose of them correctly at your local community waste collection/recycling centre.

## Environmental Advice for Users Region **A** (mainly Europe)

### Users in the EU, Switzerland and Norway

#### Consumables yield

Please refer to either the User's Manual for this information or the packaging of the consumable.

#### Recycled paper

The machine can use recycled paper which is produced in accordance with European standard EN 12281:2002 or DIN 19309. For products using EP printing technology, the machine can print on 64 g/m<sup>2</sup> paper, which contains less raw materials and represents a significant resource reduction.

### Duplex printing (if applicable)

Duplex printing enables both sides of a sheet of paper to be used. This saves paper and reduces the size of printed documents so that fewer sheets are used. We recommend that this feature is enabled whenever you print.

### Toner and ink cartridge return program

Toner and ink cartridge for recycling will be accepted free of charge from users in accordance with local regulations.

For details about the return program, please refer to the Web page below or consult your service person.

<https://www.rioh-return.com/>

### Energy efficiency

The amount of electricity a machine consumes depends as much on its specifications as it does on the way you use it. The machine is designed to allow you to reduce electricity costs by switching to Ready mode after it prints the last page. If required, it can immediately print again from this mode. If no additional prints are required and a specified period of time passes, the device switches to an energy saving mode.

In these modes, the machine consumes less power (watts). If the machine is to print again, it needs a little longer to return from an energy saving mode than from Ready mode.

For maximum energy savings, we recommend that the default setting for power management is used.

Products that comply with the Energy Star requirement are always energy efficient.

---

## Notice To Wireless LAN Interface Users Region **A** (mainly Europe)

---



Declaration of Conformity

Notice to Users in EEA Countries

This product complies with the essential requirements and provisions of Directive 2014/53/EU.

The CE Declaration of Conformity is available by accessing the URL: [http://www.rioh.com/products/ce\\_doc/](http://www.rioh.com/products/ce_doc/)

and selecting the product applicable.

Operating frequency band: 2400 - 2483.5 MHz

maximum radio-frequency power: less than 20.0 dBm

As this equipment with the radiating part is not intended to be used in close proximity to the human body, it is recommended to use at least 20cm apart from the user.

Model Number: SP 325SNw/SP 325SFNw

---

## NOTICE TO USERS (NEW ZEALAND)

---

The grant of a Telepermit for any item of terminal equipment indicates only that Telecom has accepted that the item complies with minimum conditions for connection to its network. It indicates no endorsement of the product by Telecom, nor does it provide any sort of warranty. Above all, it provides no assurance that any item will work correctly in all respects with another item of Telepermitted equipment of a different make or model, nor does it imply that any product is compatible with all of Telecom's network services.

This equipment is not capable, under all operating conditions, of correct operation at the higher speeds for which it is designed. Telecom will accept no responsibility should difficulties arise in such circumstances.

Devices connected to the telephone port may lose their memory if this fax machine is on line for extended periods. To prevent this, such devices should have the facility for battery or similar backup of memory.

This device may be subject to ringing or bell tinkle when certain other devices are connected to the same line. If this occurs, the problem should not be referred to the Telecom Faults Service.

This equipment should not be used under any circumstances that may constitute a nuisance to other Telecom customers.

Telepermitted equipment only may be connected to the auxiliary telephone port. The auxiliary telephone port is not specifically designed for 3-wire connected equipment that may not respond to incoming ringing when attached to this port.

Model Number: SP 320SFN/SP 325SFNw

---

## Notes to users in the state of California (Notes to Users in USA)

---

Perchlorate Material - special handling may apply. See: [www.dtsc.ca.gov/hazardouswaste/perchlorate](http://www.dtsc.ca.gov/hazardouswaste/perchlorate)

---

## Notes to users in the United States of America

---

### Part 15 of the FCC Rules

---

#### Note:

This equipment has been tested and found to comply with the limits for a Class B digital device, pursuant to Part 15 of the FCC Rules. These limits are designed to provide reasonable protection against harmful interference in a residential installation. This equipment generates, uses and can

radiate radio frequency energy and, if not installed and used in accordance with the instructions, may cause harmful interference to radio communications. However, there is no guarantee that interference will not occur in a particular installation. If this equipment does cause harmful interference to radio or television reception, which can be determined by turning the equipment off and on, the user is encouraged to try to correct the interference by one or more of the following measures:

- Reorient or relocate the receiving antenna.
- Increase the separation between the equipment and receiver.
- Connect the equipment into an outlet on a circuit different from that to which the receiver is connected.
- Consult the dealer or an experienced radio /TV technician for help.

This transmitter must not be co-located or operated in conjunction with any other antenna or transmitter.

**Caution:**

Changes or modifications not expressly approved by the party responsible for compliance could void the user's authority to operate the equipment.

This equipment complies with FCC radiation exposure limits set forth for an uncontrolled environment and meets the FCC radio frequency (RF) Exposure Guidelines. This equipment has very low levels of RF energy that it deemed to comply without maximum permissive exposure evaluation (MPE). But it is desirable that it should be installed and operated keeping the radiator at least 20cm or more away from person's body (excluding extremities: hands, wrists, feet and ankles).

**Certification**

This device complies with Part 15 of the FCC Rules.

Operation is subject to the following two conditions:

- (1) This device may not cause harmful interference, and
- (2) this device must accept any interference received, including interference that may cause undesired operation.

Model Number: SP 320SN/SP 320SFN/SP 325SNw/SP 325SFNw

**Part 68 of the FCC Rules regarding Facsimile Unit**

---

1. This equipment complies with Part 68 of the FCC rules and requirements adopted by the ACTA. On the cover of this equipment is a label that contains, among other information, a product identifier in the format US:AAAEQ##TXXXXX. If requested, this number must be provided to the telephone company.
2. This equipment uses the RJ11C USOC jack.
3. A plug and jack used to connect this equipment to the premises wiring and telephone network must comply with the applicable FCC Part 68 rules and requirements adopted by the ACTA. A

compliant telephone cord and modular plug is provided with this product. It is designed to be connected to a compatible modular jack that is also compliant. See installation instructions for detail.

4. The REN is used to determine the number of devices that may be connected to a telephone line. Excessive RENs on a telephone line may result in the devices not ringing in response to an incoming call. In most but not all areas, the sum of RENs should not exceed five (5.0). To be certain of the number of devices that may be connected to a line, as determined by the total RENs, contact the local telephone company. The REN for this product is part of the product identifier that has the format US:AAAEQ##TXXXX. The digits represented by ## are the REN without a decimal point (e.g., 03 is a REN of 0.3).
5. If this equipment causes harm to the telephone network, the telephone company will notify you in advance that temporary discontinuance of service may be required. But if advance notice is not practical, the telephone company will notify the customer as soon as possible. Also, you will be advised of your right to file a complaint with the FCC if you believe it is necessary.
6. The telephone company may make changes in its facilities, equipment, operations or procedures that could affect the operation of the equipment. If this happens the telephone company will provide advance notice in order for you to make necessary modifications to maintain uninterrupted service.
7. If trouble is experienced with this equipment, for repair or warranty information, please contact Ricoh Americas Corporation Customer Support Department at 1-800-FASTFIX. If this device is causing problems with your telephone network, the telephone company may request that you disconnect the equipment until the problem is resolved.
8. In the event of operation problems (document jam, copy jam, communication error indication), see the manual provided with this machine for instruction on resolving the problem.
9. Connection to party line service is subject to state tariffs. Contact the state public utility commission, public service commission or corporation commission for information.
10. If your home has specially wired alarm equipment connected to the telephone line, ensure the installation of this equipment does not disable your alarm equipment. If you have questions about what will disable alarm equipment, consult your telephone company or a qualified installer.

#### **WHEN PROGRAMMING EMERGENCY NUMBERS AND/OR MAKING TEST CALLS TO EMERGENCY NUMBERS:**

1. Remain on the line and briefly explain to the dispatcher the reason for the call before hanging up.
2. Perform such activities in the off-peak hours, such as early morning hours or late evenings.

The Telephone Consumer Protection Act of 1991 makes it unlawful for any person to use a computer or other electronic device, including FAX machines, to send any message unless such message clearly contains in a margin at the top or bottom of each transmitted page or on the first page of the transmission, the date and time it is sent and an identification of the business or other entity, or other individual sending the message and the telephone number of the sending machine or such business,

other entity, or individual. (The telephone number provided may not be a 900 number or any other number for which charges exceed local or long-distance transmission charges.)

In order to program this information into your FAX machine, you should complete the following steps: Follow the FAX HEADER programming procedure in the Programming chapter of the operating instructions to enter the business identification and telephone number of the terminal or business. This information is transmitted with your document by the FAX HEADER feature. In addition to the information, be sure to program the date and time into your machine.

Model Number: SP 320SFN/SP 325SFNw

---

### Notes to Canadian Users of Wireless Devices

---

This device complies with Industry Canada's licence-exempt RSSs.

Operation is subject to the following two conditions:

- (1) This device may not cause interference; and
- (2) This device must accept any interference, including interference that may cause undesired operation of the device.

This equipment complies with IC radiation exposure limits set forth for an uncontrolled environment and meets RSS-102 of the IC radio frequency (RF) Exposure rules. This equipment should be installed and operated keeping the radiator at least 20cm or more away from person's body (excluding extremities: hands, wrists, feet and ankles).

Model Number: SP 325SNw/SP 325SFNw

---

### Remarques à l'attention des utilisateurs canadiens d'appareils sans fil

---

Le présent appareil est conforme aux CNR d'Industrie Canada applicables aux appareils radio exempts de licence.

L'exploitation est autorisée aux deux conditions suivantes :

- (1) l'appareil ne doit pas produire de brouillage, et
- (2) l'utilisateur de l'appareil doit accepter tout brouillage radioélectrique subi, même si le brouillage est susceptible d'en compromettre le fonctionnement.

Cet équipement est conforme aux limites d'exposition aux rayonnements énoncées pour un environnement non contrôlé et respecte les règles d'exposition aux fréquences radioélectriques (RF) CNR-102 de l'IC. Cet équipement doit être installé et utilisé en gardant une distance de 20 cm ou plus entre le radiateur et le corps humain. (à l'exception des extrémités : mains, poignets, pieds et chevilles)

Model Number: SP 325SNw/SP 325SFNw

---

## Notes to Canadian Users

---

This product meets the applicable Innovation, Science and Economic Development Canada technical specifications.

The Ringer Equivalence Number (REN) indicates the maximum number of devices allowed to be connected to a telephone interface. The termination of an interface may consist of any combination of devices subject only to the requirement that the sum of the RENs of all the devices not exceed five.

Model Number: SP 320SFN/SP 325SFNw

---

## Remarques à l'attention des utilisateurs canadiens

---

Le présent produit est conforme aux spécifications techniques applicables d'Innovation, Sciences et Développement économique Canada

L'indice d'équivalence de la sonnerie (IES) sert à indiquer le nombre maximal de dispositifs qui peuvent être raccordés à une interface téléphonique. La terminaison d'une interface peut consister en une combinaison quelconque de dispositifs, à la seule condition que la somme des IES de tous les dispositifs n'exède pas cinq.

Model Number: SP 320SFN/SP 325SFNw

---

## ENERGY STAR Program

---

### ENERGY STAR® Program Requirements for Imaging Equipment



The ENERGY STAR® Program Requirements for Imaging Equipment encourage energy conservation by promoting energy efficient computers and other office equipment.

The program backs the development and dissemination of products that feature energy saving functions.

It is an open program in which manufacturers participate voluntarily.

Targeted products are computers, monitors, printers, facsimiles, copiers, scanners, and multifunction devices. Energy Star standards and logos are internationally uniform.

---

## Saving Energy

---

This machine is equipped with the following Energy Saver modes: Energy Saver mode 1 and Energy Saver mode 2. If the machine has been idle for a certain period of time, the machine automatically enters Energy Saver mode.

The machine recovers from Energy Saver mode when it receives a print job, prints a received fax, or when any key is pressed.

### Energy Saver mode 1









The machine enters Energy Saver mode 1 if the machine has been idle for about 30 seconds. It takes less time to recover from Energy Saver mode 1 than from power-off state or Energy Saver mode 2, but power consumption is higher in Energy Saver mode 1 than in Energy Saver mode 2.

### Energy Saver mode 2

The machine enters Energy Saver mode 2 after the period of time specified for this setting is passed. Power consumption is lower in Energy Saver mode 2 than in Energy Saver mode 1, but it takes longer to recover from Energy Saver mode 2 than from Energy Saver mode 1.



## Specifications

Energy Saver mode 1	Power Consumption *1	<ul style="list-style-type: none"> <li>• SP 320SN/SP 325SNw               <ul style="list-style-type: none"> <li> <b>Region A</b></li> <li>48.0 W</li> <li> <b>Region B</b></li> <li>47.2 W</li> </ul> </li> <li>• SP 320SFN/SP 325SFNw               <ul style="list-style-type: none"> <li> <b>Region A</b></li> <li>48.4 W</li> <li> <b>Region B</b></li> <li>48.3 W</li> </ul> </li> </ul>
	Recovery Time *1	<ul style="list-style-type: none"> <li>• SP 320SN/SP 325SNw               <ul style="list-style-type: none"> <li> <b>Region A</b></li> <li>8.2 seconds</li> <li> <b>Region B</b></li> <li>9.5 seconds</li> </ul> </li> <li>• SP 320SFN/SP 325SFNw               <ul style="list-style-type: none"> <li> <b>Region A</b></li> <li>9.1 seconds</li> <li> <b>Region B</b></li> <li>8.3 seconds</li> </ul> </li> </ul>

Energy Saver mode 2	Power Consumption <sup>*1</sup>	<ul style="list-style-type: none"> <li>SP 320SN/SP 325SNw   <b>Region A</b>  0.89 W</li> <li> <b>Region B</b>  0.79 W</li> <li>SP 320SFN/SP 325SFNw   <b>Region A</b>  0.97 W</li> <li> <b>Region B</b>  0.89 W</li> </ul>
	Default Interval	30 seconds
	Recovery Time <sup>*1</sup>	<ul style="list-style-type: none"> <li>SP 320SN/SP 325SNw   <b>Region A</b>  9.2 seconds</li> <li> <b>Region B</b>  9.4 seconds</li> <li>SP 320SFN/SP 325SFNw   <b>Region A</b>  12 seconds</li> <li> <b>Region B</b>  14 seconds</li> </ul>
Duplex Function <sup>*2</sup>		Standard

\*1 Recovery time and power consumption may differ depending on the conditions and environment of the machine.

\*2 Achieves ENERGY STAR energy savings; product fully qualifies when packaged with (or used with) a duplex tray and the duplex function is enabled as an option.

For details about Energy Saver modes, see page 206 "Administrator Settings".

**Note**

- Even if Energy Saver mode 2 is enabled, the machine will not enter Energy Saver mode 2 for two hours if Low Humidity Mode is enabled. However, the machine will enter Energy Saver mode 1 as normal (even when Energy Saver mode 1 is not enabled).
- For details about Low Humidity Mode, see page 193 "System Settings".

# Copyright Information about Installed Applications

---

## Apache License

---

Apache License

Version 2.0, January 2004

<http://www.apache.org/licenses/>

TERMS AND CONDITIONS FOR USE, REPRODUCTION, AND DISTRIBUTION

### 1. Definitions.

"License" shall mean the terms and conditions for use, reproduction, and distribution as defined by Sections 1 through 9 of this document.

"Licensor" shall mean the copyright owner or entity authorized by the copyright owner that is granting the License.

"Legal Entity" shall mean the union of the acting entity and all other entities that control, are controlled by, or are under common control with that entity. For the purposes of this definition, "control" means (i) the power, direct or indirect, to cause the direction or management of such entity, whether by contract or otherwise, or (ii) ownership of fifty percent (50%) or more of the outstanding shares, or (iii) beneficial ownership of such entity.

"You" (or "Your") shall mean an individual or Legal Entity exercising permissions granted by this License.

"Source" form shall mean the preferred form for making modifications, including but not limited to software source code, documentation source, and configuration files.

"Object" form shall mean any form resulting from mechanical transformation or translation of a Source form, including but not limited to compiled object code, generated documentation, and conversions to other media types.

"Work" shall mean the work of authorship, whether in Source or Object form, made available under the License, as indicated by a copyright notice that is included in or attached to the work (an example is provided in the Appendix below).

"Derivative Works" shall mean any work, whether in Source or Object form, that is based on (or derived from) the Work and for which the editorial revisions, annotations, elaborations, or other modifications represent, as a whole, an original work of authorship. For the purposes of this License, Derivative Works shall not include works that remain separable from, or merely link (or bind by name) to the interfaces of, the Work and Derivative Works thereof.

"Contribution" shall mean any work of authorship, including the original version of the Work and any modifications or additions to that Work or Derivative Works thereof, that is intentionally submitted to Licensor for inclusion in the Work by the copyright owner or by an individual or Legal Entity authorized to submit on behalf of the copyright owner. For the purposes of this definition, "submitted" means any

form of electronic, verbal, or written communication sent to the Licensor or its representatives, including but not limited to communication on electronic mailing lists, source code control systems, and issue tracking systems that are managed by, or on behalf of, the Licensor for the purpose of discussing and improving the Work, but excluding communication that is conspicuously marked or otherwise designated in writing by the copyright owner as "Not a Contribution."

"Contributor" shall mean Licensor and any individual or Legal Entity on behalf of whom a Contribution has been received by Licensor and subsequently incorporated within the Work.

2. Grant of Copyright License. Subject to the terms and conditions of this License, each Contributor hereby grants to You a perpetual, worldwide, non-exclusive, no-charge, royalty-free, irrevocable copyright license to reproduce, prepare Derivative Works of, publicly display, publicly perform, sublicense, and distribute the Work and such Derivative Works in Source or Object form.

3. Grant of Patent License. Subject to the terms and conditions of this License, each Contributor hereby grants to You a perpetual, worldwide, non-exclusive, no-charge, royalty-free, irrevocable (except as stated in this section) patent license to make, have made, use, offer to sell, sell, import, and otherwise transfer the Work, where such license applies only to those patent claims licensable by such Contributor that are necessarily infringed by their Contribution(s) alone or by combination of their Contribution(s) with the Work to which such Contribution(s) was submitted. If You institute patent litigation against any entity (including a cross-claim or counterclaim in a lawsuit) alleging that the Work or a Contribution incorporated within the Work constitutes direct or contributory patent infringement, then any patent licenses granted to You under this License for that Work shall terminate as of the date such litigation is filed.

4. Redistribution. You may reproduce and distribute copies of the Work or Derivative Works thereof in any medium, with or without modifications, and in Source or Object form, provided that You meet the following conditions:

You must give any other recipients of the Work or Derivative Works a copy of this License; and

You must cause any modified files to carry prominent notices stating that You changed the files; and

You must retain, in the Source form of any Derivative Works that You distribute, all copyright, patent, trademark, and attribution notices from the Source form of the Work, excluding those notices that do not pertain to any part of the Derivative Works; and

If the Work includes a "NOTICE" text file as part of its distribution, then any Derivative Works that You distribute must include a readable copy of the attribution notices contained within such NOTICE file, excluding those notices that do not pertain to any part of the Derivative Works, in at least one of the following places: within a NOTICE text file distributed as part of the Derivative Works; within the Source form or documentation, if provided along with the Derivative Works; or, within a display generated by the Derivative Works, if and wherever such third-party notices normally appear. The contents of the NOTICE file are for informational purposes only and do not modify the License. You may add Your own attribution notices within Derivative Works that You distribute, alongside or as an addendum to the NOTICE text from the Work, provided that such additional attribution notices cannot be construed as modifying the License.

You may add Your own copyright statement to Your modifications and may provide additional or different license terms and conditions for use, reproduction, or distribution of Your modifications, or for any such Derivative Works as a whole, provided Your use, reproduction, and distribution of the Work otherwise complies with the conditions stated in this License.

5. Submission of Contributions. Unless You explicitly state otherwise, any Contribution intentionally submitted for inclusion in the Work by You to the Licensor shall be under the terms and conditions of this License, without any additional terms or conditions. Notwithstanding the above, nothing herein shall supersede or modify the terms of any separate license agreement you may have executed with Licensor regarding such Contributions.

6. Trademarks. This License does not grant permission to use the trade names, trademarks, service marks, or product names of the Licensor, except as required for reasonable and customary use in describing the origin of the Work and reproducing the content of the NOTICE file.

7. Disclaimer of Warranty. Unless required by applicable law or agreed to in writing, Licensor provides the Work (and each Contributor provides its Contributions) on an "AS IS" BASIS, WITHOUT WARRANTIES OR CONDITIONS OF ANY KIND, either express or implied, including, without limitation, any warranties or conditions of TITLE, NON-INFRINGEMENT, MERCHANTABILITY, or FITNESS FOR A PARTICULAR PURPOSE. You are solely responsible for determining the appropriateness of using or redistributing the Work and assume any risks associated with Your exercise of permissions under this License.

8. Limitation of Liability. In no event and under no legal theory, whether in tort (including negligence), contract, or otherwise, unless required by applicable law (such as deliberate and grossly negligent acts) or agreed to in writing, shall any Contributor be liable to You for damages, including any direct, indirect, special, incidental, or consequential damages of any character arising as a result of this License or out of the use or inability to use the Work (including but not limited to damages for loss of goodwill, work stoppage, computer failure or malfunction, or any and all other commercial damages or losses), even if such Contributor has been advised of the possibility of such damages.

9. Accepting Warranty or Additional Liability. While redistributing the Work or Derivative Works thereof, You may choose to offer, and charge a fee for, acceptance of support, warranty, indemnity, or other liability obligations and/or rights consistent with this License. However, in accepting such obligations, You may act only on Your own behalf and on Your sole responsibility, not on behalf of any other Contributor, and only if You agree to indemnify, defend, and hold each Contributor harmless for any liability incurred by, or claims asserted against, such Contributor by reason of your accepting any such warranty or additional liability.

END OF TERMS AND CONDITIONS

---

## dnsmasq

---

/\* dnsmasq is Copyright (c) 2000-2006 Simon Kelley

This program is free software; you can redistribute it and/or modify it under the terms of the GNU General Public License as published by

the Free Software Foundation; version 2 dated June, 1991.

This program is distributed in the hope that it will be useful, but WITHOUT ANY WARRANTY; without even the implied warranty of MERCHANTABILITY or FITNESS FOR A PARTICULAR PURPOSE. See the GNU General Public License for more details.

\*/

---

## GPL Version 2

---

### GNU GENERAL PUBLIC LICENSE

Version 2, June 1991

Copyright (C) 1989, 1991 Free Software Foundation, Inc.,  
51 Franklin Street, Fifth Floor, Boston, MA 02110-1301 USA

Everyone is permitted to copy and distribute verbatim copies of this license document, but changing it is not allowed.

#### Preamble

The licenses for most software are designed to take away your freedom to share and change it. By contrast, the GNU General Public License is intended to guarantee your freedom to share and change free software--to make sure the software is free for all its users. This General Public License applies to most of the Free Software Foundation's software and to any other program whose authors commit to using it. (Some other Free Software Foundation software is covered by the GNU Lesser General Public License instead.) You can apply it to your programs, too.

When we speak of free software, we are referring to freedom, not price. Our General Public Licenses are designed to make sure that you have the freedom to distribute copies of free software (and charge for this service if you wish), that you receive source code or can get it if you want it, that you can change the software or use pieces of it in new free programs; and that you know you can do these things. To protect your rights, we need to make restrictions that forbid anyone to deny you these rights or to ask you to surrender the rights. These restrictions translate to certain responsibilities for you if you

distribute copies of the software, or if you modify it.

For example, if you distribute copies of such a program, whether gratis or for a fee, you must give the recipients all the rights that you have. You must make sure that they, too, receive or can get the source code. And you must show them these terms so they know their rights.

We protect your rights with two steps: (1) copyright the software, and (2) offer you this license which gives you legal permission to copy, distribute and/or modify the software.

Also, for each author's protection and ours, we want to make certain that everyone understands that there is no warranty for this free software. If the software is modified by someone else and passed on, we want its recipients to know that what they have is not the original, so that any problems introduced by others will not reflect on the original authors' reputations.

Finally, any free program is threatened constantly by software patents. We wish to avoid the danger that redistributors of a free program will individually obtain patent licenses, in effect making the program proprietary. To prevent this, we have made it clear that any patent must be licensed for everyone's free use or not licensed at all. The precise terms and conditions for copying, distribution and modification follow.

## GNU GENERAL PUBLIC LICENSE

### TERMS AND CONDITIONS FOR COPYING, DISTRIBUTION AND MODIFICATION

0. This License applies to any program or other work which contains a notice placed by the copyright holder saying it may be distributed under the terms of this General Public License. The "Program", below, refers to any such program or work, and a "work based on the Program" means either the Program or any derivative work under copyright law: that is to say, a work containing the Program or a portion of it, either verbatim or with modifications and/or translated into another language. (Hereinafter, translation is included without limitation in the term "modification".) Each licensee is addressed as "you".



Activities other than copying, distribution and modification are not covered by this License; they are outside its scope. The act of running the Program is not restricted, and the output from the Program is covered only if its contents constitute a work based on the Program (independent of having been made by running the Program). Whether that is true depends on what the Program does.

1. You may copy and distribute verbatim copies of the Program's source code as you receive it, in any medium, provided that you conspicuously and appropriately publish on each copy an appropriate copyright notice and disclaimer of warranty; keep intact all the notices that refer to this License and to the absence of any warranty; and give any other recipients of the Program a copy of this License along with the Program.

You may charge a fee for the physical act of transferring a copy, and you may at your option offer warranty protection in exchange for a fee.

2. You may modify your copy or copies of the Program or any portion of it, thus forming a work based on the Program, and copy and distribute such modifications or work under the terms of Section 1 above, provided that you also meet all of these conditions:

- a) You must cause the modified files to carry prominent notices stating that you changed the files and the date of any change.
- b) You must cause any work that you distribute or publish, that in whole or in part contains or is derived from the Program or any part thereof, to be licensed as a whole at no charge to all third parties under the terms of this License.
- c) If the modified program normally reads commands interactively when run, you must cause it, when started running for such interactive use in the most ordinary way, to print or display an announcement including an appropriate copyright notice and a notice that there is no warranty (or else, saying that you provide a warranty) and that users may redistribute the program under these conditions, and telling the user how to view a copy of this License. (Exception: if the Program itself is interactive but

does not normally print such an announcement, your work based on the Program is not required to print an announcement.)

These requirements apply to the modified work as a whole. If identifiable sections of that work are not derived from the Program, and can be reasonably considered independent and separate works in themselves, then this License, and its terms, do not apply to those sections when you distribute them as separate works. But when you distribute the same sections as part of a whole which is a work based on the Program, the distribution of the whole must be on the terms of this License, whose permissions for other licensees extend to the entire whole, and thus to each and every part regardless of who wrote it. Thus, it is not the intent of this section to claim rights or contest your rights to work written entirely by you; rather, the intent is to exercise the right to control the distribution of derivative or collective works based on the Program.

In addition, mere aggregation of another work not based on the Program with the Program (or with a work based on the Program) on a volume of a storage or distribution medium does not bring the other work under the scope of this License.

3. You may copy and distribute the Program (or a work based on it, under Section 2) in object code or executable form under the terms of Sections 1 and 2 above provided that you also do one of the following:

- a) Accompany it with the complete corresponding machine-readable source code, which must be distributed under the terms of Sections 1 and 2 above on a medium customarily used for software interchange; or,
- b) Accompany it with a written offer, valid for at least three years, to give any third party, for a charge no more than your cost of physically performing source distribution, a complete machine-readable copy of the corresponding source code, to be distributed under the terms of Sections 1 and 2 above on a medium customarily used for software interchange; or,
- c) Accompany it with the information you received as to the offer to distribute corresponding source code. (This alternative is

allowed only for noncommercial distribution and only if you received the program in object code or executable form with such an offer, in accord with Subsection b above.)

The source code for a work means the preferred form of the work for making modifications to it. For an executable work, complete source code means all the source code for all modules it contains, plus any associated interface definition files, plus the scripts used to control compilation and installation of the executable. However, as a special exception, the source code distributed need not include anything that is normally distributed (in either source or binary form) with the major components (compiler, kernel, and so on) of the operating system on which the executable runs, unless that component itself accompanies the executable.

If distribution of executable or object code is made by offering access to copy from a designated place, then offering equivalent access to copy the source code from the same place counts as distribution of the source code, even though third parties are not compelled to copy the source along with the object code.

4. You may not copy, modify, sublicense, or distribute the Program except as expressly provided under this License. Any attempt otherwise to copy, modify, sublicense or distribute the Program is void, and will automatically terminate your rights under this License. However, parties who have received copies, or rights, from you under this License will not have their licenses terminated so long as such parties remain in full compliance.

5. You are not required to accept this License, since you have not signed it. However, nothing else grants you permission to modify or distribute the Program or its derivative works. These actions are prohibited by law if you do not accept this License. Therefore, by modifying or distributing the Program (or any work based on the Program), you indicate your acceptance of this License to do so, and all its terms and conditions for copying, distributing or modifying the Program or works based on it.

6. Each time you redistribute the Program (or any work based on the Program), the recipient automatically receives a license from the original licensor to copy, distribute or modify the Program subject to these terms and conditions. You may not impose any further restrictions on the recipients' exercise of the rights granted herein. You are not responsible for enforcing compliance by third parties to this License.

7. If, as a consequence of a court judgment or allegation of patent infringement or for any other reason (not limited to patent issues), conditions are imposed on you (whether by court order, agreement or otherwise) that contradict the conditions of this License, they do not excuse you from the conditions of this License. If you cannot distribute so as to satisfy simultaneously your obligations under this License and any other pertinent obligations, then as a consequence you may not distribute the Program at all. For example, if a patent license would not permit royalty-free redistribution of the Program by all those who receive copies directly or indirectly through you, then the only way you could satisfy both it and this License would be to refrain entirely from distribution of the Program.

If any portion of this section is held invalid or unenforceable under any particular circumstance, the balance of the section is intended to apply and the section as a whole is intended to apply in other circumstances.

It is not the purpose of this section to induce you to infringe any patents or other property right claims or to contest validity of any such claims; this section has the sole purpose of protecting the integrity of the free software distribution system, which is implemented by public license practices. Many people have made generous contributions to the wide range of software distributed through that system in reliance on consistent application of that system; it is up to the author/donor to decide if he or she is willing to distribute software through any other system and a licensee cannot impose that choice.

This section is intended to make thoroughly clear what is believed to be a consequence of the rest of this License.

8. If the distribution and/or use of the Program is restricted in certain countries either by patents or by copyrighted interfaces, the original copyright holder who places the Program under this License may add an explicit geographical distribution limitation excluding those countries, so that distribution is permitted only in or among countries not thus excluded. In such case, this License incorporates the limitation as if written in the body of this License.

9. The Free Software Foundation may publish revised and/or new versions of the General Public License from time to time. Such new versions will be similar in spirit to the present version, but may differ in detail to address new problems or concerns.

Each version is given a distinguishing version number. If the Program specifies a version number of this License which applies to it and "any later version", you have the option of following the terms and conditions either of that version or of any later version published by the Free Software Foundation. If the Program does not specify a version number of this License, you may choose any version ever published by the Free Software Foundation.

10. If you wish to incorporate parts of the Program into other free programs whose distribution conditions are different, write to the author to ask for permission. For software which is copyrighted by the Free Software Foundation, write to the Free Software Foundation; we sometimes make exceptions for this. Our decision will be guided by the two goals of preserving the free status of all derivatives of our free software and of promoting the sharing and reuse of software generally.

#### NO WARRANTY

11. BECAUSE THE PROGRAM IS LICENSED FREE OF CHARGE, THERE IS NO WARRANTY FOR THE PROGRAM, TO THE EXTENT PERMITTED BY APPLICABLE LAW. EXCEPT WHEN OTHERWISE STATED IN WRITING THE COPYRIGHT HOLDERS AND/OR OTHER PARTIES PROVIDE THE PROGRAM "AS IS" WITHOUT WARRANTY OF ANY KIND, EITHER EXPRESSED OR IMPLIED, INCLUDING, BUT NOT LIMITED TO, THE IMPLIED WARRANTIES OF

MERCHANTABILITY AND FITNESS FOR A PARTICULAR PURPOSE. THE ENTIRE RISK AS TO THE QUALITY AND PERFORMANCE OF THE PROGRAM IS WITH YOU. SHOULD THE PROGRAM PROVE DEFECTIVE, YOU ASSUME THE COST OF ALL NECESSARY SERVICING, REPAIR OR CORRECTION.

12. IN NO EVENT UNLESS REQUIRED BY APPLICABLE LAW OR AGREED TO IN WRITING WILL ANY COPYRIGHT HOLDER, OR ANY OTHER PARTY WHO MAY MODIFY AND/OR REDISTRIBUTE THE PROGRAM AS PERMITTED ABOVE, BE LIABLE TO YOU FOR DAMAGES, INCLUDING ANY GENERAL, SPECIAL, INCIDENTAL OR CONSEQUENTIAL DAMAGES ARISING OUT OF THE USE OR INABILITY TO USE THE PROGRAM (INCLUDING BUT NOT LIMITED TO LOSS OF DATA OR DATA BEING RENDERED INACCURATE OR LOSSES SUSTAINED BY YOU OR THIRD PARTIES OR A FAILURE OF THE PROGRAM TO OPERATE WITH ANY OTHER PROGRAMS), EVEN IF SUCH HOLDER OR OTHER PARTY HAS BEEN ADVISED OF THE POSSIBILITY OF SUCH DAMAGES.

END OF TERMS AND CONDITIONS

How to Apply These Terms to Your New Programs

If you develop a new program, and you want it to be of the greatest possible use to the public, the best way to achieve this is to make it free software which everyone can redistribute and change under these terms.

To do so, attach the following notices to the program. It is safest to attach them to the start of each source file to most effectively convey the exclusion of warranty; and each file should have at least the "copyright" line and a pointer to where the full notice is found.

<one line to give the program's name and a brief idea of what it does.>

Copyright (C) <year> <name of author>

This program is free software; you can redistribute it and/or modify it under the terms of the GNU General Public License as published by the Free Software Foundation; either version 2 of the License, or (at your option) any later version.

This program is distributed in the hope that it will be useful, but WITHOUT ANY WARRANTY; without even the implied warranty of MERCHANTABILITY or FITNESS FOR A PARTICULAR PURPOSE. See the GNU General Public License for more details.

You should have received a copy of the GNU General Public License along

with this program; if not, write to the Free Software Foundation, Inc.,  
51 Franklin Street, Fifth Floor, Boston, MA 02110-1301 USA.

Also add information on how to contact you by electronic and paper mail.

If the program is interactive, make it output a short notice like this  
when it starts in an interactive mode:

```
Gnomovision version 69, Copyright (C) year name of author
```

```
Gnomovision comes with ABSOLUTELY NO WARRANTY; for details type `show w'.
```

```
This is free software, and you are welcome to redistribute it  
under certain conditions; type `show c' for details.
```

The hypothetical commands ``show w'` and ``show c'` should show the appropriate parts of the General Public License. Of course, the commands you use may be called something other than ``show w'` and ``show c'`; they could even be mouse-clicks or menu items--whatever suits your program.

You should also get your employer (if you work as a programmer) or your school, if any, to sign a "copyright disclaimer" for the program, if necessary. Here is a sample; alter the names:

```
Yoyodyne, Inc., hereby disclaims all copyright interest in the program  
`Gnomovision' (which makes passes at compilers) written by James Hacker.  
<signature of Ty Coon>, 1 April 1989
```

```
Ty Coon, President of Vice
```

This General Public License does not permit incorporating your program into proprietary programs. If your program is a subroutine library, you may consider it more useful to permit linking proprietary applications with the library. If this is what you want to do, use the GNU Lesser General Public License instead of this License.

---

## iperf

---

Iperf Copyright

-----

Copyright (c) The Board of Trustees of the University of Illinois

All Rights Reserved.

Iperf performance test

Mark Gates

Ajay Tirumala

Jim Ferguson

Jon Dugan

Feng Qin

Kevin Gibbs

John Estabrook

National Laboratory for Applied Network Research

National Center for Supercomputing Applications

University of Illinois at Urbana-Champaign

<http://www.ncsa.uiuc.edu>

Permission is hereby granted, free of charge, to any person obtaining a copy of this software (Iperf) and associated documentation files (the "Software"), to deal in the Software without restriction, including without limitation the rights to use, copy, modify, merge, publish, distribute, sublicense, and/or sell copies of the Software, and to permit persons to whom the Software is furnished to do so, subject to the following conditions:

Redistributions of source code must retain the above copyright notice, this list of conditions and the following disclaimers.

Redistributions in binary form must reproduce the above copyright notice, this list of conditions and the following disclaimers in the documentation and/or other materials provided with the distribution.

Neither the names of the University of Illinois, NCSA, nor the names of its contributors may be used to endorse or promote products derived from this Software without specific prior written permission.

THE SOFTWARE IS PROVIDED "AS IS", WITHOUT WARRANTY OF ANY KIND, EXPRESS OR IMPLIED, INCLUDING BUT NOT LIMITED TO THE WARRANTIES OF MERCHANTABILITY, FITNESS FOR A PARTICULAR PURPOSE AND NONINFRINGEMENT. IN NO EVENT SHALL THE CONTRIBUTORS OR COPYRIGHT HOLDERS BE LIABLE FOR ANY CLAIM, DAMAGES OR OTHER LIABILITY, WHETHER IN AN ACTION OF CONTRACT, TORT OR OTHERWISE, ARISING FROM, OUT OF OR IN CONNECTION WITH THE SOFTWARE OR THE USE OR OTHER DEALINGS IN THE SOFTWARE.

-----  
Iperf User Docs

Mark Gates

Ajay Tirumala

Jon Dugan

Kevin Gibbs

-----  
Acknowledgements



Thanks to Mark Gates (NLANR), Alex Warshavsky (NLANR) and Justin Pietsch (University of Washington) who were responsible for the 1.1.x releases of Iperf. For this release, we would like to thank Bill Cerveny (Internet2), Micheal Lambert (PSC), Dale Finkelson (UNL) and Matthew Zekauskas (Internet2) for help in getting access to IPv6 networks / machines. Special thanks to Matthew Zekauskas (Internet2) for helping out in the FreeBSD implementation. Also, thanks to Kraemer Oliver (Sony) for providing an independent implementation of IPv6 version of Iperf, which provided a useful comparison for testing our features.

---

## libHaru

---

Copyright (C) 1999-2006 Takeshi Kanno

Copyright (C) 2007-2009 Antony Dovgal

This software is provided 'as-is', without any express or implied warranty.

In no event will the authors be held liable for any damages arising from the use of this software.

Permission is granted to anyone to use this software for any purpose, including commercial applications, and to alter it and redistribute it freely, subject to the following restrictions:

1. The origin of this software must not be misrepresented; you must not claim that you wrote the original software. If you use this software in a product, an acknowledgment in the product documentation would be appreciated but is not required.
2. Altered source versions must be plainly marked as such, and must not be misrepresented as being the original software.
3. This notice may not be removed or altered from any source distribution.

---

## Libsasl

---

\* Copyright (c) 2001 Carnegie Mellon University. All rights reserved.

\*

\* Redistribution and use in source and binary forms, with or without

\* modification, are permitted provided that the following conditions

\* are met:

\*

\* 1. Redistributions of source code must retain the above copyright

\* notice, this list of conditions and the following disclaimer.

\*

\* 2. Redistributions in binary form must reproduce the above copyright

\* notice, this list of conditions and the following disclaimer in

\* the documentation and/or other materials provided with the

\* distribution.

\*

\* 3. The name "Carnegie Mellon University" must not be used to

\* endorse or promote products derived from this software without

\* prior written permission. For permission or any other legal

\* details, please contact

\* Office of Technology Transfer

\* Carnegie Mellon University

\* 5000 Forbes Avenue

\* Pittsburgh, PA 15213-3890

\* (412) 268-4387, fax: (412) 268-7395

\* tech-transfer@andrew.cmu.edu

\*

\* 4. Redistributions of any form whatsoever must retain the following

\* acknowledgment:

\* "This product includes software developed by Computing Services

\* at Carnegie Mellon University (<http://www.cmu.edu/computing/>)."

\*

\* CARNEGIE MELLON UNIVERSITY DISCLAIMS ALL WARRANTIES WITH REGARD TO

\* THIS SOFTWARE, INCLUDING ALL IMPLIED WARRANTIES OF MERCHANTABILITY

\* AND FITNESS, IN NO EVENT SHALL CARNEGIE MELLON UNIVERSITY BE LIABLE

\* FOR ANY SPECIAL, INDIRECT OR CONSEQUENTIAL DAMAGES OR ANY DAMAGES

\* WHATSOEVER RESULTING FROM LOSS OF USE, DATA OR PROFITS, WHETHER IN

\* AN ACTION OF CONTRACT, NEGLIGENCE OR OTHER TORTIOUS ACTION, ARISING

\* OUT OF OR IN CONNECTION WITH THE USE OR PERFORMANCE OF THIS SOFTWARE.

\*

---

## mDNSResponder

---

- \* Copyright (c) 2002-2006 Apple Computer, Inc. All rights reserved.
- \*
- \* Licensed under the Apache License, Version 2.0 (the "License");
- \* you may not use this file except in compliance with the License.
- \* You may obtain a copy of the License at
- \*
- \* <http://www.apache.org/licenses/LICENSE-2.0>
- \*
- \* Unless required by applicable law or agreed to in writing, software
- \* distributed under the License is distributed on an "AS IS" BASIS,
- \* WITHOUT WARRANTIES OR CONDITIONS OF ANY KIND, either express or implied.
- \* See the License for the specific language governing permissions and
- \* limitations under the License.
- \*
- \* This code is completely 100% portable C. It does not depend on any external header files
- \* from outside the mDNS project -- all the types it expects to find are defined right here.
- \*
- \* The previous point is very important: This file does not depend on any external
- \* header files. It should compile on \*any\* platform that has a C compiler, without
- \* making \*any\* assumptions about availability of so-called "standard" C functions,
- \* routines, or types (which may or may not be present on any given platform).
- \* Formatting notes:
- \* This code follows the "Whitesmiths style" C indentation rules. Plenty of discussion
- \* on C indentation can be found on the web, such as <http://www.kafejo.com/komp/1tbs.htm>,
- \* but for the sake of brevity here I will say just this: Curly braces are not syntactically
- \* part of an "if" statement; they are the beginning and ending markers of a compound statement;
- \* therefore common sense dictates that if they are part of a compound statement then they
- \* should be indented to the same level as everything else in that compound statement.
- \* Indenting curly braces at the same level as the "if" implies that curly braces are
- \* part of the "if", which is false. (This is as misleading as people who write "char\* x,y;"
- \* thinking that variables x and y are both of type "char\*" -- and anyone who doesn't

- \* understand why variable `y` is not of type `"char*"` just proves the point that poor code
- \* layout leads people to unfortunate misunderstandings about how the C language really works.)

---

## OpenCV

---

By downloading, copying, installing or using the software you agree to this license.

If you do not agree to this license, do not download, install, copy or use the software.

License Agreement

For Open Source Computer Vision Library

(3-clause BSD License)

Redistribution and use in source and binary forms, with or without modification, are permitted provided that the following conditions are met:

\* Redistributions of source code must retain the above copyright notice, this list of conditions and the following disclaimer.

\* Redistributions in binary form must reproduce the above copyright notice, this list of conditions and the following disclaimer in the documentation and/or other materials provided with the distribution.

\* Neither the names of the copyright holders nor the names of the contributors may be used to endorse or promote products derived from this software without specific prior written permission.

This software is provided by the copyright holders and contributors "as is" and any express or implied warranties, including, but not limited to, the implied warranties of merchantability and fitness for a particular purpose are disclaimed.

In no event shall copyright holders or contributors be liable for any direct, indirect, incidental, special, exemplary, or consequential damages (including, but not limited to, procurement of substitute goods or services; loss of use, data, or profits; or business interruption) however caused and on any theory of liability, whether in contract, strict liability, or tort (including negligence or otherwise) arising in any way out of the use of this software, even if advised of the possibility of such damage.

---

## Open SSL

---

### LICENSE ISSUES

=====

The OpenSSL toolkit stays under a dual license, i.e. both the conditions of the OpenSSL License and the original SSLeay license apply to the toolkit. See below for the actual license texts. Actually both licenses are BSD-style Open Source licenses. In case of any license issues related to OpenSSL please contact [openssl-core@openssl.org](mailto:openssl-core@openssl.org).

#### OpenSSL License

-----

```
/* =====
* Copyright (c) 1998-2016 The OpenSSL Project. All rights reserved.
*
* Redistribution and use in source and binary forms, with or without
* modification, are permitted provided that the following conditions
* are met:
*
* 1. Redistributions of source code must retain the above copyright
* notice, this list of conditions and the following disclaimer.
*
* 2. Redistributions in binary form must reproduce the above copyright
* notice, this list of conditions and the following disclaimer in
* the documentation and/or other materials provided with the
* distribution.
*
* 3. All advertising materials mentioning features or use of this
* software must display the following acknowledgment:
* "This product includes software developed by the OpenSSL Project
* for use in the OpenSSL Toolkit. (http://www.openssl.org/)"
*
* 4. The names "OpenSSL Toolkit" and "OpenSSL Project" must not be used to
* endorse or promote products derived from this software without
```

\* prior written permission. For written permission, please contact  
\* openssl-core@openssl.org.  
\*  
\* 5. Products derived from this software may not be called "OpenSSL"  
\* nor may "OpenSSL" appear in their names without prior written  
\* permission of the OpenSSL Project.  
\*  
\* 6. Redistributions of any form whatsoever must retain the following  
\* acknowledgment:  
\* "This product includes software developed by the OpenSSL Project  
\* for use in the OpenSSL Toolkit (<http://www.openssl.org/>)"  
\*  
\* THIS SOFTWARE IS PROVIDED BY THE OpenSSL PROJECT ``AS IS'' AND ANY  
\* EXPRESSED OR IMPLIED WARRANTIES, INCLUDING, BUT NOT LIMITED TO, THE  
\* IMPLIED WARRANTIES OF MERCHANTABILITY AND FITNESS FOR A PARTICULAR  
\* PURPOSE ARE DISCLAIMED. IN NO EVENT SHALL THE OpenSSL PROJECT OR  
\* ITS CONTRIBUTORS BE LIABLE FOR ANY DIRECT, INDIRECT, INCIDENTAL,  
\* SPECIAL, EXEMPLARY, OR CONSEQUENTIAL DAMAGES (INCLUDING, BUT  
\* NOT LIMITED TO, PROCUREMENT OF SUBSTITUTE GOODS OR SERVICES;  
\* LOSS OF USE, DATA, OR PROFITS; OR BUSINESS INTERRUPTION)  
\* HOWEVER CAUSED AND ON ANY THEORY OF LIABILITY, WHETHER IN CONTRACT,  
\* STRICT LIABILITY, OR TORT (INCLUDING NEGLIGENCE OR OTHERWISE)  
\* ARISING IN ANY WAY OUT OF THE USE OF THIS SOFTWARE, EVEN IF ADVISED  
\* OF THE POSSIBILITY OF SUCH DAMAGE.  
\* =====  
\*  
\* This product includes cryptographic software written by Eric Young  
\* (eay@cryptsoft.com). This product includes software written by Tim  
\* Hudson (tjh@cryptsoft.com).  
\*  
\* /  
Original SSLeay License  
-----

```
/* Copyright (C) 1995-1998 Eric Young (eay@cryptsoft.com)
 * All rights reserved.
 *
 * This package is an SSL implementation written
 * by Eric Young (eay@cryptsoft.com).
 * The implementation was written so as to conform with Netscapes SSL.
 *
 * This library is free for commercial and non-commercial use as long as
 * the following conditions are aheared to. The following conditions
 * apply to all code found in this distribution, be it the RC4, RSA,
 * lhash, DES, etc., code; not just the SSL code. The SSL documentation
 * included with this distribution is covered by the same copyright terms
 * except that the holder is Tim Hudson (tjh@cryptsoft.com).
 *
 * Copyright remains Eric Young's, and as such any Copyright notices in
 * the code are not to be removed.
 * If this package is used in a product, Eric Young should be given attribution
 * as the author of the parts of the library used.
 * This can be in the form of a textual message at program startup or
 * in documentation (online or textual) provided with the package.
 *
 * Redistribution and use in source and binary forms, with or without
 * modification, are permitted provided that the following conditions
 * are met:
 * 1. Redistributions of source code must retain the copyright
 * notice, this list of conditions and the following disclaimer.
 * 2. Redistributions in binary form must reproduce the above copyright
 * notice, this list of conditions and the following disclaimer in the
 * documentation and/or other materials provided with the distribution.
 * 3. All advertising materials mentioning features or use of this software
 * must display the following acknowledgement:
 * "This product includes cryptographic software written by
 * Eric Young (eay@cryptsoft.com)"
```

\* The word 'cryptographic' can be left out if the routines from the library  
\* being used are not cryptographic related :-).  
\* 4. If you include any Windows specific code (or a derivative thereof) from  
\* the apps directory (application code) you must include an acknowledgement:  
\* "This product includes software written by Tim Hudson (tjh@cryptsoft.com)"  
\*  
\* THIS SOFTWARE IS PROVIDED BY ERIC YOUNG ``AS IS'' AND  
\* ANY EXPRESS OR IMPLIED WARRANTIES, INCLUDING, BUT NOT LIMITED TO, THE  
\* IMPLIED WARRANTIES OF MERCHANTABILITY AND FITNESS FOR A PARTICULAR PURPOSE  
\* ARE DISCLAIMED. IN NO EVENT SHALL THE AUTHOR OR CONTRIBUTORS BE LIABLE  
\* FOR ANY DIRECT, INDIRECT, INCIDENTAL, SPECIAL, EXEMPLARY, OR CONSEQUENTIAL  
\* DAMAGES (INCLUDING, BUT NOT LIMITED TO, PROCUREMENT OF SUBSTITUTE GOODS  
\* OR SERVICES; LOSS OF USE, DATA, OR PROFITS; OR BUSINESS INTERRUPTION)  
\* HOWEVER CAUSED AND ON ANY THEORY OF LIABILITY, WHETHER IN CONTRACT, STRICT  
\* LIABILITY, OR TORT (INCLUDING NEGLIGENCE OR OTHERWISE) ARISING IN ANY WAY  
\* OUT OF THE USE OF THIS SOFTWARE, EVEN IF ADVISED OF THE POSSIBILITY OF  
\* SUCH DAMAGE.  
\*  
\* The licence and distribution terms for any publically available version or  
\* derivative of this code cannot be changed. i.e. this code cannot simply be  
\* copied and put under another distribution licence  
\* [including the GNU Public Licence.]  
\* /

---

## WPA Supplicant

---

WPA Supplicant

=====

Copyright (c) 2003-2016, Jouni Malinen <j@w1.fi> and contributors

All Rights Reserved.

This program is licensed under the BSD license (the one with  
advertisement clause removed).

If you are submitting changes to the project, please see CONTRIBUTIONS  
file for more instructions.



## License

-----

This software may be distributed, used, and modified under the terms of BSD license:

Redistribution and use in source and binary forms, with or without modification, are permitted provided that the following conditions are met:

1. Redistributions of source code must retain the above copyright notice, this list of conditions and the following disclaimer.
2. Redistributions in binary form must reproduce the above copyright notice, this list of conditions and the following disclaimer in the documentation and/or other materials provided with the distribution.
3. Neither the name(s) of the above-listed copyright holder(s) nor the names of its contributors may be used to endorse or promote products derived from this software without specific prior written permission.

THIS SOFTWARE IS PROVIDED BY THE COPYRIGHT HOLDERS AND CONTRIBUTORS "AS IS" AND ANY EXPRESS OR IMPLIED WARRANTIES, INCLUDING, BUT NOT LIMITED TO, THE IMPLIED WARRANTIES OF MERCHANTABILITY AND FITNESS FOR A PARTICULAR PURPOSE ARE DISCLAIMED. IN NO EVENT SHALL THE COPYRIGHT OWNER OR CONTRIBUTORS BE LIABLE FOR ANY DIRECT, INDIRECT, INCIDENTAL, SPECIAL, EXEMPLARY, OR CONSEQUENTIAL DAMAGES (INCLUDING, BUT NOT LIMITED TO, PROCUREMENT OF SUBSTITUTE GOODS OR SERVICES; LOSS OF USE, DATA, OR PROFITS; OR BUSINESS INTERRUPTION) HOWEVER CAUSED AND ON ANY THEORY OF LIABILITY, WHETHER IN CONTRACT, STRICT LIABILITY, OR TORT (INCLUDING NEGLIGENCE OR OTHERWISE) ARISING IN ANY WAY OUT OF THE USE OF THIS SOFTWARE, EVEN IF ADVISED OF THE POSSIBILITY OF SUCH DAMAGE.

# Trademarks

Adobe and Acrobat are either registered trademarks or trademarks of Adobe Systems Incorporated in the United States and/or other countries.

OS X, TrueType, and Safari are trademarks of Apple Inc., registered in the U.S. and other countries.

Firefox® is a registered trademark of the Mozilla Foundation.

Java is a registered trademark of Oracle and/or its affiliates.

LINUX® is the registered trademark of Linus Torvalds in the U.S. and other countries.

Microsoft®, Windows®, Windows Server®, Windows Vista®, and Internet Explorer® are either registered trademarks or trademarks of Microsoft Corporation in the United States and/or other countries.

PCL® is a registered trademark of Hewlett-Packard Company.

Red Hat is a registered trademark of Red Hat, Inc.

Wi-Fi® and Wi-Fi Direct® are registered trademarks of Wi-Fi Alliance.

The proper name of Internet Explorer 6 is Microsoft® Internet Explorer® 6.

The proper names of the Windows operating systems are as follows:

- The product names of Windows Vista are as follows:

Microsoft® Windows Vista® Ultimate

Microsoft® Windows Vista® Business

Microsoft® Windows Vista® Home Premium

Microsoft® Windows Vista® Home Basic

Microsoft® Windows Vista® Enterprise

- The product names of Windows 7 are as follows:

Microsoft® Windows® 7 Starter

Microsoft® Windows® 7 Home Premium

Microsoft® Windows® 7 Professional

Microsoft® Windows® 7 Ultimate

Microsoft® Windows® 7 Enterprise

- The product names of Windows 8 are as follows:

Microsoft® Windows® 8

Microsoft® Windows® 8 Pro

Microsoft® Windows® 8 Enterprise

- The product names of Windows 8.1 are as follows:

Microsoft® Windows® 8.1

Microsoft® Windows® 8.1 Pro

Microsoft® Windows® 8.1 Enterprise

- The product names of Windows 10 are as follows:

Microsoft® Windows® 10 Home Premium

Microsoft® Windows® 10 Pro

Microsoft® Windows® 10 Enterprise

Microsoft® Windows® 10 Education

- The product names of Windows Server 2003 are as follows:

Microsoft® Windows Server® 2003 Standard Edition

Microsoft® Windows Server® 2003 Enterprise Edition

Microsoft® Windows Server® 2003 Web Edition

Microsoft® Windows Server® 2003 Datacenter Edition

- The product names of Windows Server 2003 R2 are as follows:

Microsoft® Windows Server® 2003 R2 Standard Edition

Microsoft® Windows Server® 2003 R2 Enterprise Edition

Microsoft® Windows Server® 2003 R2 Datacenter Edition

- The product names of Windows Server 2008 are as follows:

Microsoft® Windows Server® 2008 Foundation

Microsoft® Windows Server® 2008 Standard

Microsoft® Windows Server® 2008 Enterprise

Microsoft® Windows Server® 2008 Datacenter

Microsoft® Windows Server® 2008 for Itanium-based Systems

Microsoft® Windows® Web Server 2008

Microsoft® Windows® HPC Server 2008

- The product names of Windows Server 2008 R2 are as follows:

Microsoft® Windows Server® 2008 R2 Foundation

Microsoft® Windows Server® 2008 R2 Standard

Microsoft® Windows Server® 2008 R2 Enterprise

Microsoft® Windows Server® 2008 R2 Datacenter

Microsoft® Windows Server® 2008 R2 for Itanium-based Systems

Microsoft® Windows® Web Server R2 2008

Microsoft® Windows® HPC Server R2 2008

- The product names of Windows Server 2012 are as follows:

Microsoft® Windows Server® 2012 Foundation

Microsoft® Windows Server® 2012 Essentials

Microsoft® Windows Server® 2012 Standard

Microsoft® Windows Server® 2012 Datacenter

- The product names of Windows Server 2012 R2 are as follows:

Microsoft® Windows Server® 2012 R2 Foundation

Microsoft® Windows Server® 2012 R2 Essentials

Microsoft® Windows Server® 2012 R2 Standard

Microsoft® Windows Server® 2012 R2 Datacenter

Other product names used herein are for identification purposes only and might be trademarks of their respective companies. We disclaim any and all rights to those marks.

Microsoft product screen shots reprinted with permission from Microsoft Corporation.

# INDEX

## A

Address book.....	95, 192
ADF (Auto Document Feeder).....	67, 267, 268
Administrator password.....	250
Administrator settings.....	250
Authentication.....	319
Auto e-mail notification settings.....	239

## B

Backup settings.....	251
Broadcast function.....	152
Bypass tray setting priority.....	228

## C

Canceling a copy.....	78
Canceling a fax.....	148, 159
Community.....	240
Configuration page.....	213, 249, 258
Configuring Network Settings Using OS X	
Ethernet.....	310
Installing Smart Organizing Monitor.....	312
Installing the driver.....	312
USB.....	309
Wireless LAN.....	312

Configuring the machine	
Printing the configuration page.....	213, 258
Using Smart Organizing Monitor.....	255
Using the control panel.....	173
Using Web Image Monitor.....	223

Confirming information	
Counter information.....	226
Printer driver settings.....	70
Status information.....	225, 255

Consumables.....	333
------------------	-----

Control panel.....	20, 21
--------------------	--------

Copier mode screen.....	76
-------------------------	----

## Copy

2-sided copy.....	82, 86
Basic operation.....	77
Combine.....	82, 86
Copying onto envelopes.....	41
Enlarge.....	80
ID Card copy.....	89
Reduce.....	80
Scan settings.....	91

Specifications.....	330
Copy key.....	24

## D

Date and time settings.....	139
Density.....	132
DNS setting.....	238

## E

E-mail notification 1.....	239
E-mail notification 2.....	239
Encryption.....	319
Encryption key exchange.....	321
Energy saver mode.....	254, 342
Entering characters.....	32
Exposure glass.....	266
Exterior.....	17

## F

Facsimile key.....	24
--------------------	----

## Fax

Fax setting workflows.....	137
LAN-Fax.....	158
Lists/Reports.....	172
Receiving a fax.....	164
Registering destinations.....	140
Sending a fax.....	145
Specifications.....	331

Fax destinations.....	142, 143, 235
-----------------------	---------------

Fax journal.....	213, 249
------------------	----------

Fax mode screen.....	138
----------------------	-----

Fax Speed Dial destination list.....	213, 249
--------------------------------------	----------

Fax TX standby file list.....	249
-------------------------------	-----

FAX/TEL manual mode.....	166
--------------------------	-----

Function priority.....	24
------------------------	----

## G

General status.....	236
---------------------	-----

## I

I/O timeout.....	234
------------------	-----

IKE settings.....	245
-------------------	-----

Image density.....	91, 156
--------------------	---------

Immediate transmission.....	145
-----------------------------	-----

Interior.....	19
---------------	----

Introduction.....	13
IPsec global settings.....	245
IPsec policy settings.....	245
IPsec settings.....	245
IPsec transmission.....	319
IPv6 configuration.....	237

## J

Job cancel.....	73
-----------------	----

## L

LAN-Fax.....	158
Language.....	224
Lists.....	172, 213, 249
Loading paper.....	36

## M

Machine information.....	227
Machine settings.....	256
Maintaining the machine	
Cleaning the machine.....	263, 264, 266, 267, 268
Replacing the print cartridge.....	259
Maintenance page.....	213, 249
mDNS setting.....	237
Memory transmission.....	145
Menu chart.....	175
Model-specific information.....	13
Moving.....	269
Multi-access.....	25

## N

Network application.....	237
Network print setting.....	237
Network settings.....	215, 236
Network status.....	236
Non-recommended paper.....	61
Notes.....	325

## O

On hook dial.....	153
One Touch buttons.....	119
Operation modes.....	24
Operation tools.....	28
Original.....	66
Original type.....	91

## P

Page counter.....	226
Paper jam.....	281, 283, 285, 290
Paper mismatch.....	73
Paper recommendations.....	67
Paper Storage.....	62
Paper tray.....	225
Paper types.....	55
Bond Paper.....	55
Cardstock.....	55
Color Paper.....	55
Envelope.....	55
Label Paper.....	55
Letterhead.....	55
Plain Paper.....	55
Preprinted Paper.....	55
Prepunched Paper.....	55
Recycled Paper.....	55
Thick Paper 1.....	55
Thick Paper 2.....	55
Thin Paper.....	55
Pause/Redial key.....	119
Placing originals.....	65
POP3 settings.....	242
Print	
Basic operation.....	72
Combine.....	69
Duplex.....	69
Printing on envelopes.....	41
Specifications.....	329
Print area.....	62
Print cartridge.....	259, 333
Print counter.....	226
Printer features.....	198
Priority tray.....	233

## Q

Quick Dial destination list.....	213, 249
----------------------------------	----------

## R

Reception mode.....	164
Redial function.....	152
Registering information	
Administrator e-mail address.....	250
Destinations.....	95, 140
E-mail address.....	112

Fax number.....	206
Folder.....	103
FTP server.....	116
Reports.....	213, 249
Reset settings.....	250
Resolution.....	133, 157
Restore settings.....	252

## S

SA (Security Association).....	320
Scan	
Registering destinations.....	95
SANE.....	131
Scan settings.....	132
Scan to E-mail.....	112
Scan to Folder.....	103
Scan to FTP.....	116
Scan to USB.....	121
Scanning from Smart Organizing Monitor.....	123
TWAIN.....	127
WIA.....	130
Scan destinations.....	95, 100, 101, 119, 235
Scan size.....	132
Scan to E-mail.....	95, 112
Scan to Folder.....	95
Scan to FTP.....	95, 116
Scanner destination list.....	213, 249
Scanner function.....	331
Scanner journal.....	213, 249
Scanner key.....	24
Scanner send setting.....	237
Select paper.....	231
Sending a fax.....	146
Set date.....	253
Set time.....	253
Shortcut to Func. key.....	234
Shortcut to function.....	30, 234
Smart Organizing Monitor.....	28, 255
SMTP settings.....	241
SNMP settings.....	240
Sound volume adjustment.....	228
Specifications.....	326, 329, 330, 331
Specifying a custom paper size.....	48
Specifying the paper type and paper size..	48, 50, 51

Speed Dial.....	142, 143, 151
Standby file list.....	213
Status messages.....	271, 279
Supported paper.....	53
System.....	240
System information.....	225, 255
System settings.....	193

## T

TCP/IP status.....	236
Time setting.....	253
Toner management.....	233
Top page.....	223
Trademarks.....	368
Transmission mode.....	145
Trap.....	240
Tray 1.....	36
Tray paper settings.....	202, 228
Troubleshooting	
Clearing misfeeds.....	281
Error and status messages appear on Smart Organizing Monitor.....	279
Error and status messages on the screen.....	271
Other problems.....	292, 293, 295, 297, 301, 303, 304, 307

## W

Web Image Monitor.....	222
What you can do with this machine	
Copier function.....	75
Fax function.....	135
Printer function.....	69
Scanner function.....	93
Wireless LAN settings.....	242, 257

---

MEMO



---

MEMO

---

MEMO



