

TECHNICAL MANUAL

OPERATOR'S AND ORGANIZATIONAL
MAINTENANCE MANUAL

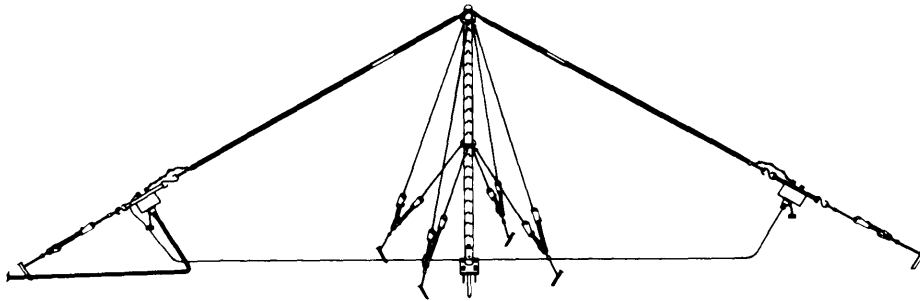

ANTENNA GROUP OE-303/GRC
(NSN 5985-01-152-5845)

EQUIPMENT
DESCRIPTION

PRINCIPLES
OF OPERATION

OPERATOR'S
CONTROLS

ANTENNA
ERECTION

PMCS

OPERATION

TROUBLESHOOTING

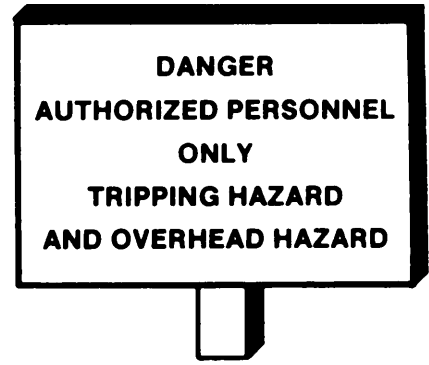
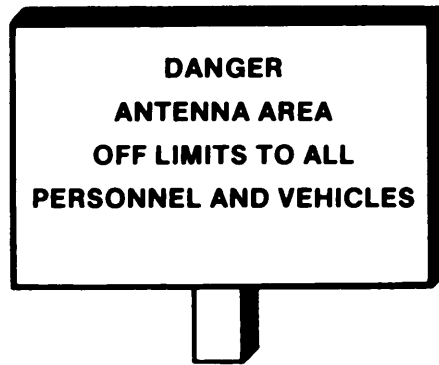
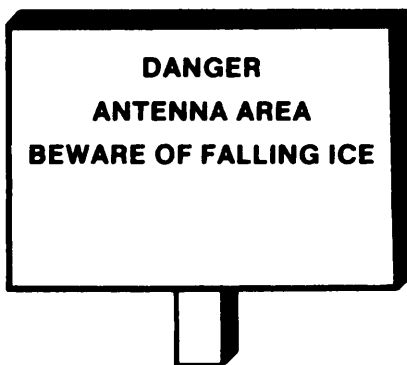
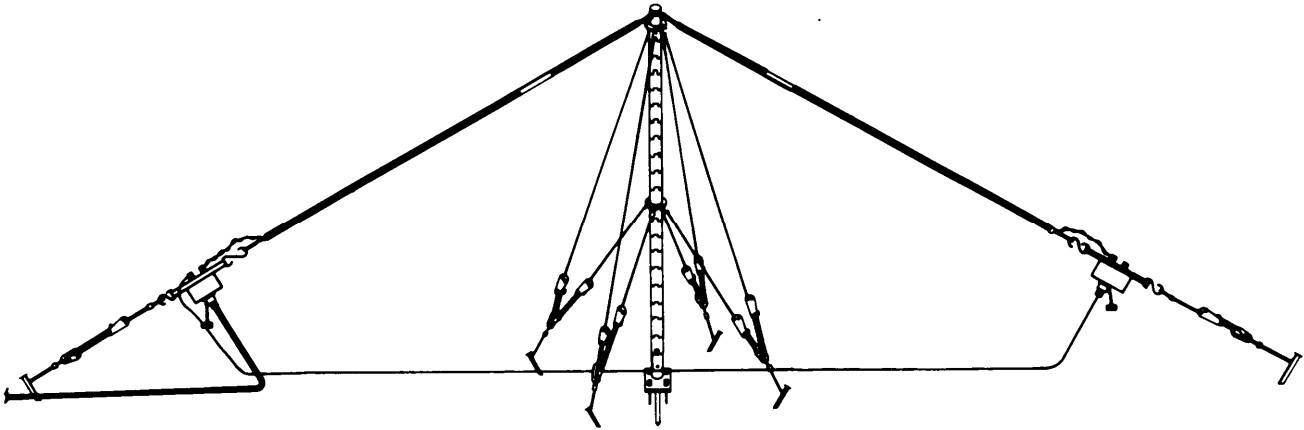

BEFORE LEAVING YOUR BASE, MAKE SURE YOU HAVE:

ENOUGH WARNING SIGNS.

EXTRA STREAMERS OR APPROVED MARKERS.

A SUPPLY OF SPECIAL ANCHORS TO USE IN THE TYPE OF SOIL YOU MAY FIND IN YOUR AREA OF OPERATIONS.

EXTRA GUY ROPES OR APPROVED SUBSTITUTES.

WARNING

**NEVER ERECT ANTENNA GROUP OE-303/GRC
UNDER POWER LINES.**

**IF YOU MUST ERECT THIS ANTENNA NEAR POWERLINES, POWER
TOWERS, POWER POLES OR BUILDINGS WITH OVERHEAD POWER
WIRES, FOLLOW THE RULE:**

“DOUBLE THE HEIGHT OF THE TALLEST THING IN THE AREA”

EXAMPLE: If a powerline tower is 80 feet tall, (your antenna is 30 feet tall) DOUBLE 80
FEET to get a SAFE DISTANCE of 160 feet AWAY FROM the
powerline tower.

WARNING

**NEVER ATTEMPT TO ERECT THIS ANTENNA WITHOUT A TEAM OF TWO
PERSONS AND THE NECESSARY HELP TO PROVIDE ADEQUATE
CONTROL OF FOOT AND VEHICLE TRAFFIC IN THE AREA DURING
ANTENNA ERECTION.**

AND

NEVER ERECT OR OPERATE THIS ANTENNA DURING AN ELECTRICAL STORM.

WARNING

**CLEARLY MARK THE ANTENNA AREA WITH SIGNS TO PREVENT PEOPLE AND
VEHICLES FROM DRIVING THROUGH THE AREA OR ATTEMPTING TO DRIVE UNDER
THE ANTENNA ITSELF. IT MAY BE NECESSARY TO POST SIGNS IN SEVERAL
LOCATIONS TO GET EFFECTIVE RESULTS.**

**IT MAY EVEN BE NECESSARY TO POST A GUARD OR WATCH DURING CERTAIN
TIMES (LIKE BLACKOUT OPERATIONS, BAD WEATHER, TROOP MOVEMENT).**

**YOUR SUPERVISOR SHOULD CONSULT WITH THE UNIT SAFETY OFFICER TO MAKE
SURE THAT ALL UNITS IN YOUR AREA ARE AWARE THAT YOUR LONG RANGE
ANTENNA IS TAKING UP A LARGE AREA AND TO BE CAREFUL.**

WARNING

**MAKE SURE THE SOIL CAN SAFELY HOLD YOUR ANTENNA ANCHORS. IF THE SOIL IS
LOOSE, MARSHY OR SANDY, IT MAY BE NECESSARY TO USE SPECIAL ANCHORS.
USE OF SPECIAL ANCHORS IS COVERED IN THIS MANUAL.
WHEN OPERATING UNDER UNUSUAL CONDITIONS, IT WILL BE NECESSARY TO
KEEP A SHARP EYE ON ALL ANCHORS UNTIL THESE CONDITIONS PASS.**

WARNING

CLEARLY MARK ALL GUY WIRES, GUY ROPES AND THE ANTENNA WIRES WITH FLAGS OR STREAMERS.
STRIPS OF CLOTH MAKE GOOD STREAMERS.

WARNING

IF THE WEATHER IN YOUR AREA CAN CAUSE ICE TO FORM ON THE ANTENNA, GUY WIRES AND GUY ROPES, ADD EXTRA GUYS TO SUPPORT THE ANTENNA. CLEARLY MARK THE AREA WITH WARNING SIGNS LIKE — “BEWARE OF FALLING ICE”.

WARNING

IF YOU SUSPECT THAT POWERLINES HAVE MADE ACCIDENTAL CONTACT WITH YOUR ANTENNA - STOP OPERATION - TURN OFF THE EQUIPMENT- ROPE OFF OR HAVE SOME PERSON GUARD THE ANTENNA AREA - AND NOTIFY YOUR TEAM CHIEF.

WARNING

WHEN SELECTING A SITE FOR YOUR ANTENNA, KEEP IN MIND THAT YOU SHOULD SELECT GROUND WHICH WILL NOT ACCUMULATE WATER WHICH CAN REACH UP TO THE TRANSFORMERS USED AT EACH END OF THE ANTENNA. THIS IS TO PREVENT A SHOCK HAZARD.

WARNING

FUMES OF TRICHLOROTRIFLOUROETHANE ARE POISONOUS. PROVIDE ADEQUATE VENTILATION WHENEVER YOU USE IT. DO NOT USE THIS SOLVENT NEAR HEAT OR OPEN FLAME. TRICHLOROTRIFLOUROETHANE WILL NOT BURN, BUT HEAT TURNS THE SOLVENT INTO POISONOUS AND IRRITATING FUMES. DO NOT BREATHE THE FUMES OR VAPORS. THIS SOLVENT DISSOLVES NATURAL SKIN OILS. DO NOT GET THE SOLVENT ON YOUR SKIN. USE GLOVES, SLEEVES AND AN APRON WHICH THE SOLVENT CANNOT PENETRATE. IF THE SOLVENT IS TAKEN INTERNALLY, CONSULT A PHYSICIAN IMMEDIATELY. USE THIS SOLVENT ONLY ON THE METAL MAST SECTIONS, DO NOT CLEAN THE TRANSFORMER HOUSINGS WITH THIS SOLVENT.

**5**

SAFETY STEPS TO FOLLOW IF SOMEONE IS THE VICTIM OF ELECTRICAL SHOCK

1

DO NOT TRY TO PULL OR GRAB THE INDIVIDUAL

2

IF POSSIBLE , TURN OFF THE ELECTRICAL POWER

3

IF YOU CANNOT TURN OFF THE ELECTRICAL POWER, PULL, PUSH, OR LIFT THE PERSON TO SAFETY USING A WOODEN POLE OR A ROPE OR SOME OTHER INSULATING MATERIAL

4

SEND FOR HELP AS SOON AS POSSIBLE

5

AFTER THE INJURED PERSON IS FREE OF CONTACT WITH THE SOURCE OF ELECTRICAL SHOCK, MOVE THE PERSON A SHORT DISTANCE AWAY AND IMMEDIATELY START ARTIFICIAL RESUSCITATION

HOW TO USE THIS MANUAL

This technical manual includes a cover index to assist you in locating the information you need to operate and maintain Antenna Group OE-303/GRC.

In addition, this manual is also divided into chapters, sections and paragraphs which are numbered sequentially.

Instructions on installation and use of this antenna equipment are presented in a detailed sequence. **DO NOT ATTEMPT ANY SHORT CUTS** in installing and using this antenna equipment. **FOLLOW THE INSTRUCTIONS IN THIS MANUAL.**

This antenna equipment has been designed to work with certain radio sets in a certain frequency range. **DO NOT ATTEMPT TO REDESIGN THIS ANTENNA.** Follow the specific **DIMENSIONS** and **MEASUREMENTS** in this manual.

TECHNICAL MANUAL
NO. 11-5985-370-12

HEADQUARTERS
DEPARTMENT OF THE ARMY
Washington, DC, 19 July 1984

**OPERATOR'S AND ORGANIZATIONAL MAINTENANCE MANUAL
FOR ANTENNA GROUP OE-303/GRC
(NSN 5985-01-152-5845)**

REPORTING ERRORS AND RECOMMENDING IMPROVEMENTS

You can help improve this manual. If you find any mistakes or if you know of a way to improve the procedures, please let us know. Mail your letter, DA Form 2028 (Recommended Changes to Publications and Blank Forms), or DA Form 2028-2 located in the back of this manual direct to: Commander, US Army Communications-Electronics Command and Fort Monmouth, ATTN: DRSEL-ME-MP Fort Monmouth, New Jersey 07703.

In either case, a reply will be furnished direct to you.

	PAGE
HOW TO USE THIS MANUAL	D
CHAPTER 1. INTRODUCTION	
Section I. General Information	1-1
II. Equipment Description	1-10
III. Principles of Operation	1-17
CHAPTER 2. OPERATING INSTRUCTIONS	
Section I. Description and Use of Operator's Controls	2-1
II. PMCS	2-4
III. Operation Under Normal Conditions	2-9
IV. Antenna Erection	2-13
V. Orienting the Half -Rhombic Antenna	2-25
VI. Operation Under Unusual Conditions	2-35

CHAPTER 3. OPERATOR MAINTENANCE

Section I. Troubleshooting 3-1

CHAPTER 4. ORGANIZATIONAL MAINTENANCE

Section I. Repair Parts and TMDE 4-1
II. PMCS 4-1
III. Troubleshooting 4-3
IV. Maintenance Procedures 4-6

APPENDIX A Reference A - 1
B Maintenance Allocation B - 1
C Components of End Item List C - 1
D Additional Authorization List (Not Applicable) D - 1
E Expendable Supplies and Materials List E - 1

CHAPTER 1

INTRODUCTION

SECTION I. GENERAL INFORMATION

1-1. SCOPE

This technical manual covers Antenna Group OE-303/GRC.

Instructions are given for:

- installation (2 person team)
- operation.
- troubleshooting.
- operator/crew maintenance.
- organizational maintenance.

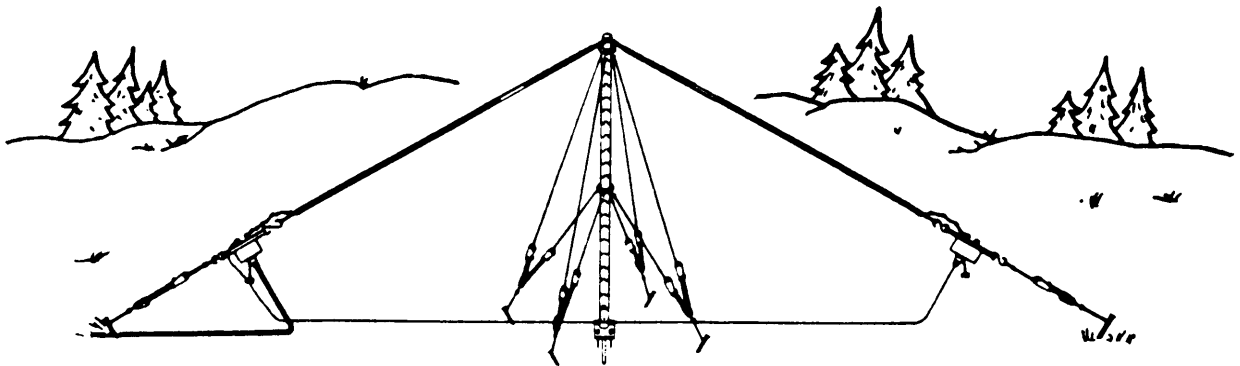

Antenna Group OE-303/GRC consists of **3 major items**:

- Antenna **AS-3490/GRC**.
- Radio Frequency Cable Assembly **CG-1889 C/U**.
- Mast Assembly **AB-1244A/GRC**.

Antenna Group OE-303/GRC has the following characteristics:

- rugged.
- lightweight.
- directional radiation.
- no adjustments required.
- easy installation.

It cannot be overemphasized that this antenna must be **used with caution**. It occupies a large area, Both foot and vehicular **traffic must be controlled** in the antenna area. The **CAUTIONS** and **WARNINGS** in the manual give you specific instructions on how to control traffic and to prevent accidents.

1-2. MAINTENANCE FORMS, RECORDS AND REPORTS

Reports of Maintenance and Unsatisfactory Equipment.

- Department of the Army forms and procedures used for equipment maintenance will be those prescribed by DA Pam 738-750 as contained in the Maintenance Management Update. Air Force personnel will use AFR 66-1 for maintenance reporting and TO-00-35D54 for unsatisfactory equipment reporting. Navy personnel will report maintenance performed utilizing the Maintenance Data Collection Subsystem (MDCS) IAW OPNAVINST 4790.2, Vol 3 and unsatisfactory material/conditions (UR submissions) IAW OPNAVINST 4790.2, Vol 2, chapter 17.

Reporting of Packaging and Handling Deficiencies.

- Fill out and forward SF 364 (Report of Discrepancy (ROD)) as prescribed in AR 735-11-2/DLAR 4140.55/NAVMATINST 4355.73A/AFR 400-54/MCO 4430.3F.

Discrepancy In Shipment Report (DISREP) (SF 361).

- Fill out and forward Discrepancy in Shipment Report (DISREP) (SF 361) as prescribed in AR 55-38/NAVSUPINST 4610.33C/AFR 75-18/MCO P4610.19D/DLAR 4500.15.

1-3. DESTRUCTION OF ARMY ELECTRONICS MATERIEL

Destruction of Army electronics materiel to prevent enemy use shall be in accordance with TM 750-244-2,

1-4. ADMINISTRATIVE STORAGE

Administrative storage of equipment issued to and used by Army activities will have preventive maintenance performed in accordance with the PMCS chart before storing. When removing the equipment from administrative storage, the PMCS should be performed to assure operational readiness.

1-5. REPORTING EQUIPMENT IMPROVEMENT RECOMMENDATIONS (EIR)

If your equipment needs improvement, let us know. Send us an EIR. You, the user are the only one who can tell us what you don't like about your equipment. Let us know why you don't like the design. Put in on SF 368 (Quality Deficiency Report). Mail it to Commander, U.S. Army Communications-Electronics Command and Fort Monmouth, ATTN: DRSEL-ME-MP, Fort Monmouth, NJ 07703. We'll send you a reply.

1.6. WARRANTY INFORMATION

Certain items of equipment are covered under a special warranty. Your C-E ORG MAINT team should have the necessary information for identifying which items are protected and the procedures for getting warranty repair and/or replacement.

1-7. NOMENCLATURE CROSS-REFERENCE LIST

COMMON NAME **OFFICIAL NOMENCLATURE AND GENERAL APPLICATION**
 FOR ANTENNA AS-3490/GRC (One of three major items making up the OE-303/GRC)

HALF—RHOMBIC ANTENNA Antenna Wire Assembly, VHF INVERTED-V. Antenna consisting of 166 feet of WD-1/TT Field Wire.

MAST INSULATOR Insulating Tube Assembly. Fits on top of the mast to insulate and form a V (half-rhombic, field wire) antenna.

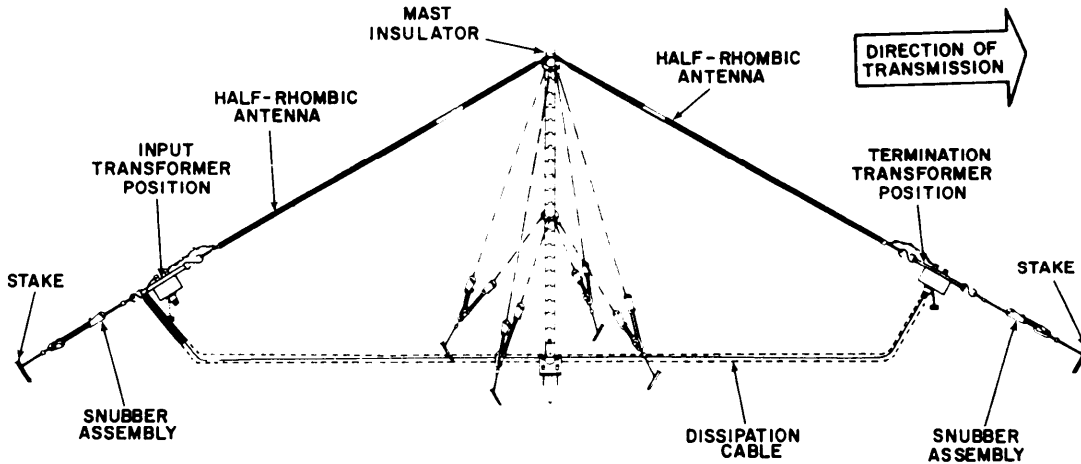

DISSIPATION CABLE TRANSMISSION LINE, DISSIPATION. 175 feet of RG-316/U.

INPUT TRANSFORMER Transformer, Matching. For proper connection to the radio set.

TERMINATION TRANSFORMER Transformer, Matching.

SNUBBER ASSEMBLY Snubber Assembly, transformer. secures transformer to a stake.

ANTENNA STAKE Stake, Antenna One for the INPUT TRANSFORMER and one for the TERMINATION TRANSFORMER.

ANTENNA REEL Reel, RL-29, one for the field wire antenna and one for the antenna DISSIPATION CABLE.

RUNNING SPARES Includes 1 each transformer, matching and 1 each stake, antenna guy.

NOTE: ANY OF THE TRANSFORMERS CAN BE PLACED IN THE INPUT OR TERMINATION TRANSFORMER POSITION. THE TERMINATION TRANSFORMER IS IN THE DIRECTION OF TRANSMISSION AND ITS GROUND TERMINAL IS LEFT UNCONNECTED.

1-7. NOMENCLATURE CROSS-REFERENCE LIST (Continued)

COMMON NAME

OFFICIAL NOMENCLATURE AND GENERAL APPLICATION

FOR RADIO FREQUENCY CABLE ASSEMBLY CG-1889C/U. The second of three major items making up Antenna Group OE-303/GRC

RADIO CABLE

Cable Assembly, RF.
50 feet of RG-213/U coaxial cable.
Used to connect the INPUT TRANSFORMER on the HALF—RHOMBIC ANTENNA to the radio set.

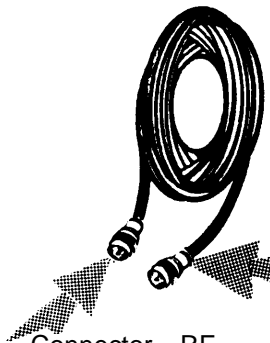

**RADIO CABLE
END CONNECTOR**

Connector, RF.
One connector is permanently installed on each end of the RADIO CABLE.

**RADIO CABLE
ADAPTER**

Connector Adapter, Part Number TRU 2064-1.
A type N female to BNC male adapter.
Required to connect certain radio that cannot accept the permanently attached RADIO CABLE END CONNECTOR .

**ANTENNA TRANSIT
BAG**

BAG, transit.
Holds two major items in Antenna Group OE-303/GRC.

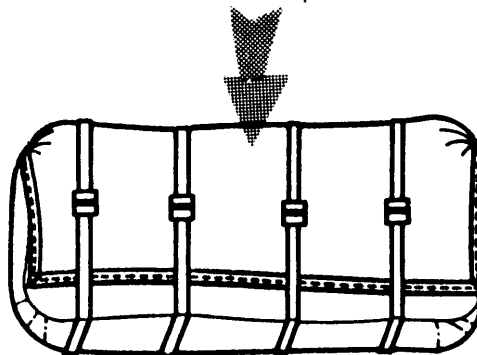

7.1 NOMENCLATURE CROSS-REFERENCE LIST (Continued)

FOR MAST ASSEMBLY AB-1244A/GRC. The third item making up ANTENNA GROUP OE-303/GRC.

COMMON NAME	OFFICIAL NOMENCLATURE AND GENERAL APPLICATION
1 MAST AND BASE ASSEMBLY	Mast and Base Assembly, 1 each. Lower part is a Stake. Upper part is a movable short mast.
2 MAST BASE PLATE	Plate, 1 each. The base for the Mast Assembly.
3 MAST BASE STAKE	Stake, 2 each. Secure Mast Base Plate.
4 LOWER MAST SECTION	Mast Section Assembly, Lower, 5 each. Form bottom part of mast.
5 LOWER ADAPTER ASSEMBLY	Adapter Assembly, Lower, 1 each. For properly holding the Lower Guy Plate.
6 LOWER GUY PLATE	Guy Plate, 1 each. Holds 4 Lower Guy Assemblies.
7 UPPER MAST SECTION	Mast Section Assembly, Upper, 5 each. Form top part of mast.
8 UPPER ADAPTER ASSEMBLY	Adapter Assembly, Upper, 1 each. For properly holding the Upper Guy Plate.
9 UPPER GUY PLATE	Guy Plate, 1 each. Holds 4 Upper Guy Assemblies.
10 UPPER GUY ASSEMBLY	Guy Assembly, 4 each. Color Code = Red.
11 LOWER GUY ASSEMBLY	Guy Assembly, 4 each. Color Code = Blue.

12 GUY STAKE

Stake Assembly, 4 Each.
Secure the 4 Upper and 4 Lower Guy Assemblies.

13 RL-28 REEL

Reel, RL-28, 2 each, for the GUY ASSEMBLIES.

14 HAMMER

Hammer, 1 each, 2½ pound.

15 MAST TRANSIT BAG

Bag, Transit, 1 each, for all Mast AB-1224A/GRC items.

16 16 STRAIN CLAMP

Clamp, electrical, conductor, strain. 1 each is issued but not used with the OE-303/GRC.

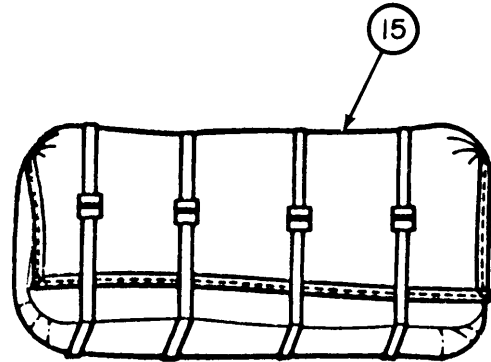
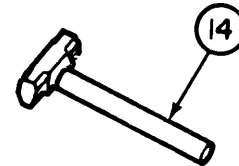
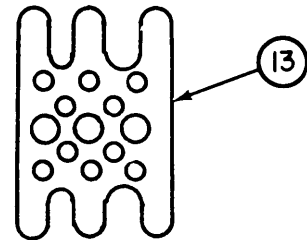
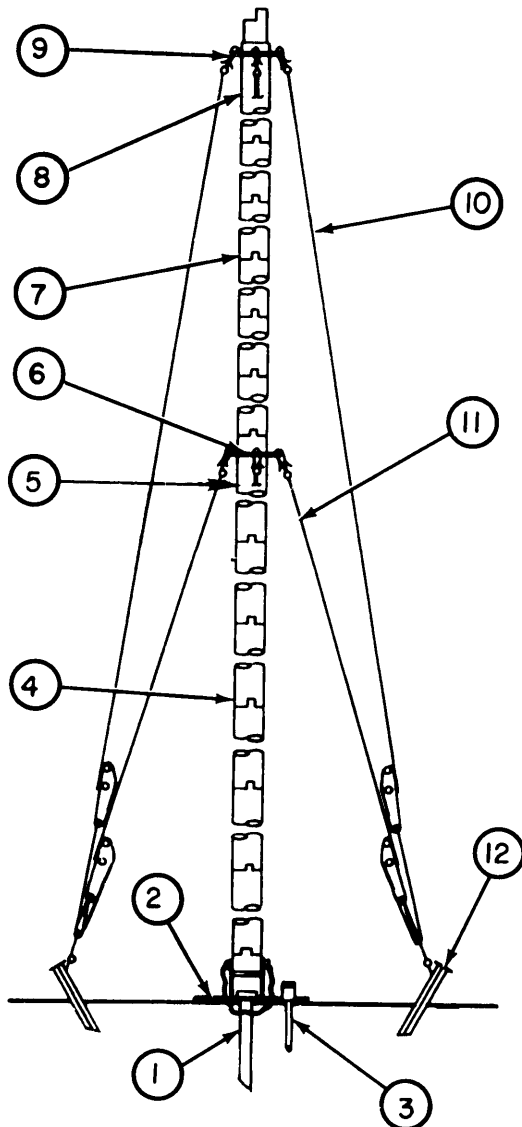

NOTE: Items used with the LOWER MAST SECTIONS and the LOWER GUYS are associated with Blue markings on components. Items used with the UPPER MAST SECTIONS and the UPPER GUYS are associated with Red markings on components.

1-7. NOMENCLATURE CROSS-REFERENCE LIST (Continued)

COMMON NAME OFFICIAL NOMENCLATURE

MULTIMETER Multimeter AN/USM-223.

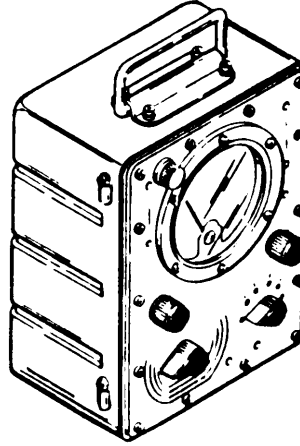

TOOL KIT Tool Kit, Electronic, TK-100/G.
(NOT SHOWN)

COMPASS Compass, Magentic.

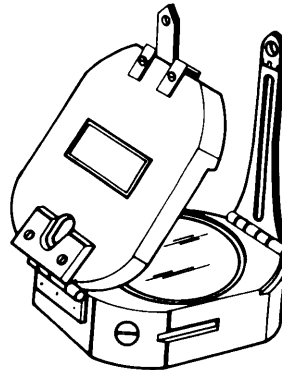

1-8. LIST OF ABBREVIATIONS

MHZ	Megahertz
RF	Radio Frequency
VHF	Very High Frequency
PMCS	Preventive Maintenance Checks and Services

1-9. GLOSSARY

BIDIRECTIONAL	Any two opposite directions.
CEOI	Communication Electronics Operating Instructions
CONFIGURATION	Arrangement or hook-up.
DISSIPATION LINE	A cable connected to form a resistance and to get rid of heat.
HALF-RHOMBIC	One half of a Rhombus.
HORIZONTAL POLARIZATION	A radio wave front from a horizontal antenna.
OMNIDIRECTIONAL	All directions.
RHOMBIC	A rhombus or diamond shape.
UNIDIRECTIONAL	Any ONE DIRECTION.
VERTICAL POLARIZATION	A radio wave front from a vertical antenna.

SECTION II. EQUIPMENT DESCRIPTION

1-10. EQUIPMENT PURPOSE, CAPABILITIES AND FEATURES

Designed to provide greater range for **two families of VHF radios:**

AN/VRC-12 series of vehicular radio sets:

- Includes AN/VRC-12, AN/VRC-43, AN/VRC-44, AN/VRC-45, AN/VRC-46, AN/VRC-47, AN/VRC-48, AN/VRC-49.

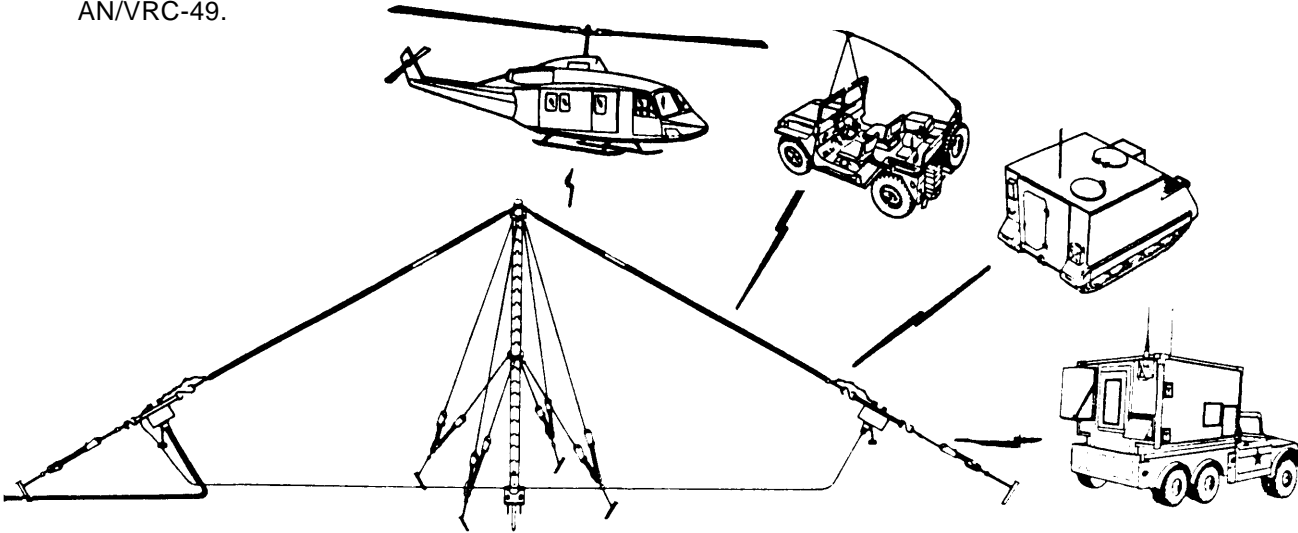

AND

Early model (partial solid state) portable radio sets

- Includes AN/PRC-25, AN/VRC-53 and AN/GRC-125.

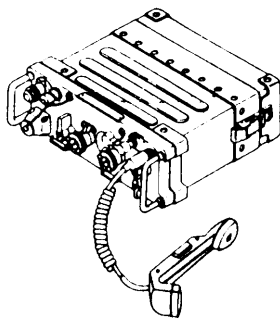

OR

Late Model (all solid state) portable radio sets:

- Includes AN/PRC-77, AN/VRC-64 and AN/GRC-160.

Simple design:

- **No complicated parts.**
- **Simple connection** to a radio set.
- **Easy to erect.**
- **Easy to disassemble.**
- **Rugged** enough to stay in a location for a long time.
- **Easily transported** in 2 TRANSIT BAGS.

The **HALF-RHOMBIC ANTENNA IS A VERTICAL ANTENNA.**

- It is a **vertically polarized antenna.**
- Radiation pattern is **UNIDIRECTIONAL:**

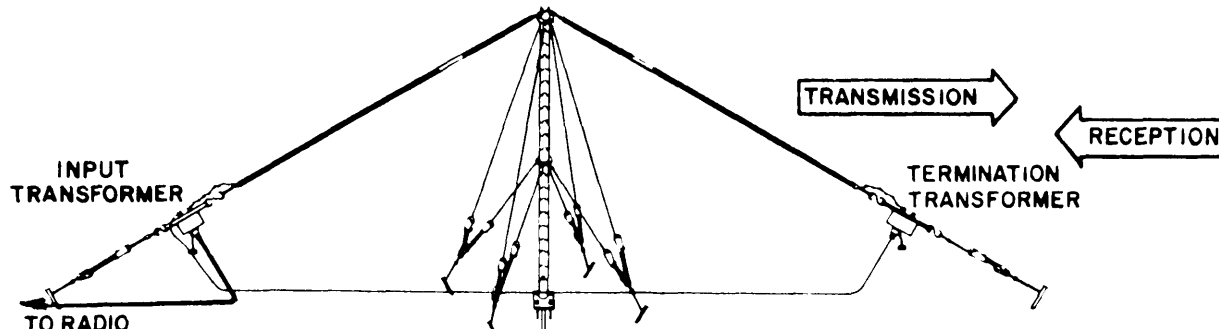

- **The end of the HALF RHOMBIC ANTENNA with the TERMINATION TRANSFORMER points in the direction of BEST TRANSMISSION AND RECEPTION.**

The **UNIDIRECTIONAL characteristic** of the HALF RHOMBIC ANTENNA also **provides:**

- **Greater Range**
- AND
- **More secure** operating conditions.

You can greatly reduce your signal towards the enemy by properly orienting your antenna.

WARNING

**DO NOT GUESS WHICH DIRECTION IS WHICH
WHEN ORIENTING YOUR ANTENNA. USE YOUR
MAPS AND COMPASS TO GET SAFE ORIENTATION.**

1-11. TYPICAL LAYOUT OF ANTENNA GROUP OE-303/GRC IN A FIELD OPERATION

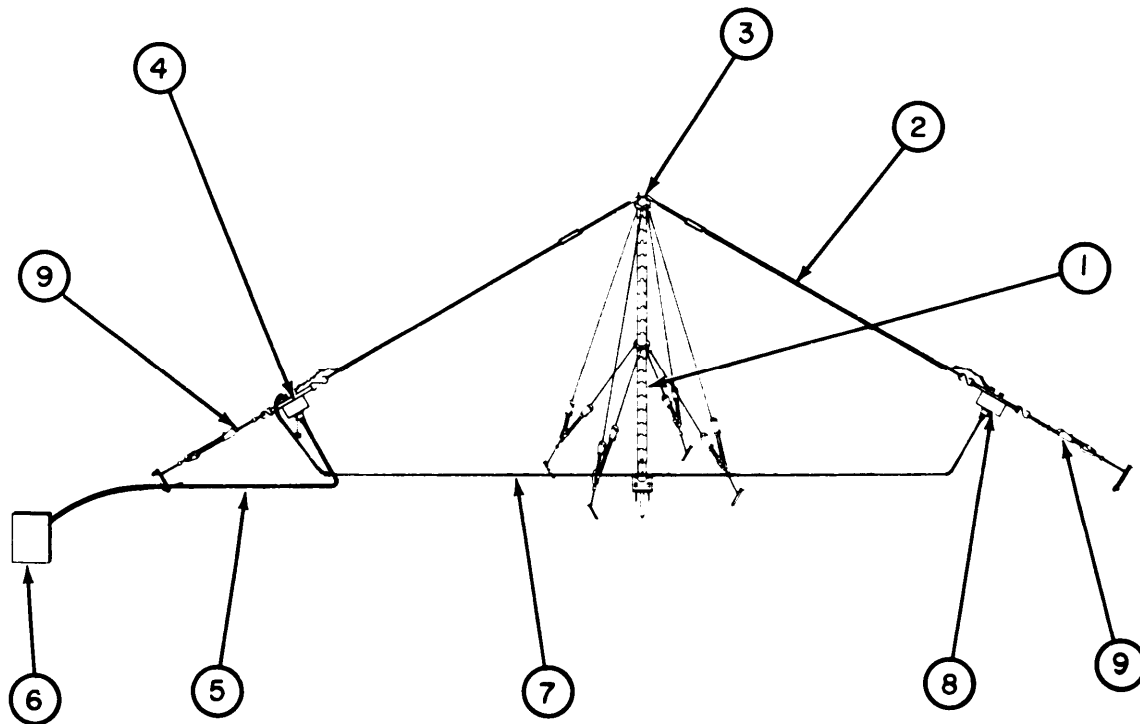

① MAST ASSEMBLY AB-1244A/GRC

- 30+ feet tall.
- 30 Same assembly is used on Antenna Groups OE-254/GRC.

- ② HALF-RHOMBIC ANTENNA
 - 166 feet of Field Wire, WD1/TT.

- ③ MAST INSULATOR
 - Insulates the HALF RHOMBIC ANTENNA from the MAST.

- ④ INPUT TRANSFORMER
 - Provides proper electrical connection to the HALF-RHOMBIC ANTENNA.

- ⑤ RADIO CABLE
 - .50 feet of coaxial cable RG-213/U.

- ⑥ RADIO SET
 - I Any one of the AN/VRC-12 series of radio sets

 - R

 - I Any one of the AN/PRC-25 or AN/PRC-77 series of radio sets.

- ⑦ DISSIPATION CABLE
 - 175 feet of coaxial cable RG-316/IJ.

 - This cable acts as a large dissipation and termination resistor when it is connected to the other end of the HALF-RHOMBIC ANTENNA through the TERMINATION TRANSFORMER.

- ⑧ TERMINATION TRANSFORMER
 - I Provides proper electrical matching for connecting the DISSIPATION CABLE to the other end of the HALF-RHOMBIC ANTENNA.

- ⑨ TRANSFORMER SNUBBER ASSEMBLY (one for each transformer)
 - Secures Transformer to Stake.

1-12. EQUIPMENT DATA

DIMENSIONS AND WEIGHTS

- **WEIGHT OF ENTIRE ANTENNA SYSTEM**

50 pounds (including the 2 TRANSIT BAGS).

- **HEIGHT OF ANTENNA**

Approximately 31 feet to top of MAST ASSEMBLY.

ELECTRONIC CHARACTERISTICS

- **FREQUENCY RANGE**

Designed to operate in the 30 mHz to 88 mHz VHF range.

- **RF POWER CAPABILITY**

350 Watts.

- **OPERATING CONDITIONS**

Rugged enough to operate in all theatres of operation.

- **VERTICAL RADIATION PATTERN**

This HALF-RHOMBIC ANTENNA produces a very desirable **VERTICAL ANGLE RADIATION PATTERN**:

- Including **good signal from** approximately **6 degrees UP to 10 degrees**.

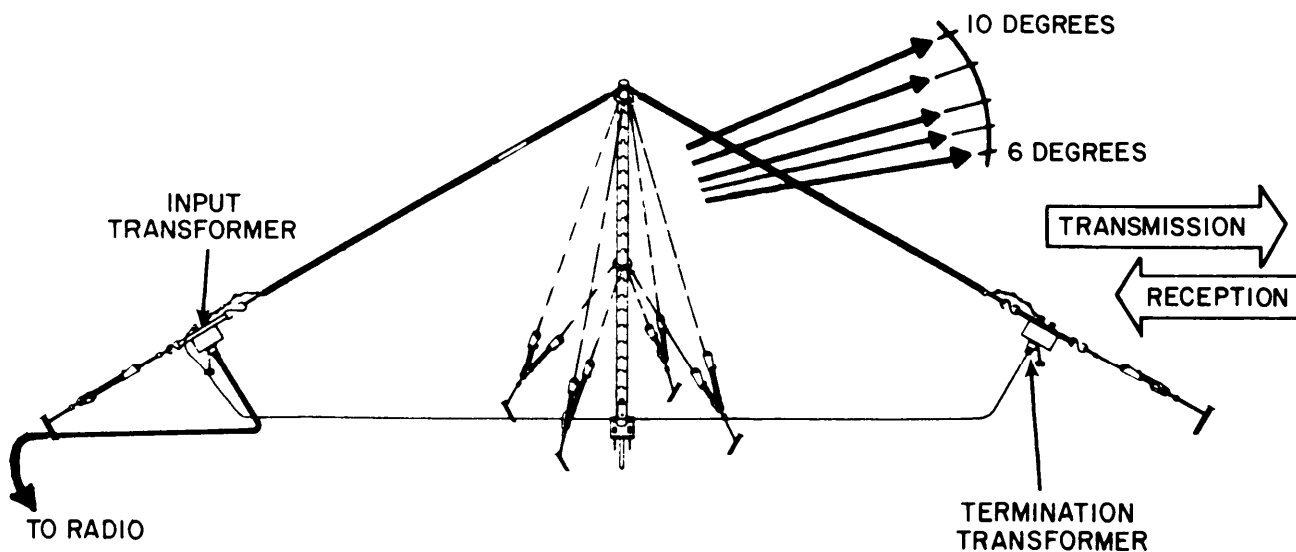

• HORIZONTAL RADIATION PATTERNS

NOTE: The  (in the drawings below) is the **direction the antenna is pointing** (the end with the TERMINATION TRANSFORMER).

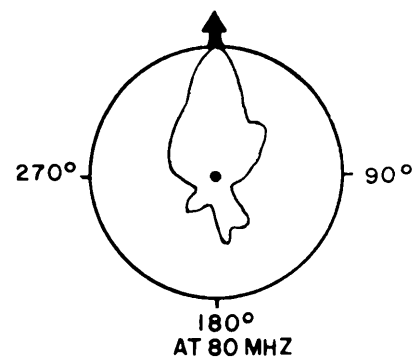
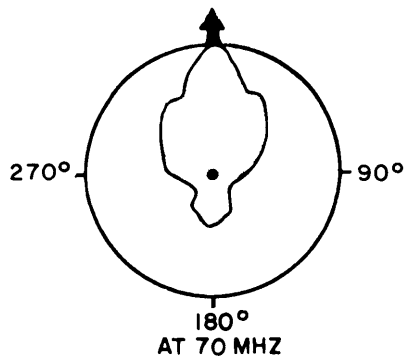
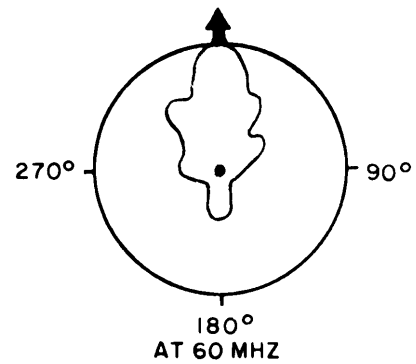
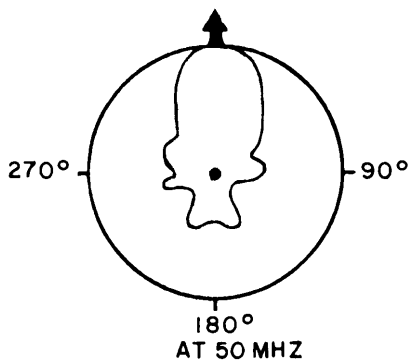
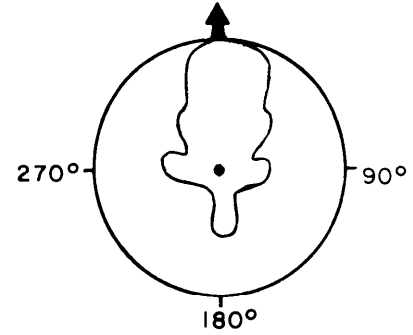
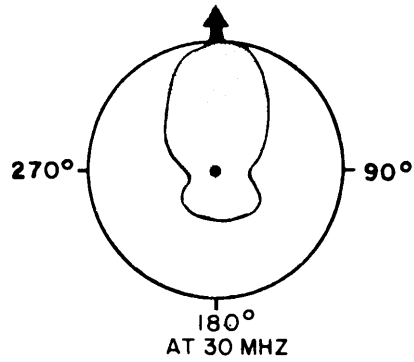

The **LOW ANGLE VERTICAL RADIATION CHARACTERISTICS** and the **UNIDIRECTIONAL HORIZONTAL RADIATION CHARACTERISTICS** make this an excellent antenna for field use.

DISTANCE RANGE FOR AN/VRC-12 SERIES OF RADIOS

CONDITIONS: Both radios on HIGH POWER
AND

Both radios using ANTENNA GROUP OE-303/GRC.

- Over average terrain = 36 miles (57.9 km)
- Over difficult terrain = 30 miles (48.3 km)

CONDITIONS: One radio using ANTENNA GROUP OE-303/GRC and other radio using whip antenna.

Both radios on HIGH POWER.

- Over average terrain = 30 miles (48.3 km)
- Over difficult terrain = 25 miles (40.3 km)

DISTANCE RANGE FOR PORTABLE RADIO SETS

INCLUDING: AN/PRC-25, AN/PRC-77, AN/VRC-53, AV/VRC-54, AN/GRC-125 and AN/GRC-160

CONDITIONS: Both radios using ANTENNA GROUP OE-303/GRC.

- Over average terrain = 12 miles (19.3 km)

CONDITIONS: One radio using ANTENNA GROUP OE-303/GRC and other radio using whip antenna.

- Over average terrain = 8 miles (12.9 km)

SECTION III. PRINCIPLES OF OPERATION

1-13. GENERAL PRINCIPLES OF OPERATION

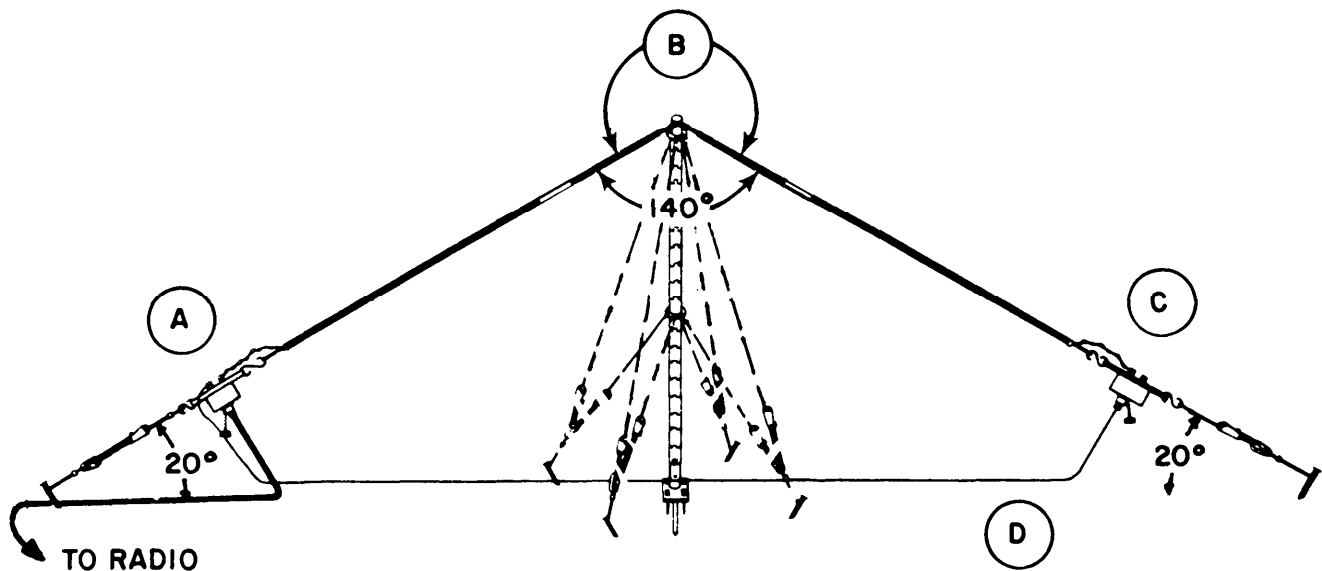

- (A) INPUT TRANSFORMER:** Your radio is connected by the 50 foot RADIO CABLE to the 166 foot HALF-RHOMBIC ANTENNA through this transformer:
- It is connected as a step-up transformer with a ratio of 1 to 9.
 - This ratio allows proper matching to get maximum transmitter power from your radio transmitter to the antenna (over a wide frequency range without adjustments) and maximum received RF signal from the antenna to your radio receiver.
- (B) HALF-RHOMBIC ANTENNA:** The 166' of field wire is the actual RF radiating and pickup element in the antenna system.
- (C) TERMINATION TRANSFORMER:** It is connected as a step-down transformer with a ratio of 9 to 1. Used to properly connect the end of the 166' antenna and the DISSIPATION CABLE.
Note: Any transformer can operate in any position.
- (D) DISSIPATION CABLE.** Acts in place of a counterpoise and a resistive element **to produce** the **SHARP-UNIDIRECTIONAL - ANTENNA PATTERN.**

Characteristics of the HALF-RHOMBIC ANTENNA

- **Broad band** (no need to change the length of the WD-1/TT Field Wire).
- Good noise and interference rejection.
- **Simple construction.**
- Highly **desirable** UNIDIRECTIONAL horizontal **radiation pattern** with a LOW ANGLE vertical radiation pattern.

Remember, the HALF RHOMBIC ANTENNA operates in a UNIDIRECTIONAL PATTERN with VERTICAL POLARIZATION.

- **FOR BEST RESULTS:**

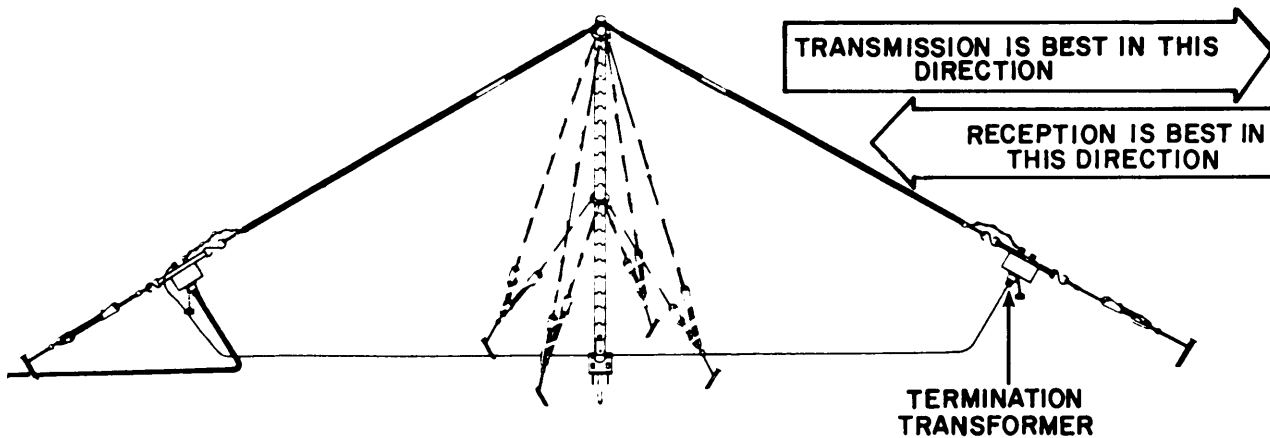

AND

BOTH RECEPTION AND TRANSMISSION WILL BE IMPROVED IF THE DISTANT STATION USES A VERTICAL ANTENNA.

CHAPTER 2

OPERATING INSTRUCTIONS

SECTION 1. DESCRIPTION AND USE OF OPERATOR'S CONTROLS, INDICATORS AND RECEPTACLES.

2-1. OPERATOR'S RECEPTACLES ON THE RADIO CABLE.

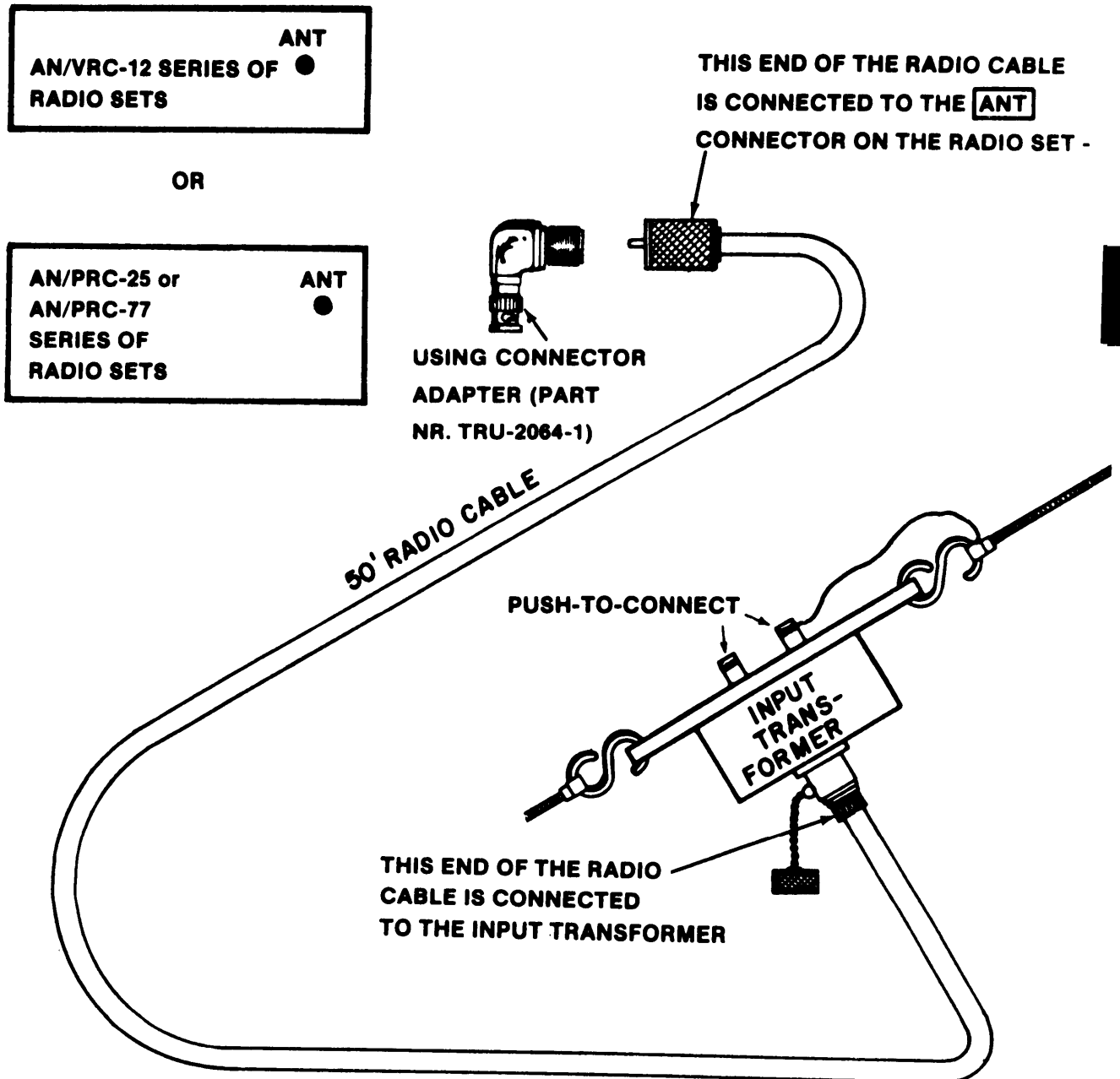

2-2. OPERATOR'S CONNECTORS AND RECEPTACLES ON OUTPUT TRANSFORMER

- ① End of HALF-RHOMBIC ANTENNA wire TO:
- ② Antenna binding post on TRANSFORMER.
- ③ Connection from **GROUND** binding post to the 6 inch ground wire on the end of the **DISSIPATION CABLE**.
- ④ 48-inch TRANSFORMER **SNUBBER ASSEMBLY**:
 - **S-HOOK** end connects to **TRANSFORMER** body.
 - Other end to **ANCHOR HOOK** on **STAKE**.
- ⑤ Connection of the 50' **RADIO CABLE**.
 - Other end goes to the **RADIO**.

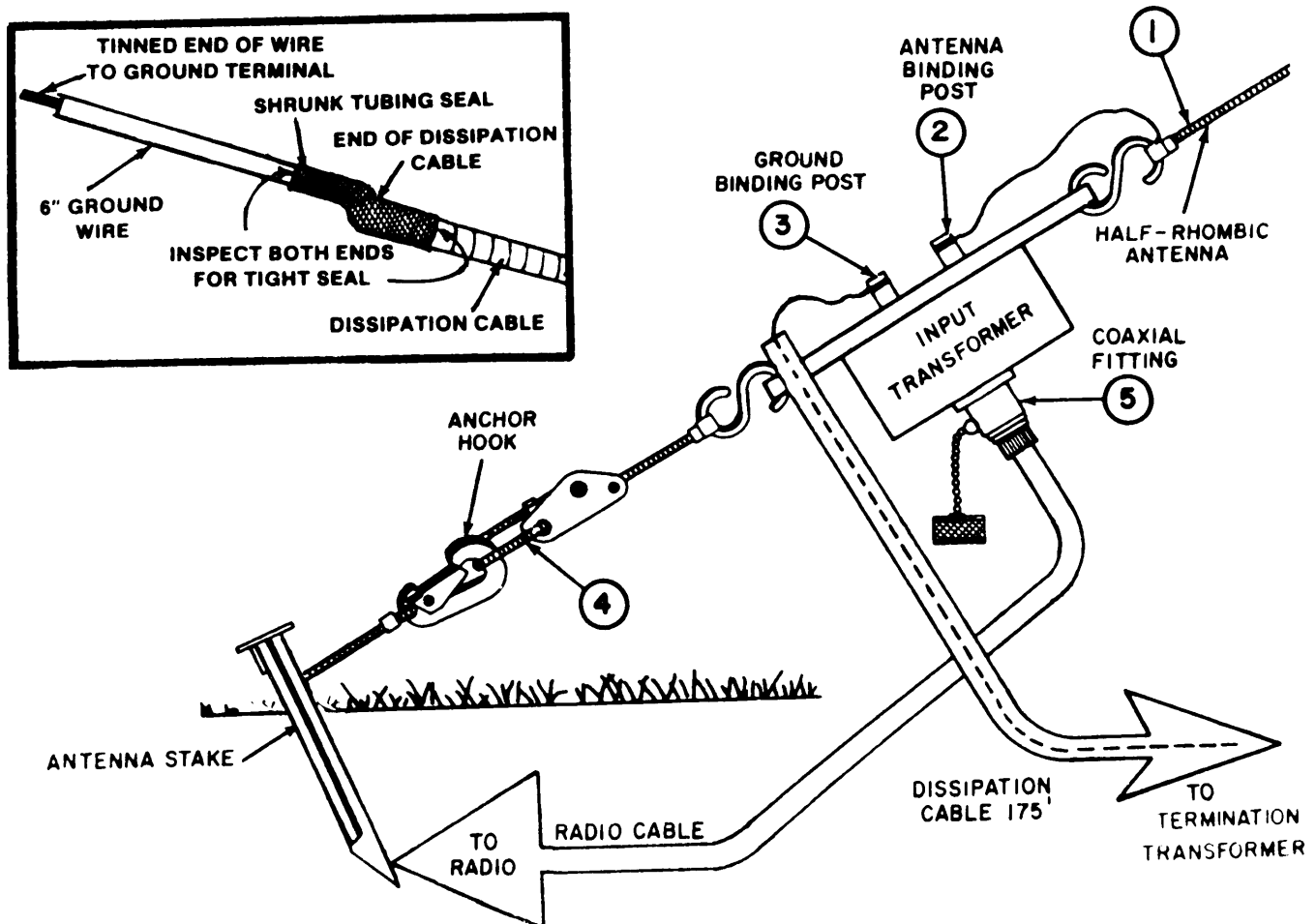

2-3. OPERATOR'S CONNECTORS AND RECEPTACLES ON TERMINATION TRANSFORMER

- ① End of HALF-RHOMBIC ANTENNA (Field Wire WD-1/TT) connected to:
- ② ANTENNA binding post (push-to-connect) on Transformer.
- ③ Ground binding post, **NO CONNECTION TO BE MADE** (when the Transformer is in the TERMINATION TRANSFORMER POSITION).
- ④ 48 inch TRANSFORMER SNUBBER ASSEMBLY:
 - S-HOOK end connects to TRANSFORMER body.
 - Other end to ANCHOR HOOK on STAKE.
- ⑤ Connection for the 175' DISSIPATION CABLE.
 - Using Connector Adapter, UG-201 A/U.

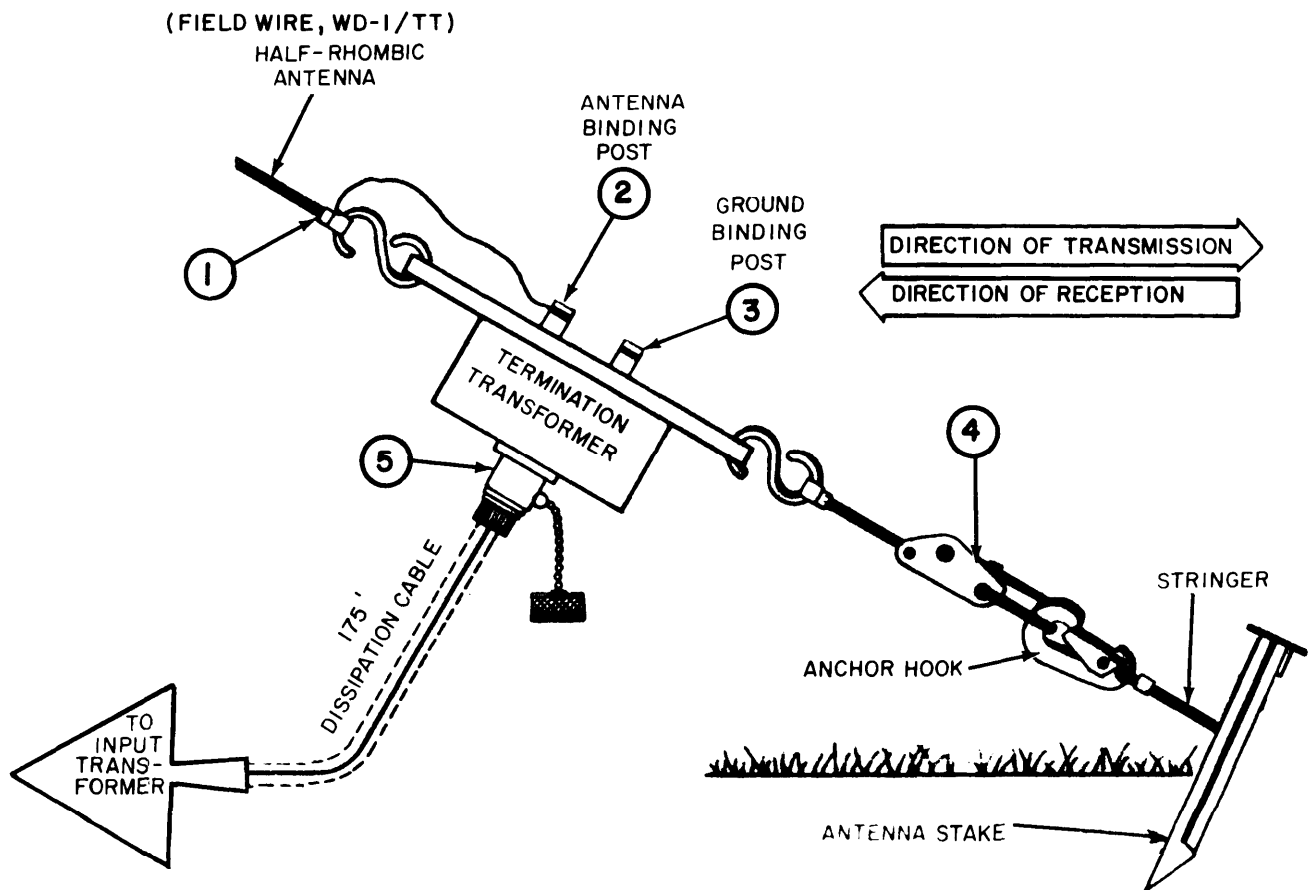

SECTION II. OPERATOR/CREW PREVENTIVE MAINTENANCE CHECKS AND SERVICES

2.4 General

To be sure that your equipment is always ready for your mission, you must do **scheduled Preeventive Maintenance Checks and Services (PMCS)** as outlined in Table 2-1.

BEFORE OPERATION perform your **(B) PMCS** to be sure that your equipment is ready to go.

DURING OPERATION perform your **(D) PMCS**. This should help you spot small problems before they become big problems.

AFTER OPERATION perform your **(A) PMCS**. This should help keep your equipment in top shape.

WEEKLY AND MONTHLY PMCS are important checks you make to keep serious problems from suddenly happening.

ROUTINE CHECKS AND SERVICES are not listed in your PMCS TABLE. These **routine checks** and services **should be done anytime you see that they are necessary**. Examples of routine checks are:

- Cleaning, dusting, washing and spot painting
- Checking for loose or binding controls, covering unused receptacles, stowing items when not in use.
- Checking for loose hardware, mountings and straps.
- Inventorying equipment, periodic operational checks.

If you find what you considers routine check in the PMCS TABLE, it was listed because others have reported it as a critical problem.

2-5. USE OF DA FORM 2404 FOR PMCS

If your equipment must be in **operation all the time**, check and service those items that can be **checked and serviced without disturbing operation**. Make the complete checks and services when the equipment is shut down.

Use the **ITEM NO.** column in your **PMCS TABLE 2-1** to get the **numbers for the TM ITEM NO.** column **on DA FORM 2404**. (Equipment Inspection and Maintenance Worksheet) when you fill out the form.

TM ITEM NO. a	STATUS b	DEFICIENCIES AND SHORTCOMINGS c	CORRECTIVE ACTION d	INITIAL WHEN CORRECTED e
4		TRANSFORMER CRACKED		

DA FORM 2404
1 JAN 64

CAUTION

The PROCEDURES column in your PMCS TABLE 2-1 instructs you to CHECK AND HAVE REPAIRED OR ADJUSTED AS NECESSARY. Carefully follow these instructions - AND - REMEMBER, YOU ARE NOT AUTHORIZED TO OPEN UP ANY UNIT.

WARNING

WHEN YOU ARE DOING ANY PMCS OR ROUTINE CHECKS, KEEP IN MIND ALL OF THE WARNINGS AND CAUTIONS IN THIS MANUAL.

CAUTION

DO NOT USE TRICHLOROTRIFLOUROETHANE TO CLEAN THE TRANSFORMERS.

TABLE 2-1. OPERATOR/CREW PREVENTIVE MAINTENANCE CHECKS AND SERVICES

B—BEFORE OPERATION
D—DURING OPERATION

A—AFTER OPERATION
W—WEEKLY

M—MONTHLY

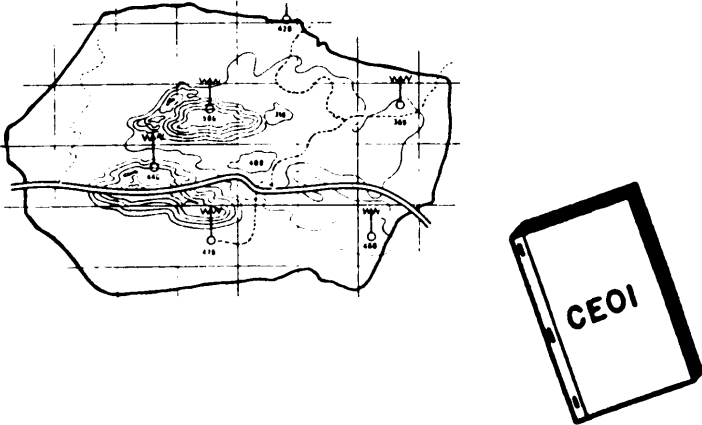
ITEM NO.	INTERVAL					ITEMS TO BE INSPECTED	PROCEDURES CHECK AND HAVE REPAIRED OR ADJUSTED AS NECESSARY	FOR READINESS REPORTING EQUIPMENT IS NOT READY AVAILABLE IF:
	B	D	A	W	M			
1	●					<p>TECHNICAL DATA SOURCES</p>	<p>MAKE SURE that the</p> <ul style="list-style-type: none"> • MAPS • Hand-held COMPASS • CEOI <p>ARE IN YOUR POSSESSION, IN THEIR PROPER PLACE AND - THAT THEY ARE THE CORRECT ITEMS AND USABLE AND READABLE.</p> <div style="text-align: center;">  </div>	<p>ANY DATA SOURCE REQUIRED FOR YOUR MISSION IS NOT AVAILABLE OR OPERABLE OR USABLE.</p>

2



SAFETY CHECKS

Periodically check:

- Your signs and antenna markers and antenna streamers and make sure they are in place.

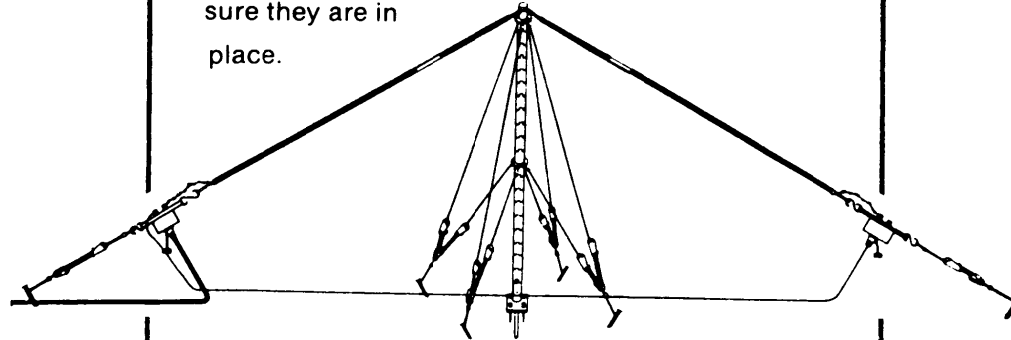

3



**OPERATION IN
BAD WEATHER**

Periodically check:

- guys,
- guy and antenna stakes
- **MAST** components,

to make sure they are **SECURE**.



4



**RADIO
COMMUNICATIONS**

During operation:

- If communications fail,
**CAREFULLY CHECK ANTENNA
COMPONENTS.**

**COMMUNICATIONS
FAIL BECAUSE A
TRANSFORMER IS
DAMAGED.**

TABLE 2-1 OPERATOR/CREW PREVENTIVE MAINTENANCE CHECKS AND SERVICES (Continued)

B—BEFORE OPERATION
D—DURING OPERATION

A—AFTER OPERATION
W—WEEKLY

M—MONTHLY

ITEM NO.	INTERVAL					ITEMS TO BE INSPECTED	PROCEDURES CHECK AND HAVE REPAIRED OR ADJUSTED AS NECESSARY	FOR READINESS REPORTING EQUIPMENT IS NOT READY AVAILABLE IF:
	B	D	A	W	M			
5					●	MWO'S	YOU MUST CHECK WITH C-E ORG MAINTENANCE ONCE A MONTH TO MAKE SURE THAT ALL MODIFICATION WORK ORDERS (MWO'S) HAVE BEEN DONE ON THE EQUIPMENT.	C-E ORG MAINT TELLS YOU THAT ONE OR MORE MWO'S HAVE NOT BEEN DONE TO YOUR EQUIPMENT.

SECTION III. OPERATION UNDER NORMAL CONDITIONS

BEFORE INSTALLING AND USING THIS ANTENNA, CAREFULLY READ THE FOLLOWING WARNINGS.

WARNING

CLEARLY MARK ALL GUY WIRE, GUY ROPES AND THE ANTENNA WIRES WITH FLAGS OR STREAMERS.

STRIPS OF CLOTH MAKE GOOD STREAMERS.

WARNING

IF THE WEATHER IN YOUR AREA CAN CAUSE ICE TO FORM ON THE ANTENNA, GUY WIRES AND GUY ROPES, ADD EXTRA GUYS TO SUPPORT THE ANTENNA. CLEARLY MARK THE AREA WITH WARNING SIGNS LIKE — “BEWARE OF FALLING ICE”.

WARNING

WHEN SELECTING A SITE FOR YOUR ANTENNA, KEEP IN MIND THAT YOU SHOULD SELECT GROUND WHICH WILL NOT ACCUMULATE WATER WHICH CAN REACH UP TO THE TRANSFORMERS USED AT EACH END OF THE ANTENNA. THIS IS TO PREVENT A SHOCK HAZARD.

WARNING

FUMES OF TRICHLOROTRIFLOUROETHANE ARE POISONOUS. PROVIDE ADEQUATE VENTILATION WHENEVER YOU USE IT. DO NOT USE THIS SOLVENT NEAR HEAT OR OPEN FLAME. TRICHLOROTRIFLOUROETHANE WILL NOT BURN, BUT HEAT TURNS THE SOLVENT INTO POISONOUS AND IRRITATING FUMES. DO NOT BREATHE THE FUMES OR VAPORS. THIS SOLVENT DISSOLVES NATURAL SKIN OILS. DO NOT GET THE SOLVENT ON YOUR SKIN. USE GLOVES, SLEEVES AND AN APRON WHICH THE SOLVENT CANNOT PENETRATE. IF THE SOLVENT IS TAKEN INTERNALLY, CONSULT A PHYSICIAN IMMEDIATELY. USE THIS SOLVENT ONLY ON THE METAL MAST SECTIONS, DO NOT CLEAN THE TRANSFORMER HOUSINGS WITH THE SOLVENT.

2.6. ANTENNA SITE SELECTION

Because this antenna is highly directional, many potential antenna sites may not be suitable.

Before making any site selection, you should know:

- The **direction of transmission** (or the magnetic azimuth for the distant station).
- The **paths and tracks of both foot and vehicle traffic** in the antenna area.

Select a site with NO OBSTRUCTIONS in the direction of transmission.

Examples of obstructions are:

- Tall trees.
- Buildings.
- Hills and mountains,

It is a good idea to select both a primary and alternate antenna site. Then, if any problems arise at the primary site, a quick move can be made to the alternate site.

Remember, sites must be within 50 feet of the radio. Only 50 feet of cable is available to connect the radio to the antenna.

2-7. ANTENNA SITE INSPECTION

Before making a final site selection, **carefully inspect the three Site areas which you will use to secure your stakes.**

In the antenna site area example below, INSPECT:

- **AREA A**, the center of the site area where you will locate the **stakes for the antenna mast.**
- **AREA B and AREA C** where you will locate the **antenna stakes.**

The three **stake areas should be usable.**

Examples:

- The **soil** should be **able to hold** your **stakes.**
- The **area** should be **free of small trees, shrubs and undesirable foliage.** Poison ivy is an example of undesirable foliage.

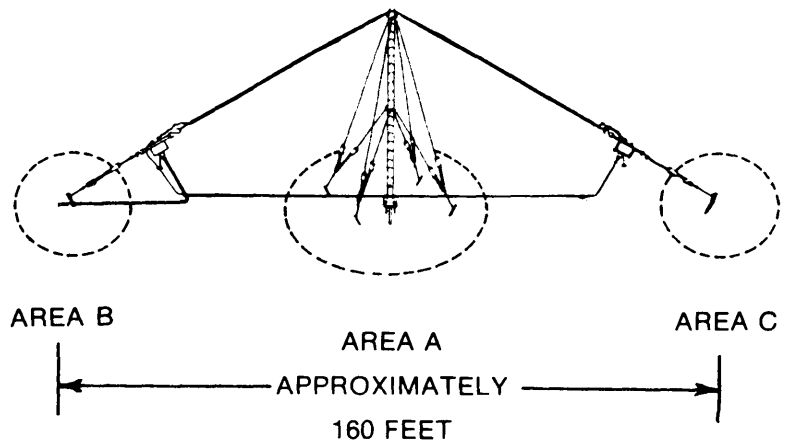

2-8. PRELIMINARY STEPS

Before you leave your base, **make sure you have:**

- Usable **maps** for your area of operations.
- A **working** hand-held **compass**.
- A **CURRENT CEOI**.

It is also a **good idea to take along:**

- A supply of **WARNING SIGNS**.
- Extra **cloth** for **streamers**.
- A supply of **special stakes** to use in the type of terrain you may find in your area of operations.
- Measurement standard, short/long.

Antenna site selection and antenna erection should be rehearsed as much as possible. This practice is very important when team members change.

To help you when practicing antenna site selection and antenna erection, you should make use of 20 foot and 83 foot standards of length to help you make accurate stake placement.

These standards can be very helpful during night operations.

Examples of a 20 foot SHORT STANDARD (to accurately place mast guy stakes) are:

- A **40 foot GUY LINE** (COLOR CODE RED) **folded in half**.
- A **20 foot length of field wire**. Make sure it is tagged.

An **83 foot length of field wire makes a good long standard** for establishing the location of the two HALF-RHOMBIC ANTENNA stakes.

Section IV. ANTENNA ERECTION

2-9. ASSEMBLY AND INSTALLATION OF MAST AB-1244A/GRC AND ANTENNA AS-3490/GRC

Orienting the HALF-RHOMBIC ANTENNA (as described in paragraph 2-6) must be done before orienting MAST AB-1244A/GRC.

- STEP 1** PLACE the **MAST PLATE** (ribs up) with its **center** in the approximate center of the erection area.

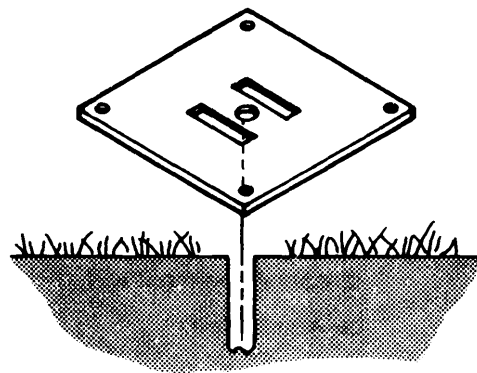

- STEP 2** Drive the **stake** part of MAST AND BASE ASSEMBLY - **through the center hole** of the MAST BASE PLATE - into the ground.

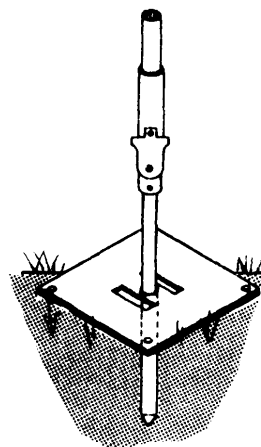

- STEP 3** Secure the MAST BASE PLATE with the **two MAST BASE STAKES**.

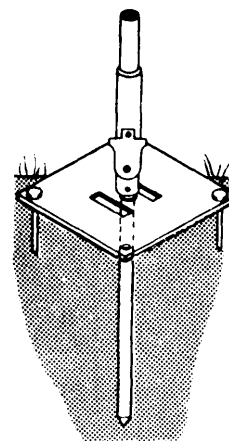

STEP 4 PLACE a short **STANDARD (20')** over the short **MAST** of the **MAST AND BASE ASSEMBLY** and **stretch out** the **STANDARD**.

Locate four points, each **90 degrees** apart - **20 feet** away from the mast AND permanently install **4 GUY STAKES**, use the **HAMMER**.

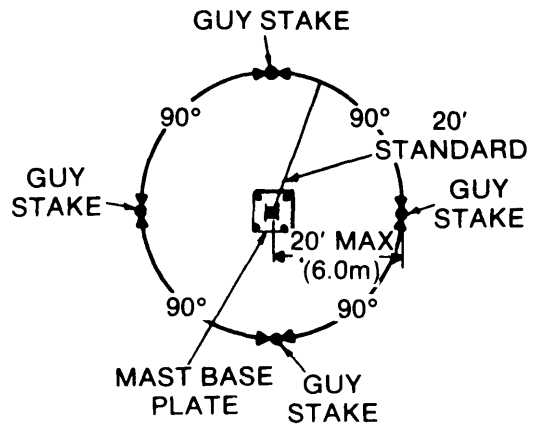

STEP 5 Position the movable short **MAST** on the **MAST AND BASE ASSEMBLY** so it lays on the **MAST BASE PLATE** in the direction the mast will be assembled.

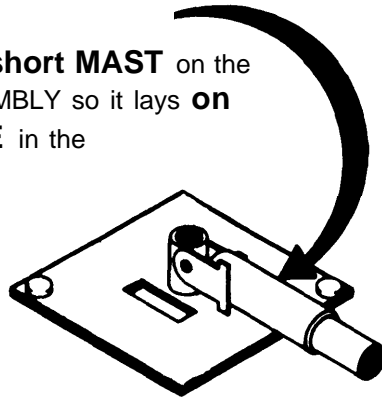

STEP 6 Assemble the **5 LOWER MAST sections** (insert the keyed male end into the keyed female end).

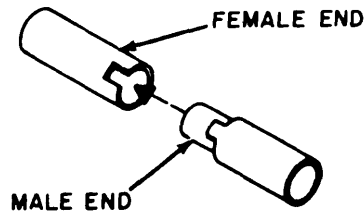

STEP 7 Add the assembled **5 LOWER MAST SECTIONS** to the **short MAST** on the **MAST AND BASE ASSEMBLY**.

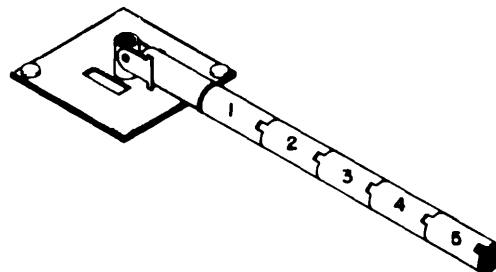

STEP 8 Slide the **LOWER GUY PLATE** (color code **BLUE**) onto the male end of the **LOWER ADAPTER ASSEMBLY**.

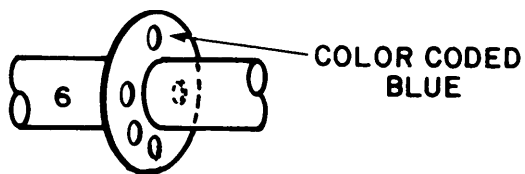

STEP 9 Add the **LOWER ADAPTER ASSEMBLY WITH** the installed **LOWER GUY PLATE** to the **masts** on the ground.

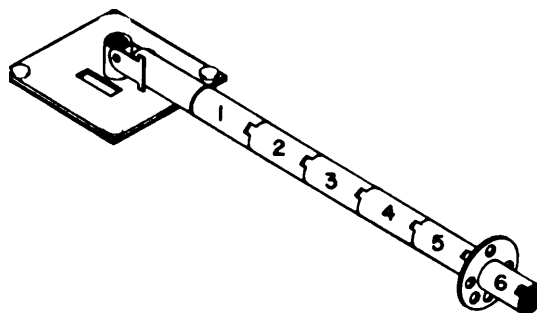

STEP 10 Assemble the 5 **UPPER MAST SECTIONS** AND **join** them to the **masts** on the ground.

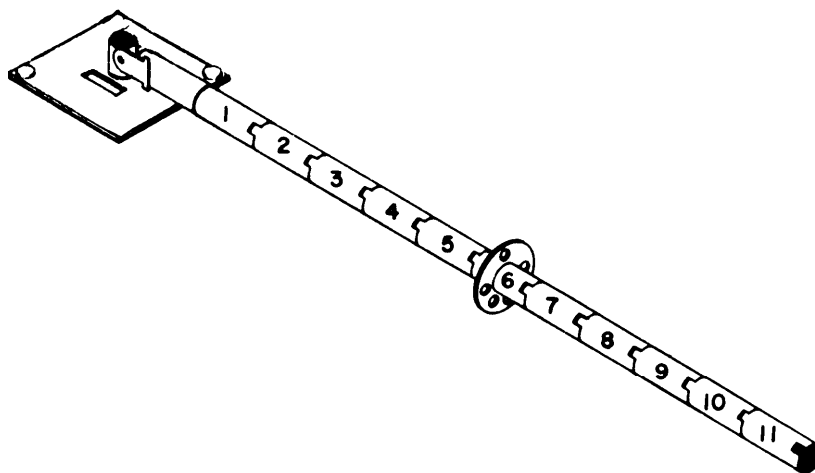

STEP 11 Slide the **UPPER GUY PLATE** (color code **RED**) onto the male end of the **UPPER ADAPTER ASSEMBLY**.

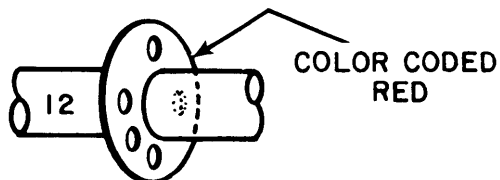

STEP 12 Add the **UPPER MAST ADAPTER ASSEMBLY** with the installed **UPPER GUY PLATE** to the masts on the ground.

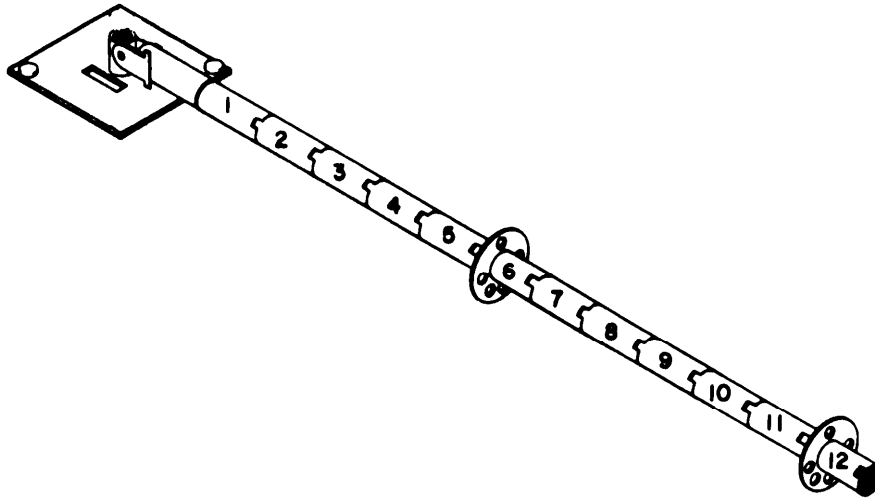

STEP 13 Turn both the **UPPER** and **LOWER GUY PLATES** so that one hole is uppermost:

4 holes will be used to connect the GUY HOOKS.

HOLE 1 for FRONT GUY HOOK -

hole 3 for BACK GUY HOOK -

HOLES 2 and 4 for SIDE GUY HOOKS -

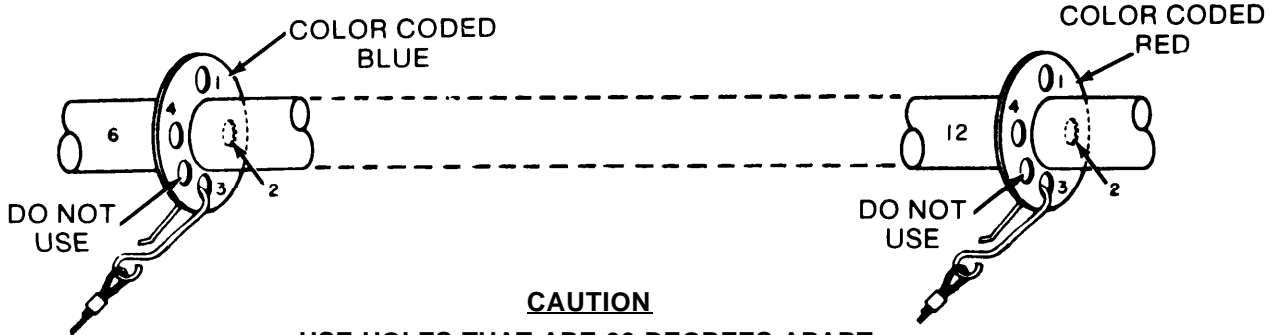

CAUTION
 USE HOLES THAT ARE 90 DEGREES APART.
 SOME PLATES MAY HAVE A FIFTH HOLE
 WHICH WILL NOT BE USED.

STEP 14 Attach each of the 4 GUY HOOKS (color code BLUE) to the proper hole on the LOWER GUY PLATE.

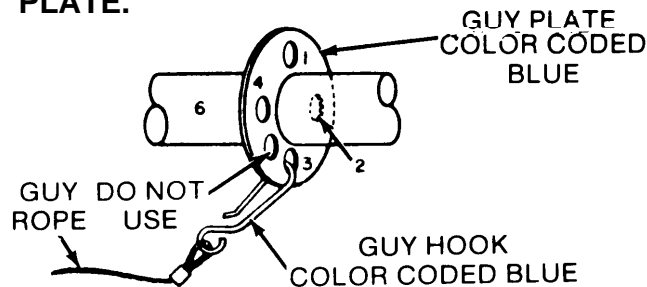

STEP 15 Carefully and neatly:

Extend the **other end of each "SIDE" GUY rope** (holes 2 and 4) **towards** the appropriate **"SIDE" GUY STAKE**.

(the other end contains the GUY SNUBBER and the GUY LOOP)

Attach each **GUY rope LOOP** to an **ANCHOR HOOK** which is attached to the end of each **GUY STAKE'S** stringer.

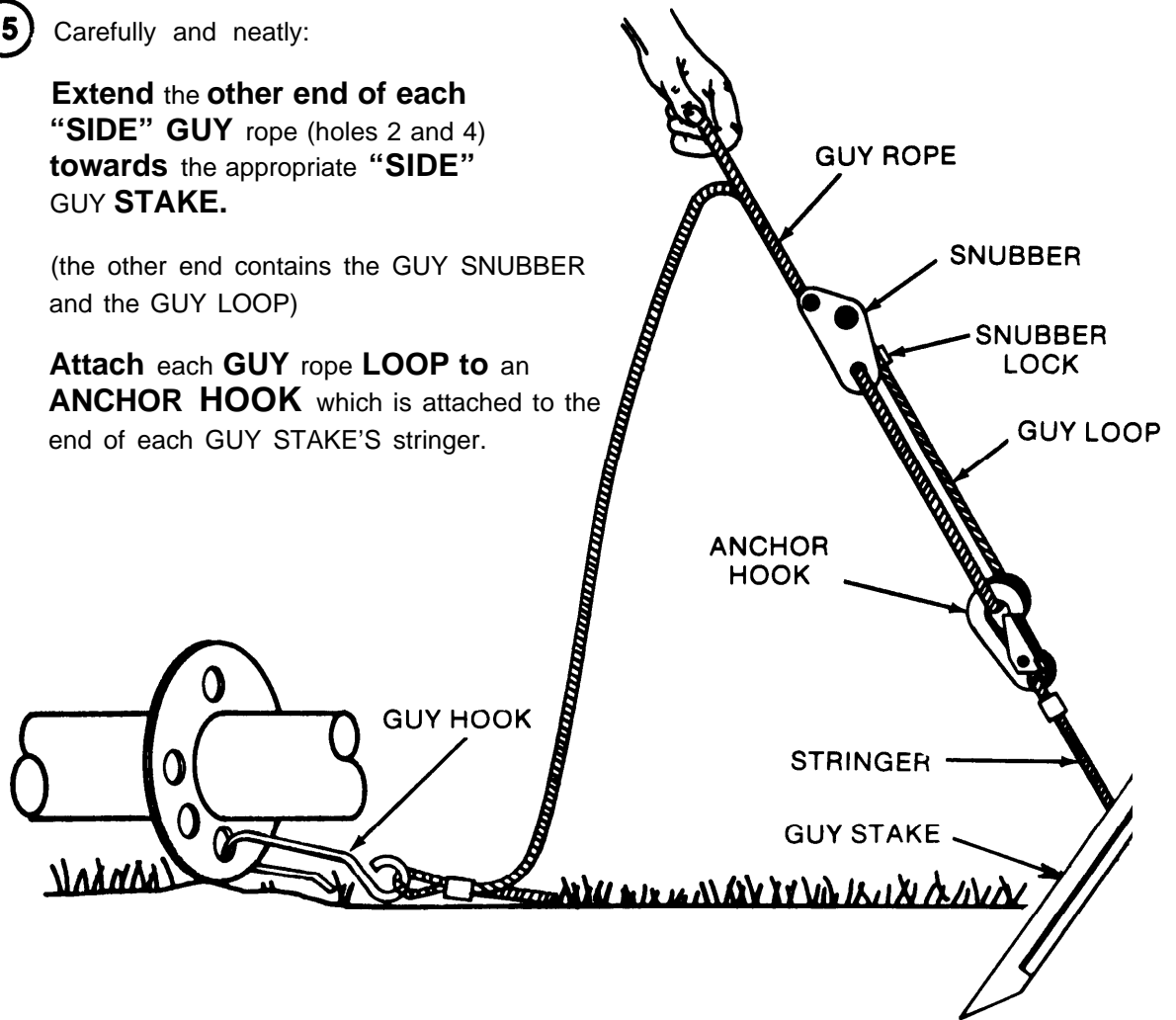

STEP 16 Carefully and neatly: **attach** each of the **4 GUY HOOKS** (color code **RED**) to the proper hole on the **UPPER GUY PLATE**.

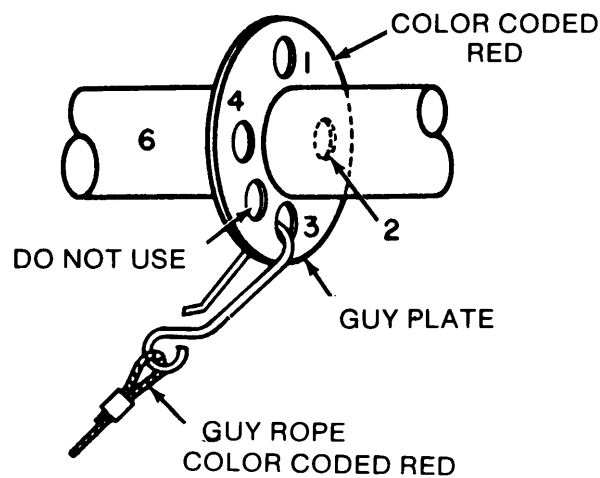

STEP 17 Carefully and neatly: **extend** the **other end** of each "SIDE" GUY rope (holes 2 and 4) **towards** the appropriate **SIDE GUY STAKE**.
(the other end contains the GUY SNUBBER and the GUY LOOP)

Carefully **attach each** GUY "SIDE" GUY **LOOP** to an **ANCHOR HOOK** attached to the end of each GUY STAKE'S stringer.

NOTE: Each ANCHOR HOOK on each GUY STAKE will hold one GUY LOOP of a LOWER GUY and one GUY LOOP of an UPPER GUY.

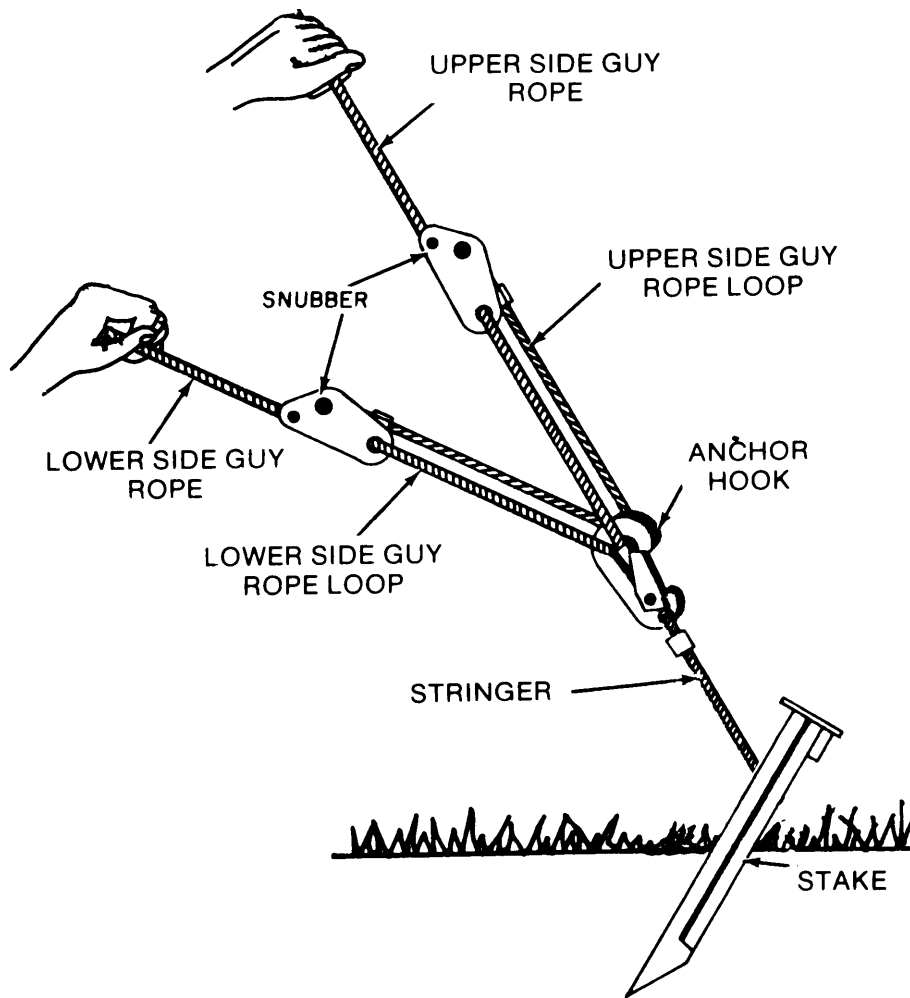

STEP 18 Pull the 4 “**SIDE**” **GUY** ropes, 2 **UPPER** **GUYS** (holes 2 and 4) and 2 **LOWER** **GUYS** (Holes 2 and 4) **taut**.

TO PULL A GUY ROPE **TAUT**:

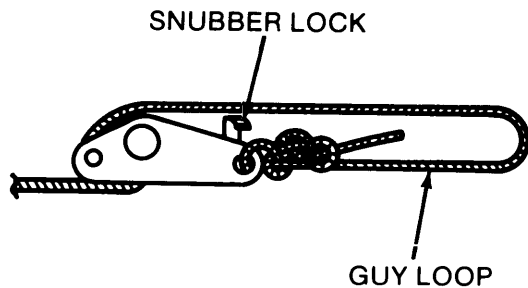

Remove the guy rope from the SNUBBER LOCK -

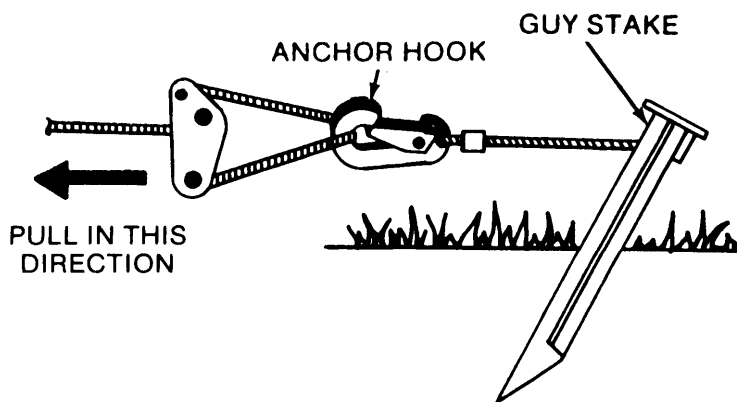

- pull the SNUBBER in the direction shown (towards the MAST) -
then secure the guy rope under the SNUBBER LOCK.

STEP 19 Adjust the **UPPER "BACK" GUY** (hole 3) and **LOWER "BACK" GUY** (hole 3):

Lay them alongside one set of TAUT "SIDE" GUYS and adjust the "BACK" GUYS to the same length.

Attach the **GUY LOOPS** of the UPPER "BACK" GUY and the LOWER "BACK" GUY to the **ANCHOR HOOK** on the "BACK" GUY STAKE. THE BACK GUYS WILL NOT BE TAUT AT THIS TIME.

NOTE: This now leaves the "FRONT" LOWER GUY rope and the "FRONT" UPPER GUY rope free and unconnected. You will use these free GUYS during erection. The other 3 LOWER GUYS and 3 UPPER GUYS are now connected to GUY STAKES.

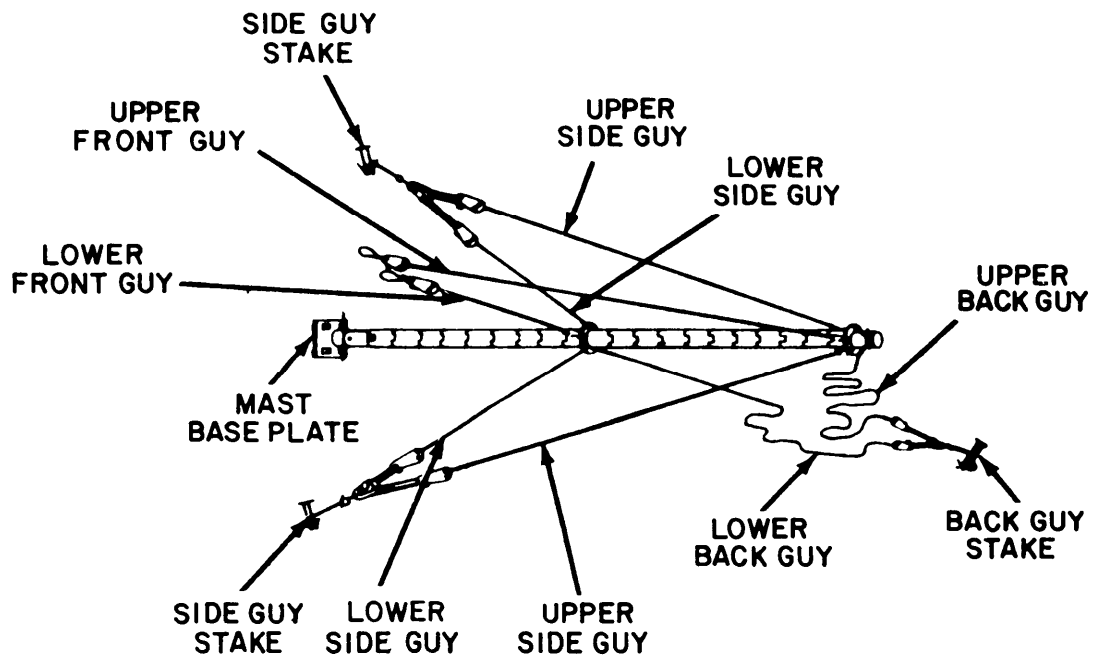

- STEP 20** Install the **plastic HALF-HOMBIC ANTENNA MAST INSULATOR** on top of the MAST.
- STEP 21** Feed one-half of the field wire **antenna (83')** through the **MAST INSULATOR** (Approximately midway between the white markers),
- STEP 22** Carefully and neatly: **spread** the 83' of field wire **antenna on each side** of the MAST, as far out of the way as possible.

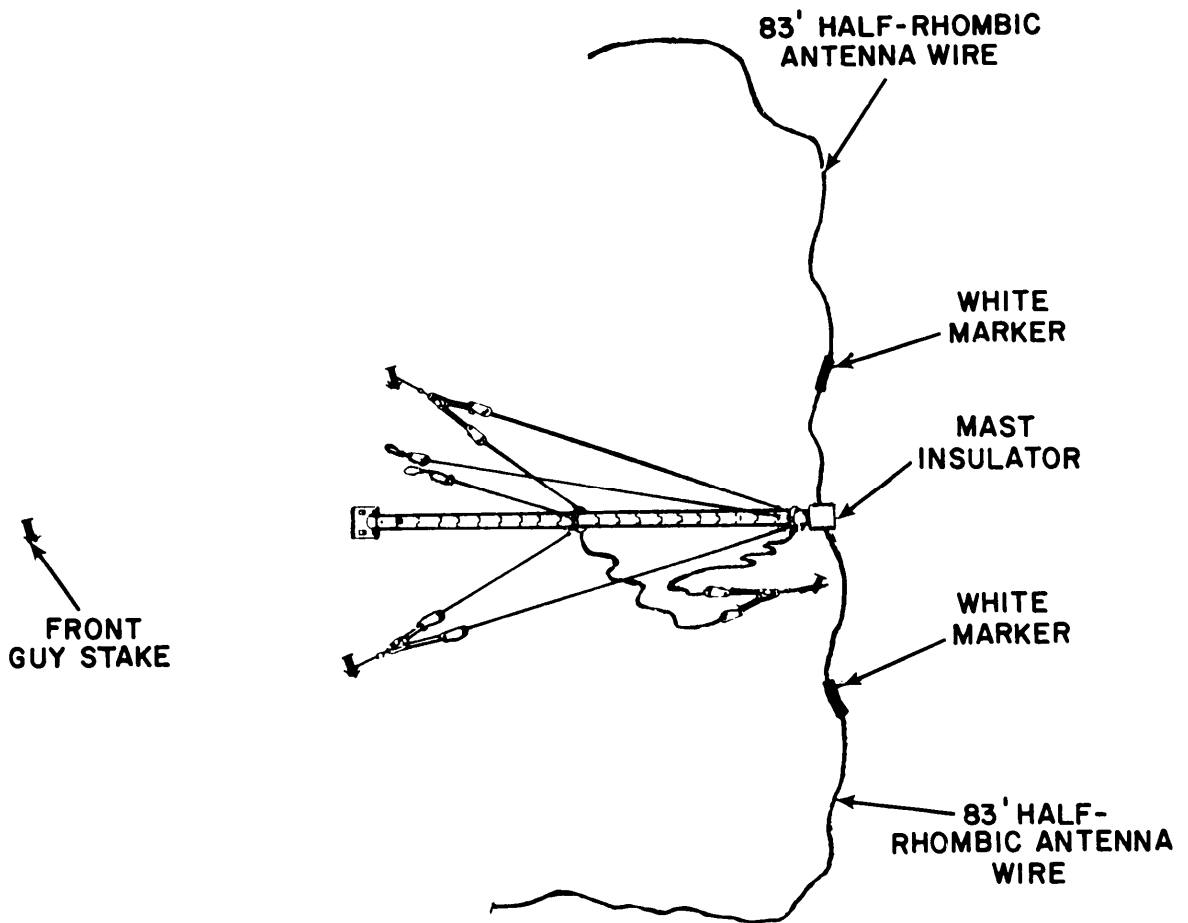

2.8 ANTENNA ERECTION

WARNING

REVIEW ALL THE WARNINGS IN THE FRONT OF THIS MANUAL AND IN SECTION III OF THIS CHAPTER. DO NOT TAKE ANY SHORT CUTS.

Double check the **eight GUYS** (4 UPPER, color coded **RED** and 4 LOWER, color coded **BLUE**)

- **2 LOWER “SIDE” GUYS** and **2 UPPER “SIDE” GUYS** should be **taut**.
- **1 LOWER** and **1 UPPER “BACK” GUY LOOP** should be connected to the **BACK GUY STAKE** - BUT - **not taut**.
- **1 LOWER** and **1 UPPER “FRONT” GUY** should be **free** for use during erection.

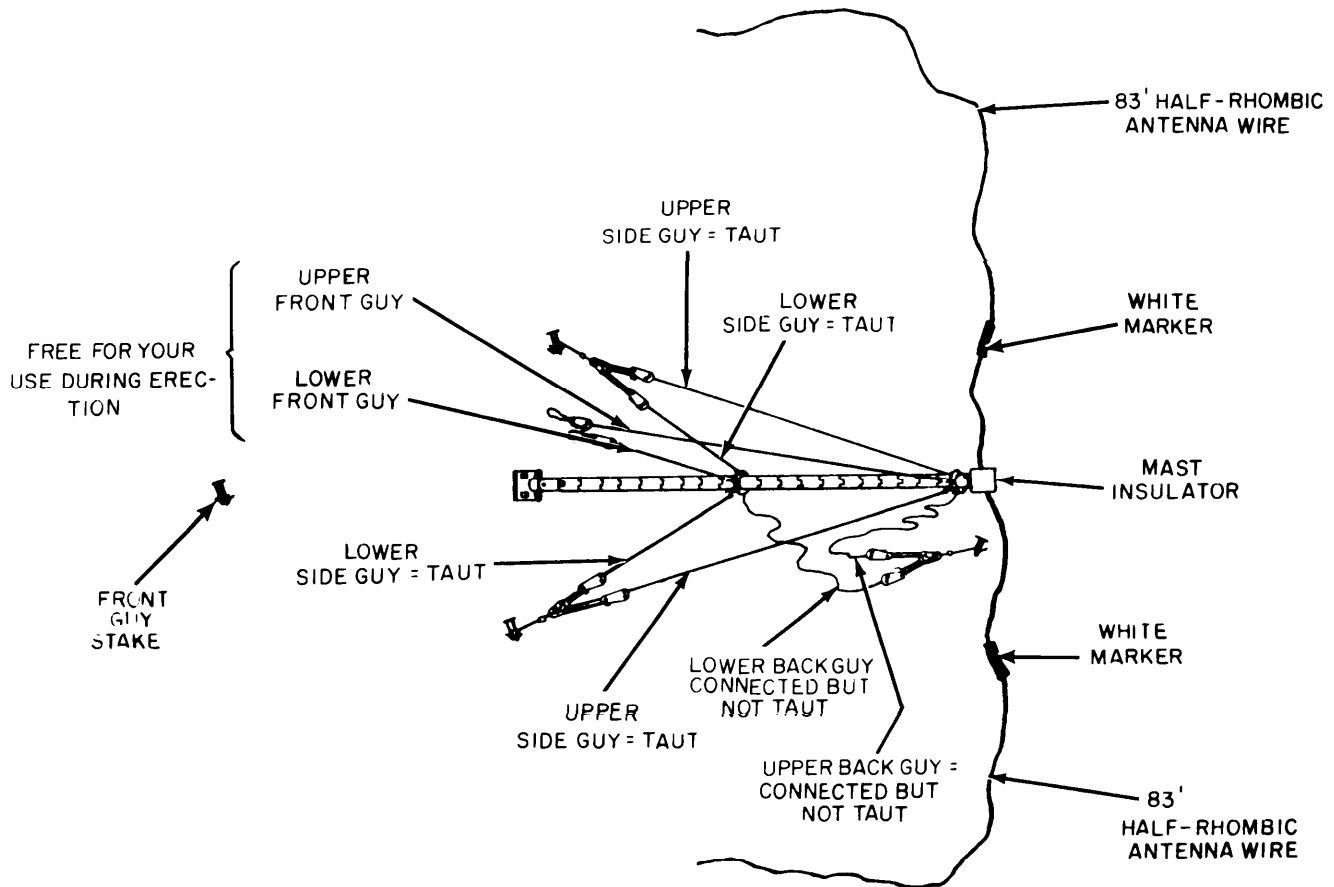

AND

Make sure the 83' of **field wire antenna** on each side of the MAST INSULATOR is untangled and laying loosely on the ground.

STEP 1 The **FIRST PERSON** stands near the **MAST BASE PLATE**- **in-line** with the **MAST BASE PLATE AND** either the **FRONT GUY STAKE** or the **BACK GUY STAKE**.

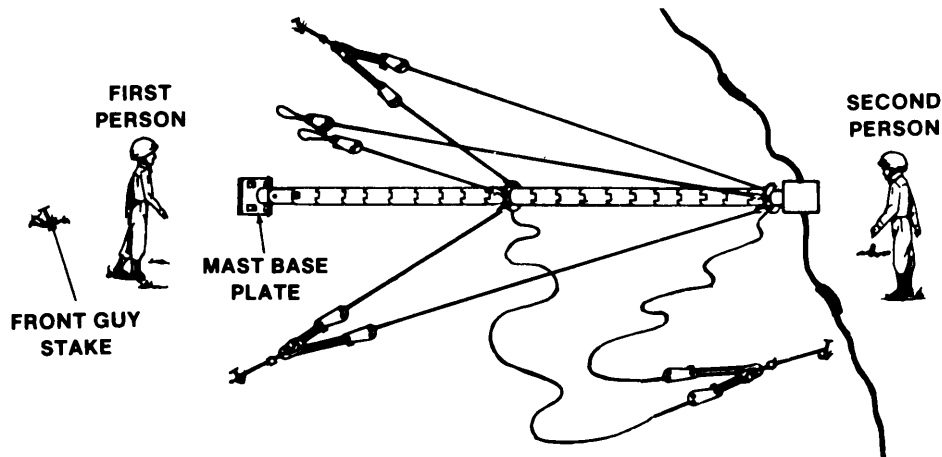

STEP 2 The **SECOND PERSON** stands **at the end of the MAST**.

STEP 3 The **FIRST PERSON** pulls both the **UPPER** and **LOWER FRONT GUY ROPES** taut until there is a slight bow in the top-end of the **MAST**,

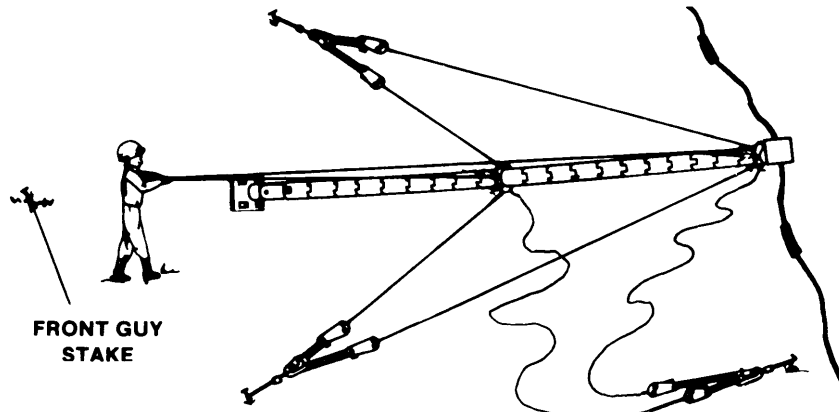

AND

The **SECOND PERSON** starts to raise the top of the **MAST** as high as possible.

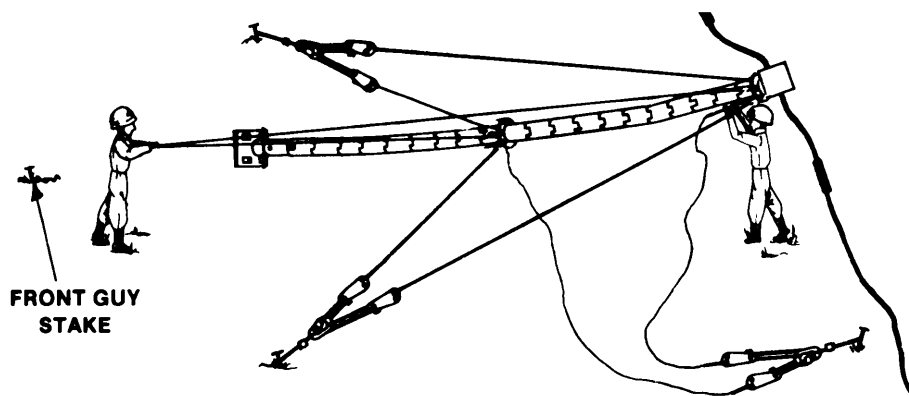

STEP 4 The **SECOND PERSON** starts walking towards the **MAST BASE** WHILE at the same time pushing the **MAST** upward.

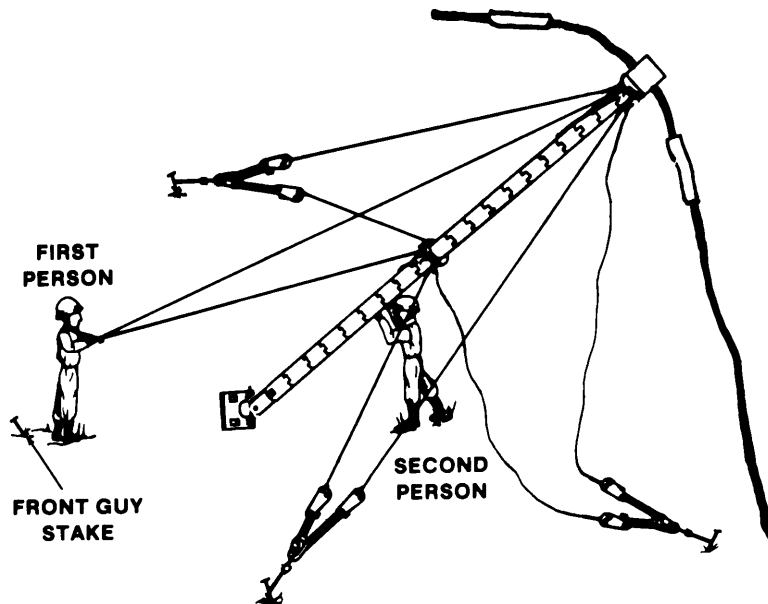

The **FIRST PERSON** walks backwards towards the **FRONT GUY STAKE** pulling on the **FRONT GUY ROPES** to assist in raising the **MAST** and in keeping the slight bow in the **MAST**.

Both **PERSONS** continue the above actions until the **MAST** is in the **vedical** position.

STEP 5 When the **MAST** is vertical:

- The 2 '**SIDE**' **GUYS** and the **BACK GUYS** should be taut enough to support the mast.
- then - connect the **UPPER FRONT GUY LOOP** and **LOWER FRONT GUY LOOP** TO the **ANCHOR HOOK** on the **FRONT GUY STAKE**

AND

adjust the **SNUBBERS** enough to support the mast.

STEP 6 Carefully check the MAST to make sure it is truly vertical.

- Readjust all **SNUBBERS** to minimize any bow in the MAST

NOTE: Leave a little slack in each GUY to allow for expansion and contraction of the MAST and GUYS. Check the tautness each morning and several times during the day. Check more often during bad weather. Experience with the temperature conditions in your area of operations will help you determine how taut each GUY should be.

Section IV. ORIENTING THE HALF-RHOMBIC ANTENNA

2-11. ORIENTATION PROCEDURES

The **HALF-RHOMBIC** field wire antenna must be oriented and secured after the MAST HAS BEEN properly guyed.

It is necessary to install two antenna stakes to properly AIM and SECURE the **HALF-RHOMBIC** antenna.

REMEMBER: The **TERMINATION TRANSFORMER** is located at the end of the antenna pointing in the **DIRECTION OF TRANSMISSION**.

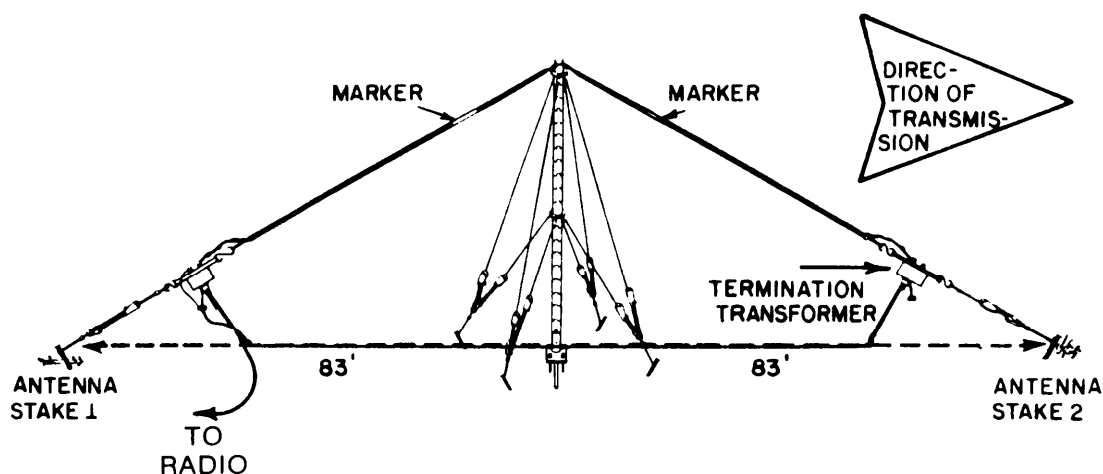

In the step-by-step procedure that follows, you will place two antenna stakes, each 83' away from the mast.

2-12. BASIC ORIENTATION PROCEDURES

In the following steps we will use 50 degrees as an example of the desired direction of transmission (azimuth to the desired station):

STEP ① At the selected antenna site:
 Use your compass to establish the general direction of 50 degrees.

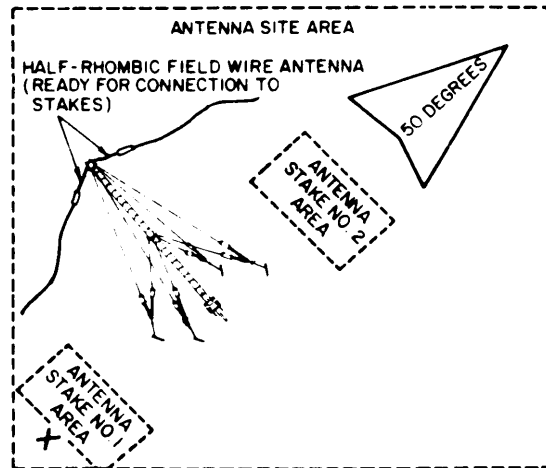

STEP ② Place yourself with your compass in the ANTENNA STAKE NO. 1 AREA.

STEP ③ Have your partner connect or loop the end of the LONG STANDARD (83') to the MAST BASE and pull the LONG STANDARD out to its full length into ANTENNA STAKE NO. 2 AREA.

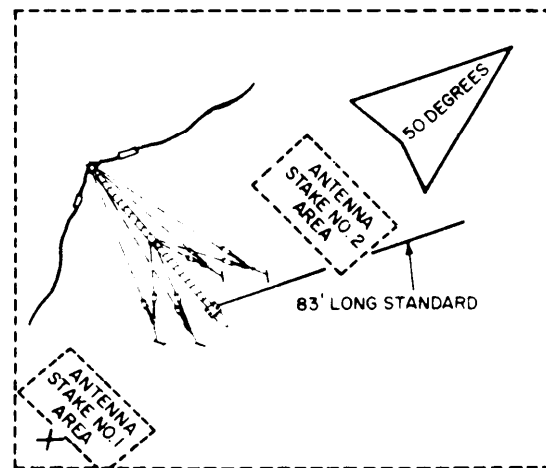

STEP ④ While sighting through your compass at 50 degrees: Tell your partner to slowly move the LONG STANDARD in the desired direction so it lines up as you are sighting 50 degrees through the MAST and down the LONG STANDARD.

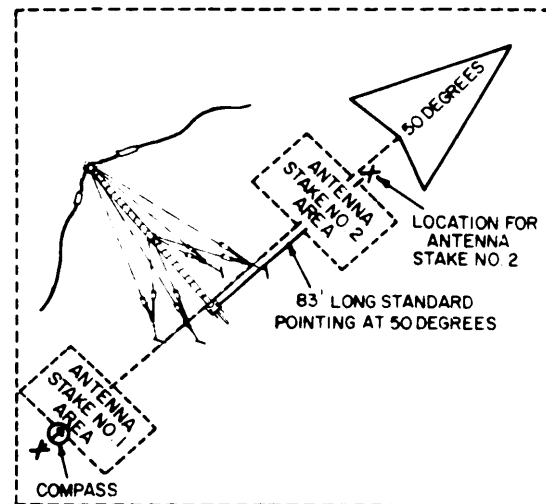

STEP ⑤ Have your partner permanently install **ANTENNA STAKE NO. 2** at the end of the **LONG STANDARD**.

The stake should be installed as shown so its **ANCHOR HOOK** can accept the **TRANSFORMER SNUBBER ASSEMBLY**.

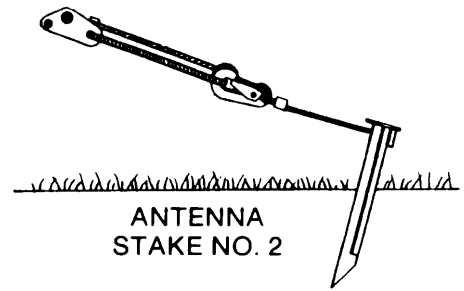

STEP ⑥ Have your partner pull the **LONG STANDARD** out to its full length towards you in the **ANTENNA STAKE NO. 1 AREA**.

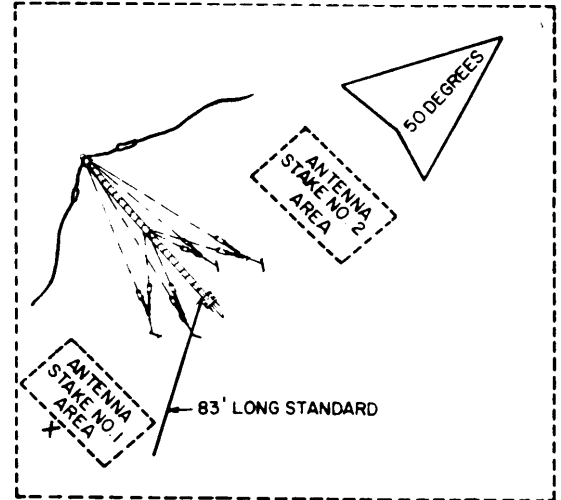

STEP ⑦ While sighting through your **compass** at 50 degrees: Tell your partner to slowly move the **LONG STANDARD** in the desired direction so it lines up as you are sighting 50 degrees through the **LONG STANDARD**, through the **mast** and to the other **ANTENNA STAKE**.

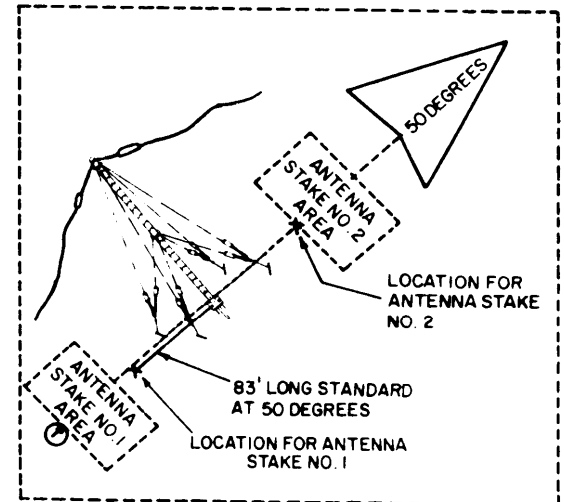

STEP ⑧ Have your partner permanently install **ANTENNA STAKE NO. 1** at the end of the **LONG STANDARD**.

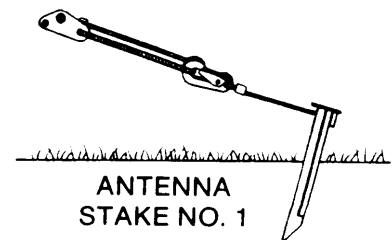

Your **team chief** may develop modifications to the above steps in order to **meet special situations**.

For Example:

- Blackout operations may require that the antenna site be prepared ahead of time. This advance preparation could include determining and marking the MAST location and marking the locations of the two ANTENNA STAKES and the four MAST guy stakes.

2-13. ALTERNATE ORIENTATION PROCEDURES

The following ALTERNATE PROCEDURE can be used by a team chief when it is necessary to layout an antenna site including MAST and all stake locations.

STEP ① Place a **TEMPORARY STAKE** in the center of the antenna site.

This will mark the location of the **MAST**.

STEP ② Loop the **SHORT STANDARD** (20') over the **TEMPORARY STAKE** and mark the four locations for the 4 MAST **GUY STAKES**.

REMEMBER: These stakes should be 90 degrees apart.

STEP ③ Have your partner loop the **LONG STANDARD** (83') over the **TEMPORARY STAKE**, **AND** pull the **LONG STANDARD** out to its **full length** - into the **ANTENNA STAKE NO. 2 AREA**.

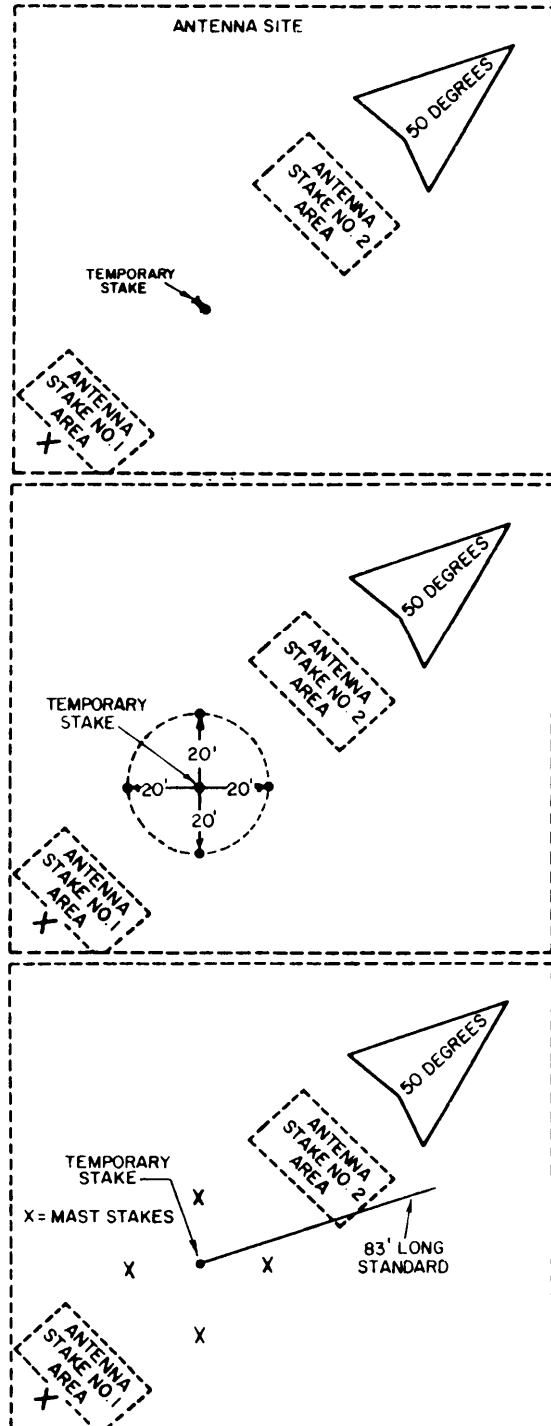

STEP ④ Place yourself in **ANTENNA STAKE NO. 1 AREA.**

While sighting through your **Compass** at 50 degrees:

Tell your **partner to slowly move the LONG STANDARD** in the desired direction **so it lines up** as you are sighting 50 degrees **through the TEMPORARY STAKE** and down the **LONG STANDARD**

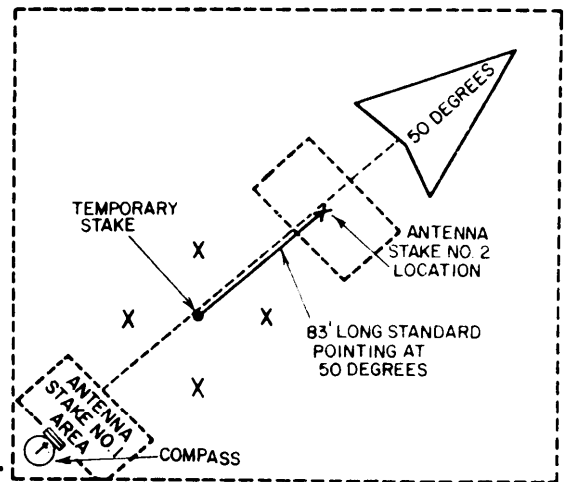

STEP ⑤ Have your partner mark the **location of ANTENNA STAKE NO. 2** at the end of the LONG STANDARD. OR, if desired, the ANTENNA STAKE may be permanently installed.

STEP ⑥ Have your partner pull the **LONG STANDARD out to its full length:** **towards you** in ANTENNA STAKE NO. 1 AREA.

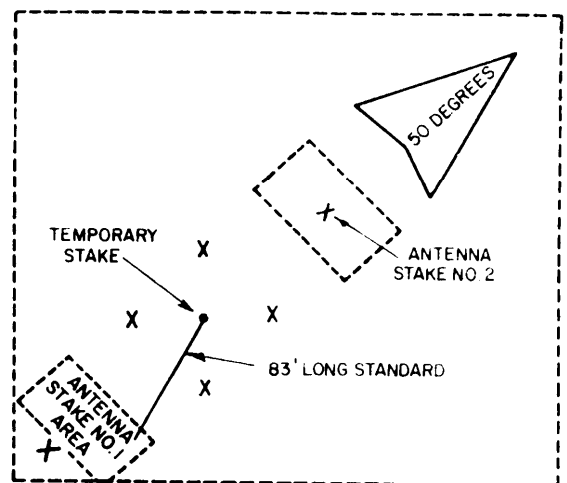

STEP ⑦ While sighting through your **compass** at 50 degrees: Tell your **partner to slowly move the LONG STANDARD** in the desired direction **so it lines up** as you are sighting 50 degrees **through the LONG STANDARD,** through the **TEMPORARY STAKE** and to the other antenna stake.

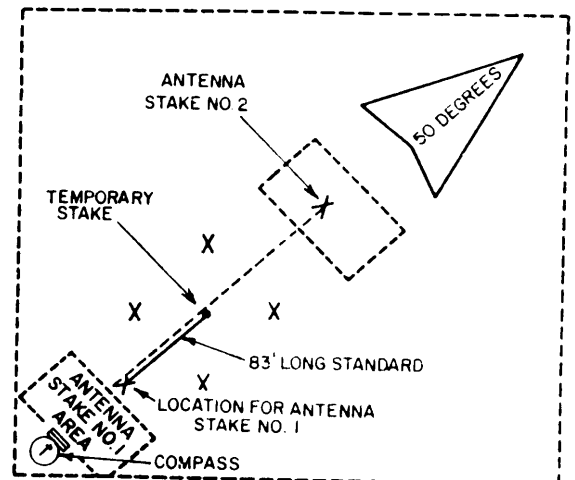

STEP ⑧ Have your partner mark the **location of ANTENNA STAKE NO. 1.** Or, have it permanently installed.

2-14. ANTENNA ORIENTATION USING ANTENNA MARKERS

Certain terrain and conditions may make it difficult to use the sighting steps in the **BASIC** and **ALTERNATIVE PROCEDURES**. For example:

- An antenna site area with tall grass or thick low growing plants could prevent accurate and rapid use of a LONG STANDARD.
- Rocky and slightly uneven terrain is another problem site.

The following procedure describes the **use of the two MARKERS** (factory installed) **on the HALF-RHOMBIC antenna during sighting**. This procedure may help if it is necessary to use antenna sites that are not ideal.

STEP ① At the selected antenna site:

Use your compass to establish the general direction of 50 degrees.

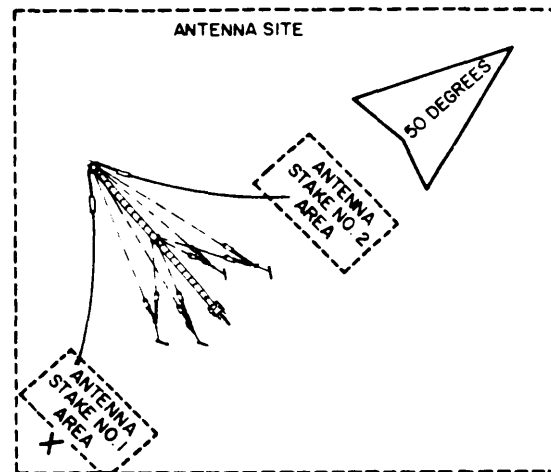

STEP ② Place the end of the **HALF-RHOMBIC ANTENNA** (the end for ANTENNA STAKE NO. 1) in **one hand** and your **compass** in the **other hand**.

Carefully **walk into** the ANTENNA STAKE NO. 1 AREA.

STEP ③ Have your partner take the other end of the **HALF-RHOMBIC ANTENNA** into the ANTENNA STAKE NO. 2 AREA.

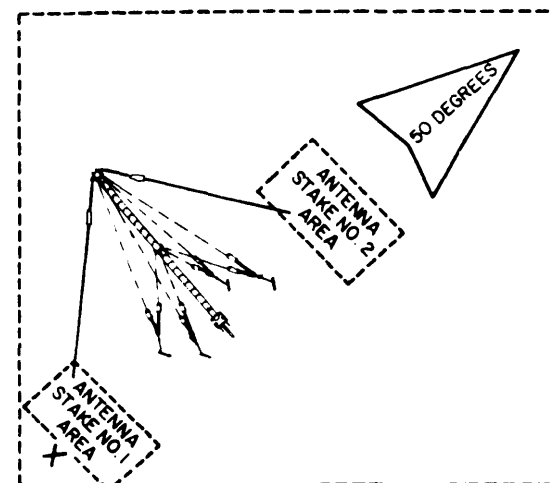

STEP ④ Tell your partner to carefully **pull out his half** of the antenna **to form a V** while you **are doing** the **same** with your half.

STEP 5 While sighting through your compass at 50 degrees:

Tell your partner to slowly move in the desired direction.

Coordinate your partner's movement, and yours until you are able to sight:

Up the wire, through the MARKER, on your side, through the MAST to the other MARKER.

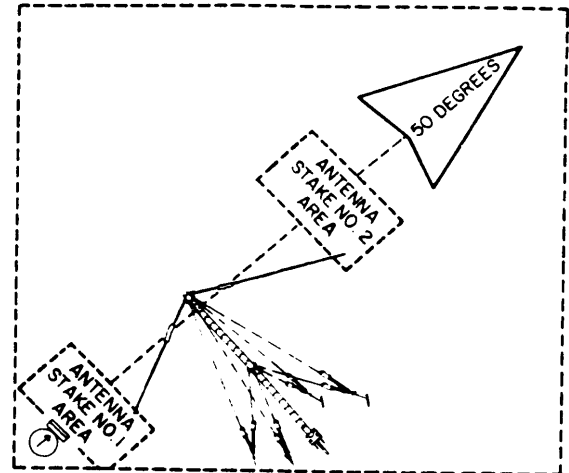

STEP 6 Once you are alined:

Have your partner mark the location for his antenna stake: preferably 2 or 3 feet beyond the spot on the ground where his half of the antenna touched at the time of proper alinement.

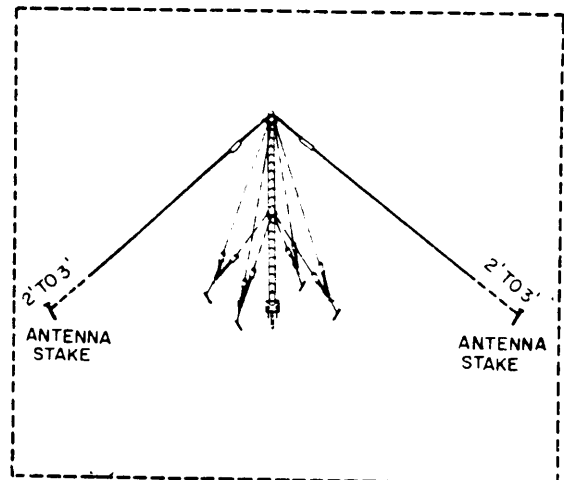

STEP 7 When your partner is finished, do the same marking at your end.

NOTE: IT MAY BE NECESSARY IN CERTAIN SITUATIONS TO USE THE ANTENNA MARKERS DURING THE SIGHTING STEPS IN THE BASIC AND ALTERNATIVE PROCEDURES.

YOUR TEAM CHIEF IS RESPONSIBLE FOR THE PROCEDURES YOU SHOULD USE.

2-15. TRANSFORMER CONNECTIONS

STEP ① At the **INPUT TRANSFORMER STAKE**, neatly and carefully:

- **Connect** the end of the **HALF-RHOMBIC ANTENNA** with its **S-Hook** to the body of the **INPUT TRANSFORMER**.
- **Connect** the **end of the field wire** to the **ANTENNA BINDING POST** on the **INPUT TRANSFORMER**.
Push in the **BINDING POST** and attach the wire.
- Use the **TRANSFORMER SNUBBER ASSEMBLY** to connect the **INPUT TRANSFORMER** to its **STAKE**.

- **Connect the 50' RADIO CABLE** to the **INPUT TRANSFORMER**:

Uncap the coaxial connector on the **INPUT TRANSFORMER** and connect the **50' RADIO CABLE** to the receptacle.

THEN

Take the **other end of the RADIO CABLE** to the **RADIO SITE**.

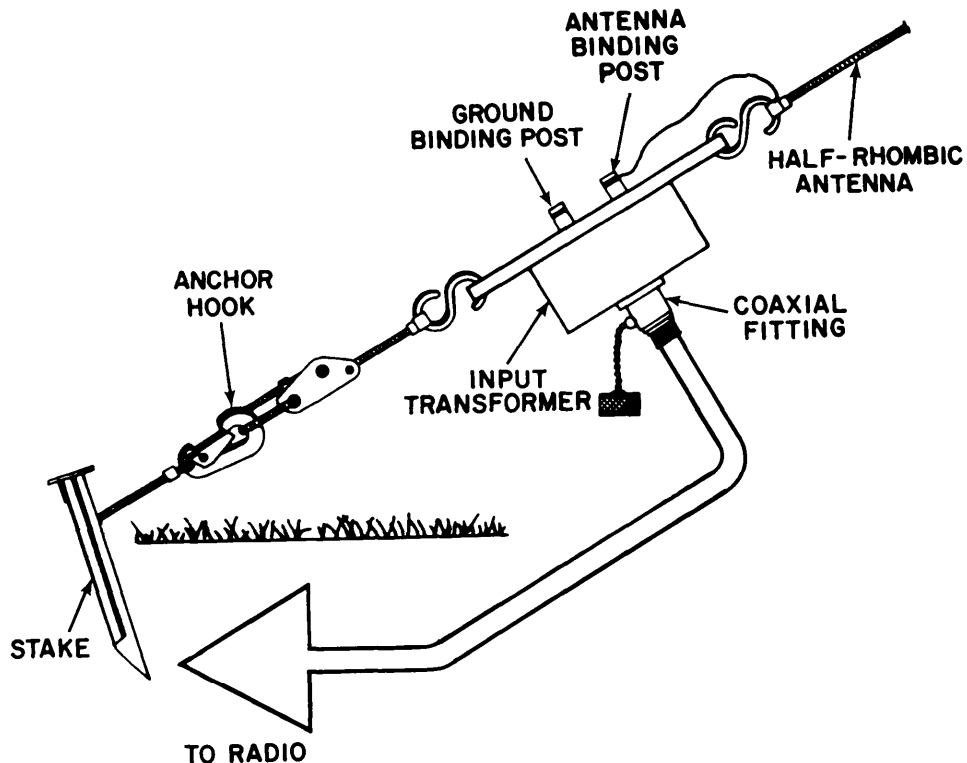

STEP ② At the **TERMINATION TRANSFORMER STAKE**, neatly and carefully:

- **Connect** the end of the **HALF-RHOMBIC ANTENNA** with its **S-HOOK** to the body of the **TERMINATION TRANSFORMER**.
- **Connect** the end of the field wire to the **ANTENNA BINDING POST** on the **TERMINATION TRANSFORMER**:

Push in the **BINDING POST** and attach the wire,

- **MAKE SURE THAT NOTHING IS CONNECTED TO THE TERMINATION TRANSFORMER GROUND BINDING POST,**
- **Use the TRANSFORMER SNUBBER ASSEMBLY to connect the TERMINATION TRANSFORMER to Its STAKE.**
- **Connect the 175' DISSIPATION CABLE to the TERMINATION TRANSFORMER:**

Uncap the coaxial connector on the **TERMINATION TRANSFORMER** and connect the 175' **DISSIPATION CABLE** to the receptacle.

THEN

CAREFULLY run the **DISSIPATION CABLE** directly under the **HALF-RHOMBIC ANTENNA** towards the **INPUT TRANSFORMER**.

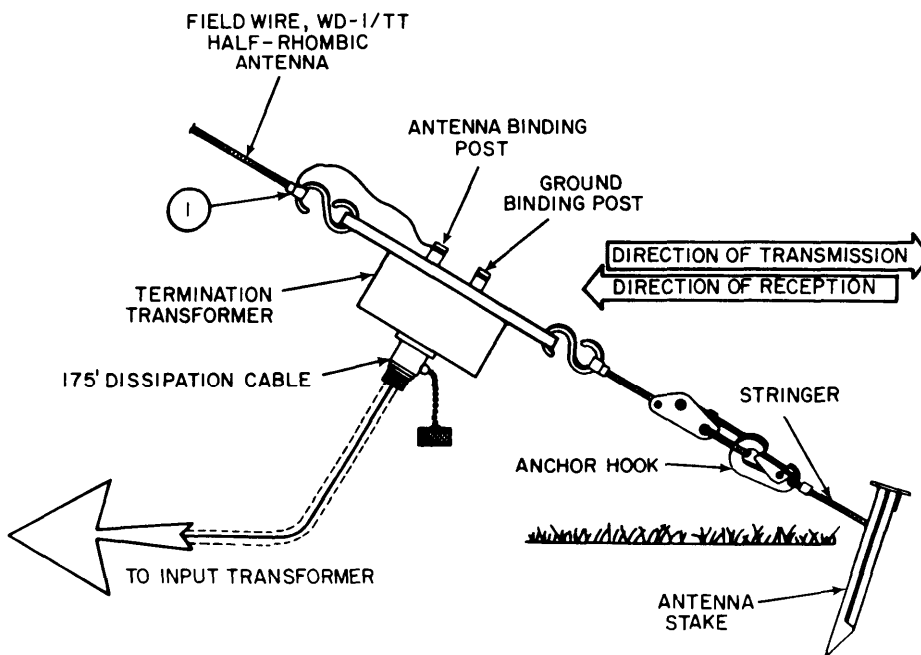

STEP ③ When you reach the **INPUT TRANSFORMER**, neatly and carefully:

- I **Connect the 6 inch ground wire** on the end of the **DISSIPATION CABLE** to the **GROUND BINDING POST** on the **INPUT TRANSFORMER**:
Push in the **BINDING POST** and attach the wire.
- I **Check to see that the shrunken TUBING SEAL** on the end of the **DISSIPATION CABLE** is **good**.

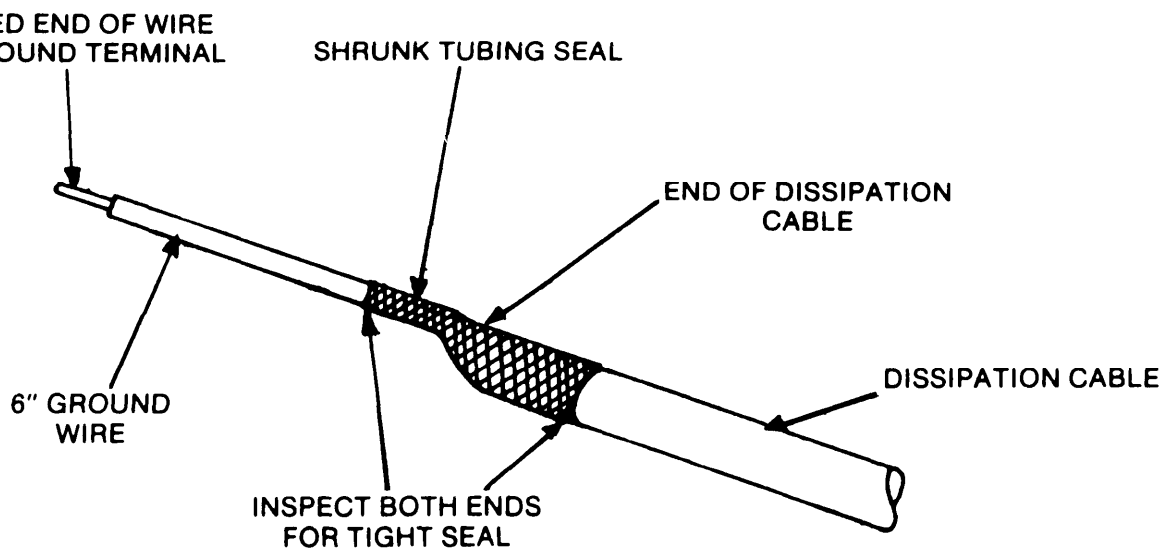

2-16. NORMAL OPERATION WITH A RADIO

The **radio set** is connected to the **HALF-RHOMBIC ANTENNA** using the **50' RADIO CABLE**.

- **NO ADJUSTMENT IS NECESSARY.**
- After a period of operation, make the following checks:

WARNING

MAKE SURE THE RADIO SET IS TURNED OFF.

- **CONDITION OF THE 2 TRANSFORMERS:**
ARE THEY LEAKING, CRACKED OR TOO HOT TO TOUCH?
- **CONDITION OF THE DISSIPATION CABLE:**
IS THE CABLE TOO HOT TO TOUCH?
- **Report any problems to C-E ORG MAINTENANCE.**

SECTION IV. OPERATION UNDER UNUSUAL CONDITIONS

2-17. OPERATION IN UNUSUAL WEATHER

The GUYs and the **markers/streamers** should be periodically **checked** when you are operating **during bad weather**.

If there is a **possibility of ice** forming on your antenna, **post WARNING SIGNS**.

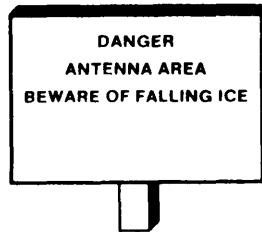

2-18. OPERATION IN UNUSUAL TERRAIN

Loose, soft, sandy, clay type, rocky **soils may not be able to** safely **hold your ANTENNA STAKES**.

Before leaving your **base**:

- make sure you **have** a **supply of** the **special anchors** you may need to use in the soil you could find in your area of operations,

AND

- make sure that you **have** the **special tools** required **to install** the **specil anchors**.

Examples of special anchors:

SCREW ANCHOR

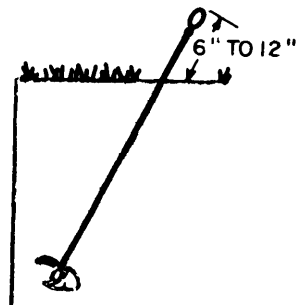

SCREW ANCHOR INTO THE GROUND IN LINE WITH THE POINT OF ATTACHMENT OF THE GUY ON THE POLE. THIS ANCHOR MUST BE SCREWED INTO SOIL. IT MUST NOT BE DRIVEN OR POUNDED WHEN INSTALLED.

ROCK ANCHOR

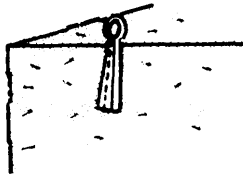

WHERE ROCK EXTENDS TO THE SURFACE, DRILL A 2 INCH HOLE TO NECESSARY DEPTH AND ANCHOR THE GUY AS SHOWN. WHERE NECESSARY TO FILL IN THE HOLE AROUND ANCHOR, USE CEMENT.

DEAN-MAN ANCHOR

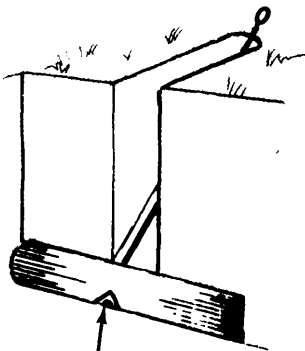

CUT AWAY SAPWOOD UNDER WASHER, SCREW NUT ON AS FAR AS IT WILL GO.

IN EXCAVATING FOR ANCHOR LOG, DIG THE HOLE SO THAT ANCHOR LOG, WHERE PRACTICABLE, WILL BE SET HORIZONTAL AND AT RIGHT ANGLES TO THE GUY. THE LENGTH AND WIDTH OF EXCAVATION SHALL BE AS SMALL AS PRACTICABLE, ESPECIALLY AT THE SURFACE OF THE GROUND.

2-19. EMERGENCY PROCEDURES

There are no satisfactory field expedients or emergency procedures that can be done when you have a defective transformer

C-E ORG MAINT can help you out if you have a bad DISSIPATION CABLE. Ask them to fabricate a substitute cable.

There are many **field expedients** and emergency procedures to compensate for a defective mast or broken guys. Training Circular, **TC-11-5, KNOW HOW TO REPAIR & FABRICATE ANTENNAS can be very useful. Ask your supervisor to get you a copy.**

CHAPTER 3 OPERATOR/CREW MAINTENANCE

SECTION I. TROUBLESHOOTING PROCEDURES

3-1. TROUBLESHOOTING GUIDELINES

The simple and rugged construction of ANTENNA GROUP OE-303/GRC reduces troubleshooting and maintenance procedures.

The following table covers the troubleshooting steps you should take if there is a communications failure. If your trouble cannot be corrected, notify C-E ORG MAINTENANCE.

The table does not cover troubleshooting the radio set. Before troubleshooting the antenna, make sure that the radio is not the cause of the trouble by using the radio set troubleshooting guidance in the Radio Set Technical Manual.

TABLE 3-1. TROUBLESHOOTING

TROUBLE
<p style="text-align: center;">Test or Inspection</p> <p style="text-align: center;">● Corrective Action</p>
<p>COMMUNICATIONS CANNOT BE ESTABLISHED WITH THE DISTANT STATION</p> <p>STEP 1</p> <p>Double check the magnetic azimuth heading of the HALF-RHOMBIC ANTENNA.</p> <ul style="list-style-type: none"> ● Reorient the HALF—RHOMBIC ANTENNA if it is not properly oriented. <p>STEP 2</p> <p>Carefully check all antenna components and connections starting at the radio set.</p> <ul style="list-style-type: none"> ● Tighten loose connections and replace defective cables and/or components. ● Report any transformer too hot to touch or damaged receptacles to C-E ORG MAINTENANCE. <p>STEP 3</p> <p>Check TRANSFORMER hookup.</p> <ul style="list-style-type: none"> ● Reconnect the TRANSFORMERS so that the TERMINATION TRANSFORMER is at the antenna end pointing towards the distant station.

SECTION II. OPERATOR/CREW MAINTENANCE PROCEDURES

3-2. Cleaning

Clean components with **CLEAR WATER** and clean rags. **DO NOT USE SOLVENTS ON THE TRANSFORMERS.**

Clean coaxial cable fittings with a small stiff brush. If a solvent must be used, use TRICHLOROTRIFLOUROETHANE and OBSERVE THE FOLLOWING WARNING.

WARNING

FUMES OF TRICHLOROTRIFLOUROETHANE ARE POISONOUS. PROVIDE ADEQUATE VENTILATION WHENEVER YOU USE IT. DO NOT USE THIS SOLVENT NEAR HEAT OR OPEN FLAME. TRICHLOROTRIFLOUROETHANE WILL NOT BURN, BUT HEAT TURNS THE SOLVENT INTO POISONOUS AND IRRITATING FUMES. DO NOT BREATHE THE FUMES OR VAPORS. THIS SOLVENT DISSOLVES NATURAL SKIN OILS. DO NOT GET THE SOLVENT ON YOUR SKIN. USE GLOVES, SLEEVES AND AN APRON WHICH THE SOLVENT CANNOT PENETRATE. IF THE SOLVENT IS TAKEN INTERNALLY, CONSULT A PHYSICIAN IMMEDIATELY. USE THIS SOLVENT ONLY ON THE METAL MAST SECTIONS, DO NOT CLEAN THE TRANSFORMER HOUSINGS WITH THIS SOLVENT.

3-3. MOISTUREPROOFING COAXIAL CONNECTORS

If your antenna installation is to stay up several months, it is desirable to moistureproof the coaxial cable connectors.

STEP 1 First clean the area on the outside of the connectors (5 to 6 inches).

STEP 2 With the coaxial cable connected, apply several layers of electrical tape.

CHAPTER 4

ORGANIZATIONAL MAINTENANCE

SECTION I. REPAIR PARTS, SPECIAL TOOLS, TMDE AND SUPPORT EQUIPMENT

4-1. COMMON TOOLS

For authorized common tools and equipment, refer to the Modified Table of Organization and Equipment (MTOE) applicable to your unit.

4-2. TMDE, SPECIAL TOOLS AND SUPPORT EQUIPMENT

Refer to the Maintenance Allocation Chart (MAC), Appendix B in the back of this manual.

4-3. REPAIR PARTS

Refer to: TM 11-5985-370-20P, Organizational Repair Parts and Special Tools Lists for Antenna Group OE-303/GRC.

SECTION II. ORGANIZATIONAL PMCS

4-4. GENERAL

To be sure that your equipment is always ready for your mission, you must do scheduled PMCS as outlined in Table 4-1.

Organizational Maintenance PMCSS are scheduled monthly and quarterly.

Use the ITEM NO. in your PMCS table to get the numbers for the TM ITEM NO. column on DA Form 2404 (Equipment Inspection and Maintenance Worksheet) when you fill out the form.

TM ITEM NO. a	STATUS b	DEFICIENCIES AND SHORTCOMINGS c	CORRECTIVE ACTION d	INITIAL WHEN CORRECTED e
1		UPPER GUY PLATE MISSING		

DA FORM 2404
1 JAN 66

TABLE 2-1. ORGANIZATIONAL PREVENTIVE MAINTENANCE CHECKS AND SERVICES

M = MONTHLY

Q = QUARTERLY

ITEM NO.	INTERVAL		ITEM TO BE INSPECTED	PROCEDURES CHECK FOR AND HAVE REPAIRED OR ADJUSTED AS NECESSARY
	M	Q		
1.		•	Completeness	All components required to make the OE-303/GRC operational are on hand (see Appendix C-1)
2.		•	Publications	The necessary technical manuals are on hand ????
3.	•		Modifications	Check DA Pam 310-1 to see if any modification work orders (MWO's) are listed for the OE-303/GRC or its components. All URGENT MWO's must be applied immediately and all NORMAL MWO's must be scheduled.
4.		•	Metal Surfaces	Remove rust, corrosion and fungus, spot paint bare metal spots as necessary.
5.		•	Weatherproofed Connectors	Remove old and install new electrical tape.

Section III. TROUBLESHOOTING

4-5. TROUBLESHOOTING GUIDLINES

Troubleshooting by Organizational Maintenance involves the use of the MULTIMETER AN/USM-223.

Before performing your troubleshooting or use your test equipment- MAKE SURE THAT THE OPERATOR/- CREW TROUBLESHOOTING PROCEDURES IN THIS MANUAL HAVE BEEN DONE.

4-6. TROUBLESHOOTING THE MULTIMETER

This task covers:

- a. Setup.
- b. Testing.

INITIAL SETUP

Test Equipment

Multimeter AN/USM-223

Personnel Required:

1

Special Environmental Conditions:

None.

STEP ①

Check the continuity of the center conductor in the RADIO CABLE.

Connect the MULTIMETER as shown:

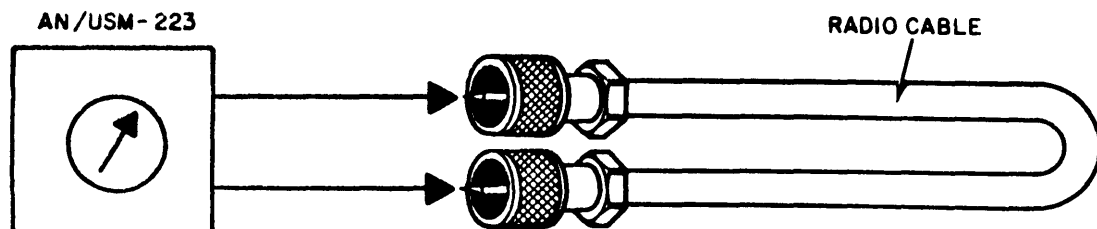

Use the **LOWEST** resistance range:

- A good conductor gives a reading of 1 or 2 ohms.
- An **open or defective** conductor gives a resistance of infinity.

STEP 2

Check for leakage or short between the **center conductor and** the **shield** in the RADIO CABLE.

AND

Repeat this test **on** the **DISSIPATION CABLE**.

Connect the MULTI METER as shown below:

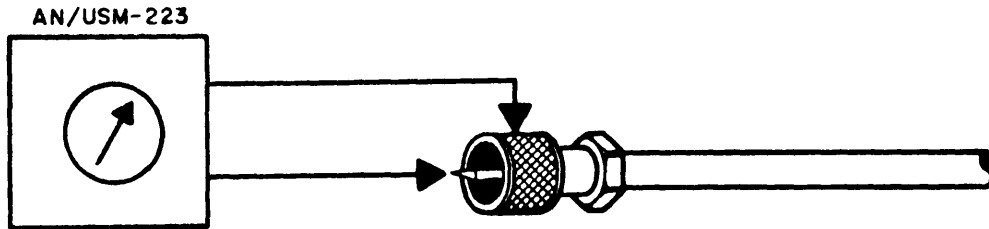

Use the **HIGHEST** resistance **range**.

- A **good** cable will give a reading of **infinity**.
- A **defective** cable will give a reading of **some continuity**.

STEP 3

Check for an **open braid** or shield in the RADIO CABLE,

AND

REPEAT this test **on** the **DISSIPATION CABLE**.

Connect the MULTIMETER as shown:

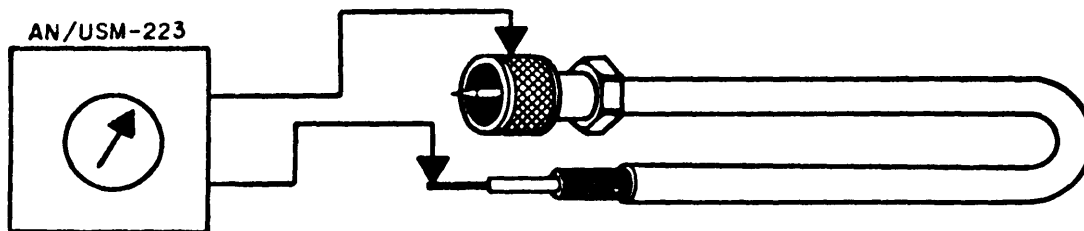

Use the **LOWEST** resistance **range**.

- A **good braid** or shield gives a reading of 1 or 2 ohms.
- An open or **defective braid** gives a **high resistance** reading (or even infinity).

STEP ④

Check the resistance of each transformer.

Connect the multimeter as shown:

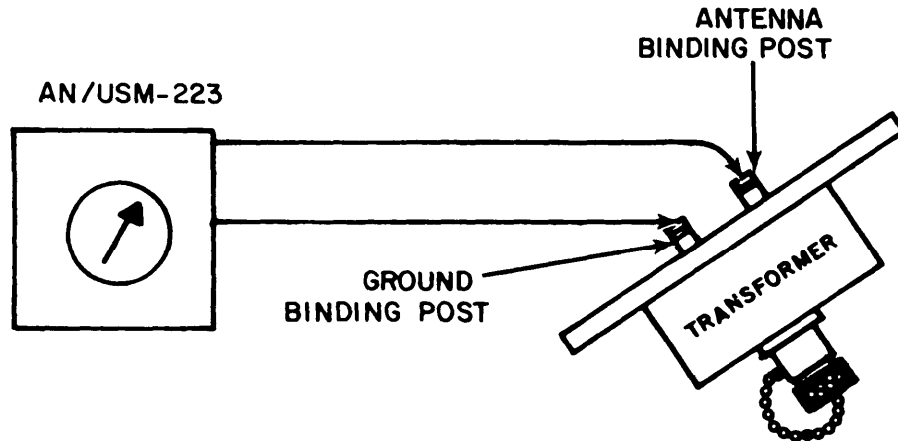

Use the **LOWEST** resistance range.

- A **good transformer** should give a reading of **less than 1 OHM**. This indicates normal continuity.

NOTE

Even though the resistance check indicates normal continuity, this is no guarantee that the transformer will operate properly with radio frequencies. The best check of a transformer is in an operating hookup.

- A reading of **MORE THAN 1 OHM** on the lowest scale
OR
 a reading of **INFINITY ON ANY SCALE**
INDICATES TRANSFORMER PROBLEMS.

SECTION IV. ORGANIZATIONAL MAINTENANCE PROCEDURES

4-7. SCOPE OF ORGANIZATIONAL MAINTENANCE

Organizational Maintenance personnel should be familiar with:

- Operator/Crew operating and maintenance procedures for the radio equipment connected to the HALF-RHOMBIC ANTENNA.
- Operator/Crew operating and maintenance procedures for the HALF-RHOMBIC ANTENNA.

PMCS and troubleshooting procedures by Organizational Maintenance have been covered in previous paragraphs.

Parts replacement is covered in the following paragraph.

4.8. REPLACEMENT PARTS

See the TM 11-5985-370-20P for authorized replacement parts.

APPENDIX A REFERENCES

A-1. SCOPE

This appendix lists forms, field manuals, technical manuals and miscellaneous publications referenced in this manual,

A-2. FORMS

DA Form 2028	Recommended Changes to Publications and Blank Forms.
DA Form 2028-2	Recommended Changes to Equipment Technical Publications.
SF 361	Discrepancy in Shipment Report (DISREP)
SF 368	Quality Deficiency Report.

A-3. FIELD MANUALS

FM 21-11	Artificial Respiration
FM 21-26	Map Reading

A-4. TECHNICAL MANUALS

TM 11-5820-398-12	Operator's and Organizational Maintenance Manual Including Repair Parts and Special Tools List: Radio Set AN/PRC-25 (Including Receiver-Transmitter, Radio RT-505/PRC-25).
TM 11-5820-401-10-1	Operator's Manual: Radio Sets AN/VRC-12 (NSN 5820-00-223-7412), AN/VRC-43 (5820-00-223-7415), AN/VRC-44 (5820-00-223-7471), AN/VRC-45 (5820-00-223-7418), AN/VRC-46 (5820-00-223-7533), AN/VRC-47 (5820-00-223-7434), AN/VRC-48 (5820-00-223-7435) and AN/VRC-49 (5820-00-223-7437) Used With an Intercom System).
TM 11-5820-401-10-2	Operator's Manual: Radio Sets AN/VRC-12 (NSN 5820-00-223-7412), AN/VRC-43 (5820-00-223-7415), AN/VRC-44 (5820-00-223-7417), AN/VRC-45 (5820-00-223-7418), AN/VRC-46 (5820-00-223-7433) , AN/VRC-47 (5820-00-223-7434) , AN/VRC-48 (5820-00-223-7435) and AN/VRC-49 (5820-00-223-7437) Used With an Intercom System).
TM 11-5820-401-20-1	TM 11-5820-401-20-1, Organizational Maintenance Manual: RADIO SETS: AN/VRC-12 (NSN 5820-00-223-7412), AN/VRC-43 (NSN 5820-00-223-7415), AN/VRC-44 (NSN 5820-00-223-7417), AN/VRC-45 (NSN 5800-00-223-7418), AN/VRC-46 (NSN 5820-00-223-7434), AN/VRC-48 (NSN 5820-00-223-7435), AN/VRC-49 (NSN 5820-00-223-7437) (Used without intercom set)
TM 11-5820-401-20-2	TM 11-5820-401-20-2, Organizational Maintenance Manual: RADIO SETS: AN/VRC-12 (NSN 5820-00-223-7412), AN/VRC-43 (NSN 5820-00-223-7415), AN/VRC-44 (NSN 5820-00-223-7417), AN/VRC-45 (NSN 5820-00-223-7418), AN/VRC-46 (NSN 5820-00-223-7433), AN/VRC-47 (NSN 5820-00-223-7434), AN/VRC-48 (NSN 5820-00-223-7435), AN/VRC-49 (NSN 5820-00-223-7437) (Used with intercom set AN/VIC-1 (V))

- TM 11-5820-498-12** Operator's and Organizational Maintenance Manual: Radio Sets AN/VRC-53 (NSN 5820-00-223-7467), AN/VRC-64, (NSN 5820-00-223-7475), AN/GRC-125 (NSN 5820-00-223-7411), and AN/GRC-125 5820-00-223-7411), and AN/GRC-160 (NSN 5820-00-223-7473), and Amplifier-Power Supply Groups OA-3633/GRC and OA-3633A/GRC (NSN 5820-00-973-3333).
- TM 11-5820-667-12** Operator's and Organizational Maintenance Manual (Including Repair Parts List): Radio Set AN/PRC-77 (NSN 5820-00-930-3724) (Including Receiver-Transmitter, Radio RT-841/PRC-77 (NSN 5820-00-930-3725)).
- TM 11 5985-370-12-HR** Hand Receipt Covering Contents of Components of End Item (COEI) Basic Issue Items, (BII), and Additional Authorization List (AAL) for Antenna Group OE-303/GRC (NSN) 5985-01-152-5845)
- TM 11-5985-370-20P** Organizational Repair Parts and Special Tools Lists For Antenna Group OE-303/GRC.
- TM 11-6625-654-14** Operator's Organizational, Direct Support, and General Support Maintenance Repair Parts and Special Tools List (Including Depot Maintenance Repair Parts and Special Tools List) for Multimeter AN/USM-223.

A-5. MISCELLANEOUS PUBLICATIONS

- AMDF** (AR708-1) IAW Packaging Segment of AMDF by NSN.
- AR 735-11-2** Reporting of Item and Packaging Discrepancies.
- AR 750-244-2** Destruction of Army Materiel.
- DA PAM 310-1** Consolidated Index of Army Publications and Blank Forms.
- 0A PAM 738-750** The Army Maintenance-Management System (TAMMS).
- SB 11-573** Painting and Preserving of Supplies Available for Field Use for Electronics Command Equipment.
- SB 11-614** Caution Notice for Antenna Bases, Towers, and Other Mast Structures.
- TB 43-0018** Field Instructions for Painting and Preserving Electronics Command Equipment Including Camouflage Pattern Painting of Electrical Equipment Shelters.
- TB SIG 291** Safety Measures to be Observed When Installing and Using Whip Antennas. Field Type Masts, Towers, Antennas, and Metal Poles That Are Used with Communication, Radar, and Direction Finder Equipment.

APPENDIX B MAINTENANCE ALLOCATION

Section I. INTRODUCTION

B-1. General

This appendix provides a summary of the maintenance operations for Antenna Group OE-303/GRC. It authorizes categories of maintenance for specific maintenance functions on repairable items and components and the tools and equipment required to perform each function. This appendix may be used as an aid in planning maintenance operations.

B-2. Maintenance Function.

Maintenance functions will be limited to and defined as follows:

a. Inspect. To determine the serviceability of an item by comparing its physical, mechanical, and/or electrical characteristics with established standards through examination.

b. Test. To verify serviceability and to detect incipient failure by measuring the mechanical or electrical characteristics of an item and comparing those characteristics with prescribed standards.

c. Service. Operations required periodically to keep an item in proper operating condition, i.e., to clean (decontaminate), to preserve, to drain, to paint, or to replenish fuel, lubricants, hydraulic fluids, or compressed air supplies.

d. Adjust. To maintain, within prescribed limits, by bringing into proper or exact position, or by setting the operating characteristics to the specified parameters.

e. Align. To adjust specified variable elements of an item to bring about optimum or desired performance.

f. Calibrate. To determine and cause corrections to be made or to be adjusted on instruments or test measuring and diagnostic equipments used in precision measurement. Consists of comparisons of two instruments, one of which is a certified standard of known accuracy, to detect and adjust any discrepancy in the accuracy of the instrument being compared.

g. Install. The act of emplacing, seating, or fixing into position an item, part, module (component or assembly) in a manner to allow the proper functioning of the equipment or system.

h. Replace. The act of substituting a serviceable like type part, subassembly, or module (component or assembly) for the unserviceable counterpart.

i. Repair. The application of maintenance services (inspect, test, service, adjust, align, calibrate, replace) or other maintenance actions (welding, grinding, riveting, straightening, facing, remachining, or resurfacing) to restore serviceability to an item by correcting specific damage, fault, malfunction, or failure in a part, subassembly, module (component or assembly), end item, or system.

j. Overhaul. That maintenance effort (service/action) necessary to restore an item to a completely serviceable/operational condition as prescribed by maintenance standards (i.e., DMWR) in appropriate technical publications. Overhaul is normally the highest degree of maintenance performed by the Army. Overhaul does not normally return an item to like new condition.

k. Rebuild. Consists of those services/actions necessary for the restoration of unserviceable equipment to a like new condition in accordance with original manufacturing standards. Rebuild is the highest degree of material maintenance applied to Army equipment. The rebuild operation includes the act of returning to zero those age measurements (hours, miles, etc.) considered in classifying Army equipments/components.

B-3. Column Entries.

a. Column 1, Group Number. Column 1 lists group numbers, the purpose of which is to identify components, assemblies, subassemblies, and modules with the next higher assembly.

b. Column 2, Component Assembly. Column 2 contains the noun names of components, assemblies, subassemblies, and modules for which maintenance is authorized.

c. Column 3, Maintenance Functions. Column 3 lists the functions to be performed on the item listed in column 2. When items are listed without maintenance functions, it is solely for purpose of having the group numbers in the MAC and RPSTL coincide.

d. Column 4, Maintenance Category. Column 4 specifies, by the listing of a "work time" figure in the appropriate subcolumn(s), the lowest level of maintenance authorized to perform the function listed in column 3. This figure represents the active time required to perform that maintenance function at the indicated category of maintenance. If the number or complexity of the tasks within the listed maintenance function vary at different maintenance categories, appropriate "work time" figures will be shown for each category. The number of task-hours specified by the "work time" figure represents the average time required to restore an item (assembly, subassembly, component, module, end item or system) to a serviceable condition under typical field operating conditions. This time includes preparation time, troubleshooting time, and quality assurance/quality control time in addition to the time required to perform the specific tasks identified for the maintenance functions authorized in the maintenance allocation chart. Subcolumns of column 4 are as follows:

C - Operator/Crew

O - Organizational

F - Direct Support

H - General Support

D - Depot

e. Column 5, Tools and Equipment. Column 5 specifies by code, those common tool sets (not individual tools) and special tools, test, and support equipment required to perform the designated function.

f. Column 6, Remarks. Column 6 contains an alphabetic code which leads to the remark in section IV, Remarks, which is pertinent to the item opposite the particular code.

B-4. TOOL and Test Equipment Requirements (Sect. III).

a. Tool or Test Equipment Reference Code. The numbers in this column coincide with the numbers used in the tools and equipment column of the MAC. The numbers indicate the applicable tool or test equipment for the maintenance functions.

b. Maintenance Category. The codes in this column indicate the maintenance category allocated the tool or test equipment.

c. Nomenclature. This column lists the noun name and nomenclature of the tools and test equipment required to perform the maintenance functions.

d. National/NATO Stock Number. This column lists the National/NATO stock number of the specific tool or test equipment.

e. Tool Number. This column lists the manufacturer's part number of the tool followed by the Federal Supply Code for manufacturers (5-digit) in parentheses.

B-5. Remarks (Sect. IV).

a. Reference Code. This code refers to the appropriate item in section II, column 6.

b. Remarks. This column provides the required explanatory information necessary to clarify items appearing in section II.

SECTION II MAINTENANCE ALLOCATION CHART
FOR
ANTENNA GROUP OE-303/GRC

(1) GROUP NUMBER	(2) COMPONENT/ASSEMBLY	(3) MAINTENANCE FUNCTION	(4) MAINTENANCE CATEGORY					(5) TOOLS AND EQPT.	(6) REMARKS
			C	O	F	H	D		
00	ANTENNA GROUP OE-303/GRC	Inspect	0.17						A
		Test	0.1						B
		Replace		1.0				1	
		Repair		0.3				1,2,3	C
01	ANTENNA AS-3490 ()/GRC	Test		0.12				3	D
		Replace		0.3				1	
		Repair		0.2				2	E
02	MAST AB-1244A/GRC	Replace		0.3				1	
		Repair		0.2				1	E

SECTION III TOOL AND TEST EQUIPMENT REQUIREMENTS
 FOR
 ANTENNA GROUP OE-303/GRC

TOOL OR TEST EQUIPMENT REF CODE	MAINTENANCE CATEGORY	NOMENCLATURE	NATIONAL/ NATO STOCK NUMBER	TOOL NUMBER
1	C	HAND HAMMER	5120-00-203-4656	10206 (89753)
2	0	TOOL KIT TK-101/G	5180-00-064-5178	
3	0	MULTIMETER AN/USM-223	6625-00-999-7465	

SECTION IV. REMARKS
 ANTENNA GROUP OE-303/GRC

REFERENCE CODE	REMARKS
A	Inspect guys, stakes and mast components for security, inspect for rust, fungus, frayed electrical tape, transformer base for cracks.
B	Operational Test.
C	Repair by replacement of parts/assemblies.
D	Test for opens, shorts and continuity on electrical components.
E	Repair by replacement of parts.

APPENDIX C

COMPONENTS OF END ITEM AND BASIC ISSUE ITEMS LIST

Section I. INTRODUCTION

C-1. Scope

This appendix lists components of end item and basic issue items for Antenna Group OE-303/GRC to help you inventory items required for safe and efficient operation.

C-2. General

The components of End Item and Basic Issue Items Lists are divided into the following sections:

a. Section II — Components of End Item. This listing is for information purposes only, and is not authority to requisition replacements. These items are part of the end item, but are removed and separately packaged for transportation or shipment. As part of the end item, these items must be with the end item whenever it is issued or transferred between property accounts. Illustrations are furnished to assist you in identifying the items.

b. Section III — Basic Issue Items. These are the minimum essential items required to place the Antenna Group OE-303/GRC in operation, to operate it, and to perform emergency repairs. Although shipped separately packaged, BII must be with the Antenna Group OE-303/GRC during operation and whenever it is transferred between property accounts. The illustrations will assist you with hard-to-identify items. This manual is your authority to request/requisition replacement BII, based on TOE/MTOE authorization of the end item.

C-3. Explanation of Columns

The following provides an explanation of columns found in the tabular listings:

a. Column (1) — Illustration Number (Illus Number). This column indicates the number of the illustration in which the item is shown.

b. Column (2) — National Stock Number. Indicates the National stock number assigned to the item. The National stock numbers in section III will be used for requisitioning basic issue items.

c. Column (3) — Description. Indicates the National item name and, if required, a minimum description to identify and locate the item. The last line for each item indicates the FSCM (in parentheses) followed by the part number.

d. Column (4) — Unit of Measure (U/M). Indicates the measure used in performing the actual operational/maintenance function. This measure is expressed by a two-character alphabetical abbreviation (e.g., ea, in, pr).

e. Column (5) — Quantity required (Qty Rqd). Indicates the quantity of the item authorized to be used with/on the equipment.

OE-303/GRC

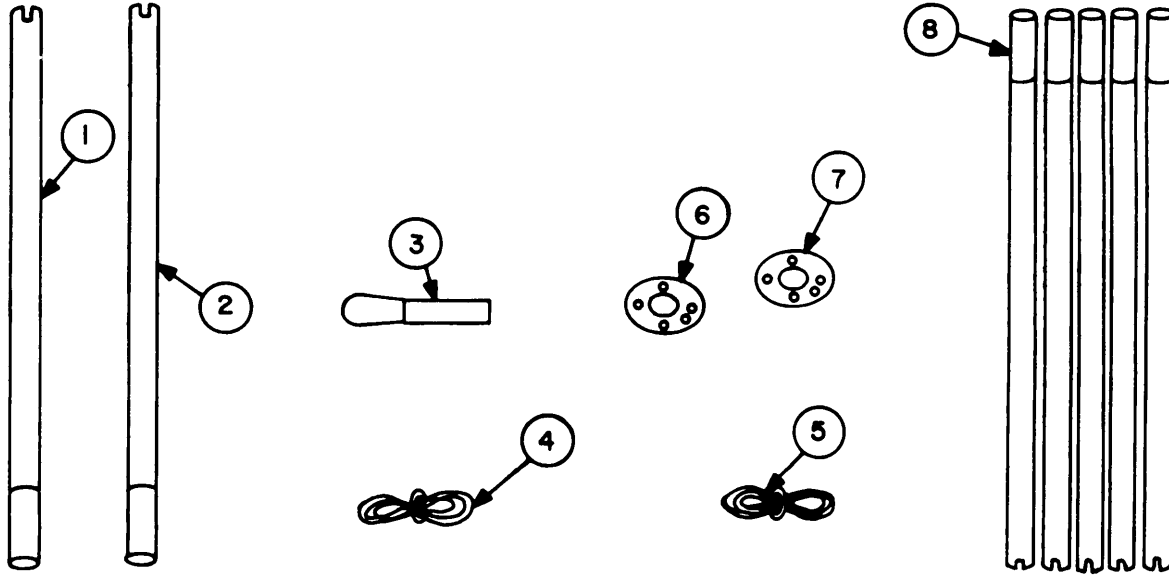

SECTION II. COMPONENTS OF END ITEM

(1) ILLUS NO.	(2) NATIONAL STOCK NUMBER	(3) DESCRIPTION (FSCM) AND PART NUMBER USABLE ON CODE	(4) U/M	(5) QTY REQD
<p>ANTENNA GROUP (80058) OE-303/GRC CONSISTS OF: MAST AB-1244A/GRC (80063) SM-D-886154 CONSISTS OF:</p>				
1	5985-01-072-8015	ADAPTER ASSEMBLY, LOWER (80063) SM-D-659279	EA	1
2	5985-01-072-8016	ADAPTER ASSEMBLY, UPPER (80063) SM-D-659286	EA	1
3	5985-01-072-4496	CLAMP, ELECTRICAL CONDUCTOR, STRAIN (80063) PF-211/G: SC-DL-14203	EA	1
4	5985-01-072-4414	GUY ASSEMBLY (80063) SC-D-659410-GP1	EA	4
5	5985-01-072-4415	GUY ASSEMBLY (80063) SC-D-659410-GP2	EA	4
6	4030-01-074-7881	GUY PLATE (80063) SM-B-659290-1	EA	1
7	4030-01-072-8126	GUY PLATE (80063) SM-B-659290-2	EA	1
8	5985-01-072-8065	MAST SECTION ASSEMBLY, LOWER (80063) SM-C-659276	EA	5

OE-303/GRC

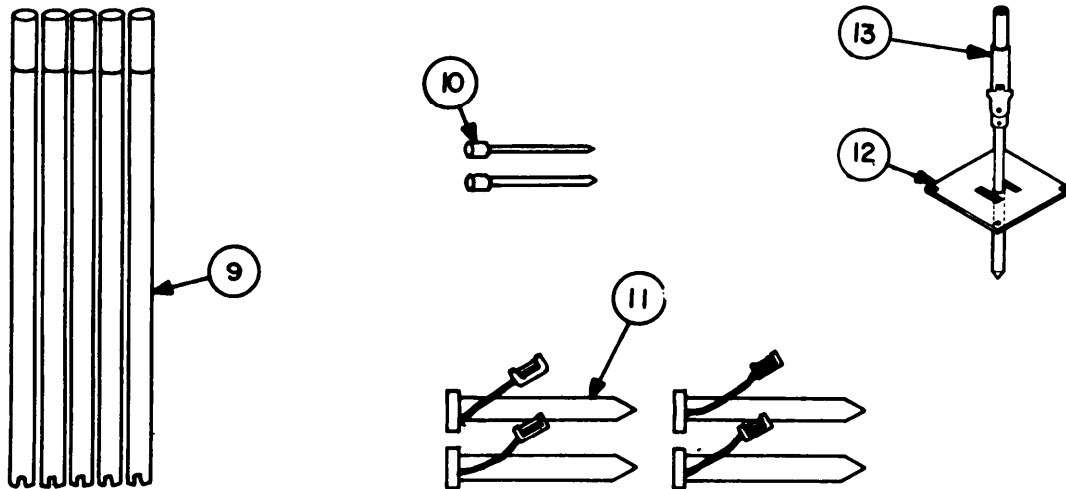

SECTION II. COMPONENTS OF END ITEM

(1) ILLUS NO.	(2) NATIONAL STOCK NUMBER	(3) DESCRIPTION (FSCM) AND PART NUMBER	(4) U/M	(5) QTY REQD
9	5985-01-072-8066	MAST SECTION ASSEMBLY, UPPER (80063) SM-C-659283	EA	5
10	4030-01-072-8017	STAKE (80063) SC-B-729924	EA	2
11	5985-01-073-6103	STAKE ASSEMBLY (80063) SM-C-659375	EA	4
12	5985-01-127-2133	PLATE (80063) A3002872	EA	1
13	5985-01-124-5431	MAST AND BASE ASSEMBLY (80063) A3002868	EA	1

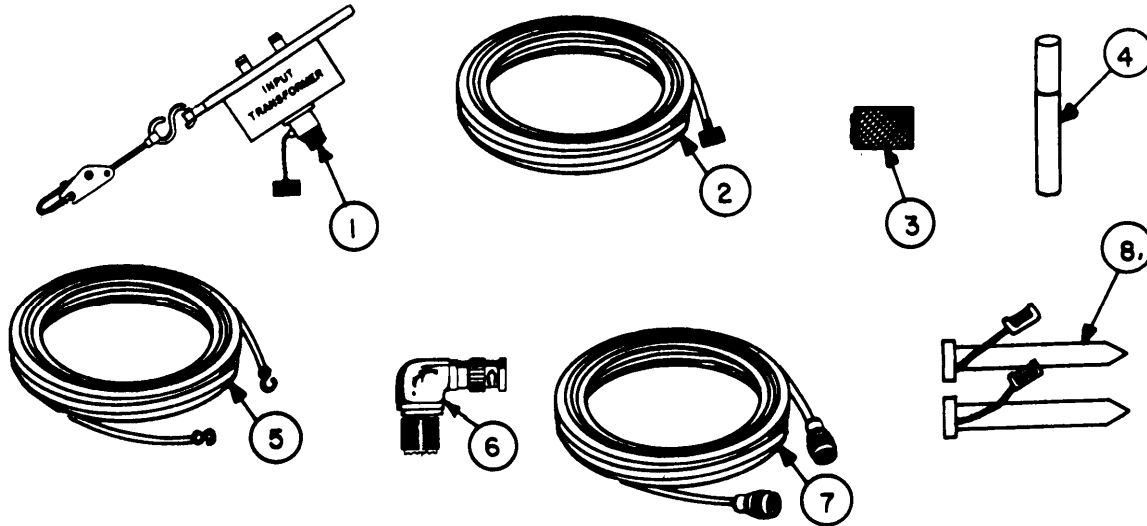

SECTION II. COMPONENTS OF END ITEM

(1) ILLUS NO.	(2) NATIONAL STOCK NUMBER	(3) DESCRIPTION (FSCM) AND PART NUMBER	(4) U/M	(5) QTY REQD
1		ANTENNA ASSEMBLY (80058) AS-3490/GRC CONSISTS OF: MATCHING TRANSFORMER (80063) A3010435	EA	2
2		DISSIPATION TRANSMISSION LINE (80063) A3010413	EA	1
3		CONNECTOR ADAPTER (80058) UG-201A/U	EA	1
4		INSULATING TUBE ASSEMBLY (80063) A3010414	EA	1
5		ANTENNA WIRE ASSEMBLY (80063) A3010411	EA	1
6		CONNECTOR ADAPTER (92180) TRU-2064	EA	1
7		CABLE ASSEMBLY (80058) CG-1889C/U	EA	1
8	5985-01-073-6103	STAKE ASSEMBLY (80063) SM-C-659375	EA	2

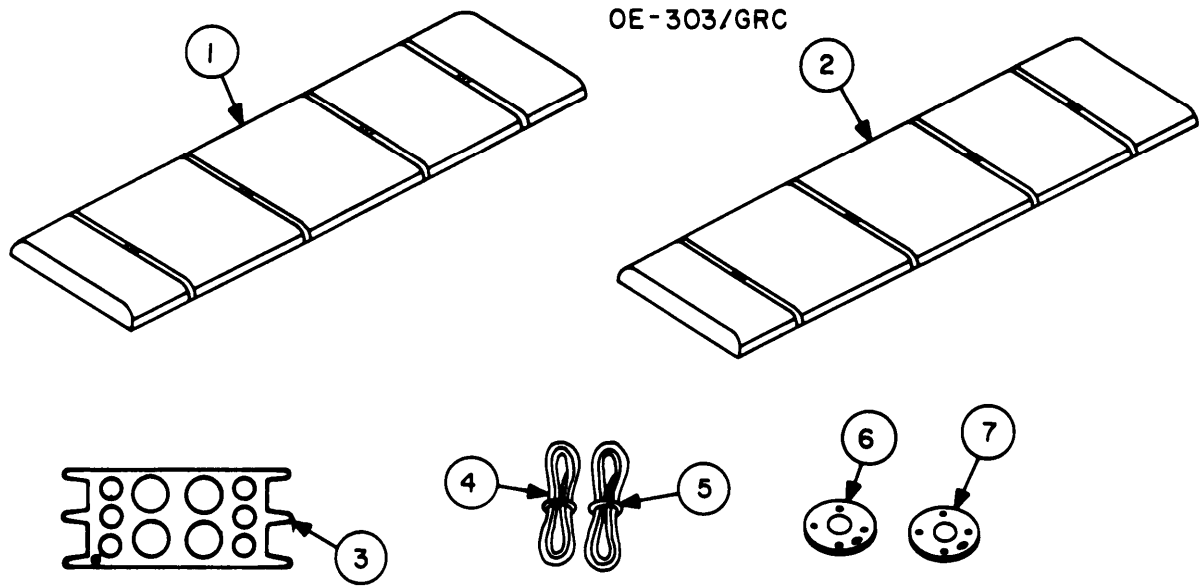

SECTION III. BASIC ISSUE ITEMS

(1) ILLUS NO.	(2) NATIONAL STOCK NUMBER	(3) DESCRIPTION (FSCM) AND PART NUMBER USABLE ON CODE	(4) U/M	(5) QTY REQD
1		BAG MAST TRANSIT (80063) A3010437	EA	1
2		BAG ANTENNA TRANSIT (80063) A3010436	EA	1
3	8130-00-355-7616	REEL, ASSEMBLY (8005b) RL-28	EA	4
4	5985-01-072-4414	*GUY ASSEMBLY (80063) SM-D-659410-GP1	EA	1
5	5985-01-072-4415	*GUY ASSEMBLY (80063) SM-D-659410-GP2	EA	1
6	4030-01-074-7881	*GUY PLATE (80063) SM-B-659290-1	EA	1
7	4030-01-072-8126	*GUY PLATE (80063) SM-B-659290-2	EA	1
		*RUNNING SPARES		

OE-303/GRC

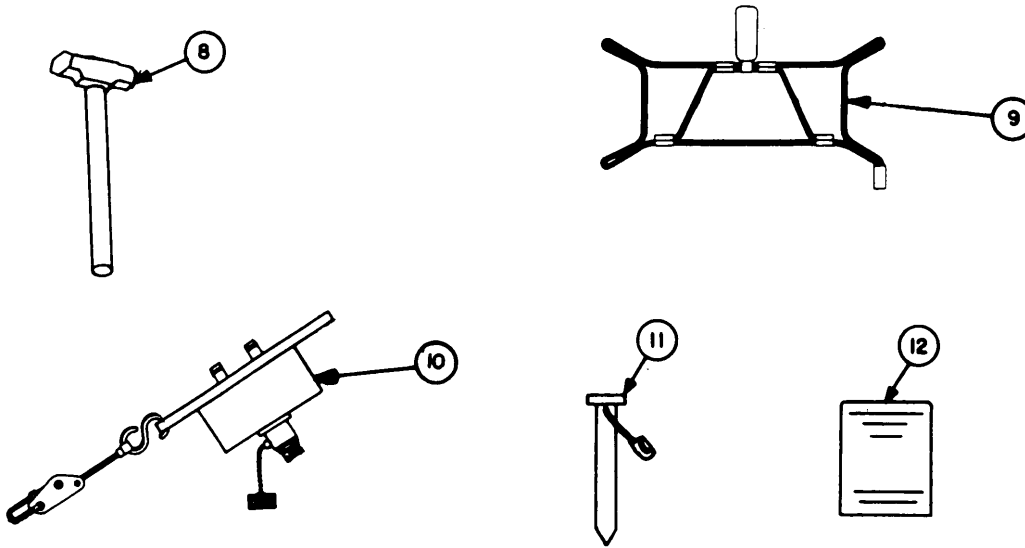

SECTION III. BASIC ISSUE ITEMS

(1) ILLUS NO.	(2) NATIONAL STOCK NUMBER	(3) DESCRIPTION (FSCM) AND PART NUMBER	(4) U/M	(5) QTY REQD
8	5120-00-203-4656	HAMMER HAND, 2-½ LB. (81348) TYPE X, CLASS 1, GGG-H-86C	EA	1
9		REEL (80058) KL-29	EA	2
10		*MATCHING TRANSFORMER (80063) A3010435	EA	1
11	5985-01-073-6103	*STAKE ASSEMBLY (80063) SM-C-659375	EA	1
12		TECHNICAL MANUAL: TM-11-5985-357-12 *RUNNING SPARES	EA	1

APPENDIX E

EXPENDABLE SUPPLIES AND MATERIALS LIST

Section I. INTRODUCTION

E-1 Scope

This appendix lists expendable supplies and materials you will need to operate and maintain Antenna Group OE-303/GRC. These items are authorized to you by CTA 50-970. Expendable Items (Except Medical, Class V, Repair Parts, or Heraldic Items).

E-2. Explanation of Columns

a. Column 1 — Item Number. This number is assigned to the entry in the listing and is referenced in the narrative instructions to identify the material) e.g., “Use cleaning compound, item 5, App. D”).

b. Column 2— Level. This column identifies the lowest level of maintenance that requires the listed item.

- C — Operator/Crew
- O — Organizational Maintenance
- F — Direct Support Maintenance
- H — General Support Maintenance

c. Column 3 — National Stock Number. This is the National stock number assigned to the item; use it to request or requisition the item.

d. Column 4 — Description. Indicates the Federal item name and, if required, a description to identify the item. The last line for each item indicates the part number followed by the Federal Supply Code for Manufacturer (FSCM) in parentheses, if applicable.

e. Column 5 — Unit of Measure (U/M). Indicates the measure used in performing the actual maintenance function. This measure is expressed by a two-character alphabetical abbreviation (e.g., ea, in, pr). If the unit of measure differs from the unit of issue, requisition the lowest unit of issue that will satisfy your requirements,

SECTION II EXPENDABLE SUPPLIES AND MATERIALS LIST

(1) ITEM NO.	(2) LEVEL	(3) NATIONAL STOCK NUMBER	(4) DESCRIPTION PART NO. AND FSCM	(5) UNIT OF MEAS
1	C	5970-00-419-4291	ELECTRICAL TAPE	RL
2	C,0	6810-00-292-9625	TRICHLOROTRIFLUOROETHANE OT620 (81348)	OZ
3	0	8010-00-039-5939	PAINT, SOLAR REFLECTING, FOREST GREEN, MIL-E-52789A (ME)	QT

RECOMMENDED CHANGES TO EQUIPMENT TECHNICAL PUBLICATIONS



THEN... JOT DOWN THE DOPE ABOUT IT ON THIS FORM. CAREFULLY TEAR IT OUT. FOLD IT AND DROP IT IN THE MAIL!

SOMETHING WRONG WITH THIS PUBLICATION?

FROM: (PRINT YOUR UNIT'S COMPLETE ADDRESS)
 Commander
 Stateside Army Depot
 ATTN: AMSTA-US
 Stateside, N.J. 07703

DATE SENT
 10 July 1975

PUBLICATION NUMBER
 TM 11-5840-340-12

PUBLICATION DATE
 23 Jan 74

PUBLICATION TITLE
 Radar Set AN/PRC-76

BE EXACT PIN-POINT WHERE IT IS

PAGE NO	PARA-GRAPH	FIGURE NO	TABLE NO
2-25	2-28		
3-10	3-3		3-1
5-6	5-8		

IN THIS SPACE TELL WHAT IS WRONG AND WHAT SHOULD BE DONE ABOUT IT:

Recommend that the installation antenna alignment procedure be changed throughout to specify a 2° IFF antenna lag rather than 1°.

REASON: Experience has shown that with only a 1° lag, the antenna servo system is too sensitive to wind gusting in excess of 25 knots, and has a tendency to rapidly accelerate and decelerate as it hunts, causing strain to the drive train. Hunting is minimized by adjusting the lag to 2° without degradation of operation.

Item 5, Function column. Change "2 db" to "3db."

REASON: The adjustment procedure for the TRANS POWER FAULT indicator calls for a 3 db (500 watts) adjustment to light the TRANS POWER FAULT indicator.

Add new step f.1 to read, "Replace cover plate removed in step e.1, above."

REASON: To replace the cover plate.

Zone C 3. On J1-2, change "+24 VDC to "+5 VDC."

REASON: This is the output line of the 5 VDC power supply. +24 VDC is the input voltage.

PRINTED NAME GRADE OR TITLE AND TELEPHONE NUMBER
 SSG I. M. DeSpiritof 999-1776

SIGN HERE

TEAR ALONG PERFORATED LINE

FILL IN YOUR
UNIT'S ADDRESS

FOLD BACK

DEPARTMENT OF THE ARMY

POSTAGE AND FEES PAID
DEPARTMENT OF THE ARMY
DOD 314



OFFICIAL BUSINESS
PENALTY FOR PRIVATE USE \$300

SAMPLE

Commander
US Army Communications-Electronics Command
and Fort Monmouth
ATTN: DRSEL-ME-MP
Fort Monmouth, New Jersey 07703

TEAR ALONG PERFORATED LINE

RECOMMENDED CHANGES TO EQUIPMENT TECHNICAL PUBLICATIONS



THEN...JOT DOWN THE DOPE ABOUT IT ON THIS FORM. CAREFULLY TEAR IT OUT, FOLD IT AND DROP IT IN THE MAIL.

SOMETHING WRONG WITH THIS PUBLICATION?

FROM: (PRINT YOUR UNIT'S COMPLETE ADDRESS)

DATE SENT

PUBLICATION NUMBER

TM 11-5985-370-12

PUBLICATION DATE

19 JULY 1984

PUBLICATION TITLE

Antenna Group OE-303/GRC

BE EXACT PIN-POINT WHERE IT IS

PAGE NO.	PARA-GRAPH	FIGURE NO.	TABLE NO.

IN THIS SPACE TELL WHAT IS WRONG AND WHAT SHOULD BE DONE ABOUT IT:

TEAR ALONG PERFORATED LINE

PRINTED NAME GRADE OR TITLE AND TELEPHONE NUMBER

SIGN HERE

DA FORM 2028-2
1 JUL 79

PREVIOUS EDITIONS ARE OBSOLETE

P.S.--IF YOUR OUTFIT WANTS TO KNOW ABOUT YOUR RECOMMENDATION MAKE A CARBON COPY OF THIS AND GIVE IT TO YOUR HEADQUARTERS.

FILL IN YOUR
UNIT'S ADDRESS

FOLD BACK

DEPARTMENT OF THE ARMY

OFFICIAL BUSINESS
PENALTY FOR PRIVATE USE \$300

POSTAGE AND FEES PAID
DEPARTMENT OF THE ARMY
DOD 314



TEAR ALONG PERFORATED LINE

Commander
US Army Communications-Electronics Command
and Fort Monmouth
ATTN: DRSEL-ME-MP
Fort Monmouth, New Jersey 07703

FILL IN YOUR
UNIT'S ADDRESS

FOLD BACK

DEPARTMENT OF THE ARMY

OFFICIAL BUSINESS
PENALTY FOR PRIVATE USE \$300

POSTAGE AND FEES PAID
DEPARTMENT OF THE ARMY
DOD 314



TEAR ALONG PERFORATED LINE

Commander
US Army Communications-Electronics Command
and Fort Monmouth
ATTN: DRSEL-ME-MP
Fort Monmouth, New Jersey 07703

RECOMMENDED CHANGES TO EQUIPMENT TECHNICAL PUBLICATIONS



THEN...JOT DOWN THE DOPE ABOUT IT ON THIS FORM. CAREFULLY TEAR IT OUT, FOLD IT AND DROP IT IN THE MAIL.

SOMETHING WRONG WITH THIS PUBLICATION?

FROM: (PRINT YOUR UNIT'S COMPLETE ADDRESS)

DATE SENT

PUBLICATION NUMBER

TM 11-5985-370-12

PUBLICATION DATE

19 JULY 1984

PUBLICATION TITLE

Antenna Group OE-303/GRC

BE EXACT PIN-POINT WHERE IT IS

PAGE NO.	PARA-GRAPH	FIGURE NO.	TABLE NO.

IN THIS SPACE TELL WHAT IS WRONG AND WHAT SHOULD BE DONE ABOUT IT:

TEAR ALONG PERFORATED LINE

PRINTED NAME GRADE OR TITLE AND TELEPHONE NUMBER

SIGN HERE

DA FORM 2028-2
1 JUL 79

PREVIOUS EDITIONS ARE OBSOLETE

P.S.--IF YOUR OUTFIT WANTS TO KNOW ABOUT YOUR RECOMMENDATION MAKE A CARBON COPY OF THIS AND GIVE IT TO YOUR HEADQUARTERS.

FILL IN YOUR
UNIT'S ADDRESS

FOLD BACK

DEPARTMENT OF THE ARMY

OFFICIAL BUSINESS
PENALTY FOR PRIVATE USE \$300

POSTAGE AND FEES PAID
DEPARTMENT OF THE ARMY
DOD 314



TEAR ALONG PERFORATED LINE

Commander
US Army Communications-Electronics Command
and Fort Monmouth
ATTN: DRSEL-ME-MP
Fort Monmouth, New Jersey 07703

By Order of the Secretary of the Army:

Official:

JOHN A. WICKHAM JR.
General, United States Army
Chief of Staff

ROBERT M. JOYCE
Major General, United States Army
The Adjutant General

Distribution:

To be distributed in accordance with special list.

