

Hose Ends - Crimp

Table of Contents

Coll-O-Crimp		229 'P' Series	J-33
'E' Series	J-2 thru J-8	265 'P' Series	J-34
069 'E' Series	J-9 thru J-12	338 'P' Series	J-35 thru J-37
327 'E' Series	J-13 thru J-14	'S' Series	J-38
336 'E' Series	J-15 thru J-18	'U' Series	J-39 thru J-57
470 'E' Series	J-19 thru J-23	430 'U' Series	J-58 thru J-68
757 'E' Series	J-24 thru J-31	WeatherGRIP™ 'Z' Series	J-69 thru J-94
057 'P' Series	J-32	WeatherTIGHT™ '4SP/6SP' Series	J-95 thru J-105



Coll-O-Crimp

'E' Series

Hose End 'E' Series

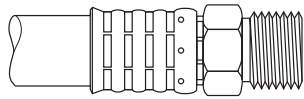

Refer to the Weatherhead Hose End and Tool Selector Chart W-HOOV-TM001-E2 for qualified sizes.

⚠ WARNING

For Teflon® hose applications, 'E' series fittings must be used with H243 and H277 .030" thin wall hose only.

Ordering Information: Order individually part number.

⚠ Refer to important safety information on pages A-2-3.

Teflon® is a registered trademark of DuPont used under license by Eaton.

Application: General purpose low- and medium-pressure hydraulics. Use H277 or H435 where shock hazards exist.

Compatible Hose

H009, H209, H243, H265, H275, H277, H285, H435, H436

Pressure: Determined by maximum operating pressure for hose size and hose end configuration whichever is lesser. See pages A-15-16 for operating pressure ratings for hose end configurations.

Material: Low Carbon Steel

Plating: Zinc; Clear Trivalent Chromate

To determine the correct length of hose, subtract the cut-off factor for each end fitting from the overall length of assembly.

Advantages: Wide selection of hose and end configurations allowing for a diverse number of applications where hose compatibility is a problem.

Assemble With: ET1000, ET4000, T-400-1, T-410-1, T-420-1, T-440-1, T-460, T-462, T-465-1, T480.

Label Set: FS-1200

Note:

Refer to current price list for availability of cataloged items. Configurations and dimensions subject to change without notice.

Male Pipe Rigid

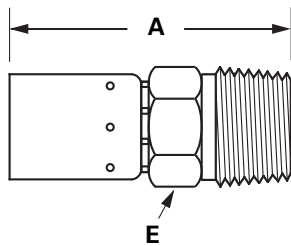

Hose I.D.	Pipe Size	Part Number	Thread Size	A	Hose Cut-Off Factor	Hole Dia.	Hex E
3/16	1/8	03E-102	1/8-27	1.58	.75	.09	7/16
3/16	1/4	03E-104	1/4-18	1.83	1.00	.09	9/16
1/4	1/8	04E-102	1/8-27	1.60	.75	.16	7/16
1/4	1/4	04E-104	1/4-18	1.79	1.00	.16	9/16
1/4	3/8	04E-106	3/8-18	1.82	1.00	.16	11/16
5/16	1/4	05E-104	1/4-18	1.86	.94	.22	9/16
5/16	3/8	05E-106	3/8-18	1.89	1.00	.22	11/16
3/8	1/4	06E-104	1/4-18	1.90	1.00	.27	9/16
3/8	3/8	06E-106	3/8-18	1.93	1.00	.27	11/16
3/8	1/2	06E-108	1/2-14	2.17	1.25	.27	7/8
1/2	3/8	08E-106	3/8-18	2.02	1.00	.38	3/4
1/2	1/2	08E-108	1/2-14	2.27	1.25	.38	7/8
3/4	3/4	12E-112	3/4-14	2.51	1.31	.61	1-1/16
1	1	16E-116	1-11-1/2	2.95	1.63	.84	1-3/8

Male Pipe Swivel

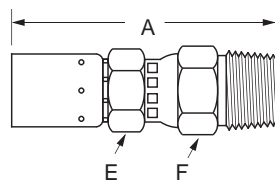

Hose I.D.	Pipe Size	Part Number	Thread Size	A	Hose Cut-Off Factor	Hole Dia.	Hex E	Hex F
1/4	1/4	04E-J04	1/4-18	2.68	1.81	.16	5/8	13/16
5/16	1/4	05E-J04	1/4-18	2.75	1.81	.22	5/8	13/16
3/8	3/8	06E-J06	3/8-18	2.79	1.81	.27	11/16	7/8
1/2	1/2	08E-J08	1/2-14	3.03	2.00	.39	3/4	7/8
3/4	3/4	12E-J12	3/4-14	3.73	2.50	.61	1-1/4	1-1/4

Note:

Swivel for installation purposes only. (Not for temperatures above 212°F.)

Coll-O-Crimp

'E' Series

To determine the correct length of hose, subtract the cut-off factor for each end fitting from the overall length of assembly.

JIC 37° Male Rigid

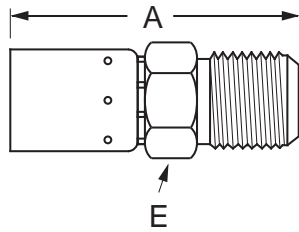

Hose I.D.	Tube Size	Part Number	Thread Size	A	Hose Cut-Off Factor	Hole Dia.	Hex E
1/4	1/4	04E-504	7/16-20	1.78	.94	.16	1/2
1/4	5/16	04E-505	1/2-20	1.78	.94	.19	9/16
1/4	3/8	04E-506	9/16-18	1.82	1.00	.22	5/8
5/16	5/16	05E-505	1/2-20	1.86	.94	.22	9/16
3/8	3/8	06E-506	9/16-18	1.92	1.00	.27	5/8
3/8	1/2	06E-508	3/4-16	2.08	1.19	.27	13/16
1/2	1/2	08E-508	3/4-16	2.18	1.19	.27	13/16
1/2	5/8	08E-510	7/8-14	2.31	1.25	.42	15/16
3/4	3/4	12E-512	1-1/16-12	2.63	1.44	.61	1-1/8
1	1	16E-516	1-5/16-12	2.83	1.50	.84	1-3/8

Inverted Male Swivel Straight

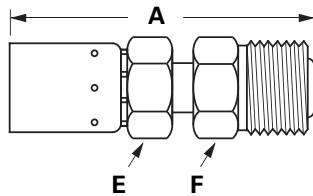

Hose I.D.	Pipe Size	Part Number	Thread Size	A	Hose Cut-Off Factor	Hole Dia.	Hex E	Hex F
1/4	3/16	04E-B03	3/8-24	3.06	2.19	.12	7/16	3/8
1/4	1/4	04E-B04	7/16-24	2.44	1.63	.15	7/16	7/16
1/4	5/16	04E-B05	1/2-20	3.71	2.88	.16	7/16	1/2
5/16	5/16	05E-B05	1/2-20	2.57	1.61	.21	9/16	1/2
3/8	5/16	06E-B05	1/2-20	2.56	1.63	.21	9/16	1/2
3/8	3/8	06E-B06	5/8-18	2.81	1.81	.24	5/8	5/8
1/2	1/2	08E-B08	3/4-18	3.14	2.06	.33	3/4	3/4

Air Brake Connection – Tube

(For Use With H243 Teflon Hose Only)

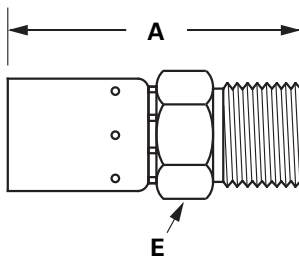

Hose I.D.	Tube Size	Part Number	Thread Size	A	Hose Cut-Off Factor	Hole Dia.	Hex E	Tube Size	Part Number Sleeve	Part Number Nut
1/2	1/2	08E-Y58	11/16-20	2.12	1.06	.38	3/4	3/8	1360x6	1361x6
1/2	5/8	08E-Y60	13/16-18	2.18	1.13	.38	7/8	1/2	1360x8	1361x8
3/4	5/8	12E-Y60	13/16-18	2.31	1.13	.53	1	5/8	1360x10	1361x10
3/4	3/4	12E-Y62	1-18	2.38	1.19	.61	1	3/4	1360x12	1361x12

Teflon® is a registered trademark of DuPont used under license by Eaton.

Flareless Tube Rigid

(With Ermeto Nut and Sleeve)

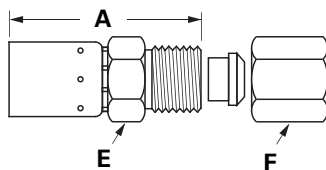

Hose I.D.	Tube Size	Part Number	Thread Size	A	Hose Cut-Off Factor	Hole Dia.	Hex E	Hex F
5/16	3/8	05E-756	9/16-18	1.88	1.00	.22	5/8	11/16
3/8	5/16	06E-755	1/2-20	1.78	.88	.23	9/16	5/8
3/8	3/8	06E-756	9/16-18	1.82	.88	.27	5/8	11/16
1/2	1/2	08E-758	3/4-16	2.08	1.06	.38	13/16	7/8

(For replacement nuts and sleeves, see page L-80.)

J

Hose Ends - Crimp

Coll-O-Crimp

'E' Series

To determine the correct length of hose, subtract the cut-off factor for each end fitting from the overall length of assembly.

^a Swivel nuts are universal — both SAE 37° and 45° connections.

JIC 37° Female Swivel

(Exceptions Noted)

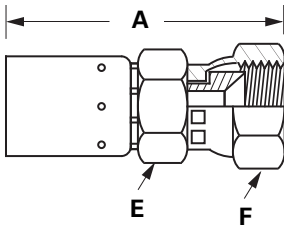

Hose I.D.	Tube Size	Part Number	Thread Size	A	Hose Cut-Off Factor	Hole Dia.	Hex E	Hex F
3/16	1/4	03E-604 ^a	7/16-20	1.89	1.00	.09	7/16	9/16
1/4	1/4	04E-604 ^a	7/16-20	1.92	1.13	.16	7/16	9/16
1/4	5/16	04E-605 ^a	1/2-20	2.00	1.19	.16	1/2	5/8
1/4	3/8	04E-606	9/16-18	2.06	1.25	.16	9/16	11/16
5/16	5/16	05E-605 ^a	1/2-20	2.07	1.19	.22	1/2	5/8
5/16	3/8	05E-606	9/16-18	2.12	1.19	.22	9/16	11/16
3/8	3/8	06E-606	9/16-18	2.19	1.25	.27	9/16	11/16
3/8	1/2	06E-608 ^a	3/4-16	2.30	1.38	.27	3/4	7/8
1/2	1/2	08E-608 ^a	3/4-16	2.39	1.38	.38	3/4	7/8
1/2	5/8	08E-610 ^a	7/8-14	2.51	1.50	.38	7/8	1
3/4	3/4	12E-612	1-1/16-12	2.76	1.56	.61	1	1-1/4
1	1	16E-616	1-5/16-12	3.05	1.75	.84	1-1/4	1-1/2

SAE 45° Female Swivel

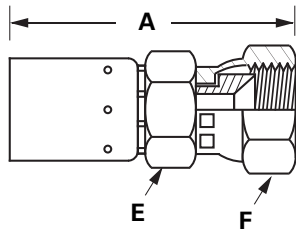

Hose I.D.	Tube Size	Part Number	Thread Size	A	Hose Cut-Off Factor	Hole Dia.	Hex E	Hex F
5/16	3/8	05E-406	5/8-18	2.03	1.13	.22	9/16	3/4
3/8	3/8	06E-406	5/8-18	2.06	1.13	.27	9/16	3/4
3/4	3/4	12E-412	1-1/16-14	2.76	1.56	.61	1	1-1/4

British Standard (BSPP) 60° Cone Female Pipe Swivel

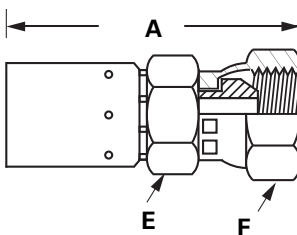

Hose I.D.	Tube Size	Part Number	Thread Size	A	Hose Cut-Off Factor	Hole Dia.	Hex E	Hex F
3/16	1/4	03E-354	G-1/4-19*	2.01	1.19	.16	9/16	11/16
1/4	1/4	04E-354	G-1/4-19*	2.07	1.25	.16	9/16	3/4
3/8	3/8	06E-356	G-3/8-19*	2.09	1.13	.27	3/4	7/8
3/8	1/2	06E-358	G-1/2-14*	2.47	1.50	.27	13/16	1
1/2	1/2	08E-358	G-1/2-14*	2.56	1.50	.39	13/16	1
1/2	5/8	08E-360	G-5/8-14*	2.70	1.63	.39	7/8	1-3/16
3/4	3/4	12E-362	G-3/4-14*	2.94	1.69	.61	1	1-1/4
1	1	16E-366	G-1-11*	3.38	2.00	.84	1-1/4	1-1/2

*G as part of thread size is ISO designation for parallel thread.

Female Swivel JIS 30° Flare Parallel Pipe Swivel

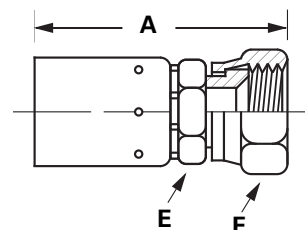

Hose I.D.	Tube Size	Part Number	Thread Size	A	Hose Cut-Off Factor	Hole Dia.	Hex E	Hex F
1/4	1/4	04E-04L	G-1/4-19*	2.03	1.19	.16	9/16	3/4
3/8	3/8	06E-06L	G-3/8-19*	2.22	1.25	.27	11/16	7/8
1/2	1/2	08E-08L	G-1/2-14*	2.30	1.25	.39	13/16	1-1/16
3/4	3/4	12E-12L	G-3/4-14*	2.75	1.50	.81	1	1-5/16
1	1	16E-16L	G-1-11*	3.15	1.81	.84	1-1/4	1-1/2

*G as part of thread size is ISO designation for parallel thread.

J Hose Ends - Crimp

Coll-O-Crimp

'E' Series

To determine the correct length of hose, subtract the cut-off factor for each end fitting from the overall length of assembly.

Female FOR-SEAL® Swivel Straight

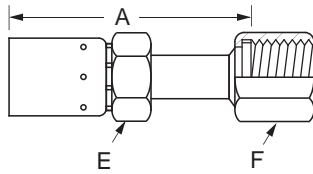

Hose I.D.	Tube Size	Part Number	Thread Size	A	Hose Cut-Off Factor	Hole Dia.	Hex E	Hex F
1/4	1/4	04E-S64	9/16-18	2.14	1.31	.15	5/8	11/16
1/4	3/8	04E-S66	11/16-16	2.20	1.38	.16	5/8	13/16
5/16	3/8	05E-S66	11/16-16	2.28	1.38	.22	9/16	13/16
3/8	3/8	06E-S66	11/16-16	2.37	1.44	.24	9/16	13/16
3/8	1/2	06E-S68	13/16-16	2.65	1.69	.24	5/8	15/16
1/2	1/2	08E-S68	13/16-16	2.74	1.69	.33	3/4	15/16
1/2	5/8	08E-S70	1-14	2.83	1.81	.39	3/4	1-1/8
3/4	3/4	12E-S72	1-3/16-12	3.10	1.88	.59	1	1-3/8
1	1	16E-S76	1-7/16-12	3.76	2.44	.78	1-1/4	1-5/8

Straight Tube — Brass

(For Use With H243 Teflon Hose Only)

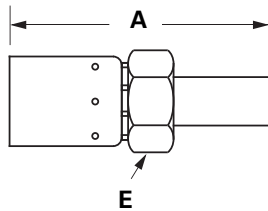

Hose I.D.	Tube Size	Part Number	A	Hose Cut-Off Factor	Hole Dia.	Hex E
1/2	1/2	08E-T58	3.32	2.31	.39	3/4
1/2	5/8	08E-T60	3.45	2.44	.47	3/4
3/4	5/8	12E-T60	3.66	2.44	.47	1
3/4	3/4	12E-T62	4.00	2.81	.61	1

Insert — Brass
Collar — Steel

Teflon® is a registered trademark of DuPont used under license by Eaton.

Compatible Air Brake Nuts & Sleeves (order separately)

Tube Size	Part Number Sleeve	Part Number Nut
1/2	1360x8	1361x8
5/8	1360x10	1361x10
3/4	1360x12	1361x12

Compressor Discharge Flange End — GM Bus Only

(For Use With H243 Teflon Hose Only)

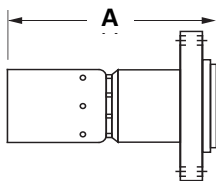

Hose I.D.	Part Number	A	Hose Cut-Off Factor	Hole Dia.
3/4	12E-X92	2.64	1.38	.61

Note:
Part will not crimp in T-420 press.

Teflon® is a registered trademark of DuPont used under license by Eaton.

Inverted Male Swivel 45° Tube Elbow

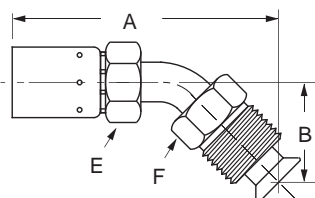

Hose I.D.	Tube Size	Part Number	Thread Size	A	B	Hose Cut-Off Factor	Hole Dia.	Hex E	Hex F
1/4	3/16	04E-B43	3/8-24	2.82	.69	2.00	.12	7/16	3/8
1/4	1/4	04E-B44	7/16-24	2.94	.93	2.13	.15	7/16	7/16
3/8	5/16	06E-B45	1/2-20	3.37	1.14	2.44	.21	9/16	1/2
3/8	3/8	06E-B46	5/8-18	3.63	1.34	2.69	.24	5/8	5/8
1/2	1/2	08E-B48	3/4-18	4.32	1.58	3.25	.33	3/4	3/4
1/2	5/8	08E-B50	7/8-18	4.45	1.75	3.44	.39	3/4	7/8

J

Hose Ends - Crimp

Coll-O-Crimp

'E' Series

To determine the correct length of hose, subtract the cut-off factor for each end fitting from the overall length of assembly.

^a Swivel nuts are universal — both SAE 37° and 45° connections.

JIC 37° Female Swivel 45° Tube Elbow

(Exceptions Noted)

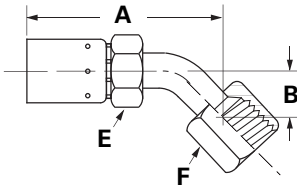

Hose I.D.	Tube Size	Part Number	Thread Size	A	B	Hose Cut-Off Factor	Hole Dia.	Hex E	Hex F
1/4	1/4	04E-684 ^a	7/16-20	2.37	.33	1.56	.15	7/16	9/16
1/4	5/16	04E-685 ^a	1/2-20	2.50	.36	1.63	.16	7/16	5/8
5/16	3/8	05E-686	9/16-18	2.65	.39	1.69	.22	9/16	11/16
3/8	3/8	06E-686	9/16-18	2.74	.39	1.75	.24	5/8	11/16
3/8	1/2	06E-688 ^a	3/4-16	2.99	.56	2.00	.27	5/8	7/8
1/2	1/2	08E-688 ^a	3/4-16	2.88	.56	1.78	.33	3/4	7/8
1/2	5/8	08E-690 ^a	7/8-14	3.28	.63	2.25	.39	3/4	1
3/4	3/4	12E-692	1-1/16-12	3.72	.78	2.38	.58	1	1-1/4
1	1	16E-696	1-5/16-12	4.67	1.10	3.31	.83	1-1/4	1-1/2

Female FOR-SEAL[®] Swivel 45° Tube Elbow

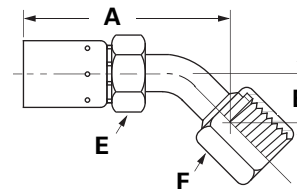

Hose I.D.	Tube Size	Part Number	Thread Size	A	B	Hose Cut-Off Factor	Hole Dia.	Hex E	Hex F
1/4	1/4	04E-L64	9/16-18	2.46	.41	1.63	.15	7/16	11/16
1/4	3/8	04E-L66	11/16-16	2.69	.43	1.75	.15	5/8	13/16
5/16	3/8	05E-L66	11/16-16	2.70	.43	1.75	.22	9/16	13/16
3/8	3/8	06E-L66	11/16-16	2.79	.43	1.81	.24	5/8	13/16
1/2	1/2	08E-L68	13/16-16	3.14	.60	2.13	.33	3/4	15/16
3/4	3/4	12E-L72	1-3/16-12	3.83	.83	2.63	.59	1	1-3/8
1	1	16E-L76	1-7/16-12	4.31	.94	3.00	.76	1-1/4	1-5/8

Inverted Male Swivel 90° Tube Elbow

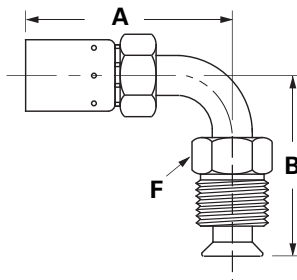

Hose I.D.	Tube Size	Part Number	Thread Size	A	B	Hose Cut-Off Factor	Hole Dia.	Hex E	Hex F
1/4	3/16	04E-B63	3/8-24	2.23	1.06	1.38	.12	7/16	3/8
1/4	1/4	04E-B64	7/16-24	2.25	1.36	1.31	.15	7/16	7/16
3/8	5/16	06E-B65	1/2-20	2.49	1.61	1.56	.21	9/16	1/2
3/8	3/8	06E-B66	5/8-18	2.92	1.97	1.94	.24	5/8	5/8
1/2	1/2	08E-B68	3/4-18	3.03	2.32	2.00	.33	3/4	3/4

JIC 37° Female Swivel 90° Tube Elbow

(Exceptions Noted)

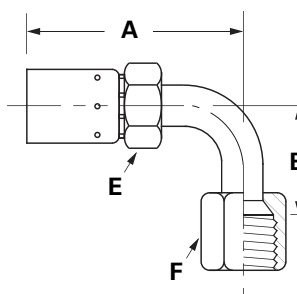

Hose I.D.	Tube Size	Part Number	Thread Size	A	B	Hose Cut-Off Factor	Hole Dia.	Hex E	Hex F
1/4	1/4	04E-664 ^a	7/16-20	2.27	.68	1.44	.15	7/16	9/16
1/4	5/16	04E-665 ^a	1/2-20	2.47	.77	1.63	.16	7/16	5/8
5/16	5/16	05E-665 ^a	1/2-20	2.58	.77	1.63	.21	9/16	5/8
5/16	3/8	05E-666	9/16-18	2.57	.85	1.62	.22	9/16	11/16
3/8	3/8	06E-666	9/16-18	2.63	.85	1.68	.24	5/8	11/16
3/8	1/2	06E-668 ^a	3/4-16	2.76	1.09	1.81	.27	5/8	7/8
1/2	1/2	08E-668 ^a	3/4-16	2.82	1.09	1.75	.33	3/4	7/8
1/2	5/8	08E-670 ^a	7/8-14	3.34	1.23	2.31	.39	3/4	1
3/4	3/4	12E-672	1-1/16-12	3.70	1.82	2.50	.59	1	1-1/4
1	1	16E-676	1-5/16-12	4.39	2.14	3.00	.83	1-1/4	1-1/2

J Hose Ends - Crimp

Coll-O-Crimp

'E' Series

To determine the correct length of hose, subtract the cut-off factor for each end fitting from the overall length of assembly.

^a Swivel nuts are universal — both SAE 37° and 45° connections.

SAE 45° Female Swivel 90° Tube Elbow

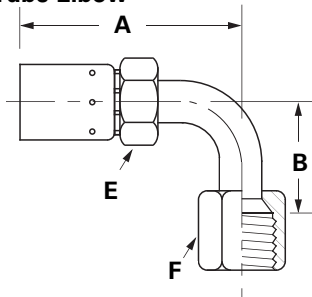

Hose I.D.	Tube Size	Catalog Number	Thread Size	A	B	Hose Cut-Off Factor	Hole Dia.	Hex E	Hex F
3/8	3/8	06E-466	5/8-18	2.72	.85	1.75	.24	5/8	3/4

JIC 37° Female Swivel Long Drop 90° Tube Elbow (Exceptions Noted)

(Exceptions Noted)

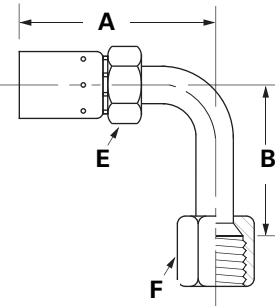

Hose I.D.	Tube Size	Part Number	Thread Size	A	B	Hose Cut-Off Factor	Hole Dia.	Hex E	Hex F
1/4	1/4	04E-644 ^a	7/16-20	2.27	1.80	1.42	.15	7/16	9/16
1/4	5/16	04E-645 ^a	1/2-20	2.51	1.80	1.63	.16	7/16	5/8
5/16	3/8	05E-646	9/16-18	2.63	2.18	1.69	.22	9/16	11/16
3/8	3/8	06E-646	9/16-18	2.66	2.18	1.69	.24	5/8	11/16
3/8	1/2	06E-648 ^a	3/4-16	2.83	2.43	1.88	.27	5/8	7/8
1/2	1/2	08E-648 ^a	3/4-16	2.82	2.43	1.75	.33	3/4	7/8
1/2	5/8	08E-650 ^a	7/8-14	2.96	2.57	1.94	.39	3/4	1
3/4	3/4	12E-652	1-1/16-12	3.74	3.73	2.50	.58	1	1-1/4
1	1	16E-656	1-5/16-12	4.36	4.33	3.00	.83	1-1/4	1-1/2

British Standard (BSPP) 60° Cone Female Pipe Swivel 90° Elbow

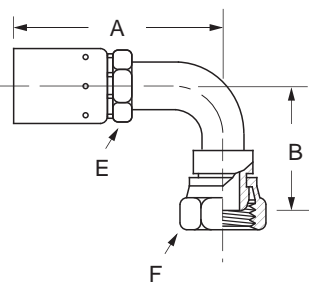

Hose I.D.	BSPP Pipe Size	Part Number	Thread Size	A	B	Hose Cut-Off Factor	Hole Dia.	Hex E	Hex F
1/4	1/4	04E-74P	G-1/4-19*	2.89	1.50	2.06	.16	7/16	3/4
3/8	3/8	06E-76P	G-3/8-19*	2.96	1.66	2.00	.27	5/8	7/8
1/2	1/2	08E-78P	G-1/2-14*	2.95	1.73	1.88	.37	3/4	1
3/4	3/4	12E-82P	G-3/4-14*	3.83	2.43	2.61	.61	1	1-1/4

*G as part of thread size is ISO designation for parallel thread.

J

Hose Ends - Crimp

Coll-O-Crimp

'E' Series

To determine the correct length of hose, subtract the cut-off factor for each end fitting from the overall length of assembly.

Female FOR-SEAL[®] Swivel Short Drop 90° Elbow

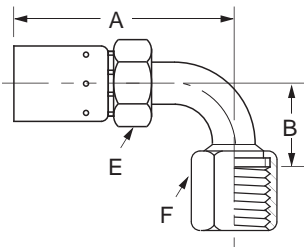

Hose I.D.	Tube Size	Part Number	Thread Size	A	B	Hose Cut-Off Factor†	Hole Dia.	Hex E	Hex F
1/4	1/4	04E-A24	9/16-18	2.27	.81	1.44	.21	7/16	11/16
1/4	3/8	04E-A26	11/16-16	2.54	.90	1.69	.16	5/8	13/16
5/16	3/8	05E-A26	11/16-16	2.62	.90	1.69	.22	9/16	13/16
3/8	3/8	06E-A26	11/16-16	2.71	.90	1.75	.24	5/8	13/16
3/8	1/2	06E-A28	13/16-16	2.81	1.15	1.88	.27	5/8	15/16
1/2	1/2	08E-A28	13/16-16	2.90	1.15	1.88	.33	3/4	15/16
3/4	3/4	12E-A32	1-3/16-12	3.70	1.88	2.50	.59	1	1-3/8
1	1	16E-A36	1-7/16-12	4.01	2.21	2.69	.76	1-1/4	1-5/8

Female FOR-SEAL Swivel Long Drop 90° Tube Elbow

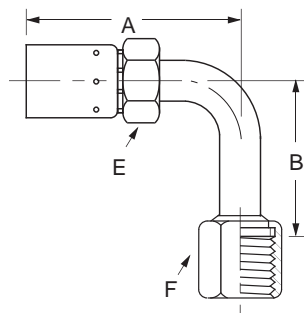

Hose I.D.	Tube Size	Part Number	Thread Size	A	B	Hose Cut-Off Factor	Hole Dia.	Hex E	Hex F
1/4	1/4	04E-A64	9/16-18	2.41	1.80	1.56	.21	7/16	11/16
5/16	3/8	05E-A66	11/16-16	2.73	2.12	1.81	.22	9/16	13/16
3/8	3/8	06E-A66	11/16-16	2.82	2.12	1.88	.24	5/8	13/16
3/8	1/2	06E-A68	13/16-16	2.80	2.50	1.88	.27	5/8	15/16
1/2	1/2	08E-A68	13/16-16	2.89	2.50	1.88	.33	3/4	15/16

J

Hose Ends - Crimp

Coll-O-Crimp

069 'E' Series

To determine the correct length of hose, subtract the cut-off factor for each end fitting from the overall length of assembly.

Hose End 069 'E' Series

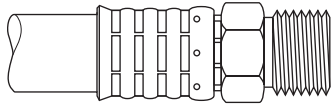

⚠ Refer to important safety information on pages A-2-3.

Ordering Information: Order individually by part number.

Application: General purpose low- and medium-pressure hydraulics. Generally used for truck and off-road vehicle applications.

Compatible Hose: H059, H069, H166, H169, H229, H239, H366, H569

Pressure: Determined by maximum working pressure for hose size and hose end configuration whichever is lesser. See page 16 for working pressure ratings for hose end configurations.

Material: Low Carbon Steel
Plating: Zinc; Clear Trivalent Chromate

Advantages: Wide selection of hose and end configurations allowing for a diverse number of applications. Limited competition and economical cost.

Assemble With: T-400-1, T-410-1, T-420-1, T-440-1, T-460, T-462, T-465-1, T-480, ET4000, ET4001

Label Set: FS-1500

Male Pipe Rigid

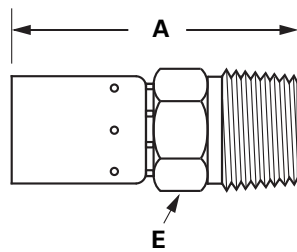

Hose I.D.	Tube Size	Part Number	Thread Size	A	Hose Cut-Off Factor	Hole Dia.	Hex E
3/16	1/8	06904E-102	1/8-27	1.70	.75	.13	7/16
3/16	1/4	06904E-104	1/4-18	1.88	1.00	.13	9/16
1/4	1/4	06905E-104	1/4-18	1.88	1.00	.18	9/16
5/16	1/4	06906E-104	1/4-18	2.04	1.00	.24	5/8
5/16	3/8	06906E-106	3/8-18	2.03	1.00	.24	11/16
13/32	3/8	06908E-106	3/8-18	2.04	1.00	.31	3/4
13/32	1/2	06908E-108	1/2-14	2.29	1.25	.31	7/8
1/2	1/2	06910E-108	1/2-14	2.41	1.38	.39	7/8
1/2	3/4	06910E-112	3/4-14	2.47	1.38	.39	1-1/16
5/8	3/4	06912E-112	3/4-14	2.52	1.25	.51	1-1/16
7/8	3/4	06916E-112	3/4-14	2.69	1.44	.71	1-1/8
7/8	1	06916E-116	1-11-1/2	2.88	1.63	.75	1-3/8
1-1/8	1-1/4	06920E-120	1-1/4-11-1/2	3.06	1.69	1.00	1-11/16
1-3/8	1-1/2	06924E-124	1-1/2-11-1/2	3.37	2.00	1.25	2
1-13/16	2	06932E-132	2-11-1/2	3.38	2.00	1.63	2-1/2

JIC 37° Male Rigid

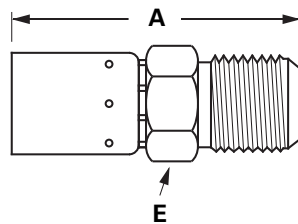

Hose I.D.	Tube Size	Part Number	Thread Size	A	Hose Cut-Off Factor	Hole Dia.	Hex E
3/16	1/4	06904E-504	7/16-20	1.87	1.00	.13	1/2
1/4	5/16	06905E-505	1/2-20	1.87	1.00	.18	9/16
5/16	3/8	06906E-506	9/16-18	2.03	1.00	.24	5/8
13/32	1/2	06908E-508	3/4-16	2.19	1.19	.31	13/16
1/2	5/8	06910E-510	7/8-14	2.43	1.25	.39	15/16
5/8	3/4	06912E-512	1-1/16-12	2.63	1.38	.51	1-1/8
7/8	1	06916E-516	1-5/16-12	2.85	1.50	.75	1-3/8
1-1/8	1-1/4	06920E-520	1-5/8-12	3.06	1.63	1.00	1-11/16
1-3/8	1-1/2	06924E-524	1-7/8-12	3.17	1.81	1.25	2

J

Hose Ends - Crimp

Coll-O-Crimp

069 'E' Series

To determine the correct length of hose, subtract the cut-off factor for each end fitting from the overall length of assembly.

^a Swivel nuts are universal — both SAE 37° and 45° connections.

Inverted Male Swivel Straight

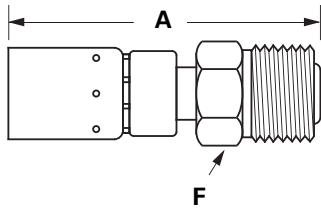

Hose I.D.	Tube Size	Part Number	Thread Size	A	Hose Cut-Off Factor	Hole Dia.	Hex F
3/16	1/4	06904E-B04	7/16-24	2.58	1.56	.13	7/16
1/4	5/16	06905E-B05	1/2-20	2.63	1.63	.18	1/2
5/16	3/8	06906E-B06	5/8-18	2.87	1.78	.24	5/8
13/32	1/2	06908E-B08	3/4-18	3.24	2.06	.31	3/4

JIC 37° Female Swivel (Exceptions Noted)

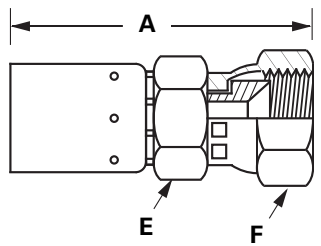

Hose I.D.	Tube Size	Part Number	Thread Size	A	Hose Cut-Off Factor	Hole Dia.	Hex E	Hex F
3/16	1/4	06904E-604 ^a	7/16-20	2.01	1.06	.13	7/16	9/16
1/4	5/16	06905E-605 ^a	1/2-20	2.09	1.19	.18	7/16	5/8
5/16	3/8	06906E-606	9/16-18	2.26	1.19	.24	9/16	11/16
5/16	1/2	06906E-608 ^a	3/4-16	2.41	1.31	.24	3/4	7/8
13/32	1/2	06908E-608 ^a	3/4-16	2.41	1.38	.31	3/4	7/8
1/2	1/2	06910E-608 ^a	3/4-16	2.53	1.44	.39	13/16	7/8
1/2	5/8	06910E-610 ^a	7/8-14	2.62	1.50	.39	13/16	1
5/8	3/4	06912E-612	1-1/16-12	2.77	1.50	.51	1	1-1/4
7/8	1	06916E-616	1-5/16-12	3.11	1.75	.75	1-1/4	1-1/2
1-1/8	1-1/4	06920E-620	1-5/8-12	3.30	1.81	1.00	1-9/16	2
1-3/8	1-1/2	06924E-624	1-7/8-12	3.45	2.13	1.25	2	2-1/4
1-13/16	2	06932E-632	2-1/2-12	4.15	2.81	1.63	2-1/2	3

SAE 45° Female Swivel

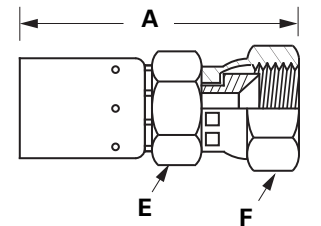

Hose I.D.	Tube Size	Part Number	Thread Size	A	Hose Cut-Off Factor	Hole Dia.	Hex E	Hex F
5/16	3/8	06906E-406	5/8-18	2.18	1.13	.24	9/16	3/4
5/8	3/4	06912E-412	1-1/16-14	2.81	1.50	.51	1	1-1/4

30° Flare Female Swivel (PTT Thread For Diesel Applications)

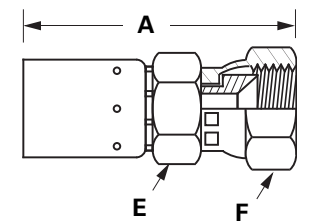

Hose I.D.	Tube Size	Part Number	Thread Size	A	Hose Cut-Off Factor	Hole Dia.	Hex E	Hex F
7/8	1	06916E-X26	1-5/16-14	2.96	1.69	.75	1-1/4	1-1/2

Hose Ends - Crimp

Coll-O-Crimp

069 'E' Series

To determine the correct length of hose, subtract the cut-off factor for each end fitting from the overall length of assembly.

^a Swivel nuts are universal — both SAE 37° and 45° connections.

Female Swivel 30° Flare

(Komatsu, Linkbelt)

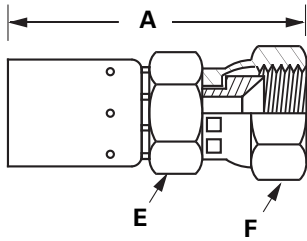

Hose I.D.	Part Number	Thread Size	A	Hose Cut-Off Factor	Hole Dia.	Hex E	Hex F
5/8	06912E-24K	M24x1.5	2.88	1.56	.52	1	1-1/4
5/8	06912E-30K	M30x1.5	2.90	1.63	.52	1-1/4	1-3/8
7/8	06916E-33K	M33x1.5	3.11	1.81	.75	1-1/4	1-1/2
1-3/8	06924E-42K	M42x1.5	3.55	2.19	1.25	2	2-1/8

Inverted Male Swivel 45° Tube Elbow

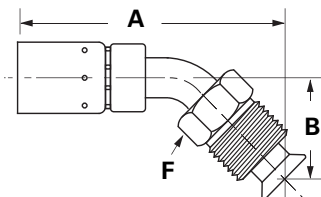

Hose I.D.	Tube Size	Part Number	Thread Size	A	B	Hose Cut-Off Factor	Hole Dia.	Hex F
3/16	1/4	06904E-E44	7/16-24	3.08	.93	2.06	.12	7/16
1/4	5/16	06905E-E45	1/2-20	3.42	1.14	2.44	.18	1/2
5/16	3/8	06906E-E46	5/8-18	3.65	1.34	2.56	.21	5/8

JIC 37° Female Swivel 45° Tube Elbow

(Exceptions Noted)

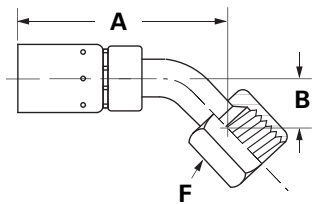

Hose I.D.	Tube Size	Part Number	Thread Size	A	B	Hose Cut-Off Factor	Hole Dia.	Hex F
3/16	1/4	06904E-684 ^a	7/16-20	2.50	.33	1.50	.13	9/16
1/4	5/16	06905E-685 ^a	1/2-20	2.63	.36	1.63	.18	5/8
5/16	3/8	06906E-686	9/16-18	2.78	.38	1.69	.24	11/16
13/32	1/2	06908E-688 ^a	3/4-16	3.07	.55	1.83	.31	7/8
1/2	5/8	06910E-690 ^a	7/8-14	3.39	.63	2.31	.45	1
5/8	3/4	06912E-692	1-1/16-12	3.70	.78	2.38	.52	1-1/4
7/8	1	06916E-696	1-5/16-12	4.68	1.10	3.38	.75	1-1/2

SAE 45° Female Swivel 45° Tube Elbow

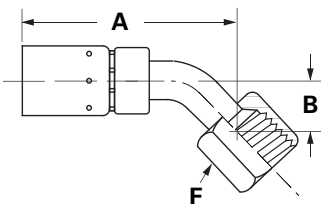

Hose I.D.	Tube Size	Part Number	Thread Size	A	B	Hose Cut-Off Factor	Hole Dia.	Hex F
5/16	3/8	06906E-486	5/8-18	2.77	.39	1.69	.24	3/4
5/8	3/4	06912E-492	1-1/16-14	3.74	.78	2.44	.52	1-1/4

J

Hose Ends - Crimp

Coll-O-Crimp

069'E' Series

To determine the correct length of hose, subtract the cut-off factor for each end fitting from the overall length of assembly.

^a Swivel nuts are universal — both SAE 37° and 45° connections.

Inverted Male Swivel 90° Tube Elbow

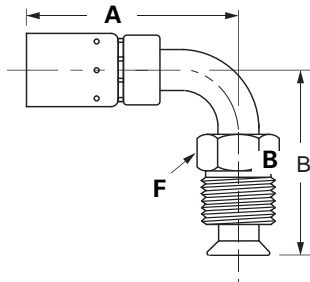

Hose I.D.	Tube Size	Part Number	Thread Size	A	B	Hose Cut-Off Factor	Hole Dia.	Hex F
3/16	1/4	06904E-E04	7/16-24	2.31	1.36	1.25	.13	7/16
1/4	5/16	06905E-E05	1/2-20	2.59	1.61	1.56	.18	1/2
5/16	1/4	06906E-E04	7/16-24	2.43	1.36	1.31	.15	7/16
5/16	5/16	06906E-E05	1/2-20	2.66	1.61	1.56	.21	1/2
5/16	3/8	06906E-E06	5/8-18	2.94	1.97	1.85	.24	5/8

JIC 37° Female Swivel 90° Tube Elbow

(Exceptions Noted, Refer to Footnotes)

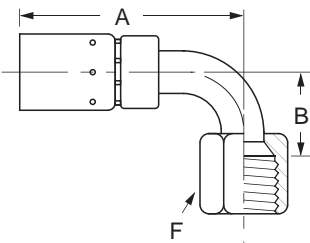

Hose I.D.	Tube Size	Part Number	Thread Size	A	B	Hose Cut-Off Factor	Hole Dia.	Hex F
3/16	1/4	06904E-664 ^a	7/16-20	2.41	.68	1.38	.13	9/16
1/4	5/16	06905E-665 ^a	1/2-20	2.62	.77	1.63	.21	5/8
5/16	3/8	06906E-666	9/16-18	2.73	.85	1.78	.24	11/16
13/32	1/2	06908E-668 ^a	3/4-16	2.87	1.09	1.75	.31	7/8
1/2	5/8	06910E-670 ^a	7/8-14	3.52	1.23	2.44	.39	1
5/8	3/4	06912E-672	1-1/16-12	3.66	1.82	2.31	.58	1-1/4
7/8	1	06916E-676	1-5/16-12	4.40	2.14	3.13	.76	1-1/2
1-1/8	1-1/4*	06920E-657 ^Δ	1-5/8-12	4.32	5.38	2.90	1.00	2
1-1/8	1-1/4*	06920E-677	1-5/8-12	4.27	3.25	2.90	1.01	2
1-3/8	1-1/2*	06924E-678	1-7/8-12	4.09	3.05	2.70	1.25	2-1/2

* 20 and 24 size ends have crimped nuts.

^Δ Long drop elbow.

SAE 45° Female Swivel 90° Tube Elbow

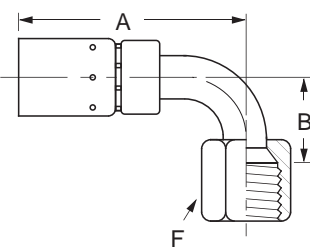

Hose I.D.	Tube Size	Part Number	Thread Size	A	B	Hose Cut-Off Factor	Hole Dia.	Hex F
5/16	3/8	06906E-466	5/8-18	2.76	.85	1.56	.24	3/4
5/8	3/4	06912E-472	1-1/16-14	3.64	1.82	2.31	.52	1-1/4

J

Hose Ends - Crimp

Coll-O-Crimp

327 'E' Series

To determine the correct length of hose, subtract the cut-off factor for each end fitting from the overall length of assembly.

Hose Fitting 327 'E' Series

Refer to the Weatherhead Hose End and Tool Selector Chart W-HOOV-TM001-E2 for qualified sizes.

Ordering Information: Order individually part number.

 Refer to important safety information on pages A-2-3.

Application: General purpose low- and medium-pressure hydraulics.

Compatible Hose
GH100

Pressure: Determined by working pressure for hose and hose size.

Material: Low Carbon Steel

Plating: Clear Trivalent Chromate

Assemble With: ET1000, ET4000, T-400-1, T-410-1, T-420-1, T-440-1, T-460, T-462, T-465-1, T480.

Label Set: FS-1200

Note:

Refer to current price list for availability of cataloged items. Configurations and dimensions subject to change without notice.

Female JIC, SAE 37° Swivel

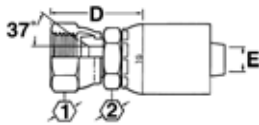

Hose I.D.	Tube Size	Part Number	Thread Size	A	Hose Cut-Off Factor	Hole Dia.	Hex E	Hex F
6	6	32706E-606	9/16-18	2.19	1.19	0.26	11/16	11/16
8	8	32708E-608	3/4-16	2.63	1.46	0.38	7/8	13/16
10	10	32710E-610	7/8-14	2.77	1.61	0.5	1	15/16
12	12	32712E-612	1 1/6-12	2.84	1.65	0.61	1 1/4	1 1/8

Female JIC/SAE 37° Swivel 45° Tube Elbow

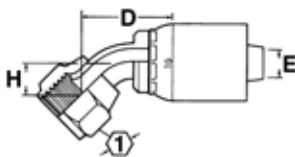

Hose I.D.	Tube Size	Part Number	Thread Size	A	H	Hose Cut-Off Factor	Hole Dia.	Hex
6	6	32706E-686	9/16-18	2.31	0.39	1.31	.24	11/16
8	8	32708E-688	3/4-16	2.82	0.55	1.65	.37	7/8
10	10	32710E-690	7/8-14	2.94	0.59	1.79	.46	1
12	12	32712E-692	1 1/6-12	3.43	0.78	2.24	.58	1 1/4

Female JIC/SAE 37° Swivel 90° Tube Elbow

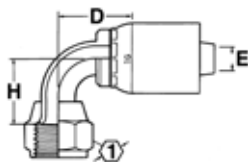

Hose I.D.	Tube Size	Part Number	Thread Size	A	H	Hose Cut-Off Factor	Hole Dia.	Hex
6	6	32706E-666	9/16-18	2.21	0.84	1.22	.24	11/16
8	8	32708E-668	3/4-16	2.59	1.09	1.42	.37	7/8
10	10	32710E-670	7/8-14	2.7	1.19	1.55	.46	1
12	12	32712E-672	1 1/6-12	3.36	1.8	2.17	.58	1 1/4

J

Hose Ends - Crimp

Coll-O-Crimp

327 'E' Series

To determine the correct length of hose, subtract the cut-off factor for each end fitting from the overall length of assembly.

Female FOR Seal

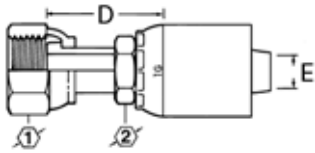

Hose I.D.	Tube Size	Part Number	Thread Size	A	Hose Cut-Off Factor	Hole Dia.	Hex E	Hex F
6	6	32706E-S66	11/16-16	2.23	1.24	0.26	13/16	11/16
8	8	32708E-S68	13/16-16	2.67	1.5	0.38	15/16	7/8
10	10	32710E-S70	1-14	2.76	1.61	0.48	1 1/8	15/16
12	12	32712E-S72	1 3/16-12	2.91	1.72	0.61	1 3/8	1 -1/8

Female FOR Seal 45° Elbow

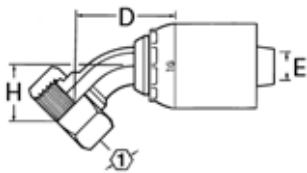

Hose I.D.	Tube Size	Part Number	Thread Size	A	H	Hose Cut-Off Factor	Hole Dia.	Hex
6	6	32706E-L66	11/16-16	2.43	0.43	1.43	.26	13/16
8	8	32708E-L68	13/16-16	2.96	0.59	1.79	.36	15/16
12	12	32712E-L72	1 3/16-12	3.57	0.83	2.38	.55	1 3/8

J

Hose Ends - Crimp

Female FOR Seal 90° Elbow

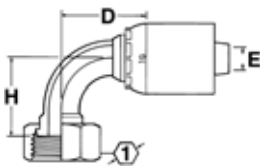

Hose I.D.	Tube Size	Part Number	Thread Size	A	H	Hose Cut-Off Factor	Hole Dia.	Hex
6	6	32706E-A26	11/16-16	2.34	0.9	1.34	.26	13/16
8	8	32708E-A28	13/16-16	2.84	1.15	1.67	.36	15/16
12	12	32710E-A30	1 3/16-12	3.49	1.88	2.3	.55	1 3/8

Coll-O-Crimp

336 'E' Series

To determine the correct length of hose, subtract the cut-off factor for each end fitting from the overall length of assembly.

Hose End 336 'E' Series

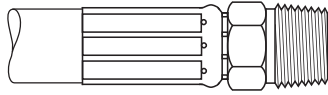

Refer to important safety information on pages A-2-3.

Ordering Information: Order individually by part number.

Application: General purpose high-pressure hydraulics. Use H335 non-conductive hose where shock hazards exist.

Compatible Hose: H335, H336

Pressure: Determined by maximum operating pressure for hose size and hose end configuration whichever is less. See pages A-4-9 for operating pressure ratings for hose end configurations.

Material: Low Carbon Steel

Plating: Zinc; Clear Trivalent Chromate

Advantages: Wide selection of hose and end configurations allowing for a diverse number of applications where hose compatibility is a problem.

Assemble With:

ET1000, ET4000, T-400-1, T-410-1, T-420-1, T-440-1, T-460, T-462, T-465, T-480

Label Set: FS-3500

Note:

Refer to current price list for availability of cataloged items. Configurations and dimensions subject to change without notice.

Male Pipe Rigid

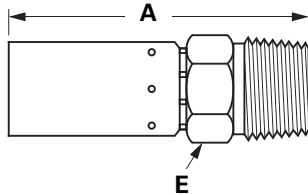

Hose I.D.	Tube Size	Part Number	Thread Size	A	Hose Cut-Off Factor	Hole Dia.	Hex E
3/16	1/8	33603E-102	1/8-27	1.88	1.06	.11	9/16
3/16	1/4	33603E-104	1/4-18	2.06	1.25	.11	11/16
1/4	1/8	33604E-102	1/8-27	2.13	1.06	.16	5/8
1/4	1/4	33604E-104	1/4-18	2.31	1.25	.16	11/16
1/4	3/8	33604E-106	3/8-18	2.40	1.31	.16	3/4
3/8	1/4	33606E-104	1/4-18	2.59	1.15	.28	3/4
3/8	3/8	33606E-106	3/8-18	2.59	1.15	.28	3/4
3/8	1/2	33606E-108	1/2-14	2.84	1.41	.28	15/16
1/2	3/8	33608E-106	3/8-18	2.78	1.13	.39	7/8
1/2	1/2	33608E-108	1/2-14	3.03	1.38	.39	15/16
3/4	3/4	33612E-112	3/4-14	3.22	1.38	.63	1-1/8
1	1	33616E-116	1-11-1/2	3.97	1.62	.81	1-3/8

Male Pipe Swivel

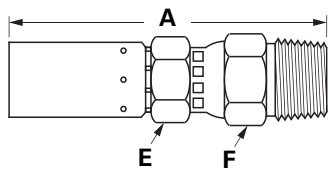

Hose I.D.	Tube Size	Part Number	Thread Size	A	Hose Cut-Off Factor	Hole Dia.	Hex E	Hex F
3/16	1/4	33603E-J04	1/4-18	2.64	1.84	.11	5/8	11/16
1/4	1/4	33604E-J04	1/4-18	2.87	1.79	.16	5/8	11/16
3/8	3/8	33606E-J06	3/8-18	3.15	1.72	.28	3/4	3/4
3/8	1/2	33606E-J08	1/2-14	3.31	1.88	.28	3/4	7/8
1/2	1/2	33608E-J08	1/2-14	3.61	1.97	.39	7/8	15/16

Note:

Swivel for installation purposes only. (Not for temperatures above 212°F.)

J

Hose Ends - Crimp

Coll-O-Crimp

336 'E' Series

To determine the correct length of hose, subtract the cut-off factor for each end fitting from the overall length of assembly.

JIC 37° Male Rigid

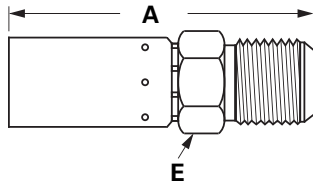

Hose I.D.	Tube Size	Part Number	Thread Size	A	Hose Cut-Off Factor	Hole Dia.	Hex E
3/16	1/4	33603E-504	7/16-20	2.05	1.25	.11	9/16
1/4	1/4	33604E-504	7/16-20	2.30	1.22	.16	5/8
1/4	5/16	33604E-505	1/2-20	2.30	1.23	.16	5/8
3/8	3/8	33606E-506	9/16-18	2.59	1.13	.28	3/4
3/8	1/2	33606E-508	3/4-16	2.69	1.25	.28	13/16
1/2	1/2	33608E-508	3/4-16	2.88	1.25	.39	7/8
1/2	5/8	33608E-510	7/8-14	3.10	1.42	.39	15/16
1/2	3/4	33608E-512	1-1/16-12	3.15	1.52	.39	1-1/8
3/4	3/4	33612E-512	1-1/16-12	3.32	1.52	.61	1-1/8

SAE 45° Flare Male Rigid

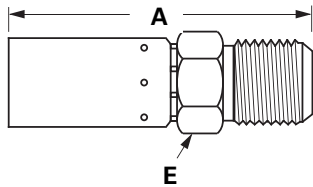

Hose I.D.	Tube Size	Part Number	Thread Size	A	Hose Cut-Off Factor	Hole Dia.	Hex E
3/16	1/4	33603E-304	7/16-20	2.00	1.19	.11	9/16
3/8	3/8	33606E-306	5/8-18	2.65	1.19	.28	3/4
1/2	1/2	33608E-308	3/4-16	3.03	1.31	.39	7/8

Male Straight Thread O-Ring Rigid

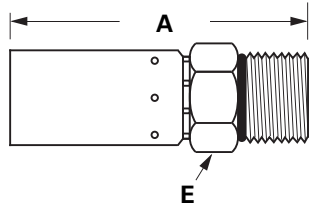

Hose I.D.	Port Size	Part Number	Thread Size	A	Hose Cut-Off Factor	Hole Dia.	Hex E
3/16	1/4	33603E-P04	7/16-20	1.86	1.06	.11	9/16
1/4	5/16	33604E-P05	1/2-20	2.11	1.03	.16	5/8
1/4	3/8	33604E-P06	9/16-18	2.14	1.06	.16	11/16
3/8	3/8	33606E-P06	9/16-18	2.42	1.00	.28	3/4
3/8	1/2	33606E-P08	3/4-16	2.47	1.03	.28	7/8
1/2	1/2	33608E-P08	3/4-16	2.78	1.03	.39	15/16
1/2	5/8	33608E-P10	7/8-14	2.84	1.16	.39	1-1/16

Female Pipe Rigid

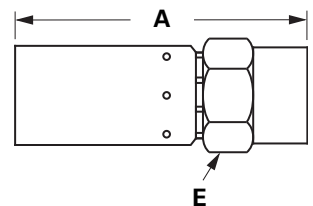

Hose I.D.	Pipe Size	Part Number	Thread Size	A	Hose Cut-Off Factor	Hole Dia.	Hex E
1/4	1/4	33604E-204	1/4-18	2.34	1.25	.16	3/4
1/2	1/2	33608E-208	1/2-14	3.03	1.31	.39	1-1/16

Female Straight Pipe Swivel

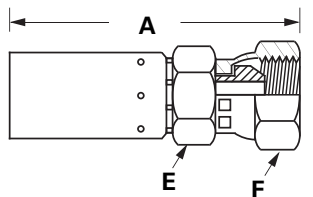

Hose I.D.	Tube Size	Part Number	Thread Size	A	Hose Cut-Off Factor	Hole Dia.	Hex E	Hex F
1/4	1/4	33604E-054	1/4-18	2.38	1.31	.16	5/8	3/4
3/8	3/8	33606E-056	3/8-18	2.66	1.22	.28	3/4	7/8
1/2	1/2	33608E-058	1/2-14	3.06	1.38	.39	1	1
3/4	3/4	33612E-062	3/4-14	3.43	1.62	.63	1-1/8	1-1/8

Note:
For use with male pipe fittings with internal seat.

J
Hose Ends - Crimp

Coll-O-Crimp

336 'E' Series

To determine the correct length of hose, subtract the cut-off factor for each end fitting from the overall length of assembly.

^a Swivel nuts are universal – both SAE 37° and 45° connections.

JIC 37° Female Swivel

(Exceptions Noted)

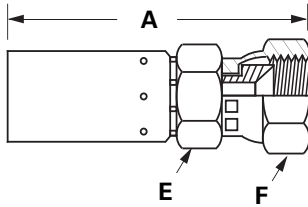

Hose I.D.	Tube Size	Part Number	Thread Size	A	Hose Cut-Off Factor	Hole Dia.	Hex E	Hex F
3/16	1/4	33603E-604 ^a	7/16-20	2.16	1.38	.11	9/16	5/8
3/16	5/16	33603E-605 ^a	1/2-20	2.16	1.38	.11	9/16	3/4
1/4	1/4	33604E-604 ^a	7/16-20	2.53	1.44	.16	5/8	5/8
1/4	5/16	33604E-605 ^a	1/2-20	2.53	1.44	.16	5/8	3/4
1/4	3/8	33604E-606	9/16-18	2.53	1.44	.16	5/8	3/4
3/8	3/8	33606E-606	9/16-18	2.81	1.38	.28	3/4	3/4
3/8	1/2	33606E-608 ^a	3/4-16	2.81	1.38	.28	3/4	15/16
1/2	1/2	33608E-608 ^a	3/4-16	3.16	1.63	.39	7/8	15/16
1/2	5/8	33608E-610 ^a	7/8-14	3.16	1.63	.39	7/8	1-1/16
3/4	3/4	33612E-612	1-1/16-12	3.44	1.63	.63	1-1/8	1-1/4
1	1	33616E-616	1-5/16-12	4.06	1.75	.81	1-3/8	1-1/2

SAE 45° Female Swivel

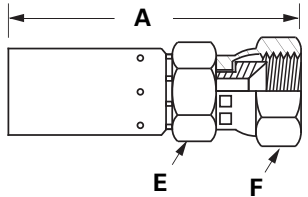

Hose I.D.	Tube Size	Part Number	Thread Size	A	Hose Cut-Off Factor	Hole Dia.	Hex E	Hex F
1/4	3/8	33604E-406	5/8-18	2.53	1.44	.16	5/8	13/16
3/8	3/8	33606E-406	5/8-18	2.81	1.38	.28	3/4	13/16

Female FOR-SEAL[®] Swivel Straight

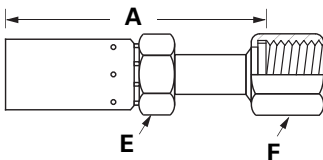

Hose I.D.	Tube Size	Part Number	Thread Size	A	Hose Cut-Off Factor	Hole Dia.	Hex E	Hex F
1/4	1/4	33604E-S64	9/16-18	2.60	1.52	.16	5/8	11/16
3/8	3/8	33606E-S66	11/16-16	2.92	1.61	.21	3/4	13/16
1/2	1/2	33608E-S68	13/16-16	3.29	1.72	.38	7/8	15/16
3/4	3/4	33612E-S72	1-3/16-12	3.71	1.95	.61	1-1/8	1-3/8
1	1	33616E-S76	1-7/16-12	4.36	2.11	.81	1-3/8	1-5/8

JIC 37° Female Swivel 45° Tube Elbow

(Exceptions Noted)

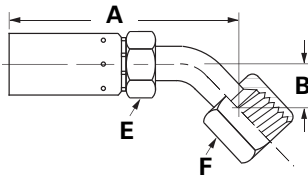

Hose I.D.	Tube Size	Part Number	Thread Size	A	B	Hose Cut-Off Factor	Hole Dia.	Hex E	Hex F
3/16	1/4	33603E-684 ^a	7/16-20	2.30	.47	1.50	.11	9/16	9/16
1/4	5/16	33604E-685 ^a	1/2-20	2.65	.53	1.56	.16	5/8	5/8
3/8	3/8	33606E-686	9/16-18	2.92	.59	1.48	.28	3/4	11/16
3/8	1/2	33606E-688 ^a	3/4-16	3.10	.71	1.66	.28	3/4	7/8
1/2	1/2	33608E-688 ^a	3/4-16	3.28	.71	1.66	.39	7/8	7/8
1/2	5/8	33608E-690 ^a	7/8-14	3.52	.84	1.84	.39	7/8	1
3/4	3/4	33612E-692	1-1/16-12	4.33	1.12	2.44	.62	1-1/8	1-1/4

Inverted Male Swivel 45° Tube Elbow

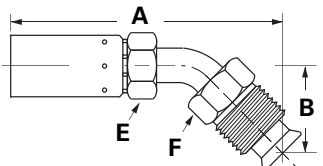

Hose I.D.	Tube Size	Part Number	Thread Size	A	B	Hose Cut-Off Factor	Hole Dia.	Hex E	Hex F
3/8	3/8	33606E-B46	5/8-18	3.30	.97	1.88	.28	3/4	5/8

J
Hose Ends - Crimp

Coll-O-Crimp

336 'E' Series

To determine the correct length of hose, subtract the cut-off factor for each end fitting from the overall length of assembly.

^a Swivel nuts are universal – both SAE 37° and 45° connections.

Male Pipe Swivel 90° Elbow

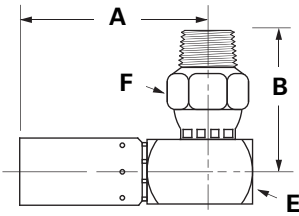

Hose I.D.	Tube Size	Part Number	Thread Size	A	B	Hose Cut-Off Factor	Hole Dia.	Hex E	Hex F
3/8	3/8	33606E-M06	3/8-18	2.19	1.64	.88	.28	.81	3/4
1/2	1/2	33608E-M08	1/2-14	2.48	1.95	.94	.39	1	15/16

Note:

Swivel for installation purposes only.
(Not for temperatures above 212°F.)

JIC 37° Female Swivel 90° Tube Elbow

(Exceptions Noted)

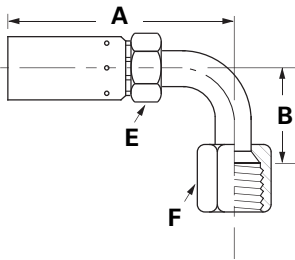

Hose I.D.	Tube Size	Part Number	Thread Size	A	B	Hose Cut-Off Factor	Hole Dia.	Hex E	Hex F
1/4	1/4	33604E-664 ^a	7/16-20	2.28	.88	1.31	.16	5/8	9/16
1/4	5/16	33604E-665 ^a	1/2-20	2.38	1.00	1.31	.16	5/8	5/8
3/8	3/8	33606E-666	9/16-18	2.63	1.13	1.19	.28	3/4	11/16
3/8	1/2	33606E-668 ^a	3/4-16	2.75	1.38	1.31	.28	3/4	7/8
1/2	1/2	33608E-668 ^a	3/4-16	2.94	1.38	1.31	.39	7/8	7/8
1/2	5/8	33608E-670 ^a	7/8-14	3.06	1.63	1.44	.39	7/8	1
3/4	5/8	33612E-670 ^a	7/8-14	3.38	1.63	1.56	.50	1-1/8	1
3/4	3/4	33612E-672	1-1/16-12	3.88	2.31	2.06	.62	1-1/8	1-1/4
1	1	33616E-676	1-5/16-12	4.75	2.50	2.31	.58	1-3/8	1-1/2

JIC 37° Female Swivel Long Drop 90° Tube Elbow

(Exceptions Noted)

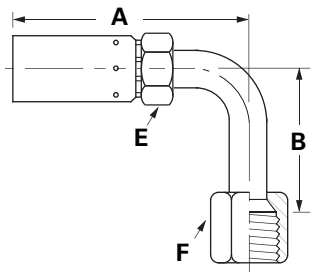

Hose I.D.	Tube Size	Part Number	Thread Size	A	B	Hose Cut-Off Factor	Hole Dia.	Hex E	Hex F
1/4	5/16	33604E-645	1/2-20	2.38	1.77	1.30	.16	5/8	5/8
3/8	3/8	33606E-646	9/16-18	2.63	2.18	1.19	.28	3/4	11/16
3/8	1/2	33606E-648	3/4-16	2.75	2.43	1.31	.28	3/4	7/8
1/2	5/8	33608E-650	7/8-14	3.06	2.57	1.44	.39	7/8	1
3/4	3/4	33612E-652	1-1/16-12	3.88	3.73	2.06	.62	1-1/8	1-1/4

Female FOR-SEAL® Swivel Short Drop 90° Elbow

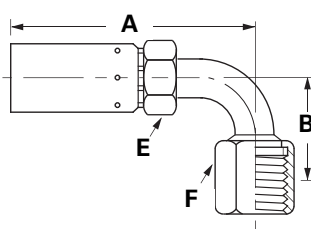

Hose I.D.	Tube Size	Part Number	Thread Size	A	B	Hose Cut-Off Factor	Hole Dia.	Hex E	Hex F
1/4	1/4	33604E-A24	9/16-18	2.31	.78	1.23	.16	5/8	11/16
3/8	3/8	33606E-A26	11/16-16	2.74	.90	1.43	.28	3/4	13/16
1/2	1/2	33608E-A28	13/16-16	3.04	1.15	1.48	.39	7/8	15/16
3/4	3/4	33612E-A32	1-3/16-12	3.78	1.88	2.02	.63	1-1/8	1-3/8

J Hose Ends - Crimp

Coll-O-Crimp

470 'E' Series

To determine the correct length of hose, subtract the cut-off factor for each end fitting from the overall length of assembly.

Hose End 470 'E' Series

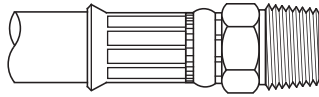

⚠ WARNING

47032E ends can ONLY be crimped on the T-440 or ET4000.

⚠ Refer to important safety information on pages A-2-3.

Ordering Information: Order individually by part number; reference individual hose end listings for details. For split flange kits, refer to pages L-89-92.

Application: Very high pressure hydraulic lines subjected to extreme pressure surges and flexing. Some applications include mining, construction, farming and high performance industrial equipment.

Compatible Hose: H470

Pressure: Determined by maximum operating pressure for hose size and hose end configuration whichever is lesser. See pages A-4-9 for operating pressure ratings for hose end configurations.

Material: Low Carbon Steel

Plating: Zinc; Clear Trivalent Chromate

Advantages: Excellent series for very high pressure

hydraulics. Compatible with Caterpillar, John Deere, and most major manufacturers of equipment using high pressure applications.

Assemble With: T-410-1 Coll-O-Crimp II, T-420-1 Coll-O-Crimp Super I, T-440-1 Coll-O-Crimp II Plus, T-480, ET4001 or ET4000 depending on size.

Label Set: FS-1800

Male Pipe Rigid

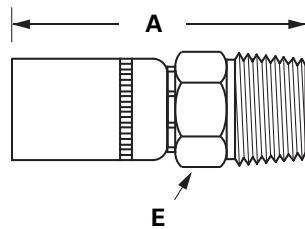

Hose I.D.	Pipe Size	Part Number	Thread Size	A	Hose Cut-Off Factor	Hole Dia.	Hex E
1/2	1/2	47008E-108	1/2-14	2.79	1.38	.38	7/8
3/4	3/4	47012E-112	3/4-14	3.80	1.75	.61	1-1/16
1	1	47016E-116	1-11-1/2	4.30	1.94	.80	1-3/8
1-1/4	1-1/4	47020E-120	1-1/4-11-1/2	5.56	2.44	1.00	1-3/4
1-1/2	1-1/2	47024E-124	1-1/2-11-1/2	5.61	2.25	1.25	2-1/8
2	2	47032E-132	2-11-1/2	6.53	2.75	1.56	2-3/4

Male DIN 24° Seat

s.Rh. (Heavy)

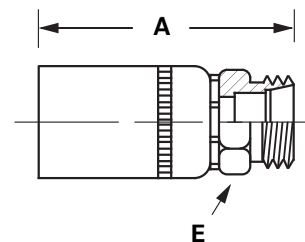

Hose I.D.	Pipe Size	Part Number	Thread Size	A	Hose Cut-Off Factor	Hole Dia.	Hex E
3/4	25	47012E-25F	M36-2.0	3.56	1.61	.58	1-3/8
1	30	47016E-30F	M42-2.0	4.26	1.88	.79	1-3/4
1-1/4	38	47020E-38F	M52-2.0	5.22	3.81	1.00	2-1/4

JIC 37° Female Swivel

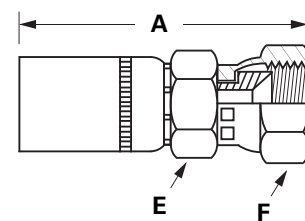

Hose I.D.	Tube Size	Part Number	Thread Size	A	Hose Cut-Off Factor	Hole Dia.	Hex E	Hex F
1/2	1/2	47008E-608	3/4-16	2.97	1.56	.39	7/8	7/8
3/4	3/4	47012E-612	1-1/16-12	3.90	1.88	.58	1-1/16	1-1/4
3/4	1	47012E-616	1-5/16-12	3.98	1.94	.58	1-1/4	1-1/2
1	1	47016E-616	1-5/16-12	4.34	2.00	.80	1-3/8	1-1/2
1-1/4	1-1/4	47020E-620	1-5/8-12	5.72	2.56	1.00	1-3/4	2
1-1/2	1-1/2	47024E-624	1-7/8-12	6.04	2.63	1.25	2-1/8	2-1/4
2	2	47032E-632 ^Δ	2-1/2-12	6.98	3.22	1.56	2-3/4	3

⚠ **WARNING:** ^Δ Before crimping this fitting on a ET4000 C-O-C machine, refer to ET4000 crimping procedures on page N-29.

J
Hose Ends - Crimp

Coll-O-Crimp

470 'E' Series

To determine the correct length of hose, subtract the cut-off factor for each end fitting from the overall length of assembly.

Female Swivel DIN 24° Seat

s. Rh. DKO (Heavy)

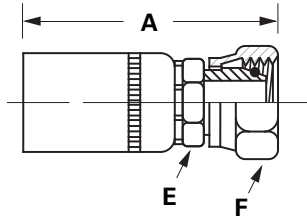

Hose I.D.	Tube Size (mm)	Part Number	Thread Size	A	Hose Cut-Off Factor	Hole Dia.	Hex E	Hex F
3/4	25	47012E-75C	M36x2.0	3.94	1.88	.58	1-5/16	1-13/16
1	30	47016E-80C	M42x2.0	4.60	2.25	.79	1-5/8	2
1-1/4	38	47020E-88C	M52x2.0	5.96	2.63	1.00	2	2-3/8

(Includes o-ring)

British Standard (BSPP) 60° Cone Female Pipe Swivel

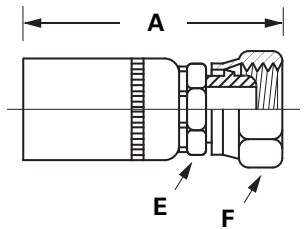

Hose I.D.	BSPP Pipe Size	Part Number	Thread Size	A	Hose Cut-Off Factor	Hole Dia.	Hex E	Hex F
3/4	3/4	47012E-362	G-3/4-14*	3.99	1.69	.58	1-1/16	1-1/4
1	1	47016E-366	G-1-11*	4.75	2.23	.79	1-3/8	1-1/2
1-1/4	1-1/4	47020E-370	G-1-1/4-11*	6.26	2.44	1.00	1-7/8	1-7/8
1-1/2	1-1/2	47024E-374	G-1-1/2-11*	6.46	3.04	1.18	2	2-1/4
2	2	47032E-375	G-2-11*	6.85	3.06	1.56	2-3/4	2-3/4

*G as part of thread size is ISO designation for parallel thread.

Swivel Nut style may vary.

Female FOR-SEAL Swivel Straight

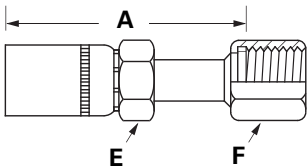

Hose I.D.	Tube Size	Part Number	Thread Size	A	Hose Cut-Off Factor	Hole Dia.	Hex E	Hex F
3/4	3/4	47012E-S72	1-3/16-12	4.20	2.16	.55	1-1/8	1-3/8
1	1	47016E-S76	1-7/16-12	4.65	2.31	.79	1-3/8	1-5/8
1	1-1/4	47016E-S80	1-11/16-12	4.65	2.31	.79	1-3/8	1-7/8
1-1/4	1-1/4	47020E-S80	1-11/16-12	5.76	2.62	1.00	1-3/4	1-7/8

Split Flange Straight

(SAE Code 61)

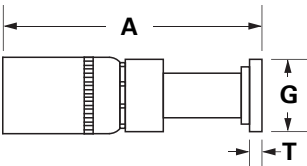

Hose I.D.	Nominal Flange Size	Part Number	Thread Size	A	Hose Cut-Off Factor	Hole Dia.	Dia. G	Nominal
1/2	1/2	47008E-G08	8x252	3.79	2.38	.38	1.19	.265
3/4	3/4	47012E-G12	12x252	4.46	2.44	.58	1.50	.265
3/4	1	47012E-G16	16x252	4.46	2.44	.58	1.75	.315
1	1	47016E-G16	16x252	4.91	2.56	.77	1.75	.315
1-1/4	1-1/4	47020E-G20	20x252	5.84	2.69	1.00	2.00	.315
1-1/2	1-1/2	47024E-G24	24x252	6.83	3.50	1.25	2.38	.315
2	2	47032E-G32	32x252	7.82	4.06	1.81	2.81	.375

(For Split Flange Kits, see pages L-89 thru L-92.)

Coll-O-Crimp

470 'E' Series

To determine the correct length of hose, subtract the cut-off factor for each end fitting from the overall length of assembly.

Split Flange Straight (SAE Code 62)

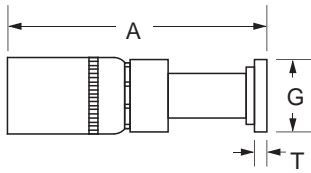

Hose I.D.	Nominal Flange Size	Part Number	Replacement O-Ring (Not Included)	A	Hose Cut-Off Factor	Hole Dia.	Dia. G	T Nominal
3/4	3/4	47012E-D12	12x252	4.75	2.75	.58	1.62	.345
3/4	1	47012E-D16	16x252	4.94	2.88	.58	1.88	.375
1	1	47016E-D16	16x252	4.91	2.56	.77	1.88	.375
1	1-1/4	47016E-D20	20x252	5.10	2.75	.77	2.12	.405
1	1-1/2	47016E-D24	24x252	5.30	2.94	.77	2.50	.495
1-1/4	1-1/4	47020E-D20	20x252	5.73	2.63	1.00	2.12	.405
1-1/4	1-1/2	47020E-D24	24x252	5.91	2.75	1.00	2.50	.495
1-1/2	1-1/4	47024E-D20	20x252	6.87	3.44	1.00	2.12	.405
1-1/2	1-1/2	47024E-D24	24x252	6.71	3.31	1.25	2.50	.495

(For Split Flange Kits, see pages L-89 thru L-92.)

Split Flange 30° Tube Elbow (SAE Code 62)

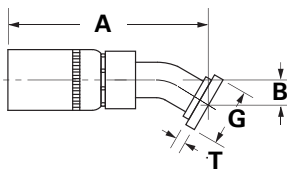

Hose I.D.	Nominal Flange Size	Part Number	Replacement O-Ring (Not Included)	A	B	Hose Cut-Off Factor	Hole Dia.	Dia. G	T Nominal
1	1-1/2	47016E-N25	24x252	6.46	1.11	4.06	.75	2.50	.495
1-1/4	1-1/2	47020E-N25	24x252	7.45	1.09	4.31	1.06	2.50	.495

(For Split Flange Kits, see pages L-89 thru L-92.)

JIC 37° Female Swivel 45° Tube Elbow

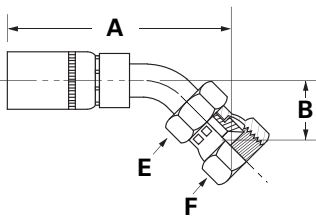

Hose I.D.	Tube Size	Part Number	Thread Size	A	B	Hose Cut-Off Factor	Hole Dia.	Hex E	Hex F
1/2	1/2	47008E-688	3/4-16	4.24	1.14	2.81	.39	7/8	7/8
3/4	3/4	47012E-692	1-1/16-12	5.79	1.66	3.75	.61	1-1/8	1-1/4
1	1	47016E-696	1-5/16-12	6.35	1.72	3.98	.80	1-3/16	1-1/2

British Standard (BSPP) 60° Cone Female Pipe Swivel 45° Elbow

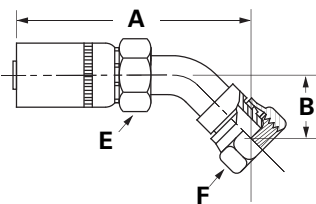

Hose I.D.	Tube Size	Part Number	Thread Size	A	B	Hose Cut-Off Factor	Hole Dia.	Hex E	Hex F
3/4	3/4	47012E-52P	G-3/4-14*	5.80	1.66	3.75	.61	1-1/16	1-1/4
1	1	47016E-56P	G-1-11*	6.54	1.92	4.19	.75	1-3/8	1-1/2

*G as part of thread size is ISO designation for parallel thread.

J

Hose Ends - Crimp

Coll-O-Crimp

470 'E' Series

To determine the correct length of hose, subtract the cut-off factor for each end fitting from the overall length of assembly.

Split Flange 45° Tube Elbow

(SAE Code 61)

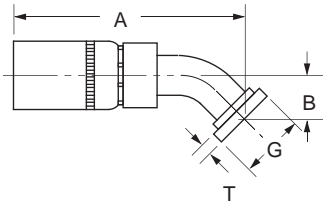

Hose I.D.	Nominal Flange Size	Replacement Part Number	O-Ring (Not Included)	A	B	Hose Cut-Off Factor	Hole Dia.	Dia. G	T Nominal
1/2	1/2	47008E-G41	8x252	3.94	.78	2.50	.38	1.19	.265
3/4	3/4	47012E-G42	12x252	5.50	1.38	3.46	.58	1.50	.265
1	1	47016E-G46	16x252	5.88	1.25	3.12	.75	1.75	.315
1-1/4	1-1/4	47020E-G50	20x252	7.16	1.50	4.02	1.00	2.00	.315
1-1/2	1-1/2	47024E-G54	24x252	7.81	1.41	4.38	1.25	2.38	.315
2	2	47032E-G62	32x252	9.17	2.00	5.40	1.81	2.81	.375

(For Split Flange Kits, see pages L-89 thru L-92.)

Split Flange 45° Tube Elbow

(SAE Code 62)

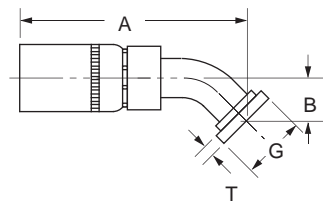

Hose I.D.	Nominal Flange Size	Part Number	Replacement O-Ring (Not Included)	A	B	Hose Cut-Off Factor	Hole Dia.	Dia. G	T Nominal
3/4	3/4	47012E-D42	12x252	5.50	1.38	3.45	.58	1.62	.345
3/4	1	47012E-D46	16x252	5.50	1.38	3.45	.58	1.88	.375
1	1	47016E-D46	16x252	5.88	1.25	3.52	.79	1.88	.375
1	1-1/4	47016E-D50	20x252	5.88	1.25	3.52	.79	2.12	.405
1-1/4	1-1/4	47020E-D50	20x252	7.16	1.50	4.02	1.00	2.12	.405
1-1/4	1-1/2	47020E-D54	24x252	7.16	1.50	4.02	1.00	2.50	.495
1-1/2	1-1/2	47024E-D54	24x252	8.00	1.60	4.59	1.19	2.50	.495

Split Flange 60° Tube Elbow

(SAE Code 62)

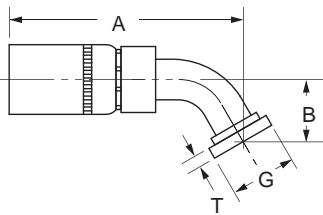

Hose I.D.	Nominal Flange Size	Part Number	Replacement O-Ring (Not Included)	A	B	Hose Cut-Off Factor	Hole Dia.	Dia. G	T Nominal
1-1/4	1-1/2	47020E-N55	24x252	7.36	2.28	4.21	1.06	2.50	.495

(For Split Flange Kits, see pages L-89 thru L-92.)

Split Flange 67 1/2° Tube Elbow

(SAE Code 62)

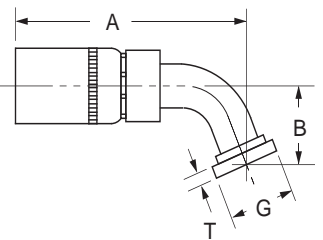

Hose I.D.	Nominal Flange Size	Part Number	Replacement O-Ring (Not Included)	A	B	Hose Cut-Off Factor	Hole Dia.	Dia. G	T Nominal
1	1	47016E-N63	16x252	6.02	2.24	3.63	.75	1.88	.375

(For Split Flange Kits, see pages L-89 thru L-92.)

JIC 37° Female Swivel 90° Tube Elbow

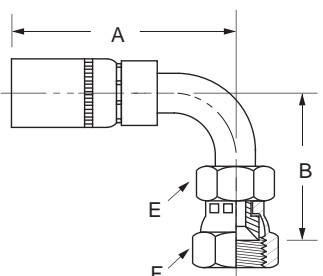

Hose I.D.	Nominal Flange Size	Part Number	Replacement O-Ring (Not Included)	A	B	Hose Cut-Off Factor	Hole Dia.	Dia. G	T Nominal
1/2	1/2	47008E-668	3/4-16	3.53	2.12	2.11	.39	7/8	7/8
3/4	3/4	47012E-672	1-1/16-12	5.00	2.88	2.95	.61	1-1/8	1-1/4
1	1	47016E-676	1-5/16-12	5.52	3.46	3.16	.80	1-3/16	1-1/2

Hose Ends - Crimp

Coll-O-Crimp

470 'E' Series

To determine the correct length of hose, subtract the cut-off factor for each end fitting from the overall length of assembly.

Female FOR-SEAL Swivel 90° Tube Elbow Short Drop

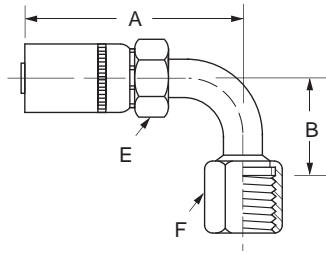

Hose I.D.	Tube Size	Part Number	Thread Size	A	B	Hose Cut-Off Factor	Hole Dia.	Hex E	Hex F
1-1/4	1-1/4	47020E-A40	1-11/16-12	6.37	2.50	3.22	1.00	1-3/4	1-7/8

British Standard (BSPP) 60° Cone Female Pipe Swivel 90° Elbow

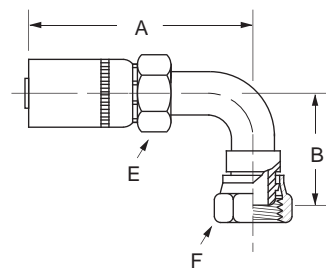

Hose I.D.	Tube Size	Part Number	Thread Size	A	B	Hose Cut-Off Factor	Hole Dia.	Hex E	Hex F
3/4	3/4	47012E-82P	G-3/4-14*	4.98	2.49	2.94	.61	1-1/8	1-1/4
1	1	47016E-86P	G-1-11*	5.52	3.43	3.13	.75	1-3/8	1-1/2

*G as part of thread size is ISO designation for parallel thread.

Split Flange 90° Tube Elbow (SAE Code 61)

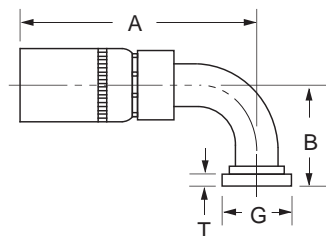

Hose I.D.	Nominal Flange Size	Part Number	Replacement O-Ring (Not Included)	A	B	Hose Cut-Off Factor	Hole Dia.	Dia. G	T Nominal
1/2	1/2	47008E-G71	8x252	3.59	1.62	2.17	.50	1.19	.265
3/4	3/4	47012E-G72	12x252	5.00	2.66	2.95	.61	1.50	.265
3/4	1	47012E-G76	16x252	5.00	2.66	2.95	.58	1.75	.315
1	1	47016E-G76	16x252	5.52	2.80	3.16	.75	1.75	.315
1-1/4	1-1/4	47020E-G80	20x252	6.43	2.62	3.29	1.12	2.00	.315
1-1/2	1-1/2	47024E-G84	24x252	7.66	3.13	4.24	1.44	2.38	.315
2	2	47032E-G92	32x252	8.85	4.50	5.08	1.81	2.81	.375

(For Split Flange Kits, see pages L-89 thru L-92.)

Split Flange 90° Tube Elbow (SAE Code 62)

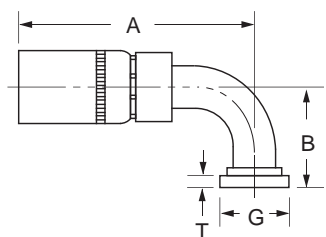

Hose I.D.	Nominal Flange Size	Part Number	Replacement O-Ring (Not Included)	A	B	Hose Cut-Off Factor	Hole Dia.	Dia. G	T Nominal
3/4	3/4	47012E-D72	12x252	5.01	2.62	2.94	.64	1.62	.345
3/4	1	47012E-D76	16x252	5.01	2.81	2.94	.60	1.88	.375
1	1	47016E-D76	16x252	5.52	2.79	3.13	.86	1.88	.375
1	1-1/4	47016E-D80	20x252	5.52	2.94	3.13	.86	2.12	.405
1	1-1/2	47016E-D84	24x252	5.75	3.42	3.39	.75	2.50	.495
1-1/4	1-1/4	47020E-D80	20x252	6.61	3.02	3.50	1.03	2.12	.405
1-1/4	1-1/4	47020E-D80L47	20x252	6.61	4.70	3.50	1.03	2.12	.405
1-1/4	1-1/4	47020E-D80L60	20x252	6.61	6.00	3.50	1.03	2.12	.405
1-1/4	1-1/2	47020E-D84	24x252	6.61	3.68	3.50	1.03	2.50	.495
1-1/2	1-1/4	47024E-D80	20x252	6.77	3.02	3.38	1.03	2.12	.405
1-1/2	1-1/2	47024E-D84	24x252	7.57	3.68	4.19	1.28	2.50	.495

(For Split Flange Kits, see pages L-89 thru L-92.)

Hose Ends - Crimp

Hose End 757 'E' Series

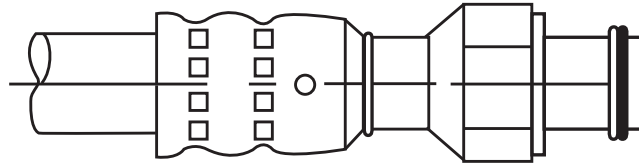

Ordering Information:

Order individually by catalog number.

 Refer to important safety information on pages A-2-3.

Typical Applications:

Used with R134a and R12 applications. Ideal for heavy duty truck use as well as industrial and automotive applications.

Compatible Hose: H757

Pressure: Determined by hose burst pressure. See pages A-15-16 for operating pressure ratings for hose end configurations.

Material: Carbon steel

Plating: Zinc; Clear Trivalent Chromate

Advantages: Wide selection of hose ends which include the flareless ends, allowing use of existing tubing. Steel hose ends handle heavy duty demands.

Assemble With: T-400-1, T-410-1, T-420-1, T-440-1, T-460, T-462, T-465-1, T-475-1, T-480, ET4000, ET4001

Label Set: FS-3200

Note:

Refer to current price list for availability of cataloged items. Configurations and dimensions subject to change without notice.

757 'E' Series Air Conditioning Procedure

The Coll-O-Crimp system can be used to make original equipment assemblies using factory replacement ends as listed on pages J-23 to J-29. If the required hose end is not found, our Flareless hose end can be used. By following the instructions on this page, a new hose assembly can be made by combining Weatherhead hose end with the original equipment end configuration.

- Typical original equipment assembly
- Typical assembly of a Flareless hose end used with an old original equipment end configuration
- Weatherhead replacement assemblies using original equipment tubing with Weatherhead 757 'E' Series hose ends.

Preparation – Flareless Tube Assembly

1. Remove the bad tube assembly or if room permits, perform the cutting procedure in place. Cut the tube squarely and as close to the hose connection as possible. Allow an adequate straight area for the flareless nut and sleeve to move freely for installation purposes. Deburr the inside and outside diameters of the tubing.

Make Presetting Operation

1. Slide nut and then sleeve onto tube. Shoulder of sleeve must be toward nut.
2. Lubricate threads, seat in hose end, and flareless sleeve with a good grade of lubricant. Insert tube into seat of hose end, making sure that tube is bottomed, **TIGHTEN HAND TIGHT** and then tighten an **ADDITIONAL 1 to 1-1/6 turns** with a wrench.

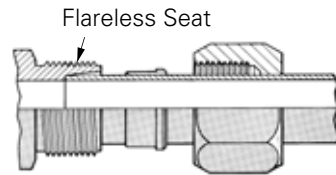
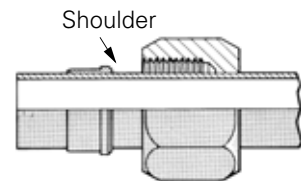
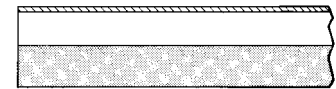

Note:

Compensate for tubing being removed by adding to the over all length of the replacement hose assembly.

Coll-O-Crimp

757 'E' Series

To determine the correct length of hose, subtract the cut-off factor for each end fitting from the overall length of assembly. All dimensions shown in inches.

Bumped Tube O-Ring Male Rigid

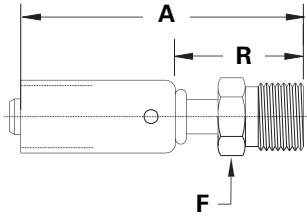

Hose I.D.	Tube Size	Part Number	Thread Size	Length A	Run R	Hose Cut-Off Factor	Hex F
5/16	3/8	75706E-W06	5/8-18	2.94	1.54	1.63	5/8
13/32	1/2	75708E-W08	3/4-16	3.26	1.86	2.00	3/4
1/2	5/8	75710E-W10	7/8-14	3.35	1.95	2.13	7/8
5/8	5/8	75712E-W10	7/8-14	3.56	2.06	2.25	7/8
5/8	3/4	75712E-W12	1-1/16-14	3.56	2.06	2.25	1-1/16

Bumped Tube O-Ring Male Swivel

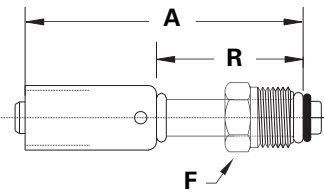

Hose I.D.	Tube Size	Part Number	Thread Size	Length A	Run R	Hose Cut-Off Factor	Hex F	O-Ring
5/16	3/8	75706E-Z06	5/8-18	2.94	1.54	1.63	5/8	ZW74706
5/16	1/2	75706E-Z08	3/4-18	3.15	1.75	1.88	3/4	ZW74708
13/32	1/2	75708E-Z08	3/4-18	3.26	1.86	2.00	3/4	ZW74708
1/2	5/8	75710E-Z10	7/8-18	3.35	1.95	2.13	7/8	ZW74710
1/2	3/4	75710E-Z12	1-1/16-16	3.46	2.06	2.25	1-1/16	ZW74712
5/8	5/8	75712E-Z10	7/8-18	3.56	2.06	2.25	7/8	ZW74710
5/8	3/4	75712E-Z12	1-1/16-16	3.56	2.06	2.25	1-1/16	ZW74712

(Includes o-ring).

Male Rigid Compression Fitting (With Nut and Sleeve)

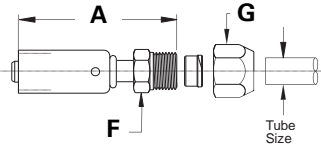

Hose I.D.	Tube Size	Part Number	Thread Size	Length A	Hose Cut-Off Factor	Hex F	Hex G
5/16	3/8	75706E-756	5/8-18	2.59	1.38	5/8	3/4
5/16	1/2	75706E-758	3/4-16	2.71	1.50	3/4	7/8
13/32	3/8	75708E-756	5/8-18	2.65	1.38	5/8	3/4
13/32	1/2	75708E-758	3/4-16	2.78	1.50	3/4	7/8
13/32	5/8	75708E-760	7/8-14	2.90	1.63	7/8	1-1/16
1/2	1/2	75710E-758	3/4-16	2.84	1.63	3/4	7/8
1/2	5/8	75710E-760	7/8-14	2.90	1.63	7/8	1-1/16
5/8	5/8	75712E-760	7/8-14	3.13	1.75	7/8	1-1/16
5/8	3/4	75712E-762	1-1/16-14	3.25	1.88	1-1/16	1-1/4

SAE 45° Male Rigid

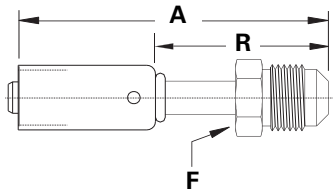

Hose I.D.	Tube Size	Part Number	Thread Size	Length A	Run R	Hose Cut-Off Factor	Hex F
5/16	3/8	75706E-306	5/8-18	3.28	1.88	2.00	5/8
13/32	1/2	75708E-308	3/4-16	3.40	2.00	2.13	3/4
1/2	5/8	75710E-310	7/8-14	3.71	2.31	2.50	7/8
5/8	3/4	75712E-312	1-1/16-14	4.00	2.50	2.75	1-1/16

Coll-O-Crimp

757 'E' Series

To determine the correct length of hose, subtract the cut-off factor for each end fitting from the overall length of assembly. All dimensions shown in inches.

Bumped Tube O-Ring Female Swivel

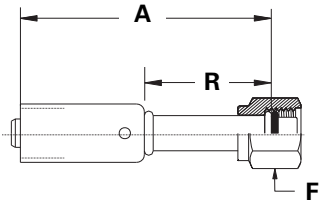

Hose I.D.	Tube Size	Part Number	Thread Size	Length A	Run R	Hose Cut-Off Factor	Hex F	O-Ring
5/16	3/8	75706E-Z47	5/8-18	2.78	1.38	1.50	3/4	ZW74706
5/16	1/2	75706E-Z49	3/4-16	2.90	1.50	1.63	7/8	ZW74708
13/32	1/2	75708E-Z49	3/4-16	3.06	1.66	1.75	7/8	ZW74708
13/32	5/8	75708E-Z51	7/8-14	3.09	1.69	1.88	1-1/16	ZW74710
1/2	5/8	75710E-Z51	7/8-14	3.09	1.69	1.88	1-1/16	ZW74710
1/2	3/4	75710E-Z53	1-1/16-14	3.21	1.81	2.00	1-1/4	ZW74712
5/8	5/8	75712E-Z51	7/8-14	3.31	1.81	2.00	1-1/16	ZW74710
5/8	3/4	75712E-Z53	1-1/16-14	3.31	1.81	2.00	1-1/4	ZW74712

(Includes o-ring).

Bumped Tube O-Ring Female Swivel W/R134a Service Port

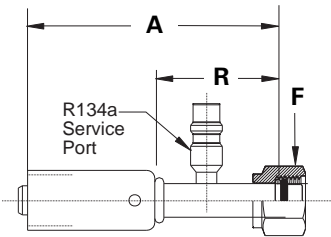

Hose I.D.	Tube Size	Part Number	Thread Size	Length A	Run R	Hose Cut-Off Factor	Hex F	O-Ring
5/16	3/8	75706E-Z57*	5/8-18	4.28	1.88	3.00	3/4	ZW74706
13/32	1/2	75708E-Z59*	3/4-16	4.28	1.88	3.00	7/8	ZW74708
1/2	5/8	75710E-Z61**	7/8-14	4.52	2.12	3.25	1-1/16	ZW74710
5/8	5/8	75712E-Z61**	7/8-14	4.62	3.05	3.25	1-1/16	ZW74710

*High Side Port

**Low Side Port

(Includes o-ring)

SAE 45° Flare Female Swivel

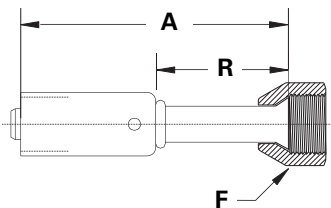

Hose I.D.	Tube Size	Part Number	Thread Size	Length A	Run R	Hose Cut-Off Factor	Hex F
5/16	3/8	75706E-406	5/8-18	2.78	1.38	1.50	3/4
5/16	1/2	75706E-408	3/4-16	2.90	1.50	1.75	7/8
13/32	1/2	75708E-408	3/4-16	2.84	1.44	1.56	7/8
1/2	5/8	75710E-410	7/8-14	3.09	1.69	1.81	1-1/16
5/8	5/8	75712E-410	7/8-14	3.25	1.75	2.00	1-1/16
5/8	3/4	75712E-412	1-1/16-14	3.25	1.75	2.00	1-1/4

Hose Splicer

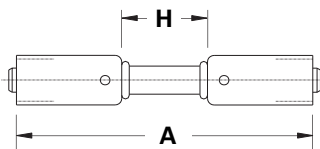

Hose I.D.	Hose I.D.	Part Number	Length A	Run R	Hose Cut-Off Factor
5/16	5/16	75706E-Y36	4.30	1.50	1.50
5/16	13/32	75706E-Y38	4.30	1.50	1.50
13/32	13/32	75708E-Y38	4.30	1.50	1.50
13/32	1/2	75708E-Y40	4.43	1.63	1.63
1/2	1/2	75710E-Y40	4.43	1.63	1.63
1/2	5/8	75710E-Y41	4.65	1.75	1.75
5/8	5/8	75712E-Y41	4.75	1.75	1.75

(For crimping information, refer to document W-H00V-TM001-E2.)

Hose Ends - Crimp

Coll-O-Crimp

757 'E' Series

To determine the correct length of hose, subtract the cut-off factor for each end fitting from the overall length of assembly. All dimensions shown in inches.

Hose Splicer W/R134a Service Port

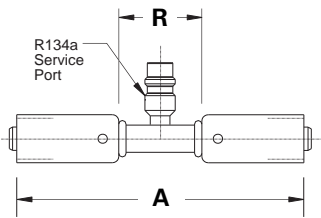

Hose I.D.	Hose I.D.	Part Number	Length A	Run A	Hose Cut-Off Factor
5/16	5/16	75706E-Y47*	5.42	2.62	1.50
13/32	13/32	75708E-Y48*	5.42	2.62	1.50
1/2	1/2	75710E-Y49**	5.42	2.62	1.63
5/8	5/8	75712E-Y50**	5.62	2.62	1.75

(For crimping information refer to document W-HOOV-TM001-E2.)

*High Side Port

**Low Side Port

SAE 45° Flare Male Rigid 45° Tube Elbow

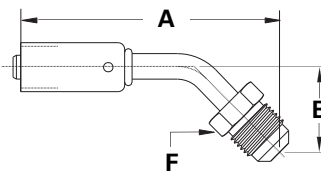

Hose I.D.	Tube Size	Part Number	Thread Size	Length A	Drop B	Hose Cut-Off Factor	Hex F
13/32	1/2	75708E-388	3/4-16	3.65	1.25	2.50	3/4
1/2	5/8	75710E-390	7/8-14	4.21	1.56	3.00	7/8

Bumped Tube O-Ring Male Swivel 45° Tube Elbow

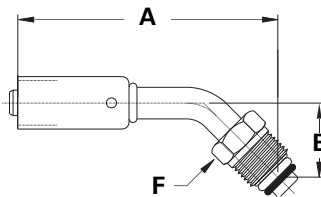

Hose I.D.	Tube Size	Part Number	Thread Size	Length A	Run R	Hose Cut-Off Factor	Hex F	O-Ring
5/16	3/8	75706E-Z26	5/8-18	3.09	.88	1.88	5/8	ZW74706
13/32	1/2	75708E-Z28	3/4-18	3.59	1.03	2.38	3/4	ZW74708
1/2	5/8	75710E-Z30	7/8-18	3.71	1.06	2.50	7/8	ZW74710
5/8	5/8	75712E-Z30	7/8-18	4.19	1.19	2.88	7/8	ZW74710
5/8	3/4	75712E-Z32	1-1/16-16	4.19	1.19	2.88	1-1/16	ZW74712

(Includes o-ring).

Bumped Tube O-Ring Female Swivel 45° Tube Elbow

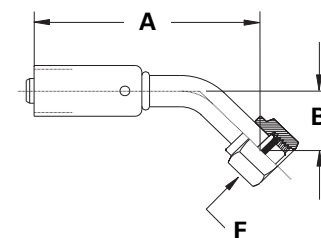

Hose I.D.	Tube Size	Part Number	Thread Size	Length A	Run R	Hose Cut-Off Factor	Hex F	O-Ring
5/16	3/8	75706E-W47	5/8-18	3.51	.68	2.25	3/4	ZW74706
13/32	1/2	75708E-W49	3/4-16	3.63	1.05	2.25	7/8	ZW74708
1/2	5/8	75710E-W51	7/8-14	3.65	1.19	2.50	1-1/16	ZW74710
5/8	5/8	75712E-W51	7/8-14	4.00	1.29	2.75	1-1/16	ZW74710
5/8	3/4	75712E-W53	1-1/16-14	3.84	.94	2.50	1-1/4	ZW74712

(Includes o-ring).

J
Hose Ends - Crimp

Coll-O-Crimp

757 'E' Series

To determine the correct length of hose, subtract the cut-off factor for each end fitting from the overall length of assembly. All dimensions shown in inches.

SAE 45° Flare Female Swivel 45° Tube Elbow

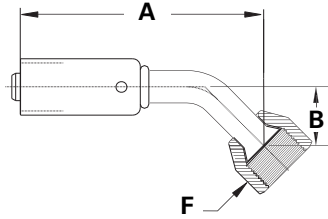

Hose I.D.	Tube Size	Part Number	Thread Size	Length A	Drop B	Hose Cut-Off Factor	Hex F
5/16	3/8	75706E-486	5/8-18	3.42	.55	2.00	3/4
13/32	1/2	75708E-488	3/4-16	3.72	.58	2.50	7/8
1/2	5/8	75710E-490	7/8-14	4.34	.72	3.00	1-1/16
5/8	5/8	75712E-490	7/8-14	5.00	1.00	3.50	1-1/16
5/8	3/4	75712E-492	1-1/16-14	4.44	.72	3.00	1-1/4

SAE 45° Male Rigid 90° Elbow

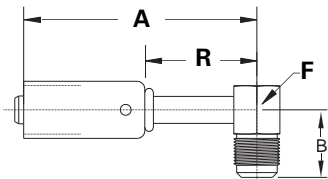

Hose I.D.	Tube Size	Part Number	Thread Size	Length A	Run R	Drop B	Hose Cut-Off Factor	Hex Square F
5/16	3/8	75706E-X06	5/8-18	4.07	2.67	.91	3.00	5/8
13/32	1/2	75708E-X08	3/4-16	4.14	2.74	1.47	3.00	7/8
1/2	5/8	75710E-X10	7/8-14	4.25	2.85	1.47	3.00	7/8
5/8	3/4	75712E-X12	1-1/16-14	4.45	2.95	1.56	3.00	1-1/16

Bumped Tube O-Ring Male Rigid 90° Tube Elbow

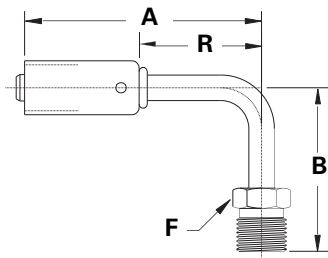

Hose I.D.	Tube Size	Part Number	Thread Size	Length A	Run R	Drop B	Hose Cut-Off Factor	Hex F
5/16	3/8	75706E-W66	5/8-18	4.00	2.60	1.53	2.75	5/8
13/32	1/2	75708E-W68	3/4-16	4.07	2.67	2.12	2.75	3/4
1/2	5/8	75710E-W70	7/8-14	4.15	2.75	2.21	2.88	7/8

Bumped Tube O-Ring Male Swivel 90° Tube Elbow

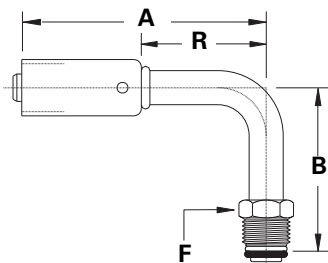

Hose I.D.	Tube Size	Part Number	Thread Size	Length A	Run R	Drop B	Hose Cut-Off Factor	Hex F	O-Ring
5/16	3/8	75706E-Z66	5/8-18	4.00	2.60	1.53	2.75	5/8	ZW74706
5/16	1/2	75706E-Z68	3/4-18	4.07	2.67	1.53	2.75	3/4	ZW74708
13/32	3/8	75708E-Z66	5/8-18	4.00	2.60	1.77	2.75	5/8	ZW74706
13/32	1/2	75708E-Z68	3/4-18	4.07	2.67	2.12	2.75	3/4	ZW74708
1/2	5/8	75710E-Z70	7/8-18	4.15	2.75	2.21	2.88	7/8	ZW74710
1/2	3/4	75710E-Z72	1-1/16-16	4.25	2.85	2.35	3.00	1-1/16	ZW74712
5/8	5/8	75712E-Z70	7/8-18	4.24	2.74	2.25	2.88	7/8	ZW74710
5/8	3/4	75712E-Z72	1-1/16-16	4.35	2.85	2.87	3.00	1-1/16	ZW74712

(Includes o-ring).

Hose Ends - Crimp

To determine the correct length of hose, subtract the cut-off factor for each end fitting from the overall length of assembly. All dimensions shown in inches.

Bumped Tube O-Ring Female Swivel 90° Tube Elbow

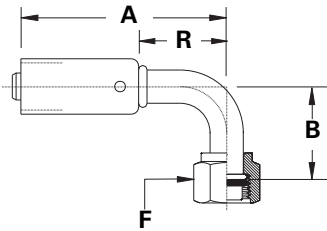

Hose I.D.	Tube Size	Part Number	Thread Size	Length A	Run R	Drop B	Hose Cut-Off Factor	Hex F	O-Ring
5/16	3/8	75706E-Z87	5/8-18	4.07	2.67	1.12	2.75	3/4	ZW74706
5/16	1/2	75706E-Z89	3/4-16	4.14	2.74	1.31	2.88	7/8	ZW74708
13/32	3/8	75708E-Z87	5/8-18	4.07	2.67	1.31	2.75	3/4	ZW74706
13/32	1/2	75708E-Z89	3/4-16	4.14	2.74	1.50	2.88	7/8	ZW74708
1/2	5/8	75710E-Z91	7/8-14	4.25	2.85	1.75	3.00	1-1/16	ZW74710
5/8	5/8	75712E-Z91	7/8-14	4.35	2.85	1.75	3.00	1-1/16	ZW74710
5/8	3/4	75712E-Z93	1-1/16-14	4.45	2.95	1.75	3.13	1-1/4	ZW74712

(Includes O-Ring)

Bumped Tube O-Ring Female Swivel 90° Tube Elbow W/R134a Service Port

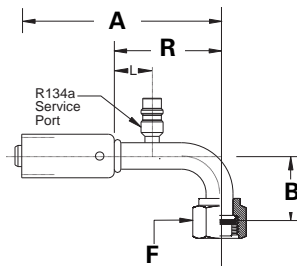

Hose I.D.	Tube Size	Part Number	A	Thread Size	Run R	Drop B	Hose Cut-Off Factor	Hex F	Length L	O-Ring
5/16	3/8	75706E-Z97*	2.52	5/8-18	2.12	1.12	2.75	3/4	1.50	ZW74706
13/32	1/2	75708E-Z99*	4.15	3/4-16	2.75	1.68	2.88	7/8	1.50	ZW74708
1/2	5/8	75710E-Z01**	3.78	7/8-14	2.38	1.50	3.00	1-1/16	1.50	ZW74710
5/8	5/8	75712E-Z01**	4.61	7/8-14	3.11	1.95	3.00	1-1/16	1.50	ZW74710

(Includes o-ring).

(For crimping information refer to document W-HOOV-TM001-E2.)

*High Side Port

**Low Side Port

SAE 45° Flare Female Swivel 90° Tube Elbow

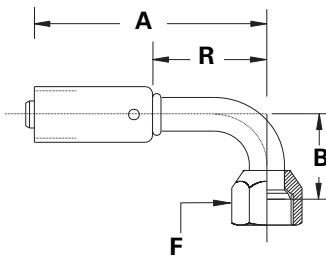

Hose I.D.	Tube Size	Part Number	A	Thread Size	Run R	Drop B	Hose Cut-Off Factor	Hex F
5/16	3/8	75706E-466	4.07	5/8-18	2.67	1.12	2.75	3/4
13/32	1/2	75708E-468	4.14	3/4-16	2.74	1.31	2.88	7/8
1/2	5/8	75710E-470	4.25	7/8-14	2.85	1.56	3.00	1-1/16
5/8	5/8	75712E-470	4.35	7/8-14	2.85	1.50	3.00	1-1/16
5/8	3/4	75712E-472	4.45	1-1/16-14	2.95	1.75	3.13	1-1/4

Bumped Tube O-Ring Service Port Adapter W/R134a Service Port

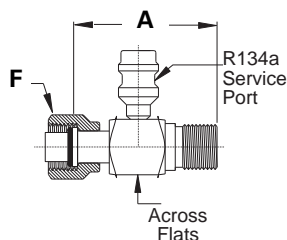

Tube A	Part Number	Thread Size	Length A	Across Flats	Hex F	O-Ring
3/8	75701*	5/8-18	2.02	5/81	3/4	ZW74706
1/2	75702*	3/4-16	2.22	7/8	7/8	ZW74708
5/8	75704**	7/8-14	2.63	7/8	1-1/16	ZW74710
3/4	75706**	1-1/16-14	2.89	1-1/16	1-1/4	ZW74712

(Includes o-ring).

*High Side Port

**Low Side Port

J

Hose Ends - Crimp

Coll-O-Crimp

757 'E' Series

To determine the correct length of hose, subtract the cut-off factor for each end fitting from the overall length of the assembly. All dimensions shown in inches.

Bumped Tube O-Ring Service Port Adapter W/R12 Service Port

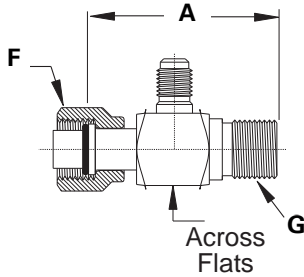

Tube Size	Part Number	Thread Size G	Length A	Across Flats	Hex F	Service Port Thread	O-Ring
3/8	R12-Z56*	5/8-18	2.02	5/81	3/4	3/8-24	ZW74706
1/2	R12-Z58*	3/4-16	2.22	7/8	7/8	3/8-24	ZW74708
5/8	R12-Z60**	7/8-14	2.63	7/8	1-1/16	3/8-24	ZW74710
3/4	R12-Z62**	1-1/16-14	2.89	1-1/16	1-1/4	7/16-20	ZW74712

(Includes o-ring).
*High Side Port
**Low Side Port

90° Bumped Tube O-Ring R134a Service Port Adapter

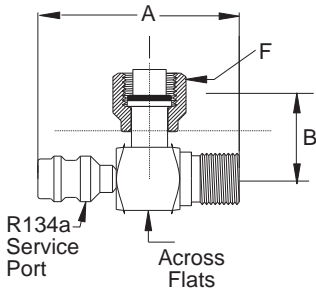

Tube Size	Part Number	Thread Size G	Length A	Drop B	Across Flats	Hex F	O-Ring
3/8	75729*	5/8-18	2.40	1.05	5/8	3/4	ZW74706
1/2	75730*	3/4-16	2.60	1.15	7/8	7/8	ZW74708
5/8	75731**	7/8-14	2.74	1.30	7/8	1-1/16	ZW74710
3/4	75732**	1-1/16-14	3.10	1.39	1-1/16	1-1/4	ZW74712

(Includes o-ring).
*High Side Port
**Low Side Port

90° Bumped Tube O-Ring R12 Service Port Adapter

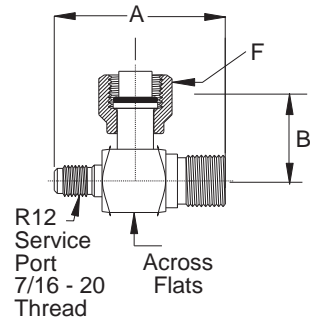

Tube Size	Part Number	Thread Size G	Length A	Drop B	Across Flats	Hex F	O-Ring
3/8	R12-Z96*	5/8-18	2.07	1.05	5/8	3/4	ZW74706
1/2	R12-Z97*	3/4-16	2.27	1.15	7/8	7/8	ZW74708
5/8	R12-Z98**	7/8-14	2.41	1.30	7/8	1-1/16	ZW74710
3/4	R12-Z99**	1-1/16-16	2.77	1.39	1-1/16	1-1/4	ZW74712

(Includes o-ring).
*High Side Port
**Low Side Port

Replacement O-Rings

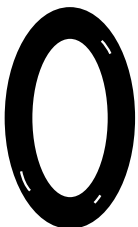

Tube O.D.	Part Number
3/8	ZW74706
1/2	ZW74708
5/8	ZW74710
3/4	ZW74712

Material: Hydrogenated Nitrile (HNBR), 70 Durometer

Temperature Range: -40°F to +250°F (-40°C to +121°C)

Color: Green

Coll-O-Crimp

757 'E' Series

To determine the correct length of hose, subtract the cut-off factor for each end fitting from the overall length of the assembly. All dimensions shown in inches.

Rotalok to MIO

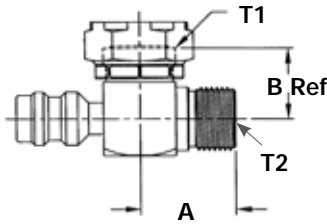

Part Number	Tube Size	Thread Size (T1)	Thread Size (T2)	Drop A	Ref Drop	B Port	Ref
75750	1/2	1-14	3/4-16	1.15	0.84	Hi-Side	—
75751	5/8	1-14	7/8-16	1.29	0.84	Low-Side	—
75760*	Same as 75750, except includes threaded cap for Rotalock end.					—	—
75761*	Same as 75751, except includes threaded cap for Rotalock end.					—	—

* High Side Port

** Low Side Port

Service Instructions for Replacement of Damaged O.E. Hose Assemblies

Weatherhead service port adapters offer an alternative to the high cost of replacement and time out of service which can occur when an air conditioning assembly is damaged. By using the Weatherhead adapter, service personnel can remove the damaged end and replace it with a standard Weatherhead 757 'E' series hose end used in conjunction with a Weatherhead service port adapter. This is a welcome solution to get your customer back on the road without special orders and long delays.

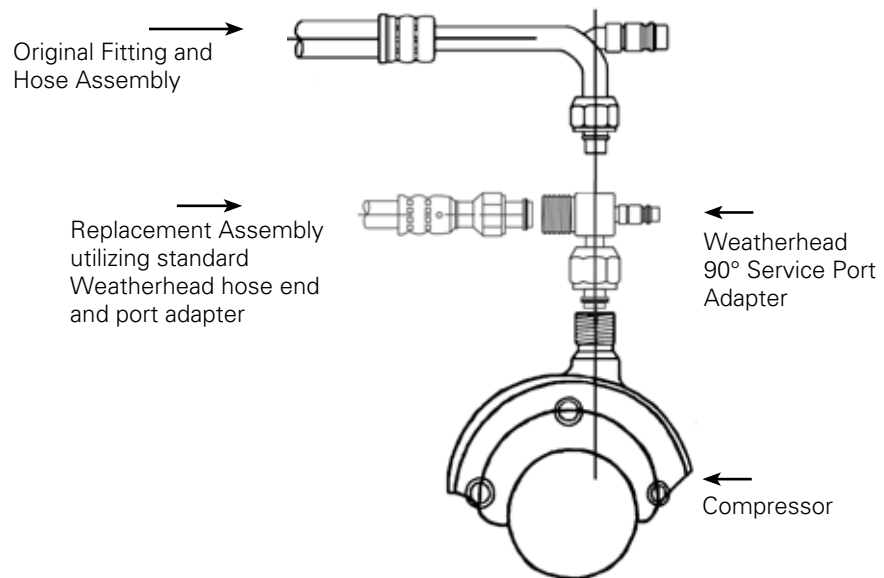

Coll-O-Crimp

057 'P' Series

Hose End 057 'P' Series

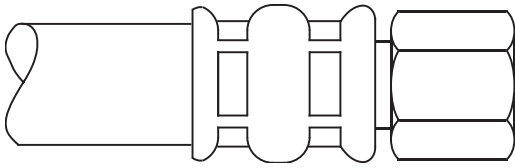

Ordering Information: Order individually by part number.

 Refer to important safety information on pages A-2-3.

Application: High pressure truck hose for use in transmission oil cooler lines, fuel lines and diesel fuel lines.

Compatible Hose: H429

Pressure: Determined by hose burst pressure. See pages A-15-16 for operating pressure ratings for hose end configurations.

Material: CA 360 Brass

Advantages: For use with hot oil and high temperature petroleum oils.

Assemble With: T-400-1, T-410-1, T-420-1, T-440-1, T-460, T-462, T-465-1, T-480, ET4000, ET4001

To determine the correct length of hose, subtract the cut-off factor for each end fitting from the overall length of assembly.

SAE 45° Female Swivel

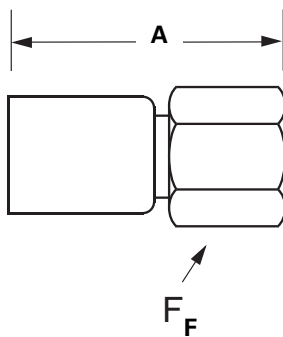

Hose I.D.	Tube Size	Part Number	Thread Size	A	Hose Cut-Off Factor	Hose Dia.	Hex F
1/2	1/2	05708P-408	7/8-14	1.96	.99	.34	7/8
5/8	5/8	05710P-410	3/7-16	1.08	1.10	.44	1

J

Hose Ends - Crimp

Coll-O-Crimp

229 'P' Series

Hose End 229 'P' Series

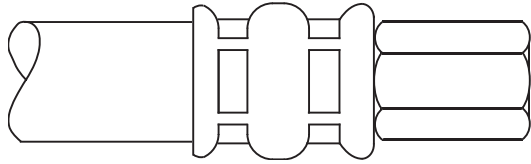

Ordering Information:

Order individually by catalog number.

Refer to important safety information on pages A-2-3.

Application: Medium pressure air, fuel, grease, oil, truck and power steering lines.

Compatible Hose: H059, H229, H239

Pressure: Determined by maximum operating pressure for hose size. See pages A-15-16 for operating pressure ratings for hose end configurations.

Material: CA360 Brass

Advantages: A permanent hose end saves time and is easy to assemble. Brass material offers excellent resistance against corrosion.

Assemble With: T-400-1, T-410-1, T-420-1, T-440-1, T-460, T-462, T-465-1, T-480, ET4000, ET4001

Note: Refer to current price list for availability of cataloged items. Configurations and dimensions subject to change without notice.

SAE 45° Flare Female Swivel

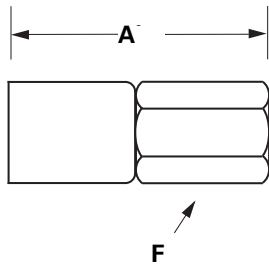

Hose I.D.	Tube Size	Part Number	Thread Size	A	Hose Cut-Off Factor	Hose DIA.	Hex F
5/16	3/8	22906P-406	5/8-18	1.80	.81	.25	3/4
13/32	1/2	22908P-408	3/4-16	1.96	1.00	.34	7/8
1/2	5/8	22910P-410	7/8-14	2.08	1.12	.44	1

Note:
Collar is not attached to insert.

To determine the correct length of hose, subtract the cut-off factor for each end fitting from the overall length of assembly.

Componentry for 229 'P' & 265 'P' Series Hose Ends

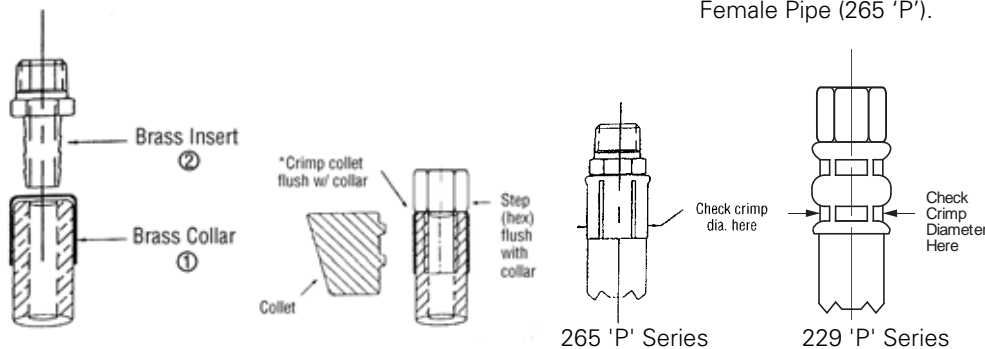

1. Brass Collar

2. Brass Insert.

Female SAE 45° Swivel (229 'P'), Male Pipe or Female Pipe (265 'P').

Assembly Instructions for 229 'P' & 265 'P' Series Hose Ends

1. Push collar onto hose until bottomed.
2. Push insert into hose until step on insert (or hex) is flush with collar.
3. Check for bottoming by checking collar movement along insert. Hose is bottomed when collar cannot slide along insert.
4. Position top of collar so that it is flush with the top of the collet. Follow recommended Coll-O-Crimp operating procedures found in the back of this catalog.

J

Hose Ends - Crimp

Coll-O-Crimp

265 'P' Series

Hose End 265 P Series

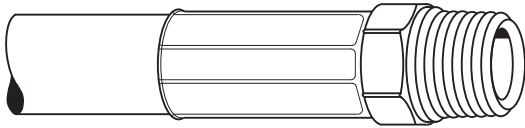

Ordering Information:

Order individually by catalog number. To order replacement collar only, use base number followed by "COO" suffix.
(Example: 26504P-COO)

 Refer to important safety information on pages A-2-3.

Typical Application: General purpose low- pressure air and water lines.

Compatible Hose:

H265, H275, H285

Pressure: Determined by maximum operating pressure for hose size.

Material: CA360 Brass

Advantages: One piece construction, easy to assemble, corrosion resistant.

Assemble With: T-400-1, T-410-1, T-420-1, T-440-1, T-460, T-462, T-465-1, T-480, ET4000, ET4001

Note:

For Assembly Instructions see page J-31.

To determine the correct length of hose, subtract the cut-off factor for each end fitting from the overall length of assembly.

Male Pipe Rigid

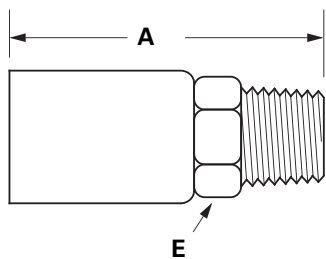

Hose I.D.	Pipe Size	Part Number	Thread Size	A	Hose Cut-Off Factor	Hole Dia.	Hex E
1/4	1/8	26504P-102	1/8-27	1.56	.56	.18	7/16
1/4	1/4	26504P-104	1/4-18	1.63	.63	.18	9/16
1/4	3/8	26504P-106	3/8-18	1.75	.75	.18	11/16
3/8	1/8	26506P-102	1/8-27	1.56	.56	.25	7/16
3/8	1/4	26506P-104	1/4-18	1.75	.75	.31	9/16
3/8	3/8	26506P-106	3/8-18	1.74	.75	.28	11/16
3/8	1/2	26506P-108	1/2-14	1.94	1.00	.28	7/8
1/2	1/4	26508P-104	1/4-18	1.73	.75	.37	9/16
1/2	3/8	26508P-106	3/8-18	1.71	.75	.37	11/16
1/2	1/2	26508P-108	1/2-14	1.94	1.00	.37	7/8
1/2	3/4	26508P-112	3/4-18	1.94	1.00	.37	1-1/8
3/4	1/2	26512P-108	1/2-14	1.94	1.00	.37	1-1/8
3/4	3/4	26512P-112	3/4-14	1.92	1.00	.56	1-1/8

Note:

Collar is not attached to insert.

Female Pipe Rigid

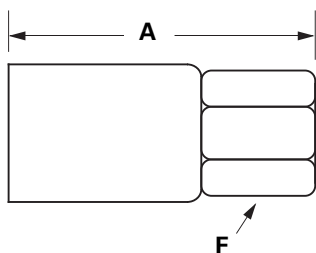

Hose I.D.	Pipe Size	Part Number	Thread Size	A	Hose Cut-Off Factor	Hole Dia.	Hex F
1/4	1/8	26504P-202	1/8-27	1.49	.50	.18	9/16
1/4	1/4	26504P-204	1/4-18	1.60	.63	.18	11/16
3/8	1/8	26506P-202	1/8-27	1.49	.50	.28	9/16
3/8	1/4	26506P-204	1/4-18	1.60	.63	.28	11/16
3/8	3/8	26506P-206	3/8-18	1.66	.69	.28	13/16
1/2	1/4	26508P-204	1/4-18	1.57	.63	.37	11/16
1/2	3/8	26508P-206	3/8-18	1.63	.69	.37	13/16
1/2	1/2	26508P-208	1/2-14	1.85	.88	.37	1

Note:

Collar is not attached to insert.

Coll-O-Crimp

338 'P' Series

Hose End 338 'P' Series

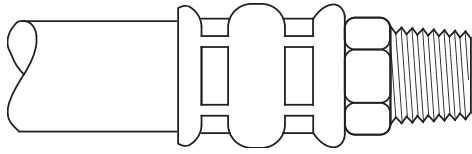

Ordering Information: Order individually by part number.

 Refer to important safety information on pages A-2-3.

Application: Air brake hose lines

Compatible Hose: H338

Pressure: Determined by hose burst pressure. See pages A-15-16 for operating pressure ratings for hose end configurations.

Material: CA360 Brass

Advantages: A permanent hose end saves time and is easy to assemble. Brass material offers excellent resistance against corrosion.

Assemble With: T-400-1, T-410-1, T-420-1, T-440-1, T-460, T-462, T-465, T-480, ET4000 and ET4001
(For Field Attachable Ends refer to Section K.)

Label Set: FS-2900

Note:

See page N-48 for important hose labeling information.

Componentry

1. Brass Collar
2. Brass Insert. Male pipe or brass swivel insert with brass SAE nut.
3. Brass A.B.S. insert with steel A.B.S. swivel nut.

Assembly Instructions

1. Push collar onto hose until bottomed.
2. Push insert into hose until step on insert (or hex) is flush with collar.

Note:

Swivel fittings require the use of a mandrel or an assembled adapter to push on the insert for assembly. Adapter can be removed after fitting assembly. Light lubricant may be required to assemble fitting into hose.

3. Check for bottoming by checking collar movement along insert. Hose is bottomed when collar cannot slide along insert.
4. Depending on Coll-O-Crimp system, follow recommended operating procedures.

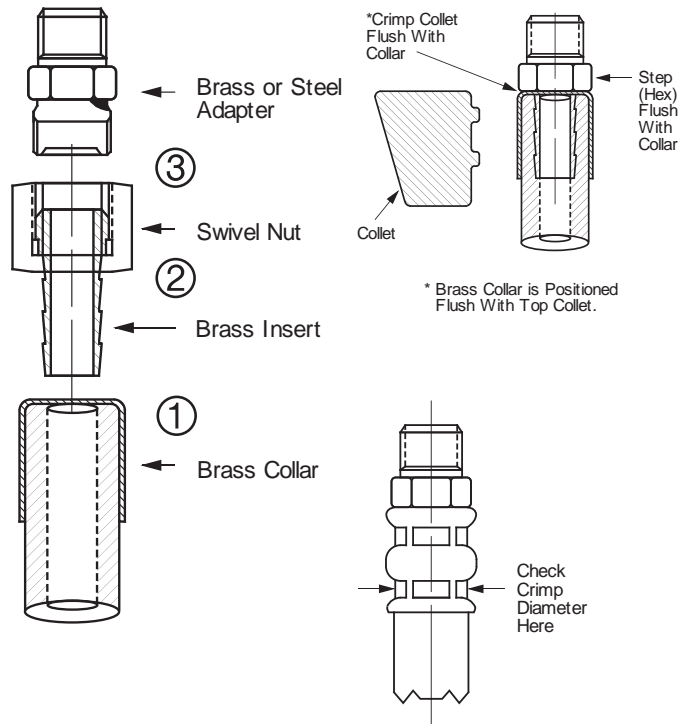

J

Hose Ends - Crimp

Coll-O-Crimp

338 'P' Series

To determine the correct length of hose, subtract the cut-off factor for each end fitting from the overall length of assembly.

Male Pipe Rigid

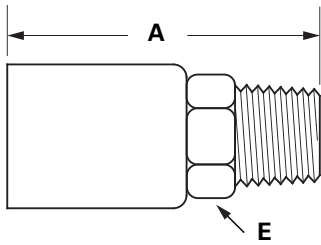

Hose I.D.	Part Size	Catalog Number	Thread Size	A	Hose Cut-Off Factor	Hole Dia.	Hex E
3/8	1/4	33806P-104	1/4-18	1.71	.75	.28	9/16
3/8	3/8	33806P-106	3/8-18	1.72	.81	.28	11/16
3/8	1/2	33806P-108	1/2-14	1.95	1.00	.28	7/8
1/2	3/8	33808P-106	3/8-18	1.73	.81	.38	11/16
1/2	1/2	33808P-108	1/2-14	1.94	1.00	.38	7/8

Male Pipe Swivel

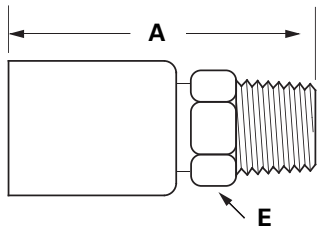

Hose I.D.	Pipe Size	Part Number	Thread Size	A	Hose Cut-Off Factor	Hole Dia.	Hex E
3/8	3/8	33806P-J06	3/8-18	1.66	.81	.28	11/16

Note:
Swivel for installation purposes only.

SAE 45° Female Swivel

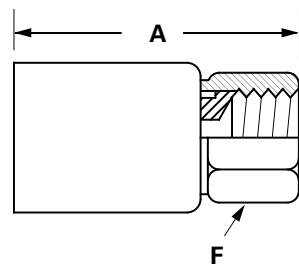

Hose I.D.	Tube Size	Part Number	Thread Size	A	Hose Cut-Off Factor	Hole Dia.	Hex F
3/8	3/8	33806P-406	5/8-18	1.31	1.00	.28	3/4
1/2	1/2	33808P-408	3/4-16	1.36	1.00	.38	7/8

Air Brake Slider Line

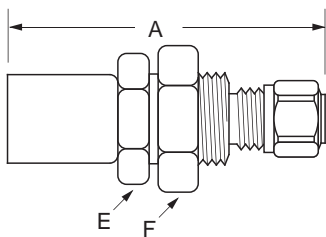

Hose I.D.	Tube Size	Part Number	Thread Size	A	Hose Cut-Off Factor	Hole Dia.	Hex E	Hex F
3/8	3/8	33806P-Y66	17/32-24	2.41	1.00	.28	1-1/16	1-1/8
3/8	1/2	33806P-Y68	11/16-20	2.51	1.00	.28	1-1/16	1-1/8
1/2	1/2	33808P-Y68	11/16-20	2.69	1.28	.41	7/8	13/16

Hose Ends - Crimp

Coll-O-Crimp

338 'P' Series

To determine the correct length of hose, subtract the cut-off factor for each end fitting from the overall length of assembly.

Air Brake Swivel

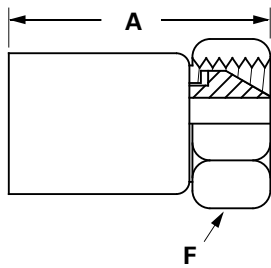

Hose I.D.	ABS Size	Part Number	Thread Size	A	Hose Cut-Off Factor	Hole Dia.	Hex F
3/8	3/8	33806P-Y76	3/4-20	1.38	1.00	.28	7/8
1/2	3/8	33808P-Y76	3/4-20	1.38	1.00	.28	7/8
1/2	1/2	33808P-Y78	7/8-20	1.44	1.00	.38	1

Adapter

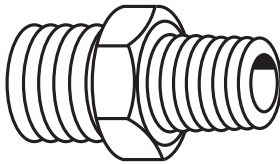

ABS Thread Size	Pipe Size	Part Number	Overall Length	ABS Thread Size
3/8	1/4	1390x6	1.18	3/4-20
3/8	3/8	1390x6x6	1.18	3/4-20
3/8	1/2	1390x6x8	1.37	3/4-20
1/2	3/8	1390x8	1.18	7/8-20
1/2	1/2	1390x8x8	1.37	7/8-20



Coll-O-Crimp

'S' Series

Hose End 'S' Series (Stainless Steel)

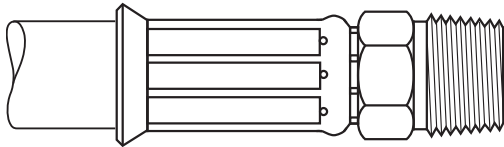

Note:

Refer to current price list for availability of cataloged items. Configurations and dimensions subject to change without notice.

Ordering Information: Order individually by part number.

⚠ Refer to important safety information on pages A-2-3.

Application: Low, medium, and high pressure hydraulic applications calling for corrosion resistance. Marine, logging, mining.

Compatible Hose:

H039, H104, H114, H145, H245, H425

Pressure: Determined by the maximum operating pressure for hose size and hose end configuration, whichever is lesser. See pages A-15-16 for operating pressure ratings for hose end configurations.

Material:

316 Stainless Steel

Advantages: Stainless steel protection from the elements.

Assemble With:

T-400-1, T-410-1, T-420-1, T-440-1, T-460, T-462, T-465-1, T-480, ET4000, ET4001

†To determine the correct length of hose, subtract the cut-off factor for each end fitting from the overall length of assembly.

^a Swivel nuts are universal – both SAE 45° and 37° connections.

Male Pipe Rigid

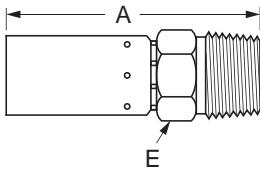

Hose I.D.	Pipe Size	Part Number	Thread Size NPTF	A	Hose Cut-Off Factor	Hole Dia.	Hex E
1/4	1/4	04S-104	1/4-18	2.49	1.00	.16	5/8
3/8	3/8	06S-106	3/8-18	2.52	1.00	.25	3/4
1/2	1/2	08S-108	1/2-14	2.75	1.31	.36	7/8
3/4	3/4	12S-112	3/4-14	3.61	1.44	.61	1-1/8
1	1	16S-116	1-11-1/2	4.23	2.00	.81	1-3/8
1-1/4	1-1/4	*20S-120	1-1/4-11-1/2	4.61	2.31	1.02	1-11/16

*Part number will crimp in Coll-O-Crimp ET4000, T-410-1, T-420-1, T-440-1, and T-480-1 presses only.

JIC 37° Female Swivel (Refer to Footnotes)

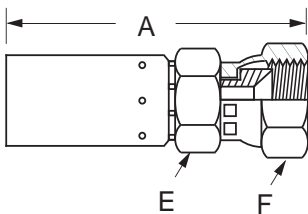

Hose I.D.	Pipe Size	Part Number	Thread Size NPTF	A	Hose Cut-Off Factor	Hole Dia.	Hex E	Hex F
1/4	1/4	04S-604 ^a	7/16-20	2.61	1.13	.16	9/16	9/16
3/8	3/8	06S-606	9/16-18	2.77	1.31	.25	11/16	11/16
1/2	1/2	08S-608 ^a	3/4-16	2.79	1.38	.36	13/16	7/8
1/2	5/8	08S-610 ^a	7/8-14	3.00	1.56	.36	13/16	1
3/4	3/4	12S-612	1-1/16-12	3.86	1.69	.61	1	1-1/4
1	1	16S-616	1-5/16-12	4.46	2.25	.81	1-1/4	1-1/2
1-1/4	1-1/4	*20S-620	1-5/8-12	4.90	2.63	1.02	1-11/16	2

*Part number will crimp in Coll-O-Crimp ET4000, T-410-1, T-420-1, T-440-1, and T-480-1 presses only.

Coll-O-Crimp

'U' Series

U Series Part Description	Part Number Example	Page Number
General Information		J-38
Male Pipe Rigid	04U-104	J-38
British Standard Tapered Male Pipe (BSPT/JIS) Rigid	06U-156	J-39
British Standard 60° (BSPP) Cone Male Pipe Rigid	06U-P56	J-39
Male DIN 24° Seat (Light)	04U-08A	J-39
Male DIN 24° Seat (Heavy)	08U-16F	J-40
Male Pipe Swivel	06U-J06	J-40
FOR-SEAL Male Rigid	06U-E70	J-40
JIC/37° Male Rigid	06U-506	J-41
SAE 45° Female Swivel	06U-306	J-41
Inverted Male Swivel Straight	04U-B03	J-41
Flareless Tube Rigid Ermeto 7000 Series	06U-754	J-42
Male Straight Thread O-ring Swivel	06U-R04	J-42
Male Straight Thread O-ring Rigid	08U-P12	J-43
Female Grease Tap	04U-C34	J-43
Female Pipe Rigid	06U-206	J-43
Female Pipe Swivel	06U-256	J-44
JIC/37° Female Swivel	04U-606	J-44
Female Straight Pipe Swivel (NPSM)	04U-054	J-44
SAE 45° Female Swivel	06U-406	J-45
Female Swivel DIN Universal Seat (Light)	04U-08C	J-45
Female Swivel DIN 24° Seat (Heavy)	06U-64C	J-45
Female Swivel 30° Flare	08U-22K	J-45
British Standard (BSPP) 60° Cone Female Pipe Swivel	08U-360	J-46
Female JIS 30° Flare Parallel Pipe Swivel	16U-16L	J-46
Female FOR-SEAL® Swivel Straight	12U-S72	J-46
BSPP Flat Face Female Swivel	08U-12P	J-47
READY-LOK® Male Connector	04U-04S	J-47
Split Flange Straight (SAE Code 61)	12U-G12	J-47
Metric Split Flange Straight (Komatsu, Linkbelt, etc.)	10U-G09	J-47
Banjo	06U-L06	J-48
Metric Standpipe Straight Tube	06U-44T	J-48
Standpipe Straight Tube	06U-T06	J-48
SAE 37° Female Swivel 30° Tube Elbow	10U-L22	J-48
Inverted Male Swivel 45° Tube Elbow	04U-B43	J-49
SAE 37° Female Swivel 45° Tube Elbow	06U-486	J-49
Female Swivel DIN Universal Seat 45° Tube Elbow	04U-08D	J-49
Flareless 45° Tube Elbow 7000 Ermeto Series	06U-956	J-49
JIC 37° Female Swivel 45° Tube Elbow	06U-686	J-50
Male Swivel 45° Tube Elbow O-ring Port	08U-L50	J-50
Split Flange 45° Tube Elbow (SAE Code 61)	08U-G41	J-50
British Standard (BSPP) 60° Cone Female 45° Tube Elbow	08U-48P	J-51
Female FOR-SEAL® Swivel 45° Tube Elbow	06U-L68	J-51
Metric Split Flange 45° Tube Elbow (Komatsu, Linkbelt, etc.)	10U-G69	J-51
Inverted Male Swivel 90° Tube Elbow	04U-B63	J-51
SAE 37° Male Rigid 90° Elbow	06U-X60	J-52
Male Pipe Swivel 90° Elbow	08U-M08	J-52
JIC/37° Female Swivel 90° Long Drop Tube Elbow	04U-644	J-52
SAE 45° Female Swivel Long Drop 90° Tube Elbow	06U-446	J-52
Flareless 90° Tube Elbow 7000 Ermeto Series	06U-976	J-53
JIC/37° Female Swivel 90° Tube Elbow	04U-666	J-53
Female Swivel DIN Universal Seat 90° Tube Elbow (Light)	08U-65D	J-53
Female Swivel DIN 24° Seat 90° Tube Elbow	08U-66E	J-53
British Standard (BSPP) 60° Cone Female Pipe Swivel 90° Tube Elbow	08U-78P	J-54
Female FOR-SEAL® Swivel Short Drop 90° Elbow	06U-A28	J-54
Female FOR-SEAL® Swivel Medium Drop 90° Tube Elbow	06U-J38	J-54
JIC 37° Female Swivel 90° Elbow	04U-554	J-55
Male Straight Thread O-ring Swivel 90° Elbow	08U-R68	J-55
Female FOR-SEAL® Swivel Long Drop 90° Tube Elbow	06U-A68	J-55
Split Flange 90° Tube Elbow (SAE Code 61)	08U-G71	J-55

Coll-O-Crimp

'U' Series

To determine the correct length of hose, subtract the cut-off factor for each end fitting from the overall length of assembly.

Hose End 'U' Series

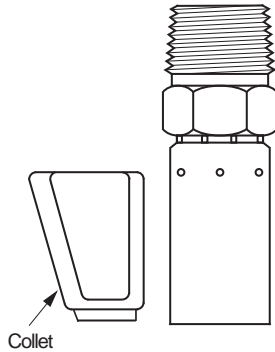
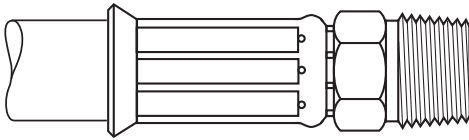

Note:

Refer to current price list for availability of cataloged items. Configurations and dimensions subject to change without notice.

Ordering Information: Order individually by part number. O-rings not supplied with flange hose ends. Order o-rings by catalog number; reference individual listings for details. For split flange kits, refer to pages L-89-92.

 Refer to important safety information on pages A-2-3.

Application: General purpose low, medium, and high pressure hydraulic.

Compatible Hose: H017, H039, H104, H114, H115, H145, H146, H245, H324, H325, H350, H425, H545, H900, H1812, H0105, H0106, H116, H1981, H1982, H9949, H1776, H1777, H1571, H6002 (-8 & -20)

Pressure: Determined by maximum operating pressure for hose size and hose end configuration whichever is lesser. See pages A-15-16 for operating pressure ratings for hose end configurations.

Material: Low Carbon Steel

Plating: Zinc; Clear Trivalent Chromate

Advantages: Wide selection of hose and end configurations allowing a diverse number of applications. An ideal series to introduce hydraulics.

Assemble With: T-400-1, T-410-1, T-420-1, T-440, T-460, T-462, T-465, T-480, ET1000, ET4000, and ET4001.

Label Set: FS-1100

Male Pipe Rigid

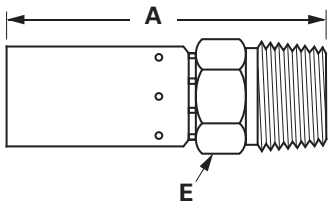

Hose I.D.	Pipe Size	Part Number	Thread Size	A	Hose Cut-Off Factor	Hole Dia.	Hex E
1/4	1/8	04U-102	1/8-27	2.31	.75	.16	9/16
1/4	1/4	04U-104	1/4-18	2.49	.94	.16	9/16
1/4	3/8	04U-106	3/8-18	2.52	1.00	.16	11/16
1/4	1/2	04U-108	1/2-14	2.77	1.06	.16	7/8
3/8	1/4	06U-104	1/4-18	2.52	1.00	.25	11/16
3/8	3/8	06U-106	3/8-18	2.52	1.00	.25	11/16
3/8	1/2	06U-108	1/2-14	2.77	1.25	.25	7/8
1/2	1/4	08U-104	1/4-18	2.56	.88	.28	13/16
1/2	3/8	08U-106	3/8-18	2.57	1.14	.36	3/4
1/2	1/2	08U-108	1/2-14	2.75	1.31	.36	13/16
1/2	3/4	08U-112	3/4-14	2.83	1.28	.36	1-1/16
5/8	3/8	10U-106	3/8-18	3.12	1.13	.48	15/16
5/8	1/2	10U-108	1/2-14	3.31	1.38	.48	15/16
5/8	3/4	10U-112	3/4-14	3.31	1.30	.48	1-1/16
3/4	1/2	12U-108	1/2-14	3.62	1.44	.61	1
3/4	3/4	12U-112	3/4-14	3.61	1.44	.61	1-1/16
3/4	1	12U-116	1-11-1/2	3.84	1.69	.61	1-3/8
1	3/4	16U-112	3/4-14	4.23	1.88	.81	1-1/4
1	1	16U-116	1-11-1/2	3.90	1.69	.81	1-3/8
1-1/4	1-1/4	20U-120	1-1/4-11-1/2	4.61	2.31	1.02	1-11/16

British Standard Tapered Male Pipe (BSPT/JIS) Rigid

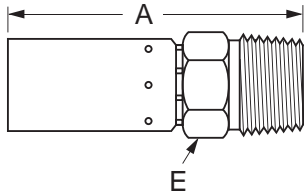

Hose I.D.	BSPT Pipe Size	Part Number	Thread Size	A	Hose Cut-Off Factor	Hole Dia.	Hex E
1/4	1/4	04U-154	R-1/4-19*	2.51	1.00	.16	3/4
3/8	3/8	06U-156	R-3/8-19*	2.54	1.06	.25	11/16
1/2	1/2	08U-158	R-1/2-14*	2.78	1.31	.36	7/8
3/4	3/4	12U-162	R-3/4-14*	3.62	1.44	.61	1-1/8
1	1	16U-166	R-1-11*	4.23	2.00	.81	1-3/8

*R as part of thread size is ISO designation for tapered thread.

British Standard 60° (BSPP) Cone Male Pipe Rigid

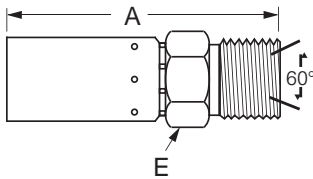

Hose I.D.	BSPT Pipe Size	Part Number	Thread Size	A	Hose Cut-Off Factor	Hole Dia.	Hex E
1/4	1/4	04U-P54	G-1/4-19**	2.38	.88	.16	11/16
3/8	3/8	06U-P56	G-3/8-19**	2.48	.94	.25	3/4
3/8	1/2	06U-P58	G-1/2-14**	2.62	1.06	.25	1
1/2	3/8	08U-P56	G-3/8-19**	2.54	1.13	.32	13/16
1/2	1/2	08U-P58	G-1/2-14**	2.62	1.19	.36	1
5/8	5/8	10U-P60	G-5/8-14**	3.25	1.31	.48	1-1/8
3/4	3/4	12U-P62	G-3/4-14**	3.65	1.50	.61	1-1/8
1	1	16U-P66	G-1-11**	3.91	1.69	.81	1-3/8
1-1/4	1-1/4	20U-P67	G-1-1/4-11**	4.41	2.13	1.02	1-3/4

**G as part of thread size is ISO designation for parallel thread.

Male DIN 24° Seat

I. Rh. (Light)

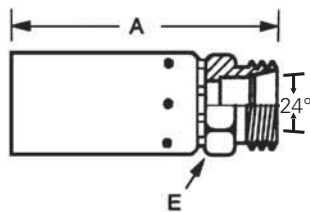

Hose I.D.	Tube Size (mm)	Part Number	Thread Size	A	Hose Cut-Off Factor	Hole Dia.	Hex E
1/4	8	04U-08A	M14x1.5	2.27	.81	.16	9/16
1/4	10	04U-10A	M16x1.5	2.36	.88	.16	11/16
3/8	10	06U-10A	M16x1.5	2.36	.94	.25	11/16
3/8	12	06U-12A	M18x1.5	2.36	.94	.25	3/4
1/2	15	08U-15A	M22x1.5	2.42	1.00	.36	7/8
5/8	18	10U-18A	M26x1.5	2.99	1.06	.48	1-1/16
3/4	22	12U-22A	M30x2.0	3.45	1.31	.61	1-1/4
1	28	16U-28A	M36x2.0	3.73	1.50	.81	1-1/2

Coll-O-Crimp

'U' Series

To determine the correct length of hose, subtract the cut-off factor for each end fitting from the overall length of assembly.

Male DIN 24° Seat

s. Rh. (Heavy)

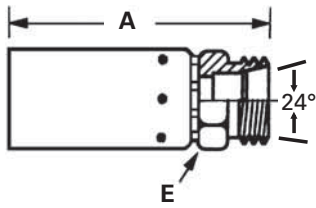

Hose I.D.	Tube Size (mm)	Part Number	Thread Size	A	Hose Cut-Off Factor	Hole Dia.	Hex E
1/4	8	04U-08F	M16x1.5	2.39	.88	.16	11/16
1/4	10	04U-10F	M18x1.5	2.40	.88	.16	3/4
3/8	10	06U-10F	M18x1.5	2.40	.94	.25	3/4
3/8	12	06U-12F	M20x1.5	2.42	1.00	.25	13/16
3/8	14	06U-14F	M22x1.5	2.50	1.06	.25	7/8
1/2	16	08U-16F	M24x1.5	2.57	1.13	.36	1
5/8	20	10U-20F	M30x2	3.21	1.28	.48	1-1/4
3/4	20	12U-20F	M30x2	3.53	1.38	.61	1-1/4
3/4	25	12U-25F	M36x2	3.71	1.56	.61	1-1/2
1	30	16U-30F	M42x2	3.98	1.75	.81	1-11/16

Male Pipe Swivel

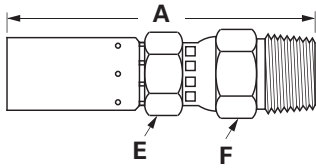

Hose I.D.	Tube Size (mm)	Part Number	Thread Size	A	Hose Cut-Off Factor	Hole Dia.	Hex E	Hex F
1/4	1/4	04U-J04	1/4-18	3.38	1.88	.16	5/8	13/16
3/8	1/4	06U-J04	1/4-18	3.40	1.94	.25	11/16	13/16
3/8	3/8	06U-J06	3/8-18	3.38	1.94	.25	11/16	7/8
3/8	1/2	06U-J08	1/2-14	3.60	2.13	.25	3/4	7/8
1/2	3/8	08U-J06	3/8-18	3.45	2.00	.36	13/16	7/8
1/2	1/2	08U-J08	1/2-14	3.60	2.19	.36	13/16	7/8
3/4	3/4	12U-J12	3/4-14	4.73	2.56	.61	1	1-1/4
1	1	16U-J16	1-11-1/2	4.83	2.63	.80	1-1/4	1-3/8

Note:

Swivel for installation purposes only. (Not for temperatures above 212°F.)

FOR-SEAL Male Rigid

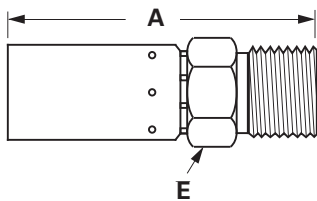

Hose I.D.	Tube Size	Part Number	Thread Size	O-Ring	A	Hose Cut-Off Factor	Hole Dia.	Hex E
1/4	1/4	04U-E64	9/16-18	4629x4	2.34	.88	.16	5/8
3/8	3/8	06U-E66	11/16-16	4629x6	2.43	1.00	.25	13/16
3/8	1/2	06U-E68	13/16-16	4629x8	2.54	1.13	.38	7/8
3/8	5/8	06U-E70	1-14	4629x10	2.70	1.27	.25	1-1/16
1/2	1/2	08U-E68	13/16-16	4629x8	2.54	1.13	.36	7/8
1/2	5/8	08U-E70	1-14	4629x10	2.78	1.35	.36	1-1/16
1/2	3/4	08U-E72	1-3/16-12	4629x12	2.76	1.31	.36	1-1/4
5/8	5/8	10U-E70	1-14	4629x10	3.20	1.25	.48	1-1/16
5/8	3/4	10U-E72	1-3/16-12	4629x12	3.45	1.50	.48	1-1/4
3/4	3/4	12U-E72	1-3/16-12	4629x12	3.58	1.44	.61	1-1/4
3/4	1	12U-E76	1-7/16-12	4629x16	3.60	1.44	.61	1-1/2
1	1	16U-E76	1-7/16-12	4629x16	3.73	1.50	.81	1-1/2
1-1/4	1-1/4	20U-E80	1-11/16-12	4629x20	4.10	1.81	1.02	1-3/4

Does not include o-ring. See page L-34 for o-rings.

Hose Ends - Crimp

Coll-O-Crimp

'U' Series

To determine the correct length of hose, subtract the cut-off factor for each end fitting from the overall length of assembly.

JIC 37° Male Rigid

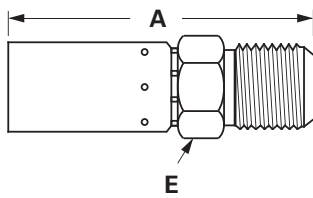

Hose I.D.	Tube Size	Part Number	Thread Size	A	Hose Cut-Off Factor	Hole Dia.	Hex E
1/4	1/4	04U-504	7/16-20	2.48	1.00	.16	1/2
1/4	5/16	04U-505	1/2-20	2.51	1.00	.16	9/16
1/4	3/8	04U-506	9/16-18	2.55	1.00	.16	5/8
3/8	3/8	06U-506	9/16-18	2.54	1.00	.25	11/16
3/8	1/2	06U-508	3/4-16	2.67	1.25	.25	13/16
3/8	5/8	06U-510	7/8-14	2.83	1.31	.25	15/16
1/2	1/2	08U-508	3/4-16	2.70	1.19	.38	13/16
1/2	5/8	08U-510	7/8-14	2.83	1.31	.36	15/16
1/2	3/4	08U-512	1-1/16-12	2.87	1.44	.36	1-1/8
5/8	1/2	10U-508	3/4-16	3.22	1.31	.39	15/16
5/8	5/8	10U-510	7/8-14	3.32	1.38	.48	15/16
5/8	3/4	10U-512	1-1/16-12	3.42	1.44	.48	1-1/8
3/4	5/8	12U-510	7/8-14	3.64	1.44	.43	1
3/4	3/4	12U-512	1-1/16-12	3.74	1.56	.61	1-1/16
3/4	7/8	12U-514	1-3/16-12	3.81	1.63	.61	1-1/4
3/4	1	12U-516	1-5/16-12	3.81	1.63	.61	1-3/8
1	7/8	16U-514	1-3/16-12	4.18	1.94	.72	1-1/4
1	1	16U-516	1-5/16-12	4.20	2.00	.81	1-3/8
1	1-1/4	16U-520	1-5/8-12	4.02	1.81	.81	1-11/16
1-1/4	1-1/4	20U-520	1-5/8-12	4.60	2.31	1.02	1-11/16

SAE 45° Flare Male Rigid

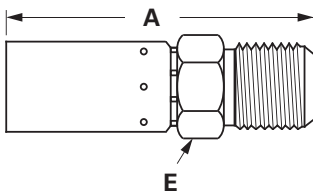

Hose I.D.	Tube Size	Part Number	Thread Size	A	Hose Cut-Off Factor	Hole Dia.	Hex E
3/8	3/8	06U-306	5/8-18	2.60	1.13	.28	11/16
3/4	3/4	12U-312	1-1/16-14	3.87	1.69	.61	1-1/8

Inverted Male Swivel Straight

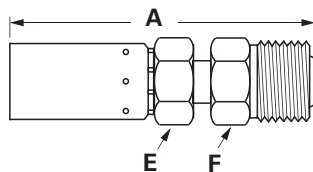

Hose I.D.	Tube Size	Part Number	Thread Size	A	Hose Cut-Off Factor	Hole Dia.	Hex E	Hex F
1/4	3/16	04U-B03	3/8-24	3.75	2.25	.12	9/16	3/8
1/4	1/4	04U-B04	7/16-24	3.14	1.69	.16	9/16	7/16
1/4	5/16	04U-B05	1/2-20	3.13	1.63	.21	9/16	1/2
3/8	1/4	06U-B04	7/16-24	3.13	1.69	.16	11/16	7/16
3/8	5/16	06U-B05	1/2-20	3.16	1.75	.21	11/16	1/2
3/8	3/8	06U-B06	5/8-18	3.33	1.94	.24	11/16	5/8
3/8	7/16	06U-B07	11/16-18	3.33	1.94	.24	11/16	11/16
1/2	1/2	08U-B08	3/4-18	3.69	2.25	.33	13/16	3/4
1/2	5/8	08U-B10	7/8-18	3.43	2.00	.33	13/16	7/8



Hose Ends - Crimp

To determine the correct length of hose, subtract the cut-off factor for each end fitting from the overall length of assembly.

Flareless Tube Rigid Ermeto 7000 Series (With Nut and Sleeve)

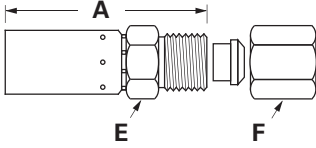

Hose I.D.	Tube Size	Part Number	Thread Size	A	Hose Cut-Off Factor	Hole Dia.	Hex E	Hex F
1/4	1/4	04U-754	7/16-20	2.38	.94	.16	9/16	9/16
1/4	5/16	04U-755	1/2-20	2.41	.93	.16	11/16	5/8
3/8	1/4	06U-754	7/16-20	2.40	1.00	.20	11/16	9/16
3/8	5/16	06U-755	1/2-20	2.40	1.00	.23	11/16	5/8
3/8	3/8	06U-756	9/16-18	2.42	1.00	.25	11/16	11/16
1/2	1/2	08U-758	3/4-16	2.51	1.13	.36	13/16	7/8
1/2	5/8	08U-760	7/8-14	2.64	1.25	.36	15/16	1
3/4	3/4	12U-762	1-1/16-12	3.55	1.38	.61	1-1/8	1-1/4
1	1	16U-766	1-5/16-12	3.98	1.75	.81	1-3/8	1-1/2
1-1/4	1-1/4	20U-770	1-5/8-12	4.35	2.00	1.02	1-11/16	2

(For replacement ermeto nuts and sleeves, see page L-80.)

Male Straight Thread O-Ring Swivel

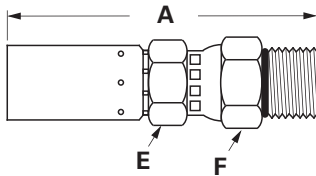

Hose I.D.	Port Size	Part Number	Thread Size	A	Hose Cut-Off Factor	Hole Dia.	Hex E	Hex F
1/4	1/4	04U-R04	7/16-20	3.33	1.81	.16	5/8	13/16
3/8	3/8	06U-R06	9/16-18	3.29	1.86	.25	11/16	7/8
3/8	1/2	06U-R08	3/4-16	3.25	1.75	.25	11/16	7/8
1/2	1/2	08U-R08	3/4-16	3.27	1.81	.36	13/16	7/8
1/2	5/8	08U-R10	7/8-14	3.41	2.00	.36	13/16	1-1/8
1/2	3/4	08U-R12	1-1/16-12	3.57	2.06	.36	13/16	1-1/4
5/8	1/2	10U-R08	3/4-16	3.96	1.88	.42	15/16	1-1/8
3/4	5/8	12U-R10	7/8-14	4.23	2.06	.50	1	1-1/8

(Includes o-ring. for replacement o-ring, see page L-64.)

Note:

Swivel for installation purposes only. (Not for temperatures above 212°F.)

Male Straight Thread O-Ring Rigid

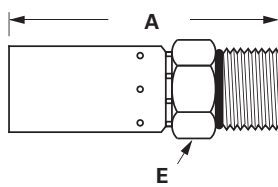

Hose I.D.	Port Size	Part Number	Thread Size	A	Hose Cut-Off Factor	Hole Dia.	Hex E
1/4	1/4	04U-P04	7/16-20	2.29	.81	.16	9/16
1/4	5/16	04U-P05	1/2-20	2.32	.88	.16	5/8
1/4	3/8	04U-P06	9/16-18	2.35	.88	.16	11/16
3/8	3/8	06U-P06	9/16-18	2.35	.94	.25	11/16
3/8	1/2	06U-P08	3/4-16	2.46	1.06	.25	7/8
3/8	5/8	06U-P10	7/8-14	2.57	1.13	.25	1
1/2	1/2	08U-P08	3/4-16	2.46	1.06	.36	7/8
1/2	5/8	08U-P10	7/8-14	2.55	1.13	.36	1
1/2	3/4	08U-P12	1-1/16-12	2.66	1.25	.36	1-1/4
5/8	1/2	10U-P08	3/4-16	3.00	1.13	.48	15/16
5/8	5/8	10U-P10	7/8-14	3.06	1.13	.48	1
5/8	3/4	10U-P12	1-1/16-12	3.15	1.25	.48	1-1/4
3/4	5/8	12U-P10	7/8-14	3.36	1.19	.50	1
3/4	3/4	12U-P12	1-1/16-12	3.49	1.31	.61	1-1/4
3/4	1	12U-P16	1-5/16-12	3.50	1.31	.61	1-1/2
1	1	16U-P16	1-5/16-12	3.63	1.44	.81	1-1/2
1-1/4	1-1/4	20U-P20	1-5/8-12	4.23	1.94	1.02	1-7/8

(Includes O-ring. For replacement O-ring, see page L-64.)

Female Grease Tap

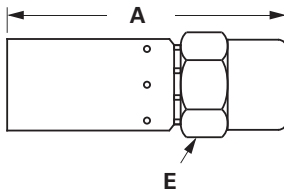

Hose I.D.	Part Number	Thread Size	A	Cut-Off Factor	Hose Hole Dia.	Hex E
1/4	04U-C34	.511-27	2.45	.90	.16	3/4
3/8	06U-C36	.511-27	2.44	.90	.25	3/4

Female Pipe Rigid

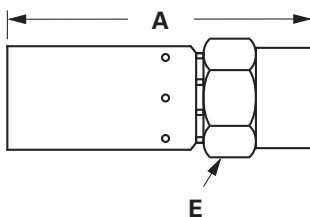

Hose I.D.	Pipe Size	Part Number	Thread Size	A	Hose Cut-Off Factor	Hole Dia.	Hex E
1/4	1/8	04U-202	1/8-27	2.20	.75	.16	5/8
1/4	1/4	04U-204	1/4-18	2.43	.94	.16	3/4
3/8	1/4	06U-204	1/4-18	2.46	1.06	.25	3/4
3/8	3/8	06U-206	3/8-18	2.57	1.13	.25	7/8
1/2	1/2	08U-208	1/2-14	2.82	1.38	.36	1-1/8
3/4	3/4	12U-212	3/4-14	3.71	1.56	.61	1-3/8

To determine the correct length of hose, subtract the cut-off factor for each end fitting from the overall length of assembly.

^a Swivel nuts are universal – both SAE 37° and 45° connections.

Female Pipe Swivel

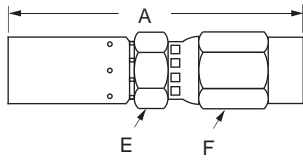

Hose I.D.	Pipe Size	Part Number	Thread Size	A	Hose Cut-Off Factor	Hole Dia.	Hex E	Hex F
1/4	1/4	04U-254	1/4-18	3.52	2.06	.20	5/8	13/16
3/8	3/8	06U-256	3/8-18	3.61	2.19	.32	11/16	7/8
1/2	1/2	08U-258	1/2-14	3.85	2.38	.43	13/16	1-1/8
3/4	3/4	12U-262	3/4-14	4.81	2.63	.61	1	1-3/8
1	1	16U-266	1-11-1/2	5.26	3.06	.80	1-1/4	1-5/8

Note:

Swivel for installation purposes only.
(Not for temperatures above 212°F.)

JIC 37° Female Swivel

(Exceptions Noted)

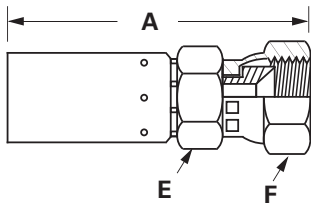

Hose I.D.	Pipe Size	Part Number	Thread Size	A	Hose Cut-Off Factor	Hole Dia.	Hex E	Hex F
1/4	1/4	04U-604 ^a	7/16-20	2.61	1.13	.16	9/16	9/16
1/4	5/16	04U-605 ^a	1/2-20	2.67	1.18	.16	9/16	5/8
1/4	3/8	04U-606	9/16-18	2.72	1.25	.16	9/16	11/16
3/8	1/4	06U-604 ^a	7/16-20	2.66	1.25	.16	11/16	9/16
3/8	3/8	06U-606	9/16-18	2.77	1.31	.25	11/16	11/16
3/8	1/2	06U-608 ^a	3/4-16	2.86	1.44	.25	11/16	7/8
3/8	5/8	06U-610 ^a	7/8-14	3.00	1.56	.25	7/8	1
3/8	3/4	06U-612	1-1/16-12	3.15	1.69	.25	1	1-1/4
1/2	3/8	08U-606	9/16-18	2.68	1.25	.30	13/16	11/16
1/2	1/2	08U-608 ^a	3/4-16	2.79	1.38	.36	13/16	7/8
1/2	5/8	08U-610 ^a	7/8-14	3.00	1.56	.36	13/16	1
1/2	3/4	08U-612	1-1/16-12	3.12	1.44	.36	1	1-1/4
1/2	1	08U-616	1-5/16-12	3.17	1.75	.36	1-1/4	1-1/2
5/8	1/2	10U-608 ^a	3/4-16	3.48	1.56	.39	15/16	7/8
5/8	5/8	10U-610 ^a	7/8-14	3.53	1.63	.48	15/16	1
5/8	3/4	10U-612	1-1/16-12	3.64	1.75	.48	1	1-1/4
3/4	5/8	12U-610 ^a	7/8-14	3.75	1.56	.48	1	1
3/4	3/4	12U-612	1-1/16-12	3.86	1.69	.61	1	1-1/4
3/4	7/8	12U-614	1-3/16-12	3.88	1.69	.61	1-1/8	1-3/8
3/4	1	12U-616	1-5/16-12	4.07	1.88	.61	1-1/4	1-1/2
1	3/4	16U-612	1-1/16-12	4.37	2.13	.61	1-1/4	1-1/4
1	7/8	16U-614	1-3/16-12	4.35	2.13	.72	1-1/4	1-3/8
1	1	16U-616	1-5/16-12	4.46	2.25	.81	1-1/4	1-1/2
1	1-1/4	16U-620	1-5/8-12	4.30	2.19	.81	1-5/8	2
1-1/4	1-1/4	20U-620	1-5/8-12	4.90	2.63	1.02	1-11/16	2

^a Swivel nuts are universal – both SAE 37° and 45° connections.

Female Straight Pipe Swivel (NPSM)

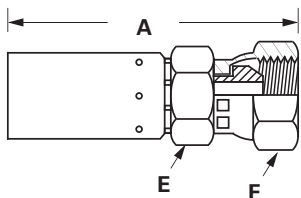

Hose I.D.	Pipe Size	Part Number	Thread Size	A	Hose Cut-Off Factor	Hole Dia.	Hex E	Hex F
1/4	1/4	04U-054	1/4-18	2.55	1.06	.16	1/2	11/16
3/8	3/8	06U-056	3/8-18	2.65	1.19	.27	11/16	7/8
1/2	1/2	08U-058	1/2-14	2.85	1.44	.36	13/16	1
3/4	3/4	12U-062	3/4-14	3.77	1.63	.61	1	1-1/4
1	1	16U-066	1-11-1/2	4.34	2.13	.81	1-1/4	1-1/2
1-1/4	1-1/4	20U-070	1-1/4-11-1/2	4.76	2.44	1.08	1-11/16	1-7/8

(Connects to male pipe fitting with internal seat.)

Coll-O-Crimp

'U' Series

To determine the correct length of hose, subtract the cut-off factor for each end fitting from the overall length of assembly.

SAE 45° Female Swivel

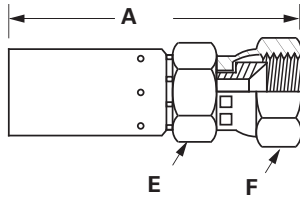

Hose I.D.	Tube Size	Part Number	Thread Size	A	Hose Cut-Off Factor	Hole Dia.	Hex E	Hex F
3/8	3/8	06U-406	5/8-18	2.68	1.25	.25	11/16	3/4
3/4	3/4	12U-412	1-1/16-14	3.86	1.69	.61	1	1-1/4

Female Swivel DIN Universal Seat

I. Rh. (Light)

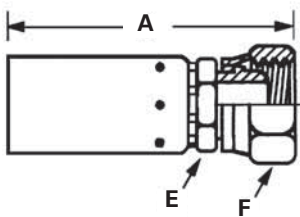

Hose I.D.	Tube Size (mm)	Part Number	Thread Size	A	Hose Cut-Off Factor	Hole Dia.	Hex E	Hex F
1/4	6	04U-06C	M12x1.5	2.73	1.25	.16	9/16	11/16
1/4	8	04U-08C	M14x1.5	2.76	1.25	.16	9/16	11/16
1/4	10	04U-10C	M16x1.5	2.82	1.38	.16	9/16	3/4
3/8	10	06U-10C	M16x1.5	2.78	1.38	.25	11/16	3/4
3/8	12	06U-12C	M18x1.5	2.93	1.50	.25	11/16	7/8
1/2	15	08U-15C	M22x1.5	2.98	1.56	.36	13/16	1-1/16
5/8	18	10U-18C	M26x1.5	3.61	1.69	.48	15/16	1-1/4
3/4	22	12U-22C	M30x2.0	4.03	1.88	.61	1-1/8	1-7/16
1	28	16U-28C	M36x2.0	4.47	2.25	.78	1-1/4	1-5/8
1-1/4	35	20U-35C	M45x2.0	4.61	2.25	1.02	1-3/4	2-1/8

Female Swivel DIN 24° Seat

s. Rh. DKO (Heavy)

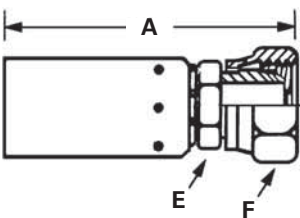

Hose I.D.	Tube Size (mm)	Part Number	Thread Size	A	Hose Cut-Off Factor	Hole Dia.	Hex E	Hex F
1/4	8	04U-58C	M16x1.5	2.88	1.40	.16	9/16	3/4
1/4	10	04U-60C	M18x1.5	2.78	1.31	.16	5/8	7/8
1/4	12	04U-62C	M20x1.5	2.67	1.19	.16	3/4	1
3/8	10	06U-60C	M18x1.5	2.78	1.38	.22	3/4	7/8
3/8	12	06U-62C	M20x1.5	2.87	1.44	.25	3/4	1
3/8	14	06U-64C	M22x1.5	2.92	1.50	.25	3/4	1-1/16
1/2	16	08U-66C	M24x1.5	3.06	1.63	.36	7/8	1-1/8
5/8	20	10U-70C	M30x2.0	3.46	1.69	.48	1-1/8	1-7/16
3/4	20	12U-70C	M30x2.0	3.91	1.75	.48	1-1/8	1-7/16
3/4	25	12U-75C	M36x2.0	4.24	2.06	.61	1-1/4	1-5/8
1	30	16U-80C	M42x2.0	4.34	2.13	.81	1-5/8	2
1-1/4	38	20U-88C*	M52x2.0	4.80	2.50	1.02	2	2-3/8

*20U-88C for use with H42520 only. Crimp on Super I, COC II or COC II Plus only. Contact Eaton for crimping instructions. (Includes o-ring.)

Female Swivel 30° Flare

(Komatsu, Linkbelt)

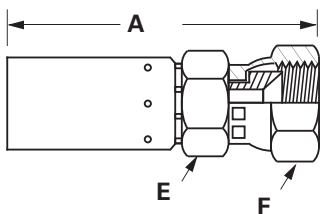

Hose I.D.	Part Number	Thread Size	A	Cut-Off Factor	Hole Dia.	Hex E	Hex F
1/4	04U-14K	M14x1.5	2.89	1.19	.18	9/16	3/4
3/8	06U-18K	M18x1.5	2.86	1.44	.31	11/16	7/8
1/2	08U-22K	M22x1.5	2.99	1.56	.39	13/16	1
5/8	10U-24K	M24x1.5	3.64	1.69	.50	1	1-1/4
3/4	12U-30K	M30x1.5	3.86	1.69	.61	1-1/8	1-3/8
1	16U-33K	M33x1.5	4.53	2.31	.81	1-1/4	1-5/8
1-1/4	20U-36K	M36x1.5	5.24	2.94	.92	1-5/8	1-3/4

J

Hose Ends - Crimp

British Standard (BSPP) 60° Cone Female Pipe Swivel

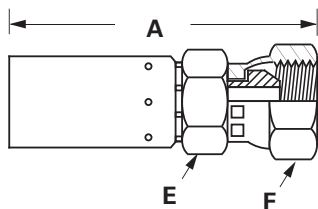

Hose I.D.	BSPP Pipe Size	Part Number	Thread Size	A	Hose Cut-Off Factor	Hole Dia.	Hex E	Hex F
1/4	1/4	04U-354	G-1/4-19*	2.75	1.25	.16	9/16	3/4
1/4	3/8	04U-356	G-3/8-19*	2.84	1.38	.16	3/4	7/8
3/8	3/8	06U-356	G-3/8-19*	2.84	1.44	.25	3/4	7/8
3/8	1/2	06U-358	G-1/2-14*	2.97	1.56	.25	7/8	1-1/16
1/2	1/2	08U-358	G-1/2-14*	3.05	1.63	.36	13/16	1-1/16
1/2	5/8	08U-360	G-5/8-14*	2.96	1.56	.36	13/16	1-3/16
5/8	5/8	10U-360	G-5/8-14*	3.71	1.75	.48	15/16	1-3/16
3/4	3/4	12U-362	G-3/4-14*	3.87	1.75	.61	1	1-1/4
1	1	16U-366	G-1-11*	4.47	2.25	.81	1-1/4	1-1/2
1-1/4	1-1/4	20U-370	G-1-1/4-11*	4.81	2.50	1.02	1-5/8	1-7/8

*G as part of thread size is ISO designation for parallel thread.

Female JIS 30° Flare Parallel Pipe Swivel

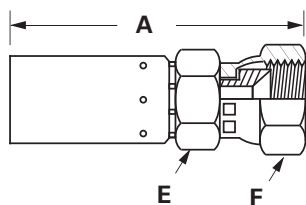

Hose I.D.	Tube Size	Part Number	Thread Size	A	Hose Cut-Off Factor	Hole Dia.	Hex E	Hex F
1/4	1/4	04U-04L	G-1/4-19	2.73	1.25	.16	9/16	3/4
3/8	3/8	06U-06L	G-3/8-19	2.84	1.38	.25	11/16	7/8
1/2	1/2	08U-08L	G-1/2-14	3.02	1.56	.36	13/16	1-1/16
5/8	3/4	10U-12L	G-3/4-14	3.52	1.56	.48	1	1-5/16
3/4	3/4	12U-12L	G-3/4-14	3.85	1.75	.61	1	1-1/4
1	1	16U-16L	G-1-11	4.13	1.94	.81	1-1/4	1-1/2

*G As Part of Thread Size is ISO Designation for Parallel Thread.

Female FOR-SEAL® Swivel Straight

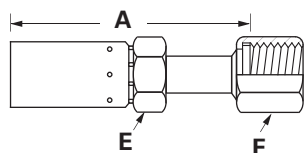

Hose I.D.	Tube Size	Part Number	Thread Size	A	Hose Cut-Off Factor	Hole Dia.	Hex E	Hex F
1/4	1/4	04U-S64	9/16-18	2.56	1.08	.16	9/16	11/16
1/4	3/8	04U-S66	11/16-16	2.85	1.37	.26	9/16	13/16
1/4	1/2	04U-S68	13/16-16	3.19	1.75	.36	11/16	15/16
3/8	1/4	06U-S64	9/16-18	2.81	1.38	.16	11/16	5/8
3/8	3/8	06U-S66	11/16-16	2.64	1.21	.26	11/16	13/16
3/8	1/2	06U-S68	13/16-16	2.80	1.37	.28	11/16	15/16
3/8	5/8	06U-S70*	1-14	3.03	1.60	.25	15/16	1-1/8
1/2	3/8	08U-S66	11/16-16	2.75	1.32	.26	13/16	13/16
1/2	1/2	08U-S68	13/16-16	2.80	1.37	.36	13/16	15/16
1/2	5/8	08U-S70	1-14	3.30	1.87	.46	13/16	1-1/8
1/2	3/4	08U-S72	1-3/16-12	3.38	1.94	.36	1	1-3/8
5/8	5/8	10U-S70	1-14	3.53	1.60	.48	15/16	1-1/8
5/8	3/4	10U-S72	1-3/16-12	3.84	1.94	.55	1	1-3/8
3/4	5/8	12U-S70	1-14	3.85	1.70	.46	1	1-1/8
3/4	3/4	12U-S72	1-3/16-12	3.95	1.80	.61	1-1/8	1-3/8
3/4	1	12U-S76	1-7/16-12	4.78	2.81	.61	1-1/4	1-5/8
1	3/4	16U-S72	1-3/16-12	4.36	2.16	.55	1-1/4	1-3/8
1	1	16U-S76	1-7/16-12	4.24	2.04	.78	1-1/4	1-5/8
1	1-1/4	16U-S80	1-11/16-12	4.20	2.00	.81	1-1/2	1-7/8
1-1/4	1-1/4	20U-S80	1-11/16-12	4.54	2.25	1.04	1-5/8	1-7/8

* Crimp nut design

BSPP Flat Face Female Swivel

(HIAB Cranes-Swedish)

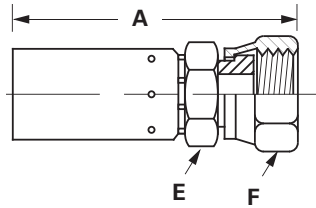

Hose I.D.	Tube Size	Part Number	Thread Size	A	Hose Cut-Off Factor	Hole Dia.	Hex E	Hex F
3/8	3/8	06U-06P	G-3/8-19*	2.90	1.50	.25	11/16	7/8
3/8	1/2	06U-08P	G-1/2-14*	2.96	1.50	.25	3/4	1-1/16
1/2	1/2	08U-08P	G-1/2-14*	3.02	1.56	.36	13/16	1-1/16
1/2	3/4	08U-12P	G-3/4-14*	3.06	1.63	.36	1	1-1/4
3/4	3/4	12U-12P	G-3/4-14*	3.92	1.75	.61	1	1-1/4

*G as part of thread size is ISO designation for parallel thread.

READY-LOK Male Connector

(For Deep Mining Markets)

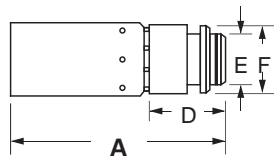

Hose I.D.	Connect. Size	Part Number	A	Hose Cut-Off Factor	Hole Dia.	Length D	Dia. E	Dia. F
1/4	1/4	04U-04S	2.82	1.31	.16	1.13	.39	.59
3/8	3/8	06U-06S	2.84	1.31	.26	1.13	.54	.78
1/2	1/2	08U-08S	2.82	1.31	.36	1.13	.70	.94
3/4	3/4	12U-12S	3.64	1.50	.61	1.13	.94	1.14
1	1	16U-16S	3.94	1.75	.81	1.34	1.22	1.53
1-1/4	1-1/4	20U-20S	4.06	1.75	1.02	1.34	1.49	1.80

(O-ring and backup ring included.)

Split Flange Straight

(SAE Code 61)

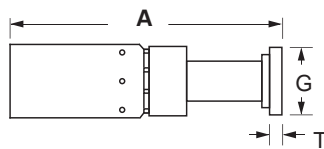

Hose I.D.	Nominal Tube Size	Part Number	Replacement O-Ring (Not Included)	A	Hose Cut-Off Factor	Hole Dia.	Dia. G	T
1/2	1/2	08U-G08	8x252	3.94	2.50	.33	1.19 (30mm)	.265
3/4	3/4	12U-G12	12x252	4.40	2.25	.58	1.50 (38mm)	.265
3/4	1	12U-G16	16x252	4.40	2.25	.58	1.75 (44mm)	.315
1	1	16U-G16	16x252	4.58	2.38	.77	1.75 (44mm)	.315
1	1-1/4	16U-G20	20x252	4.58	2.38	.77	2.00 (51mm)	.315
1-1/4	1-1/4	20U-G20	20x252	5.04	2.75	1.02	2.00 (51mm)	.315
1-1/4	1-1/2	20U-G24	24x252	5.12	2.81	1.02	2.38 (60mm)	.315

(See page L-90 for Code 61 Split Flange Kits.)

Split Flange Straight — Metric

(Komatsu, Linkbelt, etc.)

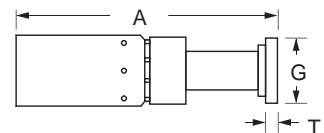

Hose I.D.	Nominal Tube Size	Part Number	Replacement O-Ring (Not Included)	A	Hose Cut-Off Factor	Hole Dia.	Dia. G	T
5/8	16mm (5/8")	10U-G09	10x252	4.18	2.25	.46	34mm (1.325")	.265

J

Hose Ends - Crimp

Coll-O-Crimp

'U' Series

To determine the correct length of hose, subtract the cut-off factor for each end fitting from the overall length of assembly.

Banjo (Ford Tractor)

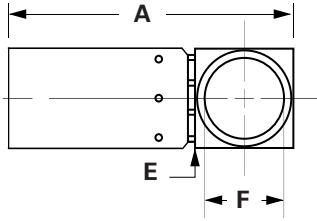

Hose I.D.	Part Number	A	Hose Cut-Off Factor	Hole Dia.	Hex E
3/8	06U-L06	2.56	.69	.62	7/8

Metric Standpipe Straight Tube

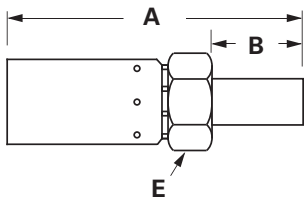

Hose I.D.	Tube O.D. (mm)	Part Number	A	B	Hose Cut-Off Factor	Hole Dia.	Hex E
1/4	8	04U-38T	3.06	1.00	1.56	.15	5/8
1/4	10	04U-40T	3.10	1.04	1.63	.15	5/8
3/8	10	06U-40T	3.10	1.04	1.63	.24	13/16
3/8	12	06U-42T	3.10	1.04	1.63	.24	13/16
3/8	14	06U-44T	3.28	1.22	1.81	.24	13/16
1/2	15	08U-45T	3.12	1.00	1.69	.35	7/8
1/2	16	08U-46T	3.34	1.22	1.91	.35	7/8
5/8	18	10U-48T	3.64	1.06	1.75	.48	1-15/16
5/8	20	10U-50T	4.00	1.42	2.06	.48	1-15/16
3/4	22	12U-52T	4.13	1.19	1.88	.61	1
3/4	25	12U-55T	4.53	1.59	2.25	.61	1
1	28	16U-58T	4.43	1.25	2.25	.81	1-1/2
1	30	16U-60T	4.89	1.71	2.69	.81	1-1/2

(See page L-66 for Metric Nuts and Sleeves.)

Standpipe Straight Tube

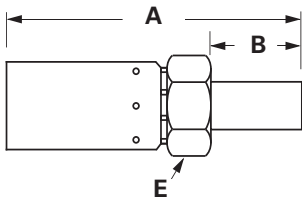

Hose I.D.	Tube O.D.	Part Number	A	B	Hose Cut-Off Factor	Hole Dia.	Hex E
1/4	1/4	04U-T04	3.16	1.10	1.69	.15	9/16
3/8	3/8	06U-T06	3.36	1.30	1.94	.25	11/16
1/2	1/2	08U-T08	3.70	1.58	2.25	.33	3/4
5/8	5/8	10U-T10	3.92	1.34	2.00	.46	15/16
3/4	3/4	12U-T12	4.11	1.17	1.94	.58	1
1	1	16U-T16	4.48	1.30	2.31	.76	1-1/4

(See pages L-80 for Ermeto nuts and sleeves.)

SAE 37° Female Swivel 30° Tube Elbow

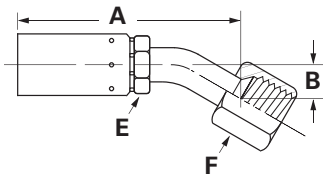

Hose I.D.	Tube Size	Part Number	Thread Size	A	B	Hose Cut-Off Factor	Hex E	Hex F
5/8	3/4	10U-L22	1-1/16-12	4.50	.46	2.56	15/16	1-1/4

J Hose Ends - Crimp

Inverted Male Swivel 45° Tube Elbow

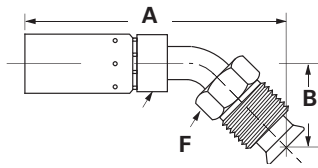

Hose I.D.	Tube Size	Part Number	Thread Size	A	B	Hose Cut-Off Factor	Hole Dia.	Hex F
1/4	3/16	04U-B43	3/8-24	3.48	.69	2.00	.12	3/8
1/4	1/4	04U-B44	7/16-24	3.61	.93	2.13	.15	7/16
1/4	5/16	04U-B45	1/2-20	3.98	1.14	2.50	.21	1/2
3/8	1/4	06U-B44	7/16-24	3.59	.93	2.19	.15	7/16
3/8	5/16	06U-B45	1/2-20	4.02	1.14	2.56	.21	1/2
3/8	3/8	06U-B46	5/8-18	4.05	1.34	2.63	.24	5/8
3/8	7/16	06U-B47	11/16-18	4.05	1.34	2.63	.24	11/16
1/2	1/2	08U-B48	3/4-18	4.85	1.58	3.44	.33	3/4

SAE 45° Female Swivel 45° Tube Elbow

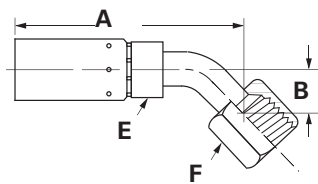

Hose I.D.	Tube Size	Part Number	Thread Size	A	B	Hose Cut-Off Factor	Hole Dia.	Hex Dia. F	Hex F
3/8	3/8	06U-486	5/8-18	3.18	.39	1.75	.21	11/16	3/4

Female Swivel DIN Universal Seat 45° Tube Elbow

I. Rh. (Light)

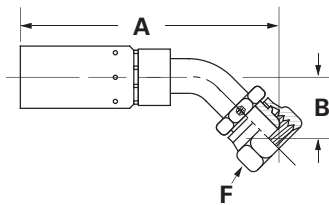

Hose I.D.	Tube Size	Part Number	Thread Size	A	B	Hose Cut-Off Factor	Hole Dia.	Hex F
1/4	8	04U-08D	M14x1.5	3.08	.73	1.63	.16	11/16
1/4	10	04U-10D	M16x1.5	3.21	.79	1.75	.16	3/4
3/8	10	06U-10D	M16x1.5	3.90	.96	2.47	.25	3/4
3/8	12	06U-12D	M18x1.5	3.93	.96	2.50	.25	7/8
1/2	15	08U-15D	M22x1.5	3.48	.91	2.06	.36	1-1/16
5/8	18	10U-18D	M26x1.5	4.40	1.08	2.50	.48	1-5/16
3/4	22	12U-22D	M30x2.0	4.62	1.19	2.44	.61	1-7/16
1	28	16U-28D	M36x2.0	5.52	1.59	3.32	.81	1-5/8

Flareless 45° Tube Elbow 7000 Ermeto Series

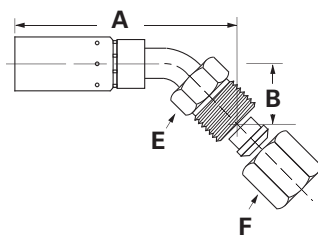

Hose I.D.	Tube Size	Part Number	Thread Size	A	B	Hose Cut-Off Factor	Hole Dia.	Hex Dia. F	Hex F
3/8	3/8	06U-956	9/16-18	4.08	.88	2.65	.28	11/16	11/16

(For replacement nuts and sleeves see pages L-80.)

J

Hose Ends - Crimp

To determine the correct length of hose, subtract the cut-off factor for each end fitting from the overall length of assembly.

^a Swivel nuts are universal – both SAE 37° and 45° connections.

JIC 37° Female Swivel 45° Tube Elbow

(Exceptions Noted)

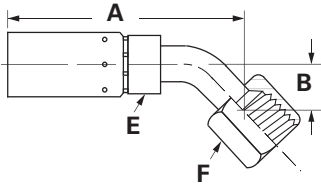

Hose I.D.	Tube Size	Part Number	Thread Size	A	B	Hose Cut-Off Factor	Hole Dia.	Hex Dia. E	Hex F
1/4	1/4	04U-684 ^a	7/16-20	2.98	.33	1.50	.15	9/16	9/16
1/4	5/16	04U-685 ^a	1/2-20	3.14	.36	1.69	.21	9/16	5/8
3/8	1/4	06U-684 ^a	7/16-20	3.08	.33	1.69	.15	11/16	9/16
3/8	3/8	06U-686	9/16-18	3.17	.39	1.75	.25	11/16	11/16
3/8	1/2	06U-688 ^a	3/4-16	3.51	.55	2.08	.25	3/4	7/8
1/2	1/2	08U-688 ^a	3/4-16	3.51	.55	2.08	.35	13/16	7/8
1/2	5/8	08U-690 ^a	7/8-14	3.76	.63	2.31	.36	13/16	1
5/8	5/8	10U-690 ^a	7/8-14	4.22	.63	2.22	.48	15/16	1
5/8	3/4	10U-692	1-1/16-12	4.37	.78	2.44	.48	15/16	1-1/4
3/4	3/4	12U-692	1-1/16-12	4.79	.78	2.64	.59	1	1-1/4
3/4	1	12U-696	1-5/16-12	5.18	1.10	3.00	.61	1-1/4	1-1/2
1	1	16U-696	1-5/16-12	5.28	1.10	3.06	.76	1-1/4	1-1/2

^a Swivel nuts are universal – both SAE 37° and 45° connections.

Male Swivel 45° Tube Elbow O-Ring Port

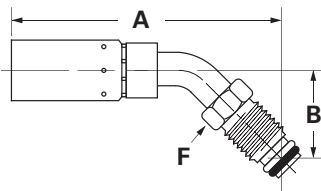

Hose I.D.	Tube O.D.	Part Number	O-Ring	Thread Size	A	B	Hose Cut-Off Factor	Hole Dia.	Hex F
1/2	5/8	08U-L50	7629x7	7/8-14	4.75	1.84	3.38	.36	7/8

Split Flange 45° Tube Elbow (SAE Code 61)

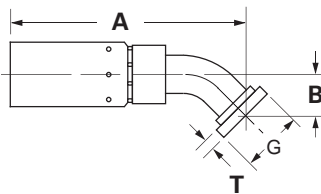

Hose I.D.	Nominal Flang Size	Part Number	Replacement O-Ring (Not Included)	A	B	Hose Cut-Off Factor	Hole Dia.	Dia. G	T Nominal
1/2	1/2	08U-G41	8x252	3.68	.78	2.25	.41	1.19 (30mm)	.265
3/4	3/4	12U-G42	12x252	5.00	1.00	2.88	.58	1.50 (38mm)	.265
3/4	1	12U-G46	16x252	5.00	1.00	2.88	.58	1.75 (44mm)	.315
1	1	16U-G46	16x252	4.82	.89	2.62	.77	1.75 (44mm)	.315
1	1-1/4	16U-G50	20x252	5.00	1.06	2.80	.77	2.00 (51mm)	.315
1-1/4	1-1/4	20U-G50	20x252	5.22	1.09	2.90	1.02	2.00 (51mm)	.315

(See page L-90 for Code 61 Split Flange Kits.)

British Standard 60° Cone (BSPP) Female Swivel 45° Tube Elbow

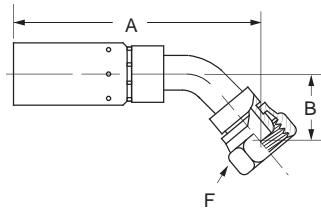

Hose I.D.	BSPP Pipe Size	Part Number	Thread Size	A	B	Hose Cut-Off Factor	Hole Dia.	Hex F
1/4	1/4	04U-44P	G-1/4-19*	3.69	.91	2.25	.15	3/4
3/8	3/8	06U-46P	G-3/8-19*	3.85	.90	2.44	.25	7/8
1/2	1/2	08U-48P	G-1/2-14*	3.88	.87	2.44	.33	1-1/16
5/8	5/8	10U-50P	G-5/8-14*	4.38	.98	2.44	.46	1-3/16
3/4	3/4	12U-52P	G-3/4-14*	5.53	1.31	3.38	.61	1-1/4
1	1	16U-56P	G-1-11*	5.39	1.46	3.19	.76	1-1/2
1-1/4	1-1/4	20U-60P**	G-1 1/4-11*	5.89	1.76	3.57	1.02	1-7/8

*G as part of thread size is ISO designation for parallel thread.

**Part number will crimp in COC ET4000, T-410-1, T-420-1, and T-440-1 presses only.

Female FOR-SEAL® Swivel 45° Tube Elbow

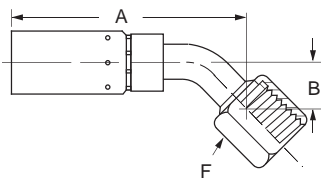

Hose I.D.	Tube Size	Part Number	Thread Size	A	B	Hose Cut-Off Factor	Hole Dia.	Hex F
1/4	1/4	04U-L64	9/16-18	3.14	.41	1.68	.16	11/16
1/4	3/8	04U-L66	11/16-16	3.24	.43	1.75	.16	13/16
3/8	3/8	06U-L66	11/16-16	3.26	.43	1.81	.26	13/16
3/8	1/2	06U-L68	13/16-16	3.58	.60	2.15	.26	15/16
1/2	3/8	08U-L66	11/16-16	3.32	.43	1.88	.26	13/16
1/2	1/2	08U-L68	13/16-16	3.56	.60	2.13	.36	15/16
1/2	5/8	08U-L70	1-14	3.67	.65	2.25	.36	1-1/8
5/8	5/8	10U-L70	1-14	4.13	.65	2.19	.46	1-1/8
5/8	3/4	10U-L72	1-3/16-12	4.53	.84	2.63	.48	1-3/8
3/4	5/8	12U-L70	1-14	4.49	.65	2.31	.46	1-1/8
3/4	3/4	12U-L72	1-3/16-12	4.96	.84	2.81	.59	1-3/8
3/4	1	12U-L76	1-7/16-12	5.29	.94	3.13	.76	1-5/8
1	3/4	16U-L72	1-3/16-12	4.99	.83	2.79	.56	1-3/8
1	1	16U-L76	1-7/16-12	5.29	.95	3.06	.76	1-5/8
1	1-1/4	16U-L80	1-11/16-12	5.00	1.07	2.79	.81	1-7/8
1-1/4	1-1/4	20U-L80	1-11/16-12	5.15	1.05	2.85	1.01	1-7/8

Split Flange 45° Tube Elbow - Metric (Komatsu, Linkbelt, etc.)

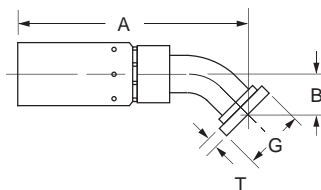

Hose I.D.	Nominal Flange Size	Part Number	Replacement O-Ring (Not Included)	A	B	Hose Cut-Off Factor	Hole Dia.	Dia. G	T Nominal
5/8	16mm (5/8)	10U-G69	10x252	4.21	.94	2.25	.46	34mm (1.335)	.265

(See page L-90 for Code 61 Split Flange Kits.)

Inverted Male Swivel 90° Tube Elbow

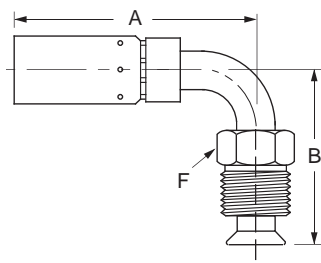

Hose I.D.	Tube Size	Part Number	Thread Size	A	B	Hose Cut-Off Factor	Hole Dia.	Hex F
1/4	3/16	04U-B63	3/8-24	2.85	1.06	1.38	.12	3/8
1/4	1/4	04U-B64	7/16-24	2.89	1.36	1.38	.15	7/16
1/4	5/16	04U-B65	1/2-20	3.08	1.61	1.63	.21	1/2
3/8	1/4	06U-B64	7/16-24	2.89	1.36	1.44	.15	7/16
3/8	5/16	06U-B65	1/2-20	3.08	1.61	1.50	.21	1/2
3/8	3/8	06U-B66	5/8-18	3.40	1.97	1.88	.24	5/8
3/8	7/16	06U-B67	11/16-18	3.40	1.97	2.00	.24	11/16
1/2	1/2	08U-B68	3/4-18	3.50	2.32	2.06	.35	3/4

Coll-O-Crimp

'U' Series

To determine the correct length of hose, subtract the cut-off factor for each end fitting from the overall length of assembly.

^a Swivel nuts are universal – both SAE 37° and 45° connections.

SAE 37° Male Rigid 90° Elbow

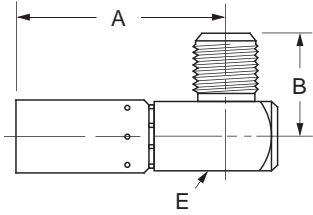

Hose I.D.	Tube Size	Part Number	Thread Size	A	B	Hose Cut-Off Factor	Hole Dia.	Sqaure E
3/8	5/8	06U-X60	7/8-14	2.50	1.10	1.06	.36	11/16
1/2	5/8	08U-X60	7/8-14	2.75	1.13	1.31	.36	3/4
3/4	5/8	12U-X60	7/8-14	4.15	1.32	2.00	.48	1-1/8

Male Pipe Swivel 90° Elbow

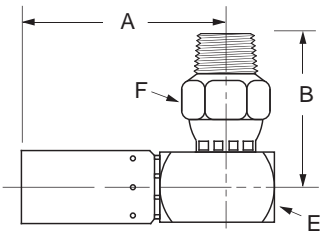

Hose I.D.	Pipe Size	Part Number	Thread Size	A	B	Hose Cut-Off Factor	Hole Dia.	Sqaure E	Hex F
1/4	1/4	04U-M04	1/4-18	2.43	1.79	1.00	.15	11/16	13/16
3/8	1/4	06U-M04	1/4-18	2.50	1.83	1.06	.24	11/16	13/16
3/8	3/8	06U-M06	3/8-18	2.50	1.84	1.06	.24	11/16	7/8
3/8	1/2	06U-M08	1/2-14	2.50	1.97	1.07	.24	11/16	7/8
1/2	1/2	08U-M08	1/2-14	2.75	1.96	1.31	.35	3/4	7/8
3/4	3/4	12U-M12	3/4-14	4.15	2.46	2.00	.61	1-1/8	1-1/4

Note:

Swivel for installation purposes only. (Not for temperatures above 212°F.)

JIC 37° Female Swivel Long Drop 90° Tube Elbow

(Exceptions Noted)

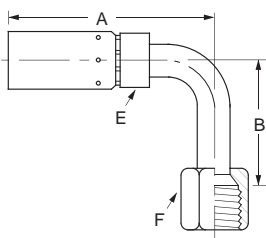

Hose I.D.	Tube Size	Part Number	Thread Size	A	B	Hose Cut-Off Factor	Hole Dia.	Hex F
1/4	1/4	04U-644 ^a	7/16-20	2.95	1.80	1.50	.15	9/16
3/8	1/4	06U-644 ^a	7/16-20	2.89	1.80	1.44	.15	9/16
3/8	3/8	06U-646	9/16-18	3.18	2.18	1.75	.24	11/16
3/8	1/2	06U-648 ^a	3/4-16	3.35	2.43	1.92	.24	7/8
1/2	1/2	08U-648 ^a	3/4-16	3.33	2.43	1.88	.35	7/8
1/2	5/8	08U-650 ^a	7/8-14	3.45	2.57	2.00	.36	1
5/8	5/8	10U-650 ^a	7/8-14	3.91	2.57	1.98	.48	1
3/4	3/4	12U-652	1-1/16-12	4.81	3.73	2.63	.58	1-1/4
1	1	16U-656L33	1-5/16-12	5.18	3.37	3.00	.76	1-1/2

^a Swivel nuts are universal – both SAE 37° and 45° connections.

SAE 45° Female Swivel Long Drop 90° Tube Elbow

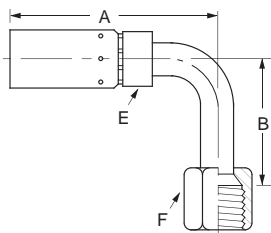

Hose I.D.	Tube Size	Part Number	Thread Size	A	B	Hose Cut-Off Factor	Hole Dia.	Hex F
3/8	3/8	06U-446	5/8-18	3.19	2.18	1.75	.24	3/4

J Hose Ends - Crimp

Coll-O-Crimp

'U' Series

To determine the correct length of hose, subtract the cut-off factor for each end fitting from the overall length of assembly.

^a Swivel nuts are universal – both SAE 37° and 45° connections.

Flareless 90° Tube 7000 Ermeto Series

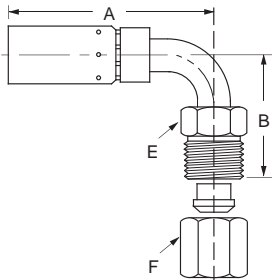

Hose I.D.	Tube Size	Part Number	Thread Size	A	B	Hose Cut-Off Factor	Hole Dia.	Hex E	Hex F
3/8	3/8	06U-976	9/16-18	3.14	1.54	1.69	.28	5/8	11/16

(For replacement nuts and sleeves, see pages L-80.)

JIC 37° Female Swivel 90° Tube Elbow

(Exceptions Noted, Refer to Footnotes)

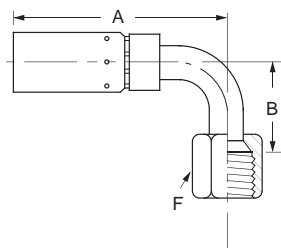

Hose I.D.	Tube Size	Part Number	Thread Size	A	B	Hose Cut-Off Factor	Hole Dia.	Hex F
1/4	1/4	04U-664 ^a	7/16-20	2.90	.68	1.44	.15	9/16
1/4	5/16	04U-665 ^a	1/2-20	3.09	.77	1.63	.21	5/8
1/4	3/8	04U-666	9/16-18	3.16	.85	1.63	.25	11/16
3/8	1/4	06U-664 ^a	7/16-20	2.85	.68	1.44	.15	9/16
3/8	3/8	06U-666	9/16-18	3.20	.85	1.75	.25	11/16
3/8	1/2	06U-668 ^a	3/4-16	3.27	1.09	1.75	.33	7/8
1/2	1/2	08U-668 ^a	3/4-16	3.33	1.09	1.88	.33	7/8
1/2	5/8	08U-670 ^a	7/8-14	3.92	1.23	2.50	.36	1
5/8	5/8	10U-670 ^a	7/8-14	4.36	1.23	2.44	.46	1
5/8	3/4	10U-672	1-1/16-12	4.96	1.82	3.00	.48	1-1/4
3/4	5/8	12U-670 ^a	7/8-14	4.29	1.23	2.14	.46	1
3/4	3/4	12U-672	1-1/16-12	4.76	1.82	2.63	.58	1-1/4
1	1	16U-676	1-5/16-12	5.03	2.14	2.81	.76	1-1/2
1	1-1/4	16U-677	1-5/8-12	5.06	3.31	2.86	.76	2
1-1/4	1-1/4	20U-677 [#]	1-5/8-12	5.29	3.34	2.99	1.01	2

^a Swivel nuts are universal – both SAE 37° and 45° connections.

Female Swivel Universal Seat DIN 90° Tube Elbow

l. Rh. (Light)

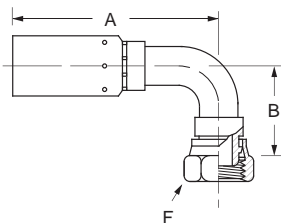

Hose I.D.	Tube Size (mm)	Part Number	Thread Size	A	B	Hose Cut-Off Factor	Hole Dia.	Hex F
1/4	8	04U-58D	M14x1.5	2.99	1.48	1.50	.16	11/16
1/4	10	04U-60D	M16x1.5	3.31	1.65	1.81	.16	3/4
3/8	10	06U-60D	M16x1.5	3.29	1.65	1.88	.25	3/4
3/8	12	06U-62D	M18x1.5	3.31	1.65	1.88	.25	7/8
1/2	15	08U-65D	M22x1.5	3.73	1.93	2.31	.36	1-1/16
5/8	18	10U-68D	M26x1.5	4.42	2.28	2.50	.48	1-1/4
3/4	22	12U-72D	M30x2.0	4.97	2.59	2.81	.61	1-7/16
1	28	16U-78D	M36x2.0	4.95	3.27	2.75	.81	1-5/8
1-1/4	35	20U-85D	M45x2.0	5.29	3.51	2.99	1.02	2-3/16

Female 24° Swivel DIN 90° Tube Elbow

s. Rh. DKO (Heavy)

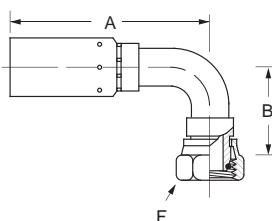

Hose I.D.	Tube Size (mm)	Part Number	Thread Size	A	B	Hose Cut-Off Factor	Hole Dia.	Hex F
3/8	12	06U-62E	M20x1.5	3.25	1.53	1.82	.25	1
3/8	14	06U-64E	M22x1.5	3.61	1.63	2.19	.25	1-1/16
1/2	16	08U-66E	M24x1.5	3.69	1.95	2.25	.33	1-1/8
5/8	20	10U-70E	M30x2.0	4.46	2.47	2.50	.48	1-7/16
3/4	25	12U-75E**	M36x2.0	5.27	2.90	3.13	.61	1-5/8
1	30	16U-80E**	M42x2.0	5.19	2.79	3.00	.77	2

**Part number will crimp in COC T-410, T-420, T-440, ET1000, and ET4000 presses only. (Includes o-ring)

J

Hose Ends - Crimp

British Standard (BSPP) 60° Cone Female Pipe Swivel 90° Tube Elbow

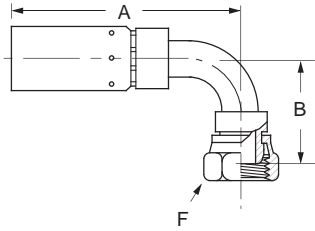

Hose I.D.	BSPP Pipe Size	Part Number	Thread Size	A	B	Hose Cut-Off Factor	Hole Dia.	Hex F
1/4	1/4	04U-74P	G-1/4-19*	2.99	1.50	1.50	.16	3/4
3/8	3/8	06U-76P	G-3/8-19*	3.26	1.60	1.83	.25	7/8
3/8	1/2	06U-78P	G-1/2-14*	3.06	1.67	1.63	.25	1-1/16
1/2	1/2	08U-78P	G-1/2-14*	3.96	1.89	2.56	.36	1-1/16
1/2	5/8	08U-80P	G-5/8-14*	3.55	1.44	2.13	.36	1-1/4
5/8	5/8	10U-80P	G-5/8-14*	4.15	1.83	2.25	.49	1-3/16
3/4	3/4	12U-82P	G-3/4-14*	5.02	2.49	2.88	.58	1-1/4
1	1	16U-86P**	G-1-11*	4.95	3.09	2.75	.77	1-1/2
1-1/4	1-1/4	20U-90P**	G-1-1/4-11*	5.37	3.57	2.99	1.51	1-7/8

*G as part of thread size is ISO designation for parallel thread.

**Part number will crimp in C-O-C ET4000, T-410, T-420, and T-440 presses only.

Female FOR-SEAL Swivel Short Drop 90° Elbow

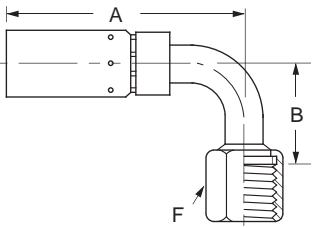

Hose I.D.	Tube Size	Part Number	Thread Size	A	B	Hose Cut-Off Factor	Hole Dia.	Hex F
1/4	1/4	04U-A24	9/16-18	3.00	.81	1.50	.16	11/16
1/4	3/8	04U-A26	11/16-16	3.13	.90	1.75	.16	13/16
3/8	1/4	06U-A24	9/16-18	3.00	.81	1.56	.16	11/16
3/8	3/8	06U-A26	11/16-16	3.13	.90	1.81	.26	13/16
3/8	1/2	06U-A28	13/16-16	3.33	1.15	1.88	.26	15/16
1/2	3/8	08U-A26	11/16-16	3.13	.90	1.75	.26	13/16
1/2	1/2	08U-A28	13/16-16	3.34	1.15	1.91	.36	15/16
1/2	5/8	08U-A30	1-14	3.46	1.27	2.03	.36	1-1/8
1/2	3/4	08U-A32	1-3/16-12	3.98	1.88	2.56	.36	1-3/8
5/8	5/8	10U-A30	1-14	3.92	1.27	2.00	.46	1-1/8
5/8	3/4	10U-A32	1-3/16-12	4.37	1.88	2.44	.46	1-3/8
3/4	5/8	12U-A30	1-14	4.26	1.27	2.13	.46	1-1/8
3/4	3/4	12U-A32	1-3/16-12	4.86	1.88	2.69	.59	1-3/8
3/4	1	12U-A36	1-7/16-12	5.14	2.21	2.98	.61	1-5/8
1	1	16U-A36	1-7/16-12	5.23	2.21	3.00	.76	1-5/8
1	1-1/4	16U-A40	1-11/16-12	5.06	2.59	2.86	.81	1-7/8
1-1/4	1-1/4	20U-A40	1-11/16-12	5.29	2.50	2.99	1.02	1-7/8
1-1/4	1-1/2	20U-A44	2-12	5.29	2.67	2.99	1.02	2-1/4

Female FOR-SEAL Swivel Medium Drop 90° Tube Elbow

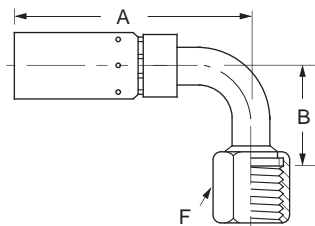

Hose I.D.	Tube Size	Part Number	Thread Size	A	B	Hose Cut-Off Factor	Hole Dia.	Hex F
1/4	1/4	04U-J34	9/16-18	3.07	1.26	1.59	.16	11/16
1/4	3/8	04U-J36	11/16-16	3.13	1.51	1.69	.16	13/16
1/4	1/2	04U-J38	13/16-16	3.37	1.62	1.88	.16	15/16
3/8	3/8	06U-J36	11/16-16	3.20	1.51	1.69	.24	13/16
3/8	1/2	06U-J38	13/16-16	3.36	1.62	1.93	.25	15/16
1/2	3/8	08U-J36	11/16-16	3.20	1.51	1.72	.24	13/16
1/2	1/2	08U-J38	13/16-16	3.37	1.62	1.94	.33	15/16
1/2	3/4	08U-J42	1-3/16-12	4.02	2.28	2.59	.36	1-3/8
5/8	5/8	10U-J40	1-14	4.29	1.85	2.13	.46	1-1/8
3/4	5/8	12U-J40	1-1/4	3.95	1.85	2.00	.46	1-1/8
3/4	3/4	12U-J42	1-3/16-12	4.83	2.28	2.69	.58	1-3/8
1	1	16U-J46	1-7/16-12	5.33	2.78	3.13	.76	1-5/8
1	1-1/4	16U-J50	1-11/16-12	5.11	3.22	3.04	.81	1-7/8
1-1/4	1-1/4	20U-J50	1-11/16-12	5.31	3.09	3.00	1.01	1-7/8

JIC 37° Female Swivel 90° Elbow

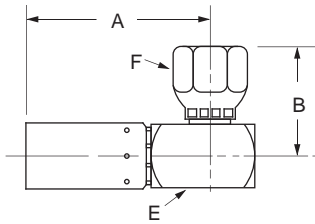

Hose I.D.	Tube Size	Part Number	Thread Size	A	B	Hose Cut-Off Factor	Hole Dia.	Sqaure E	Hex F
1/4	1/4	04U-554	7/16-20	2.43	1.06	.95	.16	11/16	9/16
3/8	3/8	06U-556	9/16-18	2.50	1.18	1.06	.25	11/16	11/16
1/2	1/2	08U-558	3/4-16	2.75	1.35	1.31	.36	3/4	7/8
1/2	5/8	08U-560	7/8-14	2.75	1.34	1.31	.36	3/4	1
3/4	5/8	12U-560	7/8-14	4.15	1.54	2.00	.61	1-1/8	1
3/4	3/4	12U-562	1-1/16-12	4.15	1.62	2.00	.61	1-1/8	1-1/4
3/4	7/8	12U-564	1-3/16-12	4.15	1.68	2.00	.61	1-1/8	1-3/8

Male Straight Thread O-Ring Swivel 90° Elbow

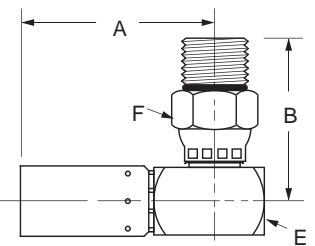

Hose I.D.	Tube Size	Part Number	Thread Size	A	B	Hose Cut-Off Factor	Hole Dia.	Sqaure E	Hex F
1/4	3/8	04U-R66	9/16-18	2.43	1.68	.94	.16	11/16	7/8
3/8	3/8	06U-R66	9/16-18	2.50	1.68	1.06	.25	11/16	7/8
3/8	1/2	06U-R68	3/4-16	2.50	1.64	1.06	.25	11/16	7/8
3/8	5/8	06U-R70	7/8-14	2.50	1.80	1.06	.25	11/16	1
1/2	1/2	08U-R68	3/4-16	2.75	1.64	1.31	.36	3/4	7/8
1/2	5/8	08U-R70	7/8-14	2.75	1.79	1.31	.36	3/4	1-1/8
1/2	3/4	08U-R72	1-1/16-12	2.75	1.89	1.31	.36	3/4	1-1/4
3/4	3/4	12U-R72	1-1/16-12	4.15	2.24	2.00	.61	1-1/8	1-7/16

(Includes o-ring. For replacement o-ring, see page L-64.)

Note: Swivel for installation purposes only. (Not for temperatures above 212°F.)

Female FOR-SEAL Swivel Long Drop 90° Tube Elbow

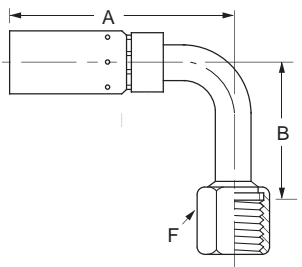

Hose I.D.	Tube Size (mm)	Part Number	Thread Size	A	B	Hose Cut-Off Factor	Hole Dia.	Hex F
1/4	1/4	04U-A64	9/16-18	3.14	1.80	1.63	.16	11/16
1/4	3/8	04U-A66	11/16-16	3.31	2.13	1.83	.16	13/16
3/8	3/8	06U-A66	11/16-16	3.34	2.13	1.91	.24	13/16
3/8	1/2	06U-A68	13/16-16	3.37	2.51	1.94	.25	15/16
1/2	1/2	08U-A68	13/16-16	3.28	2.51	1.85	.36	15/16
1/2	5/8	08U-A70	1-14	3.49	2.76	2.00	.36	1-1/8
5/8	5/8	10U-A70	1-14	3.95	2.76	2.06	.46	1-1/8
3/4	3/4	12U-A72	1-3/16-12	4.87	3.78	2.72	.59	1-3/8
1	1	16U-A76	1-7/16-12	5.34	4.50	3.13	.76	1-5/8
1-1/4	1-1/4	20U-A80	1-11/16-12	5.31	5.09	3.00	1.01	1-7/8
1-1/4	1-1/2	20U-A84	2-12	5.31	5.54	3.00	1.01	2-1/4

Split Flange 90° Tube Elbow (SAE Code 61)

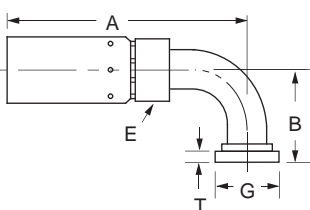

Hose I.D.	Tube Size	Part Number	Thread Size	A	B	Hose Cut-Off Factor	Hole Dia.	Sqaure E	Hex F
1/2	1/2	08U-G71	8x252	3.63	1.63	2.19	.41	1.19 (30mm)	.265
3/4	3/4	12U-G72	12x252	4.75	2.13	2.63	.58	1.50 (38mm)	.265
3/4	1	12U-G76	16x252	4.78	2.13	2.56	.58	1.75 (44mm)	.315
1	1	16U-G76	16x252	5.43	2.38	3.23	.77	1.75 (44mm)	.315
1	1-1/4	16U-G80	20x252	5.43	2.38	3.23	.77	2.00 (51mm)	.315
1-1/4	1-1/4	20U-G80	20x252	5.35	2.63	3.05	1.02	2.00 (51mm)	.315
1-1/4	1-1/2	20U-G84	24x252	5.37	2.63	3.05	1.02	2.38 (60mm)	.315

(For Split Flange Kits, see pages L-89 thru L-92.)

Coll-O-Crimp

430 'U' Series

To determine the correct length of hose, subtract the cut-off factor for each end fitting from the overall length of assembly.

Hose End 430 'U' Series

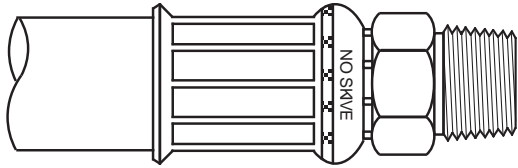

Note:

Refer to current price list for availability of cataloged items. Configurations and dimensions subject to change without notice.

Ordering Information: Order individually by part number. O-rings not supplied with split flange hose ends. Order o-rings by catalog number; reference individual hose end listings for details.

Refer to important safety information on pages A-2-3.

Application: Very high pressure hydraulic lines subjected to pressure surges and flexing. Some applications include mining, construction, farming, and high performance industrial equipment.

Compatible Hose: H039, H115, H145, H245, H425, H350, H430, H430R, H1812 (-24 only), H115 (-24 only),

H116 (-24 only), H6002 (-24 & -32 only), H6009, H1776 (-24 only), H9622, H6008

Pressure: Determined by maximum operating pressure for hose size and hose end configuration whichever is lesser. See pages A-15-16 for operating pressure ratings for hose end configurations.

Material: Low Carbon Steel

Plating: Zinc; Clear Trivalent Chromate

Advantages: Excellent selection of no-skive hose ends. Can be used with Caterpillar, John Deere, and many major manufacturers of heavy equipment.

Assemble With:

T-410-1, T-420-1, T-440-1, T-480, ET1000, ET4000, ET4001, ET4020 and ET4040

Label Set: FS-3100

Male Pipe (NPTF) Rigid

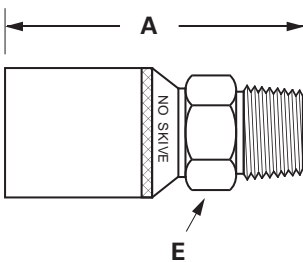

Hose I.D.	Pipe Size	Part Number	Thread Size	A	Hose Cut-Off Factor	Hole Dia.	Hex E
3/8	1/4	43006U-104	1/8-18	2.02	1.18	.26	11/16
3/8	3/8	43006U-106	3/8-18	2.11	1.28	.26	11/16
3/8	1/2	43006U-108	12-18	2.11	1.28	.26	7/8
1/2	1/2	43008U-108	1/2-14	3.56	1.69	.34	7/8
1/2	3/4	43008U-112	3/4-14	3.29	1.38	.34	1-1/16
5/8	1/2	43010U-108	1/2-18	2.61	1.58	.50	15/16
5/8	3/4	43010U-112	3/4-14	2.43	1.40	.50	1-1/16
3/4	3/4	43012U-112	3/4-14	3.68	1.69	.61	1-1/16
3/4	1	43012U-116	1-11-1/2	3.77	1.75	.61	1-3/8
1	3/4	43016U-112	3/4-14	3.86	1.81	.71	1-1/4
1	1	43016U-116	1-11-1/2	4.05	2.00	.81	1-3/8
1	1-1/4	43016U-120	1-1/4-11-1/2	4.08	2.06	.81	1-11/16
1-1/4	1-1/4	43020U-120	1-1/4-11-1/2	4.58	2.31	1.02	1-11/16
1-1/2	1-1/2	43024U-124	1-1/2-11-1/2	4.87	2.38	1.25	2
2	2	43032U-132	2-11-1/2	5.51	2.69	1.69	2-1/2

British Standard 60° Cone (BSPP) Male Pipe Rigid

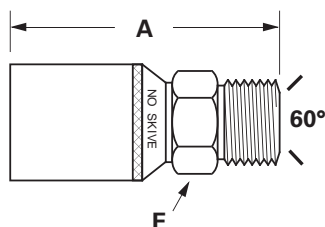

Hose I.D.	BSPP Pipe Size	Part Number	Thread Size	A	Hose Cut-Off Factor	Hole Dia.	Hex E
3/4	3/4	43012U-P62	G-3/4-14*	3.56	1.56	.61	1-1/8
1	1	43016U-P66	G-1-11*	3.73	1.69	.81	1-3/8
1-1/4	1-1/4	43020U-P67	G-1-1/4-11*	4.41	2.13	1.02	1-3/4

*G as part of thread size is ISO designation for parallel thread.

Hose Ends - Crimp

Coll-O-Crimp

430 'U' Series

To determine the correct length of hose, subtract the cut-off factor for each end fitting from the overall length of assembly.

FOR-SEAL Male Rigid

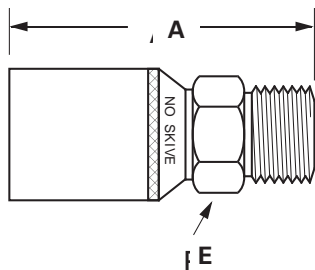

Hose I.D.	Tube Size	Part Number	Thread Size	A	Hose Cut-Off Factor	Hole Dia.	Hex E
3/8	3/8	43006U-E66	11/16-06	1.83	.99	.26	3/4
3/8	1/2	43006U-E68	13/16-16	1.79	.95	.26	7/8
1/2	1/2	43008U-E68	13/16-16	3.24	1.31	.34	7/8
3/4	3/4	43012U-E72	1-3/16-12	3.57	1.56	.61	1-1/4
1	1	43016U-E76	1-7/16-12	3.55	1.50	.81	1-1/2
1-1/4	1-1/4	43020U-E80	1-11/16-12	3.90	1.56	1.04	1-3/4

Does not include o-ring. For replacement o-ring, see page L-34.

Male Pipe Swivel

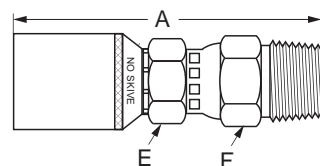

Hose I.D.	Tube Size	Part Number	Thread Size	A	Hose Cut-Off Factor	Hole Dia.	Hex E	Hex F
1	1	43016U-J16	1-11	5.02	3.00	.78	1-1/4	1-3/8

Note:

Swivel for installation purposes only. (Not for temperatures above 212°F.)

SAE 37° Male Rigid

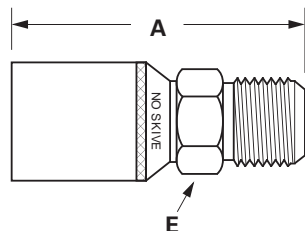

Hose I.D.	Tube Size	Part Number	Thread Size	A	Hose Cut-Off Factor	Hole Dia.	Hex E
3/8	3/8	43006U-506	9/16-18	2.00	1.17	.26	11/16
3/8	1/2	43006U-508	3/4-16	1.94	1.11	.26	13/16
1/2	1/2	43008U-508	3/4-16	3.50	1.63	.34	7/8
1/2	5/8	43008U-510	7/8-14	3.30	1.38	.34	1
5/8	5/8	43010U-510	7/8-14	2.60	1.57	.50	15/16
5/8	3/4	43010U-512	1-1/16-12	2.46	1.43	.50	1-1/8
3/4	3/4	43012U-512	1-1/16-12	3.74	1.75	.61	1-1/8
3/4	7/8	43012U-514	1-3/16-12	3.81	1.81	.61	1-1/4
3/4	1	43012U-516	1-5/16-12	4.02	2.06	.61	1-3/8
1	1	43016U-516	1-5/16-12	4.02	2	.81	1-3/8
1	1-1/4	43016U-520	1-5/8-12	3.84	1.81	.81	1-11/16
1-1/4	1-1/4	43020U-520	1-5/8-12	4.57	2.31	1.02	1-11/16
1-1/2	1-1/2	43024U-524	1-7/8-12	4.95	2.50	1.25	2
2	2	43032U-532	2-1/2-12	5.57	2.75	1.69	2-5/8

Male Straight Thread O-Ring Rigid

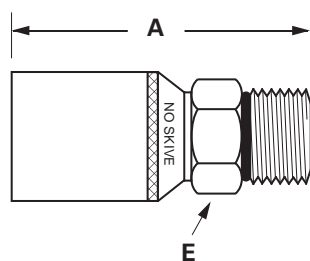

Hose I.D.	Tube Size	Part Number	Thread Size	A	Hose Cut-Off Factor	Hole Dia.	Hex E
3/8	3/8	43006U-P06	9/16-18	1.84	1.00	.26	11/16
3/8	1/2	43006U-P08	3/4-16	1.81	.98	.26	7/8
5/8	3/4	43010U-P12	1-1/16-12	2.26	1.23	.50	1-1/4
1	1	43016U-P16	1-5/16-12	3.45	1.44	.81	1-1/2

(Includes o-ring)

(Includes o-ring. For replacement o-ring, see page L-64.)

J
Hose Ends - Crimp

Coll-O-Crimp

430 'U' Series

To determine the correct length of hose, subtract the cut-off factor for each end fitting from the overall length of assembly.

^a Swivel nuts are universal — both SAE 37° and 45° connections.

JIC 37° Female Swivel

(Exceptions noted)

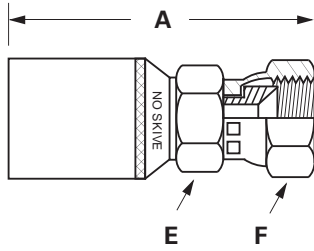

Hose I.D.	Tube Size	Part Number	Thread Size	A	Hose Cut-Off Factor	Hole Dia.	Hex E	Hex F
3/8	1/4	43006U-604	7/16-20	2.03	1.19	.17	11/16	9/16
3/8	3/8	43006U-606	9/16-18	2.12	1.28	.26	9/16	9/16
3/8	1/2	43006U-608	3/4-16	2.15	1.31	.26	11/16	7/8
1/2	3/8	43008U-606	9/16-18	3.56	1.69	.34	13/16	11/16
1/2	1/2	43008U-608 ^a	3/4-16	3.67	1.75	.34	13/16	7/8
1/2	5/8	43008U-610 ^a	7/8-14	3.72	1.81	.34	13/16	1
1/2	3/4	43008U-612	1-1/16-12	3.76	1.88	.34	1	1-1/4
5/8	5/8	43010U-610	7/8-14	2.64	1.61	.50	15/16	1
3/4	5/8	43012U-610	7/8-14	3.97	1.97	.61	1	1
5/8	3/4	43010U-612	1-1/16-12	2.59	1.57	.50	1	1-1/4
3/4	3/4	43012U-612	1-1/16-12	4.08	2.06	.61	1	1-1/4
3/4	7/8	43012U-614	1-3/16-12	3.90	1.88	.61	1-1/4	1-3/8
3/4	1	43012U-616	1-5/16-12	4.01	2.00	.61	1-1/4	1-1/2
1	3/4	43016U-612	1-1/16-12	4.19	2.19	.61	1-1/4	1-1/4
1	1	43016U-616	1-5/16-12	4.28	2.25	.81	1-1/4	1-1/2
1	1-1/4	43016U-620	1-5/8-12	4.12	2.06	.81	1-5/8	2
1-1/4	1-1/4	43020U-620	1-5/8-12	4.87	2.63	1.02	1-11/16	2
1-1/4	1-1/2	43020U-624	1-7/8-12	5.03	2.75	1.02	1-7/8	2-1/4
1-1/2	1-1/2	43024U-624	1-7/8-12	5.29	2.81	1.25	2	2-1/4
2	2	43032U-632	2-1/2-12	6.04	3.25	1.69	2-1/2	3

Female Swivel DIN Universal Seat

I. Rh. (Light) (DIN 3901/3902)

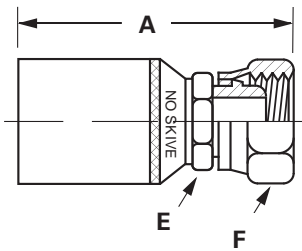

Hose I.D.	Tube Size (mm)	Part Number	Thread Size	A	Hose Cut-Off Factor	Hole Dia.	Hex E	Hex F
3/4	22	43012U-22C	M30x2.0	4.12	2.13	.61	1-1/8	1-7/16

Female Swivel DIN 24° Seat

s. Rh. DKO (Heavy)

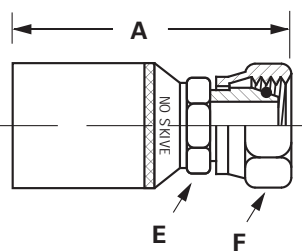

Hose I.D.	Tube Size (mm)	Part Number	Thread Size	A	Hose Cut-Off Factor	Hole Dia.	Hex E	Hex F
3/4	20	43012U-70C	M30x2.0	3.68	1.69	.61	1-1/8	1-7/16
3/4	25	43012U-75C	M36x2.0	4.14	2.13	.61	1-1/4	1-5/8
1	30	43016U-80C	M42x2.0	4.07	2.00	.81	1-5/8	2
1-1/4	30	43020U-80C	M42x2.0	4.32	2.00	1.02	1-5/8	2

(Includes o-ring)

Hose Ends - Crimp

Coll-O-Crimp

430 'U' Series

To determine the correct length of hose, subtract the cut-off factor for each end fitting from the overall length of assembly.

Female Swivel 30° Flare Metric Thread

(Komatsu, Linkbelt, etc.)

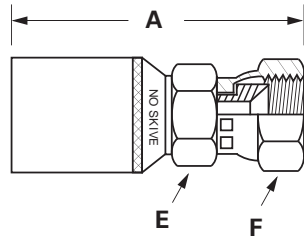

Hose I.D.	Part Number	Thread Size	A	Hose Cut-Off Factor	Hole Dia.	Hex E	Hex F
1/2	43008U-22K	M22x1.5	3.72	1.81	.34	7/8	1
3/4	43012U-30K	M30x1.5	3.96	1.94	.61	1-1/8	1-3/8
1	43016U-33K	M33x1.5	4.27	2.25	.81	1-1/4	1-1/2
1-1/4	43020U-36K	M36x1.5	5.19	2.88	.92	1-5/8	1-3/4

British Standard (BSPP) 60° Cone Female Pipe Swivel

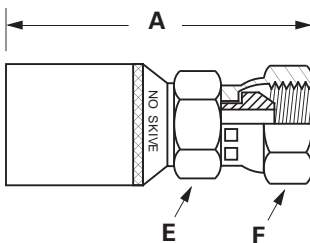

Hose I.D.	BSPP Pipe Size	Part Number	Thread Size	A	Hose Cut-Off Factor	Hole Dia.	Hex E	Hex F
1/2	1/2	43008U-358	G-1/2-14*	3.78	1.88	.34	7/8	1-1/16
3/4	3/4	43012U-362	G-3/4-14*	4.09	2.06	.61	1	1-1/4
1	1	43016U-366	G-1-11*	4.29	2.25	.81	1-1/4	1-1/2
1-1/4	1-1/4	43020U-370	G-1-1/4-11*	4.76	2.50	1.02	1-5/8	1-7/8

*G as part of thread size is ISO designation for parallel thread.

Female FOR-SEAL® Swivel Straight

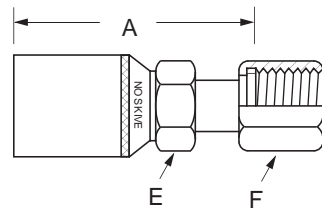

Hose I.D.	Tube Size	Part Number	Thread Size	A	Hose Cut-Off Factor	Hole Dia.	Hex E	Hex F
3/8	1/4	43006U-S64	9/16-18	1.98	1.15	.17	11/16	11/16
3/8	3/8	43006U-S66	11/16-16	2.07	1.24	.26	11/16	13/16
3/8	1/2	43006U-S68	13/16-16	2.16	1.32	.26	13/16	15/16
1/2	1/2	43008U-S68	13/16-16	3.30	1.42	.34	13/16	15/16
1/2	5/8	43008U-S70	1-14	3.40	1.52	.34	15/16	1-1/8
5/8	1/2	43010U-S68	13/16-16	2.54	1.51	.38	15/16	15/16
5/8	5/8	43010U-S70	1-14	2.63	1.61	.48	15/16	1-1/8
5/8	3/4	43010U-S72	1-3/16-12	2.66	1.63	.50	1-1/8	1-3/8
3/4	5/8	43012U-S70	1-14	4.06	2.06	.45	1	1-1/8
3/4	3/4	43012U-S72	1-3/16-12	3.85	2.09	.61	1-1/8	1-3/8
3/4	1	43012U-S76	1-7/16-12	4.15	2.13	.55	1	1-5/8
1	1	43016U-S76	1-7/16-12	4.68	2.69	.76	1-1/4	1-5/8
1	1-1/4	43016U-S80	1-11/16-12	4.33	2.31	.81	1-1/2	1-7/8
1-1/4	1-1/4	43020U-S80	1-11/16-12	4.51	2.25	1.02	1-5/8	1-7/8
1-1/2	1-1/2	43024U-S84	2-12	4.77	2.31	1.25	2	2-1/4

READY-LOK Male Connector

(For Deep Mining Markets)

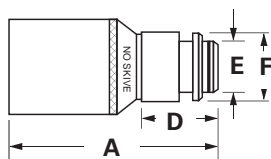

Hose I.D.	Connection Size	Part Number	A	Hose Cut-Off Factor	Hole Dia.	Length D	Dia. E	Dia. F
3/8	3/8	43006U-06S	2.14	1.30	.26	1.04	.55	.78
3/8	1/2	43006U-08S	2.14	1.30	.26	1.04	.71	.94
1/2	1/2	43008U-08S	3.31	1.43	.34	.94	.70	.94
3/4	3/4	43012U-12S	3.53	1.50	.61	1.14	.94	1.14
1	1	43016U-16S	3.76	1.75	.81	1.34	1.21	1.53
1-1/4	1-1/4	43020U-20S	4.01	1.75	1.02	1.34	1.49	1.80
1-1/2	1-1/2	43024U-24S	5.06	2.59	1.25	2.51	1.85	2.17

Hose Ends - Crimp

Coll-O-Crimp

430 'U' Series

To determine the correct length of hose, subtract the cut-off factor for each end fitting from the overall length of assembly.

Split Flange Straight

(SAE Code 61)

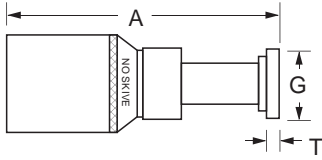

Hose I.D.	Nominal Flange Size	Part Number	Replacement O-Ring (Not Included)	A	Hose Cut-Off Factor	Hole Dia.	Dia. G	T Nominal
1/2	1/2	43008U-G08	8x252	4.18	2.25	.34	1.19 (30 mm)	.265
1/2	3/4	43008U-G12	12x252	4.24	2.31	.34	1.50 (38 mm)	.265
3/4	3/4	43012U-G12	12x252	4.16	2.13	.56	1.50 (38 mm)	.265
3/4	1	43012U-G16	16x252	4.16	2.13	.56	1.75 (44 mm)	.315
3/4	1-1/4	43012U-G20	20x252	4.16	2.13	.56	2.00 (51 mm)	.315
5/8	3/4	43010U-G12	12x252	3.13	2.10	.50	1.50 (38 mm)	.265
1	1	43016U-G16	16x252	4.40	2.38	.76	1.75 (44 mm)	.315
1	1-1/4	43016U-G20	20x252	4.40	2.38	.76	2.00 (51 mm)	.315
1	1-1/2	43016U-G24	24x252	4.46	2.44	.76	2.38 (60 mm)	.315
1-1/4	1-1/4	43020U-G20	20x252	5.01	2.75	1.02	2.00 (51 mm)	.315
1-1/4	1-1/2	43020U-G24	24x252	5.07	2.81	1.02	2.38 (60 mm)	.315
1-1/4	1-1/2	43020U-G24L64	24x252	9.60	7.31	1.01	2.38 (60 mm)	.315
1-1/4	2	43020U-G32	32x252	5.13	2.88	1.02	2.81 (71 mm)	.375
1-1/2	1-1/2	43024U-G24	24x252	5.63	3.13	1.25	2.38 (60 mm)	.315
1-1/2	2	43024U-G32	32x252	5.83	3.31	1.25	2.81 (71 mm)	.375
2	1-1/2	43032U-G24	24x252	6.23	3.38	1.56	2.38 (60 mm)	.315
2	2	43032U-G32	32x252	6.08	3.25	1.56	2.81 (71 mm)	.375

(For Split Flange Kits, see pages L-89 thru L-92.)

Split Flange Straight

(SAE Code 62)

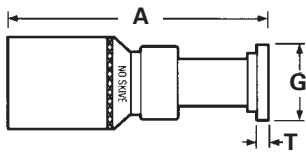

Hose I.D.	Nominal Flange Size	Part Number	Replacement O-Ring (Not Included)	A	Hose Cut-Off Factor	Hole Dia.	Dia. G	T Nominal
1/2	1/2	43008U-D08	8x252	4.25	2.38	.34	1.25 (32 mm)	.345
1/2	3/4	43008U-D12	12x252	4.27	2.38	.34	1.62 (41 mm)	.345
5/8	3/4	43010U-D12	12x252	3.13	2.11	.50	1.62 (41 mm)	.345
3/4	3/4	43012U-D12	12x252	4.19	2.19	.56	1.62 (41 mm)	.345
3/4	1	43012U-D16	16x252	4.22	2.19	.56	1.88 (48 mm)	.375
1	1	43016U-D16	16x252	4.46	2.44	.76	1.88 (48 mm)	.375
1	1-1/4	43016U-D20	20x252	4.49	2.44	.76	2.12 (54 mm)	.405
1-1/4	1-1/4	43020U-D20	20x252	5.10	2.81	1.02	2.12 (54 mm)	.405
1-1/4	1-1/2	43020U-D24	24x252	5.21	2.94	1.02	2.50 (64 mm)	.495
1-1/2	1-1/2	43024U-D24	24x252	5.63	3.13	1.25	2.50 (64 mm)	.495
2	2	43032U-D32	32x252	7.18	4.38	1.56	3.12 (79 mm)	.495

(For Split Flange Kits, see pages L-89 thru L-92.)

British Standard 60° Cone (BSPP) Female Swivel 45° Tube Elbow

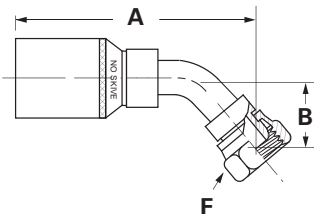

Hose I.D.	Tube Size	Part Number	Thread Size	A	B	Hose Cut-Off Factor	Hole Dia.	Hex F
3/4	3/4	43012U-52P	G-3/4-14*	5.33	1.24	3.31	.56	1-1/4
1	1	43016U-56P	G-1-11*	5.21	1.46	3.19	.76	1-1/2

*G as part of thread size is ISO designation for parallel thread.

Coll-O-Crimp

430 'U' Series

To determine the correct length of hose, subtract the cut-off factor for each end fitting from the overall length of assembly.

^a Swivel nuts are universal – both SAE 37° and 45° connections.

Split Flange 22-1/2° Tube Elbow

(SAE Code 61)

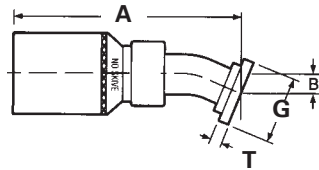

Hose I.D.	Nominal Flange Size	Part Number	Replacement O-Ring (Not Included)	A	B	Hose Cut-Off Factor	Hole Dia.	Dia. G	T Nominal
1/2	1/2	43008U-H01	8x252	4.45	.38	2.56	.34	1.19 (30mm)	.265
1/2	3/4	43008U-H02	12x252	4.50	.40	2.63	.34	1.50 (38mm)	.265
3/4	3/4	43012U-H02	12x252	4.81	.44	2.81	.56	1.50 (38mm)	.265
3/4	1	43012U-H03	16x252	4.81	.44	2.81	.56	1.75 (44mm)	.315
1	1	43016U-H03	16x252	5.09	.45	3.06	.76	1.75 (44mm)	.315
1	1-1/4	43016U-H04	20x252	6.15	.45	3.07	.76	2.00 (51mm)	.315
1-1/4	1-1/4	43020U-H04	20x252	5.21	.50	2.94	1.02	2.00 (51mm)	.315
1-1/4	1-1/2	43020U-H05	24x252	5.21	.50	2.94	1.02	2.38 (60mm)	.315
1-1/2	1-1/2	43024U-H05	24x252	6.16	.63	3.69	1.25	2.38 (60mm)	.315
1-1/2	2	43024U-H06	32x252	6.15	.63	3.69	1.25	2.81 (71mm)	.375
2	2	43032U-H06	32x252	7.67	.94	4.88	1.56	2.81 (71mm)	.375

(For Split Flange Kits, see pages L-89 thru L-92.)

JIC 37° Female Swivel 45° Tube Elbow

(Refer to Footnotes)

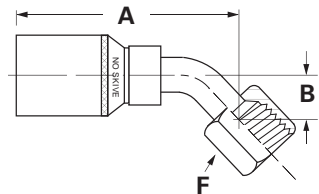

Hose I.D.	Tube Size	Part Number	Thread Size	A	B	Hose Cut-Off Factor	Hole Dia.	Hex F
3/8	3/8	43006U-686	9/16-18	2.82	.85	1.98	.24	11/16
3/8	1/2	43006U-688	3/4-16	2.98	.95	2.14	.26	7/8
1/2	1/2	43008U-688 ^a	3/4-16	4.08	.55	2.19	.34	7/8
1/2	5/8	43008U-690 ^a	7/8-14	4.28	.63	2.38	.34	1
3/4	3/4	43012U-692	1-1/16-12	4.70	.78	2.69	.56	1-1/4
1	1	43016U-696	1-5/16-12	5.67	1.53	3.84	.76	1-1/2
1-1/4	1-1/4	43020U-697	1-5/8-12	5.77	1.64	3.45	1.01	2

Split Flange 30° Tube Elbow

(SAE Code 61)

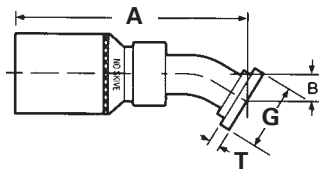

Hose I.D.	Nominal Flange Size	Part Number	Replacement O-Ring (Not Included)	A	B	Hose Cut-Off Factor	Hole Dia.	Dia. G	T Nominal
1/2	1/2	43008U-H21	8x252	4.40	.50	2.50	.34	1.19 (30mm)	.265
1/2	3/4	43008U-H22	12x252	4.45	.53	2.56	.34	1.50 (38mm)	.265
3/4	3/4	43012U-H22	12x252	4.75	.59	2.75	.56	1.50 (38mm)	.265
3/4	1	43012U-H23	16x252	4.75	.59	2.75	.56	1.75 (44mm)	.315
1	1	43016U-H23	16x252	5.09	.64	3.06	.76	1.75 (44mm)	.315
1	1-1/4	43016U-H24	20x252	5.01	.64	3.00	.76	2.00 (51mm)	.315
1-1/4	1-1/4	43020U-H24	20x252	5.33	.72	3.06	1.02	2.00 (51mm)	.315
1-1/4	1-1/2	43020U-H25	24x252	5.38	.75	3.13	1.02	2.38 (60mm)	.315
1-1/2	1-1/2	43024U-H25	24x252	6.33	.91	3.81	1.25	2.38 (60mm)	.315
1-1/2	2	43024U-H26	32x252	6.50	1.01	4.00	1.25	2.81 (71mm)	.375
2	2	43032U-H26	32x252	7.88	1.31	5.44	1.56	2.81 (71mm)	.375

(For Split Flange Kits, see pages L-89 thru L-92.)

Female FOR-SEAL Swivel 45° Tube Elbow

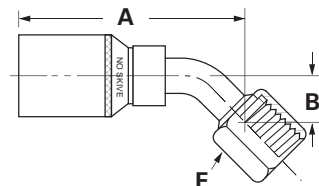

Hose I.D.	Tube Size	Part Number	Thread Size	A	B	Hose Cut-Off Factor	Hole Dia.	Hex F
3/8	3/8	43006U-L66	11/16-16	2.27	.43	1.43	.26	13/16
3/8	1/2	43006U-L68	13/16-16	2.58	.59	1.74	.26	15/16
1/2	1/2	43008U-L68	13/16-16	4.16	.59	2.25	.34	15/16
1/2	5/8	43008U-L70	1-14	4.48	.65	2.56	.34	1-1/8
5/8	5/8	43010U-L70	1-14	3.05	.65	2.02	.45	1-1/8
3/4	3/4	43012U-L72	1-3/16-12	4.80	.84	2.81	.56	1-3/8
1	1	43016U-L76	1-7/16-12	5.11	.95	3.06	.76	1-5/8
1-1/4	1-1/4	43020U-L80	1-11/16-12	5.07	1.05	2.85	1.01	1-7/8
1-1/2	1-1/2	43024U-L84	2-12	5.98	1.07	3.50	1.25	2-1/4

To determine the correct length of hose, subtract the cut-off factor for each end fitting from the overall length of assembly.

JIC 37° Female Swivel 60° Tube Elbow

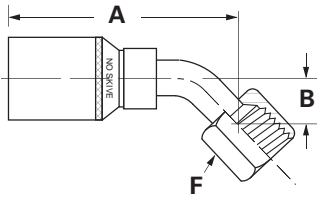

Hose I.D.	Tube Size	Part Number	Thread Size	A	B	Hose Cut-Off Factor	Hole Dia.	Hex F
1/2	5/8	43008U-C60	7/8-14	4.48	1.00	2.63	.34	1
3/4	3/4	43012U-C62	1-1/16-12	5.12	1.71	3.13	.56	1-1/4
1	1	43016U-C66	1-5/16-12	5.74	1.53	3.69	.76	1-1/2

Split Flange 45° Tube Elbow (SAE Code 61)

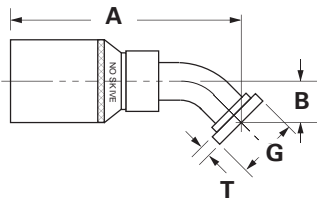

Hose I.D.	Nominal Flange Size	Part Number	Replacement O-Ring (Not Included)	A	B	Hose Cut-Off Factor	Hole Dia.	Dia. G	T Nominal
1/2	1/2	43008U-G41	8x252	4.51	.78	2.63	.34	1.19 (30 mm)	.265
1/2	3/4	43008U-G42	12x252	4.55	.82	2.63	.34	1.50 (38 mm)	.265
1/2	1	43008U-G46	16x252	4.86	.82	3.00	.34	1.75 (44 mm)	.315
5/8	3/4	43010U-G42	12x252	3.56	1.00	2.53	.50	1.50 (38 mm)	.265
3/4	3/4	43012U-G42	12x252	4.92	1.00	2.94	.56	1.50 (38 mm)	.265
3/4	1	43012U-G46	16x252	4.92	1.00	2.94	.56	1.75 (44 mm)	.315
1	1	43016U-G46	16x252	4.64	.89	2.62	.76	1.75 (44 mm)	.315
1	1-1/4	43016U-G50	20x252	4.82	1.06	2.81	.76	2.00 (51 mm)	.315
1-1/4	1-1/4	43020U-G50	20x252	5.22	1.09	2.90	1.01	2.00 (51 mm)	.315
1-1/4	1-1/2	43020U-G54	24x252	5.14	1.09	2.90	1.01	2.38 (60 mm)	.315
1-1/2	1-1/2	43024U-G54	24x252	6.39	1.41	3.93	1.25	2.38 (60 mm)	.315
1-1/2	2	43024U-G62	32x252	6.39	1.41	3.93	1.25	2.81 (71 mm)	.375
2	2	43032U-G62	32x252	8.04	2.00	5.23	1.56	2.81 (79 mm)	.375

(For Split Flange Kits, see pages L-89 thru L-92.)

Split Flange 45° Tube Elbow (SAE Code 62)

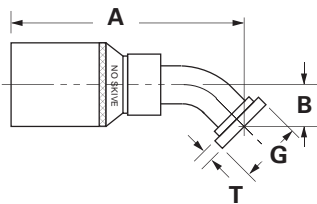

Hose I.D.	Nominal Flange Size	Part Number	Replacement O-Ring (Not Included)	A	B	Hose Cut-Off Factor	Hole Dia.	Dia. G	T Nominal
1/2	1/2	43008U-D41	8x252	4.82	.94	2.94	.34	1.25 (32 mm)	.345
1/2	3/4	43008U-D42	12x252	4.82	1.00	2.94	.34	1.62 (41 mm)	.345
3/4	3/4	43012U-D42	12x252	5.19	1.27	3.19	.56	1.62 (41 mm)	.345
3/4	1	43012U-D46	16x252	5.21	1.29	3.19	.56	1.88 (48 mm)	.375
1	1	43016U-D46	16x252	5.57	1.34	3.56	.76	1.88 (48 mm)	.375
1	1-1/4	43016U-D50	20x252	5.56	1.44	3.50	.76	2.12 (54 mm)	.405
1-1/4	1-1/4	43020U-D50	20x252	6.60	1.68	4.31	1.01	2.12 (54 mm)	.405
1-1/4	1-1/2	43020U-D54	24x252	6.67	1.75	4.38	1.01	2.50 (64 mm)	.495
1-1/2	1-1/2	43024U-D54	24x252	7.25	1.86	4.75	1.25	2.50 (64 mm)	.495
2	2	43032U-D62	32x252	8.74	2.25	5.94	1.56	3.12 (79 mm)	.495

(For Split Flange Kits, see pages L-89 thru L-92.)

Split Flange 60° Tube Elbow (SAE Code 61)

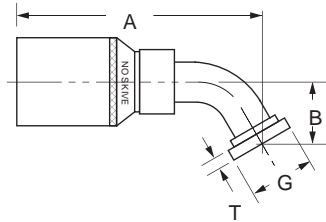

Hose I.D.	Nominal Flange Size	Part Number	Replacement O-Ring (Not Included)	A	B	Hose Cut-Off Factor	Hole Dia.	Dia. G	T Nominal
1/2	1/2	43008U-H51	8x252	4.59	1.05	2.69	.34	1.19 (30 mm)	.265
1/2	3/4	43008U-H52	12x252	4.62	1.10	2.75	.34	1.50 (38 mm)	.265
3/4	3/4	43012U-H52	12x252	4.98	1.38	2.94	.56	1.50 (38 mm)	.265
3/4	1	43012U-H53	16x252	4.98	1.38	2.94	.56	1.75 (44 mm)	.315
1	1	43016U-H53	16x252	5.47	1.51	3.44	.76	1.75 (44 mm)	.315
1	1-1/4	43016U-H54	20x252	5.58	1.51	3.56	.76	2.00 (51 mm)	.315
1-1/4	1-1/4	43020U-H54	20x252	5.57	1.69	3.31	1.01	2.00 (51 mm)	.315
1-1/4	1-1/2	43020U-H55	24x252	5.57	1.66	3.30	1.01	2.38 (60 mm)	.315
1-1/2	1-1/2	43024U-H55	24x252	6.51	2.08	4.00	1.25	2.38 (60 mm)	.315
1-1/2	2	43024U-H56	32x252	6.61	2.25	4.13	1.25	2.81 (71 mm)	.375
2	2	43032U-H56	32x252	8.19	2.87	5.38	1.56	2.81 (71 mm)	.375

(For Split Flange Kits, see pages L-89 thru L-92.)

Split Flange 67-1/2° Tube Elbow (SAE Code 61)

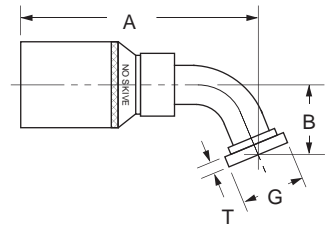

Hose I.D.	Nominal Flange Size	Part Number	Replacement O-Ring (Not Included)	A	B	Hose Cut-Off Factor	Hole Dia.	Dia. G	T Nominal
1/2	1/2	43008U-H61	8x252	4.40	1.25	2.50	.34	1.19 (30 mm)	.265
1/2	3/4	43008U-H62	12x252	4.46	1.25	2.56	.34	1.50 (38 mm)	.265
1/2	1	43008U-H63	16x252	4.69	1.25	2.81	.34	1.75 (44 mm)	.315
3/4	3/4	43012U-H62	12x252	4.99	1.59	3.00	.56	1.50 (38 mm)	.265
3/4	1	43012U-H63	16x252	4.99	1.59	3.00	.56	1.75 (44 mm)	.315
3/4	1-1/4	43012U-H64	20x252	4.99	1.59	3.00	.56	2.00 (51 mm)	.315
1	1	43016U-H63	16x252	5.25	1.76	3.19	.76	1.75 (44 mm)	.315
1	1-1/4	43016U-H64	20x252	5.25	1.76	3.19	.76	2.00 (51 mm)	.315
1-1/4	1-1/4	43020U-H64	20x252	5.55	1.94	3.25	1.01	2.00 (51 mm)	.315
1-1/4	1-1/2	43020U-H65	24x252	5.57	2.00	3.30	1.01	2.38 (60 mm)	.315
1-1/2	1-1/2	43024U-H65	24x252	6.53	2.37	4.07	1.25	2.38 (60 mm)	.315
1-1/2	2	43024U-H66	32x252	6.53	2.37	4.07	1.25	2.81 (71 mm)	.375
2	2	43032U-H66	32x252	8.39	3.40	5.56	1.56	2.81 (71 mm)	.375

(For Split Flange Kits, see pages L-89 thru L-92.)

British Standard (BSPP) 60° Cone Female Pipe Swivel 90° Elbow

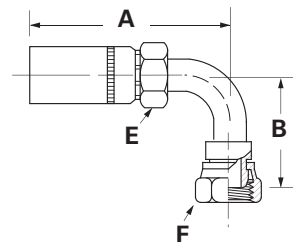

Hose I.D.	BSPP Size	Part Number	Thread Size	A	B	Hose Cut-Off Factor	Hole Dia.	Hex E	Hex F
3/4	3/4	43012U-82P	G-3/4-14*	4.58	2.46	2.97	.56	1-1/8	1-1/4
1	1	43016U-86P	G-1-11*	4.77	3.09	2.75	.76	1-1/4	1-1/2

*G as part of thread size is ISO designation for parallel thread.

Coll-O-Crimp

430 'U' Series

To determine the correct length of hose, subtract the cut-off factor for each end fitting from the overall length of assembly.

Swivel nuts are universal — both SAE 37° and 45° connections.

JIC 37° Female Swivel 90° Tube Elbow

(Refer to Footnotes)

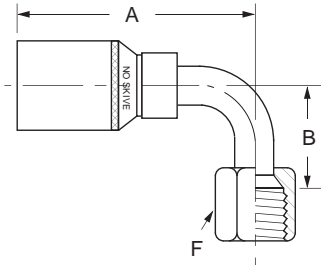

Hose I.D.	Tube Size	Part Number	Thread Size	A	B	Hose Cut-Off Factor	Hole Dia.	Hex F
3/8	3/8	43006U-666	9/16-18	2.26	1.50	1.42	.24	11/16
3/8	3/8	43006U-646	9/16-18	2.26	2.73	1.42	.24	11/16
3/8	1/2	43006U-668	3/4-16	2.55	1.87	1.71	.26	7/8
1/2	1/2	43008U-648L36 ^a	3/4-16	4.04	3.60	2.13	.34	7/8
1/2	1/2	43008U-648L45 ^a	3/4-16	4.04	4.50	2.13	.34	7/8
1/2	1/2	43008U-668 ^a	3/4-16	3.85	1.09	1.94	.34	7/8
1/2	5/8	43008U-650 ^a	7/8-14	4.14	2.57	2.25	.34	1
1/2	5/8	43008U-670 ^a	7/8-14	4.11	1.23	2.19	.34	1
5/8	5/8	43010U-670	7/8-14	2.94	1.52	1.91	.45	1
5/8	3/4	43010U-672	1-1/16-12	3.20	2.35	2.18	.50	1-1/4
3/4	3/4	43012U-652	1-1/16-12	4.65	3.62	2.63	.56	1-1/4
3/4	3/4	43012U-672	1-1/16-12	4.65	2.50	2.63	.56	1-1/4
1	1	43016U-656L33	1-5/16-12	5.00	3.37	3.00	.76	1-1/2
1	1	43016U-656L56	1-5/16-12	5.00	5.62	3.00	.76	1-1/2
1	1	43016U-676	1-5/16-12	5.27	3.00	3.25	.76	1-1/2
1	1	43016U-676L22	1-5/16-12	4.83	2.22	2.81	.76	1-1/2
1-1/4	1-1/4	43020U-677 ⁺	1-5/8-12	5.21	3.34	2.99	1.01	2
1-1/2	1-1/2	43024U-678 ⁺	1-7/8-12	6.11	3.95	3.62	1.19	2-1/4

+ Crimp style swivel nut.

Female FOR-SEAL® Swivel 90° Short Drop Tube Elbow

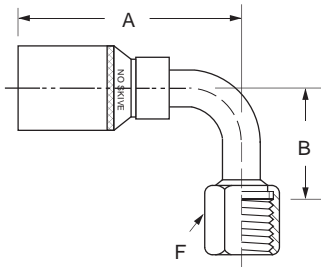

Hose I.D.	Tube Size	Part Number	Thread Size	A	B	Hose Cut-Off Factor	Hole Dia.	Hex F
3/8	3/8	43006U-A26	11/16-16	2.18	.90	1.34	.26	13/16
3/8	1/2	43006U-A28	13/16-16	2.46	1.15	1.62	.26	15/16
1/2	1/2	43008U-A28	13/16-16	3.90	1.15	2.00	.34	15/16
1/2	5/8	43008U-A30	1-14	4.21	1.27	2.31	.34	1-1/8
5/8	5/8	43010U-A30	1-14	2.94	1.27	1.91	.45	1-1/8
5/8	3/4	43010U-A32	1-3/16-12	3.31	1.88	2.29	.50	1-3/8
3/4	5/8	43012U-A30	1-14	4.24	1.27	2.25	.46	1-1/8
3/4	3/4	43012U-A32	1-3/16-12	4.78	1.88	2.75	.56	1-3/8
1	1	43016U-A36	1-7/16-12	4.95	2.21	2.93	.76	1-5/8
1-1/4	1-1/4	43020U-A40	1-11/16-12	5.26	2.51	3.00	1.02	1-7/8
1-1/4	1-1/2	43020U-A44	2-12	5.26	2.55	3.00	1.01	2-1/4
1-1/2	1-1/2	43024U-A44	2-12	6.11	2.70	3.63	1.25	2-1/4

Female FOR-SEAL® Swivel Long Drop 90° Tube Elbow

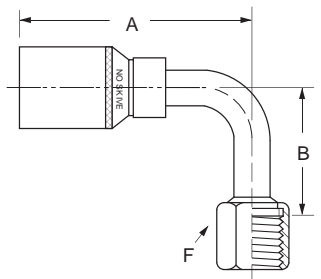

Hose I.D.	Tube Size	Part Number	Thread Size	A	B	Hose Cut-Off Factor	Hole Dia.	Hex F
3/8	3/8	43006U-A66	11/16-16	2.18	2.13	1.34	.26	13/16
3/8	1/2	43006U-A68	13/16-16	2.55	2.50	1.71	.26	15/16
1/2	1/2	43008U-A68	13/16-16	4.32	2.51	2.44	.34	15/16
1/2	5/8	43008U-A70	1-14	4.61	2.76	2.75	.34	1-1/8
3/4	3/4	43012U-A72	1-3/16-12	4.73	3.78	2.75	.56	1-3/8
1	1	43016U-A76	1-7/16-12	5.16	4.50	3.13	.76	1-5/8
1-1/4	1-1/4	43020U-A80	1-11/16-12	5.26	5.09	3.00	1.01	1-7/8
1-1/4	1-1/2	43020U-A84	2-12	5.26	5.54	3.00	1.01	2-1/4
1-1/2	1-1/2	43024U-A84	2-12	6.11	5.54	3.63	1.25	2-1/4

Hose Ends - Crimp

Coll-O-Crimp

430 'U' Series

To determine the correct length of hose, subtract the cut-off factor for each end fitting from the overall length of assembly.

Split Flange 90° Tube Elbow (SAE Code 61)

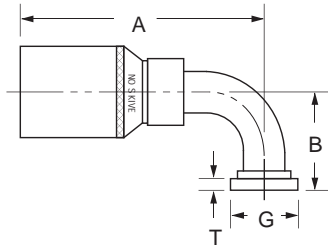

Hose I.D.	Nominal Flange Size	Part Number	Replacement O-Ring (Not Included)	A	B	Hose Cut-Off Factor	Hole Dia.	Dia. G	T Nominal
1/2	1/2	43008U-G71	8x252	4.18	1.63	2.25	.34	1.19 (30 mm)	.265
1/2	1/2	43008U-G71L32	8x252	4.04	3.20	2.13	.34	1.19 (30 mm)	.265
1/2	3/4	43008U-G72	12x252	4.53	1.68	2.63	.34	1.50 (38 mm)	.265
1/2	1	43008U-G76	16x252	4.63	1.68	2.75	.34	1.75 (44 mm)	.315
5/8	3/4	43010U-G72	12x252	3.31	2.13	2.29	.50	1.50 (38 mm)	.265
3/4	3/4	43012U-G72	12x252	4.65	2.12	2.63	.56	1.50 (38 mm)	.265
3/4	3/4	43012U-G72L37	12x252	4.65	3.75	2.63	.56	1.50 (38 mm)	.265
3/4	3/4	43012U-G72L50	12x252	4.74	5.00	2.75	.56	1.50 (38 mm)	.265
3/4	1	43012U-G76	16x252	4.65	2.12	2.63	.56	1.75 (44 mm)	.315
3/4	1	43012U-G76L31	16x252	4.65	3.12	2.63	.56	1.75 (44 mm)	.315
3/4	1-1/4	43012U-G80	20x252	5.65	2.12	3.63	.56	2.00 (51 mm)	.315
1	1	43016U-G76	16x252	5.25	2.38	3.23	.76	1.75 (44 mm)	.315
1	1	43016U-G76L21	16x252	5.06	2.12	3.06	.76	1.75 (44 mm)	.315
1	1	43016U-G76L46	16x252	5.15	4.62	3.13	.76	1.75 (44 mm)	.315
1	1-1/4	43016U-G80	20x252	5.21	2.38	2.94	.76	2.00 (51 mm)	.315
1	1-1/4	43016U-G80L46	20x252	5.12	4.62	3.13	.76	2.00 (51 mm)	.315
1	1-1/2	43016U-G84	24x252	5.15	2.44	3.13	.76	2.38 (60 mm)	.315
1-1/4	1-1/4	43020U-G80	20x252	5.32	2.63	3.05	1.01	2.00 (51 mm)	.315
1-1/4	1-1/4	43020U-G80L31	20x252	5.32	3.00	3.05	1.02	2.00 (51 mm)	.315
1-1/4	1-1/4	43020U-G80L40	20x252	5.26	4.00	3.00	1.02	2.00 (51 mm)	.315
1-1/4	1-1/4	43020U-G80L51	20x252	5.32	5.13	3.05	1.02	2.00 (51 mm)	.315
1-1/4	1-1/4	43020U-G80L66	20x252	5.26	6.62	3.00	1.02	2.00 (51 mm)	.315
1-1/4	1-1/2	43020U-G84	24x252	5.37	2.63	3.05	1.01	2.38 (60 mm)	.315
1-1/4	1-1/2	43020U-G84L46	24x252	5.26	4.68	3.00	1.02	2.38 (60 mm)	.315
1-1/2	1-1/2	43024U-G84	24x252	6.03	3.12	3.73	1.25	2.38 (60 mm)	.315
1-1/2	1-1/2	43024U-G84L58	24x252	6.11	5.80	3.63	1.21	2.38 (60 mm)	.315
1-1/2	1-1/2	43024U-G84L67	24x252	6.11	6.70	3.63	1.21	2.38 (60 mm)	.315
1-1/2	2	43024U-G92	32x252	6.11	3.13	3.65	1.25	2.81 (71 mm)	.375
1-1/2	2	43024U-G92L45	32x252	6.11	4.50	3.63	1.21	2.81 (71 mm)	.375
1-1/2	2	43024U-G92L67	32x252	6.11	6.70	3.63	1.21	2.81 (71 mm)	.375
2	1-1/2	43032U-G84	24x252	6.63	3.12	3.81	1.19	2.38 (60 mm)	.315
2	2	43032U-G92	32x252	7.83	4.50	4.91	1.56	2.81 (71 mm)	.375
2	2	43032U-G92L65	32x252	7.95	6.50	5.13	1.56	2.81 (71 mm)	.375
2	2	43032U-G92L80	32x252	7.98	8.00	5.14	1.56	2.81 (71 mm)	.375

(For Split Flange Kits, see pages L-89 thru L-92.)

Split Flange 90° Tube Elbow (SAE Code 62)

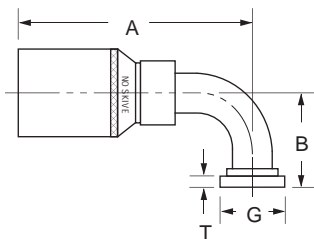

Hose I.D.	Nominal Flange Size	Part Number	Replacement O-Ring (Not Included)	A	B	Hose Cut-Off Factor	Hole Dia.	Dia. G	T Nominal
1/2	1/2	43008U-D71	8x252	4.49	1.72	2.56	.34	1.25 (32 mm)	.345
1/2	3/4	43008U-D72	12x252	4.53	1.90	2.63	.34	1.62 (41 mm)	.345
3/4	3/4	43012U-D72	12x252	4.84	2.41	2.81	.56	1.62 (41 mm)	.345
3/4	1	43012U-D76	16x252	4.84	2.70	2.81	.56	1.88 (48 mm)	.375
1	1	43016U-D76	16x252	5.42	2.75	3.38	.76	1.88 (48 mm)	.375
1	1-1/4	43016U-D80	20x252	5.31	2.90	3.25	.76	2.12 (54 mm)	.405
1-1/4	1-1/4	43020U-D80	20x252	5.79	3.24	3.50	1.01	2.12 (54 mm)	.405
1-1/4	1-1/2	43020U-D84	24x252	5.79	3.35	3.50	1.01	2.50 (64 mm)	.405
1-1/2	1-1/2	43024U-D84	24x252	6.11	3.70	3.63	1.25	2.50 (64 mm)	.495
1-1/2	2	43024U-D92	32x252	6.11	4.26	3.63	1.25	3.12 (79 mm)	.495
2	2	43032U-D92	32x252	7.81	4.84	5.00	1.56	3.12 (79 mm)	.495

(For Split Flange Kits, see pages L-89 thru L-92.)

J

Hose Ends - Crimp

To determine the correct length of hose, subtract the cut-off factor for each end fitting from the overall length of assembly.

Split Flange 100° Tube Elbow

(SAE Code 61)

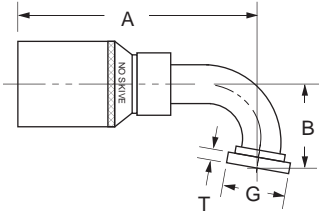

Hose I.D.	Nominal Flange Size	Part Number	Replacement O-Ring (Not Included)	A	B	Hose Cut-Off Factor	Hole Dia.	Dia. G	T Nominal
3/4	3/4	43012U-H72	12x252	4.78	2.33	2.81	.61	1.50 (38 mm)	.265
3/4	1	43012U-H73	16x252	4.94	2.33	2.81	.61	1.75 (44 mm)	.315

(For Split Flange Kits, see pages L-89 thru L-92.)

Split Flange 110° Tube Elbow

(SAE Code 61)

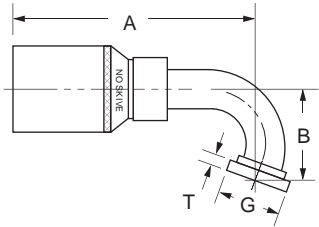

Hose I.D.	Nominal Flange Size	Part Number	Replacement O-Ring (Not Included)	A	B	Hose Cut-Off Factor	Hole Dia.	Dia. G	T Nominal
1	1	43016U-H83	16x252	4.48	2.84	2.46	.76	1.75 (44 mm)	.315
1-1/4	1-1/4	43020U-H84	20x252	4.82	3.12	2.56	1.01	2.00 (51 mm)	.315
1-1/4	1-1/2	43020U-H85	24x252	5.24	3.17	2.94	1.01	2.38 (60 mm)	.315
1-1/2	1-1/2	43024U-H85	24x252	5.49	3.69	3.00	1.25	2.38 (60 mm)	.315
2	2	43032U-H86	32x252	7.26	5.65	4.44	1.56	2.81 (71 mm)	.375

(For Split Flange Kits, see pages L-89 thru L-92.)

Split Flange 135° Tube Elbow

(SAE Code 61)

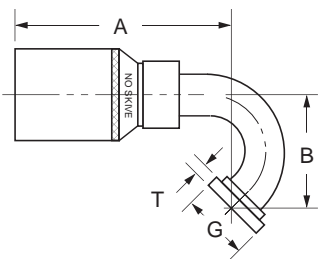

Hose I.D.	Nominal Flange Size	Part Number	Replacement O-Ring (Not Included)	A	B	Hose Cut-Off Factor	Hole Dia.	Dia. G	T Nominal
1/2	1/2	43008U-H91	8x252	4.06	2.12	2.19	.34	1.19 (30 mm)	.265
3/4	3/4	43012U-H92	12x252	4.04	3.00	2.06	.61	1.50 (38 mm)	.265

(For Split Flange Kits, see pages L-89 thru L-92.)

WeatherGRIP™ Z-Series Hose Ends

General Information

The next generation technology of Eaton's WeatherGRIP™ hose ends are compatible with the most Weatherhead standard and newer generation hose styles combining best-in-class technologies to meet and exceed the highest globally recognized standards for 1 and 2 wire braid hydraulic hose assemblies.

Now, with the addition of 168 new hose ends, the total array of over 550 WeatherGRIP hose ends meets virtually all customer needs for domestic and non-North American thread styles and configurations. The resulting hose assemblies provide superior performance in the demanding applications often encountered within mobile and industrial equipment.

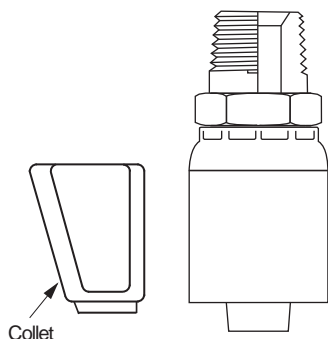

Ordering Information:

Order individually by catalog number. O-rings not supplied with flange hose ends. Order O-rings by catalog number; reference individual listings for details. For split flange kits and O-ring part numbers, refer to pages L89-92.

Note:

Refer to current price list for availability of cataloged items. Configurations and dimensions subject to change without notice.

Compatible Hose Styles:

H104
H145
H145R
H190
H190H
H245
H245L
H280
H290
H290H
H290L
H345

Easy Assembly

WeatherGRIP® hose ends are assembled with Weatherhead hose using existing Coll-O-Crimp® machines.

The hose ends have a scribe line around the circumference of the socket to easily identify the location where the Coll-O-Crimp collets are positioned for crimping.



Bite-the-Wire Type Technology

WeatherGrip hose ends feature advanced "Bite-the-Wire" technology:

- Advanced "Bite-the-Wire" design provides higher operating and burst pressure
- Eliminates cool down leakage
- Flat crimp for easier routing
- Compatible with multiple hose styles to accommodate most application needs



Typical Application:

General purpose low, medium, and high pressure hydraulic.

Pressure: Determined by maximum working pressure for hose size and hose end configuration whichever is less. For working pressure ratings for hose end configurations, refer to pages A-15-16.

Material: Low Carbon Steel

Plating: Trivalent Zinc Plated

Advantages:

Wide selection of hose and end configurations allowing a diverse number of applications.

Assemble With:

T-400-1, T-410-1, T-420-1, T-440, T-460, T-462, T-465, T-480, ET1000, ET4000, ET4001, ET4020 and ET4040.

Label Set: FF90645

H275 (-04 thru -16)
H1812 (-04 thru -20)
H0106 (-04 thru -10)
H0105 (-06 thru -12, -20)
H116 (-04, -06, -08)
H115 (-04 thru -20)
H1982 (-06 thru -16)
H1981 (-04, -06, -08)
H9949

Z Series Part Description	Part Number Example	Page Number
General Information		J-69
Male Pipe Rigid	08Z-108	J-71
Male Pipe Swivel	08Z-J08	J-71
Female Pipe Rigid	08Z-208	J-72
Female Pipe Swivel	08Z-258	J-72
Female Straight Pipe Swivel (NPSM)	08Z-058	J-72
Male Pipe Swivel 90° Elbow	08Z-M08	J-73
JIC/37° Female Swivel	08Z-608	J-73
JIC/37° Female Swivel 30° Tube Elbow	10Z-L22	J-74
JIC/37° Female Swivel 45° Tube Elbow	08Z-688	J-74
JIC/37° Female Swivel 90° Tube Elbow	08Z-668	J-75
JIC/37° Female Swivel 90° Long Drop Tube Elbow	08Z-648	J-75
JIC/37° Male Rigid	08Z-508	J-76
SAE 45° Female Swivel	08Z-408	J-76
SAE 45° Female Swivel 45° Tube Elbow	06Z-486	J-76
SAE 45° Female Swivel Long Drop 90° Tube Elbow	06Z-446	J-77
SAE 45° Flare Male Rigid	06Z-306	J-77
Female FOR-SEAL® Swivel	08Z-S68	J-77
Female FOR-SEAL® Swivel 45° Tube Elbow	08Z-L68	J-78
Female FOR-SEAL® Swivel Short Drop 90° Tube Elbow	08Z-A28	J-78
Female FOR-SEAL® Swivel Medium Drop 90° Tube Elbow	08Z-J38	J-79
Female FOR-SEAL® Swivel Long Drop 90° Tube Elbow	08Z-A68	J-79
FOR-SEAL® Male Rigid	08Z-E68	J-80
Male Straight Thread O-ring Rigid	08Z-P08	J-80
Male Straight Thread O-ring Swivel	08Z-R08	J-81
Male Straight Thread O-ring Swivel 90° Elbow	08Z-R68	J-81
Flareless Tube Rigid Ermeto 7000 Series	08Z-758	J-81
Flareless 45° Tube Elbow 7000 Ermeto Series	06Z-956	J-82
Flareless 90° Tube Elbow 7000 Ermeto Series	06Z-976	J-82
Inverted Male Swivel Straight	08Z-B08	J-82
Inverted Male Swivel 45° Tube Elbow	08Z-B48	J-83
Inverted Male Swivel 90° Tube Elbow	08Z-B68	J-83
Split Flange Straight (SAE Code 61)	12Z-G12	J-83
Split Flange 22.5° Tube Elbow (SAE Code 61)	16Z-H03	J-84
Split Flange 45° Tube Elbow (SAE Code 61)	12Z-G42	J-84
Split Flange 60° Tube Elbow (SAE Code 61)	16Z-H53	J-85
Split Flange 90° Tube Elbow (SAE Code 61)	12Z-G72	J-85
Metric Split Flange Straight (Komatsu, Linkbelt, etc.)	10Z-G09	J-86
Metric Split Flange 45° Tube Elbow (Komatsu, Linkbelt, etc.)	10Z-G69	J-86
Metric Split Flange 90° Tube Elbow (Komatsu, Linkbelt, etc.)	10Z-G99	J-86
READY-LOK® Male Connector	08Z-085	J-87
Standpipe Straight Tube	08Z-T08	J-87
Metric Standpipe Straight Tube	08Z-45T	J-87
Pressure Washer Connection	06Z-6PW	J-88
BSPP Flat Face Female Swivel	08Z-08PA	J-88
British Standard (BSPP) 60° Cone Female Swivel Straight	08Z-358	J-88
British Standard (BSPP) 60° Cone Female 45° Tube Elbow	08Z-48P	J-89
British Standard (BSPP) 60° Cone Female 90° Tube Elbow	08Z-78P	J-89
British Standard (BSPT) Tapered Male Rigid	08Z-158	J-89
British Standard (BSPP) 60° Cone Male Rigid	08Z-P58	J-90
Female JIS 30° Flare Swivel Straight	08Z-08L	J-90
Female Swivel 30° Flare (Komatsu, Linkbelt)	08Z-22K	J-90
Female Swivel DIN 24° Seat l.Rh DKO (Light)	08Z-15C	J-91
Female Swivel DIN Universal Seat 45° Tube Elbow (Light)	08Z-15D	J-91
Female Swivel DIN Universal Seat 90° Tube Elbow (Light)	08Z-65D	J-91
Male DIN 24° Seat l.Rh (Light)	08Z-15A	J-92
Female Swivel DIN 24° Seat s.Rh DKO (Heavy)	08Z-64C	J-92
Female Swivel DIN 24° Seat 45° Tube Elbow s.Rh (Heavy)	08Z-16E	J-92
Female Swivel DIN 24° Seat 90° Tube Elbow s.Rh DKO (Heavy)	08Z-66E	J-93
Male DIN 24° Seat s.Rh (Heavy)	08Z-16F	J-93
STC Male Straight	08Z-BC08	J-94
STC Male 45° Tube Elbow	08Z-BC48	J-94
STC Male 90° Tube Elbow	08Z-BC68	J-94
STC Male 90° Long Drop Tube Elbow	08Z-BC88	J-94

Male Pipe Rigid

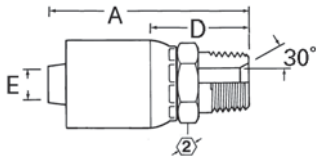

Z-Series Part #	Thd.	Hose Size	A		Hose Cut-Off Factor (D)		EØ		②
			mm	in	mm	in	mm	in	
04Z-102	1/8-27	-04	46,7	1.84	23,4	0.92	4,3	0.17	9/16
04Z-104	1/4-18	-04	52,3	2.06	29,0	1.14	4,3	0.17	9/16
04ZR-104*	1/4-18	-04	52,3	2.06	29,0	1.14	4,3	0.17	9/16
04Z-106	3/8-18	-04	48,3	1.90	24,9	0.98	4,3	0.17	11/16
04Z-108	1/2-14	-04	51,3	2.02	31,2	1.23	4,3	0.17	7/8
06Z-104	1/4-18	-06	55,4	2.18	30,0	1.18	6,6	0.26	11/16
06Z-106	3/8-18	-06	57,7	2.27	32,5	1.28	6,6	0.26	11/16
06ZR-106*	3/8-18	-06	57,7	2.27	32,5	1.28	6,6	0.26	11/16
06Z-108	1/2-14	-06	57,7	2.27	32,5	1.28	4,1	0.16	7/8
08Z-104	1/4-18	-08	61,0	2.40	31,2	1.23	7,6	0.30	13/16
08Z-106	3/8-18	-08	63,2	2.49	33,5	1.32	9,7	0.38	13/16
08Z-108	1/2-14	-08	69,6	2.74	39,6	1.56	9,7	0.38	7/8
08ZR-108*	1/2-14	-08	69,6	2.74	39,6	1.56	9,7	0.38	7/8
08Z-112	3/4-14	-08	65,0	2.56	35,3	1.39	9,7	0.38	1 1/16
10Z-106	3/8-18	-10	59,9	2.36	33,8	1.33	10,7	0.42	15/16
10Z-108	1/2-14	-10	69,6	2.74	40,1	1.58	12,7	0.50	15/16
10Z-112	3/4-14	-10	65,0	2.56	35,6	1.40	12,7	0.50	1 1/16
12Z-108	1/2-14	-12	70,6	2.78	40,6	1.60	14,2	0.56	1 1/8
12Z-112	3/4-14	-12	72,1	2.84	41,9	1.65	15,5	0.61	1 1/8
12ZR-112*	3/4-14	-12	72,1	2.84	41,9	1.65	15,5	0.61	1 1/8
12Z-116	1-11 1/2	-12	71,1	2.80	40,9	1.61	15,5	0.61	1 3/8
16Z-112	3/4-14	-16	76,7	3.02	42,4	1.67	19,3	0.76	1 3/8
16Z-116	1-11 1/2	-16	81,8	3.22	47,2	1.86	20,8	0.82	1 3/8
16ZR-116*	1-11 1/2	-16	81,8	3.22	47,2	1.86	20,8	0.82	1 3/8
16Z-120	1 1/4-11 1/2	-16	78,2	3.08	43,7	1.72	20,8	0.82	1 11/16
20Z-116	1-11 1/2	-20	93,0	3.66	49,0	1.93	24,1	0.95	1 3/4
20ZA-116	1-11 1/2	-20	93,0	3.66	49,0	1.93	24,1	0.95	1 3/4
20Z-120	1 1/4-11 1/2	-20	89,4	3.52	45,5	1.79	26,7	1.05	1 13/16
20ZA-120	1 1/4-11 1/2	-20	89,4	3.52	45,5	1.79	26,7	1.05	1 13/16
24Z-124	1 1/2-11 1/2	-24	106,2	4.18	59,9	2.36	32,0	1.26	2
32Z-132	2-11 1/2	-32	116,6	4.59	66,3	2.61	44,5	1.75	2 1/2

Note: 20ZA fittings should only be used with one wire braided hose. 20Z fittings should only be used with two wire braided hose.

* Stainless Steel

Male Pipe Swivel

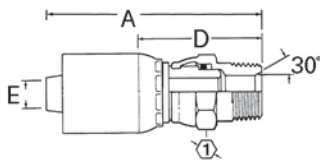

Z-Series Part #	Thd.	Hose Size	A		Hose Cut-Off Factor (D)		EØ		①
			mm	in	mm	in	mm	in	
04Z-J04	1/4-18	-04	64,5	2.54	41,4	1.62	4,3	0.17	3/4
06Z-J04	1/4-18	-06	63,5	2.54	42,4	1.67	6,6	0.26	3/4
06Z-J06	3/8-18	-06	67,6	2.66	42,4	1.67	6,6	0.26	7/8
06Z-J08	1/2-14	-06	72,4	2.85	47,0	1.85	6,6	0.26	7/8
08Z-J06	3/8-18	-08	73,2	2.88	43,4	1.71	9,7	0.38	7/8
08Z-J08	1/2-14	-08	79,5	3.13	49,8	1.96	9,7	0.38	15/16
12Z-J12	3/4-14	-12	82,3	3.24	52,1	2.05	15,5	0.61	1 3/8
16Z-J16	1-11 1/2	-16	98,6	3.88	64,3	2.53	20,6	0.81	1 1/2

Female Pipe Rigid

Dryseal NPTF

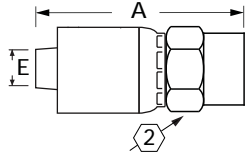

Z-Series Part #	Thd.	Hose Size	A		Hose Cut-Off Factor		EØ		Ⓜ2
			mm	in	mm	in	mm	in	
04Z-202	1/8-27	-04	52,6	2.07	32,5	1.28	4,3	0.17	9/16
04Z-204	1/4-18	-04	58,4	2.30	38,4	1.51	4,3	0.17	3/4
06Z-204	1/4-18	-06	58,4	2.30	37,1	1.46	6,6	0.26	3/4
06Z-206	3/8-18	-06	61,2	2.41	39,9	1.57	6,6	0.26	7/8
08Z-208	1/2-14	-08	66,5	2.62	42,0	1.65	9,7	0.38	1 1/16
12Z-212	3/4-14	-12	90,9	3.58	64,0	2.52	15,5	0.61	1 5/16

* G as part of thread size is ISO Designation for parallel thread.

Female Pipe Swivel

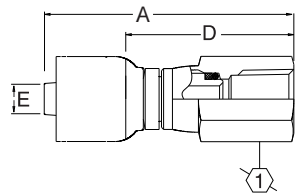

Z-Series Part #	Thd.	Hose Size	A		Hose Cut-Off Factor (D)		EØ		Ⓜ1
			mm	in	mm	in	mm	in	
04Z-254	1/4-18	-04	72,9	2.87	49,5	1.95	4,3	0.17	3/4
06Z-256	3/8-18	-06	75,4	2.97	50,0	1.97	6,6	0.26	7/8
08Z-258	1/2-14	-08	90,9	3.58	61,2	2.41	9,7	0.38	1 1/16
12Z-262	3/4-14	-12	92,2	3.63	62,0	2.44	15,5	0.61	1 3/8
16Z-266	1-11 1/2	-16	111,0	4.37	77,5	3.05	20,6	0.81	1 5/8

J

Hose Ends - Crimp

Female Straight Pipe Swivel (NPSM)

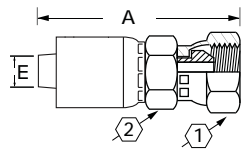

Z-Series Part #	Thd.	Hose Size	A		Hose Cut-Off Factor (D)		EØ		Ⓜ2	Ⓜ1
			mm	in	mm	in	mm	in		
04Z-054	1/4-18	-04	47,8	1.88	27,7	1.09	4,3	0.17	9/16	1 1/16
06Z-056	3/8-18	-06	51,8	2.04	30,5	1.20	6,6	0.26	1 1/16	7/8
08Z-058	1/2-14	-08	61,0	2.40	35,8	1.41	9,7	0.38	7/8	1
12Z-062	3/4-14	-12	66,5	2.62	39,6	1.56	15,5	0.61	1 1/8	1 1/4
16Z-066	1-11 1/2	-16	79,0	3.11	29,9	1.18	20,8	0.81	1 3/8	1 1/2
20Z-070	1 1/4-11 1/2	-20	92,7	3.65	53,3	2.10	26,7	1.05	1 3/4	1 7/8

**Male Pipe Swivel
90° Elbow**

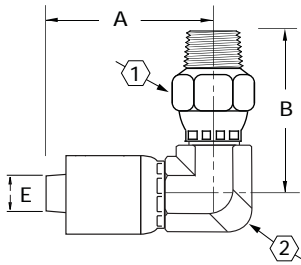

Z-Series Part #	Thd.	Hose Size	A		Hose Cut-Off Factor (D)		EØ		⊕2	⊕1	B
			mm	in	mm	in	mm	in			
04Z-M04	1/4-18	-04	54,6	2.15	31,2	1.23	4,3	0.17	3/4	3/4	1.81
06Z-M04	1/4-18	-06	54,9	2.16	33,7	1.33	6,6	0.26	3/4	7/8	1.96
06Z-M06	3/8-18	-06	59,2	2.33	33,7	1.33	6,6	0.26	3/4	7/8	1.80
08Z-M08	1/2-14	-08	68,1	2.68	38,3	1.51	9,6	0.38	3/4	15/16	2.05
12Z-M12	3/4-14	-12	94,5	3.72	64,2	2.53	15,4	0.61	1 1/4	1 3/8	2.72

JIC/37° Female Swivel

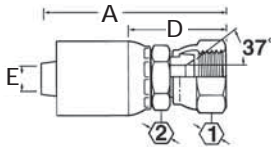

Z-Series Part #	Thd.	Hose Size	A		Hose Cut-Off Factor (D)		EØ		⊕1	⊕2
			mm	in	mm	in	mm	in	in	in
04Z-603	3/8-24	-04	49,3	1.94	25,9	1.02	3,3	0.13	1/2	9/16
04Z-604	7/16-20	-04	50,8	2.00	27,2	1.07	4,3	0.17	9/16	9/16
04ZR-604*	7/16-20	-04	50,8	2.00	27,2	1.07	4,3	0.17	9/16	9/16
04Z-605	1/2-20	-04	50,3	1.98	26,9	1.06	4,3	0.17	5/8	9/16
04Z-606	9/16-18	-04	51,6	2.03	28,2	1.11	4,3	0.17	11/16	9/16
06Z-604	7/16-20	-06	55,6	2.19	30,2	1.19	4,3	0.17	9/16	11/16
06Z-605	1/2-20	-06	56,9	2.24	31,5	1.24	5,8	0.23	5/8	11/16
06Z-606	9/16-18	-06	57,9	2.28	32,5	1.28	6,6	0.26	11/16	11/16
06ZR-606*	9/16-18	-06	57,9	2.28	32,5	1.28	6,6	0.26	11/16	11/16
06Z-608	3/4-16	-06	58,7	2.31	33,3	1.31	6,6	0.26	7/8	11/16
06Z-610	7/8-14	-06	57,4	2.26	13,2	0.52	6,6	0.26	1	13/16
06Z-612	1 1/16-12	-06	59,5	2.34	38,4	1.51	6,7	0.26	1 1/4	1
08Z-606	9/16-18	-08	59,9	2.36	34,5	1.36	9,6	0.33	11/16	13/16
08Z-608	3/4-16	-08	66,8	2.63	37,1	1.46	9,7	0.38	7/8	13/16
08ZR-608*	3/4-16	-08	66,8	2.63	37,1	1.46	9,7	0.38	7/8	13/16
08Z-610	7/8-14	-08	67,1	2.64	37,3	1.47	9,7	0.38	1	13/16
08Z-612	1 1/16-12	-08	69,3	2.73	39,6	1.56	9,7	0.38	1 1/4	1
08Z-616	1 5/16-12	-08	77,7	3.06	48,0	1.89	9,7	0.38	1 1/2	1 1/4
10Z-608	3/4-16	-10	67,3	2.65	38,1	1.50	9,9	0.39	7/8	15/16
10Z-610	7/8-14	-10	70,4	2.77	40,9	1.61	12,7	0.50	1	15/16
10ZR-610*	7/8-14	-10	70,4	2.77	40,9	1.61	12,7	0.50	1	15/16
10Z-612	1 1/16-12	-10	69,1	2.72	39,9	1.57	12,7	0.50	1 1/4	1
12Z-608	3/4-16	-12	66,0	2.60	38,8	1.53	9,9	0.39	7/8	1 1/8
12Z-610	7/8-14	-12	71,4	2.81	41,4	1.63	12,2	0.48	1	1 1/8
12Z-612	1 1/16-12	-12	72,1	2.84	41,9	1.65	15,5	0.61	1 1/4	1 1/8
12ZR-612*	1 1/16-12	-12	72,1	2.84	41,9	1.65	15,5	0.61	1 1/4	1 1/8
12Z-614	1 3/16-12	-12	72,1	2.84	41,9	1.65	15,5	0.61	1 3/8	1 1/8
12Z-616	1 5/16-12	-12	73,9	2.91	43,7	1.72	15,5	0.61	1 1/2	1 1/4
16Z-612	1 1/16-12	-16	80,0	3.15	45,7	1.80	15,5	0.61	1 1/4	1 3/8
16Z-614	1 3/16-12	-16	80,0	3.15	46,5	1.83	20,6	0.81	1 3/8	1 3/8
16Z-616	1 5/16-12	-16	83,6	3.29	49,0	1.93	20,6	0.81	1 1/2	1 3/8
16ZR-616*	1 5/16-12	-16	83,6	3.29	49,0	1.93	20,6	0.81	1 1/2	1 3/8
16Z-620	1 5/8-12	-16	80,5	3.17	46,0	1.81	20,6	0.81	2	
20Z-616	1 5/16-12	-20	87,9	3.46	43,9	1.73	21,6	0.85	1 1/2	
20ZA-616	1 5/16-12	-20	87,9	3.46	43,9	1.73	21,6	0.85	1 1/2	
20Z-620	1 5/8-12	-20	91,7	3.61	47,8	1.88	26,7	1.05	2	
20ZA-620	1 5/8-12	-20	91,7	3.61	47,8	1.88	26,7	1.05	2	
24Z-624	1 7/8-12	-24	99,1	3.90	52,6	2.07	32,0	1.26	2 1/4	
32Z-632	2 1/2-12	-32	110,2	4.34	60,7	2.39	44,5	1.75	2 7/8	

Note: 20ZA fittings should only be used with one wire braided hose.
20Z fittings should only be used with two wire braided hose.

* Stainless Steel

^a Swivel nuts are universal – both SAE 37° and 45° connections.

**JIC/37° Female Swivel
30° Tube Elbow**

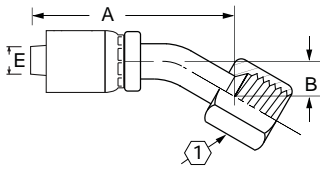

Z-Series Part #	Thd.	Hose Size	A		Hose Cut-Off Factor (D)		EØ		1	B
			mm	in	mm	in	mm	in		
10Z-L22	1 ¹ / ₁₆ -12	-10	86,1	3.39	60,5	2.38	12,7	0.51	1/4 Hex	0.69

**JIC/37° Female Swivel
45° Tube Elbow**

(Exceptions noted, refer to footnotes)

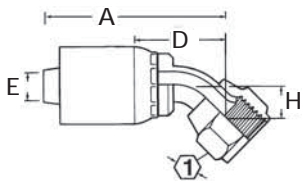

Z-Series Part #	Thd.	Hose Size	A		Hose Cut-Off Factor (D)		EØ		H		1
			mm	in	mm	in	mm	in	mm	in	
04Z-684 ^a	7/16-20	-04	49,8	1.96	26,4	1.04	3,8	0.15	8,4	0.33	9/16
04Z-685 ^a	1/2-20	-04	51,8	2.04	28,4	1.12	4,3	0.17	9,4	0.37	5/8
04Z-686	9/16-18	-04	53,1	2.09	29,7	1.17	4,3	0.17	9,9	0.39	11/16
06Z-684 ^a	7/16-20	-06	44,5	1.75	23,4	0.92	4,1	0.16	8,4	0.33	9/16
06Z-686	9/16-18	-06	58,7	2.31	33,3	1.31	6,1	0.24	9,9	0.39	11/16
06Z-688 ^a	3/4-16	-06	67,3	2.65	42,2	1.66	6,6	0.26	14,0	0.55	7/8
08Z-688 ^a	3/4-16	-08	71,6	2.82	41,9	1.65	9,4	0.37	14,0	0.55	7/8
08Z-690 ^a	7/8-14	-08	77,0	3.03	47,2	1.86	9,7	0.38	15,0	0.59	1
10Z-690 ^a	7/8-14	-10	74,7	2.94	45,5	1.79	11,7	0.46	15,0	0.59	1
10Z-692	1 ¹ / ₁₆ -12	-10	85,9	3.38	56,4	2.22	12,7	0.50	19,8	0.78	1 ¹ / ₄
12Z-696	1 ⁵ / ₁₆ -12	-12	87,1	3.43	60,2	2.37	15,5	0.61	26,9	1.06	1 ¹ / ₂
12Z-692	1 ¹ / ₁₆ -12	-12	87,1	3.43	56,9	2.24	14,7	0.58	19,8	0.78	1 ¹ / ₄
16Z-696	1 ⁵ / ₁₆ -12	-16	95,0	3.74	60,7	2.39	19,3	0.76	27,2	1.07	1 ¹ / ₂
20Z-697	1 ⁵ / ₈ -12	-20	112,8	4.44	68,8	2.71	25,7	1.01	31,0	1.22	2
20ZA-697	1 ⁵ / ₈ -12	-20	112,8	4.44	68,8	2.71	25,7	1.01	31,0	1.22	2

^a Swivel nuts are universal – both SAE 37° and 45° connections.

Note: 20ZA fittings should only be used with one wire braided hose. 20Z fittings should only be used with two wire braided hose.

^a Swivel nuts are universal – both SAE 37° and 45° connections.

JIC/37° Female Swivel 90° Elbow

(Exceptions noted, refer to footnotes)

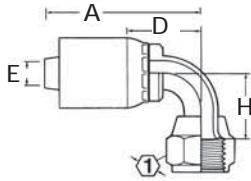

Note: 20ZA fittings should only be used with one wire braided hose.
20Z fittings should only be used with two wire braided hose

Z-Series Part #	Thd.	Hose Size	A		Hose Cut-Off Factor (D)		EØ		H		in
			mm	in	mm	in	mm	in	mm	in	
04Z-664 ^a	7/16-20	-04	46,7	1.84	23,4	0.92	3,8	0.15	17,3	0.68	9/16
04Z-665 ^a	1/2-20	-04	48,8	1.92	25,4	1.00	4,3	0.17	19,3	0.76	5/8
04Z-666	9/16-18	-04	50,8	2.00	27,4	1.08	4,3	0.17	21,3	0.84	11/16
06Z-664 ^a	7/16-20	-06	46,0	1.81	24,9	0.98	4,1	0.16	17,3	0.68	9/16
06Z-666	9/16-18	-06	56,1	2.21	31,0	1.22	6,1	0.24	21,3	0.84	11/16
06Z-668 ^a	3/4-16	-06	61,5	2.42	36,1	1.42	6,6	0.26	27,7	1.09	7/8
08Z-666	9/16-18	-08	61,7	2.43	32,0	1.26	6,1	0.24	21,3	0.84	11/16
08Z-668 ^a	3/4-16	-08	65,8	2.59	36,1	1.42	9,4	0.37	27,7	1.09	7/8
08Z-670 ^a	7/8-14	-08	70,6	2.78	41,0	1.61	9,7	0.38	30,2	1.19	1
10Z-670 ^a	7/8-14	-10	68,6	2.70	39,4	1.55	11,4	0.45	30,2	1.19	1
10Z-672	1 1/16-12	-10	84,1	3.31	54,9	2.16	12,7	0.50	45,7	1.80	1 1/4
12Z-670 ^a	7/8-14	-12	65,3	2.57	39,6	1.56	11,7	0.46	30,2	1.19	1
12Z-672	1 1/16-12	-12	85,4	3.36	55,1	2.17	17,4	0.58	45,7	1.80	1 1/4
12Z-676	1 5/16-12	-12	85,6	3.37	55,4	2.18	15,5	0.61	60,7	2.39	1 1/2
16Z-676	1 5/16-12	-16	90,4	3.56	55,9	2.20	19,3	0.76	60,7	2.39	1 1/2
16Z-677	1 5/8-12	-16	95,8	3.77	62,2	2.45	20,8	0.82	69,9	2.75	2
20Z-677	1 5/8-12	-20	108,0	4.25	64,0	2.52	25,7	1.01	69,9	2.75	2
20ZA-677	1 5/8-12	-20	108,0	4.25	64,0	2.52	25,7	1.01	69,9	2.75	2
24Z-678	1 7/8-12	-24	117,6	4.63	71,4	2.81	32,0	1.26	80,5	3.17	2 1/4

^a Swivel nuts are universal – both SAE 37° and 45° connections.

JIC/37° Female Swivel 90° Long Drop Tube Elbow

(Exceptions noted, refer to footnotes)

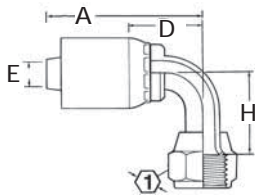

Note: 20ZA fittings should only be used with one wire braided hose.
20Z fittings should only be used with two wire braided hose.

Z-Series Part #	Thd.	Hose Size	A		Hose Cut-Off Factor (D)		EØ		H		in
			mm	in	mm	in	mm	in	mm	in	
04Z-644 ^a	7/16-20	-04	46,7	1.84	23,4	0.92	3,8	0.15	45,7	1.80	9/16
04Z-645 ^a	1/2-20	-04	48,8	1.92	25,4	1.00	4,3	0.17	45,7	1.80	5/8
06Z-644 ^a	7/16-20	-06	46,0	1.81	24,9	0.98	4,3	0.17	45,7	1.80	9/16
06Z-646	9/16-18	-06	56,4	2.22	31,2	1.23	6,1	0.24	55,4	2.18	11/16
06Z-648 ^a	3/4-16	-06	64,5	2.54	39,1	1.54	6,6	0.26	62,2	2.45	7/8
08Z-648 ^a	3/4-16	-08	68,8	2.71	39,1	1.54	9,4	0.37	62,2	2.45	7/8
08Z-650 ^a	7/8-14	-08	70,6	2.78	40,9	1.61	9,7	0.38	65,3	2.57	1
10Z-650 ^a	7/8-14	-10	68,6	2.70	39,1	1.54	11,7	0.46	65,3	2.57	1
12Z-652	1 1/16-12	-12	85,3	3.36	55,1	2.17	14,7	0.58	94,0	3.70	1 1/4
16Z-656	1 5/16-12	-16	90,4	3.56	55,9	2.20	19,3	0.76	116,3	4.58	1 1/2
20Z-657	1 5/8-12	-20	108,0	4.25	64,0	2.52	25,7	1.01	140,5	5.53	2
20ZA-657	1 5/8-12	-20	108,0	4.25	64,0	2.52	25,7	1.01	140,5	5.53	2

^a Swivel nuts are universal – both SAE 37° and 45° connections.

JIC/37° Male Rigid

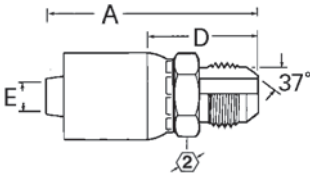

Note: 20ZA fittings should only be used with one wire braided hose.
20Z fittings should only be used with two wire braided hose.

Z-Series Part #	Thd.	Hose Size	A		Hose Cut-Off Factor (D)		EØ		②
			mm	in	mm	in	mm	in	
04Z-504	7/16-20	-04	50,8	2.00	27,2	1.07	4,3	0.17	9/16
04Z-505	1/2-20	-04	46,7	1.84	23,4	0.92	4,3	0.17	9/16
04Z-506	9/16-18	-04	47,0	1.85	23,6	0.93	4,3	0.17	5/8
06Z-506	9/16-18	-06	54,9	2.16	29,7	1.17	6,6	0.26	11/16
06Z-508	3/4-16	-06	53,3	2.10	28,2	1.11	6,6	0.26	13/16
06Z-510	7/8-14	-06	53,3	2.10	30,7	1.21	6,6	0.26	15/16
08Z-508	3/4-16	-08	65,3	2.57	35,8	1.41	9,7	0.38	13/16
08Z-510	7/8-14	-08	61,5	2.42	32,0	1.26	9,7	0.38	15/16
08Z-512	1 1/16-12	-08	65,8	2.59	36,1	1.42	9,7	0.38	1 1/8
10Z-508	3/4-16	-10	61,7	2.43	35,8	1.41	12,7	0.50	15/16
10Z-510	7/8-14	-10	69,3	2.73	39,9	1.57	12,2	0.48	15/16
10Z-512	1 1/16-12	-10	65,8	2.59	36,3	1.43	12,7	0.50	1 1/8
12Z-510	7/8-14	-12	70,6	2.78	40,4	1.59	12,2	0.48	1 1/8
12Z-512	1 1/16-12	-12	74,7	2.94	44,5	1.75	15,5	0.61	1 1/8
12Z-514	1 3/16-12	-12	69,3	2.73	39,1	1.54	15,5	0.61	1 1/4
12Z-516	1 5/16-12	-12	69,9	2.75	39,6	1.56	15,5	0.61	1 3/8
16Z-514	1 3/16-12	-16	79,0	3.11	45,7	1.80	18,3	0.72	1 3/8
16Z-516	1 5/16-12	-16	82,6	3.25	48,3	1.90	20,8	0.82	1 3/8
16Z-520	1 5/8-12	-16	77,0	3.03	43,4	1.71	20,6	0.81	1 11/16
20Z-520	1 5/8-12	-20	98,8	3.89	54,9	2.16	26,7	1.05	1 3/4
20ZA-520	1 5/8-12	-20	98,8	3.89	54,9	2.16	26,7	1.05	1 3/4
24Z-524	1 7/8-12	-24	109,5	4.31	63,2	2.49	32,0	1.26	2

SAE 45° Female Swivel

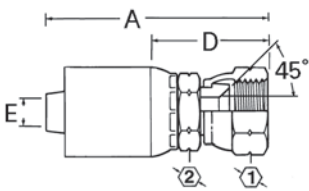

Z-Series Part #	Thd.	Hose Size	A		Hose Cut-Off Factor (D)		EØ		①	②
			mm	in	mm	in	mm	in		
04Z-404	7/16-20	-04	50,8	2.00	27,2	1.07	4,3	0.17	9/16	9/16
06Z-404	7/16-20	-06	55,6	2.19	30,2	1.19	4,8	0.19	9/16	11/16
06Z-406	5/8-18	-06	58,7	2.31	33,3	1.31	6,6	0.26	3/4	11/16
06Z-408	3/4-16	-06	58,7	2.31	33,3	1.31	6,6	0.26	7/8	11/16
08Z-408	3/4-16	-08	66,8	2.63	37,1	1.46	9,7	0.38	7/8	13/16
08Z-410	7/8-14	-08	67,1	2.64	37,3	1.47	9,7	0.38	1	13/16
12Z-412	1 1/16-14	-12	72,1	2.84	41,9	1.65	15,5	0.61	1 1/4	1 1/8

SAE 45° Female Swivel 45° Tube Elbow

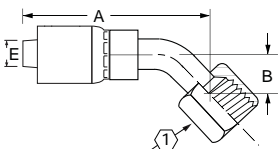

Z-Series Part #	Thd.	Hose Size	A		Hose Cut-Off Factor (D)		EØ		①	B
			mm	in	mm	in	mm	in		
06Z-486	5/8-18	-06	58,2	2.29	36,8	1.45	6,1	0.24	3/4	0.73

J
Hose Ends - Crimp

SAE 45° Female Swivel Long Drop 90° Tube Elbow

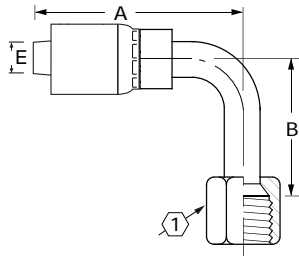

Z-Series Part #	Thd.	Hose Size	A		Hose Cut-Off Factor (D)		EØ		1	B
			mm	in	mm	in	mm	in		
06Z-446	5/8-18	-06	47,5	1.87	26,2	1.03	6.1	0.24	3/4	2.18

SAE 45° Flare Male Rigid

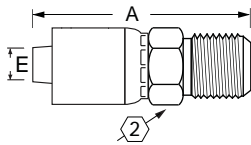

Z-Series Part #	Thd.	Hose Size	A		Hose Cut-Off Factor (D)		EØ		2
			mm	in	mm	in	mm	in	
06Z-306	5/8-18	-06	52,3	2.06	31,2	1.23	6,6	0.26	11/16
12Z-312	1 1/16-14	-12	74,7	2.94	47,8	1.88	15,5	0.61	1 1/8

Female FOR-SEAL® Swivel

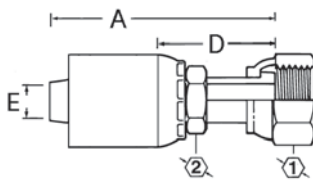

Z-Series Part #	Thd.	Hose Size	A		Hose Cut-Off Factor (D)		EØ		1	2
			mm	in	mm	in	mm	in		
04Z-S64	9/16-18	-04	49,5	1.95	26,2	1.03	4,3	0.17	11/16	9/16
04Z-S66	11/16-16	-04	51,8	2.04	28,4	1.12	4,3	0.17	13/16	5/8
04Z-S68	13/16-16	-04	52,3	2.06	32,5	1.28	4,1	0.16	13/16	15/16
06Z-S64	9/16-18	-06	54,4	2.14	29,2	1.15	4,3	0.17	11/16	11/16
06Z-S66	11/16-16	-06	56,6	2.23	31,5	1.24	6,6	0.26	13/16	11/16
06Z-S68	13/16-16	-06	58,9	2.32	33,5	1.32	6,6	0.26	15/16	13/16
08Z-S66	11/16-16	-08	63,8	2.51	34,0	1.34	6,6	0.26	13/16	7/8
08Z-S68	13/16-16	-08	67,8	2.67	38,1	1.50	9,7	0.38	15/16	7/8
08Z-S70	1-14	-08	67,1	2.64	37,3	1.47	9,7	0.38	1 1/8	15/16
08Z-S72	1 3/16-12	-08	71,1	2.80	41,4	1.63	9,7	0.38	1 3/8	1 1/8
10Z-S68	13/16-16	-10	67,8	2.67	38,4	1.51	9,7	0.38	15/16	15/16
10Z-S70	1-14	-10	70,1	2.76	40,9	1.61	12,2	0.48	1 1/8	15/16
10Z-S72	1 3/16-12	-10	70,9	2.79	41,4	1.63	12,7	0.50	1 3/8	1 1/8
12Z-S70	1-14	-12	71,4	2.81	41,4	1.62	12,2	0.48	1 1/8	1 1/8
12Z-S72	1 3/16-12	-12	73,9	2.91	43,7	1.72	15,5	0.61	1 3/8	1 1/8
12Z-S76	1 7/16-12	-12	75,7	2.98	45,5	1.79	15,5	0.61	1 5/8	1 3/8
16Z-S72	1 3/16-12	-16	81,8	3.22	47,2	1.86	15,5	0.61	1 3/8	1 3/8
16Z-S76	1 7/16-12	-16	83,6	3.29	49,3	1.94	20,6	0.81	1 5/8	1 3/8
16Z-S80	1 11/16-12	-16	82,6	3.25	48,3	1.90	20,6	0.81	1 7/8	1 5/8
20Z-S80	1 11/16-12	-20	98,8	3.89	59,2	2.33	25,9	1.02	1 7/8	1 3/4
20ZA-S80	1 11/16-12	-20	98,8	3.89	59,2	2.33	25,9	1.02	1 7/8	1 3/4
20Z-S84	2-12	-20	94,6	3.88	54,6	2.15	26,7	1.05	2 1/4	1 13/16
20ZA-S84	2-12	-20	94,6	3.88	54,6	2.15	26,7	1.05	2 1/4	1 13/16
24Z-S84	2-12	-24	102,1	4.02	55,6	2.19	32,0	1.26	2 1/4	2

Note: 20ZA fittings should only be used with one wire braided hose. 20Z fittings should only be used with two wire braided hose.

Hose Ends - Crimp

Z-Series

Female FOR-SEAL® Swivel
45° Tube Elbow

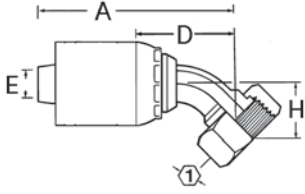

Z-Series Part #	Thd.	Hose Size	A		Hose Cut-Off Factor (D)		EØ		H		in
			mm	in	mm	in	mm	in	mm	in	
04Z-L64	9/16-18	-04	53,8	2.12	30,5	1.20	4,3	0.17	10,2	0.40	11/16
04Z-L66	11/16-16	-04	58,4	2.30	35,1	1.38	4,3	0.17	10,9	0.43	13/16
06Z-L64	9/16-18	-06	58,4	2.30	33,0	1.30	4,3	0.17	10,4	0.41	11/16
06Z-L66	11/16-16	-06	61,7	2.43	36,3	1.43	6,6	0.26	10,9	0.43	13/16
06Z-L68	13/16-16	-06	69,6	2.74	44,2	1.74	6,6	0.26	15,0	0.59	15/16
08Z-L66	11/16-16	-08	67,3	2.65	37,6	1.48	6,6	0.26	10,9	0.43	13/16
08Z-L68	13/16-16	-08	75,2	2.96	45,5	1.79	9,1	0.36	15,0	0.59	15/16
08Z-L70	1-14	-08	80,8	3.18	51,1	2.01	9,7	0.38	16,5	0.65	1 1/8
08Z-L72	1 3/16-12	-08	89,2	3.51	59,4	2.34	9,7	0.38	21,1	0.83	1 3/8
10Z-L70	1-14	-10	77,5	3.05	51,1	2.01	11,4	0.45	16,5	0.65	1 1/8
10Z-L72	1 3/16-12	-10	89,4	3.52	59,9	2.36	12,7	0.50	21,1	0.83	1 3/8
12Z-L70	1-14	-12	78,5	3.09	51,8	2.04	11,4	0.45	16,5	0.65	1 1/8
12Z-L72	1 3/16-12	-12	90,7	3.57	60,5	2.38	14,0	0.55	21,1	0.83	1 3/8
12Z-L76	1 7/16-12	-12	102,6	4.04	72,4	2.85	15,5	0.61	23,9	0.94	1 5/8
16Z-L72	1 3/16-12	-16	94,5	3.72	60,9	2.40	14,0	0.55	21,1	0.83	1 3/8
16Z-L76	1 7/16-12	-16	107,4	4.23	73,2	2.88	19,8	0.78	23,9	0.94	1 5/8
16Z-L80	1 11/16-12	-16	117,3	4.62	83,8	3.30	20,7	0.81	25,4	1.00	1 7/8
20Z-L80	1 11/16-12	-20	129,5	5.10	85,6	3.37	25,9	1.02	25,4	1.00	1 7/8
20ZA-L80	1 11/16-12	-20	129,5	5.10	85,6	3.37	25,9	1.02	25,4	1.00	1 7/8
20Z-L84	2-12	-20	139,4	5.49	95,5	3.76	25,7	1.01	27,2	1.07	2 1/4
24Z-L84	2-12	-24	115,3	4.54	68,8	2.71	32,0	1.26	27,2	1.07	2 1/4

Female FOR-SEAL® Swivel
Short Drop
90° Tube Elbow

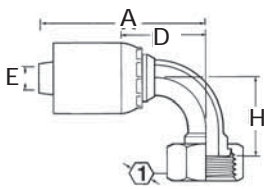

Z-Series Part #	Thd.	Hose Size	A		Hose Cut-Off Factor (D)		EØ		H		in
			mm	in	mm	in	mm	in	mm	in	
04Z-A24	9/16-18	-04	53,1	2.09	29,7	1.17	4,3	0.17	20,8	0.82	11/16
04Z-A26	11/16-16	-04	56,4	2.22	33,0	1.30	4,3	0.17	22,9	0.90	13/16
06Z-A24	9/16-18	-06	56,1	2.21	30,7	1.21	4,3	0.17	20,8	0.82	11/16
06Z-A26	11/16-16	-06	59,4	2.34	34,0	1.34	6,6	0.26	22,9	0.90	13/16
06Z-A28	13/16-16	-06	66,5	2.62	41,4	1.62	6,6	0.26	29,2	1.15	15/16
08Z-A26	11/16-16	-08	65,0	2.56	35,3	1.39	6,6	0.26	22,9	0.90	13/16
08Z-A28	13/16-16	-08	72,1	2.84	42,4	1.67	9,1	0.36	29,2	1.15	15/16
08Z-A30	1-14	-08	78,0	3.07	48,5	1.91	9,7	0.38	32,3	1.27	1 1/8
08Z-A32	1 3/16-12	-08	87,6	3.45	57,9	2.28	9,7	0.38	47,8	1.88	1 3/8
10Z-A30	1-14	-10	78,0	3.07	48,5	1.91	11,4	0.45	32,3	1.27	1 1/8
10Z-A32	1 3/16-12	-10	87,4	3.44	58,2	2.29	12,7	0.50	47,8	1.88	1 3/8
12Z-A30	1-14	-12	79,0	3.11	49,0	1.93	11,4	0.45	32,3	1.27	1 1/8
12Z-A32	1 3/16-12	-12	88,6	3.49	58,4	2.30	14,0	0.55	47,8	1.88	1 3/8
12Z-A36	1 7/16-12	-12	102,6	4.04	72,4	2.85	15,5	0.61	56,1	2.21	1 5/8
16Z-A36	1 7/16-12	-16	107,2	4.22	72,9	2.87	20,6	0.81	56,1	2.21	1 5/8
16Z-A40	1 11/16-12	-16	123,2	4.85	89,0	3.50	20,6	0.81	63,8	2.51	1 7/8
20Z-A40	1 11/16-12	-20	134,6	5.30	90,7	3.57	25,9	1.02	63,8	2.51	1 7/8
20ZA-A40	1 11/16-12	-20	134,6	5.30	90,7	3.57	25,9	1.02	63,8	2.51	1 7/8
20Z-A44	2-12	-20	109,7	4.32	70,4	2.77	26,6	1.05	68,6	2.70	2 1/4
24Z-A40	1 11/16-12	-24	117,6	4.63	71,4	2.81	32,0	1.26	68,6	2.70	2 1/4
24Z-A44	2-12	-24	117,6	4.63	71,4	2.81	32,0	1.26	68,6	2.70	2 1/4

Note: 20ZA fittings should only be used with one wire braided hose.
20Z fittings should only be used with two wire braided hose.

Hose Ends - Crimp

**Female FOR-SEAL® Swivel
Medium Drop
90° Tube Elbow**

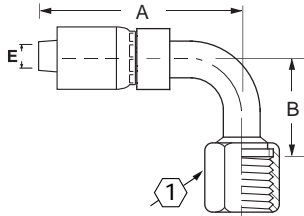

Z-Series Part #	Thd.	Hose Size	A		Hose Cut-Off Factor (D)		EØ		1	B
			mm	in	mm	in	mm	in		
04Z-J34	9/16-18	-04	49,5	1.95	29,7	1.17	4,3	0.17	11/16	1.26
04Z-J36	11/16-16	-04	55,1	2.17	32,8	1.29	4,3	0.17	13/16	1.51
04Z-J38	13/16-16	-04	55,9	2.20	35,8	1.41	4,3	0.17	15/16	1.67
06Z-J36	11/16-16	-06	55,1	2.17	34,0	1.34	6,6	0.26	13/16	1.51
06Z-J38	13/16-16	-06	57,4	2.26	36,1	1.42	6,6	0.26	15/16	1.67
08Z-J36	11/16-16	-08	63,0	2.48	37,6	1.48	6,1	0.24	13/16	1.51
08Z-J38	13/16-16	-08	67,6	2.66	42,4	1.67	9,1	0.36	15/16	1.62
08Z-J42	13/16-12	-08	98,3	3.87	72,9	2.87	9,7	0.38	13/8	2.13
10Z-J40	1-14	-10	74,4	2.93	48,5	1.91	11,4	0.45	11/8	1.85
12Z-J40	1-14	-12	67,6	2.66	40,6	1.60	11,4	0.45	11/8	1.78
12Z-J42	13/16-12	-12	85,3	3.36	58,4	2.30	13,9	0.55	13/8	2.28
16Z-J46	17/16-12	-16	106,2	4.18	72,6	2.86	19,8	0.78	15/8	2.78
16Z-J50	111/16-12	-16	141,2	5.56	107,7	4.24	20,6	0.81	17/8	3.06
20Z-J50	111/16-12	-20	148,8	5.86	109,5	4.31	23,6	0.93	17/8	3.06

**Female FOR-SEAL® Swivel
Long Drop
90° Tube Elbow**

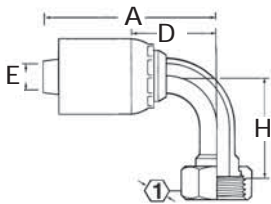

Z-Series Part #	Thd.	Hose Size	A		Hose Cut-Off Factor (D)		EØ		H		1
			mm	in	mm	in	mm	in	mm	in	
04Z-A64	9/16-18	-04	53,1	2.09	29,7	1.17	4,3	0.17	45,7	1.80	11/16
04Z-A66	11/16-16	-04	56,4	2.22	33,0	1.30	4,3	0.17	54,1	2.13	13/16
04Z-A68	13/16-16	-04	65,8	2.59	42,4	1.67	4,3	0.17	64,8	2.55	15/16
06Z-A66	11/16-16	-06	59,4	2.34	34,0	1.34	6,1	0.24	54,1	2.13	13/16
06Z-A68	13/16-16	-06	68,8	2.71	43,4	1.71	6,6	0.26	64,8	2.55	15/16
08Z-A68	13/16-16	-08	72,9	2.87	43,2	1.70	9,4	0.37	64,8	2.55	15/16
08Z-A70	1-14	-08	78,0	3.07	48,5	1.91	9,7	0.38	70,1	2.76	11/8
10Z-A70	1-14	-10	78,0	3.07	48,5	1.91	11,7	0.46	70,1	2.76	11/8
12Z-A72	13/16-12	-12	88,4	3.48	58,2	2.29	14,2	0.56	96,0	3.78	13/8
12Z-A76	17/16-12	-12	102,6	4.04	72,4	2.85	15,5	0.61	114,3	4.50	15/8
16Z-A76	17/16-12	-16	107,2	4.22	72,6	2.86	19,8	0.78	114,3	4.50	15/8
20Z-A80	111/16-12	-20	134,6	5.30	90,7	3.57	25,7	1.01	129,3	5.09	17/8
20Z-A84	2-12	-20	109,7	4.32	70,4	2.77	26,7	1.05	140,7	5.54	21/4
24Z-A84	2-12	-24	117,6	4.63	71,4	2.81	32,0	1.26	140,7	5.54	21/4

Z-Series

FOR-SEAL® Male Rigid

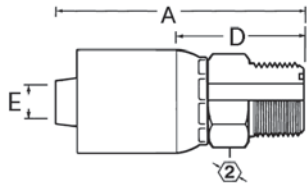

Z-Series Part #	Thd.	Hose Size	A		Hose Cut-Off Factor (D)		EØ		in
			mm	in	mm	in	mm	in	
04Z-E64	9/16-18	-04	45,2	1.78	21,8	0.86	4,3	0.17	5/8
06Z-E66	11/16-16	-06	50,5	1.99	25,1	0.99	6,6	0.26	3/4
06Z-E68	13/16-16	-06	49,5	1.95	24,1	0.95	6,6	0.26	7/8
08Z-E68	13/16-16	-08	58,4	2.30	28,7	1.13	9,7	0.38	7/8
08Z-E70	1-14	-08	55,1	2.17	29,7	1.17	9,7	0.38	1 1/16
08Z-E72	1 3/16-12	-08	57,7	2.27	32,3	1.27	9,7	0.38	1 1/4
10Z-E70	1-14	-10	57,4	2.26	31,5	1.24	12,2	0.48	1 1/16
10Z-E72	1 3/16-12	-10	57,4	2.26	31,5	1.24	12,7	0.50	1 1/4
12Z-E72	1 3/16-12	-12	66,8	2.63	36,6	1.44	15,5	0.61	1 1/4
12Z-E76	1 7/16-12	-12	64,3	2.53	34,0	1.34	15,5	0.61	1 1/2
16Z-E76	1 7/16-12	-16	75,2	2.96	41,7	1.64	20,7	0.81	1 1/2
20Z-E80	1 11/16-12	-20	85,1	3.35	45,7	1.80	26,2	1.03	1 3/4

Does not include o-ring. See page L-34 for o-ring part number.

Male Straight Thread O-ring Rigid

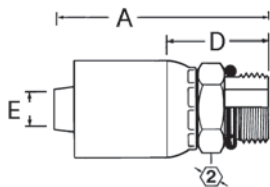

Z-Series Part #	Thd.	Hose Size	A		Hose Cut-Off Factor (D)		EØ		in
			mm	in	mm	in	mm	in	
04Z-P04	7/16-20	-04	46,7	1.84	23,4	0.92	4,3	0.17	9/16
04Z-P05	1/2-20	-04	46,7	1.84	23,4	0.92	4,3	0.17	5/8
04Z-P06	9/16-18	-04	45,2	1.78	21,8	0.86	4,3	0.17	11/16
06Z-P06	9/16-18	-06	50,8	2.00	25,4	1.00	6,6	0.26	11/16
06Z-P08	3/4-16	-06	50,0	1.97	24,9	0.98	6,6	0.26	7/8
06Z-P10	7/8-14	-06	47,8	1.88	26,7	1.05	6,6	0.26	1
08Z-P08	3/4-16	-08	59,9	2.36	30,2	1.19	9,7	0.38	7/8
08Z-P10	7/8-14	-08	57,4	2.26	27,7	1.09	9,7	0.38	1
08Z-P12	1 1/16-12	-08	60,7	2.39	31,0	1.22	9,7	0.38	1 1/4
10Z-P08	3/4-16	-10	56,1	2.21	30,2	1.19	12,7	0.50	15/16
10Z-P10	7/8-14	-10	59,4	2.34	33,5	1.32	12,7	0.50	1
10Z-P12	1 1/16-12	-10	60,7	2.39	31,2	1.23	12,7	0.50	1 1/4
12Z-P10	7/8-14	-12	64,3	2.53	37,1	1.46	12,2	0.48	1 1/8
12Z-P12	1 1/16-12	-12	62,0	2.44	31,8	1.25	15,5	0.61	1 1/4
12Z-P16	1 5/16-12	-12	65,0	2.56	34,8	1.37	15,5	0.61	1 1/2
16Z-P16	1 5/16-12	-16	69,6	2.74	35,3	1.39	20,8	0.82	1 1/2
20Z-P20	1 5/8-12	-20	92,2	3.63	48,3	1.90	26,7	1.05	1 7/8
20ZA-P20	1 5/8-12	-20	92,2	3.63	48,3	1.90	26,7	1.05	1 7/8
24Z-P24	1 7/8-12	-24	92,2	3.63	46,0	1.81	32,0	1.26	2 1/8

See page L-64 for replacement o-rings.

Hose Ends - Crimp

Note: 20ZA fittings should only be used with one wire braided hose. 20Z fittings should only be used with two wire braided hose.

Male Straight Thread O-ring Swivel

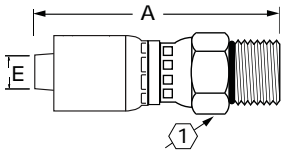

Z-Series Part #	Thd.	Hose Size	A		Hose Cut-Off Factor (D)		EØ		Ø
			mm	in	mm	in	mm	in	
04Z-R04	7/16-20	-04	64,0	2.52	40,3	1.59	4,3	0.17	3/4
06Z-R06	9/16-18	-06	69,1	2.72	43,9	1.73	6,6	0.26	7/8
06Z-R08	3/4-16	-08	67,6	2.66	42,4	1.67	6,6	0.26	7/8
08Z-R08	3/4-16	-08	76,5	3.01	46,7	1.84	9,6	0.38	1
08Z-R10	7/8-14	-08	77,0	3.03	47,2	1.86	9,6	0.38	1
08Z-R12	1 1/16-12	-08	88,6	3.49	58,9	2.32	9,6	0.38	1 1/16
10Z-R08	3/4-16	-10	76,7	3.02	47,2	1.86	12,7	0.5	1
12Z-R10	7/8-14	-12	87,1	3.43	56,9	2.24	15,5	0.61	1 1/16

Includes o-ring. See page L-64 for replacement o-rings.

Male Straight Thread O-ring Swivel 90° Elbow

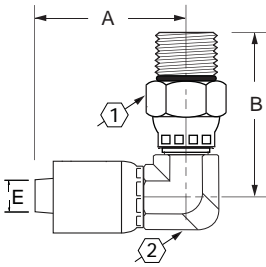

Z-Series Part #	Thd.	Hose Size	A		Hose Cut-Off Factor (D)		EØ		Ø	B
			mm	in	mm	in	mm	in		
04Z-R66	9/16-18	-04	55,4	2.18	32,0	1.26	4,3	0.17	3/4	1,87
06Z-R66	9/16-18	-06	59,2	2.33	33,7	1.33	6,6	0.26	3/4	1,87
06Z-R68	3/4-16	-06	59,2	2.33	33,7	1.33	6,6	0.26	3/4	1,93
06Z-R70	7/8-14	-06	59,2	2.33	33,7	1.33	6,6	0.26	3/4	1,95
08Z-R68	3/4-16	-08	68,1	2.68	38,3	1.51	9,7	0.38	3/4	1,93
08Z-R70	7/8-14	-08	68,1	2.68	38,3	1.51	9,7	0.38	3/4	1,97
08Z-R72	1 1/16-12	-08	79,2	3.12	49,5	1.95	9,7	0.38	1 1/16	2,43
12Z-R72	1 1/16-12	-12	94,5	3.72	64,2	2.53	15,5	0.61	32	2,65

Includes o-ring. See page L-64 for replacement o-rings.

Flareless Tube Rigid Ermeto 7000 Series

(With Nut and Sleeve)

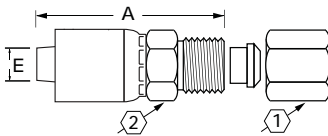

Z-Series Part #	Thd.	Tube O.D.	Hose Size	A		Hose Cut-Off Factor (D)		EØ		Ø	Ø
				mm	in	mm	in	mm	in		
04Z-754	7/16-20	1/4	-04	41,9	1.65	21,8	0.86	4,3	0.17	9/16	9/16
04Z-755	1/2-20	5/16	-04	40,1	1.58	20,3	0.80	4,3	0.17	9/16	5/8
06Z-754	7/16-20	1/4	-06	46,0	1.81	24,6	0.97	6,6	0.26	11/16	9/16
06Z-755	1/2-20	5/16	-06	46,0	1.81	24,6	0.97	5,8	0.23	11/16	5/8
06Z-756	9/16-18	3/8	-06	46,2	1.82	25,2	0.99	6,6	0.26	11/16	11/16
08Z-758	3/4-16	1/2	-08	54,6	2.15	29,5	1.16	9,7	0.38	13/16	7/8
08Z-760	7/8-14	5/8	-08	53,8	2.12	28,5	1.12	9,7	0.38	15/16	1
12Z-762	1 1/16-12	3/4	-12	61,0	2.40	34,0	1.34	15,5	0.61	1 1/8	1 1/4
16Z-766	1 5/16-12	1	-16	96,5	3.80	37,6	1.48	20,6	0.81	1 3/8	1 1/2
20Z-770	1 5/8-12	1 1/4	-20	85,1	3.35	45,7	1.80	26,7	1.05	1 3/4	2

See page L-80 for replacement nuts and sleeves.

Z-Series

Flareless 45° Tube Elbow 7000 Ermeto Series

(With Nut and Sleeve)

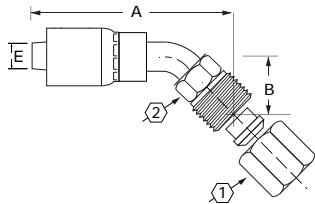

Z-Series Part #	Thd. T	Tube O.D.	Hose Size	A		Hose Cut-Off Factor (D)		EØ		1	2	B
				mm	in	mm	in	mm	in			
06Z-956	9/16-18	3/8	-06	62,0	2.44	39,6	1.56	6,6	.26	1 1/16	5/8	0.83

See page L-80 for replacement nuts and sleeves.

Flareless 90° Tube Elbow 7000 Ermeto Series

(With Nut and Sleeve)

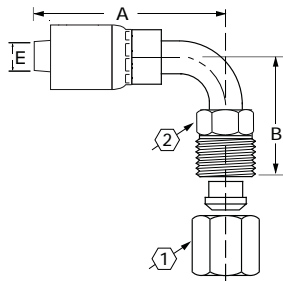

Z-Series Part #	Thd. T	Tube O.D.	Hose Size	A		Hose Cut-Off Factor (D)		EØ		2	1	B
				mm	in	mm	in	mm	in			
06Z-976	9/16-18	3/8	-06	52,1	2.05	30,9	1.22	6,6	0.26	5/8	1 1/16	1.46

See page L-80 for replacement nuts and sleeves.

Hose Ends - Crimp

Inverted Male Swivel Straight

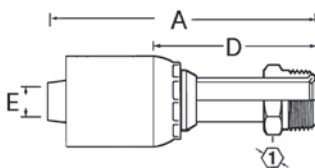

Z-Series Part #	Thd.	Hose Size	A		Hose Cut-Off Factor (D)		EØ		1
			mm	in	mm	in	mm	in	in
04Z-B03	3/8-24	-04	76,2	3.00	55,9	2.20	2,5	0.10	3/8
04Z-B04	7/16-24	-04	60,7	2.39	37,1	1.46	4,3	0.17	7/16
04Z-B05	1/2-20	-04	60,7	2.39	37,1	1.46	4,3	0.17	1/2
06Z-B04	7/16-24	-06	64,3	2.53	38,9	1.53	4,3	0.17	7/16
06Z-B05	1/2-20	-06	66,0	2.60	40,9	1.61	6,1	0.24	1/2
06Z-B06	5/8-18	-06	66,0	2.60	40,9	1.61	6,6	0.26	5/8
06Z-B07	1 1/16-18	-06	62,2	2.45	40,6	1.60	6,6	0.26	1 1/16
08Z-B08	3/4-18	-08	70,9	2.79	41,4	1.62	9,7	0.38	3/4
08Z-B10	7/8-18	-08	74,7	2.94	49,0	1.93	9,7	0.38	7/8

**Inverted Male Swivel
45° Tube Elbow**

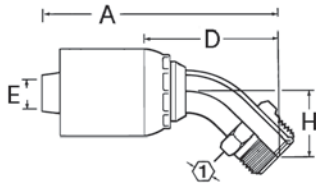

Z-Series Part #	Thd.	Hose Size	A		Hose Cut-Off Factor (D)		EØ		H		in
			mm	in	mm	in	mm	in	mm	in	
04Z-B43	3/8-24	-04	69,9	2.75	49,8	1.96	2,5	0.10	17,5	0.69	3/8
04Z-B44	7/16-24	-04	67,8	2.67	44,5	1.75	4,3	0.17	24,4	0.96	7/16
04Z-B45	1/2-20	-04	64,5	2.54	44,5	1.75	4,3	0.17	24,4	0.96	1/2
06Z-B45	1/2-20	-06	69,1	2.72	48,0	1.89	6,1	0.24	24,4	0.96	1/2
06Z-B46	5/8-18	-06	73,2	2.88	48,0	1.89	6,6	0.26	24,4	0.96	5/8
06Z-B47	11/16-18	-06	69,3	2.73	48,0	1.89	6,6	0.26	24,4	0.96	11/16
08Z-B48	3/4-18	-08	78,0	3.07	48,3	1.90	9,7	0.38	23,6	0.93	3/4

**Inverted Male Swivel
90° Tube Elbow**

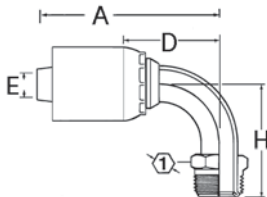

Z-Series Part #	Thd.	Hose Size	A		Hose Cut-Off Factor (D)		EØ		H		in
			mm	in	mm	in	mm	in	mm	in	
04Z-B63	3/8-24	-04	53,8	2.12	33,5	1.32	2,5	0.10	27,9	1.06	3/8
04Z-B64	7/16-24	-04	58,2	2.29	34,8	1.37	4,3	0.17	42,3	1.69	7/16
04Z-B65	1/2-20	-04	55,1	2.17	34,8	1.37	4,3	0.17	43,9	1.73	1/2
06Z-B64	7/16-24	-06	57,8	2.28	36,6	1.44	4,3	0.17	42,3	1.69	7/16
06Z-B65	1/2-20	-06	63,8	2.51	38,4	1.51	6,1	0.24	43,9	1.73	1/2
06Z-B66	5/8-18	-06	63,8	2.51	38,4	1.51	6,6	0.26	43,9	1.73	5/8
06Z-B67	11/16-18	-06	62,0	2.44	40,9	1.61	6,6	0.26	43,9	1.73	11/16
08Z-B68	3/4-18	-08	69,3	2.73	39,6	1.56	9,7	0.38	44,5	1.75	3/4

**Split Flange Straight
(SAE Code 61)**

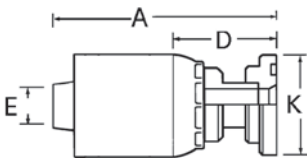

Z-Series Part #	Nominal Flange Size	Thd. Flange Head Dia. K Ø	Hose Size	A		Hose Cut-Off Factor (D)		EØ	
				mm	in	mm	in	mm	in
08Z-G08	1/2	1.19	-08	82,0	3.23	52,3	2.06	9,7	0.38
08Z-G12	3/4	1.50	-08	83,1	3.27	53,3	2.10	9,7	0.38
10Z-G12	3/4	1.50	-10	82,8	3.26	53,3	2.10	12,7	0.50
12Z-G12	3/4	1.50	-12	84,1	3.31	53,8	2.12	15,5	0.61
12Z-G16	1	1.75	-12	84,1	3.31	53,8	2.12	15,5	0.61
12Z-G20	1 1/4	2.00	-12	91,7	3.61	61,5	2.42	15,5	0.61
16Z-G16	1	1.75	-16	88,6	3.49	54,4	2.14	20,8	0.82
16Z-G20	1 1/4	2.00	-16	96,3	3.79	62,0	2.44	20,8	0.82
20Z-G16	1	1.75	-20	100,1	3.94	56,1	2.21	20,8	0.82
20ZA-G16	1	1.75	-20	100,1	3.94	56,1	2.21	20,8	0.82
20Z-G20	1 1/4	2.00	-20	107,7	4.24	63,8	2.51	26,7	1.05
20ZA-G20	1 1/4	2.00	-20	107,7	4.24	63,8	2.51	26,7	1.05
20Z-G24	1 1/2	2.38	-20	108,5	4.27	64,5	2.54	26,7	1.05
20ZA-G24	1 1/2	2.38	-20	108,5	4.27	64,5	2.54	26,7	1.05
20Z-G32	2	2.81	-20	108,5	4.27	64,5	2.54	25,7	1.01
24Z-G24	1 1/2	2.38	-24	111,8	4.40	65,5	2.58	32,0	1.26
24Z-G32	2	2.81	-24	111,8	4.40	65,5	2.58	30,2	1.19
32Z-G32	2	2.81	-32	117,1	4.61	66,8	2.63	44,5	1.75
32Z-G33	2 1/2	3.31	-32	116,8	4.60	66,8	2.63	44,5	1.75

Note: 20ZA fittings should only be used with one wire braided hose.
20Z fittings should only be used with two wire braided hose.

See pages L-90 thru L-92 for split flange kits.

Hose Ends - Crimp

Split Flange 22.5° Tube Elbow (SAE Code 61)

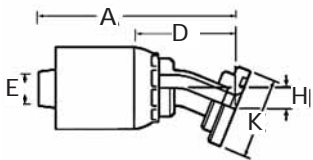

Z-Series Part #	Nominal Flange Size	Flange Head Dia. K Ø	Hose Size	A		Hose Cut-Off Factor (D)		EØ		H	
				mm	in	mm	in	mm	in	mm	in
16Z-H03	1	1.75	-16	117,9	4.64	83,6	3.29	19,3	0.76	11,4	0.45
16Z-H04	1 1/4	2.00	-16	130,0	5.12	95,8	3.77	19,3	0.76	11,7	0.46
20Z-H04	1 1/4	2.00	-20	141,5	5.57	97,3	3.83	25,7	1.01	11,7	0.46

See pages L-90 thru L-92 for split flange kits.

Split Flange 45° Tube Elbow (SAE Code 61)

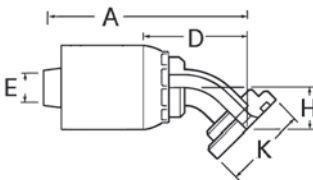

Z-Series Part #	Nominal Flange Size	Flange Head Dia. K Ø	Hose Size	A		Hose Cut-Off Factor (D)		EØ		H	
				mm	in	mm	in	mm	in	mm	in
08Z-G41	1/2	1.19	-08	79,0	3.11	49,3	1.94	9,4	0.37	19,8	0.78
08Z-G42	3/4	1.50	-08	92,5	3.64	62,7	2.47	9,4	0.37	25,4	1.00
10Z-G42	3/4	1.50	-10	93,5	3.68	64,3	2.53	11,7	0.46	25,4	1.00
12Z-G42	3/4	1.50	-12	93,2	3.67	63,0	2.48	14,7	0.58	25,7	1.01
12Z-G46	1	1.75	-12	105,7	4.16	75,4	2.97	14,7	0.58	26,9	1.06
16Z-G46	1	1.75	-16	110,5	4.35	76,2	3.00	19,3	0.76	26,9	1.06
16Z-G50	1 1/4	2.00	-16	122,2	4.81	87,6	3.45	19,3	0.76	29,2	1.15
20Z-G46	1	1.75	-20	121,9	4.80	77,7	3.06	19,3	0.76	26,9	1.06
20ZA-G46	1	1.75	-20	121,9	4.80	77,7	3.06	19,3	0.76	26,9	1.06
20Z-G50	1 1/4	2.00	-20	134,1	5.28	90,2	3.55	25,7	1.01	30,0	1.18
20ZA-G50	1 1/4	2.00	-20	134,1	5.28	90,2	3.55	25,7	1.01	30,0	1.18
20Z-G54	1 1/2	2.37	-20	146,2	5.76	106,7	4.20	25,7	1.01	35,8	1.41
20ZA-G54	1 1/2	2.37	-20	150,9	5.94	106,7	4.20	25,7	1.01	35,8	1.41
24Z-G54	1 1/2	2.37	-24	151,6	5.97	107,0	4.25	32,0	1.26	35,8	1.41
24Z-G62	2	2.81	-24	154,2	6.07	108,0	4.25	32,0	1.26	35,8	1.41
32Z-G54	1 1/2	2.37	-32	159,3	6.27	109,0	4.29	32,0	1.26	35,8	1.41
32Z-G62	2	2.81	-32	190,2	7.49	140,2	5.52	44,5	1.75	50,8	2.00

Note: 20ZA fittings should only be used with one wire braided hose. 20Z fittings should only be used with two wire braided hose.

See pages L-90 thru L-92 for split flange kits.

Split Flange 60° Tube Elbow (SAE Code 61)

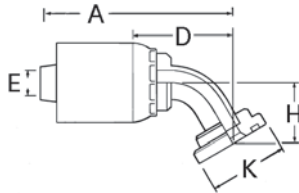

Z-Series Part #	Nominal Flange Size	Flange Head Dia. K Ø	Hose Size	A		Hose Cut-Off Factor (D)		EØ		H	
				mm	in	mm	in	mm	in	mm	in
16Z-H53	1	1.75	-16	132,5	5.22	98,7	3.89	19,9	0.78	38,3	1.51
24Z-H55	1-1/2	2.37	-24	187,1	7.37	143,4	5.65	32,0	1.26	46,1	1.81

See pages L-90 thru L-92 for split flange kits.

Split Flange 67° Tube Elbow (SAE Code 61)

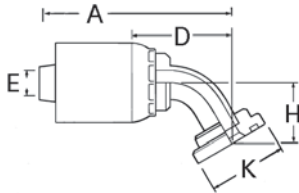

Z-Series Part #	Nominal Flange Size	Flange Head Dia. K Ø	Hose Size	A		Hose Cut-Off Factor (D)		EØ		H	
				mm	in	mm	in	mm	in	mm	in
20Z-H60	1-1/4	2.00	-20	157,0	6.18	112,8	4.44	25,7	1.01	46,5	1.83
20Z-H64	1-1/2	2.37	-24	189,7	7.47	143,5	5.65	30,2	1.19	46,0	1.81

Split Flange 90° Tube Elbow (SAE Code 61)

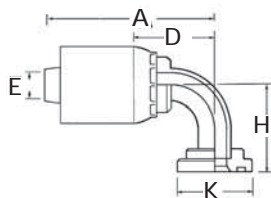

Z-Series Part #	Nominal Flange Size	Flange Head Dia. K Ø	Hose Size	A		Hose Cut-Off Factor (D)		EØ		H	
				mm	in	mm	in	mm	in	mm	in
08Z-G71	1/2	1.19	-08	72,6	2.86	42,3	1.69	9,4	0.37	41,4	1.63
08Z-G72	3/4	1.50	-08	87,6	3.45	57,9	2.28	9,4	0.37	54,1	2.13
10Z-G72	3/4	1.50	-10	87,4	3.44	58,2	2.29	12,7	0.50	54,1	2.13
12Z-G72	3/4	1.50	-12	88,6	3.49	58,4	2.30	14,7	0.58	54,1	2.13
12Z-G76	1	1.75	-12	102,4	4.03	72,1	2.84	14,7	0.58	60,5	2.38
12Z-G80	1 1/4	2.00	-12	118,6	4.67	88,4	3.48	14,7	0.58	66,5	2.62
16Z-G76	1	1.75	-16	107,2	4.22	72,6	2.86	19,3	0.76	60,5	2.38
16Z-G80	1 1/4	2.00	-16	123,2	4.85	89,0	3.50	19,3	0.76	66,5	2.62
16Z-G84	1 1/2	2.37	-16	142,0	5.59	107,7	4.24	19,3	0.76	79,2	3.12
20Z-G76	1	1.75	-20	118,4	4.66	74,4	2.93	19,3	0.76	60,5	2.38
20ZA-G76	1	1.75	-20	118,4	4.66	74,4	2.93	19,3	0.76	60,5	2.38
20Z-G80	1 1/4	2.00	-20	134,6	5.30	90,7	3.57	25,7	1.01	66,5	2.62
20ZA-G80	1 1/4	2.00	-20	134,6	5.30	90,7	3.57	25,7	1.01	66,5	2.62
20Z-G84	1 1/2	2.37	-20	153,4	6.04	109,4	4.31	26,6	1.05	79,3	3.12
20ZA-G84	1 1/2	2.37	-20	153,4	6.04	109,4	4.31	26,6	1.05	79,3	3.12
24Z-G80	1 1/4	2.00	-24	137,9	5.43	91,7	3.61	25,7	1.01	66,5	2.62
24Z-G84	1 1/2	2.37	-24	157,0	6.18	110,5	4.35	32,0	1.26	79,3	3.12
24Z-G92	2	2.81	-24	184,9	7.28	138,4	5.45	32,0	1.26	114,3	4.50
32Z-G92	2	2.81	-32	182,9	7.20	119,9	4.72	41,4	1.62	114,3	4.50
32Z-G93	2 1/2	3.31	-32	182,9	7.20	119,9	4.72	41,4	1.62	115,8	4.56

Note: 20ZA fittings should only be used with one wire braided hose. 20Z fittings should only be used with two wire braided hose.

See pages L-90 thru L-92 for split flange kits.

Metric Split Flange Straight
(Komatsu, Linkbelt, etc.)

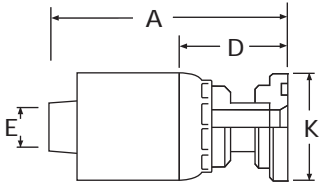

Z-Series Part #	Nominal Flange Size	Flange Head Dia. K Ø		Hose Size	A		Hose Cut-Off Factor (D)		EØ	
		mm	in		mm	in	mm	in	mm	in
10Z-G09	5/8	34,2	1.35	-10	94,2	0.16	64,8	2.55	11,5	0.45

Metric Split Flange 45° Tube Elbow
(Komatsu, Linkbelt, etc.)

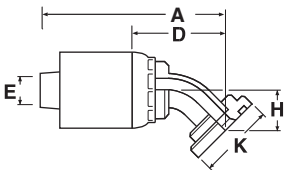

Z-Series Part #	Nominal Flange Size	Flange Head Dia. K Ø		Hose Size	A		Hose Cut-Off Factor (D)		EØ		H
		mm	in		mm	in	mm	in	mm	in	
10Z-G69	5/8	34,2	1.35	-10	86,1	3.39	56,7	2.23	11,5	0.45	21,8 0.86

J

Hose Ends - Crimp

Metric Split Flange 90° Tube Elbow
(Komatsu, Linkbelt, etc.)

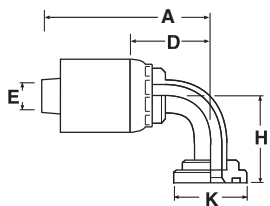

Z-Series Part #	Nominal Flange Size	Flange Head Dia. K Ø		Hose Size	A		Hose Cut-Off Factor (D)		EØ		H
		mm	in		mm	in	mm	in	mm	in	
10Z-G69	5/8	34,2	1.35	-10	77,9	3.07	48,5	1.91	11,5	0.45	51,3 2.02

READY-LOK® Male Connector

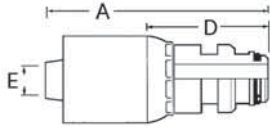

Note: 20ZA fittings should only be used with one wire braided hose.
20Z fittings should only be used with two wire braided hose.

Z-Series Part #	Connect. Size	Hose Size	A		Hose Cut-Off Factor (D)		EØ	
			mm	in	mm	in	mm	in
04Z-04S	1/4	-04	55,4	2.18	32,0	1.26	4,3	0.17
06Z-06S	3/8	-06	58,4	2.30	33,0	1.30	6,6	0.26
06Z-08S	1/2	-06	58,4	2.30	33,0	1.30	6,6	0.26
08Z-08S	1/2	-08	64,0	2.52	34,3	1.35	9,7	0.38
12Z-12S	3/4	-12	65,0	2.56	34,8	1.37	15,5	0.61
16Z-16S	1	-16	74,9	2.95	40,6	1.60	20,6	0.81
20ZA-20S	1 1/4	-20	86,4	3.40	42,4	1.67	26,7	1.05

(O-ring and backup ring included.)

Standpipe Straight Tube

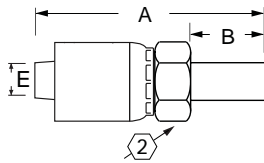

Z-Series Part #	Tube O.D.	Hose Size	A		Hose Cut-Off Factor (D)		EØ		Ø	B	
			mm	in	mm	in	mm	in		mm	in
04Z-T04	1/4	-04	55,6	2.19	35,56	1.40	4,3	0.17	9/16	25,4	1.00
06Z-T06	3/8	-06	59,7	2.35	38,61	1.52	6,6	0.26	11/16	25,4	1.00
08Z-T08	1/2	-08	68,3	2.69	43,18	1.70	9,7	0.38	13/16	27,9	1.10
10Z-T10	5/8	-10	71,1	2.80	45,47	1.79	12,7	0.50	15/16	29,2	1.15
12Z-T12	3/4	-12	73,7	2.90	46,74	1.84	15,5	0.61	1 1/8	30,2	1.19
16Z-T16	1	-16	87,1	3.43	53,59	2.11	20,6	0.81	1 3/8	33,5	1.32

See page L-80 for Ermeto nuts and sleeves.

Metric Standpipe Straight Tube

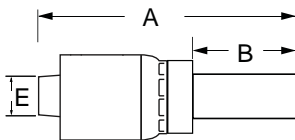

Z-Series Part #	Tube O.D.	Hose Size	A		Hose Cut-Off Factor (D)		EØ		B	
			mm	in	mm	in	mm	in	mm	in
04Z-38T	8	-04	56,4	2.22	33,0	1.30	4,1	0.16	23	0.91
04Z-40T	10	-04	56,4	2.22	33,0	1.30	4,3	0.17	23	0.91
06Z-40T	10	-06	59,4	2.34	34,3	1.35	6,6	0.26	23	0.91
06Z-42T	12	-06	60,5	2.38	35,0	1.38	6,6	0.26	24	0.95
06Z-44T	14	-06	61,5	2.42	36,1	1.42	6,6	0.26	25	0.98
08Z-45T	15	-08	66,8	2.63	37,1	1.46	9,7	0.38	25	0.98
08Z-46T	16	-08	68,1	2.68	38,4	1.51	9,7	0.38	26	1.02
10Z-48T	18	-10	69,1	2.72	39,6	1.56	12,7	0.50	27	1.06
10Z-50T	20	-10	69,1	2.72	39,6	1.56	12,7	0.50	27	1.06
12Z-52T	22	-12	71,1	2.80	40,9	1.61	15,5	0.61	28	1.10
12Z-55T	25	-12	70,1	2.76	39,9	1.57	15,5	0.61	27	1.06
16Z-58T	28	-16	75,7	2.98	41,4	1.63	20,6	0.81	28	1.10
16Z-60T	30	-16	75,9	2.99	41,7	1.64	20,6	0.81	28	1.10

See page L-66 for metric nuts and sleeves.

Z-Series

Pressure Washer Connection

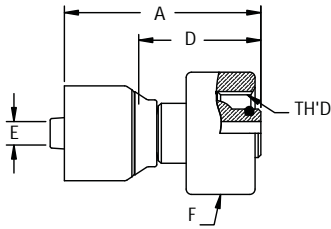

Z-Series Part #	Thd.	Hose Size	A		Hose Cut-Off Factor (D)		EØ		F Dia.	
			mm	in	mm	in	mm	in	mm	in
04Z-6PW	M22x1.5	-04	55,4	2.18	35,3	1.39	4,2	0.17	34,9	1.38
06Z-6PW	M22x1.5	-06	56,1	2.21	34,9	1.38	6,7	0.26	34,9	1.38

BSPP Flat Face Female Swivel

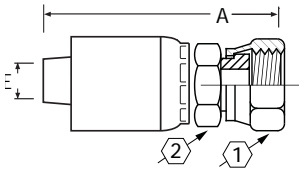

Z-Series Part #	Thd.	Hose Size	A		Hose Cut-Off Factor (D)		EØ		2	1
			mm	in	mm	in	mm	in	in	in
06Z-06PA	G 3/8-19	-06	57,2	2.25	36,7	1.42	6,6	0.26	11/16	3/4
06Z-08PA	G 1/2-14	-06	58,7	2.31	37,6	1.48	6,6	0.26	3/4	11/16
08Z-08PA	G 1/2-14	-08	66,8	2.63	41,7	1.64	9,2	0.36	13/16	11/16
08Z-12PA	G 3/4-14	-08	67,1	2.64	41,9	1.65	9,7	0.38	1	11/4
12Z-12PA	G 3/4-14	-12	71,1	2.80	44,2	1.74	15,5	0.61	11/8	11/4

* G as part of thread size is ISO Designation for parallel thread.

Hose Ends - Crimp

British Standard (BSPP) 60° Cone Female Swivel Straight

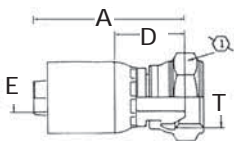

Z-Series Part #	Thd. T	Hose Size	A		Hose Cut-Off Factor (D)		EØ		1	
			mm	in	mm	in	mm	in	mm	in
04Z-354	G 1/4 -19*	-04	42,3	1.66	18,9	0.74	4,2	0.16	19,0	0.75
04Z-356	G 3/8-19*	-04	45,5	1.79	22,1	0.87	4,3	0.17	22,0	0.87
06Z-356	G 3/8 -19*	-06	46,4	1.83	21,1	0.83	6,7	0.26	22,0	0.87
06Z-358	G 1/2 -14*	-06	47,9	1.88	22,6	0.89	6,7	0.26	27,0	1.06
08Z-358	G 1/2 -14*	-08	53,5	2.11	23,8	0.94	9,6	0.38	27,0	1.06
08Z-360	G 5/8 -14*	-08	56,4	2.22	26,7	1.05	9,6	0.38	30,0	1.18
10Z-360	G 5/8 -14*	-10	54,1	2.13	24,7	0.97	12,7	0.50	30,0	1.18
12Z-362	G 3/4 -14*	-12	55,5	2.18	25,3	1.00	15,5	0.61	32,0	1.26
16Z-366	G 1 -11*	-16	62,0	2.44	27,6	1.09	20,7	0.81	41,0	1.61
20Z-370	G 1 1/4 -11*	-20	73,6	2.90	29,6	1.16	26,6	1.05	50,0	1.97

* G as part of thread size is ISO Designation for parallel thread.

**British Standard (BSPP)
60° Cone Female
45° Tube Elbow**

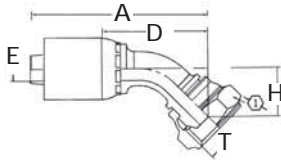

Z-Series Part #	Thd. T	Hose Size	A		Hose Cut-Off Factor (D)		EØ		H		①	
			mm	in	mm	in	mm	in	mm	in	mm	in
04Z-44P	G 1/4 -19*	-04	65,3	2.57	41,9	1.65	4,2	0.16	16,5	0.65	19,0	0.75
06Z-46P	G 3/8 -19*	-06	73,8	2.90	48,5	1.91	6,7	0.26	19,0	0.75	22,0	0.87
08Z-48P	G 1/2 -14*	-08	91,5	3.60	61,8	2.43	9,6	0.38	24,8	0.98	27,0	1.06
10Z-50P	G 5/8 -14*	-10	100,4	3.95	71,0	2.79	12,7	0.50	27,4	1.08	30,0	1.18
12Z-52P	G 3/4 -14*	-12	108,8	4.28	78,6	3.09	15,5	0.61	29,4	1.16	32,0	1.26
16Z-56P	G 1 -11*	-16	126,8	4.99	92,4	3.09	20,7	0.81	33,2	1.31	41,0	1.61
20Z-60P	G 1 1/4 -11*	-20	153,6	6.05	109,6	4.31	26,6	1.05	37,2	1.46	50,0	1.97

* G as part of thread size is ISO Designation for parallel thread.

**British Standard (BSPP)
60° Cone Female
90° Tube Elbow**

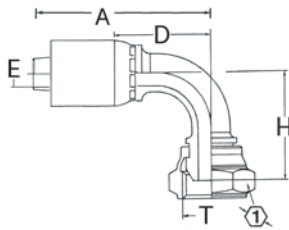

Z-Series Part #	Thd. T	Hose Size	A		Hose Cut-Off Factor (D)		EØ		H		①	
			mm	in	mm	in	mm	in	mm	in	mm	in
04Z-74P	G 1/4 -19*	-04	45,8	1.80	22,4	0.88	4,2	0.16	24,8	0.98	17,0	0.67
06Z-76P	G 3/8 -19*	-06	58,9	2.32	33,6	1.32	6,7	0.26	35,0	1.38	22,0	0.87
06Z-78P	G 1/2 -14*	-06	75,7	2.98	50,4	1.98	6,7	0.26	47,8	1.88	27,0	1.06
08Z-78P	G 1/2 -14*	-08	64,0	2.52	34,3	1.35	9,6	0.38	37,6	1.48	27,0	1.06
08Z-80P	G 5/8 -14*	-08	90,7	3.57	61,0	2.40	9,6	0.38	56,3	2.22	27,0	1.06
10Z-80P	G 5/8 -14*	-10	90,6	3.57	61,2	1.41	12,7	0.50	56,3	2.22	27,0	1.06
12Z-82P	G 3/4 -14*	-12	82,2	3.24	52,0	2.05	15,5	0.61	47,5	1.87	32,0	1.26
16Z-86P	G 1 -11*	-16	118,2	4.65	83,8	3.30	20,7	0.81	71,5	2.81	41,0	1.61
20Z-90P	G 1 1/4 -11*	-20	146,2	5.75	102,2	4.02	26,6	1.05	82,5	3.25	50,0	1.97

* G as part of thread size is ISO Designation for parallel thread.

**British Standard (BSPT)
Tapered Male Rigid**

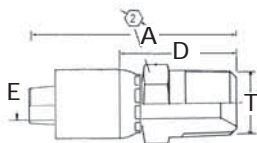

Z-Series Part #	Thd. T	Hose Size	A		Hose Cut-Off Factor (D)		EØ		②	
			mm	in	mm	in	mm	in	mm	in
04Z-154	R 1/4 -19*	-04	50,6	1.99	27,2	1.07	4,2	0.16	14,0	0.55
06Z-156	R 3/8 -19*	-06	54,9	2.16	29,6	1.16	6,7	0.26	19,0	0.75
08Z-158	R 1/2 -14*	-08	66,2	2.61	36,5	1.44	9,6	0.38	22,0	0.87
12Z-162	R 3/4 -14*	-12	71,1	2.80	40,9	1.61	15,5	0.61	30,0	1.18
16Z-166	R 1 -11*	-16	81,2	3.20	46,8	1.84	20,7	0.81	36,0	1.42
20Z-170	R 1 1/4 -11*	-20	96,2	3.79	52,2	2.05	26,6	1.05	46,0	1.81

* R as part of thread size is ISO Designation for tapered thread.

Z-Series

British Standard (BSPP)
60° Cone Male Rigid

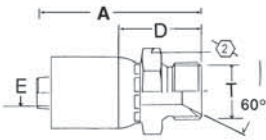

Z-Series Part #	Thd. T	Hose Size	A		Hose Cut-Off Factor (D)		EØ		⌀2	
			mm	in	mm	in	mm	in	mm	in
04Z-P54	G 1/4 -19*	-04	44,3	1.74	20,9	0.82	4,2	0.16	19,0	0.75
06Z-P56	G 3/8 -19*	-06	48,4	1.90	23,1	0.91	6,7	0.26	22,0	0.87
08Z-P56	G 3/8 -19*	-08	55,9	2.20	26,4	1.04	9,6	0.38	22,0	0.87
06Z-P58	G 1/2 -14*	-06	52,4	2.06	27,1	1.07	6,7	0.26	27,0	1.06
08Z-P58	G 1/2 -14*	-08	58,0	2.28	28,3	1.11	9,6	0.38	27,0	1.06
10Z-P60	G 5/8 -14*	-10	62,0	2.44	35,5	1.25	12,7	0.50	30,0	1.18
12Z-P62	G 3/4 -14*	-12	63,1	2.48	32,9	1.29	15,5	0.61	32,0	1.26
16Z-P66	G 1 -11*	-16	70,9	2.79	36,5	1.44	20,7	0.81	41,0	1.61
20Z-P67	G 1 1/4 -11*	-20	86,1	3.39	42,2	1.66	26,6	1.50	50,0	1.97

* G as part of thread size is ISO Designation for parallel thread.

Female JIS 30° Flare
Swivel Straight

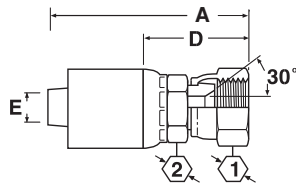

Z-Series Part #	Thd.	Hose Size	A		Hose Cut-Off Factor (D)		EØ		⌀1		⌀2	
			mm	in	mm	in	mm	in	mm	in	mm	in
04Z-04L	G 1/4 -19*	-04	53,2	2.09	29,8	1.17	4,2	0.16	19,0	0.75	19,0	0.75
06Z-06L	G 3/8 -19*	-06	59,2	2.33	33,9	1.33	6,7	0.26	22,0	0.87	22,0	0.87
08Z-08L	G 1/2 -14*	-08	66,3	2.61	36,6	1.44	9,6	0.38	27,0	1.06	27,0	1.06
10Z-12L	G 3/4 -14*	-10	70,6	2.78	45,2	1.78	12,7	0.50	32,0	1.26	36,0	1.42
12Z-12L	G 3/4 -14*	-12	73,3	2.88	43,1	1.70	15,5	0.61	32,0	1.26	36,0	1.42
16Z-16L	G 1 -11*	-16	83,6	3.29	49,2	1.94	20,7	0.81	41,0	1.61	41,0	1.61
20Z-20L	G 1 1/4 -11*	-20	102,1	4.02	58,1	2.29	26,6	1.05	50,0	1.97	46,0	1.81

* G as part of thread size is ISO Designation for parallel thread.

Hose Ends - Crimp

Female Swivel
30° Flare
(Komatsu, Linkbelt)

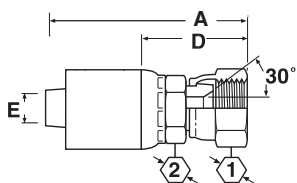

Z-Series Part #	Thd.	Hose Size	A		Hose Cut-Off Factor (D)		EØ		⌀1		⌀2	
			mm	in	mm	in	mm	in	mm	in	mm	in
04Z-14K	M14 x 1.5	-04	56,1	2.21	32,7	1.29	42,2	1.66	19,0	0.75	19,0	0.75
06Z-18K	M18 x 1.5	-06	60,4	2.38	35,1	1.38	6,7	0.26	24,0	0.94	22,0	0.87
08Z-22K	M22 x 1.5	-08	69,5	2.74	39,8	1.57	9,6	0.38	27,0	1.06	27,0	1.06
10Z-24K	M24 x 1.5	-10	75,4	2.97	46,0	1.81	12,4	0.49	32,0	1.26	30,0	1.18
12Z-30K	M30 x 1.5	-12	81,5	3.21	51,3	2.02	15,5	0.61	36,0	1.42	36,0	1.42
16Z-33K	M33 x 1.5	-16	91,4	3.60	57,0	2.24	20,7	0.81	41,0	1.61	41,0	1.61

**Female Swivel DIN 24° Seat
I.Rh DKO (Light)**

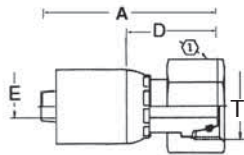

Z-Series Part #	Thd. T	Tube O.D.	Hose Size	A		Hose Cut-Off Factor (D)		EØ		①	
				mm	in	mm	in	mm	in	mm	in
04Z-06C	M12 x 1.5	6	-04	48,0	1.89	24,6	0.97	4,2	0.16	17,0	0.67
04Z-08C	M14 x 1.5	8	-04	46,0	1.81	22,6	0.89	4,2	0.16	17,0	0.67
04Z-10C	M16 x 1.5	10	-04	48,3	1.90	24,9	0.98	4,3	0.17	19,0	0.75
06Z-10C	M16 x 1.5	10	-06	56,9	2.24	31,6	1.24	6,7	0.26	19,0	0.75
06Z-12C	M18 x 1.5	12	-06	51,2	2.01	25,9	1.02	6,7	0.26	22,0	0.87
08Z-15C	M22 x 1.5	15	-08	58,3	2.29	28,6	1.12	9,6	0.38	27,0	1.06
10Z-18C	M26 x 1.5	18	-10	59,2	2.33	29,8	1.17	12,7	0.50	32,0	1.26
12Z-22C	M30 x 2.0	22	-12	62,5	2.46	32,3	1.27	15,5	0.61	36,0	1.42
16Z-28C	M36 x 2.0	28	-16	68,2	2.68	33,8	1.33	20,7	0.81	41,0	1.61
20Z-35C	M45 x 2.0	35	-20	83,7	3.29	39,7	1.56	26,6	1.05	50,0	1.97

**Female Swivel DIN 24° Seat
45° Tube Elbow
I. Rh. (Light)**

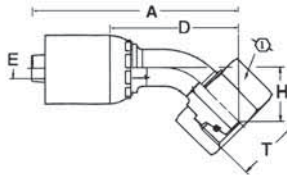

Z-Series Part #	Thd. T	Tube O.D.	Hose Size	A		Hose Cut-Off Factor (D)		EØ		H		①	
				mm	in	mm	in	mm	in	mm	in	mm	in
04Z-08D	M14 X 1.5	8	-04	6,2	2.46	3,9	1.54	0,4	0.17	17,5	0.69	17,0	0.67
04Z-10D	M16 X 1.5	10	-04	6,5	2.55	4,1	1.63	0,4	0.17	18,4	0.72	19,0	0.75
06Z-10D	M16 X 1.5	10	-06	6,7	2.63	4,1	1.63	0,7	0.26	19,0	0.75	19,0	0.75
06Z-12D	M18 X 1.5	12	-06	7,0	2.76	4,5	1.76	0,7	0.26	17,6	0.69	22,0	0.87
08Z-15D	M22 X 1.5	15	-08	8,3	3.27	5,3	2.10	1,0	0.38	20,5	0.81	27,0	1.06
10Z-18D	M26 X 1.5	18	-10	9,1	3.59	6,2	2.44	1,3	0.50	22,0	0.87	32,0	1.26
12Z-22D	M30 X 2.0	22	-12	10,1	3.97	7,1	2.78	1,5	0.61	24,3	0.96	36,0	1.42
16Z-28D	M36 X 2.0	28	-16	10,3	4.06	6,9	2.70	2,1	0.81	26,6	1.05	41,0	1.61

**Female Swivel DIN 24° Seat
90° Tube Elbow
I. Rh. (Light)**

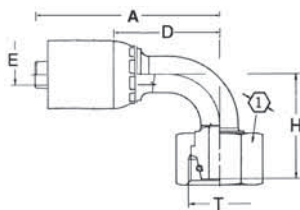

Z-Series Part #	Thd. T	Tube O.D.	Hose Size	A		Hose Cut-Off Factor (D)		EØ		H		①	
				mm	in	mm	in	mm	in	mm	in	mm	in
04Z-58D	M14 x 1.5	8	-04	51,1	2.01	27,7	1.09	4,3	0.17	31,5	1.24	17,0	0.67
04Z-60D	M16 x 1.5	10	-04	55,4	2.18	32,0	1.26	4,3	0.17	35,5	1.40	19,0	0.75
06Z-60D	M16 x 1.5	10	-06	58,4	2.30	33,5	1.32	6,6	0.26	33,5	1.32	19,0	0.75
06Z-62D	M18 x 1.5	12	-06	59,7	2.35	34,5	1.36	6,6	0.26	34,2	1.35	22,0	0.87
08Z-65D	M22 x 1.5	15	-08	75,2	2.96	45,7	1.80	9,7	0.38	40,0	1.57	27,0	1.06
10Z-68D	M26 x 1.5	18	-10	86,4	3.40	56,9	2.24	12,7	0.50	46,5	1.83	32,0	1.26
12Z-72D	M30 x 2.0	22	-12	92,5	3.64	62,2	2.45	15,5	0.61	50,7	2.00	36,0	1.42
16Z-78D	M36 x 2.0	28	-16	100,1	3.94	65,5	2.58	20,6	0.81	61,0	2.40	41,0	1.61
20Z-85D	M45 x 2.0	35	-20	130,0	5.12	86,1	3.39	26,7	1.05	79,0	3.11	50,0	1.97

Z-Series

Male DIN 24° Seat
l.Rh (Light)

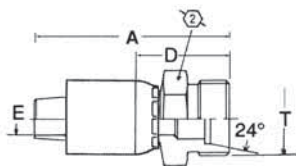

Z-Series Part #	Thd. T	Tube O.D.	Hose Size	A		Hose Cut-Off Factor (D)		EØ		②	
				mm	in	mm	in	mm	in	mm	in
04Z-06A	M12 x 1.5	6	-04	44,7	1.76	21,3	0.84	4,2	0.16	12,0	0.47
04Z-08A	M14 x 1.5	8	-04	44,5	1.75	21,1	0.83	4,2	0.16	14,0	0.55
04Z-10A	M16 X 1.5	10	-04	46,0	1.81	22,6	0.89	4,3	0.17	17,0	0.67
06Z-10A	M16 x 1.5	10	-06	52,0	2.05	26,7	1.05	6,7	0.26	17,0	0.67
06Z-12A	M18 x 1.5	12	-06	49,0	1.93	23,7	0.93	6,7	0.26	19,0	0.75
08Z-15A	M22 x 1.5	15	-08	56,0	2.20	26,3	1.03	9,6	0.38	24,0	0.94
10Z-18A	M26 x 1.5	18	-10	56,0	2.20	26,6	1.05	12,7	0.50	27,0	1.06
12Z-22A	M30 x 2.0	22	-12	62,0	2.44	31,8	1.25	15,5	0.61	32,0	1.26
16Z-28A	M36 x 2.0	28	-16	66,0	2.60	31,6	1.24	20,7	0.81	41,0	1.61
20Z-35A	M45 x 2.0	35	-20	79,4	3.12	35,4	1.39	26,6	1.05	46,0	1.81

Female Swivel
DIN 24° Seat
s.Rh DKO (Heavy)

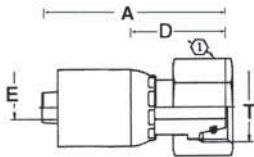

Z-Series Part #	Thd. T	Tube O.D.	Hose Size	A		Hose Cut-Off Factor (D)		EØ		①	
				mm	in	mm	in	mm	in	mm	in
04Z-58C	M16 x 1.5	8	-04	49,6	1.95	26,2	1.03	4,2	0.16	19,0	0.75
04Z-60C	M18 x 1.5	10	-04	50,8	2.00	27,4	1.08	4,2	0.16	22,0	0.87
04Z-62C	M20 X 1.5	12	-04	50,8	2.00	27,4	1.08	4,3	0.17	24,0	0.94
06Z-60C	M18 X 1.5	10	-06	52,8	2.08	27,7	1.09	6,6	0.26	27,0	1.06
06Z-62C	M20 x 1.5	12	-06	53,8	2.12	28,5	1.12	6,7	0.26	24,0	0.94
06Z-64C	M22 x 1.5	14	-06	56,9	2.24	31,6	1.24	6,7	0.26	27,0	1.06
08Z-64C	M22 x 1.5	14	-08	55,2	2.17	25,5	1.00	9,6	0.38	27,0	1.06
08Z-66C	M24 x 1.5	16	-08	62,4	2.46	32,7	1.29	9,6	0.38	30,0	1.18
10Z-70C	M30 x 2.0	20	-10	66,9	2.63	37,5	1.48	12,7	0.50	36,0	1.42
12Z-75C	M36 x 2.0	25	-12	72,0	2.83	41,8	1.64	15,5	0.61	46,0	1.81
12Z-70C	M30 X 2.0	20	-12	60,2	2.37	30,2	1.19	14,0	0.55	36,0	1.42
16Z-80C	M42 x 2.0	30	-16	78,5	3.09	44,1	1.44	20,7	0.81	50,0	1.97
20Z-88C	M52 X 2.0	38	-20	93,7	3.69	49,8	1.96	26,6	1.05	60,0	2,36

Hose Ends - Crimp

Female Swivel
DIN 24° Seat 45° Tube Elbow
s.Rh (Heavy)

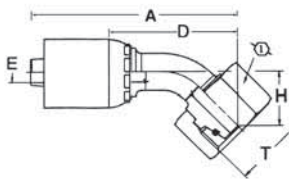

Z-Series Part #	Thd. T	Tube O.D.	Hose Size	A		Hose Cut-Off Factor (D)		EØ		H		①	
				mm	in	mm	in	mm	in	mm	in	mm	in
04Z-10E	M18 x 1.5	10	-04	61,4	2.42	38,0	1.50	4,2	0.16	17,0	0.67	22,0	0.87
06Z-12E	M20 x 1.5	12	-06	68,3	2.69	43,0	1.69	6,7	0.26	19,0	0.75	24,0	0.94
06Z-14E	M22 x 1.5	14	-06	68,8	2.71	43,5	1.71	6,7	0.26	20,0	0.79	27,0	1.06
08Z-16E	M24 x 1.5	16	-08	79,7	3.14	50,0	1.97	9,6	0.38	23,0	0.90	30,0	1.18
10Z-20E	M30 x 2.0	20	-10	89,3	3.51	59,9	2.36	12,7	0.50	26,0	1.02	36,0	1.42
12Z-25E	M36 x 2.0	25	-12	107,4	4.23	77,2	3.04	15,5	0.61	32,5	1.28	46,0	1.81
16Z-30E	M42 x 2.0	30	-16	121,4	4.78	87,0	3.42	20,7	0.81	37,5	1.48	55,0	2.16

Z-Series

**Female Swivel
DIN 24° Seat 90° Tube Elbow**
s.Rh DKO (Heavy)

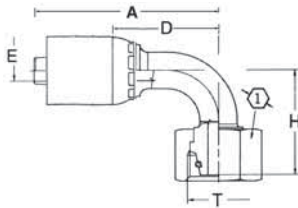

Z-Series Part #	Thd. T	Tube O.D.	Hose Size	A		Hose Cut-Off Factor (D)		EØ		H		①	
				mm	in	mm	in	mm	in	mm	in		mm
04Z-58E	M16 x 1.5	10	-04	54,0	2.13	30,6	1.20	4,2	0.16	28,6	1.13	19,0	0.75
04Z-60E	M18 x 1.5	10	-04	54,5	2.14	31,0	1.22	4,2	0.16	33,5	1.32	22,0	0.87
06Z-62E	M20 x 1.5	12	-06	60,3	2.37	35,0	1.38	6,7	0.26	35,0	1.38	24,0	0.94
06Z-64E	M22 x 1.5	14	-06	63,8	2.51	38,5	1.51	6,7	0.26	42,0	1.65	27,0	1.06
08Z-66E	M24 x 1.5	16	-08	73,7	2.90	44,0	1.73	9,6	0.38	49,0	1.93	30,0	1.18
10Z-70E	M30 x 2.0	20	-10	82,0	3.23	52,6	2.07	12,7	0.50	53,5	2.11	36,0	1.42
12Z-75E	M36 x 2.0	25	-12	93,0	3.66	62,8	2.47	15,5	0.61	64,5	2.54	46,0	1.81
16Z-80E	M42 x 2.0	30	-16	104,0	4.09	69,6	2.74	20,7	0.81	74,0	2.91	50,0	1.97

Male DIN 24° Seat
s.Rh (Heavy)

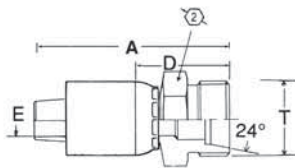

Z-Series Part #	Thd. T	Tube O.D.	Hose Size	A		Hose Cut-Off Factor (D)		EØ		②	
				mm	in	mm	in	mm	in		mm
04Z-08F	M16 x 1.5	8	-04	47,5	1.87	24,1	0.95	4,2	0.16	17,0	0.67
04Z-10F	M18 x 1.5	10	-04	40,7	1.60	23,6	0.93	4,2	0.16	19,0	0.75
06Z-10F	M18 X 1.5	10	-06	49,5	1.95	24,1	0.95	6,7	0.26	19,0	0.75
06Z-12F	M20 x 1.5	12	-06	50,3	1.98	25,0	0.98	6,7	0.26	22,0	0.87
06Z-14F	M22 x 1.5	14	-06	52,6	2.07	27,3	1.07	6,7	0.26	24,0	0.94
08Z-16F	M24 x 1.5	16	-08	58,0	2.28	28,3	1.11	9,6	0.38	27,0	1.06
10Z-20F	M30 x 2.0	20	-10	62,0	2.44	32,6	1.28	12,7	0.50	32,0	1.26
12Z-20F	M30 X 2.0	20	-12	57,7	2.27	30,7	1.21	15,5	0.61	32,0	1.26
12Z-25F	M36 x 2.0	25	-12	65,5	2.58	35,3	1.39	15,5	0.61	41,0	1.61
16Z-30F	M42 x 2.0	30	-16	72,3	2.85	37,9	1.49	20,7	0.81	46,0	1.81

STC Male Straight

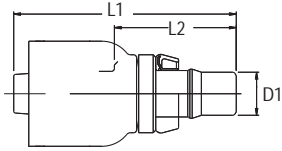

Z-Series Part #	D1		L1		L2	
	mm	in	mm	in	mm	in
04Z-BC04	4,2	0.17	49,9	1.97	26,5	1.04
04Z-BC06	4,2	0.17	52,4	2.06	29,0	1.14
06Z-BC06	6,7	0.26	55,5	2.19	30,2	1.19
06Z-BC08	6,7	0.26	60,6	2.39	35,4	1.39
08Z-BC08	9,6	0.38	66,3	2.61	36,6	1.44
10Z-BC10	12,8	0.50	69,0	2.72	39,6	1.56
12Z-BC12	15,5	0.61	74,6	2.94	44,4	1.75
16Z-BC16	0,7	0.82	83,7	3.30	49,3	1.94

STC Male 45° Tube Elbow

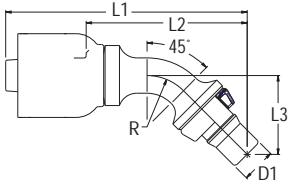

Z-Series Part #	D1		L1		L2		L3		R	
	mm	in	mm	in	mm	in	mm	in	mm	in
04Z-BC46	4,2	0.17	69,8	2.75	46,4	1.83	22,2	0.86	14,0	0.55
06Z-BC46	6,7	0.26	72,9	2.87	47,6	1.87	22,2	0.87	14,0	0.55
08Z-BC48	8,8	0.35	89,9	3.54	60,2	2.37	29,6	1.17	19,0	0.75
10Z-BC50	11,5	0.45	97,8	3.85	68,4	2.69	33,6	1.32	22,0	0.87
12Z-BC52	13,9	0.55	110,2	4.34	80,0	3.15	40,7	1.60	31,0	1.22

STC Male 90° Tube Elbow

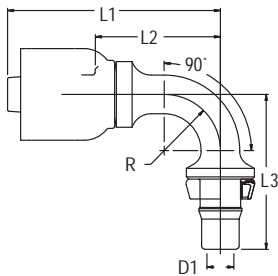

Z-Series Part #	D1		L1		L2		L3		R	
	mm	in	mm	in	mm	in	mm	in	mm	in
04Z-BC64	4,2	0.17	53,1	2.09	29,6	1.17	36,1	1.42	13,0	0.51
06Z-BC66	6,7	0.26	59,3	2.33	34,0	1.34	39,6	1.56	14,0	0.55
06Z-BC68	6,7	0.26	66,4	2.61	41,1	1.62	53,0	2.09	19,0	0.75
08Z-BC68	8,8	0.35	72,0	2.83	42,3	1.67	53,0	2.09	19,0	0.75
10Z-BC70	11,5	0.45	77,9	3.07	48,5	1.91	60,4	2.36	22,0	0.87
12Z-BC72	13,9	0.55	88,7	3.49	58,5	2.30	75,7	2.98	31,0	1.22
16Z-BC76	19,9	0.78	107,3	4.22	72,9	2.87	90,0	3.54	38,0	1.50

STC Male 90° Long Drop Elbow

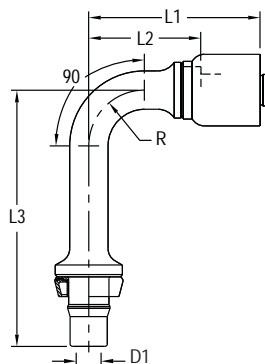

Z-Series Part #	D1		L1		L2		L3		R	
	mm	in	mm	in	mm	in	mm	in	mm	in
06Z-BC86	6,4	0.25	59,3	2.33	34,0	1.34	70,6	2.78	14,0	0.55
08Z-BC88	9,1	0.36	72,0	2.84	42,3	1.67	88,1	3.46	19,0	0.75
12Z-BC92	13,9	0.55	88,7	3.49	58,5	2.30	123,7	4.87	31,0	1.22

Hose Ends - Crimp

WeatherTIGHT™ 4SP/6SP Series Hose Ends

For use with H464, H470, H471, H485, H487

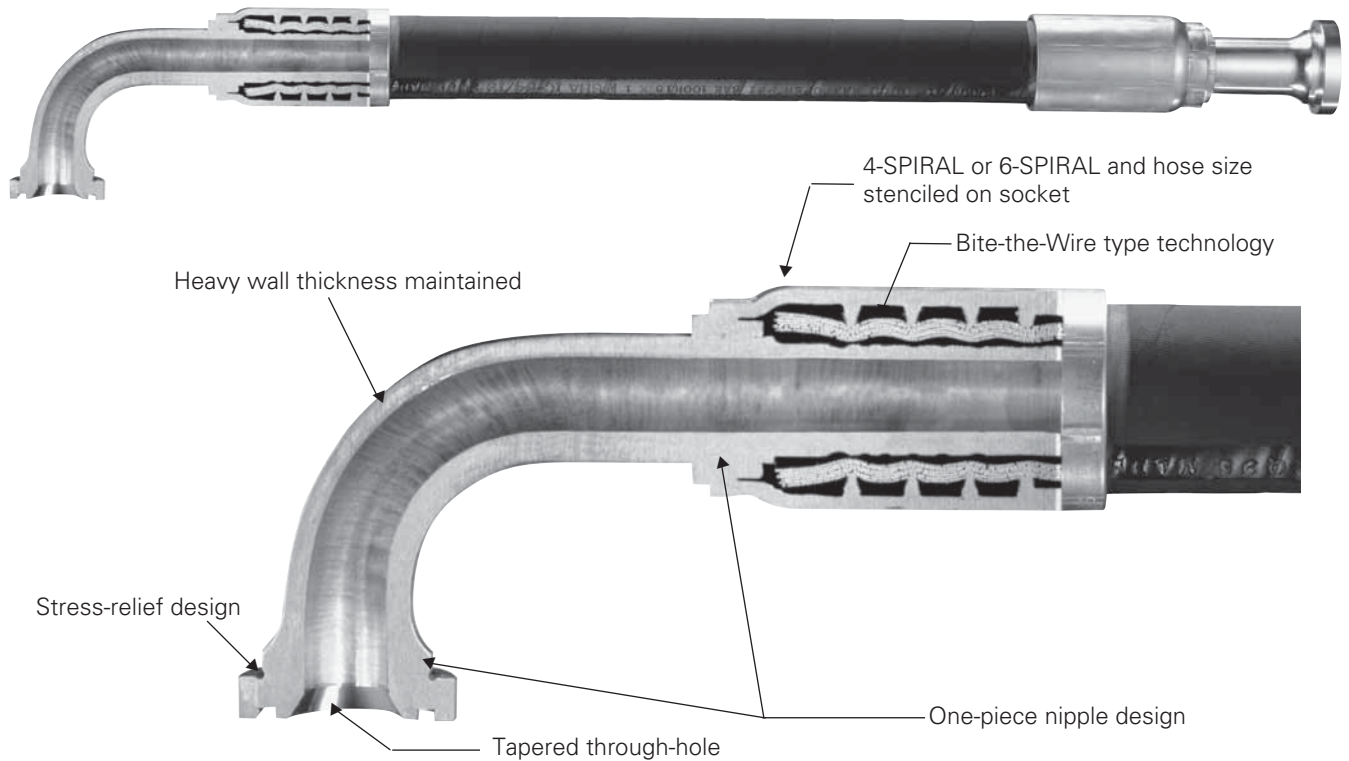

Features	Benefits
Bite the Wire type technology	Skiving not required, saves time in assembly
One-piece nipple design	Stronger design, no braze joints
One-piece hose end	Easier to assemble
Stress-relief design	Maximizes durability
Heavy wall thickness	Heavy-duty construction for heavy-duty applications
Modern micro-alloy steel	Maximizes fatigue life
Tapered through-hole	Improves flow characteristics
Global design	Global availability
Stenciled socket	Hose insertion depth
Operating pressure to 6000 psi	Perfect for hydrostatic drives and other demanding applications
Available in -12, -16, -20, -24 & -32	Multiple configurations and jump sizes to fit a wide array of applications

Label Set: FF90686

Assembly Instructions

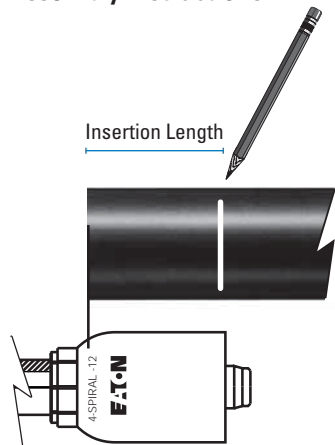

Figure 1

1. Cut hose to proper length by subtracting appropriate fitting "D" dimensions from overall assembly length.

- To determine hose insertion length (L), align end of hose to top of stenciled "4 SPIRAL" or "6 SPIRAL" (located on the socket taper) and mark hose where the socket ends (Figure 1).
- Install hose end onto hose until socket edge aligns with mark.

2. Select proper Collet and Spacer Ring, then crimp to specified diameter.

- To achieve full flat crimp locate back edge of socket approximately 1/8" (3mm) from back edge of crimp jaws as shown in Figure 2.

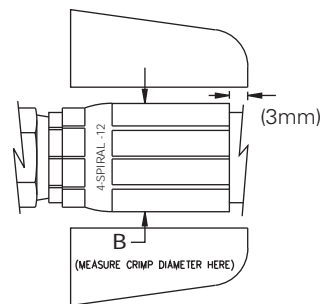

Figure 2

Hose End '4SP/6SP' Series

Ordering Information: Order individually by part number. O-rings not supplied with flange hose ends. Order o-rings by part number; reference individual listings for details. For split flange kits, refer to pages L-89-92.

Typical Application: General purpose high pressure hydraulic.

Pressure: Determined by the maximum working pressure for hose size and hose end configuration, whichever is lesser. See pages A15-16 for operating pressure ratings for hose end configurations.

Material:
Carbon Steel

Plating:
Clear silver hexavalent chromium-free plating

Advantages: Wide selection of hose and end configurations allowing a diverse number of applications.

Label Set:
FF90686

4SP Hose Ends

Compatible Hose:

H464: All sizes
H470*: -12 & -16 only
H471: -12 thru -24
H485: -16 only
H487: -12 & -16 only

* H470 with black cover only

Assemble With:

ET4000
ET4001
ET4040
T-440-1: -12 & -16 only

6SP Hose Ends

Compatible Hose:

H470*: -20 thru -32
H471: -32
H485: -20 & -24
H487: -20 & -24

* H470 with black cover only

Assemble With:

ET4000
ET4001
ET4040

4SP Hose Ends

For Use with Hose:

H464, H485 (-16 only),
H470 (-12 & -16 only)*
H471 (-12 thru -24),
H487 (-12 & -16 only)

Assembled with:

ET4000, ET4001, ET4040
T-440-1 (-12 & -16 only)

6SP Hose Ends

For Use with Hose:

H470 (-20, -24, -32 only)*
H485 (-20 & -24 only),
H471 (-32 only), H487 (-20 & -24)
*H470 with black cover only

Assembled with:

ET4000, ET4001, ET4040

Straight Split Flange

Code 61

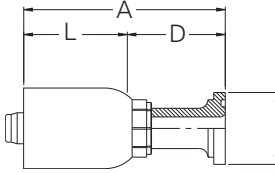

Fitting Part Number	Flange Head Dia. K		Hose A Size		D		Insertion Length - L		H		
	inch	mm	inch	mm	inch	mm	inch	mm	inch	mm	
Straight split flange - Code 61 (SAE J518)											
4SP12W-G12	1.50	38.1	-12	3.92	99.5	2.15	54.5	1.77	45.0	-	-
4SP12W-G16	1.75	44.4	-12	3.78	96.1	2.01	51.1	1.77	45.0	-	-
4SP16W-G16	1.75	44.4	-16	4.78	121.3	2.22	56.3	2.56	65.0	-	-
4SP16W-G20	2.00	50.8	-16	4.94	125.5	2.38	60.5	2.56	65.0	-	-
4SP20W-G20	2.00	50.8	-20	5.57	141.5	2.62	66.5	2.95	75.0	-	-
4SP20W-G24	2.38	60.3	-20	6.45	163.8	3.50	88.8	2.95	75.0	-	-
4SP24W-G24	2.38	60.3	-24	6.61	167.8	3.54	89.8	3.07	78.0	-	-
4SP24W-G32	2.81	71.4	-24	6.73	170.9	3.66	92.9	3.07	78.0	-	-
4SP32W-G32	2.81	71.4	-32	6.81	173.0	3.74	95.0	3.07	78.0	-	-
6SP20W-G20	2.00	50.8	-20	5.57	141.5	2.62	66.5	2.95	75.0	-	-
6SP24W-G24	2.38	60.3	-24	6.61	167.8	3.54	89.8	3.07	78.0	-	-
6SP32W-G32	2.81	71.4	-32	6.81	173.0	3.74	95.0	3.07	78.0	-	-

45° Elbow Split Flange

Code 61

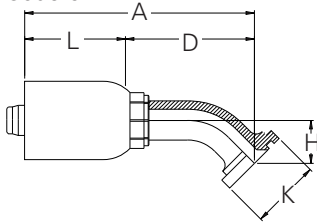

Fitting Part Number	Flange Head Dia. K		Hose A Size		D		Insertion Length - L		H		mm
	inch	mm	inch	mm	inch	mm	inch	mm	inch		
45° split flange - Code 61 (SAE J518)											
4SP12W-G42	1.50	38.1	-12	4.93	125.3	3.16	80.3	1.77	45.0	1.06	27.0
4SP12W-G46	1.75	44.4	-12	5.37	136.5	3.60	91.5	1.77	45.0	1.26	32.0
4SP16W-G46	1.75	44.4	-16	6.37	161.7	3.81	96.7	2.56	65.0	1.26	32.0
4SP16W-G50	2.00	50.8	-16	6.99	177.4	4.43	112.4	2.56	65.0	1.54	39.0
4SP20W-G50	2.00	50.8	-20	7.61	193.4	4.66	118.4	2.95	75.0	1.54	39.0
4SP20W-G54	2.38	60.3	-20	8.12	206.3	5.17	131.3	2.95	75.0	1.77	45.0
4SP24W-G54	2.38	60.3	-24	8.28	210.3	5.21	132.3	3.07	78.0	1.77	45.0
4SP24W-G62	2.81	71.4	-24	9.73	247.2	6.66	169.2	3.07	78.0	2.26	57.5
4SP32W-G62	2.81	71.4	-32	9.81	249.3	6.74	171.3	3.07	78.0	2.26	57.5
6SP20W-G50	2.00	50.8	-20	7.61	193.4	4.66	118.4	2.95	75.0	1.54	39.0
6SP24W-G54	2.38	60.3	-24	8.28	210.3	5.21	132.3	3.07	78.0	1.77	45.0
6SP32W-G62	2.81	71.4	-32	9.81	249.3	6.74	171.3	3.07	78.0	2.26	57.5

90° Elbow Split Flange

Code 61

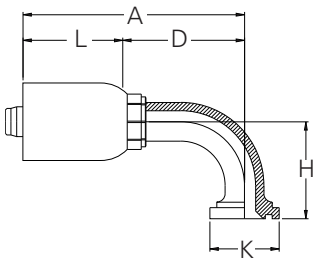

Fitting Part Number	Flange Head Dia. K		Hose A Size		D		Insertion Length - L		H		mm
	inch	mm	inch	mm	inch	mm	inch	mm	inch		
90° split flange - Code 61 (SAE J518)											
4SP12W-G72	1.50	38.1	-12	4.72	120.0	2.95	75.0	1.77	45.0	2.32	59.0
4SP12W-G76	1.75	44.4	-12	5.17	131.4	3.40	86.4	1.77	45.0	2.80	71.0
4SP16W-G76	1.75	44.4	-16	6.17	156.6	3.61	91.6	2.56	65.0	2.80	71.0
4SP16W-G80	2.00	50.8	-16	6.79	172.4	4.23	107.4	2.56	65.0	3.50	89.0
4SP20W-G80	2.00	50.8	-20	7.41	188.4	4.46	113.4	2.95	75.0	3.50	89.0
4SP20W-G84	2.38	60.3	-20	7.92	201.1	4.96	126.1	2.95	75.0	4.09	104.0
4SP24W-G84	2.38	60.3	-24	8.07	205.1	5.00	127.1	3.07	78.0	4.09	104.0
4SP24W-G92	2.81	71.4	-24	9.59	243.6	6.52	165.6	3.07	78.0	5.43	138.0
4SP32W-G92	2.81	71.4	-32	9.67	245.7	6.60	167.7	3.07	78.0	5.43	138.0
6SP20W-G80	2.00	50.8	-20	7.41	188.4	4.46	113.4	2.95	75.0	3.50	89.0
6SP24W-G84	2.38	60.3	-24	8.07	205.1	5.00	127.1	3.07	78.0	4.09	104.0
6SP32W-G92	2.81	71.4	-32	9.67	245.7	6.60	167.7	3.07	78.0	5.43	138.0

(For Split Flange Kits, see pages L-89 thru L-92.)

4SP Hose Ends

For Use with Hose:

H464, H485 (-16 only),
H470 (-12 & -16 only)*
H471 (-12 thru -24),
H487 (-12 & -16 only)

Assembled with:

ET4000, ET4001, ET4040
T-440-1 (-12 & -16 only)

6SP Hose Ends

For Use with Hose:

H470 (-20, -24, -32 only)*
H485 (-20 & -24 only),
H471 (-32 only), H487 (-20 & -24)
*H470 with black cover only

Assembled with:

ET4000, ET4001, ET4040

Straight Split Flange

Code 62

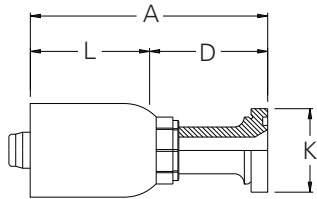

Fitting Part Number	Flange Head Dia. K		Hose Size	A		D		Insertion Length - L		H		
	inch	mm		inch	mm	inch	mm	inch	mm	inch	mm	
Cat-flange - Code 62 (SAE J518)												
4SP12W-D12	1.62	41.3	-12	4.16	105.8	2.39	60.8	1.77	45.0	-	-	
4SP12W-D16	1.88	47.6	-12	4.33	110.0	2.56	65.0	1.77	45.0	-	-	
4SP16W-D16	1.88	47.6	-16	5.32	135.2	2.76	70.2	2.56	65.0	-	-	
4SP16W-D20	2.12	54.0	-16	5.22	132.6	2.66	67.6	2.56	65.0	-	-	
4SP20W-D20	2.12	54.0	-20	5.85	148.6	2.90	73.6	2.95	75.0	-	-	
4SP20W-D24	2.50	63.5	-20	7.31	185.6	4.35	110.6	2.95	75.0	-	-	
4SP24W-D24	2.50	63.5	-24	7.46	189.6	4.39	111.6	3.07	78.0	-	-	
4SP24W-D32	3.13	79.4	-24	7.90	200.6	4.83	122.6	3.07	78.0	-	-	
4SP32W-D32	3.13	79.4	-32	7.98	202.7	4.91	124.7	3.07	78.0	-	-	
6SP20W-D20	2.12	54.0	-20	5.85	148.6	2.90	73.6	2.95	75.0	-	-	
6SP20W-D24	2.50	63.5	-20	7.31	185.6	4.35	110.6	2.95	75.0	-	-	
6SP24W-D24	2.50	63.5	-24	7.46	189.6	4.39	111.6	3.07	78.0	-	-	
6SP24W-D32	3.13	79.4	-24	7.90	200.6	4.83	122.6	3.07	78.0	-	-	
6SP32W-D32	3.13	79.4	-32	7.98	202.7	4.91	124.7	3.07	78.0	-	-	

45° Elbow Split Flange

Code 62

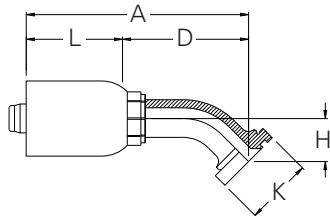

Fitting Part Number	Flange Head Dia. K		Hose Size	A		D		Insertion Length - L		H		
	inch	mm		inch	mm	inch	mm	inch	mm	inch	mm	
45° split flange - Code 62 (SAE J518)												
4SP12W-D42	1.62	41.3	-12	4.93	125.3	3.16	80.3	1.77	45.0	1.06	27.0	
4SP12W-D46	1.88	47.6	-12	5.37	136.5	3.60	91.5	1.77	45.0	1.26	32.0	
4SP16W-D46	1.88	47.6	-16	6.37	161.7	3.81	96.7	2.56	65.0	1.26	32.0	
4SP16W-D50	2.12	54.0	-16	6.99	177.4	4.43	112.4	2.56	65.0	1.54	39.0	
4SP20W-D50	2.12	54.0	-20	7.61	193.4	4.66	118.4	2.95	75.0	1.54	39.0	
4SP20W-D54	2.50	63.5	-20	8.12	206.3	5.17	131.3	2.95	75.0	1.77	45.0	
4SP24W-D54	2.50	63.5	-24	8.28	210.3	5.21	132.3	3.07	78.0	1.77	45.0	
4SP24W-D62	3.13	79.4	-24	9.73	247.2	6.66	169.2	3.07	78.0	2.26	57.5	
4SP32W-D62	3.13	79.4	-32	9.81	249.3	6.74	171.3	3.07	78.0	2.26	57.5	
6SP20W-D50	2.12	54.0	-20	7.61	193.4	4.66	118.4	2.95	75.0	1.54	39.0	
6SP20W-D54	2.50	63.5	-20	8.12	206.3	5.17	131.3	2.95	75.0	1.77	45.0	
6SP24W-D54	2.50	63.5	-24	8.28	210.3	5.21	132.3	3.07	78.0	1.77	45.0	
6SP24W-D62	3.13	79.4	-24	9.73	247.2	6.66	169.2	3.07	78.0	2.26	57.5	
6SP32W-D62	3.13	79.4	-32	9.81	249.3	6.74	171.3	3.07	78.0	2.26	57.5	

90° Elbow Split Flange

Code 62

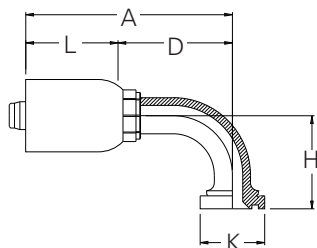

Fitting Part Number	Flange Head Dia. K		Hose Size	A		D		Insertion Length - L		H		
	inch	mm		inch	mm	inch	mm	inch	mm	inch	mm	
90° split flange - Code 62 (SAE J518)												
4SP12W-D72	1.62	41.3	-12	4.72	120.0	2.95	75.0	1.77	45.0	2.32	59.0	
4SP12W-D76	1.88	47.6	-12	5.17	131.4	3.40	86.4	1.77	45.0	2.80	71.0	
4SP16W-D76	1.88	47.6	-16	6.17	156.6	3.61	91.6	2.56	65.0	2.80	71.0	
4SP16W-D80	2.12	54.0	-16	6.79	172.4	4.23	107.4	2.56	65.0	3.50	89.0	
4SP20W-D80	2.12	54.0	-20	7.41	188.4	4.46	113.4	2.95	75.0	3.50	89.0	
4SP20W-D84	2.50	63.5	-20	7.92	201.1	4.96	126.1	2.95	75.0	4.09	104.0	
4SP24W-D84	2.50	63.5	-24	8.07	205.1	5.00	127.1	3.07	78.0	4.09	104.0	
4SP24W-D92	3.13	79.4	-24	9.59	243.6	6.52	165.6	3.07	78.0	5.43	138.0	
4SP32W-D92	3.13	79.4	-32	9.67	245.7	6.60	167.7	3.07	78.0	5.43	138.0	
6SP20W-D80	2.12	54.0	-20	7.41	188.4	4.46	113.4	2.95	75.0	3.50	89.0	
6SP20W-D84	2.50	63.5	-20	7.92	201.1	4.96	126.1	2.95	75.0	4.09	104.0	
6SP24W-D84	2.50	63.5	-24	8.07	205.1	5.00	127.1	3.07	78.0	4.09	104.0	
6SP24W-D92	3.13	79.4	-24	9.59	243.6	6.52	165.6	3.07	78.0	5.43	138.0	
6SP32W-D92	3.13	79.4	-32	9.67	245.7	6.60	167.7	3.07	78.0	5.43	138.0	

(For Split Flange Kits, see pages L-89 thru L-92.)

4SP Hose Ends

For Use with Hose:

H464, H485 (-16 only),
H470 (-12 & -16 only)*
H471 (-12 thru -24),
H487 (-12 & -16 only)

Assembled with:

ET4000, ET4001, ET4040
T-440-1 (-12 & -16 only)

6SP Hose Ends

For Use with Hose:

H470 (-20, -24, -32 only)*
H485 (-20 & -24 only),
H471 (-32 only), H487 (-20 & -24)
*H470 with black cover only

Assembled with:

ET4000, ET4001, ET4040

Cat-Flange Straight

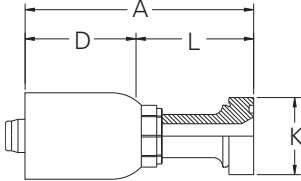

Fitting Part Number	Flange Head Dia. K		Hose Size	A		D		Insertion Length - L		H		
	inch	mm		inch	mm	inch	mm	inch	mm	inch	mm	
Cat-flange - Straight split flange												
4SP12W-K12	1.62	41.3	-12	4.38	111.3	2.61	66.3	1.77	45.0	-	-	
4SP12W-K16	1.88	47.6	-12	4.51	114.7	2.74	69.7	1.77	45.0	-	-	
4SP16W-K16	1.88	47.6	-16	5.51	139.9	2.95	74.9	2.56	65.0	-	-	
4SP16W-K20	2.12	54.0	-16	5.37	136.5	2.81	71.5	2.56	65.0	-	-	
4SP20W-K20	2.12	54.0	-20	6.00	152.5	3.05	77.5	2.95	75.0	-	-	
6SP20W-K20	2.12	54.0	-20	6.00	152.5	3.05	77.5	2.95	75.0	-	-	
6SP20W-K24	2.50	63.5	-20	7.37	187.3	4.42	112.3	2.95	75.0	-	-	
6SP24W-K24	2.50	63.5	-24	7.53	191.3	4.46	113.3	3.07	78.0	-	-	
6SP24W-K32	3.13	79.4	-24	7.96	202.3	4.89	124.3	3.07	78.0	-	-	
6SP32W-K32	3.13	79.4	-32	8.05	204.4	4.98	126.4	3.07	78.0	-	-	

Compatible only with D-Ring FF90319. See page J-100.

Cat-Flange - 22.5° Elbow

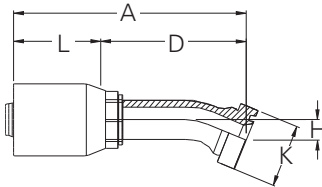

Fitting Part Number	Flange Head Dia. K		Hose Size	A		D		Insertion Length - L		H		
	inch	mm		inch	mm	inch	mm	inch	mm	inch	mm	
Cat-flange - 22.5°												
4SP12W-BD12	1.62	41.3	-12	5.43	137.9	3.66	92.9	1.77	45.0	0.54	13.7	
4SP16W-BD16	1.88	47.6	-16	6.88	174.8	4.32	109.8	2.56	65.0	0.60	15.3	
4SP16W-BD20	2.12	54.0	-16	7.56	191.9	5.00	126.9	2.56	65.0	0.70	17.8	
6SP20W-BD20	2.12	54.0	-20	8.19	207.9	5.23	132.9	2.95	75.0	0.70	17.8	
6SP20W-BD24	2.50	63.5	-20	8.67	220.1	5.71	145.1	2.95	75.0	0.76	19.4	
6SP24W-BD24	2.50	63.5	-24	8.82	224.1	5.75	146.1	3.07	78.0	0.76	19.4	

Compatible only with D-Ring FF90319. See page J-100.

Cat-Flange - 30° Elbow

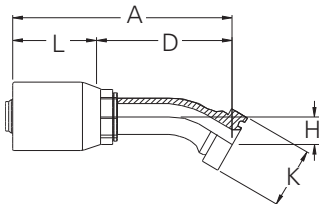

Fitting Part Number	Flange Head Dia. K		Hose Size	A		D		Insertion Length - L		H		
	inch	mm		inch	mm	inch	mm	inch	mm	inch	mm	
Cat-flange - 30°												
4SP12W-BD42	1.62	41.3	-12	5.34	135.7	3.57	90.7	1.77	45.0	0.75	19.1	
4SP16W-BD46	1.88	47.6	-16	6.79	172.4	4.23	107.4	2.56	65.0	0.85	21.6	
4SP16W-BD50	2.12	54.0	-16	7.45	189.1	4.89	124.1	2.56	65.0	1.00	25.3	
6SP20W-BD50	2.12	54.0	-20	8.08	205.1	5.12	130.1	2.95	75.0	1.00	25.3	
6SP20W-BD54	2.50	63.5	-20	8.55	217.1	5.59	142.1	2.95	75.0	1.09	27.7	
6SP24W-BD54	2.50	63.5	-24	8.70	221.1	5.63	143.1	3.07	78.0	1.09	27.7	
6SP24W-BD62	3.13	79.4	-24	10.26	260.5	7.19	182.5	3.07	78.0	1.37	34.8	
6SP32W-BD62	3.13	79.4	-32	10.34	262.6	7.27	184.6	3.07	78.0	1.37	34.8	

Compatible only with D-Ring FF90319. See page J-100.

Cat-Flange - 45° Elbow

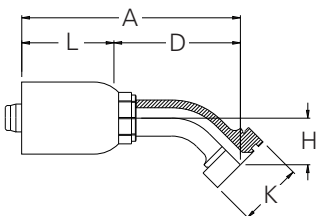

Fitting Part Number	Flange Head Dia. K		Hose Size	A		D		Insertion Length - L		H		
	inch	mm		inch	mm	inch	mm	inch	mm	inch	mm	
Cat-flange - 45° split flange												
4SP12W-K42	1.62	41.3	-12	5.08	129.2	3.31	84.2	1.77	45.0	1.22	30.9	
4SP12W-K46	1.88	47.6	-12	5.50	139.8	3.73	94.8	1.77	45.0	1.39	35.3	
4SP16W-K46	1.88	47.6	-16	6.50	165.0	3.94	100.0	2.56	65.0	1.39	35.3	
4SP16W-K50	2.12	54.0	-16	7.10	180.2	4.54	115.2	2.56	65.0	1.65	41.8	
4SP20W-K50	2.12	54.0	-20	7.72	196.2	4.77	121.2	2.95	75.0	1.65	41.8	
6SP20W-K50	2.12	54.0	-20	7.72	196.2	4.77	121.2	2.95	75.0	1.65	41.8	
6SP20W-K54	2.50	63.5	-20	8.17	207.5	5.22	132.5	2.95	75.0	1.82	46.2	
6SP24W-K54	2.50	63.5	-24	8.33	211.5	5.26	133.5	3.07	78.0	1.82	46.2	
6SP24W-K62	3.13	79.4	-24	9.78	248.4	6.71	170.4	3.07	78.0	2.31	58.7	
6SP32W-K62	3.13	79.4	-32	9.86	250.5	6.79	172.5	3.07	78.0	2.31	58.7	

4SP Hose Ends

For Use with Hose:

H464, H485 (-16 only),
H470 (-12 & -16 only)*
H471 (-12 thru -24),
H487 (-12 & -16 only)

Assembled with:

ET4000, ET4001, ET4040
T-440-1 (-12 & -16 only)

6SP Hose Ends

For Use with Hose:

H470 (-20, -24, -32 only)*
H485 (-20 & -24 only),
H471 (-32 only), H487 (-20 & -24)
*H470 with black cover only

Assembled with:

ET4000, ET4001, ET4040

Cat-Flange - 60° Elbow

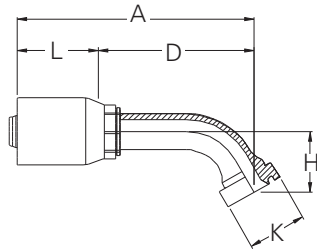

Fitting Part Number	Flange Head Dia. K		Hose Size	A	D	Insertion Length - L		H			
	inch	mm		inch	mm	inch	mm	inch	mm		
Cat-flange - 60°											
4SP12W-BD72	1.62	41.3	-12	5.83	148.1	4.06	103.1	1.77	45.0	1.66	42.3
4SP16W-BD76	1.88	47.6	-16	7.45	189.3	4.89	124.3	2.56	65.0	1.92	48.7
4SP16W-BD80	2.12	54.0	-16	8.36	212.4	5.80	147.4	2.56	65.0	2.33	59.3
6SP20W-BD80	2.12	54.0	-20	8.99	228.4	6.04	153.4	2.95	75.0	2.33	59.3
6SP20W-BD84	2.50	63.5	-20	9.70	246.4	6.75	171.4	2.95	75.0	2.62	66.6
6SP24W-BD84	2.50	63.5	-24	9.86	250.4	6.79	172.4	3.07	78.0	2.62	66.6
6SP24W-BD92	3.13	79.4	-24	11.94	303.2	8.87	225.2	3.07	78.0	3.44	87.3

Compatible only with D-Ring FF90319. See below.

Cat-Flange - 67.5° Elbow

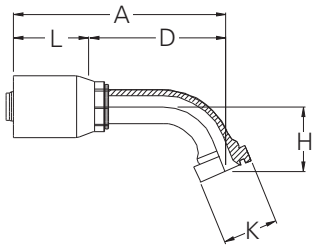

Fitting Part Number	Flange Head Dia. K		Hose Size	A	D	Insertion Length - L		H			
	inch	mm		inch	mm	inch	mm	inch	mm		
Cat-flange - 67.5°											
4SP12W-BE12	1.62	41.3	-12	5.60	142.2	3.83	97.2	1.77	45.0	1.90	48.2
4SP16W-BE16	1.88	47.6	-16	7.18	182.5	4.62	117.5	2.56	65.0	2.20	55.8
4SP16W-BE20	2.12	54.0	-16	8.04	204.1	5.48	139.1	2.56	65.0	2.68	68.1
6SP20W-BE20	2.12	54.0	-20	8.67	220.1	5.71	145.1	2.95	75.0	2.68	68.1
6SP20W-BE24	2.50	63.5	-20	9.33	237.0	6.38	162.0	2.95	75.0	3.02	76.8

Compatible only with D-Ring FF90319. See below.

Cat-Flange - 90° Elbow

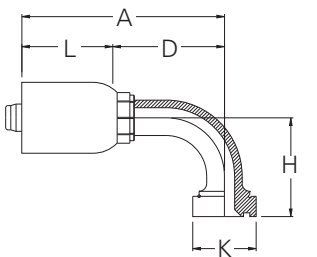

Fitting Part Number	Flange Head Dia. K		Hose Size	A	D	Insertion Length - L		H			
	inch	mm		inch	mm	inch	mm	inch	mm		
Cat-flange - 90° split flange											
4SP12W-K72	1.62	41.3	-12	4.72	120.0	2.95	75.0	1.77	45.0	2.54	64.5
4SP12W-K76	1.88	47.6	-12	5.17	131.4	3.40	86.4	1.77	45.0	2.98	75.7
4SP16W-K76	1.88	47.6	-16	6.17	156.6	3.61	91.6	2.56	65.0	2.98	75.7
4SP16W-K80	2.12	54.0	-16	6.79	172.4	4.23	107.4	2.56	65.0	3.66	92.9
4SP20W-K80	2.12	54.0	-20	7.41	188.4	4.46	113.4	2.95	75.0	3.66	92.9
6SP20W-K80	2.12	54.0	-20	7.41	188.4	4.46	113.4	2.95	75.0	3.66	92.9
6SP20W-K84	2.50	63.5	-20	7.92	201.1	4.96	126.1	2.95	75.0	4.16	105.7
6SP24W-K84	2.50	63.5	-24	7.92	201.1	4.96	126.1	2.95	75.0	4.16	105.7
6SP24W-K92	3.13	79.4	-24	9.59	243.6	6.52	165.6	3.07	78.0	5.50	139.6
6SP32W-K92	3.13	79.4	-32	9.59	243.6	6.52	165.6	3.07	78.0	5.50	139.6

Compatible only with D-Ring FF90319. See below.

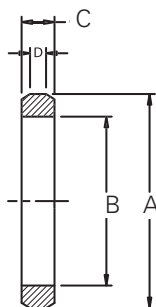
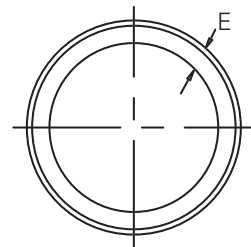

Cat-Flange D-Ring*

Part Number	A Ref	B Ref	C Ref	D Ref	E Ref
	inch	inch	inch	inch	inch
FF90319-12	1.27	1.00	.20	.10	.135
FF90319-16	1.52	1.25	.20	.10	.135
FF90319-20	1.77	1.50	.20	.10	.135
FF90319-24	2.03	1.76	.20	.10	.135
FF90319-32	2.78	2.52	.20	.10	.135

Temperature range: -40°F to +212°F.

Material: Nitrile (Buna-N).

*To be used only with Cat-Flange hose ends.

4SP Hose Ends

For Use with Hose:

H464, H485 (-16 only),
H470 (-12 & -16 only)*
H471 (-12 thru -24),
H487 (-12 & -16 only)

Assembled with:

ET4000, ET4001, ET4040
T-440-1 (-12 & -16 only)

6SP Hose Ends

For Use with Hose:

H470 (-20, -24, -32 only)*
H485 (-20 & -24 only),
H471 (-32 only), H487 (-20 & -24)
*H470 with black cover only

Assembled with:

ET4000, ET4001, ET4040

BSP/6SP Swivel - Straight

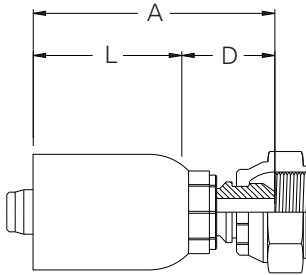

Fitting Part Number	Thread	Hose Size	A inch	mm	D inch	mm	Insertion Length - L inch	mm	H inch	mm
BSP/JIS Female Swivel										
4SP12W-362	G 3/4	-12	3.27	83.0	1.50	38.0	1.77	45.0	-	-
4SP12W-366	G 1	-12	3.22	81.7	1.44	36.7	1.77	45.0	-	-
4SP16W-366	G 1	-16	4.21	106.9	1.65	41.9	2.56	65.0	-	-
4SP16W-370	G 1 1/4	-16	4.13	104.9	1.57	39.9	2.56	65.0	-	-
4SP20W-370	G 1 1/4	-20	4.76	120.9	1.81	45.9	2.95	75.0	-	-
4SP24W-374	G 1 1/2	-24	6.04	153.5	2.97	75.5	3.07	78.0	-	-
4SP32W-375	G 2	-32	6.28	159.5	3.21	81.5	3.07	78.0	-	-
6SP24W-374	G 1 1/2	-24	6.04	153.5	2.97	75.5	3.07	78.0	-	-
6SP32W-375	G 2	-32	6.28	159.5	3.21	81.5	3.07	78.0	-	-

BSP/6SP Swivel - 45° Elbow

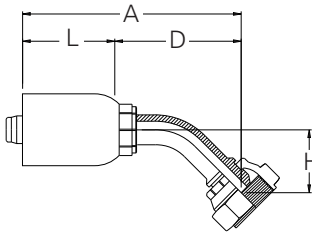

Fitting Part Number	Thread	Hose Size	A inch	mm	D inch	mm	Insertion Length - L inch	mm	H inch	mm
BSP/JIS Female Swivel, 45° elbow										
4SP12W-52P	G 3/4	-12	4.76	121.0	2.99	76.0	1.77	45.0	1.02	26.0
4SP12W-56P	G 1	-12	5.13	130.4	3.36	85.4	1.77	45.0	1.18	30.0
4SP16W-56P	G 1	-16	6.13	155.6	3.57	90.6	2.56	65.0	1.18	30.0
4SP16W-60P	G 1 1/4	-16	6.57	166.9	4.01	101.9	2.56	65.0	1.34	34.0
4SP20W-60P	G 1 1/4	-20	7.19	182.6	4.25	107.9	2.95	75.0	1.34	34.0
4SP24W-64P	G 1 1/2	-24	8.20	208.2	5.13	130.2	3.07	78.0	1.69	43.0
4SP32W-65P	G 2	-32	9.78	248.5	6.71	170.5	3.07	78.0	2.23	56.6
6SP24W-64P	G 1 1/2	-24	8.20	208.2	5.13	130.2	3.07	78.0	1.69	43.0
6SP32W-65P	G 2-32		9.78	248.5	6.71	170.5	3.07	78.0	2.23	56.6

BSP/6SP Swivel - 90° Elbow

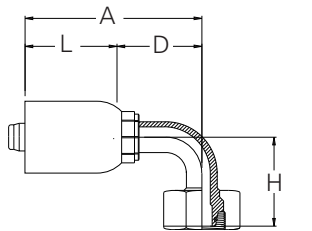

Fitting Part Number	Thread	Hose Size	A inch	mm	D inch	mm	Insertion Length - L inch	mm	H inch	mm
BSP/JIS Female Swivel, 90° elbow										
4SP12W-82P	G 3/4	-12	4.51	114.5	2.74	69.5	1.77	45.0	2.24	57.0
4SP12W-86P	G 1	-12	4.94	125.6	3.17	80.6	1.77	45.0	2.68	68.0
4SP16W-86P	G 1	-16	5.94	150.8	3.38	85.8	2.56	65.0	2.68	68.0
4SP16W-90P	G 1 1/4	-16	6.44	163.7	3.89	98.7	2.56	65.0	3.11	79.0
4SP20W-90P	G 1 1/4	-20	7.07	179.7	4.12	104.7	2.95	75.0	3.11	79.0
4SP24W-94P	G 1 1/2	-24	8.07	205.1	5.00	127.1	3.07	78.0	4.09	104.0
4SP32W-95P	G 2	-32	9.67	245.7	6.60	167.7	3.07	78.0	5.28	134.0
6SP24W-94P	G 1 1/2	-24	8.07	205.1	5.00	127.1	3.07	78.0	4.09	104.0
6SP32W-95P	G 2	-32	9.67	245.7	6.60	167.7	3.07	78.0	5.28	134.0

NOTE: The JIS parallel thread and BSP/6SP connection are interchangeable.

4SP Hose Ends

For Use with Hose:

H464, H485 (-16 only),
H470 (-12 & -16 only)*
H471 (-12 thru -24),
H487 (-12 & -16 only)

Assembled with:

ET4000, ET4001, ET4040
T-440-1 (-12 & -16 only)

6SP Hose Ends

For Use with Hose:

H470 (-20, -24, -32 only)*
H485 (-20 & -24 only),
H471 (-32 only), H487 (-20 & -24)
*H470 with black cover only

Assembled with:

ET4000, ET4001, ET4040

Male Pipe Rigid

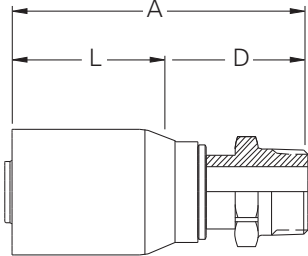

Fitting Part Number	Thread NPTF	Hose Size	A		D	Insertion Length L		H	
			inch	mm		mm	inch	mm	inch
Male Pipe Rigid									
4SP12W-112	3/4-14	-12	3.89	98.7	2.12	53.7	1.77	45	1 1/4
4SP16W-116	1-11 1/2	-16	4.94	125.4	2.38	60.4	2.56	65	1 1/2
4SP20W-120	1 1/4-11 1/2	-20	5.70	144.8	2.75	69.8	2.95	75	1 7/8
4SP24W-124	1 1/2-11 1/2	-24	5.93	150.6	2.86	72.6	3.07	78	2
4SP32W-132	2-11 1/2	-32	6.03	153.2	2.96	75.2	3.07	78	2 5/8
6SP20W-120	1 1/4-11 1/2	-20	5.70	144.8	2.75	69.8	2.95	75	1 7/8
6SP24W-124	1 1/2-11 1/2	-24	5.93	150.6	2.86	72.6	3.07	78	2
6SP32W-132	2-11 1/2	-32	6.03	153.2	2.96	75.2	3.07	78	2 5/8

4SP Hose Ends

For Use with Hose:

H464, H485 (-16 only),
H470 (-12 & -16 only)*
H471 (-12 thru -24),
H487 (-12 & -16 only)

Assembled with:

ET4000, ET4001, ET4040
T-440-1 (-12 & -16 only)

6SP Hose Ends

For Use with Hose:

H470 (-20, -24, -32 only)*
H485 (-20 & -24 only),
H471 (-32 only), H487 (-20 & -24)
*H470 with black cover only

Assembled with:

ET4000, ET4001, ET4040

Female Swivel DIN 24° Seat s.Rh. DKO (heavy)

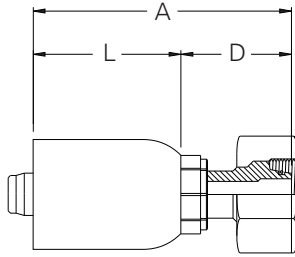

Fitting Part Number	Thread Size	Tube Size	Hose Size	A inch	mm	D inch	mm	Insertion Length - L inch	mm	H inch	mm
DKO Female Swivel, Heavy Duty											
4SP12W-75C	M36 x 2	25	-12	3.87	98.4	2.10	53.4	1.77	45.0	-	-
4SP12W-80C	M42 x 2	30	-12	3.80	96.6	2.03	51.6	1.77	45.0	-	-
4SP16W-80C	M42 x 2	30	-16	4.80	121.8	2.24	56.8	2.56	65.0	-	-
4SP16W-88C	M52 x 2	38	-16	4.82	122.3	2.26	57.3	2.56	65.0	-	-
4SP20W-88C	M52 x 2	38	-20	5.44	138.3	2.49	63.3	2.95	75.0	-	-
6SP20W-88C	M52 x 2	38	-20	5.44	138.3	2.49	63.3	2.95	75.0	-	-

Female Swivel DIN 24° Seat 45° Tube Elbow S.Rh. DKO (heavy)

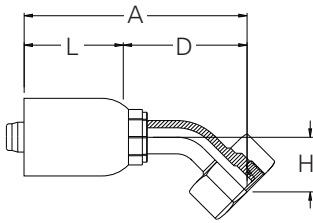

Fitting Part Number	Thread Size	Tube Size	Hose Size	A inch	mm	D inch	mm	Insertion Length - L inch	mm	H inch	mm
DKO Female Swivel, Heavy Duty, 45° Elbow											
4SP12W-25E	M36 x 2	25	-12	5.13	130.3	3.36	85.3	1.77	45.0	1.26	32.0
4SP12W-30E	M42 x 2	30	-12	5.49	139.4	3.72	94.4	1.77	45.0	1.38	35.0
4SP16W-30E	M42 x 2	30	-16	6.48	164.6	3.92	99.6	2.56	65.0	1.38	35.0
4SP16W-38E	M52 X 2	38	-16	6.98	177.3	4.42	112.3	2.56	65.0	1.54	39.0
4SP20W-38E	M52 x 2	38	-20	7.61	193.3	4.66	118.3	2.95	75.0	1.54	39.0
6SP20W-38E	M52 x 2	38	-20	7.61	193.3	4.66	118.3	2.95	75.0	1.54	39.0

Female Swivel DIN 24° Seat 90° Tube Elbow s.Rh. DKO (heavy)

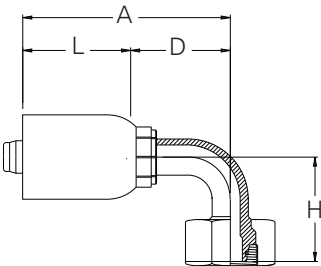

Fitting Part Number	Thread Size	Tube Size	Hose Size	A inch	mm	D inch	mm	Insertion Length - L inch	mm	H inch	mm
DKO Female Swivel, Heavy Duty, 90° elbow											
4SP12W-75E	M36 x 2	25	-12	4.72	120.0	2.95	75.0	1.77	45.0	2.56	65.0
4SP12W-80E	M42 X 2	30	-12	5.17	131.4	3.40	86.4	1.77	45.0	2.99	76.0
4SP16W-80E	M42 x 2	30	-16	6.17	156.8	3.61	91.8	2.56	65.0	2.99	76.0
4SP16W-88E	M52 X 2	38	-16	6.79	172.4	4.23	107.4	2.56	65.0	3.50	89.0
4SP20W-88E	M52 x 2	38	-20	7.41	188.4	4.46	113.4	2.95	75.0	3.50	89.0
6SP20W-88E	M52 x 2	38	-20	7.41	188.4	4.46	113.4	2.95	75.0	3.50	89.0

4SP Hose Ends

For Use with Hose:

H464, H485 (-16 only),
H470 (-12 & -16 only)*
H471 (-12 thru -24),
H487 (-12 & -16 only)

Assembled with:

ET4000, ET4001, ET4040
T-440-1 (-12 & -16 only)

6SP Hose Ends

For Use with Hose:

H470 (-20, -24, -32 only)*
H485 (-20 & -24 only),
H471 (-32 only), H487 (-20 & -24)
*H470 with black cover only

Assembled with:

ET4000, ET4001, ET4040

FOR-SEAL Swivel Straight

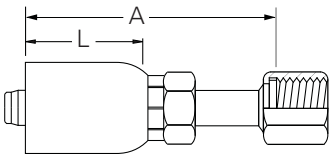

Fitting Part Number	Thread	Hose Size	A		D		Insertion Length - L		H	
			inch	mm	inch	mm	inch	mm	inch	mm
Female FOR-SEAL Swivel, Straight										
4SP12W-J72	1 3/16-12	-12	3.77	95.9	—	—	1.77	45.0	—	—
4SP12W-J76	1 7/16-12	-12	3.33	84.6	—	—	1.77	45.0	—	—
4SP16W-J76	1 7/16-12	-16	4.71	119.5	—	—	2.56	65.0	—	—
4SP16W-J80	1 11/16-12	-16	4.19	106.4	—	—	2.56	65.0	—	—
4SP20W-J80	1 11/16-12	-20	5.38	136.7	—	—	2.95	75.0	—	—
4SP24W-J84	2-12	-24	5.00	126.9	—	—	3.07	78.0	—	—
6SP20W-J80	1 11/16-12	-20	5.38	136.7	—	—	2.95	75.0	—	—
6SP24W-J84	2-12	-24	5.00	126.9	—	—	3.07	78.0	—	—

FOR-SEAL Swivel 45° Elbow

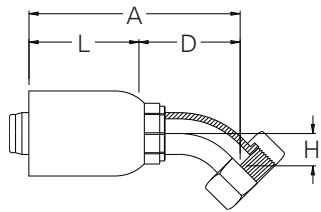

Fitting Part Number	Thread	Hose Size	A		D		Insertion Length - L		H	
			inch	mm	inch	mm	inch	mm	inch	mm
Female FOR-SEAL Swivel, 45° Elbow										
4SP12W-L72	1 3/16-12	-12	4.68	118.9	2.91	73.9	1.77	45.0	0.94	24.0
4SP12W-L76	1 7/16-12	-12	5.05	128.4	3.28	83.4	1.77	45.0	1.10	28.0
4SP16W-L76	1 7/16-12	-16	6.04	153.4	3.48	88.4	2.56	65.0	1.10	28.0
4SP16W-L80	1 11/16-12	-16	6.45	163.9	3.89	98.9	2.56	65.0	1.22	31.0
4SP20W-L80	1 11/16-12	-20	7.08	179.8	4.13	104.8	2.95	75.0	1.22	31.0
6SP20W-L80	1 11/16-12	-20	7.08	179.8	4.13	104.8	2.95	75.0	1.22	31.0

FOR-SEAL Swivel 90° Elbow

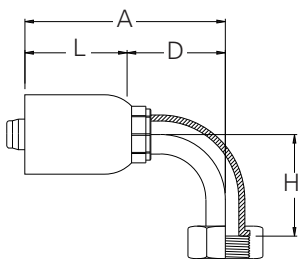

Fitting Part Number	Thread	Hose Size	A		D		Insertion Length - L		H	
			inch	mm	inch	mm	inch	mm	inch	mm
Female FOR-SEAL, 90° Elbow										
4SP12W-J42	1 3/16-12	-12	4.51	114.5	2.74	69.5	1.77	45.0	2.28	58.0
4SP12W-J46	1 7/16-12	-12	4.94	125.6	3.17	80.6	1.77	45.0	2.80	71.0
4SP16W-J46	1 7/16-12	-16	5.93	150.6	3.37	85.6	2.56	65.0	2.80	71.0
4SP16W-J50	1 11/16-12	-16	6.45	163.7	3.89	98.7	2.56	65.0	3.07	78.0
4SP20W-J50	1 11/16-12	-20	7.07	179.6	4.12	104.6	2.95	75.0	3.07	78.0
6SP20W-J50	1 11/16-12	-20	7.07	179.6	4.12	104.6	2.95	75.0	3.07	78.0

4SP Hose Ends

For Use with Hose:

H464, H485 (-16 only),
H470 (-12 & -16 only)*
H471 (-12 thru -24),
H487 (-12 & -16 only)

Assembled with:

ET4000, ET4001, ET4040
T-440-1 (-12 & -16 only)

6SP Hose Ends

For Use with Hose:

H470 (-20, -24, -32 only)*
H485 (-20 & -24 only),
H471 (-32 only), H487 (-20 & -24)
*H470 with black cover only

Assembled with:

ET4000, ET4001, ET4040

SAE 37° (JIC) Swivel Straight

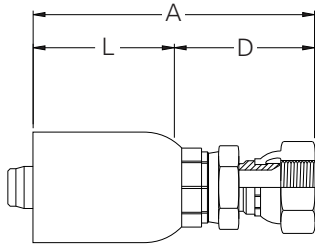

Fitting Part Number	Thread	Hose Size	A		D		Insertion Length - L		H	
			inch	mm	inch	mm	inch	mm	inch	mm
SAE 37° (JIC) Swivel, Straight										
4SP12W-612	1 1/16-12	-12	4.10	104.2	2.33	59.2	1.77	45.0	-	-
4SP12W-616	1 5/16-12	-12	4.20	106.6	2.43	61.6	1.77	45.0	-	-
4SP16W-616	1 5/16-12	-16	5.19	131.8	2.63	66.8	2.56	65.0	-	-
4SP16W-620	1 5/8-12	-16	5.26	133.7	2.70	68.7	2.56	65.0	-	-
4SP20W-620	1 5/8-12	-20	5.89	149.7	2.94	74.7	2.95	75.0	-	-
4SP20W-624	1 7/8-12	-20	6.59	167.5	3.64	92.5	2.95	75.0	-	-
4SP24W-624	1 7/8-12	-24	6.75	171.5	3.68	93.5	3.07	78.0	-	-
4SP32W-632	2 1/2-12	-32	7.32	186.0	4.25	108.0	3.07	78.0	-	-
<hr/>										
6SP20W-620	1 5/8-12	-20	5.89	149.7	2.94	74.7	2.95	75.0	-	-
6SP20W-624	1 7/8-12	-20	6.59	167.5	3.64	92.5	2.95	75.0	-	-
6SP24W-624	1 7/8-12	-24	6.75	171.5	3.68	93.5	3.07	78.0	-	-
6SP32W-632	2 1/2-12	-32	7.32	186.0	4.25	108.0	3.07	78.0	-	-

SAE 37° (JIC) Swivel 45° Elbow

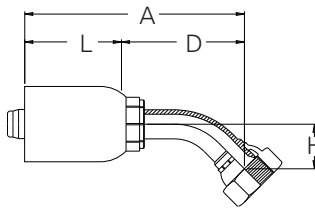

Fitting Part Number	Thread	Hose Size	A		D		Insertion Length - L		H	
			inch	mm	inch	mm	inch	mm	inch	mm
SAE 37° (JIC) Swivel, 45° Elbow										
4SP12W-692	1 1/16-12	-12	4.80	121.9	3.03	76.9	1.77	45.0	1.06	27.0
4SP12W-696	1 5/16-12	-12	5.25	133.4	3.48	88.4	1.77	45.0	1.30	33.0
4SP16W-696	1 5/16-12	-16	6.25	158.6	3.69	93.6	2.56	65.0	1.30	33.0
4SP16W-697	1 5/8-12	-16	6.70	170.2	4.14	105.2	2.56	65.0	1.46	37.0
4SP20W-697	1 5/8-12	-20	7.33	186.2	4.38	111.2	2.95	75.0	1.46	37.0
4SP24W-698	1 7/8-12	-24	8.20	208.2	5.13	130.2	3.07	78.0	1.69	43.0
<hr/>										
6SP20W-697	1 5/8-12	-20	7.33	186.2	4.38	111.2	2.95	75.0	1.46	37.0
6SP24W-698	1 7/8-12	-24	8.20	208.2	5.13	130.2	3.07	78.0	1.69	43.0

SAE 37° (JIC) Swivel 90° Elbow

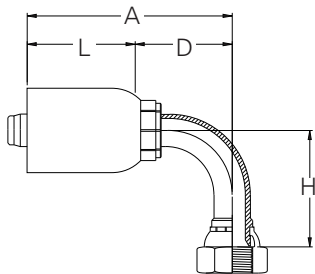

Fitting Part Number	Thread	Hose Size	A		D		Insertion Length - L		H	
			inch	mm	inch	mm	inch	mm	inch	mm
SAE 37° (JIC) Female Swivel, 90° Elbow										
4SP12W-672	1 1/16-12	-12	4.51	114.5	2.74	69.5	1.77	45.0	2.28	58.0
4SP12W-676	1 5/16-12	-12	4.94	125.6	3.17	80.6	1.77	45.0	2.80	71.0
4SP16W-676	1 5/16-12	-16	5.94	150.8	3.38	85.8	2.56	65.0	2.80	71.0
4SP16W-677	1 5/8-12	-16	6.45	163.9	3.89	98.9	2.56	65.0	3.23	82.0
4SP20W-677	1 5/8-12	-20	7.08	179.9	4.13	104.9	2.95	75.0	3.23	82.0
4SP24W-678	1 7/8-12	-24	8.07	205.1	5.00	127.1	3.07	78.0	4.09	104.0
<hr/>										
6SP20W-677	1 5/8-12	-20	7.08	179.9	4.13	104.9	2.95	75.0	3.23	82.0
6SP24W-678	1 7/8-12	-24	8.07	205.1	5.00	127.1	3.07	78.0	4.09	104.0

J

Hose Ends - Crimp



Hose Ends - Crimp