

H22



H22 User Manual

OPTICON

All information subject to change without notice.
© 2011 copyright Opticon. All rights reserved.

This manual may not, in whole or in part, be copied, photocopied, reproduced, translated, or converted to any electronic or machine readable form without prior written consent of Opticon.

Limited Warranty and Disclaimers

PLEASE READ this manual CAREFULLY before installing or using the product.

Serial Number

A serial number appears on all Opticon products. This official registration number is directly related to the device purchased. Do not remove the serial number from your Opticon device. Removing the serial number voids the warranty.

Warranty

Unless otherwise agreed in a written contract, all Opticon products are warranted against defects in materials and workmanship for two years after purchase. Opticon will repair or, at its option, replace products that are defective in materials or workmanship with proper use during the warranty period. Opticon is not liable for damages caused by modifications made by a customer. In such cases, standard repair charges will apply. If a product is returned under warranty and no defect is found, standard repair charges will apply. Opticon assumes no liability for any direct, indirect, consequential or incidental damages arising out of use, or the inability to use both the hardware and software, even if Opticon has been informed about the possibility of such damages.

Packaging

The packing materials are recyclable. We recommend that you save all packing material to use should you need to transport your scanner or send it for service. Damage caused by improper packaging during shipment is not covered by the warranty.

Trademarks

Trademarks used are the property of their respective owners.

Opticon, Inc. and Opticon Sensors Europe B.V. are wholly owned subsidiaries of OPTO ELECTRONICS Co., Ltd., 12-17, Tsukagoshi 4-chome, Warabi-shi, Saitama, Japan 335-0002. TEL +81-(0) 48-446-1183; FAX +81-(0) 48-446-1184

SUPPORT USA

Phone: 800-636-0090

Email: support@opticonusa.com

Web: www.opticonusa.com

SUPPORT Europe

Phone: 0031-23-5692728

Email: support@opticon.com

Web: www.opticon.com

Federal Communications Commission (FCC) Statement

This equipment has been tested and found to comply with the limits for a Class B digital device, pursuant to part 15 of the FCC rules. Rule 15.21: You are cautioned that changes or modifications not expressly approved by the part responsible for compliance could void the user's authority to operate the equipment. These limits are designed to provide reasonable protection against harmful interference in a residential installation. This equipment generates, uses and can radiate radio frequency energy and, if not installed and used in accordance with the instructions, may cause harmful interference to radio communications. However, there is no guarantee that interference will not occur in a particular installation. If this equipment does cause harmful interference to radio or television reception, which can be determined by turning the equipment off and on, the user is encouraged to try to correct the interference by one or more of the following measures:

- Reorient or relocate the receiving antenna.
- Increase the separation between the equipment and receiver.
- Connect the equipment into an outlet on a circuit different from that to which the receiver is connected.
- Consult the dealer or an experienced radio/TV technician for help.

This device complies with Part 15 of the FCC Rules. Operation is subject to the following two conditions:

1. This device may not cause harmful interference and
2. This device must accept any interference received, including interference that may cause undesired operation of the device.

FCC RF Radiation Exposure Statement:

For body worn operation, this phone has been tested and meets FCC RF exposure guidelines when used with an accessory that contains no metal and which positions the handset a minimum of 1.5 cm (0.59 in.) from the body. Use of other accessories may not ensure compliance with FCC RF exposure guidelines.



Declaration of Conformity (DOC) with Regards to Essential Requirements of EU Directives

Brand name: Opticon
Product: PDA Phone H-22

The above-mentioned product complies with the essential requirement specified in directives:

2004/108/EC Electromagnetic Compatibility (EMC)
1999/5/EC Radio- and Telecommunications Terminal Equipment (R&TTE)
2006/95/EC Low Voltage Directive (LVD)
2002/95/EC Restriction of Hazardous Substances (RoHS)
2002/96/EC, 2003/108/EC Waste Electrical and Electronical Equipment (WEEE)

Safety Information

General

Please read the following information carefully before you start using this device to avoid any damages caused by improper usage:

- The device is not charged when you take it out of the box. Charge the battery for at least eight hours before first use. Do not remove the battery while charging.
- Do not use batteries which have not been specified by the manufacturer and not qualified with the system per the standard of IEEE-Std-1725 -2006, as this may present a risk of fire, explosion, leakage or other hazard.
 - Do not charge the battery with an unspecified AC Adapter, as this may cause damage to both the device and the battery.
 - When discarding the batteries, dispose of them in a proper manner, according to your local laws.
 - Power off the device and remove the battery before inserting a SIM card. Make sure the SIM card snaps correctly into the SIM socket.
 - Do not open the device housing or tamper with the device, as it will void your warranty.
 - Do not apply excessive force on this product, as it may cause damage to the screen or the internal component.
- Do not use the device at gas or refueling stations, chemical plants, and places containing explosives or flammable materials. Observe local guidelines.
 - Use only manufacturer specified stylus. Do not scratch the screen with sharp objects.
- Do not clean the screen with chemical detergents. Only use cloths specifically designed for cleaning liquid displays or a soft cloth moisturized with water drops, to wipe the device screen.
- Do not expose the device to direct sunlight or leave the device in a humid environment for extended periods of time as this may cause damage to the device and battery.
 - Do not immerse the device in water.
 - The device may interfere with the navigation and/or communication systems on aircraft. The laws of most countries prohibit using this device while on an aircraft. Observe local guidelines.
- This product may cause medical equipment to malfunction. The use of this device is forbidden in most hospitals and medical clinics. Observe local guidelines.
 - Use hands-free devices if you need to use the telephony services while driving a vehicle. Observe local guidelines.
 - Do not use headphones at a high volume for prolonged periods of time to avoid permanent hearing loss.

Additional Battery Information

Please read the following information carefully to understand battery safety.

- Do not disassemble or open, crush, bend or deform, puncture, or shred the battery.
- Do not modify or remanufacture, attempt to insert foreign objects into the battery, immerse or expose to water or other liquids, or expose to fire, or explosion, or other hazard.
- Only use the battery for the system for which it was specified,
- Only use the battery with charging system that has been qualified with the system per this standard. Use of an unqualified battery or charger may present a risk of fire, explosion, leakage, or other hazard.
- Do not short circuit a battery or allow metallic or conductive objects to contact the battery terminals.
- Battery usage by children should be supervised.
- Avoid dropping the phone or battery. If the phone or battery is dropped, especially on hard surface, and the user suspect damage, take it to service center for inspection.
- Improper battery use may result in a fire, explosion, or other hazard.
 - Seek medical advice immediately if a battery has been swallowed
 - Do not leave the battery where the temperature is 60°C (140°F) or more.
 - Do not solder lead directly to the battery body.
 - Do not heat nor solder the terminals of the battery.
- Avoid reverse charging by not fully depleting the battery.
- In the event the Battery Pack leaks and the fluid gets into one's eye, do not rub the eye. Rinse well with water and immediately seek medical care. If left untreated, the battery fluid could cause damage to the eye.
- Charge the battery at least every six months. An excessive over-discharge may cause an abnormal chemical reaction, which may result in acid leakage or fire of the battery.
- Despite being rechargeable, the battery has a limited life span. Replace it when usage time becomes short.

Safety of Laser Products: International Standards Laser Class 2

This product complies with JIS C6802: 2005 Class 2, IEC60825 -1+A2: 2001 Class 2 and 21CFR 1040.10 and 1040.11 except for deviations pursuant to Laser Notice No.50, dated June 24, 2007. Class 2 Laser devices are not considered to be hazardous when used for their intended purpose. Use of controls, adjustment of procedures other than those specified herein may result in hazardous laser light exposure. Do not look directly into the light beam with optical instruments; it may pose an eye hazard.

Specific Absorption Rate

Specific Absorption Rate (SAR) is a measurement of the amount of radio waves absorbed by the body during mobile phone use. This phone meets government and regulatory standards.

Maximum SAR Values

CE: 0.179W/kg (10g) Head

FCC: 0.236 W/Kg (1g) Head, Body measurements has been performed and conforms to FCC requirements

Use with Hearing Aid

When using a wireless device together with a hearing aid, users may experience a buzzing or humming sound. Some hearing aid devices are more immune than others and the experienced buzzing or humming noise may vary depending on the amount of interference they generate. In the event of interference the user may consult with the hearing aid supplier to discuss solutions.

Federal Communication Commission (FCC) has passed regulations and ratings for wireless phones to ensure that users are able to acquire HAC (hearing aid compatible) devices. The ratings are not guarantees and the results may vary depending on the users hearing aid device. The best is to try out the phone with your hearing aid in order to evaluate it for your professional needs. M-Rating: Phones rated M3 or M4 meet FCC requirements and are likely to generate less interference to hearing aid devices than phones that are not rated. M4 is the better/higher of the two ratings. T-Rating: Phones rated T3 or T4 meet FCC requirements and are more usable with a hearing aid device's T-coil than unrated phones. T4 is the better/higher of the two ratings. Note that not all hearing aid devices have T-coil in them.

Hearing Aid Compatible

This device is rated M4 compliant and complies with applicable requirements of FCC Part 68 and CS03-Part 5. This device is not HAC compliant during Voice over IP (VOIP) calls.

Safety of Audio Equipment

The headphones and earphones used with this device comply with maximum sound pressure level measurement methodology and limit considerations as outlined in EN 50332-1:2000.

CAUTION: Do not use headphones at a high volume for prolonged periods of time. Permanent hearing loss may occur.

Table of Contents

1. Introduction.....	11
1.1. Keypad and Function Keys	12
1.2. Right and Left View	13
1.3. Top and Bottom View.....	14
1.4. Rear View.....	15
1.5. Unpacking the H-22	16
1.6. Accessories List	17
1.7. Installing the USIM Card	18
1.8. Installing and Removing the Battery	20
1.9. Power and Battery Settings.....	22
1.10. Attaching the Stylus Strap.....	22
1.11. Inserting and Removing an optional MicroSD Card	23
2. Getting Started	25
2.1. Powering On and Off.....	25
2.2. Entering and Exiting Suspend Mode.....	25
2.3. Calibrating the Touchscreen	25
2.4. Locking/Unlocking the H-22	26
2.5. Assigning Functions to Programmable Buttons	26
2.6. Customizing Up/Down control repeats.....	26
2.7. Battery Power Settings for Backlight.....	26
2.8. Home Screen	27
2.9. Windows Start Menu	28
2.10. Entering Information.....	28
2.11. Using the Hardware Keyboard.....	29
2.12. Selecting an Input Mode	32
2.13. Using the Touch Screen Keyboard	33
2.14. Using Letter Recognizer.....	33
2.15. Using Block Recognizer	34
2.16. Setting up the Calendar	35
Writing Notes.....	36
2.17. Tasks.....	39
3. Phone Operations	41
3.1. Making a Phone Call.....	41
4.1. Using Speed Dial	43
Create speed dial entries for frequently used numbers so you can call a contact by pressing a single key. A speed dial entry can only be created for numbers stored in contacts.	43
4.2. Accepting/Rejecting a Call	43
4.3. Retrieving a Voicemail Message.....	43
4.4. Configuring Phone Settings	44
5. Using Multimedia functions	49
5.1. Playing Music.....	49
5.2. Camera	49
5.3. Video recorder.....	51
7. Contacts and Messaging	52
7.1. Using Contacts.....	52
7.2. Using Text Messaging.....	53
7.3. Sending e-mail	55
8. Internet Access	59

8.1.	Connecting to the Internet.....	59
8.2.	Using Internet Explorer	62
9.	Using Wireless Manager.....	66
9.2.	WiFi Utility	67
10.	USB Connection	68
10.1.	USB function and host	68
10.2.	USB to PC settings	68
11.	Backup Manager.....	69
11.1.	Making a backup.....	69
11.2.	Restore from a backup.....	70
11.3.	Command line.....	70
12.	Kiosk Mode Web Browser	71
12.1.	Overview of the app user interface	71
12.2.	User interface elements	72
12.3.	Home.....	73
12.4.	Search.....	73
12.5.	Go to an address.....	74
12.6.	Text size.....	74
12.7.	Content.....	75
12.8.	Copy and paste	75
12.9.	Administrator.....	77
13.	Synchronization.....	78
13.1.	System Requirements.....	78
13.2.	ActiveSync, or Windows Mobile Device Center, Installation and set up	78
13.3.	Starting and Stopping Synchronization Manually.....	79
13.4.	Changing ActiveSync Settings.....	79
13.5.	Synchronization using Bluetooth.....	80
14.	Bluetooth™	81
14.1.	Bluetooth Modes	81
14.2.	Enabling Bluetooth.....	81
14.3.	Making Your Device Discoverable	81
14.4.	Pairing With Devices in Range.....	82
14.5.	Beaming Information.....	82
15.	Barcode Scanner.....	83
15.1.	Setting Up Barcode Reader	83
15.2.	Scanning and Reading Barcode Labels.....	84
16.	Applications.....	85
16.1.	Managing Memory	85
16.2.	Third Party Applications	85
16.3.	GPS.....	86
17.	Battery Hot Swap.....	87
18.	Flashdisk and Custom ROM.....	87
18.1.	Flashdisk	87
18.2.	Custom ROM	87
19.	How to update the H22 image.....	88
19.1.	From SD card.....	88

19.2. Via Remote Update Utility	88
20. Clean boot and Factory Reset	88
20.1. Clean boot	88
20.2. Factory reset	88
21. Downloadable tools (not in image).....	89
21.1. Custom ROM Tool	89
21.2. Autorun.exe.....	89
22. Appendix	90

1. Introduction

This chapter provides an overview of the H-22. This chapter describes the H-22 keypad and function keys. It outlines what items ship in the box and what accessories are available separately. The chapter covers steps for getting started: how to install the USIM card, how to install and charge the battery and how to install and remove the microSD card. Finally, it describes how to connect the stereo headset.

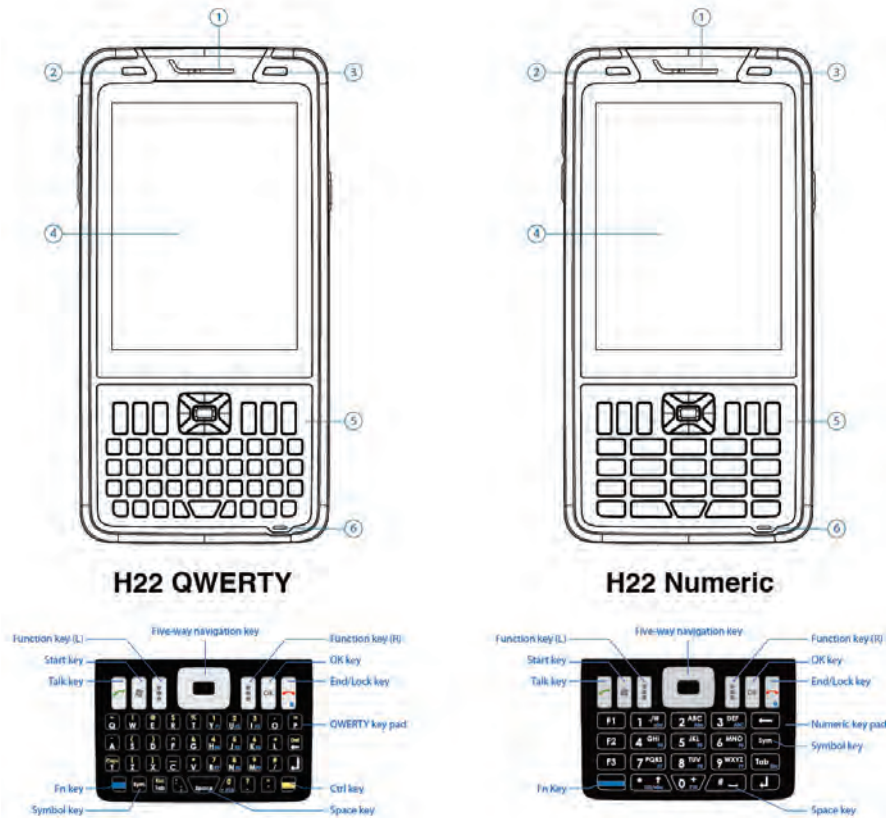

Figure 1. H-22 Front View: QWERTY and Numeric

Front View Description: H-22 QWERTY and H-22 Numeric

No.	Item	Description
1	Telephone receiver	Listen to audio from cellular phone calls through this receiver.
2	Light sensor	Detects the ambient light so the H-22 can improve visibility and conserve power.
3	Missed call/battery charging LED Indicator	Blinking red: Low power; Fixed red: Charging; Fixed green: Fully charged; Blinking green: Missed call; None: Normal operation
4	Display	The H-22 features a 3.7", TFT color touchscreen display
5	Keypad	Use the keypad to type numbers or letters.
6	Microphone	The microphone receives audio input for cellular phone calls or recording voice notes.

1.1. Keypad and Function Keys

Numeric and QWERTY Keypad

Item	Description
Five-way navigation	Press the Five-way navigation key up, down, left, or right to navigate menus: press the center button to indicate final selection.
End/Lock key	Press the End/Lock key to end a call or to close a phone application; it also locks H-22 when long pressed.
Scan key (left or right)	Press the Scan key to scan a barcode. This key is a function key that may be reprogrammed.
OK key	Press the OK key to confirm data entries or to exit the current program.
Start key	Press the Start key to open the Windows Mobile Start menu.
Talk key	Press the Talk key to dial or to answer a cellular phone call.
Sym key	Press the Sym key to change the character before the current cursor position into an accented variant.
Enter key	Press the Enter key after completing input.
Fn key (blue)	Press the function key to alter the keyboard input.
Space key	Press to enter a space between two characters.

QWERTY only keys

Item	Description
Ctrl key (Yellow)	Press to access the designated shortcuts.

1.2. Right and Left View

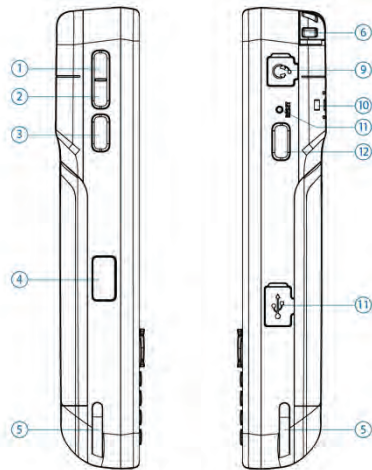

Figure 2. H-22 Right and Left Views

No.	Item	Description
1	Volume up	Press the Volume up key to turn the volume up.
2	Volume down	Press the Volume down key to turn the volume down.
3	Scan key (left)	Press the Scan key to scan barcodes.
4	IrDA port	The H-22 transmits and receives infrared signals from this port.
5	Cradle notch	This notch secures the H-22 into an optional charging cradle.
6	Stylus	Use the stylus to calibrate, write, draw or select items on the touchscreen.
7	Headset jack	This 3.5 mm audio connector provides a stereo out signal. Connector accommodates stereo handsfree headset.
8	Stylus tether notch	Attach the stylus tether to the H-22 using this notch.
9	Reset button	Press the Reset button to perform a soft reset of the H-22.
10	Scan key (right)	Press the Scan key to scan barcodes.
11	Micro-USB connector	Insert a micro-USB connector here to sync the H-22 with a PC or to charge the battery.

1.3. Top and Bottom View

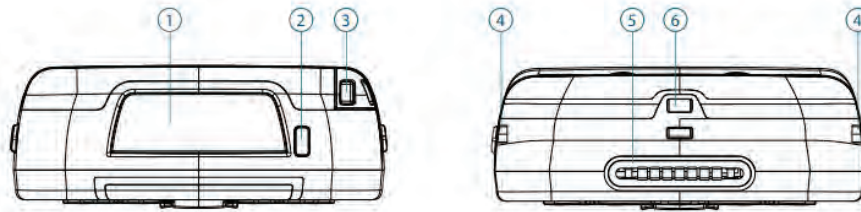

Figure 3. H-22 Top and Bottom Views

No.	Item	Description
1	Scanner window	The H-22 scans barcodes from this window.
2	Power button	Press this button to power on or off (Long press) the H-22 or to place the H-22 in suspend mode (Short press).
3	Stylus	Use the stylus to calibrate, write, draw or select items on the H-22 touchscreen display.
4	Cradle notch	This notch secures the H-22 into an optional charging cradle.
5	System connector	The connector connects the H-22 to optional cradle for charging the battery.
6	Eyelet for wrist strap	Attach the wrist strap for the H-22 through this eyelet.

1.4. Rear View

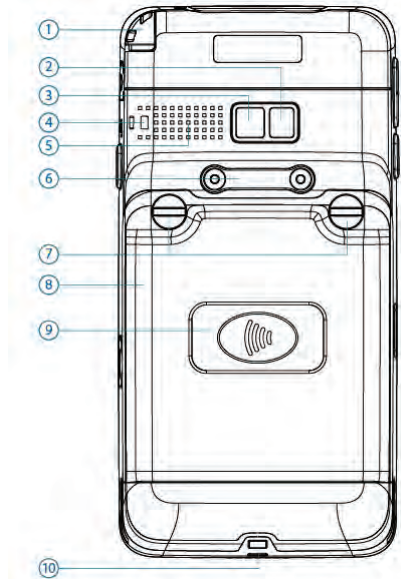

Figure 4. H-22 Rear View

No.	Item	Description
1	Stylus	Use the stylus to calibrate, write, draw or select items on the touchscreen.
2	Camera LED	The camera LED provides a flash for taking photos.
3	Camera lens	This is the H-22 camera lens through which high-resolution photos are taken.
4	Stylus tether notch	Attach the stylus tether to the H-22 using this notch.
5	Speaker	Use this speaker to listen to audio media or to make hands-free cellular phone calls.
6	Screw mounts for accessories	Attach accessories to these mounts with screws.
7	Battery screw covers	Two battery cover screws hold the H-22 battery cover in place.
8	Battery cover	The battery cover covers the battery, SIM card, RFID option and optional microSD card.
9	RFID landing zone	Landing zone for H-22 RFID option.
10	Eyelet for wrist strap	Attach the wrist strap to the H-22 through this eyelet.

1.5. Unpacking the H-22

Please ensure that all items listed in the following table are present and in good condition. If there is anything missing or damaged, contact your dealer immediately.







H-22 Package Contents			
			
H-22 QWERTY		OR	H-22 Numeric
			
Stylus and stylus strap	Battery	AC adapter, EU plug and US plug	USB cable
			
Quick Start Guide	Stereo headset	Wrist strap	

Figure 5. H-22 Package Contents

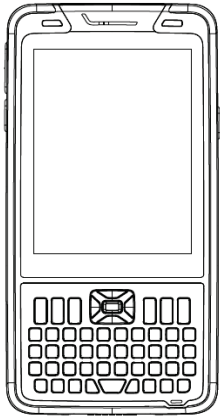
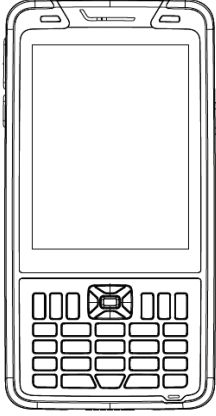
1.6. Accessories List

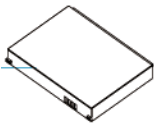
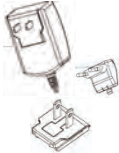
The following accessories are optional. Contact your Opticon H-22 dealer for more information about acquiring optional accessories.

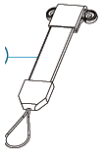
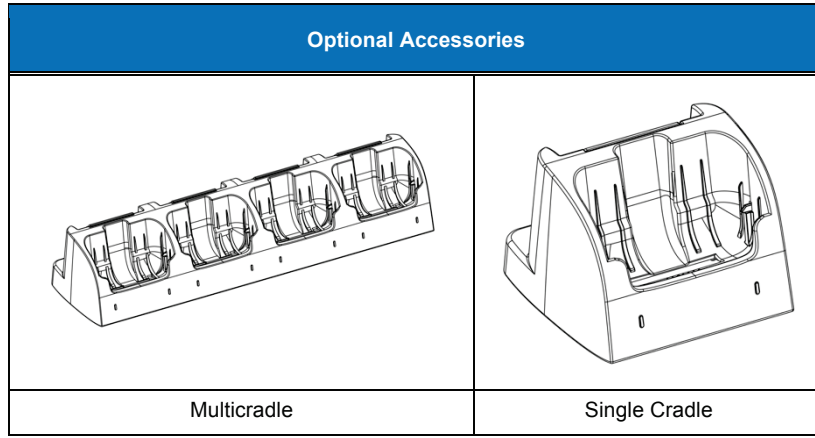

Figure 6. H-22 Accessories

1.7. Installing the USIM Card

You must install a USIM card to use the phone functions of your H-22. Perform the following procedures to install the USIM card.

Note: Power off the device and remove the battery before inserting a USIM card. Make sure the USIM card is securely positioned in the USIM socket.

1.7.1. Removing the Battery Cover

CAUTION: There is a limited amount of time during which the H22 can be without main battery power. Please refer to Chapter 16, "Battery Hot Swap."

Step 1:

Unlock the battery cover. Use a coin to turn the two battery cover screws counterclockwise. (See Fig. 7.)

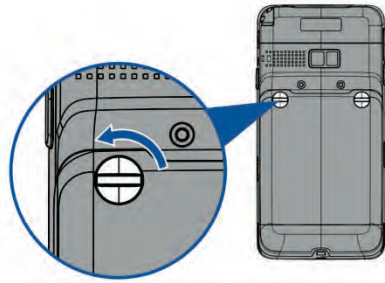

Figure 7. Unlocking the Battery Cover

Step 2:

Open the battery cover by lifting the top of the cover up and off of the H-22. (See Figs. 8 and 9.)

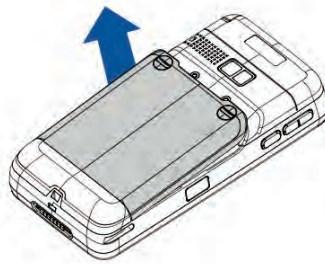

Figure 8. Lift the Battery Cover Up

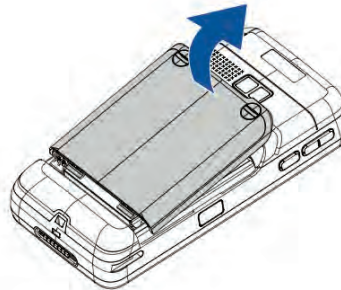

Figure 9. Lift the Battery Cover Off

1.7.2. Inserting the USIM Card

Once the battery cover and battery have been removed, you can install the USIM card using the following procedure.

Step 1:

Slide the USIM card under the metal ribbon until it is in position. See Fig 10. (A)

Step 2:

Ensure that the USIM card snaps into place. See Fig 10. (B)

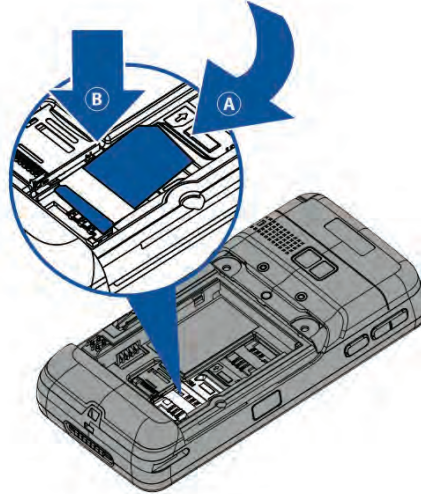

Figure 10. Install USIM Card

Step 3:

Install the battery. See "Installing the Battery" for details.

Step 4:

Replace the battery cover. See "Replacing the Battery Cover" for details.

1.8. Installing and Removing the Battery

The H-22 ships with a Lithium-ion battery in the box. Charge the battery fully before the first use. Perform the following procedure to install the battery.

Note: The battery can also be charged in the optional cradle.

1.8.1. Installing the Battery

Step 1:

Remove the battery cover. See "Removing the Battery Cover" for details.

Step 2:

Insert the battery (A) into the H-22 matching the battery contacts with the contacts inside on the left side of the H-22 case. Press down on the right side of the battery to secure it in place (B). See Fig 11.

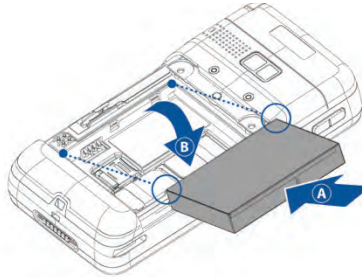

Figure 11. Install the Battery

1.8.2. Replacing the Battery Cover

Step 1:

Align the battery cover with the top of the battery bay. See Fig. 12.

Step 2:

Lower the cover in place. Secure it by turning the battery cover screws clockwise with a coin. See Fig. 13.

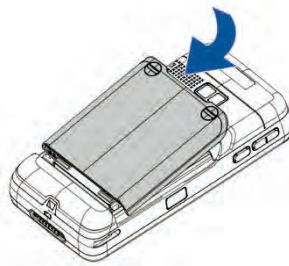

Figure 12. Align the Battery Cover

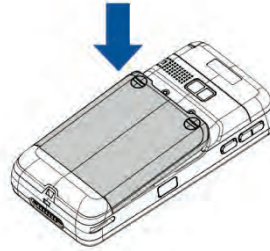

Figure 13. Lower the Battery Cover

1.8.3. Removing the Battery

Remove the battery by following the steps below:

Step 1: Remove the battery cover. See “[Removing the Battery Cover](#)” for details.

Step 2: Slide the battery out (A) and up (B). See Fig. 14.

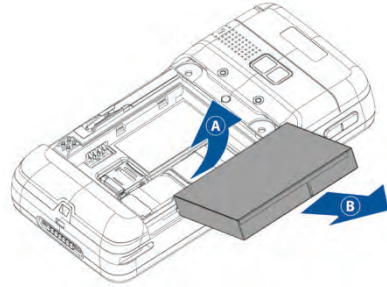

Figure 14. Remove the Battery

1.8.4. Locking the Battery Cover

Before you can power the device on, you must lock the battery cover by performing the following procedure.

Lock the battery cover by turning the two battery cover screws clockwise. See Fig. 15.

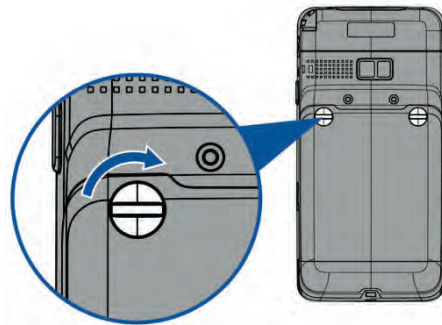



Figure 15. Lock the Battery Cover

1.9. Power and Battery Settings

The life and performance of your H-22 Lithium-ion battery depends on many factors. Under typical usage conditions, the H-22 battery will power the H-22 device for 12 hours when fully charged. To maximize the battery life, follow the instructions below

1.9.1. Viewing Battery Power

1. Tap  > **Settings** > **Power**.
The status of the main battery and the backup battery is displayed.
2. Tap OK to exit.

1.9.2. Maximize Battery Life

To optimize battery life, set the H-22 to shut down its screen if the device has not been used for a specified period of time.

1. Tap  > **Settings** > **Power** > **Advanced**.
2. Select the amount of idle time on battery power from the drop-down menu before the device shuts down.
3. Tap OK to save and exit. .

You can also adjust the backlight settings so the backlight turns off if the device is not used for a specific period of time.

1. Tap  > **Settings** > **Power** > **Advanced**.
2. Tap backlight settings link.
3. Select the amount of idle time from the drop-down menu before the backlight turns off.
4. Tap OK to save and exit.

1.9.3. Charging the Battery

To charge the battery, perform one of the following actions:

- Connect one end of the AC adapter to the H-22 through its USB port and plug the other end of the AC adapter into a wall outlet.
- Connect the device to a PC using the supplied USB cable.
- Put the H-22 into a specified cradle. (Charging cradles are optional accessories)

1.10. Attaching the Stylus Strap

Attach the stylus strap to the stylus and to the H-22 in the following order.

Step 1.

Attach the stylus strap to the stylus by threading the strap through the stylus strap holder at the top of the stylus and then threading the stylus itself back through the loop. See Fig 16.

Step 2.

Attach the other end of the stylus strap to the H-22 using the same method. See Fig. 17.



Figure 16. Insert the Strap into the Stylus



Figure 17. Insert the strap into the H-

1.11. Inserting and Removing an optional MicroSD Card

The H-22 contains a microSD card slot for expanding the device's memory. It supports memory cards up to 16 GB.

1.11.1. Inserting an optional MicroSD Card

CAUTION: Inserting a microSD card in the wrong direction can cause damage to the card and the device.

Step 1:

Remove the battery cover and remove the battery. See "Removing the Battery Cover" and "Removing the Battery" for details.

Step 2:

Slide the microSD card holder down to unlock it.

Step 3:

Lift the lid of the microSD card holder (B) and insert an optional microSD card into the holder. (A). See Fig. 18.

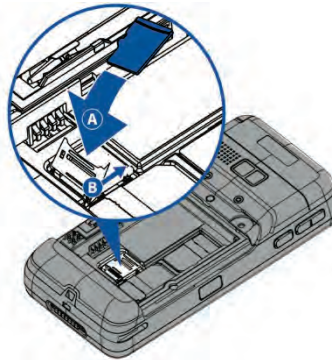

Figure 18. Insert an Optional MicroSD Card

Step 4:

Push the card holder back down into position and slide it back into the lock position (B).

Step 5:

Replace the battery and replace the battery cover. See "Installing the Battery" and "Replacing the Battery Cover" for details.

1.11.2. Removing an Optional MicroSD Card

Step 1:

Remove the battery cover and remove the battery. See "Removing the Battery Cover" and "Removing the Battery" for details.

Step 2:

Slide the microSD card lock toward the bottom of the H-22.

Step 3:

Lift the microSD card holder up and remove the microSD card from the holder. See Fig. 19.

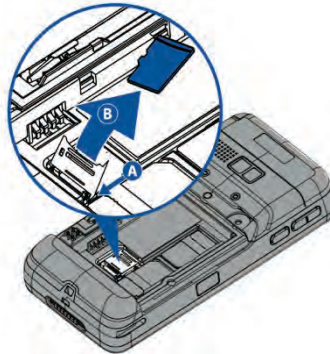

Figure 19. Remove the MicroSD Card

Step 4:

Push the card holder back down into position and slide it back into the lock position.

Step 5:

Replace the battery and replace the battery cover. See "Replacing the Battery Cover" and "Installing the Battery," for details.

1.11.3. Connecting a Headset

Step 1:

Locate the headset jack on the right side of the H-22.

Step 2:

Peel back the rubber door.

Step 3:

Insert the headphones. See Fig. 20.

CAUTION: water and dust protection is diminished when the headset or USB port rubber doors are open.

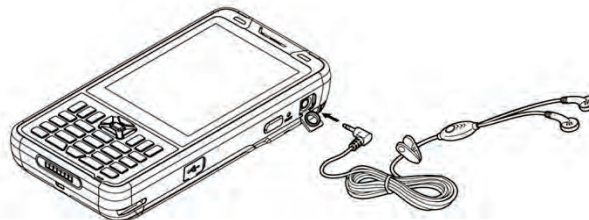

Figure 20. Insert Headphones

2. Getting Started

This chapter will instruct you on how to power the H-22 on and off, use the Home Screen and Start Menu, and set up various organizational tools.

2.1. Powering On and Off

Power On

Long press the Power button on top of the H-22 device until the display lights up.

Powering Off

Long press the Power button.

When the dialog box appears, tap Yes to power off. See Fig. 21.



Figure 21. System Shutdown Message

2.2. Entering and Exiting Suspend Mode

Suspend mode is an energy-saving mode that allows you to continue receiving phone calls and messages.

1. Enter Suspend Mode by short pressing the Power button.
2. Return from Suspend Mode by short pressing the Power button

2.3. Calibrating the Touchscreen

Calibration ensures that the correct screen items are activated when tapped. The first time you power on the H-22, the system will ask you to calibrate the touchscreen. You should also recalibrate the touchscreen when the H-22 is not responding accurately to stylus taps.

To calibrate the touchscreen, follow the instructions below:

1. Tap **Settings** > **System** > **Screen**.
2. Tap the **Align** Screen button and follow the on screen instructions. See Fig. 22.
3. Tap **OK** to save and exit.

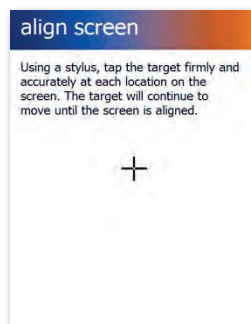

Figure 22. Align the Screen

2.4. Locking/Unlocking the H-22

Locking protects the screen from an accidental key press.

To lock/unlock the keyboard and touchscreen:

Tap  > .

The keyboard and touchscreen are now locked.

To unlock the screen simply slide the **Lock** button to either the right or left. See Fig. 23. An alternative method is to long press the End/Lock key to toggle lock on/off.

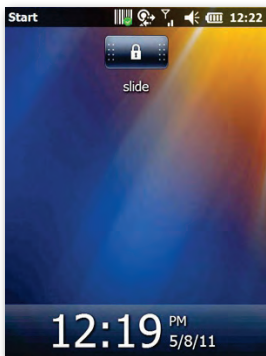

Figure 23. Slide Lock Button

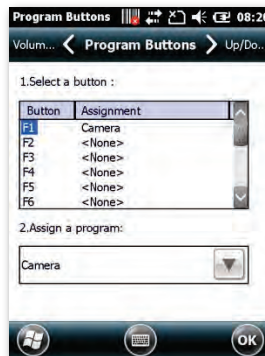



Figure 24. Program Buttons

2.5. Assigning Functions to Programmable Buttons

To assign a function to the programmable buttons:

1. Tap  > **Settings > Personal > Buttons > Program Buttons**.
2. Select a button (1) and assign a program from the drop down menu (2). See Fig. 24.
3. Tap **OK** to save and exit.

2.6. Customizing Up/Down control repeats

To customize the way your Up/Down control repeats follow the steps below.

1. Tap  > **Settings > Personal > Buttons > Up/Down Control**.
2. Drag the slider to the desired setting. See Fig. 25.
3. Tap **OK** to save.

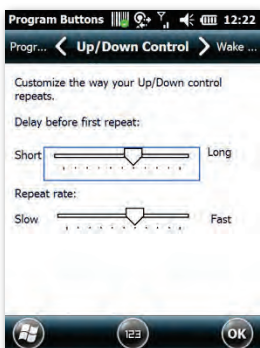

Figure 25. Customize Up/Down Controls

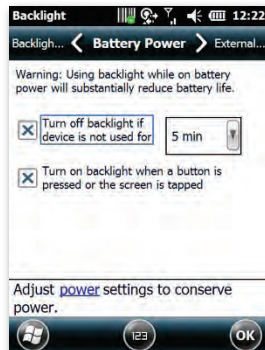



Figure 26. Battery Power Settings

2.7. Battery Power Settings for Backlight

1. Tap  > **Settings > System > Backlight**. See Fig. 26.
2. Select the time for the backlight to turn off if the device is not in use.
3. Enable or disable the backlight when a button is pressed or the screen is tapped.
4. Tap **OK** to save and exit.

2.8. Home Screen

The Home Screen is usually the first screen that displays when you turn on the H-22. It displays a list of shortcuts to phone functions, programs, and favorites. See Fig. 27.

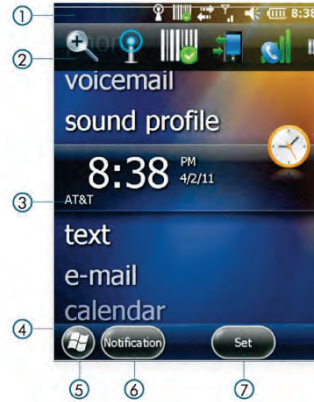

Figure 27. Home Screen

The numbered items in Fig. 27 are defined below.

N o.	Name	Description
1	Title bar	Displays status indicator icons.
2	Horizontal scroll bar	Touchable menu that scrolls horizontally to present status indicator icons for easy selection.
3	Service provider	Displays the name of the cellular service provider.
4	Tile bar	Displays all of the icons used to open and close screens, menus and features.
5	Windows Start button	Press to view Windows Start menu displaying icons for the H-22 basic functions and applications.
6	Touchable tile (left)	Soft key programmed at the factory as a Scan key.
7	Touchable tile (right)	Soft key programmed at the factory as a Scan key.

2.8.1. Accessing the Home Screen

Tap > Home.

2.8.2. Changing Home Screen Items

1. Tap > Settings > Home > Items.
2. Select the check box next to the item you want displayed on the Home screen. Deselect the check box next to the item that you do not want displayed. Refer to Fig. 28.
3. Tap OK to save and exit.

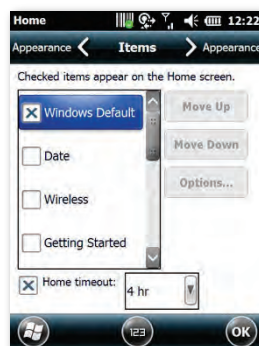

Figure 28. Changing Home Screen Setting

2.9. Windows Start Menu

The Windows Start menu displays icons for the H-22 basic functions and applications. See Fig. 29.



Figure 29. Windows Start Menu

The numbered items in Fig. 29 are defined in the table below.

No.	Name	Description
1	Title bar	Displays status indicator icons.
2	Windows Start icon	Toggles between Home screen and Windows start screen
3	Lock icon	Press to lock screen and keyboard.
4	Close icon	Press to exit Start menu and return to Home screen.

2.10. Entering Information

You can enter text, numbers and symbols using one of the following input modes: Keyboard, Letter Recognizer, Block Recognizer, Transcriber, Initial capital*, Lowercase* and Uppercase*.

Note: * Initial capital, Lowercase and Uppercase mode are only available for the numeric keyboard model.

Keyboard icons

Icon	Input Mode
	Lowercase
	Initial Capital
	Uppercase
	Letter Recognizer / Block Recognizer
	Transcriber
	Keyboard (touch panel)
	Function key (Blue)
	Sticky function key (Blue key pressed twice)
	Control key (Yellow); only available in QWERTY model.
	Sticky control key (Yellow key pressed twice)

Regardless of the input mode, the hardware keyboard can always be used to enter characters. When using the numeric keyboard, the characters you can input depend on the selected mode. You can enter numbers in Keyboard mode, Letter and Block Recognizer mode and Transcriber mode. To capitalize the first letter of every sentence you enter, use the Initial Capital mode. To enter lowercase characters or uppercase characters, use Lowercase mode or Uppercase mode, respectively. See the chapter on the numeric keyboard for more details.

The QWERTY keyboard works regardless of the mode, so it does not need special input modes.

2.11. Using the Hardware Keyboard

The H-22 features either a QWERTY keyboard or a numeric keyboard.

2.11.1. Using the QWERTY Keyboard

The QWERTY keyboard has 39 keys that function similarly to a normal PC keyboard. Press the key inscribed with the character you want to enter.

Lower case mode

By default, the QWERTY keyboard is in lower case mode. To enter a single uppercase letter, press ↑ (the shift key, located on the far left, on the lower row) followed by the key marked with the desired character. This character will then be uppercase. The next character will be lowercase again.

Upper case mode

To switch to uppercase mode, press Fn, followed by ↑ (the shift key, located on the far left, on the lower row). All characters will then become uppercase characters. To enter a single lowercase character, press ↑ followed by the key marked with the desired character. This character will then be lowercase. The next character will be uppercase again.

Symbols

To enter the symbols, printed in blue on the keys, press the Ctrl Yellow key, followed by the key with the desired marking. e.g. when you want to enter "!", press Fn, followed by W.

Special characters.

To enter special characters, accented letters, punctuation marks, currency signs etc., (e.g. à, Ç, ©) you can use the Sym key (located next to the shift key on the bottom row. You can also use the Fn key (blue) to generate F1 through F10 and the Ctrl key (yellow) to generate characters other than a-z ; , ' and /.

To use the Sym key, press the Sym key one or more times until the desired character is shown on the screen. e.g. when you want to enter Å, while in lowercase mode, press ↑, followed by A, to get the A character. Now press Sym until the Å appears on the screen. In this case, the Sym key has to be pressed 7 times.

The tables below show what characters can be made with the Sym, Fn and Ctrl keys.

Lower case characters plus symbols:

Key	After SYM	Fn + Key	Ctrl + Key	After SYM
a	àáâãäåæ		`	
b		F7	7	
c	çóç©			+±&
d	ð)]}>»
e	èéëêë		@	~
f			^	%
g			&	- +±
h		F4	4	
i	íîï	F3	3	
j		F5	5	
k		F6	6	
l	ł		+	±-
m		F9	9	

Lower case characters plus symbols, continued:

Key	After SYM	Fn + Key	Ctrl + Key	After SYM
n	ñ	F8	8	
o	òóôõöøœ		-	_+±
p	þƒ		=	
q			~	@
r	®		\$	€£¥
s	şšß		({<«
t	†		%	^
u	ùúûü	F2	2	
v			*	#
w			!	?¿
x]	
y	ý	F1	1	
z	źż		[{<«(
;	∴		:	∴
,	∴	F10	0	
.	∴		?	¿!□
'			"	'«»
/	∣		#	*
Tab			Esc	
Space				
Return				
Backspace			Del	
Shift			Caps Lock	

Upper case characters

Key	After Sym	Key	After Sym	Key	After Sym
A	À Á Â Ã Ä Å Æ	N	Ñ	U	Ù Ú Û Ü
C	Ç Ç Ć	O	Ò Ó Ô Õ Ö Ø	Y	Ý
D	Ð	P	Ʋ Ɠ	Z	Ž Ž
E	È É Ê Ë Ì	R	®		
I	Ì Í Î Ï	S	Ş Š ß		
L	Ł	T	†		

2.11.2 Using the Numeric Keyboard

The numeric keyboard has 20 keys and is optimized to enter numbers, but it can also be used to enter text and symbols. There are four different input modes that can be selected with the use of the Fn key.

- Press Fn followed by 1 to select Lowercase mode.
- Press Fn followed by 2 to select Initial uppercase mode.
- Press Fn followed by 3 to select Uppercase mode.
- Press Fn followed by * to toggle between numeric mode or alphanumeric mode.

Long press on * to toggle between numeric mode or alphanumeric mode.

- Fn + 4 -> F4
- Fn + 5 -> F5
- Fn + 6 -> F6
- Fn + 7 -> F7
- Fn + 8 -> F8
- Fn + 9 -> F9

When the keyboard is in a mode other than numeric mode, you can enter characters by pressing a number key repeatedly until desired character appears. If the next letter you want is located on the same key, wait until the cursor appears and blinks more than twice then enter the letter. For corresponding letters/numbers/symbols of each key, please see the table below.

Keys	Input Mode			
	(Numeric) keyboard	Lowercase	Initial capital	Uppercase
1	1	. , ? ! ' @ ` - _ () ; & / \ % # * 1		
2	2	abc2	ABC2	ABC2
3	3	def3	DEF3	DEF3
4	4	ghi4	GHI4	GHI4
5	5	jkl5	JKL5	JKL5
6	6	mno6	MNO6	MNO6
7	7	pqrs7	PQRS7	PQRS7
8	8	tuv8	TUV8	TUV8
9	9	wxyz9	WXYZ9	WXYZ9
*	*	Caps lock / Shift		
0	0	+ 0		
#	#	Space		

Numeric mode.

This mode is selected when the input mode is set to keyboard mode, Letter/block recognizer mode or transcriber mode. Simply press the key with the desired number on it to enter the number you want. Press Fn followed by 1 to select lowercase mode.

Initial capital mode

Initial capital mode can be used to capitalize the first letter of every sentence entered with the keypad. Press Fn followed by 2 to select Initial capital mode.

Lowercase mode

This mode can be used to input lowercase characters. Press Fn followed by 1 to select lowercase mode.

Uppercase mode

This mode can be used to input uppercase characters. Press Fn followed by 3 to select uppercase mode.

Special characters

To enter special characters, accented letters, punctuation marks, currency signs etc, (e.g. à, Ç, ®) you can use the Sym key. To do that, first press the key that has a marking that looks most close to the character that you want. Then press the Sym key one or more times until the desired character is shown of the screen. E.g. when you want to enter Ê, enter the E character first. Now press Sym until the Ê appears on the screen. In this case, the Sym key has to be pressed 3 times. The tables below show what characters can be made with the Sym key.

Key	After Sym	Key	After Sym	Key	After Sym	Key	After Sym
a	à á â ã ä å æ ã ç ä	l	ł	s	Œ œ š	0	°
A	À Á Â Ã Ä Å Æ Ā Ą Ą	L	Ł	S	Œ Š Ś	1	¹
c	ç ć Ć ©	n	ñ	t	‡	2	² ½
C	Ç Ć Ć ©	N	Ñ	T	‡	3	³
d	ð	o	ò ó ô õ ö ø œ	u	ù ú û ü ú μ	4	¼ ¾
D	Ð	O	Ò Ó Ô Õ Ö Ø Æ	U	Ù Ú Û Ü Ú Ú μ	8	⅛ ⅜ ⅝ ⅞
e	è é ê ë ě	p	þ Ꞁ	y	ý		
E	È É Ê Ë Ě	P	Þ Ꞁ	Y	Ý		
i	ì í î ï ĵ	r	®	z	ž ž		
I	Ì Í Î Ï Ĵ	R	®	Z	Ž Ž		

2.12. Selecting an Input Mode

There are two ways to select a specific input method:

1. Via the keyboard (numeric keyboard only)
 - Press Fn followed by 1 to select Lowercase mode.
 - Press Fn followed by 2 to select Initial Uppercase mode.
 - Press Fn followed by 3 to select Uppercase mode.
 - Press Fn followed by * to toggle between numeric mode or alphanumeric mode.
2. Via the upward arrow next to the input method icon. If the arrow is not visible, press the input method icon itself. See Fig. 30. In WM6.5.3, to select an input method, a long press on the round icon is required.



Figure 30. Soft Keyboard Input Method

2.12.1. Input Mode Options

The options for the various input modes can be accessed via **Windows** > **Settings** > **Personal** > **Input**. To change the options, first select the desired input method (Block Recognizer, Keyboard, Letter Recognizer, Transcriber) from the drop down menu. See Fig. 31.

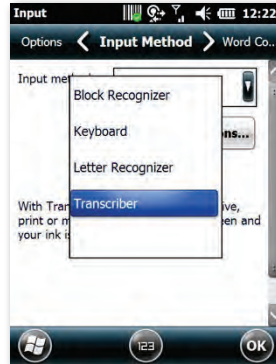

Figure 31. Input Mode Options

2.13. Using the Touch Screen Keyboard

The touch screen keyboard allows you to enter text by tapping keys with your stylus.

1. Select the touch screen keyboard as your input method. See "Selecting an Input Mode" for details on how to do that.
2. Tap the input icon located along the bottom center of the screen.
The touch screen input appears. See Fig. 32.

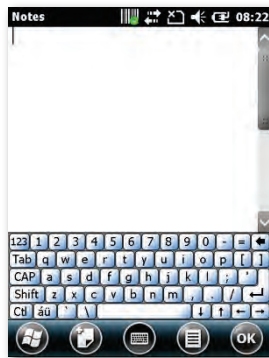

Figure 32. Touchscreen Keyboard

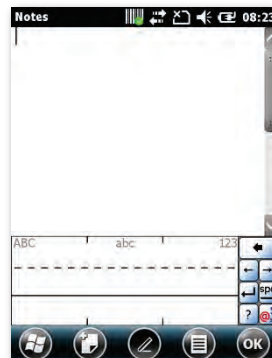

Figure 33. Letter Recognizer

3. To enter text, use your stylus to tap the keys on the touch screen keyboard.

2.14. Using Letter Recognizer

Letter recognizer interprets familiar handwriting styles, one symbol, letter, or number at a time.

1. Select the letter recognizer as your input method. See "Selecting an Input Mode" for details on how to do that.
2. Tap the input icon located along the bottom center of the screen. The Letter Recognizer screen appears. See Fig. 33.
3. Do one of the following to begin entering text:
 - Enter uppercase letters in the left (ABC) box.
 - Enter lowercase letters in the middle (abc) box.
 - Enter numbers and symbols in the right (123) box.

2.15. Using Block Recognizer

Block recognizer interprets letters written in one stroke.

1. Select the block recognizer as your input method. See "Selecting an Input Mode" for details on how to do that.
2. Tap the input icon located along the bottom center of the screen.
The block recognizer displays. See Fig. 34.



Figure 34. Block Recognizer

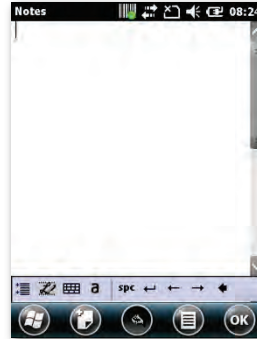

Figure 35. Transcriber

3. Do one of the following to begin entering text:
 - Enter lowercase letters in the left (abc) box.
 - Enter numbers in the right (123) box.
 - Enter symbols by tapping once in either the left or right box and begin writing.

2.15.1. Using Transcriber

Transcriber recognizes cursive and/or print handwriting.

1. Select the transcriber as your input method. See Figure 31. Soft Keyboard Input Method
2. Input
3. Tap the input icon located along the bottom center of the screen.
The transcriber displays. See Fig. 35.
4. To enter text, use your stylus to write anywhere on screen.

2.16. Setting up the Calendar

The Calendar can be used to schedule appointments, such as meetings or events. Appointments of the day can be displayed on the Home screen.

2.16.1. Creating Appointments

Tap  > **Calendar** and then tap on **Menu > New Appointment**. Enter appointment details. See Figs. 36-38. Tap OK to save and exit.

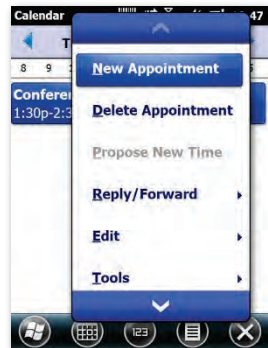

Figure 36. New Appointment

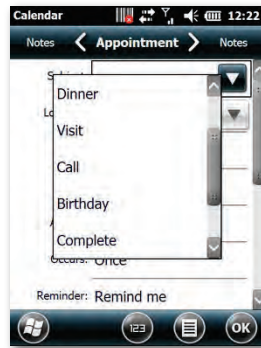

Figure 37. Select Subject

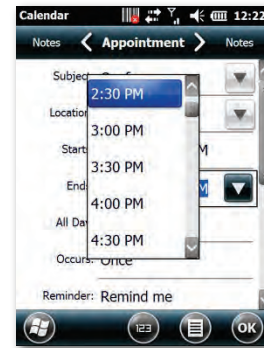



Figure 38. Select Time

2.16.2. Deleting Appointments

Tap  > **Calendar**.

From Agenda view, select the appointment to delete and Tap **Menu > Delete Appointment**. See Figs. 39-40.

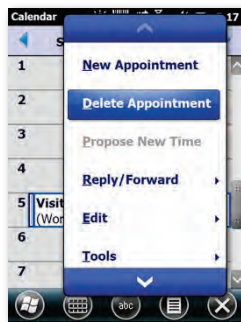

Figure 39. Delete Appointment

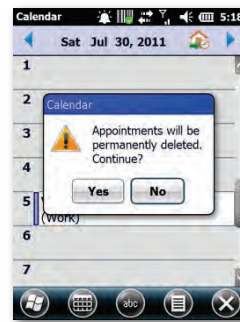

Figure 40. Delete Prompt

For recurring appointments, tap All to delete the set. To delete only the selected instance, tap One. If the appointment has been synchronized with your PC, it will be deleted from your PC the next time you synchronize. If the appointment has not been synchronized, it will only be deleted from the H-22.

2.16.3. Changing the Reminder Time

Tap **Menu** > **Calendar**.

Tap **Menu** > **Tools** > **Options** > **Appointment**.

Select the reminder time from the drop down menus. See Fig. 41.

Tap OK to save and exit.

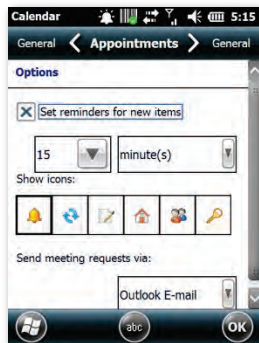

Figure 41. Calendar Reminder

2.16.4. Changing the Calendar View

1. Tap **Menu** > **Calendar**.
2. Tap **Menu** > **Tools** > **Options** > **General**.
3. Select a default view from the Start in drop down menu.
 - Agenda View: Displays the current day's activities.
 - Day View: Displays a single day's schedule in a planner layout.
 - Week View: Displays a weekly schedule.
 - Month View: Displays free and booked days during the month.
 - Year View: Displays a calendar for the entire year.
4. Tap OK to save and exit.

Writing Notes

Notes allows you to quickly compose reminders, to-do lists, meeting notes, and more. You can write using the stylus, keypad, or touchscreen keypad.

2.16.5. Setting the Default Input Method

1. Tap **Menu** > **Notes**.
2. Tap **Menu** > **Options**.
3. Select one of the following methods from the Default drop down menu as shown left below.
 - Writing: Handwrite notes using the stylus.
 - Typing: Type notes using the keypad or touchscreen keypad.
4. Tap OK to save and exit.

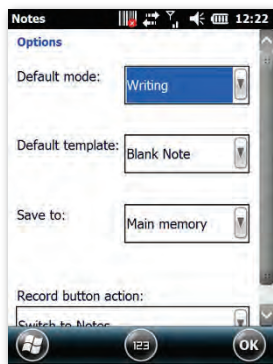

Figure 42. Input Modes

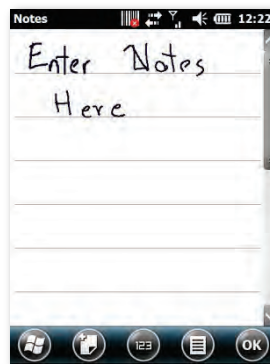

Figure 43. Enter Notes

2.16.6. Creating a New Note

1. Tap **Notes**.
2. Tap **New** and a blank template displays as shown above right.
3. Begin entering your text.
4. Tap **OK** to save your note.

2.16.7. Switching Between Typing/Writing Mode

1. Tap **Notes**.
2. Create a new note or open an existing note.
3. Tap **Menu > Draw** to switch to a different mode. Editing a Handwritten Note

To edit a handwritten note, do one of the following options. See Fig. 44.

- Tap **Menu > Undo Ink** to reverse an action.
- Tap **Menu > Redo Ink** to re-execute an undone action.
- Tap **Edit > Select All** to select all material.
- Tap **Edit > Clear** to delete all selected material.

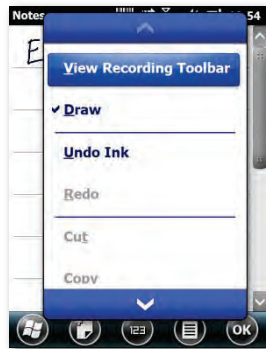

Figure 44. Handwritten Note

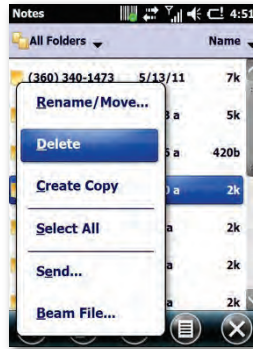

Figure 45. Delete a Note



Figure 46. Create a Template

2.16.8. Deleting a Note

1. Tap **Notes**.
2. Tap and hold the note using the stylus.
A menu displays. See Fig. 45.
3. Select **Delete** from the drop down menu.
4. Tap the **Yes** button to deleted the note.

2.16.9. Creating a Default Template

1. Tap **Notes**.
2. Create a note for saving as a template.
3. In the note list, select the new note and tap **Menu > Rename/Move**. See Fig. 46.
4. Enter a name for the template in the **Name** field.
5. Select **Templates** from the Folder drop down menu.
6. Tap **OK** to return to the note list.

2.16.10. Recording Voice Notes

1. Tap  > **Notes**.
2. If the recording toolbar is not displayed, tap **Menu > View Recording Toolbar**.
3. Tap the **Record** button on the toolbar (See Fig. 47) and speak into the microphone.
4. Tap the **Stop** button on the toolbar when finished.
5. Tap **OK** to return to the notes list.

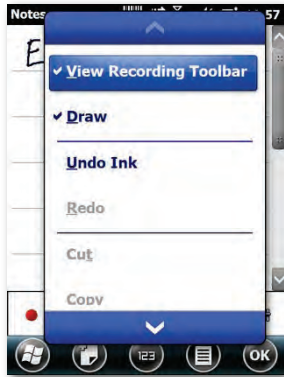

Figure 47. Record Voice Notes

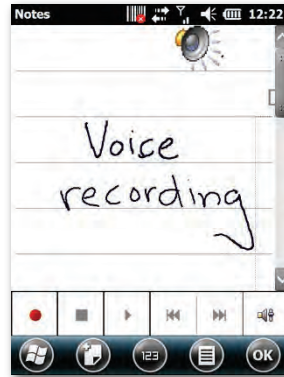



Figure 48. Add Voice Notes

2.16.11. Adding a Voice Recording to a Note

1. Tap  > **Notes**.
2. Create a new note or open an existing note.
3. If the recording toolbar is not displayed, tap **Menu > View Recording Toolbar**.
4. Tap the **Record** button on the toolbar and speak into the microphone.
5. Tap the **Stop** button on the toolbar when finished.
The audio file icon is then shown on the note. See Fig. 48.
6. Tap the audio file icon to play back the voice note.
7. Tap **OK** to return to the notes list.

2.17. Tasks

Tasks help you keep track of things you need to do. You can program tasks to be one time or recurring, set reminders, and organize them by category. If you use Outlook on your PC, you can synchronize tasks between your H-22 and PC.

2.17.1. Creating a task

1. Tap  > **Tasks**.
2. Do one of the following options to open the Tasks screen. See Fig. 49.
 - In the **Tap here to add a new task** box, enter the task name and press **Enter**.
 - Tap **Menu** > **New Task**.
3. Enter or select a subject from the **Subject** field.
4. Select a completion status from the **Status** drop down menu.
5. Pick the start and due time using the on screen calendar.
6. Set a reminder date/time from the **Reminder** field.
7. Select a category from the **Category** drop down menu.
8. Select a sensitivity setting from the **Sensitivity** drop down menu.
9. Tap **OK** to save and exit.

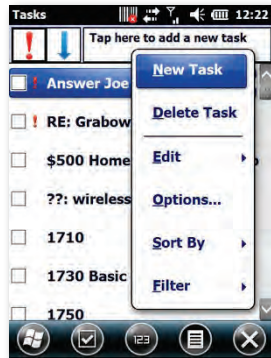

Figure 49. Create Task

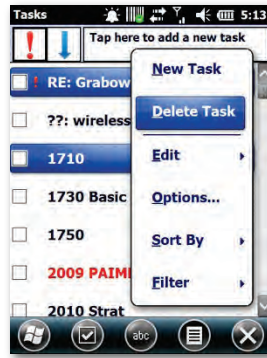

Figure 50. Delete Task

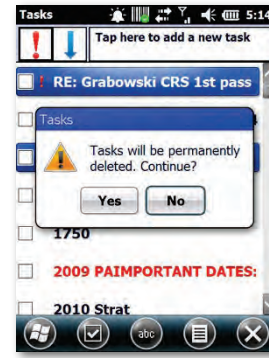



Figure 51. Confirm Task

2.17.2. Deleting a Task

1. Tap  > **Tasks**.
2. Select the task from the tasks list. See Figs. 50-51.
3. Tap **Menu** > **Delete Task** to delete the selected task.

2.17.3. Editing a Task

1. Tap  > **Tasks**.
2. Select the task from the tasks list from the screen.
3. Tap **Edit** and make any necessary changes.

2.17.4. Sorting/Filtering Tasks



1. Tap  > **Tasks**.
2. Do one of the following options. Refer to Fig. 52.
 - **Sort:** Tap **Menu** > **Sort by** and select the sorting option (Status, Priority, Subject, Start Date, Due Date).
 - **Filter:** Tap **Menu** > **Filter** and select the filtering option (All Tasks, Recently Viewed, No Categories, Active Tasks, Completed Tasks).



Figure 52. Task Filter

2.17.5. Setting Task Options

1. Tap  > **Tasks**.
2. Tap **Menu** > **Options** to open the screen as shown above middle.
3. Customize the following options:
 - Set reminders for new items
 - Show start and due dates
 - Show Tasks entry bar

2.17.6. Enabling Tasks

1. Tap  > **Settings** > **Home** > **Items**.
2. Select **Tasks**, then tap **Options** to open the screen.
3. Under **Display number of**, select the type of tasks to be displayed on the Today screen.
4. Tap **OK** to save and exit.

3. Phone Operations

This chapter instructs you on how to use the H-22 as a phone. You can make, receive, and keep track of calls, and send text messages (SMS) and multimedia messages (MMS).

3.1. Making a Phone Call

From the Phone screen, you can make calls and manage contacts.

3.1.1. Accessing the Phone Screen

To access the Phone screen, do one of the following options:

- Press the **TALK** key on your keypad.
- Tap  > **Phone**.

3.1.2. Making a Call by Entering a Phone Number

1. Tap  > **Phone**.
2. Enter a phone number using the keypad or touch screen keyboard. To turn on the touch screen keyboard, see "Using the Touch Screen Keyboard." See Fig. 53.

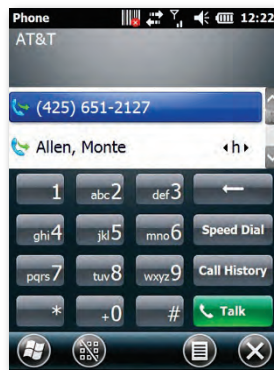



Figure 53. Make a Call

3. Do one of the following:

- If you see the number or contact name you want to call, select it and press the **TALK** key.
- If you do not see the number or contact name, finish entering the number and press the **TALK** key.

3.1.4. Making a Call from Call History

Call History displays calls you have made, received, and missed.

1. Tap  > **Phone**.
2. Tap **Keypad** to view the keypad buttons.
3. Tap **Call History** to open the screen.
4. Select the name or phone number to call. See Fig. 54.
5. Tap **Call** or press the **TALK** key to dial the number.

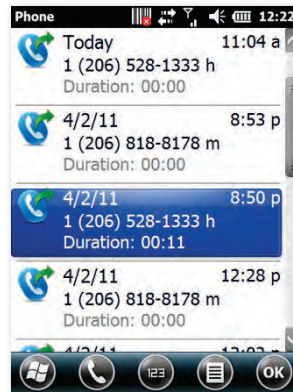



Figure 54. Select Name or Number

3.1.5. Making a Call from Contacts

1. Tap  > **Contacts**.
2. Tap the desired contact in the list.

Note: You can quickly find a contact by entering the first letter of the contact or the first number of their phone number.

3. Select the number you want to dial.
4. Tap **Call** or press **TALK**.

4.1. Using Speed Dial

Create speed dial entries for frequently used numbers so you can call a contact by pressing a single key. A speed dial entry can only be created for numbers stored in contacts.

4.1.1. To create a speed dial entry for a contact:

1. Tap  > **Contacts**.
2. Select the desired contact.
3. Select the phone number to place on speed dial. See Fig. 55.
4. Tap **Menu** > **Add to Speed Dial**.
5. In **Location**, select the speed dial number to use.
6. Tap **OK** to save and exit.

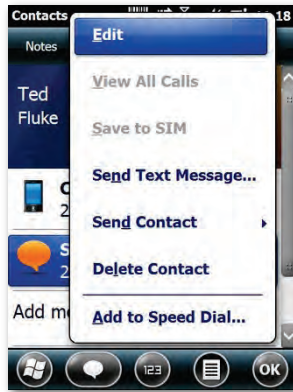

Figure 55. Add Speed Dial

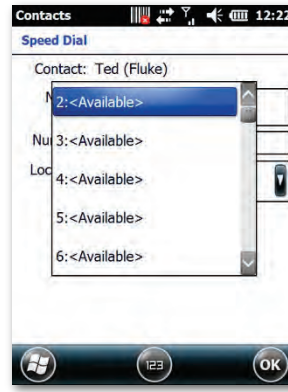



Figure 56. Delete Speed Dial

4.1.2. Deleting a Speed Dial Entry

1. Tap  > **Phone**.
2. Tap **Keypad** to view the keypad buttons.
3. Tap **Speed Dial** > **Menu** > **Delete** to delete the entry. See Fig. 56.

4.2. Accepting/Rejecting a Call

To accept a call

- Tap Answer or press the TALK key to accept an incoming call.

To reject a call

- Tap Ignore or press END to hang up.

4.3. Retrieving a Voicemail Message

Press and hold 1 to access your voice mailbox. Follow the operator's instructions to listen to your message.

4.4. Configuring Phone Settings

4.4.1. Activating PIN Security

Most SIM cards are preset with a personal identification number (PIN) provided by your wireless service provider. When PIN Security is enabled, you will be prompted to enter your PIN whenever you use your device.

1. Tap **Settings > Personal > Phone > Security**.
2. Select the check box next to **Require PIN when phone is used**. See Fig. 57.
3. Enter the PIN provided by your wireless service provider.
4. Tap Enter.



Figure 57. Activate PIN Security

Note: If your PIN is entered incorrectly three times, the SIM card will be blocked. If this happens, obtain a PIN Unblocking Key (PUK) from your wireless service provider.

4.4.2. Setting the Ring Tone and Ring Type

1. Tap **Settings > Personal > Phone**.
2. Customize the following options:
 - Select a **Ring type** from the drop down menu.
 - Select a **Ring tone** from the drop down menu.

Note: To use a custom sound file as a ring tone, use ActiveSync on your PC to copy sound files into the `/Windows/Rings` folder on your device.

4.4.3. Setting the Phone Profile

1. Tap **Settings** > **Personal** > **Sound Profile** to open the screen. See Fig. 58.
2. Select the radio button next to one of the following phone profiles described below: Normal, Meeting, Silent, Outdoor or Automatic.
3. Drag the sliders along the bottom of the screen to customize each profile's ringer volume and vibration strength.

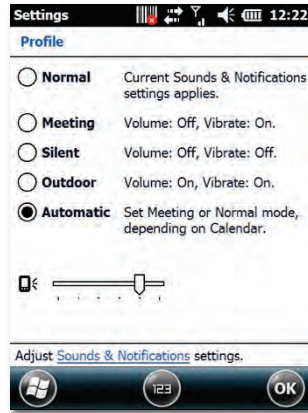

Figure 58. Set Phone Profile

4.4.4. Changing the Ringer Volume

Press the VOLUME key located on the left side of the device. Regardless of the screen that is shown on the display, the volume window will be shown on top of that screen. Adjust the slider to the appropriate volume level by sliding the bar with the stylus or pressing the VOLUME UP or VOLUME DOWN key.

4.4.5. Blocking Incoming and Outgoing Calls

You will not be able to receive or make calls according to the options you choose.

1. Tap **Settings** > **Personal** > **Phone**.
2. Tap the **Services** tab at the top of the screen.
3. Tap **Call Barring** > **Get Settings**. The H-22 will read settings from the network. See Fig. 59.
4. Choose which types of calls you want to block:
 - Block incoming calls: All calls; When roaming; or Off.
 - Block outgoing calls: All calls; International; International except to home country; or Off.
5. Tap **OK** to save and exit.

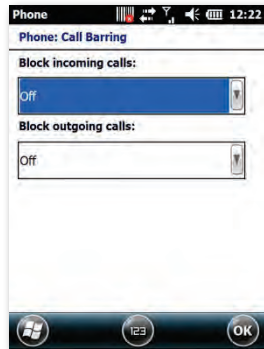

Figure 59. Block Calls

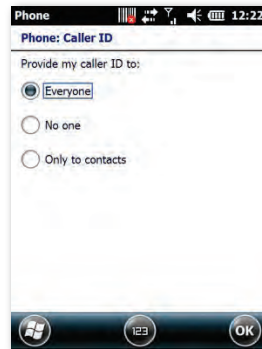

Figure 60. Display Calls

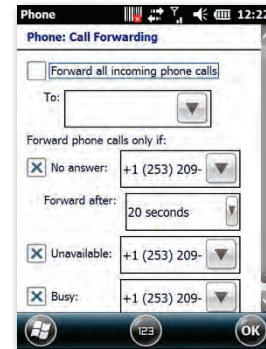

Figure 61. Forward Calls

4.4.6. Displaying Caller ID

Caller ID allows your number to be displayed to the party you dial.

1. Tap **Settings** > **Personal** > **Phone**.
2. Press the **Services** tab.
3. Tap **Caller ID** > **Get Settings**. The H-22 will read settings from the network. See Fig. 60.
4. Select **Everyone**, **No one**, or **Only to contacts**.
5. Tap **OK** to save and exit.

4.4.7. Call Forwarding

Call forwarding allows you to forward calls to another number.

1. Tap **Settings** > **Personal** > **Phone**.
2. Press the **Services** tab.
3. Tap **Call Forwarding** > **Get Settings**. The H-22 will read settings from the network. See Fig. 61.
4. To forward all calls to one number:
Select the check box next to **Forward all incoming phone calls** and enter the number in the field below.
5. Tap **OK** to save and exit.

4.4.8. Call Waiting

Call waiting notifies you of an incoming call when you're on the phone with another party.

1. Tap **Phone** > **Settings** > **Personal** > **Phone**.
2. Press the **Services** tab.
3. Tap **Call Waiting** > **Get Settings**. The H-22 will read settings from the network.
See Fig. 55.
4. Select **Notify me** or **Do not notify me**.
5. Tap **OK** to save and exit.

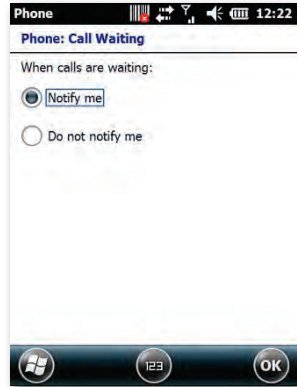

Figure 55. Call Waiting

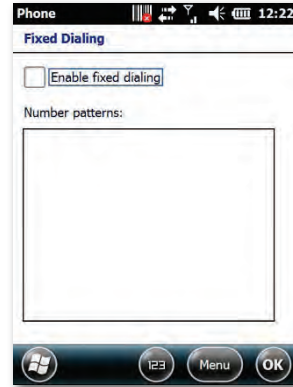

Figure 56. Fixed Dialing

4.4.9. Fixed Dialing

Fixed dialing allows outgoing calls to only specific numbers. Companies use this function to restrict the phone numbers that employees are able to dial.

1. Tap **Phone** > **Settings** > **Personal** > **Phone**.
2. Press the **Services** tab.
3. Tap **Fixed Dialing** > **Get Settings**. The H-22 will read settings from the network.
See Fig. 56. Select the check box next to **Enable fixed dialing**.
4. Tap **Menu** > **Add**.
5. Enter the name and phone number.
6. Tap **OK** to save and exit.

4.4.10. Selecting a Network Manually

1. Tap **Phone** > **Settings** > **Personal** > **Phone**
2. Press the **Network** tab.
3. In the **Network selection** list, tap **Manual**.
4. Select the network you want to use from the list of available networks.
5. Tap **OK** to save and exit.

4.4.11. In-Call Options

If you receive another incoming call while on the phone, the H-22 provides options for managing multiple calls at the same time. When you are notified of the incoming call, you can ignore, accept, switch, or set up a conference call between all three parties.

Answering another call

Tap **Answer** to accept the second call and put the first call on hold.

Tap **Swap** to switch between two calls.

To end the second call and return to the first call, press the **END** key.

Conference Call

To start a conference call, do one of the following options:

- Put a call on hold and dial a second number.
- Accept a second incoming call when you have one in progress.

Tap **Menu > Conference**.

Turning On/Off the Speakerphone

Speakerphone allows you to use the H-22 hands-free or let others hear your conversation using the built in speakerphone.

Tap **Speaker On** during a call to turn the speaker on.

Tap **Speaker Off** to turn the speaker off.

Muting the Microphone

To turn off the microphone during a call so the caller cannot hear you,

Tap **Mute** to turn the microphone off.

When you no longer want to mute the microphone,

Tap **Unmute** to turn the microphone back on.

5. Using Multimedia functions

5.1. Playing Music

Use your phone's media player to listen to music or watch videos. To launch the Windows Media player:

From the Home screen, tap  > **Windows Media** to open the screen as shown below. Browse for the desired file and select it. At the bottom of the screen, tap **Play**.

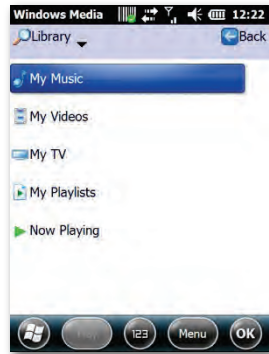

Figure 57. Windows Media

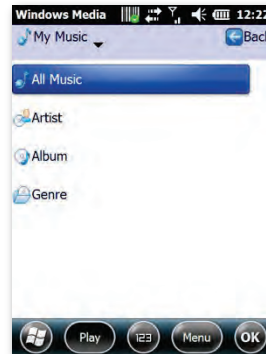



Figure 58. Browse for music.

5.2. Camera

You can use your phone's built-in camera to take photos and videos.

5.2.1. How to launch the camera

To launch the camera, Tap  > **Camera**

5.2.2. Assign shortcut key to the camera application

There is no dedicated camera shortcut key on H22. Instead a configurable button can be assigned to the camera function. To assign a key to the camera function (the default is F1):

1. Tap  > **Settings** > **Personal** > **Buttons**.
2. Tap the **Program Buttons** tab to open the screen as shown above right.
3. Select button to use as camera button.
4. Chose Camera in the "Assign a Program" box.
5. Click OK

5.2.3. Basic camera functions

Camera main screen

Below is a picture of the camera main screen.



Figure 62. Camera Main screen

At the top of the main screen are symbols for the current settings. The icons represents from left to right:

1. Shoot mode, Camera or video
2. Flash, on or off
3. Exposure
4. Zoom level
5. Number of remaining pictures using the current resolution
6. Storage target, Phone, Flashdisk or Storage Card
7. Picture quality
8. End Camera application

At the bottom of the screen is a shortcut to the Gallery Application and at the bottom right is the Settings symbol

Taking pictures

To take a picture, point the camera at the motive and press the center navigation key.

Turning the camera off

Tap the X in the upper right corner in Camera Landscape mode

5.2.4. Camera settings

Tap the wrench symbol in the lower right corner in Camera Landscape mode. This will bring up the settings menu. The Options are, from left to right: Advanced Settings, Capture mode, Brightness, Flash, White balance, Effects, Picture quality.



Figure 62a. Camera Settings

Advanced Camera settings

In the advanced camera settings it is possible to further adjust the parameters for several modes in the camera. The following options are available: Timer, burst mode, Storage target, Shutter sound, video format, video voice, Flicker reduction, Time stamp, Photo Quality, Panorama, GPS geo-tagging.



Figure 62b. Camera Timer

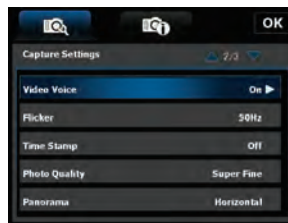

Figure 62c. Video Voice

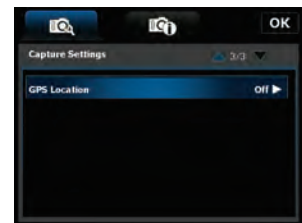

Figure 62d. GPS Location Indicator

5.3. Video recorder

It is also possible to capture video using H22.

5.3.1. Launching the video recorder

To launch the Video Camera, follow the steps below:

1. Tap > Camera.
2. Tap Setting Icon on the bottom right of the screen in landscape
3. In the Capture mode tab select video
4. Tap OK

Taking videos

With the camera in landscape mode press the middle button of the five-way navigation key to start capturing video.

Stop video capture

With the camera in landscape mode, and while the camera is capturing video, press the middle button of the five-way navigation key to stop video capture.

7. Contacts and Messaging

This chapter instructs you on using Contacts to manage addresses and phone numbers, and Messaging to send and receive SMS, MMS, and e-mail messages.

7.1. Using Contacts

The *Contacts* feature allows you to store phone numbers, e-mail addresses, birthdays, and other information that relates to a contact. Simply tap on a contact to quickly call or text message them. If you use Outlook on your PC, you can synchronize contacts between your device and the PC.

7.1.1. Creating a New Contact

1. Tap **Windows** > **Contacts** > **New** to open the screen as shown below.
2. Tap on **Outlook Contact** as shown below.
3. Enter information for the new contact as shown below.
4. Tap **OK** to save and exit.



Figure 63. New Contact

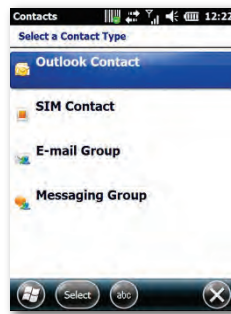

Figure 64. Select Outlook Contact

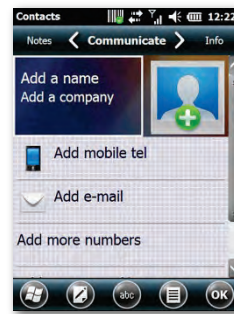

Figure 65. Enter Contact Information

7.1.2. Viewing and Editing Contact Information

1. Tap **Windows** > **Contacts**.
2. Tap the contact whose information you want to view.

Note: You can quickly search through contacts by entering the first letter of the contact.

3. Tap **Menu** > **Edit** to edit information.
4. Make any necessary changes.
5. When finished making changes, tap **OK** to save and exit.

7.1.3. Creating a SIM Contact

Contacts can be stored directly to your SIM card memory.

1. Tap **Windows** > **Contacts**.
2. Tap **New** > **SIM Contact**.
3. Enter the name and phone number of the contact.
4. Tap **OK** to save and exit.

7.2. Using Text Messaging

7.2.1. Writing a New Text Message

1. Tap **☰** > **Text**.
2. Tap **Menu** > **New** to open the screen. See below left.
3. Execute one of the following options:

- In the **To** field, enter the recipient's number.

Note: Insert a semicolon (;) between numbers to send to multiple contacts.

- Tap **Menu** > **Add Recipient** and select a contact from the contacts list.

4. Enter your message and tap **Send**.

Text messages are sent immediately.

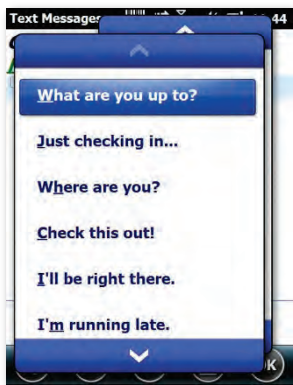

Figure 66. Writing a Text

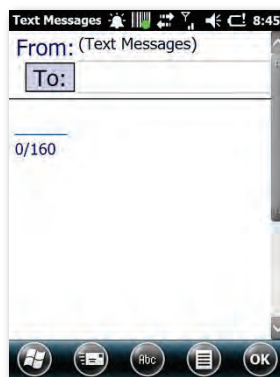

Figure 67. Reading a text

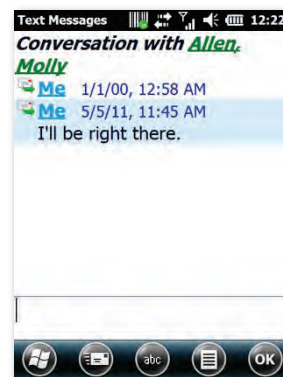

Figure 68. Reading a Text

7.2.2. Using Preset Text Messages

You can insert frequently used messages into your text message. While writing a message, tap **Menu** > **My Text** and select the preset message to insert. See above middle and right.

To Edit a Preset Message

1. Tap **Menu** > **My Text** > **Edit My Text Messages**
2. Select a message and edit,
3. Tap **OK** to save and exit.

Reading a Text Message

1. Tap **☰** > **Text** to open the screen.
2. In the message list, tap the text message you want to read.

7.2.3. Requesting Text Message Delivery Notification

1. Tap  > **Text**.
2. Tap **Menu** > **New**.
3. Tap **Menu** > **Message Options** to open the screen. See below left.
4. Select the check box next to Request **message delivery notification**.
5. Tap **OK** to save and exit.

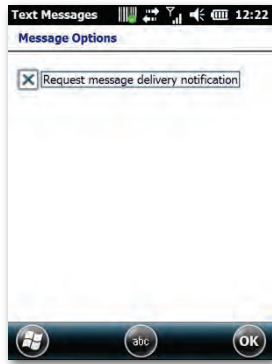

Figure 66. Delivery Notification

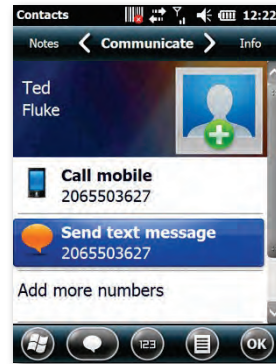



Figure 70. Sending a Text Message

7.2.4. Sending a Text Message to a Contact

1. Tap  > **Contacts**.
2. Select the contact you want to send a text message to.
3. Tap **Menu** > **Send Text Message**. See above right.
4. Write your message, and tap **Send**.

7.3. Sending e-mail

Before you set up your e-mail account, please prepare the following information:

Item	Description
User name	The username for the new email account. This is usually the first part of your email address, which appears before the "at" sign (@).
Password	The password for the new email account. You can save your password, so that you do not need to enter it each time you connect to your e-mail server.
Domain name	The domain name may be required.
Server type	The type of email server that hosts your mailbox (POP3 or IMAP4).
Account name	An account name. You must use a unique name for each account that you set up.
Network	The type of network your email server connects to.
Incoming mail server	The name of your email server (POP3 or IMAP4).
Require SSL connection	Ensures that received email for this account uses an SSL connection. NOTE: If you select this and your ISP does not support an SSL connection, you will not be able to connect to receive e-mail.
Outgoing mail server	The name of your outgoing email server (SMTP).
Outgoing server required authentication	Your outgoing email server (SMTP) may require authentication. NOTE: Your user name and password from above will be used.
Outgoing sever settings	Your outgoing email server may require different authentication settings than your incoming e-mail server.
Different user name for outgoing server	An option that allows you to enter separate settings for your outgoing email server.
User name	Your outgoing email server user name.
Password	Your outgoing email server password.
Domain name	The outgoing email server domain name.
Require SSL connection (outgoing mail server only)	Enables you to send personal information more securely. NOTE: If you select this and your ISP does not support an SSL connection, you will not be able to send email.

7.3.1. Setting up an email account:

1. Tap  > **E-mail** > **Setup E-mail**.
2. Enter your e-mail address.
3. Select the check box next to **Try to get e-mail settings automatically from the Internet** and tap **Next**. See below left and middle.
4. After Auto Setup has successfully entered your server settings, tap **Next**.

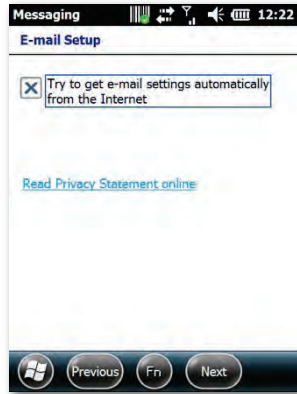

Figure 67. Get E-Mail Settings

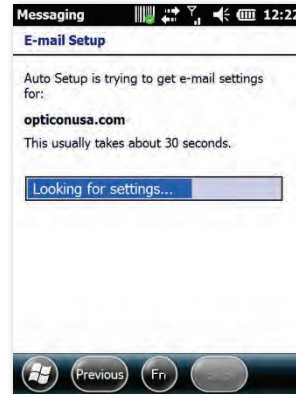

Figure 68. View Auto Setup

5. Enter the name you want to appear when you send email and tap **Next**.
6. In the **Automatic Send/Receive** drop down menu, select a frequency for sending/receiving email, or select manual.
7. Tap **Review all download settings** to edit your email settings.
8. Tap **Finish** to start downloading messages.

7.3.2. Composing an E-mail Message

1. Tap **Windows** > **Email** and select an email account.
2. Tap **Menu** > **New** to open a new email message. See below left.
3. Enter recipient in the To, Cc, or Bcc field.

Note: Insert a semicolon (;) between multiple addresses.
Note: Scroll up for the CC and Bcc fields.

4. Enter a subject in the Subject field.
5. Enter a message.
6. Tap **Send**.

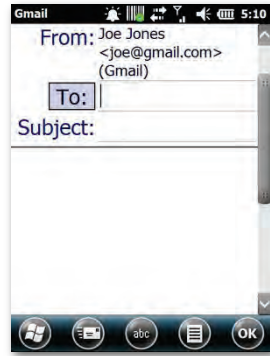

Figure 69. Compose an E-Mail

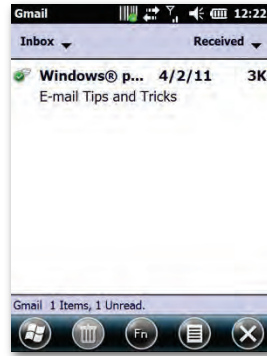



Figure 70. Read an E-mail

Note: E-mail messages are stored in Outbox and are sent to recipients the next time you synchronize to your PC or connect to your email server and send and receive mail.

7.3.3. Reading an E-mail Message

1. Tap **Windows** > **Email**.
2. Select an email account.
3. Tap the email you want to read in the message list. See above right.

7.3.4. Email Message Options

1. Tap  > **Email** and select an email account.
2. Tap **Menu** > **Options**.
3. Select **Message** Tab to open the screen as shown below left.
4. Select the options to change (Priority, Security, Permission, Language).
5. Tap **OK** to save and exit.

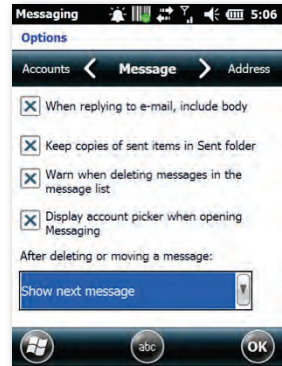



Figure 71. E-mail Message Options

7.3.5. Sending an E-mail to a Contact

1. Tap  > **Email**.
2. Tap **Menu** > **New**.
3. Tap **Menu** > **Add Recipient**.
4. Select the contact you want to send an email to.
5. Enter a subject, compose your message, and tap **Send**.

8. Internet Access

8.1. Connecting to the Internet

This chapter instructs you on how to access the Internet using the H-22. You can establish a connection via GPRS or Proxy for browsing the Web, downloading emails and more. To manually set up a connection, obtain the following information from your Internet Service Provider (ISP):

- User name
- Password
- Access point name (required for GPRS connection)
- Domain name (required for accessing a corporate network or an intranet)

8.1.1. Creating a GPRS Connection

1. Tap **Settings > Connections > Connections > Tasks**.
2. Tap **Add a new modem connection** as shown on the picture below left.
3. Enter the following information and tap Next.
 - Enter a name for the connection.
 - In the Select a modem drop down menu, select Cellular Line (GPRS).
4. In the Access point name field, enter the Connection information.

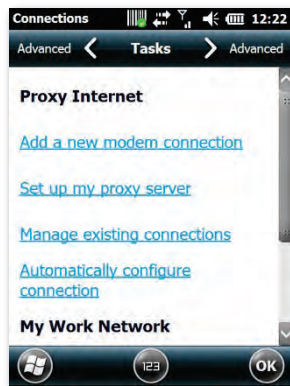

Figure 72. Add Modem Connection

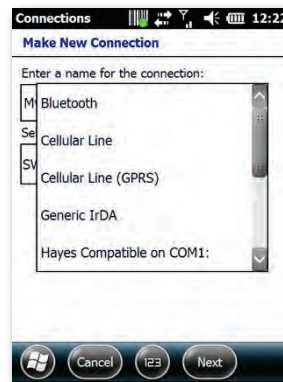

Figure 73. Make New

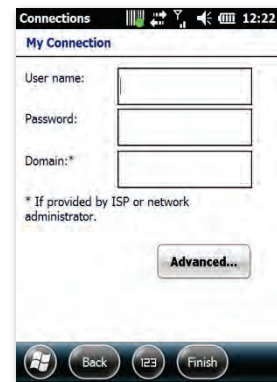
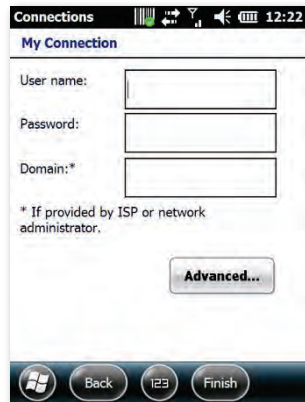

Figure 74. My Connection

5. In the User name field, enter your user name for the GPRS network, if required. See Figure 75, below.
 - In the **Password** field, enter your password, if required.
 - In the **Domain** field, enter your domain name, if provided by your ISP.
6. Tap **Advanced > Servers**.
7. Select the check box next to **Use specific server address** and enter the following information:
 - In the **DNS** field, enter the primary DNS address, if required.
 - In the **Alt DNS** field, enter the secondary DNS address, if required.
8. Tap the **TCP/IP** tab.
9. Select the check box next to **Use specific IP address** and enter the IP address for the device, if required.
10. Tap OK to update the settings.
11. Tap Finish to complete the connection setup.



The screenshot shows a mobile application interface titled 'Connections' with a sub-header 'My Connection'. It features three input fields: 'User name:', 'Password:', and 'Domain:*'. A note below the fields states '* If provided by ISP or network administrator.' and there is an 'Advanced...' button. The bottom navigation bar includes a Windows logo, 'Back', '123', and 'Finish' buttons.

Figure 75. My Connections

Note: The device uses this connection when you open a program that connects to the Internet.

8.1.2. Creating a Proxy Connection

Every network connection is different. You should gather all of the relevant information or network settings you need before starting this process.

1. Tap **Windows** > **Settings** > **Connections** > **Connections** > **Tasks**.
2. Tap **Set up my proxy server**. See Figure 80.
3. Select **This network connects to the Internet**. See Figure 81.
4. Select **This network uses a proxy server to connect to the Internet**. See Figure 82.
5. Enter the proxy server name under the **Proxy server** field.
6. If the proxy server uses a different port or requires user name and password, tap **Advanced**.
 - Select the proxy type to change its settings. See below right.
 - Enter a user name, password, and/or port number in the proper fields.
7. Tap **OK** to save and exit.

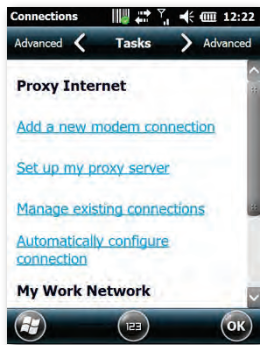

Figure 76. Set Up My Proxy



Figure 77. Enter Proxy Server



Figure 78. Advanced Proxy Settings

8.1.3. Deleting a Connection

1. Tap **Windows** > **Settings** > **Connections** > **Connections** > **Tasks**.
2. Tap **Manage existing connections**.
3. Tap and hold on the connection you want to delete.
4. Select **Delete**. See Figure 83.
5. Tap **OK** to save and exit.



Figure 79. Delete Connection

8.2. Using Internet Explorer

Internet Explorer Mobile is a web browser optimized for use on your mobile phone. You can use Internet Explorer Mobile to browse the Internet after setting up a valid Internet connection. See "Connecting to the Internet" for details.

8.2.1. Browsing the Internet

Note: A valid connection must be established before you can browse the Internet.

Note: Accessing the Internet using your mobile phone may incur extra charges from your mobile service provider. Contact your mobile service provider for more information.



1. Tap  > **Internet Explorer**. See below.
2. User options include:
 - a. Enter a URL in the Address Bar
 - b. Highlight the **Search Box** and type a search term
 - c. Tap the **Favorites** icon and select a web page
 - d. Tap the **Menu** icon. Select **History** and select a web page from the list.



Figure 80. Internet Explorer

8.2.2. Adding a Web Page to the Favorite List

1. Tap  > **Internet Explorer**.
2. Navigate to the page you want to add as a favorite. See below left.
3. Tap the **Favorites** icon.
4. Tap the **Add** icon.
5. Confirm or change the name and Web page address. See below middle.
6. Select a folder for the favorite.
7. Tap **OK**.

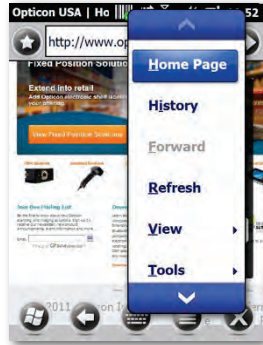

Figure 81. Navigate to Web Page

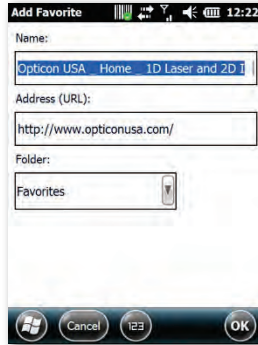

Figure 82. Add a Favorite

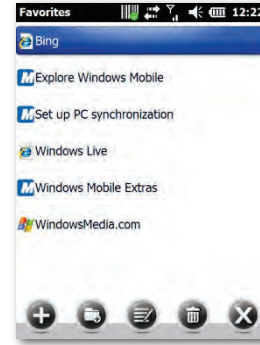



Figure 83. Select Favorite

8.2.3. Deleting a Favorite

1. Tap  > **Internet Explorer**.
2. Tap the **Favorites** icon.
3. Select the favorite to delete. See above right.
4. Tap the **Delete** icon.
5. Tap **Yes** to confirm the deletion. See below.

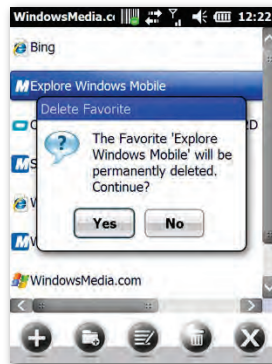



Figure 84. Delete Favorite

8.2.4. Changing the Size of Text on Web Pages

1. Tap  > **Internet Explorer**.
2. Tap **Menu > View > Text size** and select the size you want (Largest, Larger, Medium, Smaller, Smallest)

8.2.5. Showing or Hiding Pictures on Web Pages

1. Tap  > **Internet Explorer**.
2. Tap **Menu** > **Tools** > **Options**.
3. Tap **Other**.
4. Select the check box next to **Show Pictures**. See below left.
5. Tap **OK** to save and exit.

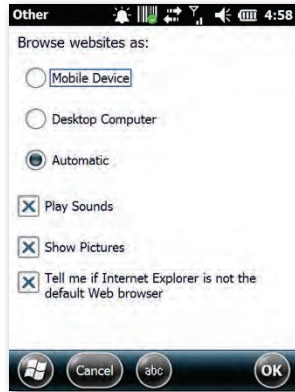

Figure 85. Show Pictures

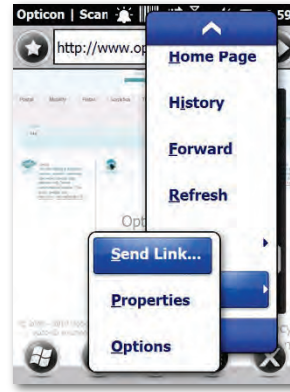



Figure 86. Send Link

8.2.6. Viewing a Page in Full Screen Mode

1. Tap  > **Internet Explorer**.
2. Do either of the following:
 - Tap **Menu** > **View** > **Full Screen**.
 - Tap and hold on the screen with stylus, and then tap **Full Screen** on the pop-up menu.

8.2.7. Sending a Link via E-mail

1. Tap  > **Internet Explorer**.
2. Go to the page you want to send.
3. Tap **Menu** > **Tools** > **Send Link**. See above right.
4. Select an email account. A new message is created with the page address inserted in the message body. You can then enter the recipient's phone number and edit the message.
5. Tap **Send** to send the message.

8.2.8. Copying Text from a Web Page

1. In **Internet Explorer Mobile**, tap and hold the page, and tap **Select All Text**.
2. Tap and hold the page.
3. Tap **Make Selection** on the pop-up menu. See Figure 91.
4. Highlight the text to copy using the stylus.
5. Tap **Copy**. See Figure 92.
6. Open an application where the text can be pasted.
7. Tap and hold on the screen.
8. Tap **Paste** on the pop-up menu.



Figure 87. Make Selection



Figure 88. Tap Copy

8.2.9. Clearing Temporary Files, Cookies, or History

1. Tap **Internet Explorer**.
2. Tap **Menu > Tools > Options** and select **Browsing History**.
3. Select one of the following file types and tap **Clear** (See Figure 93):
 - Temporary Files
 - Cookies
 - History
4. When prompted to delete all files, tap **Yes**.
5. Tap **OK** to save and exit. See Figure 93.

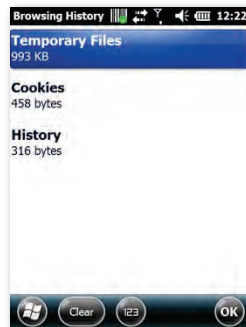

Figure 89. Clear FilesWireless Manager

9. Using Wireless Manager

Wireless Manager is a program that lets you to turn on or off your cellular phone, Bluetooth™ and Wi-Fi connections.

9.1.1. Opening Wireless Manager

To open the Wireless Manager, do one of the following:

1. Tap **Windows** > **Settings** > **Connections** > **Wireless Manager**.
2. Tap the **Signal Strength** icon and tap **Wireless Manager**. See below.



Figure 90. Wireless Manager



Figure 91. Enable Features

9.1.2. Enabling and Disabling a Feature

1. Tap **Windows** > **Settings** > **Connections** > **Wireless Manager**.
2. Customize the following options:
 - Tap the WiFi button to toggle between turning on or off Wi-Fi. See below.
 - Tap the Bluetooth button to toggle between turning on or off Bluetooth.
 - Tap the Phone button to toggle between enabling or disabling the Cellular Phone.

9.1.3. Connecting to a Wi-Fi Network

Wi-Fi allows you to access the Internet by connecting to a wireless network or hotspot.

1. Tap **Windows** > **Settings** > **Connections** > **Wireless Manager**.
2. Tap **Menu** > **Wi-Fi Settings**. See below left.
3. Select the desired wireless network and tap **Connect**.
4. In the **Connects** drop down menu, select one of the following options (see below middle) and tap Next:
 - **The Internet** for connecting to the Internet.
 - **Work** for connecting to a private network.
5. Enter a network key if required. See below right.
6. Tap **Finish** to complete setup.
- 7.



Figure 92 Wi-Fi Settings

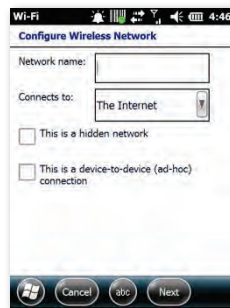

Figure 93. Configure Network

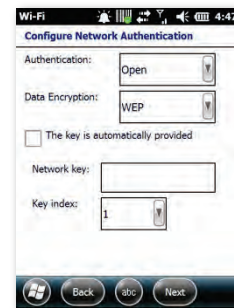



Figure 94. Network Authentication

9.1.4. Creating a Wireless Connection

1. Tap  > **Settings** > **Connections** > **Wireless Manager**.
2. Tap **Menu** > **Wi-Fi Settings**.
3. Select **Add New**.
4. Enter the following information and tap **Next**
 - Network name
 - Network type
 - If you want to connect to another device instead of a network through an access point, select **This is a device-to-device (ad-hoc) connection**.
5. Enter the following information and tap **Next**.
 - Authentication type
 - Data Encryption type
 - Network key
 - Key index
6. Enter the following information.
 - Select **Use IEEE 802.1x network access control** to use EAP (Extensible Authentication Protocol).
 - Select EAP type: PEAP or Smart Card or Certificate.
7. Tap **Finish** to complete setup.

9.1.5. Editing a Wireless Network

1. Tap  > **Settings** > **Connections** > **Wireless Manager**.
2. Tap **Menu** > **Wi-Fi Settings**.
3. Tap and hold the network you want to edit.
4. Tap **Edit** on the pop-up menu.
5. Make all the necessary changes to the wireless network settings.
6. Tap **Finish** to save changes.

9.2. WiFi Utility

The integrated WiFi Utility provides access to the following options/settings:

- Regulatory domain
- Power saving mode (e.g., prioritizing power saving or transmission speed)
- Wake on LAN
- WPA2 certificate enrollment

To locate the WiFi Utility, Tap  > **Settings** > **Connections**.

10. USB Connection

10.1. USB function and host

H22 has a USB client interface supporting USB 2.0 high speed and a USB host interface (using a USB host adapter) supporting USB Full speed. The USB host function in H22 supports the following features:

- Ethernet Cradle RNDIS driver
- USB Mass storage
- USB HID (USB keyboard only, mouse is not supported)
- The USB client mode is configured by the USB to PC settings found in the control panel application “USB to PC”, see below

10.2. USB to PC settings

A *USB to PC* utility assists with establishing the proper USB connection type when connected to a PC. The choices are:

- ActiveSync over USB Serial
- ActiveSync RNDIS
- USB-Mass storage
- Internet sharing

When the device is connected to a PC using a USB cable, the USB to PC utility window appears, and the user can select how the device should behave. See Figure 105. Either the device will:

- Activate in ActiveSync mode (over either USB or RNDIS)
- Reveal an external SD-card as a USB mass storage device
- Or, activate the Internet Sharing feature of the device]

The alternatives are presented as a radio box list. The user selection window persists in order to allow pre-selection of one of the three choices above. In case the user does not make an active selection within 5 seconds, the USB to PC settings will be closed, but the pre-selected connection type remains operative.

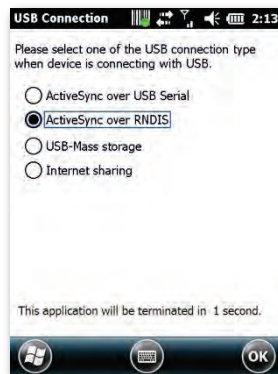

Figure 105. USB to PC connection choices

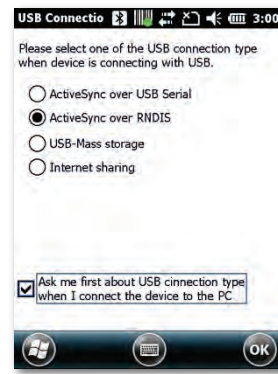

Figure 106. “Ask me first...” USB connection type

A “USB to PC” utility is available in the Connections settings. To locate this feature, Tap **Windows** > **Settings** > **Connections** > **USB to PC**. It contains the same radio list with the four USB connection types listed above (the most-recent user selection is pre-selected). A checkbox saying “Ask me first about USB connection type when I connect the device to the PC” will be visible (in default mode, the box is checked). See Figure 106, above.

1. Tap **Windows** > **Settings** > **Connections** > **USB to PC**.
2. Choose if the connections dialogue shall appear when a connection is made
3. Select the desired USB connection type and tap **OK**.

11. Backup Manager

H22 is provided with a backup manager application. The backup manager supports full backup, partial backup and selective backup. It also provides the possibility to view what is included in a backup before restoring it to the device. Backup is possible to be made to or from either SD card or the device.

1. **Full backup** mode takes a full backup of the device including all files, databases, settings and registry
2. **Partial backup** is a subset of the full backup where it is possible to select all files, databases, settings and registry individually. It is not possible to select individual files in the Partial backup mode. Selecting all items in the Partial backup mode will result in the same backup as a full backup
3. **Selective backup** enables the user to select individual files to backup. This mode allows backup and restoring of files, databases, or parts of the registry individually. Selecting all items in the Selective backup mode will result in the same backup as a full backup

It is possible to perform a selective restore from all three types (Full, Partial and Selective) of backup by selecting the items to be restored

11.1. Making a backup

To make a backup of the H22



1. Tap  > **Settings** > **System** > **BackupManager**.
2. Select **Backup** on the top bar
3. From the drop down menu, choose Full, Partial or Selective backup. See Figure 107.
4. Select the desired objects to include in the backup
5. Tap **Settings** if you want to change the target of the backed up files.
6. Tap **Backup**



Figure 107. BackupManger Pulldown Menu

11.2. Restore from a backup

To restore from a backup of H22

1. Tap  > **Settings** > **System** > **BackupManager**.
2. Select **Restore** on the top bar
3. Choose backup file to restore from, see picture below middle
4. Select the desired objects to restore
5. Tap **Restore**

11.3. Command line

The BackupManager can also be run from the command line. This can be useful to perform a silent restore of the data on the device without the user's interaction.

The command line can be executed from an *autoexec.exe* file, for example, in the user store. The default command line argument is:

BackupManager.exe \Path to backup file\name of backupfile.zip

For example: *BackupManager.exe* \Storage Card\backupfile.zip

12. Kiosk Mode Web Browser

Opticon customers with a big company-internal user base often want to limit the available device functionality so that only certain actions can be performed. The reasons for this decision can for instance be to make it easier for the user, to make the business more effective and to prevent device misuse. Companies that use the web extensively in their devices see a need to run a locked-down web browser in kiosk mode.

The definition of **kiosk mode** is a device, big or small, that performs only one function and exposes nothing other than that function to the user. When a web browser is running in kiosk mode, access to other parts of the device, like applications or the file system, must be heavily restricted. The definition of **locked web browser** is a web browser that cannot be used as the user pleases, but as the IT administrator of the company has configured it. Restrictions can be applied at various levels, like what UI elements (e.g. address bar, tool bar, etc.) will be shown, what sites the browser can navigate to, what types of content will be rendered, etc. The Kiosk Mode Web Browser is henceforth called *the app* in this chapter.

12.1. Overview of the app user interface

When the app is started for the first time, it will act as any other application since it hasn't yet been locked. Locking the app is described in the administration documentation distributed separately. The UI consists of a system indicator bar at the top, an address bar below it, the actual web page area in the middle, a status bar below it and a menu bar at the bottom. All UI elements except for the essential web page area can be optionally hidden, which will give the maximum possible screen real estate for web apps that need it:



Figure 108. Browser Default Home Page

The web page shown in Figure 108, above is the default home page of the browser. Configuring the home page is described in the section Create a new configuration.

12.2. User interface elements

The main building blocks of the app UI are these:

- The system indicator bar
- The address bar
- The web page area



Figure 109. The System Indicator Bar



Figure 110. The Address Bar



Figure 111. The Web Page Area

- The status bar

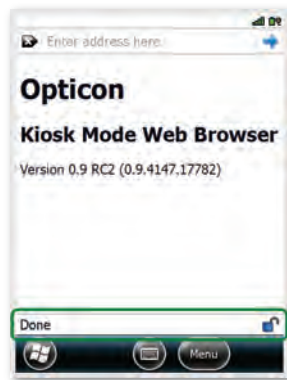

Figure 112. The Status Bar

- The menu bar



Figure 113. The Menu Bar

All the UI elements *except* the web page area can be hidden and shown using the corresponding menu options in **Menu > Settings > View**:



Figure 114. UI View Settings Command



Figure 115. UI Elements View Settings Dropdown

12.3. Home

The user can reach the Home Page at any time by selecting the menu option **Menu > Go > Home**:

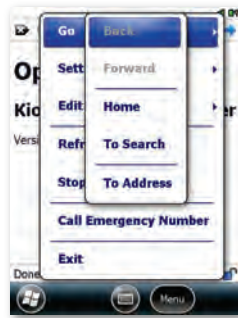

Figure 116. Navigating to the Home Page

Customization of this feature—by swapping the default home page for something that is more branded and targeted at the needs of specific users, for example, the latest company news, and company specific links—is recommended. Configuring a home page is described in the administration documentation, distributed separately.

12.4. Search

The user can reach the Search Page at any time by selecting **Menu > Go > To Search**.

There's no search provider set by default, so the first time this menu option is selected, the user is given the choice of either three established search providers or a custom favorite of the user:



Figure 117. Navigating to Search Provider Page

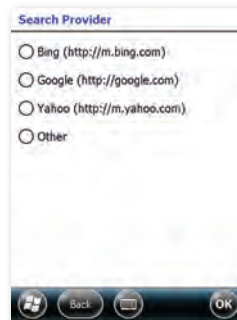

Figure 118. Search Provider Selection Page

If the user selects the **Other** search provider option, then the address of that search provider must be entered; for example, a company internal search page:

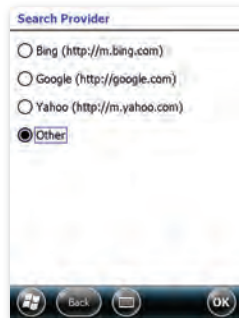

Figure 119. Selecting "Other" Search Provider



Figure 120. "Other" Search Provider Address

Once a search provider has been selected, it can only be changed by resetting the app settings. This is described in the administration documentation distributed separately. A customer's preferred search provider can be set as the default so that the search provider selection dialog is never shown to the user. This menu option can also be removed completely in locked mode. Configuring a search provider, and removing the **To Search** menu option are described in the administration documentation distributed separately.

12.5. Go to an address

The user can navigate to a desired web page at any time by selecting the menu option **Menu > Go > To Address**:

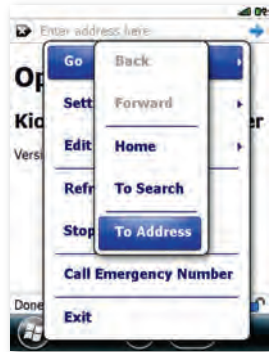

Figure 121. Reaching a Desired Web Page



Figure 122. Entering a Desired Web Address

This menu option can be removed completely in locked mode. Removing the **To Address** menu option is described in the administration documentation distributed separately.

12.6. Text size

The user can choose between 5 text sizes in the web page area by selecting a corresponding menu option in **Menu > Settings > Text Size**:



Figure 123. Text Size Settings

This menu option can be removed completely in locked mode and the text size be given a default value instead, but it's not recommended since vision quality is highly individual. However, removing the Text Size menu option is described in the administration documentation distributed separately.

12.7. Content

The user can disable various content features of a web page by selecting the corresponding menu option in **Menu > Settings > Content**:



Figure 123. Text size settings

All these menu options can be removed completely in locked mode and the underlying properties given default values instead. Removing the **Content** menu options is described in the administration documentation distributed separately.

12.8. Copy and paste

The default behavior of a web page when the user sweeps a stylus or a finger across the screen is to scroll the page vertically or horizontally, depending on the content and whether it fits in one screen. To make it possible to copy and paste interesting text on a web page, the user must enable the menu option **Menu > Edit > Selection Mode**:



Figure 124. Selection Mode Settings

When *Selection Mode* is enabled, any text on a web page can be selected and copied using the menu option **Menu > Edit > Copy**:

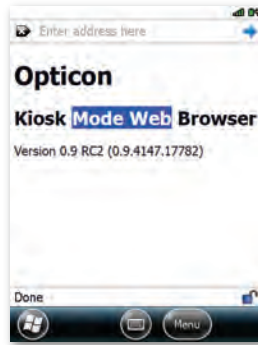

Figure 124. Selecting Web Page Text

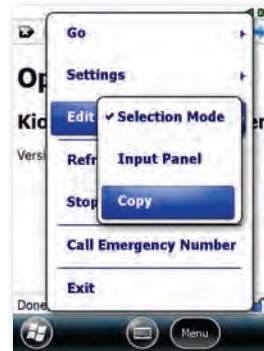

Figure 125. "Copy" Command

The selected text will then be copied to the clipboard so that it can be pasted into a textbox somewhere else:



Figure 126. "Paste" Command

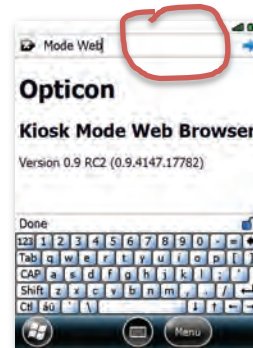

Figure 127. "Paste" Executed

The textbox context menu shown above will appear when a stylus or finger is held down on the textbox for a couple of seconds.

If, after a copy and paste operation has been completed, the user desires to continue employing page scrolling by finger, or by stylus sweeps, **Selection Mode** must be again disabled:



Figure 128. Disabling "Selection Mode"

If the software-based input panel becomes hidden unintentionally when it's needed for text input, it can be easily revealed by enabling the menu option **Menu > Edit > Input Panel**:



Figure 129. Revealing the Input Panel



Figure 130. Input Panel

12.9. Administrator

The administration view of the app is shown with the menu option **Menu > Settings > Administrator**:



Figure 131. Selecting Administrator View

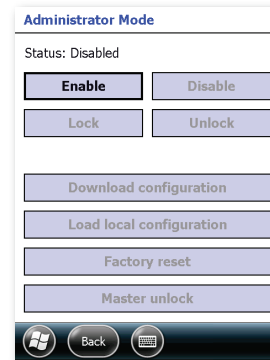

Figure 132. Administrator View

Administrator mode is disabled by default. Working within this mode is described in a document separately distributed to administrators.

13. Synchronization

This chapter instructs you on how to synchronize your H-22 phone with your Windows PC. Use ActiveSync, or Windows Mobile Device Center to:

- Synchronize Outlook e-mail, contacts, calendar, tasks, pictures, video, and music.
- Get up to date e-mail, contacts, calendar appointments, and tasks even when your PC is turned off.
- Copy files between your device and your PC without synchronizing.
- Control what type and how much information is synchronized.

13.1. System Requirements

Before downloading the synchronization software, make sure your PC meets the minimum operating requirements. Your synchronization settings will be managed through ActiveSync if you are using Windows XP, or an earlier operating system; but managed through Windows Mobile Device Center if you have Windows Vista, or Windows 7.

Supported Operating Systems for ActiveSync:

- Microsoft Windows 2000 Service Pack 4 (SP4)
- Windows Server 2003 SP1
- Windows Server 2003 Standard x64 Edition
- Windows XP (All versions)

Supported Operating Systems for Windows Mobile Device:

- Windows 7 (All versions, including the x64 versions)
- Windows Vista (All versions, including the x64 versions)
- Windows Server 2008 (All versions, including the x64 versions)

Other Requirements:

To sync your e-mail, contacts, and tasks, make sure you're running Microsoft Outlook 2002, 2003, or 2007.

13.2. ActiveSync, or Windows Mobile Device Center, Installation and set up

1. Log on to <http://www.microsoft.com/windowsmobile/en-us/help/getstarted/getstarted.mspx>
2. Download ActiveSync, or Windows Mobile Device Center.
3. Run the install wizard and follow the on-screen instructions.
4. Connect the H-22 to your PC using the provided USB cable. The Synchronization Setup Wizard will start automatically.
5. Follow the instructions on screen to complete the wizard. In the Sync Setup Wizard (ActiveSync) or the main screen (Windows Mobile Device Center), you can:
 - Create a synchronization relationship between your PC and the device.
 - Choose information types to synchronize.

13.3. Starting and Stopping Synchronization Manually

1. Turn on the device.
2. Connect the device to your PC using a USB cable.
3. Tap  > **ActiveSync**.
4. To start synchronizing, tap Sync.
5. To stop synchronizing, tap Stop.

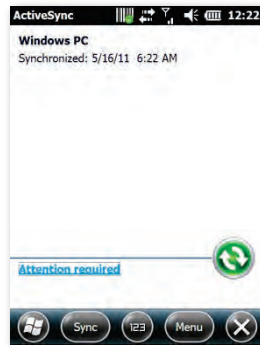



Figure 133. ActiveSync

13.4. Changing ActiveSync Settings

13.4.1. Changing which Information is Synchronized

1. Tap  > **ActiveSync**.
2. Tap **Menu** > **Options**.
3. Do one or more of the following:
 - Select the check box for the items you want to synchronize. If you cannot select a check box, you might have to clear the check box for the same information type elsewhere in the list.
 - Clear the check box for any items you want to exclude.
 - To customize synchronization of particular information, select the information type then click Settings.

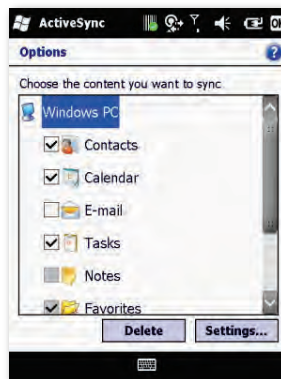

Figure 134. ActiveSync Options

13.5. Synchronization using Bluetooth

Before you synchronize using Bluetooth, make sure there is a valid Bluetooth partnership set up on your H-22. See “Pairing With Devices in Range”.

1. Tap  > **ActiveSync**.
2. Tap **Menu** > **Connect via Bluetooth**.

Note: Ensure that the device and PC are within close range, and paired as described in Chapter 12.

3. Tap **Sync**.
4. When finished, tap **Menu** > **Disconnect Bluetooth**.

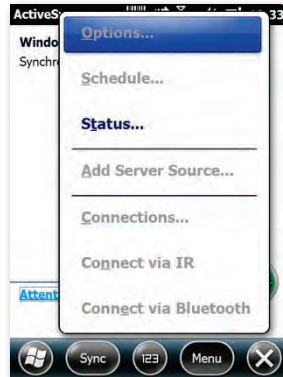

Figure 135. Connect via Bluetooth

14. Bluetooth™

This chapter instructs you how to set up a Bluetooth connection for sending information over a Wireless Personal Area Network.

14.1. Bluetooth Modes

There are three Bluetooth operational modes:

- On** Bluetooth is enabled and your device can send and receive information with other Bluetooth devices in range.
- Off** Bluetooth is disabled and can neither send nor receive information.
- Visible** Bluetooth is enabled and visible to all other Bluetooth devices in range.

14.2. Enabling Bluetooth

1. Tap  > **Settings** > **Bluetooth** > **Mode**.
2. Select the check box in front of **Turn on Bluetooth**. See below left.
3. Tap **OK** to save and exit.

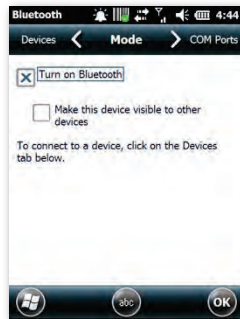

Figure 136. Turn on Bluetooth

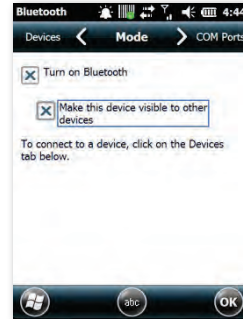



Figure 137. Device Discoverable

14.3. Making Your Device Discoverable

To allow other Bluetooth devices to detect your device and send you information, follow these steps:

1. Tap  > **Settings** > **Bluetooth** > **Mode**.
2. Select the check box in front of **Make this device visible to other devices**. See above right.
3. Tap **OK** to save and exit.

14.4. Pairing With Devices in Range

Pairing with another Bluetooth device allows you to exchange information in a secure manner. Make sure that the two devices are within a range of 10 meters and that Bluetooth is turned on and in visible mode.

1. Tap **Settings > Bluetooth > Devices**.
2. Tap **Add new device**. A list of Bluetooth enabled devices within range displays on screen.
3. Select the device to connect to and tap **Next**. See below left.
4. For a more secure connection, enter a passcode as shown below middle. The same passcode must be entered on the other device. If you do not want to use a passcode, tap **Next**. If the connection is successful, a **Device Added** confirmation message displays on screen. See below right.
5. Tap **Done**.

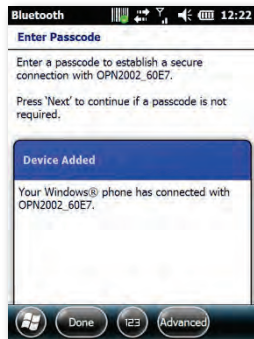

Figure 138. Bluetooth Devices

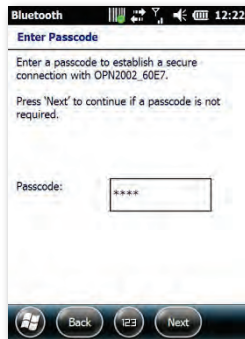

Figure 139. Enter Passcode

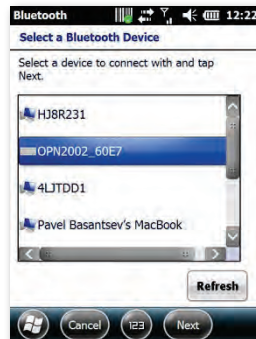

Figure 140. Device Added.

14.5. Beaming Information

To use Bluetooth to receive beams, ensure Bluetooth is turned on and that your device is visible and within close range.

14.5.1. To enable incoming beams:

1. Tap **Settings > Connections > Beam**.
2. Select the check box next to **Receive all incoming beams**. See below left.
3. Tap **OK** to save and exit.

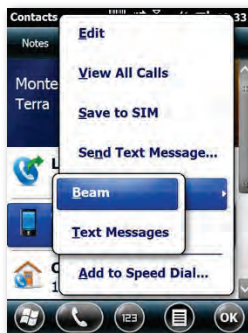

Figure 141. Receive Beams

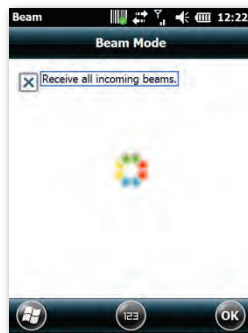

Figure 142. Beam Item

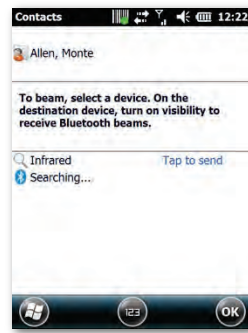

Figure 143. Visible Devices

14.5.2. To beam an item:

You can beam information from your H-22 such as an appointment in Calendar, a task in Tasks, a contact card in Contacts, a picture in Pictures, or a file in File Explorer.

1. From the program (Calendar, Tasks, Contacts etc), select the item you want to beam and Tap **Menu > Beam**.
2. Your device will now search for and display visible devices. See above middle.
3. From the list of devices, select the device to which you want to send the item. See Figure 143 above, right.
4. Tap **OK** to save and exit.

15. Barcode Scanner

The H-22 ships with either with a 1D laser barcode scanner or with a 2D imager module. In this chapter, you can learn how to enable the scanning function and configure the scanner.

15.1. Setting Up Barcode Reader

15.1.1. Enabling Barcode Reader

The barcode reader is disabled by default and must be activated before use.

1. Tap **☰** > **Settings** > **System** > **Scanner Setting** > **Basic Settings**. See below left.
2. Select the check box next to **Enable barcode reader**.
3. Select the check box next to **Enable trigger key** and select Top left, Side left, Top right or Side right.
4. Tap **OK** to save and exit.

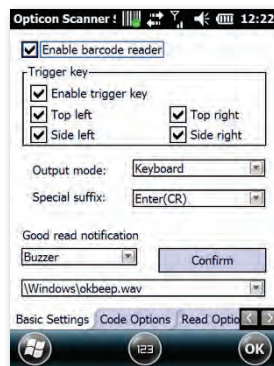

Figure 96. Barcode Settings

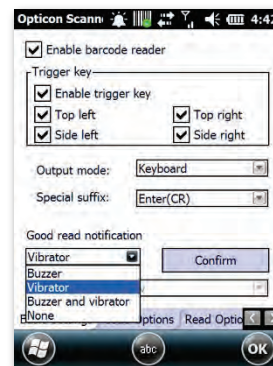

Figure 97. Read Notification

15.1.2. Setting to Multiple or Single Read Mode

Multiple read mode allows multiple barcodes to be read with just one triggering. Single read mode reads only one barcode during one triggering.

1. Tap **☰** > **Settings** > **System** > **Scanner Setting** > **Read Options**.
2. Select **Single** or **Multiple** from the drop down menu next to **Read mode**.
3. Tap **OK** to save and exit.

15.1.3. Setting Good Read Notification

When the barcode scanner successfully decodes a barcode, you can set the H-22 to notify you with a sound effect, vibration, both, or none.

1. Tap **☰** > **Settings** > **System** > **Scanner Setting** > **Basic Settings**.
2. Select the desired notification from the drop down menu under **Good read notification**.
3. Change the sound by selecting from the drop down menu under **Sound**. See above right.
4. Tap **OK** to save and exit.

15.1.4. Selecting Recognized Barcode Types

The H-22 is capable of scanning and decoding various barcode types. To select or deselect the barcode types to scan for, perform the following steps:

1. Tap  > **Settings** > **System** > **Scanner Setting** > **Code Options**.
2. Select the check box next to the barcode types you want the reader to recognize.
3. Deselect the check box next to the barcode types you don't want the reader to recognize.
4. Tap **OK** to save and exit.

15.2. Scanning and Reading Barcode Labels

The H-22 can scan and decode barcode labels, and it will normally output the data as keystrokes. (A special application might alter that behavior, though) Therefore, to see the output of the barcode scanner, open an application in which letters and numbers can be displayed.

Note: Barcode Reader must be enabled before you begin.

Open the application in which you want the decoded barcode to display after scanning. Point the barcode reader to a barcode label and press the scan key (left or right scan key, F1, or F2 depending on your trigger key setting).

Note: Adjust the distance between your device and the label, and make sure the light emitted from the scanner exceeds the width of the label.

16. Applications

16.1. Managing Memory

16.1.1. Checking Available Storage

Tap  > **Settings** > **System** > **Memory**.

- In the Main tab, you can see how much storage is available on the main memory of your device.
- In the Storage Card tab, you can see how much storage is available on your storage cards.

16.1.2. Closing a Running Program

- Tap  > Settings > System > Task Manager. A list of running programs displays.
- Select the program to close from the list. See Fig. 146.
- Tap End Task.

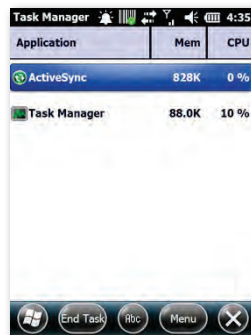

Figure146. Insert Program

16.2. Third Party Applications

16.2.1. Playing a Media File on Your Device

1. Tap  > **Windows Media**
2. Select a category (My Music, My Videos, My TV, My Playlists, Now Playing).
3. Select an item and tap **Play**. See below.



Figure 147. Windows Media

16.3. GPS

The H-22 has a built-in GPS signal receiver that can be used to get the current location of the H-22. To do anything useful with the location information, a navigating program is required, which is not part of the standard software of the H-22. This should be purchased separately.

16.3.1. GPS Settings

You may need to specify the GPS hardware port when installing the navigation software. The GPS receiver in the H-22 can output the location data on a configurable port. To configure the port, follow the steps below:

1. Tap **Windows** > **Settings** > **System** > **External GPS** > **Programs**.
2. Enter the port that will be used by the GPS receiver to send the data. See Figure 148.

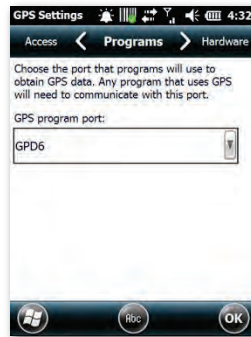

Figure 148. GPS Programs

16.3.2. Using AGPS

AGPS (Assisted Global Positioning System) enables you to acquire a location faster by downloading of a list containing current positions and orbits of GPS satellites.

To enable AGPS:

1. Tap **Windows** > **Settings** > **System** > **Express GPS Connect**.
2. Select "Download Now" to download AGPS data.
3. Tap **OK** to save and exit.



Figure 148a. Enable AGPS



Figure 148b. Preparing to Download

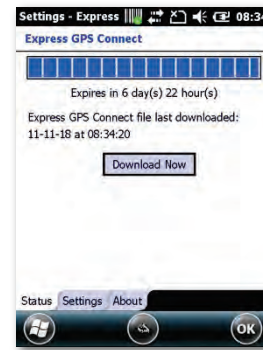

Figure 148c. Downloading Data

Improving the reception of Satellite Signals

It can take several minutes the first time you establish a GPS connection. If the device cannot detect the satellite signal, make sure the device has a sufficiently clear view of the sky

17. Battery Hot Swap

The H22 has a hot swap feature implemented, which makes it possible to change the main battery without turning off the device or losing data. When the battery cover is removed from H22 a warning message not to remove the battery will pop up until the display goes dark. The device will then automatically set the device to flight mode and disable all functionality what is absolutely necessary to maintain the device at what was its current state when the battery cover was removed. The user may remove the battery to replace it with another battery as soon as the display has gone dark.

During main battery replacement, an on board Li-ion cell dedicated to the hot-swap operation supplies system power. Pre-swap status without data loss can be sustained prior to inserting a new main battery for up to 3 minutes. When a new battery is inserted and the battery lid is closed, the device can be awakened by pressing the power key. The device will awaken in the same state as when the battery lid was removed.

H22 continually monitors the charge status of the Li-ion backup battery, and ports it through the battery control panel applet. The charging status of the li-ion battery is expressed as either "Good" or "Not Good". In case the backup battery status is indicated as "Not Good," a hot swap must not be performed, since it might result in loss of user data. The Li-ion backup battery is automatically charged from the main battery as soon as the main battery is inserted in the H22.

To check backup battery status:

1. Tap  > **Settings** > **System** > **Power**.
2. Select the Battery tab.
3. If the backup battery status is "Good" a hot swap is possible

Note: Any ongoing activity such as data transfer or voice transmission will be broken during hot swap. Data transfers and similar activities have to be restarted after a hot swap.

Note: Before performing a hot swap, check that the backup battery status is "Good" in the battery tab of the Power menu.

18. Flashdisk and Custom ROM

In addition to the traditional memory areas for customer storage in a Windows Mobile device, H22 has two additional non-volatile memory areas, the Flashdisk, and the Custom ROM areas.

18.1. Flashdisk

The FlashDisk area is a virtual drive dedicated for user data that is not wiped when doing a clean boot. This is useful for storing customer data. The FlashDisk is accessed from the File manager in H22.

18.2. Custom ROM

Custom ROM is a hidden partition where customer specific programs and applications are stored. The reason why this partition must be hidden is to prevent end users from removing or damaging the contents of this partition. The correct environment will be restored and set up from this partition after a boot operation (clean, cold, or warm), to ensure that the customer environment is set up appropriately. If there is an Autoexec.exe in the Custom ROM partition, this is automatically executed during the boot process to correctly configure the device. The Custom ROM area is accessible to the user through a Custom ROM tool provided by Opticon to Device Administrators.

19. How to update the H22 image

19.1. From SD card

To update the H22 image from a micro SD card, the card has to be prepared with the appropriate files. These files are accessible from Opticon support upon request. The files are placed in the root of a micro SD card (approved brand and density). Step by step instructions:

1. Format a micro SD card in a PC with FAT or FAT32 file system in a PC. (This is optional).
2. Copy the provided files to the micro SD card
3. Insert the micro SD card in the H22
4. Make sure that the H22 has at least 50% main battery capacity left
5. Turn on the H22 while holding both Scan keys, and the Volume Down key, simultaneously
6. Wait for the update process to finish, when this is done the H22 will reboot automatically

19.2. Via Remote Update Utility

H22 can also be updated via a desktop utility. Install Microsoft ActiveSync, available for download from Microsoft. Install the Opticon H22 USB driver available for download at the Opticon website.

1. Make sure you have received the correct update package from an Opticon authorized source
2. Make sure the H22 has at least 50% battery capacity remaining
3. Connect the H22 to the PC with a USB cable, and allow the H22 USB drivers to install, if necessary
4. Verify that the H22 is connected in active sync
5. Run the H22 update package, H22_RUU*.exe, and follow the onscreen instructions
6. Do not disconnect the USB cable until the Update is completed

20. Clean boot and Factory Reset

20.1. Clean boot

A clean boot is when the system is started from the beginning, and all drivers and settings are loaded to their initial state. All custom settings are erased. However, the Custom ROM and FlashDisk partitions are left untouched. A clean boot is performed by pressing the side scan buttons when the device is turned on, or reset, or from an option in engineering mode.

20.2. Factory reset

Factory reset is when all customer settings and data are wiped from the internal memory, including CustomROM and FlashDisk partitions, and the system is reinitialized as if it was the first boot. This can be used to solve problems when the device is not functioning as expected, or if the device should be used in another environment, to ensure no residual setting will cause incompatibility.

To perform a factory reset:

1. Tap  > **Settings** > **System** > **Factory Reset**.
2. Enter the device's password. (The default password is 1234).
3. Tap **OK**.

21. Downloadable tools (not in image)

21.1. Custom ROM Tool

The Custom ROM Tool provides for copying files to the hidden Custom ROM partition, viewing the content of the Custom ROM partition, and providing a way to format the Custom ROM partition. The Custom ROM Tool is not a part of the built in applications. Instead it is available for customers on request.

21.2. Autorun.exe

The Autorun.exe implemented by Opticon will present a way for the customer to install CAB-files, run provisioning XML, and run executables aimed at configuration in a structured way. It is also possible for customers to develop their own version of the Autoexec.exe. The Autorun.exe is placed in the Custom ROM area and will then perform the tasks described above at device start up. It is also possible to develop a custom Autoexec.exe and place in the Custom ROM area to perform company specific tasks at startup.

22. Appendix

Specifications

Item	Description
ID Shape	Bar Type
Dimension/Weight	151 x 75 x 25 mm/5.9 x 3.0 x 0.98 in
OS	Windows Mobile® 6.5.3 Professional
Network Band	GSM/EDGE/GPRS: 850, 900, 1800, 1900 MHz; WCDMA/HSPA: 800, 850, 900, 1900, 2100 MHz
CPU chipset	Marvell PXA320 @ 806 MHz
Memory	DDR SDRAM 256 MB; NAND Flash 512 MB
Display	3.7" VGA, transfective TFT color display
Input	QWERTY keyboard or numeric keyboard
Camera	3.2 megapixel with autofocus; LED flash
Wi-Fi WLAN	802.11b/g/n* (*802.11n A-MSDU/A-MPDU not supported)
GPS/AGPS	Yes – AGPS is contingent on carrier service
Bluetooth	Bluetooth 2.0+ and Enhanced Data Rate (EDR)
USB	USB 2.0 Full speed, On-the-go (OTG) client and host functionality
Scanner	Integrated 1D laser or 2D imager
RFID	RFID HF 13.56MHz available as optional model
Battery	Lithium-ion, 3060 mAh
Expansion Slot	High capacity microSD (SDHC)
Bluetooth® profile	SPP, OPP, PAN, DUN, OBEX, HSP, HFP, AVRCP, A2DP, HID
Accelerometer	Built-in accelerometer
Environmental	IP 65 Drop Test @ 1.5M on concrete