





ISO 9001 CERTIFIED

**607 NW 27th Ave
Ocala, FL 34475
Phone: (352) 629-5020 or 800-533-3569
Fax: (352)-629-2902**

OPERATION MANUAL



ES-Key
16 Output module (selectable polarity)
P/N 610-00031

  607 NW 27th Ave Ocala, FL 34475 Phone : (352) 629-5020 Fax : (352)-629-2902	FOR EXTERNAL DISTRIBUTION			PAGE	1 of 10	
	OPERATION MANUAL			DATE	8/15/2017	
	PRODUCT GROUP	ES-Key	P/N	FSG-MNL-00109	REV	1.02
	PRODUCT	16 output module			BY	GMC

1.	REVISION LOG	1
2.	MODULE OVERVIEW	2
2.1.	SCOPE	2
2.2.	PART NUMBERS.....	2
2.3.	SETUP.....	2
3.	ES-KEY OPERATION.....	3
3.1.	SELECTABLE POLARITY OUTPUTS	3
3.1.1.	<i>Output polarity selection.....</i>	3
3.2.	MODULE TYPE AND ADDRESS.....	4
3.2.1.	<i>Address selection</i>	4
3.3.	OUTPUT MEMORY SPACE	5
4.	CONNECTOR DESCRIPTION.....	6
4.1.	CONNECTOR A (GRAY)	6
4.2.	CONNECTOR B (BLACK)	6
4.2.1.	<i>Terminating resistor requirement (CAN communication).....</i>	7
4.3.	SYSTEM COMPATIBILITY	7
5.	MOUNTING.....	8
6.	DIAGNOSTICS	9
7.	GLOSSARY	10
8.	TECHNICAL DETAILS	10
8.1.	WEEE (WASTE OF ELECTRICAL AND ELECTRONIC EQUIPMENT) DIRECTIVE.....	10

1. Revision Log

Rev	Date	Approved	Changes
1.00	9-05-2014	GMC	Initial requirements
1.01	9-21-2015	MH	Corrected module description in section 6
1.02	8-15-2017	AMS	Corrected part number description text

  607 NW 27th Ave Ocala, FL 34475 Phone : (352) 629-5020 Fax : (352)-629-2902	FOR EXTERNAL DISTRIBUTION			PAGE	3 of 10	
	OPERATION MANUAL			DATE	8/15/2017	
	PRODUCT GROUP	ES-Key	P/N	FSG-MNL-00109	REV	1.02
	PRODUCT	16 output module			BY	GMC

3. Es-Key Operation

3.1. Selectable polarity outputs

The module has 16 outputs that can be configured for either positive or ground output polarity (see section 3.1.1). These outputs are activated through associations within the ES-Key database and are designed to drive inductive, capacitive, or resistive loads (relays, solenoids, indicators, etc). These outputs are overload and short circuit protected. The maximum load tied to each output should be limited to 0.25 Amps (loads more than this may cause the output to shutdown due to thermal overload). The outputs will report an over current condition to the Es-key network and if any of the outputs are in an over current situation the COM LED on the module will be flashing at a fast rate to give the user an indication that one of the outputs is in over current condition. When an output goes into an over current situation the affected output will shut down and attempt to turn back on three times. If on the third try and the over current situation is still present the output will shut down until the output is physically shut off to reset it.

3.1.1. Output polarity selection

The polarity of each output is selected by setting the output polarity selection switches (located inside of the case) to the desired positions. The switches are labeled OUT 0 through OUT 15 and are directly related to the physical outputs. Each output can be placed in the POS (positive) or NEG (ground) position. When the switch is down it is in the positive position. When the switch is up it is in the negative position.

(Note: Selection switches are only read at power up).

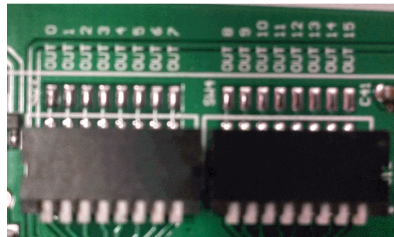



Figure 2. *Output polarity selection switches.*

  607 NW 27th Ave Ocala, FL 34475 Phone : (352) 629-5020 Fax : (352)-629-2902	FOR EXTERNAL DISTRIBUTION OPERATION MANUAL			PAGE	4 of 10
	PRODUCT GROUP	ES-Key	P/N	FSG-MNL-00109	DATE
PRODUCT	16 output module			REV	1.02
				BY	GMC

3.2. Module type and address

The 16 output Module is recognized by the ES-Key Professional software as a *switch output* module (device type 3). The module address is selected by the address switch (see section 3.2.1).

3.2.1. Address selection



The address is selected by rotating the address switch to the desired value (0-15). Use an address selection tool (or a #1 Philips screwdriver) to set the position of the switch to the desired address.



Figure 3. Address switch





Figure 4 Address selection tool.

  607 NW 27th Ave Ocala, FL 34475 Phone : (352) 629-5020 Fax : (352)-629-2902	FOR EXTERNAL DISTRIBUTION			PAGE	5 of 10	
	OPERATION MANUAL			DATE	8/15/2017	
	PRODUCT GROUP	ES-Key	P/N	FSG-MNL-00109	REV	1.02
	PRODUCT	16 output module			BY	GMC

3.3. Output memory space

The 16 Output Module uses standard ES-Key defined output memory space. The polarity selectable outputs are mapped into the output space.

OUTPUT MEMORY SPACE	
Output	DESCRIPTION
0	Physical Output 0
1	Physical Output 1
2	Physical Output 2
3	Physical Output 3
4	Physical Output 4
5	Physical Output 5
6	Physical Output 6
7	Physical Output 7
8	Physical Output 8
9	Physical Output 9
10	Physical Output 10
11	Physical Output 11
12	Physical Output 12
13	Physical Output 13
14	Physical Output 14
15	Physical Output 15

  607 NW 27th Ave Ocala, FL 34475 Phone : (352) 629-5020 Fax : (352)-629-2902	FOR EXTERNAL DISTRIBUTION			PAGE	6 of 10	
	OPERATION MANUAL			DATE	8/15/2017	
	PRODUCT GROUP	ES-Key	P/N	FSG-MNL-00109	REV	1.02
	PRODUCT	16 output module			BY	GMC

4. Connector Description

The module has two connectors and the following definitions apply:

4.1. Connector A (gray)

Mating connector: Deutsch DTM06-12SA (GRAY)		
Mating sockets: 0462-201-20141		
Wedge lock: WM12S Recommended wire gage: 18-24 AWG		
PIN	CIRCUIT	DESCRIPTION
1	Supply +	Module supply (+9VDC...+32VDC) [fused 750mA]
2	CAN High	ES-Key CAN, SAE J1939 Proprietary, 250 kbits/S
3	CAN Shield	ES-Key CAN, SAE J1939 Proprietary, 250 kbits/S
4		
5	Output 12	Digital Output (polarity selectable – positive or ground)
6	Output 14	Digital Output (polarity selectable – positive or ground)
7	Output 15	Digital Output (polarity selectable – positive or ground)
8	Output 13	Digital Output (polarity selectable – positive or ground)
9		
10		
11	CAN Low	ES-Key CAN, SAE J1939 Proprietary, 250 kbits/S
12	Supply -	Module supply (vehicle ground)

4.2. Connector B (black)

Mating connector: Deutsch DTM06-12SB (BLACK)		
Mating sockets: 0462-201-20141		
Wedge lock: WM12S Recommended wire gage: 18-24 AWG		
PIN	CIRCUIT	DESCRIPTION
1	Output 11	Digital Output (polarity selectable – positive or ground)
2	Output 9	Digital Output (polarity selectable – positive or ground)
3	Output 7	Digital Output (polarity selectable – positive or ground)
4	Output 5	Digital Output (polarity selectable – positive or ground)
5	Output 3	Digital Output (polarity selectable – positive or ground)
6	Output 1	Digital Output (polarity selectable – positive or ground)
7	Output 0	Digital Output (polarity selectable – positive or ground)
8	Output 2	Digital Output (polarity selectable – positive or ground)
9	Output 4	Digital Output (polarity selectable – positive or ground)
10	Output 6	Digital Output (polarity selectable – positive or ground)
11	Output 8	Digital Output (polarity selectable – positive or ground)
12	Output 10	Digital Output (polarity selectable – positive or ground)

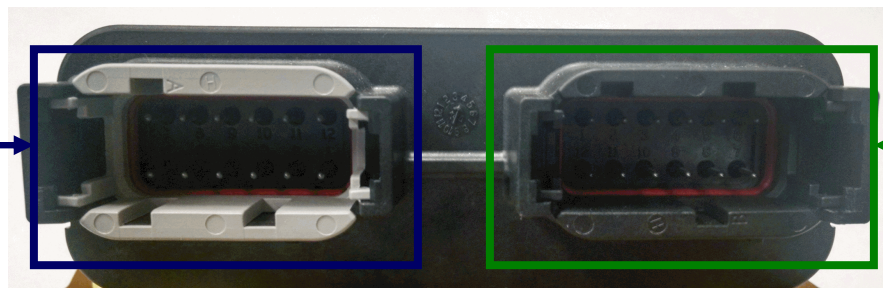



Figure 5. Connector identification.

  607 NW 27th Ave Ocala, FL 34475 Phone : (352) 629-5020 Fax : (352)-629-2902	FOR EXTERNAL DISTRIBUTION			PAGE	7 of 10	
	OPERATION MANUAL			DATE	8/15/2017	
	PRODUCT GROUP	ES-Key	P/N	FSG-MNL-00109	REV	1.02
	PRODUCT	16 output module			BY	GMC

4.2.1. Terminating resistor requirement (CAN communication)

Two terminating resistors (120 Ohm) are required on the CAN bus for proper operation (one at each end of the CAN bus). Only two terminating resistors are allowed on a CAN bus.

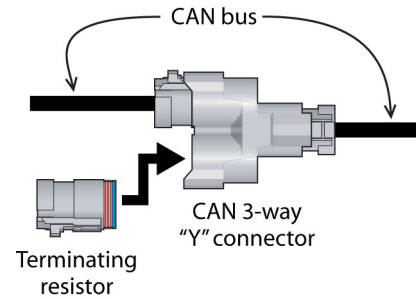

Terminating resistor p/n DT06-3S-P006

CAN 3-way "Y" connector p/n DT04-3P-P007



4.3. System compatibility

The 16 Output Module is compatible with other Class 1 CAN devices.

  607 NW 27th Ave Ocala, FL 34475 Phone : (352) 629-5020 Fax : (352)-629-2902	FOR EXTERNAL DISTRIBUTION OPERATION MANUAL			PAGE 8 of 10
	PRODUCT GROUP ES-Key	P/N FSG-MNL-00109	DATE 8/15/2017	
PRODUCT 16 output module	REV 1.02	BY GMC		

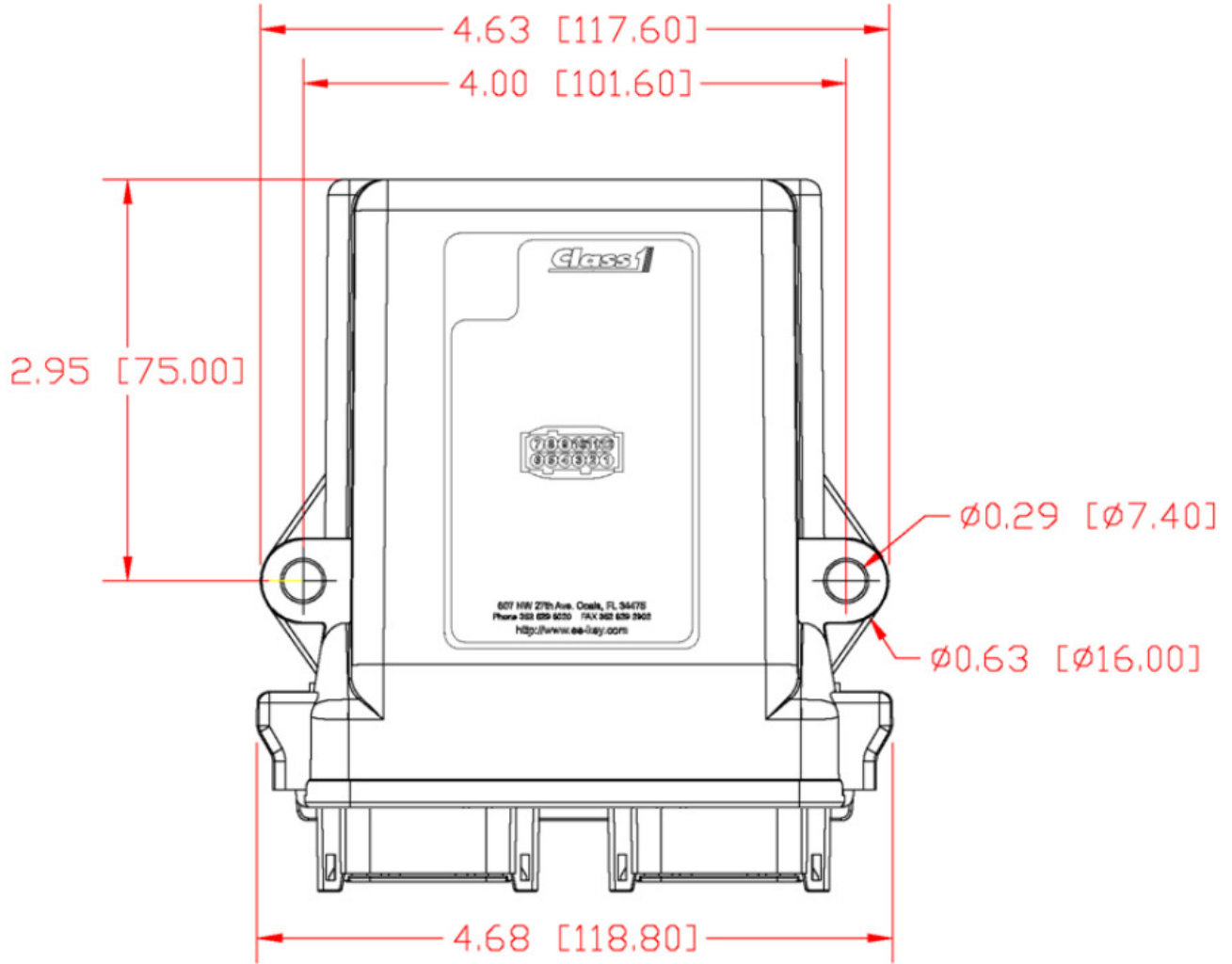

5. Mounting

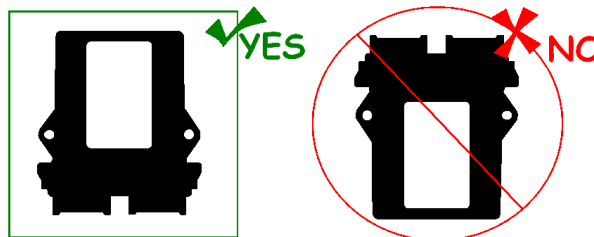

Mounting and package dimensions – inches [millimeters].

NOTE: When mounting the module vertically, make certain the connectors are pointed down so as to eliminate the possibility of standing water in the connector.



  607 NW 27th Ave Ocala, FL 34475 Phone : (352) 629-5020 Fax : (352)-629-2902	FOR EXTERNAL DISTRIBUTION			PAGE	9 of 10
	OPERATION MANUAL			DATE	8/15/2017
PRODUCT GROUP	ES-Key	P/N	FSG-MNL-00109	REV	1.02
PRODUCT	16 output module			BY	GMC

6. Diagnostics

The **16 output module** has 3 diagnostic LEDs which are viewable through the top of its amber enclosure.

PWR - +5VDC logic power
BUS - +9...+32VDC Module power
COM - Module status indicator

The COM LED indicates the module's CAN communication status.

On Solid
 Module on-line



Flashing slow (2Hz)
 CAN bus okay, but the module is not receiving messages from the Universal System Manager (USM).

Flashing fast (8Hz)
 CAN bus error, no communications or not connected.

Flashing fast (20Hz)
 Output Over Current Indication

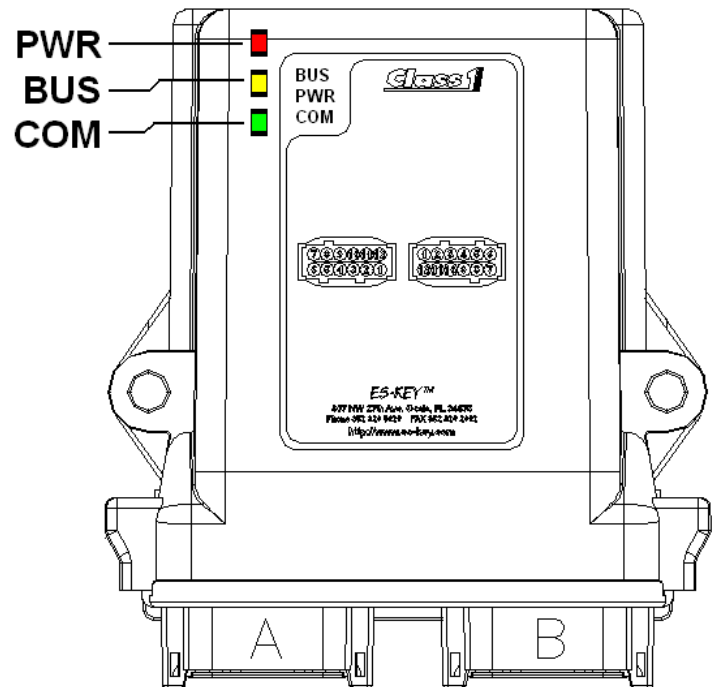
Double flash
 CAN bus has an *ACTIVE* error, no communications.



  607 NW 27th Ave Ocala, FL 34475 Phone : (352) 629-5020 Fax : (352)-629-2902	FOR EXTERNAL DISTRIBUTION			PAGE	10 of 10	
	OPERATION MANUAL				DATE	8/15/2017
	PRODUCT GROUP	ES-Key	P/N	FSG-MNL-00109	REV	1.02
	PRODUCT	16 output module			BY	GMC

7. Glossary

LED	<u>L</u> ight <u>E</u> mitting <u>D</u> iode. The lights on the display used to show tank level and information.
CAN	<u>C</u> ontroller <u>A</u> rea <u>N</u> etwork. SAE J1939 communication method.
EEPROM	<u>E</u> lectrically <u>E</u> rasable <u>P</u> rogrammable <u>R</u> ead- <u>O</u> nly <u>M</u> emory. The memory of the tank level display, used to store the display information (tank level points, display type, dim value, etc).
OEM	<u>O</u> riginal <u>E</u> quipment <u>M</u> anufacturer.
SAE	<u>S</u> ociety of <u>A</u> utomotive <u>E</u> ngineers.
ESD	<u>E</u> lectro <u>S</u> tatic <u>D</u> ischarge.
IP	<u>I</u> ngress <u>P</u> rotection (IP 67, etc).
p/n	<u>p</u> art <u>n</u> umber

8. Technical details

Product category	ES-KEY
Voltage range	+9VDC...+32VDC
Power consumption	Logic supply+ input (pin 1)
@13.8VDC	62mA ⁽¹⁾
@27.6VDC	83mA ⁽¹⁾
Output current capability	25mA per output
Operational temperature range	-40°C...+85°C
Environmental range	IP 67
CAN specification	SAE J1939 proprietary, 250 Kbits/second
Protection	Internal thermal fuse (750mA on pin 1)
	Reverse voltage protection (pins 1 and 12)
	CAN buses protected to 24V
	ESD voltage protected to SAE J1113 specification for heavy duty trucks (24V)
	Transient voltage protected to SAE J1113 specification for heavy duty trucks (24V)
Dimensions (W x L x H) in inches [mm]	Load dump voltage protected to SAE J1113 specification for heavy duty trucks (24V)
	Outputs protected for short circuit and thermal overload
Dimensions (W x L x H) in inches [mm]	4.680 [118.80] x 5.240 [133.10] x 1.420 [36.07]

⁽¹⁾ Does not include current draw due to connected external loads on outputs 0, 1, and 2.

8.1. WEEE (Waste of Electrical and Electronic Equipment) directive



This symbol [crossed-out wheeled bin WEEE Annex IV] indicates separate collection of waste electrical and electronic equipment in the European Union countries.

Please do not throw the equipment into the domestic refuse.

Each individual European Union member state has implemented the WEEE regulations into national law in slightly different ways. Please follow your national law when you want to dispose of any electrical or electronic products.

More details can be obtained from your national WEEE recycling agency.