

**metrix**

# Portable colour graphic multimeters

## **ASYC IV**

**1 00,000 cts**

**MTX 3292**

**MTX 3293B**

User's manual



**metrix**

Pôle Test et Mesure CHAUVIN ARNOUX

# Contents

<b>General directions</b> .....	<b>3</b>
Introduction, precautions and safety measures .....	3
Symbols on the instrument .....	4
Warranty, Maintenance, metrological verification, repair under warranty .....	5
Maintenance.....	6
Rechargeable and primary batteries .....	6
Clock .....	6
Replacing the fuse.....	7
Communication interface.....	7
<b>Description of the instruments</b> .....	<b>8</b>
MTX 3292/MTX 3293B frontal panel, back, terminal block .....	8
Display unit.....	9
Switch.....	12
Keypad.....	13
<b>Getting started</b> .....	<b>14</b>
Preparation for use.....	14
<b>FUNCTIONAL DESCRIPTION</b> .....	<b>15</b>
<b>1. Description of the "SETUP" menu</b> .....	<b>15</b>
<b>2. Description of the "Keypad" keys</b> .....	<b>21</b>
1. "HOLD" key.....	21
2. "MEAS" key.....	22
3. "MEM" key.....	25
4. "RANGE" key .....	28
<b>How are the various quantities measured?</b> .....	<b>29</b>
1. Voltage measurement .....	29
2. Direct measurement of a current .....	31
3. Current measurement with clamp.....	32
4. Frequency measurement.....	33
5. Resistance measurement.....	35
6. Audible continuity measurement .....	36
7. Diode test .....	37
8. Capacitance measurement.....	38
9. Temperature measurement.....	39
10. Measurement on an MLI type speed variator .....	41
11. Surveillance mode .....	42
12. Graphic mode.....	43
13. RELative mode.....	43
14. SPEC mode.....	43
15. MEAS+ mode .....	43
16. MATH mode .....	43
<b>SX-DMM software</b> .....	<b>44</b>
<b>Module Bluetooth</b> .....	<b>45</b>
<b>Technical characteristics of MTX 3292, MTX 3293B</b> .....	<b>47</b>
<b>General characteristics</b> .....	<b>60</b>
Environmental conditions .....	60
Power supply.....	60
Safety, CEM .....	60
<b>Mechanical characteristics</b> .....	<b>60</b>
Housing .....	60
<b>Supply</b> .....	<b>61</b>
<b>APPENDIX</b> .....	<b>62</b>

## General directions

### Introduction



**Congratulations!** You have just become the owner of a **portable colour graphic multimeter**.

We thank you for this sign of confidence in the quality of our products.

The line of instruments to which it belongs comprises the following models:

	<b>MTX 3292</b>	<b>MTX 3293B</b>
<a href="#">Display</a>	Graphic, colour (70x52)	
<a href="#">Power supply</a>	4 R6 primary batteries or 4 storage batteries (provided)	
Counts	100,000	
Communication	IR/USB (Bluetooth, optional)	

It complies with safety standard NF EN 61010-1 + NF EN 61010-2-030 concerning electronic measuring instruments.

For best results, read this manual closely and observe the precautions of use.

Failure to observe these warnings and/or directions may damage the instrument and/or its components and may endanger the user.

### Precautions and safety measures



- This instrument is been designed to be used as follows:

- indoors
- in an environment of pollution degree 2
- at an altitude of less than 2000m
- at a temperature between 0°C and 40°C
- at a relative humidity below 80% up to 35°C.

The safety of any system incorporating the instrument is the responsibility of the system integrator.

- It can be used for measurements on 1000V circuits in CAT III and 600V circuits in CAT IV.

However, some accessories may lead to the use of this instrument on circuits of a lower voltage and category.

#### *before use*

- Comply with the environmental and storage conditions.
- Check the integrity of the guards and insulation of the accessories. Any item of which the insulation is deteriorated (even partially) must be removed from service and scrapped. A change of colour of the insulation is a sign of deterioration.
- Supply: primary battery or Ni-MH battery and specific charger supplied with the instrument. It must be connected to line power : (230V  $\pm$ 10%, 300V - CAT II), (US version: 110V  $\pm$ 10%).

#### *during use*

- Read closely all notes preceded by the  symbol.
- As a safety measure, use only the appropriate leads and accessories supplied with the instrument or approved by the manufacturer.

## General directions (continued)

### Definitions of the measurement categories



**CAT II:** Test and measurement circuits directly connected to the points of use of the low-voltage network (power outlets and other similar points).

*E.g.: Measurements on the network circuits of household appliances, portable tools, and similar devices.*

**CAT III:** Test and measurement circuits connected to parts of the low-voltage network of the building.

*E.g.: Measurements on distribution panels (including secondary meters), circuit-breakers, wiring including cables, bus bars, branch boxes, disconnecting switches, power outlets in the fixed installation, and industrial appliances and other equipment, such as motors permanently connected to the fixed installation.*

**CAT IV:** Test and measurement circuits connected to the source of the low-voltage network of the building.

*E.g.: Measurements on devices installed before the main fuse or the circuit-breaker of the building installation.*

**Warning!** *Using a measuring instrument, a lead, or an accessory belonging to a lower measurement or voltage category derates the resulting system (instrument + leads + accessories) to the lowest measurement category and/or service voltage of any of the components.*

### Symbols on the instrument or LCD



Risk of electric shock: directions for connection and disconnection of the inputs. Always connect the probes or adapters to the instrument before connecting them to the measurement points. Always disconnect the probes or cords from the measurement points before disconnecting them from the instrument. These directions apply before the instrument is cleaned.



Warning: Hazard. The operator must refer to the manual each time this danger symbol is encountered.



Device entirely protected by double insulation or reinforced insulation.



Earth



In the European Union, this product is subject to selective collection for the recycling of electrical and electronic equipment waste in accordance with Directive WEEE 2002/96/EC: this equipment must not be treated as ordinary waste. The spent batteries must not be treated as ordinary waste. Take them in to the appropriate collection point for recycling.



The CE marking indicates conformity with the European "Low Voltage", "EMC", "WEEE" and "RoHS" directives.



USB



IP67

## General directions (continued)

---

### Warranty



This equipment is warranted for 3 years against any defect of materials or workmanship, in accordance with the general terms of sale. During the warranty period, the instrument may be repaired only by the manufacturer, who reserves the right to repair the instrument or to replace it or part of it. If the equipment is returned to the manufacturer, the cost of transport to the manufacturer is borne by the customer.

The **warranty** does not apply following:

- improper use of the equipment or use in association with incompatible equipment
- modification of the equipment without the explicit permission of the manufacturer's technical staff
- maintenance done by a person not approved by the manufacturer
- adaptation to a particular application not anticipated in the definition of the equipment or by the user manual
- a shock, a fall, or flooding.

---

### Maintenance, metrological verification

Before opening the instrument, you must disconnect it from line power and from the measurement circuits and make sure that you are not charged with static electricity, which might destroy internal components. An adjustment, maintenance, or repair of the live instrument must be undertaken only by personnel who are qualified and have familiarized themselves with the directions in this manual.

We recommend a verification of this instrument at least once a year. For checking and calibration, contact one of our accredited metrology laboratories (information and contact details available on request), at our Chauvin Arnoux subsidiary or the branch in your country.

---

### Unpacking, repacking



All of the equipment has undergone mechanical and electrical checks before being dispatched. When you receive it, carry out a quick check to detect any deterioration that may have occurred during transport. Should the need arise, immediately contact our sales department and notify the carrier of the customary reservations.

Use the original packaging to reship the equipment, if possible. Indicate as clearly as possible, by a note attached to the equipment, the reasons for the transfer.

---

### Repair under warranty and post warranty

For all repairs before or after expiry of warranty, please return the device to your distributor.

## General directions (continued)

### Maintenance



- Disconnect everything connected to the instrument and press the  key to switch it off.
- Use a soft cloth, moistened with soapy water.
- Rinse with a damp cloth and dry rapidly with a dry cloth or forced air.
- Make sure that no foreign objects interfere with the operation of the device by which the leads are snapped into place.

### Power supply

#### Charging the storage batteries



You can charge the storage batteries without removing them. Use the external charger supplied with the multimeter. During the charging, the multimeter remains operational.

 **However, some of its metrological characteristics may be altered.**

#### Instrument off

During the charging cycle, each function LED lights by turns to indicate that charging is in progress.

On the screen, the user sees the charge level of the storage batteries.

Charging stops automatically when they are fully charged (approximately 6h for 2400mAh).

For more details, refer to the "[Before recharging the storage batteries](#)" section in the Appendix.

#### Replacement (primary or storage batteries)

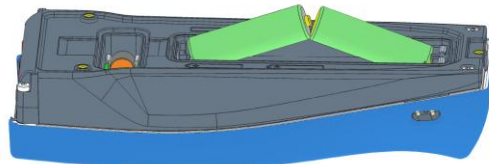

**Clock** During this replacement, the internal clock is preserved for approximately 45s.

#### Fuse

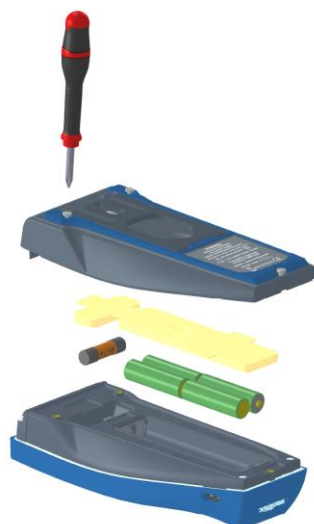

- Before replacing the fuse (reached by opening the bottom compartment), disconnect the instrument from any source of current. During the replacement, make sure that only a fuse of the appropriate rating and specified type is used. Using another type of fuse and shorting the fuse holder are strictly forbidden.

- Fuse: for example, SIBA/5019906  
11A: 10x38 -1,000V -F  
Breaking capacity: >18kA

## General directions (continued)

### Communication interfaces



The multimeter can communicate with a PC, making it possible:

- to update the embedded software → Connect the multimeter to the PC via the USB link and run the application downloaded from CHAUVIN ARNOUX's web site.
- to calibrate the multimeter using the optional SX-MTX 329X calibration software (HX0059B).
- to program using Labview and Labwindows
- to recover the data or program the device using the SX-DMM software

Your multimeter includes:

- an isolated optical USB link (type HX0056Z)
- SX-DMM processing software
- Labview and Labwindows drivers to program the devices.



***It is also possible to program using the SCPI or MODBUS protocol.***

### in Bluetooth



The [Bluetooth](#) communication interface is optional.

### in IR/USB



## Description of the instruments

### Front panel and Back



**Bluetooth version**



**Stand**



**Terminal block**



## Description of the instruments (continued)

### Display unit

*Display*

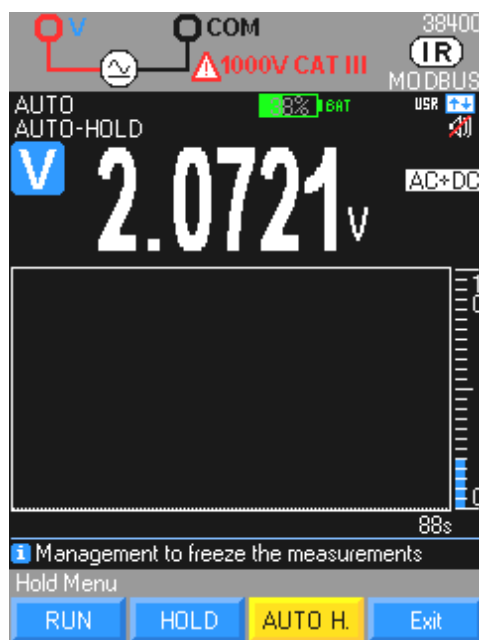

Display of the wiring diagram of the terminal block as a function of the measurement

Digital display:

- of the quantity measured,
- of the value measured,
- of the type of measurement, etc.

Secondary display:

- in graphic form
- or in the form of 3 display units

Scrolling information

Properties of the F1, F2, F3, and F4 keys

## Description of the instruments (continued)

### Principal quantities measured

- $V_{LowZ}$  AC voltage measurement at low impedance ( $V_{LowZ}$ )
- $V_{AC}$  AC voltage measurement
- $V_{AC/DC}$  DC or AC+DC voltage measurement at high impedance (V)
- A Current measurement A (AC, DC, AC+DC)
- Hz Frequency measurement
- $\Omega$  Resistance measurement
- C Capacitance measurement
- $T^{\circ}$  Temperature measurement
- % Measurement of relative value or duty cycle

### Secondary quantities

See the specific "[Table of secondary measurements](#)" chapter on screen in the SPEC, REL, MEM, SURV, and MEAS+ modes.

### REL menu









The main display unit and the horizontal bargraph track the evolution of the measurement at all times.

### Units

- V Volt
- A Ampere
- Hz Hertz
- $\Omega$  Ohm
- F Farad
- $^{\circ}F$  Degree Fahrenheit
- $^{\circ}C$  Degree Celsius
- K Kelvin
- ms millisecond
- k kilo (k $\Omega$  - kHz)
- M Mega (M $\Omega$  - MHz)
- n nano (nF)
- p pico (pF)
- $\mu$  micro ( $\mu V$  -  $\mu A$  -  $\mu F$ )
- m milli (mV - mA - mF)
- % Percentage

## Description of the instruments (continued)

<b>Symbols</b>	<b>Designation</b>
<b>AC</b>	Measurement of the RMS AC signal
<b>DC</b>	Measurement of the DC signal
<b>AC + DC</b>	Measurement of the TRMS AC and DC signal
<b>AUTO</b>	Automatic range switching
$\Delta$	Values relative to a reference
<b>REF</b>	Presence of a reference value in memory
<b>HOLD</b>	Storage and display of stored values
<b>MAX</b>	Maximum value
<b>AVG</b>	Mean value
<b>MIN</b>	Minimum value
<b>PK+</b>	Maximum peak value
<b>PK-</b>	Minimum peak value
<b>.run r.un ru.n</b>	Capacitance meter, acquisition in progress
----	Frequency measurement impossible
<b>O.L</b>	Overshoot of the measurement capacities
<b>V</b>	Volt
<b>Hz</b>	Hertz
<b>F</b>	Farad
<b>°C°F K</b>	Degree Celsius, degree Fahrenheit, kelvin
<b>A</b>	Ampere
<b>%</b>	Percentage
<b><math>\Omega</math></b>	Ohm
<b>ms</b>	millisecond
<b>n</b>	Symbol of the prefix nano-
<b>p</b>	Symbol of the prefix pico-
<b><math>\mu</math></b>	Symbol of the prefix micro-
<b>m</b>	Symbol of the prefix milli-
<b>k</b>	Symbol of the prefix kilo-
<b>M</b>	Symbol of the prefix méga-
	Symbol of the audible continuity measurement
	Symbol of the measurement and testing of a semiconductor junction
	Symbol of the Zener diode
	Warning, possibility of electric shock (*)
<b>LEADS</b>	Function selected incompatible with the connection of the lead
	Bluetooth communication
	USB communication
	MLI 300Hz filter

(\*) When voltages exceeding 60 VDC or 25 VAC are measured, the symbol flashes on the display unit.

## Description of the instruments (continued)

### Switch

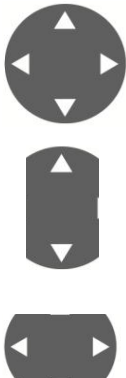

Changing from one setting to another resets the measurement mode. Around the switch, a fixed orange LED indicates which function is selected and an orange LED flashes for setup. During the charging cycle (OFF), each function LED lights by turns to indicate charging in progress.

In the centre, a "4 position" navigator is used for:

1. navigating up and down, to:
  - select a menu or a function,
  - manually select the range or graphic scale under "**Range**",
  - increment or decrement the selected variable.
2. navigating right and left, to:
  - move from one selected variable to another.

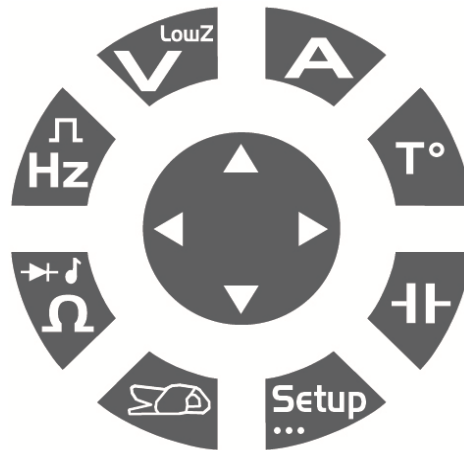

### Keys of the switch

	Short press	Successive short presses
	Current measurement in AC RMS	
	Temperature measurement T and selection of the unit	Selection of the types of sensor: - Pt 100 or Pt 1000 - TCJ or TCK
	Capacitance measurement	
	Current measurement by clamp, selection of AC, DC, or AC+DC coupling	Configuration of the "Clamp" menu: type of measurement, ratio, and unit
	Resistance measurement, audible continuity measurement, 100 Ohm range, diode test	Selection of the continuity, 100Ohm or diodes functions
	Frequency measurement	
	AC voltage measurement (AC RMS) and selection of coupling	VlowZ
	SETUP, on 3 levels	Setup 1/3, Setup 2/3, Setup 3/3

## Description of the instruments (continued)

### Keypad

The keypad has the following function keys:











The keys are taken into account and applied when pressed. If the key press is validated, the instrument beeps.

The active keys on a long press are identified by "...":

**Meas...**, **Mem...**, **Setup...**

### Function keys

	Successive short presses	Long press...
	Selection of the function parameter	
	Selection of the function parameter	
	Selection of the function parameter	
	Selection of the function parameter	
	Hold of the display Selection of RUN or HOLD	
	Measurement menu on 2 levels, 1/2 or 2/2	Reset for SURV/PEAK/REL and CNT
	Start of an acquisition; second press, stop recording	Management and configuration of records
	AUTO range change	
	Selection of the configuration menus	Exit from the SETUP mode

# Getting started

## Preparation for use

### Instructions before starting up

When you use this multimeter, you must observe the usual safety rules, which:

- protect you from electrical hazards,
- protect the multimeter from operator errors.

For your safety, use only the leads supplied with the instrument. Before each use, make sure that they are in perfect condition.

### Power supply via the charger

From 230V  $\pm 10\%$  mains (US version: 110V  $\pm 10\%$ ) with the specific charger delivered with the instrument (45 to 65 Hz).

The mains connector is on the side of the multimeter.

### Powering up, down



Press the key opposite, on the left front panel of the instrument, to switch it on or off. A switching-off page reports the switching off of the active multimeter.

### Automatic current measurement detection

The number of input terminals is limited to 3: **V**, **COM**, **A**.

Connecting the lead to the "Ampere" terminal automatically selects the corresponding function.



**When a change of function from the control keypad is incompatible with the connection of the lead, an audible and visual alert is triggered (LEADS).**

### Automatic power down

The current measurement is made in automatic range mode over the whole span.

Validate the function by the **Standby** menu: the device stops automatically after 30 minutes of operation if during this time there has been no action on the front panel and if the multimeter remains immobile.

The device is switched back on by the  key.



Automatic switching off is disabled in:

- **Surveillance mode** → SURV
- **Record mode** → MEM
- **Communication mode**  (isolated USB optical link, Bluetooth) when the quantity measured (Voltage or Current) on the inputs of the multimeter exceeds the danger threshold.

### Alert signal

An intermittent audible signal is emitted:

- \* in the "Voltage" setting, when the range is exceeded (**MANUal** and **AUTO** mode - last range)
- \* in the "Current" setting, when the range is exceeded (**MANUal** mode), starting from a measurement of 10 Amperes
- \* when the connection of the leads is incompatible with the function selected
- \* when the danger thresholds are exceeded (if the function is validated)

When the range is exceeded, the audible signal is accompanied by display of the "**O. L**" acronym.

When the  symbol is activated:

- \* the voltage on the "Volt" input exceeds **60 VDC** or **25 VAC**
- \* the current injected between the "Ampere" terminal and **COM** exceeds **10A**
- \* the range (voltage or current) is exceeded in **MANUAL** mode

# Functional description

## 1. Description of the "SETUP" menu



The **SETUP** menu configures the parameters of the multimeter according to the conditions of use and user's preferences.

This menu proposes the main adjustments or the configuration of the multimeter on 3 levels. The configurations are kept in memory when the multimeter is switched off, if the **USER** mode (USR) is active. Otherwise, the instrument starts up with the **PLANT** configuration. The menu that is not available is shaded.

### Level 1

#### SETUP menu (1/3) General configuration of the multimeter



- **UTIL**: utility for adjusting the lighting, the standby mode, the audible beep of the keys, the language, and the internal clock on 2 configuration levels.
- **Comm**: for communication and adjustments of the IR/BT type, then the IR rate in baud, and the protocol, MODBUS or SCPI.
- **Power supply**: characterization of the internal power supply of the device or type of battery, Ni-MH or Alkaline primary battery, and capacity.

#### SETUP menu (2/3) Configuration of the measurements

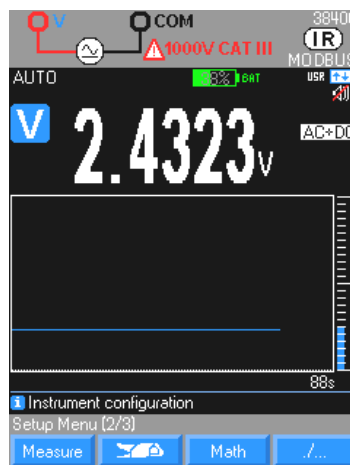

- **Measure**: configures the filter, the impedance, the reference in dBm and in power W.
- **Clamp**: configures the type of input, current or voltage, the ratio indicated on the clamp, and the unit (default is A).
- **Math**: configures the type of measurement assigned to the mathematical channel and the values and unit of A and B of the function  $Ax+B$ .

#### SETUP menu (3/3) Configuration and personalization

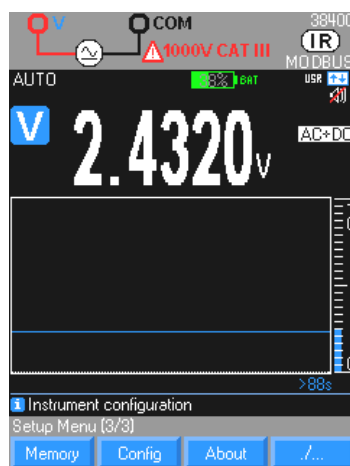

- **Memory**: reminder of the files, of the number of records (1000 is default and 6500 max for the **MTX 3293B**), and of the interval between records (1s is default; up to 23:59:59). See §. [Storage](#).
- **Config**: choice of recall of the PLANT configuration or of the User (USR) or Basic (default value) start-up mode. See §. [Default configuration](#).
- **About**: indicates the traceability of the multimeter: serial no., software and hardware versions.

# 1. Description of the “SETUP” menu (continued)

Level 2 ...

Sub-level 1/3

Display (1/2)

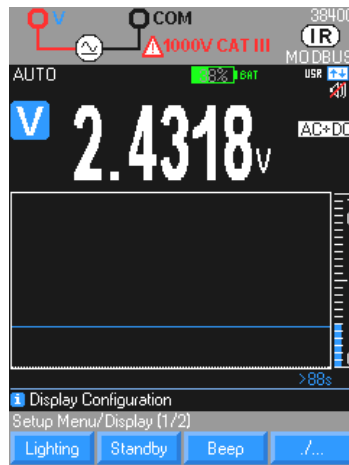

- **Lighting:** selection of 3 levels of back-lighting of the display unit in order to limit the power consumption of the multimeter, as follows: Eco, Normal, Max

The default level of extinction of the back-lighting is ECO, after 1min if there has been no action on the front panel of the multimeter.

An internal accelerometer makes it possible to wake up the multimeter by simply touching the product with the adjustment selected.

- **Standby:** validation (default: yes) or not of automatic switching off after 30 min, if there has been no action on the front panel of the multimeter.

In the SURV, MEM, or Communication mode, automatic switching off is not validated.



*For your safety, automatic switching off is disabled when the quantities measured (voltage, current) on the input exceed the danger thresholds.*

- **Beep:** validation (default) or not of the emission of an audible signal (beep) when:
  - a key is pressed,
  - there is a voltage on the "V" input exceeding 605 VDC or 30 VAC,
  - a stable measurement is captured in AUTO HOLD

**The audible signal is maintained even when the buzzer is deactivated:**

- *in a continuity test,*
- *when a range is exceeded (voltage or current),*
- *for a measurement of 10A or more,*
- *when there is an incompatibility between the connections of the leads and the function selected*
- *when the supply voltage (battery) is too low → blinking of the red batt indicator.*
- *The audible signal is maintained when the function is changed while recording is in progress (low-pitched beep).*



## Description of the “SETUP” menu (continued)

### Level 2

#### Sub-level 1/3 (continued)

#### Display (2/2)



- **Language:** selection of the language used in the menus of the multimeter. Two options are possible: French (FR, the default) or English.

- **Clock:** selection of:
  - the date, format (01/01/2014 is default)
  - the time XX:XX:XX, or h:min:sec
  - selection of variables with the navigator



- Resolution 1s

#### Communication

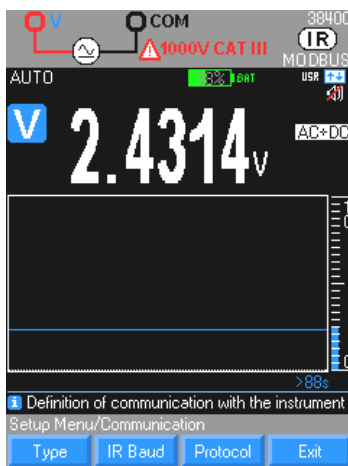

- **Type IR/BT:** choice of communication:
  - IR/USB
  - Bluetooth

- **IR Baud:** parameterizing of the infrared transmission rate from among 9600/19200/38400 (default) baud; the other transmission parameters are fixed (8 data bits, 1 stop bit, no parity)

- **Protocol:** choice of MODBUS or SCPI

#### Power supply



- **Type:** choice of type:
  - Ni-MH battery
  - Alkaline primary battery

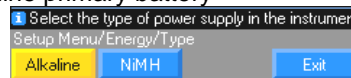

- **Capacity:** parameterizing of the capacity of the storage battery in mAh, of the batteries installed (default is 2400mAh).

1. Place the storage batteries in the multimeter, then connect the charger. The LEDs light alternately around the switch to indicate that charging is in progress.

2. Press ON to switch the multimeter on and track the course of the charging by plateau. Average charging time: 6h (with 2400mAh storage batteries). After 1h of recharging, the multimeter is ready for measurements, by pressing ON again; the level of the plateaus acquired is valid only after a full charge of the instrument.

# 1. Description of the "SETUP" menu (continued)

Level 2...  
Sub-level 2/3

## 1. Measurement Configuration of the measurement parameters



- **Filter:** 300 MHz MLI filter for measure on variator

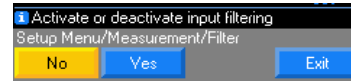

- **Impedance:** choice of desired input impedance

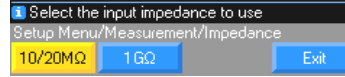

Choice between 10 and 20 MΩ



only in 100mVDC and 1000mVDC

☞ **As default, 10mV range = 10MΩ, 1,000mV range = 10MΩ**

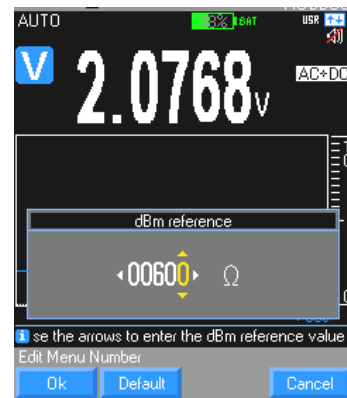

- **dBm REF:** adjustment of the reference in dBm  
Adjustment of the reference resistance (dBm REF) between 1Ω and 10000Ω, for measurements in dBm from voltage VAC or VAC+DC

- Selection of a digit by the navigation key and modification of the digit

- Validation of the reference resistance in dBm and exit from the menu by "Ok".

☞ **Default value 600Ω.**

*Reminder: a measurement of 0dBm with a reference resistance of 600Ω is made using a voltage of 0.7746 VAC.*

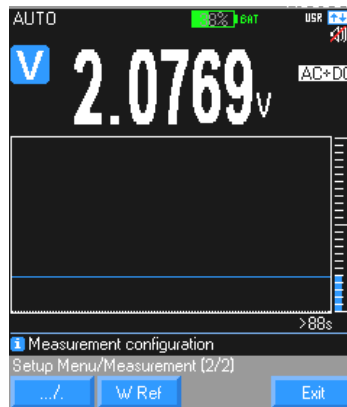

- **W Ref:** resistive power reference W  
Adjustment of the reference resistance ( ) between 1Ω and 10,000Ω, for resistive power measurements:

The calculation performed is:  
 $(\text{measured voltage})^2 / W \text{ Ref (unit W)}$   
 $(\text{measured current})^2 / W \text{ Ref (unit W)}$

*Same adjustment as for the reference resistance in dBm.*

☞ **Default value 50 Ω.**

W REF is used for the calculation of the resistive power (W) with REF = W Ref and the calculation of the power

(V A) with V (Ref) = W Ref

To calculate **VxA**, see §. [MEAS+](#).



## 1. Description of the “SETUP” menu (continued)

### 2. Clamp

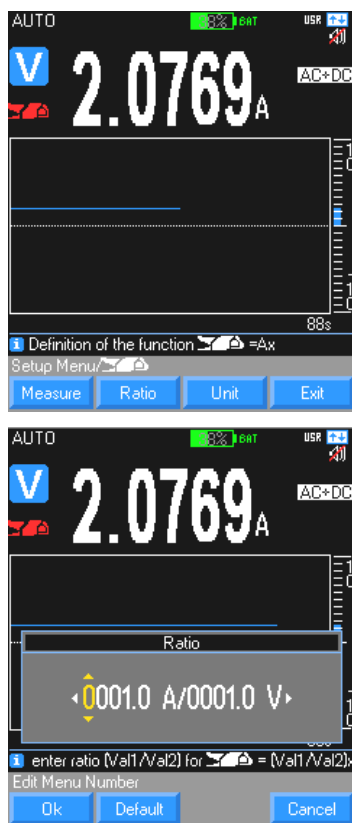

- The **CLAMP** function ( $y = Ax$ ) enables the user, measuring a current with a current clamp in:

- Volts x V/A
- Amperes x A/A

to assign the ratio (or transformation ratio) and the appropriate unit, in order to obtain a direct reading of the measured current.

Depending on the quantity measured, the device calculates the function  $Ax$  associated with it.

The programming is in 3 stages:

1. Selection of the quantity measured, Measurement (V, A)
2. Definition of the ratio A displayed on the clamp Val1/ Val2 or: xxxx.XA/xxxx.XV (default is 1A/1V)
3. Definition of the physical unit to be displayed (default is A)

☞ **The ratio A and the unit can be programmed for each quantity measured (V, A).**

### 3. Math

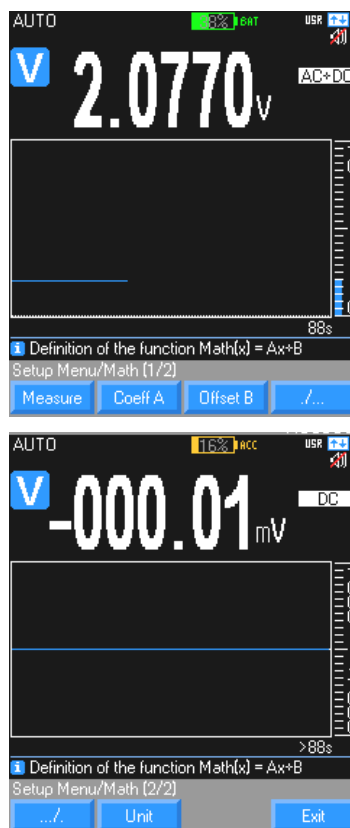

- The **MATH** function ( $y = Ax + B$ ) enables the user, measuring any physical quantity in:
  - Volts (process 0-10V or high-voltage probe, for example)
  - Amperes 4-20mA current loop or current clamp, for example)
  - Frequency (measurement of flow rates, speeds of rotation, for example)
  - Ohms (resistive position sensor, for example)

to convert it and assign the appropriate unit, in order to obtain a direct reading of the original quantity on the instrument.

Depending on the quantity measured, the device calculates the MATH function associated with it.

The programming is in 4 stages:

1. Selection of the quantity measured (V, A,  $\Omega$ , Hz)
2. Definition of the coefficient A of the function  $y = Ax + B$
3. Definition of the coefficient B of the function  $y = Ax + B$
4. Definition of the physical unit to be displayed by the navigator (Upper-case and lower-case)

☞ **The coefficients A and B and the unit can be programmed for each quantity measured (V, A,  $\Omega$ , Hz).**

# 1. Description of the “SETUP” menu (continued)

Level 2...  
Sub-level 3/3

## 1. Memory



### Reminder:

- of the files recorded
- of the number of records (1000 is default; 6500 max. for **MTX 3293B**),
- of the interval between records (1s is default; up to 23:59:59).  
See §. [Storage](#).

☞ **Maximum of 10 sequences recorded**

## 2. Config

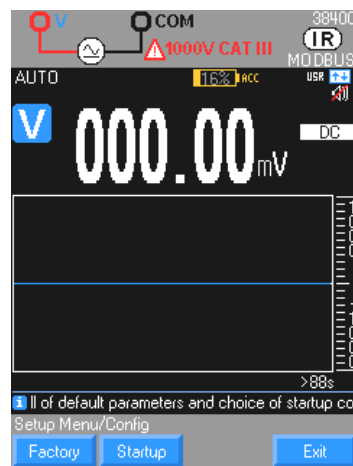

### Choice of recall:

- of the **PLANT** configuration
- of the **User (USER)** or **Basic** (default) start-up mode
- In the **User** mode, the instrument restarts in the user's personal configuration (Setup and Measurement menus) and in the function selected when switched off.
- In the **Basic** mode, the multimeter starts up in its elementary configuration (default values) and Volt function (AC+DC).

☞ **Restart configuration given assuming no leads connected. If they are connected, the connections will be taken into account in the selection of the function.**

## 3. About



### Multimeter traceability information:

- serial no.
- software versions
- hardware version

## 2. Description of the "Keypad" keys

### 1. **Hold** key

*Management and hold of the display*

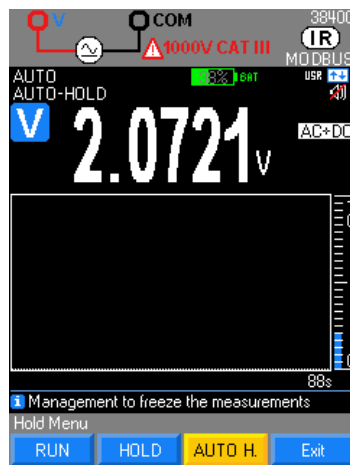
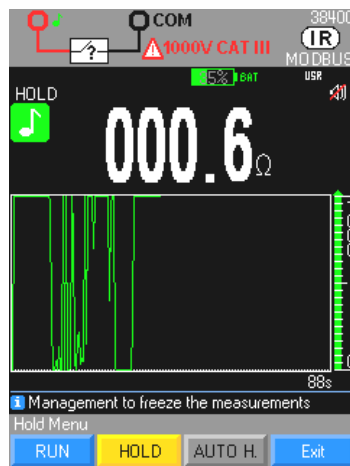

Three operating modes are possible:

- the **RUN** mode → HOLD inactive
- the **HOLD** mode → [F2]
- the **AUTO HOLD** mode → [F3]

- The **HOLD** mode freezes on the screen the main measurement in progress at the time of the press. The instrument continues to manage the measurements and to display them in the graphic window or on the secondary display unit (**REL** mode).

*👉 The type of range selection remains the same: **AUTO** or **MANUAL** depending on the configuration when this mode was entered.*

- The **AUTO HOLD** mode automatically freezes on the screen the main measurement in progress each time a stable measurement is detected. It is confirmed by the emission of an audible beep (if the "No beep" configuration was not selected in the Configuration menu).

The stored values remain displayed until the next stable measurement is made (measurement different by  $\pm 100$  digits) or until the **AUTO HOLD** mode is exited by **RUN**.

The instrument continues to manage the measurements and to display them in the graphic window or on the secondary display unit (**REL** mode).

- 👉 *The type of range selection remains the same (in **AUTO** or **MANUAL**) depending on the configuration when this mode was entered. The **AUTO HOLD** mode is available only for **V** and **A** measurements.*

## 2. Description of the “Keypad” keys (continued)

### 2. Meas... key

Level 1/2

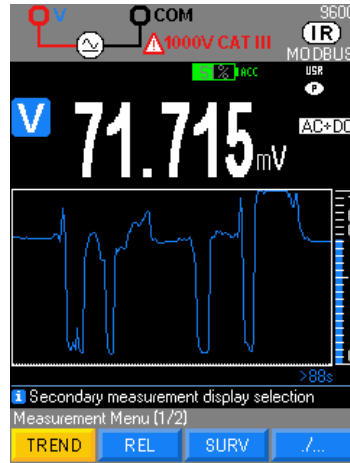

3 levels of advanced measurements are possible:

- TREND
- REL
- SURV

- **TREND**: selects graphic display of the trend buffer.

- **REL**: takes the main measurement in progress as reference. It is transcribed on the secondary display unit: REF.

- The main display continues to indicate the instantaneous measured value, as does the bargraph.

- The  $\Delta$  secondary display indicates the absolute difference between the instantaneous measured value and the recorded reference.

- The  $\Delta\%$  secondary display indicates the relative difference in % between the instantaneous measured value and the recorded reference.

☞ **Management of the ranges is "AUTOMATIC" or "MANUAL" depending on the configuration when the mode was entered.**

☞ **The  $\Delta$  and  $\Delta\%$  display units are managed in the same range.**

In the "AUTO" mode, they cannot fall below the range of the reference when the REL mode was entered.

☞ *E.g.: Measurement of a voltage of VDC with a reference set to x V:*

*When the mode is active, a long press on key [F1] Init or [F2] Enter Ref opens a window for setting reference REF.*

The navigator key is used to modify the digit.

☞ **Reset of REF by a long press on Meas ...**

## 2. Description of the “Keypad” keys (continued)

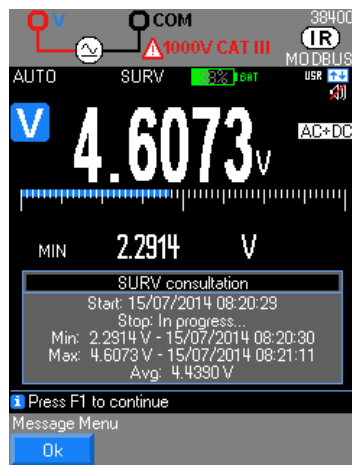

- **SURV**: monitors the variations of a signal, recording the extremes (MIN, MAX) of the main measurement and calculating its mean (AVG).

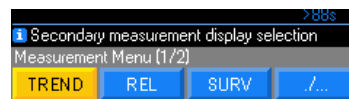

For each quantity stored, the multimeter records the corresponding date and time.

☞ **When the SURV mode is entered by Start [F1], the last MIN and MAX measurements are erased, then initialized with the present measurement; to stop this mode, press [F2] stop; [F3] to look up.**

- AVG is the calculated mean of all measurements made since the activation of the SURV mode.
- The recorded data can be looked up by pressing Look up key [F3].
- In the SURV mode:
  - management of the MANU or AUTO range management cannot be selected.
  - the present measurement, the MIN value, and the MAX value are presented in the ranges best suited to each of them.

The recorded data are accompanied by the date and time, along with the surveillance range.

- ☞ **Please update your multimeter before starting a SURveillance campaign (automatic synchronization).**
- ☞ **Reset of the MIN/MAX values by a long press on Meas ...**

## 2. Description of the “Keypad” keys (continued)

### Level 2/2

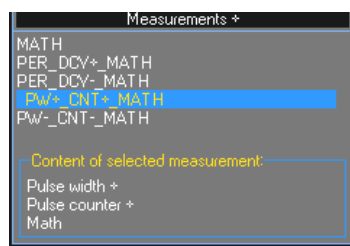
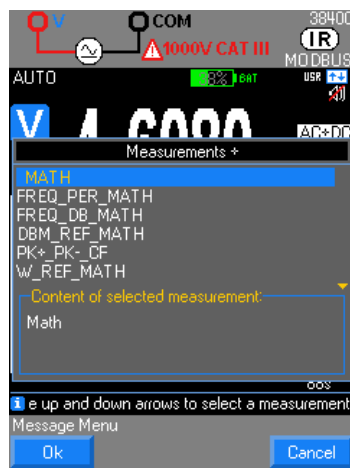
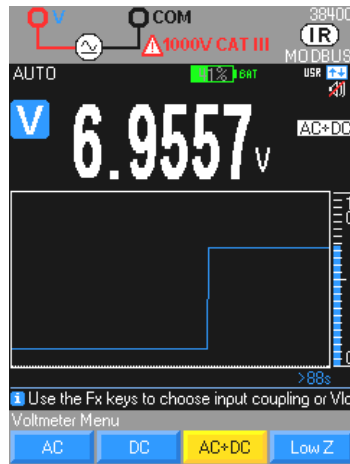

- **SPEC:** directly displays the tolerance of the measurement in progress; there is no need to search for it and calculate it.

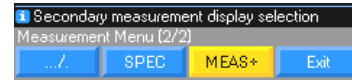

From the main measurement, the display:

- recalls the specifications ( $x\% L \pm n D$ ) according to the type of measurement, the range selected and the frequency (in AC and AC+DC)
- calculates the range in which the true value lies, if the device is within its tolerance:  
SMIN value → minimum specification  
SMAX value → maximum specification

- **MEAS+:** gives access to the secondary measurements (see [table](#) in the Appendix).

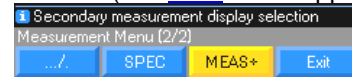

Choice of secondary functions on display units 2, 3, and 4 by selection using the navigator, according to the main measurement, and validation by OK.

A long press on MEAS... is used to exit from this menu.

**When a main measurement is chosen, the last secondary functions selected are reactivated.**

**Opposite, example of measurements available in VAC+DC.**

When dB measurements are activated, the measured value is taken as voltage reference (V ref). The calculation is the following:  
 $20 \log_{10} (V \text{ measured}/V \text{ ref})$ .

**The voltage reference (V ref) cannot be modified.**

The MATH function is displayed when its parameters allow (see the MATH Function menu).

For dBm measurements and resistive power calculations, refer to the menu for the adjustment of the associated reference resistances (**dBm REF**, **W REF**) and the calculation formulas.

The power calculation **Vx A** (VA) requires a third connection on the A input (connected to the same circuit), in order to measure simultaneously:

- the voltage (main display unit)
- the current (display unit 3), measurement always made in AC+DC.

**The link to the COM input must be short and of large diameter, in order to limit the voltage drop, which influences the Volt measurement.**



## 2. Description of the “Keypad” keys (continued)

### 3. **Mem...** key

*Storing of the measurements, recording mode*

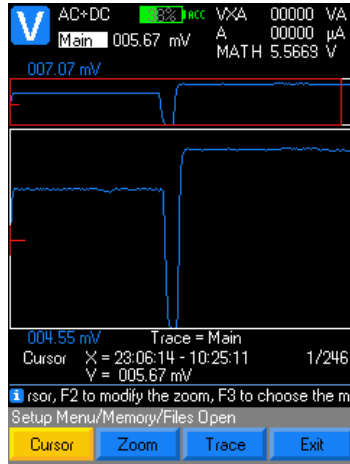

- The **MEM** mode records the content of the digital display(s) in the memory of the device at a pre-programmed rate.
- A short press on **Mem...** starts a recording series.
- The **MEM** symbol is displayed in yellow during the whole recording period; it is accompanied by the number of records made.
- Another short press on **Mem...** stops the storage of the measurements.
- The number of values to be stored for a measurement campaign can be programmed: recording then stops automatically when this number is reached.
- The records and the configuration can be looked up by a long press on **Mem...**

*Another press on **Mem...** recalls a series of records.*

Recording capacity	6,500 measurements maximum <b>MTX 3293B</b>	1 to 10 sequences (depending on memory available)
	1,000 measurements maximum <b>MTX 3292</b>	1 to 10 sequences (depending on memory available)



In this stage, it is possible to list the files and to configure the maximum number of records according to the version and the recording frequency or interval (1s is default).

- Select the **Files** menu in the **MEM** function to display the list of successive records.
- Each record is identified by its date and its start time.

## 2. Description of the “Keypad” keys (continued)

### 3. Mem... key (continued)

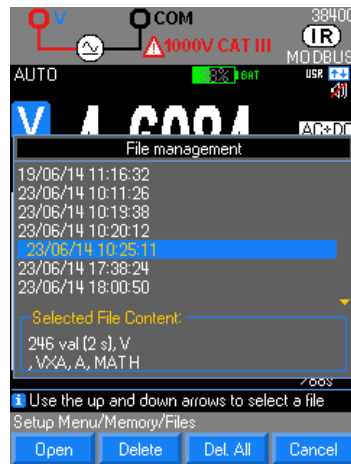

- Look-up of the recorded files under [F1] **Files** and selection by the navigator, then possibility:
  - of opening [F1],
  - of deleting a selected sequence [F2],
  - of deleting all recorded sequences [F3]
- Select the **Files** menu in the **MEM** function to display the list of successive records.
- Each record is identified by its date and its start time.



**The selection of a record is accompanied:**

- by the number of values recorded,
- by the recording interval
- by the function in which they were made,
- by the secondary functions present during the recording, if any.

**The number of recording sequences is limited to 10.**



- Programming the number of records  
Defining a number of records for a measurement campaign makes it possible to stop recording automatically. Selection of the max number of records using the navigator (6500 or 1000 measurements max.); default [F2] is 1000 records  
If **MEAS+**, **SURV**, or **REL** secondary measurements are programmed, it will be necessary to make allowance for them in the depth of recording selected.
  - Programming the recording frequency
  - Selection of the digit to be modified by the navigator key.
  - Modification of the value by the keys:



- Validation of the number of records by **Ok** [F1]
- Exit from the successive menus by the **Cancel** key [F4].

*The recording capacity is limited to 6500 measurements (1000 for the **MTX 3292**).*

## 2. Description of the “Keypad” keys (continued)

### 3. Mem... key (continued)



Validating **Freq.** by the [F3] key opens a menu for adjustment of the recording interval in hours, minutes, seconds

- Modification of the value using the  keys of the navigator
- Validation of the interval of recording of the measurements and exit from the successive menus by the **Ok** key [F1].

**The maximum recording interval is 23h, 59min, 59s. Default recording interval 1s.**

**Recall of a recording campaign on the multimeter (or on the PC using SX-DMM software, see the §. SX-DMM Software)**



A zoom is available, if the recorded value >MEM 220.

The curve displayed is adapted to the graphic window according to its min. and max. values and the number of records.



- Selection of the **Main** function, by default, and display with Cursor selected.

**Zoom and Trace on MTX 3293B version only.**

Displacement of the cursor by the navigator
- moves the zoomed part (icon present, if a zoom is active)
- activates, deactivates a zoom (icon present, if a zoom is possible)

- Zoom of the trace by selection of the zone in red border in the upper part of the record
- But access to the secondary measurements to be displayed by pressing TRACE, then selection by keys [F2] to [F4],
- Selection of the function to be displayed

*Example:*

- main function: **V**
- secondary function: **FREQ**, **dB**, **MATH**

If recording has been started, MEM is incremented and changes of function are not available (attempts produce a low-pitched beep), except for the SETUP menu, which can still be looked up. The acquisition in progress must be aborted (press MEM) to change a parameter, a function, or a configuration.

## 2. Description of the “Keypad” keys (continued)

### 4. Range key

#### Management of ranges

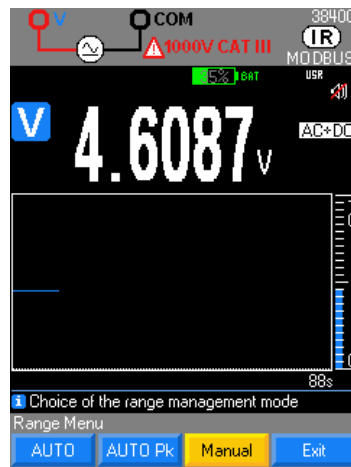

Three operating modes can be accessed by the key:

- the **AUTO** mode → [F1]
- the **AUTO Pk** mode → [F2]
- the **MANUEL** mode → [F3]

- When a measurement is being acquired, the **AUTO** mode is active as default and range selection is managed automatically by the multimeter.
- In the **AUTO PEAK** mode, changes of range occur only when the acquisition of a higher peak makes a higher range necessary.

**The AUTO PEAK mode is available only on AC and AC+DC measurements in V and A. It avoids the untimely overshoot of the peak factor specified for the instrument.**

- When the **MANUAL** mode is selected and it is valid for the function concerned,

the  keys of the navigator allow a change of the measurement range.

Measurements concerned: voltage, current (in series or clamp), resistance, capacitance

# How are the various quantities measured?

## Connection tutorial



## 1. Voltage measurement

Connecting the multimeter

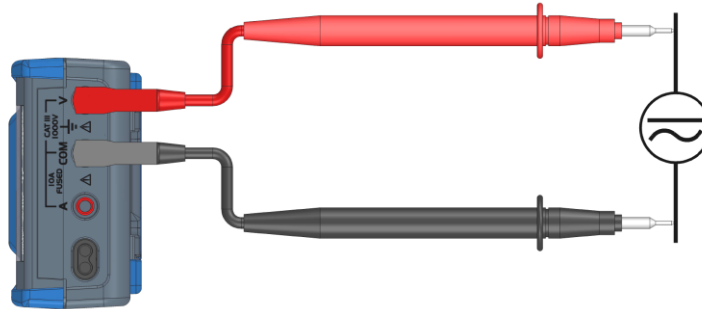

Main measurement key

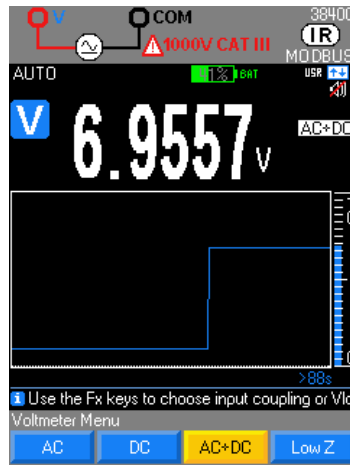

In this setting, the user can measure the true RMS value of an alternating voltage with its bias component (no capacitive coupling): "TRMS" measurement. In the "DC" mode, you measure a direct voltage or the DC component of an AC voltage.

Selection of the coupling from among:

- alternating voltage measurement **AC** [F1]
- direct voltage measurement **DC** [F2]
- alternating voltage superposed on a direct voltage **AC+DC** [F3] at high impedance

- low-impedance alternating voltage **LowZ** [F4] to make measurements on electrical installations, in order to avoid the measurement of a "phantom" voltage due to coupling between lines.

Secondary measurements  
Meas.../MEAS+

Pressing **MEAS...** gives access to the secondary measurements of the main function.

See [table of secondary measurements](#) in the Appendix.

How can one obtain the secondary quantities of the voltage measurement? By pressing **Meas... → MEAS+ →** Selecting the line (shaded, opposite)

### 1. in VAC+DC and VAC:

- the frequency, the period, and the mathematical function: .....FREQ\_PER\_MATH
- the frequency, the measurement in dB, and the mathematical function: .....FREQ\_DB\_MATH
- the power measurement in dBm, its reference, and the mathematical function: DBM\_REF\_MATH
- the measurement of Peaks+ then – and the peak factor: .....PK+\_PK-\_CF
- the resistive power, its reference, and the mathematical function: .....W\_REF\_MATH
- the power VxA, the current A, and the mathematical function: .....VxA\_A\_MATH

### 2. in VDC:

- the mathematical function: MATH
- the resistive power, its reference, and the mathematical function: .....W\_REF\_MATH
- the power VxA, the current A, and the mathematical function: .....VxA\_A\_MATH

### 3. in VLowZ:

- the mathematical function: .....MATH
- the frequency, the period: .....FREQ\_PER

## How are the various quantities measured? (continued)

### 1. Voltage measurement (continued)



### Process



The zoom is available only if the records are >220 measurements.



The 100mV range is present only in MANUAL mode, by **Range**.

In all cases, "OL" is displayed above 1050V and a beep sounds when the measurement exceeds 600V.

The hazardous voltage symbol is displayed if "V" exceeds 60 VDC or 25 VAC

1. Press on the V function, then select the coupling according to your measurements: AC, DC, AC+DC, LowZ (AC is default).
2. Connect the black lead to the COM terminal and the red lead to V.
3. Read the measurement indicated on the display unit; the graph of trend values >88s is displayed on the screen or selection of secondary measurement **Meas.../MEAS+** (4 display units max).
4. It is possible to activate an MLI filter (**SETUP/Measurement/filter/yes**) for measurements on a variator: the cutoff frequency of the filter <300Hz.
5. It is possible to display the **specifications** of the range for metrology or a RELative measurement.
6. Surveillance of voltage by activation by **Meas.../SURV**
7. Recording of data internal to the multimeter:
  - Mem → to start the campaign
  - Mem → to stop the campaign
  - then look-up of the data by long press on Mem...
  - Processing of the measurements: plot of the main measurement and display of the secondary measurements.

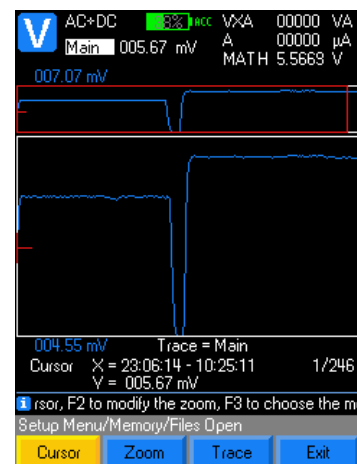

## How are the various quantities measured? (continued)

### 2. Direct measurement of current

#### Main measurement A in series in a circuit

The current is the flow of electrons through a conductor. To measure the current, you must open the circuit to be checked and connect the inputs of the multimeter in series in the circuit.

Selection of the coupling from among:

- alternating current measurement **AC** [F1] or
- direct current measurement **DC** [F2] or
- alternating current measurement superposed on a direct voltage **AC+DC** [F3], at high impedance.

#### Direct measurement of a current, key:



1. Press function A, then select the coupling according to your measurements: AC, DC, AC+DC (AC+DC is default)
2. Connect the black lead to the COM terminal, the red lead to A, and the probe tips in series between the source and the load as shown below:

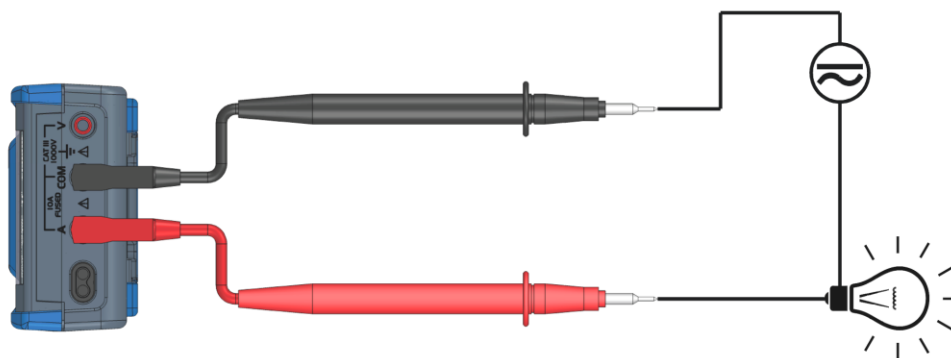

3. Read the measurement indicated on the main display unit.
4. Look up the graph of the trend values >88s if it is activated.
5. Look up the secondary measurements if they are activated (activated by **Meas... → MEAS+**).
6. It is possible to display the specifications of the range for metrology or a RELative measurement.
7. Surveillance of voltage **SURV** or Recording **MEM** of data internal to the multimeter "OL" is displayed if the current available  $I > 20A$ .

#### Reminder

When the device is in use in the 10A range, it can withstand an overload of 20% for one hour.

A overload of 20A is acceptable for 30 seconds max., with a pause of at least 5 minutes between measurements.

Reminder: Breaking capacity of the fuse = circuit 11A/1000V/>18kA

#### How are the secondary quantities obtained in current measurement A? By pressing Meas... → MEAS+ → Selecting the line (shaded, opposite)

1. in IAC and IAC+DC :
  - the MATH function associated: ..... MATH
  - the frequency, period and MATH function : ..... **FREQ\_PER\_MATH**
  - the Pk+ then Pk- measurement and crest factor : ..... **PK+ PK- CF**
  - the resistive power, its reference and MATH function : ..... **W\_REF\_MATH**
2. in IDC :
  - the MATH function associated: ..... MATH
  - the resistive power, its reference and MATH function : ..... **W\_REF\_MATH**

## How are the various quantities measured? (continued)

### 3. Current measurement with clamp



**Key:** To avoid opening a circuit, we recommend measuring the current with a current clamp, output A or V (Ax function).

To do this, proceed as follows:

- Activate the clamp function and, depending on the type of clamp connected, double-press "Clamp" or use the setup/clamp menu.
- Select the type of Measurement clamp output (V, A)
- Define ratio A displayed on the clamp Val1/Val2 or xxxx.Xa/xxxx.Xv (by default 1A/1V) to be incorporated (**Ok** to Validate, or Cancel).
- Define the physical unit to be displayed (default: A): 3 programmable fields

**Reminder** The clamp function includes a precise ratio xxxx.XA/xxxx.XV or XA, making it possible to connect a broad range of current clamps that you will find in the CHAUVIN ARNOUX catalogue; it is however necessary to verify that the input/output range of the clamp matches the ranges available on the multimeter. The accuracy of this "clamp" function depends on the accuracy of the clamp and of the range used on the multimeter.

**Connections possible in current measurement:**

a)

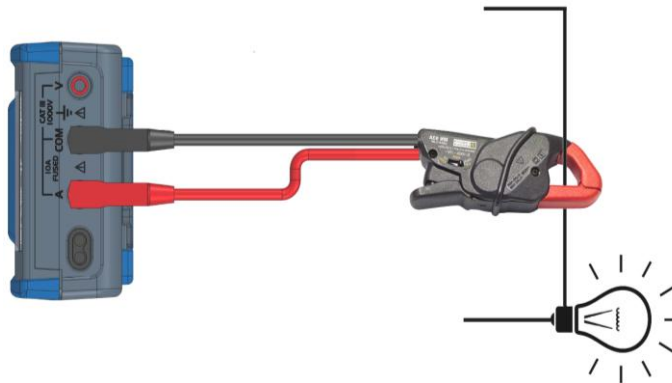

Current clamp with current output connected to the multimeter

b)

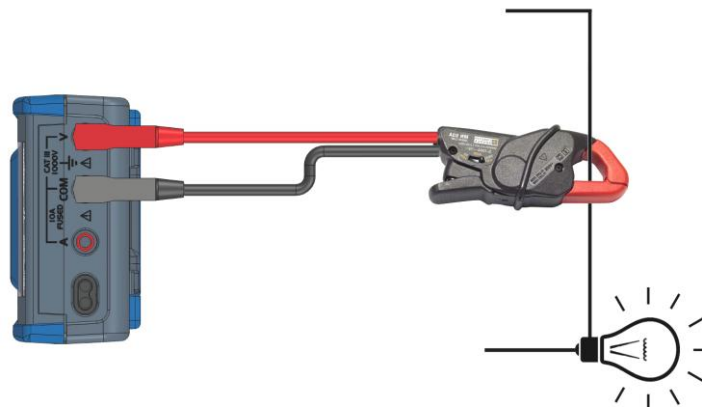

Current clamp with voltage output connected to the multimeter

or:

Measurement in series in a circuit

**No secondary measurements in this quantity**



## How are the various quantities measured? (continued)

### 4. Frequency measurement

Connecting the multimeter

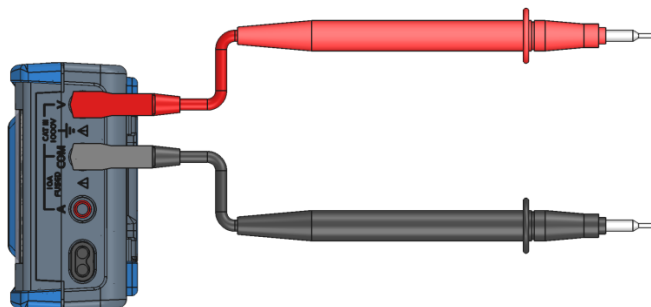

Key:



Select the Hz function to measure the frequency of the voltage  
 Measurement of the period is accessible as a secondary measurement  
 If the MLI filter is activated, the frequency that can be measured remains within the pass band limit of the 300Hz filter.  
 Below 10Hz, or if the signal is too weak, the value is forced to "--"  
 Possibility of selection of the range by "Range+ or -" or of the manual freq.  
 F <200kHz (default) or F >200kHz

Secondary measurements  
 Meas.../MEAS+

Pressing **MEAS...** gives access to the measurements of the main function:

1. DUTY CYCLE: duty cycle DCY+ or DCY-
2. CNT+ and CNT-: counting of pulses
3. PW+ and PW-: pulse width

See [table of secondary measurements](#) in the Appendix.

How can one obtain the secondary quantities of the Hz frequency measurement?  
 By pressing Meas... → MEAS+ →  
 Selecting the line (shaded, opposite)

- the mathematical function associated: ..... MATH
- the period, the positive duty cycle and the mathematical function: ..... PER\_DCY+\_MATH
- the period, the negative duty cycle and the mathematical function: ..... PER\_DCY-\_MATH
- the positive pulse width, the counting of positive pulses, its reference and the mathematical function: ..... PW+\_CNT+\_MATH
- the negative pulse width, the counting of negative pulses, its reference and the mathematical function: ..... PW-\_CNT-\_MATH

## How are the various quantities measured? (continued)

### 1. Duty Cycle or duty cycle, positive DCY+ or negative DCY-

Display of the measurement in % of a logical signal (TTL, CMOS, etc.)

DCY+ duty cycle  
DCY- duty cycle



$$= \theta$$

$$= T - \theta$$

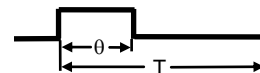

The DCY duty cycle mode is optimized to measure the active or inactive intervals of switching signals or logical signals. Electronic fuel injection systems and switching power supplies, in particular, are controlled by pulses of variable width that can be verified by a duty cycle measurement.

### 2. CNT+ and CNT- or positive or negative pulse counting



Depending on the triggering conditions of the frequency counter, calculation of the positive or negative pulses

Minimum pulse duration 5µs

Counting up to 99999

Triggering threshold 10% of range except for range 1000 VAC

This threshold is positive in , negative in

**Reset of CNT by long press on MEAS...**

**For negative events, cross the leads.**

The pulse width function  $\theta$  measures the duration during which the signal is low or high. The waveform measured must be periodic; its curve must repeat at intervals of equal duration.

### 3. PW+ and PW- or positive or negative pulse width



Depending on the triggering conditions of the frequency counter, measurement of the pulse width in ms.

Resolution 10µs

Minimum pulse width 100µs

Accuracy 0.05% ±10µs Maximum duration of a period 12.5s

Triggering threshold 20% of the range except for the 1000 VAC range

**For negative events, cross the leads.**

## How are the various quantities measured? (continued)

### 5. Resistance measurement



Key:

Connecting the multimeter

The multimeter measures resistance (opposition to the flow of current) in ohms ( $\Omega$ ). For this purpose, it sends a weak current through the measurement leads to the circuit being tested.

The input (+, COM) must not have been overloaded by the accidental application of a voltage on the input terminals with the switch set to  $\Omega$  or  $T^\circ$ .

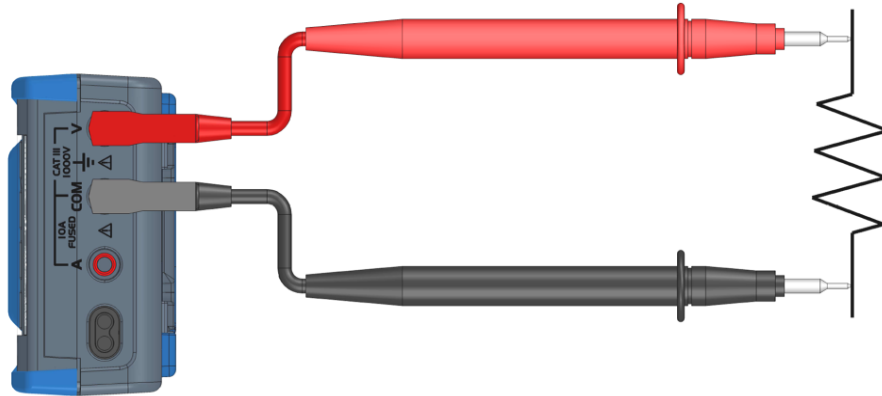

Resistance measurement

- Selection of range: automatic or manual
- "Active" protection: by PTC thermistor
- Measurement voltage: approx. 1.2V
- Max. open-circuit voltage: 4V typical

Because the measurement current of the multimeter takes all possible paths between the probe tips, the resistance measured in a circuit is often different from the nominal resistance.

The measurement leads can add from 0.1 $\Omega$  to 0.2 $\Omega$  of error to resistance measurements. To test the leads, touch the probe tips together and note the resistance of the leads.

To eliminate the resistance of the leads from the measurement, keep the probe tips together, press the Meas... function key, then REL, and integrate this measurement as REF.

A MATH secondary measurement is active in resistance measurement.

All measurements made then indicate the resistance between the probe tips.

Ohm



In the 50 M $\Omega$  range, in order to avoid the influence of the mains and guarantee the stated specifications, it is best to disconnect the multimeter from the Wall Plug.

For measurements greater than 10 M $\Omega$ , a shielded lead is recommended.

For a 2-wire link, use very short wires (<25cm) and twist them together.

## How are the various quantities measured? (continued)

### 100 Ohm measurements

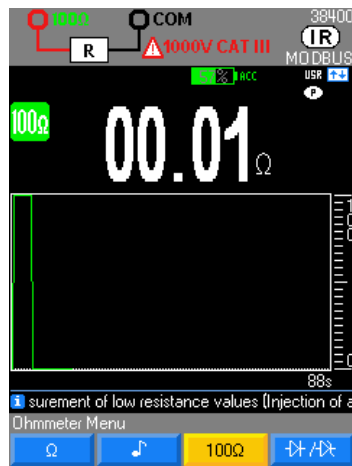

Press the F3 key to access this function.

**So as not to damage the circuit tested, note that the multimeter provides a current of approximately 10mA max. at an open-circuit voltage of 28 volts max.**

For low resistance measurements, <100 Ohm, this single range provides good resolution.

### 6. Audible continuity measurement



Measurement of a resistance up to 1000Ω, with continuous 4kHz audible indication.

Power the circuit down before making any measurement.

The continuity test monitors the circulation of the current in a complete resistive circuit. The continuity function detects open-circuits and intermittent short-circuits lasting as little as one millisecond.

If a short-circuit is detected, an audible beep sounds. If the circuit is open, **OL** is displayed.

Detection threshold in continuity mode:  $\approx 20\Omega$  (response time <10ms)

“Active” protection by PTC thermistor  
Max. open-circuit voltage: 3.5V.

### Connecting the multimeter

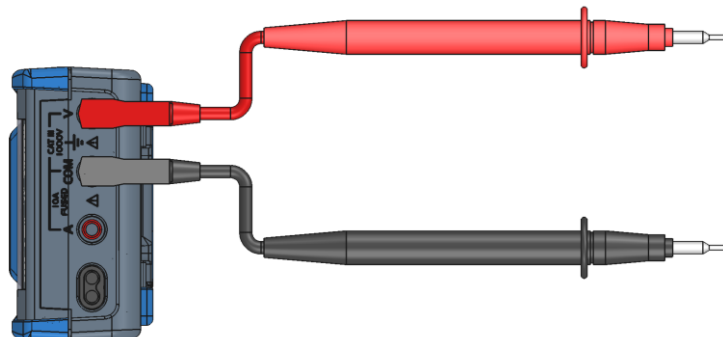

## How are the various quantities measured? (continued)

### 7. Diode test



Key:

- diodes,
- transistors,
- silicon-controlled rectifiers (thyristors)
- and other semiconductor components.

This function tests a semiconductor junction by passing a current through it and measuring the voltage drop across the junction.

Indication of the junction voltage in the forward direction from 0 to 2.6V in a single range (10V range): forward polarization.

4V



Reading of the threshold voltage; if the circuit is open or the threshold of the diode >4V, the indication is OL.

forward polarization of diode

26V

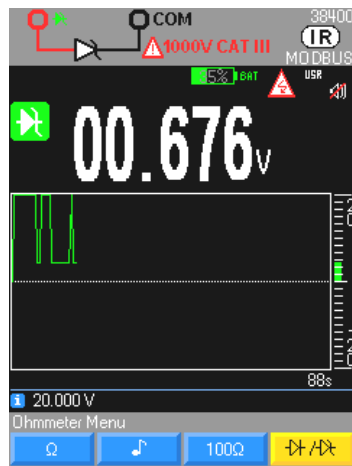

Zener diode or LED: selecting this diode applies the same function as for the diode above but with a maximum voltage of 26V and a maximum current of 10mA.

Connecting the multimeter

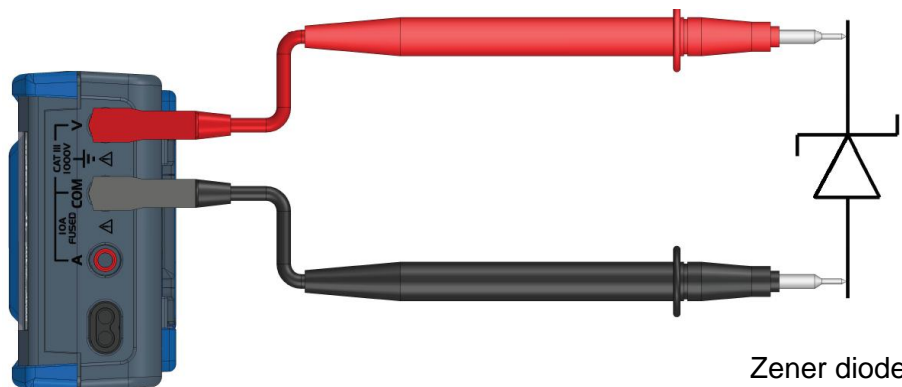

## How are the various quantities measured? (continued)

### 8. Capacitance measurement



Capacitance characterizes the ability of a component to store an electric charge. The unit of capacitance is the farad (F). Most condensers/capacitors lie within the range from nanofarads (nF) to microfarads ( $\mu\text{F}$ ). The multimeter measures capacitance by charging a capacitor with a known current for a known time and measuring the resulting voltage. The result is the capacitance.

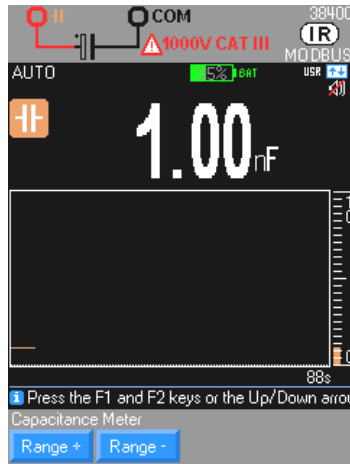

Measurement of the capacitance of a capacitor with a resolution of 1000pts

"Run" appears when the measurement is in progress.

With large capacitances, the display of "RUN" lasts longer.

"OL" is displayed if the value to be measured exceeds the range limits or if the capacitor is short-circuited.



AUTO range selection, automatic (default) or manual: Range + or Range -  
 "Active" protection by PTC thermistor  
 Maximum open-circuit Voltage: 1V typ., 4V max.

Use the REL function for values <10% of the range in order to restore the residual zero (compensation for the capacitance of the leads)

- For measurements <10nF, a shielded lead is recommended. For a 2-wire link, use very short wires (<25cm) and twist them together.
- Use the REL function to compensate for the error introduced by the measurements leads. In REL mode, changes of range are not available.

### Connecting the multimeter

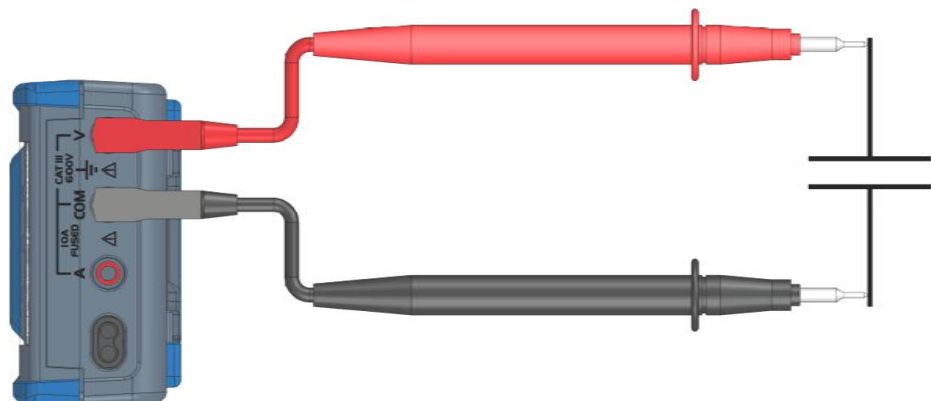

## How are the various quantities measured? (continued)

### 9. Temperature measurement



To measure a temperature:

Connect the sensor to the V and COM terminals, making sure to get the polarity right.

1. Choose the unit: °C (Celsius), K (Kelvin) or °F (Fahrenheit).
2. Select ".../...".
3. Choose the type of sensor.

Pt 100/Pt 1000

Connecting the multimeter

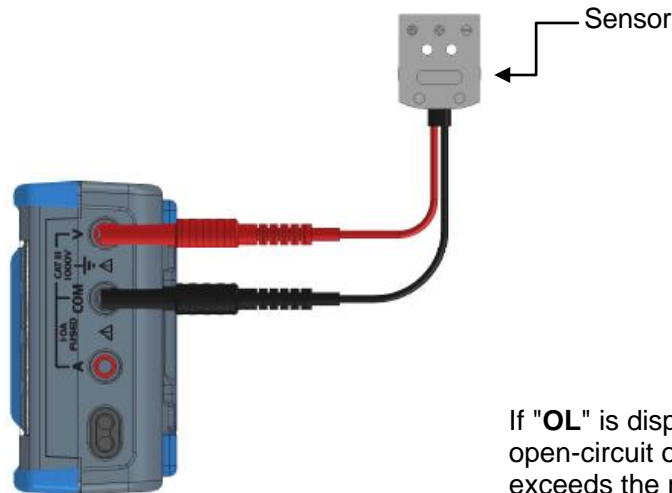

If "OL" is displayed, the sensor is open-circuit or the measured value exceeds the range limit.

2 presses



Measurement of the temperature with a sensor: Pt100/Pt1000 or ./...

“Active” protection by PTC thermistor  
To connect a 2-wire PT probe to the multimeter, we recommend the use of the PT100 probe module → HX0091.

## How are the various quantities measured? (continued)

### 9. Temperature measurement (continued)

Connecting a  
K or J thermocouple  
with the temperature-  
compensated plug  
(option)

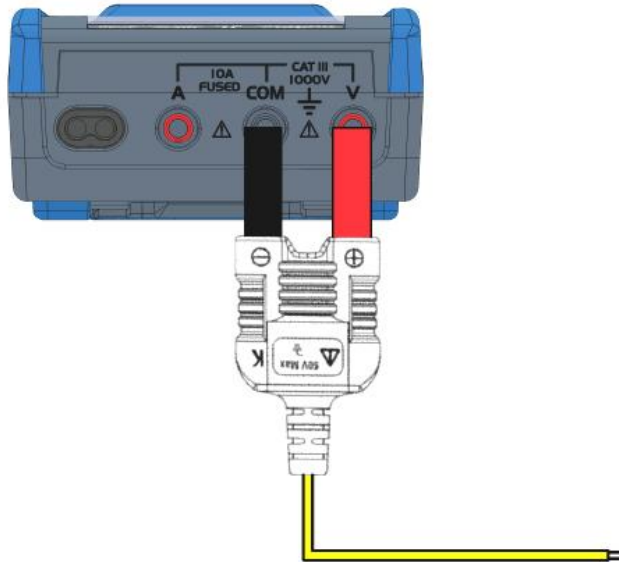

TK  
3 presses



Measurement of the temperature in °Celsius using a thermocouple between the V and COM terminals  
K thermocouple from -40°C to +1200°C  
or TCJ (J thermocouple) from -40°C to +750°C

Without a TK thermocouple, you can determine the ambient temperature inside the multimeter with a bridge between the V and COM terminals.

The keys of the navigator are used to change the scale of the graphic window.  
The scale selected is transcribed in the help line.

**TJ** Same measurement as TK

In TK and TJ, it is best to avoid subjecting the instrument to sudden changes of temperature, to preserve accuracy.



## How are the various quantities measured? (continued)

### 10. Measurement on an MLI type speed variator

The multimeter has a low-pass AC filter that blocks voltages or currents at undesirable frequencies.

The MLI filter is activated as follows:

Setup → Measurement → Filter YES: a symbol then appears on the screen.

Connecting the multimeter to filter a voltage >300Hz

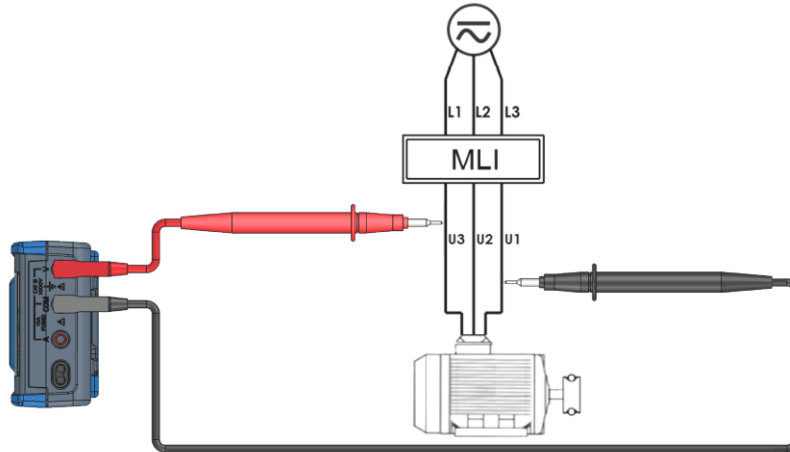

Connecting the multimeter to filter a current >300Hz

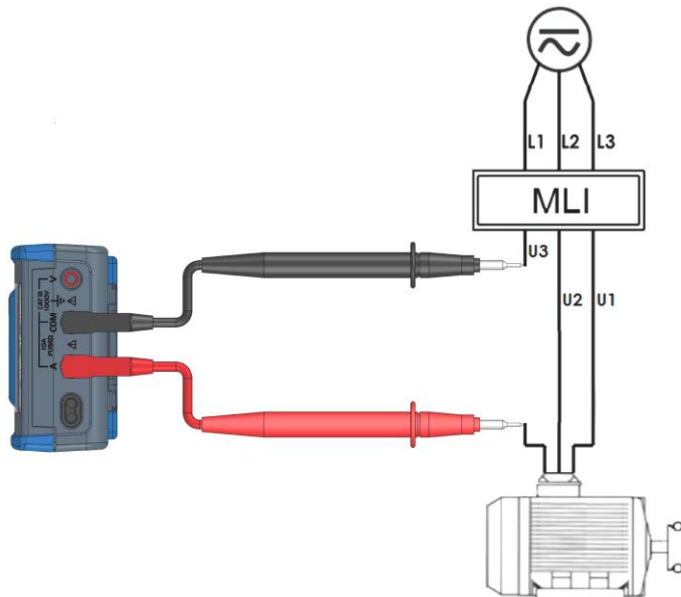

Icon: filter programmed

The multimeter continues the measurements in the chosen mode, AC, AC+DC, or VlowZ, but the signal goes through a filter that blocks undesirable voltages >300Hz.

The low-pass filter improves measurement performance on the composite sinusoidal signals often generated by inverters and variable-speed motors.

## How are the various quantities measured? (continued)

### 11. Surveillance mode



The **SURV** mode (available under **MEAS...**) monitors the variations of a signal, recording the extremes (**MIN** and **MAX**) of the main measurement and calculating its mean (**AVG**).

For each quantity stored, the multimeter records the corresponding date and time.

This mode is active for the following functions:

V, Hz, Ohm, clamp, capacitance, temperature, and current.

Integration time at least 200ms, programmable according to your configuration: **Start** → **Stop**, then look-up of the quantities on the screen, in a specific window.



It is possible to recover a screen grab of this window under our SX-DMM software, but this mode cannot be stored in the instrument.

👉 **Reset of the MIN/MAX values by a long press on MEAS...**

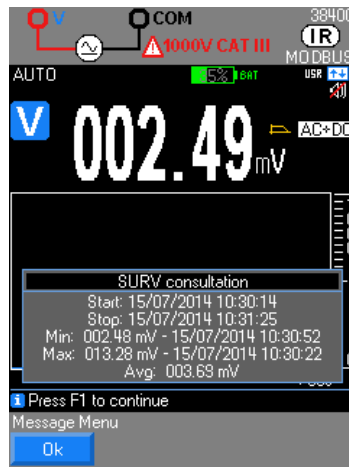

### PEAK



The rapid peak measurements are available in the **MEAS**, **MEAS+**, **PK+** and **PK-** secondary measurements for the following measurement functions: V and A (AC, AC+DC); integration time less than 250µs.

👉 **Reset of the values by a long press on MEAS...**

## How are the various quantities measured? (continued)

### 12. Graphic mode

This can be accessed by default under **Meas...** → **Trend** and is used to display the evolution of the quantity measured with respect to a fixed time scale >88s; the vertical scale may be automatic or manual (range selection).

This mode is available on all main functions measured.

### 13. RELative mode



This mode indicates that the value displayed is relative to a reference value.

It is available for the following measurement functions:  
V, Hz, Ohm, clamp, capacitance, temperature, and current.

### 14. SPEC mode



Using the internal technical specifications of the multimeter, the **SPEC** mode directly displays the tolerance on the measurement in progress, with no need to look for it and calculate it.

This mode is very useful for the metrology of the instrument.

### 15. MEAS+ mode

It gives access to the secondary measurements of the main measurement: a maximum of 3 secondary measurements can be displayed. Refer to the [Table of secondary measurements](#) in the Appendix.

This mode is available in **MEAS...** → **MEAS+** for the following measurement functions: V, Hz, Ohm, and current.

### 16. MATH mode

The MATH function  $y = Ax + B$  (A and B configurable in **Setup** → **Math** → **Coeff A** and **B**) enables the user, measuring an arbitrary physical quantity in:

- Volts (e.g.: process 0-10V or high-voltage probe)
- Amperes (4-20mA current loop or current clamp)
- Frequency (measurement of flow rates, speeds of rotation)
- Ohms (resistive position sensor)

to convert it and assign the appropriate unit so as to obtain a direct reading of the original quantity on the instrument.

It is available via **Meas...** → **MEAS+** → **MATH** under the following measurement functions: V, Hz, Ohm, and current.

## SX-DMM Software

### SX-DMM: Processing software

These multimeters can be interfaced directly with a PC or other computer using "SX-DMM" acquisition software:

In the "**General adjustments**" menu of the multimeter:

- Select infrared communication (**IR** is default) by the **Comm.** function or BT if BT version multimeter
- Select the Modbus communication protocol
- Parameterize the infrared transmission rate by the **IR baud** function: **9600/19200/38400** Baud.

👉 **The default transmission rate is 38400 Baud.**

The other transmission parameters are fixed (8 data bits, 1 stop bit, no parity).

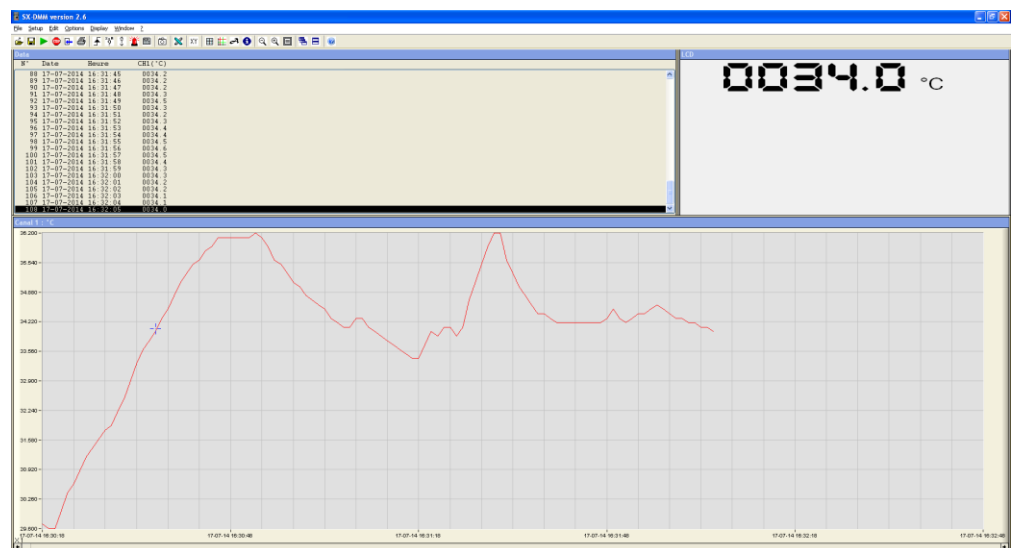

### Connection of the isolated USB optical lead supplied

1. Connect the isolated optical lead to the isolated optical input of the multimeter (on the side of the multimeter). Mechanical polarization prevents connection in reverse.

Connect the USB lead to one of the USB ports of the PC.

2. Install the USB driver on your PC (see the data sheet on the CD provided).

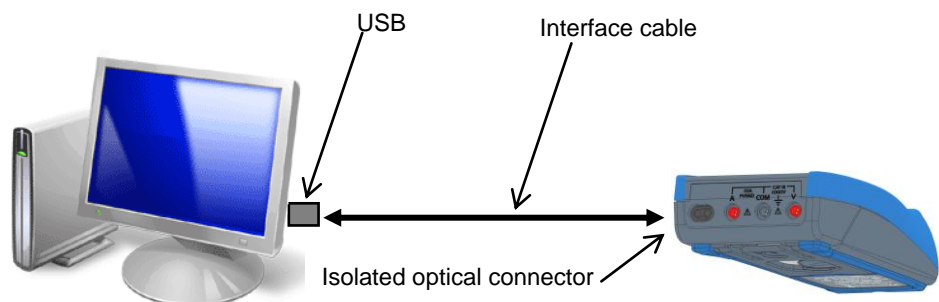

### Installing the "SX-DMM" software

1. Install the "SX-DMM" software on the PC using the CD.
2. Start the software for data acquisition and study the various display possibilities (curves, tables, etc.).

👉 The  symbol appears on the display unit when the instrument is controlled from the PC (REMOTE mode).

For more information, refer to the "Help" menu of the software.

# Bluetooth Module

## Bluetooth (on -BT version)

The -BT version multimeters are equipped with a Bluetooth module. They incorporate the Serial Port Profile service, making it possible to communicate with a computer equipped with any type of Bluetooth adapter. If your computer does not have a Bluetooth module, the USB/Bluetooth adapter for PC (ref. P0 1102112) will be necessary. For the installation of these drivers, refer to the data sheet that comes with them. Virtual RS232 serial communication between the multimeter (Server) and the PC (Client) requires the creation of a connection at the PC end. No configuration is necessary at the multimeter end, other than activation of Bluetooth communication (**BT**) using the **Comm.** function in the "**Util**" menu.

 **To activate connection with the multimeter, the Bluetooth identification code is: "0000".**

*(for first-time connection only)*

Step	Action
1	Switch the multimeter on.
2	Configure it for Bluetooth (BT) in the setup menu.
3	Create a new connection with the software driving your Bluetooth module at the PC end by:
	<ul style="list-style-type: none"> <li>clicking the <b>Bluetooth Manager</b> icon of the menu bar at the bottom of the screen</li> </ul>
	<ul style="list-style-type: none"> <li>selecting the "<b>Add a peripheral</b>" function</li> </ul>
	<ul style="list-style-type: none"> <li>selecting the <b>Bluetooth</b> peripheral of the multimeter, then clicking <b>Next</b></li> </ul>
	<ul style="list-style-type: none"> <li>clicking <b>Next</b> after configuring a COM port number x</li> </ul>

You can verify that the connection has in fact been created by viewing the icon associated with the multimeter in the window.

For more information, refer to the Help menu that comes with the Bluetooth utility.

*Example of creation of com4*

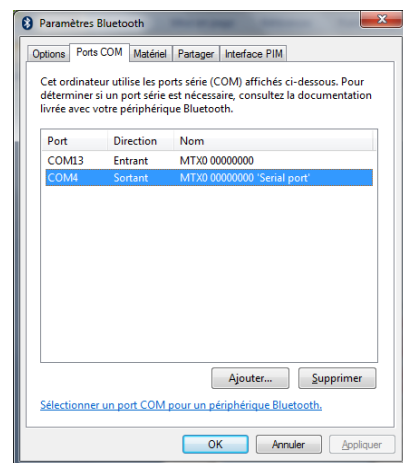
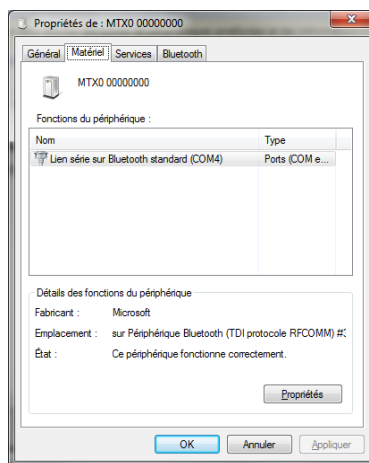

## Bluetooth Module (continued)

**Configuration of the link under SX-DMM with port COM4**

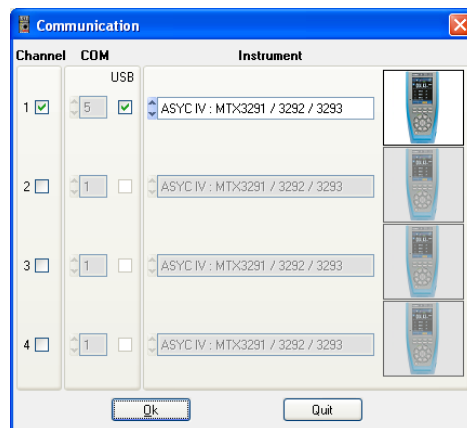

☞ **With some Bluetooth adapters, a reboot of the PC is recommended to validate the connection.**

**The connection parameters are specific to each multimeter. They must be assigned manually, the first time only.**

**Reactivation of the connection after an interruption or to look up the COM port number**

- Click the Bluetooth Manager icon of the menu bar at the bottom of the screen.
- Click the icon associated with the multimeter in the peripheral management window and note the COM port number created

**Communication with several multimeters**

The USB/Bluetooth adapter for PC makes it possible to communicate with several multimeters of the MTX Mobile family at once.

The connection procedure above must be repeated for each multimeter and a different COM port assigned to each of them.

## Technical characteristics of the MTX 3292, MTX 3293B

**Accuracy:** Only values with tolerances or limits are guaranteed values.  
 "n% L+n D" means Values without tolerances are given for guidance (standard NFC42670).  
 "n% of the reading + n Digit" The technical specifications are guaranteed only after 30 minutes of warming up. Except as otherwise indicated, they are valid from 5% to 100% of the measurement range.  
 (see CEI 485)

### DC voltage

In the "DC" mode, you measure a direct voltage or the DC component of an AC voltage.

The 100mV range is available only in manual mode, by "Range".

#### MTX 3292

Range	Input impedance	Resolution	Protection	Accuracy
100mV (*)	10MΩ/1GΩ	1μV	1,414 Vpk	0.1% L + 30 D
1,000mV	11MΩ/1GΩ	10μV		0.05% L + 8 D
10V	10.5MΩ	0.1mV		0.03% L + 8 D
100V	10MΩ	1.0mV		
1,000V	10MΩ	10mV		0.035% L + 8 D

- (\*) - REL mode activated (Δ measurement)
- Recovery after triggering of the protection (>10V) approx. 10 s.
- Protection 1 minute max.

Specifications valid from 0% to 100% of the range

Rejection: 100mV range	common mode: > 40dB at 50Hz and 60Hz
1V range	common mode: > 70dB at 50Hz and 60Hz
10V range	common mode: >100dB at 50Hz and 60Hz
	serial mode: > 60dB at 50Hz and 60Hz

Automatic or manual selection of the ranges

Protection by varistors

#### MTX 3293B

Range	Input impedance	Resolution	Protection	Accuracy
100mV (*)	10MΩ/1GΩ	1μV	1,414 Vpk	0.1% L + 30 D
1,000mV	10MΩ/1GΩ	10μV		0.05% L + 8 D
10V	10.5MΩ	0.1mV		0.02% L + 8 D
100V	10MΩ	1.0mV		
1,000V	10MΩ	10mV		0.03% L + 8 D

- (\*) - REL mode activated (Δ measurement)
- Recovery after triggering of the protection (>10V) approx. 10 s.
- Protection 1 minute max.

Specifications valid from 0% to 100% of the range

Rejection: 100mV range	common mode: > 40dB at 50Hz and 60Hz
1V range	common mode: > 70dB at 50Hz and 60Hz
10V range	common mode: >100dB at 50Hz and 60Hz
	serial mode: > 60dB at 50Hz and 60Hz

Automatic or manual selection of the ranges

Protection by varistors

# Technical characteristics of the MTX 3292, MTX 3293B (continued)

## AC and AC + DC voltages

With this function, the user can measure the true RMS (TRMS) value of an AC voltage with its DC component (no capacitive coupling) or without its DC component.

VAC RMS  
VAC+DC TRMS  
VLowZ

The 100mV range is available only in Manual mode, by " **Range**".

In the VAC & VAC+DC modes and for signals >1kHz, the range of uncertainty displayed is given for information only: we recommend using the formulas below.

VLowZ: The error should be slightly greater than the error in VAC.

### MTX 3292

Range	Input impedance	Resolution	Accuracy	
			45Hz to 1kHz	1 to 100kHz
100mV (*)	10MΩ	1μV	1% L ± 50 D	1%L + 0.1% x [F(kHz) - 1]L ± 50D
1,000mV	11MΩ	10μV	0.5% L ± 50 D	0.5%L+ 0.25% x [F(kHz) - 1]L ± 50D < 10kHz 2.75%L+ 0.04% x [F(kHz) - 10]L ± 50D > 10kHz
10V	10.5MΩ	0.1mV	0.3% L ± 50 D	0.3%L + 0.04% x [F(kHz) - 1]L ± 50D
100V	10MΩ	1mV	0.3% L ± 50 D	0.3%L+ 0.03% x [F(kHz) - 1]L ± 50D
1000V(**)	10MΩ	1mV	0.3% L ± 50 D	0.3%L+ 0.02% x [F(kHz) - 1]L ± 50D

(\*) not contractual indicative values (see curves below)

(\*\*) ⚠ limitation at high frequency

(\*\*) BP: Freq [kHz] limited to: 15,000/U input [V]

U input [V] limited to: 15,000/Freq [kHz]

Example: U input = 1,000 VAC → Max. frequency: 15,000/1,000 = 15kHz

In the presence of a DC component: additional error: (UDC/U measured)x(0.7% + 70 D)

Example: UDC = 2V, U measured = 5 Vrms → Additional error: 0.28% + 28 D

- Rejection: common mode >80dB at 50Hz or 60Hz depending on selection
- Automatic or manual selection of the ranges
- Protection by varistors
- Maximum acceptable permanent voltage: 1,414 Vpk
- Specifications valid from: 10 to 100% of the range in the band from 20kHz to 100kHz
- Influence of the peak factor on the accuracy in VAC, VAC+DC at 50% of the range: 1% for a peak factor <3.



As soon as the PEAK symbol appears, use the AUTO PEAK mode.

## Response curves

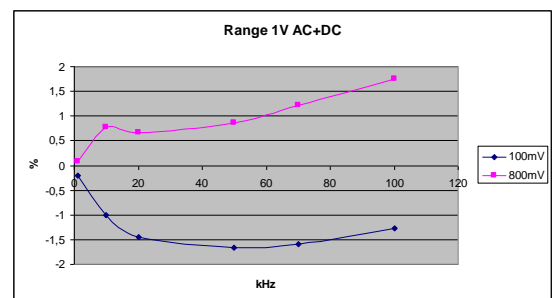
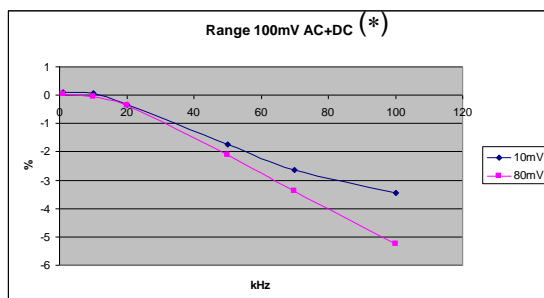



## Technical characteristics of the MTX 3292, MTX 3293B (continued)

VAC RMS  
VAC+DC TRMS  
VlowZ

The 100mV range is available only in Manual mode, by "**Range**".

In the VAC & VAC+DC modes and for signals >1kHz, the range of uncertainty displayed is given for information only: we recommend using the formulas below.

V<sub>LowZ</sub>: The error should be slightly greater than the error in VAC.

**MTX 3293B**

Range	Input impedance	Resolution	Accuracy		
			45Hz to 1kHz	1 to 100kHz	100 to 200kHz
100mV (*)	10MΩ	1μV	1% L ±50D	1%L + 0.05 % x [F(kHz) - 1] L ± 50D (*)	-
1,000mV	11MΩ	10μV	0.5% L ±40D	0.5%L + 0.2 % x [F(kHz) - 10] L ± 40D < 10 kHz 2.3%L + 0.02 % x [F(kHz) - 10] L ± 40D > 10 kHz	12%L ± 50D (*)
10V	10.5MΩ	0.1mV	0.3% L ±30D	0.3%L + 0.025 % x [F(kHz) - 1] L ± 30D	10%L ± 30D
100V	10MΩ	1mV	0.3% L ±30D	0.3%L + 0.05 % x [F(kHz) - 1] L ± 30D	8%L ± 30D
1,000V (**)	10MΩ	10mV	0.3% L ±30D	0.3%L + 0.05 % x [F(kHz) - 1] L ± 30D	-

(\*\*) ⚠ limitation at high frequency

(\*) not contractual indicative values (see curves below)

(\*\*) BP: Freq [kHz] limited to: 15,000/U input [V]

U input [V] limited to: 15,000/Freq [kHz]

🔗 Example: U input = 1,000 VAC → Max. frequency: 15,000/1,000 = 15kHz

In the presence of a DC component: Additional error: (UDC/U measured) x (0.7% L + 70 D)

🔗 Example: UDC = 2V, U measured = 5 Vrms → Additional error: 0.28% L + 28 D

- Rejection: common mode >80dB at 50Hz or 60Hz depending on selection
- Automatic or manual selection of the ranges
- Protection by varistors
- Maximum acceptable permanent voltage: 1,414 Vpk
- Specifications valid from: 10 to 100% of the range in the band from 20kHz to 200kHz
- Influence of the peak factor on the accuracy in VAC, V at 50% of the range: 1% for a peak factor < 3.



**As soon as the PEAK symbol appears, use the AUTO PEAK mode.**

Response curves

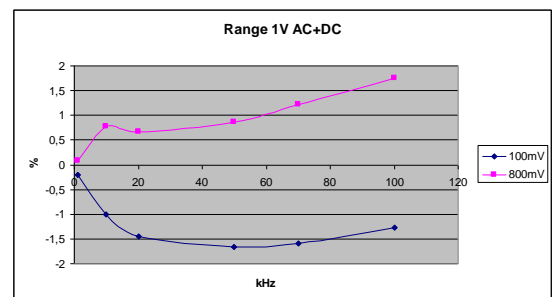
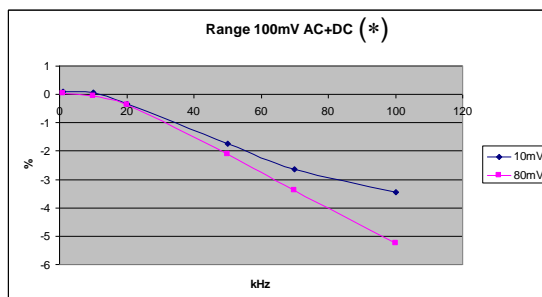

## Technical characteristics of the MTX 3292, MTX 3293B (continued)

### Currents

Three possible modes: DC, AC, AC+DC

In DC mode, you can measure a direct current or the DC component of an alternating current.

In the AC and AC+DC modes, you can measure the true RMS (TRMS) value of an alternating current with/without its direct component (no capacitive coupling in "DC" mode).

Fuse: ex.: SIBA/5019906/11A (10x38-11000-DMI-30kA-CR 1000V, very rapid action).

### DC

Range	Input impedance	Resolution	Protection	Accuracy
1,000µA	≈170Ω	10nA	11A 20A < 30s	0.1% L + 15 D
10mA	≈17Ω	0.1µA		0.08% L + 8 D
100mA	≈1,7Ω	1µA		0.15% L + 8 D
1,000mA	≈0.17Ω	10µA		0.5% L + 15 D
10A	≈0.03Ω (*)	100µA		
100A (**)		1,000µA		

(\*) with the fuse supplied with the device

(\*\*) 100A range limited to 20A

Specifications valid from 0% to 100% of the range

#### **Limiting condition on the current**

An overload of 20A is acceptable for 30 seconds max. with a pause of at least 5 minutes between measurements.

## Technical characteristics of the MTX 3292, MTX 3293B (continued)

### AC and AC+DC TRMS currents

Range	Input impedance	Resolution	Protection	Accuracy		
				45Hz to 1 kHz	1 to 20kHz	20 to 50kHz
1,000µA	≈170Ω	10nA	11A 20A<30s	0.5% L ±40 D	0.5% L + 0.25% x [F(kHz) -1] L ±30 D	-
10mA	≈17Ω	0.1µA		0.3% L ±30 D	0.3% L + 0.1% x [F(kHz) -1] L ±30 D	
100mA	≈1.7Ω	1µA		0.3% L ±30 D	0.3% L + 0.1% x[F(kHz) -1] L ±30 D	
1,000mA	≈0.17Ω	10µA		0.3% L ±30 D	0.3% L + 0.1% x [F(kHz) -1] L ±30 D	
10A	≈0.03Ω (*)	100µA		0.4% L ±400 D	0.4% L + 0.15% x [F(kHz) -1] L ±40 D	-
100A (**)		1,000µA		2.5% L ±40 D	2.5% L + 0.15% x [F(kHz) -1] L ±40 D	

(\*) with the fuse supplied with the device

(\*\*) 100A range limited to 20A

In the presence of a DC component:

Additional error:  $(I_{DC}/I_{measured}) \times (0.7\% L + 70 D)$

**A max. overload of 20A is acceptable for 30 s max. with a pause of at least 5 min between measurements.**

**From 7A, the measurement is limited to an ambient temperature of 40°C and a period of 1h30m, with a pause of at least 15 minutes between measurements. AUTO PEAK mode always activated.**

**Detection of peaks of which the duration exceeds 250µs**

mA and µA range:

Additional error 2% for a peak factor between 2.5 and 3

Additional error 15% for a peak factor between 3 and 4

10A range: Zero up to the peak factor of 2.5 at 100%

Specifications valid from 10% to 100% of the range for a sinusoidal current.

Protection 1000 VRMS by HBC ceramic fuse

Fuse 1,000V, 11A >18kA Cos φ >0.9 (10x38mm)

#### Voltage drop:

In 1mA Voltage drop approx. 160mVRMS

In 10mA Voltage drop approx. 180mVRMS

In 100mA Voltage drop approx. 180mVRMS

In 1,000mA Voltage drop approx. 210mVRMS

In 10A Voltage drop approx. 300mVRMS

## Technical characteristics of the MTX 3292, MTX 3293B (continued)

### Frequency

**Main frequency measurement**

**AC signals**

The user can measure a voltage or a current and its frequency simultaneously.

Range	Resolution	Protection	Accuracy
10 to 100 Hz	0,001 Hz	1414 Vpk	0,02 % ± 10 D
100 to 1000 Hz	0,01 Hz		
1000 Hz to 10 kHz	0,1 Hz		
10 to 100 kHz	1 Hz		
100 to 1000 kHz	10 Hz		
1 MHz to 5 MHz	100 Hz		

Range	Sensitivity (applicable only to rectangular signals)				
	100mV	1V	10V	100V	1000V
0 Hz to 10 Hz	-	-	-	-	-
10 Hz to 200 kHz	10 %	20 to 5%	5 %	5 %	5 % (*)
200 to 500 kHz	20 %	5 %	5 to 2 %	5 to 10 % (*)	5 % (*)
500 to 1000 kHz	-	5%	2 %	10 %	5 % (*)
1 MHz to 5 MHz			2 à 50 %		20 % (*)

(\*) Freq [kHz] limited to:  $15,000/U$  input [V]  
 U input [V] limited to:  $15,000/\text{Freq}$  [kHz]

(\*\*) limited to 200kHz

The measurement is made by capacitive coupling.

Manual selection of freq. range,  $F < 200\text{kHz}$  (default) or  $F > 200\text{kHz}$  by a short press.

Input resistance:  $\approx 10\text{M}\Omega$  (Freq  $< 100\text{Hz}$ )

Max. acceptable permanent voltage: 1,414 Vpk, see (\*)

Protection by varistors on the voltage input.

## Technical characteristics of the MTX 3292, MTX 3293B (continued)

### Secondary frequency measurement

Range	Resolution	Protection	Acceptable overload
10 to 100 Hz	0,001 Hz	0,02 % + 8 D	1450 Vcc (1 min max.) sur gamme 100 mV
100 to 1000 Hz	0,01 Hz		
1000 to 10 kHz	0,1 Hz		
10 to 100 kHz	1 Hz		
100 to 200 kHz	10 Hz		

Range	Sensitivity (applicable only to rectangular signals) Vrms				
	100mV	1V	10V	100V	1,000V
10 Hz to 200 kHz	15 % of the range		10 % of the range	10 % of the range	5 to 10 %
10 Hz to 10 kHz					
10 kHz to 30 kHz					

(\*) Freq limited to [kHz]:  $15,000/U$  input [V]  
 U input [V] limited to [V]:  $15,000/\text{Freq}$  [kHz]

(\*\*) at 50kHz for the «Ampere» range

The measurement is made by capacitive coupling.

Input resistance:  $\approx 10M\Omega$  (F <100Hz)

Protection by varistors on the voltage input.

## Technical characteristics of the MTX 3292, MTX 3293B (continued)

### Resistance

**Ohmmeter** In this setting, the user can measure a resistance.

Particular reference conditions:

The (+COM) input must not have been overloaded following the accidental application of a voltage to the input terminals with the switch set to  $\Omega$  or  $T^\circ$ .

If this happens, the return to normal may take about ten minutes.

Protection: 1,414 Vpk

Range	Accuracy	Resolution	Protection
1,000 $\Omega$	0.1% L + 8 D	10m $\Omega$	1,414Vpk
10k $\Omega$	0.07% L + 8 D	100m $\Omega$	
100k $\Omega$		1 $\Omega$	
1,000k $\Omega$		10 $\Omega$	
10M $\Omega$	1% L + 80 D	100 $\Omega$	
100M $\Omega$	3% L + 80 D R $\leq$ 50M $\Omega$	1k $\Omega$	

*For measurements above 5M $\Omega$ , a shielded lead is recommended. For a 2-wire link, use very short wires (<25cm) and twist them together.*

Automatic or manual range selection  
 "Active" protection by PTC thermistor  
 Measurement voltage: approx. 1.2V  
 Maximum open-circuit voltage: 3.5V typ.

**In the 100M $\Omega$  range, in order to avoid the influence of the mains and guarantee the stated specifications, it is best to disconnect the multimeter from the Wall Plug.**

### 100 $\Omega$ Measure

Range	Accuracy	Resolution	Protection
100 $\Omega$	0,2 % L + 10 D	0,01 $\Omega$	1414 Vpk

### Capacity

#### Capacitance meter

In this setting, the user can measure the capacitance of a capacitor.

Range	Operating range	Specified measurement range	Resolution	Intrinsic error	Measurement current	Measurement time
1nF	0 to 1.000nF	0.100 to 1.000nF	1pF	2.5% L $\pm$ 15D	<10 $\mu$ A	$\approx$ 400ms
10nF	0 to 10nF	0.1 to 10.00nF	10 pF	1% L $\pm$ 8D	<10 $\mu$ A	$\approx$ 400ms
100nF	0 to 100.0nF	1 to 100.0nF	0.1nF	1% L $\pm$ 8D	<50 $\mu$ A	$\approx$ 400ms
1,000nF	0 to 1,000nF	10 to 1,000nF	1nF	1% L $\pm$ 10D	<200 $\mu$ A	$\approx$ 0.125s/ $\mu$ F
10 $\mu$ F	0 to 10.00 $\mu$ F	1 to 10.00 $\mu$ F	0.01 $\mu$ F	1% L $\pm$ 10D	<200 $\mu$ A	$\approx$ 0.125s/ $\mu$ F
100 $\mu$ F	0 to 100,0 $\mu$ F	1 to 100.0 $\mu$ F	0.1 $\mu$ F	1% L $\pm$ 10D	<500 $\mu$ A	$\approx$ 0.125s/ $\mu$ F
1mF	0 to 1.000mF	0.1 to 1.000mF	1 $\mu$ F	1% L $\pm$ 15D	<500 $\mu$ A	$\approx$ 17s/mF
10mF	0 to 10.00mF	0.5 to 10.00mF	10 $\mu$ F	1.5% L $\pm$ 15D	<500 $\mu$ A	$\approx$ 17s/mF

*For measurements above 10nF, a shielded lead is recommended. For a 2-wire link, use very short wires (<25cm) and twist them together.*

(\*) Use the REL function for values <10% of the range in order to restore the residual zero (compensation for the capacitance of the leads)

Resolution 1,000 points  
 Automatic or manual range selection  
 "Active" protection by PTC thermistor  
 Maximum open-circuit voltage: 1V typ./4V max.

## Technical characteristics of the MTX 3292, MTX 3293B (continued)

### Diode test (in both modes)

Indication of the junction voltage in the forward direction, from 0 to 2.6V in a single range (10V range)

	Normal	Z Diode
Accuracy	2 % L ± 30 D	id.
Resolution	0,1 mV	10 mV
Measurement current	< 0,5 mA	< 11 mA
Max. open-circuit voltage	3,5 V max.	28 V
Indication of overshoot	In reverse direction	In reverse direction
“Active” protection by PTC thermistor	1,414 Vpk	1,414 Vpk

### Audible continuity

In this setting, you measure a resistance up to 1000Ω, with continuous 4kHz audible indication.

Range	Accuracy	Resolution	Protection
1000 Ω	0,1 % L + 8 D	100 mΩ	1414 Vpk

Detection threshold in continuity mode ≈20Ω (response time <10ms)

“Active” protection by PTC thermistor

Maximum open-circuit voltage: 3.5V 2V typ.

## Technical characteristics of the MTX 3292, MTX 3293B (continued)

### Temperature

#### Pt100/Pt1000

The user can measure the temperature by means of a Pt100/Pt1000 sensor.

Range	Measurement current	Resolution	Accuracy	Protection
-125°C to +75°C	<1mA (Pt100) <0.1mA (Pt1000)	0.1°C ---	± 0.5°C	1414 Vpk
-200°C to +800°C	<1mA (Pt100) <0.1mA (Pt1000)	0.1°C ---	0.1% L ± 1°C 0.07% L ± 1°C	

“Active” protection by PTC thermistor  
Display in °C/°F possible

#### J and K thermocouples

Function	Internal temperature	External temperature	
Type of sensor	Integrated circuit	K thermocouple	
Display range	1,000°C 1,000°F	1,000°C 1,000°F	10,000°C 10,000°F
Specified measurement domain	-10.0°C to +60.0°C +14.0°F to +140.0°F	-40.0°C to +999.9°C -40.0°F to +1,831.8°F	+1,000°C to +1,200°C +1,832°F to +2,192°F
Uncertainty (note 1)	±3°C ±5.4°F	1% L ±3°C 1% L ±5.4°F	1% L ±3°C 1% L ±5.4°F
Resolution	0.1°C 0.1°F	0.1°C 0.1°F	1°C 1°F
Thermal time constant (note 2)	0.7 min./°C	Depending on model of sensor	
Detection of sensor open-circuit	No	Yes: indication of the internal temperature although the external sensor is connected	

Note 1: The stated accuracy in external temperature measurement does not take into account the accuracy of the K thermocouple.

Note 2: Operation of the thermal time constant (0.7 min/°C):

If there is a sudden variation of the temperature of the multimeter, by 10°C for example, the multimeter will reach 99% of the final temperature at the end of 5 time constants, or 0.7min/°C x 10°C x 5 cts = 35 min (to which must be added the constant of the external sensor)

Protection: 1,414 Vpk



## Technical characteristics of the MTX 3292, MTX 3293B (continued)

### Rapid peak

Secondary quantities	Ranges	Additional error	Protection
Peak V t >500µs	100mV to 1,000V	3% L ± 50 D	1,414 V <sub>pk</sub>
Peak A t >500µs	1,000µA to 20A	4% L ± 50 D	

Specifications valid from 20% of the range in A, 10% of the range in V  
 The peak factor is calculated:  $CF = (Pk+ - Pk-)/2xV_{rms}$   
 Additional error for  $250\mu s < t < 500\mu s$ : 3%

### SURV

**MIN, MAX, AVG**

Remark: measurements time-stamped only on the **MTX 3292, MTX 3293B**  
 Accuracy and rate: same as Volt and Ampere measurement specifications

### dBm mode

Display of the measurement in dBm with respect to a resistance reference chosen by the user between 1Ω and 10kΩ (default value 600Ω).

Resolution	0.01dBm
Absolute error in dBm	0.09 x relative err. VAC expressed in %
Additional calculation error	0.01dBm
Measurement span	10mV to 1,000V
Protection	1,414 V <sub>pk</sub>

### dB mode

Display of the measurement in dB with the value measured when the mode was activated as voltage reference (V ref.).

Resolution	0.01dB
Absolute error in dB	0.09 x relative err. VAC expressed in %
Additional calculation error	0.01dB
Measurement span	10mV to 1,000V
Protection	1,414 V <sub>pk</sub>

### W ref resistive power

Display of the measurement in relative power with respect to a resistance reference chosen by the user between 1Ω and 10kΩ (default value 50Ω).

The function determined is:	$(\text{measured voltage})^2 / W \text{ Ref (W unit)}$ $(\text{measured current})^2 * W \text{ Ref (W unit)}$
Range	DC, AC and AC+DC
Resolution	100 µW
Accuracy	2 x accuracy in V <sub>DC</sub> /V <sub>AC</sub> expressed in %
Max. measurement voltage	1,000 V <sub>AC</sub> + DC
Protection	1,414 V <sub>pk</sub>
Unit of display	W

### VxA power

In AC and AC+DC voltage measurement: this calculation is limited to 400Hz.  
 The current measurement is always made in AC+DC.  
 Accuracy (typical)/Accuracy of V measurement + Accuracy of peak A measurement

👉 **The link to the COM input must be short and of large diameter, in order to limit the voltage drop that influences the Volt measurement.**

Protection: 1,414 V<sub>pk</sub>

## Technical characteristics of the MTX 3292, MTX 3293B (continued)

### Duty cycle DCY

Display of the measurement in % of a logical signal (TTL, CMOS, etc.)

DC+ duty cycle	= $\theta$
DC- Duty cycle	= $T-\theta$
Resolution	0.01%
Minimum duration for $\theta$	10 $\mu$ s
Maximum duration for T	0.8s
Minimum duration for T	200 $\mu$ s (5 kHz)
Nominal range	5 to 90% typical
Sensitivity (10V range)	> 10% of the range, Freq <1kHz > 20% of the range, Freq >1kHz
Absolute error on the duty cycle, expressed in % absolute	$\pm [0,1\% + 0,045\% \cdot (RC-50)]$ Freq < 1 kHz $\pm [0,5\% + 0,06\% \cdot (RC-50)]$ Freq > 1 kHz
Additional absolute error (slope at zero crossing)	0.1xC/P C = range in V or in A (for the 1,000V range, C = 5,000) P = slope in V/s A/s
Protection	1,414 Vpk

### Event counting CNT

Depending on frequency counter triggering conditions.

Minimum pulse width	5 $\mu$ s
Counting up to	99999
Triggering threshold	10% of the range except 1,000 VAC range
This threshold is:	positive in $\sqcup$ , negative in $\sqcap$

**For negative events, cross the leads.**

Protection	1,414 Vpk
------------	-----------

### Pulse width PW

Depending on frequency counter triggering conditions.

Resolution	10 $\mu$ s
Minimum pulse width	100 $\mu$ s
Accuracy	0.1% L $\pm$ 10 $\mu$ s
Maximum duration of a period	1.25 s (0.8Hz)
Triggering threshold	20% of the range except 1,000 VAC range

This threshold is positive in  $\sqcup$ , negative in  $\sqcap$ .

Additional error on the measurement due to the slope at the zero crossing:  
see §. Duty cycle, above.

**For negative events, cross the leads.**

Protection	1,414 Vpk
------------	-----------

### Time-stamp chronometer

Accuracy	approx. 30s/month (drift of real-time clock)
Resolution	1s
Display	hour/minute/second day/month/year

## Technical characteristics of the MTX 3292, MTX 3293B (continued)

### Variation in the nominal range of use

Quantity of influence Function	Temperature (Max. influence)	Range 10 V/m 500 MHz	Humidity	Voltage Primary battery 4.1 < U < 6.4 V Storage battery 4.1 < U < 5.5 V
$V_{DC}$	0,003 % / °C	nil		
$V_{AC+DC}$	0,05 % / °C	nil	influence	no influence
$V_{AC\ L\_Z}$	0,05 % / °C	nil	influence	no influence
Hz	0,003 % / °C	nil	nil	no influence
✎	0,015 % / °C	nil	(Objectif)	(Objectif)
$\Omega$ 10M/50M Cap	0,007 % / °C 0,14 % / °C 0,15 % / °C	nil		
mA <sub>DC</sub>	0,020 % / °C	nil		
mA <sub>AC+DC</sub>	0,05 % / °C	nil		
10 A <sub>DC</sub>	0,05 % / °C	nil		
10 A <sub>AC+DC</sub>	0,055 % / °C	nil		
Peak fast	0,025 % / °C	nil		
Loader	1,5 D / °C (Range mV)			

### Response of the filter

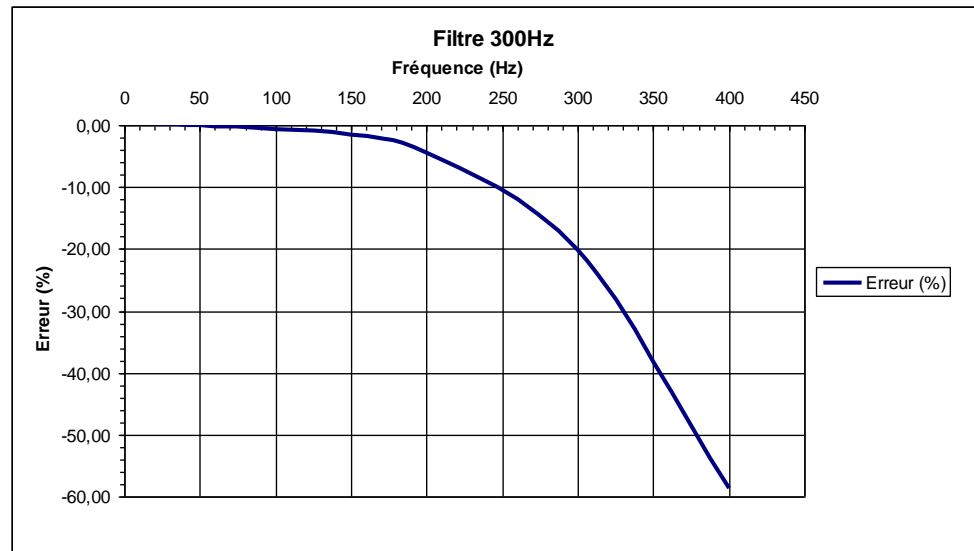

## General characteristics

### Environmental conditions

Altitude	<2000m
Reference range	23°C ±5°C
Specified range of use	0°C to 40°C
Influence of temperature	see §. Variation.
Relative humidity	0% to 80% from 0°C to 35°C 0% to 70% from 35°C to 40°C limited to 70% for the 5 and 50Ω ranges
Dust- and water-tightness	IP67 (in the event of immersion, under 1m of water for 30 mn, it is necessary to let the water flow off or to let the unit dry before putting it back into service).
Storage range	-20°C to 70°C

### Power supply (3 possibilities)

- Mains supply by 230V charger (±10%) /45Hz to 65Hz  
Voltage fluctuation between 207V and 253V  
**☝ There is a specific charger for the American market: 110V/60Hz.**
- Primary batteries: 4x1.5V nominal, LR6 Alkaline (or more if possible)  
Life: ≈100 h in VDC (ultra power)
- Storage batteries: 4x1.2V A-A storage batteries, NI-MH LSD 2400 Life: ≈80h (2400mAh). In order to optimize the life of the storage batteries, the charging of the multimeter with the charger is operational up to <35°C.

### Display

- 1 colour graphic LCD display unit, 320x240 pts, allowing the display of one main quantity and 3 secondary quantities or a graphic screen  
Dimensions of the display: 70x52mm useful
- The refresh rate of the display unit is 200ms.

### CE

#### Security

According to NF EN 61010-1:

- Insulation class 2
- Degree of pollution 2
- Use indoor
- Altitude < 2000 m
- Measurement category of the "measurement" inputs CAT III, 1000V with respect to earth
- Measurement category of the "measurement" inputs CAT IV, 600V with respect to earth

#### CEM

This instrument is designed in conformity with the EMC standards in force and its compatibility has been tested in accordance with the following standards:

- Emissions (cl. A) and Immunity NF EN 61326-1

## Mechanical characteristics

### Housing

- Dimensions 196 x 90 x 47.1mm
- Mass 570g
- Materials ABS V0
- Dust- and water-tightness IP67, according to NF EN 60529

## Supply

### supplied with the instrument

- Operating directions in 5 languages on CD-ROM with SX-DMM software
- Getting started guide on paper
- 1 set of safety leads (red and black) with double insulation probe tip (Ø of the probe tips: 4mm) 1,000V CAT III 20A
- 1 set of 4 AA/R6 Ni-MH storage batteries
- 1 230V external power supply charger
- 1 statement of manufacturer's measurements
- Optical USB communication lead
- 1 carrying case

### optional

- Current clamps (see CHAUVIN ARNOUX catalogue)
- Two-wire Pt100 temperature probe (HX0091)
- Two-wire Pt1000 temperature probe (HA1263)
- K thermocouple with banana adapter (P011021067)
- Metrology software for Windows (HX0059B)
- Set of rechargeable batteries (HX0051B)
- HV probe (SHT40KV)
- CMS clamp (HX0064)
- Bluetooth key (P011102112)
- Multifix adapter for DMM (P01102100Z)
- External charger for Ni-MH storage batteries (HX0053)

### spare

- Fuse 1,000V 11A >20kA 10x38mm  
(Get in touch with our Manumasure Regional Technical Centre)
- Kit of test accessories for DMM (P01295459Z)
- Carrying case with Multifix (HX0052C)

# APPENDIX

## Default configuration

- In **User** mode, the device restarts in the user's personal configuration (General and Measurement menus) and the function selected when switched off, but coupling in Volt function (AC+DC).
- In **Basic** mode, the default, the multimeter starts up in its elementary configuration (default values) and in the Volt function (AC+DC).

General	Language: yes Beep: yes Sleep: yes Lighting: ECO IR baud: 38400 Energy: Ni-MH Storage battery capacity: 2,400mAh Communication protocol: MODBUS	Communication: IR Configuration: basic
Measurement	Filter: NO dBm REF: 600Ω	Impedance: 10/20M W REF: 50Ω
Func. CLAMP, Func. MATH	Function: V Ratio: 1A/AV Function: V Coef. A: 1	Unit: A Unit: none Coef. B: 0
Func. MEM	Recording interval: Nb. of records 3292: 1000	1s Nb. Of records. 3293B: 6500
Main functions	V, A: AUTO, AC+DC Ω, Capacity: AUTO	Hz: 10V range ° C: ° C, Pt 100



**Restart configuration assumes no leads connected. If they are connected, they will be taken into account in the selection of the function.**

## Instructions before recharging the storage batteries

Before recharging, check that the device is equipped with all 4 storage batteries. It is not necessary to withdraw them to recharge them. If "Ni-MH" is selected in the Type of Energy menu (see paragraph), then charging is enabled. An attempt to charge with primary batteries in the device may damage the device. For safety reasons, the charging of the storage batteries is enabled only between: 0°C and 35°C.

Note: an elevation of the internal temperature by a current measurement may possibly trip the thermal safety.

In order to keep the storage batteries in good condition, use the multimeter until the min. level is reached before recharging.

Then connect the plug of the power supply unit (12 VDC) to the specific jack (illustration of the front panel).

Connect the power supply unit (12 VDC) to mains.

The symbol opposite on the display unit is used to monitor the course of the charging with a % of charge:

- battery charged → green symbol and 100%
- battery discharged → orange symbol, indicating charging recommended
- battery level at limit → red symbol and xx%
- battery level too low → blinking red symbol and % together with audible beep

The storage batteries are fully charged when the symbol is stabilized with 4 segments (each fixed plateau is acquired), after approximately 6 h.

The multimeters are delivered with 2400mAh Ni-MH storage batteries. These used storage batteries must be turned over to a recycling company or a company processing hazardous materials.

Never throw these storage batteries away with other solid waste.

For more information, contact your Manumessure agency.





Once the storage batteries are fully charged, the device stops automatically.

When the multimeter is delivered, it may happen that the storage batteries are discharged and require full recharging.

## APPENDIX (continued)

**Table of secondary measurements**

Display unit 1: mean measurement						Secondary display unit 1		Secondary display unit 2		Secondary display unit 3	
V AC V AC+DC	V DC	A AC A AC+DC	A DC	Hz	Ω	function	unit	function	unit	function	unit
X		X				FREQ	Hz	PER	S	MATH funct.	
X						FREQ	Hz	dB	dB	MATH funct.	
X						dBm	dBm	REF(dBm)	Ω	MATH funct.	
X		X				Pk+	V-A	Pk-	V -A	CF	
X	X	X	X			W	W	REF(Ω)	Ω	MATH funct.	
				X		PER	S	DC+	%	MATH funct.	
				X		PER	S	DC-	%	MATH funct.	
				X		PW+	S	CNT+		MATH funct.	
				X		PW-	S	CNT-		MATH funct.	
X	X	X	X	X	X	MATH funct.					
X	X					VxA	VA	A	A	MATH funct.	

- Key**
- MATH =  $y = Ax + B$
  - FREQ = frequency measurement
  - PER = measurement of the period
  - dB = measurement of decibel of voltage in dB
  - dBm = measurement of decibel of power in dBm with REF = dBm REF
  - Pk+ = measurement of positive peaks
  - Pk- = measurement of negative peaks
  - CF = measurement of the peak factor
  - w = calculation of the resistive power with REF = W REF
  - VxA = calculation of the power limited to 400Hz
  - DCY+ = measurement of positive duty cycle 
  - DCY- = measurement of negative duty cycle 
  - W+ = measurements of positive pulse widths or durations
  - PW- = measurements of negative pulse widths or durations
  - CNT+ = counting of positive pulses 
  - CNT- = counting of negative pulses 



06 - 2015  
X04066B02 - Ed. 01

**DEUTSCHLAND - Chauvin Arnoux GmbH**  
Ohmstraße 1, 77694 KEHL am RHEIN  
Tel: (07851) 99 26-0 - Fax: (07851) 99 26-60

**SCHWEIZ - Chauvin Arnoux AG**  
Moosacherstrasse 15 - 8804 AU / ZH  
Tel: 044 727 75 55 - Fax: 044 727 75 56

**UNITED KINGDOM - Chauvin Arnoux Ltd**  
Unit 1 Nelson Ct - Flagship Sq - Shaw Cross Business Pk  
DEWSBURY, West Yorkshire - WF12 7TH  
Tel: 01924 460 494 - Fax: 01924 455 328

**CHINA - Shanghai Pujiang Enerdis Instruments Co. Ltd**  
3 Floor, Building 1 - N° 381 Xiang De Road  
Hongkou District - 200081 SHANGHAI  
Tel: +86 21 65 21 51 96 - Fax: +86 21 65 21 61 07

**中国 - 上海浦江埃纳迪斯仪表有限公司**  
上海市虹口区祥德路381号3号楼3楼  
Tel: +86 21 65 21 51 96 - Fax: +86 21 65 21 61 07

**ITALIA - Amra SpA**  
Via Sant'Ambrogio, 23/25 - 20846 MACHERIO (MB)  
Tel: 039 245 75 45 - Fax: 039 481 561

**ESPAÑA - Chauvin Arnoux Ibérica S.A.**  
C/ Roger de Flor, 293 - 1a Planta - 08025 BARCELONA  
Tel: 902 20 22 26 - Fax: 934 59 14 43

**ÖSTERREICH - Chauvin Arnoux GmbH**  
Slamastrasse 29/24 - 1230 WIEN  
Tel: 01 61 61 9 61-0 - Fax: 01 61 61 9 61-61

**MIDDLE EAST - Chauvin Arnoux Middle East**  
P.O. BOX 60-154 - 1241 2020 JAL EL DIB (Beirut) - LEBANON  
Tel: (01) 890 425 - Fax: (01) 890 424

**SCANDINAVIA - CA Mätssystem AB**  
Sjöflygvägen 35 - SE 18304 TÄBY  
Tel: +46 8 50 52 68 00 - Fax: +46 8 50 52 68 10

**USA - Chauvin Arnoux Inc - d.b.a AEMC Instruments**  
200 Foxborough Blvd. - FOXBOROUGH - MA 02035  
Tel: (508) 698-2115 - Fax: (508) 698-2118

<http://www.chauvin-arnoux.com>

190, rue Championnet - 75876 PARIS Cedex 18 - FRANCE  
Tél. : +33 1 44 85 44 85 - Fax : +33 1 46 27 73 89 - [info@chauvin-arnoux.fr](mailto:info@chauvin-arnoux.fr)  
Export : Tél. : +33 1 44 85 44 86 - Fax : +33 1 46 27 95 59 - [export@chauvin-arnoux.fr](mailto:export@chauvin-arnoux.fr)