

VICTRIX

THERMAL IMAGING CLIP-ON SYSTEM

USER MANUAL

© 2019 AGM Global Vision. All rights reserved worldwide.

This documentation is subject to change without notice.

No parts of this manual, in whole or in part, may be copied, photocopied, translated, or transmitted by any electronic medium or in machine-readable form without the prior written permission of AGM Global Vision.

If you have questions that are not covered in this manual, or need service, contact AGM Global Vision customer support for additional information prior to returning a product.

AGM Global Vision

173 West Main Street

PO Box 962

Springerville, AZ 85938

Tel. 928.333.4300

Fax 480.393.4882

support@agmglobalvision.com

www.agmglobalvision.com

EXPORT INFORMATION

Buyer acknowledges that all products supplied by AGM Global Vision are subject to U.S. export control laws, including, but not limited to, the Export Administration Regulations, the International Economic Emergency Powers Act, and various U.S. embargoes and sanctions. AGM Global Vision products may not be exported, re-exported, or transferred contrary to U.S. export control laws. In particular, AGM Global Vision products may not be exported, re-exported, or transferred to prohibited countries, individuals, organizations, or entities, including but not limited to those individuals and entities listed on the List of Specially Designated Nationals and Blocked Persons administered or maintained by the U.S. Office of Foreign Assets Control ("OFAC"), the various lists maintained by the Bureau of Industry and Security of the Department of Commerce, and the U.S. State Department and Buyer represents and warrants that neither Buyer nor any of its officers, directors, or employees are on such lists. Distribution or resale by Buyer to such countries, individuals, organizations, or entities is expressly prohibited. Buyer has and will maintain a positive process to ensure compliance with this Section.

LIST OF CONTENTS

TITLE	PAGE
Safety Summary	4
1. GENERAL INFORMATION	6
1.1 System Description	6
1.2 Standard Components	9
1.3 Optional Equipment	10
1.4 Key Features	11
2. OPERATING INSTRUCTIONS	12
2.1 Installation and Mounting	12
2.2 Controls and Display Indicators	18
2.3 Operating Procedures	26
3. MAINTENANCE INSTRUCTIONS	29
3.1 Operator Troubleshooting	29
3.2 Maintenance	30
4. WARRANTY INFORMATION	32
4.1 Warranty Information and Registration	32
5. SPECIFICATIONS	34
5.1 Specifications	34
APPENDIX	37
A. Spare Parts List	37

SAFETY SUMMARY

- Read and follow all instructions
- Read all warnings
- Only use the attachments/accessories specified by the manufacturer
- All service must be provided by the manufacturer

WARNING:

Always make sure your firearm is unloaded before you place the equipment on the firearm. Verify that the chamber is empty, particularly if you stop the procedure and resume at a later time. Safe handling rules should be followed at all times.

WARNING:

If a scope is mounted too far to the rear of a weapon, the eyepiece can injure the shooter's brow. Shooting at an uphill angle also increases this risk, because it shortens the distance between the brow and the rear of the scope. When mounting your scope, we recommend positioning it as far forward in the mounts as possible.

With hard-recoiling rifles, serious injury or even death can result from eyepiece impact when discharging the firearm.

BEFORE SHOOTING THE FIREARM, verify that your installation provides sufficient space between the eyepiece and the scope to account for the recoil generated by your rifle.

NOTE: Give special attention to this warning when shooting uphill and/or from a prone position. These shooting conditions can dramatically reduce space allotted for recoil between your eyes and the weapon. PLEASE maintain maximum distance when shooting magnum firearms or firearms with heavy recoil. THE USER ASSUMES ALL RESPONSIBILITY AND LIABILITY FOR HAVING THE Clip-on PROPERLY MOUNTED TO A FIREARM AND USING THE Clip-on PROPERLY. ALWAYS CHECK THE CONDITION OF YOUR MOUNTING SYSTEM PRIOR TO USING YOUR FIREARM.

WARNING:

This product contains natural rubber latex, which may cause allergic reactions! The FDA has reported an increase in the number of deaths associated with sensitivity to natural latex proteins. If you are allergic to latex, learn which products contain it and strictly avoid exposure to those products.

WARNING:

Recommends that you use an eyecup on the eyepiece of the day scope, to allow for maximum comfort, space, and to remain undetected.

CAUTION:

- To prevent thermal damage to the equipment, never point it (whether ON or OFF) directly at the sun or any other source of high intensity light that the unprotected human eye cannot tolerate (such as a welding arc). To prevent accidental exposure to these types of sources, never leave the equipment around without the objective lens cap secured.
- DO NOT dismantle the equipment.
- Keep the equipment clean. Protect it from moisture, dramatic temperature changes, and electrical shocks.
- DO NOT force the equipment controls past their stopping points.
- DO NOT leave the equipment activated during periods of non-operation.
- DO NOT store the equipment without first removing the batteries.
- Thoroughly clean and dry all items before placing them into the storage case.
- To avoid deformation or damage, remove the light suppressor from the Victrix before placing the equipment in storage.
- Scope Mounting Systems are not recommended for installing the Victrix on firearms with dynamic recoil (0.308 Win or stronger).

NOTES:

- The optical axes of the Victrix and day scope should be aligned. The distance between the axes should not exceed 3 mm. If the difference in the axis heights of the Victrix and day scope above the weapon rail exceeds 3 mm, you will need to replace the day scope mounting rings or monoblock.
- To avoid losing unsaved data, DO NOT remove the batteries or disconnect the external power source while the Victrix is on.
- Inadvertent sun damage is not considered a defect in material or workmanship, and is therefore not covered in the product warranty.

1 GENERAL INFORMATION

1.1 SYSTEM DESCRIPTION

The Victrix clip-on system consists of two primary parts: a thermal imaging device and a mount. The equipment comes with the mount secured to the body of the device (as shown in Figure 1-1). The figure represents two versions of the device equipped with objective lenses with 38mm and 50mm focal length.

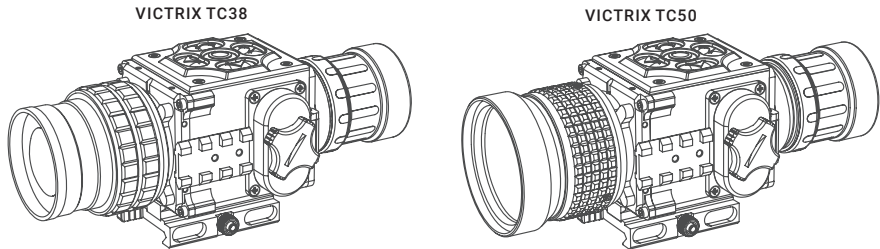

FIGURE 1-1. VICTRIX THERMAL IMAGING CLIP-ON SYSTEM

The Victrix is a thermal sensitive device. It can sense differences in heat emitted by objects in its field of view, and converts the received temperature pattern into a viewable image that represents the scene in black and white or a color pattern, depending on the selected image palette.

NOTE:

It is important that the Victrix sensor receive sufficient thermal contrast between the target and background area, or between the different parts of a target. For example, there would be a vast temperature contrast between the snow and any heat target (such as an animal), making it exceptionally easy to distinguish the target.

The Victrix is based on 17 um uncooled cameras that allow for improvements in overall image quality in a wide range of dynamic thermal environments.

To accommodate individual user needs, the Victrix has a variety of digitally controlled options such as:

- Display brightness, contrast, and sharpness
- Digital zoom
- Palette selection (color scheme)

Information on the current operating state (battery status, active profile, palette setting, the reticle running coordinate in the display etc.) is continuously displayed, making field operation of the Victrix simple and convenient.

Manufactured for exceptional durability, the Victrix has a lightweight and robust aluminum body. The clip-on is equipped with manual objective lens focusing.

Two side Picatinny/Weaver rails allow for the installation of an optional HD Video Recorder, WiFi Attachment, Extended Battery Pack, or other equipment.

An universal input/output connector enables an external video display (monitor, TV) or video recorder to be connected to the Victrix.

The Victrix is powered by two CR123A (2×3V) batteries that gives up to 5 hours of continues work. An external 6VDC/600mA power source can be connected to the Victrix. An external 5V power bank (battery pack) also can be easily connected via an USB connector for a significant increase of operating time.

The quick-release mount of the Victrix fits any Picatinny, MIL-STD-1913, or Weaver weapon rail. The mount’s lever-cam clamping device ensures quick, easy and reliable mounting and removal.

The Victrix is shown in Figure 1-2. The ITEM NO. column of Table 1-1 indicates the number used to identify items in Figure 1-2.

NOTE:

Here and below, the model Victrix with 50mm Lens is used for the example.

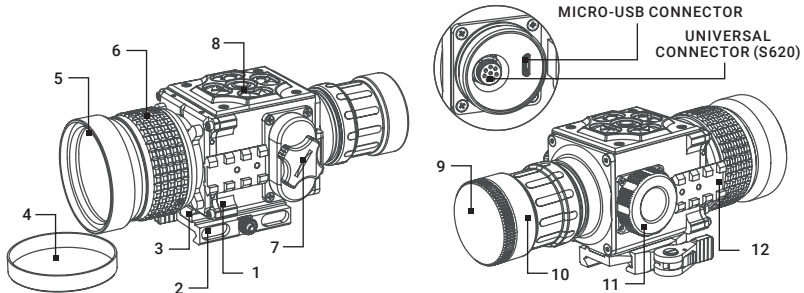

FIGURE 1-2. SYSTEM DESCRIPTION

TABLE 1-1. SYSTEM DESCRIPTION

ITEM	DESCRIPTION
1	Body
2	Mount
3	Riser
4	Objective Lens Cap
5	Objective Lens
6	Focus Ring

ITEM	DESCRIPTION
7	Battery Cap
8	Button Control Panel
9	Output Lens Cap
10	Output Lens
11	Connectors Cap
12	Side Picatinny/Weaver Rail

1.2 STANDARD COMPONENTS

The Victrix standard components are shown in Figure 1-3 and listed in Table 1-2. The ITEM NO. column indicates the number used to identify items in Figure 1-3.

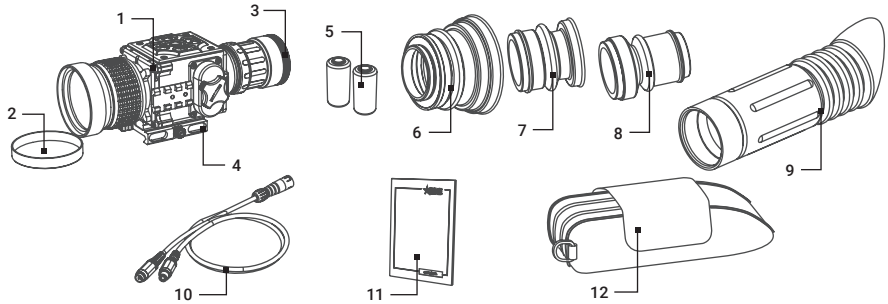

FIGURE 1-3. STANDARD COMPONENTS

TABLE 1-2. STANDARD COMPONENTS

ITEM NO.	DESCRIPTION	QUANTITY
1	Victrix Thermal Imaging Clip-On system	1
2	Objective Lens Cap	1
3	Output Lens Cap	1
4	Mount	1
5	CR123A Lithium Battery	2
6	Light Suppressor 1	1
7	Light Suppressor 2	1
8	Light Suppressor 3	1
9	Light Suppressor for Day Scope	1
10	Video Cable	1
11	Operation Manual	1
12	Carrying Case	1

1.3 OPTIONAL EQUIPMENT

Optional items are shown in Figure 1-4 and listed in Table 1-3.

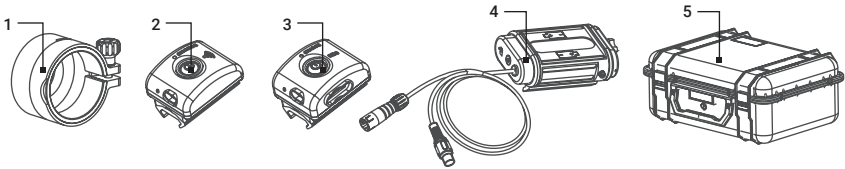

FIGURE 1-4. OPTIONAL EQUIPMENT

The ITEM NO. column indicates the number used to identify items in Figure 1-4.

The PART NO. column indicates the primary number used by the manufacturer, to identify an item.

TABLE 1-3. OPTIONAL EQUIPMENT

ITEM NO.	DESCRIPTION	PART NO.
1	Front Scope Mount 1 A mounting system used to install the Victrix on the lenses of specified day scopes. Includes a clamp with inserts that will fit 25.4 and 30 mm diameters.	6106SM11
-	Front Scope Mount 2 A mounting system used to install the Victrix on the lenses of specified day scopes. Includes a clamp with inserts that will fit 38 and 42 mm diameters.	6106SM21
-	Front Scope Mount 3 A mounting system used to install the Victrix on the lenses of specified day scopes. Includes a clamp with inserts for 46.7, 48, 48.7-49, 49.5, and 50 mm fitting diameters.	6106SM31
-	Front Scope Mount 4 A mounting system used to install the Victrix on the lenses of specified day scopes. Includes a clamp with inserts for 56, 57, and 58.7 mm fitting diameters.	6106SM41
-	Front Scope Mount 5 A mounting system used to install the Victrix on the lenses of specified day scopes. Includes a clamp with inserts for 62 mm fitting diameter.	6106SM51
2	AGM WiFi Attachment	6305WIF1
3	AGM HD Recorder	6305HDR1
4	AGM Extended Battery Pack	6308EXB1
5	Hard Case for Storage/Transportation	6610HCS1

1.4 KEY FEATURES

- Converts your day scope, sight, or binoculars into thermal imaging device
- Mounts in front of any day scope with no re-zeroing required
- High-performance thermal imaging camera
- Lightweight and robust design
- Easy to operate
- Manually adjustable objective lens
- Real-time display
- Digitally controlled features:
 - Image palette
 - Image brightness, contrast, and sharpness
 - Electronic magnification
 - Manual and Automatic Non-Uniformity Calibration (NUC)
 - Stadiametric rangefinder
 - Defective pixels repair
- Current operational state information display (battery status, palette setting)
- Analog video input and output
- Powered by two standard CR123A batteries
- Power input capability
- Digital HD video recorder (optional)
- External Wi-Fi module (optional)
- Fits any Picatinny, MIL-STD-1913, and Weaver rail with an adjustable quick-release mount
- Serviceability under severe conditions
- Filled with dry nitrogen to prevent internal fogging
- Waterproof
- Limited 3-year warranty

2 OPERATING INSTRUCTIONS

2.1 INSTALLATION AND MOUNTING

2.1.1 BATTERY INSTALLATION

CAUTION:

Verify that the equipment is OFF before installing the batteries.

To install the batteries (refer to Figure 2-1):

1. Turn the battery cover knob (A) counterclockwise and then open the battery cover (B).
2. Install two CR123A batteries (C) into the battery compartment. Align the polarity symbols on the batteries with the polarity symbols on the device body (D).
3. Close the battery cover. Turn the battery cover knob clockwise until stop.

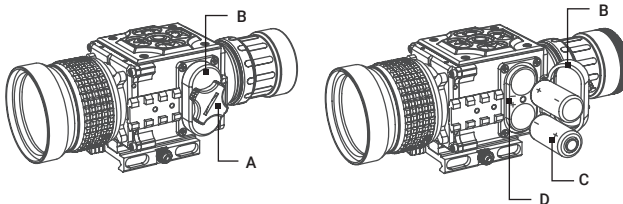

FIGURE 2-1. BATTERY INSTALLATION

When the device is on a battery charge level is displayed on the status bar (Figure 2-2).

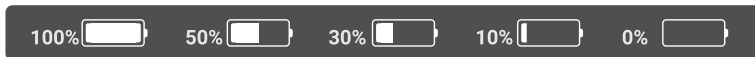

FIGURE 2-2. BATTERY STATUS BAR

WARNING:

Do not use rechargeable batteries since their use causes inaccurate battery level indication and possible disconnection during operation.

2.1.2 INSTALLING THE VICTRIX ON A PICATINNY/WEAVER RAIL

WARNING:

Always make sure your firearm is unloaded before you place the equipment on the firearm. Always verify that the chamber is empty, especially if you stop the procedure and resume later. Safe handling rules should be followed at all times.

WARNING:

AGM recommends that you use an eyecup on the day scope's eyepiece for maximum safety and comfort, as well as to escape detection.

NOTE:

The optical axes of the Victrix and day scope should be aligned. The distance between the axes should not exceed 3 mm. If the difference in the axis heights of the Victrix and day scope above the weapon rail exceeds 3 mm, you will need to replace the day scope mounting rings or monoblock.

The Victrix comes fully assembled with a Picatinny/Weaver mount (Figure 2-2).

The mount is (A) coupled with a riser (B) and attached to the Victrix seating rail (C) with two M4×20 flathead socket cap screws (D).

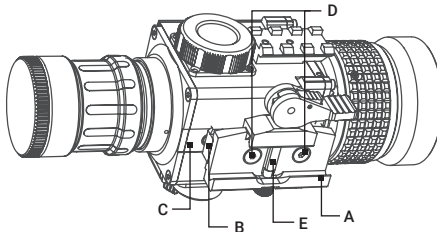

FIGURE 2-2. THE VICTRIX FULLY ASSEMBLED WITH THE MOUNT

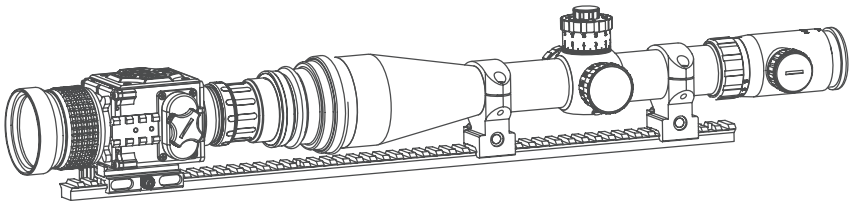

FIGURE 2-3. THE VICTRIX ON A PICATINNY RAIL IN FRONT OF A DAY SCOPE

Figure 2-3 shows the Victrix mounted in front of a day scope.

To install the Victrix on a Picatinny/Weaver rail, do the following:

1. Unscrew the output lens cap and place it in the storage case.
2. Remove the light suppressor from the storage case. Screw it into the thread of the output lens in place of the cap.

3. Unlock the clamping device (A) of the Victrix mount by pushing down on the lever holder (B, see Figure 2-4) and unlocking the cam lever (C).
4. Install the Victrix on the Picatinny/Weaver rail in front of the day scope so that the stop (E, see Figure 2-2) slides into one of the rail's transverse slot. The light suppressor should cover the day scope's objective lens.
5. Affix the Victrix to the rail by locking the cam lever (C, see Figure 2-4).

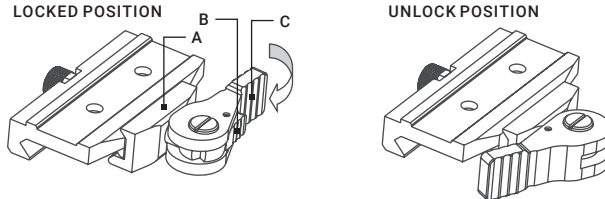

FIGURE 2-4. MOUNT. TOP VIEW

6. Verify that the clamping device is firmly secured to the Victrix. If necessary, adjust the clamping device as detailed in Part 2.1.3 (Clamping Device Adjustment).

2.1.3 CLAMPING DEVICE ADJUSTMENT

To adjust the mount's clamping device, do the following (refer to Figure 2-5):

1. Unlock the clamping device and remove the Victrix from the weapon.
2. To tighten/loosen the clamping device (B), push the cam (C) towards the arrow, which will cause the nut (A) to slide out of its hole. Turn the nut (A) CW/CCW respectively, in one-two increments (see note below). Backward-moving springs will cause the nut (A) to slide back into the hole.

NOTE:

The eight-sided nut of the clamping device will only fit into the hole if turned in one of the discrete positions using increments equal to $360^\circ/8$.

3. Verify that the adjusted clamping device is firmly secured to the Victrix.

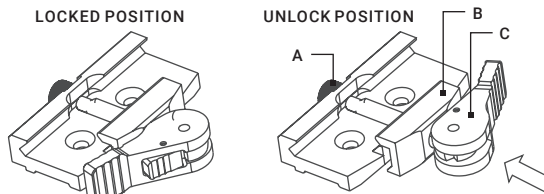

FIGURE 2-5. MOUNT. UNDERSIDE VIEW

2.1.4 INSTALLING THE VICTRIX ON THE LENS OF A DAY SCOPE

Use the optional Front Scope Mount (FSM) to install the Victrix onto day scope lenses.

NOTE:

The adapters differ in attaching diameters and must fit with the day scope parameters specified in Table 5-6 (Front Scope Mounts Data).

NOTE:

The Victrix cannot be attached to scopes that include focus rings on the housing of the objective lens.

CAUTION:

Front Scope Mounts are not recommended for installing the Victrix on firearms with dynamic recoil (0.308 Win or stronger).

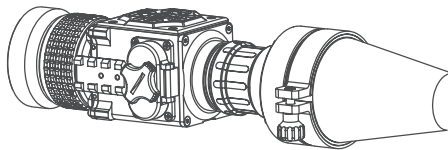

FIGURE 2-6. THE VICTRIX INSTALLED ON THE LENS OF A DAY SCOPE

Figure 2-6 shows the Victrix TC50-640 installed on the lens of a day scope.

Install the Victrix on the lens of a day scope as follows (refer to Figure 2-7):

1. Using a 2.5 mm Allen key, unscrew the M4×8 screws securing the Victrix mount. Remove the mount from the seating rail and place it, along with the screws, into the storage case.
2. Take off the output lens cap and put it into the storage case.
3. With the nut (B) loosened, place the insert (C) into the FSM's clamp (A).
4. Screw the FSM into the Victrix's output lens thread.
5. With the nut (B) loosened, slide the Victrix with the FSM onto the lens of the day scope as far as it goes.
6. Tighten the nut (B) using a screwdriver.

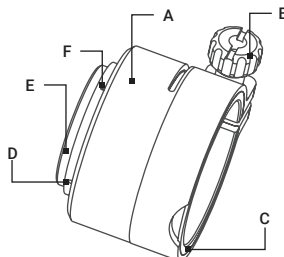

FIGURE 2-7. FRONT SCOPE MOUNT

If the position of the FSM's clamping nut is uncomfortable, change it as follows:

1. Decide on desirable position of the nut and estimate the angle through which the FSM should be turned CW (see Figure 2-8).
2. Remove the FSM from the Victrix.
3. Using a screwdriver, remove the M2×2.5 screws (F, see Figure 2-7) and then unscrew the ring (E).

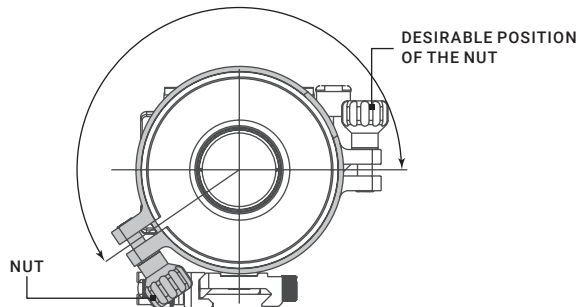

FIGURE 2-8. ESTIMATION OF THE FSM TURNING ANGLE

CAUTION:

To loosen the ring (E, Figure 2-7), use the two auxiliary non-threaded holes (D). DO NOT USE the threaded ones.

4. Using a lathe or other precision cutting tool, cut the inside face of the ring (E, Figure 2-7). The value of cuts (in millimeters) should be equal to the value of the turning angle (in angular degrees) divided by 360° .
5. Screw the ring (E) into the FSM's body with its cut end directed inwards. Tighten the screw.
6. After applying a small amount of thread lock to the threads, affix the ring (E) using the two M2×2.5 screws (F).

2.1.5 INSTALLING THE LIGHT SUPPRESSOR FOR A DAY SCOPE

The Light Suppressor for a Day Scope (A, Figure 2-9) slides over the eyepiece of your daytime scope (B). The suppressor can be used with scopes that have 40-43 mm eyepiece diameters and 100-120 mm eye relief.

The suppressor can be adjusted for the eye relief of your scope by cutting the rubber at the desired distance (C).

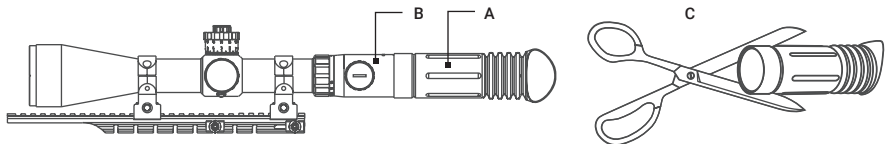

FIGURE 2-9. LIGHT SUPPRESSOR FOR A DAY SCOPE

2.1.6 INSTALLING ADDITIONAL EQUIPMENT

Use the side Picatinny/Weaver rail to install any additional equipment, such as the AGM HD Video Recorder, WiFi Attachment, or the Extended Battery Pack.

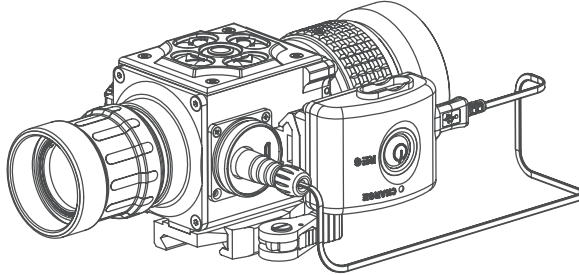

FIGURE 2-10. HD RECORDER INSTALLATION

2.1.7 CONNECTING AN ADDITIONAL EQUIPMENT

CAUTION:

Turn off the Victrix before removing the batteries or connecting/disconnecting any external equipment.

Remove the connector protective cap (see Figure 1-2).

Connect a cable of the external 5V battery bank to the Victrix Micro-USB connector.

Connect a cable of Digital Video Recorder, WiFi Attachment, or the Extended Battery Pack to the Victrix S620 universal connector.

Use the video cable plug (A, Figure 2-11) to connect an external video recorder/monitor/TV to the Victrix. Connect the video cable plug (C) to the Victrix S620 universal connector.

Use the video cable plug (B) to connect an external power source (6 VDC / 600 mA) to the Victrix. Connect the video cable plug (C) to the Victrix S620 universal connector.

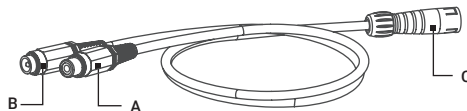

FIGURE 2-11. VIDEO CABLE

NOTE:

The external power supply must have a standard OD double-pole socket with a positive central contact.

CAUTION:

After removing the cable, replace the protective cap over the connector.

2.2 CONTROLS AND DISPLAY INDICATIONS

2.2.1 CONTROLS

CAUTION:

DO NOT force the equipment controls past their stopping points.

The Victrix controls are shown in Figures 2-12 and 2-14, and are defined in Tables 2-1 and 2-2. The ITEM NO. columns indicate the numbers used to identify items in the figures.

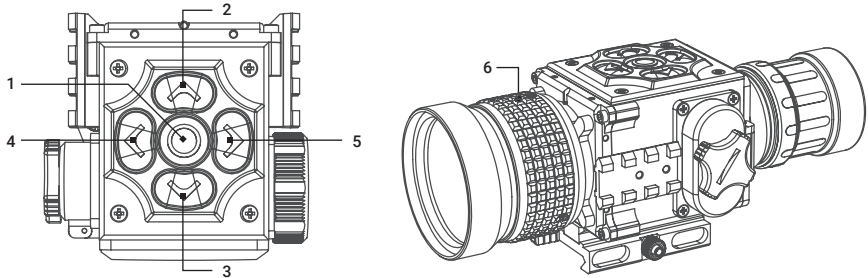

FIGURE 2-12. CONTROLS

TABLE 2-1. CONTROLS

ITEMS	CONTROLS	OPERATING MODE	FIRST SHORT PRESS	LONG PRESS
1	Central Button	Real time image	NUC	ON / OFF
		Quick menu	Exit Quick Menu	
		Main menu	Confirm selection	
2	Up Button	Real time image	Bring out quick menu	Enter main menu
		Quick menu	Change parameters	
		Main menu	Change parameters	
3	Down Button	Real time image	Bring out quick menu	NA
		Quick menu	Change parameters	
		Main menu	Change parameters	
4	Left Button	Real time image	Bring out quick menu	NA
		Quick menu	Switch function	
		Main menu	Select Setting Options	
5	Right Button	Real time image	Bring out quick menu	NA
		Quick menu	Switch function	
		Main menu	Select Setting Options	
6	Focus Ring	Focuses the objective lens for the sharpest image		

NOTE:

Various display symbols indicating the current operating state of the Victrix can be displayed permanently, may appear momentarily, or can be set to appear only when a certain function is activated.

NOTE:

Each button is responsible for some functions selected by short press or long press the button. Pushing a button for 3+ second is considered “long press.”

2.2.2 STATUS BAR

The status bar is located in the lower part of the display (Figure 2-8) and shows information about an actual operating status of the sight, including:

1. Color palette: WH (White Hot), BH (Black Hot), C1~C10.
2. Current digital zoom magnification.
3. Battery charge with current level in percent.

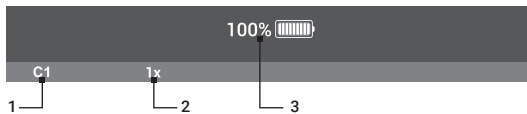

FIGURE 2-8. STATUS BAR

2.2.3 QUICK MENU

The Quick Menu allows change of basic settings. Enter the Quick menu with a short press of any button in Up/Down/Left/Right. To toggle between the functions below, press Left or Right button when Quick menu is in display. If select of Zoom, Palette, Brightness, Contrast, Sharpness functions do not take place in 5 second, the information disappear from display.



MANUAL (SILENT) CALIBRATION

Close the lens cover before calibration.

There is a mechanical shutter between the camera sensor and the lens. This shutter is used to perform a non-uniformity calibration (NUC). During NUC, the shutter presents a uniform temperature source to each detector element in the array. While imaging the flat-field source, the camera updates the offset correction coefficients, resulting in a more uniform image after the process is complete. The Victrix allows the user to manually trigger or interrupt scheduled NUC function.



BRIGHTNESS

Press the Up/Down buttons to change image brightness from 0~9.



PALETTE

Basic image mode is “White Hot” (C1). Press the Up/Down buttons to select palette C1~C10.



ZOOM

Press the Up/Down buttons to change digital zoom from 1X, 2X, 4X, and PIP. Picture in inset window under PIP mode is 2X digital zoom.



CONTRAST

Press the Up/Down buttons to change display contrast from 0~9.



SHARPNESS

Select one of the sharpness aside (Normal/Smooth/Sharp) with a short press of Up / Down.



STADIAMETRIC RANGEFINDER

Victrix clip-on is equipped with a stadiametric rangefinder which allows the user to estimate approximate distance to an object of known size.

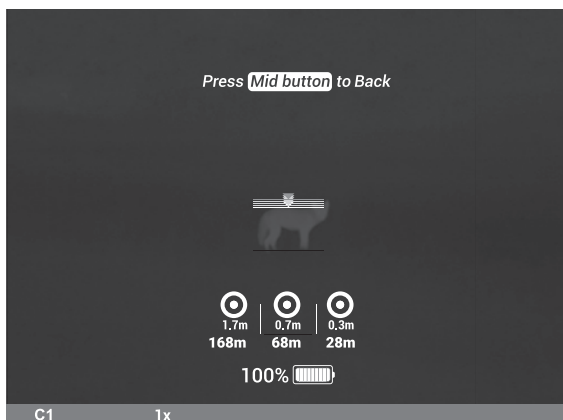

FIGURE 2-9. STADIAMETRIC RANGEFINDER

You will see on the display: measurement bars, icons of three reference objects and respective distances for the three objects.

There are three pre-set reference objects:

Object 1 - height 0.3 m

Object 2 - height 0.7 m

Object 3 - height 1.7 m

The lower fixed bar under the object automatically appear on display, press the Up/Down buttons to move the upper horizontal bar until the object fits entirely between the two lines. The distance to the object is automatically recalculated as you move the upper line.

Press Left/Right buttons to choose reference object, press Middle button to exit rangefinder mode, range information will not disappear from display automatically.

Distance to the object displays in status bar and a "> <" on reticle suggests the aiming point accordingly.

To select the unit of measurement (meters or yards), go to the respective menu option.

2.2.4 MAIN MENU

NOTE

Enter the main menu with a long press of the Up button. Press the Left/Right buttons to select between the main menu options.

All menu is displayed in the central area of the image. The reason is the reduced field of view of the day sight by higher magnifications. Reaching a low battery state the device gives a warning in the top left corner of the central area.



EXIT

Press the Up/Down button to Exit, the Main Menu will not disappear automatically.



AUTO NUC

Press the Up/Down button to turn Automatic Non-Uniformity Calibration On / Off. In the automatic mode the need for calibration is based on software algorithm, calibration starts automatically. When choose Off, user will do calibration manually by either lens cover (silent without shutter) or press middle button (with shutter). Manual calibration function is in Quick Menu.



OLED BRIGHTNESS

Press the Up / Down buttons to change LED brightness from 0, 1, 2.



UNIT

Press Up/Down to select units of measurement from Yards and Meters.



DEFECTIVE PIXEL REPAIR

Press Up/Down buttons then close lens cover to repair defective pixel. Defective pixels are found by software algorithm.





INFO

This option allows the user to view the following information about the imager.



RESET (RESTORE DEFAULT SETTING)

Press Up/Down buttons to Restore Default Setting, there will be no further indication.

The following settings will be restored to their original values before changes made by user:

- Electronic Zoom
- Image Brightness
- Image Contrast
- Image Sharpness
- OLED Brightness



ALIGNMENT

The Victrix is adjusted with accuracy from 0.1 mrad to 0.3 mrad on the laboratory test equipment.

The final accuracy depends on customer riflescope, its parallax and shooting distance.

The Victrix ensures the shooting precision tolerance within 3 to 7 cm at 100 m. To achieve better accuracy, use Alignment Correction option in the main menu (last icon).

The Victrix is preset in position: X:0, Y:0.

When the point of impact with Victrix is on the Right side of previous point of impact (previous aiming position), change value X (X- => pressing Down button), decrease X value, and vice versa.

When the point of impact with Victrix is on the Up side of previous point of impact (previous aiming position), change value Y (Y- => pressing Down button), decrease Y value, and vice versa.

While using the Alignment Correction is shown value of axis X (horizontal) and Y (vertical). One step means 0.58 MOA (1.67cm on 100m).

MANUAL FOR ELECTRONIC ACCURACY CORRECTION

- 1) Aim your day scope to the middle of target and shoot. This action will test the control of day scope accuracy.
- 2) Mount the Victrix on the riflescope. Aim to the target and shoot again.
- 3) Measure horizontal (x) and vertical distance (y) between shoot and aiming position from step 2.
- 4) Press Up button within few seconds to enter the main menu, and you will see the Alignment Correction as the last icon of the menu.

Press Up button to enter this sub-menu.

5) Press Left or Right button to move between X, Y and EXIT. Press Up button to change positive value (X+, Y+), and press Down button to change negative value (X-, Y-).

6) Press EXIT, Up or Down button to save settings.

7) Check if the value was saved correctly.

After mounting of clip-on to the weapon with day scope the clip-on optical axis can be offset off scope optical axis.

Enter submenu of "Alignment" with a short press of Up/Down and you will see:

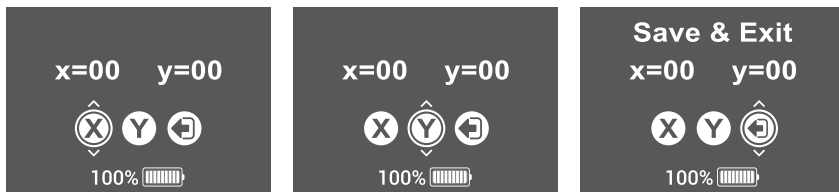

If the red cross mark of clip-on does not match with central mark of day scope reticle you need shift the image to align the marks.

While using the Alignment Correction is shown value of axis X (horizontal) and Y (vertical), one step means 0.58 MOA (1.67cm on 100m) for horizontal alignment and 0.4 MOA (1.7cm on 100m) for vertical alignment.

2.3 OPERATING PROCEDURES

2.3.1 OPERATING



WARNING:

Always make sure your firearm is unloaded before you place the equipment on the firearm. Always verify that the chamber is empty, especially if you stop the procedure and resume later. Safe handling rules should be followed at all times.

CAUTION:

DO NOT force the equipment controls past their stopping points.

CAUTION:

To prevent thermal damage to the equipment, never point it (either power is on or off) directly at the sun or any other source of high intensity light that the unprotected human eye cannot tolerate (such as a welding arc). To prevent accidental exposure to these sources, never leave the equipment around without first securing the objective lens cap.

Operating procedures are as follows:

1. Remove the Victrix from the carrying case.
2. Install the Victrix on the weapon with a day scope. Refer to Parts 2.1.2-2.1.4 for installation procedures.
3. Verify that the Victrix is securely mounted to the weapon or scope.
4. Remove the protective caps.
5. Point the equipment at an object.
6. Activate the Victrix by long press the central button. After approximately 3 sec, video of the thermal scene should appear.
7. If the day scope includes a focusing ring (i.e., parallax adjustment knob), adjust the focus for a parallax-free image.
8. Turn on the day scope's reticle illumination and adjust the reticle brightness.
9. Adjust the focus of Victrix by turning the focus ring (CW for far focus, CCW for near focus).
10. Using the QUICK MENU, configure the Victrix to adapt it to your situation.

For more information on operational setting procedures, see Part 2.2 (Controls and Display Indications).

- A. Select the Image Palette.
- B. Adjust the image brightness, contrast and sharpness for your comfort.
- C. Use digital zoom to magnify the central area of the displayed scene.

NOTE:

Digital zoom allows distant objects to appear larger; however, the resolution will be compromised.

D. Use Manual Calibration (Non-Uniformity Calibration - NUC) function to improve image quality. As the camera including the detector heats up during the use, the detector pixels will drift. The pixels do not drift uniformly. The camera software compensates for the drift up to an accurate position point, but when the limit is reached the NUC function is triggered. A uniform mechanical shutter is placed between the lens and the detector for a moment and the signal is processed.

Push the central button to manually trigger a NUC.

E. Adjust the necessary adjustment using the MAIN MENU. See Part 2.2.2 (Using the MAIN MENU).

11. To align the barrel of the weapon, place the reticle on the desired target. To allow for the bullet's travel (i.e. bullet drop, windage, and the target mobility), adjust the boresight of the day scope.

CAUTION:

DO NOT leave the equipment activated when not in use.

2.3.2 VICTRIX SHUT-DOWN

NOTE:

Shut down the Victrix to properly to avoid losing unsaved settings and data.

Shutdown the Victrix as follows:

1. Turn off the Victrix.
2. Replace the cap on the objective lens.
3. Disconnect the cable (if applicable).
4. Place the cap on the connector.
5. Dismount the Victrix from the weapon.
6. Remove the batteries.

CAUTION:

Do not store the Victrix with the batteries still installed.

7. Store the Victrix and all accessories in the carrying case.

3 MAINTENANCE INSTRUCTIONS

3.1 OPERATOR TROUBLESHOOTING

The purpose of troubleshooting is to identify the most frequent equipment malfunctions, probable causes, and corrective actions required.

Table 3-1 lists the common malfunctions that may be found during the operation or maintenance of the Victrix. Perform the tests/inspections and corrective actions in the order listed.

This table does not list all of the malfunctions that may occur with your device, or all of the tests and corrective actions that may be necessary. If you experience an equipment malfunction that is not listed, or is not fixed by the corrective actions listed in the table, please contact Customer Service center.

TABLE 3-1. OPERATOR TROUBLESHOOTING

MALFUNCTION	PROBABLE CAUSE/ TEST/ INSPECTION	CORRECTIVE ACTION
The Victrix fails to activate.	Batteries are missing or improperly installed.	Insert batteries or install correctly.
	Batteries are dead.	Replace the batteries.
	Batteries, surfaces, or contacts are dirty or corroded.	Clean the contact surfaces with a pencil eraser and/or alcohol and cotton swabs.
	The equipment is damaged.	Please contact Customer Support.
The Victrix is not responsive to control buttons.	The equipment is damaged.	Please contact Customer Support.
Poor image quality.	Check objective lens focus.	Refocus.
	Check for fogging or dirt on objective lens and output lens.	Clean the lenses as detailed in Part 3.2.2.
	The equipment is damaged.	Please contact Customer Support.
No image on an external monitor.	Video cable is damaged.	Replace the video cable with a new one. Please contact Customer Support.
	The equipment is damaged.	Please contact Customer Support.
Light is visible around light suppressor.	Check suppressor resilience.	If the suppressor is defective, please contact Customer Support.

3.2 MAINTENANCE

3.2.1 GENERAL

The Victrix operator maintenance consists of operational tests, inspections for unit serviceability, cleaning and mounting procedures, corrective actions (troubleshooting and replacement of a limited number of parts). Maintenance instructions covered elsewhere in this manual (troubleshooting, etc.) are not repeated in this section.

CAUTION:

The Victrix is a precision electro-optical instrument and must be handled carefully at all times to prevent damage.

CAUTION:

DO NOT dismantle the equipment.

3.2.2 CLEANING PROCEDURES

Clean the Victrix and optional items as follows:

1. Gently brush off any dirt from the equipment using only a clean, soft cloth.
2. Moisten the cloth with fresh water and gently wipe the external surfaces (except for optical surfaces).
3. Dry any wet surfaces (except for optical surfaces) with another clean, dry soft cloth.
4. Using a lens brush, carefully remove all loose dirt from optical surfaces (objective lens and output lens).
5. Slightly dampen a cotton swab with alcohol and gently wipe optical surface. Clean the optical surface using circular movements, starting from the center and moving out towards the edge. Do not touch the lens holder. Change the cotton swab after each circular stroke. Repeat until the optical surface is clean.
6. Clean the battery contact surfaces and contact springs with a pencil eraser and/or alcohol and cotton swabs.

CAUTION:

Thoroughly dry all items before placing them into the storage/carrying case.

4 WARRANTY INFORMATION

4.1 WARRANTY INFORMATION AND REGISTRATION

4.1.1 WARRANTY INFORMATION

This product is guaranteed to be free from manufacturing defects in material and workmanship under normal use for a period of three (3) years from the date of purchase. In the event that a defect covered by the warranty below occurs during the applicable period stated above, AGM Global Vision, at its discretion, will either repair or replace the product; such action on the part of AGM Global Vision shall be the full extent of AGM Global Vision's liability, and the Customer's sole and exclusive reparation. This warranty does not cover a product if it has been (a) used in ways other than its normal and customary manner; (b) subjected to misuse; (c) subjected to alterations, modifications or repairs by the Customer or by any party other than AGM Global Vision without prior written consent of AGM Global Vision; (d) is the result of a special order or categorized as "close-out" merchandise or merchandise sold "as-is" by either AGM Global Vision or the AGM Global Vision dealer; or (e) merchandise that has been discontinued by the manufacturer and either parts or replacement units are not available due to reasons beyond the control of AGM Global Vision. AGM Global Vision shall not be responsible for any defects or damage that in AGM Global Vision's view are a result from the mishandling, abuse, misuse, improper storage or improper operation of the device, including use in conjunction with equipment that is electrically or mechanically incompatible with, or of inferior quality to, the product, as well as failure to maintain the environmental conditions specified by the manufacturer. This warranty is extended only to the original purchaser. Any breach of this warranty shall be enforced unless the customer notifies AGM Global Vision at the address noted below within the applicable warranty period.

The customer understands and agrees that except for the foregoing warranty, no other warranties written or oral, statutory, expressed or implied, including any implied warranty of merchantability or fitness for a particular purpose, shall apply to the product. All such implied warranties are hereby and expressly disclaimed.

4.1.2 LIMITATION OF LIABILITY

AGM Global Vision will not be liable for any claims, actions, suits, proceedings, costs, expenses, damages, or liabilities arising out of the use of this product. Operation and use of the product are the sole responsibility of the Customer. AGM Global Vision's sole undertaking is limited to providing the products and services outlined herein in accordance with the terms and conditions of this Agreement. The provision of products sold and services performed by AGM Global Vision to the Customer shall not be interpreted, construed, or regarded, either expressly or implied, as being for the benefit of or creating any obligation toward any third party of legal entity outside AGM Global Vision and the Customer; AGM Global Vision's obligations under this Agreement extend solely to the Customer. AGM Global Vision's liability hereunder for damages, regardless of the form or action, shall not exceed the fees or other charges paid to AGM Global Vision by the customer or customer's dealer. AGM Global Vision shall not, in any event, be liable for special, indirect, incidental, or consequential damages, including, but not limited to, lost income, lost revenue, or lost profit, whether such damages were foreseeable or not at the time of purchase, and whether or not such damages arise out of a breach of warranty, a breach of agreement, negligence, strict liability, or any other theory of liability.

4.1.3 PRODUCT REGISTRATION

In order to validate the warranty on your product, the customer must complete and submit AGM Global Vision PRODUCT REGISTRATION FORM on our website (www.agmglobalvision.com/customer-support).

4.1.4 OBTAINING WARRANTY SERVICE

To obtain warranty service on your unit, the End-user (Customer) must notify the AGM Global Vision service department via -email. Send any requests to support@agmglobalvision.com to receive a Return Merchandise Authorization number (RMA). When returning any device, please take the product to your retailer, or send the product, postage paid and with a copy of your sales receipt, to AGM Global Vision's service center at the address listed above. All merchandise must be fully insured with the correct postage; AGM Global Vision will not be responsible for improper postage or merchandise that becomes lost or damaged during shipment. When sending product back, please clearly write the RMA# on the outside of the shipping box. Please include a letter that indicates your RMA#, the Customer's Name, a Return Address, reason for the return, contact information (valid telephone numbers and/or an e-mail address), and proof of purchase that will help us to establish the valid start date of the warranty. Product merchandise returns that do not have an RMA# listed may be refused, or a significant delay in processing may occur. Estimated Warranty service time is 10-20 business days. The End-user/Customer is responsible for postage to AGM Global Vision for warranty service. AGM Global Vision will cover return postage/shipping after warranty repair to the End-user/Customer only if the product is covered by the aforementioned warranty. AGM Global Vision will return the product after warranty service by domestic UPS Ground service and/or domestic mail. Should any other requested, required, or international shipping methods be necessary, the postage/shipping fee will be the responsibility of the End-user/Customer.

For service, repair or replacement, please contact:

AGM Global Vision

173 West Main Street

PO Box 962

Springerville, AZ 85938

Tel. 928.333.4300

Fax 480.393.4882

support@agmglobalvision.com

www.agmglobalvision.com

5 SPECIFICATIONS

5.1 SPECIFICATIONS

TABLE 5-1. SYSTEM DATA

ITEM		DATA
Magnification		Unity (1x)
Objective Lens Type		Germanium
Detector		17 μ m Uncooled Microbolometer
Resolution		384 x 288
Frame Rate		50 Hz
Display		HD Display 1024 x 768
Turn-on Time, max		3 sec
Temperature Imaging Modes (Image Palettes)		11 Image palettes
Boresighting	Accuracy	Factory aligned to 1 MOA or better
	Retention	Permanent to within 2 MOA or better
	Repeatability	Within 2 MOA
Interfacing		<ul style="list-style-type: none"> • Micro-USB (Power bank 5V) • Universal S620 connector (Power In, Analog Video In/Out, Wi-Fi Attachment, HD Recorder, Extended Battery Pack)

TABLE 5-2. OPTICAL DATA

ITEM		VICTRIX TC38	VICTRIX TC50
Field of View	- ang. X degrees	9.8	7.5
	- ang. Y degrees	7.4	5.6
Objective Focal Length		38 mm	50 mm
Objective F-number		1:1	1:1
Exit Pupil Diameter		27 mm	40 mm
Focus Method		Manual	Manual
Focusing Range		5 m to inf.	5 m to inf.

TABLE 5-3. ELECTRICAL DATA

ITEM	DATA
Battery	Two CR123A 3V Lithium batteries
Current Consumption, maximum	320 mA
Battery Life at 20°C (68 °F)	Up to 5 hr.
External Power Supply	Power bank (5V) via Micro-USB port; Extended battery pack (additional operating time up to 8 hr.) or 6V/600 mA power supply via S620 universal connector

TABLE 5-4. MECHANICAL DATA

ITEM	VICTRIX TC38	VICTRIX TC50
Weapon Mount Type	Picatinny MIL-STD-1913 and Weaver Rails	
Overall Dimensions	181 × 84 × 64 mm (7.1 × 3.3 × 2.5 in)	190 × 84 × 64 mm (7.5 × 3.3 × 2.5 in)
Height of the Scope Axis above Rail	40 mm (1.57 in)	
Weight (w/o Batteries)	0.59 kg (1.3 lb)	0.68 kg (1.5 lb)

TABLE 5-5. ENVIRONMENTAL DATA

ITEM	DATA
Operating Temperature	-40 to +50°C (-40 to +122°F)
Storage Temperature	-50 to +70°C (-58 to +158°F)
Recoil Resistance	700g
Environmental Rating	Waterproof

TABLE 5-6. FRONT SCOPE MOUNTS DATA

SCOPE MOUNTING SYSTEM	DIAMETER OF THE INSERTS, MM	CLEAR APERTURE OF DAY SCOPE LENS, MM	EXAMPLE OF THE SCOPES
Front Scope Mount 1	25,4	20; 24	Leupold 1.5-5x20 PR
	30,0		Leupold 1.5-5x20 MR/T M2; Zeiss 1.1-4x24T
Front Scope Mount 2	38,0	32; 36	Meopta Artemis 2000 4x32
	42,0		Leupold Mark 4 3-9x36; Leupold Mark 4 2.5-8x36; Kahles 4x36
Front Scope Mount 3	46,7	40; 42	Leupold 3.5-10x40; Leupold VX-II 3-9x40
	48,0		Zeiss 1.5-6x42; Swarovski PV-N 2.5-10x42
	48,7-49,0		Meopta Artemis 3000 3-9x42
	49,5		Meopta Artemis 3000 4-12x40
	50,0		Schmidt & Bender 10x42
Front Scope Mount 4	56,0	50	Zeiss 2.5 10x50
	57,0		Schmidt & Bender 3-12x50
	58,7		Leupold 4.4-14x50; Leupold VX-III 3.5-10x50
Front Scope Mount 5	62,0	56	Zeiss 3-12x56; Swarovski 2.5-10x56; Kahles CSX 3-12x56

APPENDIX

A. SPARE PARTS LIST

The parts authorized by this list of spare parts are required for the equipment operator maintenance. The list includes parts that must be be removed in order to replace authorized parts.

The PART NO. column indicates the primary number used by the manufacturer to identify an item, which controls the design and characteristics of that item by means of its engineering drawings, specifications, standards, and inspection requirements.

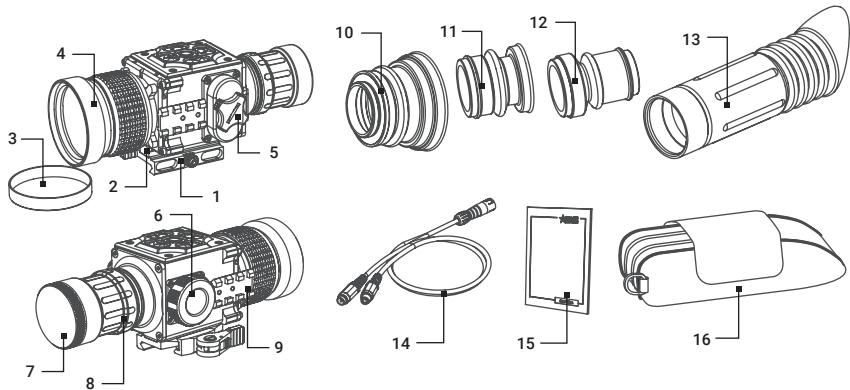

FIGURE A-1. VICTRIX SPARE PARTS LIST

TABLE A-1. VICTRIX SPARE PARTS LIST

ITEM	DESCRIPTION	PART NO.
1	Mount	AGMANQRM
2	Riser	AGMANRSR
3	Objective Lens Cap 50mm	GOL500BLCP
-	Objective Lens Cap 38mm	GOL380BLCP
4	Objective Lens Assembly 50mm	GOL500BLAS
-	Objective Lens Assembly 38mm	GOL380BLAS
5	Battery Cap	AGMTIDBCP
6	Connectors Cap	AGMTIDCNCP
7	Output Lens Cap	AGMANOPLC6
8	Output Lens Assembly 50mm	AGMANF250LA
8	Output Lens Assembly 38mm	AGMANF238LA
9	Side Picatinny/Weaver Rail	AGMTIDSPR
10	Light Suppressor 1	AGMLTSP1
11	Light Suppressor 2	AGMLTSP2
12	Light Suppressor 3	AGMLTSP3
13	Light Suppressor for Day Scope	AGMLSDS
14	Video Cable	AGMTIDVCB
15	Operation Manual	AGMANOMM
16	Carrying Case	AGMRSCC



AGM Global Vision

MAIN OFFICE

173 West Main Street

PO Box 962

Springerville, AZ 85938

USA

Tel. +1.928.333.4300

Fax +1.480.393.4882

info@agmglobalvision.com

www.agmglobalvision.com

EUROPEAN OFFICE

Andrey Lyapchev #7

Sofia, P.C. 1756

Bulgaria

Tel. +44.292.255.0509

info@agmglobalvision.eu

www.agmglobalvision.eu

AGMglobalvision.com