

Description of Device Functions

Cubemass DCI

Coriolis flowmeter

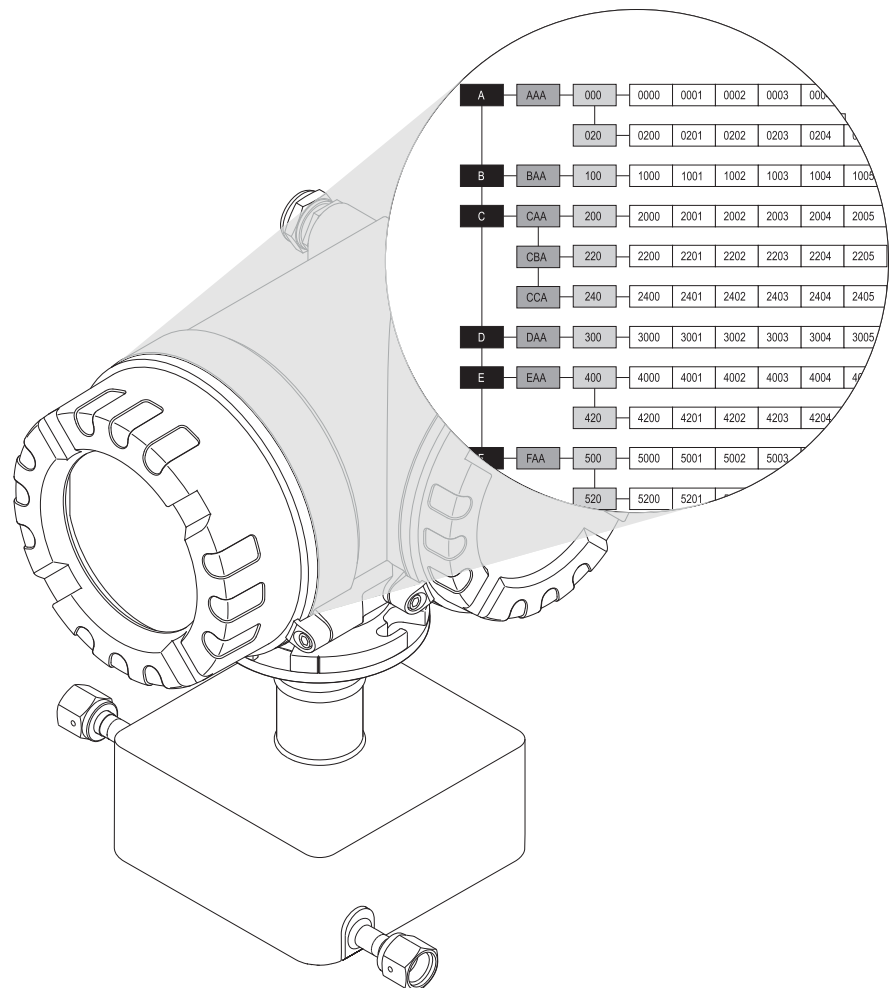



Table of contents

1	Using this manual	7
1.1	Finding a function description	7
1.1.1	Using the table of contents →  3	7
1.1.2	Using the graphic of the function matrix	7
1.1.3	Using the index of the function matrix →  121	7
2	Function matrix	8
2.1	General layout of the function matrix	8
2.1.1	Blocks (A, B, C etc.)	8
2.1.2	Groups (AAA, AEA, CAA etc.)	8
2.1.3	Function groups (000, 020, 060 etc.)	8
2.1.4	Functions (0000, 0001, 0002 etc.)	8
2.1.5	Codes identifying cells	9
2.2	Display lines on the local display	9
2.3	Function matrix	10
3	Block MEASURED VARIABLES	11
3.1	Group MEASURING VALUES	12
3.1.1	Function group MAIN VALUES	12
3.2	Group SYSTEM UNITS	13
3.2.1	Function group CONFIGURATION	13
3.2.2	Function group ADDITIONAL CONFIGURATION	16
4	Block QUICK SETUP	18
4.1	Quick Setup	20
4.1.1	Quick Setup "Commissioning"	20
4.1.2	Quick Setup "Pulsating Flow"	22
4.1.3	Quick Setup "Gas Measurement"	24
4.2	Data back-up/transfer	25
5	Block DISPLAY	26
5.1	Group CONTROL	27
5.1.1	Function group BASIC CONFIG.	27
5.1.2	Function group UNLOCKING/LOCKING	29
5.1.3	Function group OPERATION	30
5.2	Group MAIN LINE	31
5.2.1	Function group CONFIGURATION	31
5.2.2	Function group MULTIPLEX	32
5.3	Group ADDITION LINE	33
5.3.1	Function group CONFIGURATION	33
5.3.2	Function group MULTIPLEX	35
5.4	Group INFORMATION LINE	37
5.4.1	Function group CONFIGURATION	37
5.4.2	Function group MULTIPLEX	39
6	Block TOTALIZER	41
6.1	Group TOTALIZER (1 to 3)	42
6.1.1	Function group CONFIGURATION	42
6.1.2	Function group OPERATION	44
6.2	Group HANDLING TOTAL.	45

7	Block OUTPUTS	46
7.1	Group CURRENT OUTPUT 1 to 2	47
7.1.1	Function group CONFIGURATION	47
7.1.2	Function group OPERATION	56
7.1.3	Function group INFORMATION	57
7.2	Group PULSE/FREQUENCY OUTPUT (1 to 2)	58
7.2.1	Function group CONFIGURATION	58
7.2.2	Function group OPERATION	75
7.2.3	Function group INFORMATION	78
7.3	Group RELAY OUTPUT	79
7.3.1	Function group CONFIGURATION	79
7.3.2	Function group OPERATION	83
7.3.3	Function group INFORMATION	85
7.3.4	Behavior of relay output	86
7.3.5	Switching behavior of the relay output	87
8	Block INPUTS	89
8.1	Group STATUS INPUT	90
8.1.1	Function group CONFIGURATION	90
8.1.2	Function group OPERATION	91
8.1.3	Function group INFORMATION	92
9	Block BASIC FUNCTION	93
9.1	Group HART	94
9.1.1	Function group CONFIGURATION	94
9.1.2	Function group INFORMATION	95
9.2	Group PROCESSPARAMETER	96
9.2.1	Function group CONFIGURATION	96
9.2.2	Function group EPD PARAMETER	98
9.2.3	Function group REFERENCE PARAMETER	100
9.2.4	Function group ADJUSTMENT	102
9.2.5	Function group PRESSURE CORRECTION	104
9.3	Group SYSTEM PARAMETERS	105
9.3.1	Function group CONFIGURATION	105
9.4	Group SENSOR DATA	106
9.4.1	Function group CONFIGURATION	106
9.4.2	Function group FLOW COEFFICIENT	107
9.4.3	Function group DENSITY COEFFICIENT	108
9.4.4	Function group ADDITIONAL COEFFICIENT	109
10	Block SUPERVISION	110
10.1	Group SYSTEM	111
10.1.1	Functions group CONFIGURATION	111
10.1.2	Function group OPERATION	112
10.2	Group VERSION-INFO	114
10.2.1	Function group DEVICE	114
10.2.2	Function group SENSOR	115
10.2.3	Function group AMPLIFIER	116
10.2.4	Function group I/O MODULE	117
10.2.5	Function groups INPUT/OUTPUT 2 to 4	118
11	Factory settings	119
11.1	SI units (not for USA and Canada)	119
11.1.1	Low flow cut off, full scale value, pulse value	119
11.2	US units (only for USA and Canada)	119

11.2.1 Low flow cut off, full scale value, pulse value	119
Index of function matrix	121
Index.....	125

1 Using this manual

This manual must be used in conjunction with the Operating Instructions of the measuring device. A description of all the functions of the measuring device is provided here.

1.1 Finding a function description

There are various ways of locating the description of a function of your choice in the manual:

1.1.1 Using the table of contents → 3

The designations of all the cells in the function matrix are listed in the table of contents. You can use these unambiguous designations (such as USER INTERFACE, INPUTS, OUTPUTS etc.) to choose whichever functions are applicable to a particular set of conditions. The page references show you exactly where to find the detailed descriptions of the functions in question.

1.1.2 Using the graphic of the function matrix

This step-by-step, top-down approach starts with the blocks, the highest level, and factory down through the matrix to the description of the function you need:

1. All blocks available, and their related groups, are illustrated on → 10. Select the block (or the group within the block) which you need for your application and use the page reference to locate the information corresponding to the next level.
2. The page in question contains a graphic showing of the block with all its subordinate groups, function groups and functions. Select the function which you need for your application and use the page reference to locate the detailed function description.

1.1.3 Using the index of the function matrix → 121

Each "cell" in the function matrix (blocks, groups, function groups, functions) has a unique identifier in the form of a code consisting of one or three letters or a three- or four-digit number. The code identifying a selected "cell" appears at the top right on the local display.

The function matrix index lists the codes for all the available "cells" in alphabetic and consecutive order, complete with the page references for the corresponding functions.

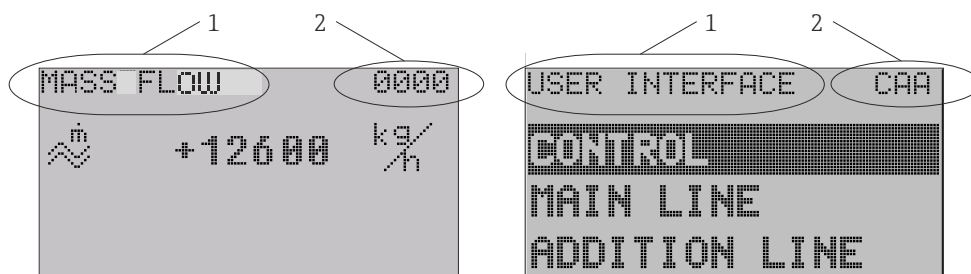

A0004821-EN

Fig. 1: Local display

- 1 Name of the function, e.g. mass flow, user interface
- 2 Function code, e.g. 0000, CAA

2 Function matrix

2.1 General layout of the function matrix

The function matrix consists of four levels:

Blocks → Groups → Function groups → Functions

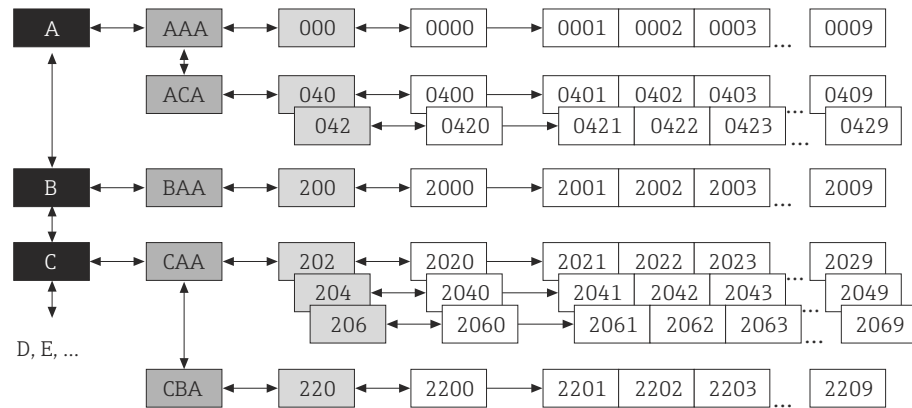

A0000961

Fig. 2: Layout of the function matrix

2.1.1 Blocks (A, B, C etc.)

The blocks are the highest-level grouping of the operation options for the device.

The blocks include, for example: MEASURED VARIABLES, QUICK SETUP, USER INTERFACE, TOTALIZER etc.

2.1.2 Groups (AAA, AEA, CAA etc.)

A block consists of one or more groups. Each group represents a more detailed selection of the operation options in the higher-order block. The groups in the "USER INTERFACE" block, for example, include: CONTROL, MAIN LINE, ADDITION LINE etc.

2.1.3 Function groups (000, 020, 060 etc.)

A group consists of one or more function groups. Each function group represents a more detailed selection of the operation options in the higher-order group. The function groups in the "CONTROL" group, for example, include: BASIC CONFIG., UNLOCKING/LOCKING, CONTROL etc.

2.1.4 Functions (0000, 0001, 0002 etc.)

Each function group consists of one or more functions. The functions are used to operate and parameterize the measuring instrument. Numerical values can be entered or parameters selected and saved.

Available functions of the function group "BASIC CONFIG." are: LANGUAGE, DISPLAY DAMPING, CONTRAST LCD etc.

The procedure for changing the language of the user interface, for example, is as follows:

1. Select the block "USER INTERFACE".
2. Select the group "CONTROL".
3. Select the function group "BASIC CONFIG.".
4. Select the function "LANGUAGE" (here you can set the language required).

2.1.5 Codes identifying cells

Each cell (block, group, function group and function) in the function matrix has an individual, unique code.

Blocks:

The code is a letter (A, B, C etc.)

Groups:

The code consists of three letters (AAA, ABA, BAA etc.).

The first letter matches the block code (i.e. each group in block A has a code starting with an A __; the codes of the groups in block B start with a B __ etc.). The other two letters are for identifying the group within the respective block.

Function groups:

The code consists of three digits (000, 001, 100 etc.).

Functions:

The code consists of four digits (0000, 0001, 0201 etc.).

The first three digits are the same as the code for the function group.

The last digit counts the functions in the function group, counting up from 0 to 9 (for example, function 0005 is the sixth function in the group 000).

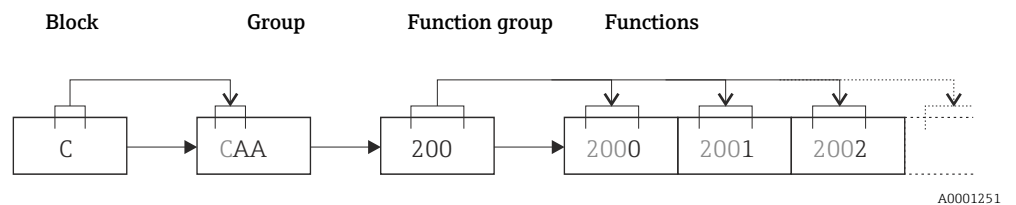

2.2 Display lines on the local display

The local display is split into various display lines.

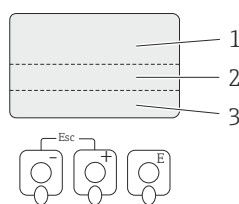

Fig. 3: Local display

- 1 Main line
- 2 Additional line
- 3 Information line

The values are assigned to the individual lines in the USER INTERFACE block → 27.

2.3 Function matrix

Blocks	Groups	Function groups
MEASURED VARIABLES A (→ 11)	MEASURING VALUES	AAA → → 12
	SYSTEM UNITS	ACA → → 13
↓↑		
QUICK SETUP B (→ 18)	Commissioning and application setups	→ → 18
↓↑		
USER INTERFACE C (→ 26)	CONTROL	CAA → → 27
	MAIN LINE	CCA → → 31
	ADDITIONAL LINE	CEA → → 33
	INFORMATION LINE	CGA → → 37
↓↑		
TOTALIZER D (→ 41)	TOTALIZER 1	DAA → → 42
	TOTALIZER 2	DAB → → 42
	TOTALIZER 3	DAC → → 42
	HANDLING TOTALIZER	DJA → → 45
↓↑		
OUTPUTS E (→ 46)	CURRENT OUTPUT 1	EAA → → 47
	CURRENT OUTPUT 2	EAB → → 47
	PULSE/FREQ. OUTPUT 1	ECA → → 58
	PULSE/FREQ. OUTPUT 2	ECB → → 58
	RELAY OUTPUT	EGA → → 79
↓↑		
INPUTS F (→ 89)	STATUS INPUT	FAA → → 90
↓↑		
BASIC FUNCTION G (→ 93)	HART	GAA → → 94
	PROCESS PARAMETER	GIA → → 96
	SYSTEM PARAMETER	GLA → → 105
	SENSOR DATA	GNA → → 106
↓↑		
SUPERVISION J (→ 110)	SYSTEM	JAA → → 111
	VERSION-INFO	JCA → → 114



3 Block MEASURED VARIABLES

Block	Groups	Function groups	Functions
MEASURED VARIABLES (A)	MEASURING VALUES (AAA) → 12	MAIN VALUES (000) → 12	VOLUME FLOW (0001) → 12
			MASS FLOW (0000) → 12
	SYSTEM UNITS (ACA) → 13	CONFIGURATION (040) → 13	CORRECTED VOL. FLOW (0004) → 12
			DENSITY (0005) → 12
	SYSTEM UNITS (ACA) → 13	ADDITIONAL CONFIGURATION (042) → 16	UNIT MASS FLOW (0401) → 13
			UNIT CORR. VOL. FLOW (0404) → 15
	SYSTEM UNITS (ACA) → 13	ADDITIONAL CONFIGURATION (042) → 16	UNIT MASS FLOW (0400) → 13
			UNIT CORR. VOL. UME (0405) → 15
	SYSTEM UNITS (ACA) → 13	ADDITIONAL CONFIGURATION (042) → 16	UNIT REFER-ENCE DENSITY (0421) → 16
			UNIT CORR. VOL. UME (0405) → 15
SYSTEM UNITS (ACA) → 13	ADDITIONAL CONFIGURATION (042) → 16	UNIT TEMPERA-TURE (0422) → 17	
		UNIT PRESSURE (0426) → 17	
SYSTEM UNITS (ACA) → 13	ADDITIONAL CONFIGURATION (042) → 16	UNIT LENGTH (0424) → 17	
		UNIT TEMPERA-TURE (0422) → 17	
SYSTEM UNITS (ACA) → 13	ADDITIONAL CONFIGURATION (042) → 16	UNIT TEMPERA-TURE (0422) → 17	
		UNIT TEMPERA-TURE (0422) → 17	

3.1 Group MEASURING VALUES

3.1.1 Function group MAIN VALUES

MEAS. VARIABLES A → MEASURING VALUES AAA → MAIN VALUES 000

Function description MEASURED VARIABLES → MEASURING VALUES → MAIN VALUES	
<p> Note!</p> <ul style="list-style-type: none"> The units of all the measured variables shown here can be set in the SYSTEM UNITS group. If the fluid in the pipe flows backwards, a negative sign prefixes the flow reading on the display. 	
MASS FLOW (0000)	<p>The currently measured mass flow appears on the display.</p> <p>Display: 5-digit floating-point number, including unit and sign (e.g. 462.87 kg/h; -731.63 lb/min etc.)</p>
VOLUME FLOW (0001)	<p>The calculated volume flow appears on the display. The volume flow is derived from the measured mass flow and the measured density of the fluid.</p> <p>Display: 5-digit floating-point number, including unit and sign (e.g. 5.5445 dm³/min; 1.4359 m³/h; -731.63 gal/d etc.)</p>
CORRECTED VOLUME FLOW (0004)	<p>The calculated corrected volume flow appears on the display. The calculated corrected volume flow is derived from the measured mass flow and the reference density of the fluid (density at reference temperature, measured or fixed entry).</p> <p>Display: 5-digit floating-point number, including unit and sign (e.g. 1.3549 Nm³/h; 7.9846 scm/day etc.)</p>
DENSITY (0005)	<p>The currently measured density or its specific gravity appears on the display.</p> <p>Display: 5-digit floating-point number, including unit (e.g. 1.2345 kg/dm³; 993.5 kg/m³; 1.0015 SG_20 °C etc.)</p>
REFERENCE DENSITY (0006)	<p>The density of the fluid, at reference temperature, appears on the display. The reference density can be calculated using the measured density or specified using the FIXED REFERENCE DENSITY function (→  100).</p> <p>Display: 5-digit floating-point number, including unit (e.g. 1.2345 kg/dm³; 993.5 kg/m³; 1.0015 SG_20 °C etc.)</p>
TEMPERATURE (0008)	<p>The currently measured temperature appears on the display.</p> <p>Display: max. 4-digit fixed-point number, including unit and sign (e.g. -23.4 °C; 160.0 °F; 295.4 K etc.)</p>

3.2 Group SYSTEM UNITS

3.2.1 Function group CONFIGURATION

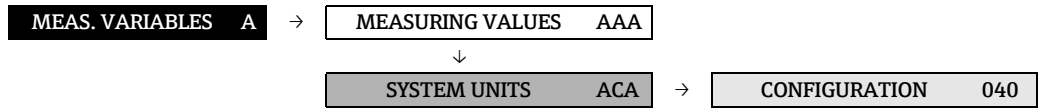

Function description MEASURED VARIABLES → SYSTEM UNITS → CONFIGURATION	
You can select the units for measured variables in this function group.	
UNIT MASS FLOW (0400)	<p>For selecting the unit for displaying the mass flow.</p> <p>The unit you select here is also valid for:</p> <ul style="list-style-type: none"> ▪ Current outputs ▪ Frequency outputs ▪ Status output switch point (limit value for mass flow, flow direction) ▪ Low flow cut off <p>Options: Metric: Gram → g/s; g/min; g/h; g/day Kilogram → kg/s; kg/min; kg/h; kg/day Ton → t/s; t/min; t/h; t/day</p> <p>US: ounce → oz/s; oz/min; oz/h; oz/day pound → lb/s; lb/min; lb/h; lb/day ton → ton/s; ton/min; ton/h; ton/day</p> <p>Factory setting: Country-dependent (kg/h or US-lb/min)</p>
UNIT MASS (0401)	<p>For selecting the unit for displaying the mass.</p> <p>The unit you select here is also valid for:</p> <ul style="list-style-type: none"> ▪ Pulse value (e.g. kg/p) <p>Options: Metric → g; kg; t</p> <p>US → oz; lb; ton</p> <p>Factory setting: Country-dependent (kg or US-lb)</p> <p> Note! The unit for the totalizers is independent of the selection made here and is selected separately for each totalizer.</p>

Function description MEASURED VARIABLES → SYSTEM UNITS → CONFIGURATION	
UNIT VOLUME FLOW (0402)	<p>For selecting the unit for displaying the volume flow. The unit you select here is also valid for:</p> <ul style="list-style-type: none"> ▪ Current outputs ▪ Frequency outputs ▪ Status output switch point (limit value for volume flow, flow direction) ▪ Low flow cut off <p>Options: Metric: Cubic centimeter → cm³/s; cm³/min; cm³/h; cm³/day Cubic decimeter → dm³/s; dm³/min; dm³/h; dm³/day Cubic meter → m³/s; m³/min; m³/h; m³/day Milliliter → ml/s; ml/min; ml/h; ml/day Liter → l/s; l/min; l/h; l/day Hectoliter → hl/s; hl/min; hl/h; hl/day Megaliter → Ml/s; Ml/min; Ml/h; Ml/day</p> <p>US: Cubic centimeter → cc/s; cc/min; cc/h; cc/day Acre foot → af/s; af/min; af/h; af/day Cubic foot → ft³/s; ft³/min; ft³/h; ft³/day Fluid ounce → oz f/s; oz f/min; oz f/h; oz f/day Gallon → gal/s; gal/min; gal/h; gal/day Kilo gallon → Kgal/s; Kgal/min; Kgal/h; Kgal/day Million gallon → Mgal/s; Mgal/min; Mgal/h; Mgal/day Barrel (normal fluids: 31.5 gal/bbl) → bbl/s; bbl/min; bbl/h; bbl/day Barrel (beer: 31.0 gal/bbl) → bbl/s; bbl/min; bbl/h; bbl/day Barrel (petrochemicals: 42.0 gal/bbl) → bbl/s; bbl/min; bbl/h; bbl/day Barrel (filling tanks: 55.0 gal/bbl) → bbl/s; bbl/min; bbl/h; bbl/day</p> <p>Imperial: Gallon → gal/s; gal/min; gal/h; gal/day Mega gallon → Mgal/s; Mgal/min; Mgal/h; Mgal/day Barrel (beer: 36.0 gal/bbl) → bbl/s; bbl/min; bbl/h; bbl/day Barrel (petrochemicals: 34.97 gal/bbl) → bbl/s; bbl/min; bbl/h; bbl/day</p> <p>Factory setting: Country-dependent (m³/h or US-Mgal/day)</p>
UNIT VOLUME (0403)	<p>For selecting the unit for displaying the volume.</p> <p>The unit you select here is also valid for:</p> <ul style="list-style-type: none"> ▪ Pulse value (e.g. m³/p) <p>Options: Metric → cm³; dm³; m³; ml; l; hl; Ml Mega</p> <p>US → cc; af; ft³; oz f; gal; Kgal; Mgal; bbl (normal fluids); bbl (beer); bbl (petrochemicals); bbl (filling tanks) Imperial → gal; Mgal; bbl (beer); bbl (petrochemicals)</p> <p>Factory setting: m³</p> <p> Note! The unit of the totalizers is independent of the selection made here and is selected separately for each totalizer.</p>

Function description MEASURED VARIABLES → SYSTEM UNITS → CONFIGURATION	
UNIT CORRECTED VOLUME FLOW (0404)	<p>For selecting the unit for displaying the corrected volume flow.</p> <p>The unit you select here is also valid for:</p> <ul style="list-style-type: none"> ▪ Current outputs ▪ Frequency outputs ▪ Status output switch point (limit value for corrected volume flow, flow direction) ▪ Low flow cut off <p>Options:</p> <p>Metric:</p> <p>Nl/s Nl/min Nl/h Nl/day Nm³/s Nm³/min Nm³/h Nm³/day</p> <p>US:</p> <p>Sm³/s Sm³/min Sm³/h Sm³/day Scf/s Scf/min Scf/h Scf/day</p> <p>Factory setting:</p> <p>Nm³/h</p>
UNIT CORRECTED VOLUME (0405)	<p>For selecting the unit for displaying the corrected volume.</p> <p>The unit you select here is also valid for:</p> <ul style="list-style-type: none"> ▪ Pulse value (e.g. Nm³/p) <p>Options:</p> <p>Metric:</p> <p>Nm³ Nl</p> <p>US:</p> <p>Sm³ Scf</p> <p>Factory setting:</p> <p>Nm³</p> <p> Note! The unit of the totalizers is independent of the selection made here and is selected separately for each totalizer.</p>

3.2.2 Function group ADDITIONAL CONFIGURATION

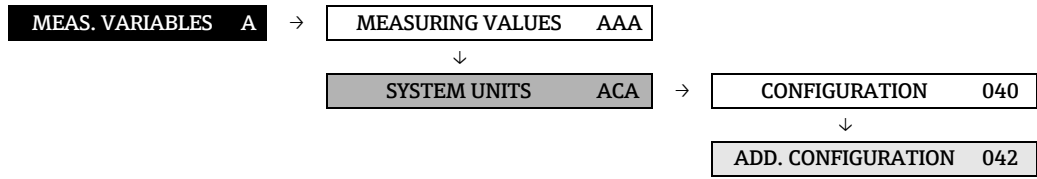



Function description MEASURED VARIABLES → SYSTEM UNITS → ADDITIONAL CONFIGURATION	
UNIT DENSITY (0420)	<p>For selecting the unit for displaying the density.</p> <p>The unit you select here is also valid for:</p> <ul style="list-style-type: none"> ▪ Current outputs ▪ Frequency outputs ▪ Status output switch point (limit value for density) ▪ Density response value for EPD ▪ Density adjustment value <p>Options: Metric: → g/cm³; g/cc; kg/dm³; kg/l; kg/m³; SD 4 °C, SD 15 °C, SD 20 °C; SG 4 °C, SG 15 °C, SG 20 °C</p> <p>US → lb/ft³; lb/gal; lb/bbl (normal fluids); lb/bbl (beer); lb/bbl (petrochemicals); lb/bbl (filling tanks)</p> <p>Imperial → lb/gal; lb/bbl (beer); lb/bbl (petrochemicals)</p> <p>Factory setting: kg/l</p> <p>SD = Specific Density, SG = Specific Gravity The specific density is the ratio of fluid density to water density (at water temperature = 4, 15, 20 °C).</p>
UNIT REFERENCE DENSITY (0421)	<p>For selecting the unit for displaying the reference density.</p> <p>The unit you select here is also valid for:</p> <ul style="list-style-type: none"> ▪ Current outputs ▪ Frequency outputs ▪ Status output switch point (limit value for standard density) ▪ Fixed reference density (for calculation of corrected volume flow) <p>Options: Metric: kg/Nm³ kg/Nl</p> <p>US: g/Scv kg/Sm³ lb/Scf</p> <p>Factory setting: kg/Nl</p>

Function description MEASURED VARIABLES → SYSTEM UNITS → ADDITIONAL CONFIGURATION	
UNIT TEMPERATURE (0422)	For selecting the unit for displaying the temperature. The unit you select here is also valid for: <ul style="list-style-type: none"> ▪ Current outputs ▪ Frequency outputs ▪ Status output switch point (limit value for temperature) ▪ Reference temperature (for corrected volume measurement with measured reference density) Options: °C (Celsius) K (Kelvin) °F (Fahrenheit) °R (Rankine) Factory setting: °C
UNIT LENGTH (0424)	For selecting the unit for displaying the length of the nominal diameter. The unit you select here is valid for: <ul style="list-style-type: none"> ▪ Nominal diameter of sensor (function NOMINAL DIAMETER (6804) → ⓘ 106) Options: MILLIMETER INCH Factory setting: MILLIMETER
UNIT PRESSURE (0426)	For selecting the unit for displaying the pressure. The unit you select here is valid for: <ul style="list-style-type: none"> ▪ Specified pressure (→function PRESSURE (6501) → ⓘ 104) Options: bar a bar g psi a psi g Factory setting: bar g

4 Block QUICK SETUP

Block	Group	Function groups	Functions				
QUICK SETUP (B)	⇒	⇒	QS COMMISS. (1002) → 18	⇒	QS PULS. FLOW (1003) → 18	SETUP GAS MEASUREMENT (1004) → 18	T-DAT SAVE/LOAD (1009) → 19



Function description QUICK SETUP	
<p> Note!</p> <ul style="list-style-type: none"> ▪ The Quick Setups are only available by means of the local display. ▪ The flowcharts of the various Quick Setups are provided on the pages to follow. ▪ For additional information on the Setups, refer to the Operating Instructions (BA00139D/06). 	
QUICK SETUP COMMISSIONING (1002)	<p>Start the setup for commissioning.</p> <p>Options: YES NO</p> <p>Factory setting: NO</p>
QUICK SETUP PULSATING FLOW (1003)	<p> Note! Function only available for devices with current or frequency output.</p> <p>Start the setup for pulsating flow.</p> <p>Options: YES NO</p> <p>Factory setting: NO</p>
QUICK SETUP GAS MEASUREMENT (1004)	<p>Start the setup for gas measurement.</p> <p>Options: YES NO</p> <p>Factory setting: NO</p>

Function description QUICK SETUP	
<p>T-DAT SAVE/LOAD (1009)</p>	<p>Use this function to save the parameter settings / configuration of the transmitter in a transmitter DAT (T-DAT), or to load the parameter settings from the T-DAT into the EEPROM (manual backup function).</p> <p>Application examples:</p> <ul style="list-style-type: none"> ▪ After commissioning, the current measuring point parameters can be saved to the T-DAT as a backup. ▪ If the transmitter is replaced for some reason, the data from the T-DAT can be loaded into the new transmitter (EEPROM). <p>Options: CANCEL SAVE (from EEPROM to T-DAT) LOAD (from the T-DAT into EEPROM)</p> <p>Factory setting: CANCEL</p> <p> Note!</p> <ul style="list-style-type: none"> ▪ If the target device has an older software version, the message "TRANSM. SW-DAT" is displayed during startup. Then only the SAVE function is available. ▪ LOAD This function is only possible if the target device has the same software version as, or a more recent software version than, the source device. ▪ SAVE This function is always available.

4.1 Quick Setup

In the case of measuring devices without a local display, the individual parameters and functions must be configured via the configuration program, e.g. FieldCare.

If the measuring device is equipped with a local display, all the important device parameters for standard operation can be configured quickly and easily by means of the "Commissioning" Quick Setup menu.

- Quick Setup Commissioning, see below
- Quick Setup Pulsating Flow →  22
- Quick Setup Gas Measurement →  24

4.1.1 Quick Setup "Commissioning"



Note!

- The display returns to the function QUICK SETUP COMMISSIONING (1002) if you press the  key combination during parameter interrogation. The stored parameters remain valid.
- The "COMMISSIONING" Quick Setup must be carried out before another Quick Setup is run.

1. The "DELIVERY SETTINGS" option sets every selected unit to the factory setting.
The "ACTUAL SETTING" option accepts the units you previously configured.
2. Only units not yet configured in the current Setup are offered for selection in each cycle.
The unit for mass, volume and corrected volume is derived from the corresponding flow unit.
3. The "YES" option remains visible until all the units have been configured.
"NO" is the only option displayed when no further units are available.
4. The prompt only appears if a current output and/or pulse/frequency output is available.
Only the outputs not yet configured in the current Setup are offered for selection in each cycle.
5. The "YES" option remains visible until all the outputs have been configured.
"NO" is the only option displayed when no further outputs are available.
6. The "automatic parameterization of the display" option contains the following basic settings/factory settings:

YES	Main line = mass flow Additional line = totalizer 1 Information line = operating/system condition
NO	The existing (selected) settings remain.
7. The execution of other Quick Setups are described in the following chapters.

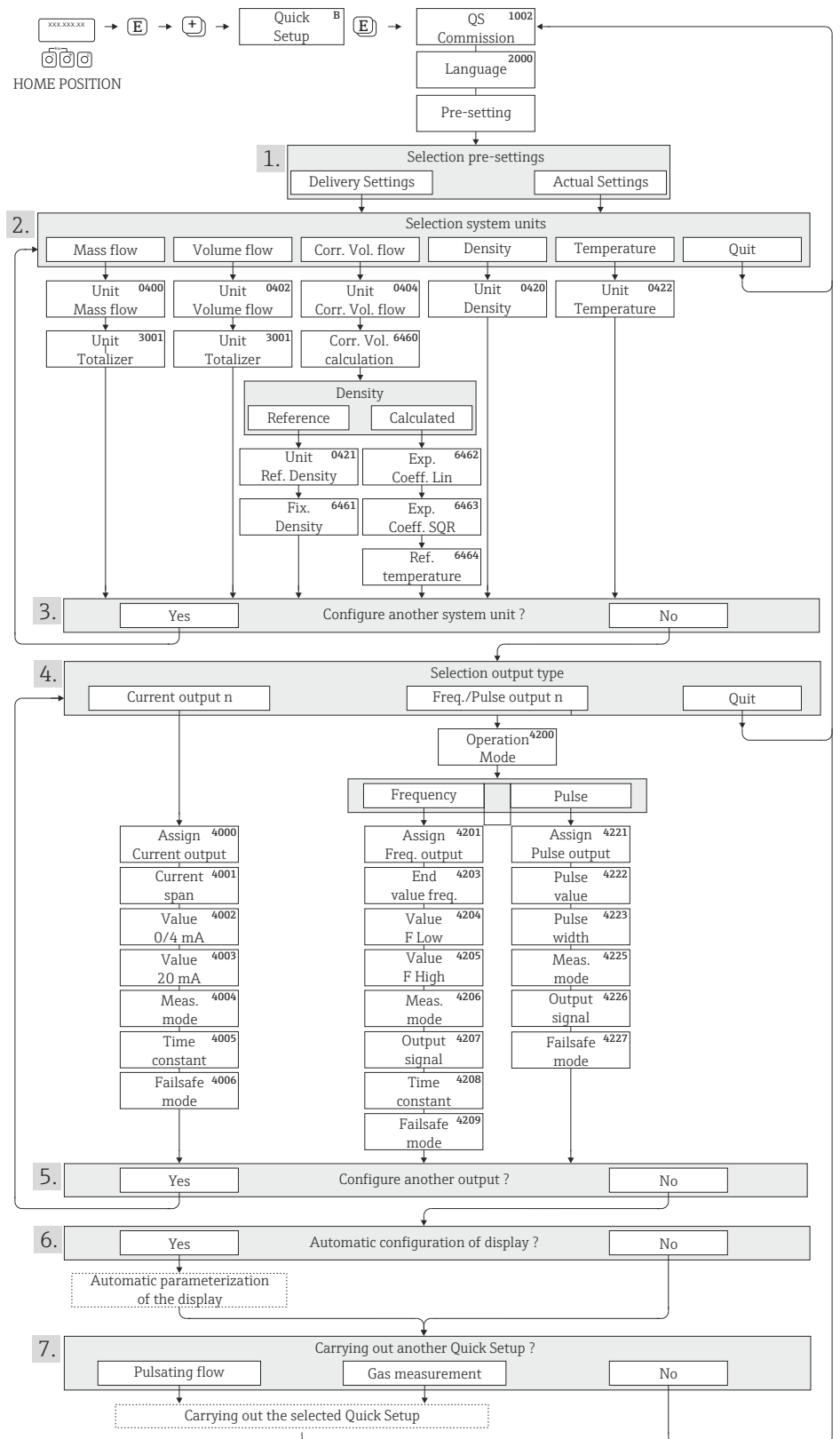

A0011949-en

Fig. 4: "QUICK SETUP COMMISSIONING"-menu for straightforward configuration of the major device functions

4.1.2 Quick Setup "Pulsating Flow"

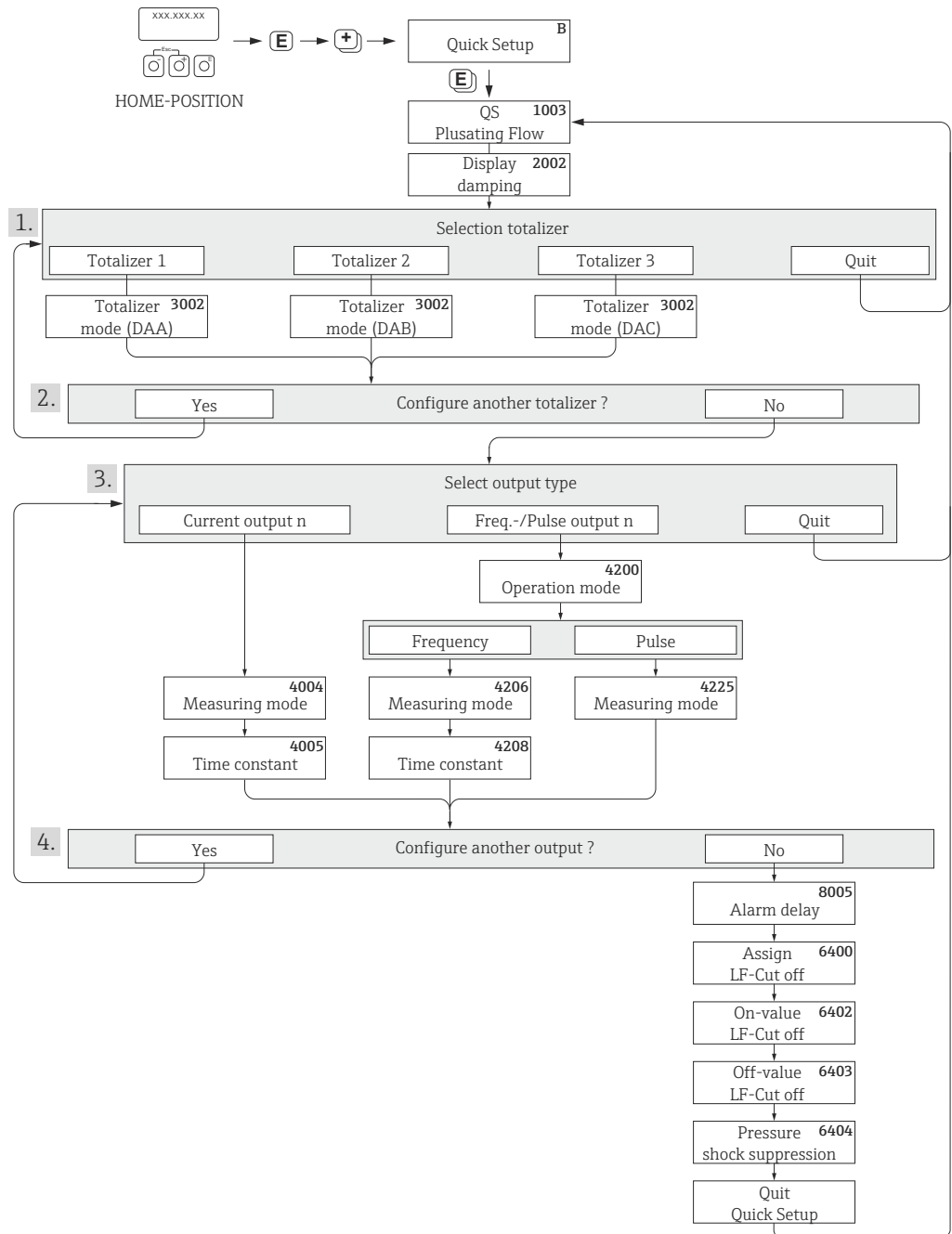

A0004431-en

Fig. 5: "QUICK SETUP PULSATING FLOW"-menu for operation with severely pulsating flow. Recommended settings are found on the following page.

1. Only totalizers not yet configured in the current Setup are offered for selection in each cycle.
2. The YES option remains visible until all the totalizers have been configured. NO is the only option displayed when no further totalizers are available.
3. Only the outputs not yet configured in the current Quick Setup are offered for selection in each cycle.
4. The YES option remains visible until all the outputs have been configured. NO is the only option displayed when no further outputs are available.



Note!

- The display returns to the function QUICK SETUP PULSATING FLOW (1003) if you press the key combination during parameter interrogation. The stored parameters remain valid.
- You can call up this Setup menu either directly from the COMMISSIONING Setup menu or manually by means of the function QUICK SETUP PULSATING FLOW (1003).

Quick Setup "Pulsating Flow"		
HOME position → → MEASURAND → → QUICK SETUP → → QS PULSATING FLOW (1003)		
Function No.	Function name	Selection with To next function with
1003	QS PULS. FLOW	YES After is pressed by way of confirmation, the Quick Setup menu calls up all the subsequent functions in succession.



Basic configuration		
2002	DISPLAY DAMPING	1 s
3002	TOTALIZER MODE (DAA)	BALANCE (Totalizer 1)
3002	TOTALIZER MODE (DAB)	BALANCE (Totalizer 2)
3002	TOTALIZER MODE (DAC)	BALANCE (Totalizer 3)
Signal type for "CURRENT OUTPUT 1"		
4004	MEASURING MODE	PULS. FLOW
4005	TIME CONSTANT	1 s
Signal type for "FREQ./PULSE OUTPUT 1" (for FREQUENCY operating mode)		
4206	MEASURING MODE	PULS. FLOW
4208	TIME CONSTANT	0 s
Signal type for "FREQ./PULSE OUTPUT 1" (for PULSE operating mode)		
4225	MEASURING MODE	PULS. FLOW
Other settings		
8005	ALARM DELAY	0 s
6400	ASSIGN LOW FLOW CUTOFF	MASS FLOW
6402	ON-VALUE LOW FLOW CUT OFF	Setting depends on diameter [kg/h]: DN 1 = 0,08 DN 2 = 0,4 DN 4 = 1,8 DN 6 = 4
6403	OFF-VALUE LOW FLOW CUTOFF	50%
6404	PRESSURE SHOCK SUPPRESSION	0 s



Back to the HOME position:
 → Press and hold down Esc key for longer than three seconds or
 → Repeatedly press and release Esc key → Exit the function matrix step by step

4.1.3 Quick Setup "Gas Measurement"

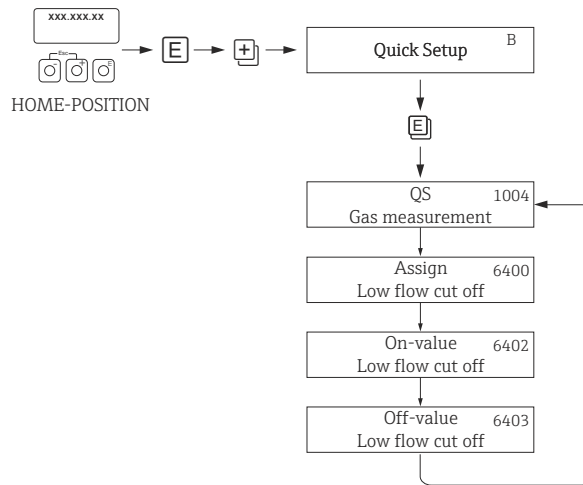

A0002502-en

Fig. 6: "QUICK SETUP GAS MEASUREMENT"-menu

Quick Setup "Gas Measurement"		
HOME position → [E] → MEASURED VARIABLE (A) MEASURED VARIABLE → [E] → QUICK SETUP (B) QUICK SETUP → [E] → QS-GAS MEASUREMENT (1004)		
Function No.	Function name	Setting to be selected ([E]) (to next function with [E])
1004	QS GAS MEASUREMENT	YES After [E] is pressed by way of confirmation, the Quick Setup menu calls up all the subsequent functions in succession.
▼		
6400	ASSIGN LOW FLOW CUTOFF	On account of the low mass flow involved when gas flows are measured, it is advisable not use a low flow cutoff. Setting: OFF
6402	ON-VALUE LOW FLOW CUT OFF	If the ASSIGNMENT LOW FLOW CUTOFF function was not set to OFF, the following applies: Setting: 0.0000 [unit] User input: Flow rates for gas measurements are low, so the value for the switch-on point (= low flow cutoff) must be correspondingly low.
6403	OFF-VALUE LOW FLOW CUTOFF	If the ASSIGNMENT LOW FLOW CUTOFF function was not set to OFF, the following applies: Setting: 50% User input: Enter the switch-off point as a positive hysteresis in %, referenced to the switch-on point.
▼		
Back to the HOME position: → Press and hold down Esc key [Esc] for longer than three seconds or → Repeatedly press and release Esc key [Esc] → Exit the function matrix step by step		



Note!
Quick Setup automatically deactivates the function EMPTY PIPE DETECTION (6420) is automatically switched off by the Quick Setup.

4.2 Data back-up/transfer

You can use the T-DAT SAVE/LOAD function to transfer data (device parameters and settings) between the T-DAT (removable memory) and the EEPROM (device memory).

This is required for the following applications:

- Creating a backup: current data are transmitted from an EEPROM to the T-DAT.
- Replacing a transmitter: current data are copied from an EEPROM to the T-DAT, then transmitted to the EEPROM of the new transmitter.
- Duplicating data: current data are copied from an EEPROM to the T-DAT, then transmitted to EEPROMs of identical measuring points.



Note!

Installing and removing the T-DAT → Operating Instructions (BA00139D/06)

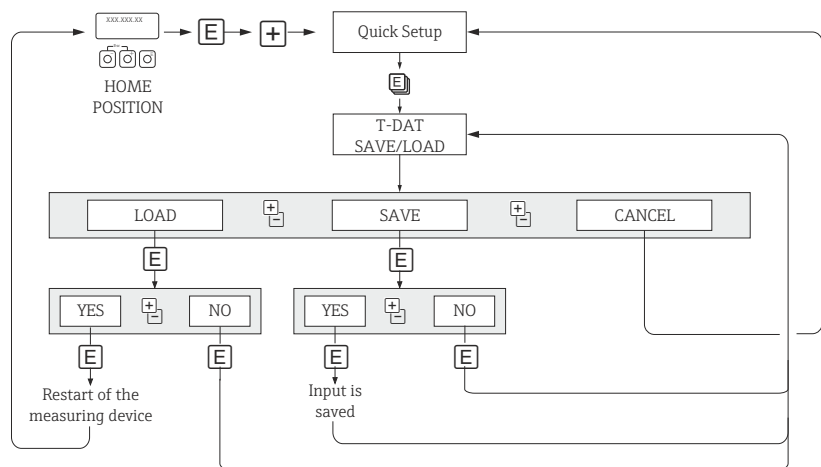

A0001221-en

Data storage/transmission with T-DAT SAVE/LOAD

Notes on the LOAD and SAVE options:

LOAD:

Data are transmitted from the T-DAT to the EEPROM.



Note!

- Previously saved settings on the EEPROM are deleted.
- This selection is available only if the T-DAT contains valid data.
- This selection can be made only if the software version of the T-DAT is the same or newer than that of the EEPROM. Otherwise, the error message "TRANSM. SW-DAT" appears after the restart and the LOAD function is subsequently no longer available.

SAVE:

Data are transmitted from the EEPROM to the T-DAT.







5 Block DISPLAY

Block	Groups	Function groups	Functions	
USER INTER-FACE (C)	OPERATION (CAA) → 27	BASIC CONFIG (200) → 27	LANGUAGE (2000) → 27	
		UNLOCKING/LOCKING (202) → 29	ACCESS CODE (2020) → 29	
		OPERATION (204) → 30	TEST DISPLAY (2040) → 30	
	MAIN LINE (CCA) → 31	CONFIGURATION (220) → 31	ASSIGN (2200) → 31	100% VALUE (2201) → 31
		MULTIPLY (222) → 32	ASSIGN (2220) → 32	100% VALUE (2221) → 32
		ADDITIONAL LINE (CEA) → 33	CONFIGURATION (240) → 33	ASSIGN (2400) → 33
	INFORMATION LINE (CGA) → 37	CONFIGURATION (260) → 37	ASSIGN (2600) → 37	100% VALUE (2601) → 37
		MULTIPLY (262) → 39	ASSIGN (2620) → 39	100% VALUE (2621) → 39
		OPERATION (2004) → 28	CONTRAST LCD (2003) → 28	BACKLIGHT (2004) → 28
	OPERATION (2021) → 29	DEFINE PRIVATE CODE (2021) → 29	STATUS ACCESS (2022) → 29	ACCESS CODE COUNTER (2023) → 29
	OPERATION (2402) → 34	FORMAT (2402) → 34	DISPLAY MODE (2403) → 34	
	OPERATION (2421) → 35	FORMAT (2421) → 35	DISPLAY MODE (2422) → 35	
	OPERATION (2602) → 38	FORMAT (2602) → 38	DISPLAY MODE (2603) → 38	
	OPERATION (2621) → 40	FORMAT (2621) → 40	DISPLAY MODE (2622) → 40	

5.1 Group CONTROL

5.1.1 Function group BASIC CONFIG.

USER INTERFACE C → CONTROL CAA → BASIC CONFIGURATION 200

Function description DISPLAY → CONTROL → BASIC CONFIG.	
<p>LANGUAGE (2000)</p>	<p>For selecting the language for all texts, parameters and messages shown on the local display.</p> <p> Note! The displayed options depend on the available language group shown in the LANGUAGE GROUP ((8226) →  116) function.</p> <p>Options: Language group WEST EU / USA: ENGLISH DEUTSCH FRANCAIS ESPANOL ITALIANO NEDERLANDS PORTUGUESE</p> <p>Language group EAST EU / SCAND: ENGLISH NORSK SVENSKA SUOMI POLISH RUSSIAN CZECH</p> <p>Language group ASIA: ENGLISH BAHASA INDONESIA JAPANESE (syllabary)</p> <p>Language group CHINA: ENGLISH CHINESE</p> <p>Factory setting: Country-dependent (→  119)</p> <p> Note!</p> <ul style="list-style-type: none"> ▪ If you press the  keys simultaneously at startup, the language defaults to ENGLISH. ▪ You can change the language group via the configuration software FieldCare. Please do not hesitate to contact your Endress+Hauser sales office if you have any questions.
<p>DISPLAY DAMPING (2002)</p>	<p>For entering a time constant which defines how the display reacts to severely fluctuating flow variables, either very quickly (enter a low time constant) or with damping (enter a high time constant).</p> <p>User input: 0 to 100 seconds</p> <p>Factory setting: 1 s</p> <p> Note! Setting the time constant to zero seconds switches off damping.</p>

Function description DISPLAY → CONTROL → BASIC CONFIG.	
CONTRAST LCD (2003)	For adjusting the display contrast to suit local operating conditions. User input: 10 to 100% Factory setting: 50%
BACKLIGHT (2004)	For adjusting the backlight to suit local operating conditions. User input: 0 to 100%  Note! Entering the value 0 means that the backlight is switched off. The display then no longer emits any light, i.e. the display texts can no longer be read in the dark. Factory setting: 50%

5.1.2 Function group UNLOCKING/LOCKING

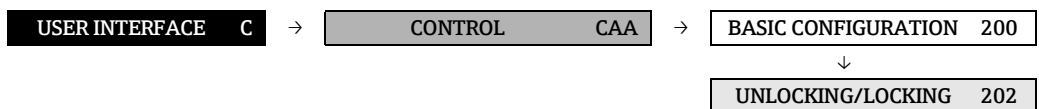

Function description	
USER INTERFACE → CONTROL → UNLOCKING/LOCKING	
ACCESS CODE (2020)	<p>All data of the measuring system are protected against inadvertent change. Programming is disabled and the settings cannot be changed until a code is entered in this function.</p> <p>If you press the or keys in any function, the measuring system automatically goes to this function and the prompt to enter the code appears on the display (when programming is disabled).</p> <p>You can enable programming by entering your personal code (Factory setting = 84, → function DEFINE PRIVATE CODE (2021)).</p> <p>User input: max. 4-digit number: 0 to 9999</p> <p> Note!</p> <ul style="list-style-type: none"> ▪ Programming is disabled if you do not press a key within 60 seconds following automatic return to the HOME position. ▪ You can also disable programming in this function by entering any number (other than the defined private code). ▪ The Endress+Hauser service organization can be of assistance if you mislay your personal code.
DEFINE PRIVATE CODE (2021)	<p>For specifying a personal code for enabling programming in the function ACCESS CODE.</p> <p>User input: 0 to 9999 (max. 4-digit number)</p> <p>Factory setting: 84</p> <p> Note!</p> <ul style="list-style-type: none"> ▪ Programming is always enabled with the code 0. ▪ Programming has to be enabled before this code can be changed. When programming is disabled this function is not available, thus preventing others from accessing your personal code.
STATUS ACCESS (2022)	<p>Indicates whether access to the function matrix is currently possible (ACCESS CUSTOMER) or whether configuration is locked (LOCKED).</p> <p>Display: ACCESS CUSTOMER (parameterization possible) LOCKED (parameterization disabled)</p>
ACCESS CODE COUNTER (2023)	<p>Displays how often the customer code, service code or the digit "0" (code-free) has been entered to gain access to the function matrix.</p> <p>Display: max. 7-digit number: 0 to 9999999</p> <p>Factory setting: 0</p>

5.1.3 Function group OPERATION

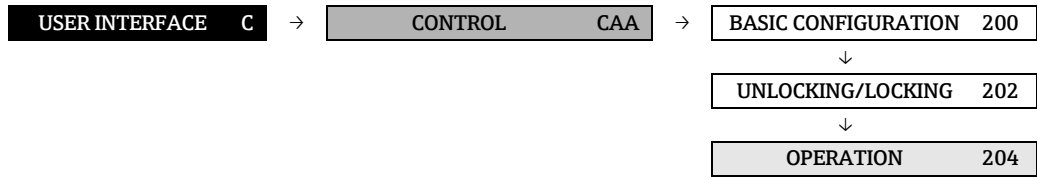

Function description USER INTERFACE → CONTROL → OPERATION	
TEST DISPLAY (2040)	<p>For testing the operability of the local display and its pixels.</p> <p>Options: OFF ON</p> <p>Factory setting: OFF</p> <p>Test sequence:</p> <ol style="list-style-type: none"> 1. Start the test by selecting ON. 2. All pixels of the main line, additional line and information line are darkened for minimum 0.75 second. 3. Main line, additional line and information line show an "8" in each field for minimum 0.75 seconds. 4. Main line, additional line and information line show a "0" in each field for minimum 0.75 seconds. 5. Main line, additional line and information line show nothing (blank display) for minimum 0.75 second. <p>When the test is completed, the local display returns to its initial state and the setting changes to OFF.</p>

5.2 Group MAIN LINE

5.2.1 Function group CONFIGURATION

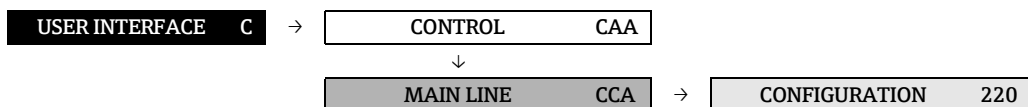

Function description USER INTERFACE → MAIN LINE → CONFIGURATION	
ASSIGN (2200)	<p>For assigning a value to be displayed to the main line (top line in the local display). This value is displayed during normal operation.</p> <p>Options: OFF MASS FLOW MASS FLOW IN % VOLUME FLOW VOLUME FLOW IN % CORRECTED VOLUME FLOW CORRECTED VOLUME FLOW IN % DENSITY REFERENCE DENSITY TEMPERATURE ACTUAL CURRENT ACTUAL VALUE FREQUENCY TOTALIZER (1 to 3)</p> <p>Factory setting: MASS FLOW</p>
100% VALUE (2201)	<p> Note! This function is not available unless one of the following was selected in the ASSIGN function (2200):</p> <ul style="list-style-type: none"> ▪ MASS FLOW IN % ▪ VOLUME FLOW IN % ▪ CORRECTED VOLUME FLOW IN % <p>For specifying the value to be shown on the display as the 100% value.</p> <p>User input: 5-digit floating-point number</p> <p>Factory setting: depends on nominal diameter and country → 119</p>
FORMAT (2202)	<p>Select the number of places after the decimal point displayed for the reading in the main line.</p> <p>Options: XXXXX. - XXXX.X - XXX.XX - XX.XXX - X.XXXX</p> <p>Factory setting: X.XXXX</p> <p> Note!</p> <ul style="list-style-type: none"> ▪ Note that this setting only affects the reading as it appears on the display, it has no influence on the accuracy of the system's calculations. ▪ The places after the decimal point as computed by the measuring device cannot always be displayed, depending on this setting and the engineering unit. In such instances an arrow appears on the display between the measuring value and the engineering unit (e.g. 1.2 →kg/h), indicating that the measuring system is computing with more decimal places than can be shown on the display.

5.2.2 Function group MULTIPLEX

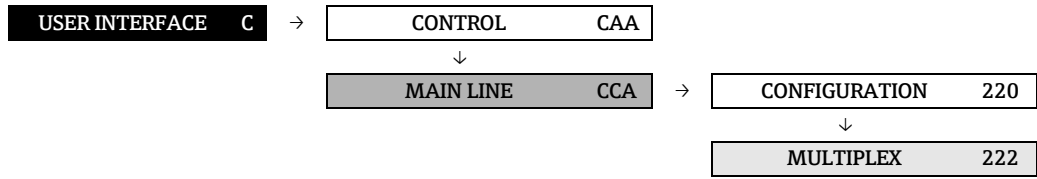





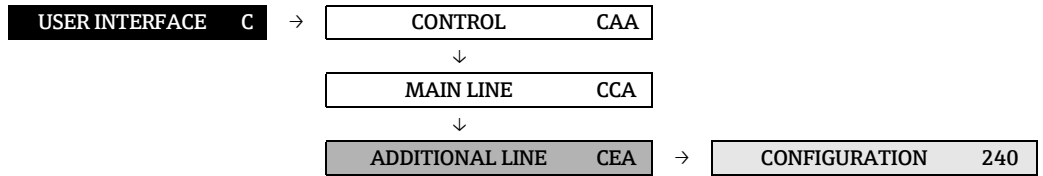

Function description USER INTERFACE → MAIN LINE → MULTIPLEX	
ASSIGN (2200)	<p>For assigning a second reading to the main line, to be displayed in the main line alternately (every 10 seconds) with the value defined in the ASSIGN function (2200).</p> <p>Options: OFF MASS FLOW MASS FLOW IN % VOLUME FLOW VOLUME FLOW IN % CORRECTED VOLUME FLOW CORRECTED VOLUME FLOW IN % DENSITY REFERENCE DENSITY TEMPERATURE ACTUAL CURRENT ACTUAL VALUE FREQUENCY TOTALIZER (1 to 3)</p> <p>Factory setting: OFF</p>
100% VALUE (2221)	<p> Note! This function is not available unless one of the following was selected in the ASSIGN function (2220):</p> <ul style="list-style-type: none"> ▪ MASS FLOW IN % ▪ VOLUME FLOW IN % ▪ CORRECTED VOLUME FLOW IN % <p>For specifying the value to be shown on the display as the 100% value.</p> <p>User input: 5-digit floating-point number</p> <p>Factory setting: depends on nominal diameter and country → 119</p>
FORMAT (2222)	<p>Select the number of places after the decimal point displayed for the second reading in the main line.</p> <p>Options: XXXXX - XXXX.X - XXX.XX - XX.XXX -X.XXXX</p> <p>Factory setting: X.XXXX</p> <p> Note!</p> <ul style="list-style-type: none"> ▪ Note that this setting only affects the reading as it appears on the display, it has no influence on the accuracy of the system's calculations. ▪ The places after the decimal point as computed by the measuring device cannot always be displayed, depending on this setting and the engineering unit. In such instances an arrow appears on the display between the measuring value and the engineering unit (e.g. 1.2 →kg/h), indicating that the measuring system is computing with more decimal places than can be shown on the display.

5.3 Group ADDITION LINE

5.3.1 Function group CONFIGURATION





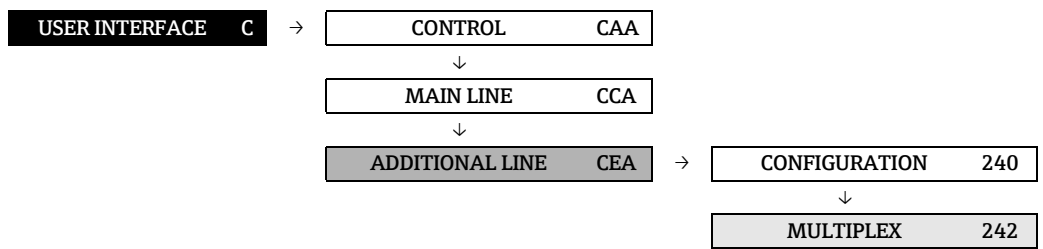

Function description USER INTERFACE → ADDITION LINE → CONFIGURATION	
ASSIGN (2400)	<p>For assigning a value to be displayed to the additional line (middle line in the local display). This value is displayed during normal operation.</p> <p>Options: OFF MASS FLOW MASS FLOW IN % VOLUME FLOW VOLUME FLOW IN % CORRECTED VOLUME FLOW CORRECTED VOLUME FLOW IN % DENSITY REFERENCE DENSITY TEMPERATURE MASS FLOW BARGRAPH IN % VOLUME FLOW BARGRAPH IN % CORRECTED VOLUME FLOW BARGRAPH IN % ACTUAL CURRENT ACTUAL VALUE FREQUENCY TOTALIZER (1 to 3) TAG NAME</p> <p>Factory setting: TOTALIZER 1</p>
100% VALUE (2401)	<p> Note! This function is not available unless one of the following was selected in the ASSIGN function (2400):</p> <ul style="list-style-type: none"> ■ MASS FLOW IN % ■ VOLUME FLOW IN % ■ CORRECTED VOLUME FLOW IN % ■ MASS FLOW BARGRAPH IN % ■ VOLUME FLOW BARGRAPH IN % ■ CORRECTED VOLUME FLOW BARGRAPH IN % <p>For specifying the value to be shown on the display as the 100% value.</p> <p>User input: 5-digit floating-point number</p> <p>Factory setting: depends on nominal diameter and country →  119</p>

Function description	
USER INTERFACE → ADDITION LINE → CONFIGURATION	
<p>FORMAT (2402)</p>	<p> Note! This function is not available unless a number was selected in the ASSIGN function (2400).</p> <p>Select the number of places after the decimal point displayed for the reading in the addition line.</p> <p>Options: XXXXX. - XXXX.X - XXX.XX - XX.XXX -X.XXXX</p> <p>Factory setting: X.XXXX</p> <p> Note!</p> <ul style="list-style-type: none"> ▪ Note that this setting only affects the reading as it appears on the display, it has no influence on the accuracy of the system's calculations. ▪ The places after the decimal point as computed by the measuring device cannot always be displayed, depending on this setting and the engineering unit. In such instances an arrow appears on the display between the measuring value and the engineering unit (e.g. 1.2 →kg/h), indicating that the measuring system is computing with more decimal places than can be shown on the display.
<p>DISPLAY MODE (2403)</p>	<p> Note! This function is not available unless one of the following was selected in the ASSIGN (2400) function:</p> <ul style="list-style-type: none"> ▪ MASS FLOW BARGRAPH IN % ▪ VOLUME FLOW BARGRAPH IN % ▪ CORRECTED VOLUME FLOW BARGRAPH IN % <p>Use this function to define the format of the bar graph.</p> <p>Options: STANDARD SYMMETRY</p> <p>Factory setting: STANDARD</p> <p>Illustration of bar graph</p> <div style="text-align: center;">  </div> <p style="text-align: right; font-size: small;">A0001258</p> <p><i>Fig. 7: Bar graph for STANDARD option Simple bar graph with 25 / 50 / 75% gradations and integrated sign.</i></p> <div style="text-align: center;">  </div> <p style="text-align: right; font-size: small;">A0001259</p> <p><i>Fig. 8: Bar graph for SYMMETRY option Symmetrical bar graph for positive and negative directions of flow, with -50 / 0 / +50% gradations and integrated sign.</i></p>

5.3.2 Function group MULTIPLEX



Function description	
USER INTERFACE → ADDITION LINE → MULTIPLEX	
ASSIGN (2420)	<p>For assigning a second reading to the addition line, to be displayed in the addition line alternately (every 10 seconds) with the value defined in the ASSIGN function (2400).</p> <p>Options: OFF MASS FLOW MASS FLOW IN % VOLUME FLOW VOLUME FLOW IN % CORRECTED VOLUME FLOW CORRECTED VOLUME FLOW IN % DENSITY REFERENCE DENSITY TEMPERATURE MASS FLOW BARGRAPH IN % VOLUME FLOW BARGRAPH IN % CORRECTED VOLUME FLOW BARGRAPH IN % ACTUAL CURRENT ACTUAL VALUE FREQUENCY TOTALIZER (1 to 3) TAG NAME</p> <p>Factory setting: OFF</p>
100% VALUE (2421)	<p> Note! This function is not available unless one of the following was selected in the ASSIGN function (2420):</p> <ul style="list-style-type: none"> ■ MASS FLOW IN % ■ VOLUME FLOW IN % ■ CORRECTED VOLUME FLOW IN % ■ MASS FLOW BARGRAPH IN % ■ VOLUME FLOW BARGRAPH IN % ■ CORRECTED VOLUME FLOW BARGRAPH IN % <p>For specifying the value to be shown on the display as the 100% value.</p> <p>User input: 5-digit floating-point number</p> <p>Factory setting: depends on nominal diameter and country →  119</p>

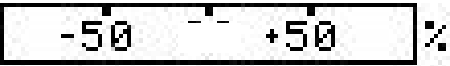

Function description USER INTERFACE → ADDITION LINE → MULTIPLEX	
<p>FORMAT (2422)</p>	<p>Select the number of places after the decimal point displayed for the second reading in the addition line.</p> <p>Options: XXXXX. - XXXX.X - XXX.XX - XX.XXX -X.XXXX</p> <p>Factory setting: X.XXXX</p> <p> Note!</p> <ul style="list-style-type: none"> ▪ Note that this setting only affects the reading as it appears on the display, it has no influence on the accuracy of the system's calculations. ▪ The places after the decimal point as computed by the measuring device cannot always be displayed, depending on this setting and the engineering unit. In such instances an arrow appears on the display between the measuring value and the engineering unit (e.g. 1.2 →kg/h), indicating that the measuring system is computing with more decimal places than can be shown on the display.
<p>DISPLAY MODE (2423)</p>	<p> Note!</p> <p>This function is not available unless one of the following was selected in the ASSIGN function (2420):</p> <ul style="list-style-type: none"> ▪ MASS FLOW BARGRAPH IN % ▪ VOLUME FLOW BARGRAPH IN % ▪ CORRECTED VOLUME FLOW BARGRAPH IN % <p>Use this function to define the format of the bar graph.</p> <p>Options: STANDARD SYMMETRY</p> <p>Factory setting: STANDARD</p> <p>Illustration of bar graph</p> <div style="text-align: center;">  </div> <p style="text-align: right; font-size: small;">A0001258</p> <p><i>Fig. 9: Bar graph for STANDARD option Simple bar graph with 25 / 50 / 75% gradations and integrated sign.</i></p> <div style="text-align: center; margin-top: 20px;">  </div> <p style="text-align: right; font-size: small;">A0001259</p> <p><i>Fig. 10: Bar graph for SYMMETRY option Symmetrical bar graph for positive and negative directions of flow, with -50 / 0 / +50% gradations and integrated sign.</i></p>

5.4 Group INFORMATION LINE

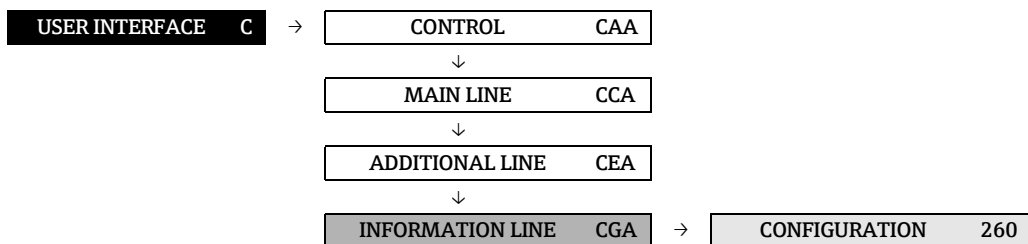
5.4.1 Function group CONFIGURATION



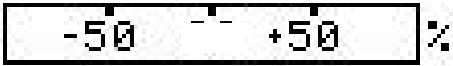

Function description USER INTERFACE → INFORMATION LINE → CONFIGURATION	
ASSIGN (2600)	<p>For assigning a value to be displayed to the information line (bottom line in the local display). This value is displayed during normal operation.</p> <p>Options: OFF MASS FLOW MASS FLOW IN % VOLUME FLOW VOLUME FLOW IN % CORRECTED VOLUME FLOW CORRECTED VOLUME FLOW IN % DENSITY REFERENCE DENSITY TEMPERATURE MASS FLOW BARGRAPH IN % VOLUME FLOW BARGRAPH IN % CORRECTED VOLUME FLOW BARGRAPH IN % ACTUAL CURRENT ACTUAL VALUE FREQUENCY TOTALIZER (1 to 3) TAG NAME OPERATING/SYSTEM CONDITIONS FLOW DIRECTION READING</p> <p>Factory setting: OPERATING/SYSTEM CONDITIONS</p>
100% VALUE (2601)	<p> Note! This function is not available unless one of the following was selected in the ASSIGN function (2600):</p> <ul style="list-style-type: none"> ■ MASS FLOW IN % ■ VOLUME FLOW IN % ■ CORRECTED VOLUME FLOW IN % ■ MASS FLOW BARGRAPH IN % ■ VOLUME FLOW BARGRAPH IN % ■ CORRECTED VOLUME FLOW BARGRAPH IN % <p>For specifying the value to be shown on the display as the 100% value.</p> <p>User input: 5-digit floating-point number</p> <p>Factory setting: depends on nominal diameter and country → 119</p>

Function description USER INTERFACE → INFORMATION LINE → CONFIGURATION	
<p>FORMAT (2602)</p>	<p>Select the number of places after the decimal point displayed for the reading in the information line.</p> <p>Options: XXXXX. - XXXX.X - XXX.XX - XX.XXX -X.XXXX</p> <p>Factory setting: X.XXXX</p> <p> Note!</p> <ul style="list-style-type: none"> ▪ Note that this setting only affects the reading as it appears on the display, it has no influence on the accuracy of the system's calculations. ▪ The places after the decimal point as computed by the measuring device cannot always be displayed, depending on this setting and the engineering unit. In such instances an arrow appears on the display between the measuring value and the engineering unit (e.g. 1.2 →kg/h), indicating that the measuring system is computing with more decimal places than can be shown on the display.
<p>DISPLAY MODE (2603)</p>	<p> Note!</p> <p>This function is not available unless one of the following was selected in the ASSIGN (2600) function:</p> <ul style="list-style-type: none"> ▪ MASS FLOW BARGRAPH IN % ▪ VOLUME FLOW BARGRAPH IN % ▪ CORRECTED VOLUME FLOW BARGRAPH IN % <p>Use this function to define the format of the bar graph.</p> <p>Options: STANDARD SYMMETRY</p> <p>Factory setting: STANDARD</p> <p>Illustration of bar graph</p> <div style="text-align: center;">  </div> <p style="text-align: right; font-size: small;">A0001258</p> <p><i>Fig. 11: Bar graph for STANDARD option Simple bar graph with 25 / 50 / 75% gradations and integrated sign.</i></p> <div style="text-align: center; margin-top: 20px;">  </div> <p style="text-align: right; font-size: small;">A0001259</p> <p><i>Fig. 12: Bar graph for SYMMETRY option Symmetrical bar graph for positive and negative directions of flow, with -50 / 0 / +50% gradations and integrated sign.</i></p>

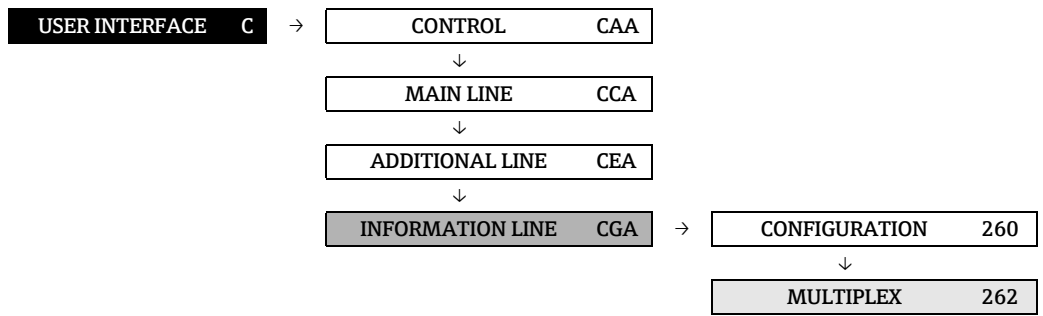
5.4.2 Function group MULTIPLEX

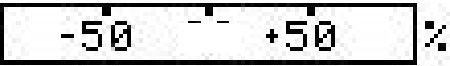

Function description	
USER INTERFACE → INFORMATION LINE → MULTIPLEX	
<p> Note!</p> <p>If you select the BATCHING OPERATING KEYS in the function ASSIGN (2600), the multiplex display functionality is not available in the information line.</p>	
<p>ASSIGN (2620)</p>	<p>For assigning a second reading to be displayed in the main line alternately (every 10 seconds) with the value defined in the ASSIGN function (2600).</p> <p>Options: OFF MASS FLOW MASS FLOW IN % VOLUME FLOW VOLUME FLOW IN % CORRECTED VOLUME FLOW CORRECTED VOLUME FLOW IN % DENSITY REFERENCE DENSITY TEMPERATURE MASS FLOW BARGRAPH IN % VOLUME FLOW BARGRAPH IN % CORRECTED VOLUME FLOW BARGRAPH IN % ACTUAL CURRENT ACTUAL FREQUENCY TOTALIZER 1 to 3 TAG NAME OPERATING/SYSTEM CONDITIONS DISPLAY FLOW DIRECTION</p> <p>Factory setting: OFF</p>
<p>100% VALUE (2621)</p>	<p> Note!</p> <p>This function is not available unless one of the following was selected in the ASSIGN function (2620):</p> <ul style="list-style-type: none"> ■ MASS FLOW IN % ■ VOLUME FLOW IN % ■ CORRECTED VOLUME FLOW IN % ■ MASS FLOW BARGRAPH IN % ■ VOLUME FLOW BARGRAPH IN % ■ CORRECTED VOLUME FLOW BARGRAPH IN % <p>For specifying the value to be shown on the display as the 100% value.</p> <p>User input: 5-digit floating-point number</p> <p>Factory setting: depends on nominal diameter and country → 119</p>

Function description USER INTERFACE → INFORMATION LINE → MULTIPLEX	
<p>FORMAT (2622)</p>	<p>Select the number of places after the decimal point displayed for the second reading in the information line.</p> <p>Options: XXXXX - XXXX.X - XXX.XX - XX.XXX -X.XXXX</p> <p>Factory setting: X.XXXX</p> <p> Note!</p> <ul style="list-style-type: none"> ▪ Note that this setting only affects the reading as it appears on the display, it has no influence on the accuracy of the system's calculations. ▪ The places after the decimal point as computed by the measuring device cannot always be displayed, depending on this setting and the engineering unit. In such instances an arrow appears on the display between the measuring value and the engineering unit (e.g. 1.2 →kg/h), indicating that the measuring system is computing with more decimal places than can be shown on the display.
<p>DISPLAY MODE (2623)</p>	<p> Note!</p> <p>This function is not available unless one of the following was selected in the ASSIGN function (2620):</p> <ul style="list-style-type: none"> ▪ MASS FLOW BARGRAPH IN % ▪ VOLUME FLOW BARGRAPH IN % ▪ CORRECTED VOLUME FLOW BARGRAPH IN % <p>Use this function to define the format of the bar graph.</p> <p>Options: STANDARD SYMMETRY</p> <p>Factory setting: STANDARD</p> <p>Illustration of bar graph</p> <div style="text-align: center;">  </div> <p style="text-align: right; font-size: small;">A0001258</p> <p><i>Fig. 13: Bar graph for STANDARD option Simple bar graph with 25 / 50 / 75% gradations and integrated sign.</i></p> <div style="text-align: center; margin-top: 20px;">  </div> <p style="text-align: right; font-size: small;">A0001259</p> <p><i>Fig. 14: Bar graph for SYMMETRY option Symmetrical bar graph for positive and negative directions of flow, with -50 / 0 / +50% gradations and integrated sign.</i></p>

6 Block TOTALIZER

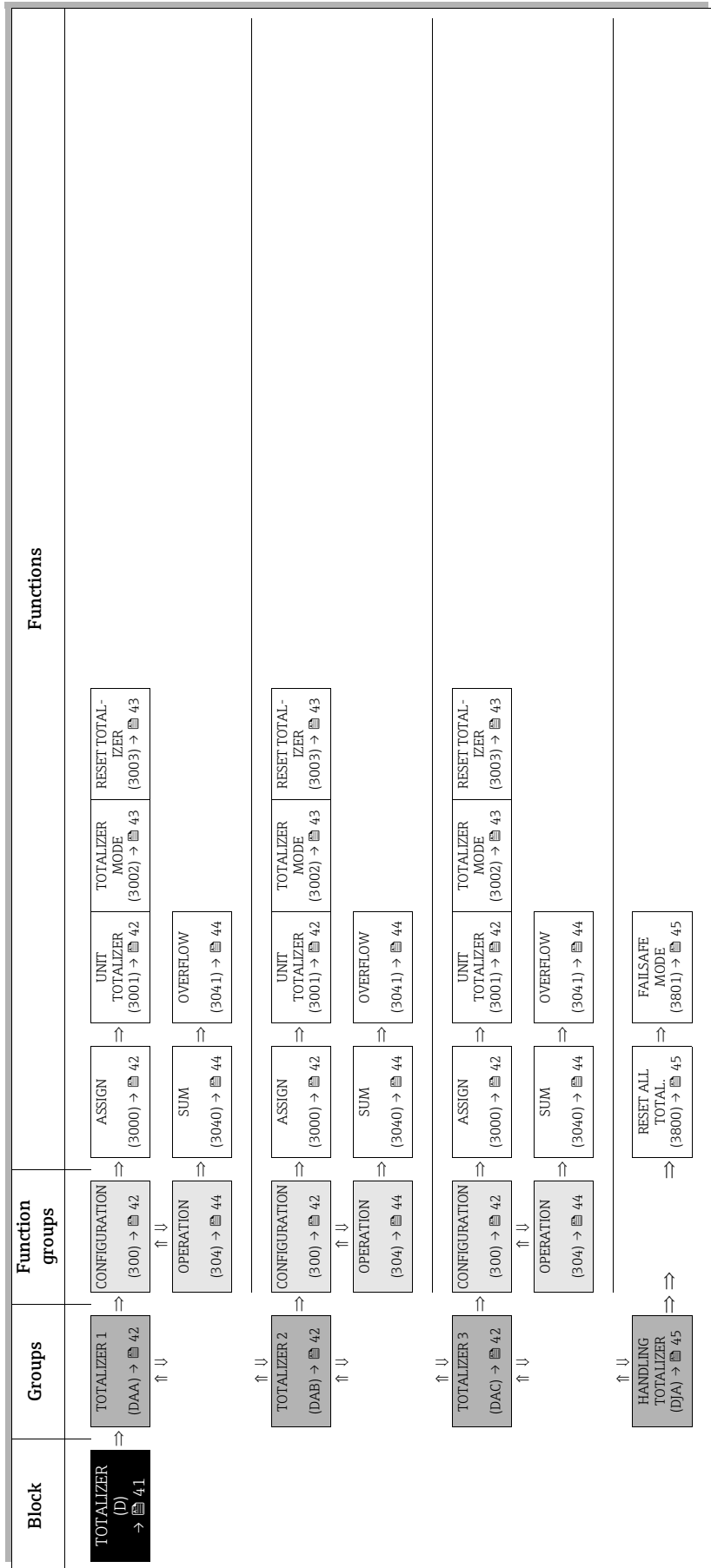

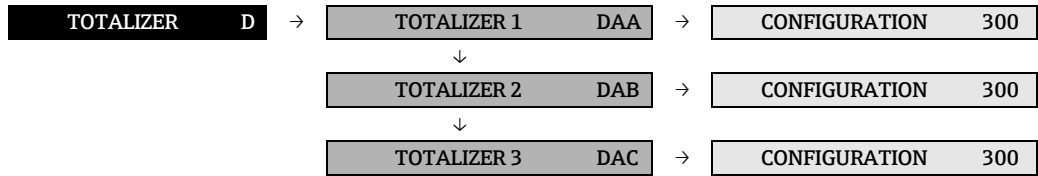

6.1 Group TOTALIZER (1 to 3)

6.1.1 Function group CONFIGURATION



Function description TOTALIZER → TOTALIZER (1 to 3) → CONFIGURATION	
<p> Note! The function descriptions below apply to totalizers 1 to 3; the totalizers are independently configurable.</p>	
<p>ASSIGN (3000)</p>	<p>For assigning a measured variable to the totalizer in question.</p> <p>Options (standard): OFF MASS FLOW VOLUME FLOW CORRECTED VOLUME FLOW</p> <p>Factory setting: MASS FLOW</p> <p> Note!</p> <ul style="list-style-type: none"> ▪ The totalizer is reset to 0 as soon as the selection is changed. ▪ If you select OFF in the function group of the totalizer in question, only the ASSIGN (ASSIGN(3000)) function remains visible.
<p>UNIT TOTALIZER (3001)</p>	<p>For selecting the unit for the measured variable assigned in the function ASSIGN (3000).</p> <p>Options: for the MASS FLOW assignment Metric → g; kg; t US → oz; lb; ton</p> <p>Factory setting: kg</p> <p>Options: for the VOLUME FLOW assignment Metric → cm³; dm³; m³; ml; l; hl; Ml Mega US → cc; af; ft³; oz f; gal; Kgal; Mgal; bbl (normal fluids); bbl (beer); bbl (petrochemicals); bbl (filling tanks) Imperial → gal; Mgal; bbl (beer); bbl (petrochemicals)</p> <p>Factory setting: m³</p> <p>Options: for the CORRECTED VOLUME FLOW assignment Metric → Nl; Nm³ US → Sm³; Scf</p> <p>Factory setting: Nm³</p>

Function description	
TOTALIZER → TOTALIZER (1 to 3) → CONFIGURATION	
TOTALIZER MODE (3002)	<p>For selecting how the totalizer should operate.</p> <p>Options: BALANCE Positive and negative flow components. The positive and negative flow components are balanced. In other words, net flow in the flow direction is registered.</p> <p>FORWARD Only positive flow components</p> <p>REVERSE Only negative flow components</p> <p>Factory setting: Totalizer 1 = BALANCE Totalizer 2 = FORWARD Totalizer 3 = REVERSE</p>
RESET TOTALIZER (3003)	<p>Resets the total and the overflow of the totalizer to zero.</p> <p>Options: NO YES</p> <p>Factory setting: NO</p> <p> Note!</p> <ul style="list-style-type: none"> ▪ If the measuring instrument is equipped with a status input, with the appropriate configuration a reset for each individual totalizer can also be triggered by a pulse (→ the function ASSIGN STATUS INPUT (5000) on →  90).

6.1.2 Function group OPERATION

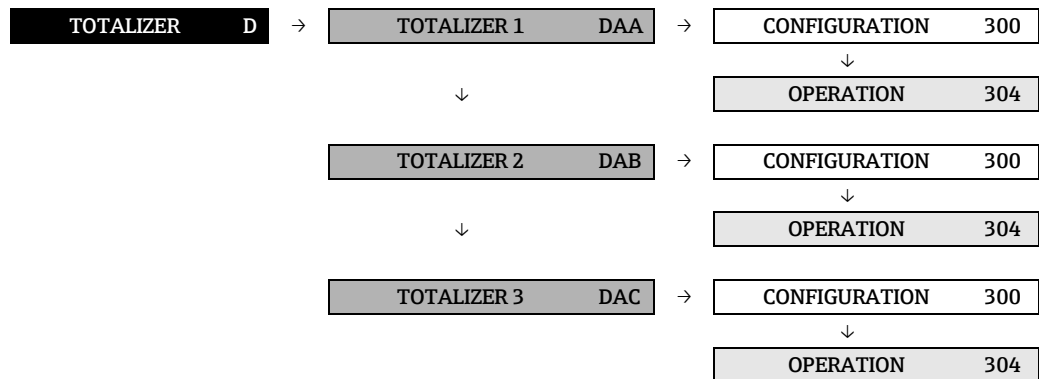

Function description TOTALIZER → TOTALIZER (1 to 3) → OPERATION	
<p> Note! The function descriptions below apply to totalizers 1 to 3; the totalizers are independently configurable.</p>	
<p>SUM (3040)</p>	<p>Displays the total for the totalizer's measured variable aggregated since measuring began. The value can be positive or negative, depending on the setting selected in the function TOTALIZER MODE (3002), and the direction of flow.</p> <p>Display: max. 7-digit floating-point number, including sign and unit (e.g. 15467.04 m³; -4925.631 kg)</p> <p> Note!</p> <ul style="list-style-type: none"> ▪ The effect of the setting in the TOTALIZER MODE function (→ 43) is as follows: <ul style="list-style-type: none"> – If the setting is BALANCE, the totalizer balances flow in the positive and negative directions. – If the setting is FORWARD, the totalizer registers only flow in the positive direction. – If the setting is REVERSE, the totalizer registers only flow in the negative direction. ▪ The totalizer's response to faults is defined in the FAILSAFE MODE (3801) function (→ 45).
<p>OVERFLOW (3041)</p>	<p>Displays the total for the totalizer's overflow aggregated since measuring began.</p> <p>Total flow quantity is represented by a floating-point number consisting of max. 7 digits. You can use this function to view higher numerical values (> 9999999) as overflows. The effective quantity is thus the total of OVERFLOW plus the value returned by the SUM function.</p> <p>Example: Reading for 2 overflows: 2 E7 kg (= 20000000 kg) The value displayed in the function SUM = 196845.7 kg Effective total quantity = 20196845.7 kg</p> <p>Display: integer with exponent, including sign and unit, e.g. 2 E7 kg</p>

6.2 Group HANDLING TOTAL.

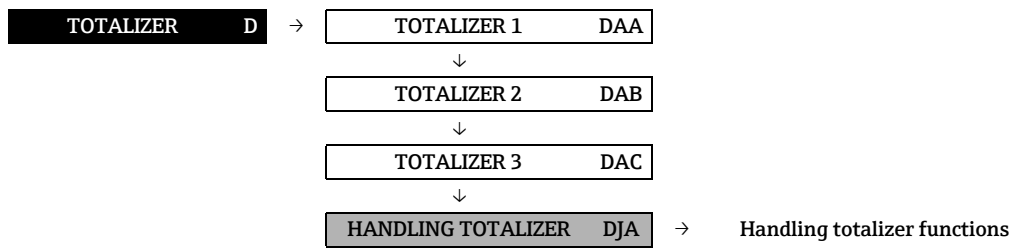

Function description	
TOTALIZER → HANDLING TOTALIZER → Handling totalizer functions	
RESET ALL TOTALIZERS (3800)	Resets the totals and the overflows of all totalizers to zero. Options: NO YES Factory setting: NO  Note! If the measuring instrument has a status input and if it is appropriately configured, a reset for the totalizer (1 to 3) can also be triggered by a pulse (→ the ASSIGN STATUS INPUT function ((5000) on → 90)).
FAILSAFE MODE (3801)	Use this function to define the common response of all totalizers (1 to 3) in case of error. Options: STOP The totalizer is paused until the fault is rectified. ACTUAL VALUE The totalizer continues to count based on the current flow measuring value. The fault is ignored. HOLD VALUE The totalizer continues to count the flow that based on the last valid flow value (before the fault occurred). Factory setting: STOP

7 Block OUTPUTS



Block	Groups	Function groups	Functions		
OUTPUTS (E)	CURR. OUTPUT 1 to 2 (EAA, EAB) → 47	CONFIGURATION (400) → 47	CURRENT SPAN VALUE 0..4 mA (4001) → 48		
		OPERATION (404) → 56	VALUE 20 mA (4003) → 51		
		INFORMATION (408) → 57	MEASURING MODE (4004) → 51		
	PUL./FREQ. 1 to 2 (ECA, ECB) → 58	CONFIGURATION (420) → 58	VALUE 0..4 mA (4002) → 49	TIME CONSTANT (4005) → 54	
		OPERATION (430) → 75	ACTUAL CURRENT (4040) → 56	MEASURING MODE (4006) → 55	
			INFORMATION (438) → 78	VALUE SIMUL. CURRENT (4042) → 56	FAILSAFE MODE (4209) → 65
	RELAY OUTPUT (EGA) → 79	CONFIGURATION (470) → 79	ASSIGN CURRENT (4000) → 47	MEASURING MODE (4206) → 62	
		OPERATION (474) → 83	ACTUAL CURRENT (4040) → 56	VALUE f HIGH (4205) → 60	
		INFORMATION (478) → 85	TERMINAL NUMBER (4080) → 57	VALUE f MIN (4204) → 60	
		OPERATION (480) → 86	MODE OF OPERATION (4200) → 58	END VALUE FREQUENCY (4203) → 59	MEASURING MODE (4227) → 71
			INFORMATION (484) → 88	FAILSAFE VALUE (4211) → 66	FAILSAFE MODE (4247) → 74
		OPERATION (490) → 91	ASSIGN PULSE (4221) → 67	PULSE VALUE (4222) → 67	MEASURING MODE (4246) → 74
			INFORMATION (494) → 93	ASSIGN STATUS (4241) → 72	OFF VALUE (4244) → 73
		OPERATION (500) → 96	ACTUAL FREQ. (4301) → 75	ON-VALUE (4242) → 72	SWITCH-OFF DELAY (4245) → 73
			INFORMATION (504) → 98	SIMULATION PULSE (4322) → 76	SWITCH-ON DELAY (4243) → 73
OPERATION (510) → 101		ACTUAL STATUS (4341) → 77	SIMULATION FREQ. (4302) → 75	VALUE SIMUL. FREQ. (4303) → 75	
		INFORMATION (514) → 103	SIMULATION PULSE (4322) → 76	VALUE SIM. SWITCH PT. (4343) → 77	
OPERATION (520) → 106		ASSIGN RELAY (4700) → 79	ON-VALUE (4701) → 80	SWITCH-ON DELAY (4702) → 80	
	INFORMATION (524) → 108	ACTUAL STATUS RELAY (4740) → 83	ON-VALUE (4701) → 80		
OPERATION (530) → 111	ASSIGN RELAY (4700) → 79	ACTUAL STATUS RELAY (4741) → 83	SWITCH POINT (4742) → 84		
	INFORMATION (534) → 113	TERMINAL NUMBER (4780) → 85	VALUE SIM. SWITCH POINT (4742) → 84		
OPERATION (540) → 116	ASSIGN RELAY (4700) → 79	ASSIGN RELAY (4700) → 79	OFF VALUE (4703) → 80		
	INFORMATION (544) → 118	ACTUAL STATUS RELAY (4740) → 83	SWITCH-OFF DELAY (4704) → 81		
OPERATION (550) → 121	ASSIGN RELAY (4700) → 79	ASSIGN RELAY (4700) → 79	MEASURING MODE (4705) → 81		
	INFORMATION (554) → 123	ACTUAL STATUS RELAY (4740) → 83	TIME CONSTANT (4706) → 82		

7.1 Group CURRENT OUTPUT 1 to 2

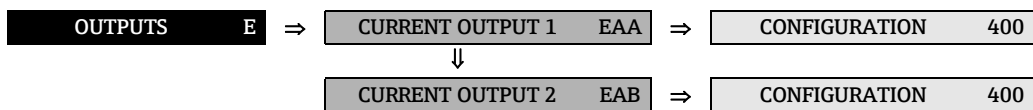
7.1.1 Function group CONFIGURATION



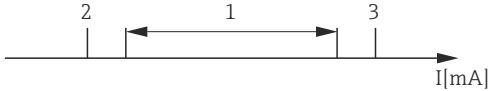

Function description	
OUTPUTS → CURRENT OUTPUT 1 to 2 → CONFIGURATION	
ASSIGN CURRENT OUTPUT (4000)	<p>For assigning a measured variable to the current output.</p> <p>Options: OFF MASS FLOW VOLUME FLOW CORRECTED VOLUME FLOW DENSITY REFERENCE DENSITY TEMPERATURE</p> <p>Factory setting: MASS FLOW</p> <p> Note! If you select OFF, the only function shown in the CONFIGURATION function group is this function, in other words ASSIGN CURRENT OUTPUT (4000).</p>

Function description																													
OUTPUTS → CURRENT OUTPUT 1 to 2 → CONFIGURATION																													
<p>CURRENT SPAN (4001)</p>	<p>For selecting the current span. The selection specifies the operational range and the lower and upper signal on alarm. For the current output 1 the option HART can be defined additionally.</p> <p>Options: 0 to 20 mA (25 mA) 4 to 20 mA (25 mA) 0 to 20 mA 4 to 20 mA 4 to 20 mA NAMUR 4 to 20 mA US</p> <p>Factory setting: 4 to 20 mA NAMUR or 4 to 20 mA US</p> <p> Note! When switching the hardware from an active (factory setting) to a passive output signal, select a current span of 4 to 20 mA → Operating Instructions (BA00139D/06).</p> <div style="text-align: center;">  </div> <table border="1" style="margin-left: auto; margin-right: auto;"> <thead> <tr> <th style="text-align: center;">a</th> <th style="text-align: center;">1</th> <th style="text-align: center;">2</th> <th style="text-align: center;">3</th> </tr> </thead> <tbody> <tr> <td>0-20 mA (25 mA)</td> <td>0 - 24 mA</td> <td>0</td> <td>25</td> </tr> <tr> <td>4-20 mA (25 mA)</td> <td>4 - 24 mA</td> <td>2</td> <td>25</td> </tr> <tr> <td>0-20 mA</td> <td>0 - 20.5 mA</td> <td>0</td> <td>22</td> </tr> <tr> <td>4-20 mA</td> <td>4 - 20.5 mA</td> <td>2</td> <td>22</td> </tr> <tr> <td>4-20 mA NAMUR</td> <td>3.8 - 20.5 mA</td> <td>3.5</td> <td>22.6</td> </tr> <tr> <td>4-20 mA US</td> <td>3.9 - 20.8 mA</td> <td>3.75</td> <td>22.6</td> </tr> </tbody> </table> <p style="text-align: right; font-size: small;">A0002959</p> <p><i>Fig. 15: Overview of current span, operational range and signal on alarm level</i></p> <p>a <i>Current span</i> 1 <i>Operational range (measuring information)</i> 2 <i>Lower signal on alarm level</i> 3 <i>Upper signal on alarm level</i></p> <p> Note!</p> <ul style="list-style-type: none"> ▪ If the measured value exceeds the measuring range (as defined in the functions VALUE 0_4 mA (4002) and VALUE 20 mA (4003)) a notice message is generated (#351 to 354, current span). ▪ In case of a fault the behavior of the current output is according to the selected option in the function FAILSAFE MODE (4006). 	a	1	2	3	0-20 mA (25 mA)	0 - 24 mA	0	25	4-20 mA (25 mA)	4 - 24 mA	2	25	0-20 mA	0 - 20.5 mA	0	22	4-20 mA	4 - 20.5 mA	2	22	4-20 mA NAMUR	3.8 - 20.5 mA	3.5	22.6	4-20 mA US	3.9 - 20.8 mA	3.75	22.6
a	1	2	3																										
0-20 mA (25 mA)	0 - 24 mA	0	25																										
4-20 mA (25 mA)	4 - 24 mA	2	25																										
0-20 mA	0 - 20.5 mA	0	22																										
4-20 mA	4 - 20.5 mA	2	22																										
4-20 mA NAMUR	3.8 - 20.5 mA	3.5	22.6																										
4-20 mA US	3.9 - 20.8 mA	3.75	22.6																										

Function description	
OUTPUTS → CURRENT OUTPUT 1 to 2 → CONFIGURATION	
<p>VALUE 0_4 mA (4002)</p>	<p>Use this function to assign the 0/4 mA current a value. The value can be higher or lower than the value assigned to 20 mA (function VALUE 20 mA (4003) → 51). Positive and negative values are permissible, depending on the measured variable in question (e.g. mass flow).</p> <p>Example: 4 mA assigned value = -250 kg/h 20 mA assigned value = +750 kg/h Calculated current value = 8 mA (at zero flow)</p> <p>Note! Note that values with different signs cannot be entered for 0/4 mA and 20 mA if SYMMETRY is the setting selected for the MEASURING MODE function (4004). In this case, the message "INPUT RANGE EXCEEDED" appears on the display.</p> <p>Example for STANDARD measuring mode:</p> <div style="text-align: center;"> </div> <p style="text-align: right; font-size: small;">A0001223</p> <p>① = Lower range-value (0 to 20 mA) ② = Lower signal on alarm level: depends on the setting in the function CURRENT SPAN ③ = Lower range-value (4 to 20 mA): depends on the setting in the function CURRENT SPAN ④ = Full scale value (0/4 to 20 mA): depends on the setting in the function CURRENT SPAN ⑤ = Maximum current value: depends on the setting in the function CURRENT SPAN ⑥ = Failsafe mode (upper signal on alarm level): depends on the functions CURRENT SPAN (→ 48) and FAILSAFE MODE (→ 45) A = Measuring range</p> <p>User input: 5-digit floating-point number, with sign</p> <p>Factory setting: 0 [kg/h] or 0.5 [kg/l] or -50 [°C]</p> <p>Note!</p> <ul style="list-style-type: none"> ■ The appropriate unit is taken from the following functions: <ul style="list-style-type: none"> - UNIT MASS FLOW (0400) - UNIT VOLUME FLOW (0402) - UNIT CORRECTED VOLUME FLOW (0404) - UNIT DENSITY (0420) - UNIT REFERENCE DENSITY (0421) - UNIT TEMPERATURE (0422) (→ 13 to → 17). <p>Caution! The current output responds differently, depending on the parameters set in the various functions. Some examples of parameter settings and their effect on the current output are given in the following section.</p> <p>(continued on next page)</p>

Function description	
OUTPUTS → CURRENT OUTPUT 1 to 2 → CONFIGURATION	
<p>VALUE 0_4 mA (continued)</p>	<p>Parameter setting example A:</p> <ol style="list-style-type: none"> VALUE 0_4 mA (4002) = not equal to zero flow (e.g. -5 kg/h) VALUE 20 mA (4003) = not equal to zero flow (e.g. 10 kg/h) or VALUE 0_4 mA (4002) = not equal to zero flow (e.g. 100 kg/h) VALUE 20 mA (4003) = not equal to zero flow (e.g. -40 kg/h) <p>and MEASURING MODE (4004) = STANDARD</p> <p>When you enter the values for 0/4 mA and 20 mA, the working range of the measuring device is defined. If the effective flow drops below or exceeds this working range (→ ①), a fault/notice message is generated (#351 to 354, current range) and the current output responds in accordance with the parameter settings in the function FAILSAFE MODE (4006).</p> <div style="display: flex; justify-content: space-around;"> <div style="text-align: center;"> <p>1)</p> </div> <div style="text-align: center;"> <p>2)</p> </div> </div> <p style="text-align: right; font-size: small;">A0001262</p> <p>Parameter setting example B:</p> <ol style="list-style-type: none"> VALUE 0_4 mA (4002) = equal to zero flow (e.g. 0 kg/h) VALUE 20 mA (4003) = not equal to zero flow (e.g. 10 kg/h) or VALUE 0_4 mA (4002) = not equal to zero flow (e.g. 100 kg/h) VALUE 20 mA (4003) = equal to zero flow (e.g. 0 kg/h) <p>and MEASURING MODE (4004) = STANDARD</p> <p>When you enter the values for 0/4 mA and 20 mA, the working range of the measuring device is defined. In doing so, one of the two values is parameterized as zero flow (e.g. 0 kg/h).</p> <p>If the effective flow drops below or exceeds the value parameterized as the zero flow, no fault/notice message is generated and the current output retains its value.</p> <p>If the effective flow drops below or exceeds the other value, a fault/notice message is generated (#351 to 354, current range) and the current output responds in accordance with the parameter settings in the function FAILSAFE MODE (4006).</p> <div style="display: flex; justify-content: space-around;"> <div style="text-align: center;"> <p>1)</p> </div> <div style="text-align: center;"> <p>2)</p> </div> </div> <p style="text-align: right; font-size: small;">A0001264</p> <p>Deliberately only one flow direction is output with this setting and flow values in the other flow direction are suppressed.</p> <p>Parameter setting example C: MEASURING MODE (4004) = SYMMETRY</p> <p>The current output signal is independent of the direction of flow (absolute amount of the measured variable). The 0_4 mA value ① and the 20 mA value ② must have the same sign (+ or -). The 20 mA VALUE ③ (e.g. backflow) corresponds to the mirrored 20 mA VALUE ② (e.g. flow).</p> <div style="text-align: center;"> </div> <p style="text-align: right; font-size: small;">A0001249</p> <p>ASSIGN STATUS (4241) = FLOW DIRECTION</p> <p>With this setting e.g. the flow direction output via a switching contact can be made.</p> <p>Parameter setting example D: MEASURING MODE (4004) = PULSATING FLOW → 51</p>

Function description	
OUTPUTS → CURRENT OUTPUT 1 to 2 → CONFIGURATION	
<p>VALUE 20 mA (4003)</p>	<p>Use this function to assign the 20 mA current a value. The value can be higher or lower than the value assigned to 0/4 mA (function VALUE 0_4 mA (4002) → 49). Positive and negative values are permissible, depending on the measured variable in question (e.g. mass flow).</p> <p>Example: 4 mA assigned value = -250 kg/h 20 mA assigned value = +750 kg/h Calculated current value = 8 mA (at zero flow)</p> <p>Note that values with different signs cannot be entered for 0/4 mA and 20 mA, if SYMMETRY is the setting selected in the function MEASURING MODE (4004). In this case, the message "INPUT RANGE EXCEEDED" appears.</p> <p>User input: 5-digit floating-point number, with sign</p> <p>Factory setting: Depends on nominal diameter [kg/h] or 2 [kg/l] or 200 [°C]</p> <p> Note! The appropriate unit is taken from the following functions: - UNIT MASS FLOW (0400) - UNIT VOLUME FLOW (0402) - UNIT CORRECTED VOLUME FLOW (0404) - UNIT DENSITY (0420) - UNIT REFERENCE DENSITY (0421) - UNIT TEMPERATURE (0422) (→ 13 to → 17).</p> <p>▪ Example for selection STANDARD in the function MEASURING MODE (4004) → 51.</p> <p> Caution! It is very important to read and comply with the information in the function VALUE 0_4 mA (4002) (under "⚠ Caution", examples of parameter settings) → 49.</p>
<p>MEASURING MODE (4004)</p>	<p>Use this function to define the measuring mode for the current output.</p> <p>Options: STANDARD SYMMETRY PULSATING FLOW</p> <p>Factory setting: STANDARD</p> <p>(continued on next page)</p>

Function description	
OUTPUTS → CURRENT OUTPUT 1 to 2 → CONFIGURATION	
MEASURING MODE (continued)	<p>Description of the individual options:</p> <p>STANDARD</p> <p>The current output signal is proportional to the measured variable. The flow components outside the scaled measuring range (defined by the 0_4 mA VALUE ① and the 20 mA VALUE ②) are taken into account as follows for signal output.</p> <ul style="list-style-type: none"> ■ If one of the values is defined as equal to the zero flow (e.g. VALUE 0_4 mA = 0 kg/h), no message is given if this value is exceeded or not achieved and the current output retains its value (in example 4 mA). If the other value is exceeded or not achieved, the message "CURRENT OUTPUT AT FULL SCALE VALUE" appears and the current output responds in accordance with the parameter setting in the function FAILSAFE MODE (4006). ■ If both values defined are not equal to the zero flow (for example VALUE 0_4 mA = -5 kg/h, VALUE 20 mA = 10kg/h), the message "CURRENT OUTPUT AT FULL SCALE VALUE" appears if the measuring range is exceeded or not achieved and the current output responds in accordance with the parameter settings in the function FAILSAFE MODE (4006). <div style="text-align: center;"> </div> <p style="text-align: right;">A0001248</p> <p><i>Fig. 16: Example for STANDARD measuring mode</i></p> <p>SYMMETRY</p> <p>The current output signal is independent of the direction of flow (absolute amount of the measured variable). The 0_4 mA value ① and the 20 mA value ② must have the same sign (+ or -). The 20 mA VALUE ③ (e.g. backflow) corresponds to the mirrored 20 mA VALUE ④ (e.g. flow).</p> <div style="text-align: center;"> </div> <p style="text-align: right;">A0001249</p> <p><i>Fig. 17: Example for SYMMETRY measuring mode</i></p> <p>Note!</p> <ul style="list-style-type: none"> ■ The direction of flow can be output via the configurable status outputs. ■ SYMMETRY cannot be selected unless the values in the VALUE 0_4 mA (4002) and VALUE 20 mA (4003) functions have the same sign or one of the values is zero. If the values have different signs, SYMMETRY cannot be selected and an "ASSIGNMENT NOT POSSIBLE" message is displayed. <p>PULSATING FLOW</p> <p>If flow is characterized by severe fluctuations as is the case, for example, with reciprocating pumps, flow components outside the measuring range are buffered, balanced and output after a maximum delay of 60 seconds. If the buffered data cannot be processed within approx. 60 seconds, a fault/notice message appears. Under certain plant conditions, flow values can aggregate in the buffer, for example in the case of prolonged and unwanted fluid backflow. However, this buffer is reset in all relevant programming adjustments which affect the current output.</p>



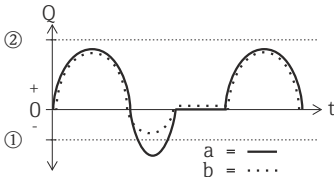
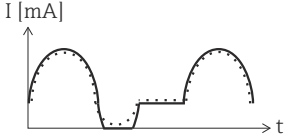
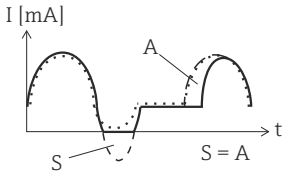

Function description OUTPUTS → CURRENT OUTPUT 1 to 2 → CONFIGURATION	
Detailed explanations and information	<p>How the current output responds under the following postulated conditions:</p> <p>1. Defined measuring range (①-②): ① and ② have the same sign</p> <div style="text-align: center;"> </div> <p style="text-align: right;">A0001248</p> <p>and the following flow behavior:</p> <div style="text-align: center;"> </div> <p style="text-align: right;">A0001265</p> <ul style="list-style-type: none"> <p>■ STANDARD The current output signal is proportional to the measured variable. The flow components outside the scaled measuring range are not taken into account for signal output.</p> <div style="text-align: center;"> </div> <p style="text-align: right;">A0001267</p> <p>■ SYMMETRY The current output signal is independent of the direction of flow.</p> <div style="text-align: center;"> </div> <p style="text-align: right;">A0001268</p> <p>■ PULSATING FLOW Flow components outside the measuring range are buffered, balanced and output after a maximum delay of 60 seconds.</p> <div style="text-align: center;"> </div> <p style="text-align: right;">A0001269</p> <p>2. Defined measuring range (①-②): ① and ② do not have the same sign.</p> <div style="text-align: center;"> </div> <p style="text-align: right;">A0001272</p> <p>(continued on next page)</p>

Function description	
OUTPUTS → CURRENT OUTPUT 1 to 2 → CONFIGURATION	
<p>Detailed explanations and information (continued)</p>	<p>Flow a (-) outside, b (- -) within the measuring range.</p>  <p style="text-align: right;">A0001273</p> <ul style="list-style-type: none"> <p>■ STANDARD</p> <p>a (-): The flow components outside the scaled measuring range cannot be taken into account for signal output. A fault message is generated (# 351 to 354, current range) and the current output responds in accordance with the parameter settings in the function FAIL-SAFE MODE (4006).</p> <p>b (- -): The current output signal is proportional to the measured variable assigned.</p>  <p style="text-align: right;">A0001274</p> <ul style="list-style-type: none"> <p>■ SYMMETRY</p> <p>This option is not available under these circumstances, because the 0_4 mA value and the 20 mA value have different signs.</p> <p>■ PULSATING FLOW</p> <p>Flow components outside the measuring range are buffered, balanced and output after a maximum delay of 60 seconds.</p>  <p style="text-align: right;">A0001275</p>
<p>TIME CONSTANT (4005)</p>	<p>Entering a time constant defines how the current output signal reacts to severely fluctuating measured variables, either very quickly (enter a low time constant) or with damping (enter a high time constant).</p> <p>User input: Fixed-point number 0.01 to 100.00 s</p> <p>Factory setting: 1.00 s</p>

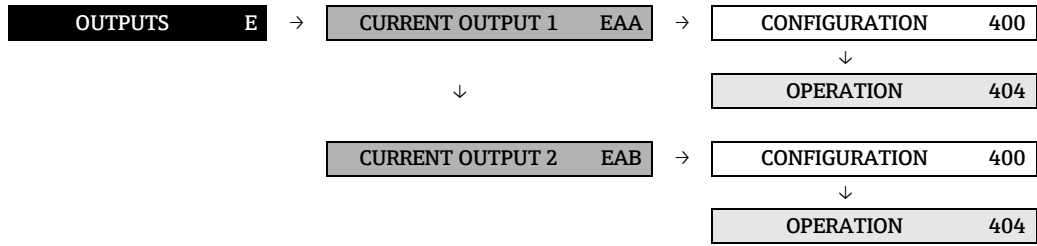
Function description	
OUTPUTS → CURRENT OUTPUT 1 to 2 → CONFIGURATION	
<p>FAILSAFE MODE (4006)</p>	<p>For safety reasons it is advisable to ensure that the current output assumes a pre-defined state in the event of a fault. The setting you select here affects only the current output. It has no effect on other outputs and the display (e.g. totalizers).</p> <p>Options:</p> <p>MIN. CURRENT The current output adopts the value of the lower signal on alarm level (as defined in the function CURRENT SPAN (4001), → 48).</p> <p>MAX. CURRENT The current output adopts the value of the upper signal on alarm level (as defined in the function CURRENT SPAN (4001), → 48).</p> <p>HOLD VALUE (not recommended) Measuring value output is based on the last measuring value saved before the error occurred.</p> <p>ACTUAL VALUE Measured value output is based on the current flow measurement. The fault is ignored.</p> <p>Factory setting: MIN. CURRENT</p>

7.1.2 Function group OPERATION



Function description	
OUTPUTS → CURRENT OUTPUT 1 to 2 → OPERATION	
ACTUAL CURRENT (4040)	<p>Use this function to view the computed actual value of the output current.</p> <p>Display: 0.00 to 25.00 mA</p>
SIMULATION CURRENT (4041)	<p>Activates simulation of the current output.</p> <p>Options: OFF ON</p> <p>Factory setting: OFF</p> <p> Note!</p> <ul style="list-style-type: none"> ▪ The "SIMULATION CURRENT OUTPUT" message indicates that simulation is active. ▪ The measuring device continues to measure while simulation is in progress, i.e. the current measured values are output correctly via the other outputs. <p> Caution! The setting is not saved in the event of a power failure.</p>
VALUE SIMULATION CURRENT (4042)	<p>Use this function to define a freely selectable value (e.g. 12 mA) to be output at the current output. This value is used to test downstream devices and the measuring device itself.</p> <p>User input: 0.00 to 25.00 mA</p> <p>Factory setting: 0.00 mA</p> <p> Note! This function is displayed only if the function SIMULATION CURR. (4041) is active (= ON).</p> <p> Caution! The setting is not saved in the event of a power failure.</p>

7.1.3 Function group INFORMATION

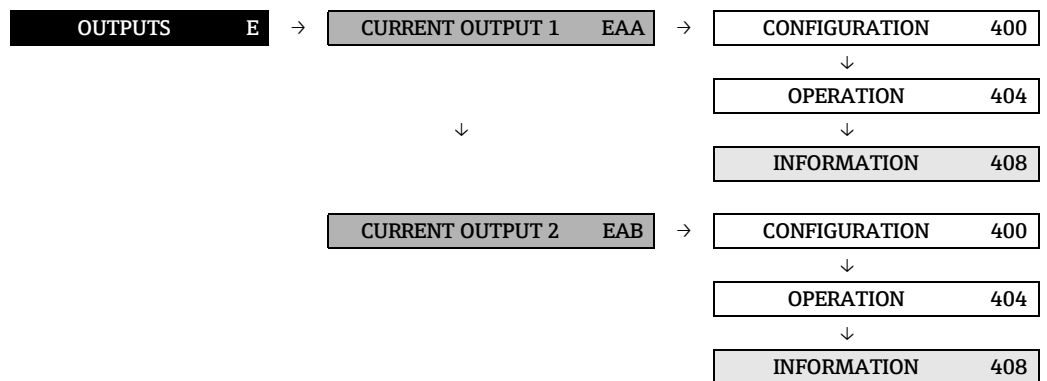





Function description	
OUTPUTS → CURRENT OUTPUT 1 to 2 → INFORMATION	
TERMINAL NUMBER (4080)	<p>Use this function to view the numbers of the terminals (in the connection compartment) and the polarity used by the current output.</p> <p>Display: 3 = 20 (+) / 21 (-)</p>

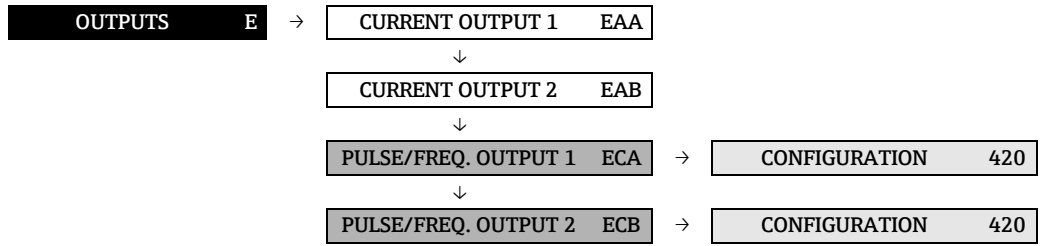

7.2 Group PULSE/FREQUENCY OUTPUT (1 to 2)

7.2.1 Function group CONFIGURATION





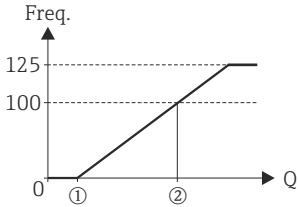

Function description	
OUTPUTS → PULSE/FREQ. OUTPUT (1 to 2) → CONFIGURATION (GENERAL)	
MODE OF OPERATION (4200)	Configuration of the output as a pulse, frequency or status output. The functions available in this function group vary, depending on which option you select here. Options: PULSE FREQUENCY STATUS Factory setting: PULSE

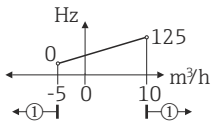
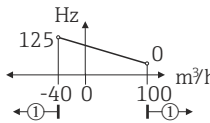
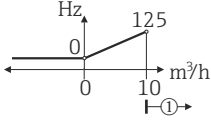
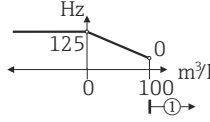
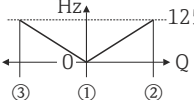

Function description	
OUTPUTS → PULSE/FREQUENCY OUTPUT (1 to 2) → CONFIGURATION (FREQUENCY)	
ASSIGN FREQUENCY (4201)	<p>For assigning a measured variable to the frequency output.</p> <p>Options: OFF MASS FLOW VOLUME FLOW CORRECTED VOLUME FLOW DENSITY REFERENCE DENSITY TEMPERATURE</p> <p>Factory setting: MASS FLOW</p> <p> Note!</p> <ul style="list-style-type: none"> ▪ This function cannot be changed unless the FREQUENCY setting was selected in the OPERATION MODE (4200) function. ▪ If you select OFF, the only function shown in the CONFIGURATION function group is ASSIGN FREQUENCY (4201).
START VALUE FREQUENCY (4202)	<p>For defining an initial frequency for the frequency output. You define the associated measured value of the measuring range in the function VALUE f MIN (4204) →  60.</p> <p>User input: 5-digit fixed-point number: 0 to 10000 Hz</p> <p>Factory setting: 0 Hz</p> <p>Example:</p> <ul style="list-style-type: none"> ▪ VALUE f LOW= 0 kg/h, start value frequency = 0 Hz This means that at a flow rate of 0 kg/h, a frequency of 0 Hz is output. ▪ VALUE F MIN. = 1 kg/h, start value frequency = 10 Hz This means that at a flow rate of 1 kg/h, a frequency of 10 Hz is output. <p> Note! This function is not available unless the PULSE option was selected in the MODE OF OPERATION(4200) function.</p>
END VALUE FREQUENCY (4203)	<p>For defining a full scale frequency for the frequency output. You define the associated measured value of the measuring range in the function VALUE f HIGH (4205) →  60.</p> <p>User input: 5-digit fixed-point number: 2 to 10000 Hz</p> <p>Factory setting: 10000 Hz</p> <p>Example:</p> <ul style="list-style-type: none"> ▪ VALUE f HIGH = 10000 kg/h, full scale value = 10000 Hz This means that at a flow rate of 10000 kg/h, a freq. of 10000 Hz is output. ▪ VALUE f HIGH = 3600 kg/h, full scale value = 10000 Hz This means that at a flow rate of 3600 kg/h, a frequency of 10000 Hz is output. <p> Note!</p> <ul style="list-style-type: none"> ▪ This function is not available unless the PULSE option was selected in the MODE OF OPERATION(4200) function. ▪ In the FREQUENCY operating mode the output signal is symmetrical (on/off ratio = 1:1). At low frequencies the pulse duration is limited to a maximum of 2 seconds, i.e. the on/off ratio is no longer symmetrical.

Function description	
OUTPUTS → PULSE/FREQUENCY OUTPUT (1 to 2) → CONFIGURATION (FREQUENCY)	
<p>VALUE f MIN (4204)</p>	<p>Use this function to assign a variable to the start value frequency ((4202) → 59). The value can be higher or lower than the value assigned to the VALUE f HIGH. Positive and negative values are permissible, depending on the measured variable in question (e.g. mass flow). You define a measuring range by defining the VALUE f LOW and VALUE f HIGH values.</p> <p>User input: 5-digit floating-point number</p> <p>Factory setting: 0 [kg/h] or 0 [kg/l] or -50 [°C]</p> <p> Note!</p> <ul style="list-style-type: none"> ▪ This function is not available unless the PULSE option was selected in the MODE OF OPERATION(4200) function. ▪ For a graphic illustration of the VALUE f LOW, →the VALUE f HIGH (4205) function. ▪ Note that values with different signs cannot be entered for VALUE f LOW and VALUE f HIGH, if SYMMETRY is the setting selected for the MEASURING MODE function (4206). In this case, the message "INPUT RANGE EXCEEDED" appears on the display. ▪ The appropriate unit is taken from the following functions: <ul style="list-style-type: none"> - UNIT MASS FLOW (0400) - UNIT VOLUME FLOW (0402) - UNIT CORRECTED VOLUME FLOW (0404) - UNIT DENSITY (0420) - UNIT REFERENCE DENSITY (0421) - UNIT TEMPERATURE (0422) (→ 13 to → 17).
<p>VALUE f HIGH (4205)</p>	<p>Use this function to assign a variable to the end value frequency ((4203) → 59). The value can be higher or lower than the value assigned to the VALUE F LOW. Positive and negative values are permissible, depending on the measured variable in question (e.g. mass flow). You define a measuring range by defining the VALUE f LOW and VALUE f HIGH values.</p> <p>User input: 5-digit floating-point number</p> <p>Factory setting: Depends on nominal diameter [kg/h] or 2 [kg/l] or 200 [°C]</p> <p> Note!</p> <ul style="list-style-type: none"> ▪ This function is not available unless the FREQUENCY option was selected in the MODE OF OPERATION (4200) function. ▪ Note that values with different signs cannot be entered for VALUE f LOW and VALUE f HIGH, if SYMMETRY is the setting selected for the MEASURING MODE function (4206). In this case, the message "INPUT RANGE EXCEEDED" appears on the display. <div style="text-align: center;">  </div> <p>① = Value f min ② = Value f max</p> <p>(continued on next page)</p>

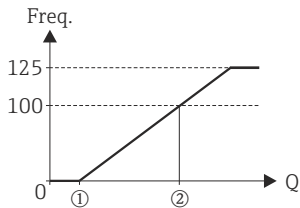
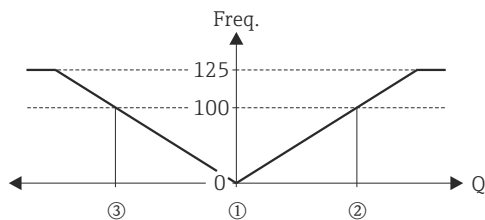
A0001279

Function description	
OUTPUTS → PULSE/FREQUENCY OUTPUT (1 to 2) → CONFIGURATION (FREQUENCY)	
<p>VALUE f HIGH (continued)</p>	<p>Parameter setting example 1:</p> <ol style="list-style-type: none"> VALUE f MIN (4204) = not equal to zero flow (e.g. -5 kg/h) VALUE f HIGH (4205) = not equal to zero flow (e.g. 10 kg/h) or VALUE f MIN (4204) = not equal to zero flow (e.g. 100 kg/h) VALUE f HIGH (4205) = not equal to zero flow (e.g. -40 kg/h) <p>and MEASURING MODE (4206) = STANDARD</p> <p>When you enter the values for VALUE f LOW and VALUE f HIGH the working range of the measuring device is defined. If the effective flow drops below or exceeds this working range (→ ①), a fault or notice message is generated (#355 to 358, frequency area) and the frequency output responds in accordance with the parameter settings in the function FAILSAFE MODE (4209).</p> <div style="display: flex; justify-content: space-around; align-items: center;">   </div> <p style="text-align: right; font-size: small;">A0001276</p> <p>Parameter setting example 2:</p> <ol style="list-style-type: none"> VALUE f MIN (4204) = not equal to zero flow (e.g. 0 kg/h) VALUE f HIGH (4205) = not equal to zero flow (e.g. 10 kg/h) or VALUE f MIN (4204) = not equal to zero flow (e.g. 100 kg/h) VALUE f HIGH (4205) = not equal to zero flow (e.g. 0 kg/h) <p>and MEASURING MODE (4206) = STANDARD</p> <p>When you enter the values for VALUE f LOW and VALUE f HIGH the working range of the measuring device is defined. In doing so, one of the two values is parameterized as zero flow (e.g. 0 kg/h). If the effective flow drops below or exceeds the value parameterized as the zero flow, no fault/notice message is generated and the frequency output retains its value. If the effective flow drops below or exceeds the other value, a fault/notice message is generated (#355 to 358, frequency area) and the frequency output responds in accordance with the FAILSAFE MODE (4209) function.</p> <div style="display: flex; justify-content: space-around; align-items: center;">   </div> <p style="text-align: right; font-size: small;">A0001277</p> <p>Deliberately only one flow direction is output with this setting and flow values in the other flow direction are suppressed.</p> <p>Parameter setting example 3: MEASURING MODE (4206) = SYMMETRY</p> <p>The frequency output signal is independent of the direction of flow (absolute amount of the measured variable). The VALUE f LOW ① and VALUE f HIGH ② must have the same sign (+ or -). The VALUE f HIGH ③ (e.g. backflow) corresponds to the mirrored VALUE f MAX ② (e.g. flow).</p> <div style="text-align: center;">  </div> <p style="text-align: right; font-size: small;">A0001278</p> <p>ASSIGN STATUS (4241) = FLOW DIRECTION</p> <p>With this setting e.g. the flow direction output via a switching contact can be made.</p> <p>Parameter setting example 4: MEASURING MODE (4206) = PULSATING FLOW → 62</p>

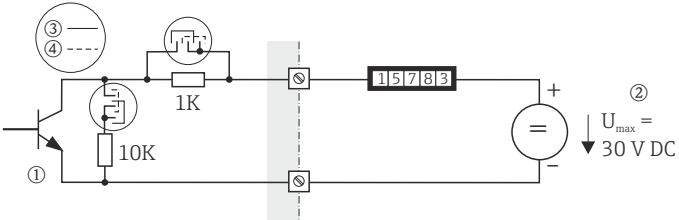



Function description	
OUTPUTS → PULSE/FREQUENCY OUTPUT (1 to 2) → CONFIGURATION (FREQUENCY)	
<p>MEASURING MODE (4206)</p>	<p> Note! This function is not available unless the PULSE option was selected in the MODE OF OPERATION(4200) function. Use this function to define the measuring mode for the frequency output.</p> <p>Options: STANDARD SYMMETRY PULSATING FLOW</p> <p>Factory setting: STANDARD</p> <p>Description of the individual options: STANDARD The frequency output signal is proportional to the measured variable. The flow components outside the scaled measuring range (defined by the VALUE f LOW ① and the VALUE f HIGH ②) are not taken into account for signal output.</p> <ul style="list-style-type: none"> ▪ If one of the values is defined as equal to the zero flow (e.g. VALUE f LOW = 0 kg/h), no message is given if this value is exceeded or not achieved and the frequency output retains its value (0 Hz in the example). If the other value is exceeded or not achieved, the message "FREQUENCY OUTPUT AT FULL SCALE VALUE" appears and the frequency output responds in accordance with the parameter setting in the function FAILSAFE MODE (4209). ▪ If both values defined are not equal to the zero flow (for example VALUE f LOW = -5 kg/h; VALUE f MAX = 10kg/h) the message "FREQUENCY OUTPUT AT FULL SCALE VALUE" appears if the measuring range is exceeded or not achieved and the frequency output responds in accordance with the parameter settings in the function FAILSAFE MODE (4209). <div style="text-align: center;">  </div> <p style="text-align: right; font-size: small;">A0001279</p> <p><i>Fig. 18: STANDARD measuring mode</i></p> <p>SYMMETRY The frequency output signal is independent of the direction of flow (absolute amount of the measured variable). The VALUE f LOW ① and VALUE f HIGH ② must have the same sign (+ or -). The VALUE f HIGH ③ (e.g. backflow) corresponds to the mirrored VALUE f HIGH ② (e.g. flow).</p> <div style="text-align: center;">  </div> <p style="text-align: right; font-size: small;">A0001280</p> <p><i>Fig. 19: SYMMETRY measuring mode</i></p> <p> Note!</p> <ul style="list-style-type: none"> ▪ The direction of flow can be output via the configurable status outputs. ▪ SYMMETRY cannot be selected unless the values in the VALUE f MIN (4204) and VALUE f HIGH (4205) functions have the same sign or one of the values is zero. If the values have different signs, SYMMETRY cannot be selected and an "ASSIGNMENT NOT POSSIBLE" message is displayed. <p>(continued on next page)</p>





Function description	
OUTPUTS → PULSE/FREQUENCY OUTPUT (1 to 2) → CONFIGURATION (FREQUENCY)	
<p>MEASURING MODE (continued)</p>	<p>PULSATING FLOW</p> <ul style="list-style-type: none"> ▪ If flow is characterized by severe fluctuations as is the case, for example, with reciprocating pumps, flow components outside the measuring range are buffered, balanced and output after a maximum delay of 60 seconds. If the buffered data cannot be processed within approx. 60 seconds, a fault/notice message appears. ▪ Under certain plant conditions, flow values can aggregate in the buffer, for example in the case of prolonged and unwanted fluid backflow. However, this buffer is reset in all relevant programming adjustments which affect the frequency output.
<p>OUTPUT SIGNAL (4207)</p>	<p>For selecting the output configuration of the frequency output.</p> <p>Options: PASSIVE - POSITIVE PASSIVE - NEGATIVE ACTIVE - POSITIVE (this selection is not supported) ACTIVE - NEGATIVE (this selection is not supported)</p> <p>Factory setting: PASSIVE - POSITIVE</p> <p>Explanation PASSIVE = power is supplied to the frequency output by means of an external power supply.</p> <p>Configuring the output signal level (POSITIVE or NEGATIVE) determines the quiescent behavior (at zero flow) of the frequency output. The internal transistor is activated as follows:</p> <ul style="list-style-type: none"> ▪ If POSITIVE is selected, the internal transistor is activated with a positive signal level. ▪ If NEGATIVE is selected, the internal transistor is activated with a negative signal level (0 V). <p> Note!</p> <ul style="list-style-type: none"> ▪ Function is not available unless the FREQUENCY setting was selected in the MODE OF OPERATION function. ▪ With the passive output configuration, the output signal levels of the frequency output depend on the external circuit (→ examples). <p>Example for passive output circuit (PASSIVE) If PASSIVE is selected, the frequency output is configured as an open collector.</p>  <p style="text-align: right; font-size: small;">A0002147</p> <p>① = Open collector ② = External power supply ③ = Line monitoring off ④ = Line monitoring on (default)</p> <p> Note! For continuous currents up to 25 mA ($I_{max} = 250 \text{ mA} / 20 \text{ ms}$).</p> <p>(continued on next page)</p>

Function description	
OUTPUTS → PULSE/FREQUENCY OUTPUT (1 to 2) → CONFIGURATION (FREQUENCY)	
<p>OUTPUT SIGNAL (continued)</p>	<p>Example for output configuration PASSIVE-POSITIVE: Output configuration with an external pull-up resistance. In the quiescent state (at zero flow), the output signal level at the terminals is 0 V.</p> <div style="text-align: center;"> </div> <p style="text-align: right;">a0004687</p> <p>① = Open collector ② = Pull-Up-Resistance ③ = Transistor activation in POSITIVE quiescent state (at zero flow) ④ = Output signal level in quiescent state (at zero flow)</p> <p>In the operating status (flow present), the output signal level changes from 0 V to a positive voltage level</p> <div style="text-align: center;"> </div> <p style="text-align: right;">a0001975</p> <p>Example for output configuration PASSIVE-POSITIVE: Output configuration with an external pull-down resistance. In the quiescent state (at zero flow), a positive voltage level is measured via the pull-down resistance.</p> <div style="text-align: center;"> </div> <p style="text-align: right;">a0004689</p> <p>① = Open collector ② = Pull-Down-Resistance ③ = Transistor activation in POSITIVE quiescent state (at zero flow) ④ = Output signal level in quiescent state (at zero flow)</p> <p>In the operating status (flow present), the output signal level changes from a positive voltage level to 0 V.</p> <div style="text-align: center;"> </div> <p style="text-align: right;">A0001981</p> <p>(continued on next page)</p>

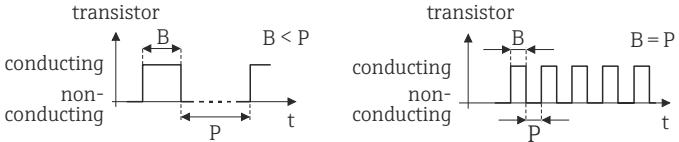

Function description	
OUTPUTS → PULSE/FREQUENCY OUTPUT (1 to 2) → CONFIGURATION (FREQUENCY)	
<p>OUTPUT SIGNAL (continued)</p>	<p>Example for output configuration PASSIVE-NEGATIVE: Output configuration with an external pull-up resistance. In the quiescent state (at zero flow), the output signal level at the terminals is at a positive voltage level.</p> <div style="text-align: center;"> </div> <p>① = Open collector ② = Pull-Up-Resistance ③ = Transistor activation in <i>NEGATIVE</i> quiescent state (at zero flow) ④ = Output signal level in quiescent state (at zero flow)</p> <p>In the operating status (flow present), the output signal level changes from a positive voltage level to 0 V.</p> <div style="text-align: center;"> </div>
<p>TIME CONSTANT (4208)</p>	<p>Entering a time constant defines how the frequency output signal reacts to severely fluctuating measured variables, either very quickly (enter a low time constant) or with damping (enter a high time constant).</p> <p>User input: Fixed-point number 0.00 to 100.00 s</p> <p>Factory setting: 0.00 s</p> <p> Note! This function is not available unless the PULSE option was selected in the MODE OF OPERATION (4200) function.</p>
<p>FAILSAFE MODE (4209)</p>	<p>For safety reasons it is advisable to ensure that the frequency output assumes a predefined state in the event of a fault. The setting you select here affects only the frequency output. It has no effect on other outputs and the display (e.g. totalizers).</p> <p>Options:</p> <p>FALLBACK VALUE Output is 0 Hz.</p> <p>FAILSAFE VALUE Output is the frequency specified in the FAILSAFE VALUE function (4211).</p> <p>HOLD VALUE Measured value output is based on the last measured value saved before the error occurred.</p> <p>ACTUAL VALUE Measured value output is based on the current flow measurement. The fault is ignored.</p> <p>Factory setting: FALLBACK VALUE</p> <p> Note! This function is not available unless the FREQUENCY option was selected in the MODE OF OPERATION (4200) function.</p>

Function description OUTPUTS → PULSE/FREQUENCY OUTPUT (1 to 2) → CONFIGURATION (FREQUENCY)	
FAILSAFE VALUE (4211)	<p> Note! This function is not available unless FREQUENCY was selected in the MODE OF OPERATION function (4200) and FAILSAFE LEVEL was selected in the FAILSAFE MODE function (4209).</p> <p>For specifying the frequency that the measuring device outputs in the event of an error.</p> <p>User input: max. 5-digit number: 0 to 12500 Hz</p> <p>Factory setting: 12500 Hz</p>

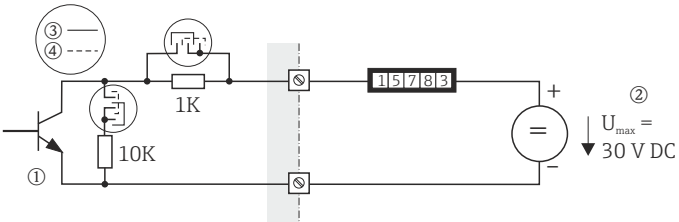
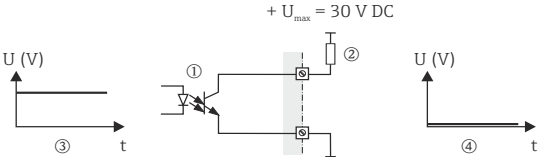

Function description	
OUTPUTS → PULSE/FREQUENCY OUTPUT (1 to 2) → CONFIGURATION (PULSE)	
<p>ASSIGN PULSE (4221)</p>	<p>Use this function to assign a measured variable to the pulse output.</p> <p>Options: OFF MASS FLOW VOLUME FLOW CORRECTED VOLUME FLOW</p> <p>Factory setting: MASS FLOW</p> <p> Note! ■ This function is not available unless the PULSE option was selected in the MODE OF OPERATION (4200) function. ■ If you select OFF, the only function shown in the CONFIGURATION function group is this function, in other words ASSIGN PULSE (4221).</p>
<p>PULSE VALUE (4222)</p>	<p>Use this function to define the flow at which a pulse is triggered. These pulses can be totaled by an external totalizer, and the total flow quantity since measuring started can be registered in this way.</p> <p>User input: 5-digit floating-point number [unit]</p> <p>Factory setting: depends on nominal diameter</p> <p> Note! ■ This function is not available unless the PULSE option was selected in the MODE OF OPERATION (4200) function. ■ The appropriate unit is taken from the functions UNIT MASS (0400), UNIT VOLUME (0402) or UNIT STANDARD VOLUME (0404) (→  13 or →  15).</p>
<p>PULSE WIDTH (4223)</p>	<p> Note! This function is not available unless the PULSE setting was selected in the function MODE OF OPERATION (4200). Use this function to enter the pulse width of the output pulse.</p> <p>User input: 0.05 to 2000 ms</p> <p>Factory setting: 100 ms</p> <p>Pulse output is always with the pulse width (B) entered in this function. The pauses (P) between the individual pulses are automatically configured. However, they must at least correspond to the pulse width (B = P).</p> <div style="text-align: center;">  </div> <p style="text-align: right; font-size: small;">A0001233-en</p> <p><i>Fig. 20: Pulse width</i></p> <p><i>B = Pulse width entered (the illustration applies to positive pulses)</i> <i>P = Pauses between the individual pulses</i></p> <p>(continued on next page)</p>

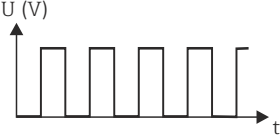
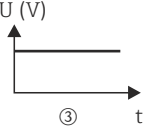
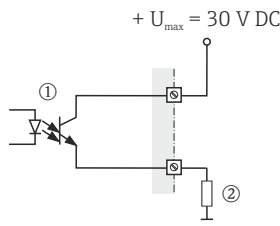
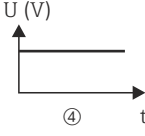
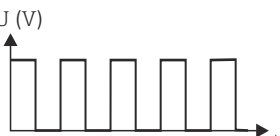
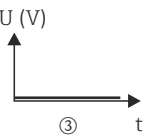
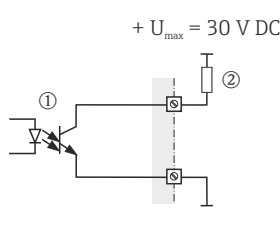
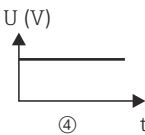

Function description	
OUTPUTS → PULSE/FREQUENCY OUTPUT (1 to 2) → CONFIGURATION (PULSE)	
PULSE WIDTH (continued)	<p> Note!</p> <ul style="list-style-type: none"> ▪ This function is not available unless the PULSE option was selected in the MODE OF OPERATION(4200) function. ▪ When entering the pulse width, select a value that can still be processed by an external totalizer (e.g. mechanical totalizer, PLC etc.). <p> Caution!</p> <p>If the pulse number or frequency resulting from the pulse value entered (→ function PULSE VALUE (4222) →  67) and from the current flow is too large to maintain the pulse width selected (the time interval is smaller than the pulse width B entered), a system error message is generated (# 359 to 362, pulse buffer) after approx. 5 seconds buffer/balance time.</p>
MEASURING MODE (4225)	<p>Use this function to define the measuring mode for the pulse output.</p> <p>Options:</p> <p>STANDARD Only positive flow components are totaled. Negative components are not taken into account.</p> <p>SYMMETRY Positive and negative flow components are taken into account.</p> <p> Note! The direction of flow can be output via the status outputs.</p> <p>PULSATING FLOW If flow is characterized by severe fluctuations, as is the case, for example, with reciprocating pumps, the positive and negative flow components are totaled, with the signs taken into account (e.g. -10 l and +25 l = 15 l).</p> <p>Flow components outside the maximum pulse number per second (value/width) are buffered, balanced and output after a maximum delay of 60 seconds. If the buffered data cannot be processed within approx. 60 seconds, a fault/notice message appears.</p> <p>Under certain plant conditions, flow values can aggregate in the buffer, for example in the case of prolonged and unwanted fluid backflow. However, this buffer is reset in all relevant programming adjustments which affect the pulse output.</p> <p>STANDARD REVERSE Only negative flow components are totaled. Positive components are not taken into account.</p> <p>Factory setting: STANDARD</p> <p> Note! This function is not available unless the PULSE option was selected in the MODE OF OPERATION (4200) function.</p>

Function description	
OUTPUTS → PULSE/FREQUENCY OUTPUT (1 to 2) → CONFIGURATION (PULSE)	
<p>OUTPUT SIGNAL (4226)</p>	<p>For selecting the output configuration of the pulse output.</p> <p>Options: PASSIVE - POSITIVE PASSIVE - NEGATIVE ACTIVE - POSITIVE (this selection is not supported) ACTIVE - NEGATIVE (this selection is not supported)</p> <p>Factory setting: PASSIVE - POSITIVE</p> <p>Explanation PASSIVE = power is supplied to the pulse output by means of an external power supply.</p> <p>Configuring the output signal level (POSITIVE or NEGATIVE) determines the quiescent behavior (at zero flow) of the pulse output. The internal transistor is activated as follows:</p> <ul style="list-style-type: none"> ▪ If POSITIVE is selected, the internal transistor is activated with a positive signal level. ▪ If NEGATIVE is selected, the internal transistor is activated with a negative signal level (0 V). <p><i>Note!</i></p> <ul style="list-style-type: none"> ▪ Function is not available unless the PULSE setting was selected in the MODE OF OPERATION(4200) function. ▪ With the passive output configuration, the output signal levels of the pulse output depend on the external circuit (→ examples). <p>Example for passive output circuit (PASSIVE) If PASSIVE is selected, the pulse output is configured as an open collector.</p>  <p style="text-align: right; font-size: small;">A0002147</p> <p>① = Open collector ② = External power supply ③ = Line monitoring off ④ = Line monitoring on (default)</p> <p><i>Note!</i> For continuous currents up to 25 mA ($I_{max} = 250 \text{ mA} / 20 \text{ ms}$).</p> <p>Example for output configuration PASSIVE-POSITIVE: Output configuration with an external pull-up resistance. In the quiescent state (at zero flow), the output signal level at the terminals is 0 V.</p>  <p style="text-align: right; font-size: small;">a0004687</p> <p>① = Open collector ② = Pull-Up-Resistance ③ = Transistor activation in POSITIVE quiescent state (at zero flow) ④ = Output signal level in quiescent state (at zero flow)</p> <p>(continued on next page)</p>

Function description	
OUTPUTS → PULSE/FREQUENCY OUTPUT (1 to 2) → CONFIGURATION (PULSE)	
<p>OUTPUT SIGNAL (continued)</p>	<p>In the operating status (flow present), the output signal level changes from 0 V to a positive voltage level.</p> <div style="text-align: center;">  </div> <p style="text-align: right;">A0001975</p> <p>Example for output configuration PASSIVE-POSITIVE: Output configuration with an external pull-down resistance. In the quiescent state (at zero flow), a positive voltage level is measured via the pull-down resistance.</p> <div style="display: flex; justify-content: space-around; align-items: center;"> <div style="text-align: center;">  <p>③</p> </div> <div style="text-align: center;">  </div> <div style="text-align: center;">  <p>④</p> </div> </div> <p style="text-align: right;">a0004689</p> <p>① = Open collector ② = Pull-Down-Resistance ③ = Transistor activation in <i>POSITIVE</i> quiescent state (at zero flow) ④ = Output signal level in quiescent state (at zero flow)</p> <p>In the operating status (flow present), the output signal level changes from a positive voltage level to 0 V.</p> <div style="text-align: center;">  </div> <p style="text-align: right;">A0001981</p> <p>Example for output configuration PASSIVE-NEGATIVE: Output configuration with an external pull-up resistance. In the quiescent state (at zero flow), the output signal level at the terminals is at a positive voltage level.</p> <div style="display: flex; justify-content: space-around; align-items: center;"> <div style="text-align: center;">  <p>③</p> </div> <div style="text-align: center;">  </div> <div style="text-align: center;">  <p>④</p> </div> </div> <p style="text-align: right;">a0004690</p> <p>① = Open collector ② = Pull-Up-Resistance ③ = Transistor activation in <i>NEGATIVE</i> quiescent state (at zero flow) ④ = Output signal level in quiescent state (at zero flow)</p> <p>In the operating status (flow present), the output signal level changes from a positive voltage level to 0 V.</p> <div style="text-align: center;">  </div> <p style="text-align: right;">A0001981</p>

Function description	
OUTPUTS → PULSE/FREQUENCY OUTPUT (1 to 2) → CONFIGURATION (PULSE)	
<p>FAILSAFE MODE (4227)</p>	<p>For safety reasons it is advisable to ensure that the pulse output assumes a pre-defined state in the event of a fault. The setting you select here affects only the pulse output. It has no effect on other outputs and the display (e.g. totalizers).</p> <p>Options: FALLBACK VALUE Output is 0 pulse.</p> <p>ACTUAL VALUE Measured value output is based on the current flow measurement. The fault is ignored.</p> <p>MAX. PULSE RATE Outputs the maximum pulse rate $f = 1 : (2 \cdot T)$</p> <p>Factory setting: FALLBACK VALUE</p> <p> Note! This function is not available unless the PULSE option was selected in the MODE OF OPERATION (4200) function.</p>

Function description	
OUTPUTS → PULSE/FREQUENCY OUTPUT (1 to 2) → CONFIGURATION (STATUS)	
ASSIGN STATUS (4241)	<p>Use this function to assign a switching function to the status output.</p> <p>Options: OFF ON (operation) FAULT MESSAGE NOTICE MESSAGE FAULT MESSAGE or NOTICE MESSAGE EMPTY PIPE DETECTION (only with active function) FLOW DIRECTION LIMIT MASS FLOW LIMIT VOLUME FLOW CORRECTED VOLUME FLOW LIMIT VALUE DENSITY LIMIT VALUE REFERENCE DENSITY LIMIT VALUE TEMPERATURE LIMIT VALUE TOTALIZER 1 LIMIT VALUE TOTALIZER 2 LIMIT VALUE TOTALIZER 3 LIMIT VALUE</p> <p>Factory setting: FAULT MESSAGE</p> <p> Note!</p> <ul style="list-style-type: none"> ▪ This function is not available unless the STATUS option was selected in the MODE OF OPERATION (4200) function. ▪ The behavior of the status output is a normally closed behavior, in other words the output is closed (transistor conductive) when normal, error-free measuring is in progress. "normal, error-free" operation: Flow direction = forwards; limit values = not exceeded; no empty or partially filled measuring tube (EPD/OED); no fault or notice message present. ▪ If you select OFF, the only function shown in the CONFIGURATION function group is this function, in other words ASSIGN STATUS (4241). ▪ Switching response like relays output →  79
ON-VALUE (4242)	<p>Use this function to assign a value to the switch-on point (activation of the status output). The value can be higher or lower than the switch-off point. Positive or negative values are permissible, depending on the measured variable in question (e.g. mass flow, totalizer reading).</p> <p>User input: 5-digit floating-point number [unit]</p> <p>Factory setting: 0 [kg/h] or 2 [kg/l] or 200 [°C]</p> <p> Note!</p> <ul style="list-style-type: none"> ▪ This function is not available unless STATUS was selected in the MODE OF OPERATION function (4200) and LIMIT VALUE or FLOW DIRECTION was selected in the ASSIGN STATUS function (4241). ▪ If SYMMETRY is selected in the function MEASURING MODE (4246) and values with different signs are entered for the switch-on and switch-off points, the notice message "INPUT RANGE EXCEEDED" appears. ▪ Only the switch-on point is available for flow direction output (no switch-off point). If you enter a value not equal to the zero flow (e.g. 5), the difference between the zero flow and the value entered corresponds to half the switchover hysteresis.







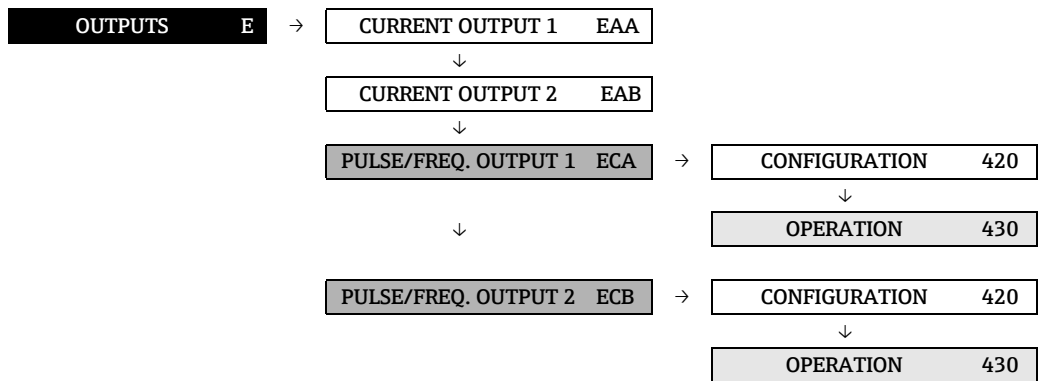

Function description	
OUTPUTS → PULSE/FREQUENCY OUTPUT (1 to 2) → CONFIGURATION (STATUS)	
<p>SWITCH-ON DELAY (4243)</p>	<p>Use this function to define a delay (0 to 100 seconds) for the switch-on (i.e. signal changes from "not conductive" to "conductive") of the status output. The delay starts when the limit value is reached. The status output does switch when the delay has timed out and the switch on condition has been valid over the delay time.</p> <p>User input: Fixed-point number 0.0 to 100.0 s</p> <p>Factory setting: 0.0 s</p> <p> Note! This function is not available unless STATUS was selected in the MODE OF OPERATION function (4200) and LIMIT VALUE or FLOW DIRECTION was selected in the ASSIGN STATUS function (4241).</p>
<p>OFF VALUE (4244)</p>	<p>Use this function to assign a value to the switch-off point (deactivation of the status output). The value can be higher or lower than the switch-on point. Positive and negative values are permissible, depending on the measured variable in question (e.g. mass flow, totalizer reading).</p> <p>User input: 5-digit floating-point number [unit]</p> <p>Factory setting: 0 [kg/h] or 2 [kg/l] or 200 [°C]</p> <p> Note!</p> <ul style="list-style-type: none"> ▪ This function is not available unless STATUS was selected in the MODE OF OPERATION function (4200) and a LIMIT VALUE was selected in the ASSIGN STATUS function (4241). ▪ The associated unit is taken from the function UNIT VOLUME FLOW (0402) or UNIT MASS FLOW (0400). ▪ If SYMMETRY is selected in the function MEASURING MODE (4246) and values with different signs are entered for the switch-on and switch-off points, the notice message "INPUT RANGE EXCEEDED" appears.
<p>SWITCH-OFF DELAY (4245)</p>	<p>Use this function to define a delay (0 to 100 seconds) for the switch-off (i.e. signal changes from "conductive" to "not conductive") of the status output. The delay starts when the limit value is reached. The status output does switch when the delay has timed out and the switch off condition has been valid over the delay time.</p> <p>User input: Fixed-point number 0.0 to 100.0 s</p> <p>Factory setting: 0.0 s</p> <p> Note! This function is not available unless the STATUS option was selected in the MODE OF OPERATION (4200) function.</p>





Function description	
OUTPUTS → PULSE/FREQUENCY OUTPUT (1 to 2) → CONFIGURATION (STATUS)	
<p>MEASURING MODE (4246)</p>	<p>Use this function to define the measuring mode for the status output.</p> <p>Options: STANDARD The status output signal switches at the defined switch points.</p> <p>SYMMETRY The status output signal switches at the defined switch points, irrespective of the sign. If you define a switch point with a positive sign, the status output signal switches as soon as the value is reached in the negative direction (negative sign) (→ illustration).</p> <p>Factory setting: STANDARD</p> <div style="text-align: center;"> </div> <p style="text-align: right; font-size: small;">A0001247</p> <p><i>Fig. 21: Example for the SYMMETRY measuring mode:</i></p> <p>Switch-on point $Q = 4$ Switch-off point $Q = 10$ ① = Status output switched on (conductive) ② = Status output switched off (non-conductive)</p> <p>Note!</p> <ul style="list-style-type: none"> ▪ This function is not available unless STATUS was selected in the MODE OF OPERATION function (4200) and the status output was assigned a limit value. ▪ SYMMETRY cannot be selected unless the values in the ON-VALUE (4242) and OFF VALUE (4244) functions have the same sign or one of the values is zero. ▪ If the values have different signs, SYMMETRY cannot be selected and an "ASSIGNMENT NOT POSSIBLE" message is displayed.
<p>TIME CONSTANT (4247)</p>	<p>Entering a time constant defines how the measuring signal reacts to severely fluctuating measured variables, either very quickly (enter a low time constant) or with damping (enter a high time constant). Damping acts on the measuring signal before the switch status changes, and consequently before switch-on or switch-off delay is activated. The purpose of damping, therefore, is to prevent the status output changing state continuously in response to fluctuations in flow.</p> <p>User input: Fixed-point number 0.00 to 100.00 s</p> <p>Factory setting: 0.00 s</p> <p>Note! This function is not available unless the STATUS option was selected in the MODE OF OPERATION(4200) function.</p>

7.2.2 Function group OPERATION



Function description OUTPUTS → PULSE/FREQUENCY OUTPUT (1 to 2) → OPERATION (FREQUENCY)	
ACTUAL FREQUENCY (4301)	<p>Use this function to view the computed actual value of the output frequency.</p> <p>Display: 0 to 12500 Hz</p> <p> Note! This function is not available unless the PULSE option was selected in the MODE OF OPERATION (4200) function.</p>
SIMULATION FREQUENCY (4302)	<p>Activates simulation of the frequency output.</p> <p>Options: OFF ON</p> <p>Factory setting: OFF</p> <p> Note!</p> <ul style="list-style-type: none"> ▪ This function is available only if the FREQUENCY setting was selected in the OPERATION MODE (4200) function. ▪ The "SIMULATION FREQUENCY OUTPUT" message indicates that simulation is active. ▪ The measuring device continues to measure while simulation is in progress, i.e. the current measured values are output correctly via the other outputs. <p> Caution! The setting is not saved in the event of a power failure.</p>
VALUE SIMULATION FREQUENCY (4303)	<p>Define a selectable frequency value (e.g. 500 Hz) which should be output at the frequency output (with maximum pulse frequency or shortened minimum pulse width). This value is used to test downstream devices and the measuring device itself.</p> <p>User input: 0 to 12500 Hz</p> <p>Factory setting: 0 Hz</p> <p> Note! This function is not available unless FREQUENCY was selected in the MODE OF OPERATION function (4200) and the SIMULATION FREQUENCY function (4302) is active (= ON).</p> <p> Caution! The setting is not saved in the event of a power failure.</p>

Function description OUTPUTS → PULSE/FREQUENCY OUTPUT (1 to 2) → OPERATION (PULSE)	
SIMULATION PULSE (4322)	<p>Activates simulation of the pulse output.</p> <p>Options: OFF</p> <p>COUNTDOWN The pulses specified in the VALUE SIMULATION PULSE function are output.</p> <p>CONTINUOUSLY Pulses are continuously output with the pulse width specified in the PULSE WIDTH function. Simulation is started once the CONTINUOUSLY option is confirmed with the  key.</p> <p> Note! Simulation is started by confirming the CONTINUOUSLY option with the  key. The simulation can be switched off again via the SIMULATION PULSE function.</p> <p>Factory setting: OFF</p> <p> Note!</p> <ul style="list-style-type: none"> ▪ This function is not available unless the PULSE option was selected in the MODE OF OPERATION(4200) function. ▪ The notice message #631 "SIM. PULSE" indicates that simulation is active. ▪ The on/off ratio is 1:1 for both types of simulation. ▪ The measuring device continues to measure while simulation is in progress, i.e. the current measured values are output correctly via the other outputs. <p> Caution! The setting is not saved in the event of a power failure.</p>
VALUE SIMULATION PULSE (4323)	<p>Specify the number of pulses (e.g. 50) to be output during the simulation. This value is used to test downstream devices and the measuring device itself. The pulses are output with the pulse width specified in the PULSE WIDTH function. The on/off ratio is 1:1.</p> <p>Simulation is started once the specified value is confirmed with the  key. The display remains at 0 if the specified pulses have been output.</p> <p>User input: 0 to 10,000</p> <p>Factory setting: 0</p> <p> Note!</p> <ul style="list-style-type: none"> ▪ This function is not available unless the COUNTDOWN setting was selected in the function SIMULATION PULSE. ▪ Simulation is started by confirming the simulation value with the  key. The simulation can be switched off again via the SIMULATION PULSE function. <p> Caution! The setting is not saved in the event of a power failure.</p>

Function description	
OUTPUTS → PULSE/FREQUENCY OUTPUT (1 to 2) → OPERATION (STATUS)	
<p>ACTUAL STATUS (4341)</p>	<p>Use this function to check the current status of the status output.</p> <p>Display: NOT CONDUCTIVE CONDUCTIVE</p> <p> Note! This function is not available unless the STATUS option was selected in the MODE OF OPERATION (4200) function.</p>
<p>SIMULATION SWITCH POINT (4342)</p>	<p>Use this function to activate simulation of the status output.</p> <p>Options: OFF ON</p> <p>Factory setting: OFF</p> <p> Note!</p> <ul style="list-style-type: none"> ▪ This function is not available unless the STATUS option was selected in the MODE OF OPERATION (4200) function. ▪ The "SIMULATION STATUS OUTPUT" message indicates that simulation is active. ▪ The measuring device continues to measure while simulation is in progress, i.e. the current measured values are output correctly via the other outputs. <p> Caution! The setting is not saved in the event of a power failure.</p>
<p>VALUE SIMULATION SWITCH POINT (4343)</p>	<p>Use this function to define the switching response of the status output during the simulation. This value is used to test downstream devices and the measuring device itself.</p> <p>Options: NOT CONDUCTIVE CONDUCTIVE</p> <p>Factory setting: NOT CONDUCTIVE</p> <p> Note! This function is not available unless STATUS was selected in the MODE OF OPERATION function (4200) and the SIMULATION SWITCH POINT function (4342) is active (= ON).</p> <p> Caution! The setting is not saved in the event of a power failure.</p>

7.2.3 Function group INFORMATION

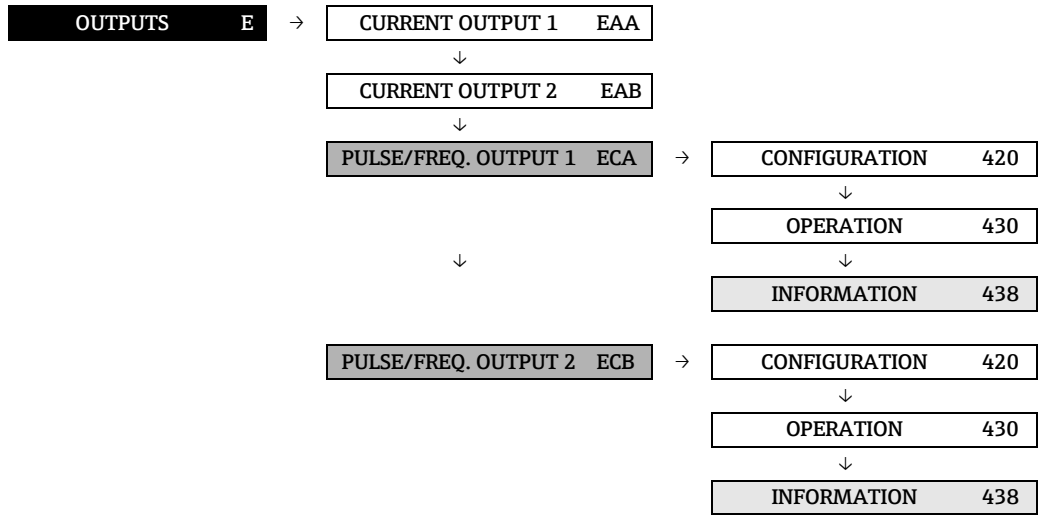





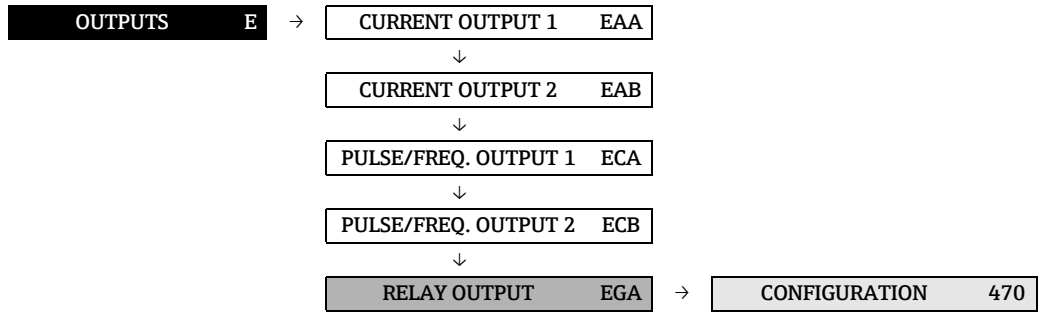

Function description	
OUTPUTS → PULSE/FREQ. OUTPUT (1 to 2) → INFORMATION	
TERMINAL NUMBER (4380)	Use this function to view the numbers of the terminals (in the connection compartment) and the polarity used by the pulse/frequency output. Display: 2 = 22 (+) / 23 (-)





7.3 Group RELAY OUTPUT

7.3.1 Function group CONFIGURATION



Function description	
OUTPUTS → RELAY OUTPUT → CONFIGURATION	
ASSIGN RELAY (4700)	<p>Use this function to assign a switching function to the relay output.</p> <p>Options (standard): OFF ON (operation) FAULT MESSAGE NOTICE MESSAGE FAULT MESSAGE or NOTICE MESSAGE EPD (Empty pipe detection, only if active) FLOW DIRECTION LIMIT MASS FLOW LIMIT VOLUME FLOW CORRECTED VOLUME FLOW LIMIT VALUE DENSITY LIMIT VALUE REFERENCE DENSITY LIMIT VALUE TEMPERATURE LIMIT VALUE LIMIT TOTALIZER 1 to 3</p> <p>Factory setting: FAULT MESSAGE</p> <p> Note!</p> <ul style="list-style-type: none"> ▪ It is very important to read and comply with the information on the switching characteristics of the relay output, (→  86). ▪ It is advisable to configure at least one relay output as a fault output and define the outputs' failsafe mode. ▪ The relay output is configured as a normally open (NO or make) contact by default. It can be reconfigured as a normally closed (NC or break) contact by means of a jumper on the relay module → Operating Instructions (BA00139D/06). ▪ If you select OFF or ON, the only function shown in the CONFIGURATION function group is this function ASSIGN RELAY (4700).

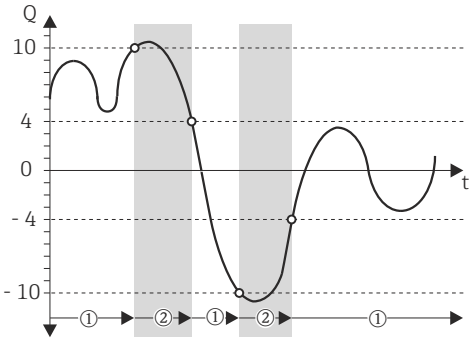

Function description OUTPUTS → RELAY OUTPUT → CONFIGURATION	
ON-VALUE (4701)	<p> Note! This function is not available unless LIMIT VALUE or FLOW DIRECTION was selected in the ASSIGN RELAY function (4700).</p> <p>Use this function to assign a value to the switch-on point (relay output pulls up). The value can be higher or lower than the switch-off point. Positive or negative values are permissible, depending on the measured variable in question (e.g. mass flow, totalizer reading).</p> <p>User input: 5-digit floating-point number [unit]</p> <p>Factory setting: 0 [kg/h] or 2 [kg/l] or 200 [°C]</p> <p> Note!</p> <ul style="list-style-type: none"> ▪ The appropriate unit is taken from the function UNIT MASS FLOW (0400) or UNIT VOLUME FLOW (0402). ▪ Only the switch-on point is available for flow direction output (no switch-off point). If you enter a value not equal to the zero flow (e.g. 5), the difference between the zero flow and the value entered corresponds to half the switchover hysteresis.
SWITCH-ON DELAY (4702)	<p> Note! This function is not available unless LIMIT VALUE or FLOW DIRECTION was selected in the ASSIGN RELAY function (4700).</p> <p>Use this function to define a delay (0 to 100 seconds) for pull-up (i.e. signal changes from 0 to 1) of the relay output. The delay starts when the limit value is reached. The relay output does switch when the delay has timed out and the switch on condition has been valid over the delay time.</p> <p>User input: fixed-point number 0.0 to 100.0 s</p> <p>Factory setting: 0.0 s</p>
OFF VALUE (4703)	<p> Note! This function is not available unless a number was selected in the ASSIGN RELAY function (4700).</p> <p>Use this function to assign a value to the switch-off point (relay drops out). The value can be higher or lower than the switch-on point. Positive or negative values are permissible, depending on the measured variable in question (e.g. mass flow, totalizer reading).</p> <p>User input: 5-digit floating-point number [unit]</p> <p>Factory setting: 0 [kg/h] or 2 [kg/l] or 200 [°C]</p> <p> Note!</p> <ul style="list-style-type: none"> ▪ The appropriate unit is taken from the function UNIT MASS FLOW (0400) or UNIT VOLUME FLOW (0402). ▪ If SYMMETRY is selected in the function MEASURING MODE (4705) and values with different signs are entered for the switch-on and switch-off points, the notice message "INPUT RANGE EXCEEDED" appears.

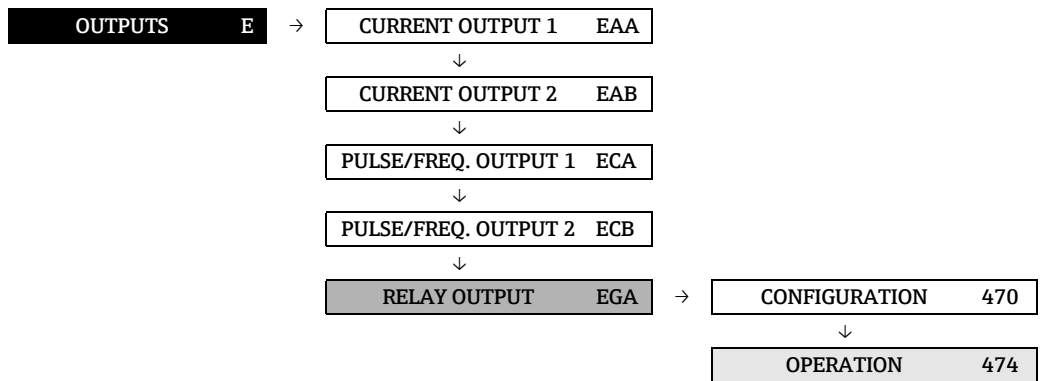

Function description	
OUTPUTS → RELAY OUTPUT → CONFIGURATION	
<p>SWITCH-OFF DELAY (4704)</p>	<p> Note! This function is not available unless a number was selected in the ASSIGN RELAY function (4700).</p> <p>Use this function to define a delay (0 to 100 seconds) for dropout (i.e. signal changes from 1 to 0) of the relay output. The delay starts when the limit value is reached. The relay output does switch when the delay has timed out and the switch off condition has been valid over the delay time.</p> <p>User input: fixed-point number 0.0 to 100.0 s</p> <p>Factory setting: 0.0 s</p>
<p>MEASURING MODE (4705)</p>	<p> Note! This function is not visible unless a limit value was assigned to the relay output.</p> <p>Use this function to define the measuring mode for the relay output.</p> <p>Options: STANDARD The relay output signal switches at the defined switch points.</p> <p>SYMMETRY The relay output signal switches at the defined switch points, irrespective of the sign. If you define a switch point with a positive sign, the relay output switches as soon as the value is reached in the negative direction (negative sign), (→ illustration).</p> <p>Factory setting: STANDARD</p> <div style="text-align: center;">  </div> <p style="text-align: right; font-size: small;">A0001247</p> <p><i>Fig. 22: Example for the SYMMETRY measuring mode</i></p> <p>Switch-on point $Q = 4$ Switch-off point $Q = 10$ ① = Relay energized ② = Relay de-energized</p> <p> Note!</p> <ul style="list-style-type: none"> ▪ SYMMETRY cannot be selected unless the values in the ON-VALUE (4701) and OFF VALUE (4703) functions have the same sign or one of the values is zero. ▪ If the values have different signs, SYMMETRY cannot be selected and an "ASSIGNMENT NOT POSSIBLE" message is displayed.

Function description OUTPUTS → RELAY OUTPUT → CONFIGURATION	
TIME CONSTANT (4706)	<p>Entering a time constant defines how the measuring signal reacts to severely fluctuating measured variables, either very quickly (enter a low time constant) or with damping (enter a high time constant). Damping acts on the measuring signal before the switch status changes, and consequently before switch-on or switch-off delay is activated. The purpose of damping, therefore, is to prevent the relay output changing state continuously in response to fluctuations in flow.</p> <p>User input: fixed-point number: 0.00 to 100.00 s</p> <p>Factory setting: 0.00 s</p>

7.3.2 Function group OPERATION



Function description OUTPUTS → RELAY OUTPUT → OPERATION	
ACTUAL STATUS RELAY (4740)	<p>Use this function to check the current status of the relay output. A jumper on the contact side defines the relay output as a normally open (NO or make) or normally closed (NC or break) contact → Operating Instruction (BA00139D/06).</p> <p>Display: MAKE CONTACT OPEN MAKE CONTACT CLOSED BREAK CONTACT OPEN BREAK CONTACT CLOSED</p>
SIMULATION SWITCH POINT (4741)	<p>Use this function to activate simulation of the relay output.</p> <p>Options: OFF ON</p> <p>Factory setting: OFF</p> <p> Note!</p> <ul style="list-style-type: none"> ▪ The "SIMULATION RELAY" message indicates that simulation is active. ▪ The measuring device continues to measure while simulation is in progress, i.e. the current measured values are output correctly via the other outputs. <p> Caution! The setting is not saved in the event of a power failure.</p>

Function description	
OUTPUTS → RELAY OUTPUT → OPERATION	
VALUE SIMULATION SWITCH POINT (4742)	<p> Note! The function is not visible unless the function SIMULATION SWITCH POINT (4741) is active (= ON).</p> <p>Use this function to define the status of the relay output during the simulation. This value is used to test downstream devices and the measuring device itself. Depending on the relay configuration (as make or break contact) the following selections are available.</p> <p>Options: Relay output configured as normally open (make) contact: MAKE CONTACT OPEN MAKE CONTACT CLOSED</p> <p>Relay output configured as normally closed (break) contact: BREAK CONTACT OPEN BREAK CONTACT CLOSED</p> <p> Caution! The setting is not saved in the event of a power failure.</p>

7.3.3 Function group INFORMATION

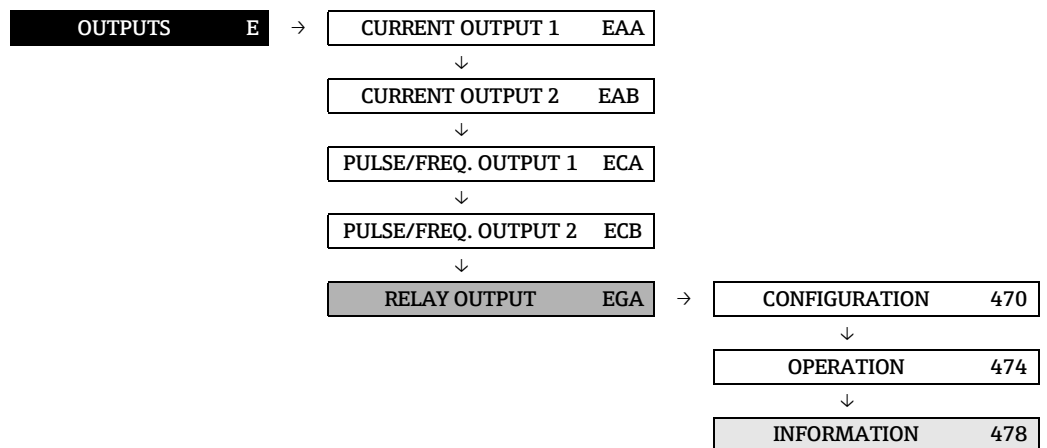

Function description	
OUTPUTS → RELAY OUTPUT → INFORMATION	
TERMINAL NUMBER (4780)	Use this function to view the numbers of the terminals (in the connection compartment) and the polarity used by the relay output. Display: 22 (+) / 23 (-) →RELAY OUTPUT 20 (+) / 21 (-) →RELAY OUTPUT

7.3.4 Behavior of relay output

General

If you have configured the relay output signal for LIMIT VALUE or FLOW DIRECTION, you can define the requisite switch points in the ON-VALUE and OFF-VALUE functions. When the measured variable in question reaches one of these predefined values, the relay output switches as shown in the illustrations below.

Relay output configured for flow direction

The value you entered in the function ON-VALUE defines the switch point for the positive and negative directions of flow.

If, for example, the switch point you define is $1 \text{ m}^3/\text{h}$, the relay output does not switch off until $-1 \text{ m}^3/\text{h}$ (non-conductive) and switches on again at $+1 \text{ m}^3/\text{h}$. Set the switch point to 0 if your process calls for direct switchover (no switching hysteresis). If low flow cut off is used, it is advisable to set hysteresis to a value higher than or equal to the low flow cut off rate.

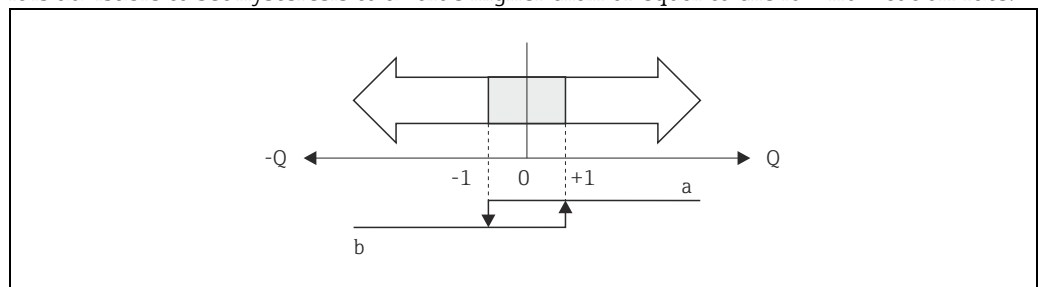

A0001236

Fig. 23: Relay output configured for "flow direction"

- a Relay energized
- b Relay de-energized

Relay output configured for limit value

The relay output signal switches as soon as the measured variable undershoots or overshoots a defined switch point.

Application: Monitoring flow or process-related boundary conditions.

Measured variable

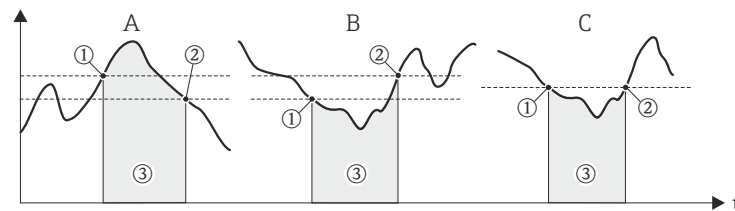

A0001235

Fig. 24: Relay output configured for "limit value"

① = Switch-off point, ② = Switch-on point, ③ = Relay de-energized









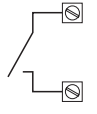
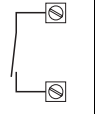

A = Maximum safety (SWITCH-OFF POINT > SWITCH-ON POINT)

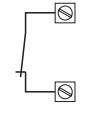
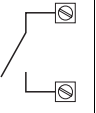
B = Minimum safety (SWITCH-OFF POINT < SWITCH-ON POINT)

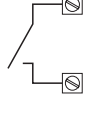
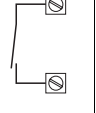
C = Minimum safety (SWITCH-OFF POINT = SWITCH-ON POINT, this configuration is to be avoided)

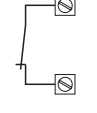
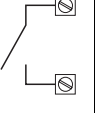
7.3.5 Switching behavior of the relay output

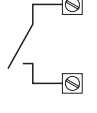
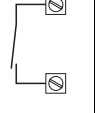
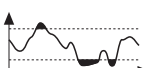
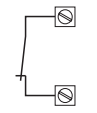
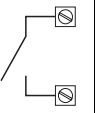
Function	State	Relay coil	Contact*	
			open	closed
ON (operation)	System in measuring mode 	energized		
	System not in measuring mode (power supply failed) 	de-energized		
Fault message	System OK 	energized		
	(System or process error) Fault → Failsafe mode, out-puts/inputs and totalizers 	de-energized		
Notice message	System OK 	energized		
	(System or process error) Fault → Continuation of mea-suring 	de-energized		
Fault message or Notice message	System OK 	energized		
	(System or process error) Fault → Response to error or Note → Continuation of mea-suring 	de-energized		

Function	State	Relay coil	Contact*	
			open	closed
Empty pipe detection (EPD)	Measuring tube full 	energized	 A0001239	 A0001237
	Measuring tube partially filled /empty measuring tube 	de-energized	 A0001240	 A0001238
Flow direction	Forward  A0001241	energized	 A0001239	 A0001237
	Reverse  A0001242	de-energized	 A0001240	 A0001238
Limit value - Mass flow - Volume flow - Corrected volume flow - Density - Reference density - Temperature - Totalizer	Limit value not overshoot or undershot  A0001243	energized	 A0001239	 A0001237
	Limit value overshoot or undershot  A0001244	de-energized	 A0001240	 A0001238
<p>* Terminal numbers in accordance with the function TERMINAL NUMBER (4780) → 85.</p> <p> Note! If the measuring device has two relays, the factory setting is:</p> <ul style="list-style-type: none"> ■ Relay 1 → normally open contact ■ Relay 2 → normally closed contact 				

8 Block INPUTS

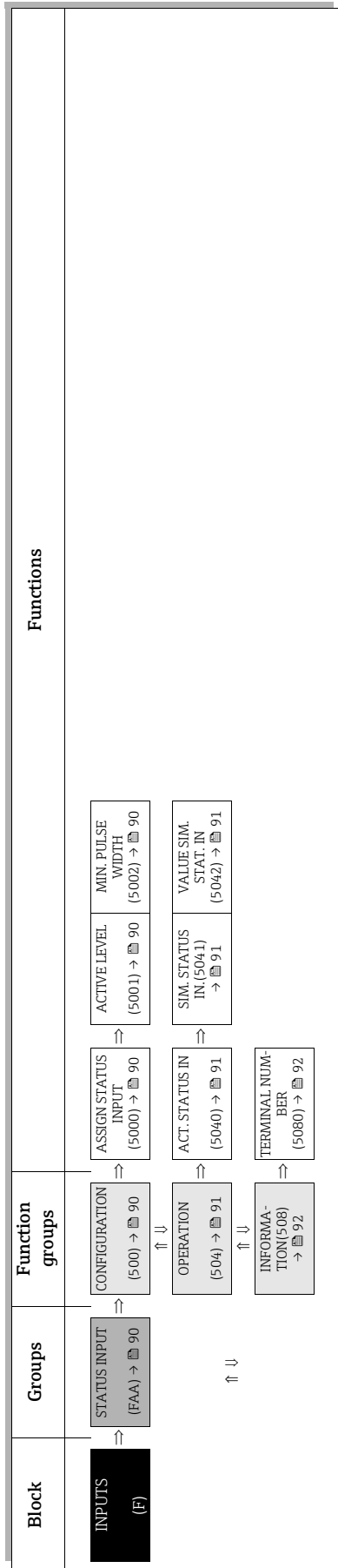

8.1 Group STATUS INPUT





8.1.1 Function group CONFIGURATION

INPUTS	F	→	STATUS INPUT	FAA	→	CONFIGURATION	500
--------	---	---	--------------	-----	---	---------------	-----

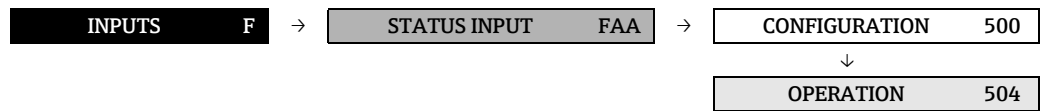
Function description	
INPUTS → STATUS INPUT → CONFIGURATION	
ASSIGN STATUS INPUT (5000)	<p>Use this function to assign a switching function to the status input.</p> <p>Options: OFF RESET TOTALIZER 1 RESET TOTALIZER 2 RESET TOTALIZER 3 RESET ALL TOTALIZERS POSITIVE ZERO RETURN RESET FAULT MESSAGE ZERO POINT ADJUSTMENT</p> <p>Factory setting: RESET FAULT MESSAGE</p> <p>☞ Caution! POSITIVE ZERO RETURN is active as long as the level is available at the status input (continuous signal). All other assignments react to a change in level (pulse) at the status input.</p>
ACTIVE LEVEL (5001)	<p>Use this function to define whether the assigned function (→ function ASSIGN STATUS INPUT(5000)) is released when the signal level is present (HIGH) or not present (LOW).</p> <p>Options: HIGH LOW</p> <p>Factory setting: HIGH</p>
MINIMUM PULSE WIDTH (5002)	<p>Use this function to define a minimum pulse width which the input pulse must achieve in order to trigger the selected switching function, (→ function ASSIGN STATUS INPUT (5000)).</p> <p>User input: 20 to 100 ms</p> <p>Factory setting: 50 ms</p>

8.1.2 Function group OPERATION



Function description INPUTS → STATUS INPUT → OPERATION	
ACTUAL STATUS INPUT (5040)	Use this function to view the current level of the status input. Display: HIGH LOW
SIMULATION STATUS INPUT (5041)	Use this function to simulate the status input, in other words to trigger the function assigned to the status input (ASSIGN STATUS INPUT (5000) → ⓘ 90). Options: OFF ON Factory setting: OFF  Note! <ul style="list-style-type: none"> ▪ The "SIMULATION STATUS INPUT" notice message indicates that simulation is active. ▪ The measuring device continues to measure while simulation is in progress, i.e. the current measured values are output correctly via the other outputs.  Caution! The setting is not saved in the event of a power failure.
VALUE SIMULATION STATUS INPUT (5042)	 Note! The function is not visible unless the function is active. Use this function to define the level to be assumed at the status output during the simulation. This value is used to test downstream devices and the measuring device itself. Options: HIGH LOW Factory setting: LOW  Caution! The setting is not saved in the event of a power failure.

8.1.3 Function group INFORMATION

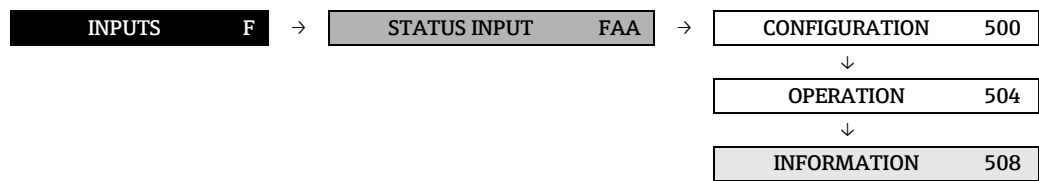

Function description INPUTS → STATUS INPUT → INFORMATION	
TERMINAL NUMBER (5080)	<p>Use this function to view the numbers of the terminals (in the connection compartment) and the polarity used by the status input.</p> <p>Display: 1 = 24 (+) / 25 (-)</p>





9 Block BASIC FUNCTION

Block	Groups	Function groups	Functions	
BASIC FUNCTION (G)	HART (GAA) → 94	CONFIGURATION (600) → 94	TAG DESCRIPTION (6001) → 94	
		INFORMATION (604) → 95	BUS ADDRESS (6002) → 94	
	PROCESS PARAMETER (GIA) → 96	MANUFACTURER ID (6040) → 95	DEVICE ID (6041) → 95	HART PROTOCOL (6003) → 94
		CONFIGURATION (640) → 96	DEVICE REVISION (6042) → 95	WRITE PROTECTION (6004) → 94
	EPD PARAMETER (642) → 98	ASSIGN LF CUT OFF (6400) → 96	ON-VALUE LF CUTOFF (6402) → 96	PRESS SHOCK SUPPR. (6404) → 97
		REFERENCE PARAMETER (646) → 100	EMPTY PIPE DETECT. (6420) → 98	OFF-POINT LF CUT OFF (6403) → 96
	ADJUSTMENT (648) → 102	CORR VOL. CALC. (6460) → 100	EMPTY PIPE DET. LOW (6423) → 98	EPD VALUE HIGH (6424) → 98
		ADJUSTMENT (648) → 102	ZERO POINT ADJUST. (6480) → 102	EPD RESP.TIME (6425) → 98
	PRESSURE CORRECTION (650) → 104	PRESSURE MODE (6500) → 104	FIXED REF. DEN-SITY (6461) → 100	EXPAN. COEFF. (6463) → 100
		SYSTEM PARAMETER (GIA) → 105	CONFIGURATION (660) → 105	DENSITY ADJUST. MODE (6482) → 102
	SENSOR DATA (GNA) → 106		INSTALL. DIR. SENSOR (6600) → 105	MEASURE FLUID 1 (6484) → 102
		FLOW COEFF. (684) → 107	K-FACTOR (6800) → 106	DENSITY SET VALUE 1 (6483) → 102
	DENSITY COEFF. (685) → 108		COEFF. KM (6840) → 107	MEASURE FLUID 2 (6486) → 103
		ADJUST. COEFF. (686) → 109	COEFF. C0 (6850) → 108	DENSITY SET VALUE 2 (6485) → 103
	MEASUREMENT (687) → 103		MIN. FLUID TEMP. (6860) → 109	MEASURE FLUID 2 (6486) → 103
		RESTORE ORG. (6488) → 103	MAX. FLUID TEMP. (6861) → 109	DENSITY ADJUSTMENT (6487) → 103
	COEFF. C5 (6855) → 108		MIN. CARRIER TEMP. (6862) → 109	RESTORE ORG. (6488) → 103
		COEFF. C4 (6854) → 108	MAX. CARRIER TEMP. (6863) → 109	MEASURE FLUID 1 (6484) → 102
	COEFF. C3 (6853) → 108		POS. ZERO RETURN (6605) → 105	DENSITY DAMPING (6602) → 105
		COEFF. C2 (6852) → 108	DENSITY DAMPING (6602) → 105	POS. ZERO RETURN (6605) → 105
	COEFF. C1 (6851) → 108		FLOW DAMPING (6603) → 105	NOMINAL DIAMETER (6804) → 106
		COEFF. KD 2 (6844) → 107	COEFF. KM 2 (6841) → 107	COEFF. KT (6842) → 107
	COEFF. KD 1 (6843) → 107		COEFF. C1 (6851) → 108	COEFF. C2 (6852) → 108
		COEFF. C5 (6855) → 108	COEFF. C0 (6850) → 108	COEFF. C3 (6853) → 108
COEFF. C4 (6854) → 108	MIN. FLUID TEMP. (6860) → 109		COEFF. C4 (6854) → 108	
	COEFF. C3 (6853) → 108	MAX. FLUID TEMP. (6861) → 109	COEFF. C5 (6855) → 108	
COEFF. C2 (6852) → 108		MIN. CARRIER TEMP. (6862) → 109	MAX. CARRIER TEMP. (6863) → 109	
	COEFF. C1 (6851) → 108	MAX. CARRIER TEMP. (6863) → 109		

9.1 Group HART

9.1.1 Function group CONFIGURATION

BASIC FUNCTION	G	→	HART	GAA	→	CONFIGURATION	600
----------------	---	---	------	-----	---	---------------	-----

Function description	
BASIC FUNCTION → HART → CONFIGURATION	
TAG NAME (6000)	Use this function to enter a tag name for the measuring device. You can edit and read this tag name via the local display or the HART protocol. User input: max. 8-character text, permissible: A-Z, 0-9, +, -, punctuation marks Factory setting: "-----" (no text)
TAG DESCRIPTION (6001)	Use this function to enter a tag description for the measuring device. You can edit and read this tag name via the local display or the HART protocol. User input: max. 16-character text, permissible: A-Z, 0-9, +, -, punctuation marks Factory setting: "-----" (No text)
BUS ADDRESS (6002)	Use this function to define the address for the exchange of data with the HART protocol. User input: 0 to 15 Factory setting: 0  Note! Addresses 1 to 15: a constant 4 mA current is applied.
HART PROTOCOL (6003)	Use this function to display if the HART protocol is active. Display: OFF = HART protocol not active ON = HART protocol active  Note! The HART protocol can be activated with the selection 4-20 mA HART or 4-20 mA (25 mA) in the function CURRENT SPAN →  48.
WRITE PROTECTION (6004)	Use this function to check whether the measuring device can be write-accessed. Display: OFF = Data exchange is possible ON = Data exchange disabled Factory setting: OFF  Note! Write protection is disabled or enabled by means of a jumper on the I/O board. For additional information on write protection, refer to the Operating Instructions (BA00139D/06).

9.1.2 Function group INFORMATION

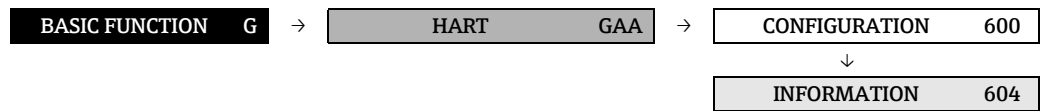

Function description BASIC FUNCTION → HART → OPERATION	
MANUFACTURER ID (6040)	<p>Use this function to view the manufacturer ID in decimal numerical format.</p> <p>Display:</p> <ul style="list-style-type: none"> - Endress+Hauser - 17 (≅ 11 hex) for Endress+Hauser
DEVICE ID (6041)	<p>Use this function to view the device ID in hexadecimal numerical format.</p> <p>Display:</p> <p>49 (≅ 73 dez) for Cubemass DCI</p>
DEVICE REVISION (6042)	<p>Displays the device-specific revision of the HART command interface.</p> <p>Display:</p> <p>e.g.: 5</p>

9.2 Group PROCESSPARAMETER

9.2.1 Function group CONFIGURATION

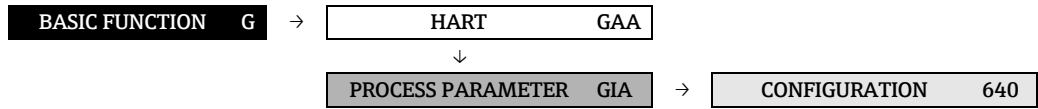





Function description BASIC FUNCTION → PROCESSPARAMETER → CONFIGURATION	
ASSIGN LOW FLOW CUT-OFF (6400)	Use this function to assign the switch point for low flow cut off rate suppression. Options: OFF MASS FLOW VOLUME FLOW CORRECTED VOLUME FLOW Factory setting: MASS FLOW
ON-VALUE LOW FLOW CUT OFF (6402)	Use this function to assign a value to the switch-on point for low flow cut off. Low flow cut off is active if the value entered is not equal to 0. The sign of the flow value is highlighted on the display to indicate that low flow cut off is active. User input: 5-digit floating-point number, [unit] Factory setting: Depends on nominal diameter 📎 Note! The appropriate unit is taken from the function group SYSTEM UNITS (→ 13).
OFF-VALUE LOW FLOW CUTOFF (6403)	Enter the off-value (b) of the low flow cut off. Enter the switch-off point as a positive hysteresis (H) from the switch-on point (a). User input: Integer 0 to 100% Factory setting: 50% <div style="text-align: center;"> </div> <p style="text-align: right;">A0003882</p>

- ① = On-value
- ② = Off-value
- a Low flow cut off is switched on
- b Low flow cut off is switched off ($a + a \cdot H$)
- H Hysteresis: 0 to 100%
- Low flow cut off active
- Q Flow

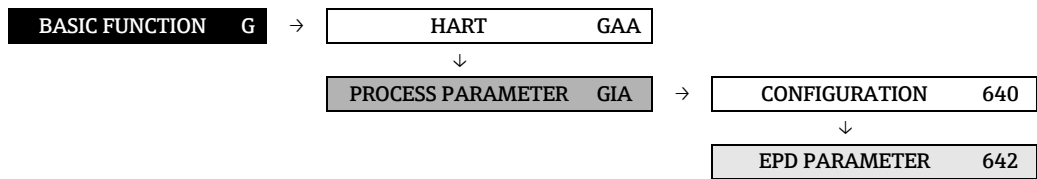
Function description	
BASIC FUNCTION → PROCESSPARAMETER → CONFIGURATION	
<p>PRESSURE SHOCK SUPPRESSION (6404)</p>	<p>The closure of a valve can cause brief but severe movements of the fluid in the piping system, movements which the measuring system registers. The pulses totaled in this way result in a totalizer reading error, particularly in the case of batching processes. For this reason, the measuring device is equipped with pressure shock suppression (= short-term signal suppression) which can eliminate system-related "disruptions".</p> <p>Note! Note that pressure shock suppression cannot be used unless the low flow cut off is active, (→function ON-VALUE LOW FLOW CUT OFF → 96).</p> <p>Use this function to define the time span for active pressure shock suppression.</p> <p>Activation of the pressure shock suppression Pressure shock suppression is activated after the flow falls below the switch-on point of the low flow cut off (→ point a in graphic). While pressure shock suppression is active, the following conditions apply:</p> <ul style="list-style-type: none"> ▪ Flow reading on display → 0 ▪ Totalizer reading → the totalizers are pegged at the last correct value. <p>Deactivation of the pressure shock suppression The pressure shock suppression is deactivated after the time interval, set in this function, has passed (→ point b in graphic).</p> <p>Note! The actual flow value is displayed and output, when the time interval for the pressure shock suppression has passed and the flow exceeds the switch-off point of the low flow cut off (→ point c in graphic).</p> <div style="text-align: center;"> </div> <p style="text-align: right; font-size: small;">A0001285-EN</p> <p>① = Off-value (low flow cut off) ② = On-VALUE (low flow cut off) a Active when value falls below the on-value of the low flow cut off b Deactivated after specified time expires c Flow values are again used to calculate the pulses ■ Suppressed values Q Flow</p> <p>User input: max. 4-digit number, incl. unit: 0.00 to 100.0 s</p> <p>Factory setting: 0.00 s</p>

9.2.2 Function group EPD PARAMETER



Function description BASIC FUNCTION → PROCESSPARAMETER → EPD PARAMETER	
EMPTY PIPE DETECTION (6420)	<p>Use this function to activate the empty pipe detection (EPD). With empty measuring tubes the density of the fluid falls below the value specified in the function EPD VALUE LOW.</p> <p>Options: OFF ON</p> <p>Factory setting: Liquid: ON Gas: OFF</p> <p> Caution!</p> <ul style="list-style-type: none"> ▪ Select a correspondingly low EPD response value in the function EPD VALUE LOW, so that the difference to the effective density of the fluid is sufficiently large enough. This ensures that totally empty measuring tubes and not partially filled ones are detected. ▪ For gas measurement we strongly recommend to switch off empty pipe detection.
EPD VALUE LOW (6423)	<p> Note! This function is not available unless the ON selection was selected in the EMPTY PIPE DETECTION function.</p> <p>Use this function to set a lower threshold for the measured density value, in order to detect possible problems in the process indicated by too low density.</p> <p>User input: 5-digit floating-point number</p> <p>Factory setting: 0.2000 kg/l</p>
EPD VALUE HIGH (6424)	<p> Note! This function is not available unless the ON selection was selected in the EMPTY PIPE DETECTION function.</p> <p>Use this function to set an upper threshold for the measured density value.</p> <p>User input: 5-digit floating-point number</p> <p>Factory setting: 6.0000 kg/l</p>
EPD RESPONSE TIME (6425)	<p>Use this function to enter the time span for which the criteria for an empty pipe have to be satisfied without interruption before a notice message or fault message is generated.</p> <p>User input: Fixed-point number 1.0 to 100 s</p> <p>Factory setting: 1.0 s</p>

Function description BASIC FUNCTION → PROCESSPARAMETER → EPD PARAMETER	
EPD EXC.CURR. (6426)	<p>Use this function to activate the empty pipe detection (EPD).</p> <p>In the event of inhomogeneous fluids or air bubbles, the exciting current of the measuring pipes increases. If the excitation current set in this function is exceeded, error message #700 is output similar to the function EPD VALUE LOW (6423) and EPD VALUE HIGH (6424).</p> <p>User input: 5-digit floating-point number</p> <p>Factory setting: 100 mA (deactivated)</p> <p> Note! The function is not activated until a value under 100 mA is input. Entering the value 100 mA deactivates the function.</p>

9.2.3 Function group REFERENCE PARAMETER

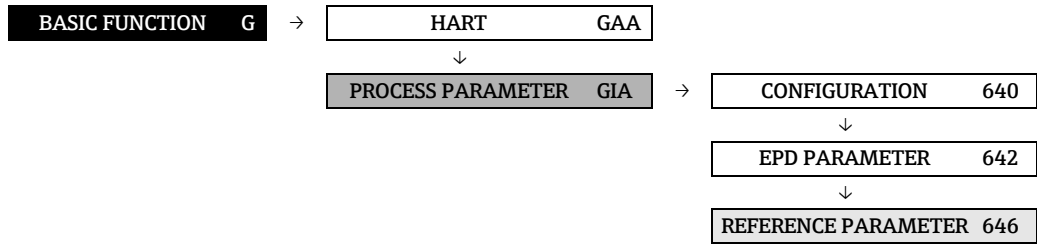



Function description	
BASIC FUNCTION → PROCESSPARAMETER → REFERENCE PARAMETER	
CORRECTED VOLUME CALCULATION (6460)	<p>This function is used to set the reference density for calculating the corrected volume flow.</p> <p>Options: FIXED REFERENCE DENSITY CALCULATED REFERENCE DENSITY</p> <p>Factory setting: CALCULATED REFERENCE DENSITY</p>
FIXED REFERENCE DENSITY (6461)	<p> Note! This function is not available unless the FIXED REFERENCE DENSITY setting was selected in the CORRECTED VOLUME CALCULATION (6460) function.</p> <p>In this function, a fixed value for the reference density can be entered, with which the corrected volume flow or corrected volume is calculated.</p> <p>User input: 5-digit floating-point number</p> <p>Factory setting: 1 kg/Nl</p>
EXPANSION COEFFICIENT (6462)	<p> Note! This function is not available unless the CALCULATED REFERENCE DENSITY setting was selected in the CORRECTED VOLUME CALCULATION function (6460).</p> <p>For temperature-compensated calculations of the reference density an expansion coefficient specific to the fluid is required and can be entered in this function (→ (6464) (→ 101) function on REFERENCE TEMPERATURE).</p> <p>User input: 5-digit floating-point number</p> <p>Factory setting: $0.5000 \text{ e}^{-3} [1/K]$</p>
EXPANSION COEFFICIENT SQUARE (6463)	<p>Use this function to enter a square expansion coefficient if the temperature compensation follows a nonlinear behavior (→ REFERENCE TEMPERATURE (6464) function on → 101).</p> <p>User input: 5-digit floating-point number</p> <p>Factory setting: $0 \text{ e}^{-6} [1/K^2]$</p>

Function description	
BASIC FUNCTION → PROCESSPARAMETER → REFERENCE PARAMETER	
<p>REFERENCE TEMPERATURE (6464)</p>	<p> Note! This function is not available unless the CALCULATED REFERENCE DENSITY setting was selected in the CORRECTED VOLUME CALCULATION function (6460).</p> <p>Entering the reference temperature for calculating the corrected volume flow, the corrected volume and the reference density.</p> <p>User input: 5-digit floating-point number</p> <p>Factory setting: 20.000 °C</p> <p>The reference density is calculated as follows: $\rho_N = \rho \cdot (1 + \alpha \Delta t + \beta \Delta t^2)$; where $\Delta t = t - t_N$</p> <p>ρ_N = Reference density ρ = Currently measured fluid density (measuring value of the measuring instrument) t = Actual measured temperature of fluid (measuring value of the measuring instrument) t_N = Reference temperature for calculating the reference density (e.g. 20 °C) α = Volumetric expansion coefficient of the fluid, Unit = [1/K]; K = Kelvin β = Square vol. expansion coefficient of the fluid, unit [1/K²]</p>

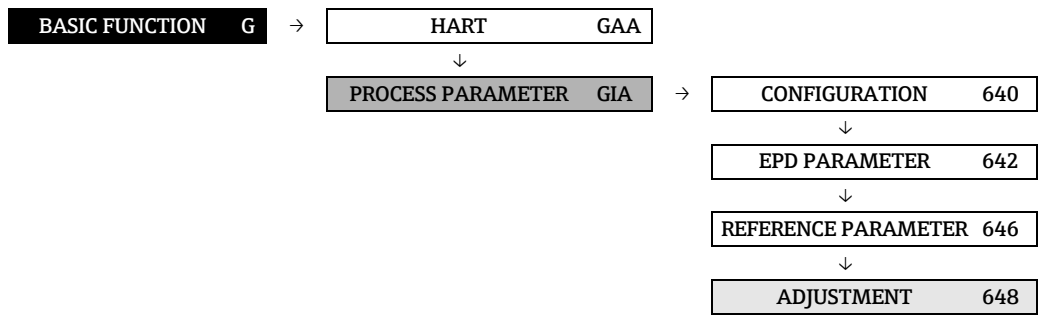
9.2.4 Function group ADJUSTMENT





Function description	
BASIC FUNCTION → PROCESSPARAMETER → ADJUSTMENT	
ZERO POINT ADJUSTMENT (6480)	<p>This function enables a zero point adjustment to be automatically carried out. The new zero point determined by the measuring system is adopted by the function ZERO POINT.</p> <p>Options: CANCEL START</p> <p>Factory setting: CANCEL</p> <p> Caution! Before carrying this out, please refer to the Operating Instructions (BA00139D/06) for a detailed description of the procedure for zero point adjustment.</p> <p> Note!</p> <ul style="list-style-type: none"> ▪ Programming is locked during zero point adjustment. The message "ZERO ADJUST RUNNING" appears on the display. ▪ If the zero point adjustment is not possible (e.g. if $v > 0.1$ m/s) or has been canceled, the alarm message "ZERO ADJUST NOT POSSIBLE" appears on the display. ▪ If the Cubemass DCI measuring electronics are fitted with a status input, then the zero point can also be activated by using this input.
DENSITY ADJUST MODE (6482)	<p>Select whether a 1-point or 2-point density adjustment should be carried out.</p> <p>Options: CANCEL 1-POINT 2-POINT</p>
DENSITY SET VALUE 1 (6483)	<p>Use this function to enter the density setpoint value for the first fluid for which you want to carry out a field density adjustment.</p> <p>User input: 5-digit floating-point number, incl. units</p> <p> Note!</p> <ul style="list-style-type: none"> ▪ The preset density entered here should not vary from the actual fluid density by a more than $\pm 10\%$. ▪ The appropriate unit is taken from the function group SYSTEM UNITS (→ 13).
MEASURE FLUID 1 (6484)	<p>Measure the actual density of the first fluid for the density adjustment.</p> <p>Options: CANCEL START</p>

Function description BASIC FUNCTION → PROCESSPARAMETER → ADJUSTMENT	
DENSITY SET VALUE 2 (6485)	Use this function to enter the density setpoint value for the second fluid for which you want to carry out a field density adjustment. User input: 5-digit floating-point number, incl. units  Note! <ul style="list-style-type: none"> ▪ The preset density entered here should not vary from the actual fluid density by a more than ±10%. ▪ The difference between the density setpoint values must be at least 0.2 kg/l. ▪ The appropriate unit is taken from the function group SYSTEM UNITS (→  13).
MEASURE FLUID 2 (6486)	Measure the actual density of the second fluid for the density adjustment. Options: CANCEL START
DENSITY ADJUSTMENT (6487)	With this function a density adjustment can be carried out on site. The density adjustment values will thus be recalculated and stored. This ensures that the values dependent on density calculations (e.g. volume flow) are as accurate as possible.  Note! Before carrying this out, please refer to the Operating Instructions (BA00139D/06) for a detailed description of the procedure for density adjustment. Two types of adjustment are possible: 1-point density adjustment (with one fluid) This type of density adjustment is necessary under the following conditions: <ul style="list-style-type: none"> ▪ The sensor does not accurately measure the density which the operator expects based on laboratory trials. ▪ The characteristics of the fluid are outside the measuring points set at the factory or reference conditions under which the flowmeter has been calibrated. ▪ The plant is used solely for measuring a fluid whose density is to be determined very accurately under constant conditions. 2-point density adjustment (with two fluids) This type of adjustment must always be carried out when the measuring tubes are changed mechanically, e.g. due to deposits, abrasion or corrosion. In such cases, the resonant frequency of the measuring tubes has been affected by these factors and is no longer compatible with the calibration data set at the factory. The 2-point density adjustment takes these mechanically-based changes into account and calculates new, adjusted calibration data. Options: CANCEL MEASURE FLUID 1 MEASURE FLUID 2 DENSITY ADJUSTMENT Factory setting: CANCEL
RESTORE ORIGINAL (6488)	Restore the original density coefficients determined at the factory. Options: NO YES Factory setting: NO

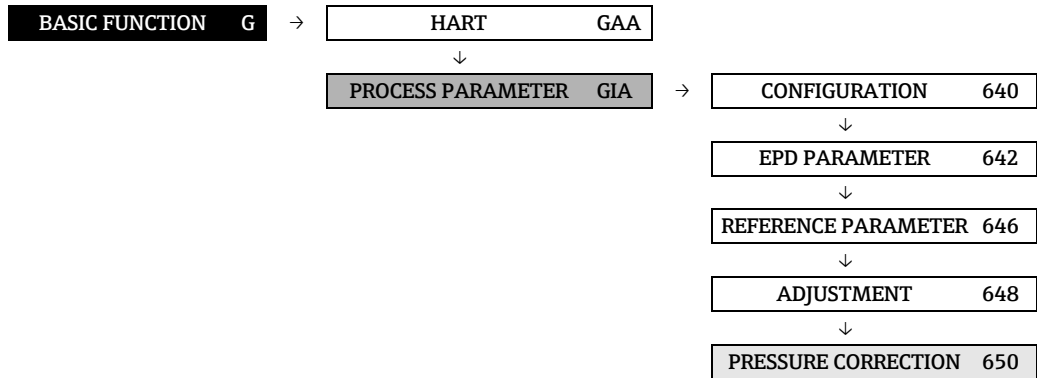
9.2.5 Function group PRESSURE CORRECTION



Function description	
BASIC FUNCTION → PROCESSPARAMETER → PRESSURE CORRECTION	
<p>PRESSURE MODE (6500)</p>	<p>Use this function to configure an automatic pressure correction. In this way, the effect of a pressure deviation between the calibration and process pressures on the measured error for mass flow can be compensated for. For additional information on this topic, refer to the Operating Instructions (BA00139D/06) in the chapter on accuracy.</p> <p>Options: OFF FIX (a fixed process pressure for pressure correction is specified).</p> <p>Factory setting: OFF</p>
<p>PRESSURE (6501)</p>	<p> Note! This function is not available unless the FIX option was selected in the PRESSURE MODE (6500) function.</p> <p>Use this function to enter the value for the process pressure which should be used during pressure correction.</p> <p>User input: 7-digit floating-point number</p> <p>Factory setting: 0 bar g</p> <p> Note! The appropriate unit is taken from the function group SYSTEM UNITS (→  13).</p>

9.3 Group SYSTEM PARAMETERS

9.3.1 Function group CONFIGURATION

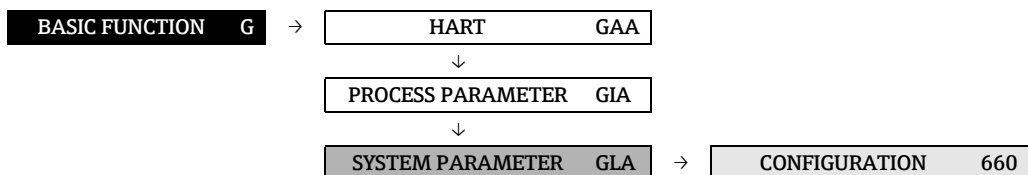



Function description BASIC FUNCTION → SYSTEM PARAMETER → CONFIGURATION	
INSTALLATION DIRECTION SENSOR (6600)	<p>Use this function to reverse the sign of the flow direction, if necessary.</p> <p> Note! Ascertain the actual direction of fluid flow with reference to the direction indicated by the arrow on the sensor (nameplate).</p> <p>Options: NORMAL (flow as indicated by the arrow) INVERSE (flow opposite to direction indicated by the arrow)</p> <p>Factory setting: NORMAL</p>
DENSITY DAMPING (6602)	<p>The density filter allows the sensitivity of the density measuring signal to be lowered with respect to variations in the density of the fluid, e.g. with inhomogeneous liquids. The damping acts on all functions and outputs of the measuring device.</p> <p>User input: max. 5-digit number, incl. unit: 0.00 to 100.00 s</p> <p>Factory setting: 0.00 s</p>
FLOW DAMPING (6603)	<p>Setting the filter depth of the digital filter. The sensitivity of the flow measurement signal can be reduced with respect to interference peaks (e.g. in the event of a high solid content, gas bubbles in the fluid etc.). The reaction time of the measuring device increases with every increase in the filter setting. The damping acts on all functions and outputs of the measuring device.</p> <p>User input: 0 to 100 s</p> <p>Factory setting: Liquid: 0.00 s Gas: 0.25 s</p>
POSITIVE ZERO RETURN (6605)	<p>Use this function to interrupt evaluation of measured variables. This is necessary when a piping system is being cleaned, for example. This setting acts on all function and outputs of the measuring device.</p> <p>Options: OFF ON (signal output is set to the ZERO FLOW value, temperature and density are still output)</p> <p>Factory setting: OFF</p>

9.4 Group SENSOR DATA

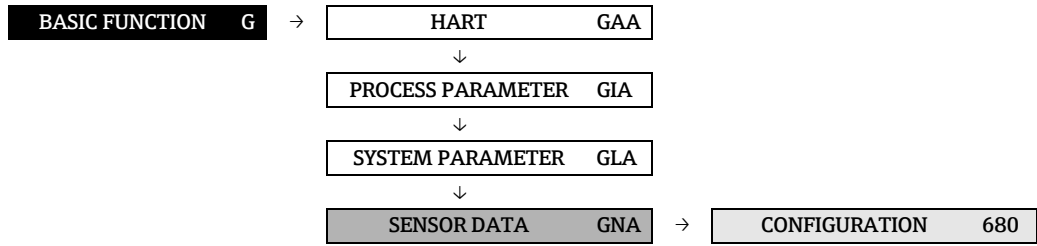
9.4.1 Function group CONFIGURATION



Function description	
BASIC FUNCTION → SENSOR DATA → CONFIGURATION	
<p>All sensor data (calibration factor, zero point and nominal diameter) are set at the factory and saved on the S-DAT sensor memory chip.</p> <p> Caution! Under normal circumstances you should not change the following parameter settings, because changes affect numerous functions of the entire measuring facility in general and the accuracy of the measuring system in particular. For this reason, the functions described below cannot be changed even when you enter your personal code. Contact your Endress+Hauser service organization if you have any questions about these functions.</p> <p> Note! The individual values of the functions are also provided on the sensor nameplate.</p>	
<p>K-FACTOR (6800)</p>	<p>This function shows the current calibration factor for the sensor.</p> <p>Factory setting: Depends on nominal diameter and calibration.</p>
<p>ZERO POINT (6803)</p>	<p>This function shows the current zero point correction value for the sensor.</p> <p>Display: max. 5-digit number: -99999 to +99999</p> <p>Factory setting: Depends on calibration.</p>
<p>NOMINAL DIAMETER (6804)</p>	<p>Display: Nominal diameter of the sensor DN 1 or 1/24" DN 2 or 1/12" DN 4 or 1/8" DN 6 or 1/4"</p>

9.4.2 Function group FLOW COEFFICIENT

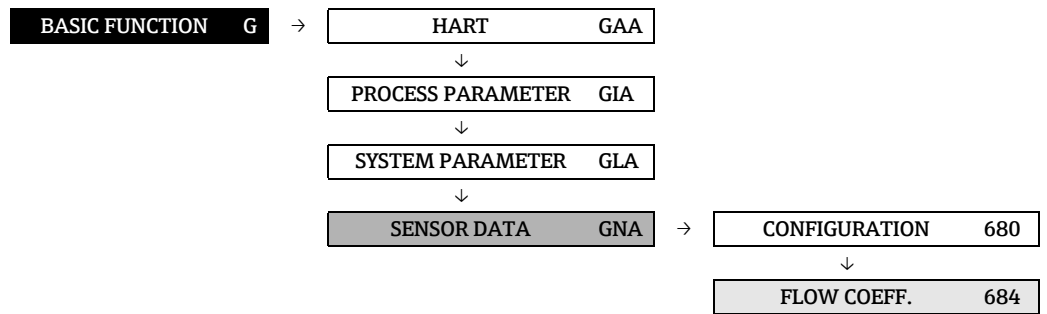

Function description	
BASIC FUNCTION → SENSOR DATA → FLOW COEFFICIENT	
<p>All flow coefficients are set at the factory. All the sensor's parameter settings are saved on the S-DAT memory chip.</p> <p>Contact your Endress+Hauser service organization if you have any questions about these functions.</p>	
TEMPERATURE COEFFICIENT KM (6840)	This function shows the temperature coefficient KM.
TEMPERATURE COEFFICIENT KM 2 (6841)	This function shows the temperature coefficient KM 2.
TEMPERATURE COEFFICIENT KT (6842)	This function shows the temperature coefficient KT.
CALIBRATION COEFFICIENT KD 1 (6843)	This function shows the calibration coefficient KD 1.
CALIBRATION COEFFICIENT KD 2 (6844)	This function shows the calibration coefficient KD 2.

9.4.3 Function group DENSITY COEFFICIENT

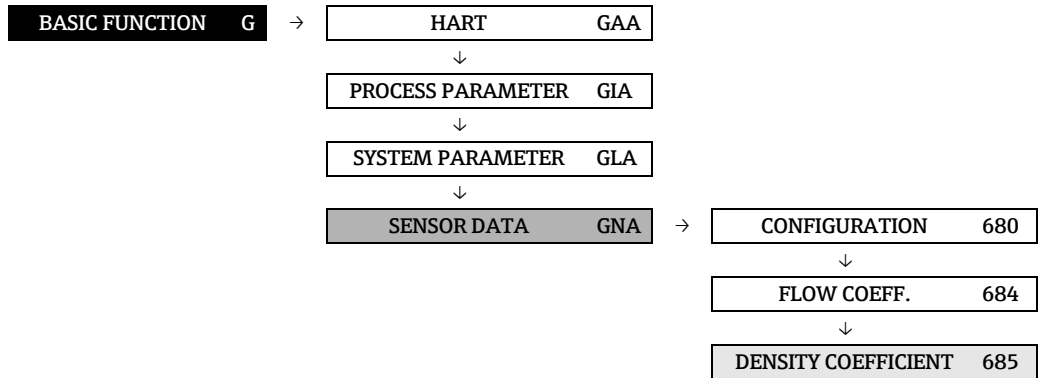

Function description	
BASIC FUNCTION → SENSOR DATA → DENSITY COEFFICIENT	
<p>All density coefficients are set at the factory. All the sensor's parameter settings are saved on the S-DAT memory chip.</p> <p>Contact your Endress+Hauser service organization if you have any questions about these functions.</p>	
DENSITY COEFFICIENT C0 (6850)	<p>This function shows the actual density coefficient C0.</p> <p> Caution! A density adjustment can alter the calibration value of this coefficient.</p>
DENSITY COEFFICIENT C1 (6851)	<p>This function shows the actual density coefficient C1.</p> <p> Caution! A density adjustment can alter the calibration value of this coefficient.</p>
DENSITY COEFFICIENT C2 (6852)	<p>This function shows the actual density coefficient C2.</p> <p> Caution! A density adjustment can alter the calibration value of this coefficient.</p>
DENSITY COEFFICIENT C3 (6853)	<p>This function shows the actual density coefficient C3.</p> <p> Caution! A density adjustment can alter the calibration value of this coefficient.</p>
DENSITY COEFFICIENT C4 (6854)	<p>This function shows the actual density coefficient C4.</p> <p> Caution! A density adjustment can alter the calibration value of this coefficient.</p>
DENSITY COEFFICIENT C5 (6855)	<p>This function shows the actual density coefficient C5.</p> <p> Caution! A density adjustment can alter the calibration value of this coefficient.</p>

9.4.4 Function group ADDITIONAL COEFFICIENT

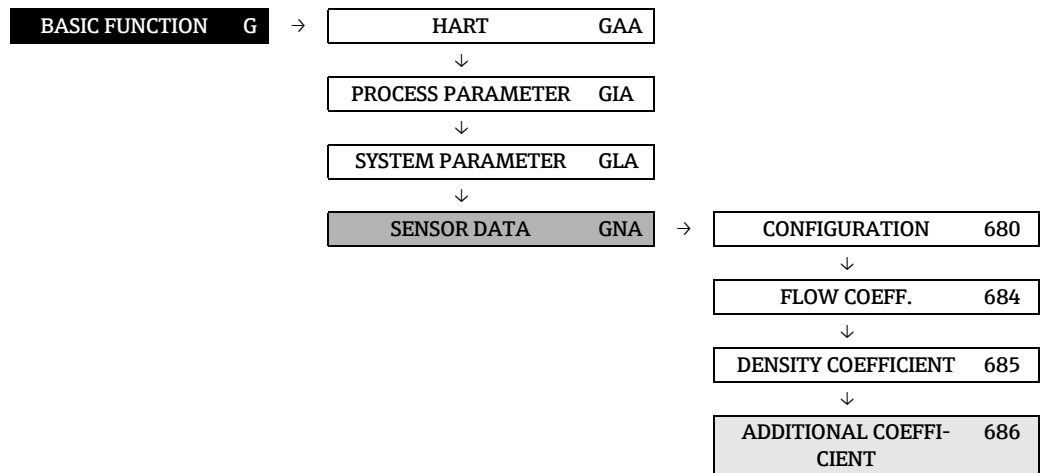

Function description	
BASIC FUNCTION → SENSOR DATA → ADDITIONAL COEFFICIENT	
<p>All sensor data are set at the factory. All the sensor's parameter settings are saved on the S-DAT memory chip.</p> <p> Caution! These functions are used for displaying device parameters only and consequently cannot be accessed.</p> <p>Contact your Endress+Hauser service organization if you have any questions about these functions.</p>	
MINIMUM FLUID TEMPERATURE (6860)	The lowest fluid temperature measured appears on the display.
MAXIMUM FLUID TEMPERATURE (6861)	The highest fluid temperature measured appears on the display.
MINIMUM TEMP. CARRIER TUBE (6862)	The lowest carrier tube temperature measured appears on the display.
MAXIMUM TEMP. CARRIER TUBE (6863)	The highest carrier tube temperature measured appears on the display.

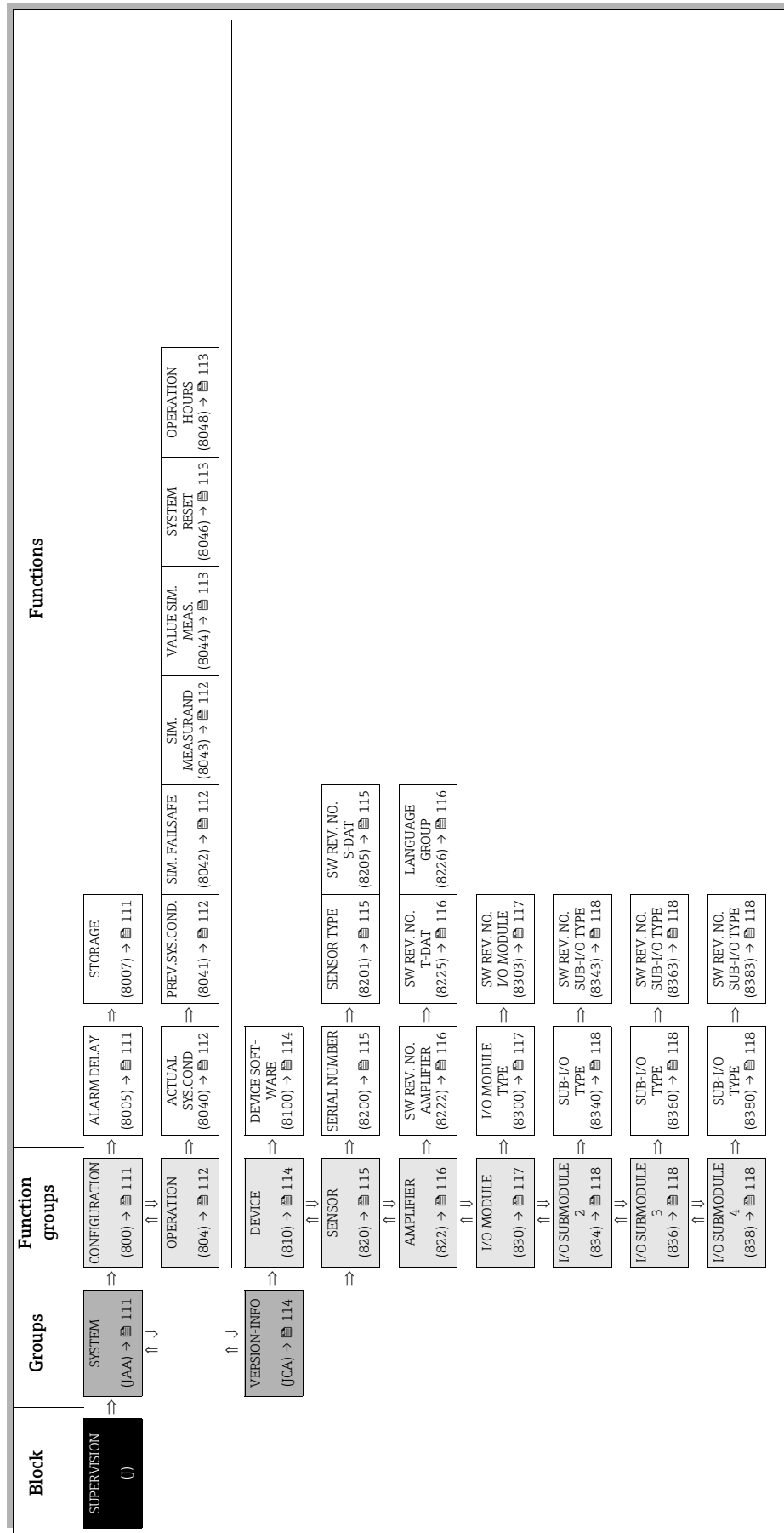

10 Block SUPERVISION



10.1 Group SYSTEM

10.1.1 Functions group CONFIGURATION



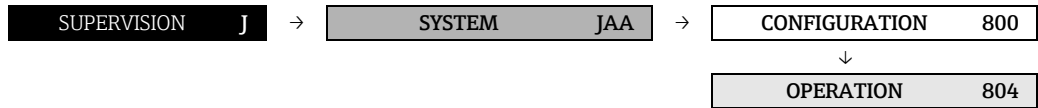

Function description MONITORING → SYSTEM → CONFIGURATION	
<p>ALARM DELAY (8005)</p>	<p>Enter the time span for which the criteria for an error have to be satisfied without interruption before a fault or notice message is generated.</p> <p>This suppression acts on:</p> <ul style="list-style-type: none"> ▪ Display ▪ Current output ▪ Frequency output ▪ Relay output <p>Input: 0 to 100 s (in one-second increments)</p> <p>Factory setting: 0 s</p> <p> Caution! If this function is activated, fault and notice messages are delayed by the time corresponding to the setting before being transmitted to the higher-order controller (process controller etc.). It is therefore imperative to check in advance in order to make sure whether a delay of this nature could affect the safety requirements of the process. If fault and notice messages may not be suppressed, a value of 0 seconds must be entered here.</p>
<p>STORE PERMANENTLY (8007)</p>	<p>Displays whether the automatic, permanent storage of parameter changes in the EEPROM is switched on or off.</p> <p>Display: OFF ON</p> <p>Factory setting: ON</p> <p> Caution!</p> <ul style="list-style-type: none"> ▪ The selection in the function can be changed by the Endress+Hauser service organization. ▪ If you select OFF, all parameter changes are not stored permanently in the EEPROM. This means that these parameter changes are no longer available after a power failure. In this case, the measuring instrument starts up with the last parameter configurations saved in the EEPROM.

10.1.2 Function group OPERATION



Function description SUPERVISION → SYSTEM → OPERATION	
ACTUAL SYSTEM CONDITION (8040)	<p>Use this function to check the present system condition.</p> <p>Display: "SYSTEM OK" or the fault / notice message with the highest priority.</p> <p> Note! For additional information, refer to the "System or process error messages" section in the Operating Instructions (BA00139D/06).</p>
PREVIOUS SYSTEM CONDITION (8041)	<p>Use this function to view the fifteen most recent fault and notice messages since measuring last started.</p> <p>Display: The 15 most recent fault or notice messages.</p> <p> Note! For additional information, refer to the "System or process error messages" section in the Operating Instructions (BA00139D/06).</p>
SIMULATION FAILSAFE MODE (8042)	<p>Use this function to set all inputs, outputs and totalizers to their defined failsafe modes, in order to check whether they respond correctly. During this time, the message "SIMULATION FAILSAFE MODE" appears on the display.</p> <p>Options: ON OFF</p> <p>Factory setting: OFF</p>
SIMULATION MEASURAND (8043)	<p>Use this function to set all inputs, outputs and totalizers to their defined flow-response modes, in order to check whether they respond correctly. During this time, the message "SIMULATION MEASURAND" appears on the display.</p> <p>Options: OFF MASS FLOW VOLUME FLOW CORRECTED VOLUME FLOW DENSITY REFERENCE DENSITY TEMPERATURE</p> <p>Factory setting: OFF</p> <p> Caution!</p> <ul style="list-style-type: none"> ▪ The measuring device cannot be used for measuring while this simulation is in progress. ▪ The setting is not saved in the event of a power failure.

Function description SUPERVISION → SYSTEM → OPERATION	
VALUE SIMULATION MEASURAND (8044)	<p> Note! The function is not visible unless the function SIMULATION MEASURAND (8043) is active.</p> <p>Use this function to define a freely selectable value (e.g. 12 m³/s). This is used to test the associated functions in the device itself and downstream signal loops.</p> <p>User input: 5-digit floating-point number [unit]</p> <p>Factory setting: 0 [unit]</p> <p> Caution!</p> <ul style="list-style-type: none"> ▪ The setting is not saved in the event of a power failure. ▪ The appropriate unit is taken from the function group SYSTEM UNITS (ACA) (→  13).
SYSTEM RESET (8046)	<p>Use this function to perform a reset of the measuring system.</p> <p>Options: NO RESTART SYSTEM (restart without interrupting power supply)</p> <p>Factory setting: NO</p>
OPERATION HOURS (8048)	<p>The hours of operation of the device appear on the display.</p> <p>Display: Depends on the number of hours of operation elapsed: Hours of operation < 10 hours → display format = 0:00:00 (hr:min:sec) Hours of operation 10 to 10,000 hours → display format = 0000:00 (hr:min) Hours of operation > 10,000 hours → display format = 000000 (hr)</p>

10.2 Group VERSION-INFO

10.2.1 Function group DEVICE

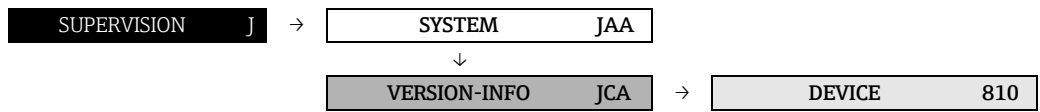

Function description MONITORING → VERSION-INFO → DEVICE	
DEVICE SOFTWARE (8100)	Displays the current device software version.

10.2.2 Function group SENSOR

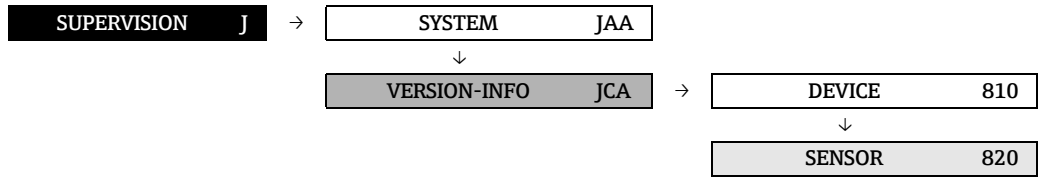

Function description MONITORING → VERSION-INFO → SENSOR	
SERIAL NUMBER (8200)	Use this function to view the serial number of the sensor.
SENSOR TYPE (8201)	Use this function to view the sensor type.
SW REV.-NR. S-DAT (8205)	Use this function to view the software revision number of the software used to create the content of the S-DAT.

10.2.3 Function group AMPLIFIER

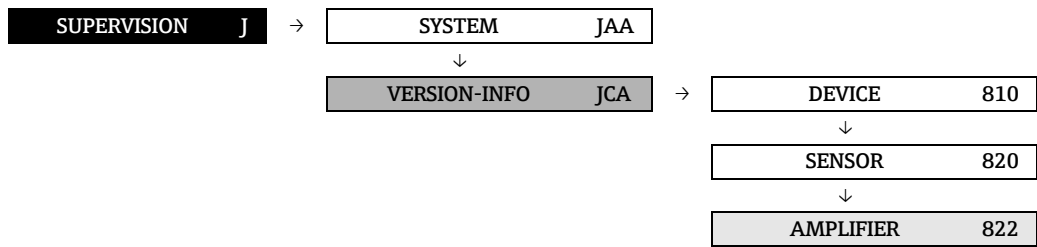

Function description MONITORING → VERSION-INFO → AMPLIFIER	
SOFTWARE REVISION NUMBER AMPLIFIER (8222)	Use this function to view the software revision number of the amplifier.
SOFTWARE REVISION NUMBER T-DAT (8225)	Use this function to view the software revision number of the software used to create the content of the T-DAT.
LANGUAGE GROUP (8226)	<p>Displays the installed language group.</p> <p>Display: TYPE UNKNOWN WEST EU / USA EAST EU / SCAND ASIA CHINA</p> <p> Note!</p> <ul style="list-style-type: none"> ▪ The language options of the available language group are displayed in the function LANGUAGE (2000). ▪ You can change the language group via the configuration software FieldCare. Please do not hesitate to contact your Endress+Hauser sales office if you have any questions.

10.2.4 Function group I/O MODULE

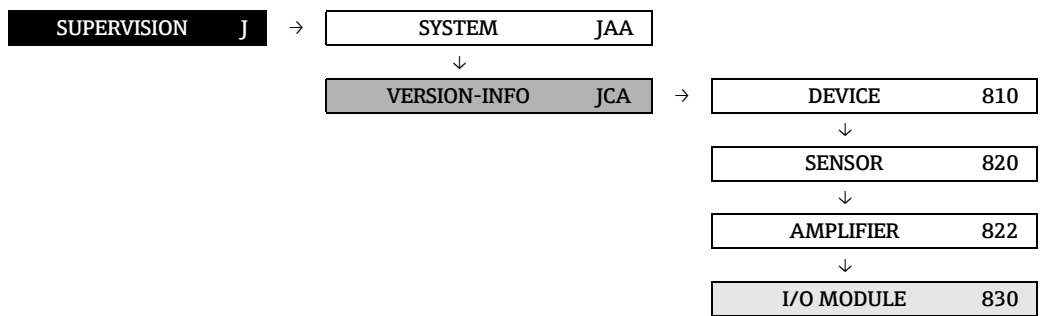

Function description	
SUPERVISION → VERSION-INFO → I/O MODULE	
I/O MODULE TYPE (8300)	Use this function to view the configuration of the I/O module complete with terminal numbers.
SW REV.-NR. I/O MODULE (8303)	Use this function to view the software revision number of the I/O module.

10.2.5 Function groups INPUT/OUTPUT 2 to 4

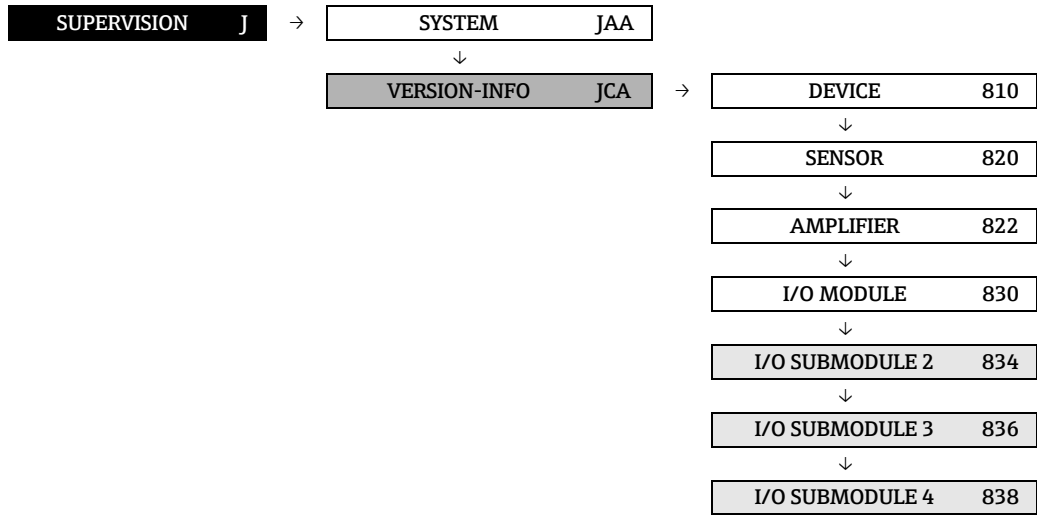

Function description SUPERVISION → VERSION-INFO → I/O SUBMODULE 2 to 4	
SUB I/O TYPE (8340)	Displays the configuration of the I/O submodule 2. Display: STATUS INPUT
SW REV.-NR. SUB I/O TYPE (8343)	Use this function to view the software revision number of the submodule 2.
SUB I/O TYPE (8360)	Displays the configuration of the I/O submodule 3. Display: TYPE UNKNOWN PULS/FREQ. OUT. STATUS/REL. OUT
SW REV.-NR. SUB I/O TYPE (8363)	Use this function to view the software revision number of the submodule 3.
SUB I/O TYPE (8380)	Displays the configuration of the I/O submodule 4. Display: TYPE UNKNOWN CURRENT OUTPUT STATUS/REL. OUT
SW REV.-NR. SUB I/O TYPE (8383)	Use this function to view the software revision number of the submodule. 4

11 Factory settings

11.1 SI units (not for USA and Canada)

11.1.1 Low flow cut off, full scale value, pulse value

Nominal diameter [mm]	Low flow cut off [kg/h]	Full scale value Current output [kg/h]	Pulse value [kg/p]
1	0.08	4	0.001
2	0.4	20	0.010
4	1.8	90	0.010
6	4.0	200	0.100

11.2 US units (only for USA and Canada)

11.2.1 Low flow cut off, full scale value, pulse value

Nominal diameter [inch]	Low flow cut off [lb/min]	Full scale value Current output [lb/min]	Pulse value [lb/p]
$\frac{1}{24}$ "	0.003	0.15	0.002
$\frac{1}{12}$ "	0.015	0.75	0.020
$\frac{1}{8}$ "	0.066	3.30	0.020
$\frac{1}{4}$ "	0.15	7.4	0.200

Index of function matrix

Blocks

A = MEASURED VARIABLES	11
B = QUICK SETUP	18
C = USER INTERFACE	26
D = TOTALIZER	41
E = OUTPUT	46
F = INPUT	89
G = BASIC FUNCTION	93
J = SUPERVISION	110

Groups

AAA = MEASURING VALUES	12
ACA = SYSTEM UNITS	13
CAA = CONTROL	27
CCA = MAIN LINE	31
CEA = ADDITIONAL LINE	33
CGA = INFORMATION LINE	37
DAA = TOTALIZER 1	42
DAB = TOTALIZER 2	42
DAC = TOTALIZER 3	42
DJA = HANDLING TOTALIZER	45
EAA = CURRENT OUTPUT 1	47
ECA = PULSE/FREQUENCY OUTPUT 1	58
ECB = PULSE/FREQUENCY OUTPUT 2	58
EGA = RELAY OUTPUT	79
FAA = STATUS INPUT	90
GAA = HART	94
GIA = PROCESS PARAMETER	96
GLA = SYSTEM PARAMETER	105
GNA = SENSOR DATA	106
JAA = SYSTEM	111
JCA = VERSION INFO	114

Function groups

000 = MAIN VALUES	12
040 = CONFIGURATION	13
042 = ADDITIONAL CONFIGURATION	16
200 = BASIC CONFIGURATION	27
202 = UNLOCKING/LOCKING	29
204 = OPERATION	30
220 = CONFIGURATION	31
222 = MULTIPLEX	32
240 = CONFIGURATION	33
242 = MULTIPLEX	35
260 = CONFIGURATION	37
262 = MULTIPLEX	39
300 = CONFIGURATION	42
304 = OPERATION	44
400 = CONFIGURATION	47
404 = OPERATION	56
408 = INFORMATION	57
420 = CONFIGURATION	58
430 = OPERATION	75
438 = INFORMATION	78
470 = CONFIGURATION	79
474 = OPERATION	83

478 = INFORMATION	85
500 = CONFIGURATION	90
504 = OPERATION	91
508 = INFORMATION	92
600 = CONFIGURATION	94
604 = INFORMATION	95
640 = CONFIGURATION	96
642 = EPD PARAMETER	98
646 = REFERENCE PARAMETER	100
648 = ADJUSTMENT	102
650 = PRESSURE CORRECTION	104
660 = CONFIGURATION	105
680 = CONFIGURATION	106
684 = FLOW COEFFICIENT	107
685 = DENSITY COEFFICIENT	108
686 = ADDITIONAL COEFFICIENT	109
800 = CONFIGURATION	111
804 = OPERATION	112
810 = DEVICE	114
820 = SENSOR	115
822 = AMPLIFIER	116
830 = I/O MODULE	117
832 = INPUT/OUTPUT 1	118
834 = INPUT/OUTPUT 2	118
836 = INPUT/OUTPUT 3	118
838 = INPUT/OUTPUT 4	118

Functions 0...

0000 = MASS FLOW	12
0001 = VOLUME FLOW	12
0004 = CORRECTED VOLUME FLOW	12
0005 = DENSITY	12
0006 = REFERENCE DENSITY	12
0008 = TEMPERATURE	12
0400 = UNIT MASS FLOW	13
0401 = UNIT MASS	13
0402 = UNIT VOLUME FLOW	14
0403 = UNIT VOLUME	14
0404 = UNIT CORRECTED VOLUME FLOW	15
0405 = UNIT CORRECTED VOLUME	15
0420 = UNIT DENSITY	16
0421 = UNIT REFERENCE DENSITY	16
0422 = UNIT TEMPERATURE	17
0424 = UNIT LENGTH	17
0426 = UNIT PRESSURE	17

1...

1002 = QUICK SETUP COMMISSIONING	18
1003 = QUICK SETUP PULSATING FLOW	18
1004 = QUICK SETUP GAS MEASUREMENT	18
1009 = T DAT SAVE/LOAD	19

2...

2000 = LANGUAGE	27
2002 = DISPLAY DAMPING	27
2003 = CONTRAST LCD	28

2004 = BACKLIGHT.....	28	4208 = TIME CONSTANT.....	65
2020 = ACCESS CODE.....	29	4209 = FAILSAFE MODE.....	65
2021 = DEFINE PRIVATE CODE.....	29	4211 = FAILSAFE VALUE.....	66
2022 = STATUS ACCESS.....	29	4221 = ASSIGN PULSE.....	67
2023 = ACCESS CODE.....	29	4222 = PULSE VALUE.....	67
2040 = TEST DISPLAY.....	30	4223 = PULSE WIDTH.....	67,68
2200 = ASSIGN.....	31	4225 = MEASURING MODE.....	68
2201 = 100% VALUE.....	31	4226 = OUTPUT SIGNAL.....	69
2202 = FORMAT.....	31	4227 = FAILSAFE MODE.....	71
2220 = ASSIGN.....	32	4241 = ASSIGN STATUS.....	72
2221 = 100% VALUE.....	32	4242 = ON-VALUE.....	72
2222 = FORMAT.....	32	4243 = SWITCH-ON DELAY.....	73
2400 = ASSIGN.....	33	4244 = OFF-VALUE.....	73
2401 = 100% VALUE.....	33	4245 = SWITCH-OFF DELAY.....	73
2402 = FORMAT.....	34	4246 = MEASURING MODE.....	74
2403 = DISPLAY MODE.....	34	4247 = TIME CONSTANT.....	74
2420 = ASSIGN.....	35	4301 = ACTUAL FREQUENCY.....	75
2421 = 100% VALUE.....	35	4302 = SIMULATION FREQUENCY.....	75
2422 = FORMAT.....	36	4303 = VALUE SIMULATION FREQUENCY.....	75
2423 = DISPLAY MODE.....	36	4322 = SIMULATION PULSE.....	76
2600 = ASSIGN.....	37	4323 = VALUE SIMULATION PULSE.....	76
2601 = 100% VALUE.....	37	4341 = ACTUAL STATUS.....	77
2602 = FORMAT.....	38	4342 = SIMULATION SWITCH POINT.....	77
2603 = DISPLAY MODE.....	38	4343 = VALUE SIMULATION SWITCH POINT.....	77
2620 = ASSIGN.....	39	4380 = TERMINAL NUMBER.....	78
2621 = 100% VALUE.....	39	4700 = ASSIGN RELAY.....	79
2622 = FORMAT.....	40	4701 = ON-VALUE.....	80
2623 = DISPLAY MODE.....	40	4702 = SWITCH-ON DELAY.....	80
3...		4703 = OFF-VALUE.....	80
3000 = ASSIGN.....	42	4704 = SWITCH-OFF DELAY.....	81
3001 = UNIT TOTALIZER.....	42	4705 = MEASURING MODE.....	81
3002 = TOTALIZER MODE.....	43	4706 = TIME CONSTANT.....	82
3003 = RESET TOTALIZER.....	43	4740 = ACTUAL STATUS RELAY.....	83
3040 = SUM.....	44	4741 = SIMULATION SWITCH POINT.....	83
3041 = OVERFLOW.....	44	4742 = VALUE SIMULATION SWITCH POINT.....	84
3800 = RESET ALL TOTALIZERS.....	45	4780 = TERMINAL NUMBER.....	85
3801 = FAILSAFE MODE.....	45	5...	
4...		5000 = ASSIGN STATUS INPUT.....	90
4000 = ASSIGN CURRENT OUTPUT.....	47	5001 = ACTIVE LEVEL.....	90
4001 = CURRENT SPAN.....	48	5002 = MINIMUM PULSE WIDTH.....	90
4002 = VALUE 0_4 mA.....	49	5040 = ACTUAL STATUS INPUT.....	91
4003 = VALUE 20 mA.....	51	5041 = SIMULATION STATUS INPUT.....	91
4004 = MEASURING MODE.....	51	5042 = VALUE SIMULATION STATUS INPUT.....	91
4005 = TIME CONSTANT.....	54	5080 = TERMINAL NUMBER.....	92
4006 = FAILSAFE MODE.....	55	6...	
4040 = ACTUAL CURRENT.....	56	6000 = TAG NAME.....	94
4041 = SIMULATION CURRENT.....	56	6001 = TAG DESCRIPTION.....	94
4042 = VALUE SIMULATION CURRENT.....	56	6002 = BUS ADDRESS.....	94
4080 = TERMINAL NUMBER.....	57	6003 = HART PROTOCOL.....	94
4200 = OPERATION MODE.....	58	6004 = WRITE PROTECTION.....	94
4201 = ASSIGN FREQUENCY.....	59	6040 = MANUFACTURER ID.....	95
4202 = START VALUE FREQUENCY.....	59	6041 = DEVICE ID.....	95
4203 = END VALUE FREQUENCY.....	59	6042 = DEVICE REVISION.....	95
4204 = VALUE f LOW.....	60	6400 = ASSIGN LOW FLOW CUT OFF.....	96
4205 = VALUE f HIGH.....	60	6402 = ON-VALUE LOW FLOW CUT OFF.....	96
4206 = MEASURING MODE.....	62	6403 = OFF-VALUE LOW FLOW CUT OFF.....	96
4207 = OUTPUT SIGNAL.....	63	6404 = PRESSURE SHOCK SUPPRESSION.....	97

6420 = EMPTY PIPE DETECTION..... 98
 6423 = EPD VALUE LOW 98
 6424 = EPD VALUE HIGH..... 98
 6425 = EPD RESPONSE TIME..... 98
 6426 = EPD EXC.CURR..... 99
 6460 = CORRECTED VOLUME CALCULATION.....100
 6461 = FIXED REFERENCE DENSITY.....100
 6462 = EXPANSION COEFFICIENT100
 6463 = EXPANSION COEFF. SQR.100
 6464 = REFERENCE TEMPERATURE101
 6480 = ZEROPOINT ADJUST.....102
 6482 = DENSITY ADJUST MODE102
 6483 = DENSITY SETPOINT 1.....102
 6484 = MEASURE FLUID 1.....102
 6485 = DENSITY SETPOINT 2.....103
 6486 = MEASURE FLUID 2.....103
 6487 = DENSITY ADJUST103
 6488 = RESTORE ORIGINAL.....103
 6500 = PRESSURE MODE104
 6501 = PRESSURE104
 6600 = INSTALLATION DIRECTION SENSOR.....105
 6602 = DENSITY DAMPING105
 6603 = SYSTEM DAMPING.....105
 6605 = POSITIVE ZERO RETURN.....105
 6800 = K-FACTOR.....106
 6803 = ZERO POINT106
 6804 = NOMINAL DIAMETER106
 6840 = TEMPERATURE COEFFICIENT KM.....107
 6841 = TEMPERATURE COEFFICIENT KM 2107
 6842 = TEMPERATURE COEFFICIENT KT107
 6843 = CALIBRATION COEFFICIENT KD 1107
 6844 = CALIBRATION COEFFICIENT KD 2107
 6850 = DENSITY COEFFICIENT C0.....108
 6851 = DENSITY COEFFICIENT C1.....108

6852 = DENSITY COEFFICIENT C2 108
 6853 = DENSITY COEFFICIENT C3 108
 6854 = DENSITY COEFFICIENT C4 108
 6855 = DENSITY COEFFICIENT C5 108
 6860 = MINIMAL TEMP. MEASURED 109
 6861 = MAXIMAL TEMP. MEASURED 109
 6862 = MINIMAL TEMP. CARRIER TUBE 109
 6863 = MAXIMAL TEMP. CARRIER TUBE..... 109

8...

8005 = ALARM DELAY 111
 8007 = STORE PERMANENTLY..... 111
 8040 = ACTUAL SYSTEM CONDITION 112
 8041 = PREVIOUS SYSTEM CONDITION 112
 8042 = SIMULATION FAILSAFE MODE..... 112
 8043 = SIMULATION MEASURAND..... 112
 8044 = VALUE SIMULATION MEASURAND..... 113
 8046 = SYSTEM RESET..... 113
 8048 = OPERATION HOURS 113
 8100 = DEVICE SOFTWARE 114
 8200 = SERIAL NUMBER..... 114,115
 8201 = SENSOR TYPE..... 115
 8222 = SW REV. NO. AMPLIFIER..... 116
 8225 = SOFTWARE REV. NO. T-DAT..... 116
 8226 = LANGUAGE GROUP 116
 8303 = SW REV.-NR. I/O MODULE TYPE..... 117
 8340 = SUB I/O MODULE TYPE 118
 8343 = SW REV.-NR. SUB I/O TYPE 118
 8360 = SUB I/O MODULE TYPE 118
 8363 = SW-REV-NR. SUB I/O-MODUL TYPE..... 118
 8380 = SUB I/O MODULE TYPE 118
 8383 = SW-REV-NR. SUB I/O-MODUL TYPE..... 118

Index

A

Access code	29
Active level	90
Actual	
Current (current output)	56
Frequency	75
Actual status	
Relay output	83
Status input	91
Switch point (pulse/frequency output)	77
Actual System condition	112
Additional configuration	16
Additional line	
Configuration	33
Multiplex	35
Adjustment	
Density	103
Zero point	102
Alarm delay	111
Amplifier (Version Info)	116
Anzeigezeilen der Vor-Ort-Bedienung	9
Assign	
Additional line	33
Additional line (Multiplex)	35
Current output	47
Frequency (Pulse/Freq. output)	59
Information line	37
Information line (Multiplex)	39
Low flow cut off	96
Main line	31
Main line (Multiplex)	32
Pulse	67
Relay (relay output)	79
Status input	90
Status (Pulse/Freq. output)	72
Totalizer	42

B

Backlight (user interface)	28
Basic Configuration (user interface)	27
Basic functions	93
Block	
Basic functions	93
Display	26
Inputs	89
Measured variables	11
Outputs	46
Quick Setup	18
Supervision	110
Totalizer	41
Bus address	94

C

Calibrate	
Coefficient	
KD 1	107

KD 2	107
Coefficient	
Calibration	
KD 1	107
KD 2	107
Density	
C0 to C5	108
Expansion	100
Expansion Square	100
Temperature	
KM	107
KM 2	107
KT	107
Commissioning	18
Configuration	
Additional line	33
Current output	47
HART	94
Information line	37
Main line	31
Process parameter	96
Pulse/frequency output	58
Relay output	79
Sensor data	106
Status input	90
System	111
System parameter	105
System units	13
Totalizer	42
Contrast LCD	28
Corrected Volume calculation	100
Corrected volume flow	12
Current output	
Configuration	47
Information	57
Operation	56
Current span	
Current output	48

D

Damping	
Density	105
System	105
Define private code	29
Density	12
Adjustment	103
Coefficient C0 to C5	108
Damping	105
Density Adjust mode	102
Device ID	95
Device revision	95
Device (version-info)	114
Display	26
Display damping	27
Display lighting	28
Display lines on the local display	9

Display mode	
Additional line	34
Additional line (Multiplex)	36
Information line	38
Information line (Multiplex)	40
E	
Empty pipe detection (EPD)	98
End value frequency	59
EPD	
Empty pipe detection	98
Parameter	98
Response time	98
Value high	98
Value low	98
Excitation current (EPD)	99
Expansion coefficient	100
Expansion coefficient Square	100
F	
Factory settings	
Full scale value	119
Low flow cut off	119
Pulse value	119
Failsafe mode	
All totalizers	45
Current output	55
Frequency output	65
Pulse output	71
Failsafe value	66
Fixed Reference density	100
Flow direction, see installation direction	105
Format	
Additional line	34
Additional line (Multiplex)	36
Information line	38
Information line (Multiplex)	40
Main line	31
Main line (Multiplex)	32
Function group	
Additional coefficient	109
Additional configuration	16
Adjustment	102
Amplifier	116
Basic Configuration (user interface)	27
Configuration	
Additional line	33
Current output	47
HART	94
Information line	37
Main line	31
Process parameter	96
Pulse/Freq. output	58
Relay output	79
Sensor data	106
Status input	90
System	111
System parameter	105
System units	13
Totalizer	42
Density coefficient	108
Device	114
EPD parameter	98
Flow coefficient	107
Information	
Current output	57
HART	95
Pulse/Frequency output	78
Relay output	85
Status input	92
Input/Output	118
I/O Module	117
Main values	12
Multiplex	
Additional line	35
Information line	39
Main line	32
Operation	
Current output	56
Pulse/frequency output	75
Relay output	83
Status input	91
System	112
Totalizer	44
Operation (user interface)	30
Pressure correction	104
Reference parameter	100
Sensor	115
Unlocking/Locking (user interface)	29
Function matrix	
Codes identifying	9
General layout	8
Overview	10
G	
Gas measurement	18
Group	
Additional line	33
Current output	47
Handling Totalizer	45
HART	94
Information line	37
Main line	31
Measuring values	12
Operation (user interface)	27
Process parameter	96
Pulse/frequency output	58
Relay output	79
Sensor data	106
Status input	90
System	111
System parameter	105
System units	13
Version Info	114
H	
Handling Totalizer	45
HART	

Configuration	94	Main line	32
Information	95	N	
HART Protocol	94	Nominal diameter	106
I		O	
Information		Off value	
Current output	57	Low flow cut off	96
Pulse/Frequency output	78	Relay output	80
Relay output	85	Status (Pulse/Freq. output)	73
Status input	92	On value	
Information line		Low flow cut off	96
Configuration	37	Relay output	80
Multiplex	39	Status (Pulse/Freq. output)	72
Inputs	89	Operation	
Input/output 1 to 4	118	Basic configuration	27
Installation direction sensor	105	Current output	56
I/O Module	117	Operation	30
I/O Sub-Modul Typ 2...4	118	Pulse/frequency output	58, 75
I/O submodule		Relay output	83
Type 2	118	Status input	91
K		System	112
K-Factor	106	Totalizer	44
L		Unlocking/Locking	29
Language		User interface	30
Language group (display)	116	Operation hours	113
Options	27	Output signal	
LCD contrast	28	Frequency output	63
Low flow cut off		Pulse output	69, 70
Assign	96	Outputs	46
Off value	96	Overflow	
On value	96	Totalizer	44
M		P	
Main line		Positive zero return	105
Configuration	31	Pressure	104
Multiplex	32	Pressure correction	104
Manufacturer ID	95	Pressure Mode	104
Mass flow	12	Pressure Shock suppression	97
Maximal		Previous system condition	112
Temperature carrier tube	109	Process parameter	
Temperature measured	109	Adjustment	102
Measure Fluid 1	102	Configuration	96
Measure Fluid 2	103	EPD parameter	98
Measured variables	11	Pressure correction	104
Measuring mode		Reference parameter	100
Current output	51	Pulsating flow	18
Frequency (Pulse/Freq. output)	62	Pulse value	67
Pulse output	68	Pulse Width	67
Relay output	81	Pulse/frequency output	
Status (Pulse/Freq. output)	74	Configuration	58
Measuring values	12	Information	78
Minimal		Operation	75
Temperature carrier tube	109	Q	
Temperature measured	109	Quick Setup	18
Minimum Pulse width	90	Commissioning	18
Multiplex		Gas measurement	18
Additional line	35	Pulsating flow	18
Information line	39		

R

Reference density	12
Reference density (fixed)	100
Reference Temperature	101
Relay output	
Configuration	79
Information	85
Operation	83
Switching behavior	87
Reset	
All totalizers	45
System	113
Totalizer	43
Restore original	103

S

Sensor data	
Additional coefficient	109
Configuration	106
Density coefficient	108
Flow coefficient	107
Sensor type	115
Sensor (Version info)	115
Serial number sensor	114, 115
Setpoint	
Density 1	102
Density 2	103
Simulation	
Current (current output)	56
Failsafe mode	112
Frequency	75
Measured variable	112
Status input	91
Switch point (Relay output)	83
Simulation Pulse	76
Software revision number	
Amplifier	116
I/O Module	117
S-DAT	115
T-DAT	116
Start value frequency	59
Status access	29
Status input	
Configuration	90
Information	92
Operation	91
Store permanently	111
Sum	
Totalizer	44
Supervision	110
Switching behavior of the relay output	87
Switch-off delay	
Relay output	81
Status (Pulse/Freq. output)	73
Switch-on delay	
Relay output	80
Status (Pulse/Freq. output)	73
System	
Configuration	111

Damping	105
Operation	112
Operation hours	113
Reset	113
System condition	
Actual	112
Previous	112
System parameter	
Configuration	105
System units	
Additional configuration	16
Configuration	13

T

Tag Description	94
Tag Name	94
T-DAT Save/Load	19
Temperature	12
Coefficient	
KM	107
KM 2	107
KT	107
Terminal number	
Current output	57
Pulse/Frequency output	78
Relay output	85
Status input	92
Test display	30
Time constant	
Current output	54
Frequency output	65
Relay output	82
Status (Pulse/Freq. output)	74
Totalizer	41
Configuration	42
Operation	44
Totalizer Mode	43
Totalizer Reset	43
Type	
Input/output 1 to 4	118
I/O Module	117
Sub-input/output 1 to 4	118

U

Unit	
Corrected volume	15
Corrected volume flow	15
Density	16
Length	17
Mass	13
Mass flow	13
Pressure	17
Reference density	16
Temperature	17
Totalizer	42
Volume	14
Volume flow	14
Unlocking/Locking (user interface)	29

V

VALUE f HIGH	60
Value F Low	60
Value simulation	
Current (current output)	56
Frequency	75
Measured variable	113
Status input	91
Switch point (pulse/freq. output)	77
Switch point (Relay output)	84
Value Simulation Pulse	76
Value 0_4 mA	49
Value 20 mA	51
Version Info	
Amplifier	116
Input/output 1 to 4	118
I/O Module	117
Sensor	114

Volume flow	12
-------------------	----

W

Write protection	94
------------------------	----

Z

Zero point	106
Zero point adjustment	102

Numbers

100% Value	
Additional line	33
Additional line (Multiplex)	35
Information line	37
Information line (Multiplex)	39
Main line	31
Main line (Multiplex)	32

www.addresses.endress.com
