

CAR:LINK™

COMPLETE INSTALLATION & PROGRAMMING GUIDE

CLLRCC Digital BLE / LoRa system



This system must be installed by a professional.

NOTICE

The manufacturer will accept no responsibility for any electrical damage resulting from improper installation of this product, be that either damage to the vehicle itself or to the installed device. This device must be installed by a certified technician. Please review the Installation Guide carefully before beginning any work.

CARLINK™ **TABLE OF CONTENTS**

HARDWARE PARTS	3
iDATASTART HCx	4
iDATASTART VWx	6
iDATASTART BM or BZ	8
AKX or OEM	10
ADS-AL-CA / OL-MDB-ALL	12
CRIMESTOPPER	14
FLASHLOGIC FL-CAN	16
FLASHLOGIC FLRS	18
FLASHLOGIC FLRSBA	20
FLASHLOGIC FLCMVW	22
COMPUSTAR CM7000 / CM7200 / POLARSTART PRS-16	24
COMPUSTAR CM6200	26
COMPUSTAR DC2	28
COMPUSTAR DC3	30
POLARSTART PRS-13	32
DIRECTED DBALL 2	34
DIRECTED DB3	36
DIRECTED 4X10 - 5X10 - AF-D600 - ASD200 - ASD-600	38
DIRECTED DS4 - DS4+	40
FORTIN EVO-ALL	42
FORTIN EVO-ONE	44
PRESTIGE (E) Models	46
PRESTIGE (Z) Models	48
PURSUIT (E) Models	50
CODE SYSTEMS	52
OLDER CODE SYSTEMS	54
OMEGA RS-X70	56
OMEGA AL-XX70-B	58
OMEGA OL-RS	60
MIDCITY SMARTKEY STARTER	62
DSE 503AIR 5R-85	64
DSE iSTART2 - 3	66
System LED Status & Protocol Reference Chart	68
Reset Procedure	68



CREATE AN ACCOUNT

Before beginning the installation and setting the configurations of a Carlink CLBTLR system, we strongly recommend downloading the Application from the App store and create a user account.

- a. Go to the App store (Apple) or Play store (Android) and Search for “Carlink CLBTLR”. Download and install the Free Application.
- b. Launch the newly installed SmartControl Application on your smartphone or tablet
- c. Click “Create an Account”
- d. Fill in all the required fields
- e. Once done, Log into the Application using your email and your newly created password.



XTX-3000



BLCC





IVU-CAB-4W







HRN-CRF-02

PARTS REQUIRED FOR INSTALLATION OF : iDATASTART HCx

<p>XTX-3000</p> 	<p>IVU-CAB-4W</p> 	<p>iDatastart HCx</p> 	
---	---	--	--

STEP 1. CONFIGURE THE REMOTE STARTER

The ADS Weblink (ADS-USB) is required to properly configure the iDatastart HCx remote starter to accept the RF kit system. When flashing the iDatastart HCx remote starter, **please follow this procedure in order to configure correctly your remote starter.**

<p>a. Go to www.idatalink.com and click on “Flash your module”</p>	
<p>b. Using the new Weblink configurator, Choose vehicle Make, Year, Model, Trim.</p>	
<p>c. In the Remote Configuration section, Select the Brand drop-down and Choose “CONNECTED” and select the Connected RF system you are using.</p>	
<p>d. This will load a firmware starting with:</p>	<p>“IDPP-XX(XX)-XXX (X.X)”</p>
<p>e. Click “Flash your device”</p>	

CARLINK™ INSTALLATION, WIRING & PROGRAMMING GUIDE

STEP 2. CONNECT

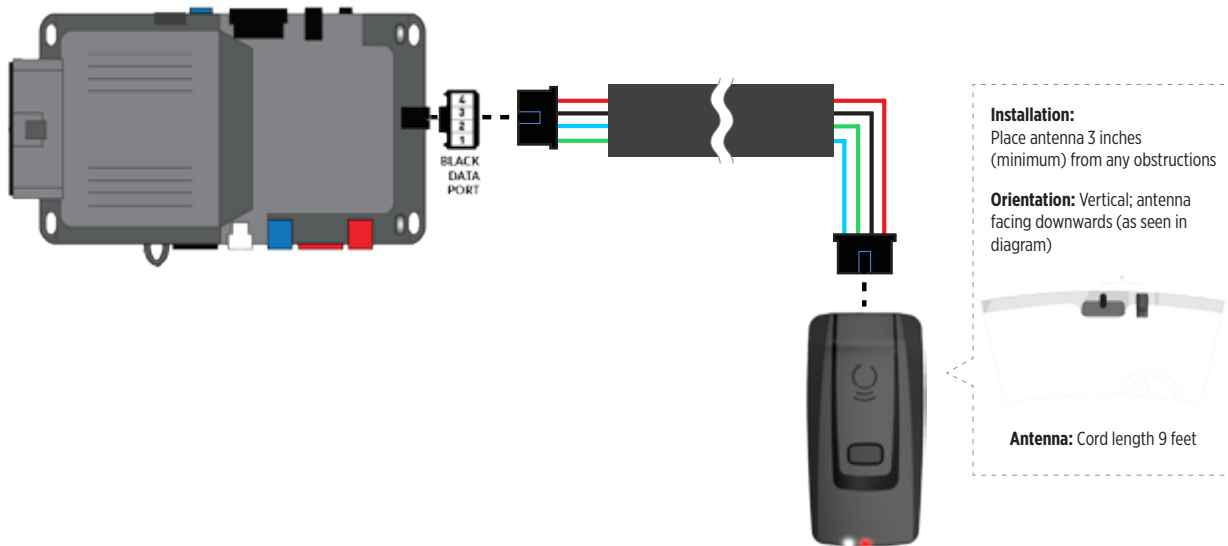

STEP 3. ADD A DEVICE/VEHICLE TO AN ACCOUNT

- Download the App and Log into your account (see page 2 of this document for details)
- Click the “+” sign at the bottom right of the Application screen. This will allow you to temporarily add and configure your customers system inside your personal account. A system refers to the Antenna being installed in the windshield of the vehicle.
- Before adding a system to your device, ensure the remote starter **IS NOT armed/locked or in Valet mode** and set the ignition of the vehicle to the On position.
- Then Tap to “Scan QR Code” and use the smartphone camera to scan the QR Code located on top of the antenna.
- Once connected, the system is in “Installer Mode”. Follow the on-screen instructions for configuring the system.

STEP 4. PRE-CONFIGURE THE APPLICATION EXPERIENCE FOR YOUR CUSTOMER

- Start by setting the protocol of the antenna being used. This is achieved by selecting the Brand, Model and protocol used inside the Remote starter. When done, click on “Confirm”. System will now try to communicate with the remote starter to confirm that all settings related to protocol are valid.
- Once back in the control panel, click on the Settings Gear at the top right of the screen and edit the Vehicle name, configure the Auxiliaries that might have been added (if applicable) and click “OK” when done. Then choose the vehicle to display inside the control panel in the VEHICLE IMAGE section and click OK.
- When your configurations are all completed, click “OK” at the top right corner. All Configurations will take effect.



STEP 5. TESTING THE SYSTEM

When the system is connected and fully configured, testing can begin. Test all the application functions (Start, Stop, Lock, Unlock, Auxiliaries, Etc.) When testing is completed, tap on the “installer icon” at the top of control screen. When prompted Click “Yes, and delete system from account” since this is the installer mode and not the End User mode. This will make the system “Ready for Customer Delivery”.

Also make sure that the Owners Card is handed to the Owner of the vehicle or attached to the vehicle keychain. Doing this will ensure that the instructions on how to setup their App, Account and add the System is done correctly by using the system QR Code affixed on the windshield mounted antenna.





NOTE : UNDER ANY CIRCUMSTANCES, PLEASE DO NOT REMOVE THE QR CODE FROM THE ANTENNA!

PARTS REQUIRED FOR INSTALLATION OF : iDATASTART VWx

<p>XTX-3000</p> 	<p>IVU-CAB-4W</p> 	<p>iDatastart VWx</p> 	
---	---	--	--

STEP 1. CONFIGURE THE REMOTE STARTER

The ADS Weblink (ADS-USB) is required to properly configure the iDatastart VWx remote starter to accept the RF kit system. When flashing the iDatastart VWx remote starter, **please follow this procedure in order to configure correctly your remote starter.**

<p>a. Go to www.idatalink.com and click on “Flash your module”</p>	
<p>b. Using the new Weblink configurator, Choose vehicle Make, Year, Model, Trim.</p>	
<p>c. In the Remote Configuration section, Select the Brand drop-down and Choose “CONNECTED” and select the Connected RF system you are using.</p>	
<p>d. This will load a firmware starting with:</p>	<p>“IDPP-XX(XX)-XXX (X.X)”</p>
<p>e. Click “Flash your device”</p>	

CARLINK™ INSTALLATION, WIRING & PROGRAMMING GUIDE

STEP 2. CONNECT

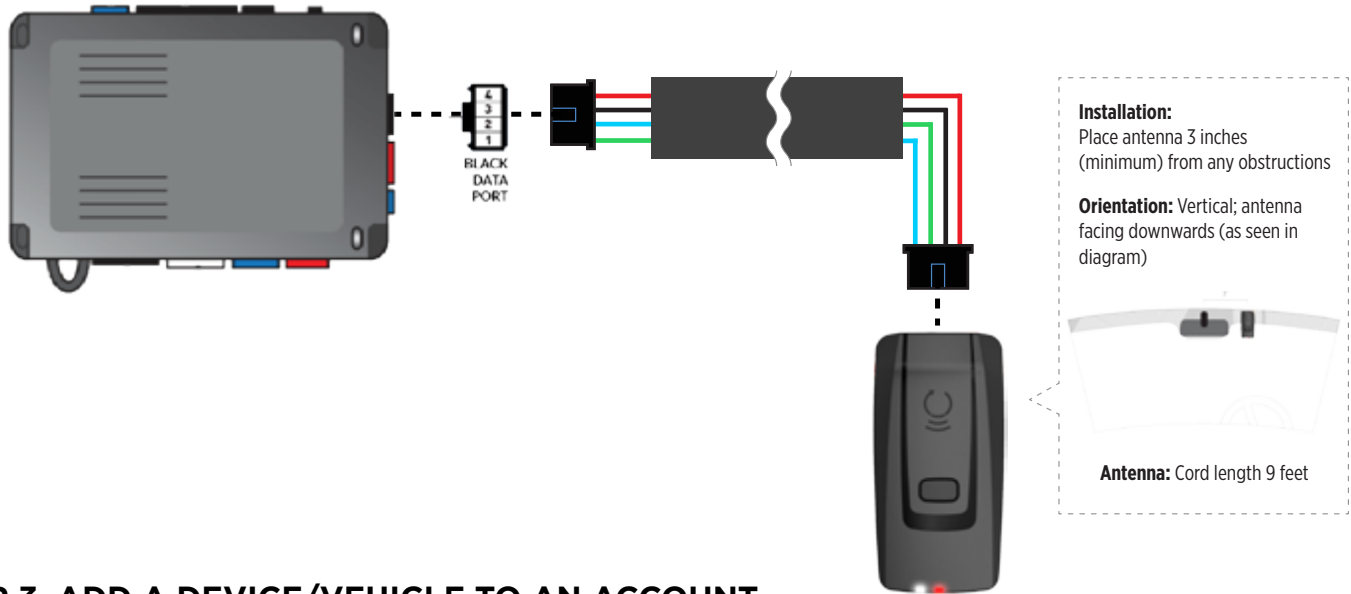

STEP 3. ADD A DEVICE/VEHICLE TO AN ACCOUNT

- Download the App and Log into your account (see page 2 of this document for details)
- Click the “+” sign at the bottom right of the Application screen. This will allow you to temporarily add and configure your customers system inside your personal account. A system refers to the Antenna being installed in the windshield of the vehicle.
- Before adding a system to your device, ensure the remote starter IS NOT armed/locked or in Valet mode and set the ignition of the vehicle to the On position.
- Then Tap to “Scan QR Code” and use the smartphone camera to scan the QR Code located on top of the antenna.
- Once connected, the system is in “Installer Mode”. Follow the on-screen instructions for configuring the system.

STEP 4. PRE-CONFIGURE THE APPLICATION EXPERIENCE FOR YOUR CUSTOMER

- Start by setting the protocol of the antenna being used. This is achieved by selecting the Brand, Model and protocol used inside the Remote starter. When done, click on “Confirm”. System will now try to communicate with the remote starter to confirm that all settings related to protocol are valid.
- Once back in the control panel, click on the Settings Gear at the top right of the screen and edit the Vehicle name, configure the Auxiliaries that might have been added (if applicable) and click “OK” when done. Then choose the vehicle to display inside the control panel in the VEHICLE IMAGE section and click OK.
- When your configurations are all completed, click “OK” at the top right corner. All Configurations will take effect.



STEP 5. TESTING THE SYSTEM

When the system is connected and fully configured, testing can begin. Test all the application functions (Start, Stop, Lock, Unlock, Auxiliaries, Etc.) When testing is completed, tap on the “installer icon” at the top of control screen. When prompted Click “Yes, and delete system from account” since this is the installer mode and not the End User mode. This will make the system “Ready for Customer Delivery”.

Also make sure that the Owners Card is handed to the Owner of the vehicle or attached to the vehicle keychain. Doing this will ensure that the instructions on how to setup their App, Account and add the System is done correctly by using the system QR Code affixed on the windshield mounted antenna.





NOTE : UNDER ANY CIRCUMSTANCES, PLEASE DO NOT REMOVE THE QR CODE FROM THE ANTENNA!

PARTS REQUIRED FOR INSTALLATION OF : iDATASTART BM or BZ

<p>XTX-3000</p> 	<p>IVU-CAB-4W</p> 	<p>iDatastart BM or BZ</p> 	
---	---	---	--

STEP 1. CONFIGURE THE REMOTE STARTER

The ADS Weblink (ADS-USB) is required to properly configure the iDatastart BM or BZ remote starter to accept the RF kit system. When flashing the iDatastart BM or BZ remote starter, **please follow this procedure in order to configure correctly your remote starter.**

<p>a. Go to www.idatalink.com and click on “Flash your module”</p>	
<p>b. Choose vehicle Make, Model, Year, Trim</p>	
<p>c. Choose “CONNECTED RF KIT & Telematics”</p>	
<p>d. This will load a firmware starting with:</p>	<p>“IDPP-XX(XX)-XXX (X.X)”</p>
<p>e. Click “Flash!”</p>	

CARLINK™ INSTALLATION, WIRING & PROGRAMMING GUIDE

STEP 2. CONNECT

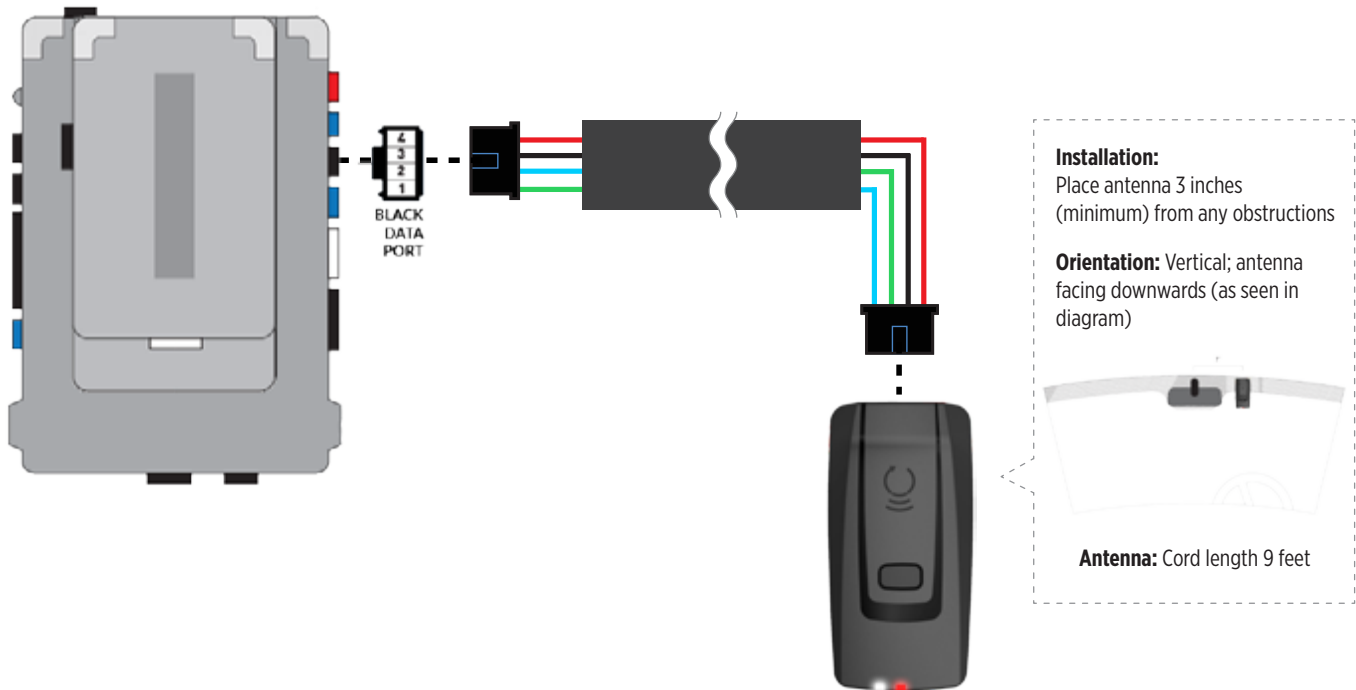

STEP 3. ADD A DEVICE/VEHICLE TO AN ACCOUNT

- Download the App and Log into your account (see page 2 of this document for details)
- Click the “+” sign at the bottom right of the Application screen. This will allow you to temporarily add and configure your customers system inside your personal account. A system refers to the Antenna being installed in the windshield of the vehicle.
- Before adding a system to your device, ensure the remote starter IS NOT armed/locked or in Valet mode and set the ignition of the vehicle to the On position.
- Then Tap to “Scan QR Code” and use the smartphone camera to scan the QR Code located on top of the antenna.
- Once connected, the system is in “Installer Mode”. Follow the on-screen instructions for configuring the system.

STEP 4. PRE-CONFIGURE THE APPLICATION EXPERIENCE FOR YOUR CUSTOMER

- Start by setting the protocol of the antenna being used. This is achieved by selecting the Brand, Model and protocol used inside the Remote starter. When done, click on “Confirm”. System will now try to communicate with the remote starter to confirm that all settings related to protocol are valid.
- Once back in the control panel, click on the Settings Gear at the top right of the screen and edit the Vehicle name, configure the Auxiliaries that might have been added (if applicable) and click “OK” when done. Then choose the vehicle to display inside the control panel in the VEHICLE IMAGE section and click OK.
- When your configurations are all completed, click “OK” at the top right corner. All Configurations will take effect.



STEP 5. TESTING THE SYSTEM

When the system is connected and fully configured, testing can begin. Test all the application functions (Start, Stop, Lock, Unlock, Auxiliaries, Etc.) When testing is completed, tap on the “installer icon” at the top of control screen. When prompted Click “Yes, and delete system from account” since this is the installer mode and not the End User mode. This will make the system “Ready for Customer Delivery”.

Also make sure that the Owners Card is handed to the Owner of the vehicle or attached to the vehicle keychain. Doing this will ensure that the instructions on how to setup their App, Account and add the System is done correctly by using the system QR Code affixed on the windshield mounted antenna.





NOTE : UNDER ANY CIRCUMSTANCES, PLEASE DO NOT REMOVE THE QR CODE FROM THE ANTENNA!

PARTS REQUIRED FOR INSTALLATION OF : AKX or OEM

<p>XTX-3000</p> 	<p>IVU-CAB-4W</p> 	<p>AKX or OEM</p> 	
---	---	--	--

STEP 1. CONFIGURE THE REMOTE STARTER

The ADS Weblink (ADS-USB) is required to properly configure the AKX or OEM remote starter to accept the RF kit system. When flashing the AKX or OEM remote starter, **please follow this procedure in order to configure correctly your remote starter.**

<p>a. Go to www.idatalink.com and click on “Flash your module”</p>	
<p>b. Choose vehicle Make, Model, Year, Trim</p>	
<p>c. Choose “CONNECTED RF KIT & Telematics”</p>	
<p>d. This will load a firmware starting with:</p>	<p>“IDPP-XX(XX)-XXX (X.X)”</p>
<p>e. Click “Flash!”</p>	

CAR:LINK™ INSTALLATION, WIRING & PROGRAMMING GUIDE

STEP 2. CONNECT

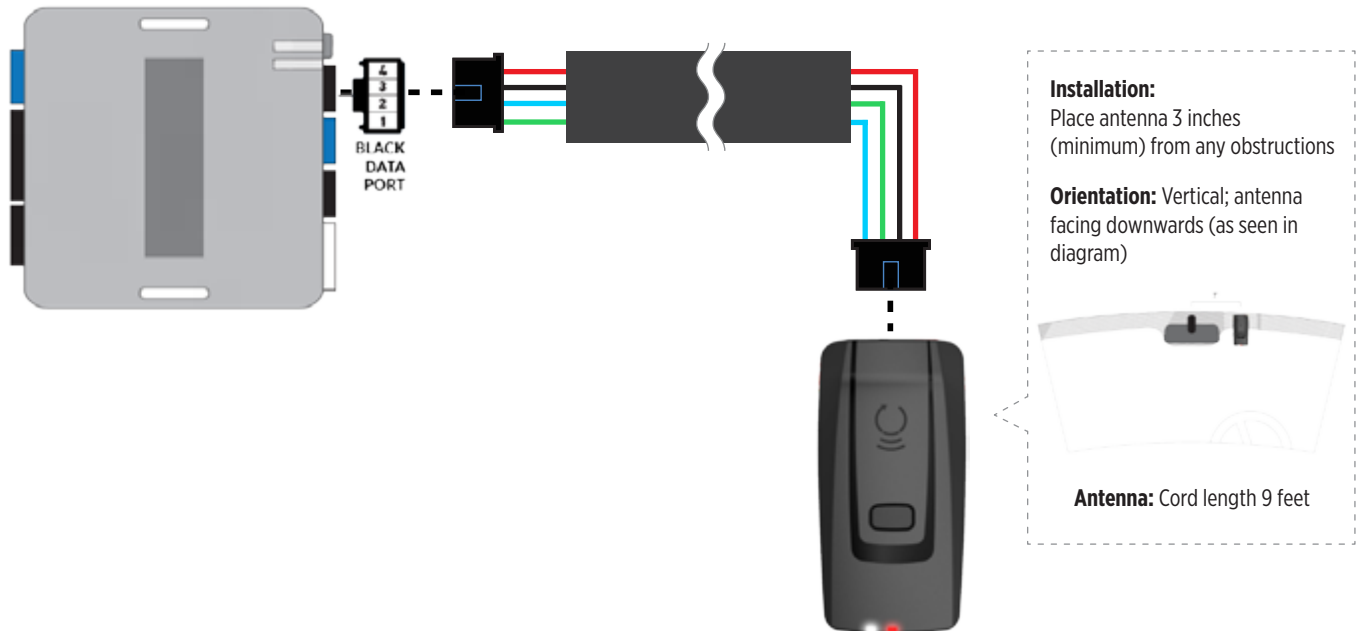

STEP 3. ADD A DEVICE/VEHICLE TO AN ACCOUNT

- Download the App and Log into your account (see page 2 of this document for details)
- Click the “+” sign at the bottom right of the Application screen. This will allow you to temporarily add and configure your customers system inside your personal account. A system refers to the Antenna being installed in the windshield of the vehicle.
- Before adding a system to your device, ensure the remote starter IS NOT armed/locked or in Valet mode and set the ignition of the vehicle to the On position.
- Then Tap to “Scan QR Code” and use the smartphone camera to scan the QR Code located on top of the antenna.
- Once connected, the system is in “Installer Mode”. Follow the on-screen instructions for configuring the system.

STEP 4. PRE-CONFIGURE THE APPLICATION EXPERIENCE FOR YOUR CUSTOMER

- Start by setting the protocol of the antenna being used. This is achieved by selecting the Brand, Model and protocol used inside the Remote starter. When done, click on “Confirm”. System will now try to communicate with the remote starter to confirm that all settings related to protocol are valid.
- Once back in the control panel, click on the Settings Gear at the top right of the screen and edit the Vehicle name, configure the Auxiliaries that might have been added (if applicable) and click “OK” when done. Then choose the vehicle to display inside the control panel in the VEHICLE IMAGE section and click OK.
- When your configurations are all completed, click “OK” at the top right corner. All Configurations will take effect.





STEP 5. TESTING THE SYSTEM

When the system is connected and fully configured, testing can begin. Test all the application functions (Start, Stop, Lock, Unlock, Auxiliaries, Etc.) When testing is completed, tap on the “installer icon” at the top of control screen. When prompted Click “Yes, and delete system from account” since this is the installer mode and not the End User mode. This will make the system “Ready for Customer Delivery”.

Also make sure that the Owners Card is handed to the Owner of the vehicle or attached to the vehicle keychain. Doing this will ensure that the instructions on how to setup their App, Account and add the System is done correctly by using the system QR Code affixed on the windshield mounted antenna.





NOTE : UNDER ANY CIRCUMSTANCES, PLEASE DO NOT REMOVE THE QR CODE FROM THE ANTENNA!

PARTS REQUIRED FOR INSTALLATION OF : ADS-AL-CA / OL-MDB-ALL

<p>XTX-3000</p> 	<p>IVU-CAB-4W</p> 	<p>ADS-AL-CA / OL-MDB-ALL</p> 	<p>HRN-CRF-02</p> 
---	---	--	---

STEP 1. CONFIGURE THE REMOTE STARTER

The ADS Weblink (ADS-USB) is required to properly configure the ADS-AL-CA remote starter to accept the RF kit system. When flashing the ADS-AL-CA remote starter, **please follow this procedure in order to configure correctly your remote starter.**

<p>a. Go to www.idatalink.com and click on “Flash your module”</p>	
<p>b. Choose vehicle Make, Model, Year, Trim</p>	
<p>c. Choose “CONNECTED SmartControl”</p>	
<p>d. This will load a firmware starting with:</p>	<p>“RFP-XX(XX)-XXX (X.X)”</p>
<p>e. Click “Flash!”</p>	

CARLINK™ INSTALLATION, WIRING & PROGRAMMING GUIDE

STEP 2. CONNECT

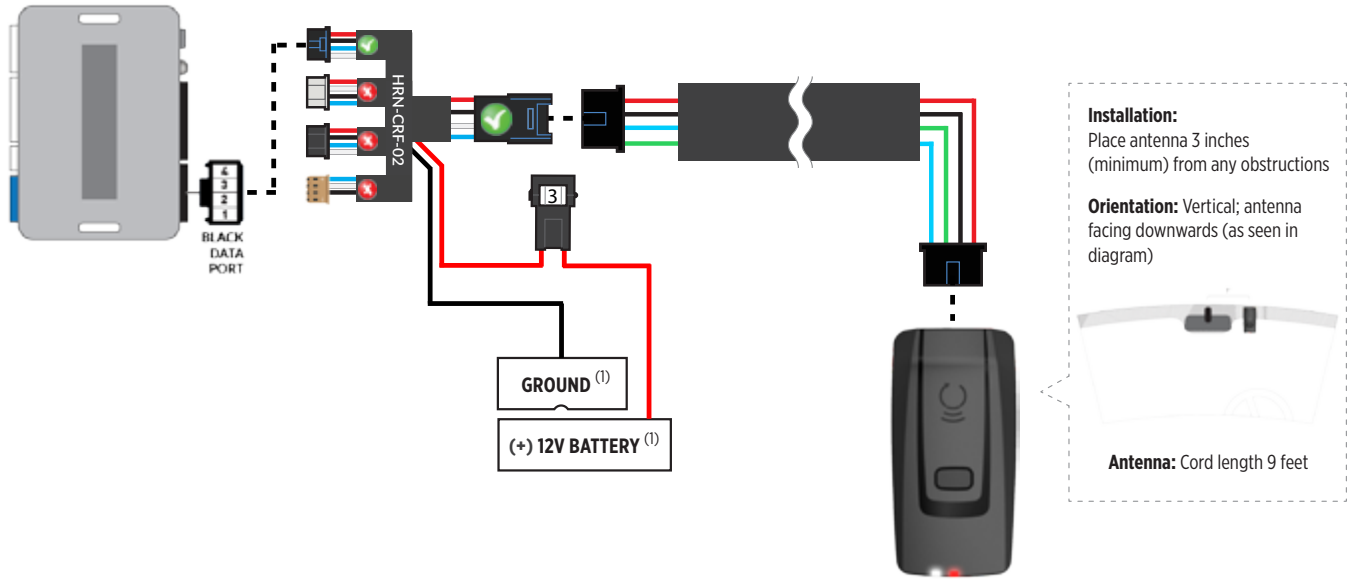

(1) Connect when using with ADS-AL-CA.

STEP 3. ADD A DEVICE/VEHICLE TO AN ACCOUNT

- Download the App and Log into your account (see page 2 of this document for details)
- Click the “+” sign at the bottom right of the Application screen. This will allow you to temporarily add and configure your customers system inside your personal account. A system refers to the Antenna being installed in the windshield of the vehicle.
- Before adding a system to your device, ensure the remote starter IS NOT armed/locked or in Valet mode and set the ignition of the vehicle to the On position.
- Then Tap to “Scan QR Code” and use the smartphone camera to scan the QR Code located on top of the antenna.
- Once connected, the system is in “Installer Mode”. Follow the on-screen instructions for configuring the system.

STEP 4. PRE-CONFIGURE THE APPLICATION EXPERIENCE FOR YOUR CUSTOMER

- Start by setting the protocol of the antenna being used. This is achieved by selecting the Brand, Model and protocol used inside the Remote starter. When done, click on “Confirm”. System will now try to communicate with the remote starter to confirm that all settings related to protocol are valid.
- Once back in the control panel, click on the Settings Gear at the top right of the screen and edit the Vehicle name, configure the Auxiliaries that might have been added (if applicable) and click “OK” when done. Then choose the vehicle to display inside the control panel in the VEHICLE IMAGE section and click OK.
- When your configurations are all completed, click “OK” at the top right corner. All Configurations will take effect.

STEP 5. TESTING THE SYSTEM

When the system is connected and fully configured, testing can begin. Test all the application functions (Start, Stop, Lock, Unlock, Auxiliaries, Etc.) When testing is completed, tap on the “installer icon” at the top of control screen. When prompted Click “Yes, and delete system from account” since this is the installer mode and not the End User mode. This will make the system “Ready for Customer Delivery”.

Also make sure that the Owners Card is handed to the Owner of the vehicle or attached to the vehicle keychain. Doing this will ensure that the instructions on how to setup their App, Account and add the System is done correctly by using the system QR Code affixed on the windshield mounted antenna.

NOTE : UNDER ANY CIRCUMSTANCES, PLEASE DO NOT REMOVE THE QR CODE FROM THE ANTENNA!

PARTS REQUIRED FOR INSTALLATION OF : CRIMESTOPPER

XTX-3000



IVU-CAB-4W







CrimeStopper



IMPORTANT NOTE: THESE REMOTE STARTER MODELS ARE CURRENTLY NOT SUPPORTED BY THIS PRODUCT.





CAR:LINK™ INSTALLATION, WIRING & PROGRAMMING GUIDE

PARTS REQUIRED FOR INSTALLATION OF : FLASHLOGIC FL-CAN

<p>XTX-3000</p> 	<p>IVU-CAB-4W</p> 	<p>Flashlogic FL-CAN</p> 	<p>HRN-CRF-02</p> 
---	---	---	---

STEP 1. CONFIGURE THE REMOTE STARTER

The ADS Weblink (ADS-USB) is required to properly configure the Flashlogic FL-CAN remote starter to accept the RF kit system. When flashing the Flashlogic FL-CAN remote starter, **please follow this procedure in order to configure correctly your remote starter.**

<p>a. Go to www.flashlogic.com and click on “Flash your module”</p>	
<p>b. Choose vehicle Make, Model, Year, Trim</p>	
<p>c. Choose “ASCLBTLR”</p>	
<p>d. This will load a firmware starting with:</p>	<p>“CFLI-XX(XX)-XXX (X.X)”</p>
<p>e. Click “Flash!”</p>	

CARLINK™ INSTALLATION, WIRING & PROGRAMMING GUIDE

STEP 2. CONNECT

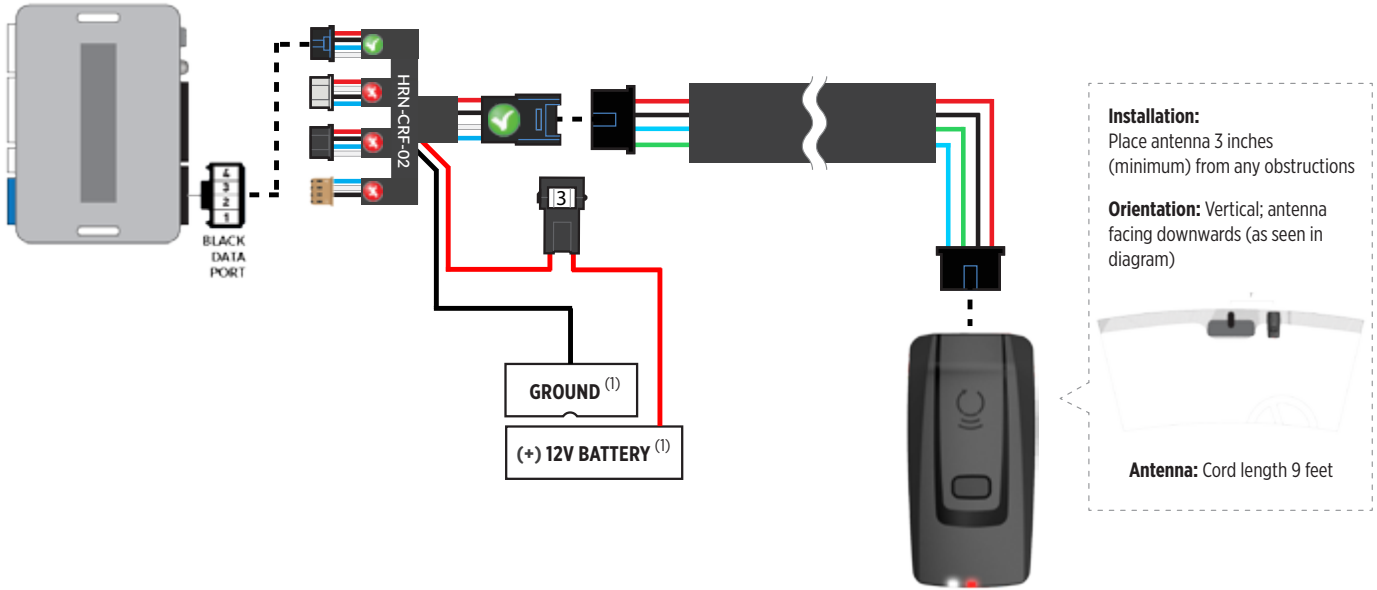

(1) Connect when using with FL-CAN.

STEP 3. ADD A DEVICE/VEHICLE TO AN ACCOUNT

- Download the App and Log into your account (see page 2 of this document for details)
- Click the “+” sign at the bottom right of the Application screen. This will allow you to temporarily add and configure your customers system inside your personal account. A system refers to the Antenna being installed in the windshield of the vehicle.
- Before adding a system to your device, ensure the remote starter IS NOT armed/locked or in Valet mode and set the ignition of the vehicle to the On position.
- Then Tap to “Scan QR Code” and use the smartphone camera to scan the QR Code located on top of the antenna.
- Once connected, the system is in “Installer Mode”. Follow the on-screen instructions for configuring the system.

STEP 4. PRE-CONFIGURE THE APPLICATION EXPERIENCE FOR YOUR CUSTOMER

- Start by setting the protocol of the antenna being used. This is achieved by selecting the Brand, Model and protocol used inside the Remote starter. When done, click on “Confirm”. System will now try to communicate with the remote starter to confirm that all settings related to protocol are valid.
- Once back in the control panel, click on the Settings Gear at the top right of the screen and edit the Vehicle name, configure the Auxiliaries that might have been added (if applicable) and click “OK” when done. Then choose the vehicle to display inside the control panel in the VEHICLE IMAGE section and click OK.
- When your configurations are all completed, click “OK” at the top right corner. All Configurations will take effect.



STEP 5. TESTING THE SYSTEM

When the system is connected and fully configured, testing can begin. Test all the application functions (Start, Stop, Lock, Unlock, Auxiliaries, Etc.) When testing is completed, tap on the “installer icon” at the top of control screen. When prompted Click “Yes, and delete system from account” since this is the installer mode and not the End User mode. This will make the system “Ready for Customer Delivery”.

Also make sure that the Owners Card is handed to the Owner of the vehicle or attached to the vehicle keychain. Doing this will ensure that the instructions on how to setup their App, Account and add the System is done correctly by using the system QR Code affixed on the windshield mounted antenna.





NOTE : UNDER ANY CIRCUMSTANCES, PLEASE DO NOT REMOVE THE QR CODE FROM THE ANTENNA!

PARTS REQUIRED FOR INSTALLATION OF : FLASHLOGIC FLRS

<p>XTX-3000</p> 	<p>IVU-CAB-4W</p> 	<p>Flashlogic FLRS</p> 	
---	---	---	--

STEP 1. CONFIGURE THE REMOTE STARTER

The ADS Weblink (ADS-USB) is required to properly configure the Flashlogic FLRS remote starter to accept the RF kit system. When flashing the Flashlogic FLRS remote starter, **please follow this procedure in order to configure correctly your remote starter.**

<p>a. Go to www.flashlogic.com and click on “Flash your module”</p>	
<p>b. Choose vehicle Make, Model, Year, Trim</p>	
<p>c. Choose “ASCLBTLR”</p>	
<p>d. This will load a firmware starting with:</p>	<p>“CFLI-XX(XX)-XXX (X.X)”</p>
<p>e. Click “Flash!”</p>	

CARLINK™ INSTALLATION, WIRING & PROGRAMMING GUIDE

STEP 2. CONNECT

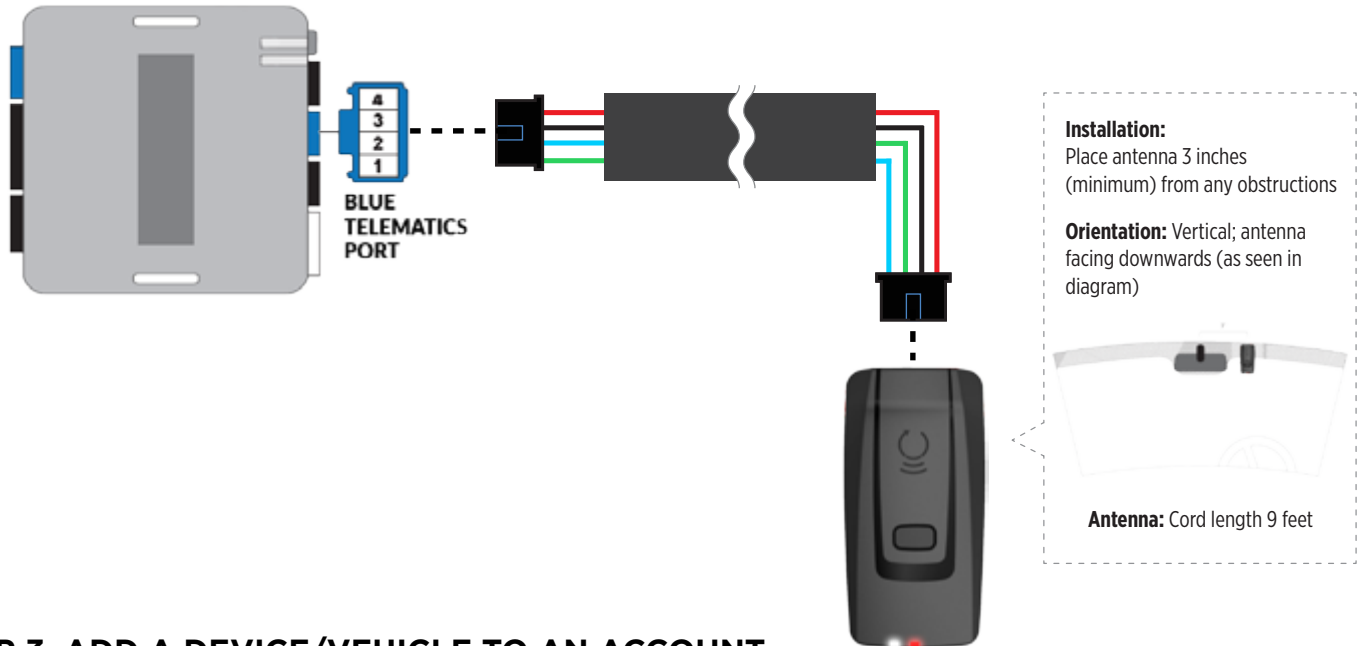

STEP 3. ADD A DEVICE/VEHICLE TO AN ACCOUNT

- Download the App and Log into your account (see page 2 of this document for details)
- Click the "+" sign at the bottom right of the Application screen. This will allow you to temporarily add and configure your customers system inside your personal account. A system refers to the Antenna being installed in the windshield of the vehicle.
- Before adding a system to your device, ensure the remote starter IS NOT armed/locked or in Valet mode and set the ignition of the vehicle to the On position.
- Then Tap to "Scan QR Code" and use the smartphone camera to scan the QR Code located on top of the antenna.
- Once connected, the system is in "Installer Mode". Follow the on-screen instructions for configuring the system.

STEP 4. PRE-CONFIGURE THE APPLICATION EXPERIENCE FOR YOUR CUSTOMER

- Start by setting the protocol of the antenna being used. This is achieved by selecting the Brand, Model and protocol used inside the Remote starter. When done, click on "Confirm". System will now try to communicate with the remote starter to confirm that all settings related to protocol are valid.
- Once back in the control panel, click on the Settings Gear at the top right of the screen and edit the Vehicle name, configure the Auxiliaries that might have been added (if applicable) and click "OK" when done. Then choose the vehicle to display inside the control panel in the VEHICLE IMAGE section and click OK.
- When your configurations are all completed, click "OK" at the top right corner. All Configurations will take effect.

STEP 5. TESTING THE SYSTEM

When the system is connected and fully configured, testing can begin. Test all the application functions (Start, Stop, Lock, Unlock, Auxiliaries, Etc.) When testing is completed, tap on the "installer icon" at the top of control screen. When prompted Click "Yes, and delete system from account" since this is the installer mode and not the End User mode. This will make the system "Ready for Customer Delivery".

Also make sure that the Owners Card is handed to the Owner of the vehicle or attached to the vehicle keychain. Doing this will ensure that the instructions on how to setup their App, Account and add the System is done correctly by using the system QR Code affixed on the windshield mounted antenna.





NOTE : UNDER ANY CIRCUMSTANCES, PLEASE DO NOT REMOVE THE QR CODE FROM THE ANTENNA!

PARTS REQUIRED FOR INSTALLATION OF : FLASHLOGIC FLRSBA

<p>XTX-3000</p> 	<p>IVU-CAB-4W</p> 	<p>Flashlogic FLRSBA</p> 	
---	---	---	--

STEP 1. CONFIGURE THE REMOTE STARTER

The ADS Weblink (ADS-USB) is required to properly configure the Flashlogic FLRSBA remote starter to accept the RF kit system. When flashing the Flashlogic FLRSBA remote starter, **please follow this procedure in order to configure correctly your remote starter.**

<p>a. Go to www.flashlogic.com and click on “Flash your module”</p>	
<p>b. Using the new Weblink configurator, Choose vehicle Make, Year, Model, Trim.</p>	
<p>c. In the Remote Configuration section, Select the Brand drop-down and Choose “Code Alarm, Prestige or Pursuit”.</p>	
<p>d. This will load a firmware starting with:</p>	<p>“ICO-BA-XXX-XXX” or “IVO-BA-XXX-XXX”</p>
<p>e. Click “Flash your device”</p>	

CAR:LINK™ INSTALLATION, WIRING & PROGRAMMING GUIDE

STEP 2. CONNECT

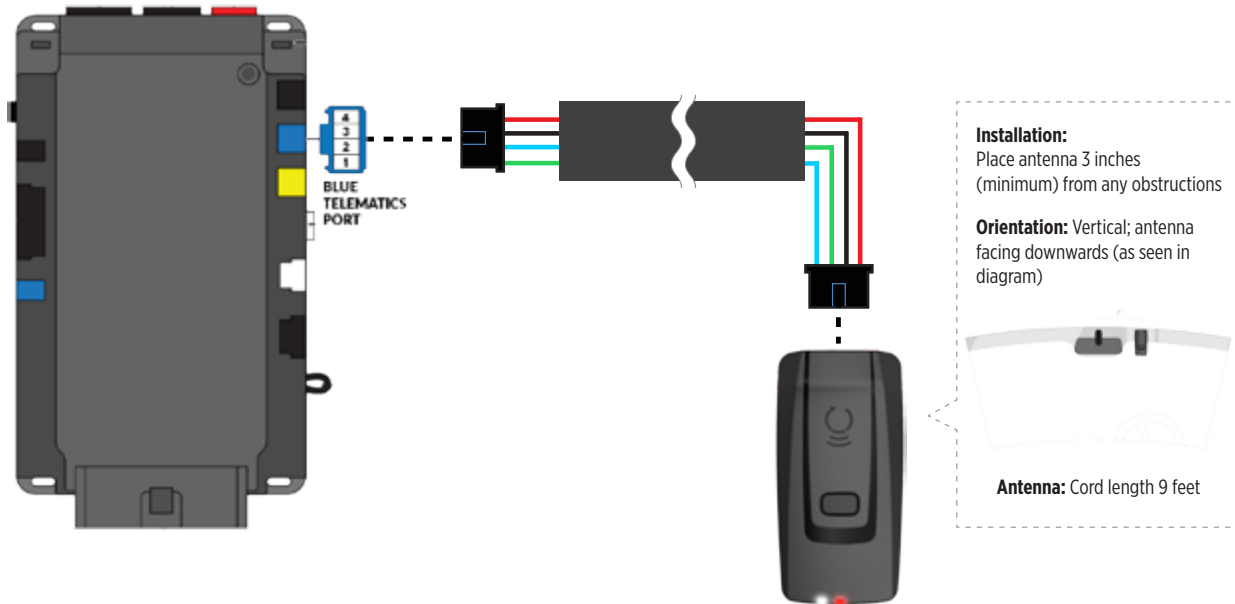

STEP 3. ADD A DEVICE/VEHICLE TO AN ACCOUNT

- Download the App and Log into your account (see page 2 of this document for details)
- Click the “+” sign at the bottom right of the Application screen. This will allow you to temporarily add and configure your customers system inside your personal account. A system refers to the Antenna being installed in the windshield of the vehicle.
- Before adding a system to your device, ensure the remote starter **IS NOT armed/locked or in Valet mode** and set the ignition of the vehicle to the On position.
- Then Tap to “Scan QR Code” and use the smartphone camera to scan the QR Code located on top of the antenna.
- Once connected, the system is in “Installer Mode”. Follow the on-screen instructions for configuring the system.

STEP 4. PRE-CONFIGURE THE APPLICATION EXPERIENCE FOR YOUR CUSTOMER

- Start by setting the protocol of the antenna being used. This is achieved by selecting the Brand, Model and protocol used inside the Remote starter. When done, click on “Confirm”. System will now try to communicate with the remote starter to confirm that all settings related to protocol are valid.
- Once back in the control panel, click on the Settings Gear at the top right of the screen and edit the Vehicle name, configure the Auxiliaries that might have been added (if applicable) and click “OK” when done. Then choose the vehicle to display inside the control panel in the VEHICLE IMAGE section and click OK.
- When your configurations are all completed, click “OK” at the top right corner. All Configurations will take effect.

STEP 5. TESTING THE SYSTEM

When the system is connected and fully configured, testing can begin. Test all the application functions (Start, Stop, Lock, Unlock, Auxiliaries, Etc.) When testing is completed, tap on the “installer icon” at the top of control screen. When prompted Click “Yes, and delete system from account” since this is the installer mode and not the End User mode. This will make the system “Ready for Customer Delivery”.

Also make sure that the Owners Card is handed to the Owner of the vehicle or attached to the vehicle keychain. Doing this will ensure that the instructions on how to setup their App, Account and add the System is done correctly by using the system QR Code affixed on the windshield mounted antenna.





NOTE : UNDER ANY CIRCUMSTANCES, PLEASE DO NOT REMOVE THE QR CODE FROM THE ANTENNA!

PARTS REQUIRED FOR INSTALLATION OF : FLASHLOGIC FLCMVW

<p>XTX-3000</p> 	<p>IVU-CAB-4W</p> 	<p>Flashlogic FLCMVW</p> 	
---	---	---	--

STEP 1. CONFIGURE THE REMOTE STARTER

The ADS Weblink (ADS-USB) is required to properly configure the Flashlogic FLCMVW remote starter to accept the RF kit system. When flashing the Flashlogic FLCMVW remote starter, **please follow this procedure in order to configure correctly your remote starter.**

<p>a. Go to www.flashlogic.com and click on “Flash your module”</p>	
<p>b. Using the new Weblink configurator, Choose vehicle Make, Year, Model, Trim.</p>	
<p>c. In the Remote Configuration section, Select the Brand drop-down and Choose “Code Alarm, Prestige or Pursuit”.</p>	
<p>d. This will load a firmware starting with:</p>	<p>“ICO-BA-XXX-XXX” or “IVO-BA-XXX-XXX”</p>
<p>e. Click “Flash your device”</p>	

CAR:LINK™ INSTALLATION, WIRING & PROGRAMMING GUIDE

STEP 2. CONNECT

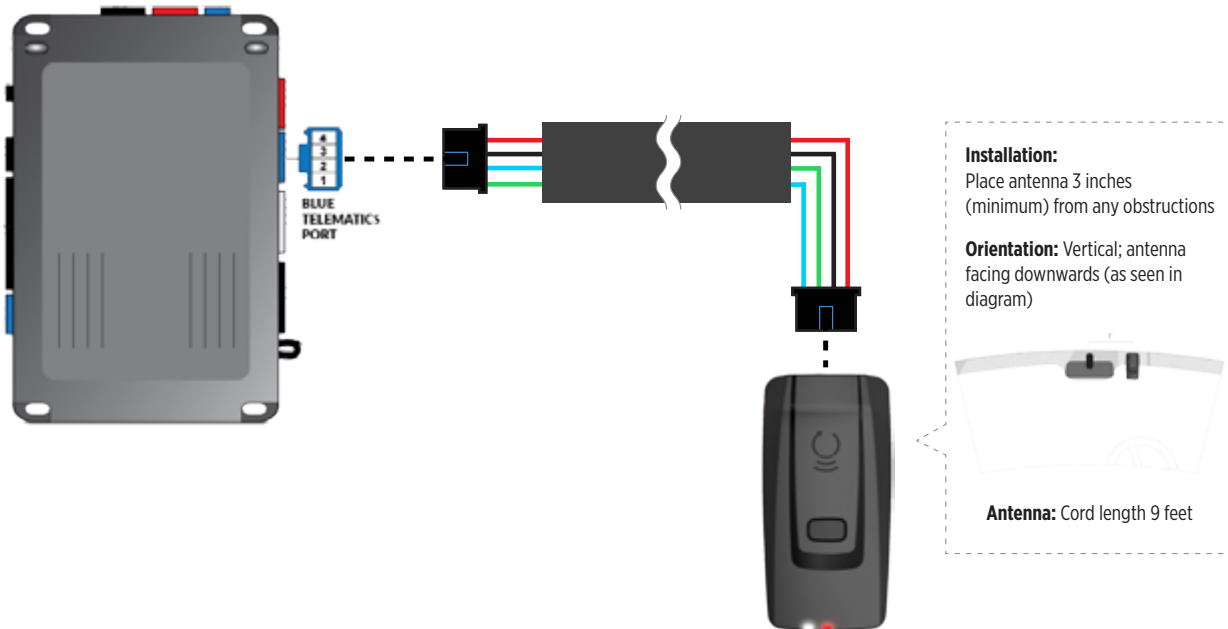

STEP 3. ADD A DEVICE/VEHICLE TO AN ACCOUNT

- Download the App and Log into your account (see page 2 of this document for details)
- Click the “+” sign at the bottom right of the Application screen. This will allow you to temporarily add and configure your customers system inside your personal account. A system refers to the Antenna being installed in the windshield of the vehicle.
- Before adding a system to your device, ensure the remote starter **IS NOT armed/locked or in Valet mode** and set the ignition of the vehicle to the On position.
- Then Tap to “Scan QR Code” and use the smartphone camera to scan the QR Code located on top of the antenna.
- Once connected, the system is in “Installer Mode”. Follow the on-screen instructions for configuring the system.

STEP 4. PRE-CONFIGURE THE APPLICATION EXPERIENCE FOR YOUR CUSTOMER

- Start by setting the protocol of the antenna being used. This is achieved by selecting the Brand, Model and protocol used inside the Remote starter. When done, click on “Confirm”. System will now try to communicate with the remote starter to confirm that all settings related to protocol are valid.
- Once back in the control panel, click on the Settings Gear at the top right of the screen and edit the Vehicle name, configure the Auxiliaries that might have been added (if applicable) and click “OK” when done. Then choose the vehicle to display inside the control panel in the VEHICLE IMAGE section and click OK.
- When your configurations are all completed, click “OK” at the top right corner. All Configurations will take effect.





STEP 5. TESTING THE SYSTEM

When the system is connected and fully configured, testing can begin. Test all the application functions (Start, Stop, Lock, Unlock, Auxiliaries, Etc.) When testing is completed, tap on the “installer icon” at the top of control screen. When prompted Click “Yes, and delete system from account” since this is the installer mode and not the End User mode. This will make the system “Ready for Customer Delivery”.

Also make sure that the Owners Card is handed to the Owner of the vehicle or attached to the vehicle keychain. Doing this will ensure that the instructions on how to setup their App, Account and add the System is done correctly by using the system QR Code affixed on the windshield mounted antenna.



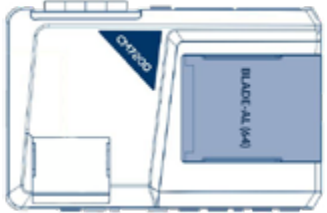

NOTE : UNDER ANY CIRCUMSTANCES, PLEASE DO NOT REMOVE THE QR CODE FROM THE ANTENNA!

PARTS REQUIRED FOR INSTALLATION OF : COMPUSTAR CM7000 / CM7200 / POLARSTART PRS-16

<p>XTX-3000</p> 	<p>IVU-CAB-4W</p> 	<p>CM7000 / CM7200 / PRS-16</p> 	<p>BLADE-AL (64)</p> 
---	---	--	--

STEP 1. CONFIGURE THE REMOTE STARTER

The ADS Weblink (ADS-USB) is required to properly configure the Compustar or Polarstart remote starter to accept the RF kit system. When flashing the Compustar or Polarstart remote starter, **please follow this procedure in order to configure correctly your remote starter.**

<p>a. Go to www.idatalink.com and click on “Flash your module”</p>	
<p>b. Under the ADS-BLADE AL tab, Choose vehicle Make, Model, Year, Trim</p>	
<p>c. Click “Flash!”</p>	
<p>d. Once done click on the Remote Starter tab and click on “Flash my starter” in order to update the remote starter firmware</p>	
<p>e. Click “Flash!”</p>	

CARLINK™ INSTALLATION, WIRING & PROGRAMMING GUIDE

STEP 2. CONNECT

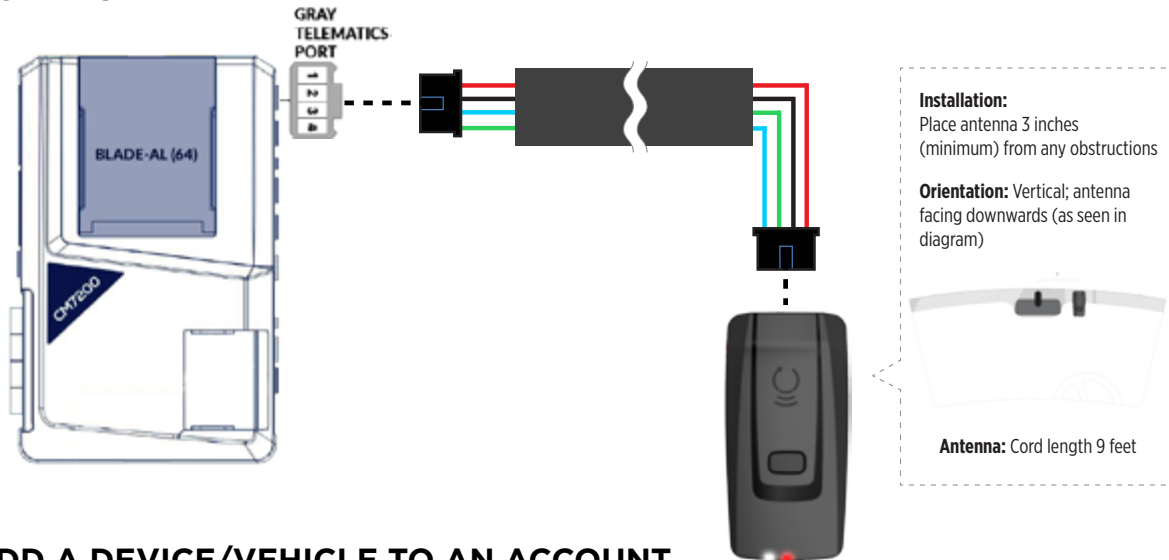

STEP 3. ADD A DEVICE/VEHICLE TO AN ACCOUNT

- Download the App and Log into your account (see page 2 of this document for details)
- Click the “+” sign at the bottom right of the Application screen. This will allow you to temporarily add and configure your customers system inside your personal account. A system refers to the Antenna being installed in the windshield of the vehicle.
- Before adding a system to your device, ensure the remote starter IS NOT armed/locked or in Valet mode and set the ignition of the vehicle to the On position.
- Then Tap to “Scan QR Code” and use the smartphone camera to scan the QR Code located on top of the antenna.
- Once connected, the system is in “Installer Mode”. Follow the on-screen instructions for configuring the system.

STEP 4. PRE-CONFIGURE THE APPLICATION EXPERIENCE FOR YOUR CUSTOMER

- Start by setting the protocol of the antenna being used. This is achieved by selecting the Brand, Model and protocol used inside the Remote starter. When done, click on “Confirm”. System will now try to communicate with the remote starter to confirm that all settings related to protocol are valid.
- Once back in the control panel, click on the Settings Gear at the top right of the screen and edit the Vehicle name, configure the Auxiliaries that might have been added (if applicable) and click “OK” when done. Then choose the vehicle to display inside the control panel in the VEHICLE IMAGE section and click OK.
- When your configurations are all completed, click “OK” at the top right corner. All Configurations will take effect.





STEP 5. TESTING THE SYSTEM

When the system is connected and fully configured, testing can begin. Test all the application functions (Start, Stop, Lock, Unlock, Auxiliaries, Etc.) When testing is completed, tap on the “installer icon” at the top of control screen. When prompted Click “Yes, and delete system from account” since this is the installer mode and not the End User mode. This will make the system “Ready for Customer Delivery”.

Also make sure that the Owners Card is handed to the Owner of the vehicle or attached to the vehicle keychain. Doing this will ensure that the instructions on how to setup their App, Account and add the System is done correctly by using the system QR Code affixed on the windshield mounted antenna.



NOTE : UNDER ANY CIRCUMSTANCES, PLEASE DO NOT REMOVE THE QR CODE FROM THE ANTENNA!

PARTS REQUIRED FOR INSTALLATION OF : COMPUSTAR CM6200

<p>XTX-3000</p> 	<p>IVU-CAB-4W</p> 	<p>Compustar CM6200</p> 	<p>BLADE-AL (64)</p> 
---	---	--	--

STEP 1. CONFIGURE THE REMOTE STARTER

The ADS Weblink (ADS-USB) is required to properly configure the CM6200 remote starter to accept the RF kit system. When flashing the CM6200 remote starter, **please follow this procedure in order to configure correctly your remote starter.**

<p>a. Go to www.idatalink.com and click on “Flash your module”</p>	
<p>b. Under the ADS-BLADE AL tab, Choose vehicle Make, Model, Year, Trim</p>	<p>VEHICLE SELECTION</p> <p>FILTER: <input type="text" value="Select a make"/> <input type="text" value="All Years"/> <input type="text" value="All models"/> <input type="text" value="All trims"/> <input type="button" value="NEXT ..."/></p>
<p>c. Click “Flash!”</p>	
<p>d. Once done click on the Remote Starter tab and click on “Flash my starter” in order to update the remote starter firmware</p>	
<p>e. Click “Flash!”</p>	

CARLINK™ INSTALLATION, WIRING & PROGRAMMING GUIDE

STEP 2. CONNECT

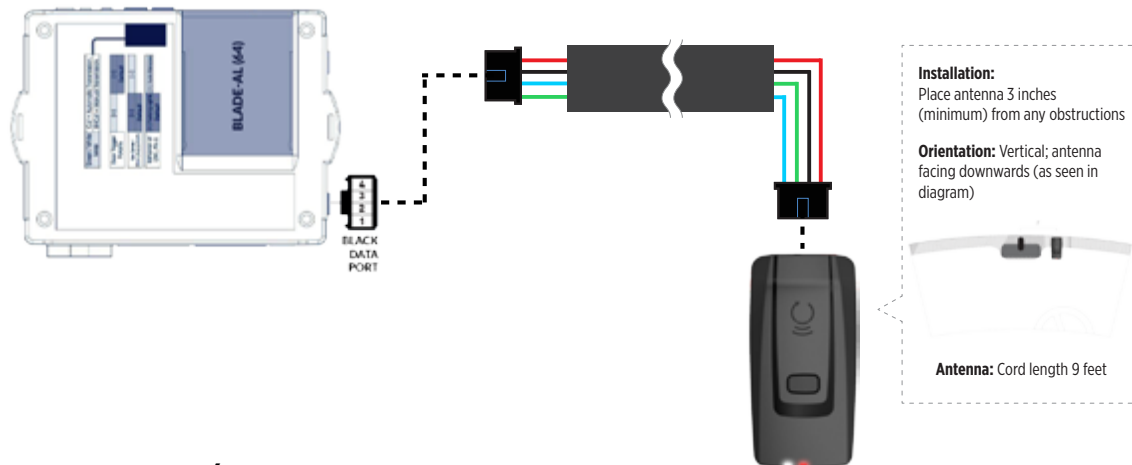

STEP 3. ADD A DEVICE/VEHICLE TO AN ACCOUNT

- Download the App and Log into your account (see page 2 of this document for details)
- Click the “+” sign at the bottom right of the Application screen. This will allow you to temporarily add and configure your customers system inside your personal account. A system refers to the Antenna being installed in the windshield of the vehicle.
- Before adding a system to your device, ensure the remote starter IS NOT armed/locked or in Valet mode and set the ignition of the vehicle to the On position.
- Then Tap to “Scan QR Code” and use the smartphone camera to scan the QR Code located on top of the antenna.
- Once connected, the system is in “Installer Mode”. Follow the on-screen instructions for configuring the system.

STEP 4. PRE-CONFIGURE THE APPLICATION EXPERIENCE FOR YOUR CUSTOMER

- Start by setting the protocol of the antenna being used. This is achieved by selecting the Brand, Model and protocol used inside the Remote starter. When done, click on “Confirm”. System will now try to communicate with the remote starter to confirm that all settings related to protocol are valid.
- Once back in the control panel, click on the Settings Gear at the top right of the screen and edit the Vehicle name, configure the Auxiliaries that might have been added (if applicable) and click “OK” when done. Then choose the vehicle to display inside the control panel in the VEHICLE IMAGE section and click OK.
- When your configurations are all completed, click “OK” at the top right corner. All Configurations will take effect.



STEP 5. TESTING THE SYSTEM

When the system is connected and fully configured, testing can begin. Test all the application functions (Start, Stop, Lock, Unlock, Auxiliaries, Etc.) When testing is completed, tap on the “installer icon” at the top of control screen. When prompted Click “Yes, and delete system from account” since this is the installer mode and not the End User mode. This will make the system “Ready for Customer Delivery”.

Also make sure that the Owners Card is handed to the Owner of the vehicle or attached to the vehicle keychain. Doing this will ensure that the instructions on how to setup their App, Account and add the System is done correctly by using the system QR Code affixed on the windshield mounted antenna.



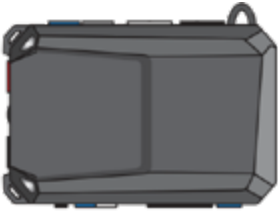

NOTE : UNDER ANY CIRCUMSTANCES, PLEASE DO NOT REMOVE THE QR CODE FROM THE ANTENNA!

PARTS REQUIRED FOR INSTALLATION OF : COMPUSTAR DC2

<p>XTX-3000</p> 	<p>IVU-CAB-4W</p> 	<p>Compustar DC2</p> 	
---	---	---	--

STEP 1. CONFIGURE THE REMOTE STARTER

The ADS Weblink (ADS-USB) is required to properly configure the Compustar DC2 remote starter to accept the RF kit system. When flashing the Compustar DC2 remote starter, **please follow this procedure in order to configure correctly your remote starter.**

<p>a. Go to www.idatalink.com and click on “Flash your module”</p>	
<p>b. Using the new Weblink configurator, Choose vehicle Make, Year, Model, Trim.</p>	
<p>c. In the Telematics Device section, Turn On the Drone Telematics option</p>	
<p>d. This will load a firmware starting with:</p>	<p>“COM-XXX-XXX-XXX”</p>
<p>e. Click “Flash your device”</p>	

CAR:LINK™ INSTALLATION, WIRING & PROGRAMMING GUIDE

STEP 2. CONNECT

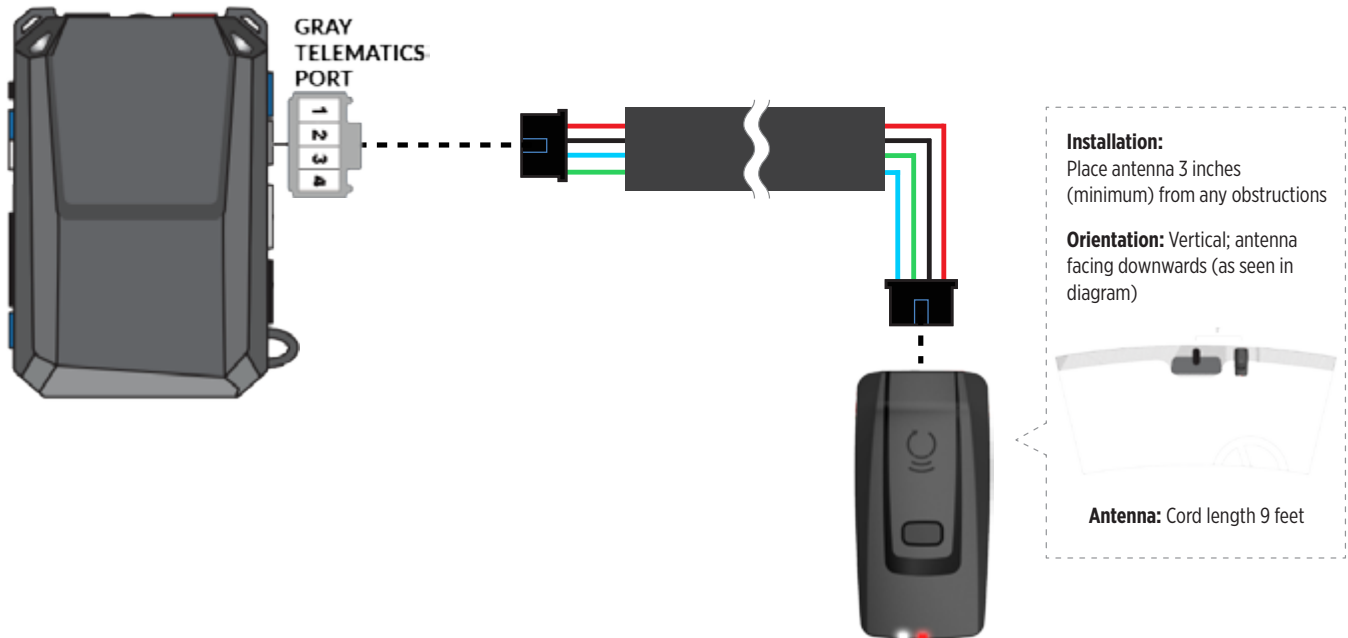

STEP 3. ADD A DEVICE/VEHICLE TO AN ACCOUNT

- Download the App and Log into your account (see page 2 of this document for details)
- Click the “+” sign at the bottom right of the Application screen. This will allow you to temporarily add and configure your customers system inside your personal account. A system refers to the Antenna being installed in the windsheild of the vehicle.
- Before adding a system to your device, ensure the remote starter IS NOT armed/locked or in Valet mode and set the ignition of the vehicle to the On position.
- Then Tap to “Scan QR Code” and use the smartphone camera to scan the QR Code located on top of the antenna.
- Once connected, the system is in “Installer Mode”. Follow the on-screen instructions for configuring the system.

STEP 4. PRE-CONFIGURE THE APPLICATION EXPERIENCE FOR YOUR CUSTOMER

- Start by setting the protocol of the antenna being used. This is achieved by selecting the Brand, Model and protocol used inside the Remote starter. When done, click on “Confirm”. System will now try to communicate with the remote starter to confirm that all settings related to protocol are valid.
- Once back in the control panel, click on the Settings Gear at the top right of the screen and edit the Vehicle name, configure the Auxiliaries that might have been added (if applicable) and click “OK” when done. Then choose the vehicle to display inside the control panel in the VEHICLE IMAGE section and click OK.
- When your configurations are all completed, click “OK” at the top right corner. All Configurations will take effect.

STEP 5. TESTING THE SYSTEM

When the system is connected and fully configured, testing can begin. Test all the application functions (Start, Stop, Lock, Unlock, Auxiliaries, Etc.) When testing is completed, tap on the “installer icon” at the top of control screen. When prompted Click “Yes, and delete system from account” since this is the installer mode and not the End User mode. This will make the system “Ready for Customer Delivery”.

Also make sure that the Owners Card is handed to the Owner of the vehicle or attached to the vehicle keychain. Doing this will ensure that the instructions on how to setup their App, Account and add the System is done correctly by using the system QR Code affixed on the windsheild mounted antenna.





NOTE : UNDER ANY CIRCUMSTANCES, PLEASE DO NOT REMOVE THE QR CODE FROM THE ANTENNA!

PARTS REQUIRED FOR INSTALLATION OF : COMPUSTAR DC3

<p>XTX-3000</p> 	<p>IVU-CAB-4W</p> 	<p>Compustar DC3</p> 	
---	---	---	--

STEP 1. CONFIGURE THE REMOTE STARTER

The ADS Weblink (ADS-USB) is required to properly configure the Compustar DC3 remote starter to accept the RF kit system. When flashing the Compustar DC3 remote starter, **please follow this procedure in order to configure correctly your remote starter.**

<p>a. Go to www.idatalink.com and click on “Flash your module”</p>	
<p>b. Using the new Weblink configurator, Choose vehicle Make, Year, Model, Trim.</p>	
<p>c. In the Telematics Device section, Turn On the Drone Telematics option</p>	
<p>d. This will load a firmware starting with:</p>	<p>“COM-XXX-XXX-XXX”</p>
<p>e. Click “Flash your device”</p>	

CAR:LINK™ INSTALLATION, WIRING & PROGRAMMING GUIDE

STEP 2. CONNECT

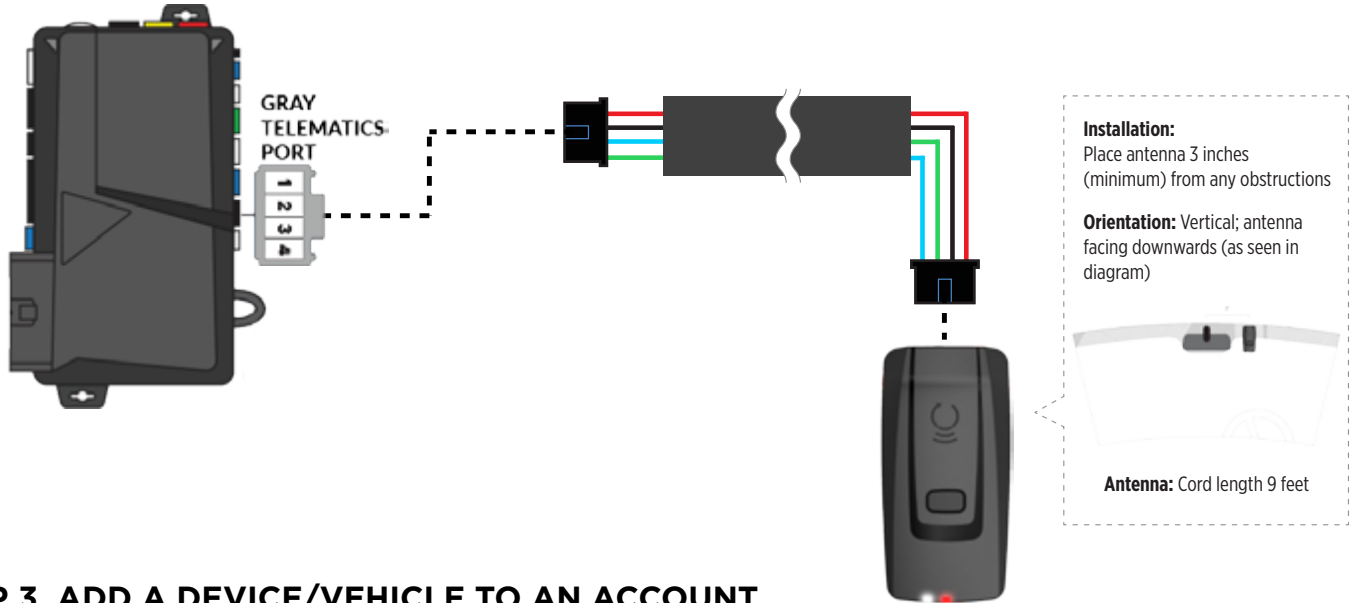

STEP 3. ADD A DEVICE/VEHICLE TO AN ACCOUNT

- Download the App and Log into your account (see page 2 of this document for details)
- Click the “+” sign at the bottom right of the Application screen. This will allow you to temporarily add and configure your customers system inside your personal account. A system refers to the Antenna being installed in the windshield of the vehicle.
- Before adding a system to your device, ensure the remote starter IS NOT armed/locked or in Valet mode and set the ignition of the vehicle to the On position.
- Then Tap to “Scan QR Code” and use the smartphone camera to scan the QR Code located on top of the antenna.
- Once connected, the system is in “Installer Mode”. Follow the on-screen instructions for configuring the system.

STEP 4. PRE-CONFIGURE THE APPLICATION EXPERIENCE FOR YOUR CUSTOMER

- Start by setting the protocol of the antenna being used. This is achieved by selecting the Brand, Model and protocol used inside the Remote starter. When done, click on “Confirm”. System will now try to communicate with the remote starter to confirm that all settings related to protocol are valid.
- Once back in the control panel, click on the Settings Gear at the top right of the screen and edit the Vehicle name, configure the Auxiliaries that might have been added (if applicable) and click “OK” when done. Then choose the vehicle to display inside the control panel in the VEHICLE IMAGE section and click OK.
- When your configurations are all completed, click “OK” at the top right corner. All Configurations will take effect.





STEP 5. TESTING THE SYSTEM

When the system is connected and fully configured, testing can begin. Test all the application functions (Start, Stop, Lock, Unlock, Auxiliaries, Etc.) When testing is completed, tap on the “installer icon” at the top of control screen. When prompted Click “Yes, and delete system from account” since this is the installer mode and not the End User mode. This will make the system “Ready for Customer Delivery”.

Also make sure that the Owners Card is handed to the Owner of the vehicle or attached to the vehicle keychain. Doing this will ensure that the instructions on how to setup their App, Account and add the System is done correctly by using the system QR Code affixed on the windshield mounted antenna.





NOTE : UNDER ANY CIRCUMSTANCES, PLEASE DO NOT REMOVE THE QR CODE FROM THE ANTENNA!

PARTS REQUIRED FOR INSTALLATION OF : POLARSTART PRS-13

<p>XTX-3000</p> 	<p>IVU-CAB-4W</p> 	<p>PRS-13</p> 	<p>BLADE-AL (64)</p> 
---	---	--	--

STEP 1. CONFIGURE THE REMOTE STARTER

The ADS Weblink (ADS-USB) is required to properly configure the Polarstart PRS-13 remote starter to accept the RF kit system. When flashing the Polarstart PRS-13 remote starter, **please follow this procedure in order to configure correctly your remote starter.**

<p>a. Go to www.idatalink.com and click on “Flash your module”</p>	
<p>b. Under the ADS-BLADE AL tab, Choose vehicle Make, Model, Year, Trim</p>	
<p>c. Click “Flash!”</p>	
<p>d. Once done click on the Remote Starter tab and click on “Flash my starter” in order to update the remote starter firmware</p>	
<p>e. Click “Flash!”</p>	

CAR:LINK™ INSTALLATION, WIRING & PROGRAMMING GUIDE

STEP 2. CONNECT

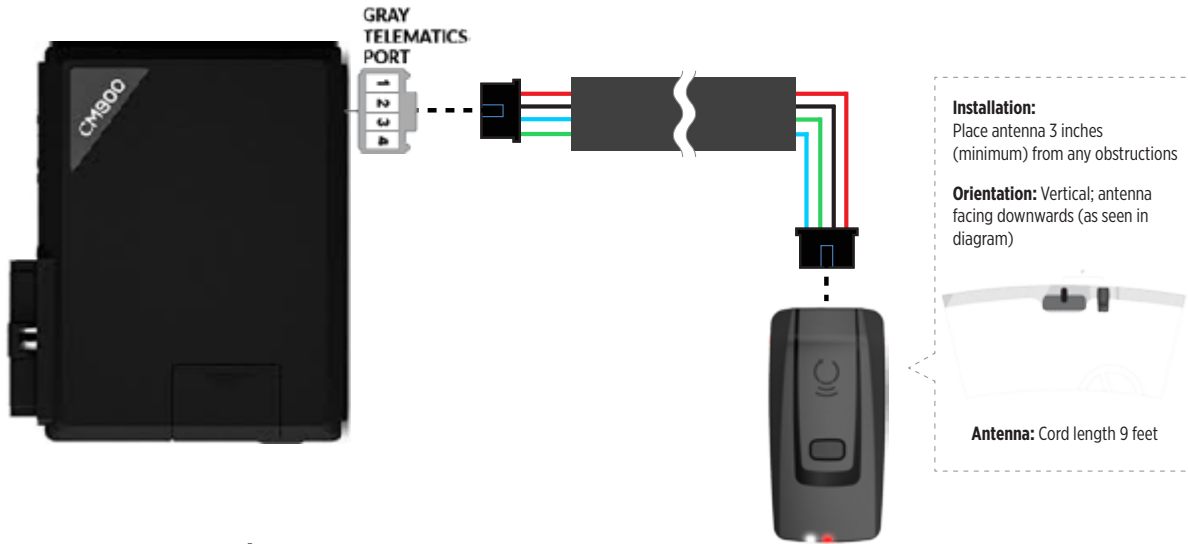

STEP 3. ADD A DEVICE/VEHICLE TO AN ACCOUNT

- Download the App and Log into your account (see page 2 of this document for details)
- Click the “+” sign at the bottom right of the Application screen. This will allow you to temporarily add and configure your customers system inside your personal account. A system refers to the Antenna being installed in the windshield of the vehicle.
- Before adding a system to your device, ensure the remote starter IS NOT armed/locked or in Valet mode and set the ignition of the vehicle to the On position.
- Then Tap to “Scan QR Code” and use the smartphone camera to scan the QR Code located on top of the antenna.
- Once connected, the system is in “Installer Mode”. Follow the on-screen instructions for configuring the system.

STEP 4. PRE-CONFIGURE THE APPLICATION EXPERIENCE FOR YOUR CUSTOMER

- Start by setting the protocol of the antenna being used. This is achieved by selecting the Brand, Model and protocol used inside the Remote starter. When done, click on “Confirm”. System will now try to communicate with the remote starter to confirm that all settings related to protocol are valid.
- Once back in the control panel, click on the Settings Gear at the top right of the screen and edit the Vehicle name, configure the Auxiliaries that might have been added (if applicable) and click “OK” when done. Then choose the vehicle to display inside the control panel in the VEHICLE IMAGE section and click OK.
- When your configurations are all completed, click “OK” at the top right corner. All Configurations will take effect.



STEP 5. TESTING THE SYSTEM

When the system is connected and fully configured, testing can begin. Test all the application functions (Start, Stop, Lock, Unlock, Auxiliaries, Etc.) When testing is completed, tap on the “installer icon” at the top of control screen. When prompted Click “Yes, and delete system from account” since this is the installer mode and not the End User mode. This will make the system “Ready for Customer Delivery”.

Also make sure that the Owners Card is handed to the Owner of the vehicle or attached to the vehicle keychain. Doing this will ensure that the instructions on how to setup their App, Account and add the System is done correctly by using the system QR Code affixed on the windshield mounted antenna.





NOTE : UNDER ANY CIRCUMSTANCES, PLEASE DO NOT REMOVE THE QR CODE FROM THE ANTENNA!

PARTS REQUIRED FOR INSTALLATION OF : DIRECTED DBALL 2

<p>XTX-3000</p> 	<p>IVU-CAB-4W</p> 	<p>DBALL2</p> 	<p>HRN-CRF-02</p> 
---	---	--	---

STEP 1. CONFIGURE THE REMOTE STARTER

The XKloader 2 or 3 is required to properly configure the DBALL 2 remote starter to accept the RF kit system. When flashing the DBALL 2 remote starter, **please follow this procedure in order to configure correctly your remote starter.**

<p>a. Go to www.directechs.com and click on “Flash module”</p>	
<p>b. Choose vehicle Make, Model, Year</p>	
<p>c. Run thru the configuration process and make sure to choose “Config for RSR”</p>	<input type="checkbox"/> Config for RSR
<p>d. Choose “SmartStart” option.</p>	<input type="checkbox"/> 
<p>e. Complete the configuration process.</p>	
<p>f. Click “Flash!”</p>	

CARLINK™ INSTALLATION, WIRING & PROGRAMMING GUIDE

STEP 2. CONNECT

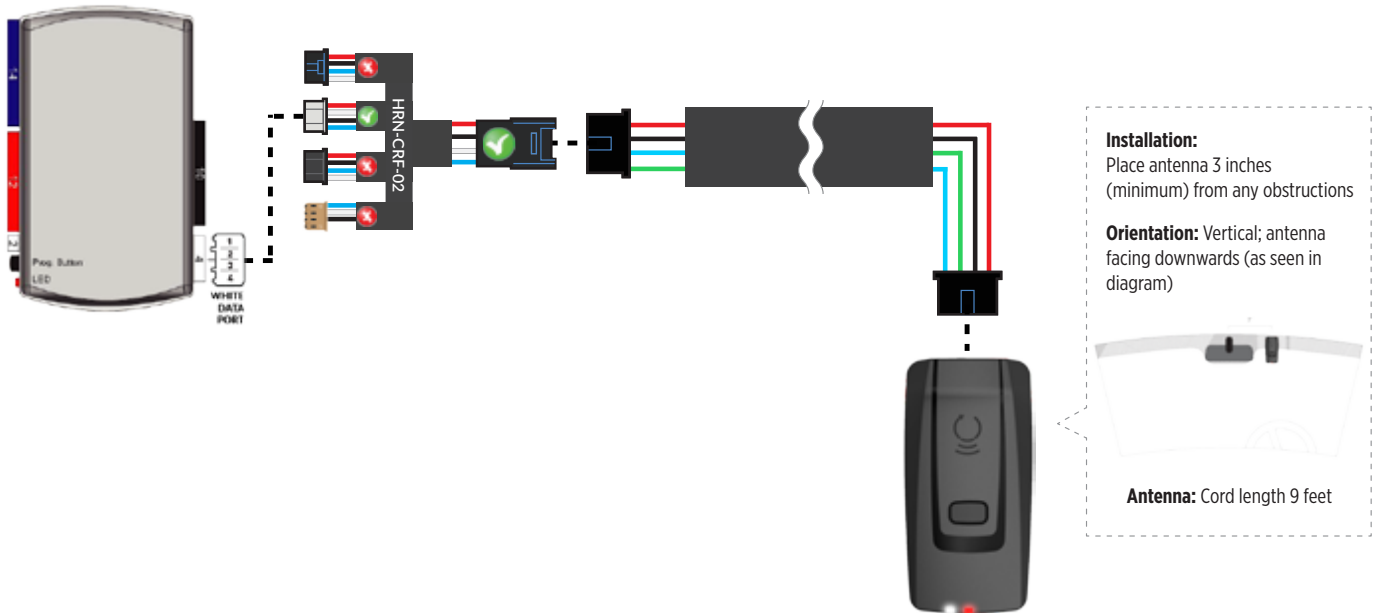

STEP 3. ADD A DEVICE/VEHICLE TO AN ACCOUNT

- Download the App and Log into your account (see page 2 of this document for details)
- Click the “+” sign at the bottom right of the Application screen. This will allow you to temporarily add and configure your customers system inside your personal account. A system refers to the Antenna being installed in the windshield of the vehicle.
- Before adding a system to your device, ensure the remote starter IS NOT armed/locked or in Valet mode and set the ignition of the vehicle to the On position.
- Then Tap to “Scan QR Code” and use the smartphone camera to scan the QR Code located on top of the antenna.
- Once connected, the system is in “Installer Mode”. Follow the on-screen instructions for configuring the system.

STEP 4. PRE-CONFIGURE THE APPLICATION EXPERIENCE FOR YOUR CUSTOMER

- Start by setting the protocol of the antenna being used. This is achieved by selecting the Brand, Model and protocol used inside the Remote starter. When done, click on “Confirm”. System will now try to communicate with the remote starter to confirm that all settings related to protocol are valid.
- Once back in the control panel, click on the Settings Gear at the top right of the screen and edit the Vehicle name, configure the Auxiliaries that might have been added (if applicable) and click “OK” when done. Then choose the vehicle to display inside the control panel in the VEHICLE IMAGE section and click OK.
- When your configurations are all completed, click “OK” at the top right corner. All Configurations will take effect.

STEP 5. TESTING THE SYSTEM

When the system is connected and fully configured, testing can begin. Test all the application functions (Start, Stop, Lock, Unlock, Auxiliaries, Etc.) When testing is completed, tap on the “installer icon” at the top of control screen. When prompted Click “Yes, and delete system from account” since this is the installer mode and not the End User mode. This will make the system “Ready for Customer Delivery”.

Also make sure that the Owners Card is handed to the Owner of the vehicle or attached to the vehicle keychain. Doing this will ensure that the instructions on how to setup their App, Account and add the System is done correctly by using the system QR Code affixed on the windshield mounted antenna.



NOTE : UNDER ANY CIRCUMSTANCES, PLEASE DO NOT REMOVE THE QR CODE FROM THE ANTENNA!

PARTS REQUIRED FOR INSTALLATION OF : DIRECTED DB3

<p>XTX-3000</p> 	<p>IVU-CAB-4W</p> 	<p>DB3</p> 	<p>HRN-CRF-02</p> 
---	---	---	---

STEP 1. CONFIGURE THE REMOTE STARTER

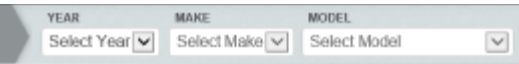
The XKloader 2 or 3 is required to properly configure the DB3 remote starter to accept the RF kit system. When flashing the DB3 remote starter, **please follow this procedure in order to configure correctly your remote starter.**

<p>a. Go to www.directechs.com and click on “Flash module”</p>	
<p>b. Choose vehicle Make, Model, Year</p>	
<p>c. Run thru the configuration process and make sure to choose “Config for RSR”</p>	<input type="checkbox"/> Config for RSR
<p>d. Choose “SmartStart” option.</p>	<input type="checkbox"/> 
<p>e. Complete the configuration process.</p>	
<p>f. Click “Flash!”</p>	

CAR:LINK™ INSTALLATION, WIRING & PROGRAMMING GUIDE

STEP 2. CONNECT

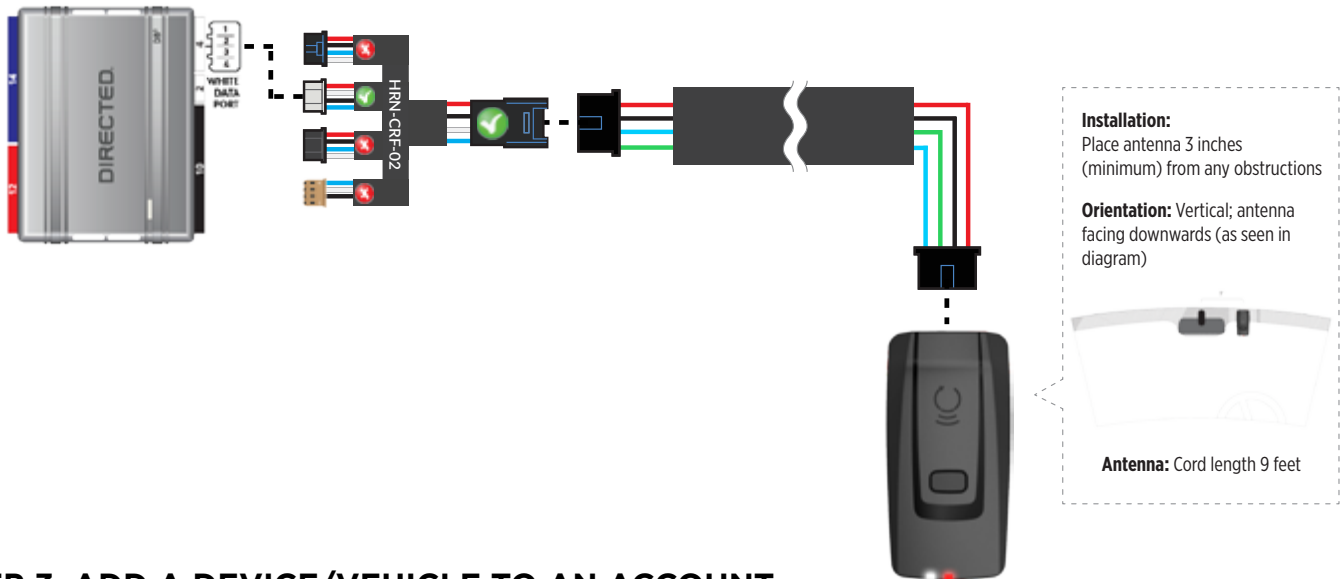

STEP 3. ADD A DEVICE/VEHICLE TO AN ACCOUNT

- Download the App and Log into your account (see page 2 of this document for details)
- Click the “+” sign at the bottom right of the Application screen. This will allow you to temporarily add and configure your customers system inside your personal account. A system refers to the Antenna being installed in the windshield of the vehicle.
- Before adding a system to your device, ensure the remote starter IS NOT armed/locked or in Valet mode and set the ignition of the vehicle to the On position.
- Then Tap to “Scan QR Code” and use the smartphone camera to scan the QR Code located on top of the antenna.
- Once connected, the system is in “Installer Mode”. Follow the on-screen instructions for configuring the system.

STEP 4. PRE-CONFIGURE THE APPLICATION EXPERIENCE FOR YOUR CUSTOMER

- Start by setting the protocol of the antenna being used. This is achieved by selecting the Brand, Model and protocol used inside the Remote starter. When done, click on “Confirm”. System will now try to communicate with the remote starter to confirm that all settings related to protocol are valid.
- Once back in the control panel, click on the Settings Gear at the top right of the screen and edit the Vehicle name, configure the Auxiliaries that might have been added (if applicable) and click “OK” when done. Then choose the vehicle to display inside the control panel in the VEHICLE IMAGE section and click OK.
- When your configurations are all completed, click “OK” at the top right corner. All Configurations will take effect.

STEP 5. TESTING THE SYSTEM

When the system is connected and fully configured, testing can begin. Test all the application functions (Start, Stop, Lock, Unlock, Auxiliaries, Etc.) When testing is completed, tap on the “installer icon” at the top of control screen. When prompted Click “Yes, and delete system from account” since this is the installer mode and not the End User mode. This will make the system “Ready for Customer Delivery”.

Also make sure that the Owners Card is handed to the Owner of the vehicle or attached to the vehicle keychain. Doing this will ensure that the instructions on how to setup their App, Account and add the System is done correctly by using the system QR Code affixed on the windshield mounted antenna.

NOTE : UNDER ANY CIRCUMSTANCES, PLEASE DO NOT REMOVE THE QR CODE FROM THE ANTENNA!

PARTS REQUIRED FOR INSTALLATION OF : DIRECTED 4X10 - 5X10 - AF-D600 - ASD200 - ASD-600

<p>XTX-3000</p> 	<p>IVU-CAB-4W</p> 	<p>4X10 - 5X10 - AF-D600 ASD200 - ASD600</p> 	<p>HRN-CRF-02</p> 
---	---	---	---

STEP 1. CONFIGURE THE REMOTE STARTER

The XKloader 2 or 3 is required to properly configure the 4X10 - 5X10 remote starter to accept the RF kit system. When flashing the 4X10 - 5X10 - AF-D600 - ASD200 - ASD600 remote starter, **please follow this procedure in order to configure correctly your remote starter.**

a. Go to www.directechs.com and click on “Flash module”	Flash Module						
b. Choose vehicle Make, Model, Year	<table border="1" style="width: 100%; border-collapse: collapse;"> <tr> <th style="font-size: small;">YEAR</th> <th style="font-size: small;">MAKE</th> <th style="font-size: small;">MODEL</th> </tr> <tr> <td style="text-align: center;">Select Year <input type="text"/></td> <td style="text-align: center;">Select Make <input type="text"/></td> <td style="text-align: center;">Select Model <input type="text"/></td> </tr> </table>	YEAR	MAKE	MODEL	Select Year <input type="text"/>	Select Make <input type="text"/>	Select Model <input type="text"/>
YEAR	MAKE	MODEL					
Select Year <input type="text"/>	Select Make <input type="text"/>	Select Model <input type="text"/>					
c. Run thru the configuration process and make sure to choose “Remote Start”	<input checked="" type="checkbox"/> Remote Start						
d. Choose “SmartStart” option.	<input type="checkbox"/> 						
e. Complete the configuration process.							
f. Click “Flash!”	Flash						

CARLINK™ INSTALLATION, WIRING & PROGRAMMING GUIDE

STEP 2. CONNECT

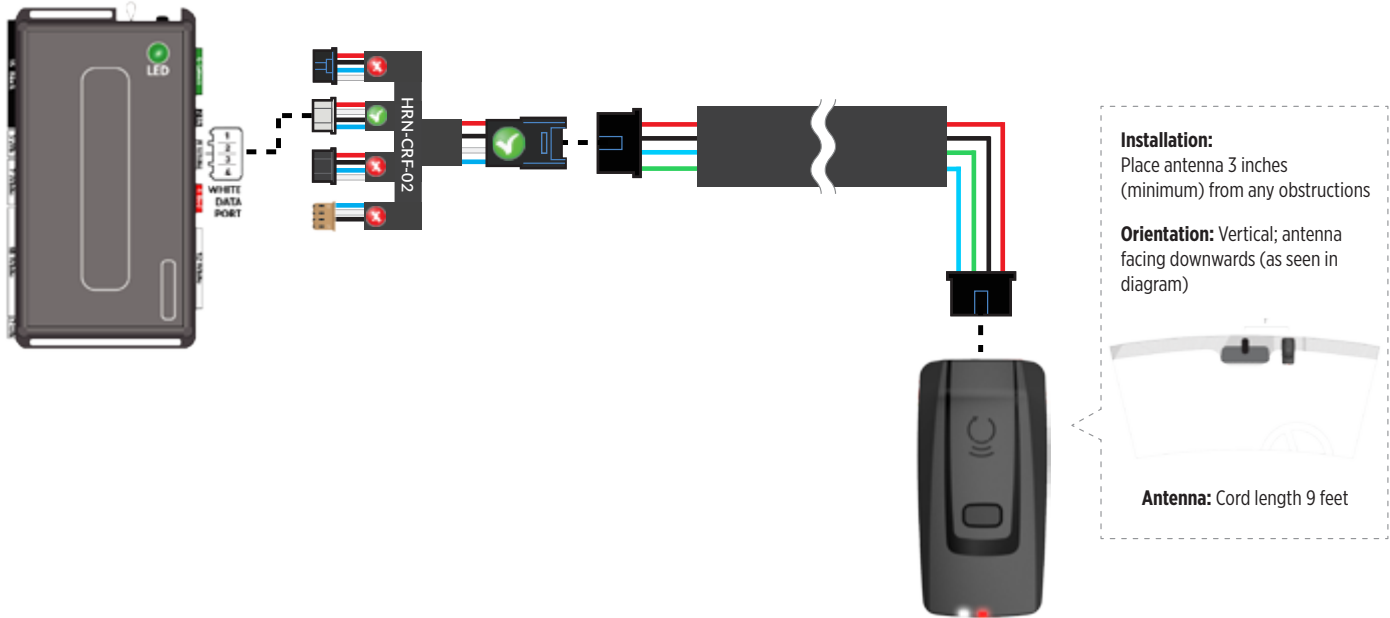

STEP 3. ADD A DEVICE/VEHICLE TO AN ACCOUNT

- Download the App and Log into your account (see page 2 of this document for details)
- Click the “+” sign at the bottom right of the Application screen. This will allow you to temporarily add and configure your customers system inside your personal account. A system refers to the Antenna being installed in the windshield of the vehicle.
- Before adding a system to your device, ensure the remote starter IS NOT armed/locked or in Valet mode and set the ignition of the vehicle to the On position.
- Then Tap to “Scan QR Code” and use the smartphone camera to scan the QR Code located on top of the antenna.
- Once connected, the system is in “Installer Mode”. Follow the on-screen instructions for configuring the system.

STEP 4. PRE-CONFIGURE THE APPLICATION EXPERIENCE FOR YOUR CUSTOMER

- Start by setting the protocol of the antenna being used. This is achieved by selecting the Brand, Model and protocol used inside the Remote starter. When done, click on “Confirm”. System will now try to communicate with the remote starter to confirm that all settings related to protocol are valid.
- Once back in the control panel, click on the Settings Gear at the top right of the screen and edit the Vehicle name, configure the Auxiliaries that might have been added (if applicable) and click “OK” when done. Then choose the vehicle to display inside the control panel in the VEHICLE IMAGE section and click OK.
- When your configurations are all completed, click “OK” at the top right corner. All Configurations will take effect.

STEP 5. TESTING THE SYSTEM

When the system is connected and fully configured, testing can begin. Test all the application functions (Start, Stop, Lock, Unlock, Auxiliaries, Etc.) When testing is completed, tap on the “installer icon” at the top of control screen. When prompted Click “Yes, and delete system from account” since this is the installer mode and not the End User mode. This will make the system “Ready for Customer Delivery”.

Also make sure that the Owners Card is handed to the Owner of the vehicle or attached to the vehicle keychain. Doing this will ensure that the instructions on how to setup their App, Account and add the System is done correctly by using the system QR Code affixed on the windshield mounted antenna.



NOTE : UNDER ANY CIRCUMSTANCES, PLEASE DO NOT REMOVE THE QR CODE FROM THE ANTENNA!

PARTS REQUIRED FOR INSTALLATION OF : DIRECTED DS4 - DS4+

<p>XTX-3000</p> 	<p>IVU-CAB-4W</p> 	<p>DS4 / DS4+</p> 	<p>HRN-CRF-02</p> 
---	---	--	---

STEP 1. CONFIGURE THE REMOTE STARTER

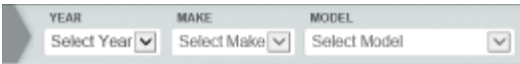
The XKloader 2 or 3 is required to properly configure the DS4 - DS4+ remote starter to accept the RF kit system. When flashing the DS4 - DS4+ remote starter, **please follow this procedure in order to configure correctly your remote starter.**

<p>a. Go to www.directechs.com and click on “Flash module”</p>	
<p>b. Choose vehicle Make, Model, Year</p>	
<p>c. Run thru the configuration process and make sure to choose “Remote Start”</p>	<input checked="" type="checkbox"/> Remote Start
<p>d. Choose “SmartStart” option.</p>	<input type="checkbox"/> 
<p>e. Complete the configuration process.</p>	
<p>f. Click “Flash!”</p>	

CARLINK™ INSTALLATION, WIRING & PROGRAMMING GUIDE

STEP 2. CONNECT

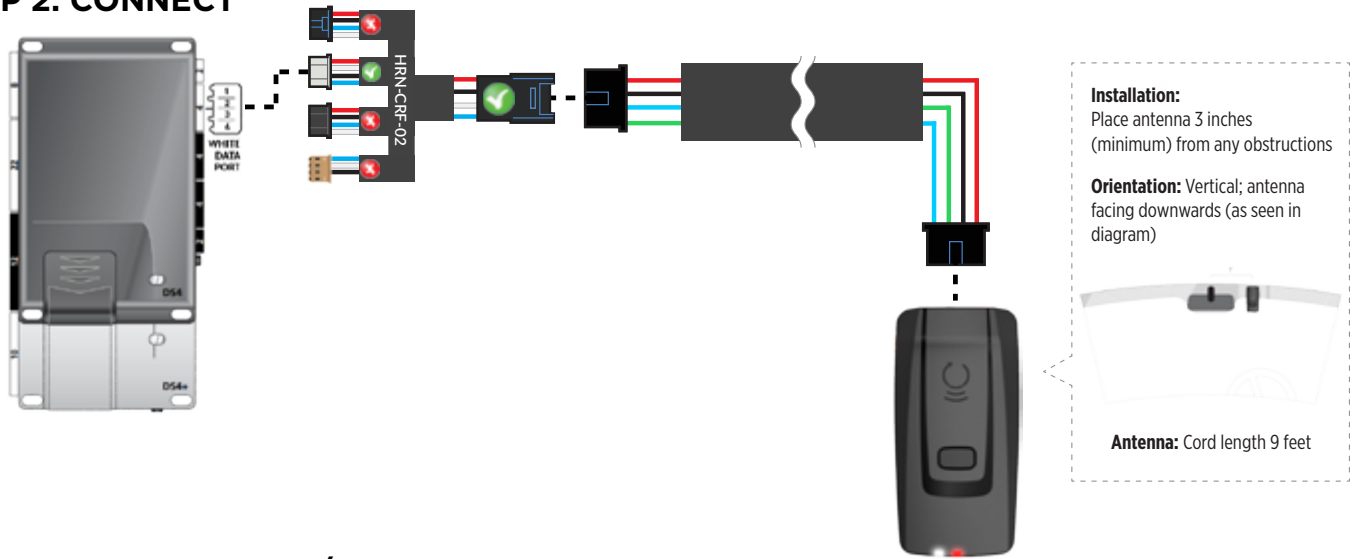

STEP 3. ADD A DEVICE/VEHICLE TO AN ACCOUNT

- Download the App and Log into your account (see page 2 of this document for details)
- Click the “+” sign at the bottom right of the Application screen. This will allow you to temporarily add and configure your customers system inside your personal account. A system refers to the Antenna being installed in the windshield of the vehicle.
- Before adding a system to your device, ensure the remote starter IS NOT armed/locked or in Valet mode and set the ignition of the vehicle to the On position.
- Then Tap to “Scan QR Code” and use the smartphone camera to scan the QR Code located on top of the antenna.
- Once connected, the system is in “Installer Mode”. Follow the on-screen instructions for configuring the system.

STEP 4. PRE-CONFIGURE THE APPLICATION EXPERIENCE FOR YOUR CUSTOMER

- Start by setting the protocol of the antenna being used. This is achieved by selecting the Brand, Model and protocol used inside the Remote starter. When done, click on “Confirm”. System will now try to communicate with the remote starter to confirm that all settings related to protocol are valid.
- Once back in the control panel, click on the Settings Gear at the top right of the screen and edit the Vehicle name, configure the Auxiliaries that might have been added (if applicable) and click “OK” when done. Then choose the vehicle to display inside the control panel in the VEHICLE IMAGE section and click OK.
- When your configurations are all completed, click “OK” at the top right corner. All Configurations will take effect.

STEP 5. TESTING THE SYSTEM

When the system is connected and fully configured, testing can begin. Test all the application functions (Start, Stop, Lock, Unlock, Auxiliaries, Etc.) When testing is completed, tap on the “installer icon” at the top of control screen. When prompted Click “Yes, and delete system from account” since this is the installer mode and not the End User mode. This will make the system “Ready for Customer Delivery”.

Also make sure that the Owners Card is handed to the Owner of the vehicle or attached to the vehicle keychain. Doing this will ensure that the instructions on how to setup their App, Account and add the System is done correctly by using the system QR Code affixed on the windshield mounted antenna.

NOTE : UNDER ANY CIRCUMSTANCES, PLEASE DO NOT REMOVE THE QR CODE FROM THE ANTENNA!

PARTS REQUIRED FOR INSTALLATION OF : FORTIN EVO-ALL

XTX-3000



IVU-CAB-4W



EVO-ALL



HRN-CRF-02



IMPORTANT NOTE: THESE REMOTE STARTER MODELS ARE CURRENTLY NOT SUPPORTED BY THIS PRODUCT.

CAR:LINK™ INSTALLATION, WIRING & PROGRAMMING GUIDE

PARTS REQUIRED FOR INSTALLATION OF : FORTIN EVO-ONE

XTX-3000



IVU-CAB-4W



EVO-ONE







HRN-CRF-02



IMPORTANT NOTE: THESE REMOTE STARTER MODELS ARE CURRENTLY NOT SUPPORTED BY THIS PRODUCT.



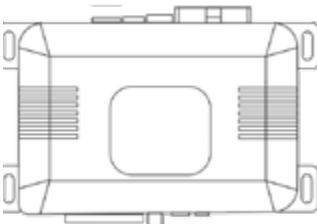

CAR:LINK™ INSTALLATION, WIRING & PROGRAMMING GUIDE

PARTS REQUIRED FOR INSTALLATION OF : PRESTIGE (E) Models

<p>XTX-3000</p> 	<p>IVU-CAB-4W</p> 	<p>(E) Model</p> 	<p>HRN-CRF-02</p> 
---	---	---	---

STEP 1. CONFIGURE THE REMOTE STARTER

The Voxx VEPROG is required to upgrade the latest Firmware and properly configure the Prestige (E) Model remote starter to accept the RF kit system. When updating the Prestige (E) Model remote starter, **please follow this procedure in order to configure correctly your remote starter.**

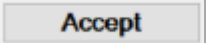
<p>a. Open "Internet Explorer 11" and go to "WWW.VEPROG.COM"</p>	
<p>b. Click on "Detect Device" button on the center of the screen</p>	
<p>c. Click on "Firmware Update" tab, then click on "FLASH" and wait for the update to be completed</p>	
<p>d. Choose from the Alarm programming menu, Feature #18, Option #3 or #4 - ADS TEL</p>	
<p>e. Click "Accept" at the bottom of the Unit option page</p>	

CARLINK™ INSTALLATION, WIRING & PROGRAMMING GUIDE

STEP 2. CONNECT

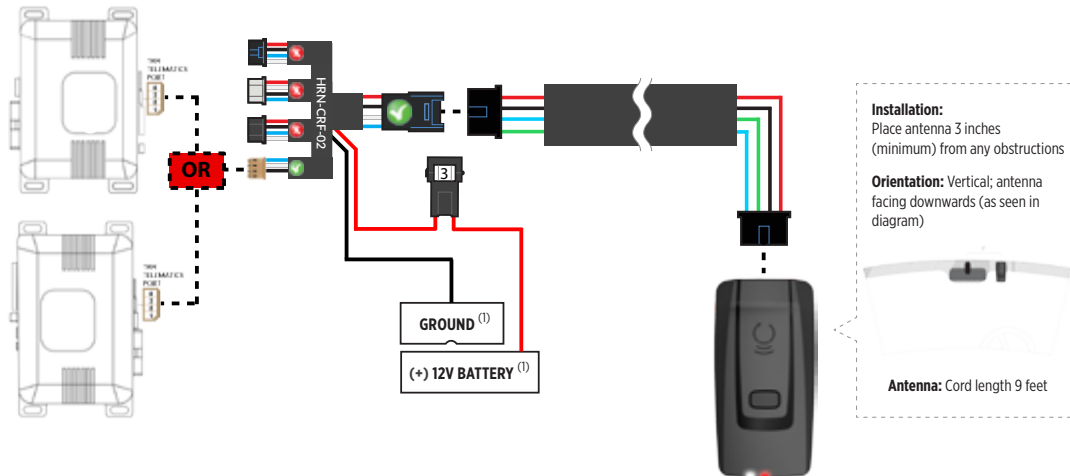

(1) Connect when using with PRESTIGE.

STEP 3. ADD A DEVICE/VEHICLE TO AN ACCOUNT

- Download the App and Log into your account (see page 2 of this document for details)
- Click the “+” sign at the bottom right of the Application screen. This will allow you to temporarily add and configure your customers system inside your personal account. A system refers to the Antenna being installed in the windshield of the vehicle.
- Before adding a system to your device, ensure the remote starter IS NOT armed/locked or in Valet mode and set the ignition of the vehicle to the On position.
- Then Tap to “Scan QR Code” and use the smartphone camera to scan the QR Code located on top of the antenna.
- Once connected, the system is in “Installer Mode”. Follow the on-screen instructions for configuring the system.

STEP 4. PRE-CONFIGURE THE APPLICATION EXPERIENCE FOR YOUR CUSTOMER

- Start by setting the protocol of the antenna being used. This is achieved by selecting the Brand, Model and protocol used inside the Remote starter. When done, click on “Confirm”. System will now try to communicate with the remote starter to confirm that all settings related to protocol are valid.
- Once back in the control panel, click on the Settings Gear at the top right of the screen and edit the Vehicle name, configure the Auxiliaries that might have been added (if applicable) and click “OK” when done. Then choose the vehicle to display inside the control panel in the VEHICLE IMAGE section and click OK.
- When your configurations are all completed, click “OK” at the top right corner. All Configurations will take effect.



STEP 5. TESTING THE SYSTEM

When the system is connected and fully configured, testing can begin. Test all the application functions (Start, Stop, Lock, Unlock, Auxiliaries, Etc.) When testing is completed, tap on the “installer icon” at the top of control screen. When prompted Click “Yes, and delete system from account” since this is the installer mode and not the End User mode. This will make the system “Ready for Customer Delivery”.

Also make sure that the Owners Card is handed to the Owner of the vehicle or attached to the vehicle keychain. Doing this will ensure that the instructions on how to setup their App, Account and add the System is done correctly by using the system QR Code affixed on the windshield mounted antenna.



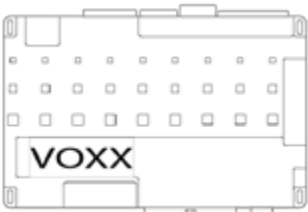

NOTE : UNDER ANY CIRCUMSTANCES, PLEASE DO NOT REMOVE THE QR CODE FROM THE ANTENNA!

PARTS REQUIRED FOR INSTALLATION OF : PRESTIGE (Z) Models

<p>XTX-3000</p> 	<p>IVU-CAB-4W</p> 	<p>(Z) Model</p> 	
---	---	---	--

STEP 1. CONFIGURE THE REMOTE STARTER

The ADS Weblink (ADS-USB) is required to properly configure the Prestige (Z) model remote starter to accept the RF kit system. When flashing the Prestige (Z) model remote starter, **please follow this procedure in order to configure correctly your remote starter.**

<p>a. Go to www.flashlogic.com and click on “Flash your module”</p>	
<p>b. Then click on “Flash my starter” in order to update the remote starter firmware</p>	
<p>c. Click “Flash!”</p>	
<p>d. Then go to “Configure my starter” and ensure the “ADS” option is selected under Programming bank 2, Data Port Protocol.</p>	
<p>e. Click “Save All”</p>	

CAR:LINK™ INSTALLATION, WIRING & PROGRAMMING GUIDE

STEP 2. CONNECT

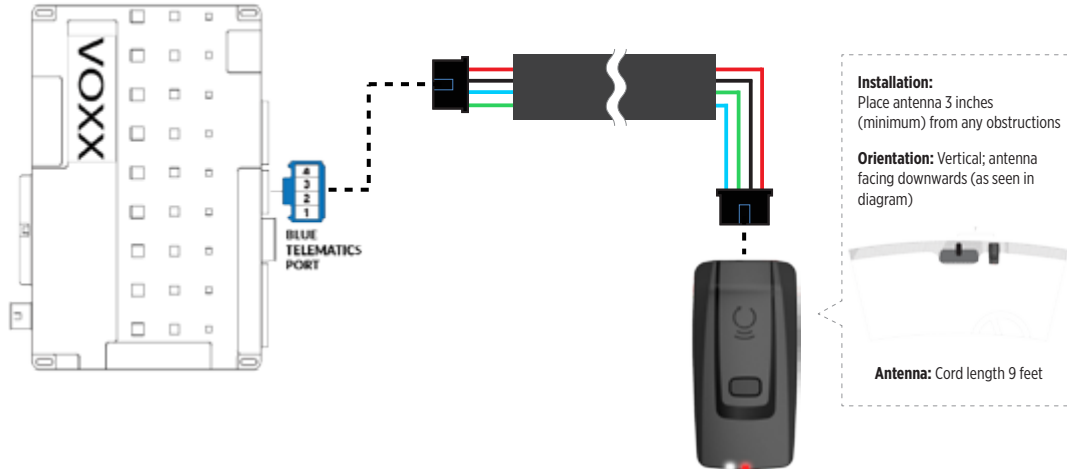

STEP 3. ADD A DEVICE/VEHICLE TO AN ACCOUNT

- Download the App and Log into your account (see page 2 of this document for details)
- Click the “+” sign at the bottom right of the Application screen. This will allow you to temporarily add and configure your customers system inside your personal account. A system refers to the Antenna being installed in the windshield of the vehicle.
- Before adding a system to your device, ensure the remote starter IS NOT armed/locked or in Valet mode and set the ignition of the vehicle to the On position.
- Then Tap to “Scan QR Code” and use the smartphone camera to scan the QR Code located on top of the antenna.
- Once connected, the system is in “Installer Mode”. Follow the on-screen instructions for configuring the system.

STEP 4. PRE-CONFIGURE THE APPLICATION EXPERIENCE FOR YOUR CUSTOMER

- Start by setting the protocol of the antenna being used. This is achieved by selecting the Brand, Model and protocol used inside the Remote starter. When done, click on “Confirm”. System will now try to communicate with the remote starter to confirm that all settings related to protocol are valid.
- Once back in the control panel, click on the Settings Gear at the top right of the screen and edit the Vehicle name, configure the Auxiliaries that might have been added (if applicable) and click “OK” when done. Then choose the vehicle to display inside the control panel in the VEHICLE IMAGE section and click OK.
- When your configurations are all completed, click “OK” at the top right corner. All Configurations will take effect.





STEP 5. TESTING THE SYSTEM

When the system is connected and fully configured, testing can begin. Test all the application functions (Start, Stop, Lock, Unlock, Auxiliaries, Etc.) When testing is completed, tap on the “installer icon” at the top of control screen. When prompted Click “Yes, and delete system from account” since this is the installer mode and not the End User mode. This will make the system “Ready for Customer Delivery”.

Also make sure that the Owners Card is handed to the Owner of the vehicle or attached to the vehicle keychain. Doing this will ensure that the instructions on how to setup their App, Account and add the System is done correctly by using the system QR Code affixed on the windshield mounted antenna.



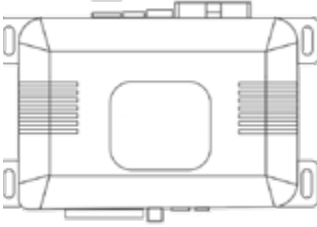

NOTE : UNDER ANY CIRCUMSTANCES, PLEASE DO NOT REMOVE THE QR CODE FROM THE ANTENNA!

PARTS REQUIRED FOR INSTALLATION OF : PURSUIT (E) Models

<p>XTX-3000</p> 	<p>IVU-CAB-4W</p> 	<p>(E) Model (Exc.PRO9233E)</p> 	<p>HRN-CRF-02</p> 
---	---	--	---

STEP 1. CONFIGURE THE REMOTE STARTER

The Voxx VEPROG is required to upgrade the latest Firmware and properly configure the Prestige (E) Model remote starter to accept the RF kit system. When updating the Prestige (E) Model remote starter, **please follow this procedure in order to configure correctly your remote starter.**

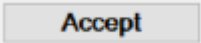
<p>a. Open "Internet Explorer 11" and go to "WWW.VEPROG.COM"</p>	
<p>b. Click on "Detect Device" button on the center of the screen</p>	
<p>c. Click on "Firmware Update" tab, then click on "FLASH" and wait for the update to be completed</p>	
<p>d. Choose from the Alarm programming menu, Feature #18, Option #3 or #4 - ADS TEL</p>	
<p>e. Click "Accept" at the bottom of the Unit option page</p>	

CAR:LINK™ INSTALLATION, WIRING & PROGRAMMING GUIDE

STEP 2. CONNECT

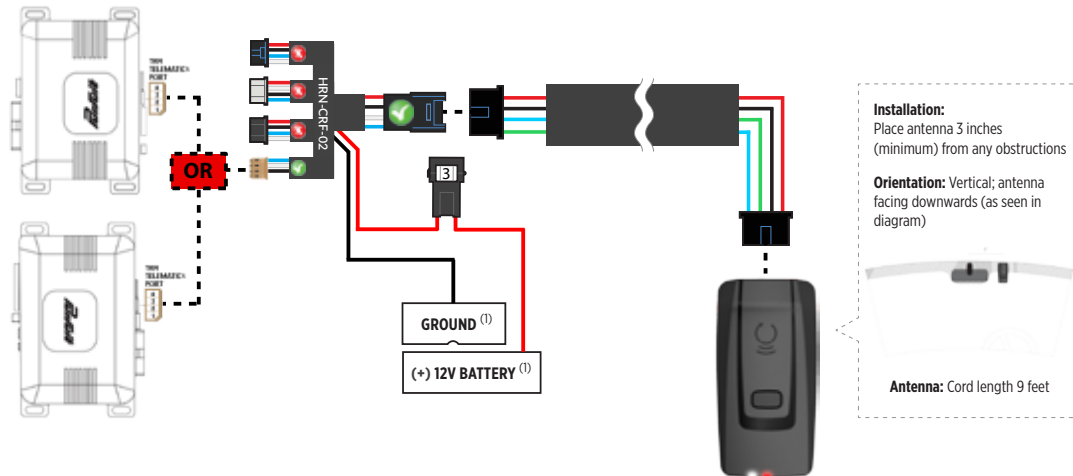

(1) Connect when using with PURSUIT.

STEP 3. ADD A DEVICE/VEHICLE TO AN ACCOUNT

- Download the App and Log into your account (see page 2 of this document for details)
- Click the “+” sign at the bottom right of the Application screen. This will allow you to temporarily add and configure your customers system inside your personal account. A system refers to the Antenna being installed in the windshield of the vehicle.
- Before adding a system to your device, ensure the remote starter IS NOT armed/locked or in Valet mode and set the ignition of the vehicle to the On position.
- Then Tap to “Scan QR Code” and use the smartphone camera to scan the QR Code located on top of the antenna.
- Once connected, the system is in “Installer Mode”. Follow the on-screen instructions for configuring the system.

STEP 4. PRE-CONFIGURE THE APPLICATION EXPERIENCE FOR YOUR CUSTOMER

- Start by setting the protocol of the antenna being used. This is achieved by selecting the Brand, Model and protocol used inside the Remote starter. When done, click on “Confirm”. System will now try to communicate with the remote starter to confirm that all settings related to protocol are valid.
- Once back in the control panel, click on the Settings Gear at the top right of the screen and edit the Vehicle name, configure the Auxiliaries that might have been added (if applicable) and click “OK” when done. Then choose the vehicle to display inside the control panel in the VEHICLE IMAGE section and click OK.
- When your configurations are all completed, click “OK” at the top right corner. All Configurations will take effect.



STEP 5. TESTING THE SYSTEM

When the system is connected and fully configured, testing can begin. Test all the application functions (Start, Stop, Lock, Unlock, Auxiliaries, Etc.) When testing is completed, tap on the “installer icon” at the top of control screen. When prompted Click “Yes, and delete system from account” since this is the installer mode and not the End User mode. This will make the system “Ready for Customer Delivery”.

Also make sure that the Owners Card is handed to the Owner of the vehicle or attached to the vehicle keychain. Doing this will ensure that the instructions on how to setup their App, Account and add the System is done correctly by using the system QR Code affixed on the windshield mounted antenna.



NOTE : UNDER ANY CIRCUMSTANCES, PLEASE DO NOT REMOVE THE QR CODE FROM THE ANTENNA!

PARTS REQUIRED FOR INSTALLATION OF : CODE SYSTEMS

<p>XTX-3000</p> 	<p>IVU-CAB-4W</p> 	<p>CASECRS, CARS, CA4555, CA4055 or CA5055</p> 	<p>HRN-CRF-02</p> 
---	---	---	---

STEP 1. CONFIGURE THE REMOTE STARTER

The Voxx VEPROG is required to upgrade the latest Firmware and properly configure the Code Alarm CASECRS, CARS, CA4555, CA4055 or CA5055 remote starter to accept the RF kit system. When updating the Code Alarm CASECRS, CARS, CA4555, CA4055 or CA5055 remote starter, **please follow this procedure in order to configure correctly your remote starter.**

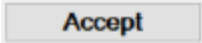
<p>a. Open the “Code Alarm Utility App”</p>	
<p>b. Click on “Firmware Update” button at the top right of the screen and wait for the update to be completed</p>	
<p>c. Choose from the programming Bank #2, Feature #9, Option #3 or #4 - ADS Telematics</p>	<p>2.9 DBI Port Protocol /Telematic Port Protocol</p> <p> <input type="radio"/> DBI /Voxx Telematic (1 LED FLASH) <input type="radio"/> ADS /Voxx Telematic (2 LED FLASH) <input type="radio"/> DBI/ ADS Telematic (3 LED FLASH) </p> <p> <input checked="" type="radio"/> ADS/ ADS Telematic (4 LED FLASH) </p>
<p>d. Click “Accept” at the bottom of the Unit option page</p>	

CARLINK™ INSTALLATION, WIRING & PROGRAMMING GUIDE

STEP 2. CONNECT

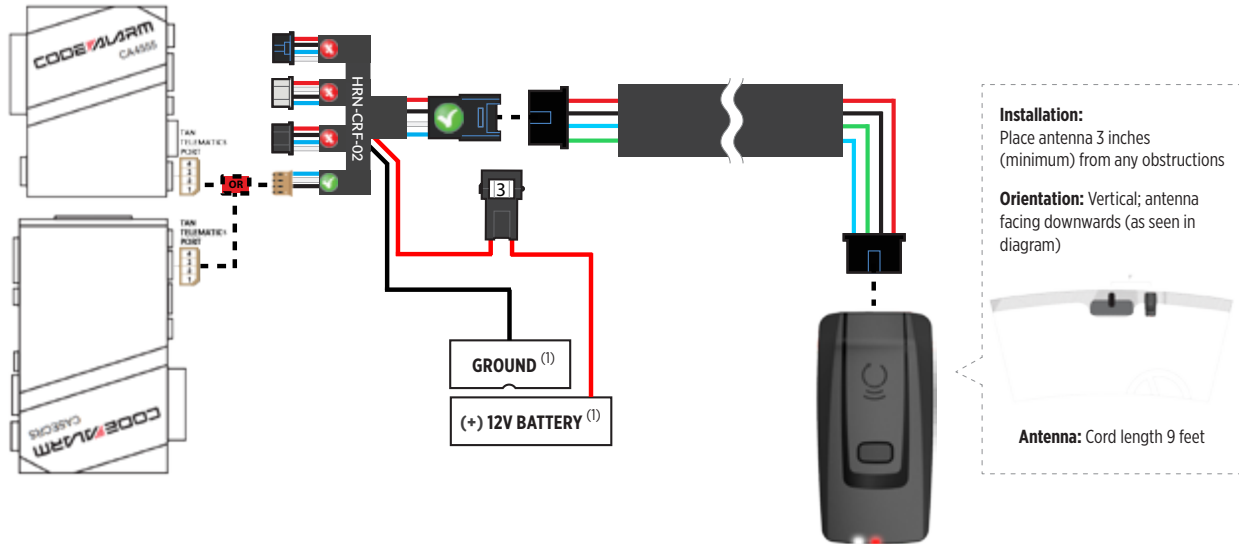

(1) Connect when using with CODE ALARM.

STEP 3. ADD A DEVICE/VEHICLE TO AN ACCOUNT

- Download the App and Log into your account (see page 2 of this document for details)
- Click the "+" sign at the bottom right of the Application screen. This will allow you to temporarily add and configure your customers system inside your personal account. A system refers to the Antenna being installed in the windshield of the vehicle.
- Before adding a system to your device, ensure the remote starter IS NOT armed/locked or in Valet mode and set the ignition of the vehicle to the On position.
- Then Tap to "Scan QR Code" and use the smartphone camera to scan the QR Code located on top of the antenna.
- Once connected, the system is in "Installer Mode". Follow the on-screen instructions for configuring the system.

STEP 4. PRE-CONFIGURE THE APPLICATION EXPERIENCE FOR YOUR CUSTOMER

- Start by setting the protocol of the antenna being used. This is achieved by selecting the Brand, Model and protocol used inside the Remote starter. When done, click on "Confirm". System will now try to communicate with the remote starter to confirm that all settings related to protocol are valid.
- Once back in the control panel, click on the Settings Gear at the top right of the screen and edit the Vehicle name, configure the Auxiliaries that might have been added (if applicable) and click "OK" when done. Then choose the vehicle to display inside the control panel in the VEHICLE IMAGE section and click OK.
- When your configurations are all completed, click "OK" at the top right corner. All Configurations will take effect.

STEP 5. TESTING THE SYSTEM

When the system is connected and fully configured, testing can begin. Test all the application functions (Start, Stop, Lock, Unlock, Auxiliaries, Etc.) When testing is completed, tap on the "installer icon" at the top of control screen. When prompted Click "Yes, and delete system from account" since this is the installer mode and not the End User mode. This will make the system "Ready for Customer Delivery".

Also make sure that the Owners Card is handed to the Owner of the vehicle or attached to the vehicle keychain. Doing this will ensure that the instructions on how to setup their App, Account and add the System is done correctly by using the system QR Code affixed on the windshield mounted antenna.

NOTE : UNDER ANY CIRCUMSTANCES, PLEASE DO NOT REMOVE THE QR CODE FROM THE ANTENNA!

PARTS REQUIRED FOR INSTALLATION OF : OLDER CODE SYSTEMS

XTX-3000



IVU-CAB-4W



OLDER CODE ALARM



HRN-CRF-02



STEP 1. CONFIGURE THE REMOTE STARTER

The Older Code Alarm remote starter are already pre-configured to accept the RF kit system. No extra programming required.

CARLINK™ INSTALLATION, WIRING & PROGRAMMING GUIDE

STEP 2. CONNECT

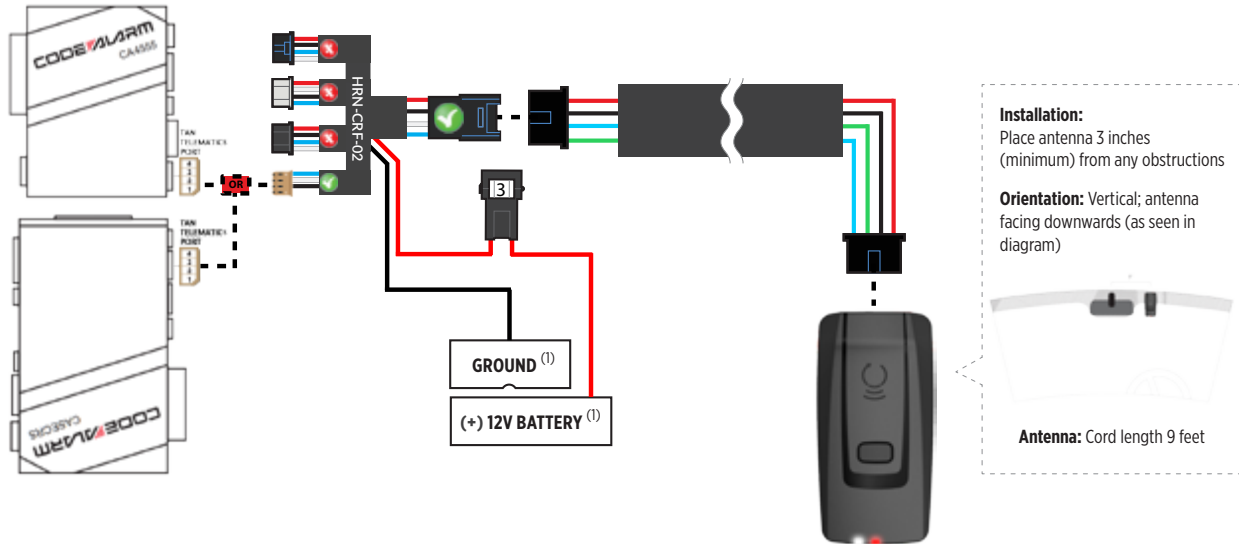

(1) Connect when using with CODE ALARM.

STEP 3. ADD A DEVICE/VEHICLE TO AN ACCOUNT

- Download the App and Log into your account (see page 2 of this document for details)
- Click the “+” sign at the bottom right of the Application screen. This will allow you to temporarily add and configure your customers system inside your personal account. A system refers to the Antenna being installed in the windshield of the vehicle.
- Before adding a system to your device, ensure the remote starter IS NOT armed/locked or in Valet mode and set the ignition of the vehicle to the On position.
- Then Tap to “Scan QR Code” and use the smartphone camera to scan the QR Code located on top of the antenna.
- Once connected, the system is in “Installer Mode”. Follow the on-screen instructions for configuring the system.

STEP 4. PRE-CONFIGURE THE APPLICATION EXPERIENCE FOR YOUR CUSTOMER

- Start by setting the protocol of the antenna being used. This is achieved by selecting the Brand, Model and protocol used inside the Remote starter. When done, click on “Confirm”. System will now try to communicate with the remote starter to confirm that all settings related to protocol are valid.
- Once back in the control panel, click on the Settings Gear at the top right of the screen and edit the Vehicle name, configure the Auxiliaries that might have been added (if applicable) and click “OK” when done. Then choose the vehicle to display inside the control panel in the VEHICLE IMAGE section and click OK.
- When your configurations are all completed, click “OK” at the top right corner. All Configurations will take effect.



STEP 5. TESTING THE SYSTEM

When the system is connected and fully configured, testing can begin. Test all the application functions (Start, Stop, Lock, Unlock, Auxiliaries, Etc.) When testing is completed, tap on the “installer icon” at the top of control screen. When prompted Click “Yes, and delete system from account” since this is the installer mode and not the End User mode. This will make the system “Ready for Customer Delivery”.

Also make sure that the Owners Card is handed to the Owner of the vehicle or attached to the vehicle keychain. Doing this will ensure that the instructions on how to setup their App, Account and add the System is done correctly by using the system QR Code affixed on the windshield mounted antenna.





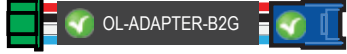

NOTE : UNDER ANY CIRCUMSTANCES, PLEASE DO NOT REMOVE THE QR CODE FROM THE ANTENNA!

PARTS REQUIRED FOR INSTALLATION OF : OMEGA RS-X70

<p>XTX-3000</p> 	<p>IVU-CAB-4W</p> 	<p>RS-X70</p> 	<p>OL-ADAPTER-B2G (optional)</p> 
---	---	--	--

STEP 1. CONFIGURE THE REMOTE STARTER

The ADS Weblink (ADS-USB) is required to properly configure the Omega RS-X70 remote starter to accept the RF kit system. **Follow this procedure in order to configure correctly your remote starter.**

<p>a. Go to www.omegaweblink.com and click on “Flash your module”</p>	
<p>b. Go Under “FLASH MY STARTER” tab</p>	
<p>c. Click “Flash!”</p>	
<p>d. Once done, click on “CONFIGURE MY STARTER” tab</p>	
<p>e. Find “Data Port Protocol” and set it to “Green=iData”</p>	
<p>f. Click “Save Now”</p>	

CARLINK™ INSTALLATION, WIRING & PROGRAMMING GUIDE

STEP 2. CONNECT

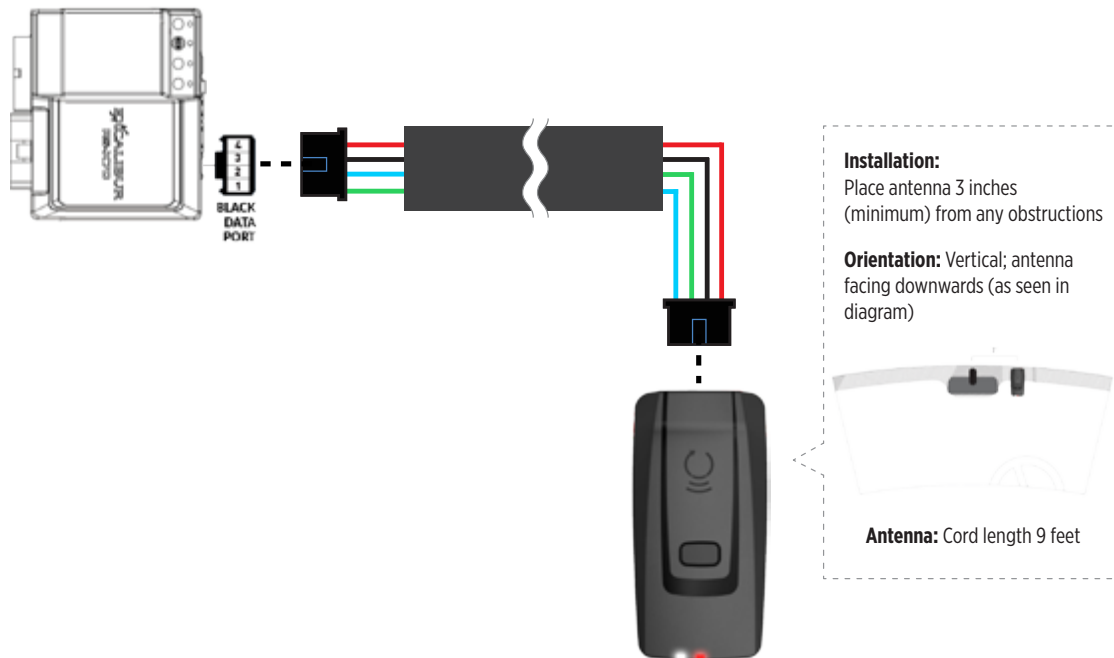

STEP 3. ADD A DEVICE/VEHICLE TO AN ACCOUNT

- Download the App and Log into your account (see page 2 of this document for details)
- Click the “+” sign at the bottom right of the Application screen. This will allow you to temporarily add and configure your customers system inside your personal account. A system refers to the Antenna being installed in the windshield of the vehicle.
- Before adding a system to your device, ensure the remote starter IS NOT armed/locked or in Valet mode and set the ignition of the vehicle to the On position.
- Then Tap to “Scan QR Code” and use the smartphone camera to scan the QR Code located on top of the antenna.
- Once connected, the system is in “Installer Mode”. Follow the on-screen instructions for configuring the system.

STEP 4. PRE-CONFIGURE THE APPLICATION EXPERIENCE FOR YOUR CUSTOMER

- Start by setting the protocol of the antenna being used. This is achieved by selecting the Brand, Model and protocol used inside the Remote starter. When done, click on “Confirm”. System will now try to communicate with the remote starter to confirm that all settings related to protocol are valid.
- Once back in the control panel, click on the Settings Gear at the top right of the screen and edit the Vehicle name, configure the Auxiliaries that might have been added (if applicable) and click “OK” when done. Then choose the vehicle to display inside the control panel in the VEHICLE IMAGE section and click OK.
- When your configurations are all completed, click “OK” at the top right corner. All Configurations will take effect.





STEP 5. TESTING THE SYSTEM

When the system is connected and fully configured, testing can begin. Test all the application functions (Start, Stop, Lock, Unlock, Auxiliaries, Etc.) When testing is completed, tap on the “installer icon” at the top of control screen. When prompted Click “Yes, and delete system from account” since this is the installer mode and not the End User mode. This will make the system “Ready for Customer Delivery”.

Also make sure that the Owners Card is handed to the Owner of the vehicle or attached to the vehicle keychain. Doing this will ensure that the instructions on how to setup their App, Account and add the System is done correctly by using the system QR Code affixed on the windshield mounted antenna.



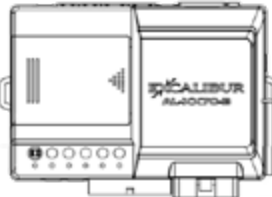
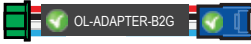



NOTE : UNDER ANY CIRCUMSTANCES, PLEASE DO NOT REMOVE THE QR CODE FROM THE ANTENNA!

PARTS REQUIRED FOR INSTALLATION OF : OMEGA AL-XX70-B

<p>XTX-3000</p> 	<p>IVU-CAB-4W</p> 	<p>AL-XX70-B</p> 	<p>OL-ADAPTER-B2G (optional)</p> 	<p>OL-BLADE-AL (64)</p> 
---	---	--	---	---

STEP 1. CONFIGURE THE REMOTE STARTER

The ADS Weblink (ADS-USB) is required to properly configure the Omega AL-XX70-B remote starter to accept the RF kit system. **Follow this procedure in order to configure correctly your remote starter.**

<p>a. Go to www.omegawebink.com and click on “Flash your module”</p>	
<p>b. Go Under “FLASH MY STARTER” tab</p>	
<p>c. Click “Flash!”</p>	
<p>d. Once done, click on “CONFIGURE MY STARTER” tab</p>	
<p>e. Find “Data Port Protocol” and set it to “Green=iData”</p>	
<p>f. Click “Save Now”</p>	

CARLINK™ INSTALLATION, WIRING & PROGRAMMING GUIDE

STEP 2. CONNECT

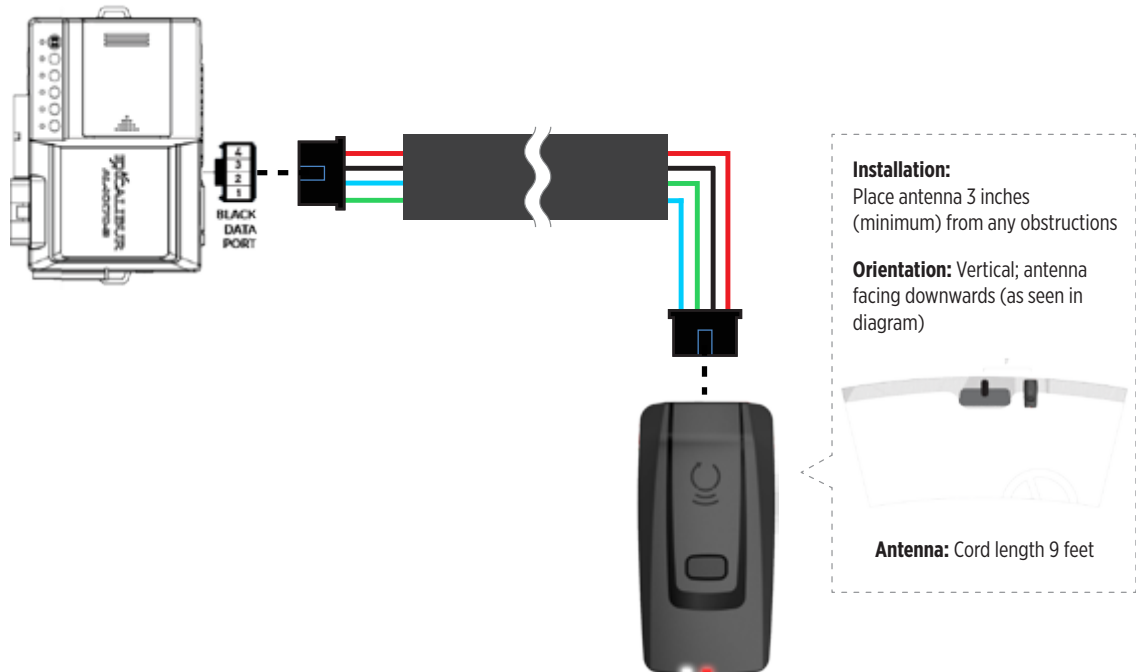

STEP 3. ADD A DEVICE/VEHICLE TO AN ACCOUNT

- Download the App and Log into your account (see page 2 of this document for details)
- Click the “+” sign at the bottom right of the Application screen. This will allow you to temporarily add and configure your customers system inside your personal account. A system refers to the Antenna being installed in the windshield of the vehicle.
- Before adding a system to your device, ensure the remote starter IS NOT armed/locked or in Valet mode and set the ignition of the vehicle to the On position.
- Then Tap to “Scan QR Code” and use the smartphone camera to scan the QR Code located on top of the antenna.
- Once connected, the system is in “Installer Mode”. Follow the on-screen instructions for configuring the system.

STEP 4. PRE-CONFIGURE THE APPLICATION EXPERIENCE FOR YOUR CUSTOMER

- Start by setting the protocol of the antenna being used. This is achieved by selecting the Brand, Model and protocol used inside the Remote starter. When done, click on “Confirm”. System will now try to communicate with the remote starter to confirm that all settings related to protocol are valid.
- Once back in the control panel, click on the Settings Gear at the top right of the screen and edit the Vehicle name, configure the Auxiliaries that might have been added (if applicable) and click “OK” when done. Then choose the vehicle to display inside the control panel in the VEHICLE IMAGE section and click OK.
- When your configurations are all completed, click “OK” at the top right corner. All Configurations will take effect.



STEP 5. TESTING THE SYSTEM

When the system is connected and fully configured, testing can begin. Test all the application functions (Start, Stop, Lock, Unlock, Auxiliaries, Etc.) When testing is completed, tap on the “installer icon” at the top of control screen. When prompted Click “Yes, and delete system from account” since this is the installer mode and not the End User mode. This will make the system “Ready for Customer Delivery”.

Also make sure that the Owners Card is handed to the Owner of the vehicle or attached to the vehicle keychain. Doing this will ensure that the instructions on how to setup their App, Account and add the System is done correctly by using the system QR Code affixed on the windshield mounted antenna.





NOTE : UNDER ANY CIRCUMSTANCES, PLEASE DO NOT REMOVE THE QR CODE FROM THE ANTENNA!

PARTS REQUIRED FOR INSTALLATION OF : OMEGA OL-RS

<p>XTX-3000</p> 	<p>IVU-CAB-4W</p> 	<p>Omega OL-RS</p> 	
---	---	---	--

STEP 1. CONFIGURE THE REMOTE STARTER

The ADS Weblink (ADS-USB) is required to properly configure the Omega OL-RS remote starter to accept the RF kit system. When flashing the Omega OL-RS remote starter, **please follow this procedure in order to configure correctly your remote starter.**

<p>a. Go to ww.omegaweblink.com and click on “Flash your module”</p>	
<p>b. Choose vehicle Make, Model, Year, Trim</p>	
<p>c. Choose “Excalibur RF Kit & Connected SmartControl”</p>	
<p>d. This will load a firmware starting with:</p>	<p>“OL-XX(XX)-XXX (X.X)”</p>
<p>e. Click “Flash!”</p>	

CARLINK™ INSTALLATION, WIRING & PROGRAMMING GUIDE

STEP 2. CONNECT

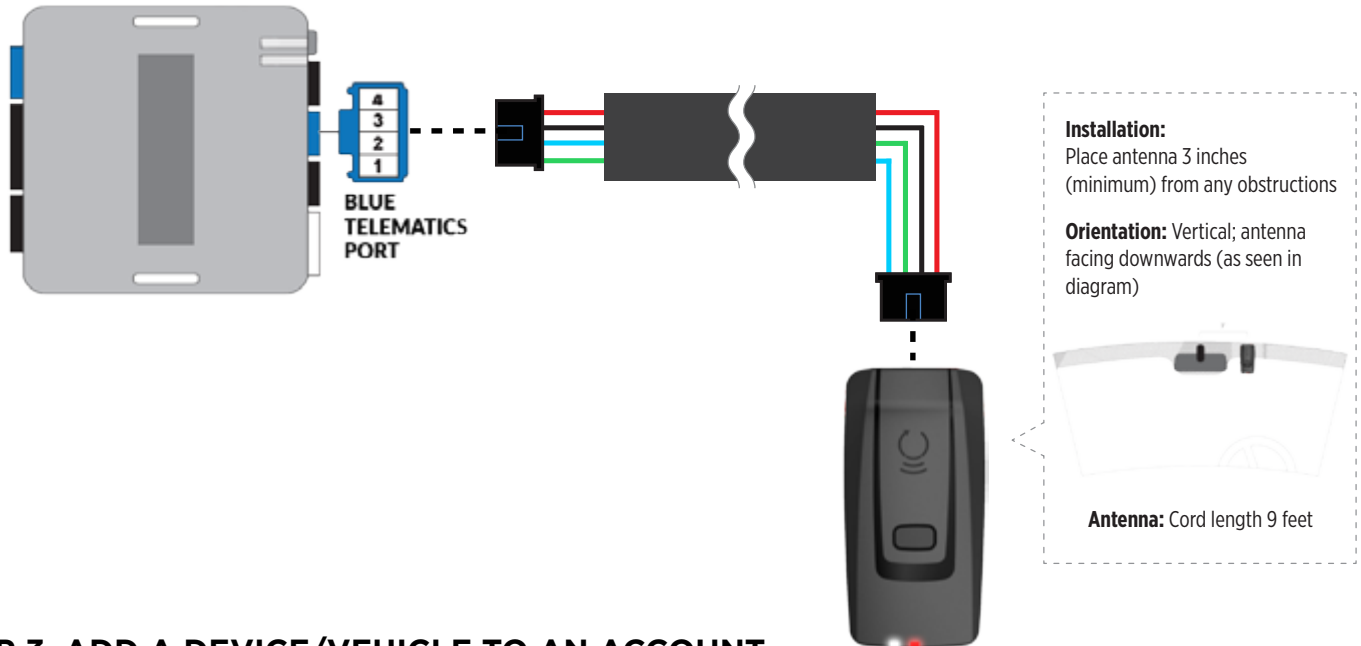

STEP 3. ADD A DEVICE/VEHICLE TO AN ACCOUNT

- Download the App and Log into your account (see page 2 of this document for details)
- Click the "+" sign at the bottom right of the Application screen. This will allow you to temporarily add and configure your customers system inside your personal account. A system refers to the Antenna being installed in the windshield of the vehicle.
- Before adding a system to your device, ensure the remote starter IS NOT armed/locked or in Valet mode and set the ignition of the vehicle to the On position.
- Then Tap to "Scan QR Code" and use the smartphone camera to scan the QR Code located on top of the antenna.
- Once connected, the system is in "Installer Mode". Follow the on-screen instructions for configuring the system.

STEP 4. PRE-CONFIGURE THE APPLICATION EXPERIENCE FOR YOUR CUSTOMER

- Start by setting the protocol of the antenna being used. This is achieved by selecting the Brand, Model and protocol used inside the Remote starter. When done, click on "Confirm". System will now try to communicate with the remote starter to confirm that all settings related to protocol are valid.
- Once back in the control panel, click on the Settings Gear at the top right of the screen and edit the Vehicle name, configure the Auxiliaries that might have been added (if applicable) and click "OK" when done. Then choose the vehicle to display inside the control panel in the VEHICLE IMAGE section and click OK.
- When your configurations are all completed, click "OK" at the top right corner. All Configurations will take effect.

STEP 5. TESTING THE SYSTEM

When the system is connected and fully configured, testing can begin. Test all the application functions (Start, Stop, Lock, Unlock, Auxiliaries, Etc.) When testing is completed, tap on the "installer icon" at the top of control screen. When prompted Click "Yes, and delete system from account" since this is the installer mode and not the End User mode. This will make the system "Ready for Customer Delivery".

Also make sure that the Owners Card is handed to the Owner of the vehicle or attached to the vehicle keychain. Doing this will ensure that the instructions on how to setup their App, Account and add the System is done correctly by using the system QR Code affixed on the windshield mounted antenna.

NOTE : UNDER ANY CIRCUMSTANCES, PLEASE DO NOT REMOVE THE QR CODE FROM THE ANTENNA!

PARTS REQUIRED FOR INSTALLATION OF : MIDCITY SMARTKEY STARTER

<p>XTX-3000</p> 	<p>IVU-CAB-4W</p> 	<p>NG Remote Starter</p> 	
---	---	---	--

STEP 1. CONFIGURE THE REMOTE STARTER

The Smartkey Starter NG series is already pre-configured to accept the telematics device. No extra programming required.

CAR:LINK™ INSTALLATION, WIRING & PROGRAMMING GUIDE

STEP 2. CONNECT

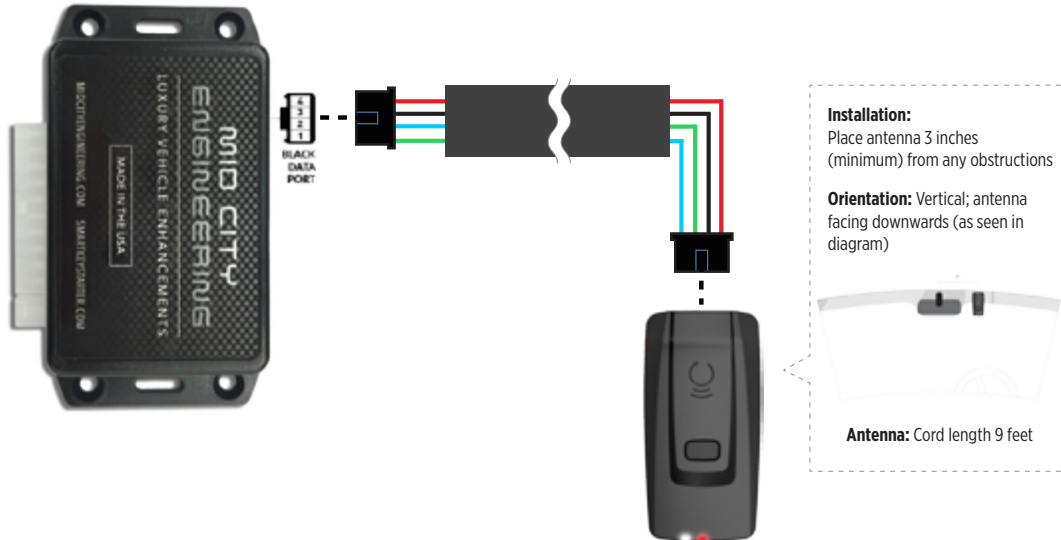

STEP 3. ADD A DEVICE/VEHICLE TO AN ACCOUNT

- Download the App and Log into your account (see page 2 of this document for details)
- Click the “+” sign at the bottom right of the Application screen. This will allow you to temporarily add and configure your customers system inside your personal account. A system refers to the Antenna being installed in the windshield of the vehicle.
- Before adding a system to your device, ensure the remote starter IS NOT armed/locked or in Valet mode and set the ignition of the vehicle to the On position.
- Then Tap to “Scan QR Code” and use the smartphone camera to scan the QR Code located on top of the antenna.
- Once connected, the system is in “Installer Mode”. Follow the on-screen instructions for configuring the system.

STEP 4. PRE-CONFIGURE THE APPLICATION EXPERIENCE FOR YOUR CUSTOMER

- Start by setting the protocol of the antenna being used. This is achieved by selecting the Brand, Model and protocol used inside the Remote starter. When done, click on “Confirm”. System will now try to communicate with the remote starter to confirm that all settings related to protocol are valid.
- Once back in the control panel, click on the Settings Gear at the top right of the screen and edit the Vehicle name, configure the Auxiliaries that might have been added (if applicable) and click “OK” when done. Then choose the vehicle to display inside the control panel in the VEHICLE IMAGE section and click OK.
- When your configurations are all completed, click “OK” at the top right corner. All Configurations will take effect.

STEP 5. TESTING THE SYSTEM

When the system is connected and fully configured, testing can begin. Test all the application functions (Start, Stop, Lock, Unlock, Auxiliaries, Etc.) When testing is completed, tap on the “installer icon” at the top of control screen. When prompted Click “Yes, and delete system from account” since this is the installer mode and not the End User mode. This will make the system “Ready for Customer Delivery”.

Also make sure that the Owners Card is handed to the Owner of the vehicle or attached to the vehicle keychain. Doing this will ensure that the instructions on how to setup their App, Account and add the System is done correctly by using the system QR Code affixed on the windshield mounted antenna.

NOTE : UNDER ANY CIRCUMSTANCES, PLEASE DO NOT REMOVE THE QR CODE FROM THE ANTENNA!

PARTS REQUIRED FOR INSTALLATION OF : DSE 503AIR 5R-85

<p>XTX-3000</p> 	<p>IVU-CAB-4W</p> 	<p>DSE 503AIR 5R85</p> 	
---	---	---	--

STEP 1. CONFIGURE THE REMOTE STARTER

The 503Air is already pre-configured to accept the RF kit system. No extra programming required.

CAR:LINK™ INSTALLATION, WIRING & PROGRAMMING GUIDE

STEP 2. CONNECT

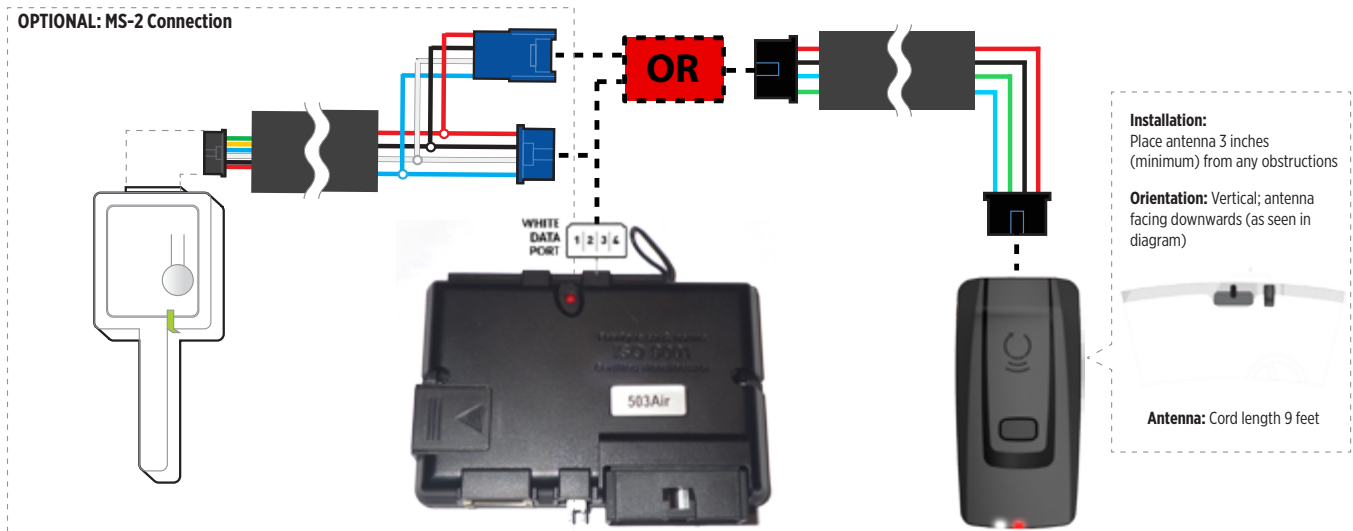

STEP 3. ADD A DEVICE/VEHICLE TO AN ACCOUNT

- Download the App and Log into your account (see page 2 of this document for details)
- Click the “+” sign at the bottom right of the Application screen. This will allow you to temporarily add and configure your customers system inside your personal account. A system refers to the Antenna being installed in the windshield of the vehicle.
- Before adding a system to your device, ensure the remote starter IS NOT armed/locked or in Valet mode and set the ignition of the vehicle to the On position.
- Then Tap to “Scan QR Code” and use the smartphone camera to scan the QR Code located on top of the antenna.
- Once connected, the system is in “Installer Mode”. Follow the on-screen instructions for configuring the system.

STEP 4. PRE-CONFIGURE THE APPLICATION EXPERIENCE FOR YOUR CUSTOMER

- Start by setting the protocol of the antenna being used. This is achieved by selecting the Brand, Model and protocol used inside the Remote starter. When done, click on “Confirm”. System will now try to communicate with the remote starter to confirm that all settings related to protocol are valid.
- Once back in the control panel, click on the Settings Gear at the top right of the screen and edit the Vehicle name, configure the Auxiliaries that might have been added (if applicable) and click “OK” when done. Then choose the vehicle to display inside the control panel in the VEHICLE IMAGE section and click OK.
- When your configurations are all completed, click “OK” at the top right corner. All Configurations will take effect.





STEP 5. TESTING THE SYSTEM

When the system is connected and fully configured, testing can begin. Test all the application functions (Start, Stop, Lock, Unlock, Auxiliaries, Etc.) When testing is completed, tap on the “installer icon” at the top of control screen. When prompted Click “Yes, and delete system from account” since this is the installer mode and not the End User mode. This will make the system “Ready for Customer Delivery”.

Also make sure that the Owners Card is handed to the Owner of the vehicle or attached to the vehicle keychain. Doing this will ensure that the instructions on how to setup their App, Account and add the System is done correctly by using the system QR Code affixed on the windshield mounted antenna.



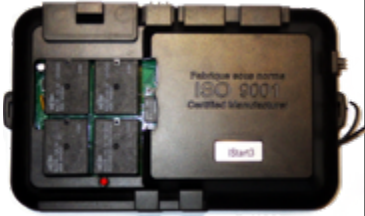

NOTE : UNDER ANY CIRCUMSTANCES, PLEASE DO NOT REMOVE THE QR CODE FROM THE ANTENNA!

PARTS REQUIRED FOR INSTALLATION OF : DSE iSTART2 - 3

<p>XTX-3000</p> 	<p>IVU-CAB-4W</p> 	<p>DSE iStart2 - 3 CI3R-86</p> 	<p>BLADE-AL (64)</p> 
---	---	---	--

STEP 1. CONFIGURE THE REMOTE STARTER

The ADS Weblink (ADS-USB) is required to properly configure the iStart2 - iStart3 remote starter to accept the RF kit system. When flashing the iStart2 - iStart3 remote starter, **please follow this procedure in order to configure correctly your remote starter.**

<p>a. Go to www.idatalink.com and click on “Flash your module”</p>	
<p>b. Under the ADS-BLADE AL tab, Choose vehicle Make, Model, Year, Trim</p>	
<p>c. Click “Flash!”</p>	
<p>d. Once done click on the Remote Starter tab and click on “Flash my starter” in order to update the remote starter firmware</p>	
<p>e. Click “Flash!”</p>	

CARLINK™ INSTALLATION, WIRING & PROGRAMMING GUIDE

STEP 2. CONNECT

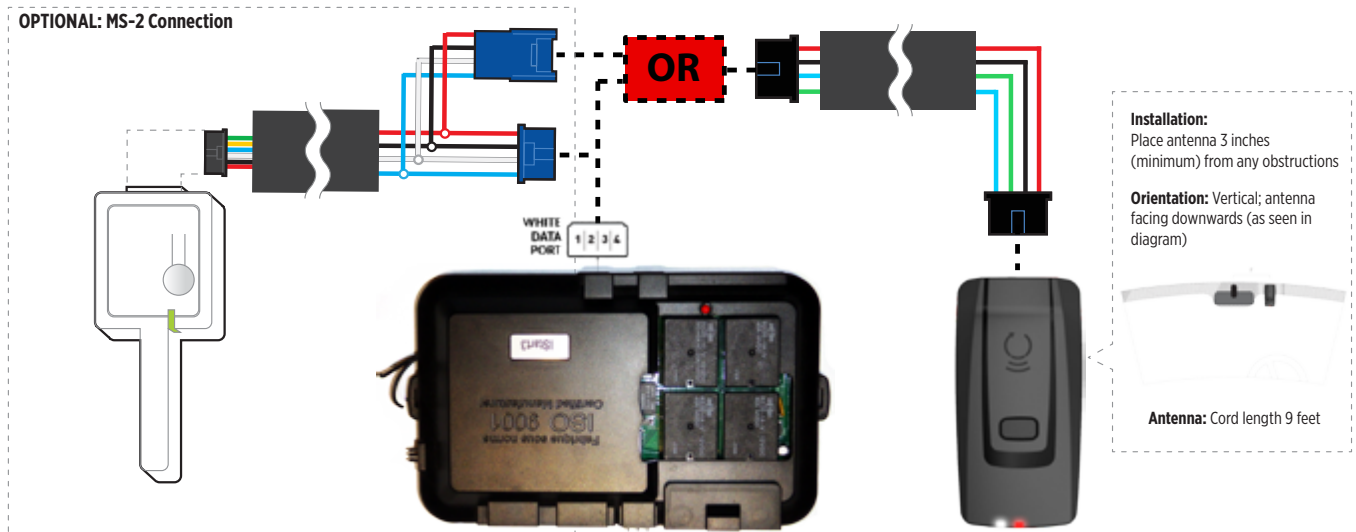

STEP 3. ADD A DEVICE/VEHICLE TO AN ACCOUNT

- Download the App and Log into your account (see page 2 of this document for details)
- Click the “+” sign at the bottom right of the Application screen. This will allow you to temporarily add and configure your customers system inside your personal account. A system refers to the Antenna being installed in the windshield of the vehicle.
- Before adding a system to your device, ensure the remote starter IS NOT armed/locked or in Valet mode and set the ignition of the vehicle to the On position.
- Then Tap to “Scan QR Code” and use the smartphone camera to scan the QR Code located on top of the antenna.
- Once connected, the system is in “Installer Mode”. Follow the on-screen instructions for configuring the system.

STEP 4. PRE-CONFIGURE THE APPLICATION EXPERIENCE FOR YOUR CUSTOMER

- Start by setting the protocol of the antenna being used. This is achieved by selecting the Brand, Model and protocol used inside the Remote starter. When done, click on “Confirm”. System will now try to communicate with the remote starter to confirm that all settings related to protocol are valid.
- Once back in the control panel, click on the Settings Gear at the top right of the screen and edit the Vehicle name, configure the Auxiliaries that might have been added (if applicable) and click “OK” when done. Then choose the vehicle to display inside the control panel in the VEHICLE IMAGE section and click OK.
- When your configurations are all completed, click “OK” at the top right corner. All Configurations will take effect.

STEP 5. TESTING THE SYSTEM

When the system is connected and fully configured, testing can begin. Test all the application functions (Start, Stop, Lock, Unlock, Auxiliaries, Etc.) When testing is completed, tap on the “installer icon” at the top of control screen. When prompted Click “Yes, and delete system from account” since this is the installer mode and not the End User mode. This will make the system “Ready for Customer Delivery”.

Also make sure that the Owners Card is handed to the Owner of the vehicle or attached to the vehicle keychain. Doing this will ensure that the instructions on how to setup their App, Account and add the System is done correctly by using the system QR Code affixed on the windshield mounted antenna.

NOTE : UNDER ANY CIRCUMSTANCES, PLEASE DO NOT REMOVE THE QR CODE FROM THE ANTENNA!

System LED Status & Protocol Reference Chart

LED Status	Protocol		
	Name	inside Application	inside Remote Starter
1x Flash	Connected RF protocol	Connected RF	IDPP
2x Flashes	Directed protocol	SMARTSTART	SMARTSTART
3x Flashes	ADS Telematics protocol	ADS TEL	ADS TEL or DRONE
4x Flashes	Fortin protocol	Fortin 2	Fortin 2
5x Flashes	Compustar	Drone	Drone
6x Flashes	Posse protocol	Voxx Tel	Voxx Tel
7x Flashes	N/A	N/A	N/A
8x Flashes	No protocol - (Default)	N/A	N/A

Reset Procedure

- 1 - Disconnect the main harness from the Antenna.
- 2 - Wait approximately 10 seconds and reconnect the main harness to the Antenna.
- 3 - Reset procedure Completed.

CAR:LINK™ INSTALLATION, WIRING & PROGRAMMING GUIDE

CAR:LINK™

400 Wright st.
Ville St-Laurent, Quebec
H4N1M6 - CANADA

©2020 Lightwave Technology Inc. All rights reserved.