

This manual should be considered a permanent part of the scooter and should remain with the scooter when it is resold.

This publication includes the latest production information available before printing. Honda Motor Co., Ltd. reserves the right to make changes at any time without notice and without incurring any obligation.

No part of this publication may be reproduced without written permission.

The vehicle pictured on the front cover may not match your vehicle.

© 2006 Honda Motor Co., Ltd.

**2007  
Honda CH80  
ELITE 80  
OWNER'S MANUAL**

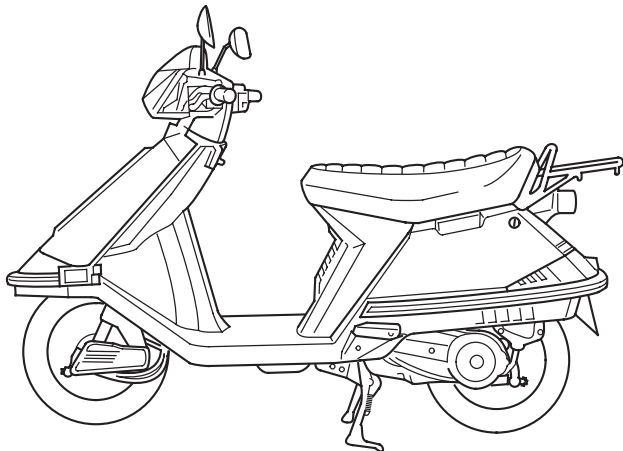

# Introduction

---

Congratulations on choosing your Honda scooter.

When you own a Honda, you're part of a worldwide family of satisfied customers — people who appreciate Honda's reputation for building quality into every product.

Before riding, take time to get acquainted with your scooter and how it works. To protect your investment, we urge you to take responsibility for keeping your scooter well maintained. Scheduled service is a must, of course. But it's just as important to observe the break-in guidelines, and perform all pre-ride and other periodic checks detailed in this manual.

We also recommend that you read this owner's manual before you ride. It's full of facts, instructions, safety information, and helpful tips. To make it easy to use, the manual contains a detailed list of topics at the beginning of each section, and both an in-depth table of contents and an index at the back of the book.

As you read this manual, you will find information that is preceded by a **NOTICE** symbol. This information is intended to help you avoid damage to your Honda, other property, or the environment.

# Introduction

---

Read the Warranties Booklet (page 173 ) thoroughly so you understand the coverages that protect your new Honda and are aware of your rights and responsibilities.

If you have any questions, or if you ever need special service or repairs, remember that your Honda dealer knows your scooter best and is dedicated to your complete satisfaction.

Please report any change of address or ownership to your Honda dealer so we will be able to contact you concerning important production information.

You may also want to visit our website at [www.honda.com](http://www.honda.com).

Happy riding!

California Proposition 65 Warning

**WARNING:** This product contains or emits chemicals known to the State of California to cause cancer and birth defects or other reproductive harm.

## A Few Words About Safety

---

Your safety, and the safety of others, is very important. And operating this scooter safely is an important responsibility.

To help you make informed decisions about safety, we have provided operating procedures and other information on labels and in this manual. This information alerts you to potential hazards that could hurt you or others.

Of course, it is not practical or possible to warn you about all hazards associated with operating or maintaining a scooter. You must use your own good judgment.

You will find important safety information in a variety of forms, including:

- **Safety Labels** — on the scooter.
- **Safety Messages** — preceded by a safety alert symbol  and one of three signal words: **DANGER**, **WARNING**, or **CAUTION**.

These signal words mean:

### Safety Messages

## A Few Words About Safety

---

### **DANGER**

You **WILL** be **KILLED** or **SERIOUSLY HURT** if you don't follow instructions.

### **WARNING**

You **CAN** be **KILLED** or **SERIOUSLY HURT** if you don't follow instructions.

### **CAUTION**

You **CAN** be **HURT** if you don't follow instructions.

- **Safety Headings** — such as Important Safety Reminders or Important Safety Precautions.
- **Safety Section** — such as Scooter Safety.
- **Instructions** — how to use this scooter correctly and safely.

This entire manual is filled with important safety information — please read it carefully.

# Contents

---

These pages give an overview of the contents of your owner's manual. The first page of each section lists the topics covered in that section.

**Scooter Safety ..... 1**

Important safety information you should know, plus a look at the safety-related labels on your scooter.

**Instruments & Controls..... 9**

The location and function of indicators and controls on your scooter and operating instructions for various controls and features.

**Before Riding..... 25**

The importance of wearing a helmet and other protective gear, how to make sure you and your scooter are ready to ride, and important information about loading.

**Basic Operation & Riding..... 39**

How to start and stop the engine, and use the brakes. Also, includes riding precautions and important information about riding with a passenger or cargo.

# Contents

---

## **Servicing Your Honda ..... 61**

Why your scooter needs regular maintenance, what you need to know before servicing your Honda, an owner maintenance schedule, and instructions for specific maintenance and adjustment items.

## **Tips ..... 125**

How to store and transport your scooter and how to be an environmentally-responsible rider.

## **Taking Care of the Unexpected ..... 133**

What to do if you have a flat tire, your engine won't start, etc.

## **Technical Information ..... 151**

ID numbers, technical specifications, and other technical facts.

## **Consumer Information ..... 169**

Information on warranties, emission controls, how to get Honda service manuals, and...

## **“Reporting Safety Defects” ..... 178**

## **Table of Contents ..... 180**

Sequential listing of topics in this owner's manual.

## **Index ..... 184**

## **Quick Reference**

Handy facts about fuel, engine oil, tire sizes, and air pressures.





# Scooter Safety

---

This section presents some of the most important information and recommendations to help you ride your scooter safely. Please take a few moments to read these pages. This section also includes information about the location of safety labels on your scooter.

Important Safety Information .....	2
Accessories & Modifications .....	5
Safety Labels .....	7

## Important Safety Information

---

Your scooter can provide many years of service and pleasure — if you take responsibility for your own safety and understand the challenges you can meet while riding.

There is much that you can do to protect yourself when you ride. You'll find many helpful recommendations throughout this manual. The following are a few that we consider most important.

### **Always Wear a Helmet**

It's a proven fact: helmets significantly reduce the number and severity of head injuries. So always wear an approved motorcycle helmet and make sure your passenger does the same. We also recommend that you wear eye protection, sturdy boots, gloves, and other protective gear (page 26 ).

## Important Safety Information

---

### Take Time to Learn & Practice

Even if you have ridden other scooters, take time to become familiar with how this scooter works and handles. Practice in a safe area until you build your skills and get accustomed to the scooter's size and weight.

Because many accidents involve inexperienced or untrained riders, we urge all riders to take a certified course approved by the Motorcycle Safety Foundation (MSF). See page 28 .

### Ride Defensively

The most frequent scooter collision happens when a car turns left in front of a scooter. Another common situation is a car moving suddenly into your lane.

Always pay attention to other vehicles around you, and do not assume that other drivers see you. Be prepared to stop quickly or make an evasive maneuver. For other riding tips, see the booklet, *You and Your Motorcycle: Riding Tips and Practice Guide*, which came with your new scooter (USA only).

# Important Safety Information

---

## **Make Yourself Easy to See**

Some drivers do not see scooters because they are not looking for them. To make yourself more visible, wear bright reflective clothing, position yourself so other drivers can see you, signal before turning or changing lanes, and use your horn when it will help others notice you.

## **Ride within Your Limits**

Pushing limits is another major cause of scooter accidents. Never ride beyond your personal abilities or faster than conditions warrant. Remember that alcohol, drugs, fatigue, and inattention can significantly reduce your ability to make good judgments and ride safely.

## **Don't Drink and Ride**

Alcohol and riding don't mix. Even one drink can reduce your ability to respond to changing conditions, and your reaction time gets worse with every additional drink. So don't drink and ride, and don't let your friends drink and ride either.

## **Keep Your Honda in Safe Condition**

It's important to keep your scooter properly maintained and in safe riding condition. To help avoid problems, inspect your scooter before every ride and perform all recommended maintenance. Never exceed load limits (page 34 ), and do not modify your scooter (page 6 ) or install accessories that would make your scooter unsafe (page 5 ).

## Accessories & Modifications

Modifying your scooter or using non-Honda accessories can make your scooter unsafe. Before you consider making any modifications or adding an accessory, be sure to read the following information.

### **⚠ WARNING**

Improper accessories or modifications can cause a crash in which you can be seriously hurt or killed.

Follow all instructions in this owner's manual regarding accessories and modifications.

### Accessories

We strongly recommend that you use only genuine Honda accessories that have been specifically designed and tested for your scooter. Because Honda cannot test all other accessories, you must be personally responsible for proper selection, installation, and use of non-Honda accessories.

Check with your Honda dealer for assistance and always follow these guidelines:

- Make sure the accessory does not obscure any lights, reduce ground clearance and lean angle, limit suspension travel or steering travel, alter your riding position, or interfere with operating any controls. (cont'd)

## Accessories & Modifications

---

- Do not add any electrical equipment that will exceed the scooter's electrical system capacity (page 159). A blown fuse can cause a loss of lights or engine power (page 143).
- Do not pull a trailer or sidecar with your scooter. This scooter was not designed for these attachments, and their use can seriously impair your scooter's handling.
- Do not install any fairing or windshield unless it was designed and tested by Honda for your scooter. Some fairings or windshields, even smaller ones, can cause unstable handling of your scooter. This is especially true if the fairing or windshield is poorly designed or improperly mounted.

### Modifications

We strongly advise you not to remove any original equipment or modify your scooter in any way that would change its design or operation. Such changes could seriously impair your scooter's handling, stability, and braking, making it unsafe to ride.

Removing or modifying your lights, exhaust system, emission control system, or other equipment can also make your scooter illegal.

## Safety Labels

---

Safety labels on your scooter either warn you of potential hazards that could cause serious injury or they provide important safety information. Read these labels carefully and don't remove them.

If a label comes off or becomes hard to read, contact your Honda dealer for a replacement.

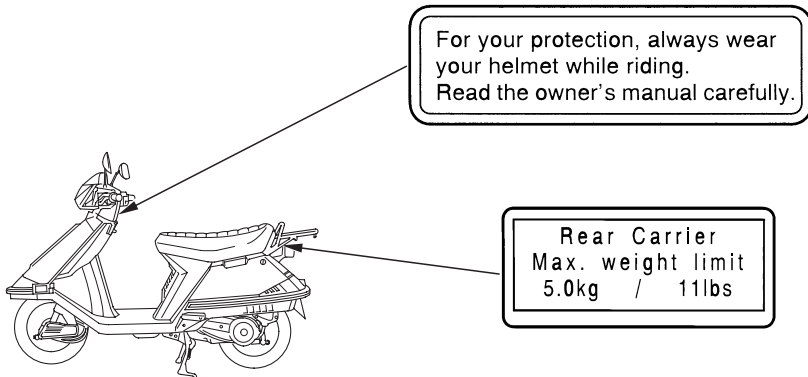



# Safety Labels

Front Compartment  
Max. weight limit  
3.0kg / 6.6lbs

**⚠ WARNING**  
Improper loading can cause a crash and you may be seriously hurt or killed.  
See "Load Limits and Guidelines" in your Owner's Manual for complete instructions.

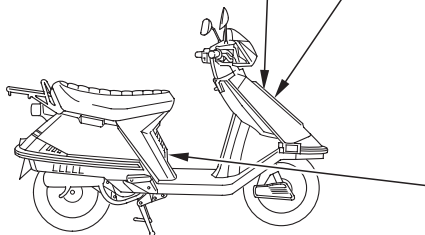

**TIRE INFORMATION**

COLD TIRE PRESSURES :	FRONT 150kPa 1.50kg/cm <sup>2</sup> 22psi
[ UP TO MAXIMUM WEIGHT CAPACITY ]	REAR 225kPa 2.25kg/cm <sup>2</sup> 33psi
[ UP TO 90kg (200lbs.) LOAD ]	FRONT 150kPa 1.50kg/cm <sup>2</sup> 22psi
	REAR 175kPa 1.75kg/cm <sup>2</sup> 25psi
MAXIMUM WEIGHT CAPACITY :	152kg (335lbs)
TIRE SIZE :	FRONT 3.50-10 51J REAR 3.50-10 51J
TIRE BRAND :	BRIDGESTONE DUNLOP IRC KIK
	ML2 K398 3R MB3

*Read Owner's Manual*

## Instruments & Controls

---

This section shows the location of all gauges, indicators, and controls you would normally use before or while riding your scooter.

The items listed on this page are described in this section. Instructions for other components are presented in other sections of this manual where they will be most useful.

Operation Component Locations .....	10
Gauges & Indicators .....	13
Fuel Gauge.....	17
Maintenance Indicator.....	18
Controls & Features.....	19
Ignition Switch .....	19
Start Button.....	20
Engine Stop Switch .....	20
Headlight Dimmer Switch .....	21
Turn Signal Switch.....	21
Horn Button .....	22
Rear Brake Lock.....	22

# Operation Component Locations

---

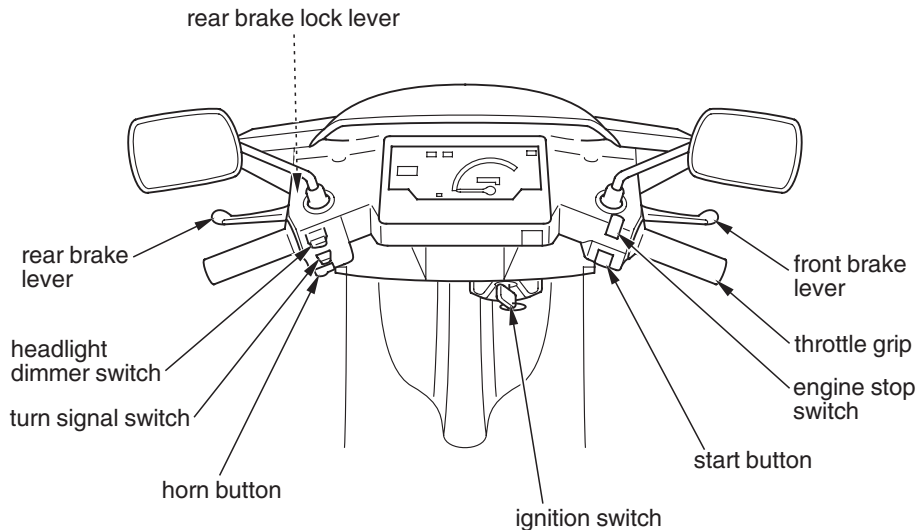

## Operation Component Locations

---

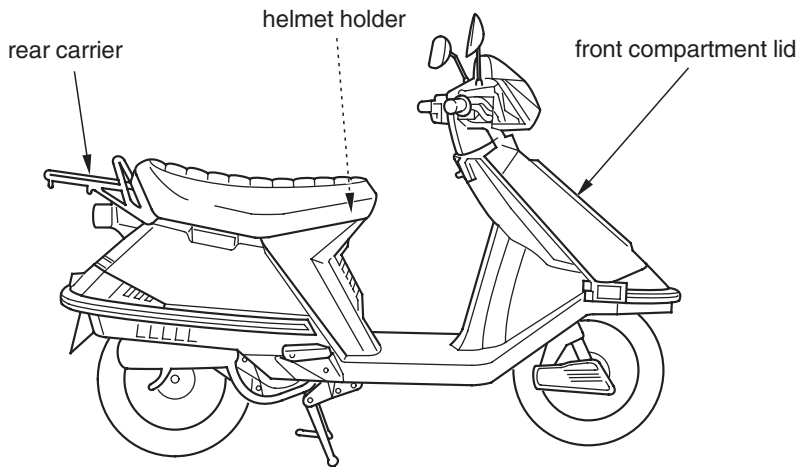

# Operation Component Locations

---

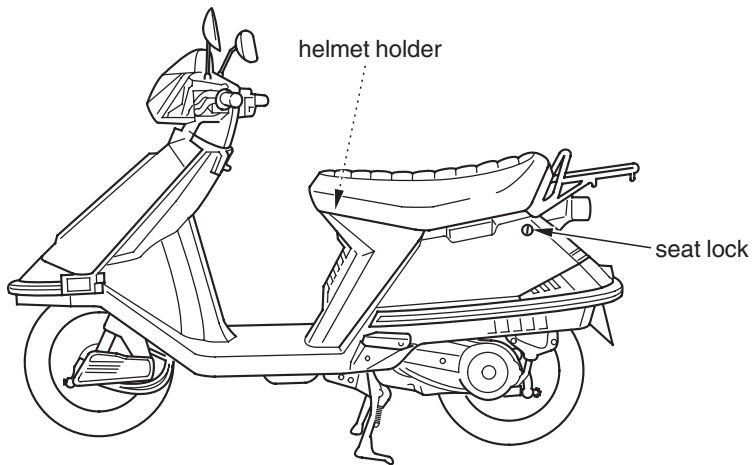

# Gauges & Indicators

The gauges and indicators on your scooter keep you informed, alert you to possible problems, and make your riding safer and more enjoyable. Refer to the gauges and indicators frequently. Their functions are described on the following pages.

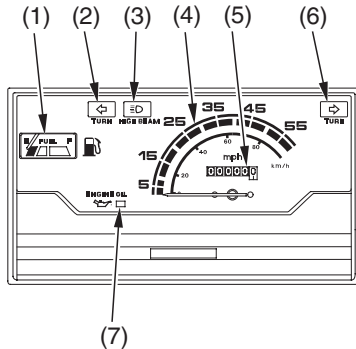

- (1) fuel gauge
- (2) left turn signal indicator
- (3) high beam indicator
- (4) speedometer
- (5) odometer
- (6) right turn signal indicator
- (7) maintenance indicator

USA: Odometer read in miles.

## Gauges & Indicators

---

### Lamp Check

When applicable, the high beam indicator comes on when you turn the ignition switch ON and remains on until you select the low beam.

If this indicator does not come on when it should, have your Honda dealer check for a burned-out bulb or other problems.

## Gauges & Indicators

---

1	fuel gauge	Shows the approximate fuel supply available, if your scooter is on a level surface (page 17 ).
2	left turn signal indicator (amber)	Flashes when the left turn signal operates.
3	high beam indicator (blue)	Lights when the headlight is on high beam.
4	speedometer	Shows riding speed in miles per hour.
5	odometer	Shows the total miles ridden.



## Gauges & Indicators

---

6	right turn signal indicator (amber)	Flashes when the right turn signal operates.
7	maintenance indicator	Indicates specified maintenance interval for engine oil change (page 18 ) has been reached by switching from green to red.

### Fuel Gauge

The fuel gauge (1) shows the approximate fuel supply available. At F (Full), the fuel tank capacity including reserve is:

1.3 US gal (5 l)

When the gauge needle enters the red band (2), fuel will be low and you should refill the tank as soon as possible.

The amount of fuel left in the tank when the needle enters the red band is approximately:

0.21 US gal (0.8 l)

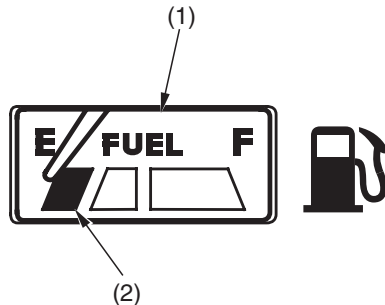

(1) fuel gauge

(2) red band

# Gauges & Indicators

## Maintenance Indicator

When the mileage on your scooter approaches the specified maintenance interval to change oil, the maintenance indicator (1) will change from green to red. After replacing the engine oil, reset the indicator by inserting the key (2) in the slot (3) below the indicator.

The indicator changes from green to red after the scooter has been ridden about 1,000 miles (1,600 km). Therefore, when 600 miles (1,000 km) have been ridden after the initial oil change, be sure to reset the indicator so the next specified maintenance will be indicated at the proper mileage.

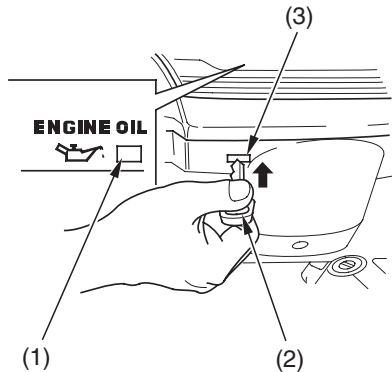

- (1) maintenance indicator
- (2) ignition key
- (3) slot

### Ignition Switch

The ignition switch is used for starting and stopping the engine (page 41 ) and to lock the steering for theft prevention (page 58 ). Insert the key and turn it to the right for the ON position. Push down on the key and turn it to the left to the LOCK (steering lock) position.

Key Position	Function
ON	Electrical circuits on.
OFF	No electrical circuits function.
LOCK (steering lock)	No electrical circuits function. Allows the steering head to be locked.

FRONT

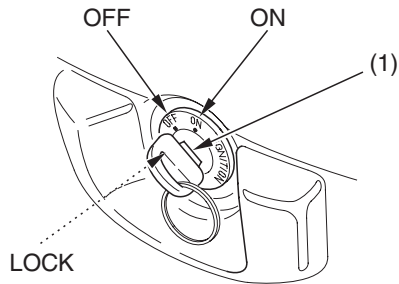

(1) ignition switch

To unlock the steering lock, insert the key and turn it to the right to the OFF position.

# Controls & Features

## Start Button

The start button ( 1 ) is used for starting the engine. Pushing the button in starts the engine. See *Starting Procedure*, page 42 .

When the start button is pushed, the starter motor will crank the engine.

The electric starter will only work when the rear brake lever is pulled in.

## Engine Stop Switch

### RIGHT HANDLEBAR

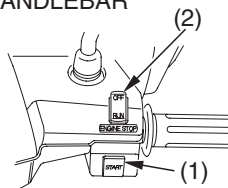

- (1) start button
- (2) engine stop switch

The engine stop switch ( 2 ) is used to stop the engine in an emergency. To operate, push the switch to the OFF position. The switch must be in the RUN position to start the engine, and it should normally remain in the RUN position even when the engine is OFF.

If your scooter is stopped with the ignition switch ON and the engine stop switch OFF, the taillight will remain on, resulting in battery discharge.

### Headlight Dimmer Switch

The headlight dimmer switch ( 1 ) is used to change between the high and low beams of the headlight. To operate, turn the switch to HI for high beam, LO for low beam.

### Turn Signal Switch

The turn signal switch ( 2 ) is used to signal a turn or a lane change. To operate, move the switch all the way in the proper direction and release it. The appropriate turn signal lights will start blinking. To cancel the light, push the switch in.

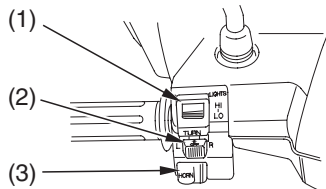

- (1) headlight dimmer switch
- (2) turn signal switch
- (3) horn button

# Controls & Features

---

## Horn Button

The horn is used to alert other motorists. To operate, push the horn button (3).

## Rear Brake Lock

Be sure the rear brake is applied while starting and warming up the engine. The rear brake lock will not function if the rear brake is not adjusted properly (page 102 ).

### To Apply the Brake Lock

Squeeze the rear brake lever ( 1 ) and set the brake lock lever ( 2 ).

The rear brake lock will not be applied if the rear brake is not adjusted properly (page 102).

## Controls & Features

### To Release the Brake Lock

Squeezing the rear brake lever releases the lock lever.

Before riding, make sure that the rear brake is fully released so there is no drag on the rear wheel.

### LEFT HANDLEBAR

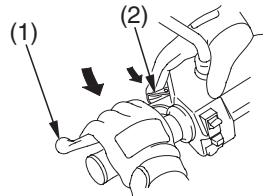

< To apply >

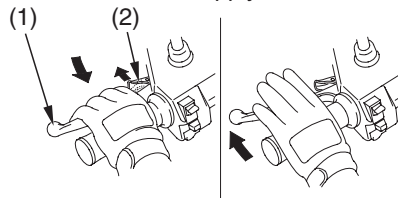

< To release >

- (1) rear brake lever
- (2) brake lock lever





## Before Riding

---

Before each ride, you need to make sure you and your Honda are both ready to ride. To help get you prepared, this section discusses how to evaluate your riding readiness, what items you should check on your scooter, and adjustments to make for your comfort, convenience, or safety. This section also includes important information about loading.

Are You Ready to Ride ? .....	26
Protective Apparel.....	26
Rider Training .....	28
Is Your Scooter Ready to Ride ? .....	30
Pre-ride Inspection .....	30
Load Limits & Guidelines.....	33
Loading .....	33
Load Limits .....	34
Loading Guidelines .....	35
Cargo Compartment .....	37
Front Compartment .....	37

## Are You Ready to Ride?

---

Before you ride your scooter for the first time, we urge you to:

- Read this owner's manual.
- Make sure you understand all the safety messages.
- Know how to operate all the controls.

Before each ride, be sure:

- You feel well and are in good physical and mental condition.
- You are wearing an approved motorcycle helmet (with chin strap tightened securely), eye protection, and other protective clothing.
- You don't have any alcohol or drugs in your system.

Make sure your passenger is ready to ride, too, and is wearing proper gear including a helmet.

If you are not riding with a passenger and want to carry an extra helmet, use a commercially-available elastic cord, strap, or net to secure the helmet to the seat.

### Protective Apparel

For your safety, we strongly recommend that you always wear an approved motorcycle helmet, eye protection, boots, gloves, long pants, and a long-sleeved shirt or jacket whenever you ride.

Although complete protection is not possible, wearing proper gear can reduce the chance of injury when you ride.

Following are suggestions to help you choose the proper gear.

## Are You Ready to Ride?

### Helmets and Eye Protection

Your helmet is your most important piece of riding gear because it offers the best protection against head injuries. A helmet should fit your head comfortably and securely. A bright-colored helmet and reflective strips can make you more noticeable in traffic.

An open-face helmet offers some protection, but a full-face helmet offers more. Regardless of the style, look for a DOT (Department of Transportation) sticker in any helmet you buy (USA only). Always wear a face shield or goggles to protect your eyes and help your vision.

### **⚠ WARNING**

Not wearing a helmet increases the chance of serious injury or death in a crash.

Be sure you and your passenger always wear a helmet, eye protection, and other protective apparel when you ride.

### Additional Riding Gear

In addition to a helmet and eye protection, we also recommend:

- Sturdy boots with non-slip soles to help protect your feet and ankles.
- Leather gloves to help protect your hands.

(cont'd)

## Are You Ready to Ride?

---

- A motorcycle riding suit or jacket for comfort as well as protection. Bright-colored and reflective clothing can help make you more noticeable in traffic. Avoid loose clothes that could get caught on any part of your scooter.

### Rider Training

Developing your riding skills is an on-going process. Even if you have ridden other scooters, take time to become familiar with how this scooter works and handles. Practice riding the scooter in a safe area to build your skills. Do not ride in traffic until you get accustomed to the scooter's controls, and feel comfortable with its size and weight.

We urge all riders to take a certified course approved by the Motorcycle Safety Foundation (MSF). New riders should start with the basic course, and even experienced riders will find the advanced course beneficial. For information about the MSF training course nearest you, call the national toll-free number: (800) 446-9227.

Other riding tips can be found in the *Riding Tips* booklet that came with your scooter (USA only).

## Are You Ready to Ride?

---

ALWAYS wear a helmet.

You should also wear a face shield or goggles.

Clothes should be close-fitting.

Wear gloves.

Wear bright or reflective clothing.

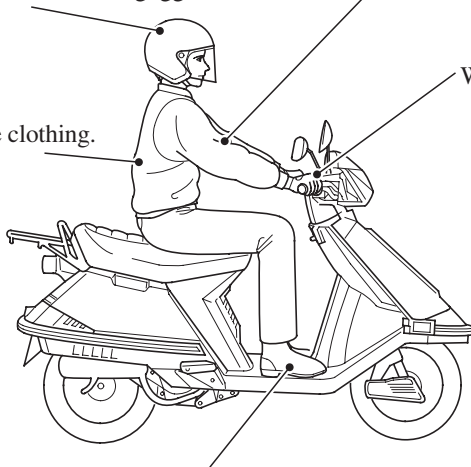

Boots should be close-fitting, have low heels and offer ankle protection.

# Is Your Scooter Ready to Ride?

---

Before each ride, it's important to inspect your scooter and make sure any problem you find is corrected. A pre-ride inspection is a must, not only for safety, but because having a breakdown, or even a flat tire, can be a major inconvenience.

## **⚠ WARNING**

Improperly maintaining this scooter or failing to correct a problem before riding can cause a crash in which you can be seriously hurt or killed.

Always perform a pre-ride inspection before every ride and correct any problems.

## **Pre-ride Inspection**

Check the following items before you get on the scooter:

*Tires & Wheels* Look at the tires. If a tire appears low, use an air pressure gauge to check its pressure. Also look for signs of excessive wear (page 107 ) or damage to the tires and wheels.

## Is Your Scooter Ready to Ride?

---

*Leaks,  
Loose  
Parts*

Walk around your scooter and look for anything that appears unusual, such as a leak or loose cable.

*Lights*

Make sure the headlight, brakelight, taillight, and turn signals are working properly.

If you are carrying a passenger or cargo, also check the following:

*Load Limits* Make sure you do not exceed the load limits (page 34 ).

*Cargo* Check that all cargo is secure.



## Is Your Scooter Ready to Ride?

---

Check these items after you get on the scooter:

- Throttle*            Rotate the throttle to check it moves smoothly without binding.
- Brakes*              Pull the front and rear brake levers to check that they operate normally.
- Indicators*         Turn the ignition on and check for normal operation of the gauges and indicators (page 13).

If you haven't ridden the scooter in over a week, you should also check other items, such as the oil level and other fluids. See *Periodic Maintenance* (page 68 ).

Periodic maintenance should also be done at least once a month, no matter how often you ride.

Remember, be sure to take care of any problem you find, or have your Honda dealer correct it before you ride.

## Load Limits & Guidelines

Your scooter has been designed to carry you and one passenger. When you carry a passenger, you may feel some difference during acceleration and braking. But so long as you keep your scooter well-maintained, with good tires and brakes, you can safely carry loads within the given limits and guidelines.

However, exceeding the weight limit or carrying an unbalanced load can seriously impair your scooter's handling, braking, and stability. Non-Honda accessories, improper modifications, and poor maintenance can also reduce your safety margin.

### Loading

How much weight you put on your scooter, and how you load it, are important to your safety. Anytime you ride with a passenger or cargo, you should be aware of the following information.

#### **WARNING**

Overloading or improper loading can cause a crash and you can be seriously hurt or killed.

Follow all load limits and other loading guidelines in this manual.

# Load Limits & Guidelines

---

## Load Limits

Following are the load limits for your scooter:

### maximum weight capacity:

335 lbs (152 kg)

includes the weight of the rider, passenger, all cargo, and all accessories.

### maximum cargo weight:

17.6 lbs (8 kg)

includes following maximum compartment weights:

rear carrier: 11 lbs (5 kg)

front compartment: 6.6 lbs (3 kg)

The weight of added accessories will reduce the maximum cargo weight you can carry.

rear carrier;

weight limit — 11 lbs (5 kg)

Be sure all cargo is secure before riding

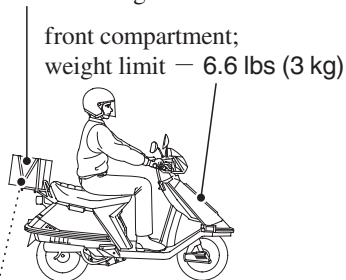

front compartment;

weight limit — 6.6 lbs (3 kg)

rear trunk (optional part);

weight limit — 6.6 lbs (3 kg)

### Loading Guidelines

Your scooter is primarily intended for transporting you and a passenger. You may wish to secure a jacket or other small items to the seat when you are not riding with a passenger.

If you wish to carry more cargo, check with your Honda dealer for advice, and be sure to read the information regarding accessories on page 5 .

Improperly loading your scooter can affect its stability and handling. Even if your scooter is properly loaded, you should ride at reduced speeds whenever you carry cargo.

## Load Limits & Guidelines

---

Follow these guidelines whenever you carry a passenger or cargo:

- Check that both tires are properly inflated, and that pressure in the rear tire is increased to suit the load (page 105).
- To prevent loose items from creating a hazard, make sure that all cargo is tied down securely before you ride.
- Place cargo weight as low and close to the center of your scooter as possible.
- Balance cargo weight evenly on both sides.

# Cargo Compartment

## Front Compartment

The front compartment (1) is designed to carry up to 6.6 lbs (3 kg).

However, regardless of compartment capacity, be sure you do not exceed the maximum load and cargo weight limits.

### To Open the Front Compartment

Insert the ignition key (2) into the lock and turn the key clockwise.

### To Close the Front Compartment

1. Turn the ignition key clockwise and close the front lid.
2. Turn the ignition key back to lock the front lid. Remove the key.

Make sure the front lid is closed securely before riding.

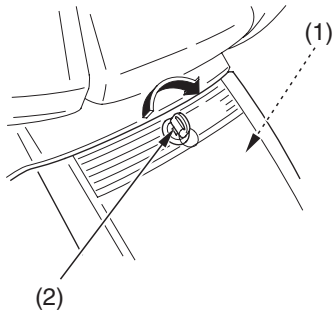

- (1) front compartment  
(2) ignition key



## Basic Operation & Riding

---

This section gives basic riding instructions, including how to start and stop your engine, and how to use the throttle and brakes. It also provides important information on riding with a passenger or cargo.

To protect your new engine and enjoy optimum performance and service life, refer to Break-in Guidelines (page 160).

For information about carburetor adjustment for riding at high altitude, see page 161.

Safe Riding Precautions .....	40
Starting & Stopping the Engine .....	41
Preparation.....	41
Starting Procedure .....	42
How to Stop the Engine .....	45
Riding.....	46
Braking .....	53
Parking .....	55
Theft-Prevention Tips .....	58
Riding with a Passenger or Cargo.....	59



## Safe Riding Precautions

---

Before riding your scooter for the first time, please review the *Scooter Safety* section beginning on page 1, and the *Before Riding* section beginning on page 26 .

Even if you have ridden other scooters, take time to become familiar with how this scooter works and handles. Practice in a safe area until you build your skills and get accustomed to the scooter's size and weight.

## Starting & Stopping the Engine

---

Always follow the proper starting procedure described below.

For your safety, avoid starting or operating the engine in an enclosed area such as a garage. Your scooter's exhaust contains poisonous carbon monoxide gas which can collect rapidly in an enclosed area and cause illness or death.

This scooter has an automatic fuel valve and choke; there is no manual operation.

Do not use the electric starter for more than 5 seconds at a time. Release the start button for approximately 10 seconds before pressing it again.

Operate the start button for slightly longer than usual without opening the throttle if the scooter has been left standing for a long time or when the fuel tank has just been refilled.

### Preparation

Before starting, insert the key, turn the ignition switch ON, and confirm the following:

- The engine stop switch is set to RUN.

# Starting & Stopping the Engine

---

## Starting Procedure

1. Place the scooter on its center stand.
2. Lock the rear wheel by squeezing the rear brake lever ( 1 ) and setting the brake lock lever ( 2 ).

### **⚠ CAUTION**

Contact with the spinning rear wheel can cause you to be hurt.

Set the parking brake when the scooter is on its center stand.

The electric starter will only work when the rear brake lever is pulled in.

## LEFT HANDLEBAR

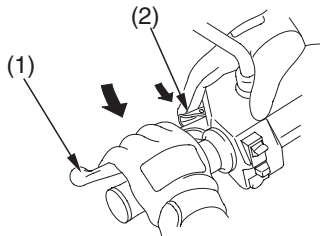

- (1) rear brake lever  
(2) brake lock lever

## Starting & Stopping the Engine

3. Make sure the engine stop switch is at RUN.
4. Turn the ignition switch (3) ON.

BELOW HANDLEBAR

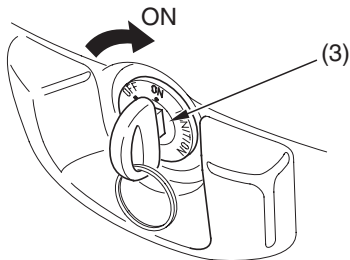

(3) ignition switch

5. With the throttle closed, push the start button (4). Release the start button as soon as the engine starts.

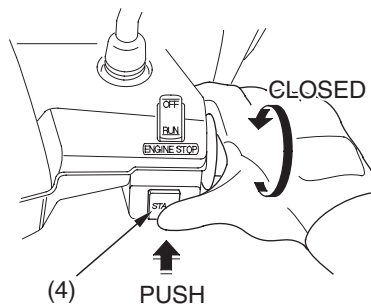

(4) start button

## Starting & Stopping the Engine

---

6. Be sure to keep the throttle (5) closed and the rear brake locked while starting and warming up the engine.
7. Allow the engine to warm up before riding (see *Riding*, page 46 ).

Do not “blip” (rapidly open and close) the throttle. This action may cause the scooter to move forward suddenly.

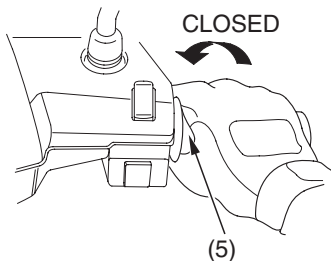

(5) throttle

### If You Cannot Restart a Warm Engine

1. Place the scooter on its center stand, squeeze the rear brake lever, and set the rear brake lock (page 22 ).
2. Open the throttle (5)  $1/8 - 1/4$  turn while starting the engine.

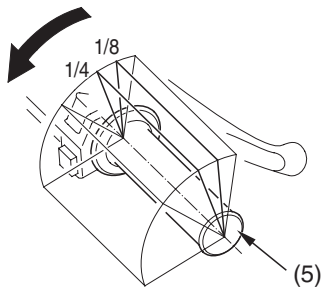

# Starting & Stopping the Engine

---

## How to Stop the Engine

### Normal Engine Stop

To stop the engine, turn the ignition switch OFF.

The engine stop switch should normally remain in the RUN position even when the engine is OFF.

If your scooter is stopped with the engine stop switch OFF and the ignition switch ON, the taillight will remain on, resulting in battery discharge.

### Emergency Engine Stop

To stop the engine in an emergency, use the engine stop switch. To operate, press the switch to the OFF position.

# Riding

---

1. To prevent unexpected movement, make sure the throttle is closed and the rear brake is locked (page 22 ) before moving the scooter off its center stand.

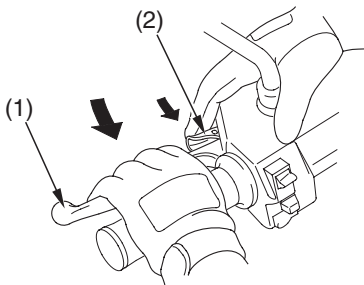

- (1) rear brake lever  
(2) brake lock lever

2. Stand on the left side of the scooter and push it forward and off the center stand.

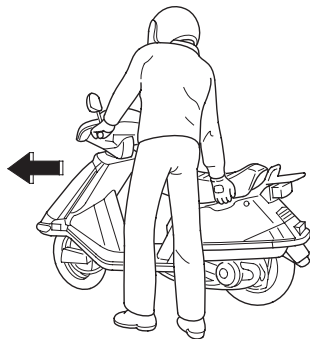

3. Mount the scooter from the left side, keeping at least one foot on the ground to steady the scooter.



4. To unlock the rear wheel, squeeze the rear brake lever (1) until the brake lock lever (2) releases.

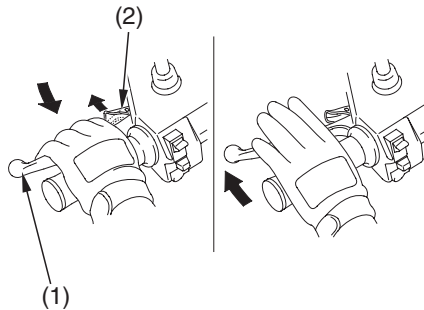

- (1) rear brake lever  
(2) brake lock lever



# Riding

---

5. Before starting off, indicate your direction with the turn signals, and check for safe traffic conditions. Grasp the handlebars firmly with both hands.

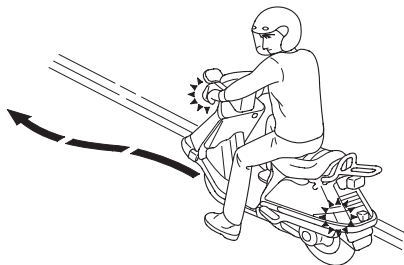

6. To accelerate, open the throttle (3) gradually. The scooter will move forward.

Do not blip (rapidly open and close) the throttle as the scooter will move forward suddenly.

7. To decelerate, close the throttle.

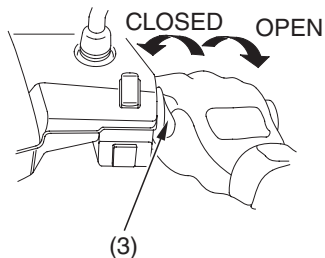

(3) throttle

8. To slow the scooter, reduce the throttle (3) and apply the front and rear brakes (4) together.

Using only one brake reduces stopping performance. Excessive brake application may cause either wheel to lock, reducing control of the scooter.

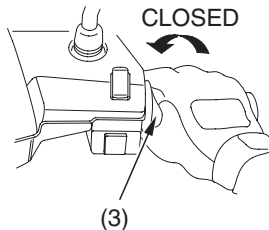

(3) throttle

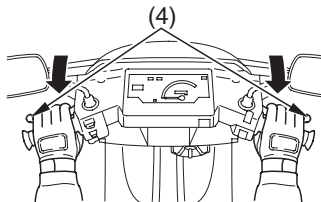

(4) front and rear brakes

# Riding

---

9. When approaching a corner or turn, slow the scooter by closing the throttle (3) fully and applying both the front (5) and rear (6) brakes at the same time.

10. After completing a turn, open the throttle gradually to accelerate the scooter.

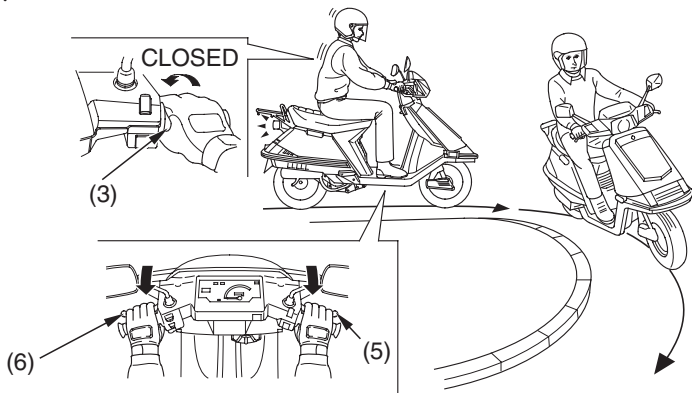

(3) throttle

(5) front brake

(6) rear brake

11. When descending a steep grade, close the throttle ( 3 ) fully and apply both the front ( 5 ) and rear ( 6 ) brakes to slow the scooter.

Avoid continued use of the brakes, which may cause the brakes to overheat and reduce braking efficiency.

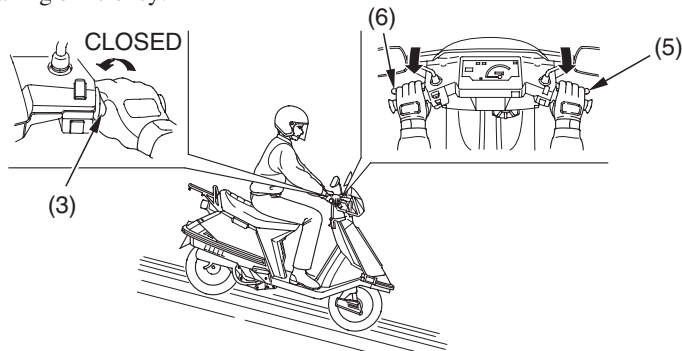

(3) throttle

(5) front brake

(6) rear brake

## Riding

---

12. When riding in wet or rainy conditions or loose surfaces, the ability to maneuver and stop is reduced. For your safety:
- Exercise extreme caution when braking, accelerating, or turning.
  - Ride at slower speeds and allow for extra stopping distance.
  - Keep the scooter as upright as possible.
  - Use extreme caution when riding over slippery surface such as railroad tracks, iron plates, manhole covers, painted lines, etc.

Your scooter is equipped with mechanically-activated drum brakes. Operating the front brake lever applies the front drum brake. Operating the rear brake lever applies the rear drum brake.

As a general rule, the front braking system provides about 70 percent of total stopping power.

For full braking effectiveness, use the front and rear brake lever simultaneously. Using both braking systems will stop your scooter faster with greater stability.

To slow or stop, apply the front and rear brake lever smoothly.

Gradually increase braking as you feel the brakes slowing your speed.

For support, before coming to a complete stop, put your left foot down first, then your right foot down.

Applying the brakes too hard may cause the wheels to lock and slide, reducing control of your scooter. If this happens, release the brake controls, steer straight ahead until you regain control, then reapply the brakes more gently.

# Braking

---

When possible, reduce your speed or complete braking before entering a turn. Avoid braking or closing the throttle quickly while turning. Either action may cause one or both wheels to slip and reduce your control of your scooter.

Your ability to brake in a turn and to brake hard in an emergency situation are important riding skills. We suggest attending a Motorcycle Safety Foundation experienced rider training course (page 28 ) to retain these skills.

When riding in wet or rainy conditions, or on loose surfaces, the ability to maneuver and stop will be reduced. All of your actions should be smooth under these conditions. Rapid acceleration, braking or turning may cause loss of control.

For your safety, exercise extreme caution when braking, accelerating or turning.

When descending a long, steep grade, use both brakes intermittently. Continuous brake application can overheat the brakes and reduce their effectiveness.

Riding with your hand on either brake lever may actuate the brakelight, giving a false indication to other drivers. It may also overheat the brakes, reducing effectiveness.

1. Look for a level parking area. If you can't park on a paved surface, make sure the ground surface is firm, especially under the center stand. If you must park on a hill, position the rear tire against the curb at a 45 degree angle.
2. Use the center stand to support the scooter while parked.
  - To lower the center stand, stand on the left side of the scooter. Hold the left handle grip and the left handrail under the seat or rear carrier. Press down on the tip of the stand with your right foot and, simultaneously, pull up and back.
  - If you have to park on a soft surface, insert something solid under the stand for support.

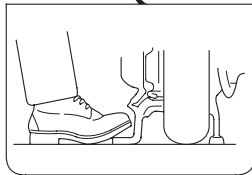

USE CENTER STAND

(cont'd)



## Parking

---

3. Use the steering lock, which locks the handlebar in place. Turn the handlebar all the way to the left or right. Push in on the ignition key (1) and turn it to LOCK. Remove the key.

(To unlock the steering lock, insert the key and turn it to the right to the OFF position.)

### LOCK STEERING

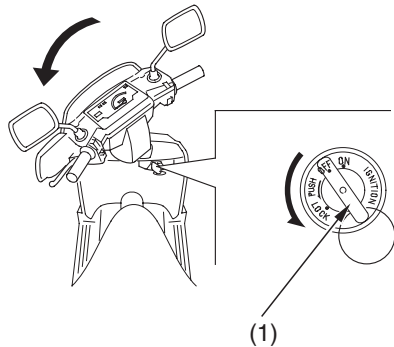

(1) ignition key

4. Use the helmet holder (2), located below the seat, to secure your helmet and your passenger's helmet with your scooter.
  - Insert the ignition key (1) into the seat lock (3) and turn it clockwise to unlock.
  - Hang your helmet on the hook at the seat hinge.
  - Lower the seat to lock.

To remove the helmet, unlock the seat lock. Lift the helmet off the holder and lower the seat, making sure it is securely locked before riding.

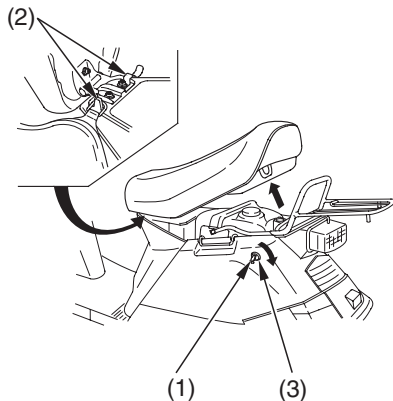

- (1) ignition key
- (2) helmet holder
- (3) seat lock

# Parking

---

## Theft-Prevention Tips

- Park your scooter in a locked garage whenever possible. If a garage isn't available, park in a concealed area or in a well-lit area with enough pedestrian traffic to discourage a thief.
  - Always take the ignition key with you.
  - Always use the steering lock (page 56), even if you're parking for just a minute or two. A thief can easily push an unlocked scooter to a waiting truck.
  - In addition to the steering lock, use a good quality anti-theft device made specifically to lock a scooter to a secure object.
- If you decide to use an anti-theft device, select one of good quality and be sure to follow the manufacturer's instructions.
  - Keep your owner's manual, current registration, and insurance information with your scooter. This will make it easier for the authorities to find you if your scooter is stolen and recovered.

## Riding with a Passenger or Cargo

---

Your scooter is designed to carry you and one passenger. Whenever you add a passenger or cargo, you must be careful not to exceed the total load limits for this vehicle (*Load Limits*, page 34). Make sure your cargo is properly secured (*Loading Guidelines*, page 35).

Be aware that carrying a passenger or heavy cargo can affect acceleration, braking, and handling.

Before riding with a passenger, make sure your passenger is wearing the proper protective apparel (page 26 ).

Tell your passenger to hold your waist, lean with you in the turns, and keep their feet on the passenger footpegs at all times, even when the scooter is stopped at a traffic light.



# Servicing Your Honda

---

To help keep your scooter in good shape, this section includes a Maintenance Schedule for required service, a list of periodic checks you should perform at least once a month, and step-by-step instructions for specific maintenance tasks. You'll also find important safety precautions, information on fuels and oils, and tips for keeping your Honda looking great.

For information about the exhaust emission and noise emission requirements of the U.S. Environmental Protection Agency (EPA) and the California Air Resources Board (CARB), see page 164 .

For information about replacing fuses, see page 143 .

USA only

**Maintenance, replacement or repair of the emission control devices and systems may be performed by any motorcycle repair establishment or individual using parts that are “certified” to EPA standards.**

## *Before You Service Your Honda*

The Importance of Maintenance .....	64
Maintenance Safety .....	65
Important Safety Precautions.....	66
Periodic Maintenance .....	68
Maintenance Schedule .....	70
Maintenance Record.....	75

(cont'd)

# Service Your Honda

---

## *Service Preparations*

Maintenance Component Locations .....	77
Owner's Manual Storage.....	80
Left Side Cover Removal.....	81

## *Service Procedures*

### Fluids & Filters

Fuel .....	82
Engine Oil.....	85
Air Cleaner .....	91
Belt Case Air Cleaner.....	93
Crankcase Breather.....	95

### Engine

Engine Idle Speed.....	96
Spark Plug.....	98

### Chassis

Brakes .....	101
Tires .....	105

### Electrical

Battery.....	112
Appearance Care .....	117

## Servicing Your Honda

---

The following table summarizes the three types of inspections and servicing recommendations for your scooter. Both the pre-ride inspection and the scheduled maintenance at the recommended intervals are necessary to assure safe and dependable performance. The periodic checks provide additional confidence in your scooter's performance.

Type of Inspection/Service	Refer to page:	When Performed	Who Performs
Pre-ride Inspection	30	before every ride	you
Periodic Maintenance	68	monthly*	you
Maintenance Schedule	70	interval on schedule	your Honda dealer**

\* more often if you ride frequently or long distances; or anytime you clean your scooter

\*\* unless you have the proper tools and service data and are mechanically qualified

An optional tool kit may be available. Check with your Honda dealer's parts department.



## The Importance of Maintenance

---

Keeping your scooter well-maintained is absolutely essential to your safety. It's also a good way to protect your investment, get maximum performance, avoid breakdowns, and have more fun. A properly maintained scooter will also help to reduce air pollution.

Remember, proper maintenance is the owner's responsibility. Be sure to inspect your scooter before each ride, perform the periodic checks, and follow the Maintenance Schedule in this section.

### **WARNING**

Improperly maintaining this scooter or failing to correct a problem before you ride can cause a crash in which you can be seriously hurt or killed.

Always follow the inspection and maintenance recommendations and schedules in this owner's manual.

If your scooter overturns or is involved in a crash, be sure your Honda dealer inspects all major parts, even if you are able to make some repairs.

This section includes instructions on how to perform some important maintenance tasks. If you have basic mechanical skills, you can perform many of these tasks with the tools provided with your scooter.

Other tasks that are more difficult and require special tools are best performed by professionals. Wheel removal should normally be handled only by a Honda technician or other qualified mechanic. Instructions are included in this manual only to assist in emergency service.

Some of the most important safety precautions follow. However, we cannot warn you of every conceivable hazard that can arise in performing maintenance. Only you can decide whether or not you should perform a given task.

### **WARNING**

Failure to properly follow maintenance instructions and precautions can cause you to be seriously hurt or killed.

Always follow the procedures and precautions in this owner's manual.

# Maintenance Safety

---

## Important Safety Precautions

- Make sure the engine is off before you begin any maintenance or repairs. This will help eliminate several potential hazards:

**Carbon monoxide poisoning from engine exhaust.** Be sure there is adequate ventilation whenever you operate the engine.

**Burns from hot scooter parts.** Let the engine and exhaust system cool before touching.

**Injury from moving parts.** Do not run the engine unless instructed to do so.

- Read the instructions before you begin, and make sure you have the tools and skills required.
- To help prevent the scooter from falling over, park it on a firm, level surface, using the side stand, center stand or a maintenance stand to provide support.
- Be sure the rear brake lock is set before running the engine while the scooter is supported by the center stand. This will prevent the rear wheel from spinning and avoid the possibility of someone being injured from contacting the wheel.
- To reduce the possibility of a fire or explosion, be careful when working around gasoline. Use only non-flammable solvent, not gasoline, to clean parts. Keep cigarettes, sparks, and flames away from all fuel-related parts.

Remember that your Honda dealer knows your scooter best and is fully equipped to maintain and repair it. To ensure the best quality and reliability, use only new genuine Honda parts or their equivalents for repair and replacement. If you have the tools and skills required for additional maintenance jobs, you can purchase an official Honda Service Manual (page 170 ).

## Periodic Maintenance

---

In addition to the regularly scheduled maintenance (page 70 ) and daily pre-ride inspection (page 30 ), consider performing the periodic checks on the following page at least once a month, even if you haven't ridden your scooter, or as often as once a week if you ride frequently or for long distances. It's a good idea to perform this maintenance any time you clean your scooter.

Check the odometer reading and perform any scheduled maintenance checks that are needed (page 70 ). Remember, more frequent checks may be needed for riding in severe conditions.

## Periodic Maintenance

Tires & Wheels	<p>Check the air pressure with a gauge and add air if needed (page 105). Examine the tread for wear (page 107). Look closely for nails, embedded objects, cuts, and other types of damage (page 107). Roll your scooter so you can inspect the entire surface. Check the condition of the wheels.</p>
Fluids	<p>Check the levels of the engine oil (page 88). Add the correct fluid as necessary, and investigate the cause of any low fluid level.</p>
Lights	<p>Make sure the headlight, brakelight, taillight, and turn signals are working properly.</p>
Freeplay	<p>Check the freeplay of the front and rear brakes lever (page101).</p>
Fuses	<p>Make sure you have a full supply of spare fuses.</p>
Nuts & Bolts	<p>Check the major fasteners and tighten as needed.</p>

## Maintenance Schedule

---

The required Maintenance Schedule that follows specifies how often you should have your scooter serviced, and what things need attention. It is essential to have your scooter serviced as scheduled to maintain safe, dependable performance and proper emission control.

The service intervals in this Maintenance Schedule are based on average riding conditions. Some items will need more frequent service if you ride in unusually wet or dusty areas or at full throttle. Consult your Honda dealer for recommendations applicable to your individual needs and use.

Some items in the Maintenance Schedule can be performed with basic mechanical skills and hand tools. Procedures for these items are provided in this manual. Other items involve more extensive procedures and may require special training, tools, and equipment. We recommend that you have your Honda dealer perform these tasks unless you have advanced mechanical skills and the required tools and equipment. Procedures for such items in this schedule are provided in an official Honda Service Manual available for purchase (page 170 ).

## Maintenance Schedule

---

If you do not feel capable of performing a given task or need assistance, remember that your Honda dealer knows your scooter best and is fully equipped to maintain and repair it. If you decide to do your own maintenance, use only genuine Honda parts or their equivalents for repair or replacement to ensure the best quality and reliability.

Perform the pre-ride inspection (page 30) and owner maintenance (page 70) at each scheduled maintenance period.

Each item on the maintenance schedule requires some mechanical knowledge. Certain items (particularly those marked \* and \*\*) may require more technical information and tools. Consult your Honda dealer.

\* Should be serviced by your Honda dealer, unless you have the proper tools and service data and are mechanically qualified. Refer to the official Honda Service Manual (page 170).

\*\* In the interest of safety, we recommend these items be serviced only by your Honda dealer.



# Maintenance Schedule

---

## *Summary of Maintenance Schedule Notes & Procedures:*

### NOTES:

1. At higher odometer readings, repeat at the frequency interval established here.
2. Service more frequently if the scooter is ridden in unusually wet or dusty areas.
3. Service more frequently if the scooter is ridden often at full throttle or in the rain.
4. California type only.

### Maintenance Procedures:

I: inspect and clean, adjust, lubricate,  
or replace, if necessary

C: clean

A: adjust

L: lubricate

R: replace

# Maintenance Schedule

			FREQUENCY		ODOMETER READING (Note 1)					Refer to page
					× 1,000 mi	0.6	2.5	5	7.5	
ITEM			NOTE	× 1,000 km	1.0	4	8	12		
EMISSION RELATED ITEMS	*	FUEL LINE				I	I	I	—	
	*	THROTTLE OPERATION				I	I	I	—	
		AIR CLEANER	2					R	91	
		CRANK CASE BREATHER	3				C	C	95	
		SPARK PLUG					R	R	98	
	*	VALVE CLEARANCE				I	I	I	I	—
		ENGINE OIL				R	R EVERY 1,000 mi (1,600 km)			85
	*	ENGINE OIL STRAINER SCREEN							C	—
	*	ENGINE IDLE SPEED					I	I	I	96
	*	EVAPORATIVE EMISSION CONTROL SYSTEM	4						I	—

- \* Should be serviced by your Honda dealer, unless you have the proper tools and service data and are mechanically qualified. Refer to the official Honda Service Manual (page 170).

# Maintenance Schedule

ITEM		FREQUENCY	NOTE	ODOMETER READING (Note 1)					Refer to page
				× 1,000 mi	0.6	2.5	5	7.5	
				× 1,000 km	1.0	4	8	12	
NON-EMISSION RELATED ITEMS		BELT CASE AIR CLEANER				C	C	C	93
		BRAKE SHOE WEAR							104
		BRAKE SYSTEM							101
	*	BRAKE LIGHT SWITCH							—
	*	HEADLIGHT AIM							—
	**	CLUTCH SHOE WEAR							—
	*	SUSPENSION							—
	*	NUTS, BOLTS, FASTENERS							—
	**	WHEELS/TIRES							—
	**	STEERING HEAD BEARINGS							

- \* Should be serviced by your Honda dealer, unless you have the proper tools and service data and are mechanically qualified. Refer to the official Honda Service Manual (page 170).
- \*\* In the interest of safety, we recommend these items be serviced only by your Honda dealer.

## Maintenance Record

---

Keeping an accurate maintenance record will help ensure that your scooter is properly maintained. Retain detailed receipts to verify the maintenance was performed. If the scooter is sold, these receipts should be transferred with the scooter to the new owner. Make sure whoever performs the maintenance completes this record. All scheduled maintenance, including the 600 mile (1,000 km) initial maintenance, is considered a normal owner operating cost and will be charged for by your dealer. Use the space under Notes to record anything you want to remind yourself about or mention to your dealer.

<b>Miles (km)</b>	<b>Odometer</b>	<b>Date</b>	<b>Performed By:</b>	<b>Notes</b>
600 (1,000)				
2,500 (4,000)				
5,000 (8,000)				
7,500 (12,000)				
10,000 (16,000)				

## Maintenance Record

---

Miles (km)	Odometer	Date	Performed By:	Notes
12,500 (20,000)				
15,000 (24,000)				
17,500 (28,000)				
20,000 (32,000)				
22,500 (36,000)				
25,000 (40,000)				
27,500 (44,000)				
30,000 (48,000)				

## Maintenance Component Locations

---

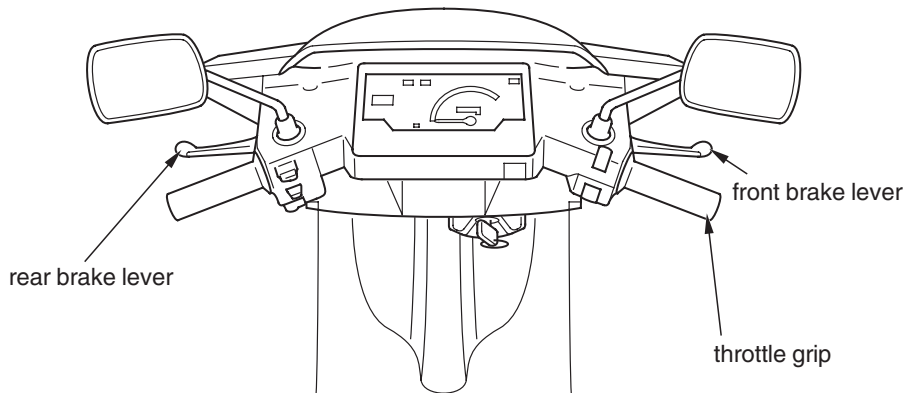

## Maintenance Component Locations

---

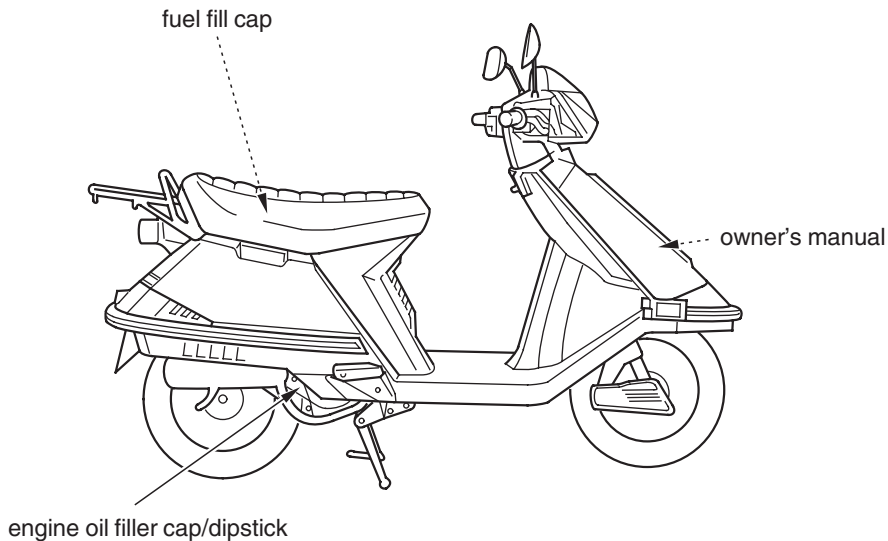

# Maintenance Component Locations

---

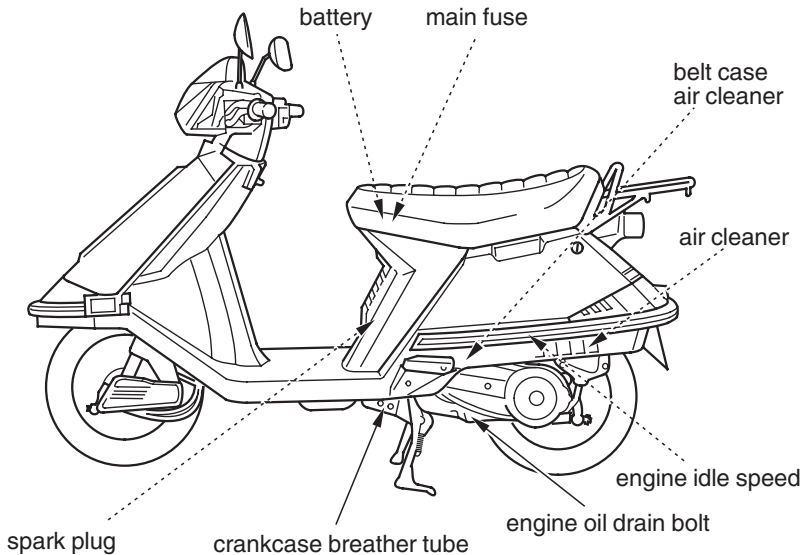



## Owner's Manual Storage

---

Your scooter provides storage for the owner's manual so you'll have it with you for easy reference. Store your owner's manual (and other documents) in the plastic storage bag in the front compartment (1) (page 37).

Be careful not to flood this area when washing your scooter.

### INSIDE FRONT COMPARTMENT

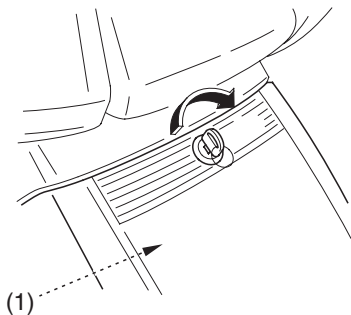

(1) front compartment

## Left Side Cover Removal

Refer to *Safety Precautions* on page 66 .

The left side cover must be removed to service the air cleaner, belt case air cleaner and spark plug.

LEFT SIDE

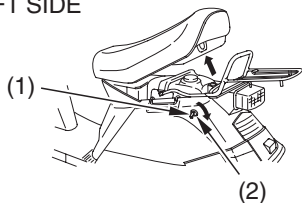

(1) ignition key      (2) seat lock

1. Insert the ignition key (1) in the seat lock (2) and turn it clockwise to unlock and lift the seat.

2. Unscrew the knob securing the center cover (3).
3. Remove the center cover.
4. Remove the screw (4) securing the left side cover (5).
5. Remove the left side cover.

LEFT SIDE

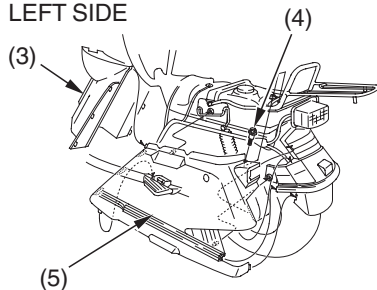

(3) center cover      (4) screw  
(5) left side cover

# Fuel

---

Refer to *Safety Precautions* on page 66 .

## Fuel Recommendation

type	unleaded
pump octane number	86 (or higher)

We recommend that you use unleaded fuel because it produces fewer engine deposits and extends the life of exhaust system components.

Your engine is designed to use any gasoline that has a pump octane number of 86 or higher. Gasoline pumps at service stations normally display the pump octane number. For information on the use of oxygenated fuels, see page 167 .

Use of lower octane gasoline can cause persistent “pinging” or “spark knock” (a loud rapping noise) which, if severe, can lead to engine damage. Light pinging experienced while operating under a heavy load, such as climbing a hill, is no cause for concern.

If pinging or spark knock occurs at a steady engine speed under normal load, change brands of gasoline. If pinging or spark knock persists, consult your Honda dealer.

Never use stale or contaminated gasoline or an oil/gasoline mixture. Avoid getting dirt, dust, or water in the fuel tank.

## Fuel Capacity

Fuel tank capacity, including reserve:  
1.3 US gal (5 l)

## Refueling Procedure

Refer to *Safety Precautions* on page 66 .

### LEFT SIDE

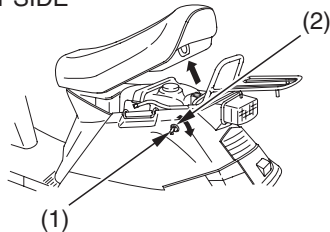

(1) ignition key

(2) seat lock

1. Insert the ignition key (1) in the seat lock (2) and turn it clockwise to unlock and lift the seat. (cont'd)

# Fuel

2. Remove the fuel fill cap (3) by turning it counterclockwise.
3. Add fuel until the level reaches the bottom of the filler neck (4). Avoid overfilling the tank. There should be no fuel in the filler neck.

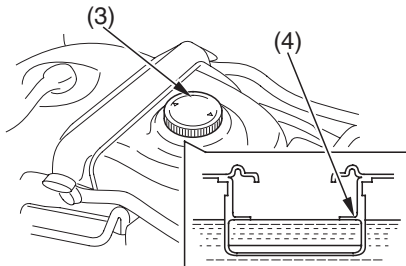

- (3) fuel fill cap  
(4) filler neck

## **⚠ WARNING**

Gasoline is highly flammable and explosive. You can be burned or seriously injured when handling fuel.

- Stop the engine and keep heat, sparks and flame away.
- Handle fuel only outdoors.
- Wipe up spills immediately.

4. After refueling, install the fuel fill cap by turning it clockwise.
5. Lower and push the seat until it locks.
6. Remove the ignition key from the seat lock.

Engine oil quality is a major factor that affects both the performance and the service life of the engine.

Using the proper oil (page 85 ) and regularly checking, adding, and changing oil will help extend your engine's life. Even the best oil wears out. Changing oil helps get rid of dirt and deposits in the engine. Operating the engine with old or dirty oil can damage your engine. Running the engine with insufficient oil can cause serious damage to the engine and transmission.

Change the engine oil as specified in the maintenance schedule on page 73 .

When running in very dusty conditions, oil changes should be performed more frequently than specified in the maintenance schedule.

### Oil Recommendation

API classification	SG or higher except oils labeled as energy conserving on the circular API service label
viscosity (weight)	SAE 10W-30
JASO T 903 standard	MA

# Engine Oil

## suggested oil\*

Pro Honda GN4 4-stroke oil (USA & Canada), or Honda 4-stroke oil (Canada only), or an equivalent motorcycle oil.

\* Suggested oils are equal in performance to SJ oils that are not labeled as energy conserving on the circular API service label.

- Your scooter does not need oil additives. Use the recommended oil.
- Do not use oils with graphite or molybdenum additives.
- Do not use API SH or higher oils displaying a circular API “energy conserving” service label on the container. They may affect lubrication.



NOT RECOMMENDED



OK

- Do not use non-detergent, vegetable, or castor based racing oils.

Other viscosities shown in the following chart may be used when the average temperature in your riding area is within the indicated range.

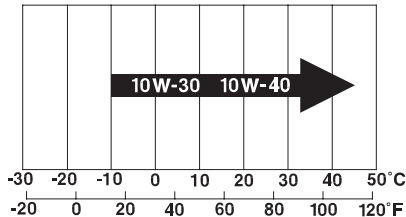

The JASO T 903 standard is an index for engine oils for 4-stroke motorcycle engines.

There are two classes: MA and MB. Oil conforming to the standard is labeled on the oil container. For example, the following label shows the MA classification.

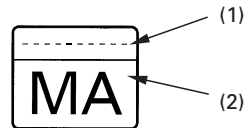

PRODUCT MEETING JASO T 903  
COMPANY GUARANTEEING THIS MA PERFORMANCE:

- (1) code number of the sales company of the oil
- (2) oil classification



# Engine Oil

## Checking & Adding Oil

Refer to *Safety Precautions* on page 66 .

RIGHT SIDE

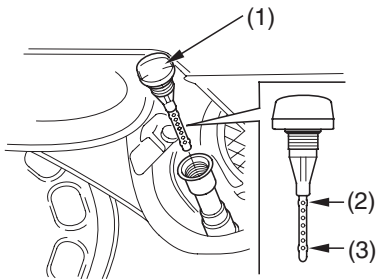

- (1) oil filler cap/dipstick
- (2) upper level mark
- (3) lower level mark

1. Park your scooter on its center stand on a firm, level surface.
2. Start the engine and let it idle for 3–5 minutes.
3. Stop the engine and wait 2–3 minutes.
4. Remove the oil filler cap/dipstick (1) and wipe it clean.
5. Insert the oil filler cap/dipstick until it seats, but don't screw it in.
6. Remove the oil filler cap/dipstick and check the oil level.
  - If the oil is at or near the upper level mark (2) — you do not have to add oil.
  - If the oil is below or near the lower level mark (3) — add the recommended oil until it reaches the upper level mark. (Do not overfill.)
7. Reinstall the oil filler cap/dipstick.
8. Check for oil leaks.

## Changing Engine Oil

Refer to *Safety Precautions* on page 66 .

This procedure requires mechanical skill and professional tools such as a torque wrench, as well as a means for disposing of the drained fluid (page 131 ). If you do not have the skills or the tools, see your Honda dealer.

1. Park the scooter on its center stand on a firm, level surface.
2. If the engine is cold, start it and let it idle for 3–5 minutes. Turn the engine off. Wait 2–3 minutes for the oil to settle.
3. Place a drain pan under the crankcase drain bolt ( 1 ).

4. To drain the oil, remove the oil filler cap/dipstick ( 2 ), crankcase drain bolt, and sealing washer ( 3 ).

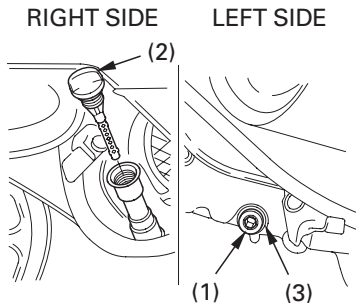

- ( 1 ) crankcase drain bolt
- ( 2 ) oil filler cap/dipstick
- ( 3 ) sealing washer

(cont'd)

# Engine Oil

---

5. Pour the drained oil into a suitable container and dispose of it in an approved manner (page 131 ).

## NOTICE

*Improper disposal of drained fluids is harmful to the environment.*

6. Check the condition of the sealing washer on the engine oil drain bolt. Replace the washer every other time the oil is changed.
7. Install the engine oil drain bolt and tighten it to the specified torque:  
**18 lbf·ft (25 N·m , 2.5 kgf·m)**
8. Fill the crankcase with the recommended oil (page 85 ), approximately:  
**0.6 US qt (0.6 ℓ)**

9. Install the oil filler cap/dipstick securely.
10. Lock the rear wheel (page 22 ).
11. Start the engine and let it idle for 3–5 minutes.
12. Stop the engine. Wait 2–3 minutes.
13. Check that the oil level is at the upper level mark on the oil filler cap/dipstick.
14. Check that there are no oil leaks.

If a torque wrench is not used for installation, see your Honda dealer as soon as possible to verify proper assembly.

Refer to *Safety Precautions* on page 66 .

Service the air cleaner more frequently if you ride in unusually wet or dusty areas. Your Honda dealer can help you determine the correct service interval for your riding conditions.

Your scooter's air cleaner has very specific performance requirements. Use a new genuine Honda air cleaner specified for your model or an air cleaner of equivalent quality.

### NOTICE

*Using the wrong air cleaner may result in premature engine damage.*

Proper air cleaner maintenance can prevent premature engine wear or damage, expensive repairs, low engine power, poor gas mileage, and spark plug fouling.

### NOTICE

*Improper or lack of proper air cleaner maintenance can cause poor performance and premature engine wear.*

# Air Cleaner

## Replacement

1. Remove the left side cover (page 81).
2. Remove the air cleaner housing cover (1) by removing the screws (2).

### LEFT SIDE

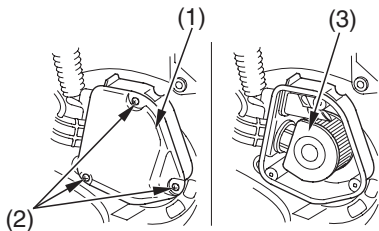

(1) air cleaner  
housing cover

(2) screws  
(3) air cleaner

3. Discard the air cleaner (3).
4. Install a new air cleaner.
5. Install the removed parts in reverse order of removal.

## Belt Case Air Cleaner

Refer to *Safety Precautions* on page 66 .

1. Remove the left side cover (page 81).
2. Loosen the air cleaner duct band screw (1), and remove the air cleaner duct (2).

LEFT SIDE

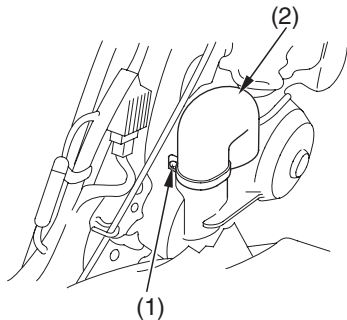

- (1) screw  
(2) air cleaner duct

3. Remove the element holder (3) and element (4).

LEFT SIDE

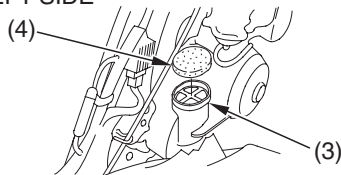

- (3) element holder    (4) element

4. Gently wash the element in clean, non-flammable (high flash point) solvent such as kerosene — not gasoline. After cleaning, gently squeeze out the remaining solvent.

Avoid twisting or wringing the element. This can tear the foam.

(cont'd)

## Belt Case Air Cleaner

---

5. Inspect the element for cracks or tears in the foam or seams. Replace the element if it is damaged.
6. Allow the element to dry thoroughly before installation.

### NOTICE

*Do not apply oil to the element. The drive belt may be damaged.*

7. Install the element and element holder.
8. Install the air cleaner duct.
9. Install the left side cover.

## Crankcase Breather

Refer to *Safety Precautions* on page 66 .

Service the crankcase breather more frequently if your scooter is ridden in the rain or often at full throttle. Service the breather if you can see deposits in the transparent section of the drain tube.

### Draining

#### LEFT SIDE

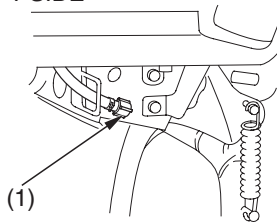

#### (1) crankcase breather tube plug

1. Place a drain pan under the crankcase breather tube plug ( 1 ).
2. Remove the plug to drain the deposits in the tube.
3. Reinstall the crankcase breather tube plug.



## Engine Idle Speed

---

The best way to assure proper carburetion is to see your Honda dealer for regularly scheduled servicing, including carburetor adjustment.

Remember, idle speed adjustment is not a “cure-all” for other problems in your engine’s fuel-delivery system. Adjusting the idle will not compensate for a fault elsewhere.

The engine must be at normal operating temperature for accurate idle speed adjustment.

For information about high altitude carburetor adjustment, see page 161 .

### Idle Speed Adjustment

Refer to *Safety Precautions* on page 66 .

LEFT SIDE

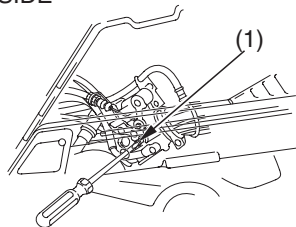

(1) throttle stop screw

1. If the engine is cold, start it and warm it up with ten minutes of stop-and-go riding. Stop the engine.
2. Place your scooter on its center stand on a firm, level surface.

## Engine Idle Speed

---

3. Remove the center cover and left side cover (page 81 ).
4. Lock the rear wheel by squeezing the rear brake lever and setting the rear brake lock lever (page 22 ). Start the engine.
5. Connect a tachometer to the engine.
6. Adjust idle speed with the throttle stop screw ( 1 ).

Idle speed (in neutral):

**1,700 ± 100 rpm**

# Spark Plug

---

## Spark Plug Recommendation

standard spark plug	CR7HS (NGK) or U22FSR-U (DENSO)
for cold climate (below 5°C, 41°F)	CR6HS (NGK) or U20FSR-U (DENSO)
for extended high speed riding	CR8HS (NGK) or U24FSR-U (DENSO)

Use only the recommended type of spark plugs in the recommended heat range.

### NOTICE

*Using spark plugs with an improper heat range can cause engine damage.*

## Spark Plug Replacement

Refer to *Safety Precautions* on page 66 .

1. Remove the center cover and left side cover (page 81 ).
2. Disconnect the spark plug cap. Take care to avoid damaging the spark plug wire when disconnecting the cap.
3. Clean any dirt from around the spark plug base.
4. Using a spark plug wrench, remove the spark plug.

## Spark Plug

5. Discard the spark plug.
6. Check the spark plug gap (1), using a wire-type feeler gauge. If adjustment is necessary, bend the side electrode (2) carefully.

The gap should be:

0.024 – 0.028 in (0.60 – 0.70 mm)

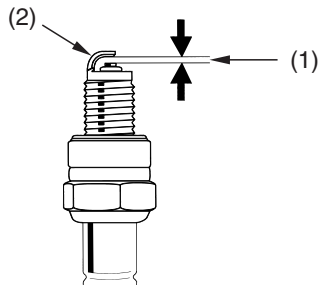

(1) spark plug gap      (2) side electrode

7. With the plug washer attached, thread the spark plug in by hand to prevent cross-threading.

(cont'd)

## Spark Plug

---

8. Tighten the spark plug:
  - If the old plug is good:  
1/8 turn after it seats.
  - If installing a new plug, tighten it twice to prevent loosening:
    - a) First, tighten the plug:  
NGK: 1 turn after it seats.  
DENSO: 3/4 turn after it seats.
    - b) Then loosen the plug.
    - c) Next, tighten the plug again:  
1/8 turn after it seats.
9. Reinstall the spark plug cap. Take care to avoid pinching any cables or wires.
10. Reinstall the left side cover and center cover (page 81 ).

### NOTICE

*An improperly tightened spark plug can damage the engine. If a plug is too loose, a piston may be damaged. If a plug is too tight, the threads may be damaged.*

Mechanically-activated drum braking systems on your scooter dissipate the heat generated by the friction of the brake shoes on the drum as the wheels are slowed.

## Brake Lever Freeplay

Refer to *Safety Precautions* on page 66 .

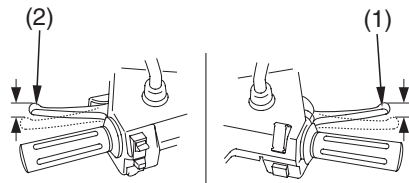

- (1) front brake lever
- (2) rear brake lever

(cont'd)

# Brakes

---

## Inspection

1. Place your scooter on its center stand.
2. Check freeplay by pulling in slowly on the front brake lever (1) and rear brake lever (2) until each brake starts to engage.

Freeplay at the tip of the brake levers should be:

3/8 – 13/16 in (10 – 20mm)

If necessary, adjust to the specified range.

## Adjustment

1. Turn the brake adjusting nut (3). Make sure the cut-out on the adjusting nut is seated on the brake arm pin (4).

LEFT FRONT

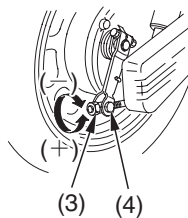

(3) adjusting nut  
(4) arm pin

LEFT REAR

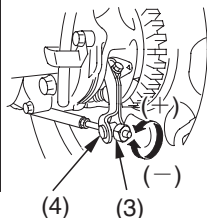

(+) increase freeplay  
(-) decrease freeplay

2. Apply the brake, release it, and then spin the wheel and check that it rotates freely. Repeat this procedure several times.
3. Check the freeplay. If you can't adjust the freeplay properly, see your Honda dealer.

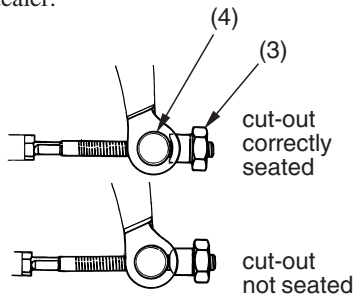

- (3) adjusting nut  
(4) arm pin

## Other Inspections

- Make sure the brake arm, spring, and fasteners are in good condition.



# Brakes

## Brake Shoe Wear

Refer to *Safety Precautions* on page 66 .

LEFT FRONT

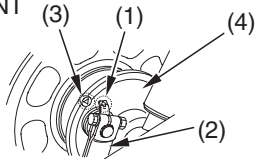

LEFT REAR

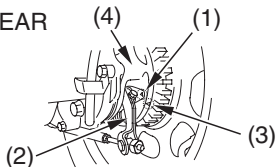

- |               |                    |
|---------------|--------------------|
| (1) arrow     | (3) reference mark |
| (2) brake arm | (4) brake panel    |

The front and rear brakes are equipped with external brake wear indicators that let you check brake wear without disassembly. Application of the brake control causes the arrow on the brake arm to move toward a reference mark on the brake panel.

1. Place your scooter on its center stand.
2. Apply the brake and check the movement of the arrow (1) on the brake arm (2). Replace the brake shoes if the arrow aligns with the reference mark (3) on the brake panel (4) upon full application of the brake. If replacement is necessary, see your Honda dealer.

To safely operate your scooter, your tires must be the proper type and size, in good condition with adequate tread, and correctly inflated for the load you are carrying.

## **WARNING**

Using tires that are excessively worn or improperly inflated can cause a crash in which you can be seriously hurt or killed.

Follow all instructions in this owner's manual regarding tire inflation and maintenance.

The following pages give detailed information on how and when to check your air pressure, how to inspect your tires

for wear and damage, and our recommendations for tire repair and replacement.

## **Air Pressure**

Refer to *Safety Precautions* on page 66 .

Properly inflated tires provide the best combination of handling, tread life, and riding comfort. Generally, underinflated tires wear unevenly, adversely affect handling, and are more likely to fail from being overheated. Overinflated tires make your scooter ride harshly, are more prone to damage from road hazards, and wear unevenly.

# Tires

---

We recommend that you visually check your tires before every ride and use an air pressure gauge to measure the air pressure at least once a month or any time you think the tires might be low. Even tires that are in good condition may lose one to two psi per month if not checked and adjusted regularly.

Always check air pressure when your tires are “cold” — after the scooter has been parked for at least three hours. If you check air pressure when your tires are “warm” — even if your scooter has only been ridden for a few miles — the readings will be higher. If you let air out of warm tires to match the recommended cold pressures, the tires will be underinflated.

The recommended “cold” tire pressures are:

front	22 psi (150 kPa , 1.50 kgf/cm <sup>2</sup> )
rear	25 psi (175 kPa , 1.75 kgf/cm <sup>2</sup> ) with less than 200 lbs (90 kg) of added weight*
	33 psi (225 kPa , 2.25 kgf/cm <sup>2</sup> ) with more than 200 lbs (90 kg) of added weight*

\* includes the weight of the rider, passenger, all cargo & all accessories

## Inspection

Refer to *Safety Precautions* on page 66 .

Whenever you check the tire pressures, you should also look for:

- Bumps or bulges in the side of the tire or the tread. Replace any tire that has a bump or bulge.
- Cuts, slits, or cracks in the tires. Replace the tire if you can see fabric or cord.
- Nails or other foreign objects embedded in the side of the tire or tread.
- Excessive tread wear.

Also, if you hit a pothole or hard object while riding, pull to the side of the road as soon as you safely can and carefully inspect the tires for damage.

## Tread Wear

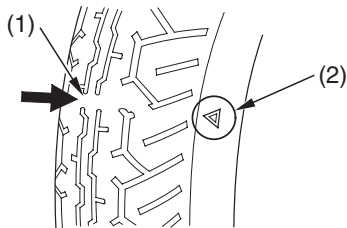

(1) wear indicator

(2) wear indicator location mark

# Tires

---

Inspect the wear indicator (1) to check for insufficient tread depth.

If the wear indicators are visible, replace the tire immediately as it is no longer safe.

## Tire & Tube Repair

Refer to *Safety Precautions* on page 66 .

We strongly recommend that you replace, not repair, any tire that is punctured or damaged. A repaired tube will not have the same reliability as a new one, and it may fail while you are riding. And the tire will have lower speed and performance limits than a new one.

A temporary repair can sometimes be made in an emergency situation.

However, since a temporary repair may not hold, you must ride very slowly, preferably without any cargo or passenger, and have the tire and tube replaced as soon as possible.

(For more information on temporary repairs, see *If You Have a Flat Tire*, page 140 .)

If you decide to only replace the tube but not the tire, you may not be able to safely carry as much weight. Repair work should be done by a professional and the wheel should be balanced before you ride.

If you have a tire and tube professionally repaired at a non-Honda facility, we recommend that you have the work checked by your Honda dealer.

## Tire Replacement

Refer to *Safety Precautions* on page 66 .

The tires that came on your scooter were designed to match the performance capabilities of your scooter and provide the best combination of handling, braking, durability, and comfort.

(cont'd)

# Tires

You should replace the tires with tires of the same size, load range, and speed rating as the originals.

## **WARNING**

Installing improper tires on your scooter can affect handling and stability. This can cause a crash in which you can be seriously hurt or killed.

Always use the size and type of tires recommended in this owner's manual.

The recommended tires for your scooter are:

front	3.50-10 51J BRIDGESTONE ML2 DUNLOP K398 IRC 3R KIK MB3
rear	3.50-10 51J BRIDGESTONE ML2 DUNLOP K398 IRC 3R KIK MB3
type	bias-ply, tube

Whenever you replace a tire, remember:

- Have the wheel balanced after the tire is installed.
- Have the tire replaced by your Honda dealer if possible.

- Have a new tube installed whenever a tire is replaced. The old tube will probably be stretched. If installed in a new tire, it could fail.

If you have a tire professionally replaced at a non-Honda facility, we recommend that you have the work checked by your Honda dealer.



## Battery

---

Your scooter has a maintenance-free type battery. You do not have to check the battery electrolyte level or add distilled water as you would with a conventional-type battery.

### NOTICE

*Your battery is a maintenance-free type and can be permanently damaged if the cap strip is removed.*

Electrical accessories use current from the battery — even when the ignition is OFF. Limited operation also allows the battery to discharge. If you have electrical accessories on your scooter — or do not ride frequently, we recommend that you charge the battery frequently (see *Battery Charging*, page 115 ).

If you do not expect to ride your scooter for at least two weeks, we recommend you remove the battery — or at least disconnect the battery cables (negative cable first).

If you plan to store your scooter, see *Battery Storage*, page 113 .

If your battery seems weak and/or is leaking electrolyte (causing slow starting or other electrical problems), see your Honda dealer.

**WARNING:** Battery posts, terminals and related accessories contain lead and lead compounds. **Wash hands after handling.**

### Battery Storage

Refer to *Safety Precautions* on page 66 .

If you plan to store your scooter, we recommend you remove the battery and store it where it can be charged at least every 30 days to maintain its service life.

If you do not remove the battery, we recommend disconnecting the battery cables (negative cable first).

You will get the best storage results from removing the battery and slow (trickle) charging it every 30 days (see *Battery Charging*, page 115 ).

Before you remove the battery, be sure to read all the information that follows, as well as the information on the battery label.

### WARNING

The battery gives off explosive hydrogen gas during normal operation.

A spark or flame can cause the battery to explode with enough force to kill or seriously hurt you.

Wear protective clothing and a face shield, or have a skilled mechanic do the battery maintenance.

# Battery

---

The battery is located in the battery box below the seat.

## UNDER SEAT

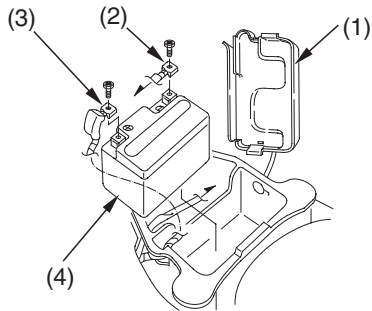

- (1) battery cover
- (2) negative ( - ) terminal lead
- (3) positive ( + ) terminal lead
- (4) battery

## Removal

1. Make sure the ignition switch is OFF.
2. Lift up the seat (page 57).
3. Remove the battery cover ( 1 ).
4. Remove the bolt that secures the negative ( - ) terminal lead ( 2 ).
5. Remove the bolt that secures the positive ( + ) terminal lead ( 3 ).
6. Pull the battery ( 4 ) out of the battery box.
7. Charge the battery (see following section), unless you have been riding regularly.
8. Store your battery in an easy-to-reach location off the floor, in an area protected from freezing temperatures and direct sunlight.

- Clean the battery box after removing the battery for storage. Dry the battery box and, if paint is missing, re-paint the area.
- Slow charge the battery (see following section) once every 30 days.

## Installation

- Reinstall in the reverse order of removal. Be sure to connect the positive (+) terminal first, then the negative (-) terminal.
- Check all bolts and other fasteners are secure.

## Battery Charging

Refer to *Safety Precautions* on page 66 .

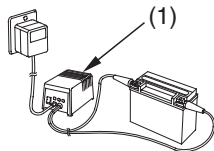

(1) “trickle” charger

Be sure to read the information that came with your battery charger and follow the instructions on the battery. Improper charging may damage the battery.

(cont'd)

## Battery

---

We recommend using a “trickle” charger (1) for home charging. These units can be left connected for long periods without risking damage to the battery. However, do not intentionally leave the charger connected longer than the time period recommended in the charger’s instructions.

Avoid using an automotive-type battery charger. An automotive charger can overheat a scooter battery and cause permanent damage.

Frequent cleaning and polishing will keep your Honda looking newer longer. Frequent cleaning also identifies you as an owner who values your scooter. A clean scooter is also easier to inspect and service.

### General Recommendations

Refer to *Safety Precautions* on page 66 .

- To clean your scooter, you may use:
  - water
  - a mild, neutral detergent and water
  - a mild spray and wipe cleaner/polisher
  - a mild spray and rinse cleaner/degreaser and water

- Avoid products that contain harsh detergents or chemical solvents that could damage the metal, paint, and plastic on your scooter.
- If your scooter is still warm from recent operation, give the engine and exhaust system time to cool off.
- Park in a shady area. Washing your scooter in bright sunlight may cause the finish to fade because water droplets intensify the sun's brightness. Spotting is also more likely because surface water can dry before you have time to wipe it off.
- Clean your scooter regularly to protect surface finishes.

(cont'd)

## Appearance Care

---

- We recommend the use of a garden hose to wash your scooter. High pressure washers (like those at coin-operated car washes) can damage certain parts of your scooter.

### NOTICE

*High pressure water (or air) can damage certain parts of your scooter.*

- After cleaning, inspect for damage, wear, and leaks (fuel, oil).

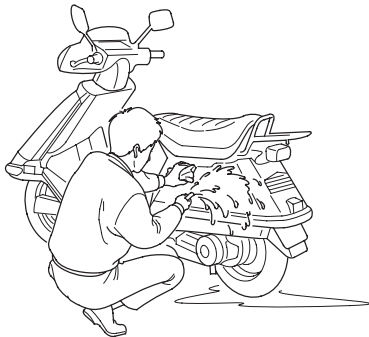

### Washing Your Scooter with a Mild Detergent

Refer to *Safety Precautions* on page 66 .

1. Rinse your scooter thoroughly with cool water to remove loose dirt.
2. Fill a bucket with cool water. Mix in a mild, neutral detergent, such as dish washing liquid or a product made especially for washing scooters or automobiles.
3. Wash your scooter with a sponge or a soft towel. As you wash, check for heavy grime. If necessary, use a mild cleaner/degreaser to remove the grime.
4. After washing, rinse your scooter thoroughly with plenty of clean water to remove any residue. Detergent residue can corrode alloy parts.
5. Dry your scooter with a chamois or a soft towel. Leaving water on the surface to air dry can cause dulling and water spots. As you dry, inspect for chips and scratches.
6. Start the engine and let it idle for several minutes. The engine heat will help dry moist areas.

(cont'd)



## Appearance Care

---

7. As a precaution, ride your scooter at a slow speed and apply the brakes several times. This will help dry the brakes and restore normal braking performance.

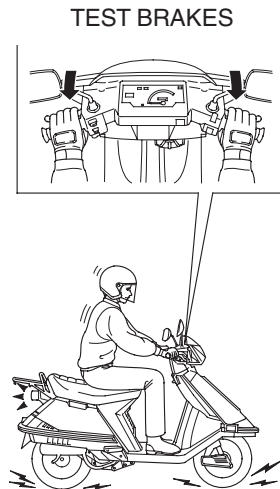

### Spray Cleaning Your Scooter

Refer to *Safety Precautions* on page 66 .

Avoid using spray cleaner products on the tires or suspension components.

Suggestions for using spray cleaner(s) follow:

## Appearance Care

---

<b>Scooter Condition</b>	<b>Recommended Cleaning</b>
Dust and fingerprint smudges.	Apply a spray cleaner/polish and wipe the paint, chrome, glass, and clear plastic.
Light road grime.	Spray any difficult-to-reach or very dirty areas with a spray cleaner/degreaser. Rinse and dry. Apply a spray cleaner/polish and wipe with a non-abrasive cloth.
Heavy grime. Oil leaks. Brake dust.	Use a spray cleaner/degreaser. If necessary, rub with a sponge. Rinse and dry. Apply a spray cleaner/polish and wipe with a non-abrasive cloth.
Dull, corroded chrome or aluminum.	Apply a high quality chrome/aluminum polish and wipe with a non-abrasive cloth.

### Finishing Touches

Refer to *Safety Precautions* on page 66 .

After washing your scooter, consider using a commercially-available spray cleaner/polish or quality liquid or paste wax to finish the job. Use only a non-abrasive polish or wax made specifically for scooters or automobiles. Apply the polish or wax according to the instructions on the container.

If a surface on your scooter is chipped or scratched, your Honda dealer has touch-up paint to match your scooter's color. Be sure to use your scooter's color code (page 154 ) when you buy touch-up paint.

If the frame has a chip that exposes the metal, first apply primer (to prevent corrosion) and then apply the touch-up paint. Several thin layers of touch-up paint are better than one thick coat.



Here's a few helpful tips on how to store and transport your Honda, and how to be an environmentally responsible scooter owner.

Storing Your Honda .....	126
Transporting Your Scooter.....	130
You & the Environment .....	131

## Storing Your Honda

---

If you won't be riding for an extended period, such as during the winter, thoroughly inspect your scooter and correct any problem before storing it. That way, needed repairs won't be forgotten and it will be easier to get your scooter running again.

For more information about storage, refer to the *Honda Motorcycle Winter Storage Guide*, available from your Honda dealer (USA only).

We suggest you perform the following procedures to keep your scooter in top condition. These storage procedures will reduce the deterioration that can occur during storage.

### Preparation for Storage

Refer to *Safety Precautions* on page 66 .

This procedure requires a means for draining and disposing of drained fuel (page 131).

1. Change the engine oil (page 89 ).
2. Fill the fuel tank. Make sure the fuel fill cap is properly installed.

## Storing Your Honda

3. Drain the carburetor into an approved gasoline container and dispose of it in an approved manner (page 131). If storage will last longer than one month, carburetor draining is important, to assure proper performance after storage.

### **WARNING**

Gasoline is highly flammable and explosive. You can be burned or seriously injured when handling fuel.

- Stop the engine and keep heat, sparks and flame away.
- Handle fuel only outdoors.
- Wipe up spills immediately.

4. To prevent rusting in the cylinder, perform the following:
  - Remove the spark plug cap from the spark plug. Using tape or string, secure the cap to any convenient plastic body part so that it is positioned away from the spark plug.
  - Remove the spark plug from the engine and store it in a safe place. Do not connect the spark plug to the spark plug cap.
  - Pour a tablespoon (15 – 20 cc) of clean engine oil into the cylinder and cover the spark plug hole with a piece of cloth.

(cont'd)



## Storing Your Honda

---

- With the engine stop switch in the RUN position, press the start button several times to crank the engine and distribute the oil.
  - Reinstall the spark plug and spark plug cap.
5. Remove the battery and charge it fully. Store it in an area protected from freezing temperatures and direct sunlight. Slow charge the battery (page 115 ) once a month.
  6. Wash and dry your scooter. Wax all painted surfaces. Apply rust-inhibiting oil to the chrome pieces.
  7. Inflate the tires to their recommended pressures (page 105 ).
  8. Store your scooter in an unheated area, free of dampness, away from sunlight, with a minimum of daily temperature variation.
  9. Place your scooter on blocks to lift both tires off the floor.
  10. Cover your scooter with a porous material. Avoid using plastic or similar non-breathing, coated materials that restrict air flow and allow heat and moisture to accumulate.

### Removal from Storage

Refer to *Safety Precautions* on page 66 .

1. Uncover and clean your scooter.
2. If your scooter has been stored for more than four months — change the engine oil (page 89 ).
3. If your scooter has been stored for more than two months — ask your Honda dealer to drain and replace the fuel.
4. Charge the battery (page 115 ) as required. Install the battery.
5. Perform a pre-ride inspection (page 30 ), then test-ride your scooter at low speeds.

## Transporting Your Scooter

---

If your scooter needs to be transported, it should be carried on a motorcycle trailer, or a truck or trailer with a flatbed area. For information about 24-hour emergency assistance, see page 177 (USA only). Do not tow your scooter, as towing can seriously damage the transmission.

When contacting a towing or transporting service, be sure to ask if they have a flatbed area, a loading ramp or power ramp to safely lift the scooter, and motorcycle tie-down straps.

## You & the Environment

---

Owning and riding a scooter can be enjoyable, but you must do your part to protect nature.

Following are tips on how you can be an environmentally-responsible scooter owner.

- **Choose Sensible Cleaners.** Use a biodegradable detergent when you wash your scooter. Avoid aerosol spray cleaners that contain chlorofluorocarbons (CFCs) which damage the atmosphere's protective ozone layer. Don't throw cleaning solvents away; see the following guidelines for proper disposal.

- **Recycle Wastes.** It's illegal and thoughtless to put used engine oil in the trash, down a drain, or on the ground. Used oil, gasoline, coolant, and cleaning solvents contain poisons that can hurt refuse workers and contaminate our drinking water, lakes, rivers, and oceans. Before changing your oil, make sure you have the proper containers. Put oil and other toxic wastes in separate sealed containers and take them to a recycling center. Call your local or state office of public works or environmental services to find a recycling center in your area, and to get instructions on how to dispose of non-recyclable wastes.



## Taking Care of the Unexpected

---

This section discusses the more common problems that can occur with your scooter while you're riding. It tells you how to evaluate each problem and what actions you can take to try to resume riding. If the problem cannot be safely solved, this section also gives instructions on the proper way to have your scooter transported.

For information about transporting your scooter, see page 130 .

General Guidelines .....	134
If Your Engine Quits or Won't Start .....	135
If You Have a Flat Tire .....	140
If a Fuse Blows.....	143
If You Crash .....	147
If You Lose Your Key .....	148
If Your Battery Is Low (or Dead) .....	149

# Taking Care of the Unexpected

---

## General Guidelines

Keeping your scooter well-maintained is the best way to reduce the possibility of having a problem on the road. However, since problems can arise even with well-maintained machines, you may consider subscribing to an emergency roadside service plan. (USA only: For information about the Honda Rider's Club of America, see page 177.)

Remember to take along your owner's manual, the tool kit that came with your scooter, and any other items (such as tire repair supplies and additional tools) that might help you solve a problem on your own.

Should you ever have a problem while riding, please follow these guidelines:

- Always put personal safety first.
- Take time to assess the situation and your options before deciding what to do.
- If the problem is relatively minor and you have the tools, supplies, and skills to make a temporary repair, be sure to have permanent repairs made as soon as possible.
- Do not continue riding if you are hurt or your scooter is not in safe riding condition.

Additional recommendations for specific problems follow.

## If Your Engine Quits or Won't Start

---

Proper operation and maintenance can prevent starting and engine performance problems. In many cases, the cause of the problem may be a simple operational oversight.

If you have a problem starting the engine — or experience poor engine performance — the following information may help you. If you can't correct the problem, see your Honda dealer.

If your scooter won't start, listen as you press the start button. If you don't hear the starter motor turning, refer to the *Starter motor doesn't operate* symptom. If you can hear the starter motor working normally, refer to the *Starter motor works, but the engine won't start* symptom.



## If Your Engine Quits or Won't Start

---

SYMPTOM: <b>Starter motor doesn't operate.</b>	
POSSIBLE CAUSE	WHAT TO DO
ignition switch OFF	Turn the ignition switch ON.
blown fuse	Replace with a new fuse of the same rating (page 143 ).
battery lead loose	Tighten the battery lead.
low (or dead) battery	Charge the battery (page 115). If charging doesn't help, see your Honda dealer.
faulty starter motor	If all possible causes are negative, the starter motor may be faulty. See your Honda dealer.

## If Your Engine Quits or Won't Start

---

SYMPTOM: <b>Starter motor works, but the engine won't start.</b>	
POSSIBLE CAUSE	WHAT TO DO
engine stop switch OFF	Turn the engine stop switch to RUN.
out of fuel	Fill the fuel tank.
loose or unconnected spark plug cap	Install the spark plug cap securely. If the engine still won't start, see your Honda dealer.
loose battery cables	Tighten the battery terminal bolts.
weak battery	Charge the battery (page 115). If charging doesn't help, see your Honda dealer.

## If Your Engine Quits or Won't Start

---

SYMPTOM: <b>Engine starts, but runs poorly.</b>	
POSSIBLE CAUSE	WHAT TO DO
idles roughly, too fast, stalls	Check engine idle adjustment (page 96 ). If the problem persists, see your Honda dealer.
runs erratically, misfires	See your Honda dealer.
blubbers (rich fuel mixture)	See your Honda dealer.

## If Your Engine Quits or Won't Start

---

SYMPTOM: <b>Engine starts, but runs poorly. (cont'd)</b>	
POSSIBLE CAUSE	WHAT TO DO
sooty exhaust (rich fuel mixture)	See your Honda dealer.
detonates or pings under load	If applicable, switch to the recommended octane gasoline (page 82 ) or change your brand of gasoline. If the problem persists, see your Honda dealer.
afterfires (backfires)	See your Honda dealer.
pre-ignition (runs on after ignition switched OFF)	See your Honda dealer.

## If You Have a Flat Tire

---

A flat tire is always unwelcome, especially if you are far from help. If you think you are losing air, or you hit a pothole or hard object, pull safely to the side of the road so you can inspect the tires and assess the situation. (Be sure to park on a firm, level surface and use the side stand for support.) You should examine the tire treads and sidewalls for foreign objects or damage.

If a tire has major damage or the bead has come loose from the rim, there is probably not much you can do except have your motorcycle transported to a Honda dealer or other qualified service facility. (USA only: For information about 24-hour emergency roadside assistance, see page 177.) Even with a simple puncture, this may be the safest and least troublesome

solution. For transporting instructions, see page 130.

Honda does not recommend that you make a temporary repair to a tube-type tire. However, if you decide to make a temporary repair so you can get to a service facility, ride cautiously at reduced speed and have the tube and tire replaced before you ride again.

## If You Have a Flat Tire

### **WARNING**

Riding your scooter with a temporary tire or tube repair can be risky. If the temporary repair fails, you can crash and be seriously injured or killed.

If you must ride with a temporary tire repair, ride slowly and carefully and do not exceed 30 mph (50 km/h) until the tire and tube are replaced.

Due to the uncertainty of any temporary repair, you should ride slowly (not over 30 mph, 50 km/h) and carefully (preferably without a passenger or cargo) until the tire and tube are replaced. Stop frequently and

check the air pressure. If the tire is losing pressure, it may be unsafe to continue riding. As the tire gets low, it will affect the handling of your motorcycle (especially with a passenger and cargo) and it may overheat and blow out.

### **Should You Repair or Replace a Tire?**

We strongly recommend that you replace, not permanently repair, any tire that is punctured or damaged, even if the tire has only a minor puncture. For a full discussion of repairs and replacement, see page 109 .

## If You Have a Flat Tire

---

### Emergency Wheel Removal/Installation

Refer to *Safety Precautions* on page 66 .

We recommend wheel removal be done only by your Honda dealer or another qualified mechanic. Do not attempt to remove the wheel on your own. Wheel removal requires mechanical skill and professional tools.

## If a Fuse Blows

---

All of the electrical circuits on your scooter have fuses to protect them from damage caused by excess current flow (short circuit or overload).

If something electrical on your scooter stops working, the first thing you should check for is a blown fuse.

Check the fuse before looking elsewhere for another possible cause of the problem. Replace a blown fuse and check component operation.

- The fuse holder is located behind the center cover.
- The spare fuse is located in the fuse holder.

### Recommended Fuses

main fuse	10A
-----------	-----

1. To prevent an accidental short circuit, turn the ignition switch OFF before checking or replacing the fuse.

(cont'd)



## If a Fuse Blows

---

2. To access the main fuse (1), remove the center cover.

### BEHIND CENTER COVER

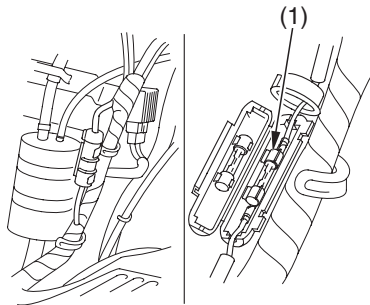

(1) main fuse

3. Open the fuse holder (2) and lift out the fuse with the clips (3).
4. Slide the old fuse out of the clips and discard it.
5. Slide the clips onto the ends of the new fuse, push them back into the fuse holder, and close the fuse holder.

Do not pry the clips open to get a fuse out; you could bend them and cause poor contact with the new fuse. A loose fuse could cause damage to the electrical system and even start a fire.

6. After replacing the fuse, be sure to return the fuse holder to its original location.

## If a Fuse Blows

### REMOVAL

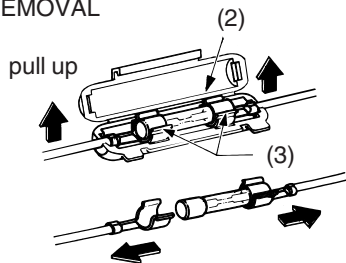

(2) fuse holder

(3) clips

### INSTALLATION

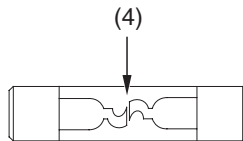
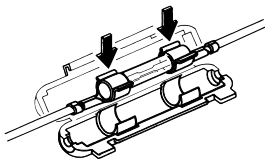

(4) blown fuse

7. Install the fuse holder and center cover.

If you do not have a replacement fuse with the proper rating for the circuit, install one with a lower rating.

#### NOTICE

*Replacing a fuse with one that has a higher rating greatly increases the chance of damage to the electrical system.*

## If a Fuse Blows

---

If you replace a blown fuse with a spare fuse that has a lower rating, replace the fuse with the correct rating as soon as you can. Also remember to replace any spare fuses that were installed.

If the replacement fuse of the same rating burns out in a short time, there is probably a serious electrical problem on your scooter. Leave the blown fuse in that circuit and have your scooter checked by your Honda dealer.

## If You Crash

---

Personal safety is your first priority after any accident. If you or anyone else has been injured, take time to assess the severity of the injuries and whether it is safe to continue riding. Call for emergency assistance if needed. Also follow applicable laws and regulations if another person or vehicle is involved in the accident.

If you decide you are capable of riding safely, carefully inspect your scooter for damage and determine if it is safe to ride. Check the tightness of critical nuts and bolts securing such parts as the handlebar, control levers, brakes, and wheels.

If there is minor damage, or you are unsure about possible damage, ride slowly and cautiously. Sometimes, crash damage is hidden or not immediately apparent, so you should have your scooter thoroughly checked at a qualified service facility as soon as possible. Also, be sure to have your Honda dealer check the frame and suspension after any serious crash.

If your scooter cannot be ridden, see *Transporting Your Scooter*, page 130 .

## If You Lose Your Key

---

Be sure to record your key number in the Quick Reference section at the rear of the manual. You'll need this number to have a duplicate key made.

A lost key won't be a problem if you take preventative action. Store one duplicate key in a safe place at home and carry a second duplicate in your wallet.

If you lose your key and aren't carrying a duplicate, either get your spare or have one made. If you don't know your key number, call the dealer you purchased your Honda from. They may have it listed in their records. If they don't, transport your scooter to them or the nearest Honda dealer. The dealer will probably have to remove the ignition switch assembly to find the key number so they can make a key for you.

## If Your Battery Is Low (or Dead)

---

Jump starting is not recommended, especially if you use an automobile battery. The greater amperage of an automobile battery when the car engine is running can damage your scooter's electrical system.

Bump starting is also not recommended.

If you can't charge the battery or it appears unable to hold a charge, contact your Honda dealer.



## Technical Information

---

This section contains dimensions, capacities, and other technical data, plus information on government requirements and how to break-in your scooter.

Vehicle Identification.....	152
Specifications .....	155
Break-in Guidelines.....	160
High Altitude Carburetor Adjustment.....	161
Emission Control Systems .....	162
Oxygenated Fuels .....	167



# Vehicle Identification

---

## Serial Numbers

The VIN and engine serial numbers are required when you register your scooter. They may also be required when ordering replacement parts. You may record these numbers in the Quick Reference section at the rear of this manual.

The VIN (vehicle identification number) is stamped on the left side of the frame body and also appears on the Safety Certification Label attached to the frame tube forward of the front cover.

LEFT SIDE

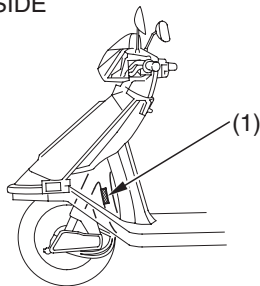

(1) VIN

## Vehicle Identification

LEFT SIDE

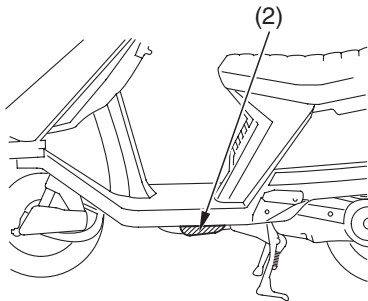

(2) VIN

The engine number (3) is stamped on the lower left side of the crankcase cover.

LEFT SIDE

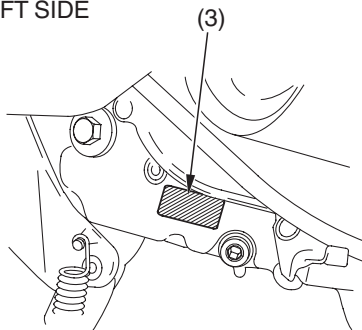

(3) engine number

# Vehicle Identification

---

## Color Label & Code

The color label is located to the fuel tank under the seat.

The color code is helpful when ordering replacement parts. You may record the color and code in the Quick Reference section at the rear of this manual.

UNDER SEAT

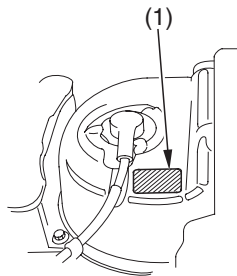

(1) color label

## Specifications

---

<b>Dimensions</b>	
overall length	68.9 in (1,750 mm)
overall width	26.4 in (670 mm)
overall height	43.1 in (1,095 mm)
wheelbase	46.1 in (1,170 mm)
ground clearance	5.1 in (130 mm)

## Specifications

---

<b>Fuel &amp; Lubricants</b>	
fuel recommendation	unleaded gasoline, pump octane number of 86 or higher
fuel tank capacity	1.3 US gal (5 ℓ) including reserve
engine oil capacity	after disassembly: 0.8 US qt (0.8 ℓ) after draining: 0.6 US qt (0.6 ℓ)
engine oil recommendation	API Service Classification SG or higher except oils labeled as energy conserving on the circular API service label, SAE 10W-30, JASO T 903 standard MA, Pro Honda GN4 4-stroke oil (USA & Canada) or Honda 4-stroke oil (Canada only), or an equivalent motorcycle oil
transmission oil capacity	0.06 US qt (0.06 ℓ)

## Specifications

<b>Capacities</b>	
passenger capacity	operator, one passenger
maximum weight capacity	335 lbs (152 kg) rider, passenger, all cargo and accessories

<b>Engine Specifications</b>	
displacement	4.86 cu-in (79.7 cm <sup>3</sup> )
bore & stroke	1.95 × 1.63 in (49.5 × 41.4 mm)
compression ratio	9.3 : 1
spark plug (standard)	CR7HS (NGK)      or      U22FSR-U (DENSO)
spark plug (cold climate)	CR6HS (NGK)      or      U20FSR-U (DENSO)
spark plug (high speed riding)	CR8HS (NGK)      or      U24FSR-U (DENSO)
valve clearance (cold)	intake: 0.002 in (0.05 mm) exhaust: 0.002 in (0.05 mm)
spark plug gap	0.024 – 0.028 in (0.60 – 0.70 mm)
idle speed	1,700 ± 100 rpm

## Specifications

---

<b>Power Transmission</b>	
primary reduction	V-Belt
final reduction	8.382

<b>Chassis &amp; Suspension</b>	
caster	26°
trail	2.7 in (68 mm)
tire size, front	3.50-10 51J BRIDGESTONE ML2      DUNLOP K398 IRC 3R                      KIK MB3
tire size, rear	3.50-10 51J BRIDGESTONE ML2      DUNLOP K398 IRC 3R                      KIK MB3
tire type	bias-ply, tube
tire pressure, front (cold)	22 psi (150 kPa , 1.50 kgf/cm <sup>2</sup> )
tire pressure, rear (cold)	25 psi (175 kPa , 1.75 kgf/cm <sup>2</sup> ) – with less than 200 lbs (90 kg) of added weight 33 psi (225 kPa , 2.25 kgf/cm <sup>2</sup> ) – with more than 200 lbs (90 kg) of added weight

## Specifications

<b>Electrical</b>	
battery	12V-4 Ah
generator	0.1 kW/5,000 rpm

<b>Lights</b>	
headlight	12V-35/35W
brake/tail light	12V-27/8W
turn signal lights	12V-23W
license light	12V-3.8W
turn signal indicator	12V-3.4W
high beam indicator	12V-1.7W

<b>Fuse</b>	
main	10A

<b>Torque Specifications</b>	
engine oil drain bolt	18 lbf·ft (25 N·m , 2.5 kgf·m)



## Break-in Guidelines

---

Help assure your scooter's future reliability and performance by paying extra attention to how you ride during the first 60 miles (100 km).

During this period, avoid full-throttle starts and rapid acceleration.

## High Altitude Carburetor Adjustment

---

Your engine's air-fuel mixture becomes overly rich when operated at high altitudes. Above 6,500 feet (2,000 m), a rich mixture can cause driveability problems, reduce engine performance, and increase fuel consumption. To compensate, you can have the carburetor adjusted for high altitude riding. See your Honda dealer.

However, the carburetor must be returned to standard factory specifications before riding again at lower altitudes (below 5,000 feet, 1,500 m). See your Honda dealer.

Sustained riding at lower altitudes with the lean high-altitude setting may cause rough idling, stalling, or engine damage from overheating.

# Emission Control Systems

---

## Exhaust Emission Requirements

The U.S. Environmental Protection Agency (EPA), the California Air Resources Board (CARB), and Environment Canada require that your scooter comply with applicable exhaust emissions standards during its useful life, when operated and maintained according to the instructions provided.

## Noise Emission Requirements

The EPA also requires that scooters built after January 1, 1983 comply with applicable noise emission standards for one year or 3,730 miles (6,000 km) after the time of sale to the ultimate purchaser, when operated and maintained according to the instructions provided. (USA only)

## Warranty Compliance

Compliance with the terms of the Distributor's Warranties for Honda Scooter Emission Control Systems is necessary in order to keep the emissions system warranty in effect. (USA only)

### UNDER SEAT

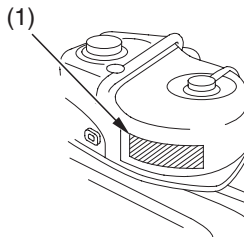

(1) vehicle emission control information label

# Emission Control Systems

---

The Vehicle Emission Control Information label (1) is attached to the right side of the fuel tank below the seat.

## **Source of Exhaust Emissions**

The combustion process produces carbon monoxide (CO), oxides of nitrogen (NO<sub>x</sub>) and hydrocarbons (HC). Control of hydrocarbons and oxides of nitrogen is very important because, under certain conditions, they react to form photochemical smog when subjected to sunlight. Carbon monoxide does not react in the same way, but it is toxic.

Honda Motor Co., Ltd. utilizes various systems to reduce carbon monoxide, oxides of nitrogen and hydrocarbons.

# Emission Control Systems

---

## **Exhaust Emission Control System**

The exhaust emission control system consists of lean carburetor settings, and no adjustment should be made except idle speed adjustment with the throttle stop screw.

## **Evaporative Emission Control System (California only)**

This scooter complies with the requirements of the California Air Resources Board (CARB) evaporative emission regulations. Fuel vapor from the fuel tank and carburetor is directed into the charcoal canister and air cleaner where it is adsorbed and stored while the engine is stopped. When the engine is running and the purge control diaphragm valve is open, fuel vapor in the charcoal canister and air cleaner is drawn into the engine through the carburetor.

# Emission Control Systems

---

## **Crankcase Emission Control System**

The engine is equipped with a closed crankcase system to prevent discharging crankcase emissions into the atmosphere. Blow-by gas is returned to the combustion chamber through the air cleaner and the carburetor.

## **Problems That May Affect Scooter Exhaust Emissions**

If you are aware of any of the following symptoms, have the vehicle inspected and repaired by your authorized Honda scooter dealer.

Symptoms:

1. Hard starting or stalling after starting
2. Rough idle
3. Misfiring or backfiring during acceleration
4. After-burning (backfiring)
5. Poor performance (driveability) and poor fuel economy

# Emission Control Systems

---

## Noise Emission Control System

### TAMPERING WITH THE NOISE CONTROL SYSTEM IS PROHIBITED:

U. S. federal law prohibits, or Canadian provincial laws may prohibit the following acts or the causing thereof: ( 1 ) The removal or rendering inoperative by any person, other than for purposes of maintenance, repair or replacement, of any device or element of design incorporated into any new vehicle for the purpose of noise control prior to its sale or delivery to the ultimate purchaser or while it is in use; or ( 2 ) the use of the vehicle after such device or element of design has been removed or rendered inoperative by any person.

### AMONG THOSE ACTS PRESUMED TO CONSTITUTE TAMPERING ARE THE FOLLOWING ACTS:

1. Removal of, or puncturing the muffler, baffles, header pipes or any other component which conducts exhaust gases.
2. Removal of, or puncturing of any part of the intake system.
3. Lack of proper maintenance.
4. Replacing any moving parts of the vehicle, or parts of the exhaust or intake system, with parts other than those specified by the manufacturer.

## Oxygenated Fuels

---

Some conventional gasolines are being blended with alcohol or an ether compound. These gasolines are collectively referred to as oxygenated fuels. To meet clean air standards, some areas of the United States and Canada use oxygenated fuels to help reduce emissions. If you use an oxygenated fuel, be sure it is unleaded and meets the minimum octane rating requirement.

Before using an oxygenated fuel, try to confirm the fuel's contents. Some states/provinces require this information to be posted on the pump.

The following are the EPA-approved percentages of oxygenates:

**ETHANOL** (ethyl or grain alcohol) 10%  
by Volume

You may use gasoline containing up to 10% ethanol by volume. Gasoline containing ethanol may be marketed under the name "Gasohol".

**MTBE** (Methyl Tertiary Butyl Ether) 15%  
by Volume

You may use gasoline containing up to 15% MTBE by volume.



## Oxygenated Fuels

---

METHANOL (methyl or wood alcohol)  
5% by Volume

You may use gasoline containing methanol containing up to 5% methanol by volume as long as it also contains cosolvents and corrosion inhibitors to protect the fuel system. Gasoline containing more than 5% methanol by volume may cause starting and/or performance problems. It may also damage metal, rubber, and plastic parts of your fuel system.

If you notice any undesirable operating symptoms, try another service station or switch to another brand of gasoline.

Fuel system damage or performance problems resulting from the use of an oxygenated fuel containing more than the percentages of oxygenates mentioned above are not covered under warranty.

Oxygenated fuels can damage paint and plastic. Be careful not to spill fuel when filling the fuel tank. Wipe up any spills immediately.

### NOTICE

*Oxygenated fuels can damage paint and plastic. Damage caused by spilled fuel is not covered by warranty.*

## Consumer Information

---

This section contains information on your warranty and how to get an official Honda Service Manual.

Authorized Manuals .....	170
Warranty Coverage .....	173
Warranty Service .....	174
Contacting Honda.....	175
Your Honda Dealer .....	176
The Honda Rider's Club (USA only) .....	177
Reporting Safety Defects (USA only) .....	179

## Authorized Manuals

---

The Service Manual used by your authorized Honda dealer is available from Helm, Inc. (USA only, Canada: See your Honda dealer to order authorized manuals.)

Also available but not necessary to service your model is the Honda Common Service Manual which explains theory of operation and basic service information for various systems common to all Honda motorcycles, motor scooters and ATVs.

These Honda manuals are written for the professional technician, but most mechanically-capable owners should find them easy to use if they have the proper tools and observe proper safety standards. Special Honda tools are necessary for some procedures.

Publication Item No.	Description	Price Each*
61GV422	2007 CH80 Service Manual	\$27.00
61CM002	Common Service Manual	\$48.00
31GV4780	2007 CH80 Owner's Manual	\$16.00

*\* Prices are subject to change without notice and without incurring obligation.*

**Order On-Line: [www.helminc.com](http://www.helminc.com)**

**Order Toll Free: 1-888-CYCLE93 (1-888-292-5393)**

*(NOTE: For Credit Card Orders Only)*

**Monday — Friday 8:00 AM — 6:00 PM EST**

**OR**

By completing this form you can order the materials desired. You can pay by check or money order, or charge to your credit card. Mail to Helm, Inc. at the address shown on the back of this order form (USA only).

Canada: See your Honda dealer to order authorized manuals.

<b>Publication Item No.</b>	<b>Item Description</b>	<b>Qty.</b>	<b>Price Each*</b>	<b>Total Price</b>
*Prices are subject to change without notice and without incurring obligation.  Orders are mailed within 10 days. Please allow adequate time for delivery.		<b>Sub Total</b>		
		<b>Purchaser's Sales Tax</b>		
		<b>Mich. Add 6 %</b>		
		<b>Calif. Add 8.25 %</b>		
		<b>Handling Charge</b>		<b>\$5.00</b>
		<b>Grand Total</b>		

**S  
H  
I  
P  
T  
O**

NOTE: Dealers and Companies please provide dealer or company name, and also the name of the person to whose attention the shipment should be sent.

Customer Name \_\_\_\_\_ Attention \_\_\_\_\_

Street Address - No P. O. Box Number \_\_\_\_\_ Apartment Number \_\_\_\_\_

City \_\_\_\_\_ State \_\_\_\_\_ Zip Code \_\_\_\_\_

Daytime Telephone Number (      ) \_\_\_\_\_

**P  
A  
Y  
M  
E  
N  
T**

Check or money order enclosed payable to Helm Inc.  
U.S. funds only. Do not send cash.

Check here if your billing address is different from the  
shipping address shown above.

MasterCard

Account Number

Expiration: Mo. Yr.

VISA

Discover

Customer Signature \_\_\_\_\_ Date \_\_\_\_\_

These Publications cannot be returned for credit without receiving advance authorization within 14 days of delivery. On returns, a restocking fee may be applied against the original order.

**HELM** P.O. BOX 07280, DETROIT, MICHIGAN 48207

## Warranty Coverage

---

Your new Honda is covered by these warranties:

- Scooter Limited Warranty
- Exhaust Emission Warranty
- Noise Control Warranty

There are responsibilities, restrictions, and exclusions which apply to these warranties. Please read the Warranties Booklet given to you by your Honda dealer at the time of purchase. Be sure to keep your Honda owner's card with your Warranties Booklet (USA only).

It is important to realize that your warranty applies to defects in material or workmanship of your Honda. Your warranty coverage does not apply to normal wear or deterioration associated with using the scooter.

Your warranty coverage will not be voided if you choose to perform your own maintenance. However, you should have the proper tools and service information and be mechanically qualified. Failures that occur due directly to improper maintenance are not covered.

Almost all of your warranty coverage can be extended through the Honda Protection Plan (USA only). For more information, see your Honda dealer.

## Warranty Service

---

Please remember that recommended maintenance interval servicing is not included in your warranty coverage. Additionally, your warranty does not apply to the normal wear of items (such as brakes, tires, etc.).

If you believe you have a problem with your scooter, call the service department of your Honda dealer. Make an appointment for an inspection and diagnosis. Remember, as the owner of the scooter, you will be asked to authorize that inspection. Your dealer will give you the results of the inspection. If the problem is covered under warranty, your dealer will perform the warranty repairs for you.

If you have questions about warranty coverage or the nature of the repair, it is best to talk to the service manager of your Honda dealer.

Sometimes, in spite of the best intentions of all concerned, a misunderstanding may occur. If you aren't satisfied with your dealer's handling of the situation, we suggest you discuss your problem with the appropriate member of the dealership's management team. If the problem has already been reviewed with the Service Manager, Parts Manager, Sales Manager, etc., contact the Owner of the dealership or their designated representative.

## Contacting Honda

---

Your owner's manual was written to cover most of the questions you might ask about your Honda. Any questions not answered in the owner's manual can be answered by your Honda dealer. If your dealer doesn't have the answer right away, they will get it for you.

If you have a difference of opinion with your dealer, please remember that each dealership is independently owned and operated. That's why it's important to work to resolve any differences at the dealership level.

If you wish to comment on your experiences with your Honda or with your dealer, please send your comments to the following address (USA only):

Motorcycle Division, American Honda Motor Co., Inc., P.O. Box 2200, Torrance, CA 90509-2200, mailstop: 100-4C-7B, telephone: (866) 784-1870.

Canada: Refer to the Warranties Booklet that was supplied with your vehicle.

Please include the following information in your letter:

- name, address, and telephone number
- product model, year, and VIN
- date of purchase
- dealer name and address

We will likely ask your Honda dealer to respond, or possibly acknowledge your comments directly.



## Your Honda Dealer

---

Once you purchase your new Honda, get familiar with the organization of your Honda dealer so you can utilize the full range of services available.

The service department is there to perform regular maintenance and unexpected repairs. It has the latest available service information from Honda. The service department will also handle warranty inspections and repairs.

The parts department offers Genuine Honda parts, Pro Honda products, Hondaline accessories (USA only), and Honda accessories and products (Canada only). The same quality that went into your Honda can be found in Genuine Honda replacement parts. You'll also find comparable quality in the accessories and

products available from the parts department.

The sales department offers the Honda Protection Plan to extend almost all of your warranty coverage (USA only). Your Honda dealer can inform you about competition and other riding events in your area. You'll also find that your dealer is a source of information about American Honda's Rider Education Centers and the Honda Rider's Club of America (USA only).

We're sure you'll be as pleased with the service your Honda dealer continues to provide after the sale as you are with the quality and dependability of your Honda.

## The Honda Rider's Club (USA only)

---

One of the best ways to get the most enjoyment from owning and riding your Honda is through the Honda Rider's Club of America. Your purchase of a new motorcycle, scooter, ATV or PWC from a participating U.S. Honda dealer entitles you to a complimentary one-year membership in the Club. There are hundreds of HRCA Chapter-sponsoring dealers across the USA with events and activities almost every weekend.

Membership benefits include:

- 24-hour, toll-free roadside assistance for your new Honda (includes roadside assistance for your transport vehicle [up to one ton] as long as your Honda is aboard or in tow). *For street-legal motorcycles and scooters only.*
- An exclusive HRCA website complete with access to the official Honda

Common Service Manual, contests, insider information and more.

- Reimbursement (up to \$75) for successful completion of a Motorcycle Safety Foundation training course. Separate, complimentary training from the Specialty Vehicle Institute of America for purchasers of new ATVs.
- One full year of *Honda Red Rider* magazine (six issues).
- Discounts from HRCA partners for experienced rider courses.
- Discounted vehicle insurance from the HRCA's insurance partner.
- Racing contingency programs and assistance at selected dual-sport, off-road and motocross events for off-road motorcycles and selected ATVs.

## The Honda Rider's Club (USA only)

---

*If you purchased an off-road motorcycle, ATV or PWC, your benefits do not include roadside assistance or trip interruption protection.*

Contact your Honda dealer for more information or call: 1-800-847-4722 or log on to [www.hrca.honda.com](http://www.hrca.honda.com).

## Reporting Safety Defects (USA only)

---

If you believe that your vehicle has a defect which could cause a crash or could cause injury or death, you should immediately inform the National Highway Traffic Safety Administration (NHTSA) in addition to notifying American Honda Motor Co., Inc.

If NHTSA receives similar complaints, it may open an investigation, and if it finds that a safety defect exists in a group of vehicles, it may order a recall and remedy campaign. However, NHTSA cannot become involved in individual problems between you, your dealer, or American Honda Motor Co., Inc.

To contact NHTSA, you may call the Vehicle Safety Hotline toll-free at 1-888-327-4236 (TTY: 1-800-424-9153); go to <http://www.safercar.gov>; or write to: Administrator, NHTSA, 400 Seventh Street, SW., Washington, DC 20590. You can also obtain other information about motor vehicle safety from <http://www.safercar.gov>.

# Table of Contents

---

The following presents the contents of each section of your owner's manual.

<b>SCOOTER SAFETY.....</b>	<b>1</b>
Important Safety Information .....	2
Accessories & Modifications .....	5
Safety Labels .....	7
 <b>INSTRUMENTS &amp; CONTROLS .....</b>	<b>9</b>
Operation Component Locations .....	10
Gauges & Indicators .....	13
Fuel Gauge.....	17
Maintenance Indicator.....	18
Controls & Features	
Ignition Switch .....	19
Start Button.....	20
Engine Stop Switch .....	20
Headlight Dimmer Switch .....	21
Turn Signal Switch.....	21
Horn Button .....	22

Rear Brake Lock.....	22
 <b>BEFORE RIDING.....</b>	<b>25</b>
Are You Ready to Ride ? .....	26
Protective Apparel.....	26
Rider Training .....	28
Is Your Scooter Ready to Ride ? .....	30
Pre-ride Inspection .....	30
Load Limit & Guidelines .....	33
Loading .....	33
Load Limits .....	34
Loading Guidelines .....	35
Cargo Compartments.....	37
Front Compartment .....	37

# Table of Contents

---

<b>BASIC OPERATION &amp; RIDING .....</b>	<b>39</b>
Safe Riding Precautions .....	40
Starting & Stopping the Engine .....	41
Preparation.....	41
Starting Procedure .....	42
How to Stop the Engine .....	45
Riding.....	46
Braking .....	53
Parking.....	55
Theft-Prevention Tips .....	58
Riding with a Passenger or Cargo.....	59

<b>SERVICING YOUR HONDA .....</b>	<b>61</b>
<i>Before You Service Your Honda</i>	
The Importance of Maintenance.....	64
Maintenance Safety .....	65
Important Safety Precautions.....	66
Periodic Maintenance.....	68
Maintenance Schedule .....	70
Maintenance Record.....	75
<i>Service Preparations</i>	
Maintenance Component Locations .....	77
Owner's Manual Storage.....	80
Left Side Cover Removal.....	81

(cont'd)

# Table of Contents

---

## **SERVICING YOUR HONDA (cont'd)**

### *Service Procedures*

#### Fluids & Filters

Fuel .....	82
Engine Oil.....	85
Air Cleaner .....	91
Belt Case Air Cleaner.....	93
Crankcase Breather.....	95

#### Engine

Engine Idle Speed.....	96
Spark Plug.....	98

#### Chassis

Brakes .....	101
Tires .....	105

#### Electrical

Battery.....	112
--------------	-----

Appearance Care .....	117
-----------------------	-----

#### **TIPS..... 125**

Storing Your Honda .....	126
Transporting Your Scooter.....	130
You & the Environment .....	131

# Table of Contents

<b>TAKING CARE OF THE UNEXPECTED .....</b>	<b>133</b>
General Guidelines .....	134
If Your Engine Quits or Won't Start .....	135
If You Have a Flat Tire .....	140
If a Fuse Blows.....	143
If You Crash .....	147
If You Lose Your Key .....	148
If Your Battery Is Low (or Dead) .....	149
<b>TECHNICAL INFORMATION .....</b>	<b>151</b>
Vehicle Identification.....	152
Specifications .....	155
Break-in Guidelines.....	160
High Altitude Carburetor Adjustment.....	161
Emission Control Systems .....	162
Oxygenated Fuels .....	167

<b>CONSUMER INFORMATION .....</b>	<b>169</b>
Authorized Manuals .....	170
Warranty Coverage .....	173
Warranty Service.....	174
Contacting Honda.....	175
Your Honda Dealer .....	176
The Honda Rider's Club (USA only) .....	177
Reporting Safety Defects (USA only) .....	179
<b>TABLE OF CONTENTS .....</b>	<b>180</b>
<b>INDEX .....</b>	<b>184</b>
<b>QUICK REFERENCE</b>	



# Index

---

## A

accessories .....	5
air cleaner.....	91
air pressure,tires.....	105
altitude, high .....	161
American Honda, contacting.....	175
apparel, protective .....	30
appearance care .....	117

## B

battery .....	112
belt case air cleaner .....	93
brakes,	
lever freeplay.....	101
shoe wear .....	104
braking .....	53

break-in guidelines .....	160
---------------------------	-----

## C

capacity, fuel .....	83
carburetor, altitude adjustment.....	161
care, appearance .....	117
cleaning, appearance care .....	117
color label .....	154
compartment,	
front .....	37
consumer information .....	169
customer service .....	175

## D

defects, safety ..... 179

## E

emission control systems..... 162

engine,

idle speed ..... 96

number ..... 152

oil ..... 85

pinging ..... 82

starting ..... 41

stop switch ..... 20

stopping..... 45

won't start ..... 135

environment..... 131

## F

flat tire..... 140

fuel,

gauge ..... 17

oxygenated..... 167

recommendation ..... 82

tank capacity ..... 83

fuses ..... 143

## G

gap, spark plug..... 99

gasohol ..... 167

gasoline ..... 82

# Index

---

## H

- headlight dimmer switch ..... 21
- helmet holder ..... 57
- high altitude carburetor adjustment ..... 161
- high beam indicator ..... 13
- Honda,
  - contacting ..... 175
  - Rider's Club..... 177
  - dealer..... 176
- Honda service manual ..... 170
- horn button..... 22

## I

- identification, vehicle..... 153
- idle speed, engine ..... 96
- ignition switch ..... 19

- indicators..... 13
- inspection, pre-ride ..... 30

## K

- key, lost..... 148

## L

- labels, safety ..... 7
- limit, weight..... 34
- load limits ..... 34
- loading guidelines..... 34
- lock, steering..... 56

## M

maintenance,	
component locations.....	77
importance .....	64
indicator .....	18
periodic .....	68
record .....	75
safety.....	65
schedule .....	73
manual, service.....	170
maximum weight limit .....	34
modifications .....	6

## N

numbers, serial.....	153
----------------------	-----

## O

odometer .....	13
oil, engine .....	85
operating controls .....	19
operation component locations .....	10
owner's manual storage.....	80
oxygenated fuels.....	167

## P

parking .....	55
pinging, engine .....	82
plug, spark.....	98
pre-ride inspection.....	30
problems, unexpected.....	133
protective apparel .....	26

# Index

---

## R

- removal,
  - left side cover ..... 81
- reporting safety defects ..... 179
- rider training ..... 3, 28
- Rider's Club, Honda ..... 177
- riding,
  - basic operation ..... 39
  - clothing ..... 26
  - precautions ..... 40
  - safety ..... 2
  - safety precautions ..... 40
  - with passenger or cargo ..... 59

## S

- safety,
  - important precautions ..... 66
  - labels ..... 7
  - reporting defects ..... 179
  - riding precautions ..... 40
- schedule, maintenance ..... 70
- serial numbers ..... 152
- service,
  - customer ..... 175
  - manuals ..... 170
  - warranty ..... 174
- spark knock ..... 82
- spark plug ..... 98
- specifications ..... 155
- start button ..... 20

starting,	
engine.....	41
troubleshooting.....	135
steering lock.....	55
stop switch, engine .....	20
stopping engine.....	45
storage,	
owner's manual .....	80
scooter.....	126
switch,	
headlight dimmer.....	21
ignition.....	19
turn signal .....	21

## T

theft prevention tips.....	58
tires,	
air pressure.....	105

flat.....	140
replacing .....	109
training, rider .....	3, 28
transporting your scooter.....	130
trouble, unexpected .....	133
troubleshooting, starting.....	135
turn signal indicator.....	13

## V

vehicle identification no. (VIN).....	152
---------------------------------------	-----

# Index

---

<b>W</b>
----------

warranty,	
coverage.....	173
extended.....	173
service.....	174
washing your scooter.....	119
weight limit.....	34







## Quick Reference

---

The following is a brief, but important collection of information you need to know about your Honda. You'll also find space to record important notes.

### How To Avoid Costly Repairs

The engine of your Honda can be the most expensive component to repair. Proper maintenance, especially the use of the recommended fluids and filters, prevents premature wear and damage.

Frequent causes of costly repairs are:

- Engine oil: insufficient quantity, improper oil.
- Air cleaner: dirty, leaking because of improper installation (poor seal).

Record important information on the following page:

## Quick Reference

---

VIN	
Engine No.	
Ignition Key No.	
Color Label	
Owner's Name	
Address	
City/State	
Phone	
Dealer's Name	
Address	
City/State	
Phone	
Service Mgr.	

## Quick Reference

---

Scheduled Maintenance	Initial: 600 miles (1,000 km) Regular: every 4,000 miles (6,400 km)
Pre-ride Inspection	Check the following items each time before you ride (page 30): tires & wheels, leaks, loose parts, brakes, indicators, lights.
Periodic Checks	Check the following items monthly (page 68 ): tires & wheels, fluids, lights, freeplay, fuse, nuts & bolts.
Fuel/Capacity	unleaded gasoline, pump octane number 86 or higher <b>1.3 US gal (5 l)</b>
Engine Oil	API Service Classification SG or higher except oils labeled as energy conserving on the circular API service label, SAE 10W-30, JASO T 903 standard MA, Pro Honda GN4 4-stroke oil or equivalent
Maximum Weight Capacity	<b>335 lbs (152 kg)</b> rider, passenger, all cargo and accessories

## Quick Reference

---

Tires	Front: 3.50-10 51J BRIDGESTONE ML2 DUNLOP K398 IRC 3R KIK MB3 Rear: 3.50-10 51J BRIDGESTONE ML2 DUNLOP K398 IRC 3R KIK MB3 Type: bias-ply, tube
Tire Pressure (cold)	Front: 22 psi (150 kPa , 1.50 kgf/cm <sup>2</sup> ) Rear: 25 psi (175 kPa , 1.75 kgf/cm <sup>2</sup> ) with less than 200 lbs (90 kg) of added weight 33 psi (225 kPa , 2.25 kgf/cm <sup>2</sup> ) with more than 200 lbs (90 kg) of added weight
Spark Plug	standard: CR7HS (NGK) or U22FSR-U (DENSO) cold climate: CR6HS (NGK) or U20FSR-U (DENSO) high speed riding: CR8HS (NGK) or U24FSR-U (DENSO)
Fuse	main: 10A

## Quick Reference