

Industrial Performance Monitors

Catalog Numbers 6186M-12PN, 6186M-12PT, 6186M-15PN, 6186M-15PT, 6186M-15PNSS, 6186M-15PTSS, 6186M-17PN, 6186M-17PT, 6186M-17PNSS, 6186M-17PTSS, 6186M-19PN, 6186M-19PT, 6186M-19PNSS, 6186M-19PTSS

| Topic | Page |
|---|-------------|
| Important User Information | 2 |
| About This Publication | 3 |
| Summary of Changes | 3 |
| Hazardous Locations | 4 |
| Control Drawing - Class I Division 2 and Zone 2 (USB Port-Type A) | 6 |
| Control Drawing - Class I Division 2 and Zone 2 (USB Port-Type B) | 7 |
| Application Information | 8 |
| European Union Directive Compliance | 8 |
| Environment and Enclosure Information | 9 |
| Before You Begin | 9 |
| Parts List | 10 |
| Required Tools | 10 |
| Installation Guidelines | 10 |
| Installing the Monitor | 12 |
| DIN Rail Mounting of the AC Power Adapter | 18 |
| Product Dimensions | 19 |
| Monitor Connections | 26 |
| Power Source Connection | 30 |
| Ship or Transport Product | 32 |
| Specifications | 33 |
| Additional Resources | 34 |

Important User Information

Solid-state equipment has operational characteristics differing from those of electromechanical equipment. Safety Guidelines for the Application, Installation and Maintenance of Solid State Controls (Publication [SG-1.1](#) available from your local Rockwell Automation sales office or online at <http://www.rockwellautomation.com/literature/>) describes some important differences between solid-state equipment and hard-wired electromechanical devices. Because of this difference, and also because of the wide variety of uses for solid-state equipment, all persons responsible for applying this equipment must satisfy themselves that each intended application of this equipment is acceptable.





In no event will Rockwell Automation, Inc. be responsible or liable for indirect or consequential damages resulting from the use or application of this equipment.

The examples and diagrams in this manual are included solely for illustrative purposes. Because of the many variables and requirements associated with any particular installation, Rockwell Automation, Inc. cannot assume responsibility or liability for actual use based on the examples and diagrams.

No patent liability is assumed by Rockwell Automation, Inc. with respect to use of information, circuits, equipment, or software described in this manual.

Reproduction of the contents of this manual, in whole or in part, without written permission of Rockwell Automation, Inc., is prohibited.

Throughout this manual, when necessary, we use notes to make you aware of safety considerations.

| | |
|---|---|
|  | WARNING: Identifies information about practices or circumstances that can cause an explosion in a hazardous environment, which may lead to personal injury or death, property damage, or economic loss. |
|  | ATTENTION: Identifies information about practices or circumstances that can lead to personal injury or death, property damage, or economic loss. Attentions help you identify a hazard, avoid a hazard and recognize the consequences. |
|  | SHOCK HAZARD: Labels may be on or inside the equipment, for example, drive or motor, to alert people that dangerous voltage may be present. |
|  | BURN HAZARD: Labels may be on or inside the equipment, for example, drive or motor, to alert people that surfaces may reach dangerous temperatures. |
| IMPORTANT | Identifies information that is critical for successful application and understanding of the product. |

About This Publication

This document provides instructions on how to install your monitor. Monitors can be installed in a panel, rack, bench, or tabletop and are VESA mount-ready. This document does not provide information on monitor configuration or setup.

Summary of Changes

This manual contains new and updated information. Changes throughout this revision are marked by change bars, as shown to the right of this paragraph.

The information below summarizes the changes since the last release.

| Topic | Page |
|---|------|
| Added "(USB Port-Type A)" to section title | 6 |
| Added USB Port Type A illustration and callout to figure | 6 |
| Added "(USB Port-Type B)" to section title | 7 |
| Added USB Port Type B illustration and callout to figure | 7 |
| Updated website link for CE Mark certification | 8 |
| Moved "Backlight Assembly Disposal" section previously located on page 33 | 8 |
| Added table with replacement mounting clips information | 12 |
| Revised instructions for panel-mounting the monitor | 14 |
| Added table with replacement analog cable and video card information | 27 |
| Added "Connecting the Optional Serial RS-232 Touch Screen Interface" section | 28 |
| Added "Connecting the USB and Optional USB Touch Screen Interface" section | 28 |
| Added "Installing the Touch Screen Driver Software" section | 29 |
| Added "Performing a Calibration" section | 29 |
| Added "Power Source Connection" title and paragraph | 30 |
| Added table with replacement AC power adapter and DIN-rail mounting accessory information | 30 |
| Revised "Secure the Cables" paragraph | 32 |
| Revised typical luminance value for 1700M monitor | 33 |
| Revised contrast ratios for 1200M and 1500M monitors | 33 |
| Revised typical response time for all monitors | 33 |
| Revised UL Listed and cUL Listed certifications | 34 |

Hazardous Locations

This equipment is suitable for hazardous locations specified on the product nameplate:

- Class I, Division 2 Groups A, B, C, D
- Non-hazardous locations

The following statement applies to use in hazardous locations.



WARNING: Explosion Hazard

- Substitution of any components may impair suitability for hazardous locations.
 - Do not disconnect equipment unless power has been removed or the area is known to be free of ignitable concentrations of flammable gases or vapors.
 - Do not connect or disconnect cables or components unless power has been removed or the area is known to be free of ignitable concentrations of flammable gases or vapors.
 - All wiring must be in accordance with Class I, Division 2 wiring methods of Article 501 of the National Electrical Code, and/or in accordance with Section 18-1J2 of the Canadian Electrical Code, and in accordance with the authority having jurisdiction.
 - The monitor and its AC adapter have a temperature code of T4 when operating in an environment that is within its specified operating temperature range. Do not install the equipment in an environment where atmospheric gases have an ignition temperature of less than 135 °C (275 °F).
 - Peripheral equipment must be suitable for the location in which it is used.
 - All hazardous-location equipment must be mounted in an enclosure that is suitably designed or rated for those specific environmental conditions that will be present, and designed to prevent personal injury resulting from accessibility to live parts.
 - The monitor may be powered directly from the included AC adapter (100...240V AC input), or an external 9...36V DC power source wired to the terminal block. Do not use the AC adapter and external DC power at the same time.
-

Environnements dangereux

Cet équipement peut être utilisé dans les environnements suivants :

- Classe I, Division 2, Groupes A, B, C et D .
- Classe II, Division 2, Groupes F et G .
- Classe III, Division 1 .
- non dangereux.

La mise en garde suivante s'applique à une utilisation en environnement dangereux.



Danger d'explosion

La substitution de composants peut rendre cet équipement impropre à une utilisation en environnement dangereux.

Ne pas déconnecter l'équipement sans s'être assuré que l'alimentation est coupée et que l'environnement est classé non dangereux.

Ne pas connecter ou déconnecter des composants sans s'être assuré que l'alimentation est coupée.

L'ensemble du câblage doit être conforme à la réglementation en vigueur dans le pays où cet équipement est installé.

L'équipement périphérique doit être adapté à l'environnement dans lequel il est utilisé.

Tout équipement utilisé en environnement dangereux doit être monté dans une armoire fournissant une protection adaptée aux conditions d'utilisation ambiantes et suffisante pour éviter toute blessure corporelle pouvant résulter d'un contact direct avec des composants sous tension.

Les écrans et l'adaptateur c.a. ont le code de température T4, c'est-à-dire une température de fonctionnement maximum de 135 °C pour une température ambiante de 50 °C. N'installez pas les écrans dans des environnements contenant des gaz atmosphériques inflammables à moins de 135 °C.

Control Drawing - Class I Division 2 and Zone 2 (USB Port-Type A)

The following control drawing is provided to comply with the National Electrical Code, Article 500 pertaining to Class I, Division 2, Groups A, B, C, D and Class I, Zone 2, Group IIC.

Industrial Performance Monitors USB Port (Type A) and Peripheral Devices

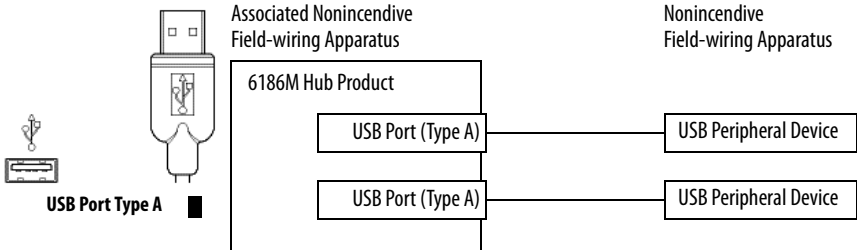

Industrial Performance Monitors USB Port (Type A) and Peripheral Device Circuit Parameters

| Parameter | Value | Parameter Definition |
|---------------|--------------|---|
| $V_{oc(USB)}$ | 5.25V DC | Open circuit voltage of each host USB port. The maximum applied voltage rating, $V_{max(peripheral)}$, of each peripheral device shall be greater than or equal to $V_{oc(USB)}$. $V_{max(peripheral)} \geq V_{oc(USB)}$, as appropriate |
| $I_{sc(USB)}$ | 950 mA | Maximum output current of each host USB port. The maximum current, $I_{max(peripheral)}$, to which each USB peripheral device can be subjected shall be greater than or equal to $I_{sc(USB)}$. $I_{max(peripheral)} \geq I_{sc(USB)}$ |
| $C_a(USB)$ | 20 μ F | This value is the maximum total capacitance that can be connected to each USB port. The total capacitance of each USB peripheral and its cable must not exceed the indicated value. The maximum total capacitance, $C_i(peripheral)$, and cable capacitance of each separate USB peripheral device shall be less than or equal to $C_a(USB)$. $C_i(peripheral) + C_{cable} \leq C_a(USB)$ |
| $L_a(USB)$ | 3.11 μ H | This value is the maximum total inductance that can be connected to each USB port. The total inductance of each peripheral device and its cable must not exceed the indicated value. The maximum total inductance, $L_i(peripheral)$, and cable inductance of each separate USB peripheral device shall be less than or equal to $L_a(USB)$. $L_i(peripheral) + L_{cable} \leq L_a(USB)$ |

Control Drawing - Class I Division 2 and Zone 2 (USB Port-Type B)

The following control drawing is provided to comply with the National Electrical Code, Article 500 pertaining to Class I, Division 2, Groups A, B, C, D and Class I, Zone 2, Group IIC.

Industrial Performance Monitors USB Port (Type B)

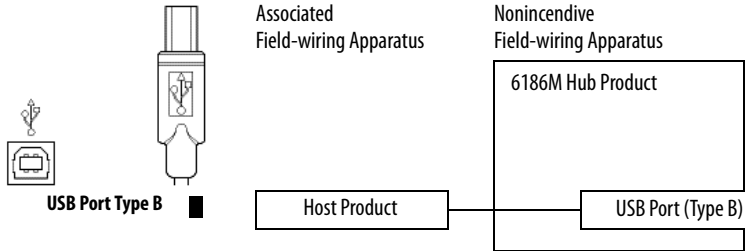

Required Circuit Parameters for USB Type B Connector - Connecting to Host

| Parameter | Value | Parameter Definition |
|------------------|------------------|--|
| $V_{Bmax} (USB)$ | 5.25V DC, max | Maximum applied voltage rating of the 6186M USB Type B connector. The output of the host product shall not exceed this value. $V_{Bmax} (USB) \geq V_{oc} (Host USB)$ |
| $I_{Bmax} (USB)$ | 110 μ A, min | Maximum current required at the 6186M USB Type B connector. The host product must be capable of a minimum of this value. $I_{sc} (Host USB) \leq I_{Bmax} (USB)$ |
| $C_{iB} (USB)$ | 0 μ F | Total capacitance of the 6186M USB Type B connector. The host product must be capable of tolerating this value of capacitance. $C_a (Host USB) \geq C_{iB} (USB) + C_{cable}$ |
| $L_{iB} (USB)$ | 0 μ H | Total Inductance of the 6186M USB Type B connector. The host product must be capable of tolerating this value of inductance. $L_a (Host USB) \geq L_{iB} (USB) + L_{cable}$ |

Application Information

The circuit parameters of associated field-wired apparatus for use in hazardous locations shall be coordinated with the host product such that their combination remains nonincendive. The Industrial Performance monitors and USB peripheral devices shall be treated in this manner.

The circuit parameters of the Industrial Performance monitors' USB ports are given in the Industrial Performance Monitors USB Port Circuit Parameters table. The monitor provides two separately powered USB ports.

The USB peripheral devices and their associated cabling shall have circuit parameters with the limits given in the Required Circuit Parameters for USB Peripheral Devices table for them to remain nonincendive when used with the Industrial Performance Monitors' USB ports.

For the comparison of C_a (USB) and C_i (peripheral), use the capacitance of each individual connected USB peripheral device and its associated cable C_{cable} .

For the comparison of L_a (USB) with L_i (peripheral), use the inductance of each individual peripheral device and its associated cable for L_i .

If cable capacitance and inductance are not known, the following values may be used:

$$C_{cable} = 60 \text{ pF/ft (197 pF/m)}$$

$$L_{cable} = 0.20 \text{ } \mu\text{H/ft (0.66 } \mu\text{H/m)}$$

European Union Directive Compliance

This product meets the European Union Directive requirements when installed within the European Union or EEA regions and has the CE mark. A copy of the Declaration of Conformity is available at the following website:

<http://www.rockwellautomation.com/products/certification/> under Product Certification.



ATTENTION: This product is intended to operate in an industrial or control-room environment, which utilizes some form of power isolation from the public low-voltage mains. Some computer configurations may not comply with the EN 61000-3-2 Harmonic Emissions standard as specified by the EMC Directive of the European Union. Obtain permission from the local power authority before connecting any computer configuration that draws more than 75 W of AC power directly from the public mains.

Backlight Assembly Disposal



ATTENTION: The backlight assembly in this unit contains mercury. At the end of its life, this equipment should be collected separately from any unsorted municipal waste.

Environment and Enclosure Information

Review the information on enclosures and environments before installing the product.



ATTENTION: Environment and Enclosure

This equipment is intended for use in a Pollution Degree 2 industrial environment, in overvoltage Category II applications (as defined in IEC publication 60664-1), at altitudes up to 2000 m (6561 ft) without derating.

This equipment is considered Group 1, Class A industrial equipment according to IEC/CISPR Publication 11. Without appropriate precautions, there may be potential difficulties ensuring electromagnetic compatibility in other environments due to conducted as well as radiated disturbance.

This equipment is supplied as open-type equipment. UL recognized and hazardous location equipment must be mounted in an enclosure that is suitably designed or rated for those specific environmental conditions that will be present, and designed to prevent personal injury resulting from accessibility to live parts. UL Listed equipment need not be mounted inside another enclosure in ordinary (nonhazardous) locations if NEMA Type and IEC ratings are not required, but the mounting method must limit the tilt of the product to $\pm 60^\circ$ from vertical. Examples include articulated arm, table-top stand, or other means having sufficient mechanical stability. The mounting means must be firmly attached to the supporting surface using screws, bolts, or clamps so the monitor cannot tip. Units ship with a gasketed bezel to meet specified NEMA and IEC ratings only when mounted in a panel or enclosure with an equivalent rating. Subsequent sections of this publication may contain additional information regarding specific enclosure-type ratings required to comply with certain product safety certifications.

In addition to this publication, see the following:

- Industrial Automation Wiring and Grounding Guidelines, Allen-Bradley publication [1770-4.1](#)
 - NEMA Standards publication 250 and IEC publication 60529, as applicable, for explanations of the degrees of protection provided by different types of enclosure
-

Before You Begin

Before unpacking the product, inspect the shipping carton for damage. If damage is visible, immediately contact the shipper and request assistance. Otherwise, proceed with unpacking.

Keep the original packing material in case you need to return the product for repair or transport it to another location. Use both the inner and outer packing cartons to be sure of adequate protection for a unit returned for service.

Parts List

The monitors are shipped with these items:

- Mounting clips and cutout template
- AC power supply and applicable power cord
- HD-15 analog video cable
- DVI cable
- Touch screen serial cable (only for monitors with touch screen display)
- USB cable
- Cable retention tie wraps
- Installation Instructions
- Accessories CD (contains the installation files for the monitor drivers and the ScreenSet monitor setup utility)

Required Tools

These tools are required for installation:

- Panel cutout tools
- #2 Phillips torque screwdriver

Installation Guidelines

Follow these guidelines to make sure your product provides safe and reliable service:

- The installation site must have sufficient power.



ATTENTION: The monitor's AC adapter must be grounded to maintain an electrically safe installation. Grounding the monitor itself is not required.

To ground the AC adapter, connect the product to earth ground using the supplied AC cord ground wire or 0.9mm² (18 AWG) or larger external wire. The ground wire should have green insulation with a yellow stripe for easy identification.

- The enclosure must have sufficient space around air inlets and outlets to provide the circulation necessary for cooling. Never allow air passages to become obstructed.

- The surrounding air temperature must not exceed the maximum operating temperature. Consider heat produced by other devices in the enclosure. You may need a user-supplied fan, heat exchanger, or air conditioner to meet this condition.

TIP Hot air rises. The temperature at the top of the enclosure is often higher than the temperature in other parts of the enclosure, especially if air is not circulating.

IMPORTANT The product can operate at a range of extremes. However, the life span of any electronic device is shortened if you continuously operate the product at its highest rated temperature.

- The humidity of the surrounding air must not exceed specified limits. In dry environments, static charges build up readily. Proper grounding of the equipment through the AC power cord helps to reduce static discharges, which may cause shocks and damage electronic components.
- The enclosure or cover must remain in place at all times during operation. The cover provides protection against high voltages inside the product and inhibits radio-frequency emissions that might interfere with other equipment.



ATTENTION: Industrial computers and monitors are not safety devices. Standard safety practice and redundancy should be followed in the application of this product.

- When mounted, the product cannot be tilted more than 60° from vertical.

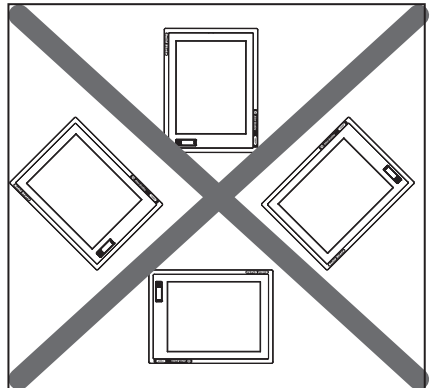
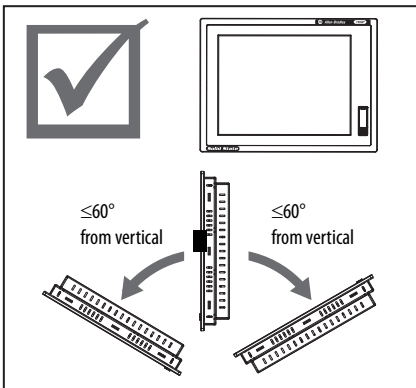

Installing the Monitor

There are various ways to install the monitors.

- Panel mount
- Rack mount
- Bench or tabletop mount

Review each mounting type and product dimensions before installation.

Panel Mounting

Monitors install directly into a panel with mounting clips. The number of clips vary by model.

| Monitor Model | Number of Clips |
|--|-----------------|
| 1200M, 1500M, and 1700M aluminum bezel | 10 |
| 1700M stainless steel bezel | 12 |
| 1900M | 14 |

| Cat. No. | Description |
|--------------|---------------------------------|
| 6189V-MCLPS3 | Replacement Mounting Clips (14) |

Mounting Adapters

Optional adapters are available to mount a monitor into the existing panel cutout of an older monitor.

| Cat. No. | Description |
|-------------|--|
| 6189V-MMA12 | Panel adapter for converting 6185-B to 1200M |
| 6189V-MMA15 | Panel adapter for converting 6185-C/F/H to 1500M |
| 6189V-MMA17 | Panel adapter for converting 6185-D/J to 1700M |

Mounting Guidelines

Observe these guidelines when installing the monitor in a panel:

- Confirm that there is adequate space behind the panel.
 - Allow a minimum of 51 mm (2.0 in.) around the back, sides, and bottom, and 77 mm (3.0 in.) on the top for ventilation.
 - A cabinet with a minimum depth of 112 mm (4.4 in.) is sufficient.
- Cut supporting panels to specifications before installation. Take precautions so metal cuttings do not enter components already installed in the panel.
- Supporting panels must be at least 14 gauge to be sure of proper sealing against water and dust and to provide proper support. The mounting hardware supplied accommodates panels up to 6.0 mm (0.236 in.) thick.
- Precautions should be made to assure that the operating temperatures, or other environmental specifications of the monitor are followed both inside and outside of the enclosure.



ATTENTION: Failure to follow these guidelines may result in personal injury or damage to the panel components.

Panel Cutout Dimensions

The table lists the panel cutout dimensions for each monitor. Use the full-size template shipped with each monitor to mark the cutout dimensions.

| Monitor Model | Cutout Dimensions, Approx. (H x W) |
|---------------|--------------------------------------|
| 1200M | 238.0 x 318.0 mm (9.37 x 12.51 in.) |
| 1500M | 285.6 x 386.6 mm (11.24 x 15.22 in.) |
| 1700M | 329.5 x 424.0 mm (12.97 x 16.69 in.) |
| 1900M | 363.5 x 449.6 mm (14.31 x 17.70 in.) |

Mount the Monitor in a Panel

Follow these directions to mount the monitor in a panel.

1. Cut the panel opening by using the appropriate cutout dimensions.
2. Attach cables to the monitor before installing the monitor if rear access to the monitor will be limited after installation. See “Monitor Connections” on page 26 for where to attach cables.
3. Verify the sealing gasket is properly positioned on the monitor.

This gasket forms a compression-type seal. Do not use sealing compounds.

4. Place the monitor in the panel cutout.
5. Slide the mounting clips into the slots on the top, bottom, and sides of the monitor.
6. Hand-tighten the mounting clips around the bezel by following the tightening sequence.
7. Tighten the mounting clips to a torque of 1.35 N•m (12 lb•in) by following the torque sequence, making sure not to overtighten.

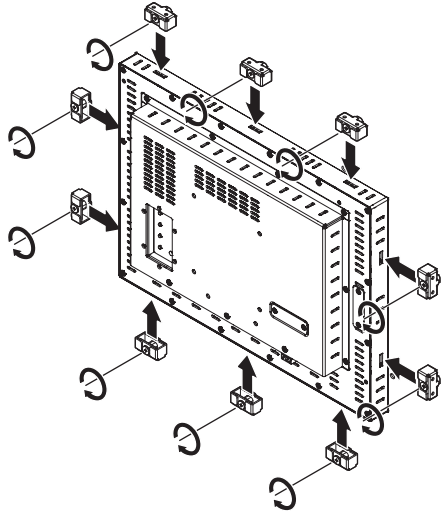

ATTENTION: Tighten the mounting clips to the specified torque to provide a proper seal and prevent damage to the product. Rockwell Automation assumes no responsibility for water or chemical damage to the product or other equipment within the enclosure because of improper installation.

8. Repeat the torque sequence at least three times until all mounting clips are torqued to 1.35 N•m (12 lb•in) and the sealing gasket is compressed uniformly against the panel.

Tightening and Torque Sequence

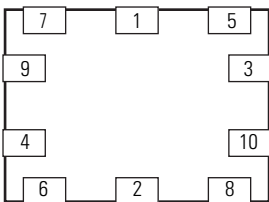

1200M, 1500M, and 1700M Monitors

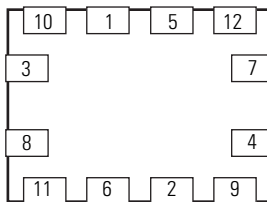

1700M Stainless Steel Bezel Monitor

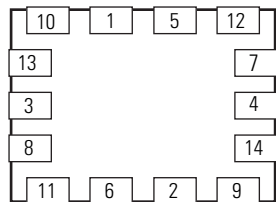

1900M Monitors

Rack Mounting

You can install the 1200M, 1500M, and 1700M monitors directly into an EIA-rack cabinet by using the appropriate rack adapters.

| Cat. No. | Description |
|-------------|--------------------------------|
| 6189V-MRA12 | Rack adapter for 1200M monitor |
| 6189V-MRA15 | Rack adapter for 1500M monitor |
| 6189V-MRA17 | Rack adapter for 1700M monitor |

Mounting Guidelines

Observe these guidelines when installing the monitor in an EIA-rack cabinet:

- The cabinet height must accommodate the monitor's panel height.
- The cabinet depth must accommodate the monitor's depth plus rear clearance for cables and airflow. A cabinet depth of 112 mm (4.4 in.) is sufficient.

Mount the Monitor in a Rack

Follow these directions to mount the monitor.

1. Place the 1200M, 1500M, or 1700M monitor in the rack adapter (1) and attach it to the rack adapter with the mounting clips provided (2).
2. Secure the adapter to the cabinet by installing screws through the holes in the adapter, and into the mounting rails (3).

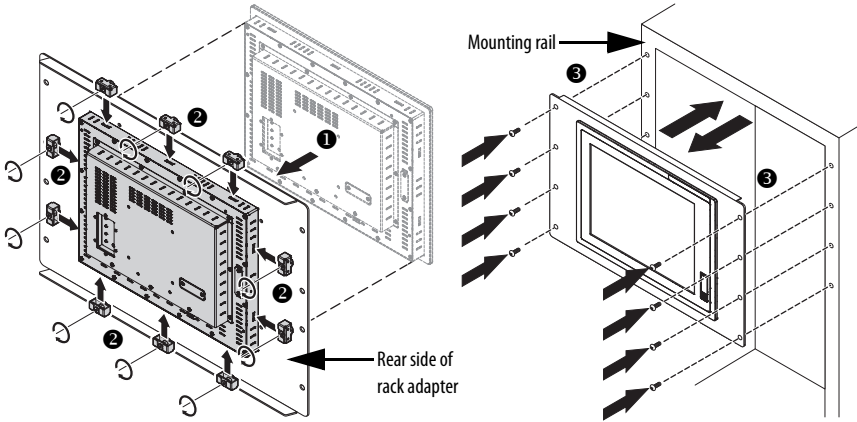

IMPORTANT

The mounting rails that run vertically along the inside edges of the front opening of an EIA-rack cabinet can be of two types: wide or universal.

- Wide rails have holes spaced 12.7 mm (0.5 in.) and 31.8 mm (1.25 in.) on centers, in a repeating pattern. Wide rails are prevalent in Europe.
- Universal rails have holes spaced 12.7 mm (0.5 in.), 15.9 mm (0.625 in.), and 31.8 mm (1.25 in.) on centers, in a repeating pattern. The universal rails have a hole pattern that contains the wide pattern but provides an additional hole at the midpoint of the pattern. Universal rails are prevalent in the United States.

Bench or Tabletop Mounting

Use the optional bench/tabletop adapter for monitors, catalog number 6189V-MBA, to mount your monitor on a bench or tabletop.

Mounting Guidelines

Observe these guidelines when installing the monitor on an arm:

- The mounting surface and the mounting arm must be strong enough to support both the monitor and the mounting hardware.
- The interface between the arm and the monitor must meet VESA FPM PMI 100 mm (3.94 in.) standards.
- The mounting location must provide adequate clearance for positioning and moving the adjustable unit, and routing cables.

Mounting the Monitor on a Bench or Tabletop

Follow these directions to mount the monitor to a bench or tabletop.

1. Mount the arm to the bench or tabletop by using screws, bolts, or clamps so the monitor cannot tip.
2. Place the monitor over the arm and insert four M4 x 0.7 screws through the arm brackets and into the monitor.

The illustration shows the mounting holes for VESA FPM PMI standard 100 mm (3.94 in.) interface pad.

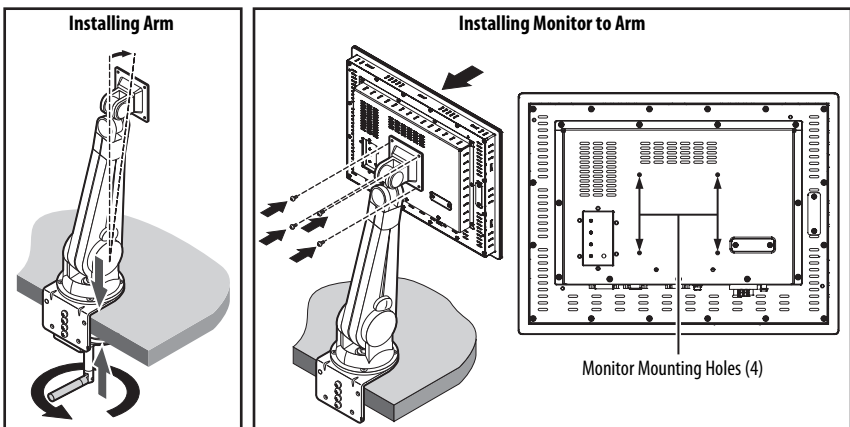

3. Tighten the screws.

DIN Rail Mounting of the AC Power Adapter

You can mount the AC power adapter on a DIN rail by using the DIN rail mounting accessory, catalog number 6189V-MPSDIN.

Follow these steps to mount the AC power adapter to a DIN rail.

1. Attach the DIN rail bracket to the bottom of the AC power adapter (1).
2. Secure the DIN rail bracket by using four of the provided M4 x 6 mm screws (2).
3. Torque the screws to 0.882 N•m (7.811 lb•in).
4. Attach the DIN rail to the wall or installation surface (3) by using two M4 x 6 mm screws (4); if using an existing DIN rail skip to the next step.
Torque the screws to 0.882 N•m (7.811 lb•in).
5. Mount the AC adapter on the DIN rail by inserting the upper lip of the DIN rail bracket on the top edge of the DIN rail (5), then pressing the AC adapter firmly against the lower edge of the rail (6).
6. Secure the installation by tightening the fastener on the DIN-rail bracket (7).

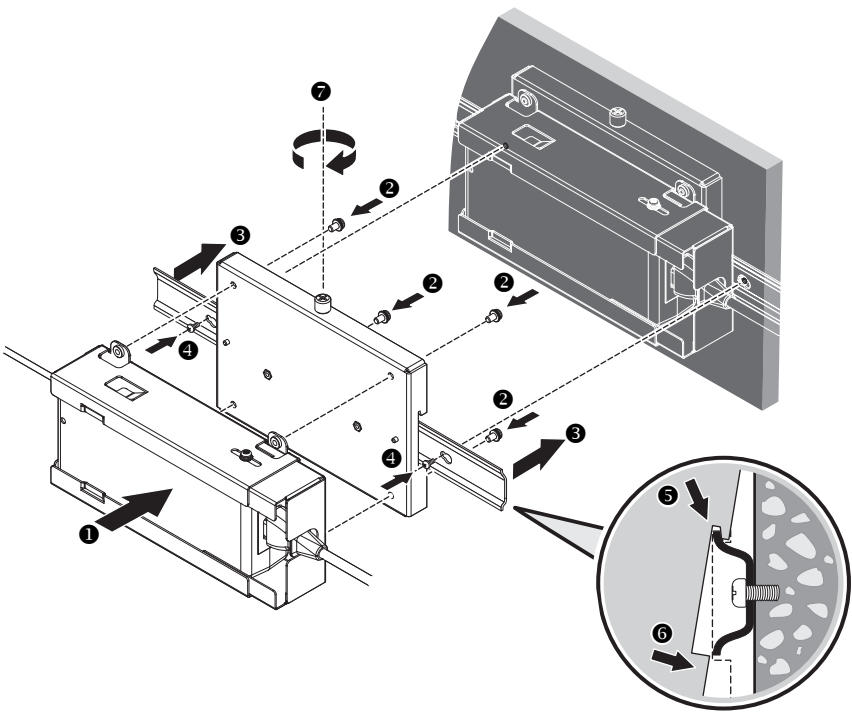

Product Dimensions

The product dimensions for the monitors are in mm (in.).

1200M Monitor

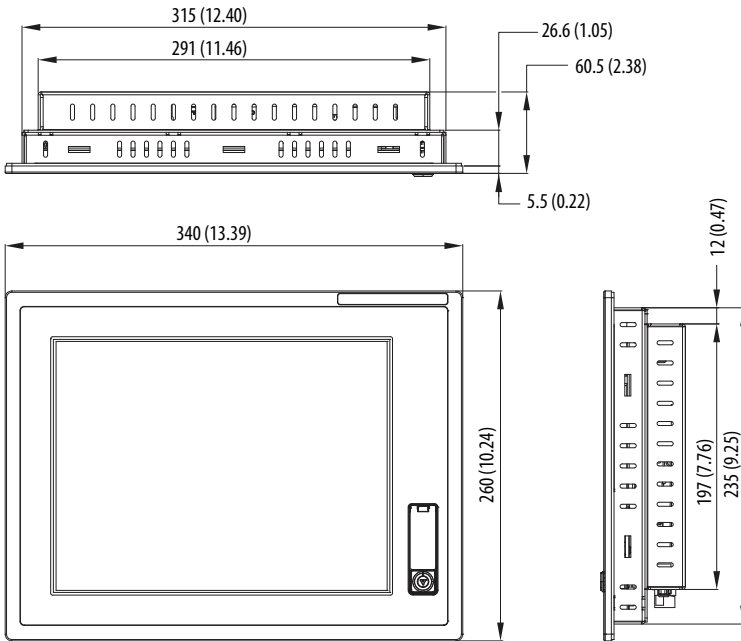

1500M Aluminum Bezel

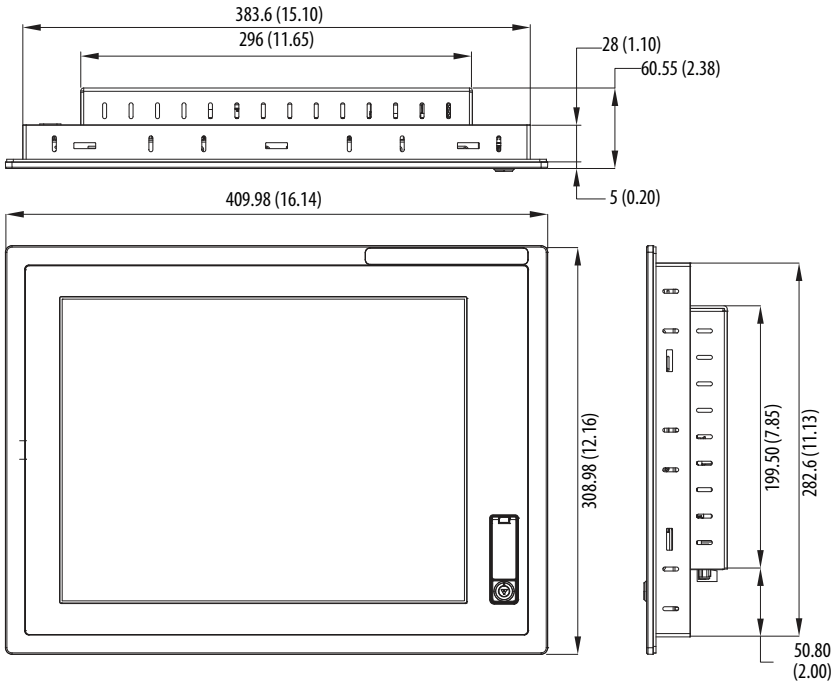

1500M Stainless Steel Bezel

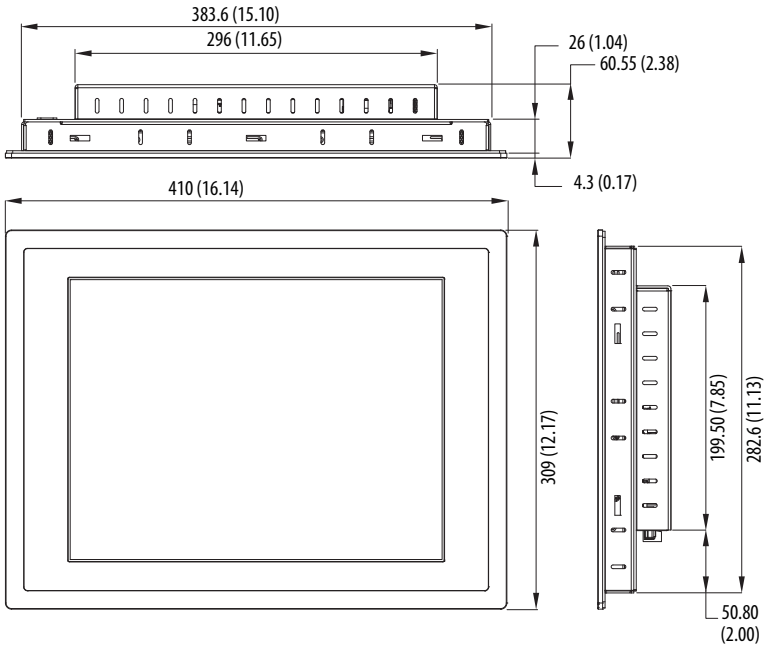

1700M Monitor - Aluminum Bezel

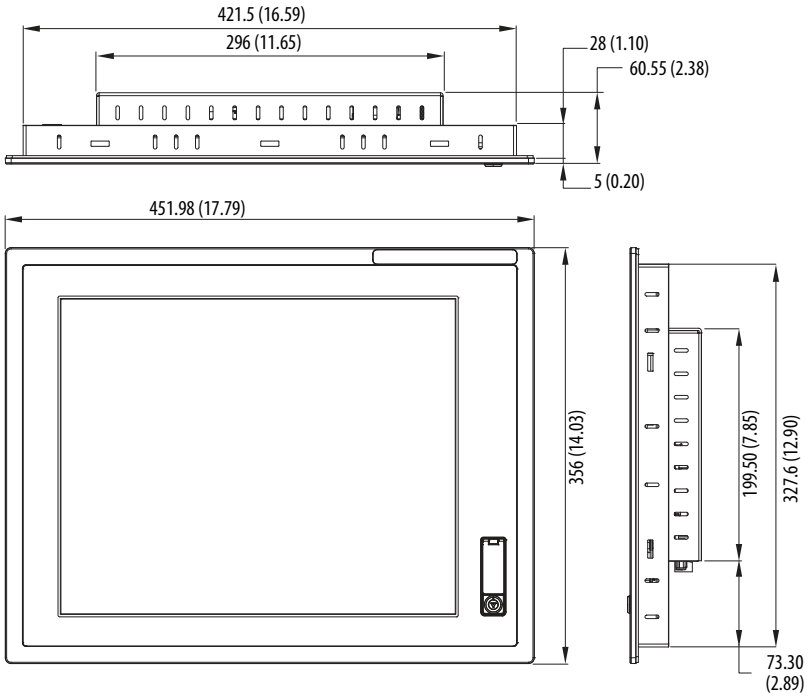

1700M Monitor - Stainless Steel Bezel

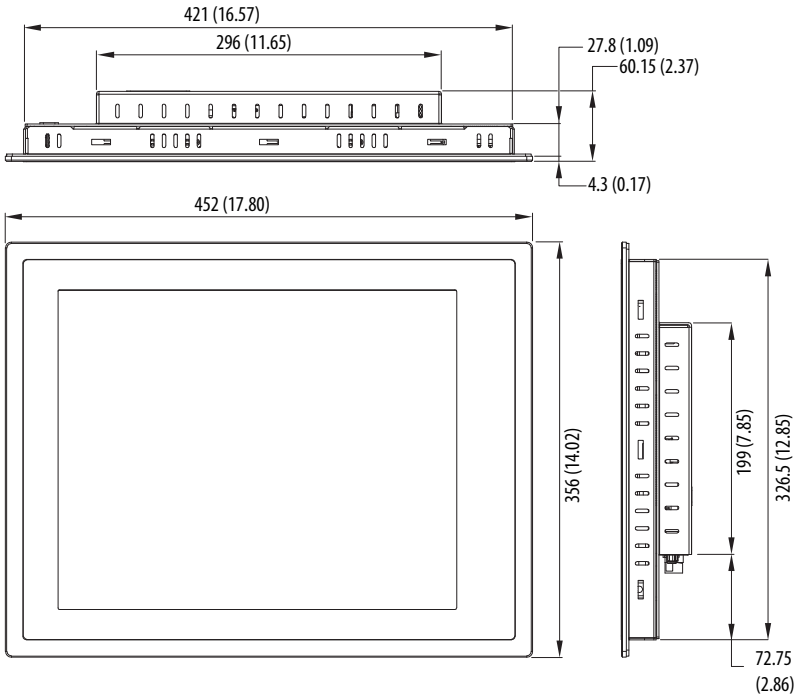

1900M Monitor - Aluminum Bezel

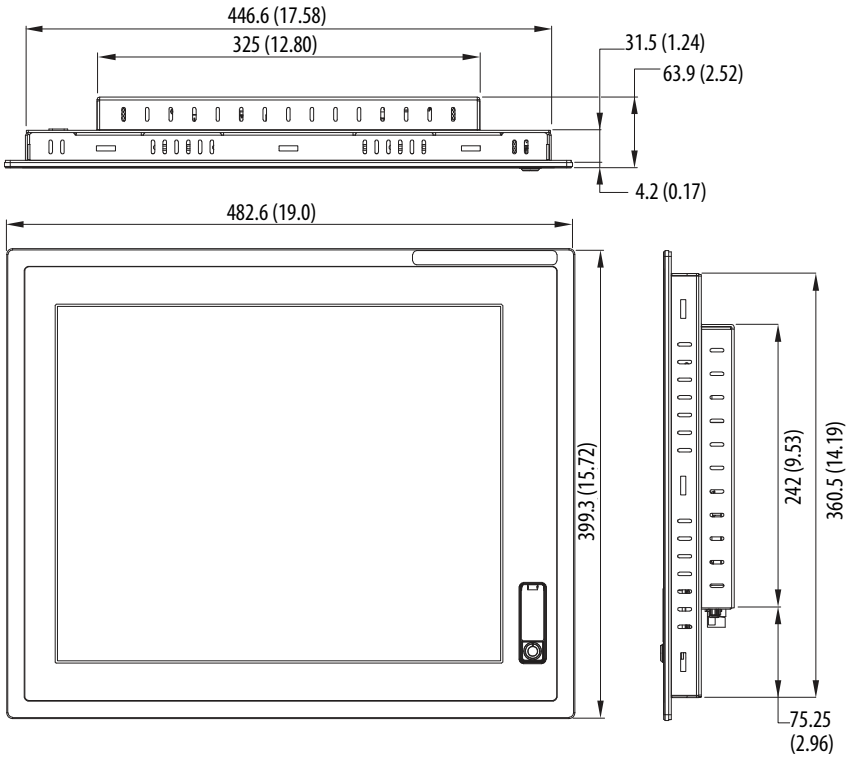

1900M Monitor - Stainless Steel Bezel

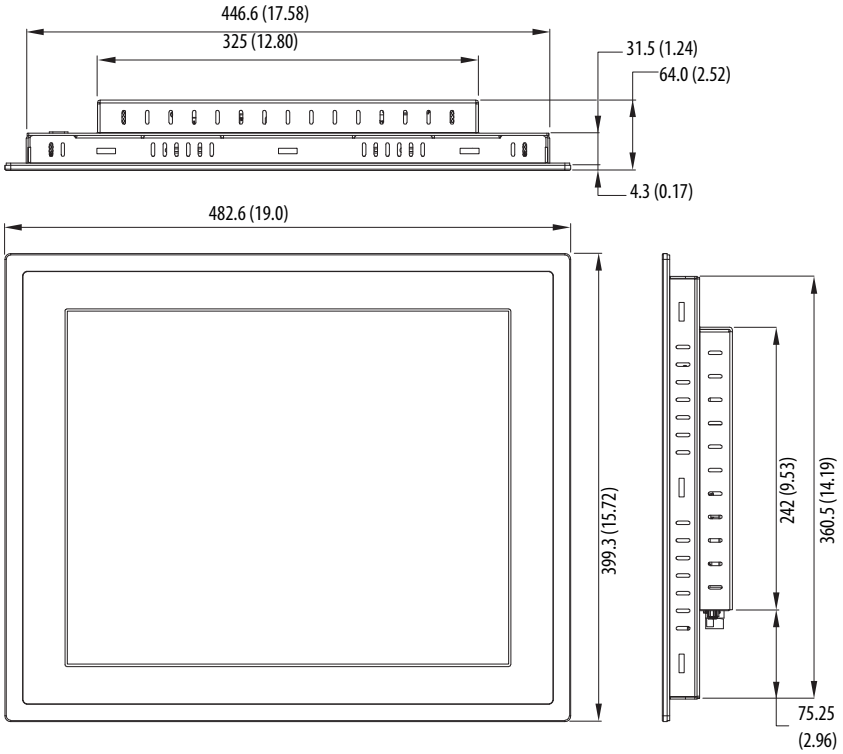

Monitor Connections

Use the connectors on the rear bottom side of the monitor to connect to a video host and a power source.

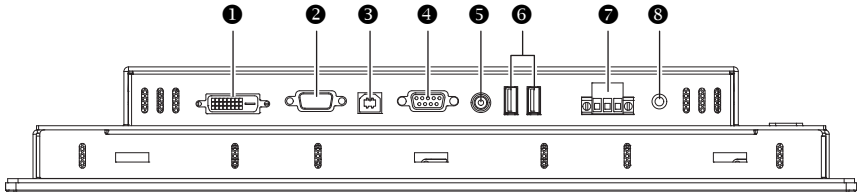

| Item | Icon | Description |
|------|------|--|
| 1 | | DVI port for digital video source |
| 2 | | HD-15 VGA port for analog video source |
| 3 | | USB port, Type B for connection to host computer |
| 4 | | Serial port (RS-232) for touch screen interface |

| Item | Icon | Description |
|------|------|--------------------------------|
| 5 | | Power input, AC adapter |
| 6 | | USB device ports, Type A (2) |
| 7 | | Power input, DC terminal block |
| 8 | | Functional ground screw |

Aluminum Bezel

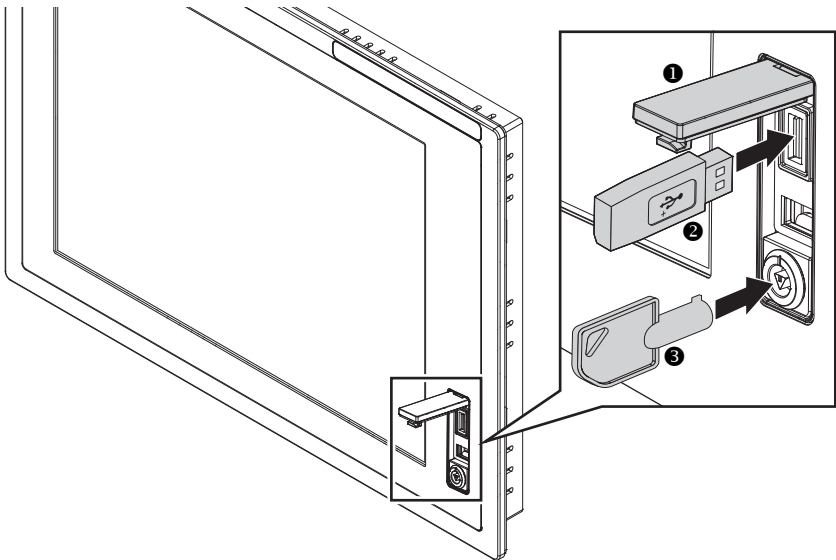

| Item | Description |
|------|---|
| 1 | Front access panel |
| 2 | USB device port, Type A (aluminum bezel only) |
| 3 | USB key |

Connect to an Analog Video Source

All monitors support analog video. Your monitor is shipped with a high-quality analog video cable. Use this video cable to connect a computer to the monitor.

| Cat. No. | Description |
|---------------|-------------------------------------|
| 6189V-VGACBL2 | Analog video cable, 1.9 m (6.3 ft) |
| 6189V-PCIDVI | Dual Analog/Digital Video Card, PCI |

Follow these steps to connect the monitor to an analog video source.

1. Connect one end of the 1.8 m (6 ft), analog video cable to the female, HD-15 video input connector on the monitor.
2. Connect the other cable end to the VGA port on the computer or to the video generator VGA port, if used.

TIP You can use a cable with a maximum length of 15 m (50 ft) at lower monitor resolutions, provided it is a high-quality video cable. Video amplifiers are available for longer distances.

TIP You can connect the monitor to a video generator that does not conform to VGA standards if the generator provides analog RGB video signals (0.714V above reference black into 75 Ω) and separate horizontal and vertical sync signals. Depending on the signal, the monitor may or may not function properly.

Connect to a Digital Video Source

All monitors support digital video. Use a digital video cable to connect a computer to the DVI connector on the monitor. This cable is not supplied, but can be purchased as an accessory.

| Cat. No. | Description |
|---------------|-------------------------------------|
| 6189V-DVICBL2 | Digital video cable, 1.8 m (6 ft) |
| 6189V-DVICBLS | Digital video cable, 5 m (16.4 ft) |
| 6189V-PCIDVI | Dual Analog/Digital Video Card, PCI |

Follow these steps to connect the monitor to a digital video source.

1. Connect one end of the digital video cable to the female, DVI video input connector on the monitor.
2. Connect the other cable end to the output of any digital DVI video source.

TIP For a DVI cable longer than 5 m (16.4 ft), use a DVI cable extension.

Connect the Optional Touch Screen Interface

An optional touch screen provides a high-resolution touch input system. The driver software included with the monitor allows the touch screen to function with many Microsoft Windows-based industrial applications such as a pointing device or mouse.

A touch screen interface to the computer can be configured using either the serial RS-232 connection or USB connection.

Connecting the Optional Serial RS-232 Touch Screen Interface

The RS-232 DB9 (female) D-shell connector on the bottom side of the monitor provides the serial touch screen interface connection to the host.

Follow these directions to connect the touch screen interface.

1. For units with the touch screen option, connect one end of the included touch screen serial cable to the RS-232 port connector on the monitor.
2. Connect the other end of the cable to a serial port on the host computer.
3. Tighten the captive screws on the cable connector to secure it.

Connecting the USB and Optional USB Touch Screen Interface

The USB type A connection to the host computer is used to allow USB devices and optional USB touch screen interface to the host computer.

| Cat. No. | Description |
|-----------------|---|
| 6189V-TCHCBL2 | Serial touch cable, RS-232 cable, 1.8 m (6 ft) |
| 6189V-USBCBL2 | USB/USB touch cable, Type A to Type B, 1.8 m (6 ft) |
| 6189V-USBKEY | USB key |

Follow these directions to connect the touch screen interface.

1. Connect the USB Type A male connector end of the included USB cable to the USB Type A female connector located on the monitor.
2. Connect the USB Type B male connector on the USB cable to the USB B Type female connector on the host computer.

Installing the Touch Screen Driver Software

1. Before installing the touch screen driver software, check the following for the interface you are using.
2. RS-232 Interface: Verify that the supplied RS-232 cable is properly installed between RS-232 input connector on the monitor and the host's COM port.
3. USB interface: Verify that the USB cable is properly installed between the USB input connector on the monitor and a USB port on the host computer.
4. Verify that the communication rate of the COM port or USB port matches the touch screen controller communications rate. The controller communication rate is factory-set at 38,400 baud.
5. You are now ready to install the touch screen driver found on the Accessories CD or at <http://www.ab.com/linked/industrialcomputers/drivers/monitors.html>.

Performing a Calibration

1. After installing the driver software, follow the calibration instructions in the touch screen documentation.
2. Following installation of the touch screen software and calibration, the touch screen is ready to use.

Power Source Connection

The monitor connects to either a 100...240V AC or a 9V...36V DC power source, but should not be connected to AC and DC voltage at the same time.

Connect AC Power

With the AC power adapter, the monitor can use a single-phase AC power supply, providing 100...240V AC at 47...63 Hz. Only use the AC adapter supplied with the monitor.

IMPORTANT

Do not use the AC adapter and external DC at the same time.

Power must be available at a grounded outlet nearby. Whenever possible, connect the monitor to the same AC source that supplies the computer.

| Cat. No. | Description |
|----------------|--|
| 6189V-MPWRSPLY | Replacement AC power adapter |
| 6189V-MPSDIN | DIN rail mounting accessory for AC power adapter |

Follow these steps to connect power to the monitor.

1. Turn off the main power switch or breaker.
2. Connect the AC adapter's 12VC input cable to the 12V DC power-input connector on the monitor (1) and secure this connection by screwing the barrel over the threads (2).

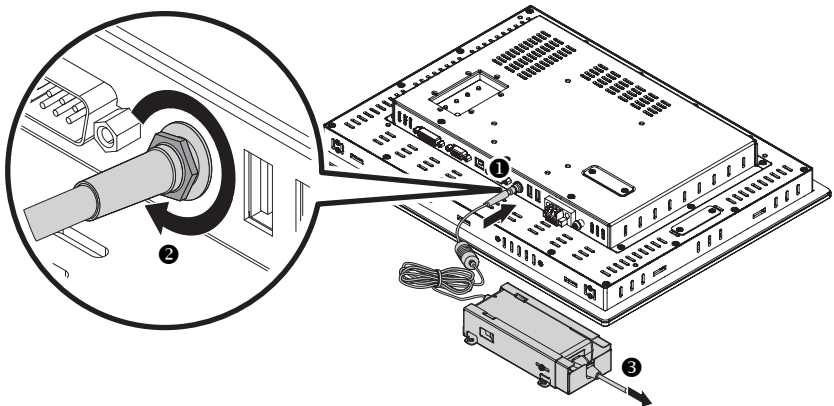

WARNING: In a hazardous location installation, secure the AC power cord by using the included metal cage.

3. Hard wire the AC power using the provided AC power cord (Ⓢ).

Make sure that the power cord is firmly secured to the AC power adapter by the metal cage already attached to the adapter.

4. Restore AC power.

Connect DC Power

The monitors connect to a DC power source using a DC input terminal block. The DC power option supports operation from either a safety-extra low (SELV) or protective extra-low voltage (PELV) power source. The power supply is internally protected against reverse voltage polarity.



ATTENTION: Use a SELV isolated and ungrounded power supply as input power to the computer. This power source provides protection so that under normal and single fault conditions, the voltage between the conductors and functional earth/protective earth does not exceed a safe value.

IMPORTANT

Do not use the AC adapter and external DC power at the same time.

Follow these steps to connect power to the monitor.

1. Turn off the main power switch or breaker.
2. Route the power wires from your DC power supply and connect the leads to the DC input terminal block on the monitor.

The monitors accept a 9...36V DC input power-supply connection.

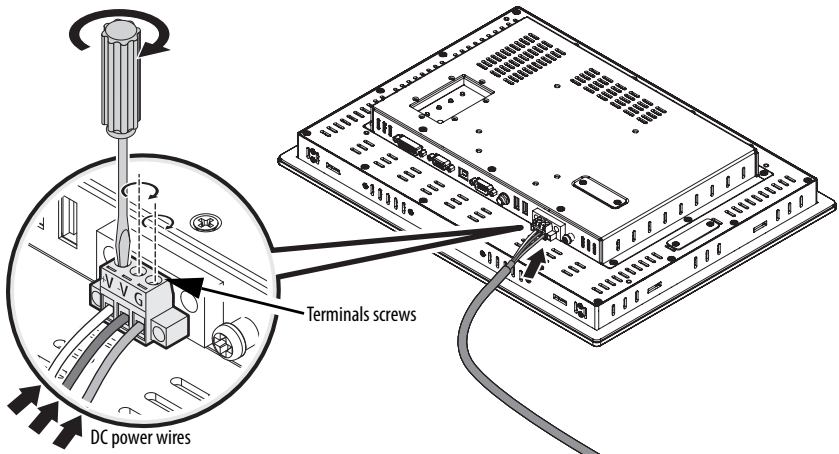

3. Tighten the screw terminals to provide a good connection.
4. Secure the terminal block connector to the unit by using the two side screws.
5. Restore DC power.

Secure the Cables

All cables should be secured to each other or a fixed object after leaving the monitor by using the supplied cable ties. Securing the cables provides strain relief and avoids loose, hanging cables. It is particularly important in shock and vibration environments to reduce movement of the cables.

Functional Ground Screw

The pre-installed functional ground screw is not required for safety or regulatory compliance. However, if a supplemental ground is desired, use the functional ground screw in the I/O port panel of the monitor (❶).

If using the functional ground screw, connect the product to earth ground (❷) by using a 1.5 mm² (16 AWG) or larger external wire. Use a ground wire with green insulation and a yellow stripe for easy identification.

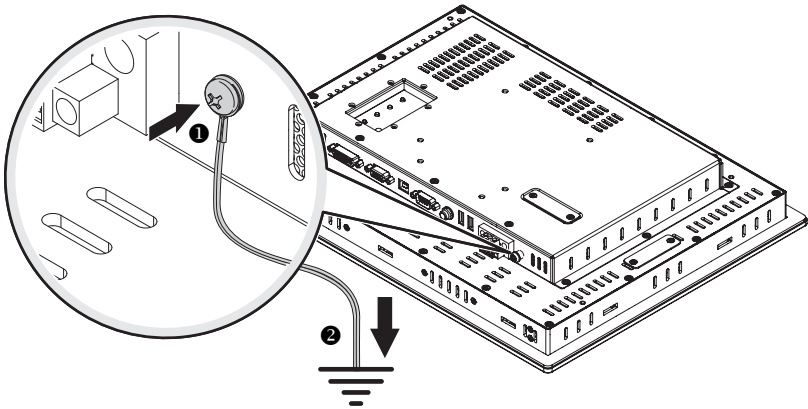

Ship or Transport Product

If you need to ship the product via common carrier or transport it to another location, you must first uninstall the product and place it in its original packing material.



ATTENTION: Do not ship or transport the product when it is installed in a machine, panel, or rack. Doing so may cause damage to the product. You must uninstall the product and place it in its original packing material before shipping. Rockwell Automation is not responsible for damage incurred to a product that is shipped or transported while installed in a machine, panel, or rack.

Specifications

Industrial Monitors - 1200M, 1500M, 1700M, 1900M

| Attribute | Specification | 1200M models | 1500M models | 1700M models | 1900M models |
|---------------|--|--|---|--|--|
| Display | Type | Color active matrix TFT | | | |
| | Touch screen description | Resistive antiglare | | | |
| | Size (diagonal), approx. | 307 mm (12.1 in.) | 381 mm (15.0 in.) | 432 mm (17.0 in.) | 483 mm (19.0 in.) |
| | Display area (W x H), approx. | 246 x 185 mm (9.7 x 7.3 in.) | 304 x 228 mm (12 x 9 in.) | 338 x 270 mm (13.3 x 10.7 in.) | 376 x 301 mm (14.8 x 11.9 in.) |
| | Resolution (native mode) | 800 x 600 256 K colors | 1024 x 768 16.2 M colors | 1280 x 1024 16.7 M colors | |
| | Luminance (typical) | 450 cd/m ² (Nits) | | 350 cd/m ² (Nits) | 300 cd/m ² (Nits) |
| | Contrast ratio (typical) | 1000:1 | 700:1 | 1000:1 | 1300:1 |
| | Response time (typical) | <35 ms | | | |
| Backlight | CCFT Tubes; 50,000 h (for 1/2 brightness) at 25 °C (77 °F) | | | | |
| Electrical | Input voltage, AC | 100...240V AC, autoswitching | | | |
| | Line frequency | 47...63 Hz | | | |
| | Power consumption, max. | 34 W | | 55 W | 57 W |
| | Input voltage, DC | 9...36V DC | | | |
| Mechanical | Dimensions (H x W x D), approx. | 260 x 340 x 61 mm (10.24 x 13.39 x 2.4 in.) | 309 x 410 x 61 mm (12.15 x 16.11 x 2.4 in.) | 356 x 452 x 61 mm (14.03 x 17.81 x 2.4 in.) | 399 x 483 x 64 mm (15.7 x 19.0 x 2.52 in.) |
| | Weight, approx. Aluminum bezel Stainless steel bezel | 4.4 kg (9.75 lb) — | 7.3 kg (16 lb) 8.6 kg (19 lb) | 8.6 kg (19 lb) 10.1 kg (22.25 lb) | 10.2 kg (22.5 lb) 11.9 kg (26.25 lb) |
| | Mounting options | Panel Bench/tabletop Rack | | | Bench/tabletop Rack |
| Environmental | Temperature, Operating ⁽¹⁾ Non-operating | 0...55 °C (32...131 °F) -20...60 °C (-4...140 °F) | | 0...50 °C (32...122 °F) -20...60 °C (-4...140 °F) | |
| | Relative humidity | 10...90% without condensation | | | |
| | Vibration ⁽²⁾ | 2 g peak (10...640 Hz) | | | |
| | Shock Operating Non-operating | 20 g (1/2 sine, 11 ms) 30 g (1/2 sine, 11 ms) | | | |
| | Enclosure ratings | NEMA UL 50 Type 1, 4, 4X and 12, IEC IP66 | | | |

(1) At 40 °C (104 °F) operating temperature, the humidity must not exceed 90%. At 50 °C (122 °F) operating temperature, the humidity must not exceed 50%. Operating the monitors beyond these limits for extended periods of time can reduce the life of the product.

(2) For operating and non-operating conditions.

Certifications

1200M, 1500M, 1700M, and 1900M models

UL Listed Class I, Division 2, per ISA 12.12.01 (when marked on the nameplate)
cUL Listed Class I, Division 2, per CSA No. 213 (when marked on the nameplate)

CE marked for all applicable directives
RoHS compliant

C-Tick

China RoHS

Turkey RoHS

Additional Resources

For additional information on the industrial monitors, refer to the Industrial Performance Monitors User manual, publication [6186M-UM002](#).

You can view or download publications at <http://www.rockwellautomation.com/literature>. To order paper copies of technical documentation, contact your local Allen-Bradley® distributor or Rockwell Automation sales representative.

Notes:

Rockwell Automation Support

Rockwell Automation provides technical information on the Web to assist you in using its products. At <http://www.rockwellautomation.com/support/>, you can find technical manuals, a knowledge base of FAQs, technical and application notes, sample code and links to software service packs, and a MySupport feature that you can customize to make the best use of these tools.

For an additional level of technical phone support for installation, configuration and troubleshooting, we offer TechConnectSM support programs. For more information, contact your local Allen-Bradley[®] distributor or Rockwell Automation sales representative, or visit <http://www.rockwellautomation.com/support/>.

Installation Assistance

If you experience a problem within the first 24 hours of installation, please review the information that's contained in this manual. You can also contact a special Customer Support number for initial help in getting your product up and running.

| | |
|---------------------------------|--|
| United States or Canada | 1.440.646.3434 |
| Outside United States or Canada | Use the Worldwide Locator at http://www.rockwellautomation.com/support/americas/phone_en.html , or contact your local Rockwell Automation representative. |

New Product Satisfaction Return

Rockwell Automation tests all of its products to ensure that they are fully operational when shipped from the manufacturing facility. However, if your product is not functioning and needs to be returned, follow these procedures.

| | |
|-----------------------|--|
| United States | Contact your local Allen-Bradley [®] distributor. You must provide a Customer Support case number (call the phone number above to obtain one) to your distributor to complete the return process. |
| Outside United States | Please contact your local Rockwell Automation representative for the return procedure. |

Documentation Feedback

Your comments will help us serve your documentation needs better. If you have any suggestions on how to improve this document, complete this form, publication [RA-DU002](#), available at <http://www.rockwellautomation.com/literature/>.

Allen-Bradley, Rockwell Software, Rockwell Automation, and TechConnect are trademarks of Rockwell Automation, Inc.

Trademarks not belonging to Rockwell Automation are property of their respective companies.

Rockwell Otomasyon Ticaret A.Ş., Kar Plaza İş Merkezi E Blok Kat:6 34752 İçerenköy, İstanbul, Tel: +90 (216) 5698400

www.rockwellautomation.com

Power, Control and Information Solutions Headquarters

Americas: Rockwell Automation, 1201 South Second Street, Milwaukee, WI 53204-2496 USA, Tel: (1) 414.382.2000, Fax: (1) 414.382.4444

Europe/Middle East/Africa: Rockwell Automation NV, Pegasus Park, De Kleetlaan 12a, 1831 Diegem, Belgium, Tel: (32) 2 663 0600, Fax: (32) 2 663 0640

Asia Pacific: Rockwell Automation, Level 14, Core F, Cyberport 3, 100 Cyberport Road, Hong Kong, Tel: (852) 2887 4788, Fax: (852) 2508 1846

Rockwell Automation Publication 6186M-IN002C-EN-P - December 2011

PN-134033

Supersedes Publication 6186M-IN002B-EN-P - November 2009

Copyright © 2011 Rockwell Automation, Inc. All rights reserved. Printed in China.



PN-134033