

Performance Series Network Video Recorder

HEN081*4

HEN161*4

HEN321*4

HEN041*3

HEN04103L

HEN32103L

(* = Storage in TB)

HEN162*4

HEN322*4

HEN642*4

HEN081*3

HEN08103L

HEN163*4

HEN323*4





HEN643*4

HEN161*3

HEN16103L

User Guide

Cautions and Warnings

	CAUTION RISK OF ELECTRIC SHOCK DO NOT OPEN		 THIS SYMBOL INDICATES THAT DANGEROUS VOLTAGE CONSTITUTING A RISK OF ELECTRIC SHOCK IS PRESENT WITHIN THE UNIT.
CAUTION: TO REDUCE THE RISK OF ELECTRIC SHOCK, DO NOT REMOVE THE COVER. NO USER-SERVICEABLE PARTS INSIDE. REFER SERVICING TO QUALIFIED SERVICE PERSONNEL.			 THIS SYMBOL INDICATES THAT IMPORTANT OPERATING AND MAINTENANCE INSTRUCTIONS ACCOMPANY THIS UNIT.



WARNING Installation and servicing should be performed only by qualified and experienced technicians to conform to all local codes and to maintain your warranty.



WARNING Use only with the supplied power converters. The Ethernet connection is not intended to be connected to an exposed (outside plant) network.

CAUTION There is a risk of explosion if the battery is replaced by an incorrect type. Dispose of used batteries in accordance to local laws.

Regulatory Statements

FCC Compliance Statement

Information to the User: This equipment has been tested and found to comply with the limits for a Class B digital device, pursuant to part 15 of the FCC Rules. These limits are designed to provide reasonable protection against harmful interference in a residential installation. This equipment generates, uses, and can radiate radio frequency energy and, if not installed and used in accordance with the instructions, may cause harmful interference to radio communications. However, there is no guarantee that interference will not occur in a particular installation.

If this equipment does cause harmful interference to radio or television reception, which can be determined by turning the equipment off and on, the user is encouraged to try to correct the interference by one or more of the following measures:

- Reorient or relocate the receiving antenna.
- Increase the separation between the equipment and receiver.
- Connect the equipment into an outlet on a circuit different from that to which the receiver is connected.
- Consult the dealer or an experienced radio/TV technician for help.

Note

Changes or modifications not expressly approved by the party responsible for compliance could void the user's authority to operate the equipment.

This Class B digital apparatus complies with Canadian ICES-003.

Cet appareil numérique de la Classe B est conforme à la norme NMB-003 du Canada.

Manufacturer's Declaration of Conformance

North America

The equipment supplied with this guide conforms to UL 60950-1 and CSA C22.2 No. 60950-1.

Europe

The manufacturer declares that the equipment supplied is compliant with the essential protection requirements of the EMC directive 2004/108/EC and the Low Voltage Directive (LVD) 2006/95/EC, conforming to the requirements of standards EN 55022 for emissions, EN 50130-4 for immunity, and EN 60950 for electrical equipment safety.

Waste Electrical and Electronic Equipment (WEEE)



Correct Disposal of this Product (applicable in the European Union and other European countries with separate collection systems).

This product should be disposed of, at the end of its useful life, as per applicable local laws, regulations, and procedures.

General Data Protection Regulation

Please be aware that this product can store personal data.

Personal data is protected by the General Data Protection Regulation (2016/679) in Europe and therefore the owners of personal data have obtained certain rights thanks to this regulation.

We strongly advise you to be fully aware of these owner (“data subjects”) rights as well as which limitations you have to obey regarding the use and distribution of this data.

Further details can be found on the GDPR website of the EU:

https://ec.europa.eu/commission/priorities/justice-and-fundamental-rights/data-protection/2018-reform-eu-data-protection-rules_en

Safety Instructions

Before installing or operating the unit, read and follow all instructions. After installation, retain the safety and operating instructions for future reference.

1. **HEED WARNINGS** - Adhere to all warnings on the unit and in the operating instructions.
2. **INSTALLATION**
 - Install in accordance with the manufacturer's instructions.

- Installation and servicing should be performed only by qualified and experienced technicians to conform to all local codes and to maintain your warranty.
 - Any wall or ceiling mounting of the product should follow the manufacturer's instructions and use a mounting kit approved or recommended by the manufacturer.
3. **POWER SOURCES** - This product should be operated only from the type of power source indicated on the marking label. If you are not sure of the type of power supplied to your facility, consult your product dealer or local power company.
 4. **MOUNTING SYSTEM** - Use only with a mounting system recommended by the manufacturer, or sold with the product.
 5. **ATTACHMENTS/ACCESSORIES** - Do not use attachments/accessories not recommended by the product manufacturer as they may result in the risk of fire, electric shock, or injury to persons.
 6. **CLEANING** - Do not use liquid cleaners or aerosol cleaners. Use a damp cloth for cleaning.
 7. **SERVICING** - Do not attempt to service this unit yourself. Refer all servicing to qualified service personnel.
 8. **REPLACEMENT PARTS** - When replacement parts are required, be sure the service technician has used replacement parts specified by the manufacturer or have the same characteristics as the original part. Unauthorized substitutions may result in fire, electric shock or other hazards. Using replacement parts or accessories other than the original manufacturers may invalidate the warranty.

Warranty and Service

Subject to the terms and conditions listed on the product warranty, during the warranty period Honeywell will repair or replace, at its sole option, free of charge, any defective products returned prepaid.











In the event you have a problem with any Honeywell product, please call Customer Service at 1.800.323.4576 for assistance or to request a **Return Merchandise Authorization (RMA)** number.

Be sure to have the model number, serial number, and the nature of the problem available for the technical service representative.

Prior authorization must be obtained for all returns, exchanges, or credits. **Items shipped to Honeywell without a clearly identified Return Merchandise Authorization (RMA) number may be refused.**

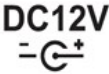
List of Symbols

The following is a list of symbols that might appear on the NVR.

Symbol	Explanation
	<p>The WEEE symbol.</p> <p>This symbol indicates that when the end-user wishes to discard this product, it must be sent to separate collection facilities for recovery and recycling. By separating this product from other household-type waste, the volume of waste sent to incinerators or landfills will be reduced, and thus natural resources will be conserved.</p>
	<p>The UL compliance logo.</p> <p>This logo indicates that the product has been tested and is listed by the Underwriters Laboratories.</p>
	<p>The FCC compliance logo.</p> <p>This logo indicates that the product conforms to Federal Communication's Commission compliance standards.</p>
	<p>The direct current symbol.</p> <p>This symbol indicates that the power input/output for the product is direct current.</p>
	<p>The alternating current symbol.</p> <p>This symbol indicates that the power input/output for the product is alternating current.</p>
	<p>The LDPE symbol.</p> <p>This symbol indicates that this product is made of Low-Density Polyethylene (LDPE).</p>
	<p>The Direct Current symbol.</p> <p>This symbol indicates that the product operates from a 12 V direct current.</p>
	<p>The Lead-free symbol.</p> <p>This symbol indicates that the product does not contain lead (Pb).</p>
	<p>The CCC compliance logo.</p> <p>This logo indicates that the product conforms with the China Compulsory Certification guidelines.</p>
	<p>The Environment Friendly Use-period symbol.</p> <p>This symbol indicates the length of time that this electronic product can be used without harming the environment.</p>
	<p>The RCM Compliance symbol.</p> <p>This symbol indicates that the product conforms with the Australian RCM guidelines.</p>



The TVU Lab symbol.

This symbol indicates that the product has been safety tested by the TUV Lab.



The Direct Current symbol.

This Direct Current symbol indicates that the product operates direct current.



This symbol indicates that the product is to be used indoors.



The CE Compliance logo.

This logo indicates that the product conforms to the relevant guidelines/standards for the European Union harmonization legislation.



The Protective Earth symbol.

This symbol indicates that the marked terminal is intended for connection to the protective earth/grounding conductor.



This symbol is used to direct attention to important information.



This symbol warns that the corresponding action could result in an electric shock.



This symbol indicates On/Standby functionality of the corresponding control/button/switch.

Contents

1	Introduction.....	1
	Overview of the Network Video Recorder.....	1
	Features of the Network Video Recorder.....	1
	Network Video Recorder Components	3
	Mouse Operation.....	8
	Using the On-screen Keyboard.....	8
	Remote Control Operation	9
2	Getting Started.....	11
	Unpacking the NVR.....	11
	Connecting External Devices.....	11
	Typical NVR Installation	12
	Starting and Shutting Down the NVR	16
	Starting the NVR.....	16
	Shutting Down the NVR.....	16
	Device Initialization.....	17
	Reset Password.....	19
	Setting Up the NVR with the Startup Wizard	21
	Using the Startup Wizard.....	21
	Setting Up Bi-Directional Communication Connection	24
	PC to an Audio Input Device.....	24
3	Viewing Live Video	26
	About Live View	26
	Camera Status	27
	Camera Toolbar	27
	Live View Toolbar	28
	Shortcut Menu.....	29
	Configuring Live View.....	29
	Setting the Screen Layout.....	29
	Controlling PTZ Cameras.....	30
	Working with the PTZ Control Panel.....	30
	Configuring PTZ Connection Settings	32
	Configuring PTZ Functions	32
	Calling Presets, Tours, and Patterns.....	35
	Configuring Auxiliary Settings.....	36
4	Recording Video.....	37
	Manual Recording Settings	37
	Automatic Recording Settings	37
	Configuring the General Recording Settings.....	38
	Configuring the Video Recording Schedule	38

	Configuring the Snapshot Recording Schedule.....	40
5	Playing Back Video	43
	Playing Back Video.....	43
	Searching For and Playing Back Video	43
	Smart Search	44
	Mark Playback.....	45
	Slice Playback.....	47
	Smart Player Playback.....	48
	Playing Back Snapshots.....	48
	Backing Up Video and Snapshots	49
	To back up from inside the playback interface	49
	To back up from outside of the playback interface.....	51
6	Configuring Camera Settings	53
	Adding a Camera.....	53
	Adding a Camera by Searching	53
	Adding a Camera Manually	54
	Configuring Camera Image Settings.....	55
	Configuring Snapshot Settings	57
	Configuring Encoding Settings	58
	Configuring the Text Overlay.....	59
	Changing a Camera Name.....	60
7	Configuring Network Settings	62
	Configuring TCP/IP Settings	62
	Configuring Port Settings.....	63
	Configuring Wireless Connection Settings.....	65
	Configuring PPPoE Settings.....	67
	Configuring DDNS Settings.....	67
	Configuring Email Settings.....	68
	Configuring UPnP Settings	70
	Configuring Sync Time Right Settings	70
	Configuring SNMP Settings.....	71
	Configuring Multicast Settings.....	73
	Configuring Registration Settings.....	73
	Configuring Alarm Center Settings.....	74
	Configuring Switch Settings.....	75
	Configuring P2P Settings.....	75
8	Configuring Event Settings	77
	Configuring Motion Detection Settings	79
	To set up motion detection regions.....	79
	To set up motion detection periods.....	81
	To set up motion detection event actions	82
	Configuring Video Loss Settings.....	83
	Configuring Video Tampering Settings.....	84
	Configuring Scene Change Settings.....	85
	Configuring Smart Plan Settings	86
	Configuring System Abnormality Event Settings.....	86

Configuring HDD Event Settings.....	86
Configuring Network Event Settings.....	87
Configuring Username Settings	88
Configuring Alarm Input Settings.....	89
Configuring IPC External Alarms	89
Configuring IPC Offline Alarm Events.....	92
Configuring Local Alarm Inputs	92
Configuring Network Alarm Inputs	93
Configuring Remote Alarm Inputs	93
Configuring Heat Map.....	94
Configuring Face Detection Settings	95
Configuring Audio Detection Settings.....	96
Configuring People Counting.....	98
Configuring Alarm Outputs.....	100
Configuring POS Settings	101
POS Type Supported by NVR.....	103
9 Configuring Storage Settings	104
Configuring the Basic Settings.....	104
Configuring the Recording Schedule.....	105
Configuring the Video Recording Schedule.....	105
Configuring the Snapshot Recording Schedule.....	106
Configuring HDD Manager Settings.....	107
Configuring FTP Settings	108
Configuring HDD Advanced Settings	110
Configuring Main Stream Settings.....	110
Configuring Sub Stream Settings.....	110
Configuring Snapshot Storage Settings	110
Configuring NAS Storage.....	111
Configuring NAS Manager.....	112
Configuring Record Settings.....	112
Configuring HDD Detect Settings.....	113
HDD Manual Detection	113
HDD Detection Reporting	114
10 Configuring System Settings	115
Configuring General System Settings	115
Configuring Device Settings	115
Configuring Date and Time Settings	116
Configuring Holiday Settings	118
Configuring Display Settings	119
Configuring Display Settings.....	119
Configuring Tour Settings.....	121
Configuring Custom Split Settings.....	122
Configuring RS232 Settings	122
Configuring PTZ Settings.....	123
Configuring Broadcast Settings.....	123

Configuring Voice Prompt Settings.....	124
Managing Voice Prompt Files.....	124
Configuring Voice Prompt Schedules.....	125
Configuring Account Settings.....	126
Managing User Accounts and Groups.....	126
Configuring Account Security Questions.....	129
Configure ONVIF User.....	130
Configuring Security Settings.....	131
To allow specific sites to access the NVR.....	131
To block specific sites from accessing the NVR.....	131
Configuring Automatic Maintenance Settings.....	132
Exporting and Importing System Configurations.....	132
To export a system configuration.....	133
To import a system configuration.....	133
To format an external USB storage device.....	134
Restoring Default Settings.....	134
Upgrading the NVR.....	135
11 Viewing Information.....	137
Viewing System Information.....	137
Viewing Hard Disk Information.....	137
Viewing Recording Information.....	138
Viewing Data Stream Information.....	139
Viewing Version Information.....	139
Viewing Event Information.....	140
Viewing Alarm Status Information.....	140
Viewing Heat Map Information.....	141
Viewing Network Information.....	141
Viewing Online Users.....	141
Viewing Network Load Information.....	142
Viewing Network Test Information.....	143
Viewing Log Information.....	144
12 Web Client Operation.....	146
Logging In.....	146
Preparing to Use the Device Web Client.....	146
Logging In.....	147
Main Window.....	150
Logging Out.....	155
Uninstalling the Web Control.....	155
Live Viewing.....	155
Live Viewing.....	156
Image/Relay-out Settings.....	157
Information.....	158
Configuration.....	161

	Camera Setup.....	162
	Network Setup.....	170
	Configuring Event Settings.....	190
	Configuring Storage.....	209
	Configuring System Settings.....	215
	Playback.....	228
	Playing Back Recorded Video.....	228
	Playing Back Slices.....	231
	Playing Back Marks.....	231
	Downloading Video.....	233
	Using the Smart Player to Playback Event Video.....	234
	Alarms.....	235
	Activating Alarms.....	235
13	Troubleshooting.....	238
14	Appendix A.....	241
	Connecting Alarm Input/Outputs.....	241
	Before Connecting Alarm Inputs and Outputs.....	241
	Alarm Input and Output Rear Panel Connections.....	241
	Guidelines for Connecting Local Alarm Input Ports.....	242
	Guidelines for Connecting Alarm Output Ports.....	242
15	Appendix B.....	243
	Installing Hard Drives.....	243
	Hard Disk Drive Recommendations.....	243
	Installing Hard Drives.....	243
	Installing a HDD on HEN081*4/HEN161*4/HEN321*4/HEN041*3/HEN081*3/ HEN161*3/ HEN04103L/ HEN08103L/ HEN16103L/ HEN32103L.....	244
	Installing a HDD on HEN162*4/HEN322*4/HEN642*4.....	246
	Installing a HDD on HEN163*4/HEN323*4/HEN643*4.....	248
	Installing an Additional HDD.....	249
	List of Compatible SATA HDDs.....	251
	List of Compatible Portable HDDs.....	253
16	Appendix C MAXPRO[®] Cloud.....	254
	Configuring for MAXPRO Cloud Mode.....	254
17	Appendix D Specifications.....	256

About This Document

This document introduces the Honeywell Performance Series Network Video Recorder. It explains how to install and operate the Performance Series Network Video Recorder.

This document is intended for installers and users.

Overview of Contents

This document contains the following chapters and appendixes:

- [Chapter 1, Introduction](#), describes the front and rear panel layout of the NVR, and mouse and remote control functions.
- [Chapter 2, Getting Started](#), describes how to connect the NVR and log on to its user interface.
- [Chapter 3, Viewing Live Video](#), describes the NVR's real-time monitoring mode and associated NVR operations, including controlling a PTZ camera (if connected).
- [Chapter 4, Recording Video](#), describes how to manually record a video clip and how to set up automatic recording.
- [Chapter 5, Playing Back Video](#), describes how to search for and play back recorded video and snapshots, and how to save recorded files to an external storage device.
- [Chapter 6, Configuring Camera Settings](#), describes how to configure camera image settings, encoder settings, snapshot settings, privacy mask settings, camera name settings, and channel type settings.
- [Chapter 7, Configuring Network Settings](#), describes how to configure the NVR's network settings, including connection settings, email settings, FTP settings, registration settings, and alarm center settings.
- [Chapter 8, Configuring Event Settings](#), describes how to configure the NVR's alarm settings, including settings for motion detection, video loss, camera tampering, and system events.
- [Chapter 9, Configuring Storage Settings](#), describes how to configure the NVR's storage settings, including recording settings and HDD management settings.
- [Chapter 10, Configuring System Settings](#), describes how to configure NVR system settings, display settings, and user accounts; export and import configuration settings to and from other NVRs; restore default settings; and upgrade the system firmware.
- [Chapter 11, Viewing Information](#), describes how to view system, event, network, and log information.
- [Chapter 12, Troubleshooting](#), lists troubleshooting steps for resolving errors that you may encounter when operating the NVR.
- [Appendix A, Connecting Alarm Input/Outputs](#), provides guidelines for connecting alarm inputs and outputs.

- [Appendix B, Installing Hard Drives](#), lists the manufacturers and models of compatible HDDs, including SATA HDDs and portable HDDs, and provides instructions for installing an additional HDD.
- [Appendix C, MAXPRO® Cloud](#), explains how to switch the NVR for MAXPRO Cloud mode.
- [Appendix D, Specifications](#), lists the NVRs' specifications.

Special Fonts and Symbols

<i>Italic</i>	Indicates referenced chapter, figure number, page number, etc. In the electronic version, click on italicized text to switch to the corresponding page.
Bold	Indicates a button, or menu item.
Note	Alerts the user to the presence of important operating and maintenance (servicing) instructions in the literature accompanying the product.

How to Use This Document

- Pictures in this manual are for reference only, please see the actual items for details.
- This product is subject to updates or changes without prior notice.
- Please familiarize yourself with this manual before operation and ensure its accessibility for future use.
- The manual has been reviewed and its accuracy is guaranteed. If there is any uncertainty or controversy, please refer to the final explanation of Honeywell. Honeywell does not take any responsibility for any consequences caused by the misunderstanding of the manual or incorrect operations by the user.

1 Introduction

This chapter contains the following sections:

- [Overview of the Network Video Recorder](#) on page 1.
- [Features of the Network Video Recorder](#) on page 1.
- [Network Video Recorder Components](#) on page 3.
- [Mouse Operation](#) on page 8.
- [Remote Control Operation](#) on page 9.

Overview of the Network Video Recorder

The Performance Series Network Video Recorder is a high-performance network video recorder. It supports:

- Local preview
- Multiple-window display
- Local recorded file storage
- Remote control and mouse shortcut menu operation
- Remote management
- Control

The Performance Series Network Video Recorder also features multiple storage options:

- Central storage: 3rd party storage, such as network storage
- Front-end storage: The NVR's HDD storage
- Client-end storage: Storage on the client's computer

Because of the flexibility of its design, the Performance Series Network Video Recorder can be used in a variety of applications, such as public security, water conservancy, transportation, and education.

Features of the Network Video Recorder

User Management

- Different user rights for each group; each user belongs to a specific group.
- User rights cannot exceed Group rights.

Storage

- Supports central server backup that follows your configuration and setup in Alarm or Schedule settings.
- Supports recording through the Internet. The recorded files are stored on the client's PC.
- Supports network storage, such as FTP, NAS.

Alarm

- Responds to external alarms almost instantly (within 200 milliseconds), based on your pre-defined relay setup. You can also configure a visual and/or noise prompt (if supported by a pre-recorded noise) upon alarm detection.
- Supports central alarm server setup, so that alarm information can automatically and remotely notify users. The alarm input can be derived from various connected peripheral devices.

Network Monitor

- The NVR supports the transmission of audio/video data that is compressed by an IP camera, which is then decoded for display. The delay time is less than 500 ms (sufficient network bandwidth support is required).
- Supports a maximum of 10 connections.
- Compatible to broadcast audio/video with the following transmission protocols: HTTP, TCP, UDP, MULTICAST, RTP/RTCP.
- Transmits some alarm data or alarm information through SMTP.
- Supports Internet access through the WAN.

Window Split

Video compression plus a digital process allows the NVR to split the monitor screen to show four video channels at the same time.

Recording

Supports a schedule for recording. The recorded files can be saved in the HDD, on the client's PC, or on a network storage server. You can search and view the recorded video that is stored locally or through the Internet connection.

Backup

Supports backing up video, through the network, to a USB 2.0 device. The recorded files can be saved on the network storage server, on a peripheral USB 2.0 device, or to a burner, for example.

Network Management

- Supports NVR configuration and management through the Ethernet.
- Supports device management through the Internet.

Peripheral Equipment Management

- Supports peripheral equipment management such as protocol setup and port connection.
- Supports transparent data transmission such as RS232 (RS-422) and RS485 (RS-485).

Auxiliary

- Supports NTSC or PAL self-adaption.
- Supports viewing real-time system resources information and running statistics display.
- Supports log file.
- Supports local GUI output and shortcut menu operation with a computer mouse.
- Supports IR control using shortcut menu operation with a computer mouse.
- Supports IP camera remote video preview and control.

Note For detailed features of each model, see [Appendix D Specifications](#) on page 256.

Network Video Recorder Components

For NVR specifications, please see [Appendix D](#) on page 256 .

Figure 1-1 NVR Front Panel

HEN081*4 / HEN161*4 / HEN321*4/HEN041*3/ HEN081*3/ HEN161*3/
HEN16103L/HEN32103L

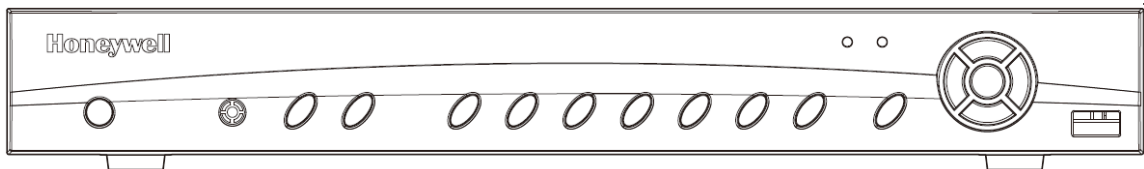

HEN162*4 / HEN322*4 / HEN642*4

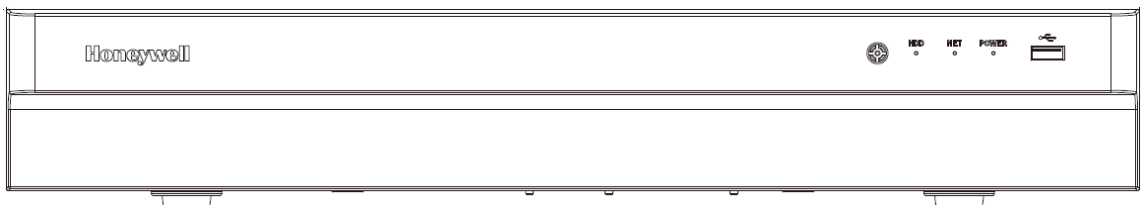

HEN163*4 / HEN323*4 / HEN643*4

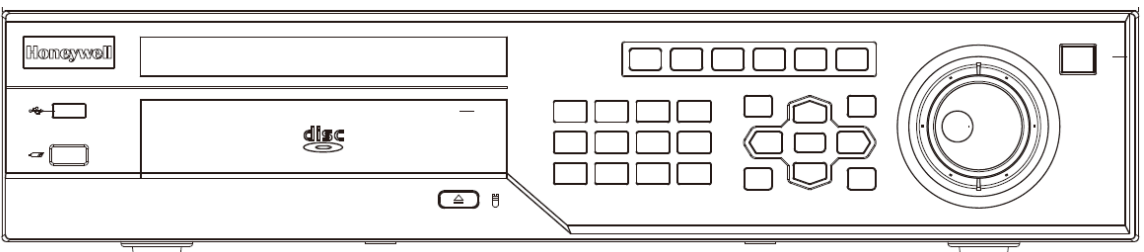

HEN04103L/HEN08103L

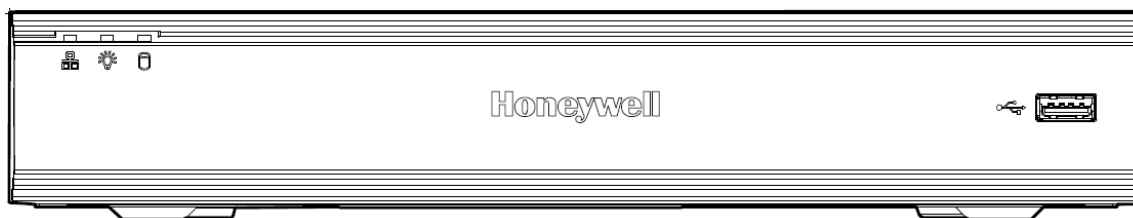

Table 1-1 NVR Front Panel Components

Component Name	Icon	Function
Power Button		Power button. Press this button for three seconds to boot up or shut down the NVR.
IR Receiver		Receives the signal from the remote control.
Shift		<ul style="list-style-type: none"> When the cursor is in a textbox, click this button to switch between numbers and letters (lower case/upper case). Enable/disable a tour.
Assistant		<ul style="list-style-type: none"> Single window monitor mode: Click this button to display the Assistant function; to start PTZ control (not supported); and to configure the image color. Backspace function: When entering letters or numbers, press and hold for 1.5 seconds to delete the last-entered character. Motion detection: Use in conjunction with the direction keys. Text mode: When entering characters, click to switch between numbers and letters (uppercase/lowercase). HDD management: Click to switch the HDD recording information and other information. (Menu prompt.) Other special functions.
Play Previous		In playback mode, play the previous video.
Play Next		In playback mode, play the next video.
Slow Play		Click to adjust the playback speed. Various slow playback speeds are available.
Fast Play		Click to adjust the playback speed. Various fast playback speeds are available.
Reverse/Pause		<ul style="list-style-type: none"> Normal playback: Click to reverse playback. Reverse playback: Click to pause playback.

Play/Pause	▶	<ul style="list-style-type: none"> • Reverse playback or pause mode: Click to return to normal playback mode. • Normal playback: Click to pause playback. • Pause mode: Click to resume playback. • Real-time monitor mode: Click to enter the Search interface.
ESC	ESC	<ul style="list-style-type: none"> • Go to the previous menu or cancel the current operation. • Playback: Click to go back to the real-time monitor mode.
Record	Rec	Click to start/stop manual recording.
Up/Down	▲ ▼	<ul style="list-style-type: none"> • Activate the current control, modify setup, and then move up and/or down. • Increase or decrease the current number. • Assistant function such as the PTZ menu (not supported).
Left/Right	◀ ▶	<ul style="list-style-type: none"> • Shift the currently active control, then move left or right. • Playback mode: Click to control the playback bar.
Enter	ENTER	<ul style="list-style-type: none"> • Confirm the current operation. • Go to the Default button. • Go to the Menu.
USB 2.0 Port		Connect to a USB 2.0 storage device, USB 2.0 mouse or CD/DVD burner.
HDD Abnormal Indication Light	HDD	Lights BLUE to indicate an HDD error or when the HDD capacity is below the specified threshold.
Network Abnormal Indication Light	Net	Lights BLUE to indicate that a network error has occurred or that there is no network connection.

Figure 1-2 NVR Back Panel HEN081*4 NVR



HEN161*4 / HEN321*4 NVR

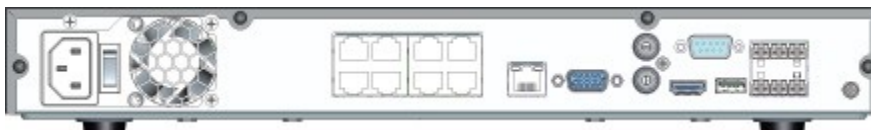
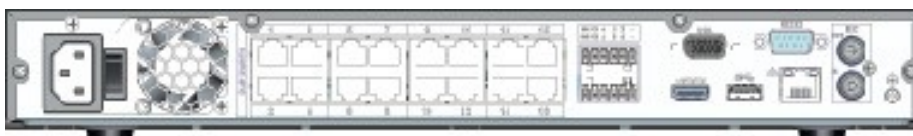

HEN162*4 / HEN322*4 / HEN642*4 / HEN163*4 / HEN323*4 / HEN643*4 NVR

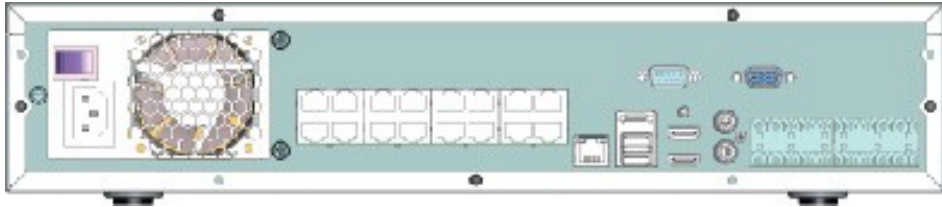

HEN04103L/HEN08103L

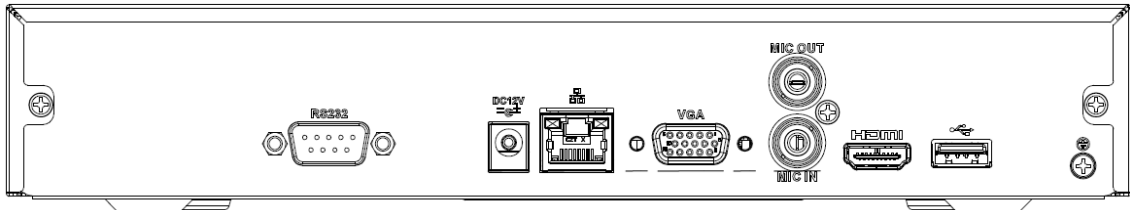

HEN16103L/HEN32103L

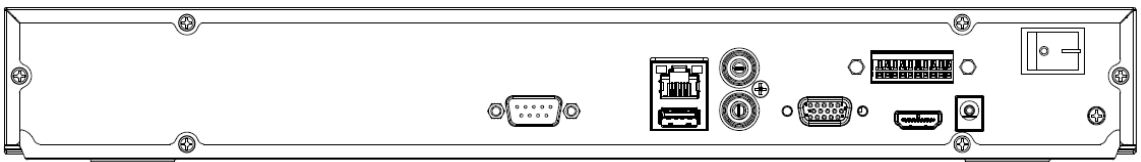

HEN041*3

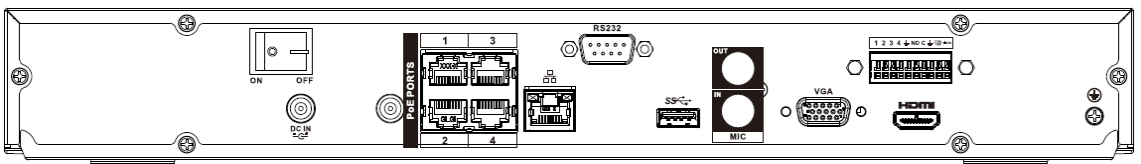

HEN081*3

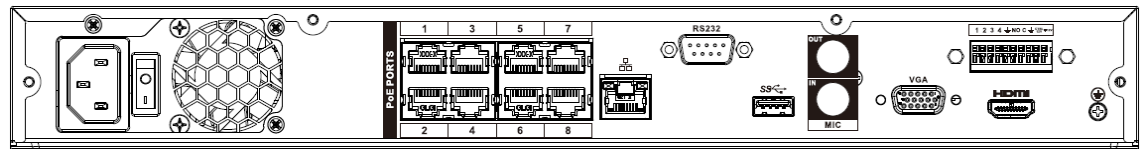

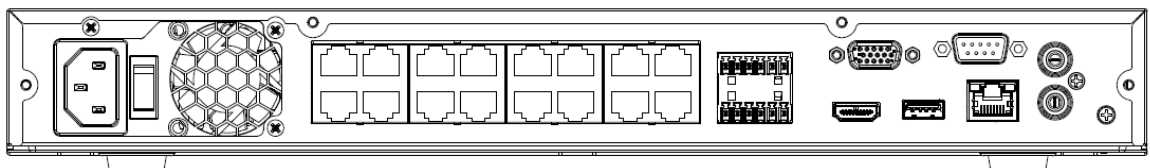

HEN161*3



Note * = storage in TB.

Table 1-2 NVR Back Panel Components

Icon/Marker	Port/Component Name	Connection	Function
	USB 2.0 Port		Connect a USB 2.0 mouse.
	Network Port		10 M / 100 M / 1000 Mbps self-adaptive Ethernet port. Connect to a network cable.
RS232 (RS-422)	232 Debug COM		For general COM debugging, to configure the IP address or to transfer transparent COM data.
HDMI	High Definition Media Interface		High definition audio and video signal output port. It transmits uncompressed high-definition video and multiple-channel data to the display device's HDMI port.
VGA	VGA Video Output Port	VGA	VGA video output port. Outputs the analog video signal. It can connect to the monitor for viewing analog video.
1-4	Alarm Input Port		<ul style="list-style-type: none"> Receives the signals from the external alarm sources. Two types: NO (normally open), NC (normally closed). When your alarm input device is using external power, please make sure the device and the NVR have the same ground.
	Alarm Input Port Ground End		Alarm input ground end.
NO1 to NO2 C1 to C2	2 channel Alarm Output Port	I/O Port	<ul style="list-style-type: none"> Two groups of alarm output ports. (Group 1: port NO1 ~ C1; Group 2: port NO2 ~ C2). Output alarm signal to the alarm device. Please make sure there is power to the external alarm device. NO: Normally open alarm output port. C: Alarm output public end.
Power Button			Power On/Off button.
PoE Ports			The built-in switch supports PoE function. It also supports up to 48 V / 50 W.
VIDEO OUT	Video Output Port		CVBS output.
MIC IN	Audio Input Port		Bi-directional communication input port. It receives the analog audio signal output from devices such as a microphone pickup.
MIC OUT	Audio Output Port		Audio output port. It outputs the analog audio signal to devices

		such as an alarm.
		<ul style="list-style-type: none"> • Bi-directional communication output. • Audio output on a 1-window video monitor. • Audio output on a 1-window video playback.
eSATA	External eSATA	External storage devices.

Mouse Operation

Your Network Video Recorder is optimized for mouse navigation. Use the supplied mouse to set up the DVR.

Figure 1-3 Mouse



Table 1-3 Mouse Operation



No.	Button	Action
1	Left	<ul style="list-style-type: none"> • Click to select a menu option. • Click in a text field to display the on-screen keyboard. • Click on the on-screen keyboard to input letters/numbers. • In multi-screen view, double-click to view the channel full screen. Double-click again to exit the full-screen mode. • Double-click video filename to play video.
2	Right	<ul style="list-style-type: none"> • Click to close the menu window without saving the changes. • Click to exit the main menu to return to the live view screen. • Click to open the shortcut menu from the live view screen.
3	Wheel	Scroll up/down.

Using the On-screen Keyboard

1. To display the on-screen keyboard, click in a text box. The keyboard appears directly below the text box.

Figure 1-4 On-screen Keyboard



2. Click the key corresponding to the letter/number/special character that you want to input in the text box.
 - To switch between lowercase and uppercase letters, click **Shift**.
 - To delete the previous character, click the  key.
 - To insert a space, click the  key.
3. Click **Enter** to close the on-screen keyboard.

Remote Control Operation

It is strongly recommended to use a mouse to operate the NVR. However, you can also use the supplied IR remote control. The following table describes basic remote control operations.

Figure 1-5 Remote Control Functions:

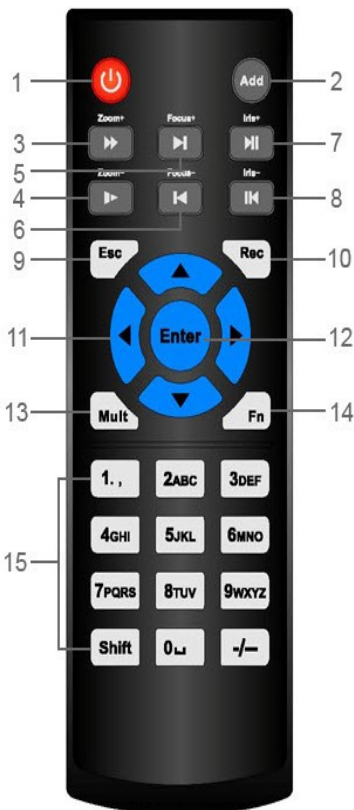

	Button	Action
1	Power	Turn the NVR on/off.
2	Add (Address)	Enter the number of the device that you
3	Forward	Increase the forward
4	Slow Play	Decrease the
5	Next Record	Select the next video
6	Previous Record	Select the previous
7	Play/Pause	Pause/resume
8	Reverse/Pause	Pause/resume
9	Esc	Return to the previous menu or
10	Rec	Manually start/stop
		While in the recording interface, use the direction buttons to select the recording channel. Press and
11	Direction Keys	Use the left/right keys to switch the

Note: This function is not available for HEN04103L/HEN08103L.

		While in playback mode, use the up/down buttons to
12	Enter	Go to the default. Go
13	Mult	Switch between the multi-channel
14	Fn	In the single-monitor mode, use the xxxx the PTZ control
15	Alphanumeric Keys	In text mode, press and hold the button to delete the last Enter passwords or switch channels.

2 Getting Started

This chapter contains the following sections:

- [Unpacking the NVR](#) on page 11.
- [Connecting External Devices](#) on page 11.
- [Starting and Shutting Down the NVR](#) on page 16.
- [Device Initialization](#) on page 17.
- [Reset Password](#) on page 19.
- [Setting Up the NVR with the Startup Wizard](#) on page 21.
- [Setting Up Bi-Directional Communication Connection](#) on page 24.

Unpacking the NVR

Before you set up the NVR, make sure that you have received the following items:

- Quick Installation Guide
- Quick Networking Guide
- Software CD
- Power adapter and cable
- Mouse
- Remote control
- CAT5e network cable
- Terminal block connectors (×2)
- Screws (×10)
- Serial ATA (SATA) cable*

If any of the items listed above are missing or damaged, contact your Honeywell dealer immediately.

Connecting External Devices

Step 1: Connect the cameras

Connect the coaxial cables from the cameras to the VIDEO IN connectors (1 Vp-p, 75 ohm).

Step 2: Connect the monitor

Connect a VGA cable (not supplied) to the VGA interface and/or an HDMI cable (not supplied) to the HDMI interface. Connect the other end to a monitor (do not use a TV). Simultaneous VGA and HDMI output is supported.

Step 3: Connect the mouse

Connect the supplied USB mouse to the USB 2.0 interface.

Step 4: Connect the Ethernet cable

Connect the supplied CAT5e Ethernet cable to the network port. Connect the other end to a router on your network.

Step 5: Connect audio devices (if applicable)

To record audio, connect the audio sources to the AUDIO IN connectors. To play audio, connect an audio output device (low-impedance headphones, speaker, or amplifier) to the AUDIO OUT connector (200 mV / 1 kilohm).

Step 6: Connect alarm devices (if applicable)

Connect alarm devices to the alarm in/out interface. If the alarm inputs use external power, the device must have the same ground as the NVR. See [Appendix A, Connecting Alarm Input/Outputs](#) for additional information.

Step 7: Connect a PTZ camera (if applicable)

Your embedded NVR communicates with PTZ cameras through the Network. Ensure that you camera is correctly connected to the Network.

Step 8: Connect the power cable

Connect the supplied 12 V DC power adapter to the power input. Use of an uninterruptible power supply (UPS) is strongly recommended.

Typical NVR Installation

The following diagram shows a typical NVR installation:

Figure 2-1 Typical NVR Installation

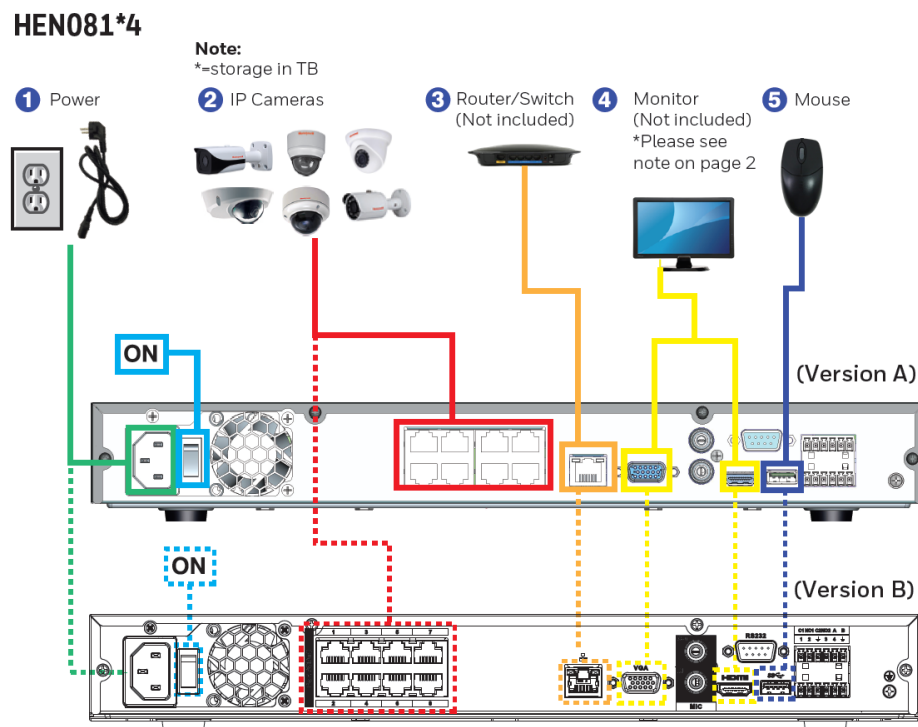

HEN162*4/HEN322*4/HEN642*4

Note:
*=-storage in TB

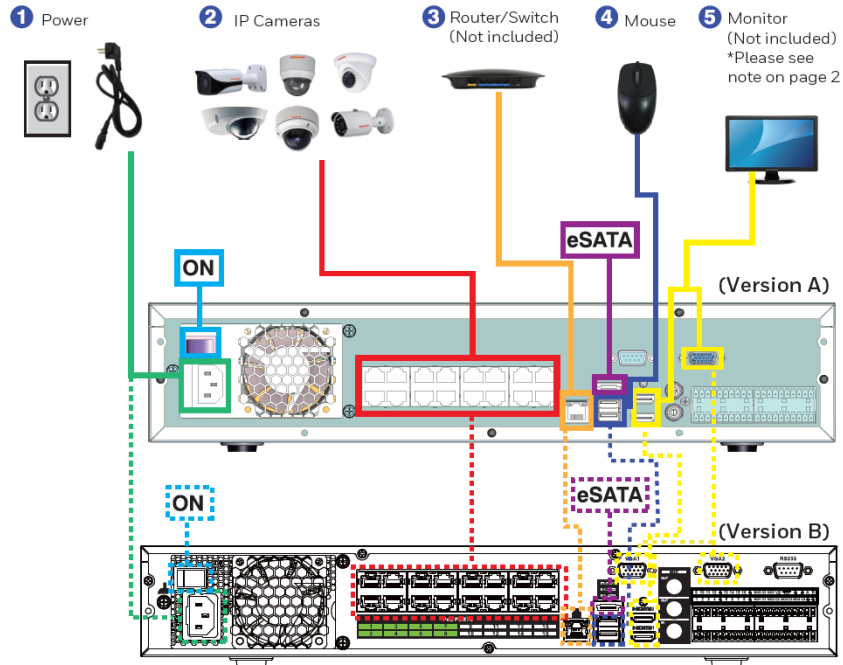

HEN163*4/HEN323*4/HEN643*4

Note:
*=-storage in TB

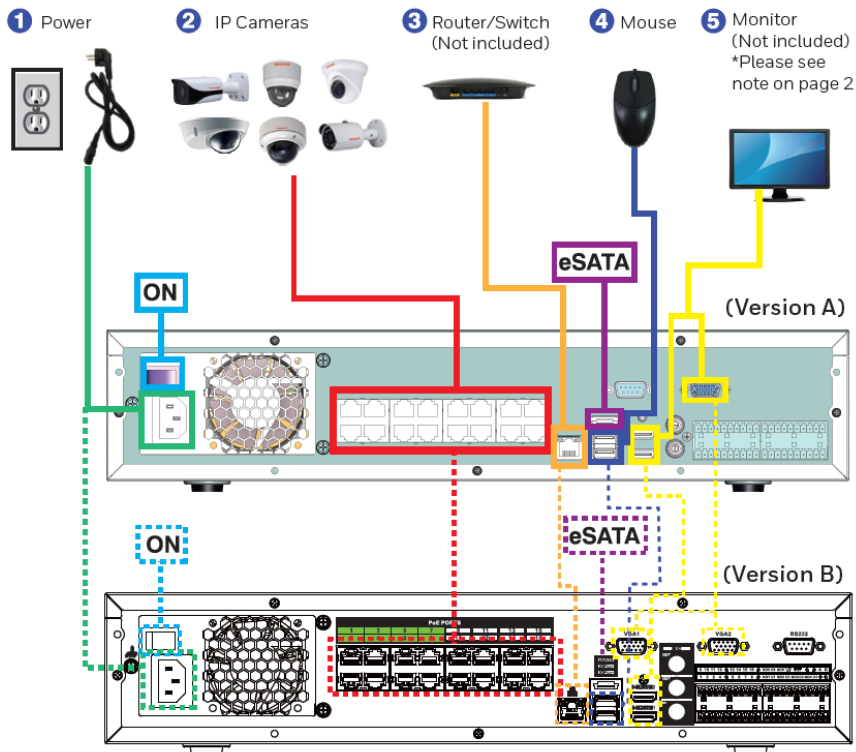

HEN161*4/HEN321*4

Note:
*=-storage in TB

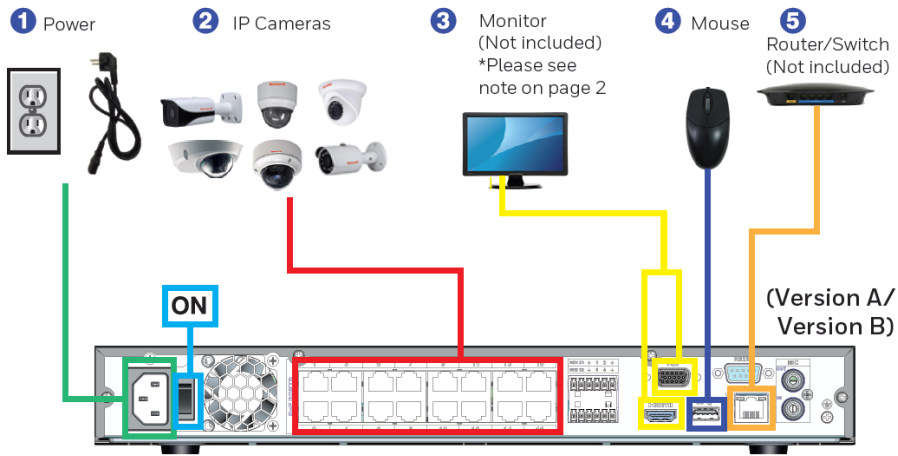

HEN041*3

Note:
*=-storage in TB

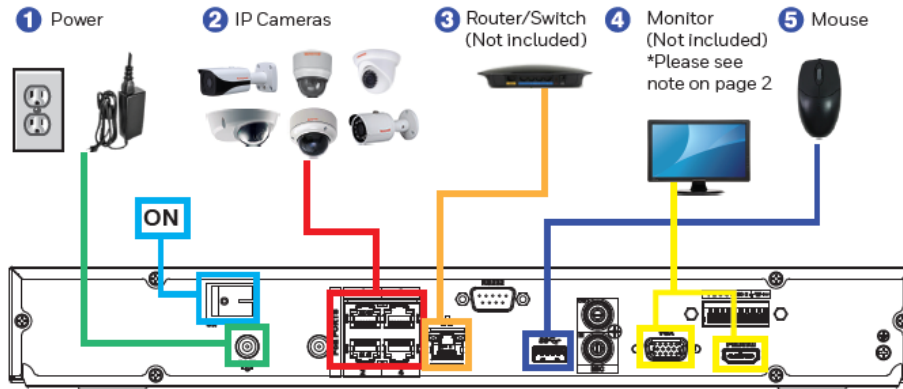

HEN081*3

Note:
*=-storage in TB

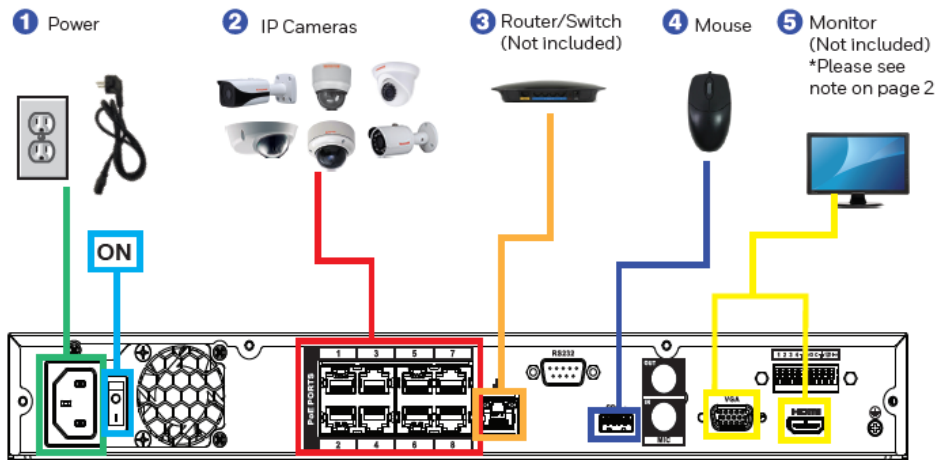

HEN161*3

Note:
*--storage in TB

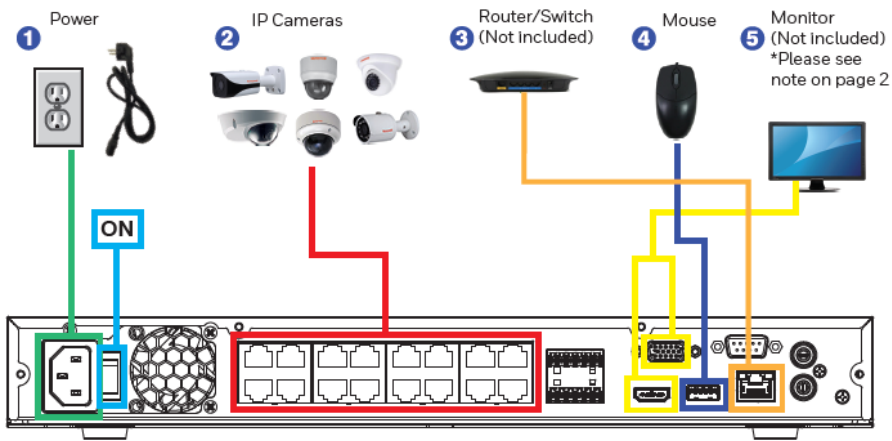

HEN04103L/HEN08103L

Note:
*--storage in TB

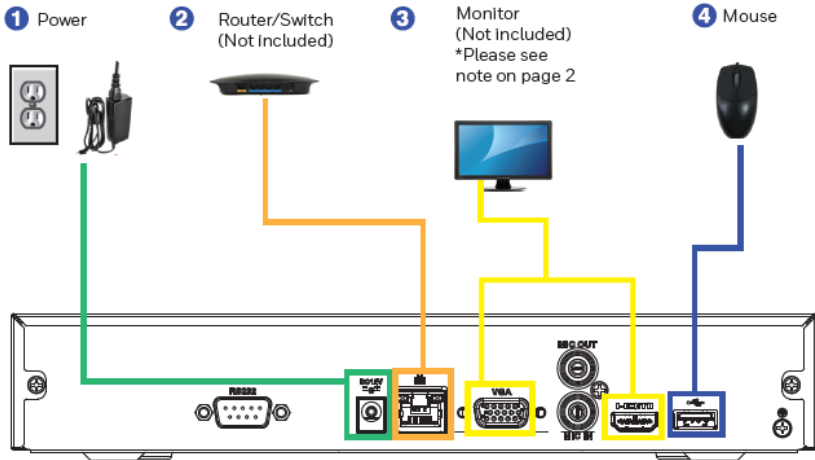

HEN16103L/HEN32103L

Note:
*--storage in TB

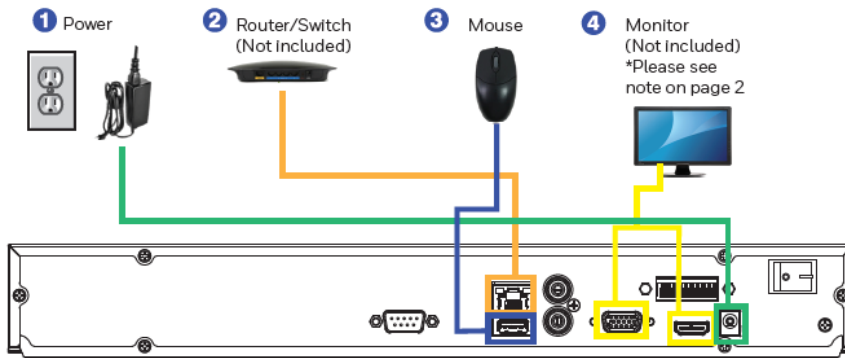

Starting and Shutting Down the NVR

Starting the NVR

1. Verify that the NVR is connected to an appropriate power source.
2. Turn on the power switch on the rear panel to start the NVR.

Note The beep at startup is normal.

Shutting Down the NVR

Note To shut down the NVR, you must be logged in as the admin user or have shutdown privileges assigned to you. See [Configuring Account Settings](#) on page 126.

To prevent damage to the hard drive, follow these steps to shut down the NVR:

1. In live view mode, click anywhere on the screen to display the shortcut menu, and then click **Main Menu**.
2. In the **Main Menu** window, click **Shutdown**.
3. In the **Shutdown** window, click **Shutdown** or **Reboot**.
4. Enter the admin password (the default password is 1234), and then click **OK**.

Device Initialization

When the NVR has booted up, the system enters the Device Initialization window.

Figure 2-2 Device Initialization – Enter Password

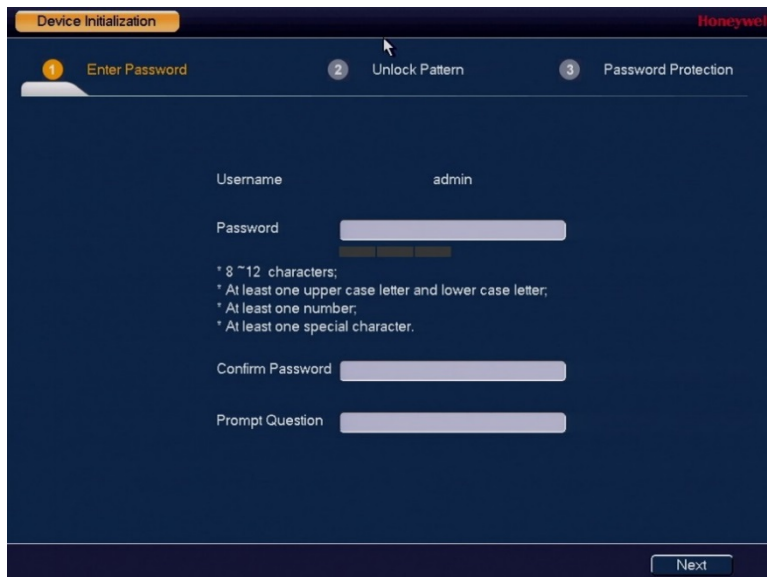

The screenshot shows the 'Device Initialization' window with the 'Enter Password' step selected. The window has a dark blue background and a white header with the Honeywell logo. The steps are: 1. Enter Password, 2. Unlock Pattern, and 3. Password Protection. The 'Enter Password' step is active. The form contains the following fields:

- Username: admin
- Password: [Redacted]
- Confirm Password: [Redacted]
- Prompt Question: [Redacted]

Below the Password field, there are password requirements:

- * 8 ~ 12 characters;
- * At least one upper case letter and lower case letter;
- * At least one number;
- * At least one special character.

A 'Next' button is located at the bottom right of the form.

1. Enter the password according to the password requirements. The default username is **admin**.

You can use the USB mouse to change the password. Click the soft keyboard button to switch the input mode between numbers and English letters; click **Shift** to change between lowercase and uppercase.

2. Click **Next** and the following window is displayed:

Figure 2-3 Device Initialization-Unlock Pattern

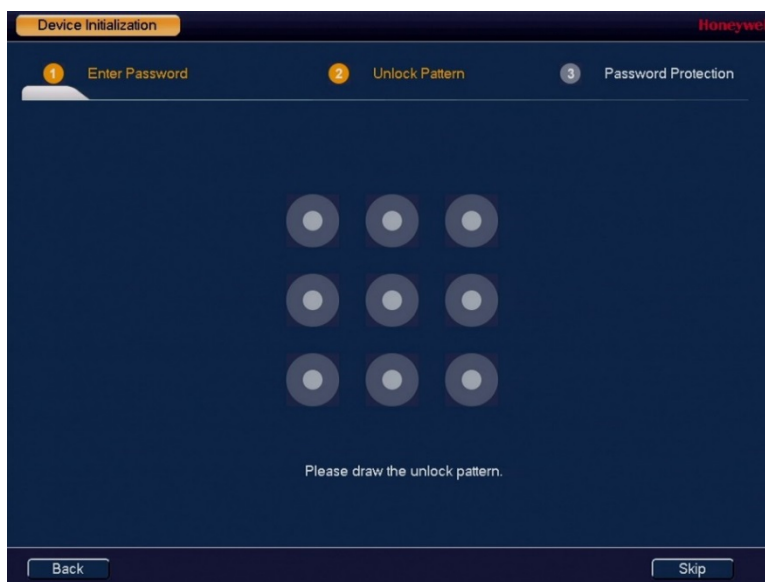

The screenshot shows the 'Device Initialization' window with the 'Unlock Pattern' step selected. The window has a dark blue background and a white header with the Honeywell logo. The steps are: 1. Enter Password, 2. Unlock Pattern, and 3. Password Protection. The 'Unlock Pattern' step is active. The form contains a 3x3 grid of circles for drawing the unlock pattern. Below the grid, the text reads: 'Please draw the unlock pattern.' At the bottom, there are 'Back' and 'Skip' buttons.

Draw the unlock patterns. You will be asked to draw two times of patterns. Make sure they are the same.

3. Click **Next** and the following window is displayed:

Figure 2-4 Device Initialization–Password Protection

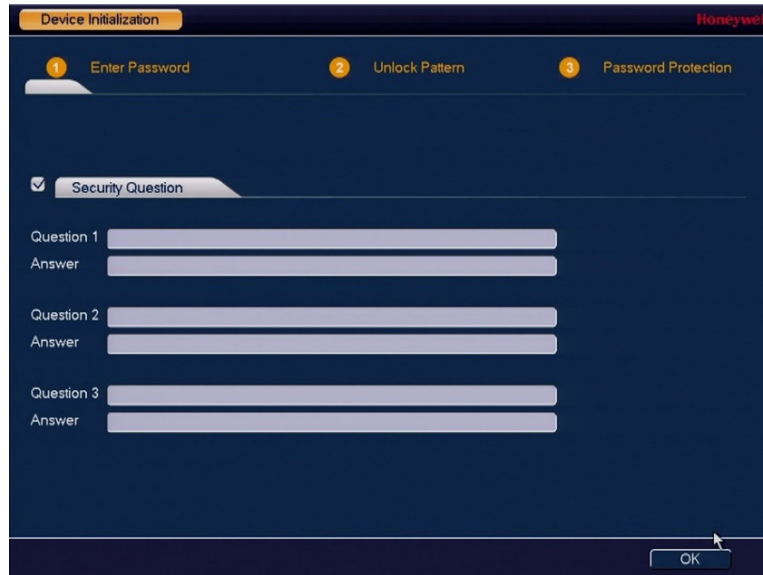

Security Question: Enter the Security Questions. You should enter all the three security questions.

If you uncheck Security Question, a warning message will be displayed as below:

Figure 2-5 Warning Message 1



If you upgrade the firmware from previous version to this version (20190129) and if you uncheck Security Question in the previous version, it will display the following message after the system reboot.

Figure 2-6 Warning Message 2

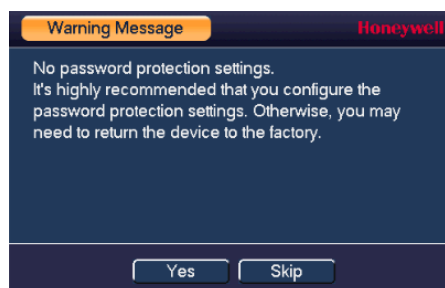

Reset Password

If you forgot the **admin** password, you can reset the password by answering the security questions.

1. Go to the system login interface as shown in the following figures:

Figure 2-7 System Login with Unlock Pattern

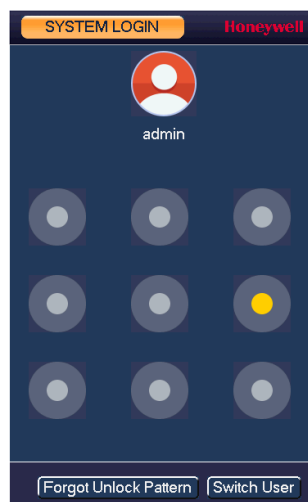
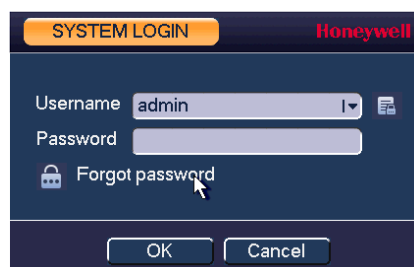

Figure 2-8 System Login with Password



- If you set the unlock pattern, NVR displays the unlock pattern login window, see [Figure 2-7](#). Click **Forgot Unlock Pattern**, NVR displays the password login window, see [Figure 2-8](#).

- If you didn't set the unlock pattern, device displays the password login window, see [Figure 2-8](#).

Note Click **Switch User**, NVR goes to general user login interface. The default user name is admin. Select a user from the username dropdown list and login via this user.

2. Click  and the following figure is displayed.

Figure 2-9 Reset – Security Question

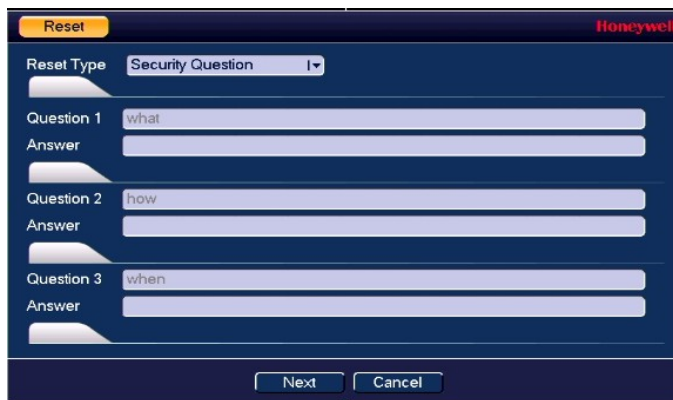

Enter the correct answers here.

3. Click **Next**. NVR displays the reset password window.

Figure 2-10 Reset – Password

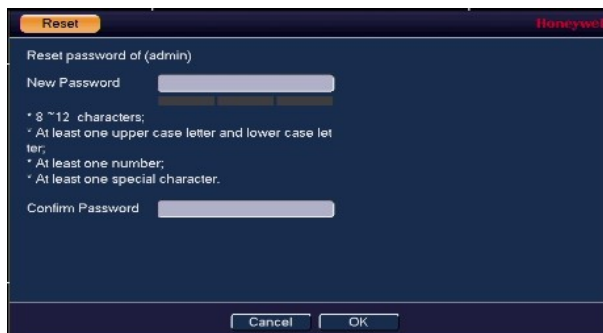

4. Enter the new password and then confirm.

Note **STRONG PASSWORD RECOMMENDED**-For your device own safety, please create a strong password of your own choosing. The password shall be at least 8-digit containing at least two types of the following categories: letters, numbers and symbols. We also recommend you change your password periodically especially in the high security system.

5. Click **OK** to complete the setup.

Setting Up the NVR with the Startup Wizard

After the device initialization, the Startup Wizard opens.

Figure 2-11 Startup Wizard

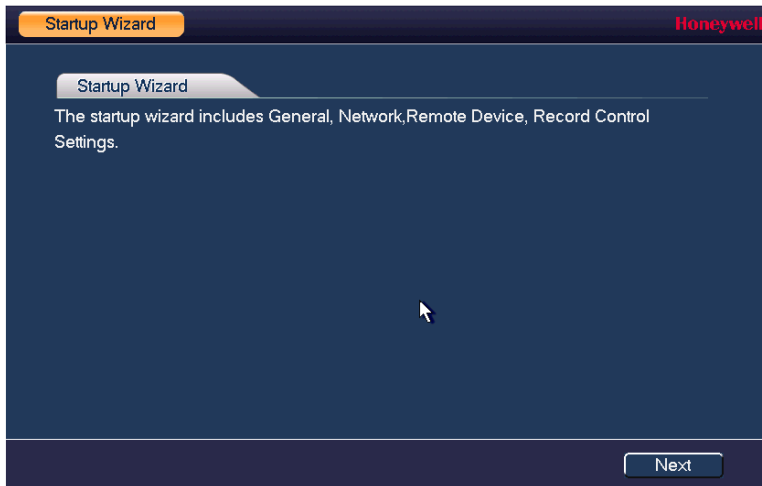

Using the wizard, you can:

- Configure general settings (device name, number, language, video standard)
- Set the date and time
- Configure video encoding settings
- Set up a recording schedule
- Configure recording settings
- Configure network settings

Using the Startup Wizard

1. Click **Next** to go to the **GENERAL** window.

Figure 2-12 Startup Wizard - GENERAL

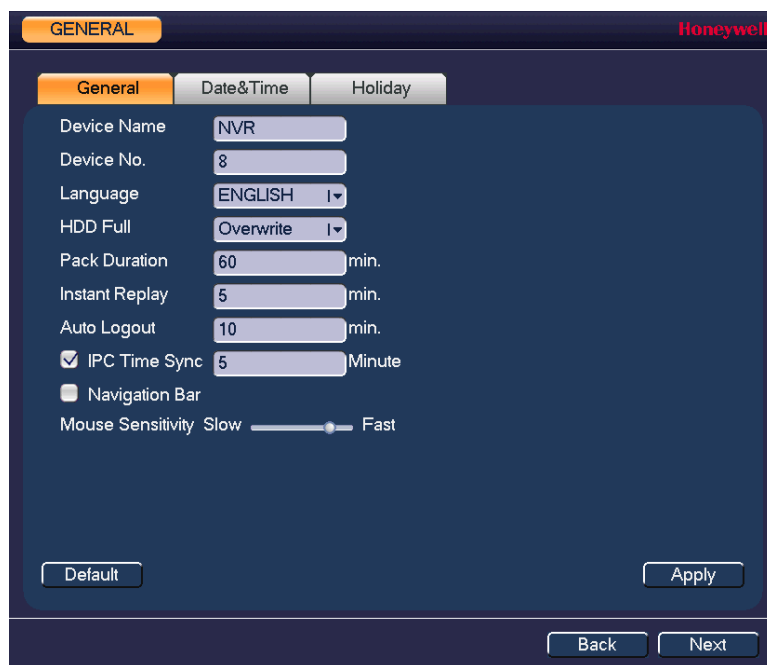

For more information about configuring settings in the **GENERAL** window, see [Configuring General System Settings](#) on page 115.

2. Click **Next** to go to the **TCP/IP** window.

Figure 2-13 Startup Wizard - TCP/IP Window



For more information about configuring settings in the **TCP/IP** window, see [Configuring TCP/IP Settings](#) on page 62.

3. Click **Next** to go to the **Camera Registration** window.

Figure 2-14 Startup Wizard - Camera Registration Window

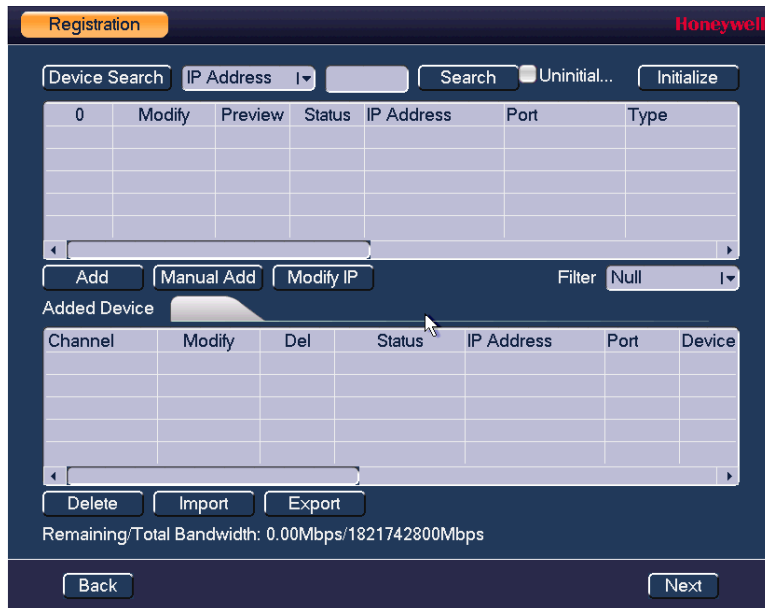

For more information about configuring settings in the **Camera Registration** window, see [Adding a Camera](#) on page 53.

4. Click **Next** to go to the **SCHEDULE** window.

Figure 2-15 Setup Wizard - SCHEDULE Window

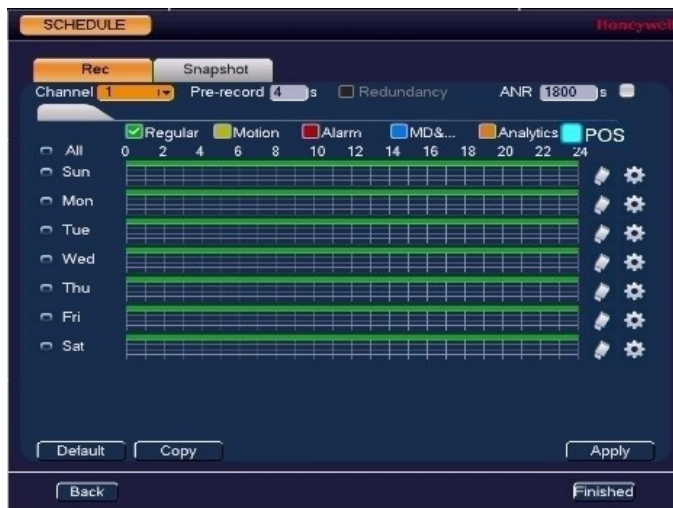

For more information about configuring settings in the **SCHEDULE** window, see [Configuring the Video Recording Schedule](#) on page 38 or [Configuring Storage Settings](#) on page 104.

5. Click **Finished**. The message "Wizard is Finished" appears.

Figure 2-16 Setup Wizard Finished

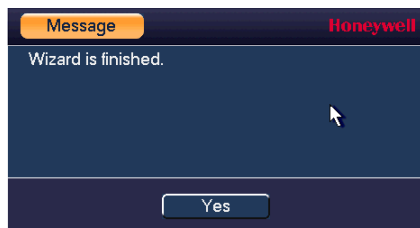

6. Click **Yes** to close the wizard.

Setting Up Bi-Directional Communication Connection

Audio Output Device to a PC

Connect:

1. Connect a microphone or pickup to the first audio input port on the NVR's rear panel.
2. Connect the earphone or the sound box to the audio output port on your PC.
3. Open the web client and log in.
4. Enable the desired channel in the web client's live view monitor.

Figure 2-17 Enabling Bi-Directional Communication



Configuring to Hear Audio From the NVR

At the NVR end, speak through the microphone or the pickup. Then you can get the audio from the speaker or earphone from the PC end.

Figure 2-18 Configuring to Hear Audio from the NVR

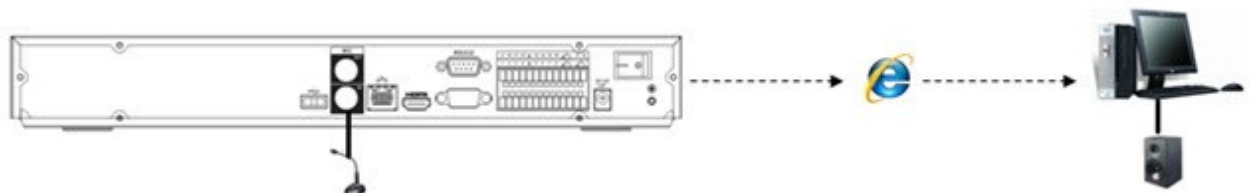

PC to an Audio Input Device

Connect:

1. Connect the microphone or the pickup to the audio input port in the PC.
2. Connect the earphone or the sound box to the audio output port on your PC.
3. Open web client and log in.
4. Enable the desired channel in the web client's live view monitor.
5. See [Figure 2-19](#) for enabling bi-directional communication.

Configuring to Hear Audio from the PC

At the PC end, speak through the microphone or the pickup. Then you can get the audio from the speaker or earphone from the NVR.

Figure 2-19 Configuring to Hear Audio from the PC

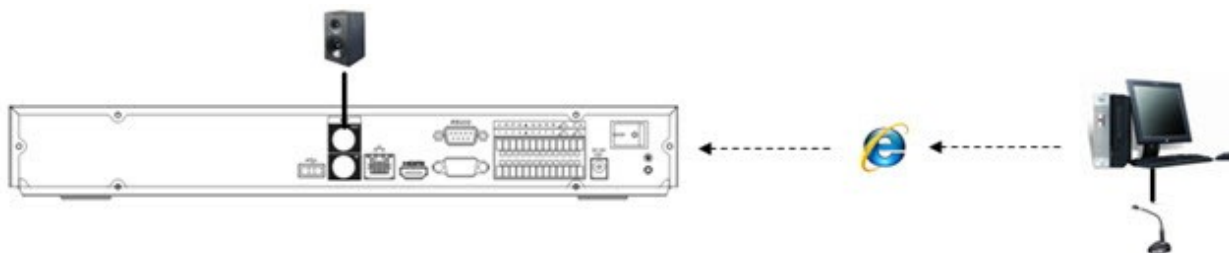

3 Viewing Live Video

This chapter contains the following sections:

- [About Live View](#) on page 26.
- [Configuring Live View](#) on page 29.
- [Controlling PTZ Cameras](#) on page 30.

About Live View



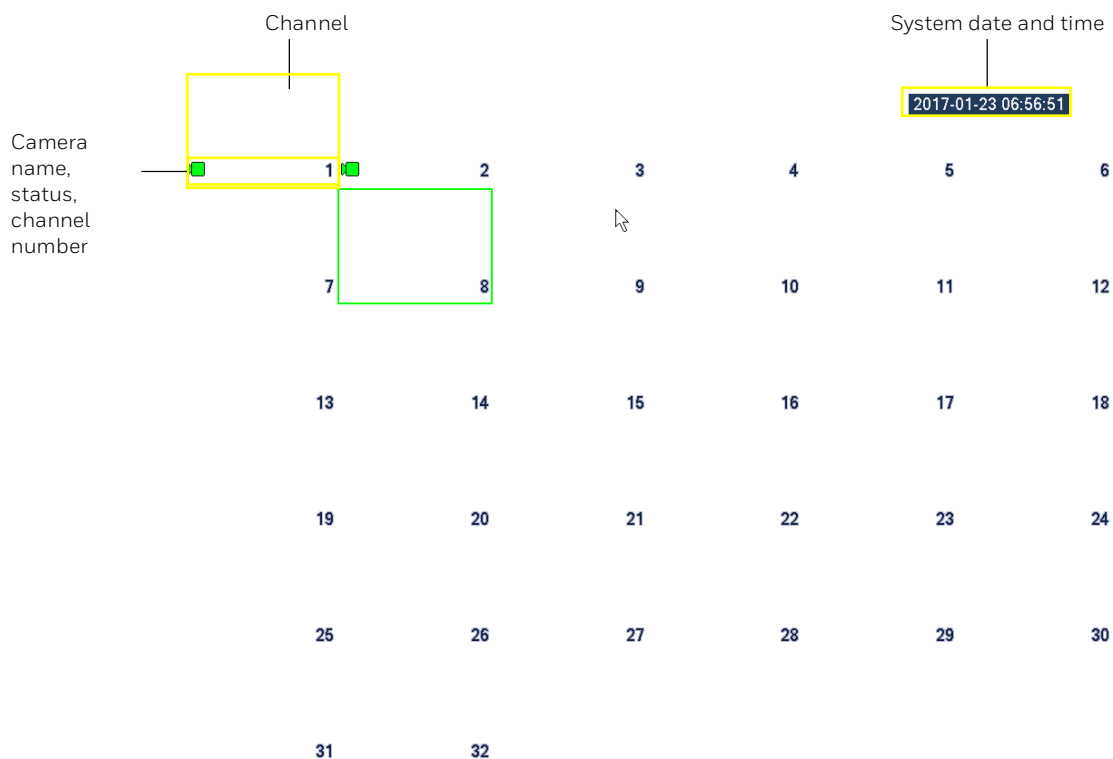

Live view is the NVR's default mode. When you start the NVR, live video from the connected cameras is displayed on the screen in a multi-channel layout (the number of channels displayed depends on whether you are using a 4-channel, 8-channel, 16-channel or 32-channel NVR).

Figure 3-1 Live View



Camera Status

Camera status icons appear at the bottom of the channel window.

	Video is being recorded		No video signal
	Motion detected in scene		Camera locked

Camera Toolbar

A camera toolbar is located at the top of each channel window. To display the toolbar, move the mouse pointer to the top of the channel window.

Figure 3-2 Live View - Camera Toolbar



Table 3-1 Live View - Camera Toolbar

Icon	Name	Function
	Instant Replay	Playback the previous 5-60 minutes record of current channel. Go to the Main menu → Setting → System → General to set instant replay time. System may pop up a dialogue box if there is no such record in current channel.
	Digital Zoom/Enlarge	Enlarge a specific area of the image. Click the button to enable digital zoom and then drag the mouse in the channel window to select the area that you want to enlarge. Right-click to undo digital zoom.
	Realtime Backup	Save a clip to a USB storage device. Click the button to start recording. Click again to stop recording. The clip is automatically saved to the connected USB storage device.
	Snapshot	Save a screen capture to the hard drive or to a connected USB storage device. To view the captured image, go to Main Menu → Operation → Search and click the File List button.
	Audio Talk	Click to enable or disable bi-directional communication with an IP camera that is equipped with both a microphone and speaker. Note: The bi-directional communication button only works in single-channel view.
	Switch Stream	Switch the camera stream between the main and sub streams.

Live View Toolbar















If enabled, the live view toolbar appears along the bottom of the live view screen.

Figure 3-3 Live View Toolbar



The toolbar is disabled by default. To enable it, right-click and go to **Main Menu** → **SETTING** > **SYSTEM** → **GENERAL** → **General** and select the **Navigation** check box. Right-click twice to return to the live view screen. Click anywhere on the screen to display the toolbar.

Table 3-2 Live View Toolbar

Icon	Name	Function
	Main Menu	Open Main Menu .
	Screen Layout	Select screen layout format.
	Previous Screen	Go to the previous screen.
	Next Screen	Go to the next screen.
	Tour Control	Enables a tour (automatically cycles through channel views). See Configuring Tour Settings on page 121.
	PTZ	Open the PTZ control panel. See Controlling PTZ Cameras on page 30.
	Image	Open the Image setting window. See Adding a Camera on page 53.
	Search	Open the playback interface. See Playing Back Video on page 43.
	Multicast	Open the Voice Broadcast interface. See Configuring Broadcast Settings on page 123.
	Alarm Status	Open the Alarm Status information window.
	Channel Info	Open the Channel Info window.
	Registration	Add and configure a device (camera). See either Using the Startup Wizard on page 21 or Adding a Camera on page 53.
	Network	Open the Network window. See Configuring TCP/IP and Port Settings on page 62.
	HDD Manager	Open the HDD Manager window. See Configuring HDD Manager Settings on page 107.



USB Manage Open the **USB Manage** window.

Shortcut Menu

The shortcut menu is displayed by right-clicking anywhere on the screen in live view mode.

Figure 3-4 Shortcut Menu

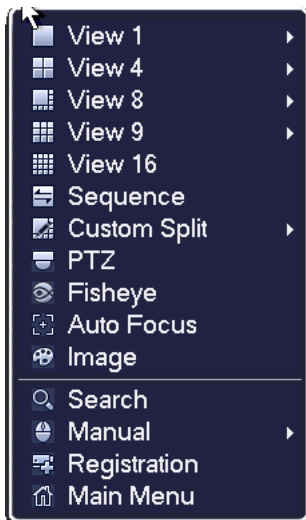

The Shortcut Menu varies according to products, refer to the actual interface of your products.

Configuring Live View

Setting the Screen Layout

The live view interface is configurable as a single-channel or multi-channel display.

To change the screen display format using the shortcut menu

1. Right-click anywhere on the screen to display the shortcut menu.
2. Point to the View you want (**View 1** is a single-channel layout, the others are multi-channel layouts), and then click the channel(s) that you want to display.

To change the screen display format using the live view toolbar

- Click a screen layout button on the live view toolbar.

To change the screen display format using the mouse

- Rotate the mouse wheel button.

To move a channel to a different location in the multi-channel grid

- Drag the channel to a new location in the multi-channel grid.

For example, to move channel 2 to the top left position occupied by channel 1, click channel 2, drag it to channel 1's position, then release the mouse button.

Controlling PTZ Cameras

This section describes how to do the following:

- Access the PTZ control panel
- Configure PTZ connection settings
- Configure and call PTZ presets, tours, and patterns

Working with the PTZ Control Panel

You can control a PTZ camera connected to the NVR through a network connection using the on-screen PTZ control panel.

Basic PTZ Control Panel

Figure 3-5 PTZ Control Panel

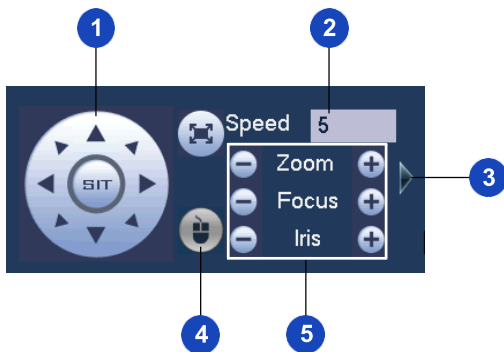

Table 3-3 PTZ Controls

#	Name	Function
1	Direction keys	Direct camera movement.
2	Speed	Adjust the camera speed. Select a value between 1 and 8 .
3	Expand Arrow	Expand the control panel to display additional options.
4	PTZ Trace	Direct camera movement by dragging the mouse. Zoom in and out by rotating the wheel button.
5	Zoom, Focus, Iris	Adjust the camera's zoom, focus, and iris settings: <ul style="list-style-type: none"> • Decrease zoom (-), increase zoom (+) • Focus near (-), focus far (+) • Iris close (-), iris open (+)

Expanded PTZ Control Panel

Figure 3-6 Expanded PTZ Control Panel

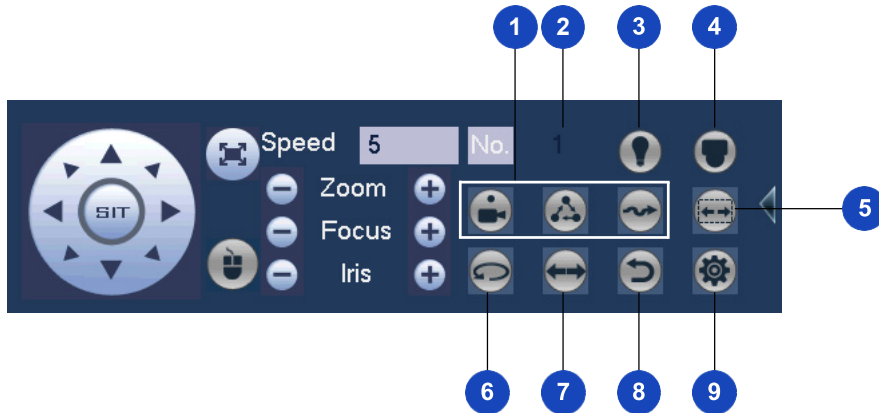

Table 3-4 Expanded PTZ Control Panel

#	Name	Function
1	Preset, Tour, Pattern	Configure/call PTZ functions.
2	No.	Enter number of PTZ function to call.
3	Aux	Call auxiliary functions.
4	Enter Menu	Enable up-the-coax OSD menu configuration for non-PTZ camera.
5	AutoScan	Cause camera to continually pan between two points that you have defined.
6	AutoPan	Cause camera to continually rotate 360 degrees.
7	Flip	Cause camera image to flip 180 degrees.
8	Reset	Restore default settings.
9	Aux Config	Configure auxiliary functions.

To display the PTZ control panel

1. Right-click anywhere on the screen to display the shortcut menu.
2. Click **PTZ**. The PTZ control panel opens.

Figure 3-7 PTZ Control Panel

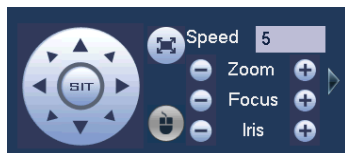

3. To expand the PTZ control panel, click the arrow at the right side of the panel.

Figure 3-8 Expanded PTZ Control Panel

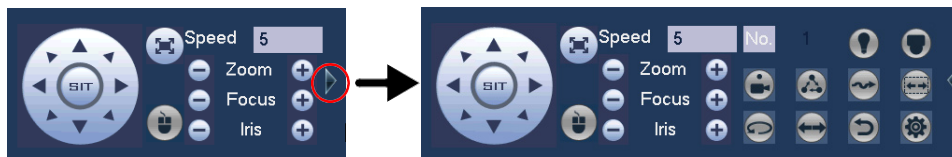

Configuring PTZ Connection Settings

Before you can control a PTZ camera with the NVR, you must configure the PTZ connection settings.

Note

This function is only available for HEN081*4/HEN162*4/HEN163*4/HEN161*4/HEN322*4/HEN323*4/HEN321*4/HEN642*4/HEN643*4.

To configure the PTZ connection settings

1. Go to **Main Menu → SETTING → SYSTEM → PTZ**, the following window is displayed:

Figure 3-9 System Setting – PTZ

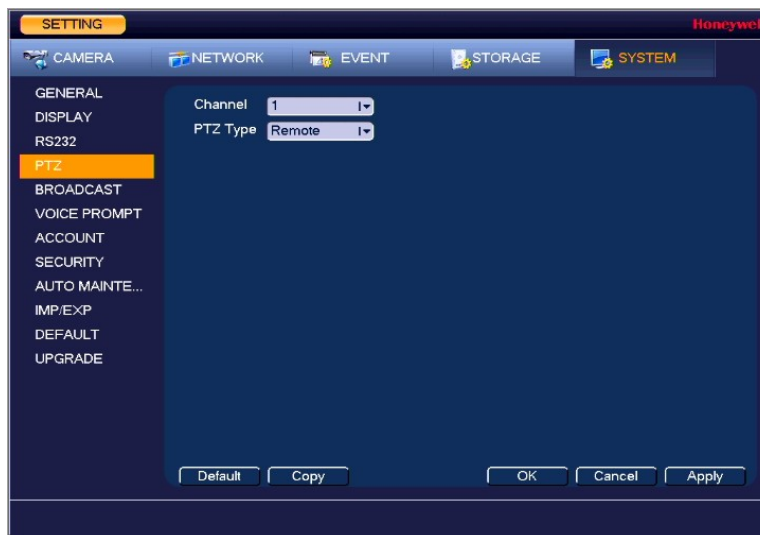

2. Configure the following settings:
 - Channel:** Select the channel (camera) for which you want to configure PTZ settings.
 - PTZ Type:** Select **Remote** for the PTZ type. A remotely connected IP camera is connected through the network.
3. Click **Apply**, and then click **OK** to save your settings and exit.

Configuring PTZ Functions

You can configure presets, tours, patterns, and borders using the PTZ control panel.

Configuring PTZ Presets

You can program preset positions for the PTZ camera. For example, you can point the camera at a specific location, such as a doorway, when an alarm event occurs.

1. On the expanded PTZ control panel, click the **PTZ Setting** button.

Figure 3-10 PTZ Setting Button

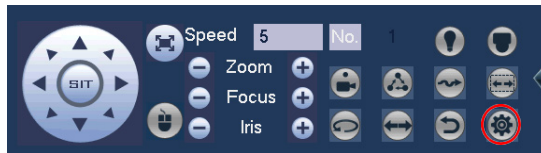

2. The PTZ window opens.

Figure 3-11 Preset



3. Use the direction arrows to point the camera where you want to set as the preset.
4. In the **Preset** box, select a preset in the dropdown list or enter a number for the preset, and then click **Setup** to save your settings.
 - To program additional presets, repeat steps 1 through 3.
 - To delete a preset, select a preset number in the dropdown list or enter the number of the preset that you want to delete in the **Preset** box, and then click **Del Preset**.

Note Some protocols do not support the Del Preset function.

Configuring PTZ Tours

You can set up the PTZ camera to go from preset to preset in a specific order, or tour.

1. On the expanded PTZ control panel, click the **PTZ Setting** button.

Figure 3-12 PTZ Setting Button

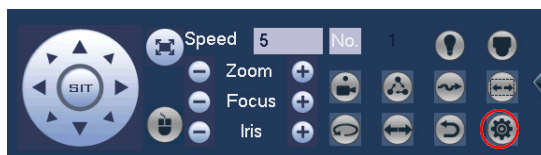

2. Select the **Tour** tab for Tour setting options.
3. In the **Preset** box, enter the number of the first preset that you want to add to the tour.

Figure 3-13 Tour



4. In the Patrol **No.** box, enter a number for the tour.
5. Click **Add Preset** to add the preset to the tour.
6. Repeat steps 1 through 5 to add additional presets to the tour.
 - To delete a preset, enter the number of the preset that you want to delete in the **Preset** box, and then click **Del Preset**.
 - To delete a tour, enter the number of the tour that you want to delete in the **Patrol No.** box, and then click **Del Tour**.

Note Some protocols do not support the **Del Preset** function.

Configuring PTZ Patterns

You can record a series of PTZ movements as a pattern. When you call the pattern in live view mode, the PTZ camera automatically moves along the path you have defined.

1. On the expanded PTZ control panel, click the **PTZ Setting** button.

Figure 3-14 PTZ Setting Button

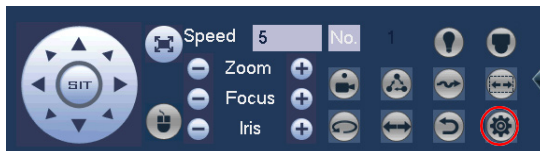

2. Select the **Pattern** tab for Pattern setting options.
3. In the **Pattern** box, enter a number for the pattern.

Figure 3-15 Pattern

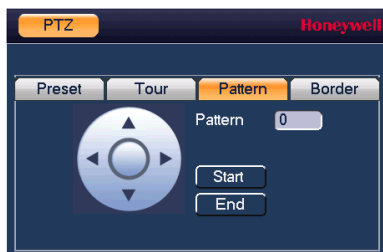

Click **Start**, and then use the direction arrows to direct the camera.

4. When you have finished directing the camera pattern, click **End**.

Configuring PTZ Borders

You can define the left and right borders of the PTZ camera's pan movement, or scan.

1. On the expanded PTZ control panel, click the **PTZ Setting** button.

Figure 3-16 PTZ Setting Button

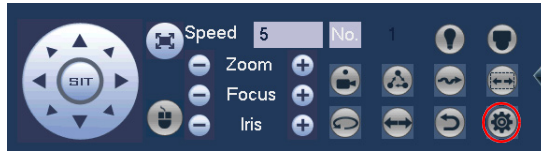

2. Select the **Border** tab for Border setting options.

Figure 3-17 Border

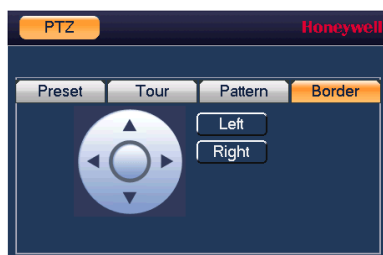

3. Use the direction arrows to move to the auto scan's leftmost limit, then click **Left**.
4. Use the direction arrows to move to the auto scan's rightmost limit, then click **Right**.

Calling Presets, Tours, and Patterns

To call a preset

1. On the expanded PTZ control panel, in the **No.** box, enter the number of the preset that you want to call, and then click the **Preset** button.

Figure 3-18 Preset Button

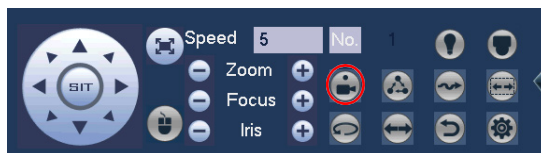

2. Click the **Preset** button again to stop calling the preset.

To call a tour

1. On the expanded PTZ control panel, in the **No.** box, enter the number of the tour that you want to call, and then click the **Tour** button.

Figure 3-19 Tour Button

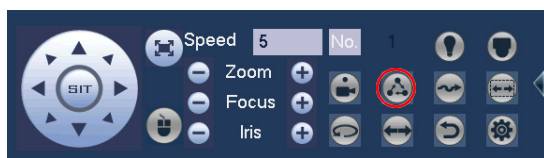

2. Click the **Tour** button again to stop calling the tour.

To call a pattern

1. On the expanded PTZ control panel, in the **No.** box, enter the number of the pattern that you want to call, and then click the **Pattern** button.

Figure 3-20 Pattern Button

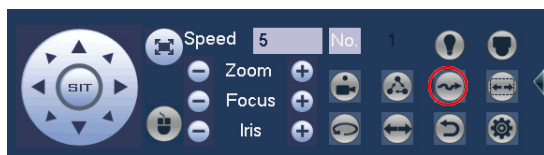

2. Click the **Pattern** button again to stop calling the pattern.

Configuring Auxiliary Settings

Refer to the user guide of your PTZ camera for details on configuring auxiliary settings.

4 Recording Video

This chapter contains the following sections:

- [Manual Recording Settings](#) on page 37.
- [Automatic Recording Settings](#) on page 37.

Manual Recording Settings

In live view mode, you can manually record a clip directly to a connected USB storage device.

Note

To back up recorded video to a connected USB storage device, please see [Backing Up Video and Snapshots](#) on page 49.

To record a video clip in live view mode

1. Connect a USB storage device (such as a USB flash drive) to one of the USB ports on the NVR. The **Find USB device** dialog box opens automatically.
2. Right-click to close the window.
3. In live view mode, move the mouse pointer to the top of the channel window to display the camera toolbar (see [Camera Toolbar](#) on page 38).
4. On the camera toolbar, click the **Realtime Backup** button  to start recording. The button changes to green while the NVR is recording.
5. Click the **Realtime Backup** button again to stop recording.

The video clip is saved automatically to the connected USB storage device. The file name uses the following format: `[NVR name]_[channel]_[video stream]_[recording start time]_[recording end time].dav`.

Automatic Recording Settings

The NVR supports independent real-time recording of each channel, even while searching and playing recorded video.

To set the NVR to automatically record, you must do two things:

1. Configure the **General Recording Settings** to enable automatic or scheduled recording.
2. Configure the Video Recording Schedule.

Configuring the General Recording Settings

In the **RECORD** configuration interface, you can do the following:

- Select **Auto/Schedule** recording for the main and sub streams
- Select **Manual** recording for the main and sub streams
- Enable and disable the **Snapshot** function

To configure the general recording settings

1. Go to **Main Menu → SETTING → STORAGE → RECORD**, the following window is displayed:

Figure 4-1 Storage Recording Settings

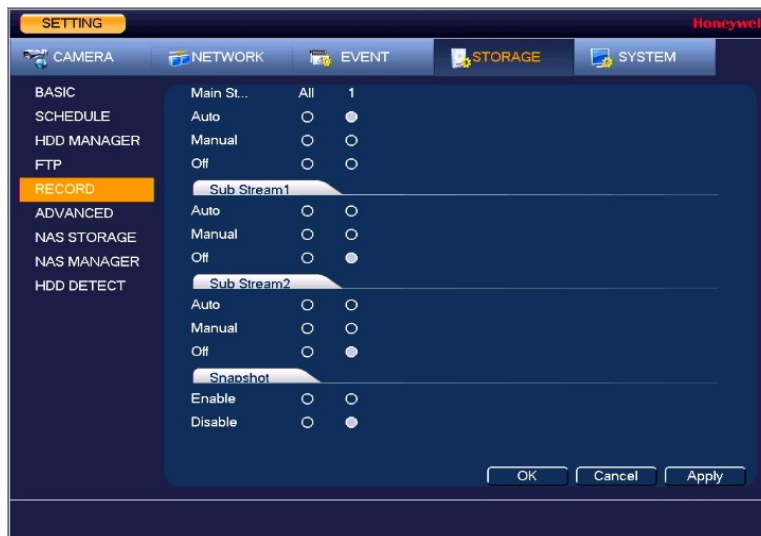

2. On the **Record** page, select the recording type (**Auto, Manual, Stop**) that you want to enable on each channel, for both the main stream and sub stream.
3. Under **Snapshot**, enable snapshot recording on the desired channels.
4. Click **Apply**, and then click **Save**.

Configuring the Video Recording Schedule

To configure the video recording schedule

1. Go to **Main Menu → SETTING → STORAGE → SCHEDULE → Rec**, the following window is displayed:

Figure 4-2 Storage Schedule Settings

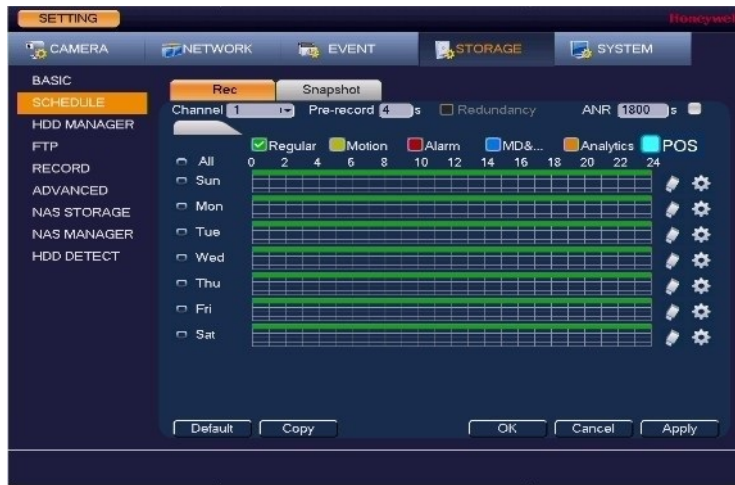

2. On the **Record** tab, in the **Channel** box, select the channel (camera) for which you want to configure a recording schedule.
3. In the **PreRecord** box, enter a time between **0** and **30** seconds. The default setting is **4** seconds. The pre-record time sets how long the NVR records before the scheduled recording start time.
4. If the NVR has two HDDs, select the **Redundancy** check box to enable redundant recording on the second HDD. This HDD must first be configured on the **HDD Manage** page (see [Configuring HDD Management Settings](#) on page 107).
5. In the **ANR** box, enter a time between 0s ~ 43200s. It is to save video to the SD card of the network camera in case the network connection fails. After the network connection resumed, the system can get the video from the SD card and there is no risk of record loss.
6. At the top of the scheduling table, select the check box(es) of the recording type(s) that you want to schedule:

General: The General recording schedule is indicated by a green bar.

Motion: The motion detection recording schedule is indicated by a yellow bar.

Alarm: The alarm recording schedule is indicated by a red bar.

MD&Alarm: The motion detection and alarm recording schedule is indicated by a blue bar.

Analytics: The video analytics recording schedule is indicated by an orange bar.

POS: The POS recording schedule is indicated by a light blue bar.

Note

The POS function is only available for
 HEN081*4/HEN162*4/HEN163*4/HEN161*4/HEN322*4/
 HEN323*4/HEN321*4/HEN642*4/HEN643*4.

7. At the left of the scheduling table, select the day(s) of the week for which you want to configure a recording schedule. To configure the same recording schedule for all of the days at the same time, select **All**.

8. Click or drag the mouse in the scheduling table to set the recording period. To erase a recording period, click the eraser icon () at the right of the table. Alternatively, for the day of the week that you want to configure, click the gear icon at the right of the table. In the **Period** window, set up to six recording periods. To copy the settings to additional days, select the appropriate check box(es) under **Copy**, and then click **OK**.
9. Click **Apply** to save your settings.
10. To copy the recording schedule settings to additional channels, click **Copy**, select the channels to which you want to copy the settings, and then click **OK**.

Configuring the Snapshot Recording Schedule

Follow these steps to configure the snapshot recording function. When enabled, the NVR can take snapshots when a motion detection, video loss, video tampering, or other alarm event occurs. See [Chapter 8, Configuring Event Settings](#) for detailed instructions.

To configure the snapshot recording schedule

1. Go to **Main Menu** → **SETTING** → **STORAGE** → **SCHEDULE** → **Snapshot**, the following window is displayed:

Figure 4-3 Snapshot Schedule Settings

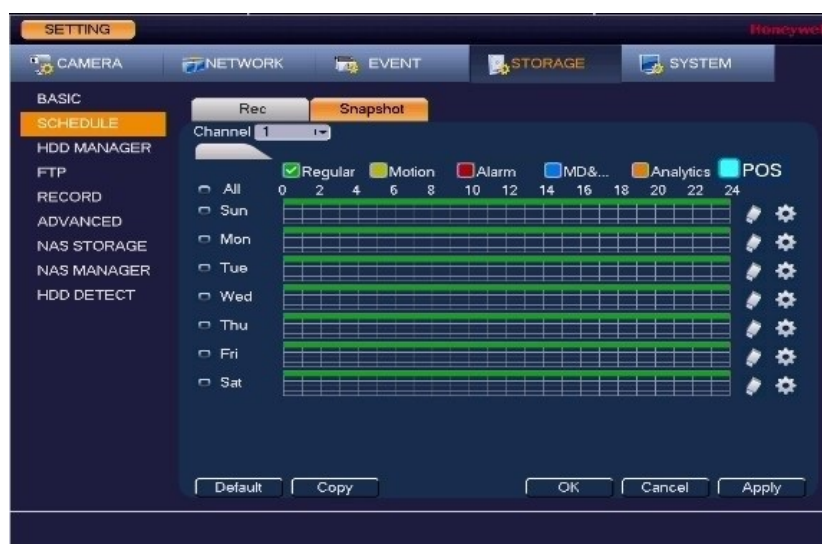

2. On the **Snapshot** tab, in the **Channel** box, select the channel (camera) for which you want to configure a snapshot schedule.
3. At the top of the scheduling table, select the check box(es) of the recording type(s) that you want to schedule:

General: The regular recording schedule is indicated by a green bar.

Motion: The motion detection recording schedule is indicated by a yellow bar.

Alarm: The alarm recording schedule is indicated by a red bar.

MD&Alarm: The motion detection and alarm schedule is indicated by a blue bar.

Analytics: The video analytics schedule is indicated by an orange bar.

POS: The POS schedule is indicated by a light blue bar.

Note The POS function is only available for HEN081*4/HEN162*4/HEN163*4/HEN161*4/HEN322*4/HEN323*4/HEN321*4/HEN642*4/HEN643*4.

4. At the left of the scheduling table, select the day(s) of the week for which you want to configure a recording schedule. To configure the same recording schedule for all of the days at the same time, select **All**.
5. Click or drag the mouse in the scheduling table to set the recording period. To erase a recording period, click the eraser icon at the right of the table. Alternatively, for the day of the week that you want to configure, click the gear icon at the right of the table. In the **Period** window, set up to six recording periods. To copy the settings to additional days, select the appropriate check box(es) under **Copy**, and then click **OK** to copy the settings and exit.
6. Click **Apply** to save your settings.
7. If you want to save your settings and exit the **SETTING** menu, click **OK**.
8. To copy the record schedule settings to additional channels, click **Copy**, select the channels to which you want to copy the settings, and then click **OK**.

To configure snapshot recording settings

1. Go to **Main Menu** → **SETTING** → **CAMERA** → **Encode** → **Snapshot**, the following window is displayed:

Figure 4-4 Camera Snapshot Settings

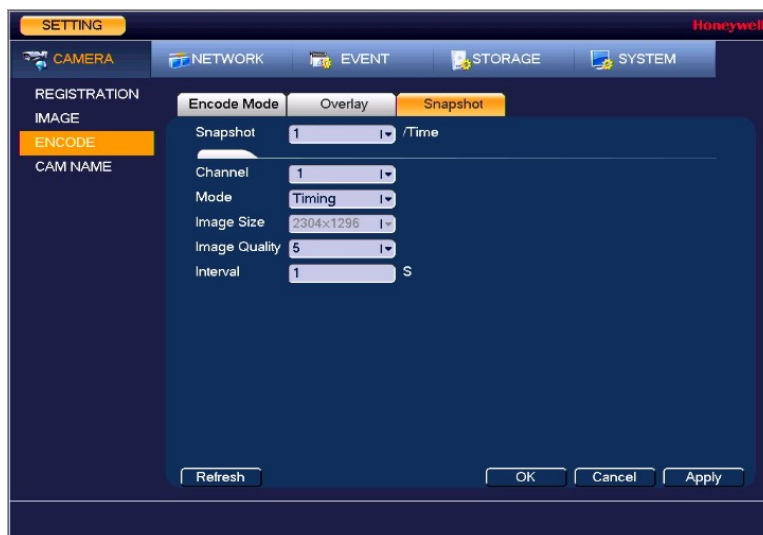

2. On the **Snapshot** tab, configure the following settings:

Snapshot: Select the number of snapshots to take at a time.

Channel: Select the channel for which you want to configure the settings.

Mode: Select **Timing** to take snapshots according to a schedule.

Select **Trigger** to take snapshots when a motion detection, video loss, video tampering, or alarm event occurs.

Image Size: The size is automatically selected, based on the resolution of the camera.

Image Quality: Select a value between **1** and **6**, with **6** being the highest quality.

Interval: Select a value between **1 SPL** (second per picture) and **7 SPL** or click **Customized** to enter your own setting.

3. Click **Apply** to save your settings.
4. To copy the settings to additional channels, click **Copy**, select the channels to which you want to copy the settings, and then click **Save**.

Note

The NVR assigns event-activated snapshots a higher priority than schedule-activated snapshots. If you have enabled both of these types of snapshots, then the system activates an activation snapshot when an alarm occurs. If there is no alarm, then the NVR takes snapshots according to the schedule setup.

5 Playing Back Video

This chapter contains the following sections:

- [Playing Back Video](#) on page 43.
- [Smart Player Playback](#) on page 48.
- [Playing Back Snapshots](#) on page 48.
- [Backing Up Video and Snapshots](#) on page 49.

Playing Back Video

Searching For and Playing Back Video

1. Go to **Main Menu** → **Operation** → **Search**, the following window is displayed:

Figure 5-1 Search Playback Interface

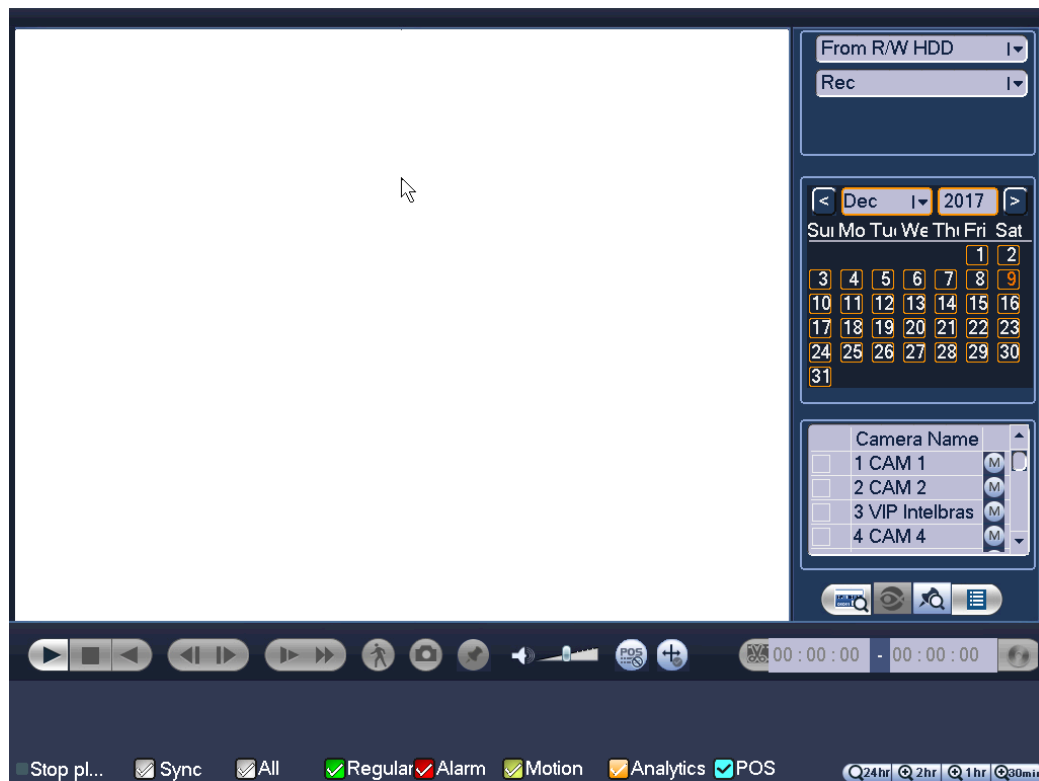

2. On the right panel of the playback interface, in the calendar area, click the date(s) that you want to search. Dates with recorded video are solid orange.
3. Below the calendar, select the camera(s) that you want to watch, and select the stream.

4. At the bottom of the screen, select the recording type(s) that you want to search (**Regular, Alarm, Motion, Analytics, POS**) or select **All** to search all recording types.

Note	The POS function is only available for HEN081*4/HEN162*4/HEN163*4/HEN161*4/HEN322*4/HEN323*4/HEN321*4/HEN642*4/HEN643*4.
-------------	--

5. Click  to display the list of search results.
6. From the list of search results, double-click the recorded video file that you want to play back. The video begins playing in the playback window.
7. Use the playback controls at the bottom of the screen to control playback. Playback modes include slow play, fast play, reverse play, and frame-by-frame playback.
8. To jump forward or backward in the video, click the time bar at the desired time. To zoom in or out on the time bar, click one of the options in the lower right corner of the screen: **24 h**, **12 h**, **1 h**, or **30 min**.

Smart Search

Note	IP cameras support Smart Search through a private protocol.
-------------	---

You must do the following in the IP camera before you can do a Smart Search with your NVR:

Note	<ul style="list-style-type: none">• Enable the VMD (Video Motion Detection) function in your IP camera.• Configure the VMD region for your IP camera. See Configuring Motion Detection Settings on page 77 for more about VMD settings.
-------------	--

To quickly locate activity using Smart Search

1. During video playback, click the **Smart Search** button. A grid is superimposed over the playback window.
2. Drag the mouse over the area that you want to search for activity.

Figure 5-2 Search For Activity

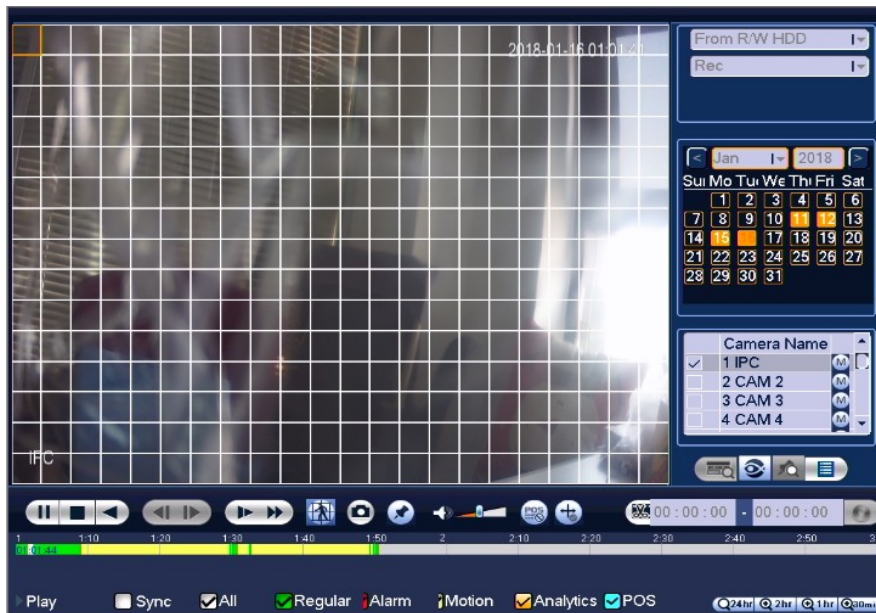

3. Click the **Smart Search** button again. Playback jumps to all the parts of the video where there is activity in that area.
4. To exit Smart Search, click the **Smart Search** button again. The message "**Are you sure to exit smart search now?**" appears. Click **OK**.

Mark Playback

Please make sure your purchased device support this function. You can use this function only if you can see the mark playback icon on the Search interface ([Figure 5-1](#)).

When you play back video record, you can mark the video record when there is important information. After the playback, you can search the corresponding record by time or the mark key words and then play it. It is very easy for you to get the important video information.

Add Mark

During the playback, click Mark button  and the following window is displayed:

Figure 5-3 Add Mark

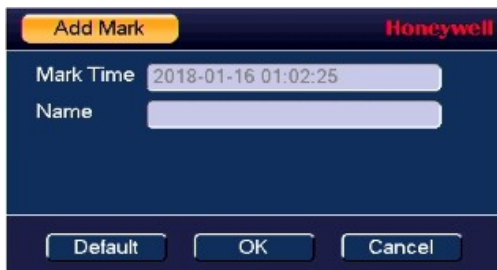

Playback Mark

During 1-window playback mode, click mark file list button , you can go to mark file list interface. Double click one mark file, you can begin playback from the mark time.

Play before mark time

Here you can set to begin playback from previous N seconds of the mark time.

Note

Usually, system can playbacks previous N seconds record if there is such kind of record file. Otherwise, system playbacks from the previous X seconds when there is such as kind of record.

Mark Manager

Click  on the Search interface (*Figure 5-1*) and the following window is displayed. System can manage all the record mark information of current channel by default. You can view all mark information of current channel by time.

Figure 5-4 Mark Manager



Modify Marks

Double click one mark information item, you can see system pops up a dialogue box for you to change mark information. You can only change mark name here.

Delete Marks

Here you can check the mark information item you want to delete and then click **Delete**, you can remove one mark item.

Note

- After you go to the mark management interface, system needs to pause current playback. System resume playback after you exit mark management interface.
- If the mark file you want to playback has been removed, system begins playback from the first file in the list.

Slice Playback

Note

This function is only available for HEN081*4/HEN162*4/HEN163*4/HEN161*4/HEN322*4/HEN323*4/HEN321*4/HEN642*4/HEN643*4.

For the large recording file, you can use the slice playback function to play the same file in several sections at the same time. It is very convenient for you to find the video footages you desire.

On the main menu, click **Search**, or right click mouse and then select Search. You will be navigated to the window as shown in [Figure 5-1](#).

On the right pane, select Slice in the dropdown list, and then select date, cameras and stream. The slice playback interface is shown as below. Each section has a small triangle; you can adjust it to set time.

Figure 5-5 Slice Playback

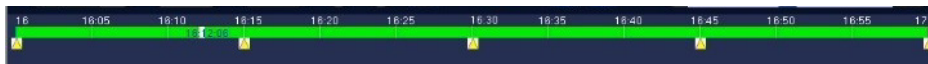

Select slice file.

- Click **Playback**, system playbacks from the first of current date by default.
- Click time bar, system playbacks from the time you click.
- Click , you can select on the file list.

Note

- The slice playback is for 1-window playback mode.
- System supports 1/4/8/16-split mode. Slight difference may be found here. The 4-channel series product supports 4-split mode. The 8-channel series product support 8-split mode. The 16-channel or higher series product supports 16-split mode.
- The min period of each section is 5 minutes. For the record less than 20 minutes, if you select 4-split mode (or more than 4-split mode), system can auto adjust so that the each section period is 5 minutes. In this situation, some channel may have no video.

Smart Player Playback

The Smart Player can be used to search for video related to analytics type events, such as face detection.

1. Go to **Main Menu → Operation → Smart Play**, the following window is displayed:

Figure 5-6 Smart Player Options Screen

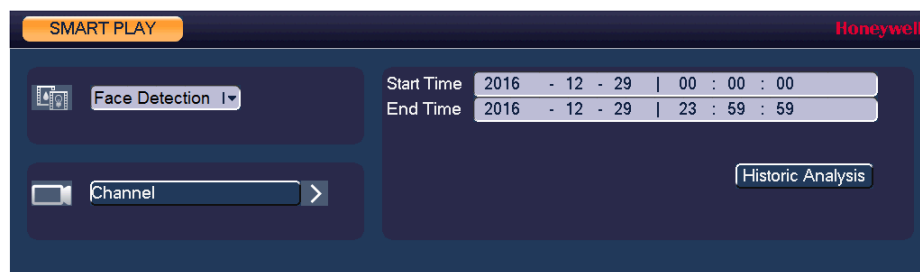

2. Select the type of event to search through in the Smart Player in the event drop-down list. In the example here, face detection is selected.
3. Select the Channel to search through in the Channel drop-down list.
4. Enter the **Start Time** and **End Time** for the Smart Player to include and click **Historic Analysis**.
5. The Smart Player screen will open with a list of the event types that have occurred on the selected channel and within the time frame. Select one of the event instances to call up the video from the event.

Playing Back Snapshots

1. Go to **Main Menu → Operation → Search**. The playback interface opens.
2. On the right panel, below the search type box at the top of the panel, select **PIC**.
3. In the **Interval** box, enter the playback interval in seconds. Enter a time between **1** and **60** seconds. The default setting is **1** second.

4. In the calendar area, click the date(s) that you want to search. Dates with saved snapshots are solid orange.
5. Below the calendar, select the camera(s) that you want to watch, and select the stream.
6. Click the **File List** button to display the list of search results.
7. In the list of search results, double-click the snapshot file that you want to play back. The snapshot appears in the playback window.
8. Playback cycles through all of the snapshot files in the file list at the interval you specified in the **Interval** box. To pause playback, click the **Pause** button in the control panel below the playback window. To go to the next snapshot, click the **Next Frame** button. To go to the previous snapshot, click the **Prev Frame** button.

Note

The green time bar in the snapshot playback interface only shows approximately when snapshots were taken. Click **File List** to do an accurate search.

Backing Up Video and Snapshots

To back up from inside the playback interface

1. Insert a USB storage device (such as a USB flash drive) into one of the USB ports on the NVR.
2. Search for the recorded video or snapshot file(s) that you want to back up (see [Playing Back Video](#) on page 43 and [Playing Back Snapshots](#) on page 48).
3. Click the **File List** button to display the list of search results.
4. In the list of search results, select the check box(es) of the file(s) that you want to back up.

Figure 5-7 Search Results



Alternatively, during video playback, in the video clip time field, enter the desired start time and end time, and then click the **Save** button.

Figure 5-8 Playback Save/Backup Button

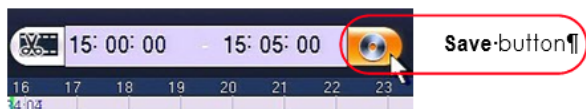

The **Backup** window opens, displaying the selected video file/clip.

5. In the Backup window, click **Backup**.

Figure 5-9 Backup Window



The **Browse** window of the USB storage device opens.

Figure 5-10 Backup - Browse USB Storage Window



6. Click **Start** to back up the file(s). If the backup is successful, the message "Backup finished" appears.

To back up from outside of the playback interface

1. Insert a USB storage device (such as a USB flash drive) into one of the USB ports on the NVR. The **Find USB device** dialog box opens.

Figure 5-11 Find USB Storage Device Window

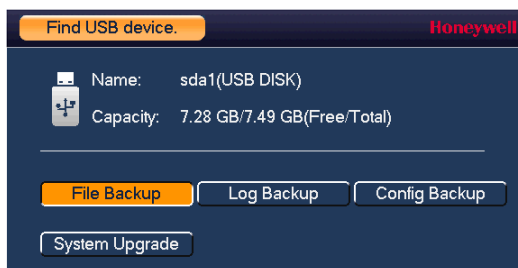

2. In the **Find USB device** dialog box, click **File Backup**.

Figure 5-12 File Back to USB Device Window

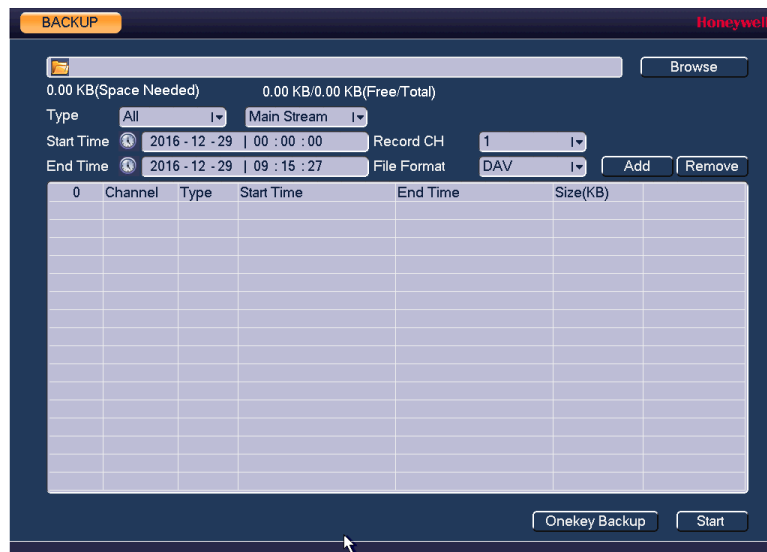

3. In the **Backup** window, configure the following settings:

Type: Select the file type for which you want to search.

Note To search for snapshots, select PIC, as All means all video files (excluding snapshots).

Start Time: Enter the start time of the search.

End Time: Enter the end time of the search.

Record CH: Select a specific channel to search or select **All** to search all channels.

File Format: Select **DAV** or **ASF** as the video file format.

4. Click **Add** to display the search results in the file list.

Note If there are too many files in the selected time, only the first 1024 files in the search period will be displayed. Refine the Start Time and End Time to find the desired files for backup.

5. Select the check box(es) of the file(s) that you want to back up, and then click **Backup**. The **Browse** window of the USB storage device opens.
6. Click **OK** to back up the file(s).

6 Configuring Camera Settings

This chapter contains the following sections:

- [Adding a Camera](#) on page 53.
- [Configuring Camera Image Settings](#) on page 55.
- [Configuring Snapshot Settings](#) on page 57.
- [Configuring Encoding Settings](#) on page 58.
- [Configuring the Text Overlay](#) on page 59.
- [Changing a Camera Name](#) on page 60.

Adding a Camera

Adding a Camera by Searching

1. Go to **Main Menu → Setting → CAMERA → Registration**, the following window is displayed:

Figure 6-1 Adding a Camera Device



2. Search the camera.

Automatically Search: Click **Device Search** to automatically find IP cameras.

Search by IP Address or MAC Address: Select IP Address or MAC Address in the dropdown list next to **Device Search**, enter the IP Address or MAC Address and Click **Search**.

- a. Click to select the found camera.
- b. Click **Add** to add the found device to the **Added Device** list.

Note If the NVR fails to display the model name of a found device, click **Device Search** to rediscover the online devices. The model name should appear in the Found Devices list.

Adding a Camera Manually

Click **Manual Add** and manually configure the following settings:

Table 6-1 Manual Add

Parameter	Function
Manufacturer	Select the manufacturer that applies to your camera from the list.
IP Address	Enter the IP address for the camera.
TCP Port	Enter the TCP port for the camera. (Optional)
Username	Enter a username.
Password	Enter a password
Channel No.	Enter a channel amount or click the Connect button to get the channel amount of the remote device. Note: We recommend click the Connect button to get remote device channel amount, the manual add operation may result in failure if the input channel amount is not right.
Remote Channel No.	After getting the remote device channel amount, click Setup to select a channel. Note: Click to select one or more remote channel numbers here.
Channel	The local channel number you want to add. One channel name has corresponding one channel number.
Decode buffer	Select from the drop-down menu of options.

Click **OK**. The newly added camera appears in the Added Device list.

Configuring Camera Image Settings

Note You can configure camera settings only if you have connected your IP cameras via a Private Protocol. If you have connected via a Private Protocol, then the Camera settings will be available. If you have connected your IP cameras via other protocols, then the Camera settings will not be available.

1. Go to **Main Menu → Setting → CAMERA → Image**, the following window is displayed:

Figure 6-2 Camera Image Settings Tab



2. Configure the following settings:

Note Parameters vary according to products.

Channel: Select a channel from the drop-down list.

Config File: Select from Config1, Config2, and Config3.

Saturation: Adjusts monitor color saturation. Choosing a higher value increases the color saturation/strength. This value has no effect on the general brightness of the video. Select from **0** to **100**. The recommended range is between **40** and **60**. The default value is **50**.

Hue: Adjusts the monitor color hue from **0** to **100**. The recommended range is between **40** and **60**. The **default** value is **50**.

Brightness: Adjusts monitor brightness. Choosing a higher value increases the video brightness. Adjustments to this value affects the brightness of the video. Select from **0** to **100**. The recommended range is between **40** and **60**. The default value is **50**.

Note If this value is too high, then the video can become hazy.

Contrast: Adjusts monitor contrast. Choosing a higher value increases the contrast. Select from **0** to **100**. The recommended range is between **40** and **60**. The default value is **50**.

Note If this value is too low, then the video can become hazy. If this value is too high, then the dark parts of the video could lose details, and the bright parts of the video could become overexposed.

Iris: **Iris** controls the aperture and automatically controls the amount of light that is let into the camera. Iris is set to **Enable** by default.

Mirror:Reverses the video image, so that they left side becomes the right side, and the right side becomes the left. Disabled by default.

Flip: The default setting is **Normal**. Choose from **180°**, which flips the video 180°; **90°**, which rotates the video by 90°; and **270°**, which rotates the video by 270°.

Day & Light: Sets the camera color and the B/W mode switch.

- **Colorful:** The camera outputs video in color.
- **Auto:** The camera switches from Color to Black & White according to the conditions, such as if the scene is generally bright, or if IR illumination is required.
- **B/W:** The camera outputs black and white video.

BLC Mode: Sets the camera backlight compensation mode.

- **Close:** BLC function is disabled. This is the default setting. **BLC Mode:** The camera auto exposures according to the environment so that the darkest area of video is clear.
- **WDR:** The camera lowers the brightest areas and enhances the darkest areas so both areas can be clearly viewed at the same time. Set the WDR value from 1 to 100.
- **HLC:** The camera lowers the brightness of the brightest area according to the HLC control level (from 1 to 100).

Scene Mode (White Balance): This is the white balance. You can select different scene modes such as Auto, Outdoor, Natural, Street Lamp or Manual, to achieve the best quality video.

Scene Modes:

- **Auto:** Auto white balance is on. The system automatically adjusts the color temperature to ensure that the video color is correct.

- **Outdoor:** The white balance threshold is set to outdoor mode. **Natural:** The white balance threshold is set to natural mode. **Street Lamp:** The white balance threshold is set to street lamp mode.
 - **Manual:** You can manually set the gain for the red/blue channel. The value ranges from **0** to **100**.
3. Click **Apply** to save your settings.
 4. If you want to save your settings and exit the **SETTING** menu, click **OK**.

Configuring Snapshot Settings

1. Go to **Main Menu → Setting → CAMERA → Encode → Snapshot**, the following window is displayed:

Figure 6-3 Camera Snapshot Settings Tab

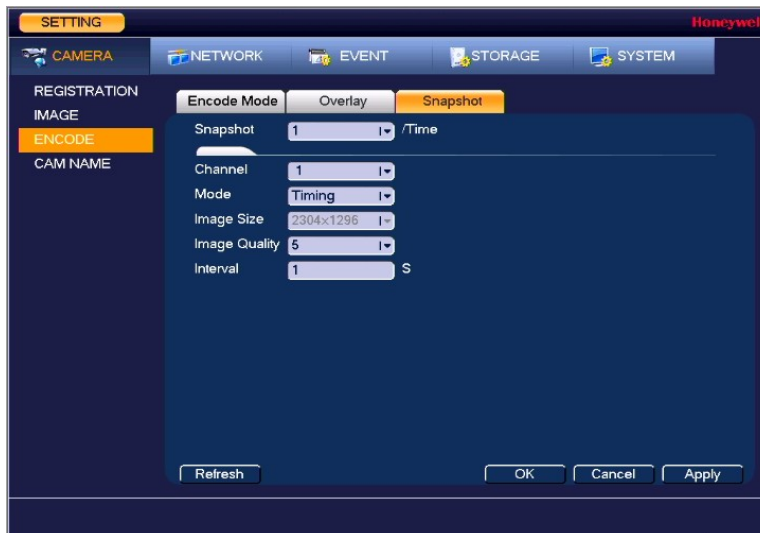

2. In the **Channel** box, select the camera that you want to configure.
 - Snapshot:** Select the maximum number of snapshots that can be taken at a time.
 - Channel:** Select a channel from the drop-down list.
 - Mode:** There are two modes: **Timing** and **Trigger**. If you set **Timing** mode, then you need to set the snapshot Interval. If you set **Trigger** mode, then you need to enable snapshots in Event Settings. Please see [To set up motion detection event actions](#) on page 82, for example.
 - Image Size:** Select a snapshot size.
 - Image Quality:** Select a snapshot quality. Select from **1** to **6**, with 6 being the highest quality setting.
 - Interval:** Set how frequently the snapshot is taken.
3. Click **Apply** to save your settings.
4. If you want to save your settings and exit the **SETTING** menu, click **OK**.

Configuring Encoding Settings

1. Go to **Main Menu** → **Setting** → **CAMERA** → **Encode** → **Encode Mode**, the following window is displayed:

Figure 6-4 Camera Encoding Settings Tab



2. On the **Encode** tab, in the **Channel** box, select the camera that you want to configure.

Note

If the NVR fails to retrieve the configuration information for your selected camera/channel, then you should navigate to a different window (such as Snapshot or Overlay), then navigate back to the Encode window.

3. Configure the following settings for the primary stream and secondary stream:

Note

Parameters vary according to products.

Code Stream Type: Set the primary stream type as General, MD (Motion Detection), or Alarm. The sub stream(s) type is not configurable.

Compression: Select the video encode mode.

Smart Codec: Set the Smart Codec as either **Close** (default) or **Enable**. This function is to reduce bit streams.

Note

After changing smart code, please reboot network camera and some network camera functions (such as IVS, ROI, SVC, lobby mode and etc.) becomes null. Please think twice before the operation.

Resolution: Set the primary stream resolution to one of the following options in the drop-down list. Set the sub stream(s) resolution to one of the available resolutions.

Frame Rate (FPS): Select a value between **1** and **30** (NTSC) or **1** and **25** (PAL).

Bit Rate Type: Set to **CBR** (constant bit rate) or **VBR** (variable bit rate).

Quality: If the bit rate type is set to **VBR**, select a value between **1** and **6**.

Note

If your device is connected to the NVR through ONVIF, then you can not select VBR. If your device is connected to the NVR through a private protocol, then you can select either CBR or VBR.

Bit Rate: Set to a value within the **Reference Bit Rate** range. To enter a bit rate that does not appear on the list, click **Customized**.

Audio/Video: Select or clear the check boxes to enable or disable audio and/or video.

I Frame Interval: Enter a value between **15** and **150**. The default value is **15**. The smaller the value, the smoother the image.

Audio Encode: Select the Audio Encode mode for the main and sub streams from either **G.711A** or **G.711Mu**. G.711A is the default setting. The Encode Mode setting applies to both the audio output and bidirectional talk modes.

Sampling Rate: Select the Sampling Rate for the camera from **8K** or **16K**.

4. Click **Apply** to save your settings.
5. To copy the settings to one or more additional cameras, follow these steps:
 - a. Click **Copy**.
 - b. Click the specific camera(s) to which you want to copy the settings, or click **All** to select all the cameras, and then click **OK**.
6. If you want to save your settings and exit the **SETTING** menu, click **OK**.

Configuring the Text Overlay

1. Go to **Main Menu** → **Setting** → **CAMERA** → **Encode** → **Overlay**, the following window is displayed:

Figure 6-5 Camera Text Overlay Setting Tab

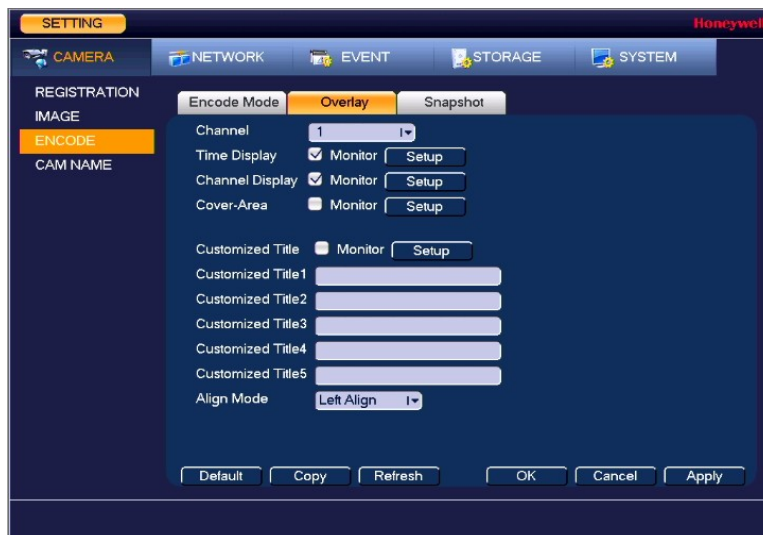

2. In the Channel box, select the camera that you want to configure.
3. To set the time display, next to **Time Display**, select the **Monitor** check box, and then click **Setup**. Drag the time display to the desired position on the screen. Right-click to save the position and return to the Overlay screen.
4. To set the channel display, next to **Channel Display**, select the **Monitor** check box, and then click **Set**. Drag the channel display to the desired position on the screen. Right-click to save the position and return to the Overlay screen.
5. To set the customized title display, enter the customized title text in the lines that apply, next to **Customized Title**, select the **Monitor** check box, and then click **Set**. Drag the title text to the desired position on the screen. Right-click to save the position and return to the Overlay screen.
6. Click **Apply** to save your settings.
7. To copy the settings to one or more additional cameras, follow these steps:
 - a. Click **Copy**.
 - b. Click the specific camera(s) to which you want to copy the settings, or click **All** to select all the cameras, and then click **OK**.
8. If you want to save your settings and exit the **SETTING** menu, click **OK**.

Changing a Camera Name

By default, the cameras are named "CAM 1", "CAM 2," "CAM 3," and so on. You can assign each camera a descriptive name specific to your application (for example, "Front Entrance").

1. Go to **Main Menu** → **Setting** → **CAMERA** → **Cam Name**, the following window is displayed:

Figure 6-6 Camera Name Settings Window



2. Select **Local** or **Remote** in the **Camera Name** dropdown list.
Local: Select it to change the channel name of NVR.
Remote: Select it to change the channel name of IPC via NVR.
3. Click the text box of the camera that you want to rename and enter the new camera name.
4. Click **Apply** to save your settings.

7 Configuring Network Settings

This chapter contains the following sections:

- [Configuring TCP/IP Settings](#) on page 62.
- [Configuring Port Settings](#) on page 63.
- [Configuring Wireless Connection Settings](#) on page 65.
- [Configuring PPPoE Settings](#) on page 67.
- [Configuring DDNS Settings](#) on page 67.
- [Configuring Email Settings](#) on page 68.
- [Configuring UPnP Settings](#) on page 70.
- [Configuring Sync Time Right Settings](#) on page 70.
- [Configuring SNMP Settings](#) on page 71.
- [Configuring Multicast Settings](#) on page 73.
- [Configuring Registration Settings](#) on page 73.
- [Configuring Alarm Center Settings](#) on page 74.
- [Configuring Switch Settings](#) on page 75.
- [Configuring P2P Settings](#) on page 75.

Configuring TCP/IP Settings

1. Go to **Main Menu** → **Setting** → **NETWORK** → **TCP/IP**, the following window is displayed:

Figure 7-1 Network TCP/IP Settings Window

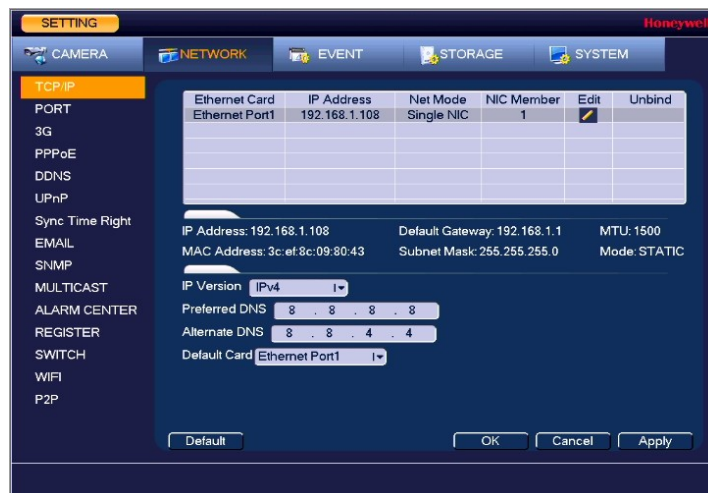

2. Click  to edit the Ethernet card as shown in the following figure:

Figure 7-2 Edit Ethernet Card



3. Select a net mode.
4. In the **IP Version** box, select **IPv4** or **IPv6**, depending on the Internet protocol that you want to use.
5. Select **DHCP** to assign the NVR with a dynamic IP address. Click to deselect **DHCP** to assign the NVR a static IP address.
6. If you deselect **DHCP**, manually enter the **IP Address**, **Subnet Mask**, and **Gateway** information. (The IP address, subnet mask, and gateway are not configurable when **DHCP** is enabled).
7. Click **OK** to save the settings and exit the **SETTING** menu.
8. If you want, enter **Preferred DNS** and **Alternate DNS** addresses.

Configuring Port Settings

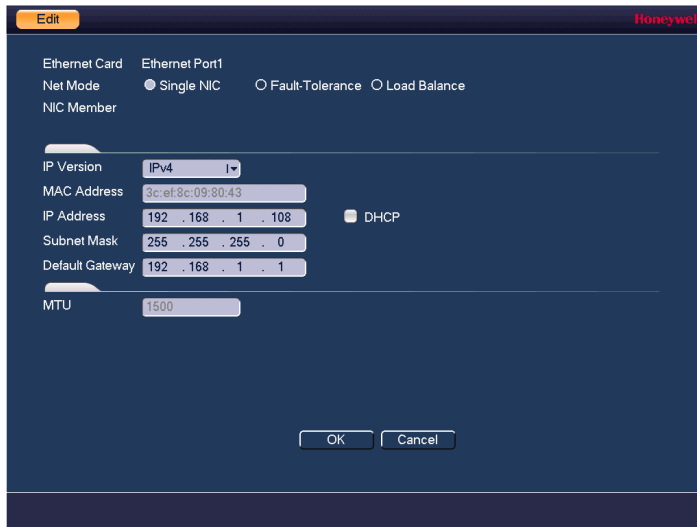
1. Go to **Main Menu** → **Setting** → **NETWORK** → **Port**, the following window is displayed:

Figure 7-3 Network Port Settings Window

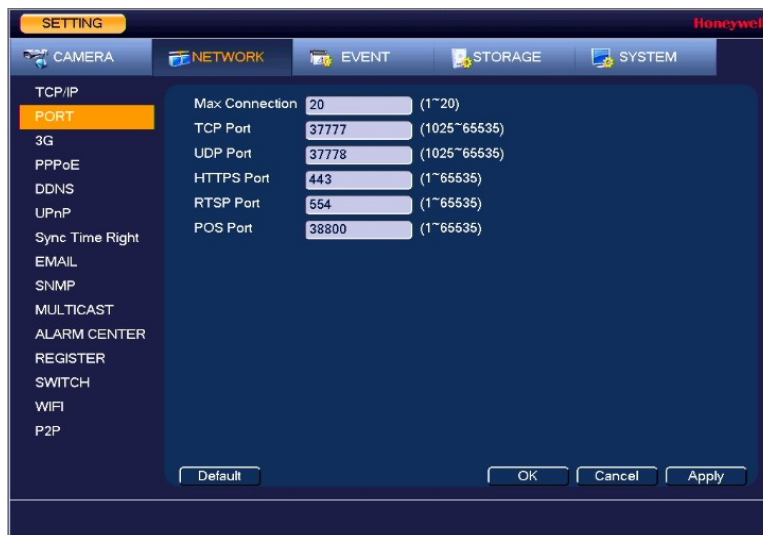

2. On the **Connection** page, you can configure the following settings:

Max Connection: Select a value between **1** and **128**. The default setting is **20**.

TCP Port: Select a value between **1025** and **65535**. The default setting is **37777**.

UDP Port: Select a value between **1025** and **65535**. The default setting is **37778**.

HTTPS Port: Select a value between **1** and **65535**. The default setting is **443**.

RTSP Port: Select a value between **1** and **65535**. The default setting is **554**.

POS Port: Select a value between **1** and **65535**. The default setting is **38800**.

Note The POS Port is only available for
HEN081*4/HEN162*4/HEN163*4/HEN161*4/HEN322*4/
HEN323*4/HEN321*4/HEN642*4/HEN643*4.

3. Click **Apply** to save your settings.
4. If you want to save your settings and exit the **SETTING** menu, click **OK**.

Note You must restart the NVR to apply any changes to the NVR's port settings. Ensure that the port settings do not conflict with each other.

Configuring Wireless Connection Settings

Note

This function is only available for HEN081*4/HEN162*4/HEN163*4/HEN161*4/HEN322*4/HEN323*4/HEN321*4/HEN642*4/HEN643*4.

To manage Wi-Fi connections

1. Go to **Main Menu** → **Setting** → **NETWORK** → **WIFI**, the following window is displayed:

Figure 7-4 Network WIFI Settings Window

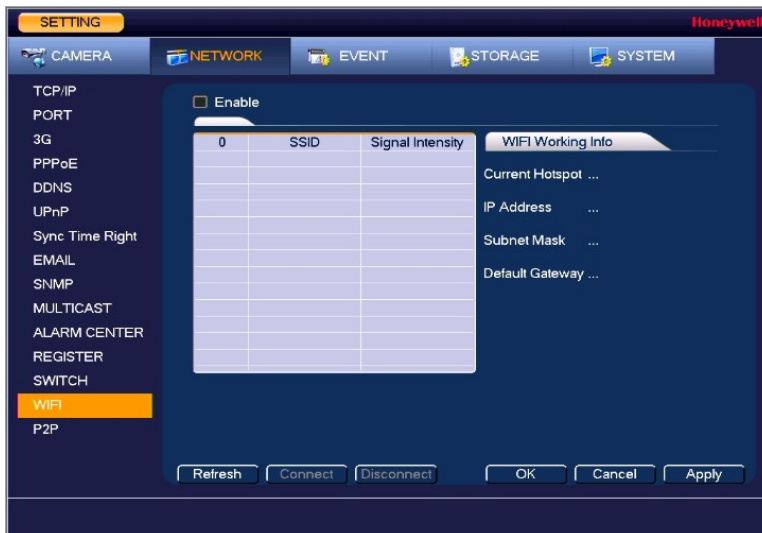

2. On the **WIFI** setting page, you can do one or more of the following:
 - To enable automatic connections to Wi-Fi hotspots, select the **Enable** check box.
 - To disable automatic connections to Wi-Fi hotspots, clear the **Enable** check box.
 - To search for Wi-Fi hotspots, click **Refresh**.
 - To manually connect to a Wi-Fi hotspot, click **Connect**.
 - To disconnect from a Wi-Fi hotspot, click **Disconnect**.

If a Wi-Fi connection is successfully established, the Wi-Fi hotspot name and connection details are displayed in the **WIFI Working Info** area.

3. Click **Apply** to save your settings.
4. If you want to save your settings and exit the **SETTING** menu, click **OK**.

Note

The system does not support WPA and WPA 2 verification types.

To configure 3G wireless connections

Note This function is only available for HEN081*4/HEN162*4/HEN163*4/HEN161*4/HEN322*4/HEN323*4/HEN321*4/HEN642*4/HEN643*4.

1. Go to **Main Menu** → **Setting** → **NETWORK** → **3G**, the following window is displayed:

Figure 7-5 Network 3G Window

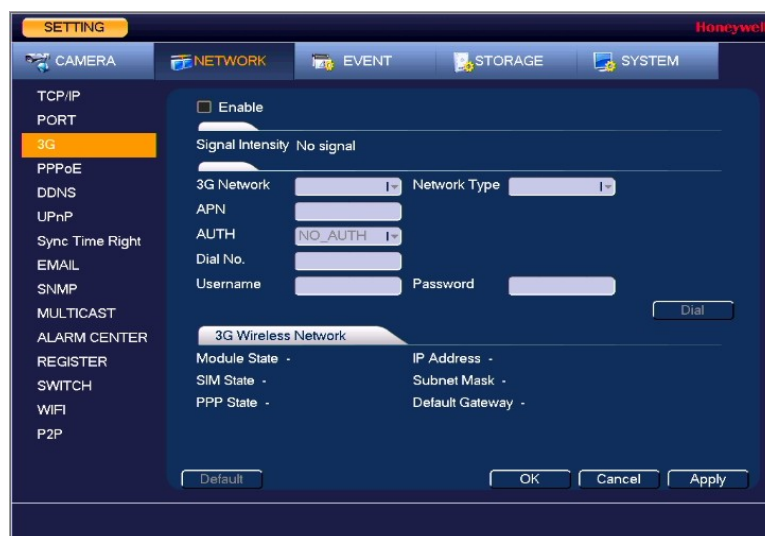

2. On the **3G** page, you can configure the following settings:
 - Enable:** Select or clear the check box to enable or disable 3G wireless connection using the selected wireless network adapter.
 - 3G Network:** Select the wireless network adapter name.
 - Network Type:** Select the network type that meets your requirements.
 - APN:** Select the wireless connection server that you want to use to access the wireless network.
 - AUTH:** Select the authentication mode that you want to use to access the wireless network: **PAP** or **CHAP**.
 - Dial No.:** Enter the 3G network dial-up number that you received from your Internet service provider.
 - User Name:** Enter a user name for logging on to the 3G network.
 - User Password:** Enter a password for logging on to the 3G network.
 - Dial:** Click **Dial** to manually enable or disable the 3G network connection.
3. Click **Apply** to save your settings.
4. If you want to save your settings and exit the **SETTING** menu, click **OK**.

Configuring PPPoE Settings

1. Go to **Main Menu** → **Setting** → **NETWORK** → **PPPoE**, the following window is displayed:

Figure 7-6 Network PPPoE Settings Window

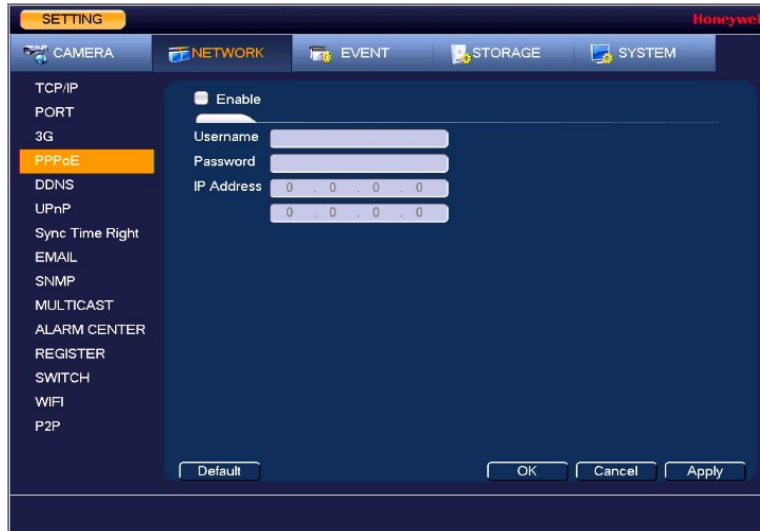

2. On the **PPPoE** page, select the **Enable** check box to enable a PPPoE network connection.
3. In the **Username** and **Password** boxes, enter the user name and password provided by your Internet service provider for PPPoE access.
4. Click **Apply** to save your settings.
5. If you want to save your settings and exit the **SETTING** menu, click **OK**.
6. Restart the NVR for the new network connection settings to take effect.

The NVR's new IP address appears on the **PPPoE** page. Use this address when accessing the NVR remotely.

Configuring DDNS Settings

To enable a Dynamic DNS (DDNS) network connection

1. Go to **Main Menu** → **Setting** → **NETWORK** → **DDNS**, the following window is displayed:

Figure 7-7 Network DDNS Settings Window

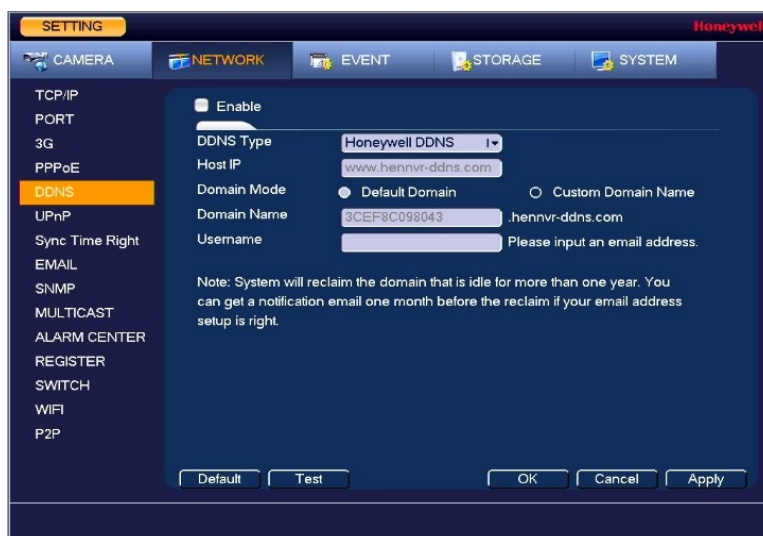

2. On the **DDNS** page, select the **Enable** check box to enable a DDNS network connection.
3. In the **DDNS Type** box, select the DDNS service that you want to use.
4. Depending on the DDNS Type you select, you may need to enter the following details:

Host IP: The address appears automatically unless **DDNS Type** is set to **Private DDNS**. In that case, enter the server IP address of your DDNS service provider.

Domain Mode: If **DDNS Type** is set to **Honeywell DDNS**, click **Default Domain** to use the default domain name or click **Custom Domain Name** to create your own domain name.

Domain Name: Enter a domain name (if you are not using a default domain name). You can obtain this from your DDNS service provider.

User Name: If applicable, enter a user name to access your DDNS service.
5. Click **Apply** to save your settings.
6. If you want to save your settings and exit the **SETTING** menu, click **OK**.
7. Restart the NVR for the new network connection settings to take effect.
8. To test the settings, on the **DDNS** page, click **Test**.

Configuring Email Settings

1. Go to **Main Menu** → **Setting** → **NETWORK** → **Email**, the following window is displayed:

Figure 7-8 Network Email Settings Window

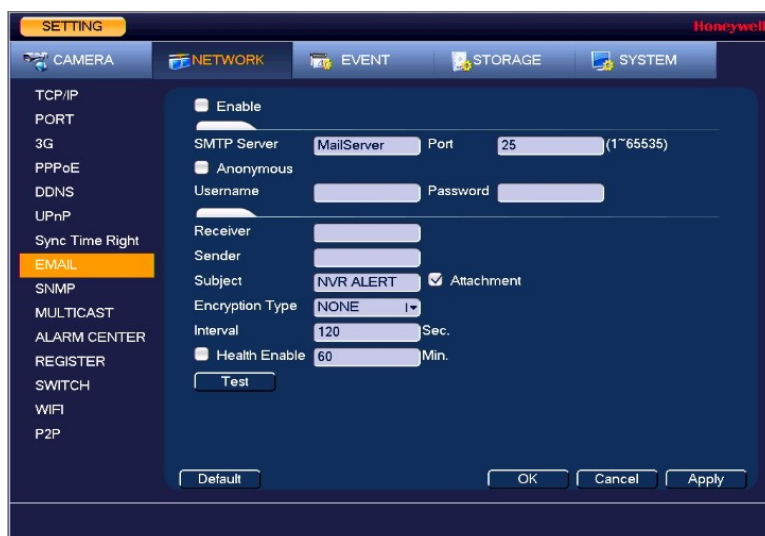

2. On the **EMAIL** page, select the **Enable** check box to enable email notifications for alarm events.
3. Configure the following settings:
 - SMTP Server:** Enter the SMTP server address of the sender's email account.
 - Port:** The default TCP/IP port used for SMTP is **25**.
 - Anonymous:** Select the check box to hide the sender's address in sent emails.
 - Username:** Enter the user name of the sender's email account.
 - Password:** Enter the password of the sender's email account.
 - Receiver:** Enter the email address where you want to send the notification. You can enter up to three email addresses.
 - Sender:** Enter the sender's email address.
 - Subject:** Enter the email subject line.
 - Attachment:** Select the check box to enable sending an image attachment with the email.
 - Encryption Type:** Select an encryption type: **None**, **SSL**, or **TLS**.
 - Interval:** This is the interval for sending emails. Enter a time between **0** and **3600** seconds. **0** means that there is no interval.
 - Health Enable:** Select the check box to enable a health check. The system sends a test email to check the connection.
 - Health Interval:** This is the interval the NVR waits between sending out health email checks. Enter a time between **30** and **1440** minutes. **30** is the default interval.
4. Click **Apply** to save your settings. To test the email settings, click **Test**.
5. If you want to save your settings and exit the **SETTING** menu, click **OK**.

Configuring UPnP Settings

The Universal Plug and Play (UPnP) protocol is used to map the relationship between the LAN and the WAN.

1. Go to **Main Menu** → **Setting** → **NETWORK** → **UPnP**, the following window is displayed:

Figure 7-9 Network UPnP Settings Window

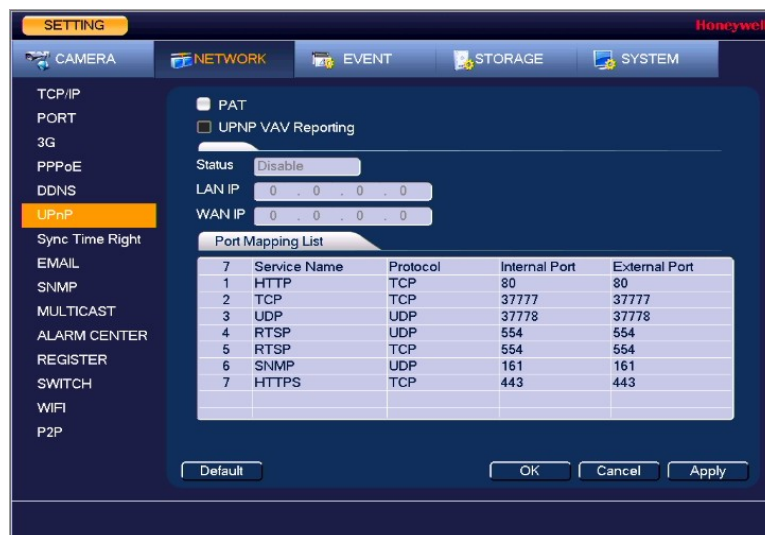

2. On the **UPnP** page, configure the following settings:
 - PAT:** Click to enable or disable PAT.
 - UPNP VAV Reporting:** Click to enable UPnP VAV reporting. When you enable this feature you will be asked to enter a password.
 - Status:** Displays the status of the UPnP connection.
 - LAN IP:** Enter the NVR's IP address from the **TCP/IP** page.
 - WAN IP:** Enter the router IP address.
3. If you want, you can edit a mapping relationship from the **Port Mapping List**. Double-click the mapping relationship that you want to edit, and then, in the **Port Info** dialog box, edit the **Service Name**, **Protocol**, **Internal Port**, and/or **External Port** details, and then click **OK**. Avoid using ports 1 to 255 or 256 to 1023.
4. Click **Apply** to save your settings.
5. If you want to save your settings and exit the **SETTING** menu, click **OK**.

Configuring Sync Time Right Settings

Note

This function is only available for HEN081*4/HEN162*4/HEN163*4/HEN161*4/HEN322*4/HEN323*4/HEN321*4/HEN642*4/HEN643*4.

1. Go to **Main Menu → Setting → NETWORK → Sync Time Right**, the following window is displayed:

Figure 7-10 Sync Time Right Settings Window

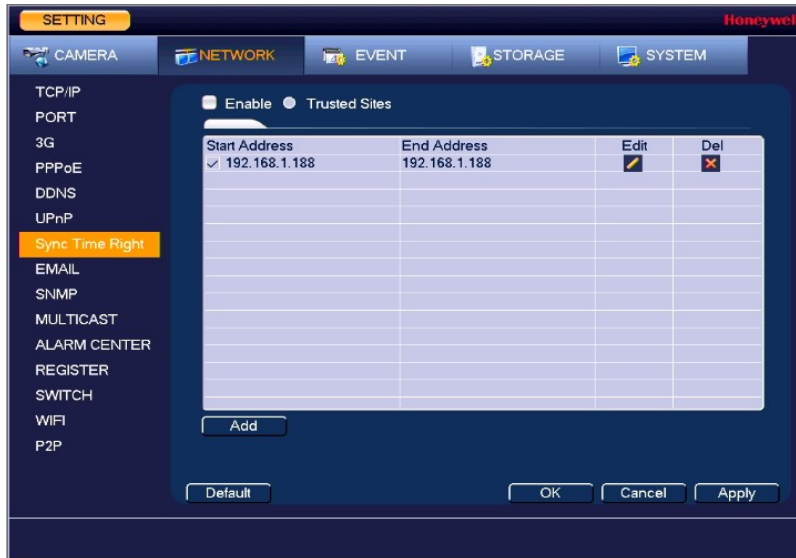

2. Select the **Enable** check box to enable Sync Time Right.
3. Next to the **Enable** check box, click **Trusted Sites**.
4. Click **Add**.
5. To add a single IP address, select **IP Address** from the drop-down list and enter the IP address of the site that you want to sync and click **OK**.
 To add a range of IP addresses, select **IP Segment** from the drop-down list and enter the starting address in the upper IP address field and the ending address in the lower field, and then click **OK**. Both IPv4 and IPv6 address are supported.
 To add a specific machine, select **MAC Address** from drop-down list and enter the MAC address of the machine you want to sync and click **OK**.
6. Click **Apply** to save your settings.
7. If you want to save your settings and exit the **SETTING** menu, click **OK**.

Configuring SNMP Settings

You can use Simple Network Management Protocol (SNMP) to receive information from the NVR remotely. You will need to install SNMP software on a PC to receive information from the NVR via SNMP.

1. Go to **Main Menu → Setting → NETWORK → SNMP**, the following window is displayed:

Figure 7-11 Network SNMP Settings Window

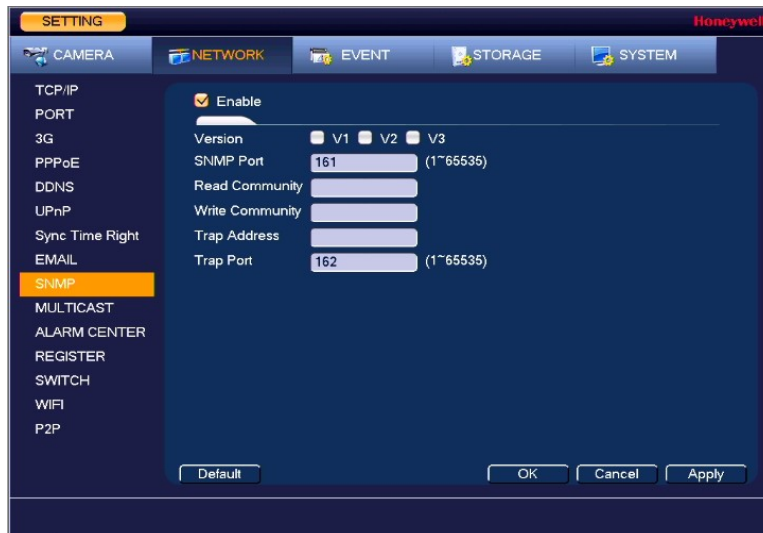

2. On the **SNMP** page, select the **Enable** check box to enable SNMP.
3. Configure the following settings:
 - Version:** Select the check boxes of the SNMP version that you are using.
 - SNMP Port:** The default setting is **161**.
 - Read Community:** The default setting is **public**.
 - Write Community:** The default setting is **private**.
 - Trap Access:** Enter the IP address of the computer running SNMP software.
 - Trap Port:** The default setting is **162**.
4. If SNMP Version **V3** is selected, the following settings are also configurable:
 - ReadOnly User:** The default setting is **public**.
 - Read/Write User:** The default setting is **private**.
 - Authorize Type:** Select the authorization type, **MD5** or **SHA**, for both the ReadOnly and Read/Write users. The default setting is **MD5**.
 - Password:** Enter the authorization passwords for both the ReadOnly and Read/Write users.
 - Encryption Type:** Select the encryption type for both the ReadOnly and Read/Write users. The default setting is **CBC-DES** and is currently the only encryption option.
 - Password:** Enter the encryption passwords for both the ReadOnly and Read/Write users.
5. Click **Apply** to save your settings.
6. If you want to save your settings and exit the **SETTING** menu, click **OK**.

Configuring Multicast Settings

Multicast allows for simultaneous real-time monitoring of live video from the NVR at multiple remote locations over the network.

1. Go to **Main Menu → Setting → NETWORK → Multicast**, the following window is displayed:

Figure 7-12 Network Multicast Settings Window

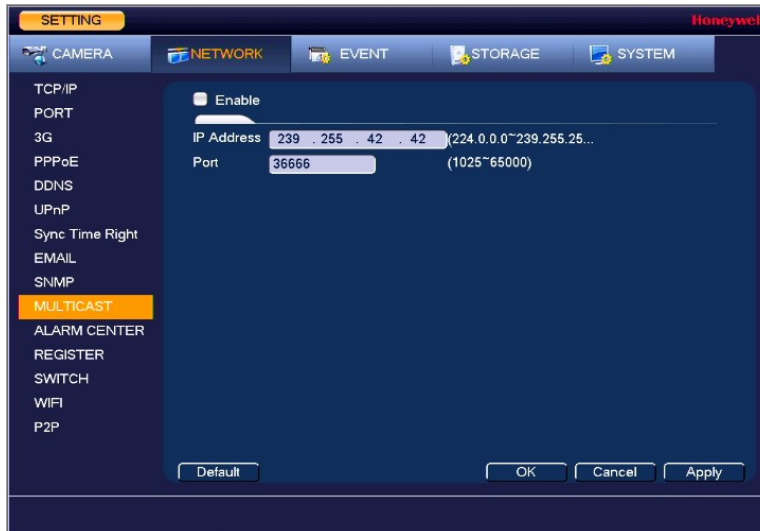

2. On the **Multicast** page, select the **Enable** check box to enable multicast.
3. In the **IP Address** box, enter a multicast IP address. The address must be valid for multicasting and should be in the range 224.0.0.0 to 239.255.255.255 for IPv4 or have the prefix ff00::/8. An address in the range 239.252.0.0 to 239.255.255.255 is recommended.
4. In the **Port** box, enter a multicast port number or use the default setting (**36666**).
5. Click **Apply** to save your settings.
6. If you want to save your settings and exit the **SETTING** menu, click **OK**.

Configuring Registration Settings

Automatic Registration allows the device to automatically register to the proxy you have specified. This allows you to use the client-end to access the NVR through the proxy, where the proxy has a switch function. In the network service, the device supports the server address of the IPv4.

1. Go to **Main Menu → Setting → NETWORK → Register**.
2. Configure the proxy Host IP address, port, and sub-device ID at the device end.

Note The proxy server generates a serial number for the sub-device ID.

3. Enable the auto register function in the NVR.
The NVR should now be able to automatically register to the proxy server.

Configuring Alarm Center Settings

1. Go to **Main Menu** → **Setting** → **NETWORK** → **Alarm Center**, the following window is displayed:

Figure 7-13 Network Alarm Center Settings Window

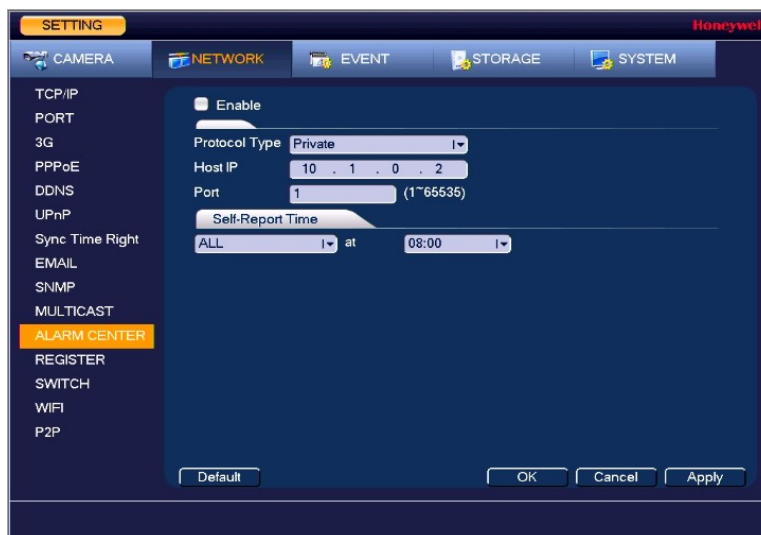

2. On the **Alarm Center** page, select the **Enable** check box to enable the alarm center function.
3. Configure the following settings:
 - Protocol Type:** Select Private.
 - Host IP:** Enter the host address of your alarm platform.
 - Port:** Enter the port of your alarm platform.
4. Set the **Self-report Time** (everyday or a specific day of the week at a specific time, or never).
5. Click **Apply** to save your settings.
6. If you want to save your settings and exit the **SETTING** menu, click **OK**.

Configuring Switch Settings

Note

This function is only available for HEN081*4/HEN162*4/HEN163*4/HEN161*4/HEN322*4/HEN323*4/HEN321*4/HEN642*4/HEN643*4/HEN041*3/HEN081*3/HEN161*3.

You can change the IP Address, Subnet Mask, and Default Gateway for setting the PoE switch settings.

1. Go to **Main Menu → Setting → NETWORK → Switch**, the following window is displayed:

Figure 7-14 Network Switch Settings Window

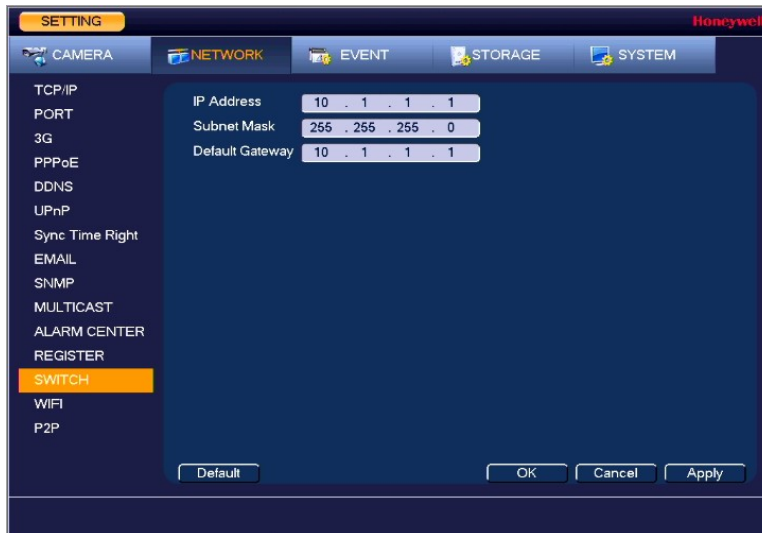

2. Configure the following settings:
 - IP Address:** Enter a new IP address.
 - Subnet Mask:** Enter a new subnet mask.
 - Default Gateway:** Enter a new default gateway.
3. Click **Apply** to save your settings.
4. If you want to save your settings and exit the **SETTING** menu, click **OK**.

Configuring P2P Settings

You can easily connect to the unit using a mobile device with the HonView Touch app using the P2P screen. To use this option you will need the HonView Touch app downloaded, installed, and have registered/created an account. When the app is setup, select to add a device and use the camera to view the QR code on the P2P screen. The device's information and connection will automatically be downloaded to the HonView Touch app and you can now connect to the NVR using your mobile device.

1. Go to **Main Menu → Setting → NETWORK → P2P**, the following window is displayed:

Figure 7-15 Network P2P Settings Window

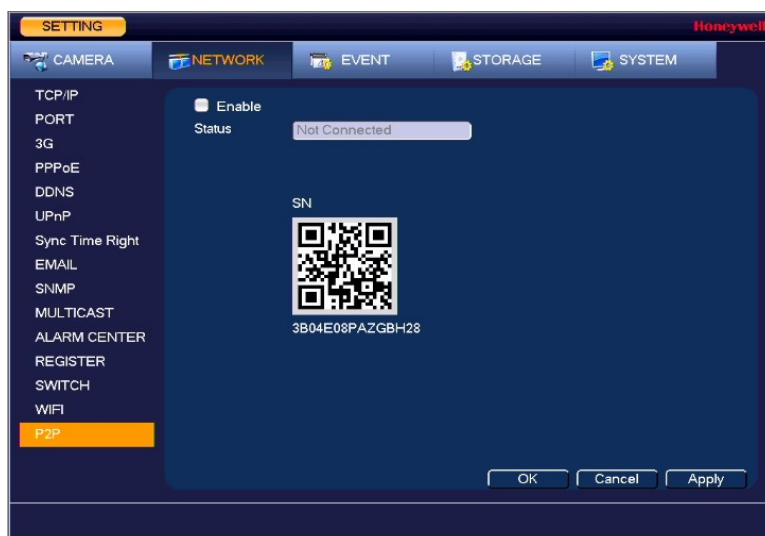

2. Check the **Enable** check box.
3. Using a mobile device running the HonView Touch app, select to add a device.
4. Use the mobile device's camera to view the QR code on the P2P screen.
5. The HonView Touch app will automatically download the NVR information and establish a connection.

8 Configuring Event Settings

This chapter contains the following sections:

- [Configuring Motion Detection Settings](#) on page 79.
- [Configuring Video Loss Settings](#) on page 83.
- [Configuring Video Tampering Settings](#) on page 84.
- [Configuring Scene Change Settings](#) on page 85.
- [Configuring System Abnormality Event Settings](#) on page 86.
- [Configuring Alarm Input Settings](#) on page 89.
- [Configuring Heat Map](#) on page 94.
- [Configuring Face Detection Settings](#) on page 95.
- [Configuring Audio Detection Settings](#) on page 96.
- [Configuring People Counting](#)

The people counting feature analyzes the video to count the number of people that pass through or appear in the video.

1. Go to **Main Menu** → **SETTING** → **EVENT** → **PEOPLE COUNTING**.

Figure 8-20 People Counting Configuration Screen

2. Select the Channel to configure for people counting from the drop-down menu and check the **Enable** check box.
3. Click **RULE** to set up an area for people counting. You can move or resize the area using your mouse. To move the area, drag one of the sides. To resize the area, drag one of the corner handles.

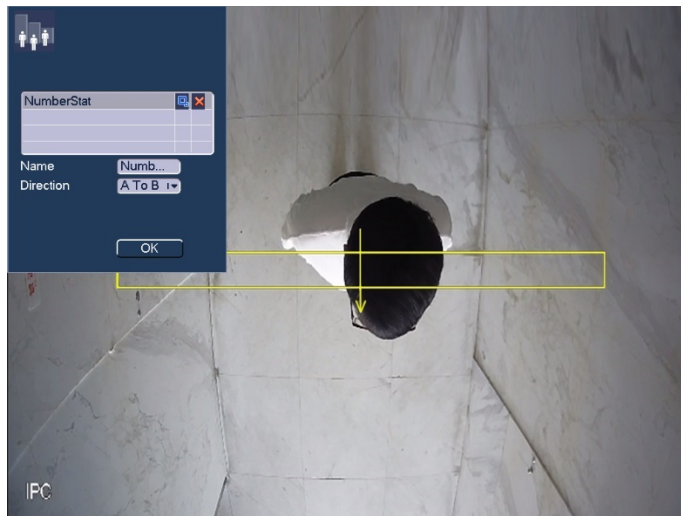
Figure 8-23 People Counting Rule

In the **Name** field, enter the name of rule. In the **Direction** field, select the direction of people counting. You can select A->B or B->A, the arrow direction always means the entrance direction.

Click  to set up the target size. You can move or resize the area using your mouse. To move the area, drag one of the sides. To resize the area, drag one of the corner handles.

To clear the people counting area, click .

4. Enable **OSD Overlay** by checking the box. Click **Clear** to clear the overlay, if necessary.
5. Enter the number of people that are allowed to enter and exit in the **Enter No.** and **Exit No.** fields. Enter the number of people that are allowed to remain in the scene in the **Stranded No.** field.
6. To set the periods when people counting is active, next to **Period**, click **Set**, and then follow the steps listed in [To set up motion detection periods](#) on page 85.
7. Select the action(s) that you want the system to initiate when a people counting event occurs:

Alarm Out: Select the check box to activate the selected alarm output(s) (**1** or **2**). In the **Latch** box, specify the amount of time (0–300 s) to delay the alarm output signal after a people counting event is triggered.

Send Email: Select the check box to enable the system to send an email notification. If the **Snapshot** function is enabled, an image can be attached to the email. To set up Email, see [Configuring Email Settings](#) on page 72.

Record Channel: Select the channel(s) that you want to record when the alarm is triggered. In the **Delay** box, specify the amount of time (10–300 s) to delay recording after a people counting event is triggered.

Note You also need to set the alarm recording period. Go to **Storage** → **Schedule** to configure the current channel for scheduled alarm recording. See [Configuring the Video Recording Schedule](#) on page [39](#).

PTZ Activation: Select the check box to activate PTZ functions, and then click **Set**. In the **PTZ Activation** window, for each PTZ camera, select the preset, tour, or pattern that you want to be called when the people counting event occurs, and then click **OK**.

Tour: Select the check box to enable a tour of the selected channels.

Snapshot: Select the check box to take a snapshot of selected channels.

Log: Select the check box to enable logging of the people counting event.

Voice Prompts: Select the check box to enable the playing of a voice prompt audio file when a people counting event is triggered. Use the **File Name** drop-down arrow to select the audio file to play for the events.

Buzzer: Select the check box to activate a buzzer noise at the NVR.

8. Click **Apply** to save your settings. To return to the main menu, click **OK**.
 - [Configuring Alarm Outputs](#) on page [98](#).
 - [Configuring POS Settings](#) on page [101](#).

Configuring Motion Detection Settings

To set up motion detection regions

1. Go to Main Menu → SETTING → EVENT → VIDEO DETECTION → Motion Detection.

Figure 8-1 Motion Detection Settings Tab

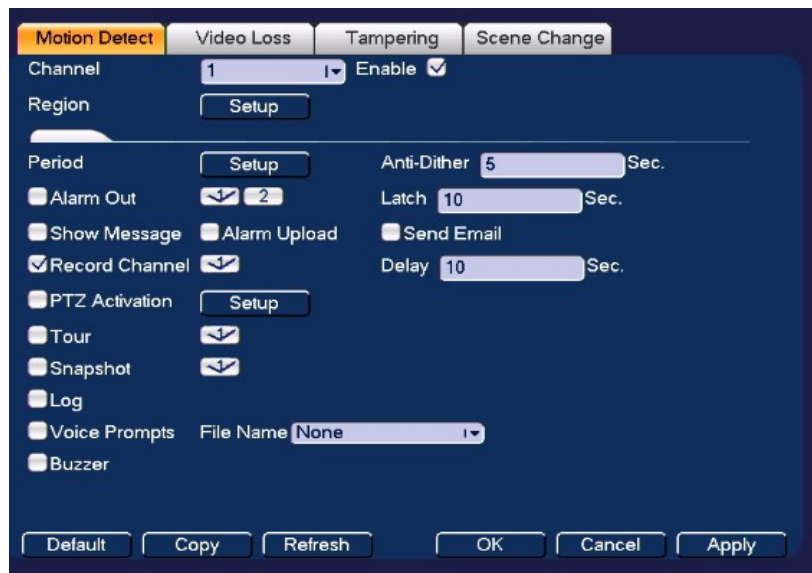

2. On the **Motion Detection** tab, in the **Channel** box, select the channel (camera) to configure for motion detection.
3. Select the **Enable** check box to enable motion detection for the selected channel.
4. Next to **Region**, click **Set** to define the motion detection region. A grid appears over the live view screen and the motion detection region dialog box appears.

Figure 8-2 Motion Detection - Region Configuration Window

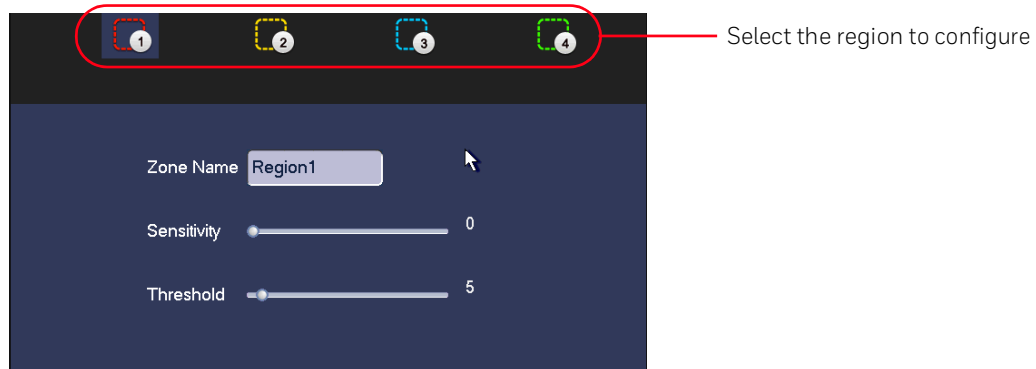

5. Set the **Sensitivity** level (0–100) and **Threshold** level (0–100) for the region(s) you want to configure. Select from region 1-4 with the icons at the top of the dialog.

Sensitivity refers to the amount of change (as a percentage) in the image pixels between frames. Moving the **Sensitivity** slider to the left decreases the sensitivity of the motion detection and therefore more movement is required to trigger a motion detection event.

Threshold is the amount of motion required to trigger an event notification.

Note

The best way to configure motion detection is to experiment with the sensitivity and threshold settings while someone is walking in front of the camera.

6. By default, motion detection **Region1** covers the whole screen.
 - To disable motion detection in part of the image, drag the mouse over the area of the image that you want to exclude. The areas *not* covered by red boxes are *not* sensitive to motion.
 - To change the threshold level in part of the image, select a different motion detection region (**Region2**, **Region3**, or **Region4**), set the **Threshold** level for that region, and then drag the mouse to define the region.
 - Each region is represented by a different color. Red=Region1, Yellow=Region2, Blue=Region3, Green=Region4. If the grid is clear of color, then no motion detection is set for that area. Test the motion detection areas to make sure motion is not triggered too much when not needed, such as by wind and background movement.
 - To change the name of a region, enter a new name for it in the **Zone Name** field.
7. Right-click to return to the **SETTING** menu.
8. Click **Apply** to save your settings.
9. If you want to save your settings and exit the **SETTING** menu, click **OK**.

To set up motion detection periods

1. On the **Motion Detection** tab, next to **Period**, click **Setup**. The **Setup** window opens.

Figure 8-3 Motion Detection Schedule Configuration Window

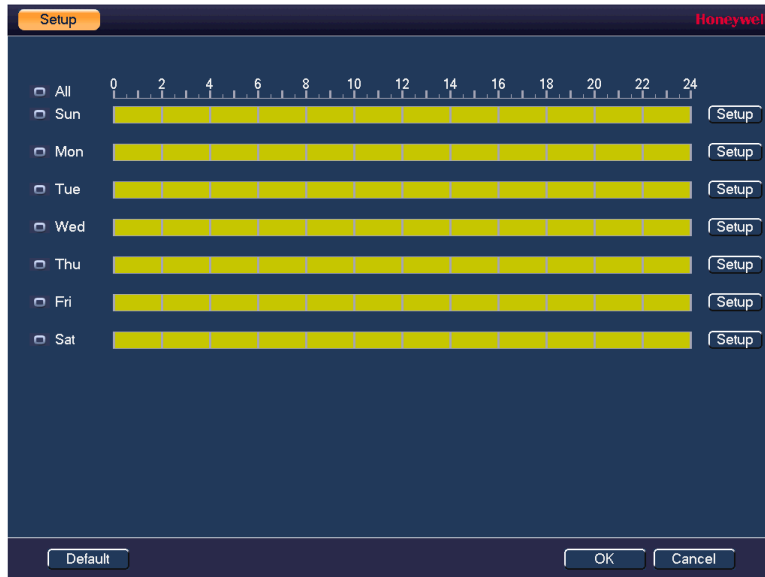

2. By default, when motion detection is enabled, it is active all the time. To modify the periods when motion detection is active for the selected channel, on each day's timeline, click the half-hour blocks when you want motion detection to be *disabled*.
3. Alternatively, for the day of the week that you want to configure, click **Setup**. The **Period** window opens.

Figure 8-4 Motion Detection Period Configuration Window



Set up to six periods in the day when you want the motion detection settings for the selected channel to be active.

- a. Select the check box next to each configured period to enable it.
 - b. To copy the settings to additional days, select the appropriate check box(es) under Copy.
 - c. Click **OK** to return to the previous window.
4. After you have finished setting up the motion detection periods, click **OK**.

To set up motion detection event actions

1. Go to Main Menu → SETTING → EVENT → VIDEO DETECTION → Motion Detection.

Figure 8-5 Motion Detection Configuration Tab

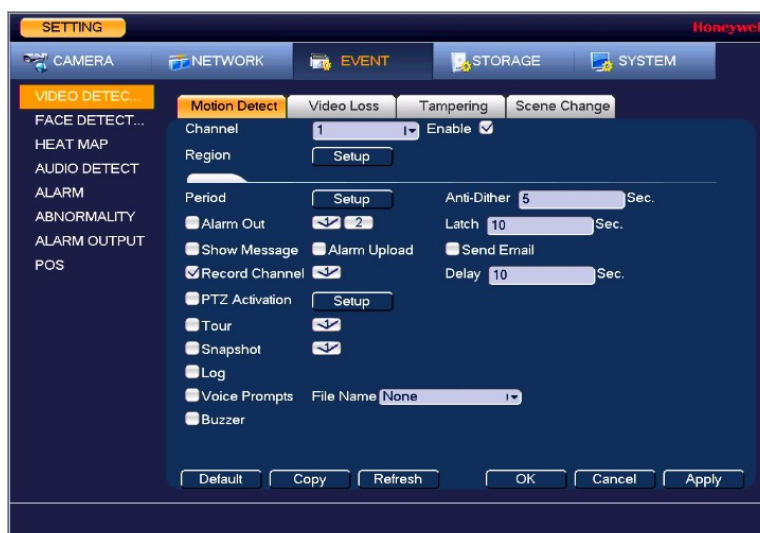

2. On the **Motion Detection** tab, select the actions that you want the system to initiate when a motion detection event occurs:

Anti-Dither: Set an anti-dither time. The value ranges from 5 to 600s. The anti-dither time refers to the alarm signal lasts time. It can be seem as the alarm signal activation stays such as the buzzer, tour, PTZ activation, snapshot, channel record.

Alarm Out: Select the alarm output(s) (**1** or **2**) to activate when motion is detected. In the **Latch** box, specify the amount of time (0–300 s) to delay the alarm output signal after a motion detection event is triggered.

Show Message: Select the check box to enable a pop-up message on your local host PC.

Alarm Upload: Select the check box to enable the system to upload an alarm signal to the network (including to an alarm center and/or web client).

Send Email: Select the check box to enable the system to send an email notification. If the **Snapshot** function is enabled, an image can be attached to the email. Email settings must be configured to use this option (see [Configuring Email Settings](#) on page 68).

Record Channel: Select the channel(s) that you want to record when motion is detected. In the **Delay** box, specify the amount of time (10–300 s) to delay recording after a motion detection event is triggered.

Note

You also need to set the motion detection recording period. Go to Storage > Schedule > Rec to configure the current channel for motion recording. See [Configuring the Video Recording Schedule](#) on page 38.

PTZ Activation: Select the check box to activate PTZ functions, and then click **Set**. In the **PTZ Activation** window, for each PTZ camera, select the preset, tour, or pattern that you want to be called when a motion detection event occurs, and then click **OK**.

Tour: Select the check box to enable a tour of the selected channels.

Snapshot: Select the check box to take a snapshot of selected channels.

Log: Select the check box to enable logging of motion detected events.

Voice Prompts: Select the check box to enable the playing of a voice prompt audio file when motion is detected. Use the **File Name** drop-down arrow to select the audio file to play when motion is detected.

Buzzer: Select the check box to activate a buzzer noise at the NVR.

3. Click **Apply** to save your settings.
4. To copy the motion detection settings to additional channels, click **Copy**, select the channels to which you want to copy the settings, and then click **OK**.

Configuring Video Loss Settings

1. Go to Main Menu → SETTING → EVENT → VIDEO DETECTION → Video Loss.

Figure 8-6 Video Loss Configuration Tab

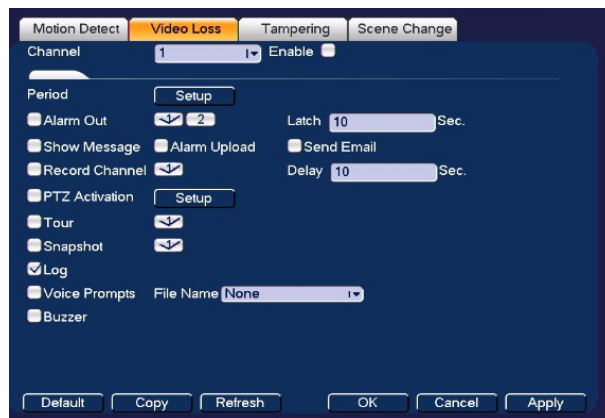

2. On the **Video Loss** tab, in the **Channel** box, select the channel (camera) for which you want to configure video loss detection settings.
3. Select the **Enable** check box to enable video loss detection for the selected channel.
4. To set the periods when video loss detection is active, next to **Period**, click **Set**, and then follow the steps listed in [To set up motion detection periods](#) on page 81.
5. To set the actions that you want the system to initiate when a video loss event occurs, follow the steps listed in [To set up motion detection event actions](#) on page 82.
6. Click **Apply** to save your settings.
7. To **copy** the settings to additional channels, click **Copy**, select the channels to which you want to copy the settings, and then click **OK**.

Configuring Video Tampering Settings

1. Go to Main Menu → SETTING → EVENT → VIDEO DETECTION → Tampering.

Figure 8-7 Video Tampering Configuration Tab

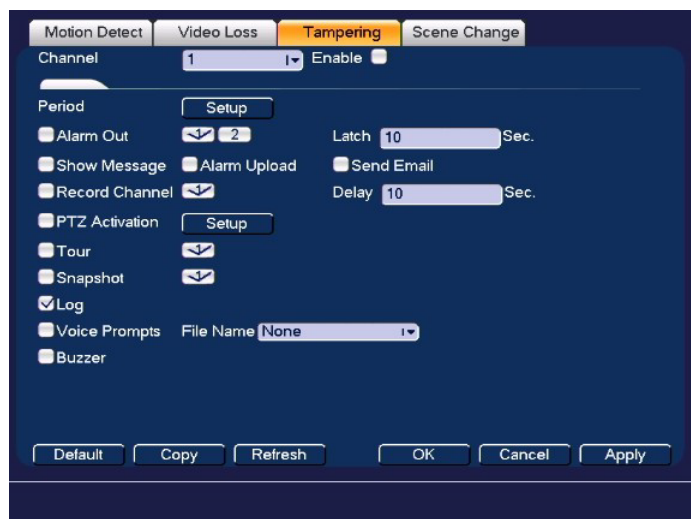

2. On the **Tampering** tab, in the **Channel** box, select the channel (camera) for which you want to configure video tampering detection settings.
3. Select the **Enable** check box to enable video tampering detection for the selected channel.
4. To set the periods when video tampering detection is active, next to **Period**, click **Set**, and then follow the steps listed in [To set up motion detection periods](#) on page 81.
5. To set the actions that you want the system to initiate when a video tampering **event** occurs, follow the steps listed in [To set up motion detection event actions](#) on page 82.
6. Click **Apply** to save your settings.
7. To **copy** the settings to additional channels, click **Copy**, select the channels to which you want to copy the settings, and then click **OK**.

Configuring Scene Change Settings

1. Go to **Main Menu → SETTING → EVENT → VIDEO DETECTION → Scene Change**.

Figure 8-8 Scene Change Configuration Tab

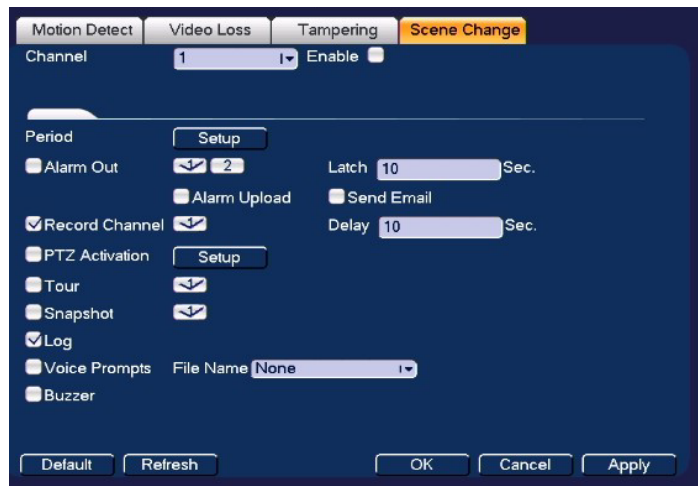

2. On the **Scene Change** tab, in the **Channel** box, select the channel (camera) for which you want to configure scene change detection settings.
3. Select the **Enable** check box to enable scene change detection for the selected channel.
4. To set the periods when scene change detection is active, next to **Period**, click **Set**, and then follow the steps listed in [To set up motion detection periods](#) on page 81.
5. To set the actions that you want the system to initiate when a scene change event occurs, follow the steps listed in [To set up motion detection event actions](#) on page 82.
6. Click **Apply** to save your settings.
7. To copy the settings to additional channels, click **Copy**, select the channels to which you want to copy the settings, and then click **OK**.

Configuring Smart Plan Settings

Smart plan is a master switch for the intelligent analytics such as Face Detection and People Counting. The device intelligent functions can be valid after smart plan is enabled.

Go to **Main Menu** → **SETTING** → **EVENT** → **SMART PLAN**. Select a channel that you want to apply the smart plan to and select the plan by clicking its icon and click **Apply**.

Figure 8-9 Smart Plan Configuration Tab

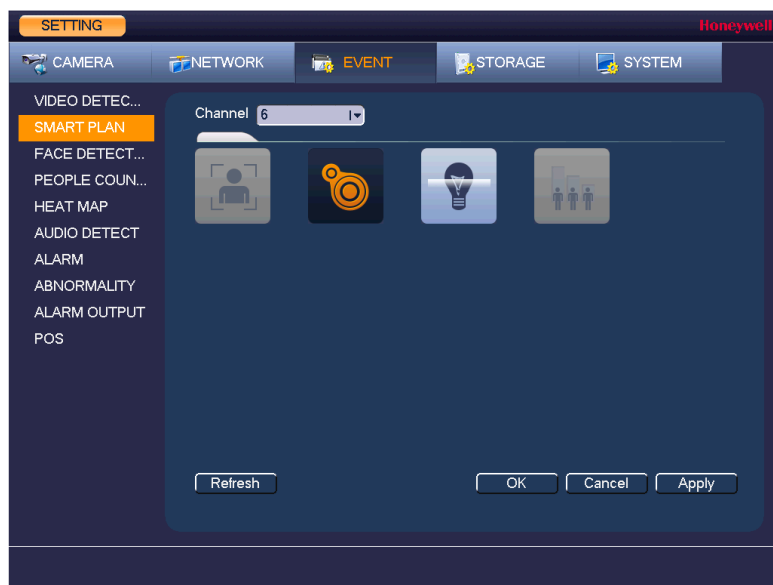

Configuring System Abnormality Event Settings

Configuring HDD Event Settings

1. Go to **Main Menu** → **SETTING** → **EVENT** → **ABNORMALITY** → **HDD**.

Figure 8-10 HDD Abnormality Configuration Tab

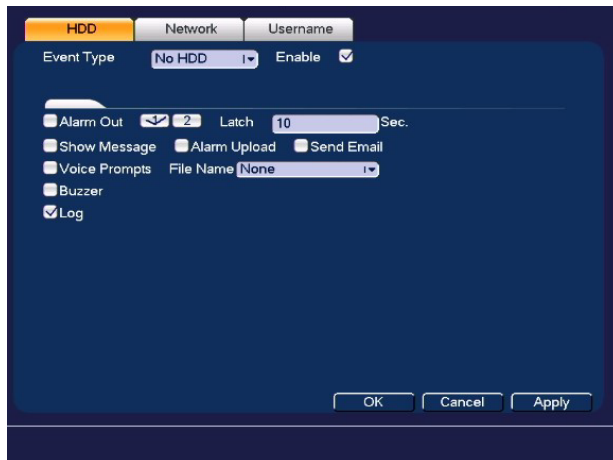

1. On the **HDD** tab, in the **Event Type** box, select the event type that you want to configure settings for: **No HDD**, **HDD Error**, **No Space**. If you select the **No Space** event, you can specify how low the HDD space will get before triggering the event in the **Less Than** field.
2. Select the **Enable** check box to enable HDD event detection for the event type selected.
3. Select the actions that you want the system to initiate when the selected event occurs:

Alarm Out: Select the alarm output(s) (**1** or **2**) that you want to activate. In the **Latch** box, specify the amount of time (0–300 s) to delay the alarm output signal after the HDD event is triggered.

Show Message: Select the check box to enable a pop-up message on your local host PC.

Alarm Upload: Select the check box to enable the system to upload an alarm signal to the network (including to an alarm center and/or web client).

Send Email: Select the check box to enable the system to send an email notification. To set up Email settings, see [Configuring Email Settings](#) on page 68.

Voice Prompts: Select the check box to enable the playing of a voice prompt audio file when an HDD event is triggered. Use the **File Name** drop-down arrow to select the audio file to play for HDD events.

Buzzer: Select the check box to activate a buzzer noise at the NVR.

Log: Select the check box to enable logging of HDD events.
4. Click **Apply** to save your settings.

Configuring Network Event Settings

1. Go to **Main Menu** → **SETTING** → **EVENT** → **ABNORMALITY** → **Network**.

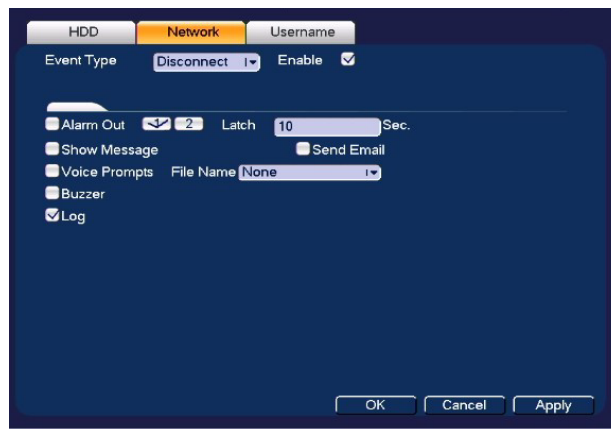
Figure 8-11 Network Abnormality Configuration Tab

2. On the **Network** tab, in the **Event Type** box, select the event type for which you want to configure settings: **Disconnect, IP Conflict, MAC Conflict**.
3. Select the **Enable** check box to enable network error detection for the selected event type.
4. Select the actions that you want the system to initiate when the selected event occurs:
 - Alarm Out:** Select the check box to activate the selected alarm output(s) (**1** or **2**). In the **Latch** box, specify the amount of time (0–300 s) to delay the alarm output signal after the network event is triggered.
 - Show Message:** Select the check box to enable a pop-up message on your local host PC.
 - Send Email:** Select the check box to enable the system to send an email notification. To set up Email settings, see [Configuring Email Settings](#) on page 68.
 - Voice Prompts:** Select the check box to enable the playing of a voice prompt audio file when a network event is triggered. Use the **File Name** drop-down arrow to select the audio file to play for network events.
 - Buzzer:** Select the check box to activate a buzzer noise at the NVR.
 - Log:** Select the check box to enable logging of network events.
5. Click **Apply** to save your settings.

Configuring Username Settings

1. Go to **Main Menu** → **SETTING** → **EVENT** → **ABNORMALITY** → **Username**.

Figure 8-12 Username Abnormality Configuration Tab

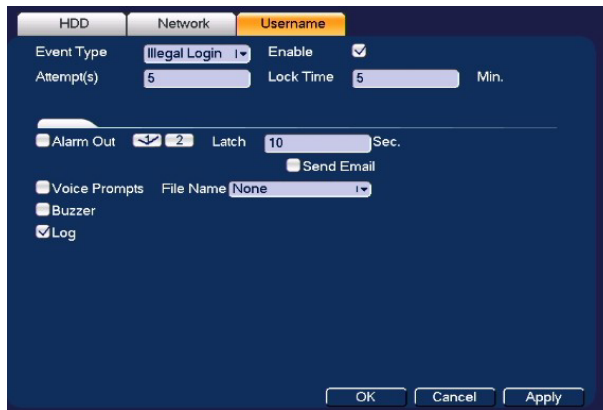

2. On the **Username** tab, in the **Event Type** box, select the event type for which you want to configure.
3. Select the **Enable** check box to enable username error detection for the selected event type.
4. Select the actions that you want the system to initiate when the selected event occurs:
 - Alarm Out:** Select the check box to activate the selected alarm output(s) (**1** or **2**). In the **Latch** box, specify the amount of time (0–300 s) to delay the alarm output signal after the network event is triggered.
 - Send Email:** Select the check box to enable the system to send an email notification. To set up Email settings, see [Configuring Email Settings](#) on page 68.
 - Voice Prompts:** Select the check box to enable the playing of a voice prompt audio file when a network event is triggered. Use the **File Name** drop-down arrow to select the audio file to play for network events.
 - Buzzer:** Select the check box to activate a buzzer noise at the NVR.
 - Log:** Select the check box to enable logging of network events.
5. Click **Apply** to save your settings.

Configuring Alarm Input Settings

Configuring IPC External Alarms

To configure IPC external alarms

1. Go to Main Menu → SETTING → EVENT → ALARM → IPC Ext.

Figure 8-13 IPC External Alarm Configuration Tab

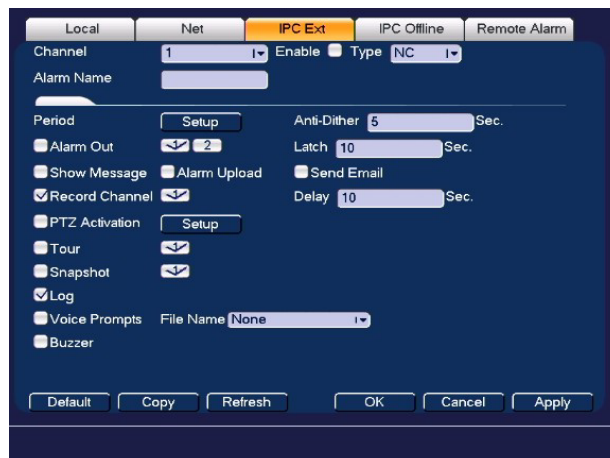

2. On the **IPC Ext** tab, select the channel to configure the external alarm settings from the drop-down menu.
3. Select the **Enable** check box to enable alarm detection of the selected alarm input.
4. In the **Type** box, select the alarm input type: **NC** (Normal Close) or **NO** (Normal Open).
5. Enter a name for the alarm in the **Alarm Name** field.

To set up alarm input detection periods

1. On the **Alarm** tab, next to **Period**, click **Set**. The **Set** window opens.

Figure 8-14 Alarm Period Setup

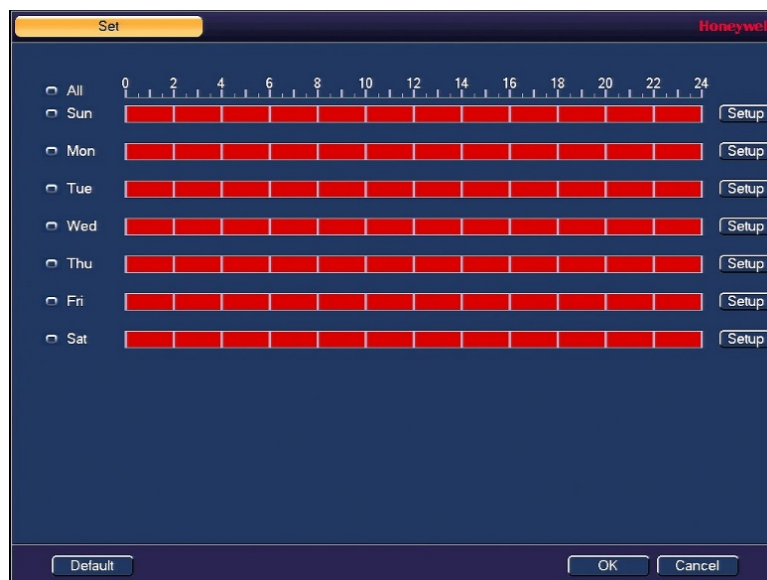

2. By default, when alarm detection is enabled, it is active all the time. To modify the periods when alarm detection is active, on each day's timeline, click the half-hour blocks when you want alarm detection for the selected alarm input to be *disabled*.
3. Alternatively, for the day of the week that you want to configure, click **Setup**. The **Period** window opens.

Figure 8-15 Period Window

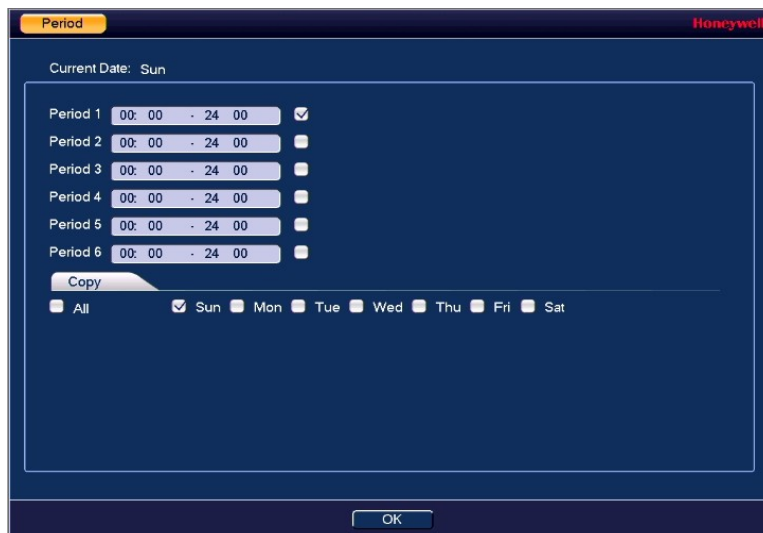

- a. Set up to six periods in the day when you want alarm detection for the selected alarm input to be active.
 - b. Select the check box next to each configured period to enable it.
 - c. To copy the settings to additional days, select the appropriate check box(es) under Copy.
 - d. Click **OK** to return to the previous window.
4. After you have finished setting up the alarm detection periods, click **OK**.

To set up alarm input event actions

1. On the **Alarm** tab, select the actions that you want the system to initiate when an alarm input trigger occurs:
 - Alarm Out:** Select the check box to activate the selected alarm output(s) (**1** or **2**). In the **Latch** box, specify the amount of time (0–300 s) to delay the alarm output signal after an alarm event is triggered.
 - Show Message:** Select the check box to enable a pop-up message on your local host PC.
 - Alarm Upload:** Select the check box to enable the system to upload an alarm signal to the network (including to an alarm center and/or web client).
 - Send Email:** Select the check box to enable the system to send an email notification. If the **Snapshot** function is enabled, an image can be attached to the email. To set up Email, see [Configuring Email Settings](#) on page 68.
 - Record Channel:** Select the channel(s) that you want to record when the alarm is triggered. In the **Delay** box, specify the amount of time (10–300 s) to delay recording after an alarm event is triggered.

Note

You also need to set the alarm recording period. Go to **Storage** → **Schedule** to configure the current channel for scheduled alarm recording. See [Configuring the Video Recording Schedule](#) on page 38.

PTZ Activation: Select the check box to activate PTZ functions, and then click **Set**. In the **PTZ Activation** window, for each PTZ camera, select the preset, tour, or pattern that you want to be called when the alarm event occurs, and then click **OK**.

Tour: Select the check box to enable a tour of the selected channels.

Snapshot: Select the check box to take a snapshot of selected channels.

Log: Select the check box to enable logging of the alarm input event.

Voice Prompts: Select the check box to enable the playing of a voice prompt audio file when an alarm input event is triggered. Use the **File Name** drop-down arrow to select the audio file to play for the alarm events.

Buzzer: Select the check box to activate a buzzer noise at the NVR.

2. Click **Apply** to save your settings.
3. To copy the alarm event settings to additional channels, click **Copy**, select the channels to which you want to copy the settings, and then click **OK**.

Configuring IPC Offline Alarm Events

Go to **Main Menu** → **SETTING** → **EVENT** → **ALARM** → **IPC Offline**.

Figure 8-16 IPC Offline Alarm Configuration Tab

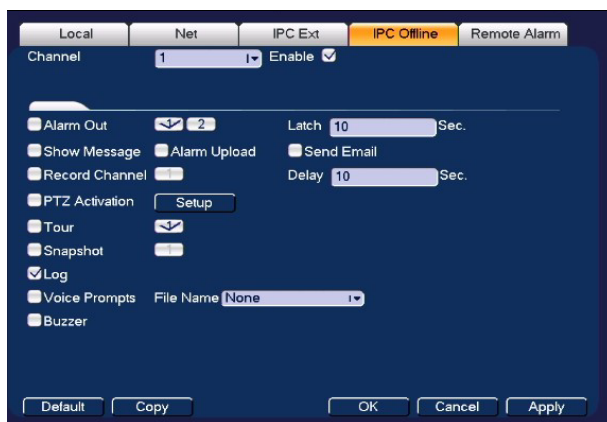

To configure for alarms for no IP camera signal, select the channel (camera) to set an alarm if the camera signal goes offline and follow the same steps as for configuring IPC External Alarm inputs event actions, on page 91.

Configuring Local Alarm Inputs

A local alarm is an alarm signal from a local device connected to the NVR.

Go to **Main Menu** → **SETTING** → **EVENT** → **ALARM** → **Local**.

Figure 8-17 Local Alarm Configuration Tab

To configure local alarm inputs, follow the same steps as for configuring IPC External Alarm inputs, on page [89](#).

Configuring Network Alarm Inputs

Network alarms are alarm signals from the network.

Go to **Main Menu** → **SETTING** → **EVENT** → **ALARM** → **Net**.

Figure 8-18 Net Alarm Configuration Tab

A network alarm is an alarm signal originating from the TCP/IP network connection. You can use NET SDK protocol to activate the network alarm.

To configure network alarm input actions, follow the same steps as for configuring IPC External Alarm inputs event actions, on page [89](#).

Configuring Remote Alarm Inputs

A remote alarm is an alarm signal from a remote site connected to the NVR.

Go to **Main Menu** → **SETTING** → **EVENT** → **ALARM** → **Remote Alarm**.

Figure 8-19 Remote Alarm Configuration Tab



To configure remote alarm input actions, follow the same steps as for configuring IPC External Alarm inputs event actions, see [To set up alarm input event actions](#) on page 91.

Configuring Heat Map

The heat mapping feature detects moving objects in the camera scene that can be generated as a report based on the object's heat. The heat colors range from blue to red, with blue representing the minimum heat value and red representing the maximum heat value. This information can then be searched and generate reports (see [Viewing Heat Map Information](#) on page 141).

Note This function is only available for HEN081*4/HEN162*4/HEN163*4/HEN161*4/HEN322*4/HEN323*4/HEN321*4/HEN642*4/HEN643*4.

1. Go to **Main Menu** → **SETTING** → **EVENT** → **Heat Map**.

Figure 8-20 Heat Map Configuration Screen

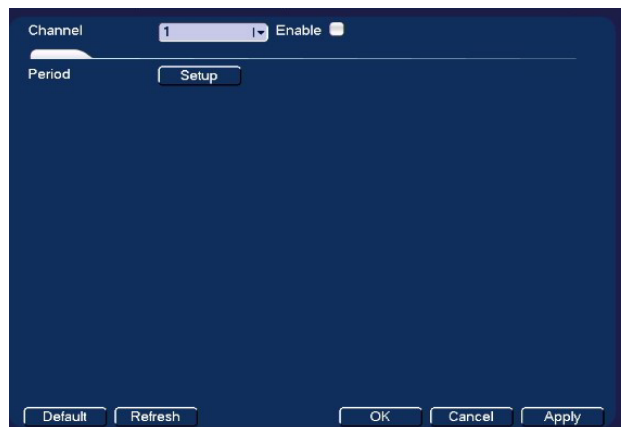

2. Select the Channel to configure for heat mapping from the drop-down menu and check the **Enable** check box.
3. To set the periods when heat mapping is active, next to **Period**, click **Set**, and then follow the steps listed in [To set up motion detection periods](#) on page 81.

Configuring Face Detection Settings

The face detection feature analyzes the video to detect if there are any human faces appearing in the video. If a face appears it will capture the face with either snapshots, recordings, or alarms so it can be processed or analyzed further.

1. Go to **Main Menu** → **SETTING** → **EVENT** → **Face Detection**.

Figure 8-21 Face Detection Configuration Screen

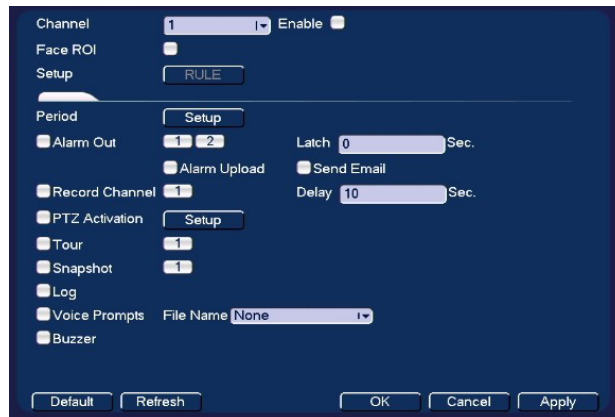

2. Select the **Channel** to configure for face detection from the drop-down menu and check the **Enable** check box.
3. Check the **Face ROI** (region of interest) check box if you want a region of interest showing the detected face to be displayed when an event occurs.
4. Click **RULE** to open a video image to set the **Min Size** and **Max Size** of a face that will trigger face detection. Use the mouse to drag and resize the Min and Max size boxes in the video image.
5. To set the periods when face detection is active, next to **Period**, click **Set**, and then follow the steps listed in [To set up motion detection periods](#) on page 81.
6. Select the action(s) that you want the system to initiate when a face detection event occurs:

Alarm Out: Select the check box to activate the selected alarm output(s) (**1** or **2**). In the **Latch** box, specify the amount of time (0–300 s) to delay the alarm output signal after a face detection event is triggered.

Alarm Upload: Select the check box to enable the system to upload an alarm signal to the network (including to an alarm center and/or web client).

Send Email: Select the check box to enable the system to send an email notification. If the **Snapshot** function is enabled, an image can be attached to the email. To set up Email, see [Configuring Email Settings](#) on page 68.

Record Channel: Select the channel(s) that you want to record when the alarm is triggered. In the **Delay** box, specify the amount of time (10–300 s) to delay recording after a face detection event is triggered.

Note You also need to set the alarm recording period. Go to **Storage** → **Schedule** to configure the current channel for scheduled alarm recording. See [Configuring the Video Recording Schedule](#) on page 38.

PTZ Activation: Select the check box to activate PTZ functions, and then click **Set**. In the **PTZ Activation** window, for each PTZ camera, select the preset, tour, or pattern that you want to be called when the face detection event occurs, and then click **OK**.

Tour: Select the check box to enable a tour of the selected channels.

Snapshot Select the check box to take a snapshot of selected channels.

Log: Select the check box to enable logging of the face detection event.

Voice Prompts: Select the check box to enable the playing of a voice prompt audio file when a face detection event is triggered. Use the **File Name** drop-down arrow to select the audio file to play for the events.

Buzzer: Select the check box to activate a buzzer noise at the NVR.

- Click **Apply** to save your settings. To return to the main menu, click **OK**.

Configuring Audio Detection Settings

The audio detection feature detects audio changes in the camera scene that can generate events and corresponding actions.

- Go to **Main Menu** → **SETTING** → **EVENT** → **Audio Detection**.

Figure 8-22 Audio Detection Configuration Screen

The screenshot shows the 'Audio Detection' configuration window. At the top, 'Channel' is set to '1'. There are two checkboxes: 'Input Abnormal' (checked) and 'Intensity Change' (unchecked). Below are sliders for 'Sensitivity' and 'Threshold', both set to '1' with a range of '(1 - 100)'. A 'Period' section has a 'Setup' button. Under 'Alarm Out', there is a dropdown set to '2' and a 'Latch' field set to '10' seconds. There are also checkboxes for 'Alarm Upload' and 'Send Email'. The 'Record Channel' checkbox is checked, with a dropdown set to '1' and a 'Delay' field set to '10' seconds. Below are checkboxes for 'PTZ Activation' (with a 'Setup' button), 'Tour', and 'Snapshot', each with a dropdown arrow. The 'Log' checkbox is checked. 'Voice Prompts' is unchecked with a 'File Name' dropdown set to 'None'. The 'Buzzer' checkbox is unchecked. At the bottom are buttons for 'Default', 'Refresh', 'OK', 'Cancel', and 'Apply'.

- Select the **Channel** to configure for audio detection from the drop-down menu and check one or both of the **Input Abnormal** and **Intensity Change** check boxes.

Input Abnormal: Detects if the audio input changes from the "normal" audio that is typically generated at the site.

Intensity Change: Detects if the audio intensity changes, meaning the volume level becomes stronger than the typical levels.

3. Set the **Sensitivity** level (1–100) and **Threshold** level (1–100) for the audio detection. Sensitivity refers to the audio recognition sensitivity (as a percentage). Moving the

Sensitivity slider to a higher sensitivity setting increases the audio detection sensitivity which will detect more events.

Threshold is the intensity change threshold, or the amount of audio required to trigger an event notification. The smaller the Threshold value, the more events will be detected.

Note

The best way to configure audio detection is to experiment with the sensitivity and threshold settings while someone is generating sound in front of the camera.

4. To set the periods when audio detection is active, next to **Period**, click **Set**, and then follow the steps listed in [To set up motion detection periods](#) on page 81.
5. Select the action(s) that you want the system to initiate when an audio detection event occurs:

Alarm Out: Select the check box to activate the selected alarm output(s) (**1** or **2**). In the **Latch** box, specify the amount of time (0–300 s) to delay the alarm output signal after an audio detection event is triggered.

Alarm Upload: Select the check box to enable the system to upload an alarm signal to the network (including to an alarm center and/or web client).

Send Email: Select the check box to enable the system to send an email notification. If the **Snapshot** function is enabled, an image can be attached to the email. To set up Email, see [Configuring Email Settings](#) on page 68.

Record Channel: Select the channel(s) that you want to record when the alarm is triggered. In the **Delay** box, specify the amount of time (10–300 s) to delay recording after an audio detection event is triggered.

Note

You also need to set the alarm recording period. Go to **Storage** → **Schedule** to configure the current channel for scheduled alarm recording. See [Configuring the Video Recording Schedule](#) on page 38.

PTZ Activation: Select the check box to activate PTZ functions, and then click **Set**. In the **PTZ Activation** window, for each PTZ camera, select the preset, tour, or pattern that you want to be called when the audio detection event occurs, and then click **OK**.

Tour: Select the check box to enable a tour of the selected channels.

Snapshot: Select the check box to take a snapshot of selected channels.

Log: Select the check box to enable logging of the audio detection event.

Voice Prompts: Select the check box to enable the playing of a voice prompt audio file when an audio detection event is triggered. Use the **File Name** drop-down arrow to select the audio file to play for the events.

Buzzer: Select the check box to activate a buzzer noise at the NVR.

6. Click **Apply** to save your settings. To return to the main menu, click **OK**.

Configuring People Counting

The people counting feature analyzes the video to count the number of people that pass through or appear in the video.

1. Go to **Main Menu** → **SETTING** → **EVENT** → **PEOPLE COUNTING**.

Figure 8-20 People Counting Configuration Screen

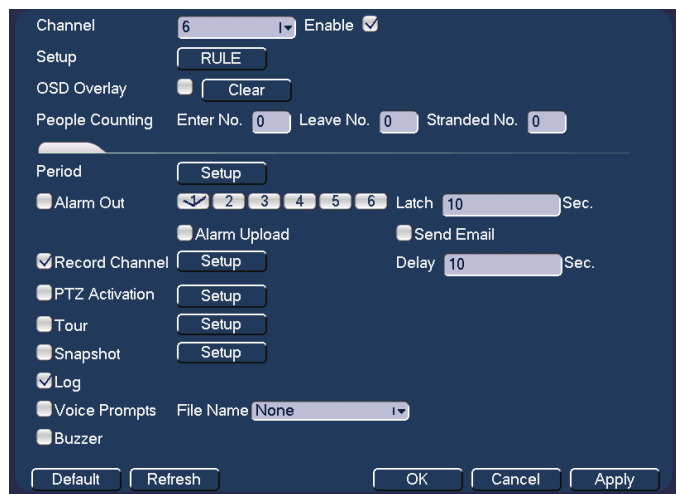

2. Select the Channel to configure for people counting from the drop-down menu and check the **Enable** check box.
3. Click **RULE** to set up an area for people counting. You can move or resize the area using your mouse. To move the area, drag one of the sides. To resize the area, drag one of the corner handles.

Figure 8-23 People Counting Rule

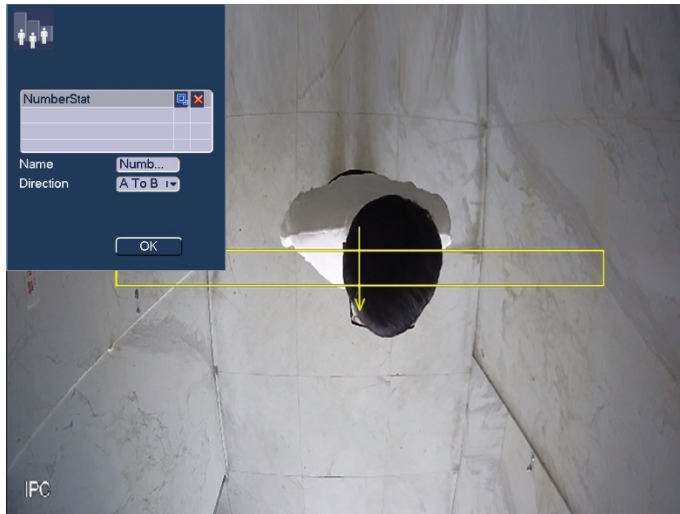

In the **Name** field, enter the name of rule. In the **Direction** field, select the direction of people counting. You can select A->B or B->A, the arrow direction always means the entrance direction.

Click  to set up the target size. You can move or resize the area using your mouse. To move the area, drag one of the sides. To resize the area, drag one of the corner handles.

To clear the people counting area, click .

4. Enable **OSD Overlay** by checking the box. Click **Clear** to clear the overlay, if necessary.
5. Enter the number of people that are allowed to enter and exit in the **Enter No.** and **Exit No.** fields. Enter the number of people that are allowed to remain in the scene in the **Stranded No.** field.
6. To set the periods when people counting is active, next to **Period**, click **Set**, and then follow the steps listed in [To set up motion detection periods](#) on page 81.
7. Select the action(s) that you want the system to initiate when a people counting event occurs:

Alarm Out: Select the check box to activate the selected alarm output(s) (**1** or **2**). In the **Latch** box, specify the amount of time (0–300 s) to delay the alarm output signal after a people counting event is triggered.

Send Email: Select the check box to enable the system to send an email notification. If the **Snapshot** function is enabled, an image can be attached to the email. To set up Email, see [Configuring Email Settings](#) on page 68.

Record Channel: Select the channel(s) that you want to record when the alarm is triggered. In the **Delay** box, specify the amount of time (10–300 s) to delay recording after a people counting event is triggered.

Note

You also need to set the alarm recording period. Go to **Storage** → **Schedule** to configure the current channel for scheduled alarm recording. See [Configuring the Video Recording Schedule](#) on page 38.

PTZ Activation: Select the check box to activate PTZ functions, and then click **Set**. In the **PTZ Activation** window, for each PTZ camera, select the preset, tour, or pattern that you want to be called when the people counting event occurs, and then click **OK**.

Tour: Select the check box to enable a tour of the selected channels.

Snapshot: Select the check box to take a snapshot of selected channels.

Log: Select the check box to enable logging of the people counting event.

Voice Prompts: Select the check box to enable the playing of a voice prompt audio file when a people counting event is triggered. Use the **File Name** drop-down arrow to select the audio file to play for the events.

Buzzer: Select the check box to activate a buzzer noise at the NVR.

8. Click **Apply** to save your settings. To return to the main menu, click **OK**.

Configuring Alarm Outputs

1. Go to **Main Menu** → **SETTING** → **EVENT** → **Alarm Out**.

Figure 8-24 Alarm Output Configuration Screen

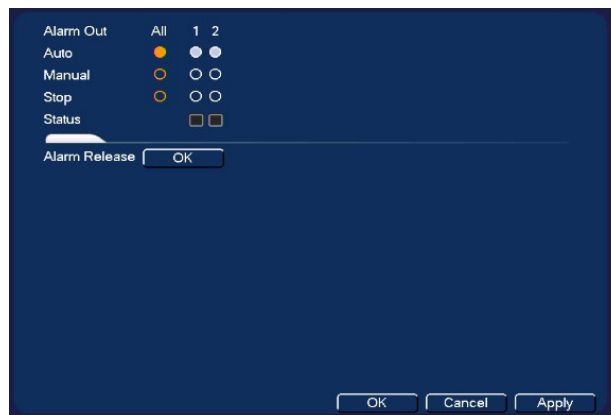

2. On the **Alarm Output** page, set the alarm type for each alarm output:

Auto: Select the alarm output(s) that you want to apply the recording schedule settings to. For more details, see [Configuring the Video Recording Schedule](#) on page 38 and [Configuring the Snapshot Recording Schedule](#) on page 40.

Manual: Select the alarm output(s) that you want to enable for all channels.

Stop: Select the alarm output(s) that you want to disable for all channels.

3. To turn off triggered alarm outputs, next to **Alarm Release**, click **OK**.

4. Click **Apply** to save your changes, and then click **OK**.

Configuring POS Settings

Note This function is only available for HEN081*4/HEN162*4/HEN163*4/HEN161*4/HEN322*4/HEN323*4/HEN321*4/HEN642*4/HEN643*4.

Use the POS settings screen to setup a connection to a point of sales device, such as a cash register, to enable POS info to be synchronized with video data.

1. Go to **Main Menu → SETTING → EVENT → POS**.

Figure 8-25 POS Configuration Window



2. Select a POS name in the **Name** dropdown list. Click  to edit the name if you want.
3. Select the **Enable** checkbox to enable the POS that you select in step 2.
4. Next to Event, click **Setup** to configure the POS arm/disarm period, record channel, etc. for the POS. See [Configuring Motion Detection Settings](#) on page 77 for the detailed information.
5. Next to Privacy, click **Setup** to configure the privacy character for the POS. After this function is enabled, once the overlay information contains the privacy character, it displays as *. For example, the privacy character is 12,56,89, the local preview and WEB surveillance information is shown as **34**7** if the overlay information is 123456789.

Figure 8-26 Privacy Set



6. Other parameters are described in the following section:

Connect Type: Select the type of connection to the POS device. Click **Setup** to enter the connection details for Source IP and Port, and Destination IP and Port. Click **OK** to confirm.

Protocol Type: Select the communication protocol for the POS device. The default setting is POS.

Convert: Set the font type.

Overlay: Set overlay mode, including turn and roll.

- Turn: Once the overlay information has reached 8 lines, it turns to the next page.
- Roll: Once the overlay information has reached 8 lines, it displays the next new line and delete the oldest line.

Network Overtime: Enter a value to set the network overtime. Once there is no POS data for the specified period, NVR automatically deletes POS information after the specified period.

Time Display: Enter the amount of time in between time display instances.

FontSize: Set the overlay font size

Color: Set the overlay font color

POS Info: Check the box to overlay information on the local preview window

Advanced: Click  to enter advanced settings interface.

Transaction Start/End: Select the transaction start and end times. This field cannot be modified when POS is the selected protocol.

Line delimiter: Set the line delimiter to display the overlay information after the delimiter in the new line. For example, the line delimiter is 45 and the overlay information is 123456789, NVR displays 123 in the first line and displays 6789 in the second line.

Hex: Check the Hex to switch to the ASCII code.

Case insensitive: Check the box to enable case insensitive function.

7. Click **Apply** to save your settings.
8. If you want to save your settings and exit the **SETTING** menu, click **OK**.

POS Type Supported by NVR

NVR supports the following types of POS:

Table 8-1 POS Type Supported by NVR

Area	POS Brand	POS Controlling Software
North Eastern Europe Poland	POSNET Thermal HD 2.01	PXE_Sender_ENG
North Eastern Europe Bulgaria	Mistral;Eltrade;Microinvest	Software supplied by the manufacturer
North America	PC America	Cash Register Express
Western Europe France	2secure	TCPSEnder.exe

9 Configuring Storage Settings

This chapter contains the following sections:

- [Configuring the Basic Settings](#) on page 104.
- [Configuring the Recording Schedule](#) on page 105.
- [Configuring HDD Manager Settings](#) on page 107.
- [Configuring FTP Settings](#) on page 108.
- [Configuring HDD Advanced Settings](#) on page 110.
- [Configuring NAS Storage](#) on page 111.
- [Configuring NAS Manager](#) on page 112.
- [Configuring Record Settings](#) on page 112.
- [Configuring HDD Detect Settings](#) on page 113.

Configuring the Basic Settings

Go to Main Menu → SETTING → STORAGE → BASIC.

Figure 9-1 Storage Basic Configuration Tab

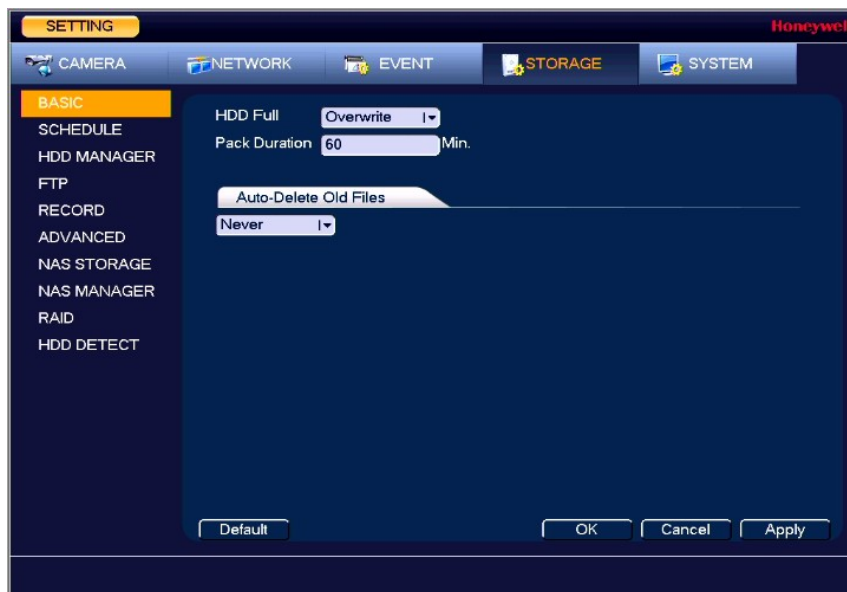

HDD Full: Set to Overwrite to continue recording over old data when the HDD is full. Set to Stop Record to stop recording when the HDD is full. The default setting is Overwrite.

Pack Duration: Set the recording duration. Specify a time between 1 and 120 minutes. The default setting is 60 min.

Auto Delete Old Files: Select **Never** or **Customized**. If **Customized** is selected, in the **Days Ago** box, enter the amount of time to elapse before the files are automatically deleted.

Configuring the Recording Schedule

Configuring the Video Recording Schedule

1. Go to Main Menu → SETTING → STORAGE → SCHEDULE → Rec.

Figure 9-2 Recording Schedule Configuration Tab

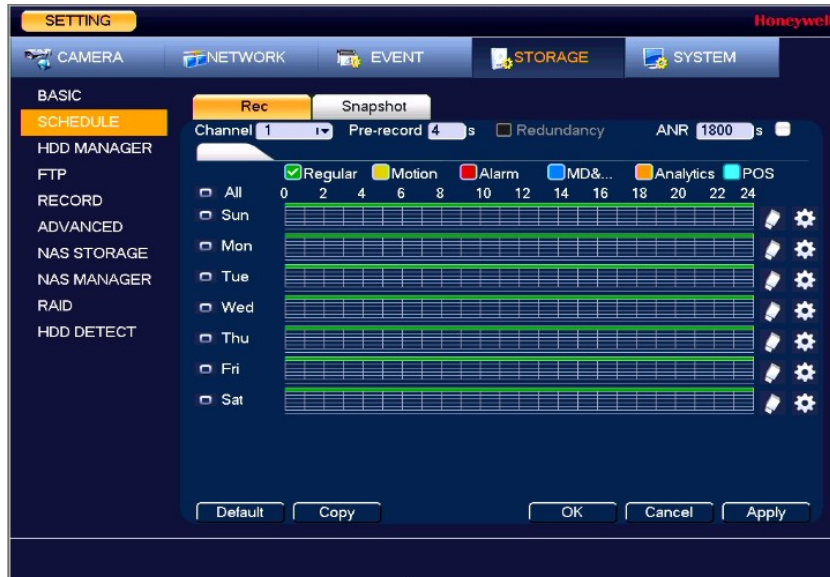

2. On the **Rec tab**, in the **Channel** box, select the channel (camera) for which you want to configure a recording schedule.
3. In the **PreRecord** box, enter a time between **0** and **30** seconds. The default setting is **4** seconds. The pre-record time sets how long the NVR records before the scheduled recording start time. For example, if the NVR is scheduled to start recording at 12:00 and the pre-record time is set to 4 seconds, the NVR will start recording at 11:59:56.
4. If the NVR has two HDDs, select the **Redundancy** check box to enable redundant **recording** on the second HDD. This HDD must first be configured as redundant on the **HDD Manager** page (see [Configuring HDD Manager Settings](#) on page 107).
5. In the **ANR** box, enter a time between 0s ~ 43200s. It is to save video to the SD card of the network camera in case the network connection fails. After the network connection resumed, the system can get the video from the SD card and there is no risk of record loss.
6. At the top of the scheduling table, select the check box(es) of the recording type(s) that you want to schedule:

Regular: The regular recording schedule is indicated by a green bar.

Motion: The motion detection recording schedule is indicated by a yellow bar.

Alarm: The alarm recording schedule is indicated by a red bar.

MD&Alarm: The motion detection and alarm schedule is indicated by a blue bar.

Analytics: The video analytics schedule is indicated by an orange bar.

POS: The POS schedule is indicated by a light blue bar.

Note	The POS function is only available for HEN081*4/HEN162*4/HEN163*4/HEN161*4/HEN322*4/ HEN323*4/HEN321*4/HEN642*4/HEN643*4.
-------------	---

7. At the left of the scheduling table, select the day(s) of the week for which you want to configure a recording schedule. To configure the same recording schedule for all of the days at the same time, select **All**.
8. **Click** or drag the mouse in the scheduling table to set the recording period. To erase a recording period, click the eraser icon () at the right of the table. Alternatively, for the day of the week that you want to configure, click the gear icon at the right of the table. In the **Period** window, set up to six recording periods. To copy the settings to additional days, select the appropriate check box(es) under **Copy**, and then click **Save**.
9. Click **Apply** to save your settings.
10. To **copy** the settings to additional channels, click **Copy**, select the channels to which you want to copy the settings, and then click **OK**.

Configuring the Snapshot Recording Schedule

Follow these steps to configure the snapshot recording function. When enabled, the NVR can take snapshots when a motion detection, video loss, video tampering, or other alarm event occurs. See [Chapter 8, Configuring Event Settings](#) for detailed instructions.

1. Go to **Main Menu** → **SETTING** → **STORAGE** → **SCHEDULE** → **Snapshot**.

Figure 9-3 Snapshot Schedule Settings



2. On the **Snapshot** tab, in the **Channel** box, select the channel (camera) for which you want to configure a snapshot schedule.
3. At the top of the scheduling table, select the check box(es) of the recording type(s) that you want to schedule:
 - Regular:** The regular recording schedule is indicated by a green bar.
 - Motion:** The motion detection recording schedule is indicated by a yellow bar.
 - Alarm:** The alarm recording schedule is indicated by a red bar.
 - MD&Alarm:** The motion detection and alarm schedule is indicated by a blue bar.
 - Analytics:** The video analytics schedule is indicated by an orange bar.
 - POS:** The POS schedule is indicated by a light blue bar.
4. At the left of the scheduling table, select the day(s) of the week for which you want to configure a snapshot schedule. To configure the same schedule for all of the days at the same time, select **All**.
5. **Click** or drag the mouse in the scheduling table to set the recording period. To erase a recording period, click the eraser icon at the right of the table. Alternatively, for the day of the week that you want to configure, click the gear icon at the right of the table. In the **Period** window, set up to six snapshot recording periods. To copy the settings to additional days, select the appropriate check box(es) under **Copy**, and then click **Save**.
6. Click **Apply** to save your settings.
7. To **copy** the settings to additional channels, click **Copy**, select the channels to which you want to copy the settings, and then click **OK**.

Configuring HDD Manager Settings

1. Go to **Main Menu** → **SETTING** → **STORAGE** → **HDD MANAGER**.

Figure 9-4 HDD Manager Window

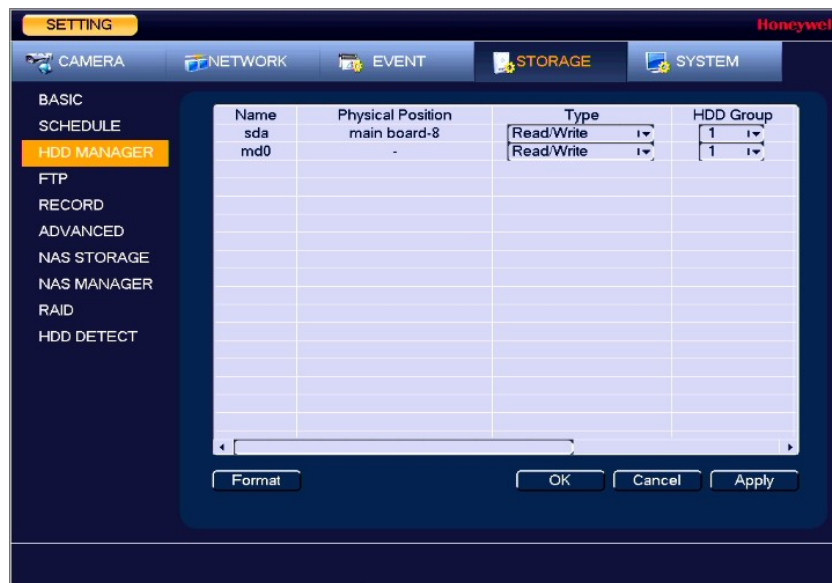

Name: The HDD name.

Physical Position: Indicates which hard drive slot the HDD currently occupies.

Type: The HDD type (read-write or read-only).

HDD Group: The HDD group that the hard drive belongs to.

Status: The current operating status of the HDD.

Free Space/ Total Space: The amount of free space remaining on the HDD/ The total capacity of the HDD.

- The HDD is configured as read-write by default. To change the HDD type to read-only, in the **Type** column, select **Read-only HDD**.

Note The NVR restarts to apply the new setting.

- To erase all the data from a HDD, select it and click **Format**. A confirmation message appears: "Confirm format on the selected device?" Click **OK** to continue.

Configuring FTP Settings

You can configure an FTP connection to upload image files at regular intervals to an FTP server.

- Go to **Main Menu** → **SETTING** → **STORAGE** → **FTP**.

Figure 9-5 Network FTP Window

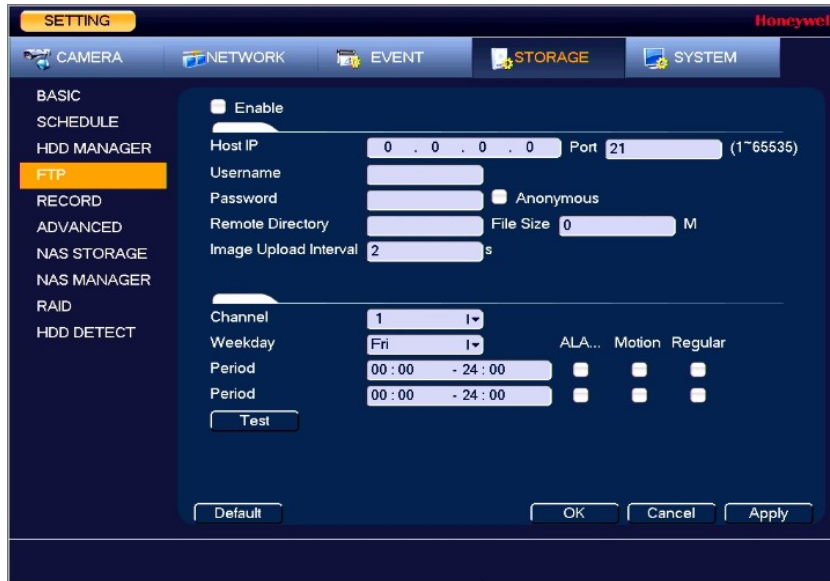

2. On the **FTP** page, click the **Enable** check box to enable uploading images to an FTP server.
3. Configure the following settings:
 - Host IP:** Enter the address of the FTP server.
 - Port:** Enter the port of the FTP server.
 - Username:** Enter the user name for logging on to the FTP server.
 - Password:** Enter the password for logging on to the FTP server.
 - Anonymous:** Select the check box to hide user name when logged on to the FTP server.
 - Remote Directory:** Enter a name for the remote directory. If this is left blank, the NVR will automatically create folder names.
 - File Size:** This is the maximum size for image files being uploaded to the FTP server. Enter a value between **0** and **65535** MB.
 - Image Upload Interval:** This is the interval for uploading images to the FTP server. Enter a time between 1 and 600 seconds.
 - Channel:** Select a channel to upload images from, or select **All** to select all channels.
 - Weekday:** Select a day of the week to upload images on, or select **All** to upload images every day.
 - Time Periods:** You can configure up to two time periods for uploading images. For each period, select either **Alarm&Analytics**, **Motion**, or **Regular** images.
4. Click **Apply** to save your settings. To test the FTP connection, click **Test**.
5. If you want to save your settings and exit the **SETTING** menu, click **OK**.

Configuring HDD Advanced Settings

Configuring Main Stream Settings

Here, you can assign the main stream to a particular HDD group.

1. Go to **Main Menu** → **SETTING** → **STORAGE** → **Advanced** → **Main Stream**.

Figure 9-6 Main Stream Storage Configuration Tab



2. You can set the HDD group for all channels or set each channel individually:
 - Select a HDD group from the drop-down **Set All Channels** menu. Click **All** to apply the parameter settings to all channels.
 - Select an HDD group from the drop-down menu for each channel, as required.
3. Click **Apply** to save your settings.

Configuring Sub Stream Settings

Configuring the sub stream channel settings is the same as for the main stream (see [Configuring Main Stream Settings](#) on page 110).

Configuring Snapshot Storage Settings

1. Go to **Main Menu** → **SETTING** → **STORAGE** → **Advanced** → **Snapshot**.

Figure 9-7 Snapshot Storage Configuration Tab



2. You can set the HDD group for all channels or set each channel individually:
 - Select a HDD group from the drop-down **Set All Channels** menu. Click **All** to apply the parameter settings to all channels.
 - Select an HDD group from the drop-down menu for each channel, as required.
3. Click **Apply** to save your settings.

Configuring NAS Storage

Go to Main Menu → SETTING → STORAGE → NAS STORAGE.

Figure 9-8 NAS Storage Configuration Tab

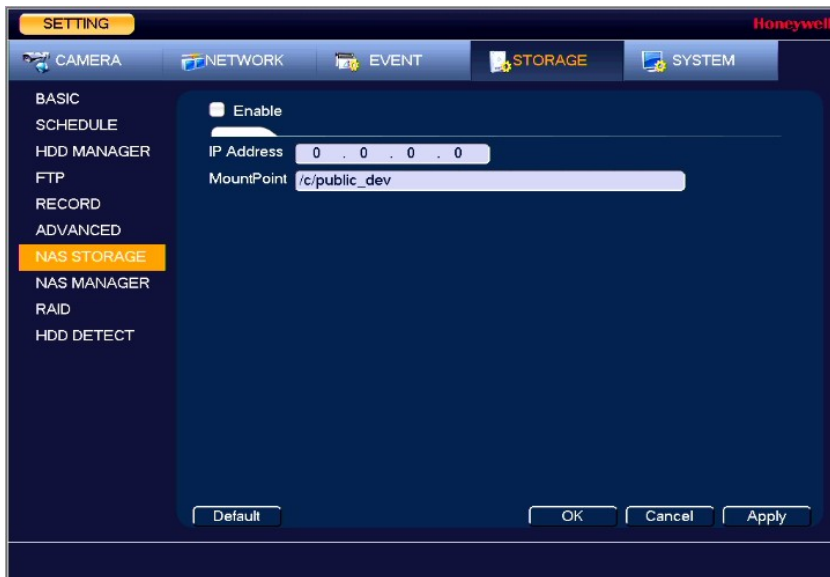

Enable: Select the **Enable** check box to enable the NAS storage function.

IP Address: Enter the IP address of the NAS Storage.

Mount Point: Enter the path of the NAS Storage.

Configuring NAS Manager

Go to Main Menu → SETTING → STORAGE → NAS MANAGER.

Figure 9-9 NAS Manager Configuration Tab



1	Name	Type	Status	Free Space/Total S...
1	NAS Storage	NFS	Normal	0.00 KB/24.00 MB

Name: The NAS name.

Type: The NAS type.

Status: The current operating status of the NAS.

Free Space/ Total Space: The amount of free space remaining on the NAS/ The total capacity of the NAS.

Configuring Record Settings

Go to Main Menu → SETTING → STORAGE → RECORD.

Figure 9-10 Recording Storage Configuration Window

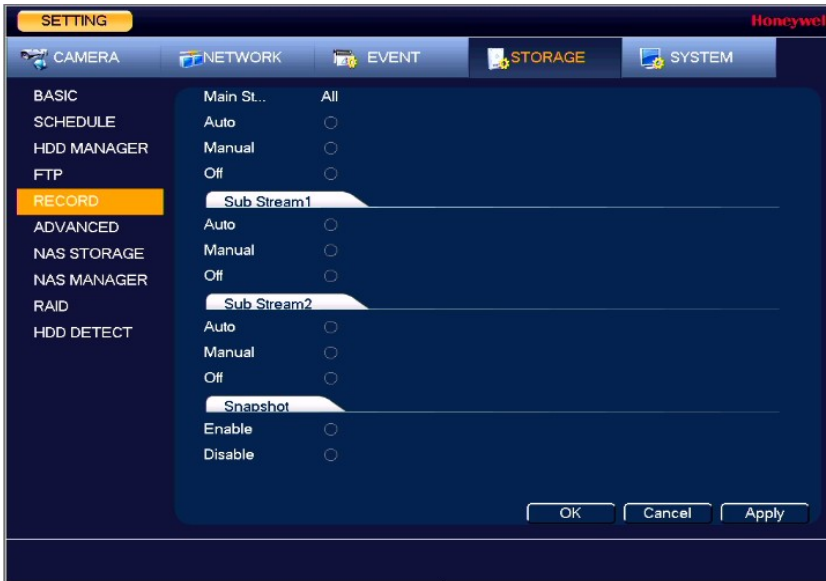

1. On the **Record** window, select the record types (**Auto**, **Manual**, **Off**) that you want to enable on each channel for both the main stream and secondary streams.
2. Under **Snapshot**, enable or disable snapshot recording on each channel.
3. Click **Apply** to save your settings.

Configuring HDD Detect Settings

HDD Manual Detection

Hard Disk Drives can be detected and scanned for total space and errors with a Quick Detect or Global Detect function.

1. Go to **Main Menu** → **SETTING** → **STORAGE** → **HDD Detect** → **Manual Detect**.
2. Select the hard drive to use the detection on from the **HDD** drop-down list.
3. Select the **Type** of detection to use, either **Global Detect** or **Quick Detect** and click **Start Detect**.
4. Click **Stop Detect** at any time to stop the detection process.

Once complete, the hard drive detection results will display in the table below, indicating hard drive details such as good, bad and blocked sectors, and total space.

Figure 9-11 HDD Manual Detection Screen

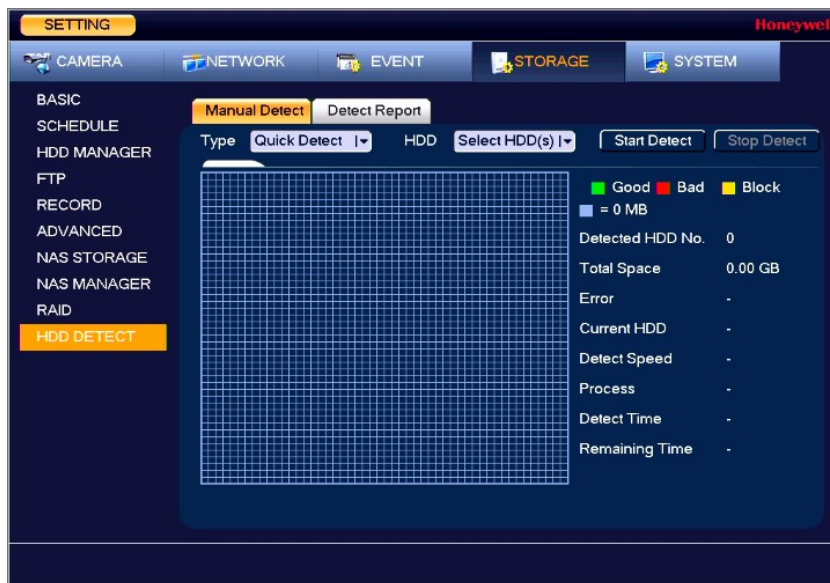

HDD Detection Reporting

Hard Disk Drives detection results are compiled on the detect report screen for easy reference.

1. Go to Main Menu → SETTING → STORAGE → HDD Detect → Detect Report.

Figure 9-12 HDD Detection Report Screen

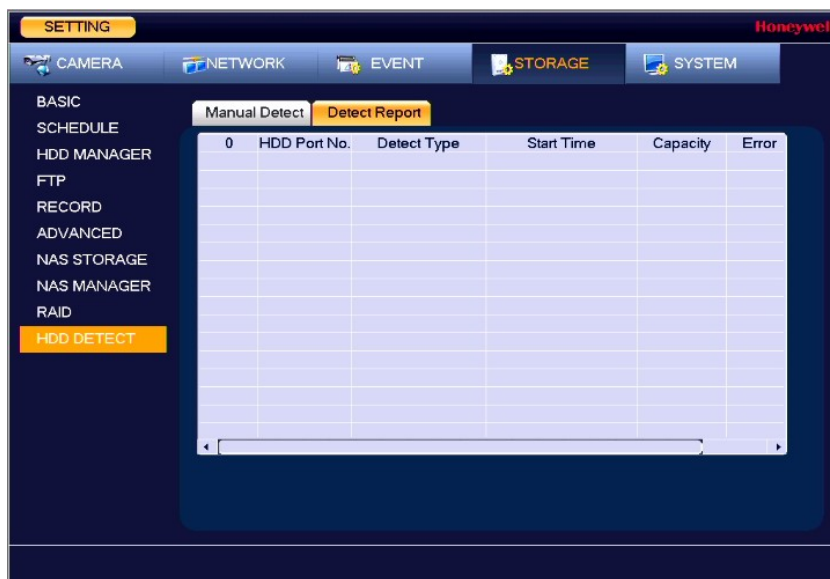

2. Use the **Detect Report** tab to view hard drive detection reports from previous detections. Click on a report row in the table to view the detection report details.

10 Configuring System Settings

This chapter contains the following sections:

- [Configuring General System Settings](#) on page 115.
- [Configuring Display Settings](#) on page 119.
- [Configuring RS232 Settings](#) on page 122.
- [Configuring PTZ Settings](#) on page 123.
- [Configuring Broadcast Settings](#) on page 123.
- [Configuring Voice Prompt Settings](#) on page 124.
- [Configuring Account Settings](#) on page 126.
- [Configuring Security Settings](#) on page 131.
- [Configuring Automatic Maintenance Settings](#) on page 132.
- [Exporting and Importing System Configurations](#) on page 132.
- [Restoring Default Settings](#) on page 134.
- [Upgrading the NVR](#) on page 135.

Configuring General System Settings

Configuring Device Settings

1. Go to Main Menu → SETTING → SYSTEM → GENERAL → General.

Figure 10-1 General Configuration Tab

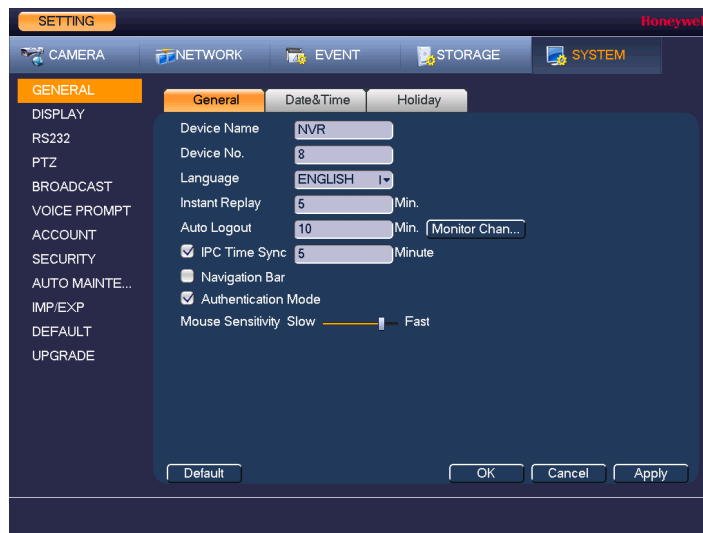

2. On the **General** tab, configure the following settings:
 - Device Name:** Enter a device name for the NVR.
 - Device No.:** Enter a device number for the NVR.
 - Language:** Set the language of the user interface.
 - Instant Replay:** Set the length of time to play back video using the instant replay playback function in live view mode. Specify a time between **5** and **60** minutes. The default setting is **5 min.**
 - Auto Logout:** Set the length of time the NVR waits before logging out an inactive user. Specify a time between **0** and **60** minutes. The default setting is **10 min.**
 - Monitor Channel(s) when logout:** Select the channels that you want to monitor after the logout.
 - IPC Time Sync:** Select the check box to have the NVR sync time with connected IP cameras at a set interval. Set the interval from **1** to **1440** minutes. The default setting is **5** minutes.
 - Navigation Bar:** Select the check box to display the live view toolbar on the live view screen. Clear the check box to hide the live view toolbar.
 - Authentication Mode:** Check to enable the authentication mode for using the keyboard. If the authentication mode is not applicable to your keyboard, uncheck it.
 - Mouse Sensitivity:** Set the desired mouse speed using the slider.
3. Click **Apply** to save your settings.
4. If you want to save your settings and exit the **SETTING** menu, click **Save**.

Configuring Date and Time Settings

To configure the system time settings

1. Go to Main Menu → **SETTING** → **SYSTEM** → **GENERAL** → **Date&Time**.

Figure 10-2 Date and Time Configuration Tab



2. On the **Date&Time** tab, configure the following settings:

Date Format: Select the date format that you want to use for the system time: **YYYY MM DD**, **MM DD YYYY**, or **DD MM YYYY**.

Time Format: Select the time format that you want to use for the system time: **24-Hour** or **12-Hour**.

Date Separator: Select the separator that you want to use for the system time: period (.), hyphen (-), or forward slash (/).

System Time: Enter the system time and time zone, and then click **Save**.

3. Click **Apply** to save your settings.
4. If you want to save your settings and exit the **SETTING** menu, click **OK**.

To configure the Daylight Saving Time (DST) settings

1. Go to **Main Menu** → **SETTING** → **SYSTEM** → **GENERAL** → **Date&Time**.
2. On the **Date&Time** tab, click to select the **DST** check box.
3. Specify when Daylight Saving Time begins and ends. Select **DST Type** as either **Date** (DST applies to specific dates) or **Week** (specify which week and time of each year to apply to DST).

For example:

- a. Since the specific dates change every year, select **Week** as the **DST Type**.
 - b. Set the **Start Time** as **Mar 2nd Su 02:00** (the second Sunday in March at 2:00 a.m.).
 - c. Set the **End Time** as **Nov 1st Su 02:00** (the first Sunday in November at 2:00 a.m.).
4. Click **Apply** to save your settings.
 5. If you want to save your settings and exit the **SETTING** menu, click **OK**.

To synchronize the system time with the Network Time Protocol (NTP)

1. Ensure that the NVR is connected to the Internet.
2. Go to **Main Menu → SETTING → SYSTEM → GENERAL → Date&Time**.
3. On the Date&Time tab, click to select the NTP check box.
4. In the Server box, enter the IP address of the NTP server that you want to use (for example, time.nist.gov).
5. Ensure that Port is set to 123.
6. To change the frequency with which the system time synchronizes with the NTP server, enter a new time in the Interval box. The default setting is 60 min.
7. Click Manual Update to manually synchronize your system time with the NTP server.
8. Click Apply to save your settings.
9. If you want to save your settings and exit the SETTING menu, click OK.

Configuring Holiday Settings

1. Go to **Main Menu → SETTING → SYSTEM → GENERAL → Holiday**.

Figure 10-3 Holiday Tab

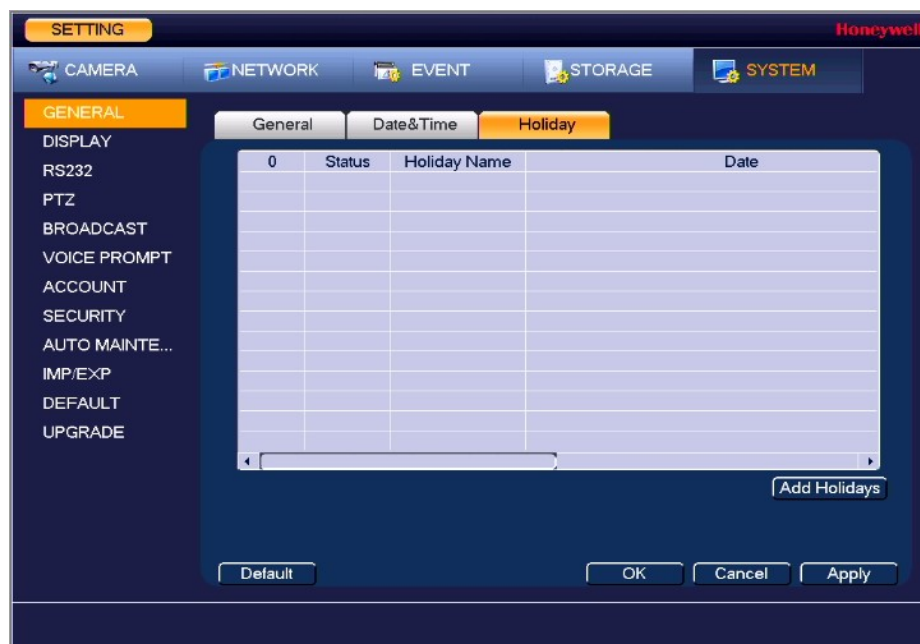

2. On the **Holiday** tab, click **Add Holidays**. The **Add Holidays** window appears.

Figure 10-4 Add Holidays Window

3. In the **Holiday Name** box, enter the name of the holiday that you want to add.
4. Set Repeat Mode to Once or Always.

Note

If you want the NVR to recognize a particular day of the week as a holiday year-round (for example, every Friday), set Repeat Mode to Always.

5. Set **Holiday Range** to **Date** or **Week** depending on whether you want to designate a single day or one or more weeks as a holiday.
 - If **Date** is selected, enter the year, month, and day in the **Start Time** and **End Time** boxes.
 - If **Week** is selected, enter the year, month, week of the month (1st, 2nd, 3rd, 4th, Last), and day.
6. If you want to add more holidays, select the **Add More** check box.
7. Click **Add** to add the holiday.
8. After you have added the new holidays, on the **Holiday** tab, set the **Status** of each holiday. Select **Open** to enable the holiday or select **Stop** to disable it.

Configuring Display Settings

Configuring Display Settings

1. Go to Main Menu → SETTING → SYSTEM → DISPLAY → Display.

Figure 10-5 Display Configuration Tab

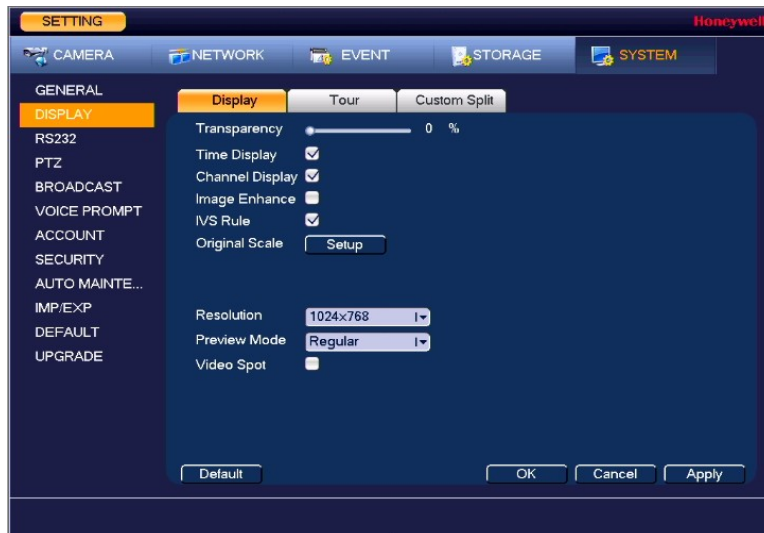

2. On the **Display** tab, configure the following settings:

Transparency: Set the transparency of the graphical user interface (GUI) to a value between **0** and **100**, with **0** being totally opaque and **100** being totally transparent.

Time Display: To display the current time in each channel window in live view mode, select the check box. To hide the time, clear the check box.

Channel Display: To display the camera name, status, and channel number in each channel window, select the check box. To hide the camera name, status, and channel number, clear the check box.

Image Enhance: To enhance the display image, select the check box. To keep the default settings, clear the check box.

Analytics Rule: To display the active analytics rule in each channel window in live view mode, select the check box. To hide the analytics rule info, clear the check box.

Original Scale: Click **Setup** to select the channel(s) to display in the original aspect ratio, then click **OK**. Select **All** to display all the channels in the original aspect ratio. Unselected channels display in full screen.

Resolution: Set the resolution of your display select in the **Screen NO** field.

Note

You must restart the NVR for new display resolution settings to take effect.

Preview Mode: Select the Preview Mode from the drop-down list from **Regular** or **Show Face List**.

Video Spot: Check to select VGA Output or HDMI Output. In the selected output, the user operation is disabled and it only displays the playback.

3. Click **Apply** to save your settings.
4. If you want to save your settings and exit the **SETTING** menu, click **OK**.

Configuring Tour Settings

In a tour, the NVR cycles through different channel views. You can specify which views and cameras you want to appear in the tour.

1. Go to **Main Menu** → **SETTING** → **SYSTEM** → **DISPLAY** → **Tour**.

Figure 10-6 Tour Configuration Tab

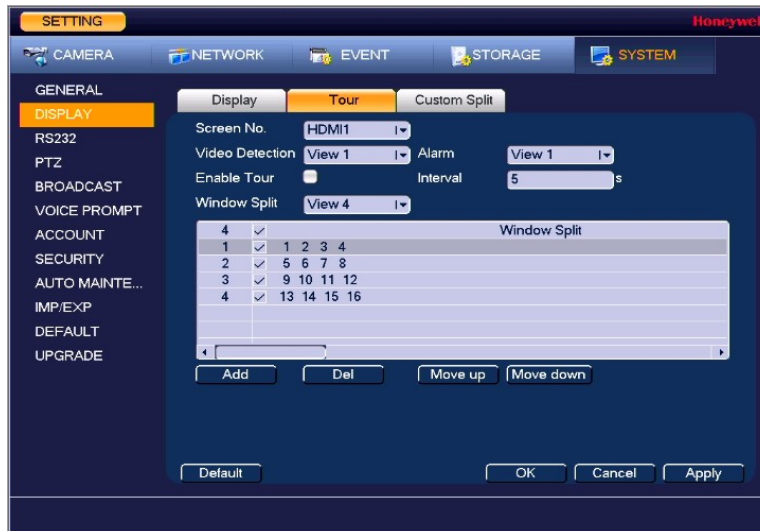

2. Select the monitor to display the tour with the **Screen NO** drop-down list.
3. If you want, you can add or delete cameras from the **Channel Group** list. You can only add cameras that do not already appear in the list.

Note

On some NVR models you can change the Video Detection tour and Alarm tour from View 1 (single-channel view) to View 8 (eight-channel view).

4. Select the **Enable Tour** check box to enable the tour function or clear the check box to disable the tour function.
5. In the **Interval** box, enter the amount of time in seconds (from 5-120) that you want each view to appear on the screen before displaying the next view in the tour. The default setting is **5** seconds.
6. Do one of the following:
 - To cycle through all of the cameras in all of the available views, keep the default settings.
 - To create a custom tour, for each view in the **Window Split** list (**View 1**, **View 4**, and so on), clear the check box on the top row of the **Channel Group** list to deselect all of the cameras for that view, then select the cameras for each view that you want to appear in the custom tour.

For example, to create a tour showing only cameras 2, 3, and 5 in single-channel view, set **Window Split** to **View 1** and then select cameras **2**, **3**, and **5**. There should be no other cameras selected in View 1 or in any of the other views.

7. Click **Apply** to save your settings.
8. If you want to save your settings and exit the **SETTING** menu, click **OK**.

Configuring Custom Split Settings

Note This function is only available for HEN081*4/HEN162*4/HEN163*4/HEN161*4/HEN322*4/HEN323*4/HEN321*4/HEN642*4/HEN643*4.

Use the Custom Split tab to configure a customized split screen display.

1. Go to **Main Menu** → **SETTING** → **SYSTEM** → **DISPLAY** → **Custom Split**.

Figure 10-7 Custom Split Configuration Tab

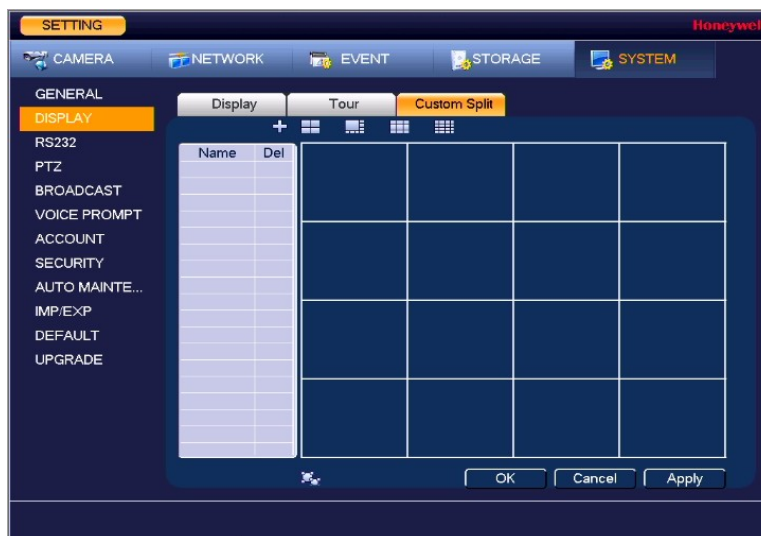

2. On the Custom Split tab, click + to add the selected split view to the list.
3. Use the mouse to click and drag the display grid to configure it, as needed. You can combine small squares into a larger display area, or split them up to view more channels at once.
4. Click **Apply** to save your settings.
5. If you want to save your settings and exit the SETTING menu, click **OK**.

Configuring RS232 Settings

1. Go to **Main Menu** → **SETTING** → **SYSTEM** → **RS232**.

Figure 10-8 RS232 Configuration Window

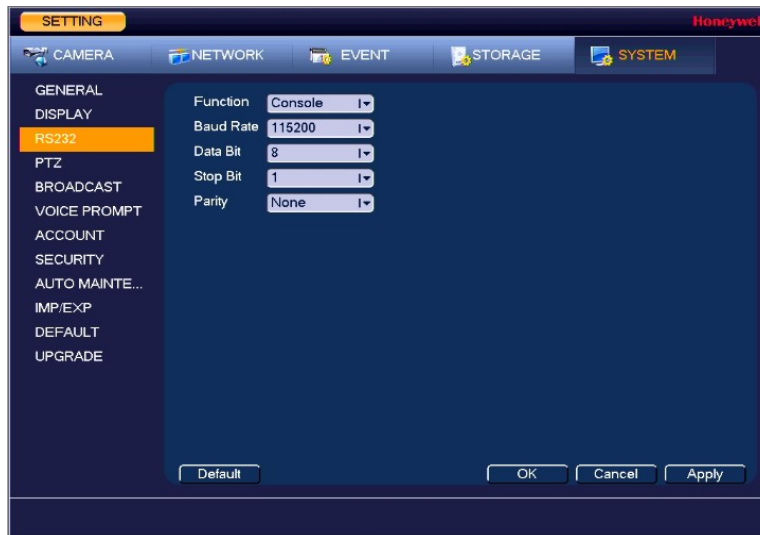

2. Configure the following settings:

Function: Select **Console** or **Adapter**, depending on the type of RS232 device that you have connected to the NVR.

Baud Rate: Select a value between **1200** and **115200**. The default setting is **115200**.

Data Bit: Select a value between **5** and **8**. The default setting is **8**.

Stop Bit: Select **1**, **1.5**, or **2**. The default setting is **1**.

Parity: Select **None**, **Odd**, **Even**, **Mark**, or **Space**. The default setting is **None**.

3. Click **Apply** to save your settings.
4. If you want to save your settings and exit the **SETTING** menu, click **OK**.

Configuring PTZ Settings

See [Configuring PTZ Connection Settings](#) on page 32 for more information.

Configuring Broadcast Settings

Note

This function is only available for HEN081*4/HEN162*4/HEN163*4/HEN161*4/HEN322*4/HEN323*4/HEN321*4/HEN642*4/HEN643*4.

Use the Broadcast screen to setup a group of channels that be broadcast with bi-directional audio. This enables system users to output an audio message to several camera with audio outputs at the same time.

1. Go to **Main Menu** → **SETTING** → **SYSTEM** → **Broadcast**.

Figure 10-9 Broadcast Configuration Window

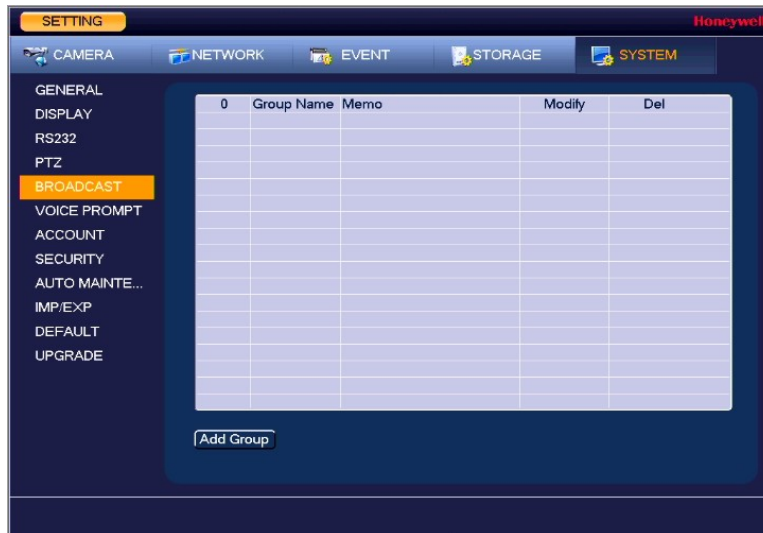

2. Click **Add Group** to add a new broadcast group. Enter a Group Name and select the channels to be part of the group.
3. Click **Save** to save the group.

Configuring Voice Prompt Settings

Voice prompt files can be used to as alarm audio and can be set as actions when events are triggered.

Managing Voice Prompt Files

Use the Voice Prompt File Manage screen to manage the voice prompt sound files and set the volume.

1. Go to **Main Menu** → **SETTING** → **SYSTEM** → **Voice Prompt** → **File Manage**.

Figure 10-10 Voice Prompt File Configuration Window

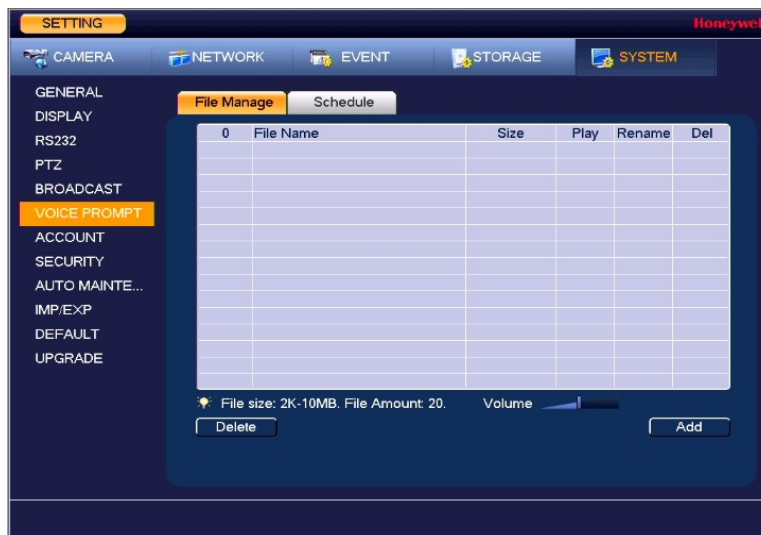

2. Click **Add** to add a new audio file for Voice Prompts. You must have a connected USB device with audio files saved to it.
3. Double-click on folders to navigate to the new voice prompt file, select the check box for the file(s) you want to add and click **Import**. Click **OK** to return to the previous page. The file will populate in the File Manage table.

You can **Play**, **Rename**, or **Delete** the file using the table controls. Use the **Volume** slider to set the volume level.

Configuring Voice Prompt Schedules

Use the Voice Prompt Schedules screen to set the voice prompt schedule and timing. With the schedules, different voice prompt audio files can be enabled for different times of the day/week. For example, an *after hours* audio message can be played on weekends and nights.

1. Go to **Main Menu → SETTING → SYSTEM → Voice Prompt → Schedule**.
2. You can configure up to 6 scheduling periods to repeat on each day.
3. For each voice prompt schedule:
 - a. Set the time range in the **Period** field.
 - b. Select the voice prompt file to be played from the **File Name** drop-down list.
 - c. Enter the number of times the voice prompt should repeat in the **Repeat** field and set the interval between repetitions in minutes in the **Interval** field.
 - d. Select the audio device to play the voice prompt from the **Output** drop-down list.
 - e. Place a check in the check box for each period that you configure.

Figure 10-11 Voice Prompt Schedule Configuration Window

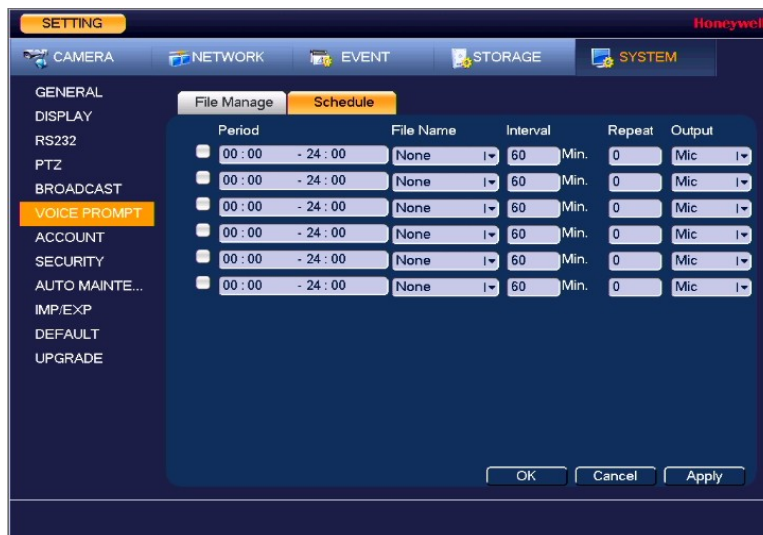

4. Click **Apply** to save your settings.
5. If you want to save your settings and exit the **SETTING** menu, click **OK**.

Configuring Account Settings

You can add, edit, or delete user accounts. By default, the NVR has an admin user account and a default user account. The admin user account has permission to perform all the operation and configuration functions of the NVR. The default user account only has permission to monitor live video.

Managing User Accounts and Groups

To add a user account

1. Go to Main Menu → **SETTING** → **SYSTEM** → **ACCOUNT** → **User**.

Figure 10-12 User Account Configuration Tab

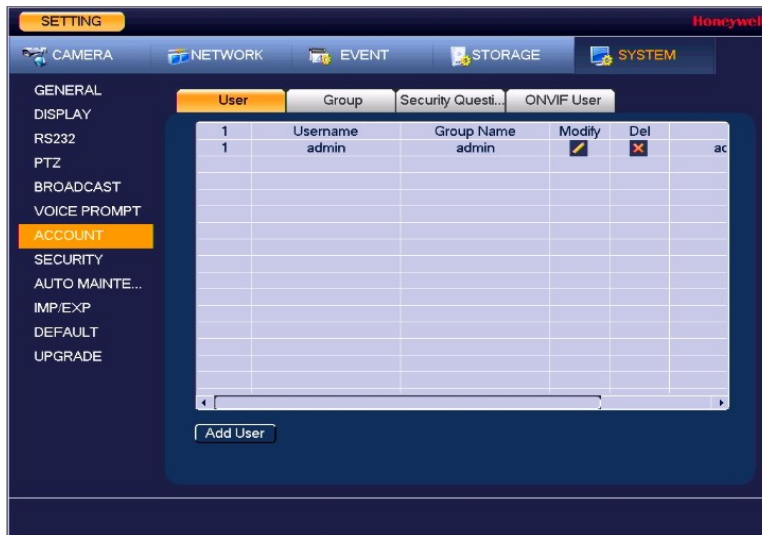

2. On the **User** tab, click **Add User**. The **Add User** page opens.

Figure 10-13 Add User Window

Username Password Confirm Password
 Memo
 Group

Authority
 All
 ACCOUNT SYSTEM MANA... SYSTEM INFO MANUAL CONT...
 STORAGE EVENT MANA... NETWORK MA... CAMERA
 SECURITY File Backup Device Mainten...

3. On the **Add User** page, configure the following settings for the new user:
 - Username:** Enter a user name for the account.
 - Password:** Enter a password for the account.
 - Confirm Password:** Re-enter the password.
 - Memo:** Optionally, enter a brief description of the account.
 - Group:** Assign the user to a group (**admin**, **user**, or another group that you have defined).
 - Authority:** Assign privileges by selecting or clearing check boxes on the three tabs in the Authority section.

Note

By default, the user group is set up to allow a new user to monitor live video from all cameras, play back recorded video from all cameras, control PTZ cameras, view information, manually control the NVR, back up files, and adjust color settings. To assign additional privileges, change the user settings on the Group tab.

4. Click **Save** to save your settings.

To edit a user account

1. Go to **Main Menu → SETTING → SYSTEM → ACCOUNT → User**.
2. On the **User** tab, click the **Modify** icon  for the user account that you want to edit. The **Modify User** page opens.
3. On the **Modify User** page, you can change any of the following settings:
 - Username
 - Password
 - User Group
 - Memo
 - Authority Tabs
4. When you have finished making changes, click **Save** to save your settings.

To delete a user account

1. Go to **Main Menu → SETTING → SYSTEM → ACCOUNT → User**.
2. On the **User** tab, click the **Delete** icon  for the user account that you want to delete.
3. The message "Are you sure that you want to delete now?" appears. Click **OK** to delete the account.

Note

You can only delete an account that you have created. You cannot delete the admin and default user accounts.

To add a user group

1. Go to **Main Menu → SETTING → SYSTEM → ACCOUNT → Group**.

Figure 10-14 Group Configuration Tab



2. On the **Group** tab, click **Add Group**.
3. On the **Add Group** page, enter a name for the group in the **Group Name** box, enter a description of the group in the **Memo** box, and then assign user permissions on the **Authority** tabs.
4. Click **Save** to save your settings.

To edit a user group

1. Go to **Main Menu** → **SETTING** → **SYSTEM** → **ACCOUNT** → **Group**.
2. On the **Group** tab, click the **Modify** icon of the user group that you want to edit. The **Modify Group** page opens.
3. On the **Modify Group** page, you can change any of the following settings:
 - Group
 - Group Name
 - Memo
 - Authority Tabs
4. When you have finished making changes, click **Save** to save your settings.

To delete a user group

1. Go to **Main Menu** → **SETTING** → **SYSTEM** → **ACCOUNT** → **Group**.
2. On the **Group** tab, click the **Delete** icon of the user group that you want to delete.
3. The message "Are you sure that you want to delete now?" appears. Click **OK** to delete the group.

Configuring Account Security Questions

In case that the admin password is lost or forgotten, you can setup security questions for the admin account that can be answered if the password is ever forgotten.

1. Go to **Main Menu → SETTING → SYSTEM → ACCOUNT → Secure Question.**

Figure 10-15 Secure Question Configuration Tab

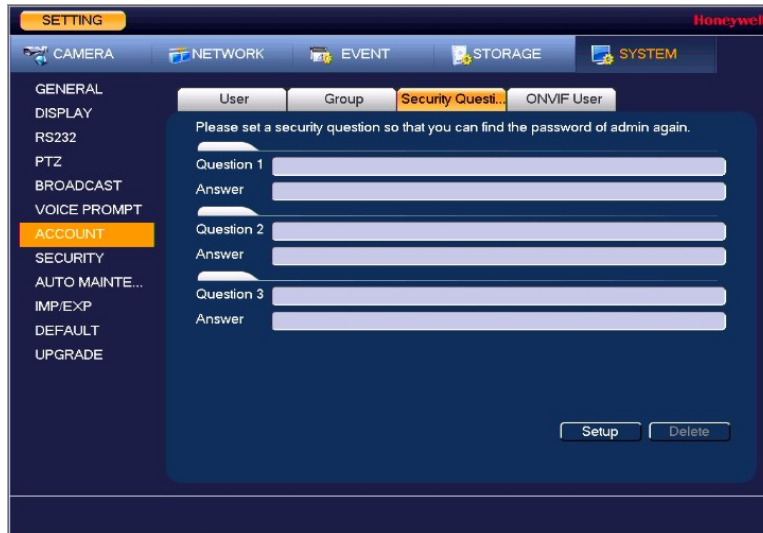

2. Select a security question from both the **Question 1** and **Question 2** drop-down lists. If the default questions are not suitable, select **Customized** to enter your own question text in the field.
3. Enter the answer to each question in the corresponding **Answer** field.
4. Click **Set** to save your settings.

Configure ONVIF User

You can add, edit, or delete ONVIF user accounts.

Figure 10-16 ONVIF User

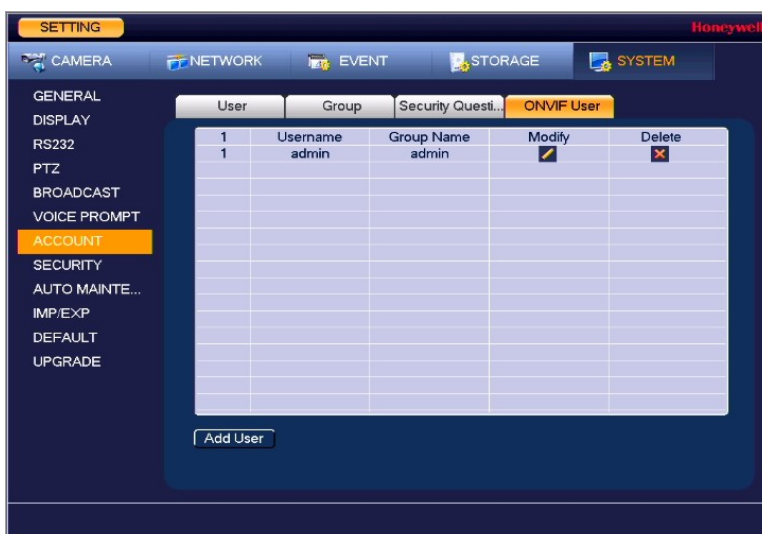

The configuration for **ONVIF User** is very similar to the configuration for **User**, see [Managing User Accounts and Groups](#) on page 126 for more information.

Configuring Security Settings

To allow specific sites to access the NVR

1. Go to Main Menu → SETTING → SYSTEM → Security.

Figure 10-17 System Security Settings Window

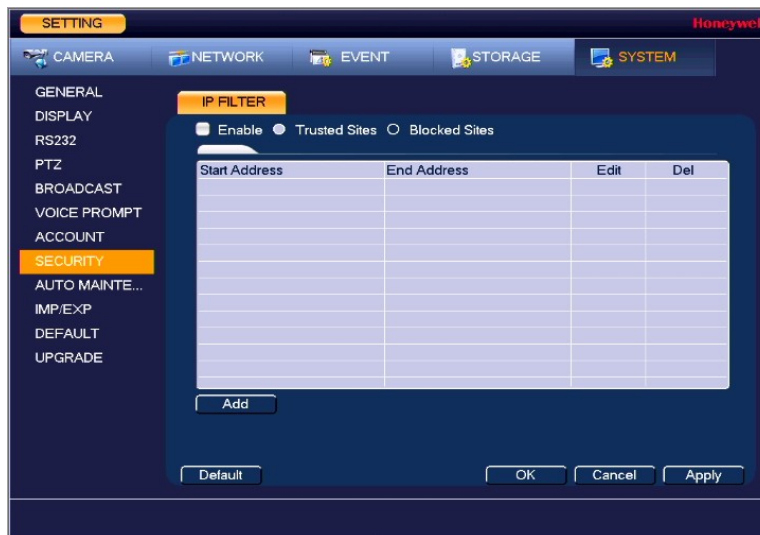

2. Select the **Enable** check box to enable IP filtering.
3. Next to the **Enable** check box, click **Trusted Sites**.
4. Click **Add**.
5. To add a single IP address, select **IP Address** from the drop-down list and enter the IP address of the site that you want to allow and click **OK**.
To add a range of IP addresses, select **IP Section** from the drop-down list and enter the starting address in the upper IP address field and the ending address in the lower field, and then click **OK**. Both IPv4 and IPv6 address are supported.
To add a specific machine, select **MAC Address** from drop-down list and enter the MAC address of the machine you want to allow and click **OK**.
6. Click **Apply** to save your settings.
7. If you want to save your settings and exit the **SETTING** menu, click **OK**.

To block specific sites from accessing the NVR

1. Go to Main Menu → SETTING → SYSTEM → Security.
2. On the **IP Filter** page, select the **Enable** check box to enable IP filtering.

3. Next to the **Enable** check box, click **Blocked Sites**.
4. Click **Add**.
5. To add a single IP address, select **IP Address** from the drop-down list and enter the IP address of the site that you want to block and click **OK**.

To add a range of IP addresses, select IP Section from the drop-down list and enter the starting address in the upper IP address field and the ending address in the lower field, and then click **OK**. Both IPv4 and IPv6 address are supported.

6. Click **Apply** to save your settings.
7. If you want to save your settings and exit the **SETTING** menu, click **OK**.

Configuring Automatic Maintenance Settings

You can set up the NVR to automatically restart.

1. Go to **Main Menu** → **SETTING** → **SYSTEM** → **AUTO MAINTAIN**.

Figure 10-18 Auto Maintenance Configuration Window

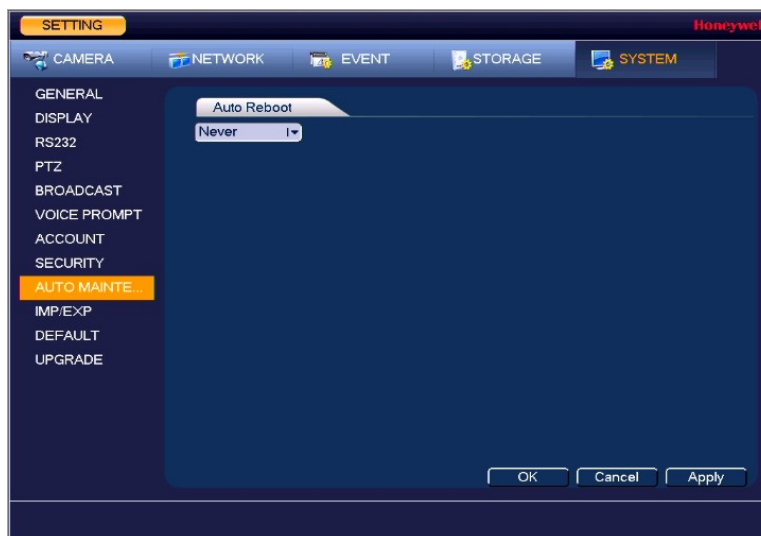

2. Select one of the following options: **Never**, **ALL**, **Sunday**, **Monday**, **Tuesday**, **Wednesday**, **Thursday**, **Friday**, or **Saturday**, and select a time of day to auto reboot from the drop-down menu.
3. Click **Apply** to save your settings.
4. If you want to save your settings and exit the **SETTING** menu, click **OK**.

Exporting and Importing System Configurations

You can export and/or import NVR system configurations if you are installing several NVRs requiring the same setup.

To export a system configuration

1. Go to **Main Menu** → **SETTING** → **SYSTEM** → **IMP/EXP**.
2. Insert a USB storage device (such as a USB flash drive) into one of the USB ports on the NVR. The **Find USB device** dialog box opens.

Figure 10-19 Find USB Device Window

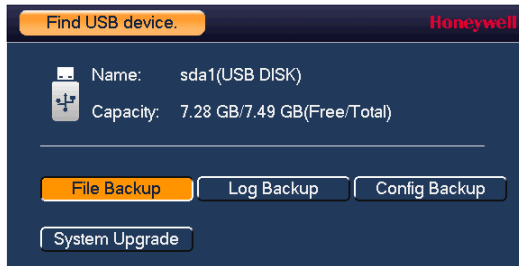

3. In the **Find USB device** dialog box, click **Config Backup**.
4. On the **IMP/EXP** page, click **Refresh**. The page populates with the details of the storage device.

Figure 10-20 Configuration Backup Window

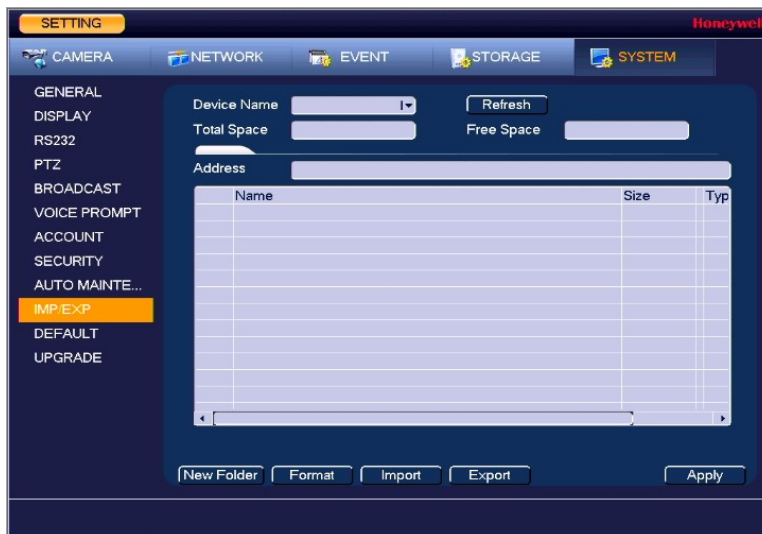

5. Click **EXPORT**. A message appears confirming that the export was successful and the system configuration file (named Config_[YYYYMMDDhhmmss]) is added to the file list.

To import a system configuration

1. Insert a USB storage device containing a system configuration file (exported from another NVR) into one of the USB ports on the NVR. The **Find USB device** dialog box opens.
2. In the Find USB device dialog box, click **CONFIG BACKUP**.
3. On the **IMP/EXP** page, click **Refresh** to show the contents of the USB device. Select the configuration file that you want to import (named Config_[YYYYMMDDhhmmss]), and then click **Import**.

4. Restart the NVR to apply the new settings.

To format an external USB storage device

1. Go to **Main Menu** → **SETTING** → **SYSTEM** → **IMP/EXP**.
2. Insert a USB storage device (such as a USB flash drive) into one of the USB ports on the NVR. The **Find USB device** dialog box opens.
3. In the Find USB device dialog box, click **CONFIG BACKUP**.
4. On the **IMP/EXP** page, click **Refresh**. The page populates with the details of the storage device.
5. Click **Format**.
6. The message "**Confirm format on the selected device?**" appears. Click **OK** to format the storage device.

Restoring Default Settings

You can restore camera, network, event, storage, and system default settings.

Note Restoring the default settings will cause all changes to the system menu color, language, time display mode, video format, IP address, and user accounts to be lost.

1. Go to **Main Menu** → **SETTING** → **SYSTEM** → **DEFAULT**.

Figure 10–21 Default Configuration Window

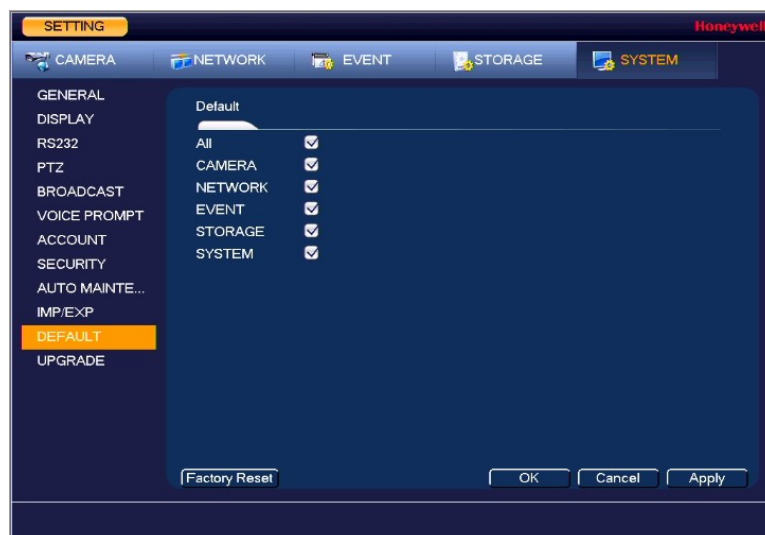

2. Select the check boxes of the items that you want to restore to their default settings, or select **All** to restore all of them to their default settings.

3. Click **Apply** to save your settings.
4. If you want to save your settings and exit the **SETTING** menu, click **OK**.

Note	To return the NVR to its factory default settings, click Factory Reset .
-------------	---

Upgrading the NVR

You can upgrade the system firmware locally at the NVR.

1. Go to **Main Menu** → **SETTING** → **SYSTEM** → **UPGRADE**.

Figure 10-22 Upgrade Window

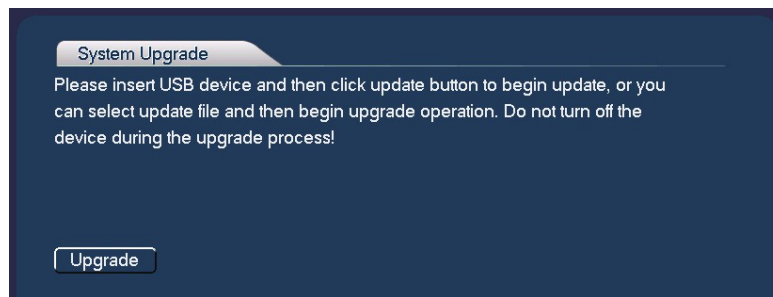

2. Insert a USB storage device (such as a USB flash drive) containing the new firmware into one of the USB ports on the NVR. The **Find USB device** dialog box opens.

Figure 10-23 Find USB Device Window

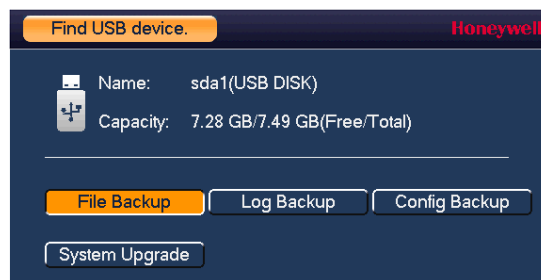

3. In the Find USB device dialog box, click **System Upgrade**.
4. On the **Upgrade** page, click **Upgrade**. The **Upgrade** window opens.

Figure 10-24 Upgrade Window

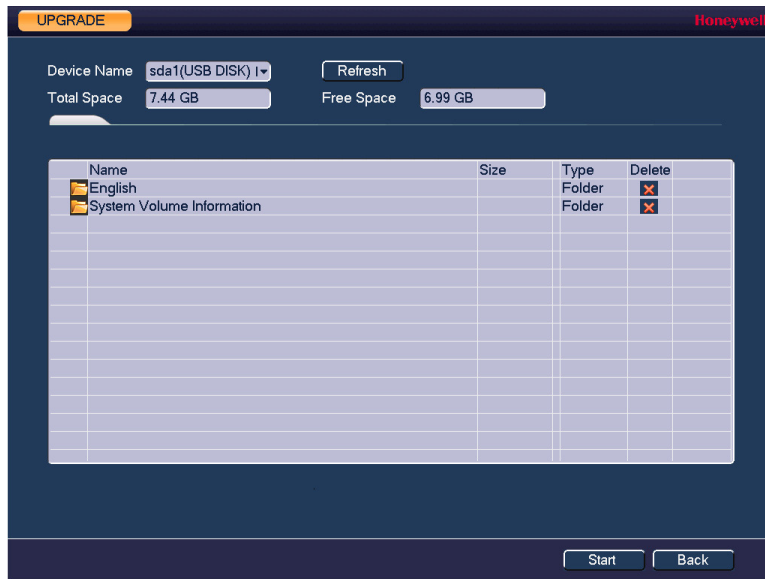

5. Select the firmware file from the file list, and then click **Start**.

11 Viewing Information

This chapter contains the following sections:

- [Viewing System Information](#), on page 137
- [Viewing Event Information](#), on page 140
- [Viewing Network Information](#), on page 141
- [Viewing Log Information](#), on page 144

Viewing System Information

In the system information interface you can view the following:

- Hard Disk information
- Recording information
- Bit stream statistics
- Version details

Viewing Hard Disk Information

1. Go to Main Menu → INFO → SYSTEM → HDD.

Figure 11-1 View HDD Information Window

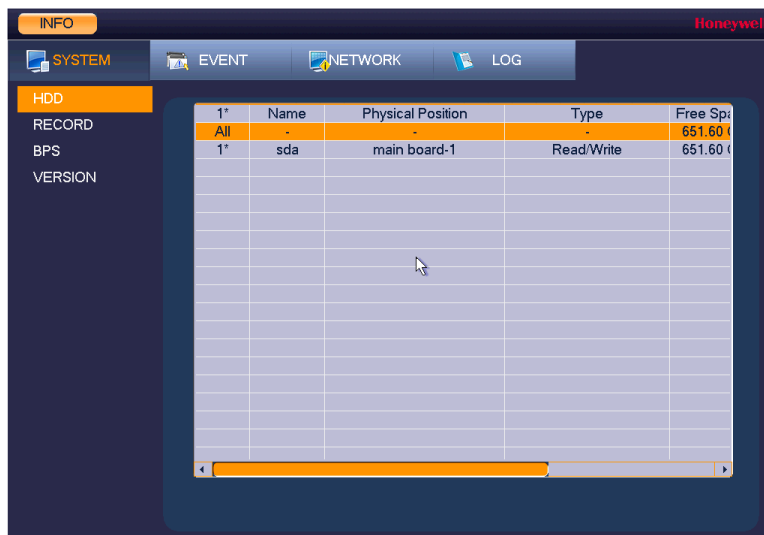

1*	Name	Physical Position	Type	Free Spa
All	-	-	-	651.60
1*	sda	main board-1	Read/Write	651.60

2. Refer to the following table to interpret the HDD information:

SATA: **o** indicates the current HDD is normal.

- x indicates there is an error.
- indicates that there is no HDD.
- ? indicates that a HDD is damaged.

Device Name: Shows the name you have given the device.

Physical Position: Describes the hard drive bay where the hard drive is installed.

Type: Indicates the HDD type (for example, **Read/Write**).

Free Space: Indicates the amount of free space remaining on the HDD.

Total Space: Indicates the total capacity of the HDD.

Status: Indicates the operating status of the HDD.

S.M.A.R.T.: Indicates S.M.A.R.T (Self-Monitoring, Analysis, and Reporting Technology) status.

3. In the list of HDDs, double-click a HDD to view more details .

Figure 11-2 S.M.A.R.T. Information Window

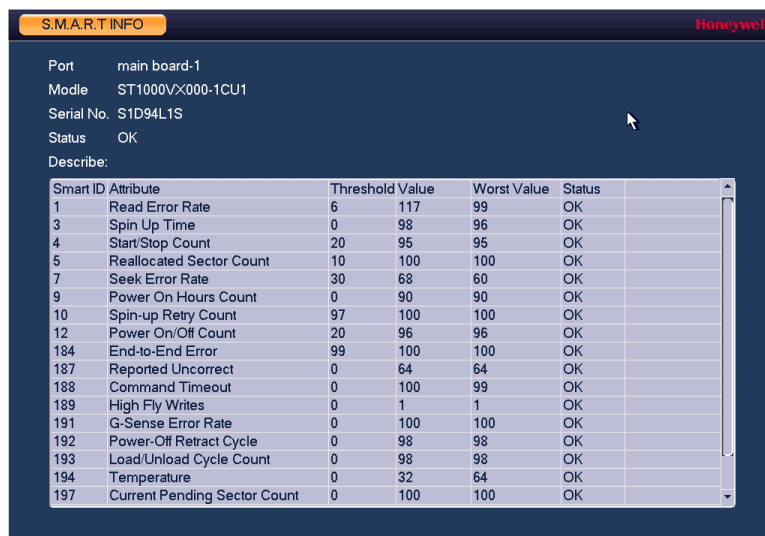

4. Right-click to return to the previous screen.

Viewing Recording Information

Go to **Main Menu** → **INFO** → **SYSTEM RECORD**.

Figure 11-3 Recording Information Window

All	Device Name	Start Time	End Time
All		2000-00-00 00:00:00	2000-00-00 00:00:00

On the **Record Info** page, you can view the device name as well as the start and end times for recorded video.

Viewing Data Stream Information

Go to Main Menu → INFO → SYSTEM → BPS.

Figure 11-4 BPS Information Window

Channel	Kb/S	Resolution	Wave
1	3789	1920*1080	[]
2	3789	1920*1080	[]

On the **BPS** page, you can view the current video data stream rates and resolutions for each channel.

Viewing Version Information

Go to Main Menu → INFO → SYSTEM → VERSION.

Figure 11-5 Version Information Window



On the **VERSION** page, you can view the number of channels, number of alarm inputs and outputs, system version number, build date, web and ONVIF versions, and serial number.

Viewing Event Information

Viewing Alarm Status Information

Go to Main Menu → INFO → EVENT → Alarm Status.

Figure 11-6 Alarm Status Information Window



On the **Alarm Status** page, you can view alarm status information at the device level and at the channel level. The NVR automatically refreshes this information.

Viewing Heat Map Information

Note

This function is only available for HEN081*4/HEN162*4/HEN163*4/HEN161*4/HEN322*4/HEN323*4/HEN321*4/HEN642*4/HEN643*4.

Go to **Main Menu** → **INFO** → **EVENT** → **Heat Map**.

Figure 11-7 Heat Map Information Window

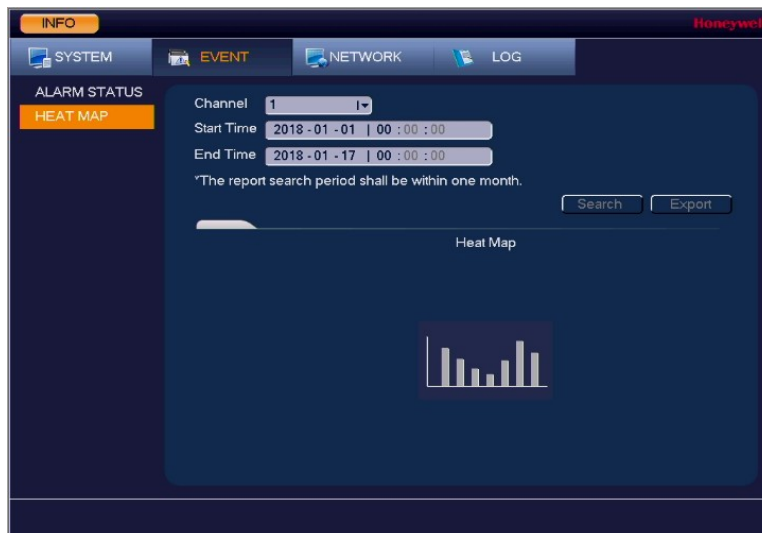

On the **Heat Map** page, you can search and export the heat map information.

To search the heat map information, select a channel, start time and end time, and then click **Search**.

After the search, if you want to export the heat map information, click **Export**.

Viewing Network Information

In the network information interface you can view and/or block online users, view network data transmission details, and perform network tests.

Viewing Online Users

You can view the user name, IP address, and login time of all online users. You can also block an online user for a specified period of time.

To view online users

Go to **Main Menu** → **INFO** → **NETWORK** → **ONLINE USERS**.

Figure 11-8 Viewing Online Users

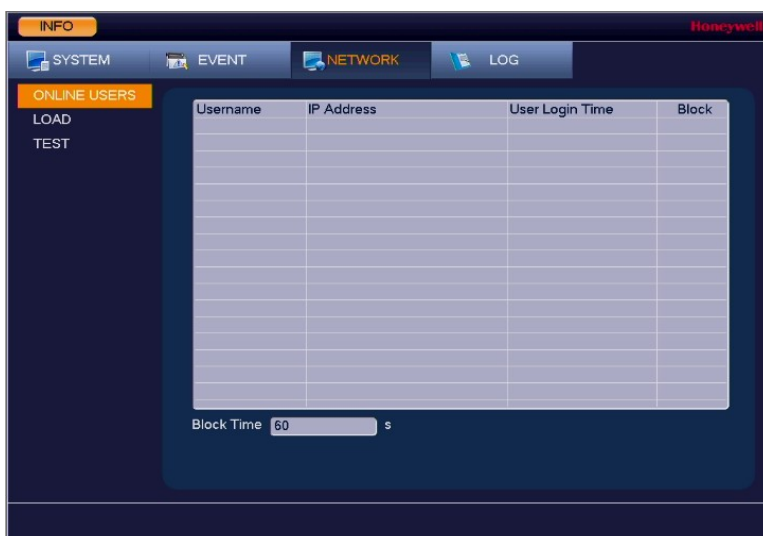

Note Every five seconds, the NVR system detects newly added or dropped users, and updates the list of online users.

To block an online user

1. Go to **Main Menu** → **INFO** → **NETWORK** → **ONLINE USERS** .
2. Click the **Block for** icon in the user list, and then, in the **Block for** box at the bottom of the screen, enter the time in seconds that you want to block the user for. You can enter up to **65535** seconds (18.2 hours).

Viewing Network Load Information

Go to **Main Menu** → **INFO** → **NETWORK** → **Load**.

Figure 11-9 Viewing Network Load

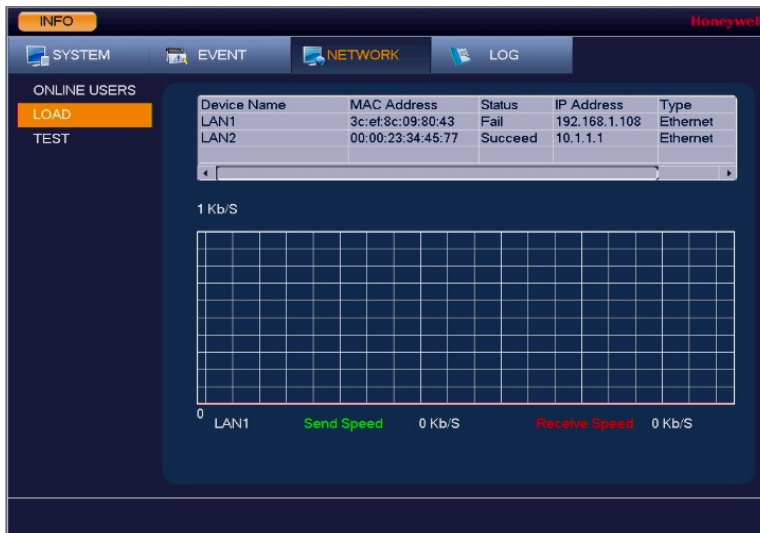

On the **Load** page, you can view the network device name, MAC address, status (**Succeed** or **Failed**), device IP address, network type, the maximum transmission unit (MTU), send speed, and receive speed.

Viewing Network Test Information

1. Go to Main Menu → INFO → NETWORK → Test.

Figure 11-10 Testing the Network



2. On the **Test** page, under **TEST**, enter a valid IPv4 address or domain name in the **Destination IP** box, and then click **Test**.

The test result displays the average delay and packet loss rate. It also indicates if the network status is **OK**, **Bad**, or **No Connection**.

To back up network packet data to an external USB storage device

3. Insert a USB storage device (such as a USB flash drive) into one of the USB ports on the NVR.
4. On the **Test** page, under **Network Sniffer Packet Backup**, click **Refresh**. The connected USB storage device should appear in the Device Name box.
5. If you want, click **Browse** to set the saving path.
6. In the network devices list, in the **Sniffer Packet Backup** column, click the green arrow button to start capturing the data. Click the button again to stop capturing the data.

Viewing Log Information

To view log information

1. Go to **Main Menu** → **INFO** → **LOG**.

Figure 11-11 Viewing Log Information

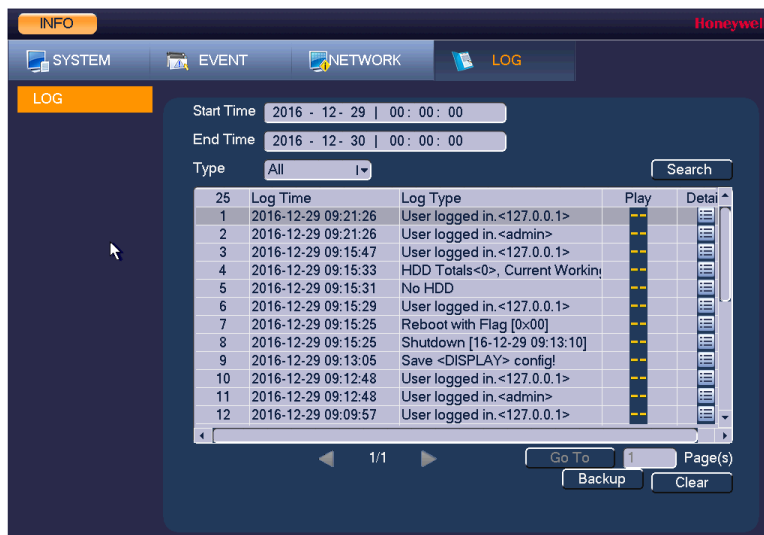

2. In the **Start Time** and **End Time** boxes, enter the time period to search the log.
3. In the **Type** box, select a specific log type to view (**System, Config, Storage, Alarm, Record, Account, Clear, Playback, Connection**) or select **All** to view all logs, and then click **Search**.

The search results are displayed in an ordered list. The NVR can save up to **1024** log files.

4. To view more details about a log entry, click the **Details** button for that row.

To back up log information to an external USB storage device

1. Insert a USB storage device (such as a USB flash drive) into one of the USB ports on the NVR. The **Find USB device** dialog box opens.

Figure 11-12 Find USB Device Window



2. In the **Find USB device** dialog box, click **Log Backup**.
3. On the **Log** page, click **Backup**. The log file (**FileLog.txt**) is located in a folder named **Log_[YYYYMMDDhhmmss]** on your storage device.

12 Web Client Operation

This chapter describes how to access Honeywell's Performance Series Network Video Recorder remotely using a browser-based web client.

This chapter is intended for remote users of the NVRs.

Logging In

This chapter includes:

- PC requirements for the web client software
- Logging in to the web client software
- The web client software's main page

Preparing to Use the Device Web Client

PC Requirements

Table 12-1 PC Requirements

Component	Minimum Requirement
Processor	Quad core
System memory (RAM)	2G or higher
Non-integrated video card	256M or higher

Before You Log In

Ensure that the following conditions are met:

- Ensure that the network connection is good.
- Ensure that the NVR and PC network setup is correct. See the network setup: **Main Menu** → **Setting** → **Network**.
- Ping to ensure that the network connection is good. Ping `*** **` (where `*** **` is the NVR's IP address). The return TTL should be less than 225.

Note

Before you uninstall the web control, close all web pages. If you do not, then the uninstallation procedure might result in an error.

- The current NVR supports various browsers such as Apple Safari and Mozilla Firefox. The NVR supports multiple-channel monitoring (depending on your model) on an Apple PC.

Logging In

1. Open a Web browser window.

Note These instructions were created using IE. You can use Internet Explorer (IE), Safari, or FireFox.

Figure 12-1 IE Window

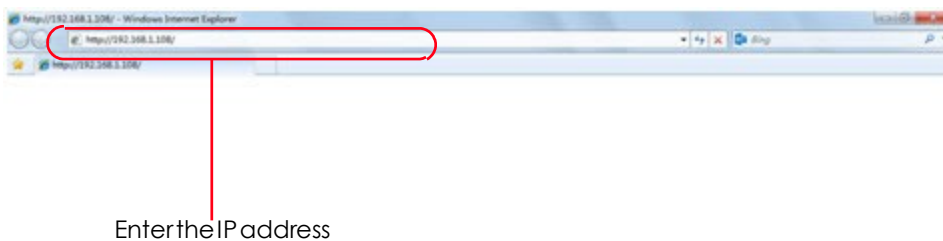

2. Enter the NVR IP address in the address field.

For example, if your NVR's IP address is **192.168.1.108**, then enter **http://192.168.1.108** in the address field.

Press **Enter** on the keyboard and the following window is displayed:

Figure 12-2 Security Problem

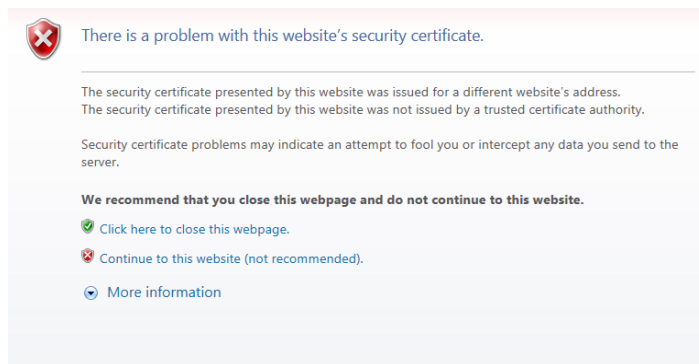

3. Click **Continue to this website (not recommended)**. The following window is displayed:

Figure 12-3 Enter Password

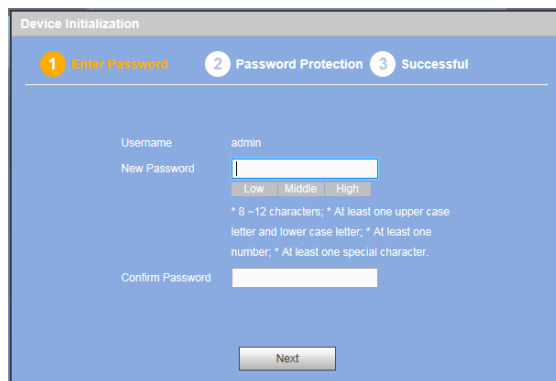

4. Enter new password and confirm password. Click **Next** and the following window is displayed:

Figure 12-4 Password Protection

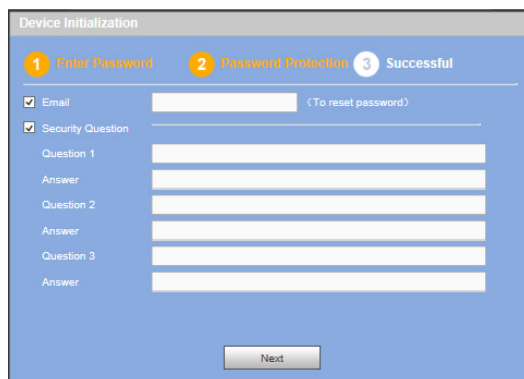

Email: Enter an E-mail address. It is used when you want to reset the password.

Security Question: Enter the Security Questions. You should enter all the three security questions.

If you uncheck Email and Security Question, a warning message will be displayed as below:

Figure 12-5 Warning Message 1

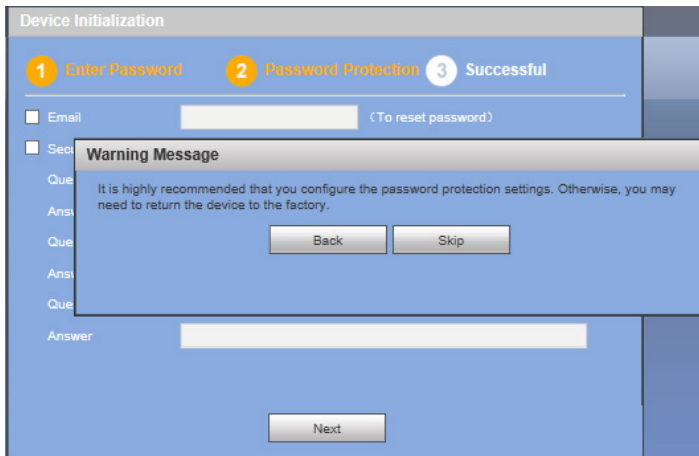

If you upgrade the firmware from previous version to this version (20190129) and if you uncheck Email and Security Question in the previous version, it will display the following message after the system reboot.

Figure 12-6 Warning Message 2

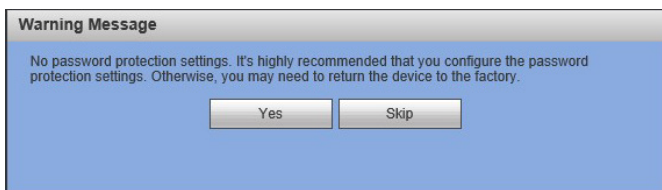

5. After you configured the password protection settings, the following figure is displayed:

Figure 12-7 Successful

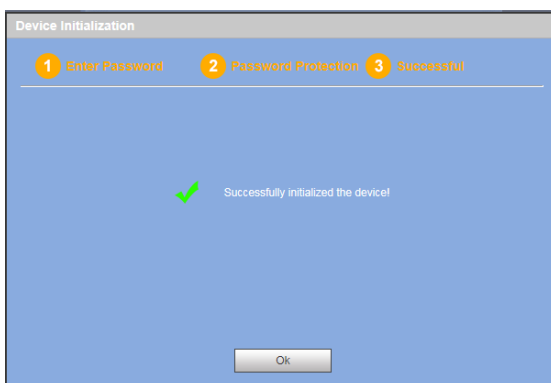

Click **OK** and the following window is displayed:

Figure 12-8 Web Service Login Window

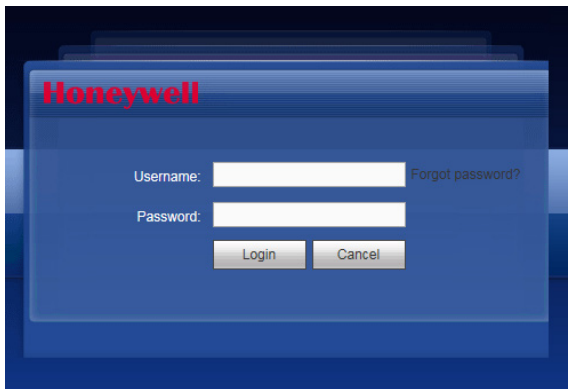

6. Enter your username and password, then click **Login**.
A message pops up asking if you want to install controls.

Figure 12-9 Controls Installation Popup Message

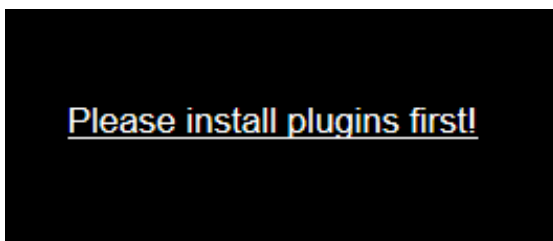

7. Click the message and the following message is displayed:

Figure 12-10 Run Plugin Message



8. Click **Run** to run the plugin. The relevant plug-ins might be blocked by your web browser security settings as shown in the following figure:

Figure 12-11 Unblocking Security Plug-ins

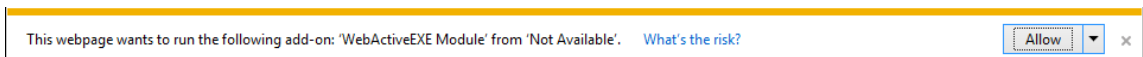

9. Click **Allow**.

Main Window

The main window is divided into 4 main sections. You can select different channels and different modes at the bottom of the interface.

Figure 12-12 Main Window

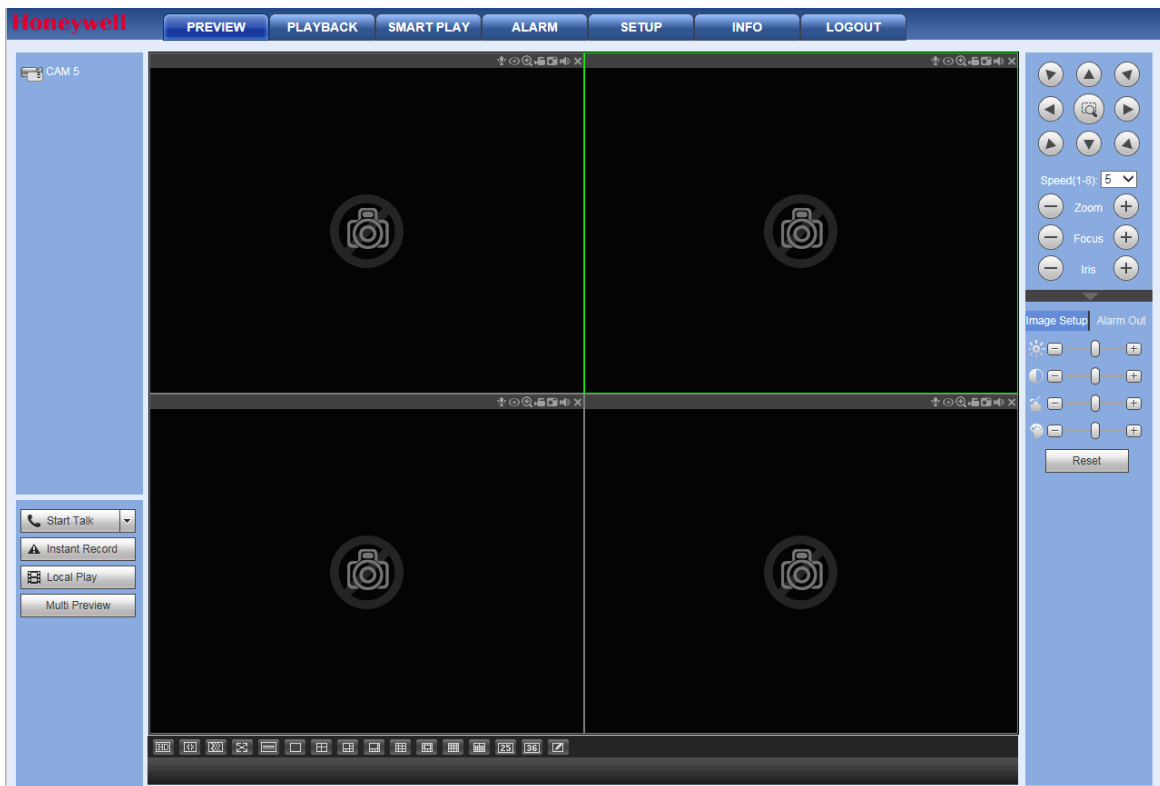

Section 1: Function Buttons

Figure 12-13 Main Window Function Tabs



There are six function tabs:

- **Preview:** You are currently in the Preview (Live) mode, where you can see all these tabs.
- **Playback:** See [Playback](#) on page 228
- **Smart Play:** See [Using the Smart Player to Playback Event Video](#) on page 234
- **Alarm:** See [Alarms](#) on page 235
- **Setup:** See [Configuration](#) on page 161
- **Info:** See [Information](#) on page 158
- **Logout:** See [Logging Out](#) on page 155

Section 2: Monitor Channels and Function Buttons

Figure 12-14 Monitor Channels Section and Function Buttons

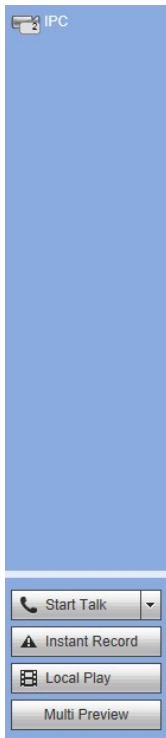

Monitor Channels

The **Monitor Channels** section displays monitor channels that are successfully connected to the NVR. Left-click to select a channel for viewing.

Main Stream and **Sub Stream** - Navigate your mouse to a camera channel window to find the Main Stream and the Sub Stream.

Figure 12-15 Main Stream and Sub Stream

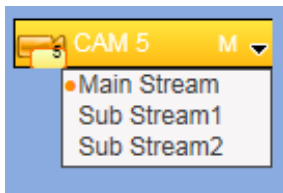

Start Talk Button

Figure 12-16 Start Talk Button

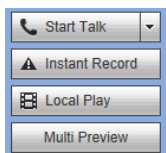

Enabling Bi-Directional Communication

1. Click to enable bi-directional communication.
2. Click ▼ in the control panel on the right to select the bi-directional communication mode. There are four options for the communication mode: **DEFAULT**, **G711a**, **G711u**, and **PCM**.

Figure 12-17 Talk Mode Options

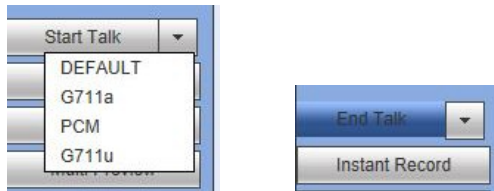

Note

After you enable bi-directional communication, if the audio input port that goes from the device to the client end is using the first channel audio input port, then the system will not encode the audio data from that one channel. See [Setting Up Bi-Directional Communication Connection](#) on page 24 for more about the audio connections.

Disabling Bi-Directional Communication

After turning on Bi-directional Communication, the **Start Talk** button turns into an **End Talk** button. Click this button to end bi-directional communication.

Instant Record Button

Figure 12-18 Instant Record Button

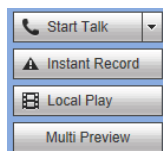

Click **Instant Record**, and the button turns blue. The NVR begins manual recording. Click **Instant Record** again to restore the NVR to the previous recording mode.

Local Play Button

The NVR can play back saved files (in the.dav format) in the PC.

1. Click **Local Play**, and an interface appears for selecting the playback file.

Figure 12-19 Local Play - Select a File Interface

2. Select a file, then click **Open**. A media player opens and plays the selected video.

Section 3: PTZ Control Panel, Image and Alarm Configuration Panels

PTZ Control Panel

See [Controlling PTZ Cameras](#) on page 30 for more about controlling PTZ cameras.

Image and Alarm Configuration Panels





See [Configuring Camera Image Conditions Settings](#) on page 163 for more information about Image settings.

See [Alarms](#) on page 235 for more information about Alarms.

Section 4: Viewer Configuration Controls

Table 12-2 Viewer Configuration Controls

Button	Name	Description
	Video Quality	Click to select the video quality. Select either High quality or Low quality.
	Aspect Ratio	Click to switch between the camera's native aspect ratio and the best aspect ratio to fit in the current video panel.
	Fluency	Click to configure the fluency. Select from Fluency Level 1 , Fluency Level 2 , Fluency Level 3 , Middle level , Latency Level 1 , Latency Level 2 , and Latency Level 3 .
	Full Screen	Click to switch the viewer to show video full screen. Click Esc (on your PC) to quit full screen.

	Vertical Synchronization	Click to configure vertical synchronization.
	Single-channel Window	Click to switch to single channel viewing.
	Multi-channel Windows	Click to switch to different viewing window configurations.
	Custom Split	Select the window split mode that you set in the Custom Split window. See Custom Split Configurations on page 218.

Logging Out

Click the **Logout** tab in the **Main Menu**. The NVR returns to the **Login** interface.

Figure 12-20 Login Interface

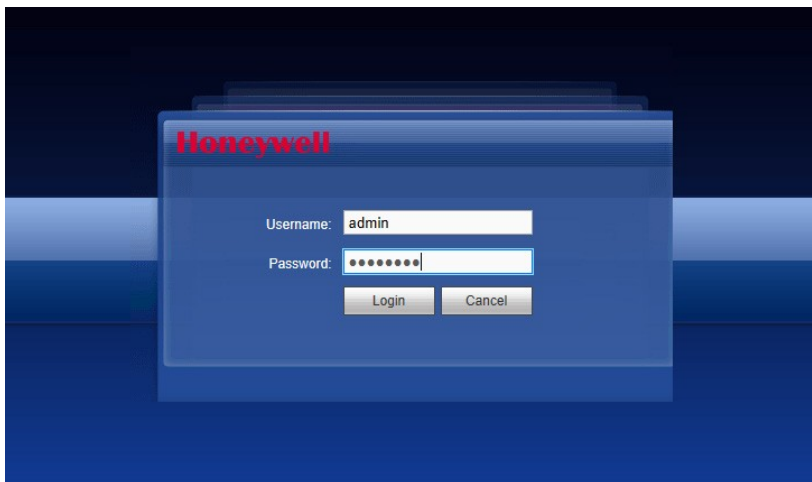

Uninstalling the Web Control

You can use the web un-install tool **uninstall_web.bat** to uninstall the web control plugin.

Note Before un-installing the web control plugin, close all web pages. If you do not, then errors may occur to the system.

Live Viewing

This chapter includes:

- A description of the NVR web client.
- Descriptions of image/relay output settings, including image settings.
- Descriptions of the Information available for viewing in live view, including system version, log, connection log, and online user information.

Live Viewing

Left-click a channel name in Section 2, the **Monitors Channel** section, to select that channel for viewing.

The video window shows statistics about the video.

Figure 12-21 Live View Video Window



Table 12-3 Live View Video Window Controls

Control	Description
Display Device Information	Shows the following information about the video: <ul style="list-style-type: none"> • IP address • Channel number • Bit rate • Stream: Displays M for Main stream or S1/S2 for a sub stream
Audio Talk	Click this button to enable/disable bi-directional audio talking.

Fisheye Mode	Click this button to change the camera display mode to Fisheye mode. This display mode is only supported by fisheye cameras. See your Fisheye camera manual for more information.
Digital Zoom	Click this button and then left drag the mouse in the zone to zoom in. Right-click the mouse to return to the original viewing status.
Local Record	When you click the Local Record button, the system/NVR begins recording. The recorded file is saved to the default system folder: \RecordDownload .
Snapshot	Click to take a snapshot of the currently viewed video. All images are saved to the default system folder: \picture download .
Audio	Turn audio On or Off . Note: This control has nothing to do with the system audio setup.
Close Window	Close video in the current window.

Image/Relay-out Settings

Configuring Image Settings

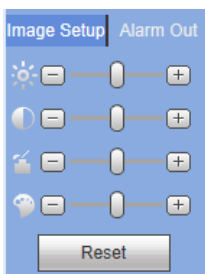

Here you can adjust the selected channel's brightness, contrast, hue, and saturation.

Figure 12-22 Image Settings



1. Click to select one channel's video. The currently selected channel border turns Green to indicate it is selected.
2. Click the Image adjustment buttons in Section 8.

Table 12-4 Image Settings

Setting	Description
	Adjusts the monitor's video brightness.
	Adjusts the monitor's video contrast.
	Adjusts the monitor's video hue.

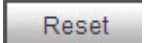
	Adjusts the monitor's video hue.
	Adjusts the monitor's video hue.

To return the NVR system to default settings, click **Reset**.

Note All of these configurations apply to the Web Viewer only.

Information

Version

1. Click **Info** to see the Info menu tree.
2. Click **Version** to open the **Version** interface.

Figure 12-23 Version Interface



Here you can view the recording channel, the alarm input/output information, the software version, and the release date. None of these values can be changed; they are viewable only.

Log

Click **Log** in the **Info** menu to open the **Log** configuration interface.

Figure 12-24 Log Configuration Interface

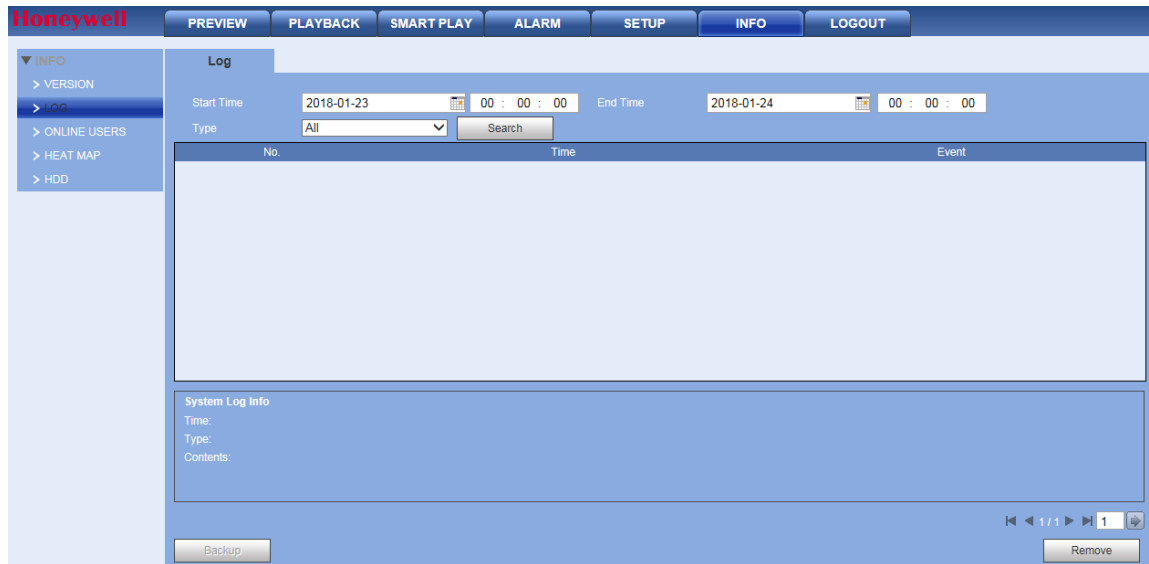

Table 12-5 Log Configurations

Configuration	Description
Start Time	Set a start time for the log.
End Time	Set an end time for the log.
Type	Select from System, Config Operation, Storage, Alarm, Record Operation, Account, Clear Log, Playback, Connection, and All.
Search	Click Search to find a log or logs that fit the search requirements (Start time, End time, and Type). You can click Stop to terminate the current search.
System Log Info	Select one log item to see its detailed information.
Remove	Click to clear the found log files. Note You cannot clear by log file.
Backup	Click to backup the currently selected files to the selected PC.

Online User

Click **Online Users** in the **Info** menu to open the **Online User** interface.

Figure 12-25 Online User Configuration Interface

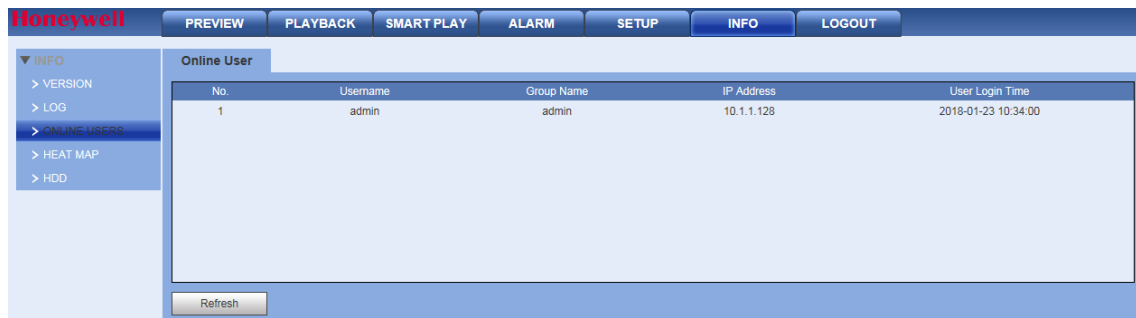

You can view the user name, group name, IP address, and login time of all online users.

Heat Map

On the **Heat Map** page, you can search and export the heat map information.

Note

This function is only available for HEN081*4/HEN162*4/HEN163*4/HEN161*4/HEN322*4/HEN323*4/HEN321*4/HEN642*4/HEN643*4.

Click **Heat Map** in the **Info** menu to open the **Heat Map** interface.

Figure 12-26 Heat Map Configuration Interface

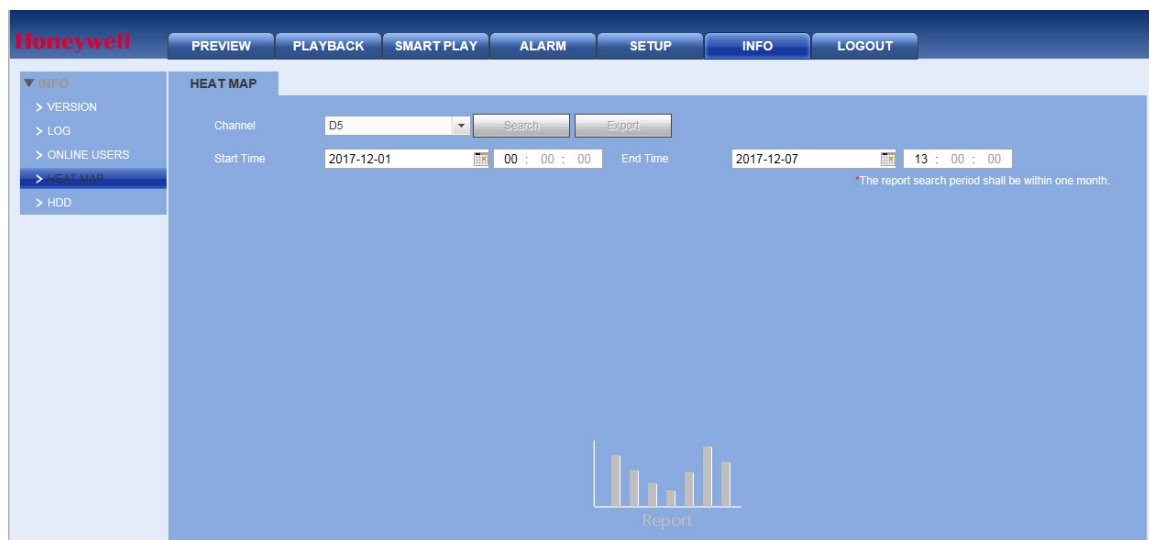

To search the heat map information, select a channel, start time and end time, and then click **Search**.

After the search, if you want to export the heat map information, click **Export**.

Hard Disk Drive Info

1. Click **HDD** in the **Info** menu to open the **HDD** interface.

Figure 12-27 HDD Interface



2. Refer to the following table to interpret the HDD information:

Table 12-6 HDD Information

Device Name	Shows the name you have given the device.
Physical Position	Describes the hard drive bay where the hard drive is installed.
Free Space	Indicates the amount of free space remaining on the HDD.
Total Space	Indicates the total capacity of the HDD.
Status	Indicates the operating status of the HDD.
S.M.A.R.T.	Indicates S.M.A.R.T (Self-Monitoring, Analysis, and Reporting Technology) status.

3. Click **HDD Time** to view the time information for the selected hard disk.
4. In the list of HDDs, double-click a HDD to view more details, if necessary.

Configuration

This chapter includes descriptions about how to configuring the following:

- Camera setup
- Network setup
- Event settings
- Storage
- General settings, including the following:
 - the device's name and number
 - the interface language
 - the video standard
 - what happens when the HDD is full
 - the pack duration

Camera Setup

You can add IP cameras to the NVR either by automatically discovering and adding the camera or by manually entering the camera details to add the camera.

Adding a Camera by Searching

1. In the **Setup** tab, go to **IMAGE → Registration**.

Figure 12–28 Camera Registration Interface

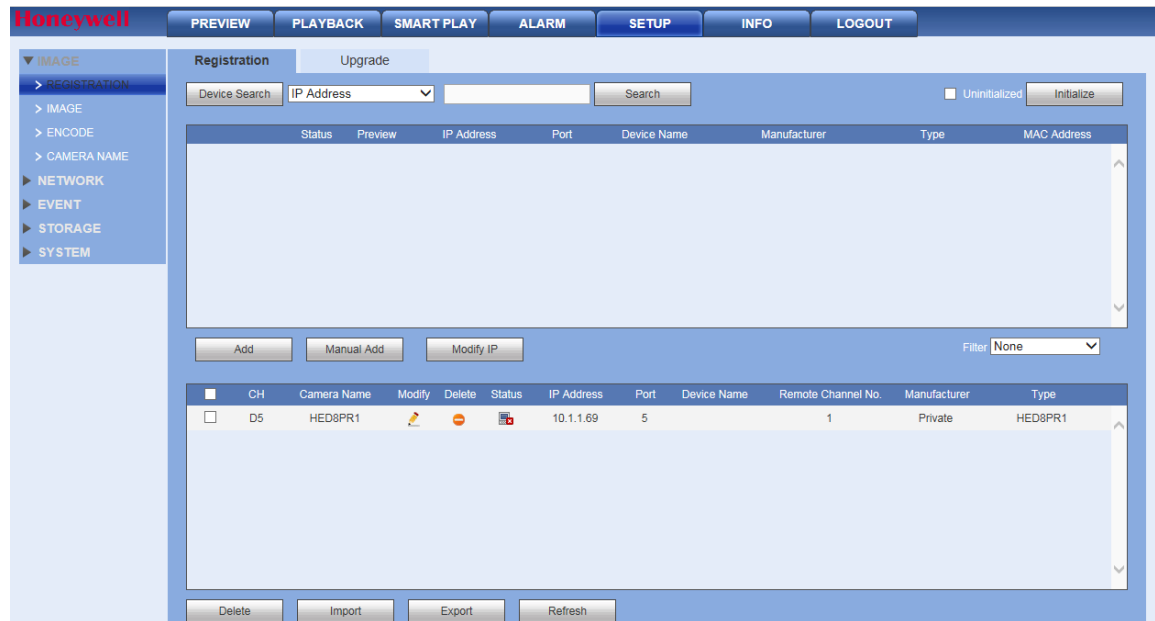

2. Search the camera.

Automatically Search: Click **Device Search** to automatically find IP cameras.

Search by IP Address or MAC Address: Select IP Address or MAC Address in the dropdown list next to **Device Search**, enter the IP Address or MAC Address and Click **Search**.

- a. Click to select the found camera.
- b. Click **Add** to add the found device to the **Added Device** list.

Note

If the NVR fails to display the model name of a found device, click **Device Search** to rediscover the online devices. The model name should appear in the Found Devices list.

Adding a Camera Manually

Click **Manual Add** as shown in [Figure 12-28](#) and manually configure the following settings:

Figure 12-29 Manually Adding a Camera Window

Table 12-7 Manual Add

Parameter	Function
Manufacturer	Select the manufacturer that applies to your camera from the list.
IP Address	Enter the IP address for the camera.
TCP Port	Enter the TCP port for the camera. (Optional)
Username	Enter a username.
Password	Enter a password
Channel No.	Enter a channel amount or click the Connect button to get the channel amount of the remote device. Note: We recommend click the Connect button to get remote device channel amount, the manual add operation may result in failure if the input channel amount is not right.
Remote Channel No.	After getting the remote device channel amount, click Setup to select a channel. Note: Click to select one or more remote channel numbers here.
Channel	The local channel number you want to add. One channel name has corresponding one channel number.
Decode buffer	Select from the drop-down menu of options.

Click **OK**. The newly added camera appears in the Added Device list.

Configuring the Camera Setup through the Remote Interface

If the NVR connects to an IP camera through a private protocol, then the **Camera Image Conditions** page displays. If the NVR connects to an IP camera through the ONVIF protocol, then the **Camera Image Conditions** does not display.

Configuring Camera Image Conditions Settings

In the **Camera Image Conditions** window, you can view the camera device properties. Any changes are immediately active after you set them.

On the **Setup** tab, click **Image** under **IMAGE** to open the **Conditions**. After making any Condition changes, click **OK** to save the changes.

Note

The NVR automatically defaults to selecting channel 1 when you navigate between configuration interfaces. For example, if you have selected channel 3 on the Motion Detection configuration interface, and then navigate to the Channel Name configuration interface, the NVR defaults to channel 1 in the Channel selection drop-down. If there is no channel 1 connected, the NVR defaults to the first available channel.

Figure 12-30 Camera Image Conditions Interface

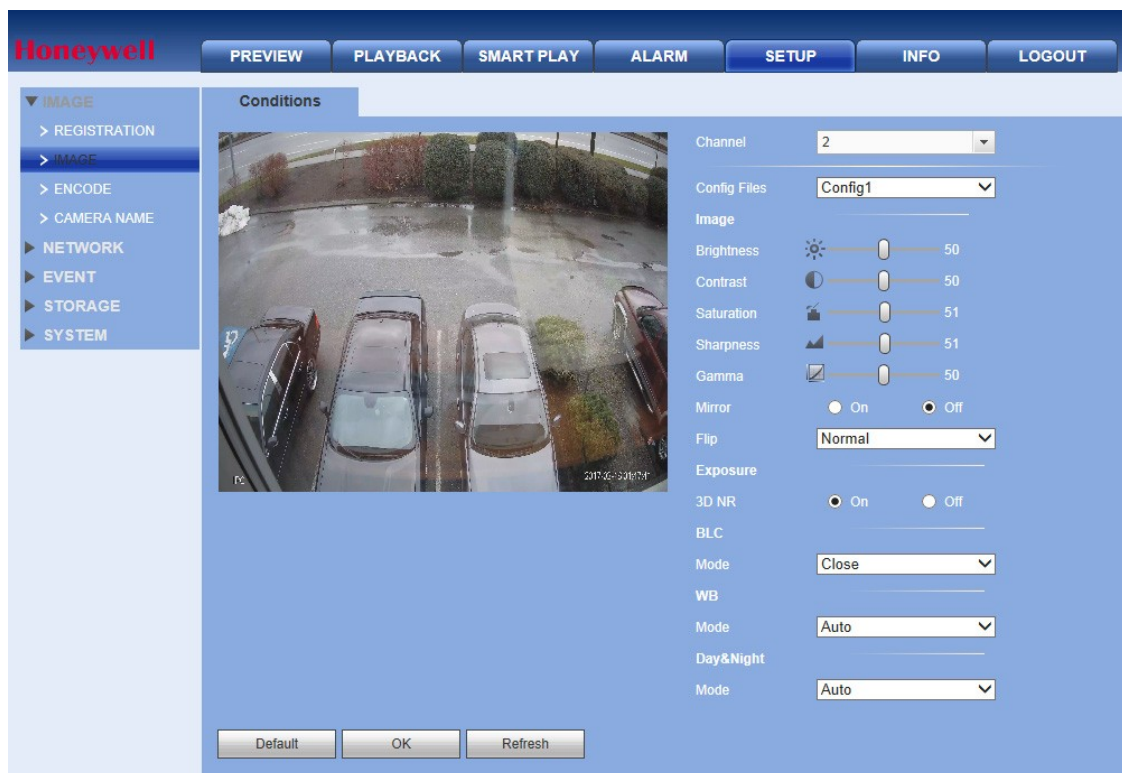

Table 12-8 Camera Image Conditions

Setting	Description
Channel	Select a channel from the dropdown list. Note The NVR shows only the number of connected cameras.
Config File	Select a pre-programmed configuration files for different kinds of settings as programmed by the user. Select from Config1, Config2, or Config3.
Brightness	Adjusts the monitor window brightness. The default setting is 50. The higher the number, the brighter the video. When you select a value, the bright and dark elements of the video are adjusted. Use this function to adjust video brightness when the entire picture is too dark or too bright. Select from 0 to 100. The recommended range is 40 to 60.

	<p>Note The video might become washed out if you select a high brightness value.</p>
Contrast	<p>Adjusts monitor window contrast. Select from 0 to 100. The default setting is 50. The recommended range is 40 to 60.</p> <p>The higher the value, the higher the contrast between light and dark elements in the image. Use when the video brightness is good, but the contrast is not.</p> <p>The video might become washed out if you select a low contrast value. If the value is too high, the dark sections might lose brightness and the light parts might become overexposed.</p>
Saturation	<p>Adjusts monitor window saturation. Select from 0 to 100. The default setting is 50. The recommended range is 40 to 60.</p> <p>The higher the number, the stronger the color. This value has no effect on the general brightness of the video. The video color might become too strong if the value is too high.</p> <p>Note If the value is too low, the video might be poor.</p>
Sharpness	<p>Affects the edge definition of objects in the image. The higher the setting, the more image detail is apparent.</p> <p>Note Noise in the image might become noticeable at higher settings.</p>
Gamma	<p>Adjusts video gamma correction. Choosing a higher value increases the brightness of the video without washing it out as the Brightness value could do. Select from 0 to 100. The recommended range is between 40 and 60. The default value is 50.</p>
Mirror	<p>Enable or disable the mirror function, which reverses the video image so the left side becomes the right side. Disabled by default.</p>
Flip	<p>Select an angle on which the video will be flipped. Options are Normal (default), 180°, 90°, and 270°.</p>
3D NR	<p>Enable/disable 3D noise reduction.</p>
BLC Mode	<p>Sets the camera backlight compensation mode. BLC Modes:</p> <p>Close: BLC function is disabled. This is the default setting.</p> <p>BLC Mode: The camera auto exposures according to the environment so that the darkest area of video is clear.</p> <p>WDR: The camera lowers the brightest areas and enhances the darkest areas so both areas can be clearly viewed at the same time. Set the WDR value from 1 to 100.</p> <p>HLC: The camera lowers the brightness of the brightest area according to the HLC control level (from 1 to 100).</p>
WB Mode	<p>This is the white balance. You can select different scene modes such as Auto,</p> <p>Outdoor, Natural, Street Lamp or Manual, to achieve the best quality video. Scene Modes:</p> <p>Auto: Auto white balance is on. The system automatically adjusts the color temperature to ensure that the video color is correct.</p> <p>Outdoor: The white balance threshold is set to outdoor mode.</p> <p>Natural: The white balance threshold is set to natural mode.</p>

	<p>Street Lamp: The white balance threshold is set to street lamp mode.</p> <p>Manual: You can manually set the gain for the red/blue channel. The value ranges from 0 to 100.</p>
Day/Night	<p>Sets the camera color and the B/W mode switch. Day&Night Modes:</p> <p>Colorful: The camera outputs video in color.</p> <p>Auto: The camera switches from Color to Black & White according to the conditions, such as if the scene is generally bright, or if IR illumination is required.</p> <p>B/W: The camera outputs black and white video.</p>

Configuring Encoding Settings

Click **ENCODE** under **Image** to open the **Encode** interface. After making any Encoding changes, click **OK** to save the changes.

Figure 12-31 Encode Configuration Interface

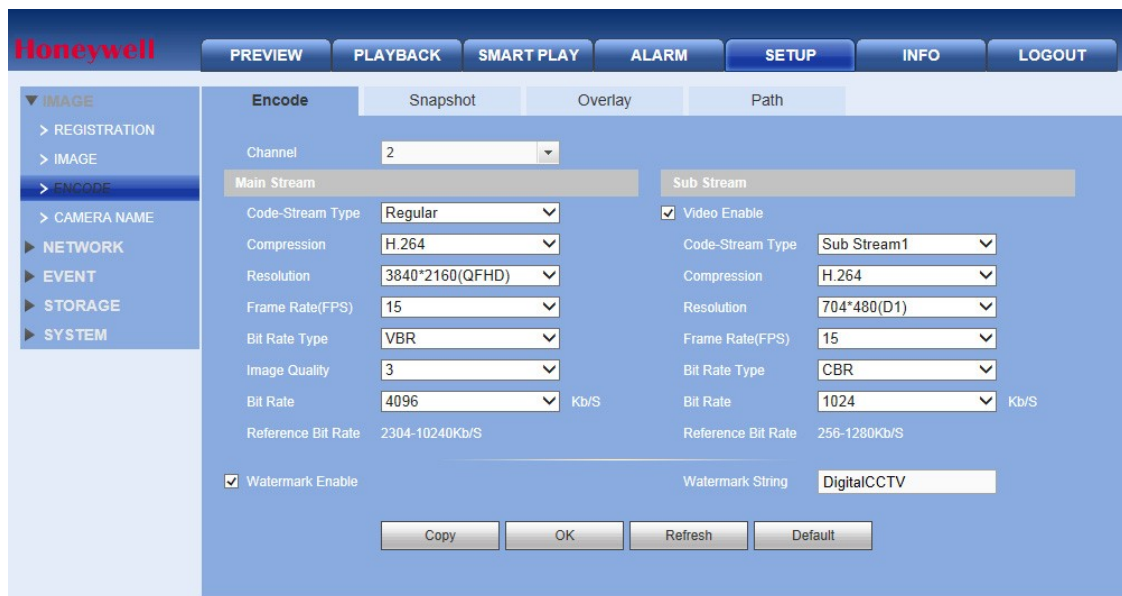

Note If the NVR fails to retrieve the configuration information for your selected camera/channel, then you should navigate to a different window (such as **Snapshot** or **Overlay**), then navigate back to the **Encode** window to refresh it.

Table 12-9 Encoding Configurations

Setting	Description
Channel	Select a channel from the drop-down list.
Code Stream Type	Select from Regular, MD, and Alarm. You can select different encoding frame rates for different recorded events.

	<p>The NVR system supports active control frame function (ACF), which allows you to record in different frame rates.</p> <p>For example, you can use a high frame rate to record important events, and configure a lower frame rate for recording scheduled events. ACF allows you to set different frame rates for motion detection recording and alarm recording.</p>
Video Enable	Click to enable the extra video stream. Enabled by default.
Compression	The NVR supports H.264, H.265 and MJPEG. compressions.
Resolution	<p>The NVR system supports various resolutions, which you can select from a drop-down list.</p> <p>Note The selection is different for each NVR series and the camera that is connected.</p>
Frame Rate	<p>PAL: 1 to 25 fps</p> <p>NTSC: 1 to 30 fps</p>
Bit Rate Type	<p>Select either CBR (constant bit rate) or VBR (variable bit rate).</p> <p>Note If your device is connected to the NVR through ONVIF, then you can not select VBR. If your device is connected to the NVR through a private protocol, then you can select either CBR or VBR.</p>
Image Quality	If the bit rate type is set to VBR, select a value between 1 and 6.
Bit Rate	Set to a value within the Reference Bit Rate range. To enter a bit rate that does not appear on the list, click Customized.
Watermark Enable	Allows you to verify that the video has not been tampered.
Watermark String	<p>Enter the text for the watermark. The default watermark is DigitalCCTV.</p> <p>The maximum text length is 85 characters. You can use only letters, numbers, and an underline.</p>

Configuring Snapshot Settings

Go to **SETUP → IMAGE → ENCODE → Snapshot**. After making any Snapshot changes, click **OK** to save the changes.

Figure 12-32 Snapshot Settings Interface



Table 12-10 Snapshot Settings

Setting	Description
Channel	Select a channel.
Mode	Select from two modes: Timing (scheduled) and Trigger . Timing : the snapshot is available during the period you specify. Trigger : the snapshot is available only when a motion detection alarm, tampering alarm, local activation, or other alarm occurs.
Image Size	Matches the resolution of the main stream.
Quality	Select from six quality levels.
Interval	Set the snapshot frequency. The value ranges from 1SPL to 7SPL , or you can set a Customized time. The maximum is 3600s/picture.

Configuring Video Overlay

Go to **SETUP** → **IMAGE** → **ENCODE** → **Overlay**. After making any Overlay changes, click **OK** to save the changes.

Figure 12-33 Video Overlay Configurations

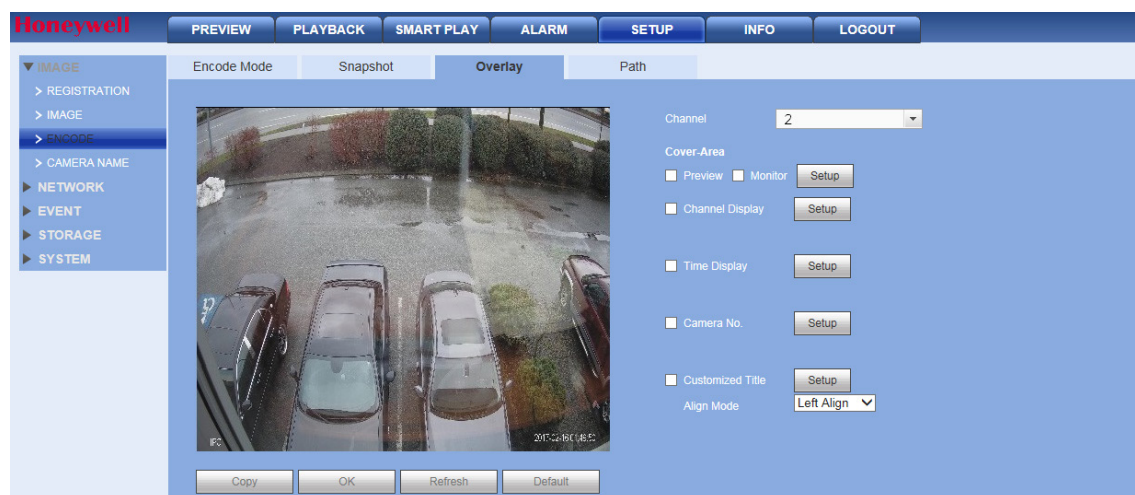

Table 12-11 Video Overlay Configurations

Setting	Description
Channel	Select a channel.
Cover-Area	The cover area has two types: Preview and Monitor. In the Preview type, the privacy mask zone cannot be viewed by user when system is in preview status. In the Monitor mode, the privacy mask zone cannot be viewed by the user when system is in monitor status. To set up the cover area: <ol style="list-style-type: none"> Click the Preview or Monitor check box. Click Setup, then draw privacy masks on the video image, as needed. The NVR system supports a maximum of four privacy zones.

Channel Display	<p>Enable this function so that the system overlays channel information in the video window.</p> <p>Use the mouse to drag the channel display into position.</p> <p>You can see the channel on the live WEB video or the playback video.</p>
Time Display	<p>Enable this function so that the system overlays time information in the video window.</p> <p>Use the mouse to drag the time display into position.</p> <p>You can see the time on the live WEB video or the playback video.</p>
Customized Title	<p>Enable this function so that the system overlays time information in the video window.</p> <p>Use the mouse to drag the time display into position.</p> <p>You can see the time on the live WEB video or the playback video.</p>
Align Mode	Select a align mode in the dropdown list.

Configuring the Save Path



Go to **SETUP → IMAGE → ENCODE → Path**. Configure the save path for snapped images (click  in the preview interface) or recorded video (click  in the preview interface).

Figure 12-34 Save Path Configuration Interface



The default save path is **C:\PictureDownload** for snapshots and **C:\RecordDownload** for recorded video.

Click **Browse** to change the save path. Click **OK** to save the setting.

Configuring the Camera Name

1. Go to **SETUP → IMAGE → CAMERA NAME → Camera Name**.

Figure 12-35 Camera Name Configuration Interface



2. Click the text box of the channel that you want to rename and enter the new channel name.

Camera Name: Select it to change the channel name of IPC via NVR.
Local: Select it to change the channel name of NVR.

3. Click **OK**.

Network Setup

Configuring TCP/IP

1. Go to **SETUP** → **NETWORK** → **TCP/IP**.

Figure 12-36 TCP/IP Configuration Interface

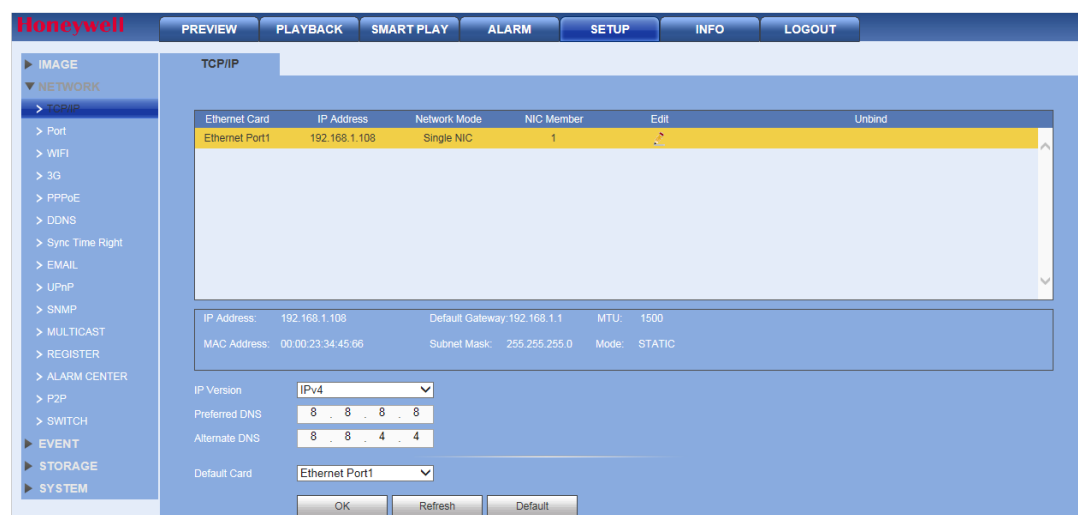

- Click the Edit icon for the Ethernet connection that you want to modify. The Edit screen opens.

Figure 12-37 Edit TCP/IP Screen

- Make any changes to the TCP/IP settings as needed, and then click **OK**.

Table 12-12 TCP/IP Configurations

Configuration	Description
Mode	<p>There are two modes: STATIC and DHCP.</p> <ul style="list-style-type: none"> The IP address, subnet mask, and gateway is inactive and not configurable when you select the DHCP mode to automatically search for the IP address. If you select STATIC mode, then you need to manually configure the IP address, subnet mask, and gateway. If you select DHCP mode, then you can only view the IP address, subnet mask, and gateway. You cannot configure these values. If you switch from the DHCP mode to the static mode, then you need to reset the IP parameters. The IP address, subnet mask, gateway, and DHCP are read-only values when the PPPoE dial is OK.
MAC Address	Displays the MAC address. This field is not configurable.
MTU	Use the default MTU (maximum transmission unit) value.
IP Version	<p>Select the IP version, either IPv4 or IPv6.</p> <p>You can use either version to access the camera's IP address.</p>
IP Address	<ol style="list-style-type: none"> Use your PC's keyboard to enter the IP address. Set the Subnet mask and Default gateway.
Subnet Mask	If you selected the STATIC mode, then enter a Subnet Mask value.
Default Gateway	If you selected the STATIC mode, then enter a Default Gateway value.
Preferred DNS	Enter the DNS IP address.
Alternate DNS	Enter an alternate DNS IP address.

Note For the IPv6 version IP address, the Preferred DNS and Alternate DNS shall be no more the 128 digits. They also cannot be left blank.

Configuring the Ports

Go to **SETUP → NETWORK → PORT → PORT**. Make any changes to the Port settings, as needed, and then click **OK** to save the settings.

Figure 12-38 Port Configuration Interface

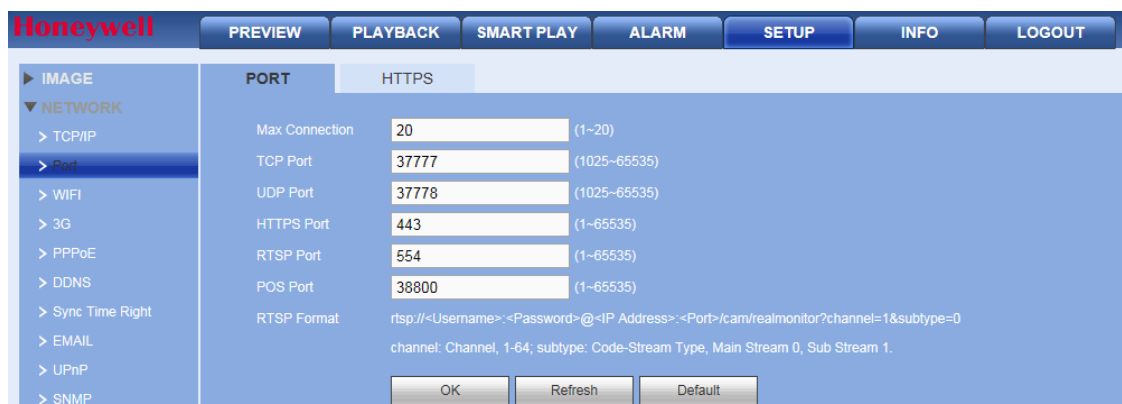

Table 12-13 Network Port Configurations

Configuration	Description
Max Connection	The maximum Web connection for the same NVR. The value ranges from 1 to 20 . The default is 20 .
TCP Port	The default is 37777 . You can enter the actual port number, if necessary.
UDP Port	The default is 37778 . You can enter the actual port number, if necessary.
HTTPS Port	Select a value between 1 and 65535 . The default setting is 443 .
RTSP Port	The default is 554 .
POS Port	Select a value between 1 and 65535 . The default setting is 38800 .
RTSP Format	A non-configurable field that shows the RTSP format.

Note The POS Port is only available for HEN081*4/HEN162*4/HEN163*4/HEN161*4/HEN322*4/HEN323*4/HEN321*4/HEN642*4/HEN643*4.

Configuring HTTPS

With these settings, you can ensure that the PC successfully logs in through HTTPS to guarantee communication data security. This reliable and stable technology can secure user information and device safety.

Figure 12-39 HTTPS Configuration Interface



Note If you have changed the device's IP, then you'll need to implement the server certificate again.

Note If this is your first time to use HTTPS on your PC, then you'll need to download the root certificate.

Import Certificate

Perform the following steps to import the CA certificate and the Key certificate together:

1. Click **Browse** to select the CA certificate.
 2. Click **Browse** to select the Key certificate.
 3. Click **Import** to import the two certificates.
-

Note Use Firefox to import the certificate.

HTTPS Configuration Overview

1. Go to **SETUP** → **NETWORK** → **PORT** → **HTTPS**.
2. Create a **Server Certificate** if this is the first time you are using this function. See [Creating a Server Certificate](#) on page 174.
OR
Download an already established root certificate. See [Downloading a Root Certificate](#) on page 174.
3. View and set the HTTPS port. See [Viewing and Setting the HTTPS Port](#) on page 177.

4. Open the Login interface through the browser. See [Login Configurations](#) on page 177.

Creating a Server Certificate

Follow these steps if this is the first time you are using this function.

1. Click  to open the **Create Server Certificate** window.

Figure 12-40 Create Server Certificate Window

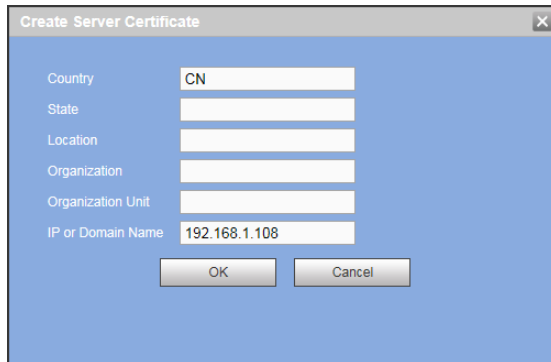

2. Enter a **Country** name, a **State**, a **City**, **Organization**, etc, then click **OK**.

A message appears to confirm that you have succeeded in creating a new server certificate.

Downloading a Root Certificate

1. Click  to open a File Download - Security Warning window.

Figure 12-41 File Download Warning



2. Click **Open** to open the **Certificate** window.

Figure 12-42 Certificate Window

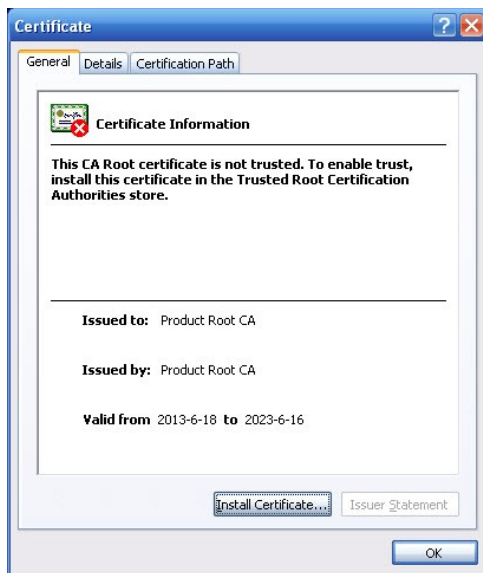

3. Click **Install Certificate** to open the **Certificate Import Wizard**.

Figure 12-43 Certificate Import Wizard



4. Click **Next** to open the Certificate Store window.

Figure 12-44 Certificate Import Wizard - Certificate Store Window

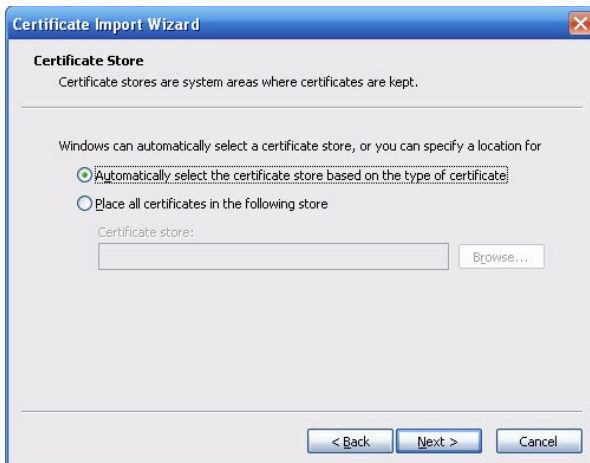

5. Select a location for the certificate.
6. Click **Next** to complete the process. A message appears to let you know the process is complete.

Figure 12-45 Certificate Import Wizard - Completion Message



7. Click **Finish**, and a security warning pops up.

Figure 12-46 Security Warning



8. Click **Yes**. When the installation is complete, a confirmation message appears.

Figure 12-47 Certificate Import - Confirmation Message



Viewing and Setting the HTTPS Port

Go to **SETUP** → **NETWORK** → **Port**.

Figure 12-48 Port Interface

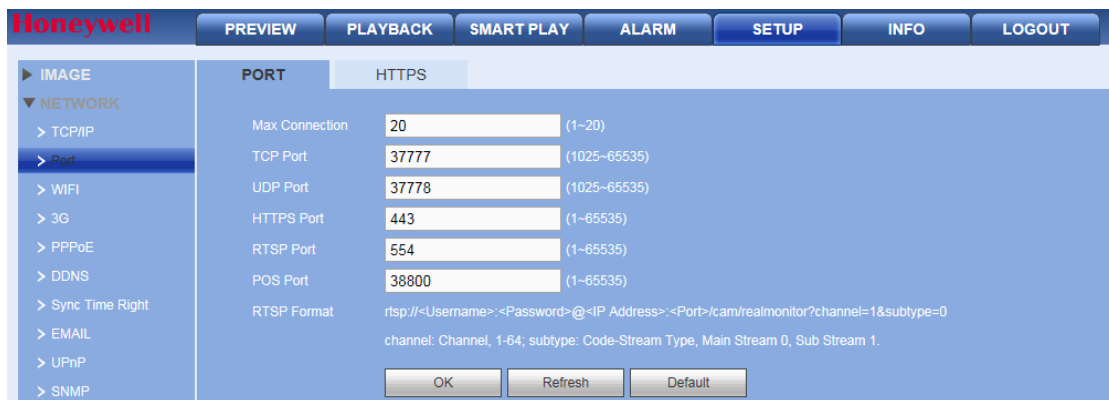

Login Configurations

1. Open the browser, then enter **https://xx.xx.xx.xx:port**, where xx.xx.xx.xx is your device's IP or domain name.

The port is your HTTPS port. If you are using **443** (the default HTTPS value), then you do not need to add port information here.

2. Enter **https://xx.xx.xx.xx** to access.

If you have the correct settings, then you should see the login interface.

Configuring WIFI

Note This function is only available for HEN081*4/HEN162*4/HEN163*4/HEN161*4/HEN322*4/HEN323*4/HEN321*4/HEN642*4/HEN643*4.

Note This section applies only to devices with Wifi capability, such as tablet computers, smartphones, and laptop computers.

1. Go to **SETUP** → **NETWORK** → **Wifi**.

Figure 12-49 Wifi Configuration Interface

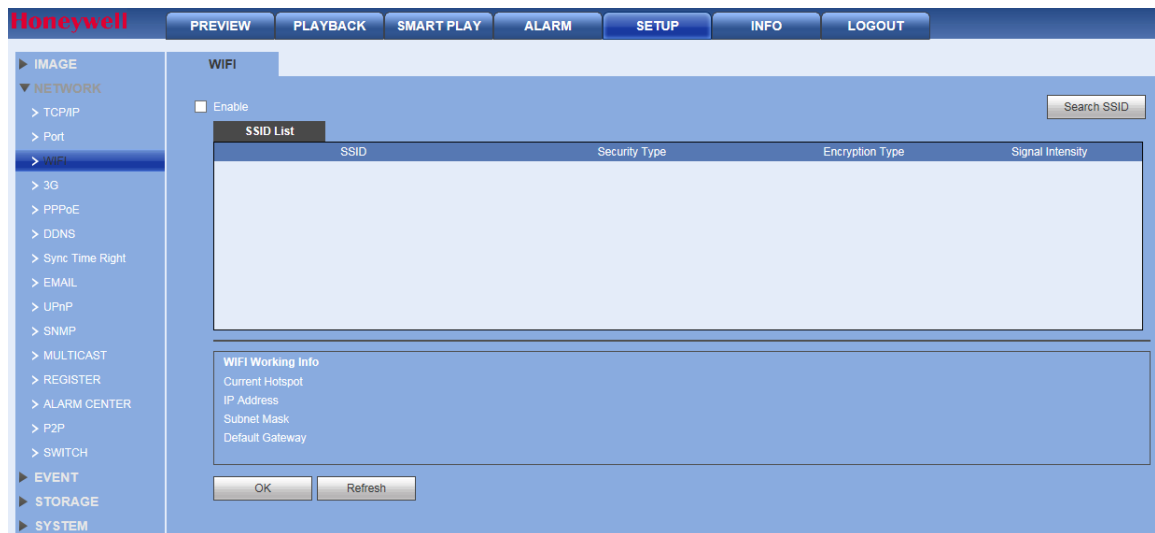

2. Click to enable **Wifi**.
3. Double-click the name of a wireless device to connect to it.
4. Click **OK** to save your settings.

Note Click **Refresh** to update the list of wireless network information.

Configuring 3G

Note This function is only available for HEN081*4/HEN162*4/HEN163*4/HEN161*4/HEN322*4/HEN323*4/HEN321*4/HEN642*4/HEN643*4.

1. Go to **SETUP → NETWORK → 3G**.
2. Make any configuration changes needed and click **OK** to save the changes.

Figure 12-50 3G Configuration Interface

The screenshot shows the Honeywell web client interface for 3G configuration. The top navigation bar includes buttons for PREVIEW, PLAYBACK, SMART PLAY, ALARM, SETUP, INFO, and LOGOUT. The left sidebar has a menu with options like IMAGE, NETWORK, TCP/IP, Port, WIFI, 3G (selected), PPPoE, DDNS, Sync Time Right, EMAIL, UPnP, SNMP, MULTICAST, and REGISTER. The main content area is titled '3G Mobile' and contains the following configuration fields:

- WLAN Type:** A dropdown menu.
- APN:** A text input field.
- AUTH:** A dropdown menu set to 'PAP'.
- Dial No.:** A text input field.
- Username:** A text input field.
- Password:** A text input field.
- WLAN Status:** A text input field.
- IP Address:** A text input field.
- Wireless Signal:** A section with a 'Search' button and 'OK', 'Refresh', and 'Default' buttons.
- Checkboxes:** 'Boot up' and 'Dial/SMS Activate'.

Table 12-14 3G Configurations

Configuration	Description
WLAN Type	Select a 3G network type to distinguish this 3G module from different ISPs. Choose from WCDMA, CDMA1x, for example.
APN & Dial No.	APN and the Dial No. are important PPPoE parameters. The APN (Access Point Name) and the Dial No. are automatically received by the NVR after connecting to a 3G module.
Dial/SMS Activate	Enable/disable Dial/SMS Activate. When enabled, if the user sends an "ON" message by phone to the NVR, then the NVR dials and connects with CDMA/GPRS. If the user sends an "OFF" message by phone to the NVR, then the NVR breaks the link with CDMA/GPRS.
AUTH	Authorization. Choose from PAP, CHAP, or NO_AUTH.
Username / Password	Enter a username and password for logging onto the 3G network.
Pulse Interval	Configure a time for ending the 3G connection after you close the extra stream monitor. For example, if you select 60 here, the NVR ends the 3G connection 60 seconds after you close the extra stream monitor. Note: If the Pulse Interval is 0, then the system does not end the 3G connection after you close the extra stream monitor. Note: The Pulse Interval here is for the extra stream only. This field is inactive if you are using a main stream monitor.
IP Address	Non-configurable. After the NVR connects to the network through CDMA/GPRS, it receives an IP address, which displays here.
Wireless Signal	When the NVR connects to 3G through GPRS/CDMA, by clicking SEARCH, you can see the signal strength.

Configuring the Mobile Settings

Go to **SETUP** → **NETWORK** → **3G** → **Mobile**.

Figure 12-51 Mobile Setup Configuration Interface

Activate/deactivate 3G connected phones or mobile phones, or the phone you configured to get alarm messages.

Configuring PPPoE

1. Click **PPPoE** under **NETWORK** to open the **PPPoE** configuration interface.

Figure 12-52 PPPoE Configuration Interface

2. Enable the **PPPoE** function.
3. Enter the **PPPoE User name** and **Password**, which you receive from your Internet Service Provider (ISP).
4. Click **OK** to save the changes.
5. **Reboot** the device to activate these changes.

After rebooting, the device should connect to the Internet through the PPPoE connection. The IP address is found in the WAN from the IP address column.

Note

You need to use the previous IP address in the LAN to log into the device. Go to the IP address field, which is found in the device's current device information. You can access the NVR through this new address.

Configuring DDNS

Use DDNS to connect the various servers so that you can access the system through the server.

1. Go to the corresponding service website to apply for a domain name.
2. Access the system through that domain name.

Note This works even if your IP address has changed.

3. Select **DDNS** from the DDNS Type drop-down list.

Table 12-15 DDNS Configuration Options

Configuration	Description
DDNS Type	Select the DDNS protocol from the drop-down list, then enable the DDNS function.
Server IP	The DDNS server IP address.
Domain Mode	The DDNS server port.
Domain Name	The DDNS server port.
Email Address	The DDNS server port.

Honeywell DDNS

The Honeywell DDNS function works with a special DDNS server and special Professional Surveillance Software (PSS).

Click **DDNS** under **NETWORK** to open the **DDNS** configuration interface.

Figure 12-53 DDNS Configuration Interface

The screenshot shows the Honeywell web client interface. At the top, there are navigation tabs: PREVIEW, PLAYBACK, SMART PLAY, ALARM, SETUP, INFO, and LOGOUT. On the left, a sidebar menu shows 'IMAGE' and 'NETWORK' (expanded) with sub-items: TCP/IP, Port, WIFI, 3G, PPPoE, DDNS (selected), Sync Time Right, and EMAIL. The main content area is titled 'DDNS' and contains the following configuration options:

- Enable
- DDNS Type: Honeywell DDNS (dropdown menu)
- Host IP: www.hennvr-ddns.com (text input)
- Domain Mode: Default Domain Custom Domain Name
- Domain Name: 000023344566.hennvr-ddns.com (text input)
- Username: (text input) Please input an email address.

At the bottom of the form are three buttons: OK, Refresh, and Default.

Operation

Before you can use Honeywell DDNS, you need to enable this service and configure the proper server address, port value, and domain name.

Table 12-16 DDNS Configurations

Parameter	Description
DDNS Type	You can select the DDNS protocol from the drop-down list, and then enable the DDNS function. Select the Honeywell DDNS server (which is free) to enable the DDNS function.
Host IP	This is the DDNS host IP address. Under Honeywell DDNS , the default server address is www.hennvr-ddns.com .
Domain Mode	Select Default Domain or Custom Domain Name . The default is Default Domain . If you select Custom Domain Name , then you must enter a domain name.
Domain Name	The default domain name is MAC address.hennvr-ddns.com . You can define the prefix.
Username	Optional. Enter your email address
Note	Do not register frequently. You need to wait at least 60 seconds between registration requests. Too many registration requests might leave your server vulnerable to attacks.
Note	The system DDNS server might take back a domain name that is idle for one year. If you configure your email address in the DDNS configuration, you will get a notification email before the domain name is taken back.

Quick DDNS and Client-end Introduction

Background Introduction

If you use ADSL to log into the network, then the device IP is not fixed. The DDNS function allows you to access the NVR via the registered domain name. Additional to the general DDNS, the Quick DDNS works with the manufacturer's device so that it can add the extension function.

Function Introduction

The quick DDNS client has the same function as other DDNS client ends. It bonds the domain name and the IP address. Currently, the DDNS server only works with our own devices. You must regularly refresh the bonding relationship between the domain and the IP. There is no username, password, or ID registration on the server. However, each device has a default domain name (generated by the MAC address). You can also use a customized valid domain name which has not been registered.

Quick DDNS Operation

Before you use Quick DDNS, you must enable this service, and configure the correct server address, port value, and domain name.

Server address: www.quickddns.com

Port number: 80

Domain name: There are two modes: Default domain name and customized domain name. Except for the default domain name registration, you can also use a customized domain name. After you have successfully registered a domain name, you can log in using it instead of the device IP.

User name: Optional. Enter your email address.

IMPORTANT! Do not register frequently. You must wait at least 60 seconds between attempts at logging in.

Too many attempts might cause a server crash.

The system might take back a domain name if it is idle for one year. If your email is set up correctly, you will get an email notification before the domain name is canceled.

Configuring the Sync Time Right

Note This function is only available for HEN081*4/HEN162*4/HEN163*4/HEN161*4/HEN322*4/HEN323*4/HEN321*4/HEN642*4/HEN643*4.

1. Click **Sync Time Right** under **NETWORK** to open the **Sync Time Right** configuration interface.

Figure 12-54 Sync Time Right Configuration Interface



2. Click to enable **Trusted Sites**, and only the listed IP addresses can sync time with the NVR.

Adding Trusted Sites

1. Click **Add** to open the **Add** configuration interface.
2. Select **IP Address**, **IP Segment** or **MAC Address** from the drop-down menu.

3. Select **IPv4** or **IPv6** from the drop-down menu. This option is not available if **MAC Address** was selected in step 2.
4. Enter the IP address or MAC address in the address field (depending on what option you selected in step 2).
5. Click **OK**.

Configuring Email

1. Click **Email** under **NETWORK** to open the **Email** configuration interface.

Figure 12-55 Email Configuration Interface.

2. Configure the email settings and click **OK** to save your settings.

Table 12-17 Email Configurations

Parameter	Description
Enable	Click to enable the email function.
SMTP Server	Enter the email SMTP server IP.
Port	Enter the corresponding port. Default is 25 .
Anonymous	Only available if the server supports the anonymity function. This function allows you to automatically log in anonymously, so you do not need to enter your user name, password, or sender's information.
User Name	Enter the user name for logging in to the sender's email box.
Password	Enter the login password here.
Sender	Enter the sender's email address.
Encrypt Type	Select from NONE , or SSL .

Subject	Enter an email subject. You can use up to 32 letters or numbers.
Attachment	Click to enable so that a snapshot can be attached to the email.
Receiver	Enter the receiver's email address. You can enter up to 3 email boxes. You can use SSL or TSL email boxes.
Interval	The interval for sending ranges from 0 to 3600 seconds. 0 means that there is no interval. Note: The system will not send an email immediately when the alarm occurs. When an alarm, motion detection, or video abnormality triggers an email, the system sends out the email according to the interval that is specified here. This function is very useful when there are too many emails activated by events, which might result in an overload for the email server.
Health Enable	Click to enable the email health check. The NVR sends a test email to check the network connection. After enabling Health Enable , you can configure how frequently the NVR sends out emails to test the network connection.
Email Test	Click Test to send a test email. A popup message appears to indicate the state of the network connection.

Configuring UPnP

UPnP allows you to establish the mapping relationship between the LAN and the public network. Here you can also add, modify, or remove a UPnP item.

Preparing for UPnP

1. In the Windows OS, go to **Start → Control Panel → Add or remove programs**.
2. Click **Add/Remove Windows Components**, and then select **Network Services** from the **Windows Component Wizard**.
3. Click **Details**, then check **Internet Gateway Device Discovery and Control client** and **UPnP User Interface**. Then click **OK** to begin the installation.
4. Enable **UPnP** from the internet. If your UPnP is enabled in the Windows OS, then the NVR can automatically detect it through the **My Network Places**.

Configuring UPnP

1. Click **UPnP** in the **NETWORK** configuration interface to open the **UPnP** configuration interface.

Figure 12-56 UPnP Configuration Interface

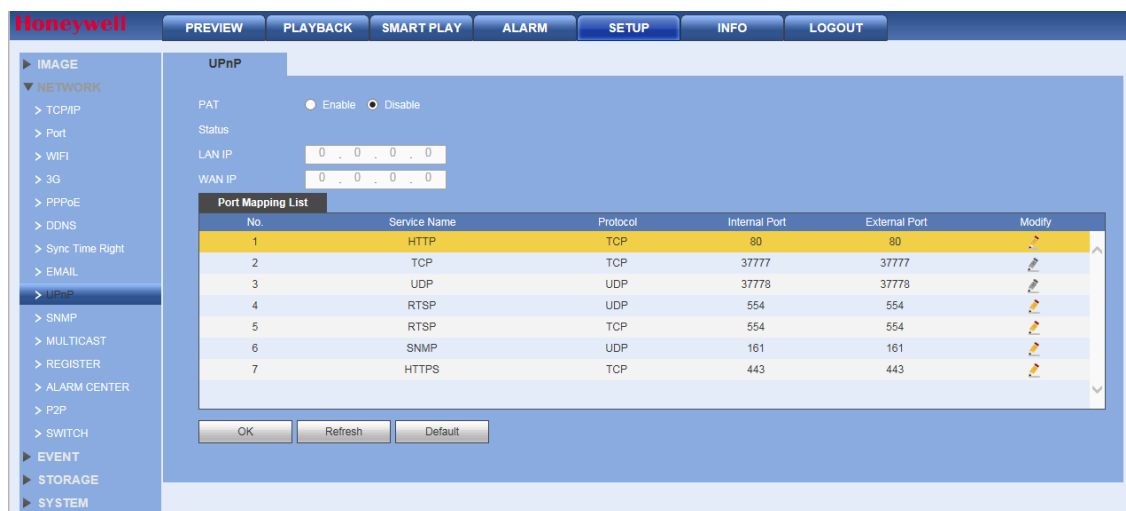

2. Configure the following settings:

Enable Click to enable or disable UPnP.

LAN IP Enter the NVR's IP address from the **TCP/IP** page.

WAN IP Enter the router's IP address.

3. (Optional) **Edit** a mapping relationship from the **Port Mapping List**:

Edit a mapping relationship: Click the modify icon for the mapping relationship that you want to edit, and then, in the **Modify** dialog box, edit the **Service Name**, **Protocol**, **Internal Port**, and/or **External Port** details, as needed, and then click **OK**.

4. Click **OK** to save your settings.

Configuring SNMP

SNMP allows the communication between the network management work station software and the proxy of the managed device. It is reserved for a third party developer.

1. Click **SNMP** under **NETWORK** to open the **SNMP** configuration interface.
2. Configure the SNMP settings and click **OK** to save your settings.

Figure 12-57 SNMP Configuration Interface

Table 12-18 SNMP Configurations

Configuration	Description
Enable	Select this check box to enable the SNMP function.
SNMP Version	If you check V1 , then the system processes only the V1 information. If you check V2 , then the system processes only the V2 information. If you check V3 , then the system processes only the V3 information.
SNMP Port	The listening port of the proxy program of the NVR. It is a UDP port, not a TCP port. This value ranges from 1 to 65535 . The default is 161 .
Read Community	This is a string, and it is a command between the managing processes and the proxy process. Read Community defines the authentication, the access control, and the management relationship between one proxy and one managers' group. Ensure that the device and the proxy are the same. The Read Community reads all the objects the SNMP supports in the specified name. The default is Public .
Write Community	This is a string, and it is a command between the managing processes and the proxy process. It defines the authentication, the access control, and the management relationship between one proxy and one manager's group. Ensure that the device and the proxy are the same. The Write Community reads, writes, and/or accesses all of the objects the SNMP supports in the specified name. The default is Write .
Trap Address	The Trap information destination address from the device's proxy program.
Trap Port	The Trap information destination port from the device's proxy program. The Trap port allows the gateway device and the client-end PC in the LAN to exchange information.

Multicast

Multicast is a transmission mode for data packets. When there are multiple hosts to receive the same data packets, multiple cast is the best option for reducing the bandwidth and the CPU load. The source host can send out just one data for transit. This function also depends on the relationship of the group member and the router group.

1. Click **Multicast** under **NETWORK** to open the **Multicast** configuration interface.

Figure 12-58 Multicast Configuration Interface

2. Select **Enable** to enable multicast.
3. Enter a multicast **IP address** in the IP Address box. The address must be valid for multicasting and should be in the range 224.0.0.0 to 239.255.255.255 for IPv4 or have the prefix ff00::/8. An address in the range 239.252.0.0 to 239.255.255.255 is recommended.
4. Enter a multicast port number in the **Port** box, or use the default setting (**36666**).
5. Click **OK** to save your settings.

Register

Register allows the device to automatically register to the proxy you have specified. This allows you to use the client-end to access the NVR through the proxy. The proxy acts as a switch. In network service, the device supports IPv4 server addresses or domains.

1. Click **Register** under **NETWORK** to open the **Register** configuration interface.

Figure 12-59 Register Configuration Interface

2. Click to enable **Register**.
3. Enter **Host IP**, **Port**, and **Sub device ID** values.
4. Click **OK** to save the settings.

Alarm Center

You can connect your alarm platform to the NVR's Alarm Center to develop alarm functions. When a local alarm occurs, the NVR system can upload alarm signals to the Alarm Centre.

1. Click **Alarm Center** under **NETWORK** to open the **Alarm Center** configuration interface.

Figure 12-60 Alarm Center Configuration Interface

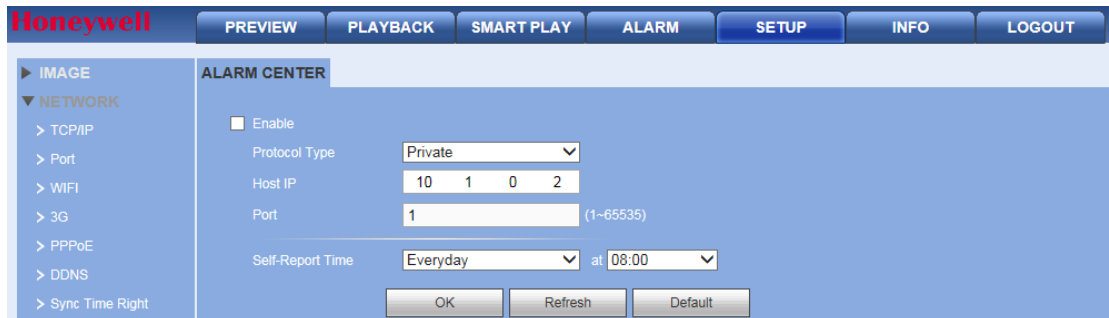

2. Before using the Alarm Center, you must configure the **Host IP**, **Port**, and **Protocol Type**. When an alarm occurs, the NVR system can send data, as defined by the protocol, to the client. You can also select a **Self-report Time** interval, or select **Never** to disable self-reporting.
3. Click **OK** to save the settings.

Configuring P2P Settings

You can easily connect to the unit using a mobile device with the HonView Touch app using the P2P screen. To use this option you will need the HonView Touch app downloaded, installed, and have registered/created an account. When the app is setup, select to add a device and use the camera to view the QR code on the P2P screen. The device's information and connection will automatically be downloaded to the HonView Touch app and you can now connect to the NVR using your mobile device.

1. Click **P2P** under **NETWORK** to open the **P2P** interface.

Figure 12-61 P2P Configuration Interface



2. Check the **Enable** check box.
3. Using a mobile device running the HonView Touch app, select to add a device.

4. Use the mobile device’s camera to view the QR code on the P2P screen.
5. The HonView Touch app will automatically download the NVR information and establish a connection.

Configuring Switch Settings

Note This function is only available for HEN081*4/HEN162*4/HEN163*4/HEN161*4/HEN322*4/HEN323*4/HEN321*4/HEN642*4/HEN643*4/HEN041*3/HEN081*3/HEN161*3.

You can change the IP Address, Subnet Mask, and Default Gateway for setting the PoE switch settings.

1. Click **Switch** under **Network** to open the **Switch** interface.

Figure 12-62 Switch Configuration Interface



2. Configure the following settings:

Table 12-19 Switch Configurations

Configuration	Description
IP Address	Enter a new IP address.
Subnet Mask	Enter a new subnet mask.
Default Gateway	Enter a new default gateway.

3. Click **OK** to save your settings.

Configuring Event Settings

Motion Detection Configurations

You can configure the system to generate a motion detection alarm when the minimum amount of motion (as defined by you) is detected in the video.

1. Click **Video Detection** → **Motion Detection** under **EVENT** to open the **Motion Detect** configuration interface.

2. Setup the motion detection settings and click **OK** to save the settings.

Figure 12-63 Motion Detect Configuration Interface

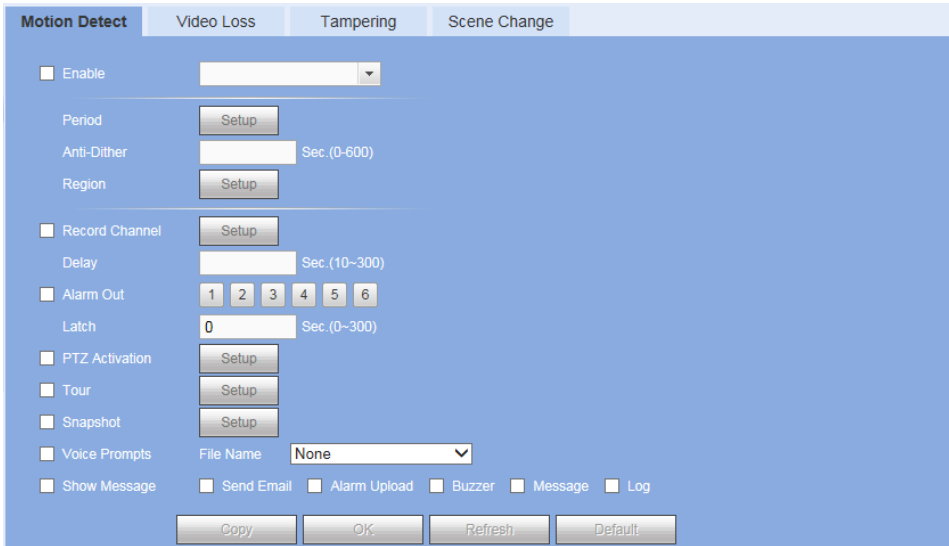
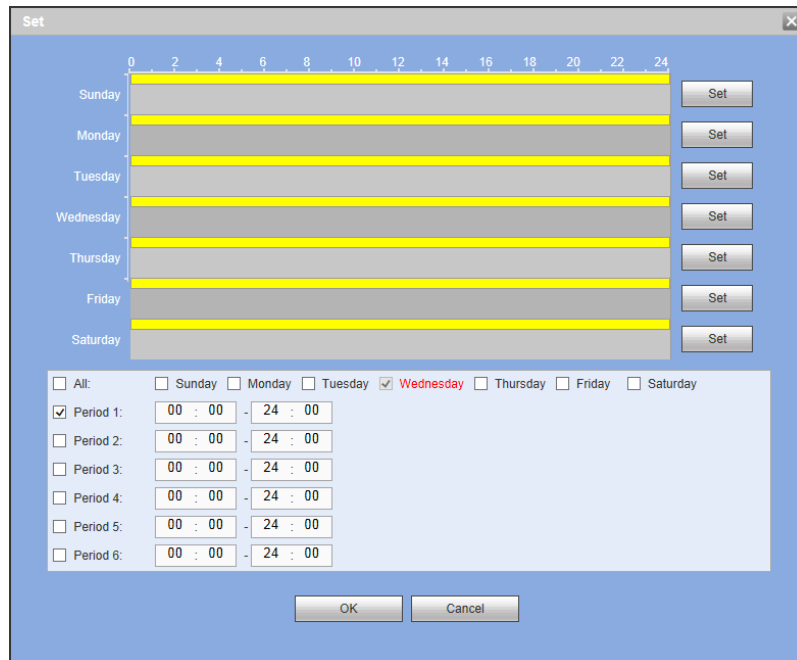

Table 12-20 WEB - Motion Detection Configurations

Configuration	Description
Enable	Click to enable motion detection. Select a channel from the drop-down list.

- Define a period during which motion detection is active.
1. Click Setup. The Set configuration interface appears.

Period



2. Select a day of the week check box. Select from a day of the **week** or **All**.

Note: If you select **All**, the set schedule will apply to all days of the week.

Note: You can configure up to 6 periods within a day.

3. Configure a time range for when the motion detection is active, then click the **Period** check box to select that time range for the selected day of the week.
4. Repeat steps 2 and 3 to set up multiple time periods in a day or to setup other days of the week, as required.
5. Click **OK**.

Alternative Setup Method You can use the time and day graph in the upper part of the screen to configure the time periods needed for motion detection. Use the mouse to click, and click/drag over different parts of the graph to enable or disable motion detection for those times/days.

Anti-Dither

Set an anti-dither time. The value ranges from 5 to 600s. The anti-dither time refers to the alarm signal lasts time. It can be seen as the alarm signal activation stays such as the buzzer, tour, PTZ activation, snapshot, channel record.

1. Click **Region Setup**. The **Zone Set** configuration interface appears.

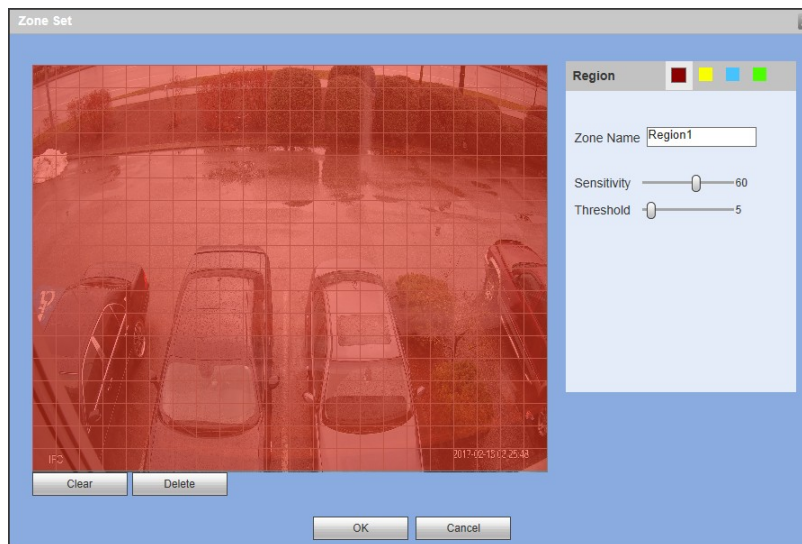

Region

2. Select the Motion Detection **Region** from the 4 regions (red, yellow, blue and green). You can configure 4 different regions of motion detection. If necessary, enter a name for the region in the **Zone Name** field.
3. Select the detection area by left-clicking and dragging the mouse over the video image.
There are 396 (PAL) or 330 (NTSC) small zones. The color of the zone tile indicates which region is setup for motion on that zone. If there is no color, then motion detection is not set for that zone.
4. Select a **Sensitivity**, from **1** to **100** for each region. The higher the number, the higher the motion detection sensitivity.
5. Select a **Threshold**, from **1** to **100** for each region. The higher the number, the more motion will be needed to trigger a motion event.

	6. Click OK to save the configurations. Click Cancel to exit the setup without saving the changes.
Record Channel	The system automatically starts recording selected channels when a motion detection alarm occurs. Click Setup to select the channel(s) to record. Note: You need to set the motion detection recording period. Go to Storage→Schedule→Record to configure the necessary channel(s) for scheduled motion detection recording.
Delay	The system can delay recording for a specified amount of time after an alarm has ended. Select from 10s to 300s .
Alarm Out	Select the device output port, 1 or 2 . Select the corresponding port(s) so the system can activate the corresponding alarm devices when a motion detection event occurs.
Latch	The system can delay the alarm output for a specified time after an alarm ends. The value ranges from 0s to 300s .
PTZ Activation	When PTZ functions are configured, the system can activate a PTZ operation when a motion event is detected. 1. Click Setup to open the PTZ Activation configuration interface. 2. Select a preset, tour, or pattern to perform from the drop-down menu. Enter the preset/tour/pattern number in the field. 3. Click OK .
Tour	Select the Tour check box and click Setup to enable a tour to be triggered by a motion event. The system supports 1/8-window tour. On the Display Settings tab, when there are two tours enabled by default, you can configure the system so an alarm triggers the system to enable the alarm tours you configured here. If there is no alarm, then the system uses the tour setup that was configured in the Display interface.
Snapshot	Click to enable the Snapshot function. Channel snapshots are taken according to the schedule you configure. Alarm snapshots are taken when an alarm occurs.
Voice Prompts	Select the check box to enable the playing of a voice prompt audio file when motion is detected. Use the File Name drop-down list to select the audio file to play when motion is detected.
Show Message	Click to enable a pop-up message on your local host PC screen to let you know an alarm has occurred.
Send Email	The system can send an email when an alarm is detected. When you have enabled the Snapshot function, the system can also send an image attached to the email. Go to Network→Email to configure the email settings.
Alarm Upload	Enable this function, and when a motion event is detected, an alarm message is uploaded to the NVR.
Buzzer	Click to enable the Buzzer function. When an alarm occurs, the buzzer beeps.

Message	Select the check box to send a text message when motion events are detected. Go to Network→3G→Mobile to configure messaging settings.
Log	Select the check box to enable logging of motion detected events.

Video Loss Detection Configurations

You can configure the system to generate a video loss alarm when the minimum amount of video loss (as defined by you) is detected in the video.

Note Video loss does not support anti-dither, sensitivity, or region setup.

1. Click **Video Detection → Video Loss** under **EVENT** to open the **Video Loss** configuration interface.
2. Setup the video loss settings and click **OK** to save the settings.

Figure 12-64 Video Loss Configuration Interface

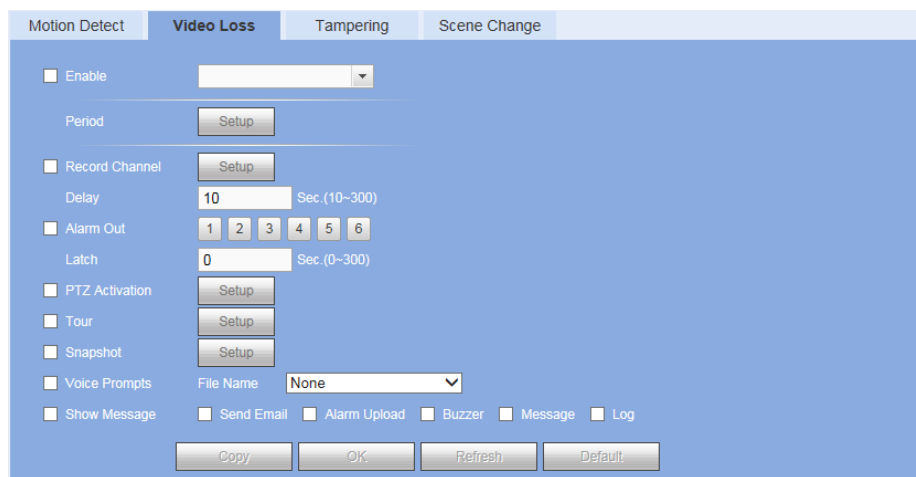

The configuration for **Video Loss Detection** is very similar to the configuration for **Motion Detection**. Please see [Motion Detection Configurations](#) on page 190 for more information.

Camera Tampering Detection Configurations

You can configure the system to generate a camera tampering alarm when the minimum amount of tampering (as defined by you) is detected in the video.

1. Click **Video Detection → Tampering** under **EVENT** to open the **Tampering** configuration interface.
2. Setup the tampering settings and click **OK** to save the settings.

Figure 12-65 Camera Tampering Configuration Interface

The configuration for **Camera Tampering Detection** is very similar to the configuration for **Motion Detection**. Please see [Motion Detection Configurations](#) on page 190 for more information.

Camera Scene Change Configurations

Note

This function is not available for HEN041*3/HEN081*3/HEN161*3/HEN04103L/HEN08103L/HEN16103L/HEN32103L on the web client. If you want to change this setting, go to the local client.

1. Click **Video Detection** → **Scene Change** under **EVENT** to open the **Scene Change** configuration interface.
2. Setup the scene change settings and click **OK** to save the settings.

Figure 12-66 Camera Scene Change Configuration Interface

The configuration for **Camera Scene Change Detection** is very similar to the configuration for **Motion Detection**. Please see [Motion Detection Configurations](#) on page 190 for more information.

Configuring Face Detection

The face detection feature analyzes the video to detect if there are any human faces appearing in the video. If a face appears it will capture the face with either snapshots, recordings, or alarms so it can be processed or analyzed further.

1. Go to **Setup → Event → Face Detection**.

Figure 12-67 Face Detection Configuration Interface

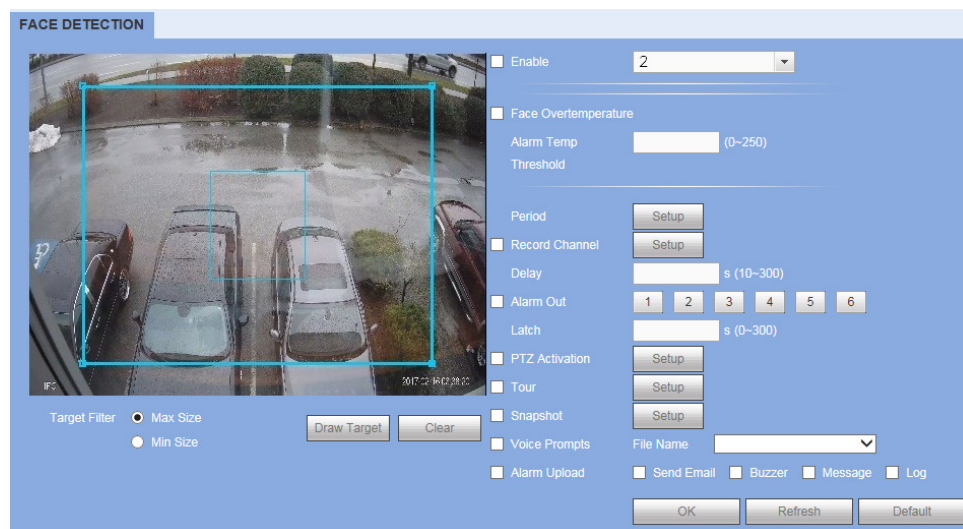

2. Select the Channel to configure for face detection from the drop-down menu and check the **Enable** check box.
3. Click **Draw Target** to draw the Min/Max Size of a face that will trigger face detection in the video. Use the mouse to drag and resize the Min and Max size boxes in the video image.
4. The configuration of **Face Detection** options is very similar to the configuration for **Motion Detection**. Please see [Motion Detection Configurations](#) on page 190 for more information on setting time periods and event actions.

Face Overtemperature: Click to enable the face overtemperature function. When the temperature of face reached the set value, an alarm will occur.

Alarm Temp Threshold: Enter a value between 0-250.

Note The face overtemperature function is only available for cameras that support this function.

5. Click **OK** to save the settings.

Heat Map

The heat map feature detects moving objects in the camera scene that can be generated as a report based on the object's heat. The heat colors range from blue to red, with blue representing the minimum heat value and red representing the maximum heat value. This information can then be searched and generate reports (see [Heat Map](#) on page 160).

Note	This function is only available for HEN081*4/HEN162*4/HEN163*4/HEN161*4/HEN322*4/HEN323*4/HEN321*4/HEN642*4/HEN643*4.
-------------	---

1. Go to **Setup → Event → Heat Map**.

Figure 12-68 Heat Map Configuration Interface

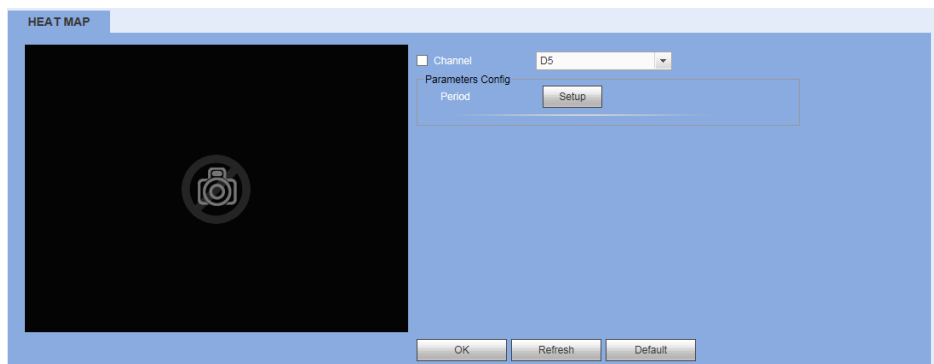

2. Select the Channel to configure for heat map from the drop-down menu and check the **Enable** check box.
3. To set the periods when heat map is active, next to **Period**, click **Set**, and then follow the steps listed in [Motion Detection Configurations](#) on page 190.

Configuring Smart Plan Settings

Smart plan is a master switch for the intelligent analytics such as Face Detection and People Counting. The device intelligent functions can be valid after smart plan is enabled.

Go to **Setup → Event → Smart Plan**. Select a channel that you want to apply the smart plan to and select the plan by clicking its icon and click **OK**.

Figure 12–69 Smart Plan Configuration Interface

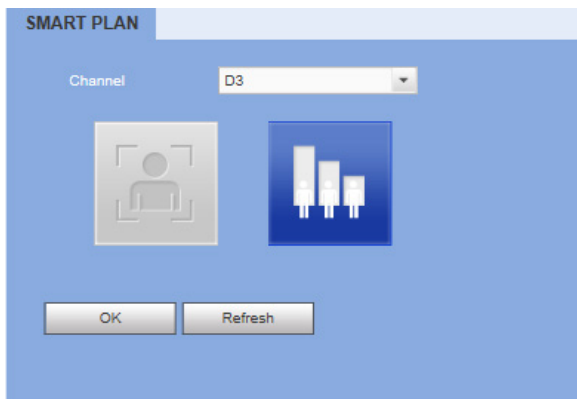

Configuring People Counting

The people counting feature analyzes the video to count the number of people that pass through or appear in the video.

1. Go to **Setup → Event → People Counting**.

Figure 8–20 People Counting Configuration Screen

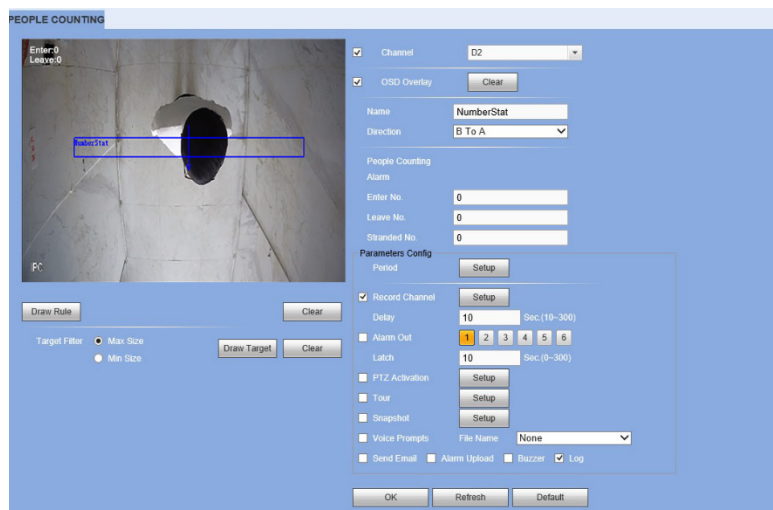

2. Select a Channel to configure for people counting from the drop-down menu and check the check box.
3. Click **Draw Rule** to set up an area for people counting. You can move or resize the area using your mouse. To move the area, drag one of the sides. To resize the area, drag one of the corner handles.
4. Click **Draw Target** to set up the target size. You can move or resize the area using your mouse. To move the area, drag one of the sides. To resize the area, drag one of the corner handles.
5. To enable OSD which displays the Enter and Leave numbers, check **OSD Overlay**. To clear the overlay, click **Clear**.
6. In the **Name** field, enter the name of rule.

7. In the **Direction** field, select the direction of people counting. You can select A->B or B->A, the arrow direction always means the entrance direction.
8. Enter the number of people that are allowed to enter and exit in the **Enter No.** and **Exit No.** fields. Enter the number of people that are allowed to remain in the scene in the **Stranded No.** field.
9. To set the periods when people counting is active and set the action(s) that you want the system to initiate when a people counting event occurs, see [Motion Detection Configurations](#) on page 190 for more information on setting time periods and event actions.
10. Click **Apply** to save the settings.

Configuring Audio Detection

The audio detection feature detects audio changes in the camera scene that can generate events and corresponding actions.

1. Go to **Setup → Event → Audio Detection**.

Figure 12-70 Audio Detection Configuration Interface

2. Select the **Channel** to configure for audio detection from the drop-down menu and check the **Enable** check box.
3. Check one or both **Input Abnormal** and **Intensity Change** check boxes:
 - **Input Abnormal:** Detects if the audio input changes from the "normal" audio that is typically generated at the site.
 - **Intensity Change:** Detects if the audio intensity changes, meaning the volume level becomes stronger than the typical levels.
4. Set the **Sensitivity** level (1–100) and **Threshold** level (1–100) for the audio detection.

- **Sensitivity** refers to the audio recognition sensitivity (as a percentage). Moving the Sensitivity slider to a higher sensitivity setting increases the audio detection sensitivity which will detect more events.
- **Threshold** is the intensity change threshold, or the amount of audio required to trigger an event notification. The smaller the Threshold value, the more events will be detected.

Note The best way to configure audio detection is to experiment with the sensitivity and threshold settings while someone is generating sound in front of the camera.

5. The configuration of **Audio Detection** options is very similar to the configuration for **Motion Detection**. Please see [Motion Detection Configurations](#) on page 190 for more information on setting time periods and event actions.
6. Click **OK** to save the settings.

Configuring Alarms

Before alarm operation, you should check that you have properly connected all alarm devices, such as buzzers and flashing lights.

Configuring Local Alarms

Click **ALARM** under **EVENT** to open the **Local Alarm** configuration interface.

Figure 12-71 WEB - Local Alarm Configuration Interface



Configure the local alarm settings as described in the following table and click **OK** to save the settings.

Table 12-21 WEB - Alarm Configurations

Configuration	Description
Enable	Click to enable alarms. Select a channel from the drop-down list.
	<ol style="list-style-type: none"> Click Setup. The Set configuration interface appears. <div data-bbox="553 394 1352 1052" data-label="Image"> </div> Select a day of the week check box. Select from a day of the week or All. <p>Note: If you select All, the set schedule will apply to all days of the week.</p> <p>Note: You can configure up to 6 periods within a day.</p> Configure a time range for when the alarm is active, then click the Period check box to select that time range for the selected day of the week. Repeat steps 2 and 3 to set up multiple time periods in a day or to setup other days of the week, as required. Click OK. <p>Alternative Setup Method You can use the time and day graph in the upper part of the screen to configure the time periods needed for alarms.</p> <p>Use the mouse to click, and click/drag over different parts of the graph to enable or disable alarms for those times/days.</p>
Anti-dither	The system can delay recording for a specified amount of time after an alarm has ended. Select from 0s to 600s .
Type	Select either NO or NC .
Record Channel	The system automatically starts recording selected channels when a motion detection alarm occurs.

	Note: You need to set the alarm recording period. Go to Storage → Schedule → Record to configure the current channel for scheduled recording.
Delay	The system can delay recording for a specified amount of time after an alarm has ended. Select from 10s to 300s .
Alarm Out	Select the device output port, 1 or 2 . Select the corresponding port(s) so the system can activate the corresponding alarm devices when an alarm occurs.
Latch	The system can delay the alarm output for a specified time after an alarm ends. The value ranges from 1s to 300s .
PTZ Activation	When PTZ activation is configured, the system can activate PTZ operation when an alarm is detected. <ol style="list-style-type: none"> 1. Click Setup to open the PTZ Activation configuration interface. 2. Select a preset, tour, or pattern from the drop-down menu. 3. Click OK.
Tour	Click to enable a tour to be triggered by an alarm. The system supports 1/8-window tour. See Configuring Display Settings on page 217 for tour interval setup. On the Display Settings tab, when there are two tours enabled by default, you can configure the system so an alarm triggers the system to enable the alarm tours you configured here. If there is no alarm, then the system uses the tour setup that was configured in the Display interface.
Snapshot	Click to enable the Snapshot function. Channel snapshots are taken according to the schedule you configure. Alarm snapshots are taken when an alarm occurs.
Voice Prompts	Select the check box to enable the playing of a voice prompt audio file when the alarm is detected. Use the File Name drop-down list to select the audio file to play when the alarm is detected.
Show Message	Click to enable a pop-up message on your local host PC screen to let you know an alarm has occurred.
Send Email	The system can send an email when an alarm is detected. When you have enabled the Snapshot function, the system can also send an image attached to the email. Go to Network→Email to configure the email settings.
Alarm Upload	Enable this function, and when an alarm event is detected, an alarm message is uploaded to the NVR.
Buzzer	Click to enable the Buzzer function. When an alarm occurs, the buzzer beeps.
Message	Select the check box to send a text message when alarm events are detected. Go to Network→3G→Mobile to configure messaging settings.
Log	Select the check box to enable logging of alarm events.

Configuring Network Alarms

Network Alarm are the alarm signals from the TCP/IP. You cannot select the sensor type or anti-dither functions.

1. Click **Net Alarm** in the **ALARM** configuration interface.
2. The configuration of **Net Alarm** options is very similar to the configuration for **Local Alarms**. Please see [Configuring Local Alarms](#) on page 200 for more information on setting time periods and event actions.
3. Click **OK** to save the settings.

Figure 12-72 WEB - Net Alarm Configuration Interface

Configuring IPC External Alarms

IPC External Alarms are the alarm signals from a connected IP camera.

1. Click **IPC External Alarm** in the **ALARM** configuration interface.
2. The configuration of **IPC External Alarm** options is very similar to the configuration for **Local Alarms**. Please see [Configuring Local Alarms](#) on page 200 for more information on setting time periods and event actions.
3. Click **OK** to save the settings.

Figure 12-73 WEB - IPC External Alarm Configuration Interface



Configuring IPC Offline Alarms

IPC Offline Alarms are the alarm signals when a connected IP camera goes offline. You cannot select the sensor type or anti-dither functions.

1. Click **IPC Offline Alarm** in the **ALARM** configuration interface.
2. The configuration of **IPC Offline Alarm** options is very similar to the configuration for **Local Alarms**. Please see [Configuring Local Alarms](#) on page 200 for more information on setting time periods and event actions.
3. Click **OK** to save the settings.

Figure 12-74 WEB - IPC Offline Alarm Configuration Interface



Configuring Alarm Outputs

1. Click **Alarm Output** under **SETTING** to open the **Alarm Output** configuration interface.

Figure 12-75 WEB - Alarm Output Configuration Interface

2. Click to enable the alarm output for each alarm. Select from **Auto**, **Manual**, or **Stop**, and **Status**.
3. Click **OK** to save these settings.

Configuring for Abnormalities

Click **Abnormality** under **EVENT** to open the **Abnormality - HDD** configuration interface.

Figure 12-76 WEB - HDD Abnormality Configuration Interface

There are seven types of abnormalities:

- No HDD
- HDD Error
- No Space
- Disconnect
- IP Conflict
- MAC Conflict
- Illegal Login

You can configure how the system responds to each kind of abnormality. The configuration is similar for each type.

Figure 12-77 Configuring for Network Abnormalities

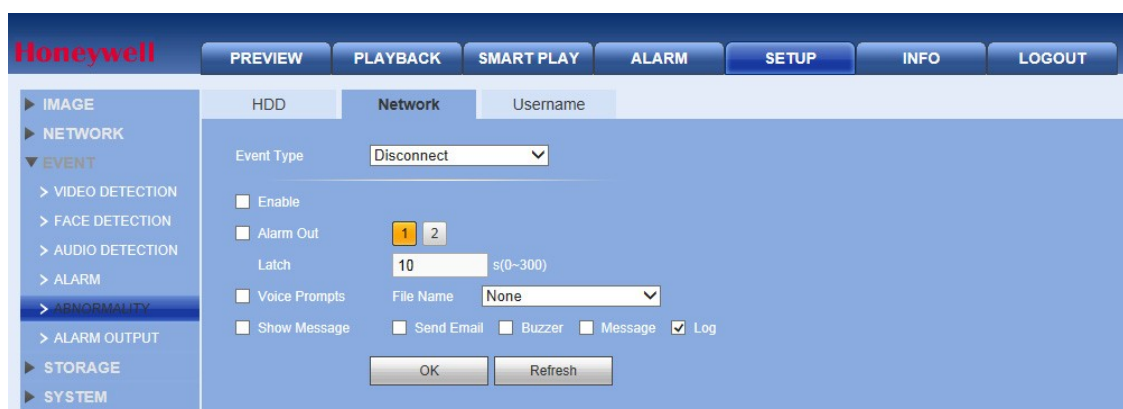

Figure 12-78 Configuring for Username Abnormalities



Table 12-22 Configuring for Abnormalities

Configuration	Description
Event Type	Select from No HDD , HDD Error , No Space , Disconnect , IP Conflict , MAC Conflict and Username . Less Than: (For No Space configuration only) Configure the minimum percentage of free space on the disk. An alarm lets you know when the disk capacity is low. You need to click to enable this function. Attempt(s) and Lock Time: (For Username configuration only) Configure the number of login Attempt(s) before the alarm is activated and the login screen is locked out for the specified Lock Time .
Enable	Click to enable this function.
Alarm Out	Select the device output port, 1 or 2. Select the corresponding port(s) so the system can activate the corresponding alarm devices when an alarm occurs.
Latch	The system can delay the alarm output for a specified time after an alarm ends. The value ranges from 1s to 300s .

Voice Prompts	Select the check box to enable the playing of a voice prompt audio file when the alarm is detected. Use the File Name drop-down list to select the audio file to play when the alarm is detected.
Show Message	Click to enable a pop-up message on your local host PC screen to let you know an alarm has occurred.
Send Email	The system can send an email when an alarm is detected. Go to Network→Email to configure the email settings.
Buzzer	Click to enable the Buzzer function. When an alarm occurs, the buzzer beeps.
Message	Select the check box to send a text message when alarm events are detected. Go to Network→3G→Mobile to configure messaging settings.
Log	Select the check box to enable logging of alarm events.

Configuring POS

Note	This function is only available for HEN081*4/HEN162*4/HEN163*4/HEN161*4/HEN322*4/HEN323*4/HEN321*4/HEN642*4/HEN643*4.
-------------	---

Use the POS settings screen to setup a connection to a point of sales device, such as a cash register, to enable POS info to be synchronized with video data.

1. Go to **SETUP→EVENT→POS**, the following window is displayed.

Figure 12-79 POS Configuration Interface

The screenshot shows the Honeywell web client interface for configuring a Point of Sale (POS) device. The interface is divided into a left-hand navigation menu and a main configuration area. The navigation menu includes options for IMAGE, NETWORK, EVENT, VIDEO DETECTION, FACE DETECTION, HEAT MAP, AUDIO DETECT, ALARM, ABNORMALITY, ALARM OUTPUT, POS, STORAGE, and SYSTEM. The main configuration area is titled 'POS' and contains the following fields and controls:

- Name:** A dropdown menu set to 'pos1' with an edit icon.
- Enable:** A checkbox that is currently unchecked.
- Protocol Type:** A dropdown menu set to 'POS'.
- Connect Type:** A dropdown menu set to 'TCP'.
- Convert:** A dropdown menu set to 'UTF-8'.
- Overlay:** A dropdown menu set to 'TURN'.
- Network Overtime:** A text input field containing '30'.
- Time Display:** A text input field containing '120'.
- FontSize:** A dropdown menu set to 'Medium'.
- COLOR:** A color palette with various color swatches.
- POS Info:** A checkbox that is currently unchecked.
- Advanced:** A button labeled 'Setup'.
- Buttons:** 'OK', 'Refresh', and 'Default' buttons are located at the bottom of the configuration area.

2. Select a POS name in the **Name** dropdown list. Click  to edit the name if you want.
3. Select the **Enable** checkbox to enable the POS that you select in step 2.

4. Next to Event, click **Setup** to configure the POS arm/disarm period, record channel, etc. for the POS. See [Configuring Motion Detection Settings](#) on page 77 for the detailed information.
5. Next to Privacy, click **Setup** to configure the privacy character for the POS. After this function is enabled, once the overlay information contains the privacy character, it displays as *. For example, the privacy character is 12,56,89, the local preview and WEB surveillance information is shown as **34**7** if the overlay information is 123456789.

Figure 12-80 Privacy Setup

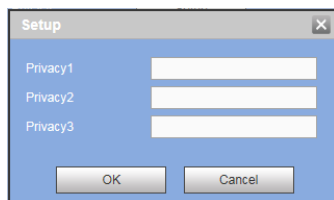

6. Other parameters are described in the following section:

Connect Type Select the type of connection to the POS device. Click **Setup** to enter the connection details for Source IP and Port, and Destination IP and Port. Click **OK** to confirm.

Protocol Type Select the communication protocol for the POS device. The default setting is POS.

Convert Set the font type.

Overlay Set overlay mode, including turn and roll.

- Turn: Once the overlay information has reached 8 lines, it turns to the next page.
- Roll: Once the overlay information has reached 8 lines, it displays the next new line and delete the oldest line.

Network Overtime Enter a value to set the network overtime. Once there is no POS data for the specified period, NVR automatically deletes POS information after the specified period.

Time Display Enter the amount of time in between time display instances.

Font Size Set the overlay font size

Color Set the overlay font color

POS Info Check the box to overlay information on the local preview window

Advanced: Click **Setup** to enter advanced settings interface.

Transaction Start/End Select the transaction start and end times. This field cannot be modified when POS is the selected protocol.

Line delimiter: Set the line delimiter to display the overlay information after the delimiter in the new line. For example, the line delimiter is 45 and the overlay information is 123456789, NVR displays 123 in the first line and displays 6789 in the second line.

Hex: Check the Hex to switch to the ASCII code.

Case insensitive: Check the box to enable case insensitive function.

Configuring Storage

Configuring Basic

Go to **SETUP**→**STORAGE**→**BASIC**, the following window is displayed:

Figure 12-81 Configuring Basic

The screenshot shows the Honeywell web client interface. At the top, there is a navigation bar with the following tabs: PREVIEW, PLAYBACK, SMART PLAY, ALARM, SETUP, INFO, and LOGOUT. On the left side, there is a sidebar menu with the following items: IMAGE, NETWORK, EVENT, STORAGE (expanded), BASIC (selected), SCHEDULE, and HDD MANAGER. The main content area is titled 'BASIC' and contains the following settings:

- HDD Full: Overwrite (dropdown menu)
- Pack Duration: 60 (input field) Min.
- Auto Delete Old Files: Never (dropdown menu)

At the bottom of the settings area, there are three buttons: OK, Refresh, and Default.

HDD Full: Set to **Overwrite** to continue recording over old data when the HDD is full. Set to **Stop Record** to stop recording when the HDD is full. The default setting is **Overwrite**.

Pack Duration: Set the recording duration. Specify a time between 1 and 120 minutes. The default setting is 60 min.

Auto Delete Old Files: Select **Never** or **Customized**. If **Customized** is selected, in the **Days Ago** box, enter the amount of time to elapse before the files are automatically deleted.

Configuring Storage Schedules

You can add or remove schedules for recording and snapshots.

There are five recording modes: **Regular** (auto), **MD**, **Alarm**, **MD&Alarm**, **Analytics** and **POS**. You can configure up to six periods per day.

Note The POS function is only available for
 HEN081*4/HEN162*4/HEN163*4/HEN161*4/HEN322*4/
 HEN323*4/HEN321*4/HEN642*4/HEN643*4.

1. Go to **SETUP** → **STORAGE**→**SCHEDULE**, the following window is displayed:

Figure 12-82 Schedule Configuration Interface

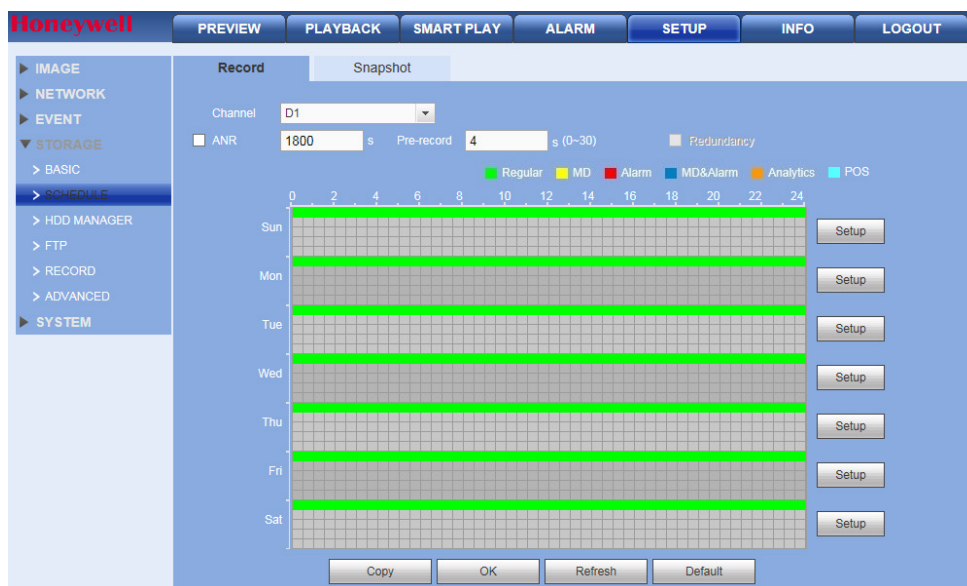

The schedules are color-coded by type:

- **Green:** Regular recording/snapshot.
- **Yellow:** Motion detection recording/snapshot.
- **Red:** Alarm recording/snapshot.
- **Blue:** MD&Alarm recording/snapshot.
- **Orange:** Analytics recording/snapshot.
- **Light Blue:** POS recording/ snapshot.

Table 12-23 Scheduled Storage Settings

Setting	Description
Channel	Select a channel from the drop-down list.
Pre-record	Enter a pre-recording time here. Select from 0 to 30 seconds.
Redundancy	You can configure the NVR to backup recorded files onto two different HDDs. Click to enable. Note: Before you can enable this function, you must configure at least one HDD as redundant. Go to Setup → Storage → HDD Manager). This function is not available if there is only one HDD.
ANR	Enter a time between 0s ~ 43200s. It is to save video to the SD card of the network camera in case the network connection fails. After the network connection resumed, the system can get the video from the SD card and there is no risk of record loss.
Snapshot	Select the Snapshot tab to configure the snapshot schedule in the same way as the recording schedule.
Copy	Allows you to copy a channel's setup to one or more other channels. Click Copy in the Configuration interface to open the Copy interface.

Select channels to which to copy the current configurations, then click **OK**.

2. Click **Setup**. The **Setup** configuration interface opens.

Figure 12-83 Set Configuration Interface

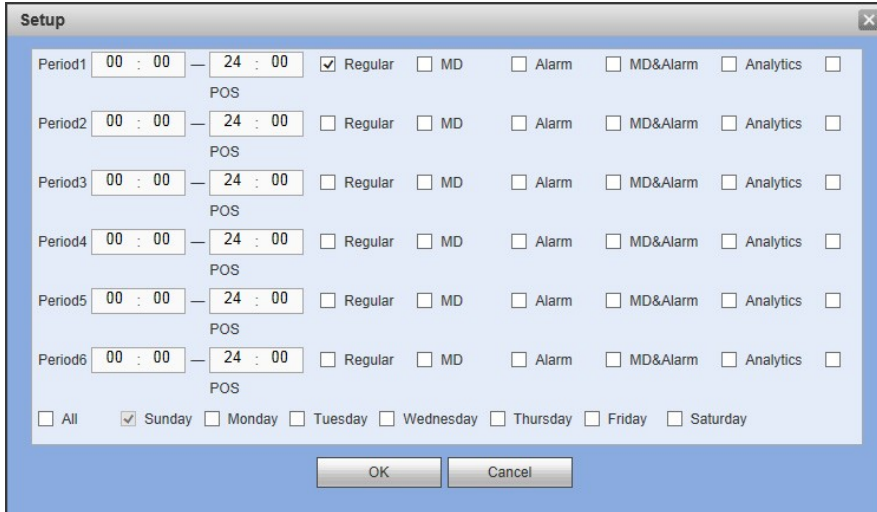

3. Configure the schedule, then click **OK**.

Table 12-24 Schedule Configurations

Configuration	Description
Regular	Check to enable the Regular schedule mode for the period.
MD	Check to enable the Motion Detection schedule mode for the period.
Alarm	Check to enable the Alarm mode for the period.
MD&Alarm	Check to enable the MD&Alarm mode for the period.
Analytics	Check to enable the Analytics mode for the period.
POS	Check to enable the POS mode for the period.

4. Click **OK** to save the settings, and then click **OK** to save the **Schedule** configuration.

Configuring HDD Manager

Click **HDD Manager** under **STORAGE** to open the **HDD Manager** configuration interface.

Figure 12-84 HDD Manager Interface

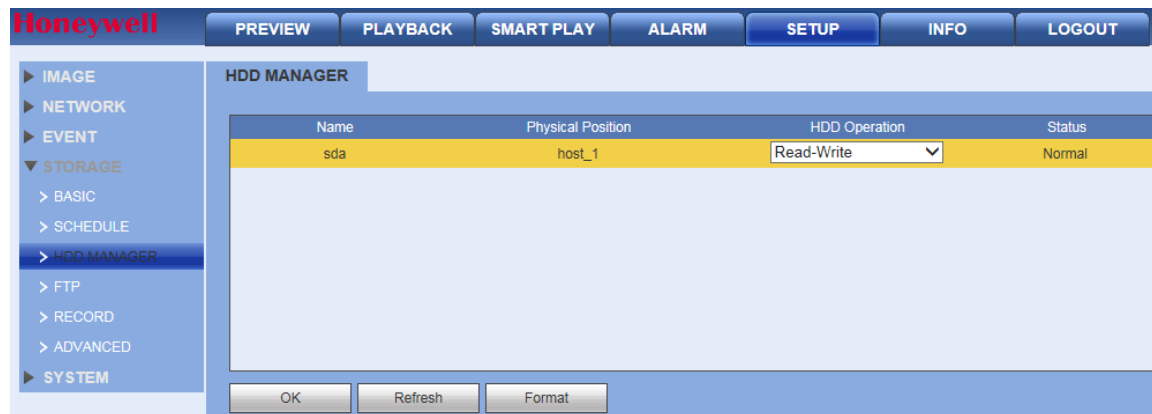

The **HDD Manager** interface shows HDD information. You can also configure read-only, read-write, redundancy (if there is more than one HDD), and format settings.

Configuring FTP

FTP allows you to configure settings for remote storage. Before you can enable FTP, you must download or buy an FTP service tool.

1. Click **FTP** under **Storage** to open the **FTP** configuration interface.

Figure 12-85 FTP Configuration Interface



2. Configure the FTP settings and click **OK** to save your settings.

Table 12-25 FTP Configurations

Setting	Description
Enable	Check this box to enable an FTP connection.
Host IP	Enter the IP address for the server.

Port	Enter the Port number for the server.
Username	Enter the user name for logging into the server.
Password	Enter the password for logging into the server.
Anonymous	Click to enable/disable anonymously logging into the server.
Remote Directory	When the remote directory is null, the NVR automatically creates folders according to the IP, time, and channel.
File Size	Here you determine the size of the upload file. If the setup file size is larger than the actual file, then the system uploads the entire file. If the setup file size is smaller than the actual file, then the system uploads only the set file size. If you enter 0 here, then the system uploads all corresponding files.
Image Upload Interval	This is the interval that the CVR waits through before uploading an image to the FTP site. Select from 0 to 3600 seconds. 0 means that there is no interval.
Channel	Select a channel.
Weekday	Select a weekday.
Time Periods	You can configure up to two time periods per channel.
Recording Type	Select from Alarm&IVS&POS , MD , or Regular .

Click **FTP Test** to test the FTP connection. A popup window shows the status of the connection.

Configuring Manual Recording Storage Settings

Click **Record** under **Storage** to open the **Record** configuration interface. The Record settings can be different for the Main Stream, Sub Streams and Snapshot recordings.

Figure 12-86 Manual Recording Storage Interface



Table 12-26 Recording Storage Interface

Setting	Description
Channel	See the channel numbers, including the maximum number of channels.
Auto	Select Auto , and the system enables the automatic recording function as you set it in the Recording Schedule Setup . See Configuring Storage Schedules on page 73.
Manual	This is the highest priority. Enable the corresponding channel to record not matter what period was applied in the Recording Setup.
Stop	Stop recording the current channel no matter what recording setup is applied to that channel.
Start All/Stop All	Select the All selections to make the same setting for all channels.

Configuring Advanced Storage Settings

1. Click **Advanced** under **Storage** to open the **Advanced** storage interface.

Figure 12-87 Advanced Storage HDD Interface



2. On the **Advanced HDD** tab, you can assign names to hard drives and hard drive groups.
3. On the **Main Stream**, **Sub Stream**, and **Snapshot** tabs you can select the hard drive or hard drive groups to store recorded data from each stream channel or snapshot channel.

Figure 12-88 Advanced Main Stream Interface

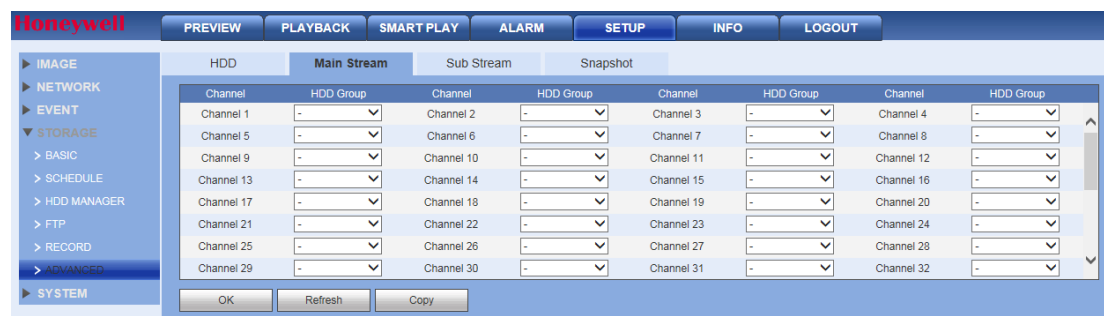

4. Click **OK** to save your settings.

Configuring System Settings

General Settings

Click **General** under **SETTING** to open the **General** settings configuration interface. Update the general settings as required and click **OK** to save the settings.

Figure 12-89 General Settings Interface

Table 12-27 General Settings Configurations

Configuration	Description
Device Name	Enter a device name.
Device No.	Enter an NVR number.
Language	Select a GUI language from the drop-down list. Note: You need to reboot the device/NVR to activate this change.
Auto Logout	Set the length of time the NVR waits before logging out an inactive user. Specify a time between 0 and 60 minutes. The default setting is 10 min.
Navigation Bar	Select the check box to display the live view toolbar on the live view screen. Clear the check box to hide the live view toolbar.
Authentication Mode	Check to enable the authentication mode for using the keyboard. If the authentication mode is not applicable to your keyboard, uncheck it.

Date and Time Settings

Click the **Date & Time** tab in the **GENERAL** configuration interface to open the **Date & Time** configuration interface. Update the date and time settings as required and click **OK** to save the settings.

Figure 12-90 Date & Time Configuration Interface

Table 12-28 Date & Time Configurations

Configuration	Description
Date Format	Select the date format from the drop-down list.
Time Format	Select from either 24 hour or 12 hour .
Date Separator	Select from a period (.), a hyphen (-), or a slash (/).
System Time	Set the NVR's time. You have to Save to activate this setting.
Sync PC	Click to synchronize your NVR's time with your PC's time.
Time Zone	Select a Time Zone for the NVR.
DST	Click to enable Daylight Saving Time (DST). Click to select a type, either Date or Week . Then configure a date and time when DST begins and ends.
NTP	Click to enable the NTP server.
NTP Server	Enter the NTP time server address.
Port	Enter the NTP time server port.
Upgrade Interval	Configure the synchronization period between the NVR and the NTP time server.

Holiday Settings

1. Click the **Holiday** tab in the **GENERAL** settings configuration interface to open the **Holiday Setup** configuration interface.

Figure 12-91 Holiday Settings Configuration Interface

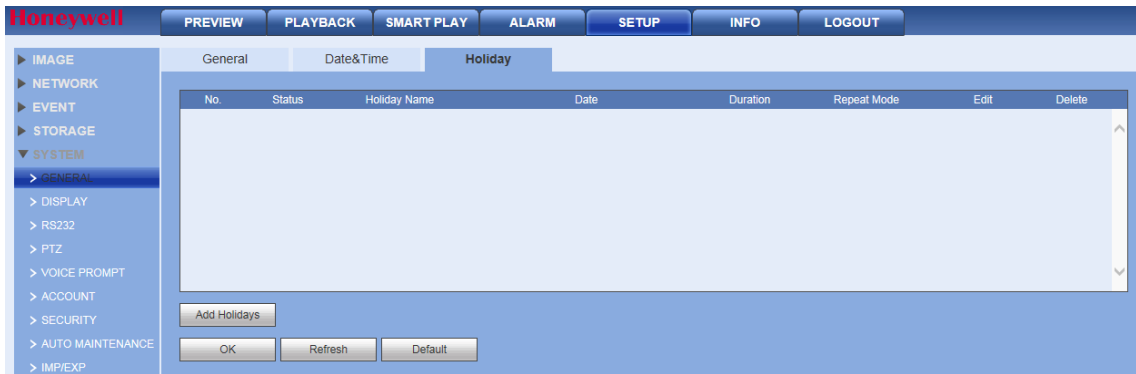

2. Click **Add Holidays** to add a holiday, enter the holiday details, then click **OK**.

Configuring Display Settings

Display Settings

Click **Display** under **System** interface to open the **Display** settings configuration interface. Update the display settings as required and click **OK** to save the settings.

Figure 12-92 Display Configuration Interface

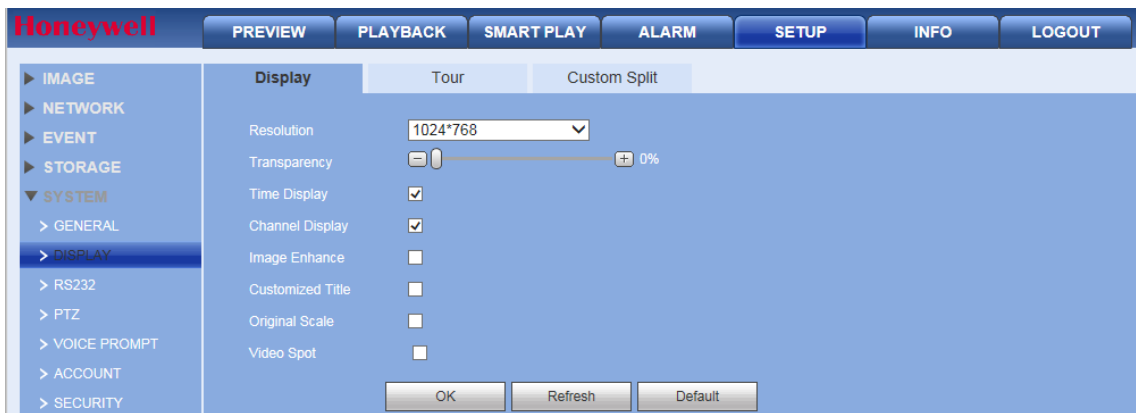

Table 12-29 Display Configurations

Configuration	Description
Resolution	Select from four options: 3840x2160 , 1920x1080 , 1280x1024 (default), 1280x720 , and 1024x768 . Note: You need to reboot the NVR to activate changes to the resolution.
Transparency	Configure the transparency of the GUI display. Select from 0% to 100% .
Time Display/Channel Display	Click to enable these functions, which display the time and channel on the video monitor.
Image Enhance	Check to enable Image Enhance , to optimize the preview video.

Customized Title	Check to enable Customized Title , which displays the customized title on the video monitor.
Original Scale	Check to show channels in their original aspect ratio. Unselected channels display in full screen.
Video Spot	Check to select VGA Output or HDMI Output. In the selected output, the user operation is disabled and it only displays the playback.

Tour Configurations

In the **Tour** interface, you can set the **Tour Interval**, **Window Split** mode, **Video Detection Tour**, and **Alarm Tour** modes.

Click the **Tour** tab in the **DISPLAY** configuration interface under **System** to open the **Tour** configuration interface.

Figure 12-93 Tour Configuration Interface

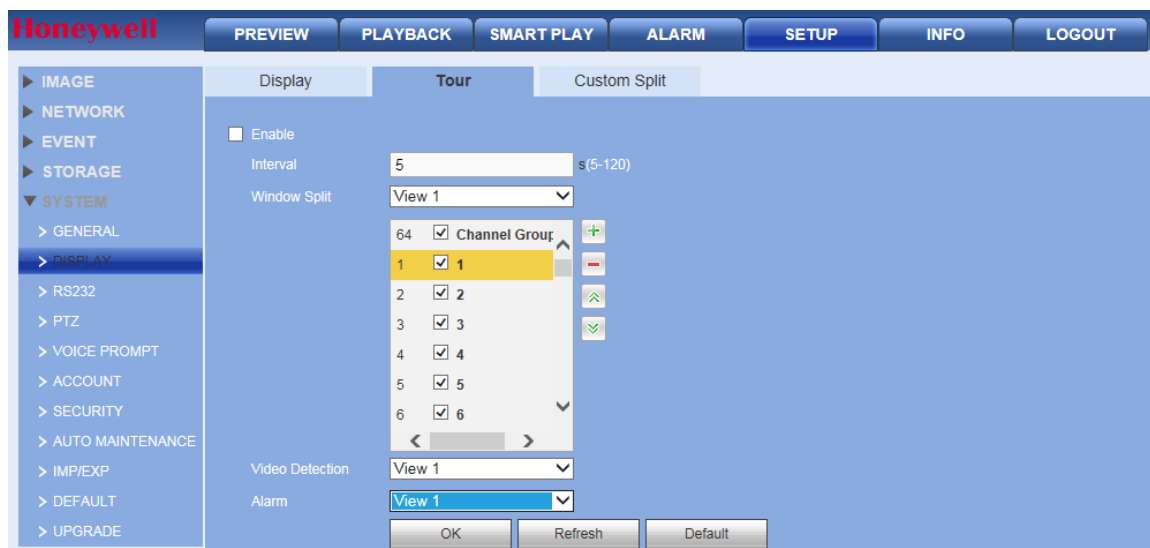

Table 12-30 Display Tour Settings

Setting	Description
Enable	Check to enable the tour function.
Interval	Adjust the tour interval between channels. Select from 5s to 120s . The default is 5s .
Window Split	Set the window mode and channel group. Depending on your NVR, it can support up to a 1/4/8/9/16/25/36/64-window split.
Channel Group	Add channels to a channel group, and when the NVR starts a tour, the tour starts only on the selected channels for the group.
Video Detection Tour / Alarm Tour	Set the Video Detection Tour and Alarm Detection Tour window modes. The NVR can support 1/8 window.

Custom Split Configurations

Note



This function is only available for
HEN081*4/HEN162*4/HEN163*4/HEN161*4/HEN322*4/HEN323*
4/HEN321*4/HEN642*4/HEN643*4.

In the **Custom Split** interface, you can configure a customized split screen display.

1. Click the **Custom Split** tab in the **DISPLAY** configuration interface under **System** to open the **Custom Split** configuration interface.

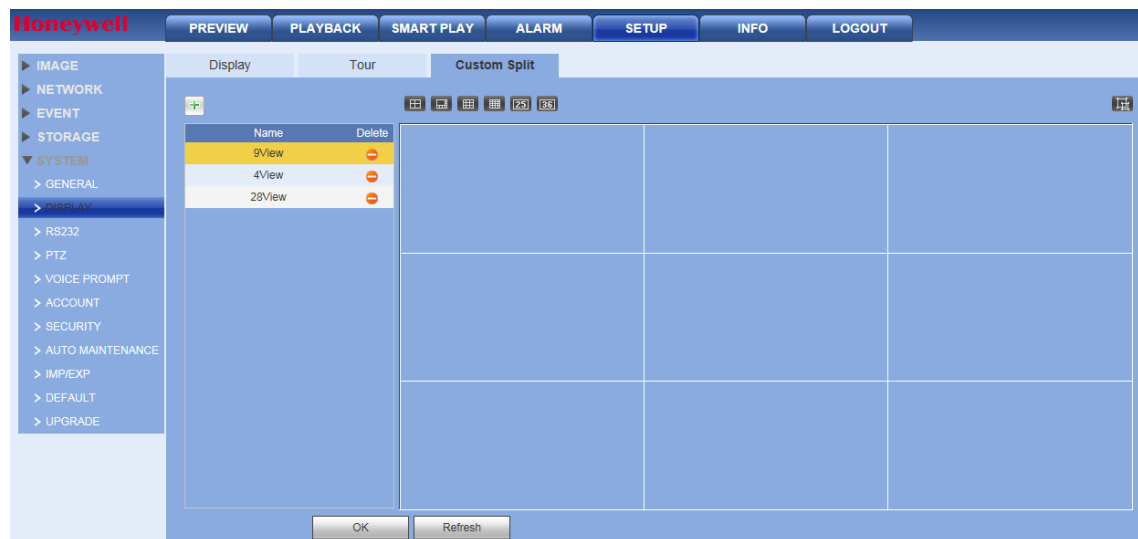
Figure 12-94 Custom Split Configuration Interface



2. On the **Custom Split** tab, click  to add the selected split view to the list.
3. Use the mouse to click and drag the display grid to configure it, as needed. You can combine small squares into a larger display area, or split them up to view more channels at once. To use the custom split window, click  on the main window (see [Figure 12-12](#)).
4. Click **OK** to save your settings.

RS232 Configurations

Note

This function is only available for
HEN081*4/HEN162*4/HEN163*4/HEN161*4/HEN322*4/HEN323*
4/HEN321*4/HEN642*4/HEN643*4/HEN04103L/HEN08103L/HE
N16103L/HEN32103L.

1. Click **RS232** under **System** to open the **RS232** configuration interface.

Figure 12-95 WEB - RS232 Configuration Interface

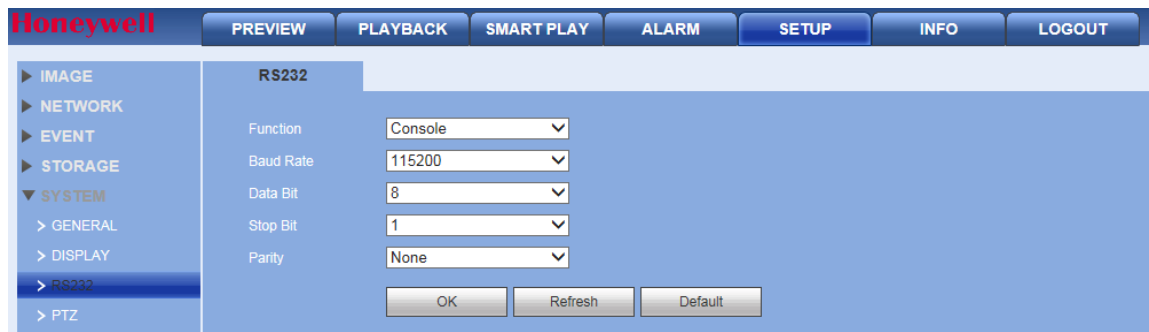

Table 12-31 RS232 Web Configurations

Setting	Description
Function	Select the corresponding dome Protocol. The default is Console .
Baud Rate	Select the Baud Rate . The default is 115200 .
Data Bit	Select from 5 to 8 . The default is 8 .
Stop Bit	Choose either 1 or 2 . The default is 1 .
Parity	Select from None , Odd , Even , Space , or Mark . The default is None .

2. Make your selections, then click **OK**.

Configuring PTZ Settings

Before configuring PTZ, please ensure the following:

- The PTZ and decoder are connected correctly, and that the decoder address setup is correct.
- That the correct decoder line is connected to the correct NVR line (A to A; B to B).

Click **PTZ** under **SYSTEM** to open the **PTZ** configuration interface

Figure 12-96 PTZ Configuration Interface

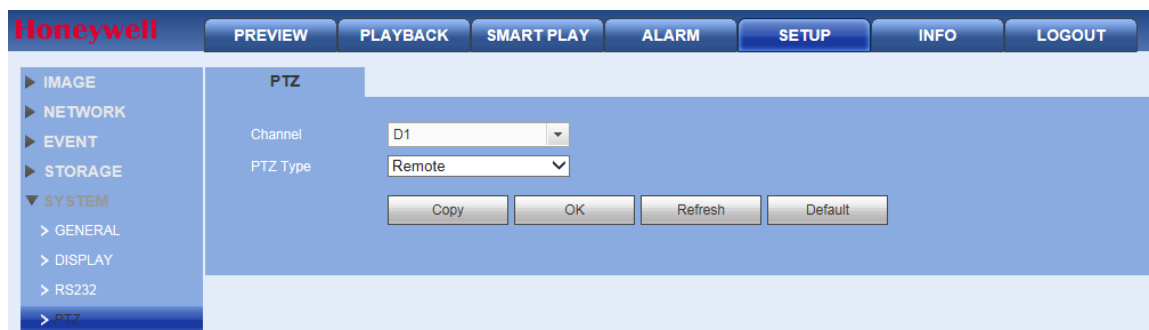

Table 12-32 PTZ Configuration Interface

Setting	Description
Channel	Select a channel.

PTZ Type	Select Remote for the PTZ type. A remotely connected IP camera is connected through the network.
-----------------	---

Configuring Voice Prompt Settings

Voice prompt files can be used as alarm audio and can be set as actions when events are triggered.

Managing Voice Prompt Files

1. Click **Voice Prompt** under **SYSTEM** to open the **File List** configuration interface

Figure 12-97 Voice Prompt File List Configuration Interface

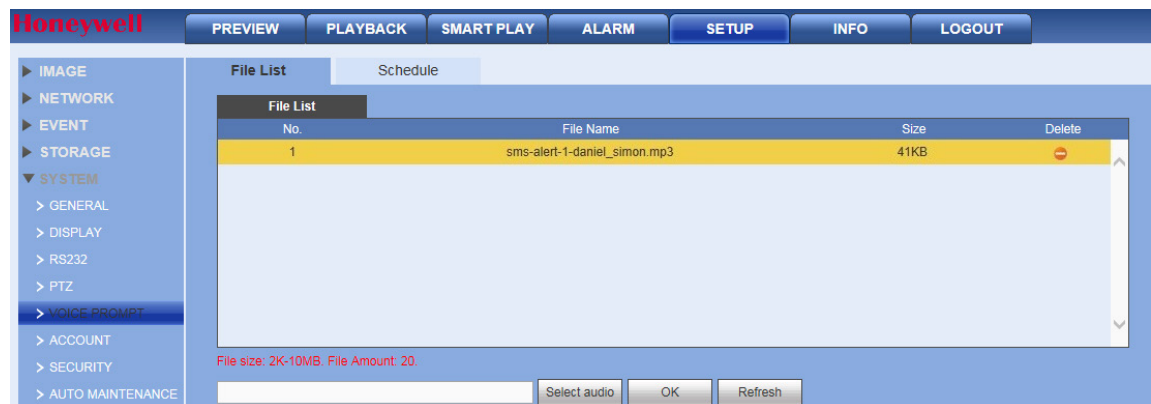

2. Click **Select audio** to search for and add a new audio file to the voice prompt file list.
3. If necessary, you can delete audio files by clicking the delete icon for that file.
4. Click **OK** to save your settings.

Configuring Voice Prompt Schedules

1. Click **Schedule** on the **Voice Prompt** screen to open the **Schedule** configuration interface
2. You can configure up to six schedule periods. Set the time range for each **Period**.
3. Select the file name to be played from the drop-down list.
4. Enter the number of times the voice prompt should repeat in the **Repeat** field and set the **Interval** between repetitions.
5. Select the audio device to play the voice prompt from the **Output** drop-down list.
6. Click **OK** to save the settings.

Configuring Accounts

Some Basic User and Group Rules

- You can use up to 6 characters for user names and group names. You can not use a space at the beginning or end of a name. You can use characters, numbers, and an underline (_).
- You can add up to 64 users and 20 groups (these are also the default settings). The default setting includes two group levels: **user** and **admin**. Configure the Group privileges, and then assign users to their groups according to the privileges those users require.

- User management involves assigning privileges to groups, and users to groups. User names can not be the same as group names; user names and group names must be unique. Users can belong to only one group.

Click **Account** under **SYSTEM** to open the **Account** settings configuration interface.

User Name

Figure 12-98 User Name Account Configurations

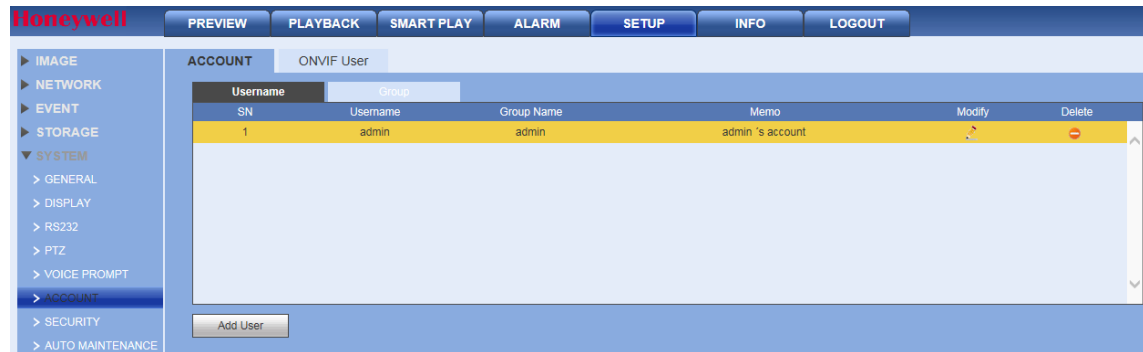

There are two default users:

- admin
- a hidden user

The hidden default user is for internal use only, and cannot be deleted. If users log in without selecting a login user, the hidden default user is automatically used. You can configure some rights for the default hidden user, such as monitor rights so that the user can view channels without logging in.

Note

- User rights cannot exceed group rights.
 - General users should have fewer rights than administrators.
-

Adding a User

1. Click **Add User**. The **Add User** configuration interface opens.
2. Enter a **Username** and a **Password**. Re-enter the Password to confirm it.
3. Select a **Group**.
4. Select **System**, **Playback**, and **Monitor** privileges.
5. Click **OK** to save these new settings.

Figure 12-99 Add User Configuration Interface

Modifying a User

1. Click  under **Modify** to open the **Modify User** configuration interface.

Figure 12-100 Modify User Configuration Interface

2. Change the settings, then click **OK**.

Modifying a Password

1. Click **Modify Password** in the **Modify User** configuration interface.
2. Enter the old **Password**, then enter the new **Password** twice.
3. Click **OK** to save the new password.

Note

Passwords can have up to 6 characters, numbers only. Users with admin rights can modify the password of other users.

Groups

Click the **Group** tab in the **Account** configuration interface to open the **Group** configuration interface.

Figure 12-101 Group Configuration Interface

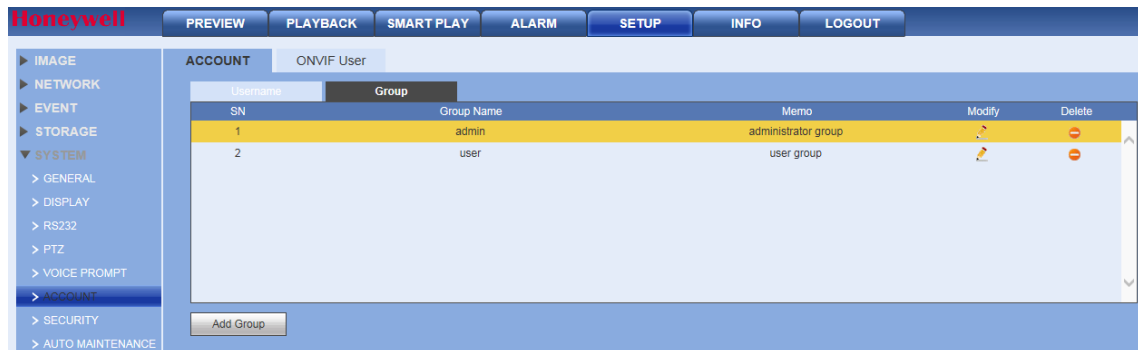

Adding a Group

1. Click **Add Group** in the **Group Account** configuration interface.

Figure 12-102 Add Group Configuration Interface

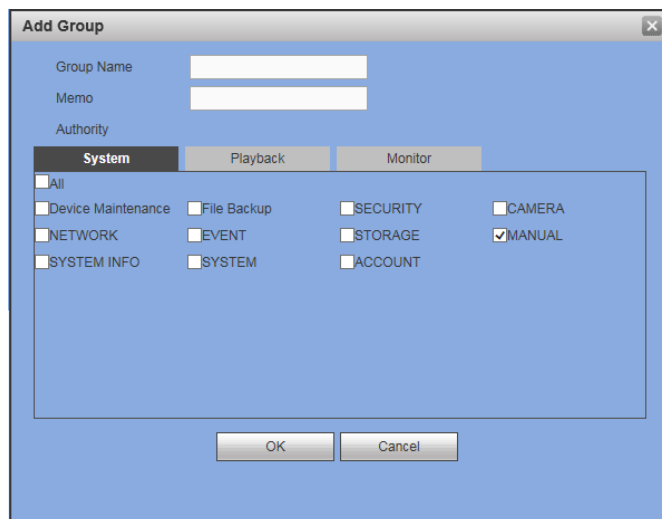

2. Enter a **Group** name.
3. Select **System**, **Playback**, and **Monitor** privileges.
4. Click **OK** to save these new settings.

Modifying a Group

1. Click under **Modify** to open the **Modify Group** configuration interface.

Figure 12-103 Modify Group Configuration Interface

2. Modify the **Group** privileges, then click **OK** to save the changes.

ONVIF User

You can add, edit, or delete ONVIF user accounts.

Go to **SETUP→SYSTEM→ACCOUNT→ONVIF User**, the following window is displayed:

Figure 12-104 ONVIF User

No.	Username	Group Name	Modify	Delete
1	admin	admin		

The configuration for **ONVIF User** is very similar to the configuration for **Username**, see on [User Name](#) on page 222 for more information.

Configuring Security

1. Go to **SETUP→SYSTEM→SECURITY**, the following window is displayed:

Figure 12-105 Security Configuration Interface



2. Click to enable **Trusted Sites**, and only the listed IP addresses can access the NVR.
- OR
- Click to enable **Blocked Sites**, and the listed IP addresses can NOT access the NVR.

Adding Trusted or Blocked Sites

1. Click **Add** to open the **Add** configuration interface.
2. Select **IP Address**, **IP Segment** or **MAC Address** from the drop-down menu.
3. Select **IPv4** or **IPv6** from the drop-down menu. This option is not available if **MAC Address** was selected in step 2.
4. Enter the IP address or MAC address in the address field (depending on what option you selected in step 2).
5. Click **OK**.

Automatic Maintenance

1. Click **Auto Maintenance** under **SYSTEM** to open the **Auto Maintenance** configuration interface.

Figure 12-106 Auto Maintenance Configuration Interface

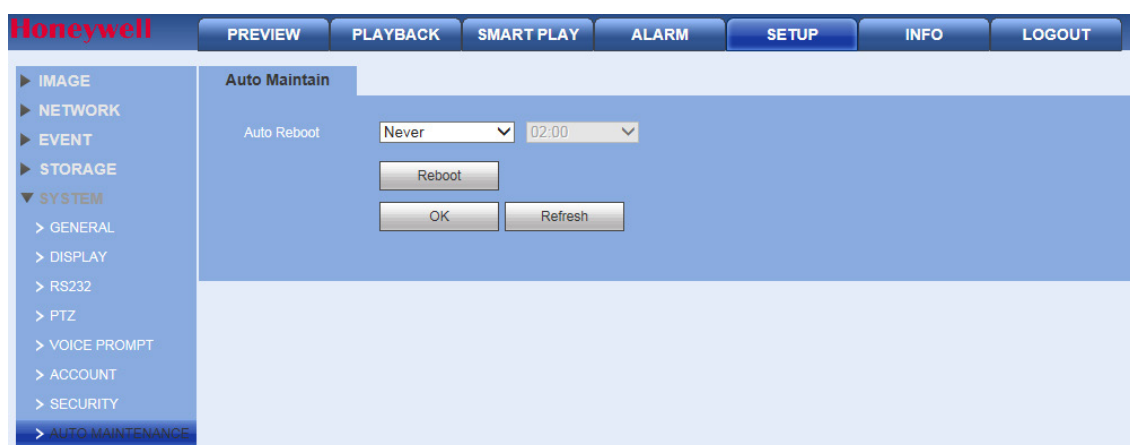

2. Select when the NVR automatically reboots, both day and time (or Never).
3. Click **OK** to save the new settings.

Note Click **Reboot** to manually reboot the NVR.

Import/Export

Click **IMP/EXP** under **SYSTEM** to open the **Import&Export** configuration interface.

Figure 12-107 Import&Export Interface



Table 12-33 Import/Export Operations

Activity	Description
Config Import	Used to import local setup files to the NVR system.
Config Export	Used to export the corresponding WEB setup to your local PC.

Default

You can select to return **Camera**, **Network**, **Event**, **Storage**, and/or **System** settings to their defaults.

1. Click **Default** under **SYSTEM** to open the **Default** configuration interface.

Figure 12-108 Default Settings Interface

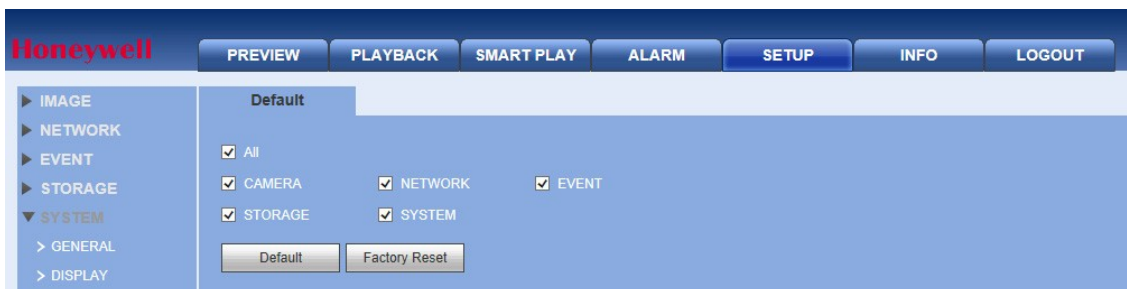

2. Click to select, or select **All**, then click **Default**.

Upgrade

Click **Upgrade** under **SYSTEM** to open the **Upgrade** configuration interface.

Figure 12-109 Upgrade Interface

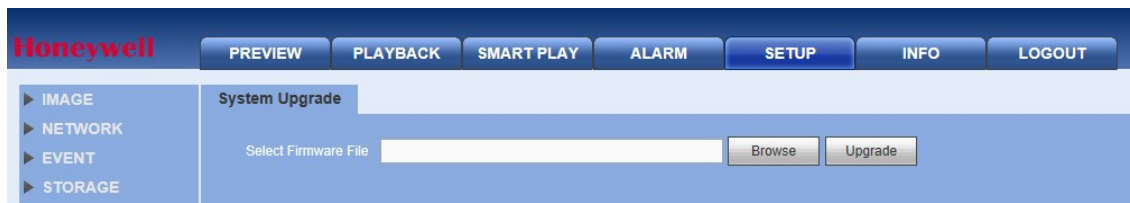

1. Click **Browse**, then click to select the upgrade file.
2. Click **Upgrade** to begin the update. The file name will end with **.bin**.

Note During the upgrade process, do not unplug the power cable, network cable, or shut down the device.

CAUTION An improper upgrade program could result in a device malfunction.

Playback

This chapter includes descriptions of the following:

- Playing back recorded video
- Playing back slices
- Downloading recorded video
- Playing back recorded events with the Smart Player

Playing Back Recorded Video

1. Click the **Playback** tab at the top of the **Main** window.
The **Playback** interface appears.

Figure 12-110 Playback Interface

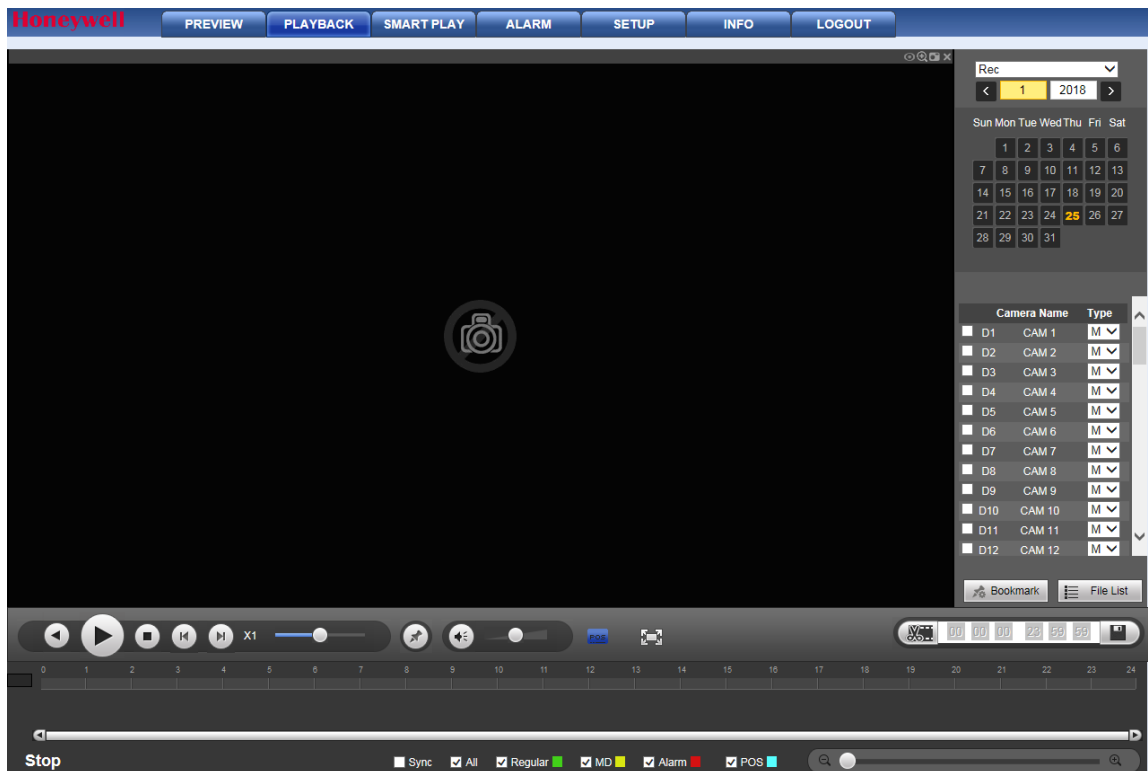

2. Select a recording type, recording date, camera(s), stream type to select video for playback.
3. Click **File List**, and the system displays a list of recorded video clips that match the search criteria from step 2.

Figure 12-111 List of Recorded Video Clips



4. Select a file from this list for playback, then click **Play**. You can play back in full screen mode.

Use the playback control bar to control playback.

Figure 12-112 Playback Control Bar



Note

For one-channel playback, the system cannot play back and download at the same time..

Playing Back Slices

Note This function is only available for HEN081*4/HEN162*4/HEN163*4/HEN161*4/HEN322*4/HEN323*4/HEN321*4/HEN642*4/HEN643*4.

For the large recording file, you can use the slice playback function to play the same file in several sections at the same time. It is very convenient for you to find the video footages you desire.

On the main window, click **Playback**. You will be navigated to the window as shown in [Figure 12-110](#).

On the right pane, select Slice in the dropdown list, and then select date, cameras and stream. The slice playback interface is shown as below. Each section has a small triangle; you can adjust it to set time.

Figure 12-113 Slice Playback

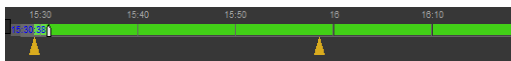

Select slice file.

- Click **Playback**, system playbacks from the first of current date by default.
- Click time bar, system playbacks from the time you click.
- Click , you can select on the file list.

Note

- The slice playback is for 1-window playback mode.
- System supports 1/4/8/16-split mode. Slight difference may be found here. The 4-channel series product supports 4-split mode. The 8-channel series product support 8-split mode. The 16-channel or higher series product supports 16-split mode.
- The min period of each section is 5 minutes. For the record less than 20 minutes, if you select 4-split mode (or more than 4-split mode), system can auto adjust so that the each section period is 5 minutes. In this situation, some channel may have no video.

Playing Back Marks

Please make sure your purchased device support this function. You can use this function only if you can see the mark playback icon on the Playback window ([Figure 12-110](#)).

When you play back video record, you can mark the video record when there is important information. After the playback, you can search the corresponding record by time or the mark key words and then play it. It is very easy for you to get the important video information.

Add Mark

During the playback, click  and the following window is displayed:

Figure 12-114 Add Mark



Click **OK**.

Playback Mark

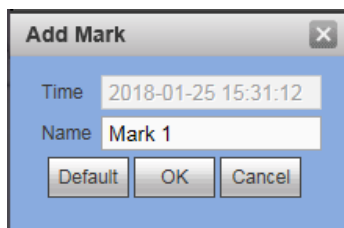
During 1-window playback mode, click  on the Playback window ([Figure 12-110](#)), you can go to mark file list interface. Double click one mark file, you can begin playback from the mark time.

Figure 12-115 Mark List



Play before mark time

Here you can set to begin playback from previous N seconds of the mark time.

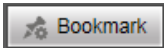
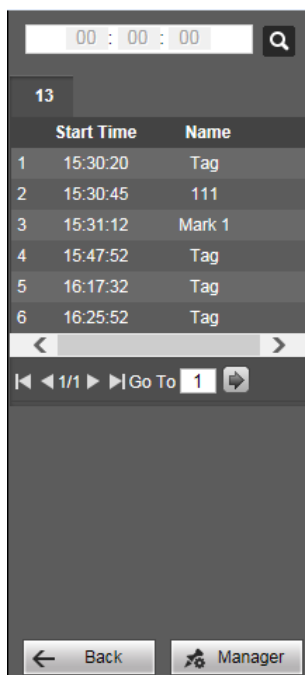
Note

Usually, system can playbacks previous N seconds record if there is such kind of record file. Otherwise, system playbacks from the previous X seconds when there is such as kind of record.

Mark Manager

Click  on the Mark List ([Figure 12-115](#)) and the following window is displayed. System can manage all the record mark information of current channel by default. You can view all mark information of current channel by time.

Figure 12-116 Mark Manager

No.	Channel	Mark Time	Name
1	13	2018-1-25 15:30:20	Tag
2	13	2018-1-25 15:30:45	111
3	13	2018-1-25 15:31:12	Mark 1
4	13	2018-1-25 15:47:52	Tag
5	13	2018-1-25 16:17:32	Tag
6	13	2018-1-25 16:25:52	Tag
7	13	2018-1-26 9:53:4	Tag

Modify Marks

Double click one mark information item, you can see system pops up a dialogue box for you to change mark information. You can only change mark name here.

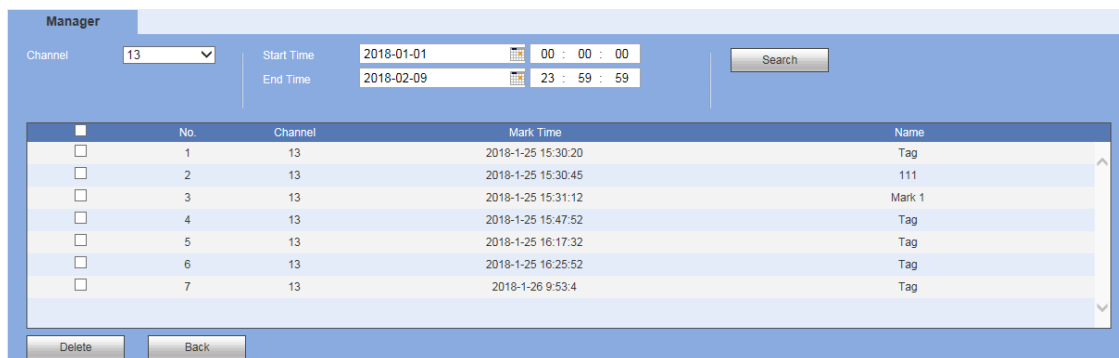
Delete Marks

Here you can check the mark information item you want to delete and then click **Delete**, you can remove one mark item.

Note

- After you go to the mark management interface, system needs to pause current playback. System resume playback after you exit mark management interface.
- If the mark file you want to playback has been removed, system begins playback from the first file in the list.

Downloading Video

After generating a list of recorded video clips by clicking **File List**, select the files you want to download, then click  **Download** (see [Figure 12-111](#)).

The **Download** button becomes the **Stop** button, and it indicates the downloading progress (in a percentage).

Go to your default **Saved Path** file to view the downloaded files. See [Configuring the Save Path](#) on page 169.

Loading More

Click **More** (see [Figure 12-111](#)), and the **Download by File/Download by Time** interfaces appear.

Figure 12-117 Download by File/Download by Time Interfaces

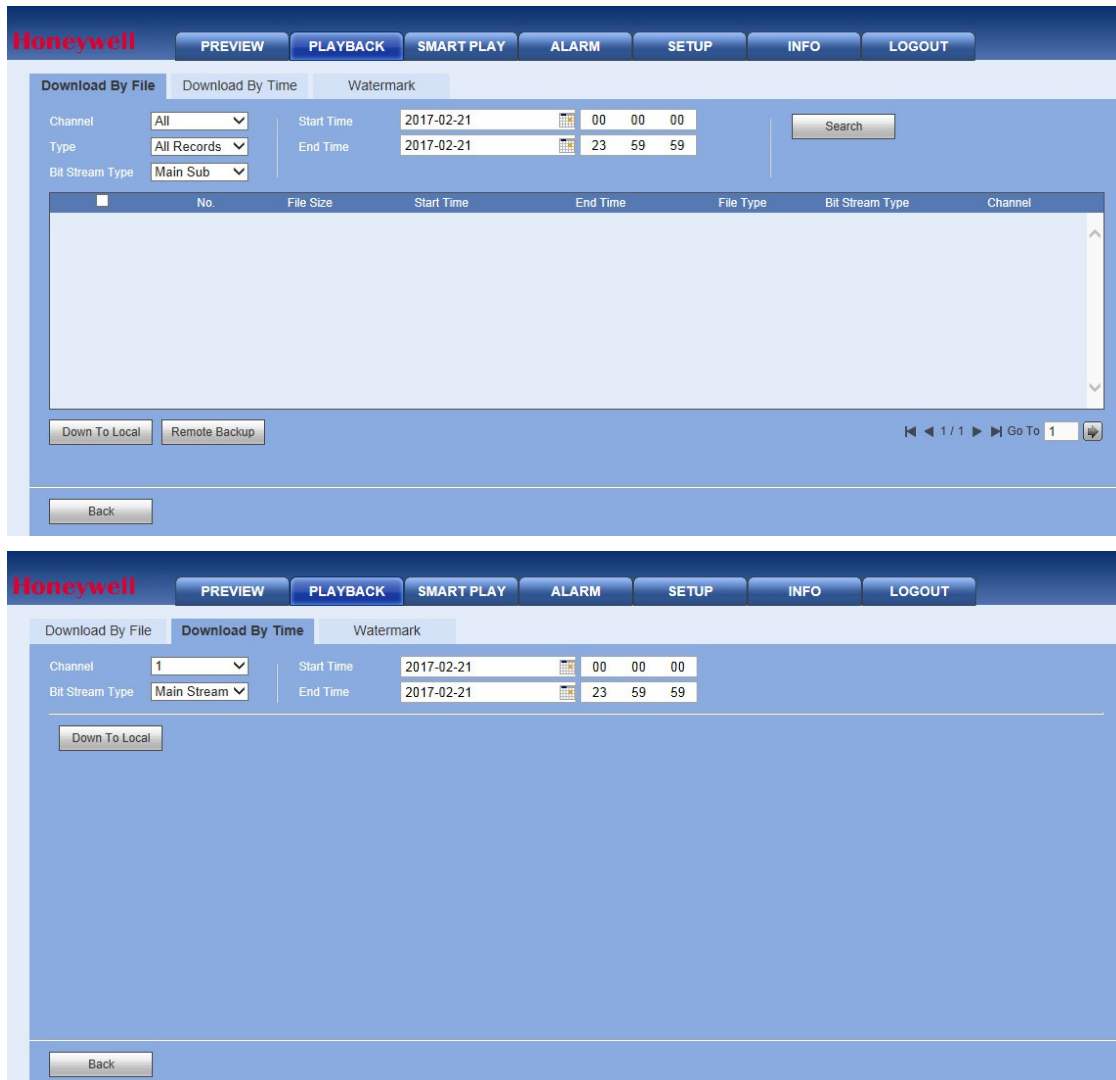

In this window, you can search for recordings or snapshots. Select the channel, recording type, and the recording time.

Using the Smart Player to Playback Event Video

The Smart Player can be used to search for video related to analytics type events, such as face detection.

1. Click the **SMART PLAY** tab at the top of the web client interface. The Smart Player interface opens.

Figure 12-118 Smart Player Options

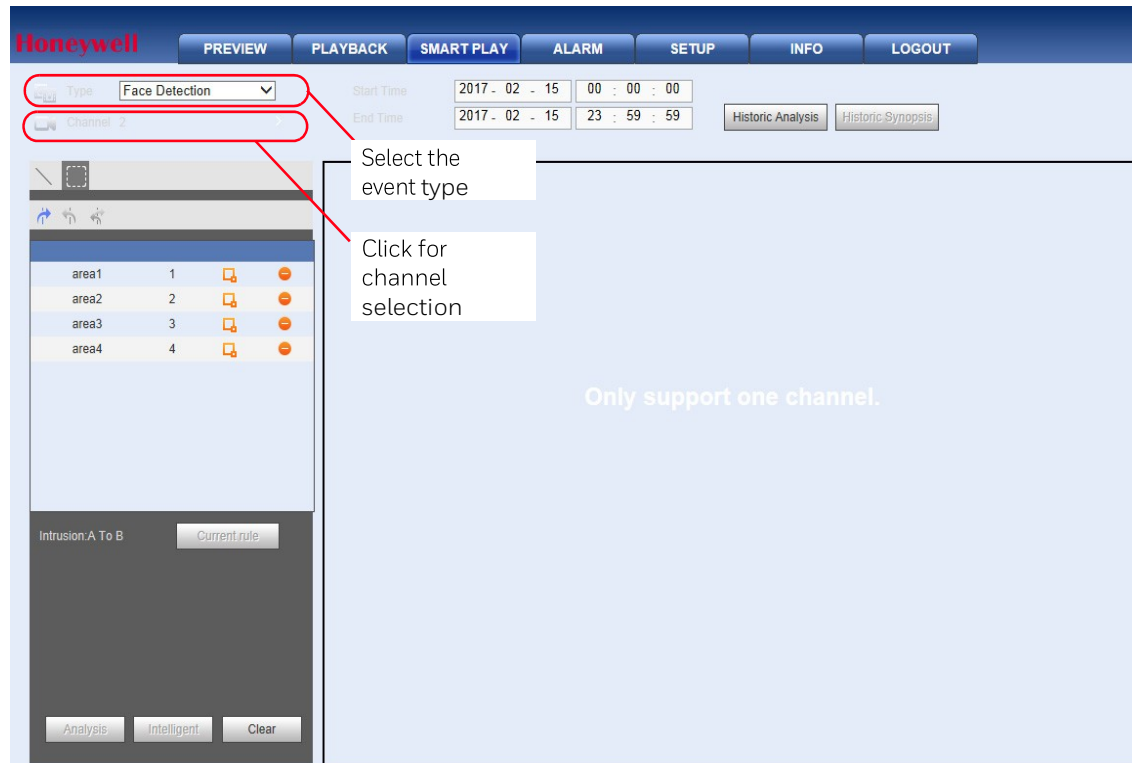

2. Select the type of event to search through with the Smart Player from the event drop-down list. In the [Figure 12-118](#) example, **Face Detection** is selected.
3. Select the Channel to search through for the events in the Channel dialog. In the [Figure 12-118](#) example, **Channel 2** is selected.
4. Enter the **Start Time** and **End Time** define the times for the Smart Player to search for the event and click **Historic Analysis**.
5. The Smart Player screen will open with a list of the events types that have occurred on the selected channel and within the specified time frame. Select one of the event instances to call up the video from the event.

Alarms

This chapter describes how to remotely activate the alarms.

Activating Alarms

Click the **Alarm** tab at the top of the **Main** window. The **Alarm** interface opens.

Figure 12-119 Alarm Interface



Table 12-34 Alarm Configurations

Configuration Type	Configuration	Description
Alarm Type	Motion Detection	Click to enable Motion Detection . The system will then trigger an alarm when motion is detected under the specified circumstances.
	Local Alarm	Click to enable Local Alarm . The system triggers an alarm when the NVR's local alarm is triggered.
	Tampering	Click to enable Tampering . The system triggers an alarm when camera tampering occurs.
	HDD Error	Click to enable the HDD Error alarm. The system triggers an alarm when a hard disk error occurs.
	Video Loss	Click to enable Video Loss . The system then an alarm when video loss occurs.
	HDD Full	Click to enable the HDD Full alarm. The system triggers an alarm when the disk is full.
	Intelligent Detect	Click to enable the Intelligent Detect alarm. The system triggers an alarm when an intelligent analytics event occurs.
	Audio Detection	Click to enable the Audio Detection alarm. The system triggers an alarm when an audio detection event occurs.
	UserLock	Click to enable the UserLock alarm. The system triggers an alarm when a user has been detected of trying to illegally access the unit.
	Scene Change	Click to enable the Scene Change alarm. The system triggers an alarm when the camera scene change event occurs.

Operation	Message	Click to enable the Message . Then the system automatically pops up an alarm message on the Main interface when there is an alarm.
Alarm Sound	Play Alarm Sound	Click to enable the Alarm Sound . Then the system triggers an alarm sound when an alarm occurs. You can choose the sound.
	Sound Path	Select the sound file.

You can use the webpage un-install tool *uninstall_web.bat* to uninstall the web control plugin.

Note	Before uninstalling the Web control, close all web pages. If you do not, then you might experience an error.
-------------	--

13 Troubleshooting

The following section describes possible problems and solutions. Refer to these troubleshooting steps before calling Technical Support. If you still require assistance, call Honeywell Technical Support at 1-800-323-4576 (North America only) or send an e-mail to <https://www.honeywellsystems.com/ss/techsupp/index.html>. International contact information is listed on the back cover.

Problem: The NVR does not turn on.

- Check that the input voltage is correct.
- Check that the power cable is connected correctly to the NVR.
- Check that the power switch is in the ON position.
- Check that there is power at the outlet. Try connecting the NVR to another outlet or test the outlet with another device.
- Remove the housing and check that the hard drive cables are firmly connected.

Problem: The NVR automatically shuts down or stops running.

- Check that the NVR is receiving power and that the input voltage is correct and stable.
- Make sure that the working environment is within the specified temperature range and is free of dust. See [Appendix D, Specifications](#).
- Remove the housing and check that the hard drive cables are firmly connected.

Problem: The NVR cannot detect the hard drive.

- Remove the housing and check that the hard drive cables are firmly connected.
- Inspect the hard drive and ribbon for damage. Replace if damaged.
- Inspect the main board SATA port for damage. Replace if damaged.

Problem: There is no picture on the monitor.

- Check that the correct input (VGA) is selected on the monitor.
- Turn off the monitor and NVR. Turn on the monitor, and then turn on the NVR.
- Check that the video cable is connected correctly to the NVR.
- Make sure that the camera's brightness setting is configured correctly. See [Configuring Camera Image Settings](#) on page 55.
- Make sure that a privacy mask is not blocking the video. See [Configuring the Text Overlay](#) on page 58.

Problem: Color of live video is distorted.

- Make sure that the camera image settings are configured correctly. See [Configuring Camera Image Settings](#) on page 55.

- Make sure that the NVR is configured to use the correct video standard (NTSC or PAL). See [Configuring General System Settings](#) on page 115.

Problem: Cannot search local records.

Check that recording is enabled. See [Configuring the General Recording Settings](#) on page 38.

Problem: There is no audio when viewing live video.

- Check the audio input and output connections on the NVR.
- Increase the volume on the headphones/speakers.

Problem: There is no audio when playing back video.

Make sure that the audio is enabled in the playback interface and the volume is turned up.

Problem: The time display is incorrect.

- Make sure that the date and time settings are configured correctly. See [Configuring Date and Time Settings](#) on page 116.
- Replace the battery on the main board.

Problem: The NVR cannot control PTZ functions.

- Check that the PTZ camera is connected correctly to the network.
- Make sure that the NVR is configured correctly for PTZ operation. The protocol and address settings of the NVR must match the protocol and address settings of the PTZ camera. See [Adding a Camera](#) on page 53 for the camera settings. See [Configuring TCP/IP Settings](#) on page 62 for NVR settings.

Problem: Motion detection does not work.

- Increase the motion detection sensitivity. It may be set too low.

To set the motion detection sensitivity, see [Configuring Motion Detection Settings](#) on page 77.

- Make sure that the motion detection schedule is configured correctly.

To setup up the Motion detection schedule, see [To set up motion detection periods](#) on page 81.

- Make sure that the motion detection zone setup is configured correctly.

To set up motion detection zone, see [Configuring Motion Detection Settings](#) on page 77.

Problem: The network connection is unstable.

Check that there is no IP address or MAC address conflict.

Problem: There is a USB backup error.

Check that the USB storage device has sufficient space available.

Problem: Alarm signal cannot be disarmed.

- Make sure that the alarm settings are correctly configured.

- Check the alarm cable connections.
- Make sure that the NVR is running the latest firmware.

Problem: Alarm function is null.

- Make sure that the alarm settings are correctly configured.
- Check the alarm cable connections.
- Check that you have not connected two loops to one alarm device.

Problem: Cannot play a downloaded file.

- Use the player included on the software CD.
- Make sure that you have DirectX8.1 or greater installed on your computer.
- If you are using Windows XP, download the plug-ins DivX503Bundle.exe and ffdshow-20041012.exe.

Problem: The accuracy of people counting is low.

- The algorithm is based on the height and shoulder width of adults, so the accuracy is low when the camera detects children.
- Luggage and other objects that have similar width to human shoulder will be counted.
- For wide entrance, if multiple cameras are installed, repeated statistics may occur in the overlapping area.
- Wrong statistics may occur when people are in fast moving, when people are wandering on the rule lines, when lights are changing instantly, when two people walk shoulder by shoulder and when the movement direction of people is not vertical to the rule lines.

14 Appendix A

Connecting Alarm Input/Outputs

This appendix contains the following sections:

- [Before Connecting Alarm Inputs and Outputs](#), on page 241
- [Alarm Input and Output Rear Panel Connections](#), on page 241
- [Guidelines for Connecting Local Alarm Input Ports](#), on page 242
- [Guidelines for Connecting Alarm Output Ports](#), on page 242

Before Connecting Alarm Inputs and Outputs

- Ensure that the alarm input mode is set to ground.
- Ensure that the signal is grounded.
- Know that the alarm inputs require low-level voltage signals.
- Ensure that the alarm input mode is set to either NC (normally closed) or NO (normally open).
- Use a relay if you are connecting two NVRs, or a NVR plus another device, to separate them.
- Do NOT directly connect the alarm output port to a high-power load. The load should be less than 1 A to avoid damage.
- Use the contactor to make the connection between the alarm output port and the load.

Alarm Input and Output Rear Panel Connections

The connections for the alarm input and output channels are described below:

Table 14-1 Alarm Input and Output Rear Panel Connections

Input/Output	Description
1 to 4	Alarms inputs 1 to 4. The inputs becomes active with low voltage.
NO1 C1, NO2 C2	Normally open activation outputs (on/off)
	Ground

Guidelines for Connecting Local Alarm Input Ports

- Ground alarm inputs. Choose from normally open (NO) or normally closed (NC).
- Connect the COM end and GND end of the alarm detector in parallel. Supply external power to the alarm detector.
- Connect the ground of the NVR and the ground of the alarm detector in parallel.
- Connect the NO/NC port of the alarm sensor to the NVR alarm input.
- Use the same ground as the NVR if you are supplying external power to the alarm device.

Guidelines for Connecting Alarm Output Ports

- Provide external power to external alarm device.
- To prevent overloading, carefully review the following relay specifications:

Table 14-2 Guidelines for Connecting Alarm Output Ports

Material	Nickel/silver contacts with gold plating	
Rating (Resistance Load)	Rated switch capacity	30 V DC 1A; 125 V AC 0.5A
	Maximum switch power	62.5 V AC, 30 W
	Maximum switch voltage	125 V AC; 60 V DC

15 Appendix B

Installing Hard Drives

The appendix contains the following sections:

- [Installing Hard Drives](#), on page 243
- [List of Compatible SATA HDDs](#), on page 251
- [List of Compatible Portable HDDs](#), on page 253

Note

Field retrofitting of the HDD storage with an incompatible HDD could invalidate the NVR warranty.

Hard Disk Drive Recommendations

- See [List of Compatible SATA HDDs](#) on page 251 for a list of recommended Hard Disk Drive (HDD) brands and models.
- Please use a HDD of 7200 rpm or higher.
- Do not use a PC HDD.

Installing Hard Drives

Note

Field retrofitting of the HDD storage with an incompatible HDD could invalidate the NVR warranty.

On some recorder models, you can install an additional hard disk drive (HDD). For a list of compatible HDDs, see the [List of Compatible SATA HDDs](#) on page 251. A 7200 rpm or higher HDD is recommended.



CAUTION
removing the cover.

Risk of electric shock. Disconnect the power before

The procedure for installing a hard drive is different depending on what NVR unit you have. Check the model number of your NVR and make sure that you refer to the section that applies to your NVR unit:

Note

- [Installing a HDD on HEN081*4/HEN161*4/HEN321*4/HEN041*3/HEN081*3/HEN161*3/HEN04103L/HEN08103L/HEN16103L/HEN32103L](#) on page 244.
 - [Installing a HDD on HEN162*4/HEN322*4/HEN642*4](#) on page 246.
 - [Installing a HDD on HEN163*4/HEN323*4/HEN643*4](#) on page 248.
-

Installing a HDD on HEN081*4/HEN161*4/HEN321*4/HEN041*3/HEN081*3/ HEN161*3/ HEN04103L/ HEN08103L/ HEN16103L/ HEN32103L

1. Loosen the screws on the upper cover and side panel of the NVR, remove the cover, and set it aside.

Figure 15-1 Removing the NVR Cover



2. Loosen four screws on the HDD.

Figure 15-2 Loosening the Four Screws in the HDD Housing



3. Align the HDD with the four holes in the bottom of the NVR housing.

Figure 15-3 Placing the HDD



4. Turn the NVR upside down, and then turn the screws to firmly attach the HDD to the NVR housing.

Figure 15-4 Securing the HDD to the NVR Housing



5. Connect the HDD cable and power cable.

Figure 15-5 Connecting the HDD and the Power Cable



6. Replace the NVR cover.

Figure 15-6 Replacing the NVR Cover



7. Secure the NVR cover in place by turning the screws in the rear and side panels.

Figure 15-7 Securing the NVR Cover



Installing a HDD on HEN162*4/HEN322*4/HEN642*4

1. Loosen the screws on the rear panel of the NVR, remove the front cover, and set it aside.

Figure 15-8 Removing the NVR Cover



2. Loosen four screws on the HDD.

Figure 15-9 Loosening the Four Screws in the HDD Housing



3. Put the HDD on the HDD bracket in the chassis and then align the HDD with the four holes in the bracket.

Figure 15-10 Placing the HDD



4. Fasten the screws to firmly attach the HDD to the NVR housing.
5. Connect the HDD data cable to the main board and the HDD port respectively.
6. Loosen the power cable from the chassis and connect another end of the power cable to the HDD port.

Figure 15-11 Connecting the HDD and the Power Cable



7. Replace the NVR cover.

Figure 15-12 Replacing the NVR Cover



8. Secure the NVR cover in place by fixing the screws in the rear panel.

Installing a HDD on HEN163*4/HEN323*4/HEN643*4

1. Loosen the screws on the rear panel of the NVR, remove the front cover, and set it aside.

Figure 15-13 Removing the NVR Cover



2. Loosen four screws on the HDD.

Figure 15-14 Loosening the Four Screws in the HDD Housing



3. Put the HDD on the HDD bracket in the chassis and then align the HDD with the four holes in the bracket.

Figure 15-15 Placing the HDD

4. Fasten the screws to firmly attach the HDD to the NVR housing.
5. Connect the HDD data cable to the main board and the HDD port respectively.
6. Loosen the power cable from the chassis and connect another end of the power cable to the HDD port.

Figure 15-16 Connecting the HDD and the Power Cable

7. Replace the NVR cover.

Figure 15-17 Replacing the NVR Cover

8. Secure the NVR cover in place by fixing the screws in the rear panel.

Installing an Additional HDD

The procedure for installing an additional hard drive is similar to the installing hard drive sections above, but different depending on what NVR unit you have. Check the model number of your NVR and make sure that you refer to the steps in the section that applies to your NVR unit when installing an additional HDD:

- Note**
- [Installing a HDD on HEN081*4/HEN161*4/HEN321*4](#) on page 244.
 - [Installing a HDD on HEN162*4/HEN322*4/HEN642*4](#) on page 246.
 - [Installing a HDD on HEN163*4/HEN323*4/HEN643*4](#) on page 248.
-

1. If the NVR is connected to a power source, disconnect it before continuing.
2. Remove the top cover from the NVR housing as described in the Installing HDD section for your unit. Refer to the corresponding section:
 - HEN081*4/HEN161*4/HEN321*4 on [page 244](#),
 - HEN162*4/HEN322*4/HEN642*4 on [page 246](#),
 - HEN163*4/HEN323*4/HEN643*4 on [page 248](#).
3. Connect the SATA and power cables to the new HDD.
4. Position the new HDD over the four open screw holes in the base of the housing or HDD bracket (depending on your NVR model), adjacent to the existing HDD.
5. Secure the new HDD to the housing using the four supplied HDD mounting screws.
6. Replace the NVR top cover on the NVR housing and secure it with the screws removed in step 2.

List of Compatible SATA HDDs

Note Upgrade the NVR firmware to the latest version to ensure the accuracy of the table below.

Table 15-1 List of Compatible SATA HDDs

Manufacturer	Series	Model	Capacity
Seagate	video 3.5	ST1000VM002	1T
Seagate	video 3.5	ST2000VM003	2T
Seagate	video 3.5	ST3000VM002	3T
Seagate	video 3.5	ST4000VM000	4T
Seagate	SkyHawk HDD	ST1000VX001	1T
Seagate	SkyHawk HDD	ST1000VX005	1T
Seagate	SkyHawk HDD	ST2000VX003	2T
Seagate	SkyHawk HDD	ST2000VX008	2T
Seagate	SkyHawk HDD	ST3000VX006	3T
Seagate	SkyHawk HDD	ST3000VX010	3T
Seagate	SkyHawk HDD	ST4000VX000	4T
Seagate	SkyHawk HDD	ST4000VX007	4T
Seagate	SkyHawk HDD	ST5000VX0001	5T
Seagate	SkyHawk HDD	ST6000VX0003	6T
Seagate	SkyHawk HDD	ST6000VX0023	6T
Seagate	SkyHawk HDD	ST8000VX0002	8T
Seagate	SkyHawk HDD	ST8000VX0022	8T
Seagate	SkyHawk HDD	ST1000VX003	1T
Seagate	SkyHawk HDD	ST2000VX005	2T
Seagate	SkyHawk HDD	ST3000VX005	3T
Seagate	SkyHawk HDD	ST4000VX002	4T
Seagate	SkyHawk HDD	ST5000VX0011	5T
Seagate	SkyHawk HDD	ST6000VX0011	6T
Seagate	SkyHawk HDD	ST8000VX0012	8T
Seagate	SkyHawk AI	ST8000VE0004	8T
Seagate	Constellation ES series	ST1000NM0055	1T
Seagate	Constellation ES series	ST2000NM0055	2T
Seagate	Constellation ES series	ST3000NM0005	3T
Seagate	Constellation ES series	ST4000NM0035	4T

Seagate	Constellation ES series	ST6000NM0115	6T
Seagate	Constellation ES series	ST8000NM0055	8T
Seagate	Constellation ES series	ST4000NM0024	4T
Seagate	Constellation ES series	ST6000NM0024	6T
TOSHIBA	Mars	DT01ABA100V	1T
TOSHIBA	Mars	DT01ABA200V	2T
TOSHIBA	Mars	DT01ABA300V	3T
TOSHIBA	Sonance	MD03ACA200V	2T
TOSHIBA	Sonance	MD03ACA300V	3T
TOSHIBA	Sonance	MD03ACA400V	4T
TOSHIBA	Sonance	MD04ABA400V	4T
Western Digital	WD Purple	WD10PURX	1T
Western Digital	WD Purple	WD20PURX	2T
Western Digital	WD Purple	WD30PURX	3T
Western Digital	WD Purple	WD40PURX	4T
Western Digital	WD Purple	WD50PURX	5T
Western Digital	WD Purple	WD60PURX	6T
Western Digital	WD Purple	WD80PURX	8T
Western Digital	WD Purple	WD10PURZ	1T
Western Digital	WD Purple	WD20PURZ	2T
Western Digital	WD Purple	WD30PURZ	3T
Western Digital	WD Purple	WD40PURZ	4T
Western Digital	WD Purple	WD50PURZ	5T
Western Digital	WD Purple	WD60PURZ	6T
Western Digital	WD Purple	WD80PURZ	8T
Western Digital	WD Purple	WD4NPURX	4T
Western Digital	WD Purple	WD6NPURX	6T
Western Digital	WD RE series	WD1004FBYZ	1T
Western Digital	WD RE series	WD2004FBYZ	2T
Western Digital	WD RE series	WD3000FYYZ	3T

Western Digital	WD RE series	WD4000FYYZ	4T
Western Digital	WD	WD2000F9YZ	2T
Western Digital	WD	WD3000F9YZ	3T
Western Digital	WD	WD4002FYYZ	4T
Western Digital	WD	WD6002FRYZ	6T
Western Digital	WD	WD8002FRYZ	8T
HITACHI	Ultrastar series	HUS724030ALA640	3T
HITACHI	Ultrastar series	HUS726060ALE610	6T
HITACHI	Ultrastar series	HUH728060ALE600	6T
HITACHI	Ultrastar series	HUH728080ALE600	8T

List of Compatible Portable HDDs

Table 15-2 List of Compatible Portable HDDs

Manufacturer	Model	Capacity
YDStar	YDStar HDD box	40 GB
Netac	Netac	80 GB
Iomega	Iomega RPHD-CG* RNAJ50U287	250 GB
WD Elements	WCAVY1205901	1.5 TB
Newsmy	Liangjian	320 GB
WD Elements	WDBAAR5000ABK-00	500 GB
WD Elements	WDBAAU0015HBK-00	1.5 TB
Seagate	FreeAgent Go (ST905003F)	500 GB
Aigo	H8169	500 GB

16 Appendix C MAXPRO® Cloud

This appendix contains the following section:

[Configuring for MAXPRO Cloud Mode](#), on page 254

Configuring for MAXPRO Cloud Mode

These cloud-ready devices can be standalone devices or can easily be connected to Honeywell's MAXPRO Cloud platform to create a fully integrated managed cloud solution. When used in MAXPRO Cloud mode, this device becomes a MAXPRO Cloud appliance that creates a secure connection to the cloud, and has the ability to stream high quality video while managing bandwidth. Critical events can be captured locally at higher resolution and frame rates, and then also stored in the cloud for safe and secure backup.

The MAXPRO Cloud solution provides the following additional added value for customers and dealers:

- Access on the go. View live or recorded video anytime anywhere on your PC, MAC, laptop, or mobile device.
- Ease of remote management, configuration and changes, f/w updates, and increase managed services from a single login.
- Real-time informative notifications with clip links and alerts for health, status, and critical events.
- Verification of site alarms, and reduction of false alarm costs and call outs.
- Adding cloud storage on the go.

Note

A MAXPRO Cloud service subscription is required. Please contact Honeywell Customer Service for details. See the back cover for contact information.

To switch to MAXPRO Cloud mode:

1. Go to **Main Menu** → **OPERATION**, then click **MAXPRO CLOUD**.

Figure 16-1 Selecting MAXPRO CLOUD

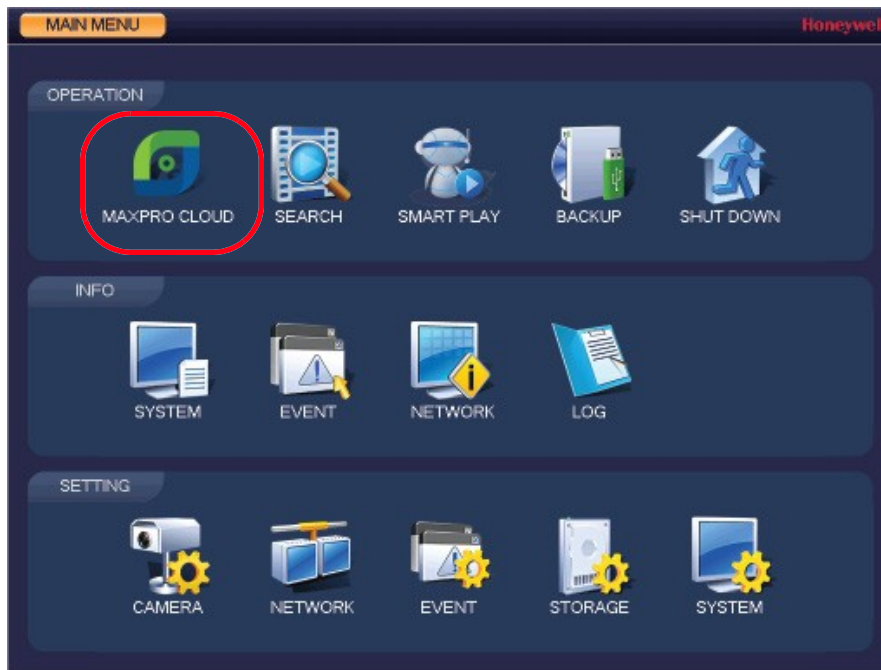

A confirmation message appears.

Figure 16-2 MAXPRO Cloud Configuration Confirmation Message

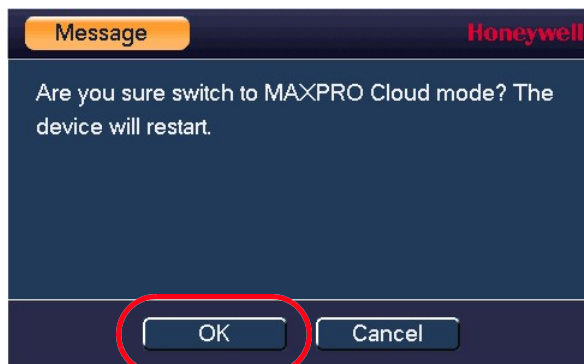

2. Click **OK** to confirm that you want to switch to MAXPRO Cloud mode. The NVR restarts and opens in MAXPRO Cloud mode.

Note

For information about operating in MAXPRO Cloud mode, please Contact Honeywell Customer Service.

17 Appendix D Specifications

Table 17-1 Specifications

HEN081*4/HEN162*4/HEN163*4/HEN161*4/HEN322*4/HEN323*4/HEN321*4/HEN642*4/HEN643*4

System	
Main Processor	Quad-core embedded processor
Operating System	Embedded LINUX
Audio and Video	
IP Camera Inputs	8-channel NVRs: 8 16-channel NVRs: 16 32-channel NVRs: 32 64-channel NVRs: 64
Two-way Talking	1 channel input; 1 channel output; RCA
Display	
Interface	2 HDMI (1 HDMI up to 3840x2160), 1 VGA HEN081*4/HEN161*4/HEN321*4: 1 HDMI, 1 VGA
Resolution	3840 x 2160; 1920 x 1080; 1280 x 1024; 1280 x 720; 1024 x 768
Display Split	8-channel NVRs: 1/4/8/9 16-channel NVRs: 1/4/8/9/16 32-channel NVRs: 1/4/8/9/16/25/36 64-channel NVRs: 1/4/8/9/16/25/36
OSD	Camera title; Time; Video loss; Camera lock; Motion detection; Recording
Recording	
Compression	H.265 / H.264 / MJPEG / MPEG4
Resolution	12MP/8MP/6MP/5MP/4MP/3MP/1080p/720p/D1/CIF
Recording Rate	320 Mbps per channel
Bit Rate	16 kbps to 20 Mbps, per channel
Recording Mode	Manual; Schedule (Regular[Continuous]; MD; Alarm); Stop
Recording	1 to 120 minutes (default: 60 minutes); Pre-recording: 1 to 30

Interval	seconds; Post-recording: 10 to 300 seconds
Video Detection and Alarms	
Trigger Events	Recording; PTZ; Tour; Alarm; Video Push; Email; FTP; Snapshot; Buzzer; Screen Tips
Video Detection	Motion Detection; Motion Detection Zones (396: 22 x 18); Video Loss
Alarm Input	16 channels HEN081*4/HEN161*4/HEN321*4: 4 channels
Relay Output	6 channels HEN081*4/HEN161*4/HEN321*4: 2 channels
Playback and Backup	
Sync Playback	HEN081*4/HEN162*4/HEN163*4: 1/4/8 HEN161*4 and 32/64-channel NVRs: 1/4/9/16
Search Mode	Time/Date; Alarm; Motion Detection; Exact Search (accurate to a second); Smart Search
Playback Function	Play; Pause; Stop; Rewind; Fast play; Slow Play; Next File; Previous File; Next Camera; Previous Camera; Full Screen; Repeat; Shuffle; Backup Selection; Digital Zoom
Backup Mode Compatibility	USB Device; Network; Internal SATA Burner; eSATA Device
Network	
Ethernet	1 RJ-45 port (10/100/1000Mbps)
PoE	HEN081*4/HEN161*4/HEN321*4: 8 ports (IEEE802.3at/af) Other NVRs: 16 ports (IEEE802.3at/af)
Network Function	HTTP, HTTPS, TCP/IP, IPv4/IPv6, UPnP, RTSP, UDP, SMTP, NTP, DHCP, DNS, IP Filter, PPPoE, DDNS, FTP, Alarm Server, IP Search; P2P
Maximum number of users	128 users
Smart Phone compatibility	iPhone; iPad; Android
Storage	
Internal Storage	HEN081*4/HEN161*4/HEN321*4: 2 SATA ports (up to 12 TB) HEN162*4/HEN322*4/HEN642*4: 4 SATA ports (up to 24 TB) HEN163*4/HEN323*4/HEN643*4: 8 SATA ports (up to 48 TB)
External HDD	HEN162*4/HEN322*4/HEN642*4: 1 eSATA port HEN163*4/HEN323*4/HEN643*4: 1 eSATA port
Auxiliary Interface	

USB	HEN081*4/HEN161*4/HEN321*4: 2 ports (1 rear USB 3.0, 1 front USB 2.0) HEN162*4/HEN322*4/HEN642*4: 3 ports (2 rear USB 3.0, 1 front USB 2.0) HEN163*4/HEN323*4/HEN643*4: 4 ports (2 rear USB 3.0, 2 front USB 2.0)
RS232	1 port, for PC communication and keyboard
Electrical	
Power Supply	100~240 V AC; 50/60 Hz
Power Consumption	HEN081*4/HEN161*4/HEN321*4: 15.2 W without HDD HEN162*4/HEN322*4/HEN642*4: 17.5 W without HDD HEN163*4/HEN323*4/HEN643*4: 17.5 W without HDD
PoE	HEN081*4/HEN161*4/HEN321*4: 8 ports (IEEE802.3at/af) total load not to exceed 130 W, maximum load on any single port 25.5 W HEN162*4/HEN322*4/HEN642*4: 16 ports (IEEE802.3at/af) total load not to exceed 150 W, maximum load on any single port 25.5 W HEN163*4/HEN323*4/HEN643*4: 16 ports (IEEE802.3at/af) total load not to exceed 150 W, maximum load on any single port 25.5 W
Environmental	
Operating Temperature	14° F to 131°F (-10°C to 55°C)
Humidity	10% to 90% relative humidity
Physical	
Dimensions	HEN081*4/HEN161*4/HEN321*4: 14.8 x 12.9 x 2.1 inches (375 x 327 x 53 mm) HEN162*4/HEN322*4/HEN642*4: 17.3 x 16.3 x 3.0 inches (440 x 413 x 75 mm) HEN163*4/HEN323*4/HEN643*4: 17.3 x 17.9 x 3.7 inches (440 x 454 x 95 mm)
Weight (without HDD)	HEN081*4/HEN161*4/HEN321*4: 5.73 pounds (2.6 kg) HEN162*4/HEN322*4/HEN642*4: 10.25 pounds (4.65 kg) HEN163*4/HEN323*4/HEN643*4: 15.43 pounds (7.0 kg)

HEN041*3/HEN081*3/HEN161*3/HEN04103L/HEN08103L/HEN16103L/HEN32103L

System	
Main Processor	Quad-core embedded processor
Operating System	Embedded LINUX

Audio and Video	
IP Camera Inputs	4-channel NVRs:4 8-channel NVRs: 8 16-channel NVRs: 16 32-channel NVRs: 32
Two-way Talking	1 channel input; 1 channel output; RCA
Display	
Interface	1 HDMI, 1 VGA
Resolution	3840 x 2160; 1920 x 1080; 1280 x 1024; 1280 x 720;
Display Split	4-channel NVRs:1/4 8-channel NVRs: 1/4/8/9 16-channel NVRs: 1/4/8/9/16 32-channel NVRs: 1/4/8/9/16/36
OSD	Camera title; Time; Video loss; Camera lock; Motion detection; Recording
Recording	
Compression	H.265 / H.264
Resolution	8Mp(3840x2160); 6Mp(3072x2048); 5MP(2560x1920); 4MP(2560x1440); 3MP(2048x1520); 1080P(1920x1080); 720P(1280x720);D1(704x576/704x480);CIF(352x288/352x240)
Recording Rate	HEN041*3/HEN081*3/HEN161*3/HEN16103L/HEN32103L : 200 Mbps per channel HEN04103L/HEN08103L : 80 Mbps per channel
Bit Rate	16 kbps to 20 Mbps, per channel
Recording Mode	Manual; Schedule (Regular[Continuous]; MD; Alarm); Stop
Recording Interval	1 to 120 minutes (default: 60 minutes); Pre-recording: 1 to 30 seconds; Post-recording: 10 to 300 seconds
Video Detection and Alarms	
Trigger Events	Recording; PTZ; Tour; Alarm; Video Push; Email; FTP; Snapshot; Buzzer; Screen Tips
Video Detection	Motion Detection; Motion Detection Zones (396: 22 x 18); Video Loss and Tampering
Alarm Input	4 Channel, Low Level Effective, Green Terminal Interface HEN04103L/HEN08103L : N/A
Relay Output	2 Channel, NO/NC Programmable, Green Terminal Interface HEN04103L/HEN08103L : N/A

Playback and Backup	
Sync Playback	4-channel NVRs:1/4 8-channel NVRs: 1/4/8 16-channel NVRs: 1/4/8/16 32-channel NVRs: 1/4/8/16
Search Mode	Time/Date; Alarm; Motion Detection; Exact Search (accurate to a second); Smart Search
Playback Function	Play; Pause; Stop; Rewind; Fast play; Slow Play; Next File; Previous File; Next Camera; Previous Camera; Full Screen; Repeat; Shuffle; Backup Selection; Digital Zoom
Backup Mode Compatibility	USB Device; Network
Network	
Ethernet	1 RJ-45 port (10/100/1000Mbps)
PoE	HEN041*3 : 4 ports (IEEE802.3at/af) HEN081*3 : 8 ports (IEEE802.3at/af) HEN161*3 : 16 ports (IEEE802.3at/af) HEN04103L/HEN08103L : N/A HEN16103L/HEN32103L : N/A
Network Function	HTTP, HTTPS, TCP/IP, IPv4/IPv6, UPnP, RTSP, UDP, SMTP, NTP, DHCP, DNS, IP Filter, PPPoE, DDNS, FTP, Alarm Server, IP Search; P2P
Maximum number of users	128 users
Smart Phone compatibility	iPhone; iPad; Android
Storage	
Internal Storage	HEN041*3/HEN081*3/HEN161*3/HEN16103L/HEN32103L : 2 SATA III Ports (up to 12 TB) HEN04103L/HEN08103L : 1 SATA III Port (up to 6 TB)
External HDD	N/A
HDD Mode	Single
Auxiliary Interface	
USB	HEN041*3/HEN081*3/HEN161*3/HEN16103L/HEN32103L : 2 USB Ports (1 USB2.0, 1 USB3.0) HEN04103L/HEN08103L : 2 USB Ports (2 USB2.0)
RS232	1 port (for PC communications)
Electrical	
Power Supply	HEN041*3 : DC48V/2A

	HEN081*3/HEN161*3: AC100V ~ 240V, 50 ~ 60 Hz HEN04103L/HEN08103L: DC12V/2A HEN16103L/HEN32103L: DC12V/4A
Power Consumption	HEN041*3: <9W (Without HDD) HEN081*3: <9.6W (Without HDD) HEN161*3: <13.2W (Without HDD) HEN04103L/HEN08103L: <6.3W (Without HDD) HEN16103L/HEN32103L: <6.9W (Without HDD)
PoE	HEN041*3: Max 25.5w for single port, 50w in total HEN081*3: Max 25.5w for single port, 80w in total HEN161*3: Max 25.5w for single port, 130w in total
Environmental	
Operating Temperature	-10°C ~ +55°C (+14°F ~ +131°F), 86 ~ 106kpa
Humidity	0 to 90% relative humidity
Physical	
Dimensions	HEN041*3/HEN16103L/HEN32103L: 1U, 375mm×281.5mm×56mm (14.8" x 11.1" x2.2") HEN081*3/HEN161*3: 1U, 375mm×327.5mm×53mm (14.8" x 12.9" x2.1") HEN04103L/HEN08103L: Compact 1U, 260mm×224.9mm×47.6mm (10.2" x 8.9" x 1.9")
Weight (without HDD)	HEN041*3/HEN16103L/HEN32103L: 1.6kg (3.5 lb) (without HDD) HEN081*3: 2.6kg (5.7lb) (without HDD) HEN161*3: 2.7kg (6.0 lb) (without HDD) HEN04103L/HEN08103L: 0.8kg (1.76 lb) (without HDD)

Honeywell Building Technologies – Security Americas (Head Office)

Honeywell Commercial Security
715 Peachtree St. NE
Atlanta, GA 30308

www.security.honeywell.com/

☎ +1 800 323 4576

Honeywell Building Technologies – Security Mexico

Mexico: Av. Santa Fe 94, Torre A, Piso 1, Col. Zedec,
CP 0121, CDMX, Mexico.

Colombia: Edificio Punto 99, Carrera 11a.
98-50, Piso 7, Bogota, Colombia.

clarsupport@honeywell.com

www.honeywell.com

☎ 01.800.083.59.25

Honeywell Colombia SAS

Carrera 11A # 98-50, Edificio Punto 99, Piso 7
Bogotá DC, Colombia

Honeywell Building Technologies – Security Middle East/N. Africa

Emaar Business Park, Sheikh Zayed Road
Building No. 2, 2nd floor, 201

Post Office Box 232362

Dubai, United Arab Emirates

www.honeywell.com/security/me

☎ +971 44541704

Honeywell Building Technologies – Security Europe/South Africa

Aston Fields Road, Whitehouse Industrial Estate
Runcorn, WA7 3DL, United Kingdom

www.honeywell.com/security/uk

☎ 08448 000 235

Honeywell Building Technologies – Security Northern Europe

Ampèrestraat 41, 1446 TR Purmerend, The Netherlands

www.security.honeywell.com/nl

☎ +31 (0) 299 410 200

Honeywell Building Technologies – Security Deutschland

Johannes-Mauthe-Straße 14 72458 Albstadt, Germany

www.security.honeywell.de

☎ +49 (0) 7431 801-0

Honeywell Building Technologies – Security France

Immeuble Lavoisier

Parc de Haute Technologie 3-7 rue Georges Besse
92160 Antony, France

www.security.honeywell.com/fr

☎ +33 (0) 1 40 96 20 50

Honeywell Building Technologies – Security Italia SpA

Via Achille Grandi 22, 20097 San Donato Milanese (MI),
ITALY

www.security.honeywell.com/it

Honeywell Building Technologies – Security España

Avenida de Italia, nº 7, 2ª planta C.T. Coslada, 28821
Coslada, Madrid, Spain

www.security.honeywell.com/es

☎ +34 902 667 800

Honeywell Building Technologies – Security Россия и СНГ

121059 Moscow, Ul, Kiev 7 Russia

www.security.honeywell.com/ru

☎ +7 (495) 797-93-71

Honeywell Building Technologies – Security Asia Pacific

Building #1, 555 Huanke Road, Zhang Jiang Hi-Tech Park
Pudong New Area, Shanghai, 201203, China

www.asia.security.honeywell.com

☎ 400 840 2233

Honeywell Building Technologies – Security and Fire (ASEAN)

Honeywell International Sdn Bhd

Level 25, UOA Corp Tower, Lobby B, Avenue 10, The Vertical,
Bangsar South City, 59200, Kuala Lumpur, Malaysia

Visit Partner Connect: www.partnerconnect.honeywell.com

Email: buildings.asean@honeywell.com

Technical support (Small & Medium
Business):

Vietnam: +84 4 4458 3369

Thailand: +66 2 0182439

Indonesia: +62 21 2188 9000

Malaysia: +60 3 7624 1530

Singapore: +65 3158 6830

Philippines: +63 2 231 3380

Honeywell Home and Building Technologies (India)

HBT India Buildings

Unitech Trade Centre, 5th Floor,

Sector – 43, Block C, Sushant Lok Phase – 1,

Gurgaon – 122002, Haryana, India

Visit Partner Connect: www.partnerconnect.honeywell.com

Email: HBT-IndiaBuildings@honeywell.com

Toll Free No: 1-800-103-0339

☎ +91 124 4975000

Honeywell Building Technologies – Security and Fire (Korea)

Honeywell Co., Ltd. (Korea)

5F SangAm IT Tower,

434, Worldcup Buk-ro, Mapo-gu,

Seoul 03922, Korea

Visit: <http://www.honeywell.com>

Email: info.security@honeywell.com

Customer support: HSG-CS-KR@honeywell.com; +82 1522-8779

☎ +82-2-799-6114

Honeywell Building Technologies – Security & Fire (Pacific)

Honeywell Ltd

9 Columbia Way

BAULKHAM HILLS NSW 2153

Visit: www.honeywellsecurity.com.au

Email: hsf.comms.pacific@Honeywell.com

Technical support:

Australia: 1300 220 345

New Zealand: +64 9 623 5050

Honeywell

www.honeywell.com/security

+1 800 323 4576 (North America only)

<https://www.honeywellsystems.com/ss/techsupp/index.html>

Document 800-24120V3 Rev A –03/2019