



OFFICEJET 7500A

# User Guide







# HP Officejet 7500A (E910) e- All-in-One

User Guide

## Copyright information

© 2010 Copyright Hewlett-Packard  
Development Company, L.P.

## Hewlett-Packard Company notices

The information contained in this document is subject to change without notice.

All rights reserved. Reproduction, adaptation, or translation of this material is prohibited without prior written permission of Hewlett-Packard, except as allowed under copyright laws.

The only warranties for HP products and services are set forth in the express warranty statements accompanying such products and services. Nothing herein should be construed as constituting an additional warranty. HP shall not be liable for technical or editorial errors or omissions contained herein.

## Acknowledgements

Microsoft® Windows®, Windows® XP, Windows Vista®, and Windows® 7 are U.S. registered trademarks of Microsoft Corporation.

ENERGY STAR® and the ENERGY STAR® mark are registered U.S. marks.

## Safety information



Always follow basic safety precautions when using this product to reduce risk of injury from fire or electric shock.

1. Read and understand all instructions in the documentation that comes with the printer.
2. Observe all warnings and instructions marked on the product.
3. Unplug this product from wall outlets before cleaning.
4. Do not install or use this product near water, or when you are wet.
5. Install the product securely on a stable surface.
6. Install the product in a protected location where no one can step on or trip over the line cord, and the line cord cannot be damaged.
7. If the product does not operate normally, see [Solve a problem](#).
8. There are no user-serviceable parts inside. Refer servicing to qualified service personnel.



---

# Contents

<b>1 Get started</b>	
Accessibility.....	9
Eco-Tips.....	10
Understand the printer parts.....	10
Front view.....	10
Printing supplies area.....	11
Back view.....	11
Use the printer control panel.....	12
Overview of buttons and lights.....	12
Control-panel display icons.....	13
Change printer settings.....	14
Select the mode.....	14
Change printer settings.....	14
Finding the printer model number.....	15
HP Digital Solutions.....	15
Select print media.....	15
Recommended papers for printing and copying.....	16
Recommended papers for photo printing.....	17
Tips for selecting and using media.....	17
Load an original on the scanner glass.....	18
Load an original in the automatic document feeder (ADF).....	19
Load media.....	20
Load standard-size media.....	20
Load Envelopes.....	22
Load cards and photo paper.....	23
Load transparencies.....	24
Load custom-size media.....	24
Insert a memory card.....	25
Maintain the printer.....	26
Clean the scanner glass.....	26
Clean the exterior.....	27
Clean the automatic document feeder (ADF).....	27
Turn off the printer.....	31
<b>2 Print</b>	
Print documents.....	32
Print documents (Windows).....	33
Print documents (Mac OS X).....	33
Print brochures.....	33
Print brochures (Windows).....	33
Print brochures (Mac OS X).....	34
Print on envelopes.....	34
Print on envelopes (Windows).....	34
Print on envelopes (Mac OS X).....	35

Print photos.....	35
Print photos on photo paper (Windows).....	35
Print photos on photo paper (Mac OS X).....	35
Print photos from a memory device .....	36
Print DPOF photos.....	37
Print on special and custom-size paper.....	37
Print on special or custom-size paper (Mac OS X).....	38
Set up custom sizes (Mac OS X).....	38
Print borderless documents.....	38
Print borderless documents (Windows).....	39
Print borderless documents (Mac OS X).....	39
<b>3 Scan</b>	
Scan an original.....	41
Scan to a computer.....	41
Scan to a memory card.....	42
Scan a larger original (A3 or 11x17 inch).....	42
Scan using Webscan.....	44
Scanning documents as editable text.....	44
<b>4 Copy</b>	
Copy documents.....	46
Change copy settings.....	47
<b>5 Fax</b>	
Send a fax.....	48
Send a standard fax.....	48
Send a standard fax from the computer.....	49
Send a fax manually from a phone.....	50
Send a fax using monitor dialing.....	51
Send a fax from memory.....	51
Schedule a fax to send later.....	52
Send a fax to multiple recipients.....	53
Send a fax in Error Correction Mode.....	53
Receive a fax.....	54
Receive a fax manually.....	54
Set up backup fax.....	55
Reprint received faxes from memory.....	55
Poll to receive a fax.....	56
Forward faxes to another number.....	56
Set the paper size for received faxes.....	57
Set automatic reduction for incoming faxes.....	57
Block unwanted fax numbers.....	58
Add numbers to the junk fax list.....	58
Remove numbers from the junk fax list.....	58
Print a Junk Fax Report.....	59
Receive faxes to your computer (Fax to PC and Fax to Mac).....	59
Fax to PC and Fax to Mac requirements.....	59
Activate Fax to PC and Fax to Mac.....	60
Modify Fax to PC or Fax to Mac settings.....	60

## Contents

Set up speed-dial entries.....	61
Set up and change speed-dial entries.....	61
Set up and change group speed-dial entries.....	62
Delete speed-dial entries.....	62
Print a list of speed-dial entries.....	63
Change fax settings.....	63
Configure the fax header.....	63
Set the answer mode (Auto answer).....	63
Set the number of rings before answering.....	64
Change the answer ring pattern for distinctive ring.....	64
Set the dial type.....	65
Set the redial options.....	66
Set the fax speed.....	66
Set the fax sound volume.....	67
Fax and digital phone services.....	67
Fax over Internet Protocol.....	67
Use reports.....	68
Print fax confirmation reports.....	68
Print fax error reports.....	69
Print and view the fax log.....	70
Clear the fax log.....	70
Print the details of the last fax transaction.....	70
Print a Caller ID Report.....	70
View the Call History.....	70
<b>6 Web</b>	
HP Apps.....	72
Marketsplash by HP.....	73
<b>7 Work with ink cartridges</b>	
Information on ink cartridges and the printhead.....	74
Check the estimated ink levels.....	75
Replace the ink cartridges.....	75
Store printing supplies.....	78
Usage information collection.....	78
<b>8 Solve a problem</b>	
HP support.....	80
Obtain electronic support.....	81
HP support by phone.....	81
Before you call.....	81
Phone support period.....	82
Telephone support numbers.....	83
After the phone support period.....	85
General troubleshooting tips and resources.....	85
Solve printing problems.....	86
The printer shuts down unexpectedly.....	86
Alignment fails.....	86
Printer takes a long time to print.....	86
Something on the page is missing or incorrect.....	86

Print troubleshooting.....	87
Envelopes print incorrectly.....	87
Borderless printing.....	88
The printer is not responding or nothing happens when I try to print.....	88
The printer prints meaningless characters.....	92
Page order.....	92
The margins are not printing as expected.....	92
Text or graphics are cut off at the edge of the page.....	93
A blank page came out while printing.....	95
Paper is not picked up from the input tray.....	96
Print quality troubleshooting.....	98
Wrong, inaccurate, or bleeding colors.....	99
Ink is not filling the text or graphics completely.....	102
The printout has a horizontal band of distortion near the bottom of a borderless print.....	104
Printouts have horizontal streaks or lines.....	105
Printouts are faded or have dull colors.....	107
Printouts seem blurry or fuzzy.....	108
Vertical streaks.....	110
Printouts are slanted or skewed.....	110
Ink streaks on the back of the paper.....	111
Poor black text.....	111
The printer prints slowly.....	113
Printhead maintenance.....	113
Clean the printhead.....	114
Align the printhead.....	114
Print and evaluate a print quality report.....	114
Advanced printhead maintenance.....	120
Advanced ink cartridge maintenance.....	125
Solve paper-feed problems.....	127
Solve copy problems.....	129
No copy came out.....	129
Copies are blank.....	130
Documents are missing or faded.....	130
Size is reduced.....	130
Copy quality is poor.....	131
Copy defects are apparent.....	131
The printer prints half a page, then ejects the paper.....	132
Paper mismatch.....	132
Copy A3/11x17 animation did not display.....	132
Solve scan problems.....	132
Scanner did nothing.....	132
Scan takes too long.....	133
Part of the document did not scan or text is missing.....	133
Text cannot be edited.....	134
Error messages appear.....	134
Scanned image quality is poor.....	134
Scan defects are apparent.....	135
Scan A3/11x17 animation did not display.....	136

## Contents

Solve fax problems.....	136
The fax test failed.....	136
Solve problems using HP Web sites and services.....	148
Solve problems using HP Web services.....	148
Solve problems using HP Web sites.....	149
Solve photo (memory card) problems.....	149
The printer cannot read the memory card.....	149
The printer cannot read photos on the memory card.....	149
Solve wired (Ethernet) network problems.....	150
General network troubleshooting.....	150
Network port created does not match printer IP address (Windows).....	150
Solve wireless problems.....	151
Basic wireless troubleshooting.....	151
Advanced wireless troubleshooting.....	151
Step 1: Make sure your computer is connected to your network.....	152
Step 2: Make sure that the printer is connected to your network.....	153
Step 3: Check to see if the firewall software is blocking communication.....	154
Step 4: Make sure the printer is online and ready.....	154
Step 5: Make sure the wireless version of the printer is set as the default printer driver (Windows only).....	155
Step 6: Make sure the HP Network Devices Support service is running (Windows only).....	155
Step 7: Add hardware addresses to a wireless access point (WAP).....	156
Configure your firewall to work with printers.....	156
Solve printer management problems.....	158
EWS cannot be opened.....	158
Troubleshoot installation issues.....	159
Hardware installation suggestions.....	159
Hardware tips.....	159
Make sure the ink cartridges are correctly installed.....	160
HP software installation suggestions.....	160
Solve network problems.....	161
Understand the Printer Status Report.....	162
Understand the network configuration page.....	163
Clear jams.....	164
Clear paper jams.....	164
Avoid paper jams.....	166
<b>A Technical information</b> .....	
Warranty information.....	167
Hewlett-Packard limited warranty statement.....	168
Ink cartridge warranty information.....	169

Printer specifications.....	170
Physical specifications.....	170
Printer features and capacities.....	170
Processor and memory specifications.....	171
System requirements.....	171
Network protocol specifications.....	171
Embedded Web server specifications.....	172
Media specifications.....	172
Understand specifications for supported media.....	172
Set minimum margins.....	176
<b>Guidelines for two-sided (duplex) printing</b> .....	177
Print resolution.....	177
Copy specifications.....	178
Fax specifications.....	178
Scan specifications.....	179
HP Web site specifications.....	179
Operating environment.....	179
Electrical requirements.....	180
Acoustic emission specification.....	180
Memory card specifications.....	180
Regulatory information.....	181
FCC statement.....	182
Notice to users in Korea.....	182
VCCI (Class B) compliance statement for users in Japan.....	182
Notice to users in Japan about the power cord.....	183
Noise emission statement for Germany.....	183
LED indicator statement.....	183
Gloss of housing of peripheral devices for Germany.....	183
Notice to users of the U.S. telephone network: FCC requirements.....	184
Notice to users of the Canadian telephone network.....	184
Notice to users in the European Economic Area.....	186
Notice to users of the German telephone network.....	186
Australia wired fax statement.....	186
Regulatory information for wireless products.....	186
Exposure to radio frequency radiation.....	187
Notice to users in Brazil.....	187
Notice to users in Canada.....	187
Notice to users in Taiwan.....	187
European Union regulatory notice.....	188
Regulatory model number.....	188
Declaration of conformity.....	189

## Contents

Environmental product stewardship program.....	190
Paper use.....	190
Plastics.....	190
Material safety data sheets.....	190
Recycling program.....	190
HP inkjet supplies recycling program.....	190
Disposal of waste equipment by users in private households in the European Union.....	191
Power consumption.....	191
Chemical Substances.....	192
RoHS notices (China only).....	192
Third-party licenses.....	193
HP Officejet 7500A (E910) e-All-in-One.....	193
<b>B HP supplies and accessories</b>	
Order printing supplies online.....	198
Supplies.....	198
Ink cartridges.....	198
HP media.....	199
<b>C Additional fax setup</b>	
Set up faxing (parallel phone systems).....	200
Choose the correct fax setup for your home or office.....	201
Case A: Separate fax line (no voice calls received).....	203
Case B: Set up the printer with DSL.....	204
Case C: Set up the printer with a PBX phone system or an ISDN line.....	205
Case D: Fax with a distinctive ring service on the same line.....	206
Case E: Shared voice/fax line.....	207
Case F: Shared voice/fax line with voice mail.....	208
Case G: Fax line shared with computer modem (no voice calls received).....	209
Set up the printer with a computer dial-up modem.....	209
Set up the printer with a computer DSL/ADSL modem.....	211
Case H: Shared voice/fax line with computer modem.....	212
Shared voice/fax with computer dial-up modem.....	212
Shared voice/fax with computer DSL/ADSL modem.....	214
Case I: Shared voice/fax line with answering machine.....	216
Case J: Shared voice/fax line with computer modem and answering machine.....	217
Shared voice/fax line with computer dial-up modem and answering machine.....	217
Shared voice/fax line with computer DSL/ADSL modem and answering machine.....	219
Case K: Shared voice/fax line with computer dial-up modem and voice mail.....	221
Serial-type fax setup.....	222
Test fax setup.....	223
<b>D Network setup</b>	
Change basic network settings.....	224
View and print network settings.....	224
Turn the wireless radio on and off.....	224

Change advanced network settings.....	224
Set link speed.....	225
View IP settings.....	225
Change IP settings.....	225
Reset network settings.....	225
Set up the printer for wireless communication.....	225
To set up a wireless communication using the Wireless Setup Wizard.....	226
Understand 802.11 wireless network settings.....	226
Test the wireless connection.....	227
Change the connection method.....	227
Guidelines for ensuring wireless network security.....	228
To add hardware addresses to a WAP.....	228
Other guidelines.....	228
Guidelines for reducing interference on a wireless network.....	229
Uninstall and reinstall the HP software.....	229
<b>E Printer management tools</b>	
HP printer software (Windows).....	231
HP Utility (Mac OS X).....	231
Embedded Web server.....	231
About cookies.....	232
To open the embedded Web server.....	232
<b>Index.....</b>	<b>239</b>



---

# 1 Get started

This guide provides details about how to use the printer and how to resolve problems.

- [Accessibility](#)
- [Eco-Tips](#)
- [Understand the printer parts](#)
- [Use the printer control panel](#)
- [Finding the printer model number](#)
- [HP Digital Solutions](#)
- [Select print media](#)
- [Load an original on the scanner glass](#)
- [Load an original in the automatic document feeder \(ADF\)](#)
- [Load media](#)
- [Insert a memory card](#)
- [Maintain the printer](#)
- [Turn off the printer](#)

---

 **NOTE:** If you are using the printer with a computer running Windows XP Starter Edition, Windows Vista Starter Edition, or Windows 7 Starter Edition, some features might not be available. For more information, see [Operating system compatibility](#).

---

## Accessibility

The printer provides a number of features that make it accessible for people with disabilities.

### Visual

The HP software provided with the printer is accessible for users with visual impairments or low vision by using your operating system's accessibility options and features. The software also supports most assistive technology such as screen readers, Braille readers, and voice-to-text applications. For users who are color blind, colored buttons and tabs used in the HP software and on the printer control panel have simple text or icon labels that convey the appropriate action.

### Mobility

For users with mobility impairments, the HP software functions can be executed through keyboard commands. The HP software also supports Windows accessibility options such as StickyKeys, ToggleKeys, FilterKeys, and MouseKeys. The printer doors, buttons, paper trays, and paper guides can be operated by users with limited strength and reach.

### Support

For more details about the accessibility of this printer and HP's commitment to product accessibility, visit HP's Web site at [www.hp.com/accessibility](http://www.hp.com/accessibility).

For accessibility information for Mac OS X, visit the Apple Web site at [www.apple.com/accessibility](http://www.apple.com/accessibility).

## Eco-Tips

HP is committed to helping customers reduce their environmental footprint. HP has provided the Eco-Tips below to help you focus on ways to assess and reduce the impact of your printing choices. In addition to specific features in this printer, please visit the HP Eco Solutions Web site for more information on HP's environmental initiatives.

[www.hp.com/hpinfo/globalcitizenship/environment/](http://www.hp.com/hpinfo/globalcitizenship/environment/)

- **Energy Savings Information:** To determine the ENERGY STAR® qualification status for this printer, see [Power consumption](#).
- **Recycled Materials:** For more information regarding recycling of HP products, please visit:

[www.hp.com/hpinfo/globalcitizenship/environment/recycle/](http://www.hp.com/hpinfo/globalcitizenship/environment/recycle/)

## Understand the printer parts

This section contains the following topics:

- [Front view](#)
- [Printing supplies area](#)
- [Back view](#)

### Front view

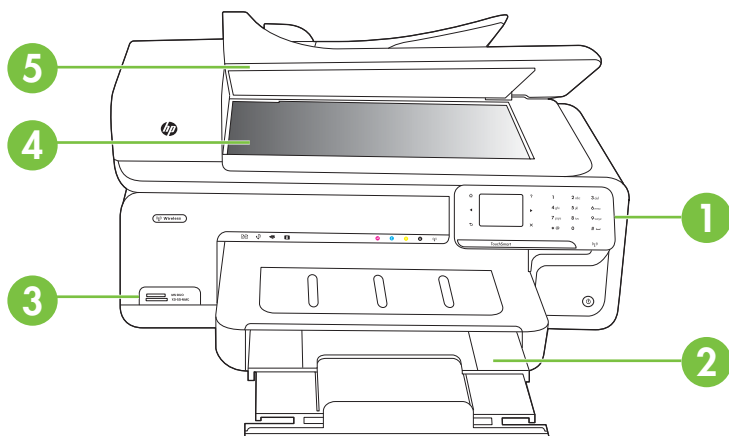

1	Control panel
2	Main tray
3	Memory card slots
4	Scanner glass
5	Automatic document feeder

## Printing supplies area

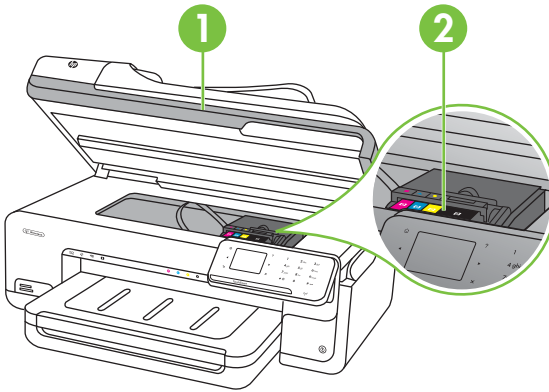

1	Cartridge access door
2	Ink cartridges

## Back view

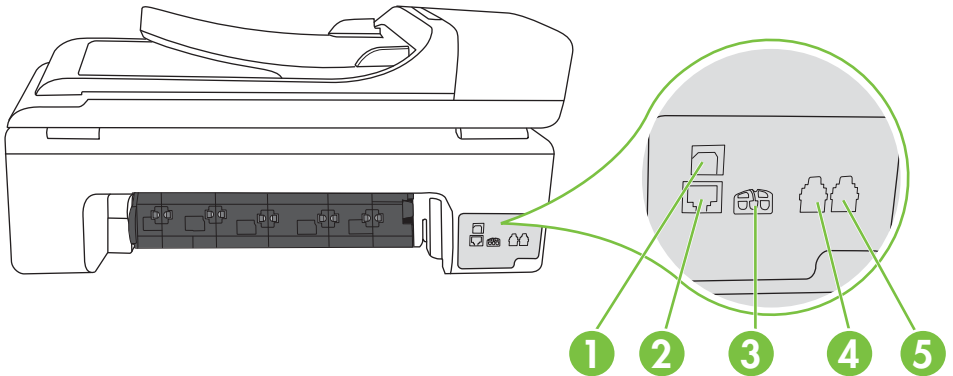

1	Universal serial bus (USB) port
2	Ethernet port
3	Power input
4	1-LINE (fax)
5	2-EXT (phone)

## Use the printer control panel

This section contains the following topics:

- [Overview of buttons and lights](#)
- [Control-panel display icons](#)
- [Change printer settings](#)





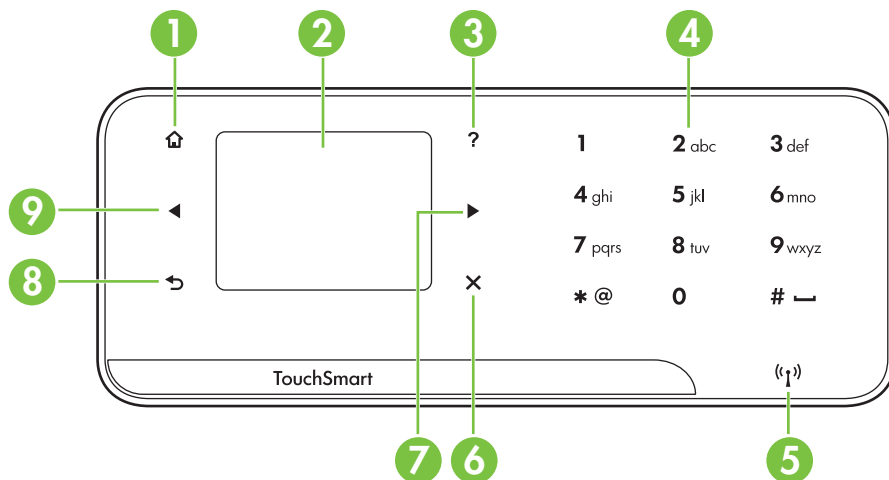

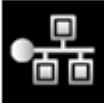

### Overview of buttons and lights

The following diagram and related table provide a quick reference to the printer control panel features.



Label	Name and Description
1	<b>Home:</b> Press this to return to the Home screen from any other screen.
2	<b>Color display:</b> Touch the icon on the color display to choose a printer function.
3	<b>Help:</b> Opens the Help screen.
4	<b>Keypad:</b> Use the keypad to enter numbers and text.
5	<b>Wireless light:</b> The light is on when the wireless radio is on.
6	<b>Cancel:</b> Stops a job, exits a screen, or exits settings.
7	<b>Right arrow:</b> Navigates through settings in the screens.
8	<b>Back:</b> Touch this to return to the previous screen.
9	<b>Left arrow:</b> Navigates through settings in the screens.

## Control-panel display icons

Icon	Purpose
	Shows that a wired network connection exists.
	Shows that a wireless network connection exists. The signal strength is indicated by the number of curved lines. This is for infrastructure mode. For more information, see <a href="#">Set up the printer for wireless communication</a> .
	<p>Displays screen where you can see information about the ink cartridges, including fill levels. This icon has a red border when an ink cartridge needs attention.</p> <p><b>NOTE:</b> Ink level warnings and indicators provide estimates for planning purposes only. When you receive a low-ink warning message, consider having a replacement cartridge available to avoid possible printing delays. You do not need to replace cartridges until prompted to do so.</p>
	Displays screen where you can make copies or select other options.
	Displays screen where you can make a fax, or choose fax settings.
	Displays a screen where you can make a scan, or change scan settings.
	Displays the Photo screen for selecting options.
	Displays the Setup screen for generating reports, changing fax and other maintenance settings, and accessing the Help screen. The topic that you select from the Help screen opens a help window on your computer screen.
	Displays the Network screen for selecting options.

## Change printer settings

Use the control panel to change the printer's mode and settings, print reports, or get help for the printer.

---



 **TIP:** If the printer is connected to a computer, you can also change the printer settings using HP software tools available on your computer, such as the HP printer software, the HP Utility (Mac OS X), or the embedded Web server (EWS). For more information about these tools, see [Printer management tools](#).

---

This section contains the following topics:

- [Select the mode](#)
- [Change printer settings](#)



### Select the mode

The home screen of the control-panel display shows the available modes for the printer. To select a mode, touch the left arrow  or the right arrow  to see the available modes, and then touch the icon to select the desired mode. Follow the prompts on the control-panel display to complete the job. The control-panel display returns to the home screen when the job is finished.

This section contains the following topics:

- [To select a different mode](#)
- [To change settings for a mode](#)

#### To select a different mode

Touch  (Back) button to return to the main menu. Touch left arrow  or right arrow  to scroll through the available modes, and then touch the icon to select the mode you want to use.

#### To change settings for a mode

1. After selecting a mode, touch the arrow buttons to scroll through the available settings, and then touch the setting you want to change.
2. Follow the prompts on the display to change the settings, and then touch **Done**.

---

 **NOTE:** Use  (Back) button to return to the previous menu.



---

## Change printer settings

To change the printer settings or print reports, use the options available in the Setup screen:

1. Touch right arrow , and then touch **Setup**.
2. Touch the arrows to scroll through the screens.
3. Touch the screen items to select screens or options.

---

 **NOTE:** Touch **Back**  to return to the previous screen.

---

## Finding the printer model number

In addition to the model name that appears on the front of the printer, this printer has a specific model number. Use this number to obtain support and to identify the supplies and accessories available for your printer.

The model number is printed on a label located inside the printer, near the ink cartridges area.

## HP Digital Solutions

The printer includes a collection of digital solutions that can help you simplify and streamline your work.

### Scan to Computer

Using the printer, you can simply walk up to the printer, touch a button on the printer's control panel, and either scan documents directly to a computer or quickly share them with business partners as e-mail attachments.

For more information, see [Scan](#).

### HP Digital Fax (Fax to PC and Fax to Mac)

Never lose important faxes misplaced within a stack of paper pages again!

Use Fax to PC and Fax to Mac to automatically receive faxes and save faxes directly to your computer. With Fax to PC and Fax to Mac, you can store digital copies of your faxes easily and also eliminate the hassle of dealing with bulky paper files.

In addition, you can turn off fax printing altogether — saving money on paper and ink, as well as helping reduce paper consumption and waste.

For more information, see [Receive faxes to your computer \(Fax to PC and Fax to Mac\)](#).

## Select print media

The printer is designed to work well with most types of office media. It is best to test a variety of print media types before buying large quantities. Use HP media for optimum print quality. Visit the HP Web site at [www.hp.com](http://www.hp.com) for more information about HP media.



HP recommends plain papers with the ColorLok logo for printing and copying of everyday documents. All papers with the ColorLok logo are independently tested to meet high standards of reliability and print quality, and produce documents with crisp, vivid color, bolder blacks and dry faster than ordinary plain papers. Look for papers with the ColorLok logo in a variety of weights and sizes from major paper manufacturers.

This section contains the following topics:

- [Recommended papers for printing and copying](#)
- [Recommended papers for photo printing](#)
- [Tips for selecting and using media](#)

## Recommended papers for printing and copying

If you want the best print quality, HP recommends using HP papers that are specifically designed for the type of project you are printing.

Depending on your country/region, some of these papers might not be available.

HP Brochure Paper HP Superior Inkjet Paper	These papers are glossy-coated or matte-coated on both sides for two-sided use. They are the perfect choice for near-photographic reproductions and business graphics for report covers, special presentations, brochures, mailers, and calendars.
HP Bright White Inkjet Paper	HP Bright White Inkjet Paper delivers high-contrast colors and sharp text. It is opaque enough for two-sided color usage with no show-through, which makes it ideal for newsletters, reports, and flyers. It features ColorLok Technology for less smearing, bolder blacks and vivid colors.
HP Printing Paper	HP Printing Paper is a high-quality multifunction paper. It produces documents that look and feel more substantial than documents printed on standard multipurpose or copy paper. It features ColorLok Technology for less smearing, bolder blacks and vivid colors. It is acid-free for longer lasting documents.
HP Office Paper	HP Office Paper is a high-quality multifunction paper. It is suitable for copies, drafts, memos and other everyday documents. It features ColorLok Technology for less smearing, bolder blacks and vivid colors. It is acid-free for longer lasting documents.
HP Office Recycled Paper	HP Office Recycled Paper is a high-quality multifunction paper made with 30% recycled fiber. It features ColorLok Technology for less smearing, bolder blacks and vivid colors. It is acid-free for longer lasting documents.
HP Premium Presentation Paper HP Professional Paper	These papers are heavy two-sided matte papers perfect for presentation, proposals, reports and newsletters. They are heavyweight for an impressive look and feel.
HP Premium Inkjet Transparency Film	HP Premium Inkjet Transparency Film makes your color presentations vivid and even more impressive. This film is easy to use and handle and dries quickly without smudging.
HP Advanced Photo Paper	This thick photo paper features an instant-dry finish for easy handling without smudging. It resists water, smears, fingerprints, and humidity. Your prints have a look and feel comparable to a store processed photo. It is available in several sizes, including A4, 8.5 x 11 inch, 10 x 15 cm (4 x 6 inch), 13x18 cm (5 x7 inch) and two finishes – glossy or soft gloss (satin matte). It is acid-free for longer lasting documents.
HP Everyday Photo Paper	Print colorful, everyday snapshots at a low cost, using paper designed for casual photo printing. This affordable, photo paper dries quickly for easy handling. Get sharp, crisp images when you use this paper with any inkjet printer. Available in semi-gloss finish in 8.5 x11 inch, A4, 4 x 6 inch and 10 x 15 cm. It is acid-free for longer lasting documents.
HP Iron-On Transfers	HP Iron-on Transfers (for color fabrics or for light or white fabrics) are the ideal solution for creating custom T-shirts from your digital photos.

To order HP papers and other supplies, go to [www.hp.com/buy/supplies](http://www.hp.com/buy/supplies). If prompted, select your country/region, follow the prompts to select your printer, and then click one of the shopping links on the page.



---

 **NOTE:** At this time, some portions of the HP Web site are available in English only.

---

### **HP Photo Value Packs:**

HP Photo Value Packs conveniently package Original HP ink cartridges and HP Advanced Photo Paper to save you time and take the guesswork out of printing affordable professional photos with your HP printer. Original HP inks and HP Advanced Photo Paper have been designed to work together so your photos are long lasting and vivid, print after print. Great for printing out an entire vacation's worth of photos or multiple prints to share.

## **Recommended papers for photo printing**

If you want the best print quality, HP recommends using HP papers that are specifically designed for the type of project you are printing.

Depending on your country/region, some of these papers might not be available.

### **HP Advanced Photo Paper**

This thick photo paper features an instant-dry finish for easy handling without smudging. It resists water, smears, fingerprints, and humidity. Your prints have a look and feel comparable to a store processed photo. It is available in several sizes, including A4, 8.5 x 11 inch, 10 x 15 cm (4 x 6 inch), 13 x 18 cm (5 x 7 inch) and two finishes – glossy or soft gloss (satin matte). It is acid-free for longer lasting documents.

### **HP Everyday Photo Paper**

Print colorful, everyday snapshots at a low cost, using paper designed for casual photo printing. This affordable, photo paper dries quickly for easy handling. Get sharp, crisp images when you use this paper with any inkjet printer. Available in semi-gloss finish in 8.5 x 11 inch, A4, 4 x 6 inch and 10 x 15 cm. It is acid-free for longer lasting documents.

### **HP Photo Value Packs**

HP Photo Value Packs conveniently package Original HP ink cartridges and HP Advanced Photo Paper to save you time and take the guesswork out of printing affordable professional photos with your HP printer. Original HP inks and HP Advanced Photo Paper have been designed to work together so your photos are long lasting and vivid, print after print. Great for printing out an entire vacation's worth of photos or multiple prints to share.

To order HP papers and other supplies, go to [www.hp.com/buy/supplies](http://www.hp.com/buy/supplies). If prompted, select your country/region, follow the prompts to select your printer, and then click one of the shopping links on the page.

---

 **NOTE:** At this time, some portions of the HP Web site are available in English only.

---

## **Tips for selecting and using media**

For the best results, observe the following guidelines.

- Always use media that conforms to the printer specifications. For more information, see [Media specifications](#).
- Load only one type of media at a time into a tray or automatic document feeder (ADF).

- When loading the trays and ADF, make sure the media is loaded correctly. For more information, see [Load media](#) or [Load an original in the automatic document feeder \(ADF\)](#).
- Do not overload the tray or ADF. For more information, see [Media specifications](#).
- To prevent jams, poor print quality, and other printing problems, avoid loading the following media in the trays or ADF:
  - Multipart forms
  - Media that is damaged, curled, or wrinkled
  - Media with cutouts or perforations
  - Media that is heavily textured, embossed, or does not accept ink well
  - Media that is too lightweight or stretches easily
  - Media that contains staples or clips

---

 **NOTE:** To scan, copy, or fax documents that contain pages that do not conform to these guidelines, use the scanner glass. For more information, see [Load an original on the scanner glass](#).

---

## Load an original on the scanner glass

You can copy, scan, or fax up to Legal-size originals by loading them on the glass.

 **NOTE:** Many of the special features do not work correctly if the glass and lid backing are not clean. For more information, see [Maintain the printer](#).

---

### To load an original on the scanner glass

Use these steps to load an original on the scanner glass.

1. Lift the scanner lid.
2. Load your original print-side down.

---

 **TIP:** For more help on loading an original, refer to the engraved guides along the edge of the glass.

---

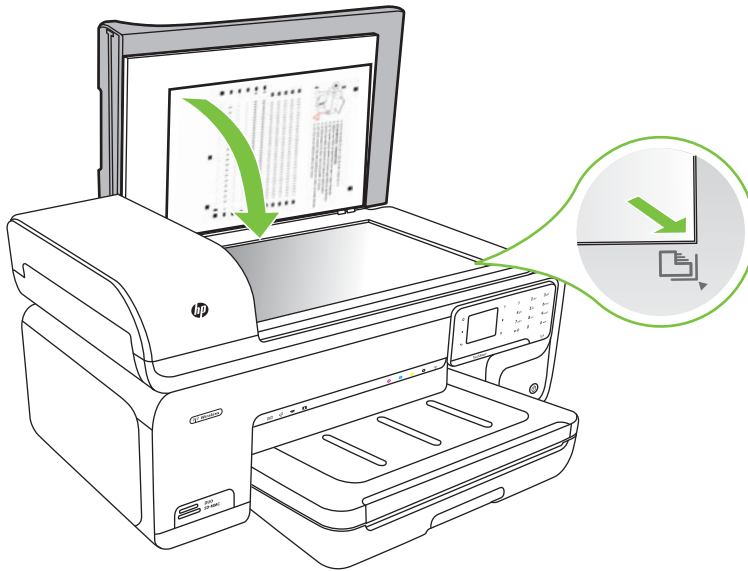

3. Close the lid.

## Load an original in the automatic document feeder (ADF)

You can copy, scan, or fax a one-sided, single- or multiple-page, A4- or Letter-size document by placing it in the automatic document feeder tray.

---

△ **CAUTION:** Do not load photos in the ADF; this might cause damage to your photos.

📄 **NOTE:** Legal-size documents cannot be scanned, copied, or faxed using the ADF.

**NOTE:** Some features, such as the **Fit to Page** copy feature, do not work when you load your originals in the ADF. You must load your originals on the glass.

---

The document feeder tray holds a maximum of 35 sheets of plain paper.

### To load an original in the document feeder tray

Use these steps to load a document in the automatic document feeder.

1. Load your original, print-side up, into the document feeder tray. Place the pages so that the top edge of the document goes in first. Slide the media into the automatic document feeder until you hear a tone or see a message on the display indicating that the loaded pages were detected.

---

💡 **TIP:** For more help on loading originals in the automatic document feeder, refer to the diagram engraved in the document feeder tray.

---

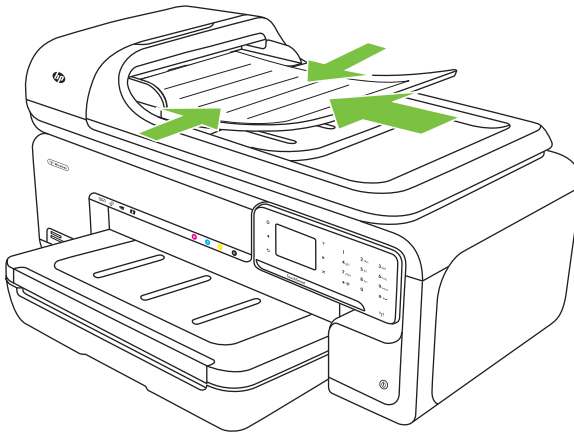

2. Slide the width guides inward until they stop at the left and right edges of the media.

---

 **NOTE:** Remove all originals from the document feeder tray before lifting the lid on the printer.

---

## Load media

This section provides instructions for loading media into the printer.

This section contains the following topics:

- [Load standard-size media](#)
- [Load Envelopes](#)
- [Load cards and photo paper](#)
- [Load transparencies](#)
- [Load custom-size media](#)

### Load standard-size media

#### To load media

Use these instructions to load standard media.

1. Lift the output tray.
2. Slide the paper width guide out as far as possible.

---

 **NOTE:** If you are loading larger-sized media, pull the input tray to extend it.

---

3. Insert the media print-side down along the right of the main tray. Make sure the media aligns with the right and back edges of the tray and does not exceed the line marking in the tray.

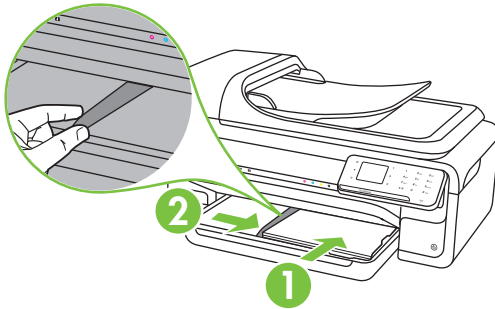

---

 **NOTE:** Do not load paper while the printer is printing.

---

4. Slide the media guides in the tray to adjust them for the media size that you have loaded.
5. Lower the output tray.
6. Pull out the tray extender.

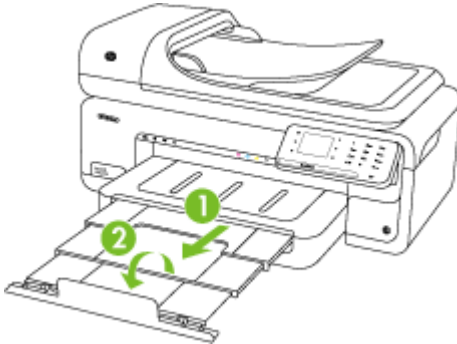

---

 **NOTE:** When printing documents larger than A3/11 x 17 inches, extend the output tray extender all the way and tilt the paper stopper.

---

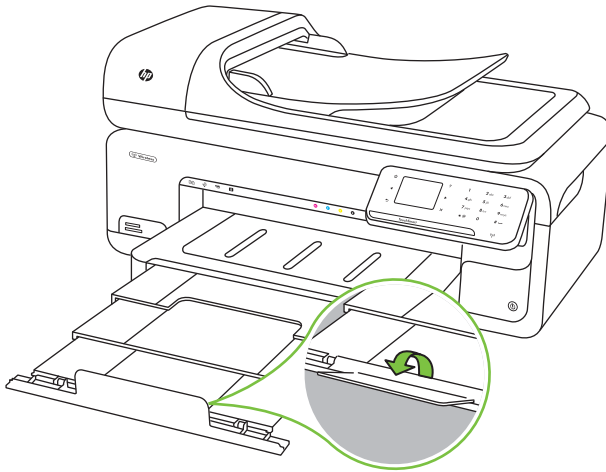

## Load Envelopes

### To load envelopes

Use these instructions to load an envelope

1. Lift the output tray.
2. Slide the paper width guide out as far as possible.



---

**NOTE:** If you are loading larger-sized media, pull the input tray to extend it.

---

3. Load envelopes according to the graphic. Make sure the stack of envelopes does not exceed the line marking in the tray.

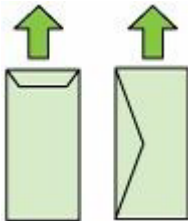

---

**NOTE:** Do not load paper while the printer is printing.

---

4. Slide the media guides in the tray to adjust them for the media size that you have loaded.

5. Lower the output tray.
6. Pull out the tray extender.

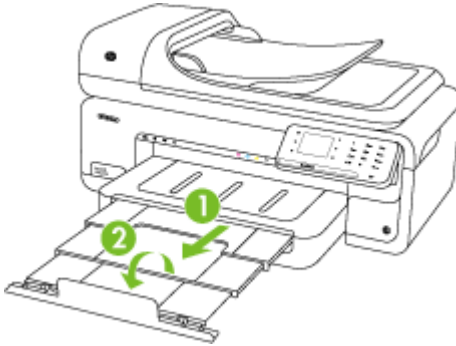

## Load cards and photo paper

### To load cards and photo paper

Use these instructions to load photo paper.

1. Lift the output tray.
2. Slide the paper width guide out as far as possible.



---

**NOTE:** If you are loading larger-sized media, pull the input tray to extend it.

3. Insert the media print-side down along the right of the main tray. Make sure the media aligns with the right and back edges of the tray and does not exceed the line marking in the tray. If the photo paper has a tab along one edge, make sure the tab is pointing towards the front of the printer.



---

**NOTE:** Do not load paper while the printer is printing.

4. Slide the media guides in the tray to adjust them for the media size that you have loaded.
5. Lower the output tray.
6. Pull out the tray extender.



## Load transparencies

### To load transparencies

Use these instructions to load transparencies.

1. Lift the output tray.
2. Slide the paper width guide out as far as possible.

---

 **NOTE:** If you are loading larger-sized media, pull the input tray to extend it.

---

3. Insert the transparencies, rough-side or print-side down, along the right of the main tray. Make sure the adhesive strip is pointing towards the back of the printer and that the stack of transparencies aligns with the right and back edges of the tray. Also, make sure the stack does not exceed the line marking in the tray.

---

 **NOTE:** Do not load paper while the printer is printing.

---

4. Slide the media guides in the tray to adjust them for the media size that you have loaded.
5. Lower the output tray.
6. Pull out the tray extender.



## Load custom-size media

### To load cards and photo paper

Use these instructions to load custom-size media.

---

 **CAUTION:** Use only custom-size media that is supported by the printer. For more information, see [Media specifications](#).

---

1. Lift the output tray.
2. Slide the paper width guide out as far as possible.

---

 **NOTE:** If you are loading larger-sized media, pull the input tray to extend it.

---



3. Insert the media print-side down along the right of the main tray. Make sure the media aligns with the right and back edges of the tray and does not exceed the line marking in the tray.

---

 **NOTE:** Do not load paper while the printer is printing.

---

4. Slide the media guides in the tray to adjust them for the media size that you have loaded.
5. Lower the output tray.
6. Pull out the tray extender.

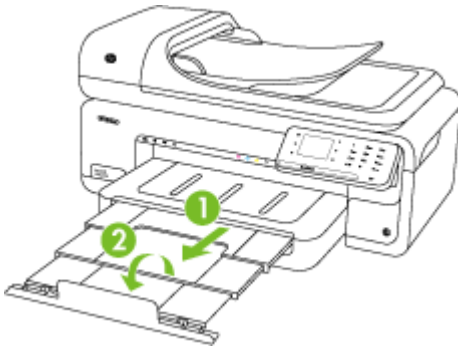

## Insert a memory card

If your digital camera uses a memory card to store photos, you can insert the memory card into the printer to print or save your photos.

---

 **CAUTION:** Attempting to remove a memory card while it is being accessed can damage files on the card. You can safely remove a card only when the photo light is not blinking. Also, never insert more than one memory card at a time as this can also damage files on the memory cards.

 **NOTE:** The printer does not support encrypted memory cards.

---

For more information on the supported memory cards, see [Memory card specifications](#).

### To insert a memory card

1. Turn the memory card so that the label faces up, and the contacts are facing the printer.
2. Insert the memory card into the corresponding memory card slot.

---

 **NOTE:** You cannot insert more than one memory card in the printer.

---

## Maintain the printer

This section provides instructions for keeping the printer in top working condition. Perform these maintenance procedures as necessary.

- [Clean the scanner glass](#)
- [Clean the exterior](#)
- [Clean the automatic document feeder \(ADF\)](#)

### Clean the scanner glass

---

 **NOTE:** Dust or dirt on the scanner glass, scanner lid backing, or scanner frame can slow down performance, degrade the quality of scans, and affect the accuracy of special features such as fitting copies to a certain page size.

---

#### To clean the scanner glass

1. Turn off the printer. For more information, see [Turn off the printer](#).
2. Lift the scanner lid.

3. Clean the glass by using a soft, lint-free cloth that has been sprayed with a mild glass cleaner. Dry the glass with a dry, soft, lint-free cloth.

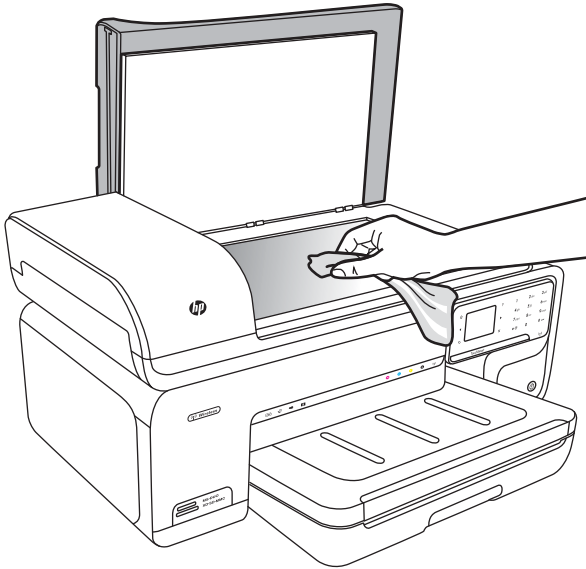

---

⚠ **CAUTION:** Use only glass cleaner to clean the scanner glass. Avoid cleaners that contain abrasives, acetone, benzene, and carbon tetrachloride, all of which can damage the scanner glass. Avoid isopropyl alcohol because it can leave streaks on the glass.

**CAUTION:** Do not spray the glass cleaner directly on the glass. If too much glass cleaner is applied, the cleaner could leak under the glass and damage the scanner.

---

4. Close the scanner lid, and turn on the printer.

## Clean the exterior

---

⚠ **WARNING!** Before cleaning the printer, turn off the power and unplug the power cord from the electrical socket. For more information, see [Turn off the printer](#).

---

Use a soft, damp, lint-free cloth to wipe dust, smudges, and stains off of the case. The exterior of the printer does not require cleaning. Keep fluids away from the interior of the printer, as well as from the printer control panel.

## Clean the automatic document feeder (ADF)

If the automatic document feeder picks up multiple pages or if it does not pick up plain paper, you can clean the rollers and separator pad. Lift the automatic document feeder cover to access the pick assembly inside the automatic document feeder, clean the rollers or separator pad, and then close the cover.

If you have lines or dust appearing on scanned documents or faxes, clean the plastic strip in the ADF.

**To clean the rollers or separator pad**

1. Remove all originals from the document feeder tray.
2. Lift the automatic document feeder cover (1).  
This provides easy access to the rollers (2) and separator pad (3).

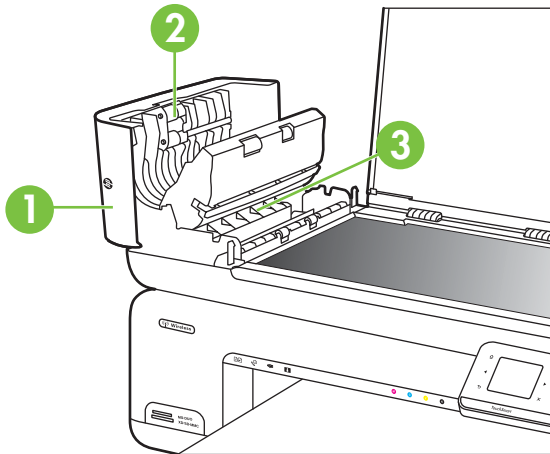

1	Automatic document feeder cover
2	Rollers
3	Separator pad

3. Lightly dampen a clean lint-free cloth with distilled water, then squeeze any excess liquid from the cloth.
4. Use the damp cloth to wipe any residue off the rollers or separator pad.

---

 **NOTE:** If the residue does not come off using distilled water, try using isopropyl (rubbing) alcohol.

---

5. Close the cover of the automatic document feeder.

## To clean the plastic strip inside the automatic document feeder

Use these instructions to clean the plastic strip inside the ADF.

1. Turn off the printer and unplug the power cord. For more information, see [Turn off the printer](#).

---

 **NOTE:** Depending how long the printer is unplugged, the date and time might be erased. You might need to reset the date and time later, when you plug the power cord back in.

---

2. Lift the cover of the automatic document feeder until it stops, and then gently pry the cover to release the catch.

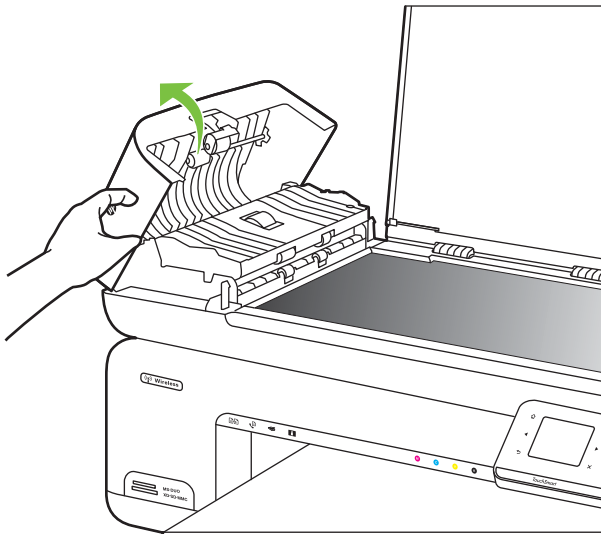

3. Continue lifting the automatic document feeder cover to the vertical position.

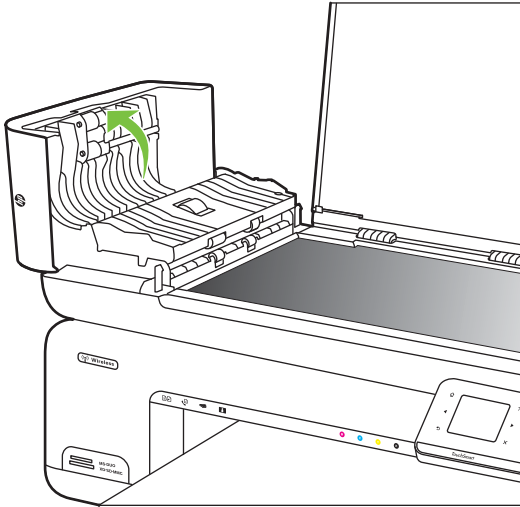

4. Lift the automatic document feeder mechanism.

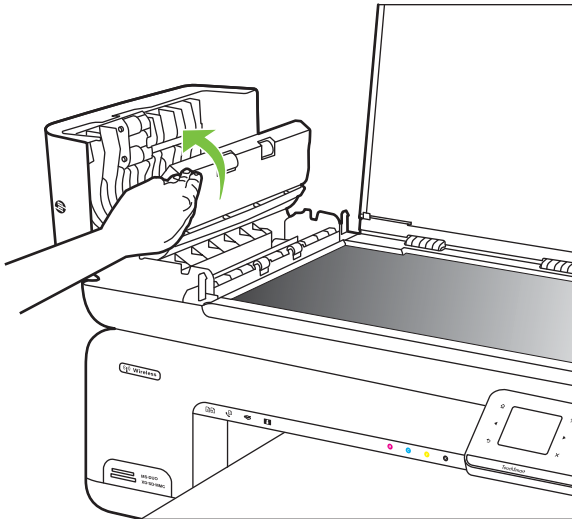

5. Clean the plastic strip with a soft cloth or sponge slightly moistened with a nonabrasive glass cleaner.

**⚠ CAUTION:** Do not use abrasives, acetone, benzene, or carbon tetrachloride on the plastic strip, since they can damage it. Do not place or spray liquid directly on the plastic strip. The liquid might seep inside and damage the printer.

6. Gently lower the automatic document feeder mechanism to avoid dislodging the plastic strip, and then close the cover of the automatic document feeder.
7. Plug in the power cord, and then turn on the printer.



**NOTE:** If you still see dust or lines on scans after cleaning the plastic strip, you may need to order a new plastic strip. For more information, see [www.hp.com/support](http://www.hp.com/support).

---

## Turn off the printer







Turn the printer off by pressing the  (power) button located on the printer. Wait until the power light turns off before unplugging the power cord or turning off a power strip. If you turn the printer off incorrectly, the print carriage might not return to the correct position causing problems with the ink cartridges and print quality issues.

---

## 2 Print

Most print settings are automatically handled by the software application. Change the settings manually only when you want to change print quality, print on specific types of paper, or use special features. For more information about selecting the best print media for your documents, see [Select print media](#).

Choose a print job to continue:

	<a href="#">Print documents</a>
	<a href="#">Print brochures</a>
	<a href="#">Print on envelopes</a>
	<a href="#">Print photos</a>
	<a href="#">Print on special and custom-size paper</a>
	<a href="#">Print borderless documents</a>

### Print documents

---

 **NOTE:** With certain types of paper, you can print on both sides of a sheet of paper (called “two-sided printing” or “duplex printing”). For more information, see [Two-sided printing \(duplexing\)](#).

**NOTE:** You can print from anywhere by using HP’s ePrint feature. For more information, see [HP ePrint](#).

---

Follow the instructions for your operating system.

- [Print documents \(Windows\)](#)
- [Print documents \(Mac OS X\)](#)



## Print documents (Windows)

1. Load paper in the tray. For more information, see [Load media](#).
2. On the **File** menu in your software application, click **Print**.
3. Make sure the printer you want to use is selected.
4. To change settings, click the option that opens the printer **Properties** dialog box. Depending on your software application, this option might be called **Properties**, **Options**, **Printer Setup**, **Printer**, or **Preferences**.
5. Change the paper orientation on the **Layout** tab, and paper source, media type, paper size, and quality settings on the **Paper/Quality** tab. To print in black and white, click the **Advanced** tab, and then change the **Print in Grayscale** option.
6. Click **OK**.
7. Click **Print** or **OK** to begin printing.

## Print documents (Mac OS X)

1. Load paper in the tray. For more information, see [Load media](#).
2. From the **File** menu in your software application, click **Print**.
3. Make sure the printer you want to use is selected.
4. Change the print settings for the option provided in the pop-up menus, as appropriate for your project.

---

 **NOTE:** Click the blue disclosure triangle next to the **Printer** selection to expand the print dialog box and access these options.

---

5. Click **Print** to begin printing.

## Print brochures

---

 **NOTE:** You can print from anywhere by using HP's ePrint feature. For more information, see [HP ePrint](#).

---

Follow the instructions for your operating system.

- [Print brochures \(Windows\)](#)
- [Print brochures \(Mac OS X\)](#)

## Print brochures (Windows)

---

 **NOTE:** To set print settings for all print jobs, make the changes in the HP software provided with the printer. For more information on the HP software, see [Printer management tools](#).

---

1. Load paper in the tray. For more information, see [Load media](#).
2. On the **File** menu in your software application, click **Print**.
3. Make sure the printer you want to use is selected.
4. To change settings, click the option that opens the printer **Properties** dialog box. Depending on your software application, this option might be called **Properties**, **Options**, **Printer Setup**, **Printer**, or **Preferences**.

5. Change the paper orientation on the **Layout** tab, and paper source, media type, paper size, and quality settings on the **Paper/Quality** tab. To print in black and white, click the **Advanced** tab, and then change the **Print in Grayscale** option.
6. Click **OK**.
7. Click **Print** or **OK** to begin printing.

### Print brochures (Mac OS X)

1. Load paper in the tray. For more information, see [Load media](#).
2. From the **File** menu in your software application, click **Print**.
3. Make sure the printer you want to use is selected.
4. Click **Paper Type/Quality** from the pop-up menu (located below the Orientation setting), and then select the following settings:
  - **Paper Type:** the appropriate brochure paper type
  - **Quality:** **Normal** or **Best**



**NOTE:** Click the blue disclosure triangle next to the **Printer** selection to access these options.

---

5. Select any other print settings that you want, and then click **Print** to begin printing.

### Print on envelopes

When choosing envelopes, avoid envelopes that have a very slick finish, self-stick adhesives, clasps, or windows. Also, avoid envelopes with thick, irregular, or curled edges, or areas that are wrinkled, torn, or otherwise damaged.

Make sure the envelopes you load in the printer are tightly constructed and that the folds are sharply creased.



**NOTE:** For more information about printing on envelopes, see the documentation available with the software program you are using.

---

Follow the instructions for your operating system.

- [Print on envelopes \(Windows\)](#)
- [Print on envelopes \(Mac OS X\)](#)

### Print on envelopes (Windows)

1. Load envelopes in the tray. For more information, see [Load media](#).
2. On the **File** menu in your software application, click **Print**.
3. Make sure the printer you want to use is selected.
4. To change settings, click the option that opens the printer **Properties** dialog box. Depending on your software application, this option might be called **Properties**, **Options**, **Printer Setup**, **Printer**, or **Preferences**.
5. On the **Layout** tab, change the orientation to **Landscape**.

6. Click the **Paper/Quality** tab, and then select the appropriate envelope type from the **Paper Size** drop-down list.

---

 **TIP:** You can change more options for the print job by using the features available on the other tabs in the dialog box.

---

7. Click **OK**, and then click **Print** or **OK** to begin printing.

### Print on envelopes (Mac OS X)

1. Load envelopes in the tray. For more information, see [Load media](#).
2. From the **File** menu in your software application, click **Print**.
3. Make sure the printer you want to use is selected.
4. Click the appropriate envelope size in the **Paper Size** pop-up menu.
5. Select the **Orientation** option.

---

 **NOTE:** Click the blue disclosure triangle next to the **Printer** selection to access these options.

---

6. Select any other print settings that you want, and then click **Print** to begin printing.

## Print photos

Do not leave unused photo paper in the input tray. The paper might start to curl, which could reduce the quality of your printout. Photo paper should be flat before printing.

Follow the instructions for your operating system.

- [Print photos on photo paper \(Windows\)](#)
- [Print photos on photo paper \(Mac OS X\)](#)
- [Print photos from a memory device](#)
- [Print DPOF photos](#)

### Print photos on photo paper (Windows)

1. Load paper in the tray. For more information, see [Load media](#).
2. On the **File** menu in your software application, click **Print**.
3. Make sure the printer you want to use is selected.
4. To change settings, click the option that opens the printer **Properties** dialog box. Depending on your software application, this option might be called **Properties**, **Options**, **Printer Setup**, **Printer**, or **Preferences**.
5. To print the photo in black and white, click the **Advanced** tab, and then change the **Print in Grayscale** option.
6. Click **OK**, and then click **Print** or **OK** to begin printing.

### Print photos on photo paper (Mac OS X)

1. Load paper in the tray. For more information, see [Load media](#).
2. From the **File** menu in your software application, click **Print**.
3. Make sure the printer you want to use is selected.

4. Click **Paper Type/Quality** from the pop-up menu (located below the **Orientation** setting), and then select the following settings:
  - **Paper Type:** The appropriate photo paper type
  - **Quality: Best** or **Maximum dpi**



**NOTE:** Click the blue disclosure triangle next to the **Printer** selection to access these options.

---

5. Select the appropriate **Photo Fix** options:
  - **Off:** applies no HP Real Life Technologies to the image.
  - **Basic:** automatically focuses the image; moderately adjusts image sharpness.
6. To print the photo in black and white, click **Grayscale** from the **Color** pop-up menu, and then select one of the following options:
  - **High Quality:** uses all the available colors to print your photo in grayscale. This creates smooth and natural shades of gray.
  - **Black Print Cartridge Only:** uses black ink to print your photo in grayscale. The gray shading is created by varying patterns of black dots, which might result in a grainy image.
7. Select any other print settings that you want, and then click **Print** to begin printing.

## Print photos from a memory device

The **Select Photos** function is only available if the memory card does not contain DPOF content.

### To print selected photos

1. Insert your memory card into the appropriate slot on the printer. The **Photo screen** appears on the control panel display.
2. Touch **View & Print**. The photos are displayed.
3. Do one of the following.
  - a. Touch **Select All**.
  - b. Touch **Settings** to make changes to layout, paper type, or date stamp, and then select **Done**.
  - c. Touch **Print**. The preview screen appears. You have options on this screen to adjust the settings or add more photos. Touch the **right** and **left** arrows to preview all photos.
  - d. Touch **Print** to print all the photos on the memory card.

- or -

- a. Touch a photo you want to print. The photo enlarges and gives you several editing options.
  - Touch the **up** and **down** arrows to specify the number of copies you want to print.
  - Touch the **Full Screen** icon to enlarge the photo to fill the screen.
  - Touch **Edit** to make changes to the photo before printing, such as Rotate, Crop, and Red Eye Removal.
- b. When you are finished making changes to the photo, touch **Done**. The preview image of the selected photo appears.
- c. Touch one of the following options.
  - Touch **Add More** to select and edit more photos.
  - Touch **Settings** to make changes to the way the photos are printed, such as layout, paper type, and date stamp, and then select **Done**.
  - Touch **Print** to print the selected photos.

## Print DPOF photos

Camera-selected photos are photos you marked for printing with your digital camera. Depending on your camera, the camera might identify page layout, number of copies, rotation, and other print settings.

The printer supports the Digital Print Order Format (DPOF) file format 1.1, so you do not have to reselect the photos to print.

When you print camera-selected photos, the printer's print settings do not apply; the DPOF settings for page layout and number of copies override those of the printer.

---

 **NOTE:** Not all digital cameras enable you to tag your photos for printing. See the documentation that came with your digital camera to see if your camera supports DPOF file format 1.1.

---

### To print camera-selected photos using the DPOF standard

1. Insert your memory card into the appropriate slot on the printer.
2. When prompted, do one of the following:
  - Touch **OK** to print all DPOF-tagged photos.  
The printer prints all DPOF-tagged photos.
  - Touch **No** to bypass DPOF printing.

## Print on special and custom-size paper

If your application supports custom-size paper, set the size in the application before printing the document. If not, set the size in the printer driver. You might need to reformat existing documents to print them correctly on custom-size paper.

Use only custom-size paper that is supported by the printer. For more information, see [Media specifications](#).

---

 **NOTE:** With certain types of paper, you can print on both sides of a sheet of paper (called “two-sided printing” or “duplex printing”). For more information, see [Two-sided printing \(duplexing\)](#).

---

Follow the instructions for your operating system.

- [Print on special or custom-size paper \(Mac OS X\)](#)
- [Set up custom sizes \(Mac OS X\)](#)

## Print on special or custom-size paper (Mac OS X)

---

 **NOTE:** Before you can print on custom-size paper, you must set up the custom size in the HP software provided with the printer. For instructions, see [Set up custom sizes \(Mac OS X\)](#).

---

1. Load the appropriate paper in the tray. For more information, see [Load media](#).
2. From the **File** menu in your software application, click **Print**.
3. Make sure the printer you want to use is selected.
4. Under **Destination Paper Size**, click **Scale to fit paper size**, and then select the custom size.  
Select any other print settings that you want, and then click **Print** to begin printing.

## Set up custom sizes (Mac OS X)

1. From the **File** menu in your software application, click **Print**.
2. Select the desired printer in the **Format for** pop-up menu.
3. Select **Manage Custom Sizes** in the **Paper Size** pop-up menu.
4. Click the + on the left side of the screen, double-click **Untitled**, and type a name for the new, custom size.
5. In the **Width** and **Height** boxes, type the dimensions, and then set the margins if you want to customize them.
6. Click **OK**.

## Print borderless documents

Borderless printing lets you print to the edges of certain photo media types and a range of standard media sizes.

---

 **NOTE:** Before printing a borderless document, open the file in a software application and assign the image size. Make sure the size corresponds to the media size on which you are printing the image.

**NOTE:** Not all applications support borderless printing.

---

Follow the instructions for your operating system.

- [Print borderless documents \(Windows\)](#)
- [Print borderless documents \(Mac OS X\)](#)

## Print borderless documents (Windows)

1. Load paper in the tray. For more information, see [Load media](#).
2. On the **File** menu in your software application, click **Print**.
3. Make sure the printer you want to use is selected.
4. To change settings, click the option that opens the printer **Properties** dialog box. Depending on your software application, this option might be called **Properties**, **Options**, **Printer Setup**, **Printer**, or **Preferences**.
5. Click the **Advanced** tab.
6. Click **Print Borderless** from the **Borderless Printing** option.
7. Click the **Paper/Quality** tab. Select the appropriate paper type from the **Media** drop-down list.
8. Click **OK**, and then click **Print** or **OK** to begin printing.

## Print borderless documents (Mac OS X)

---

 **NOTE:** Follow these instructions to enable borderless printing.

**Mac OS 10.6.** Under **Paper Type/Quality**, click to select the **Print Borderless** check box and adjust the **Borderless Expansion** setting as needed.

---

1. Load paper in the tray. For more information, see [Load media](#).
2. From the **File** menu in your software application, click **Print**.
3. Make sure the printer you want to use is selected.
4. Click **Paper Type/Quality** from the pop-up menu (located below the **Orientation** setting), and then select the following settings:
  - **Paper Type:** The appropriate paper type
  - **Quality:** **Best** or **Maximum dpi**

---

 **NOTE:** Click the blue disclosure triangle next to the **Printer** selection to access these options.

---

5. If necessary, select the appropriate **Photo Fix** options:
  - **Off:** applies no HP Real Life Technologies to the image.
  - **Basic:** automatically focuses the image; moderately adjusts image sharpness.
6. Select any other print settings that you want, and then click **Print** to begin printing.

## HP ePrint

With HP ePrint, you can print from email connected mobile phones, netbooks, or other mobile devices—anywhere, anytime. Using your mobile device service and the printer's Web Services, you can print documents to a printer that could be sitting next to you or sitting thousands of miles away.

To use the HP ePrint service, you need to have the following components:

- An HP ePrint-enabled printer that is connected to the Internet (either using an Ethernet cable or wireless connection)
- A device that has a functioning email capability

Follow the instructions on the printer's control panel to enable and set up the printer's Web Services. For more information, see [www.hp.com/go/ePrintCenter](http://www.hp.com/go/ePrintCenter).

## Two-sided printing (duplexing)

With certain types of paper, you can print on both sides of a sheet of paper (called “two-sided printing” or “duplex printing”).

You can perform manual duplexing by first printing only the odd pages, flipping the pages over, and then printing only the even pages.

For more information, see [Guidelines for two-sided \(duplex\) printing](#).



---

# 3 Scan

You can use the printer's control panel to scan documents, photos, and other originals and send them to a variety of destinations, such as a folder on a computer. You can also scan these originals from your computer using either the HP software provided with the printer or TWAIN-compliant or WIA-compliant programs.

When scanning documents, you can use the HP software to scan documents into a format that you can search, copy, paste, and edit.

---

 **NOTE:** Some scan functions are only available after you install the HP software.

 **TIP:** If you have problems scanning documents, see [Solve scan problems](#)

---

This section contains the following topics:

- [Scan an original](#)
- [Scan a larger original \(A3 or 11x17 inch\)](#)
- [Scan using Webscan](#)
- [Scanning documents as editable text](#)

## Scan an original

This section contains the following topics:

---

 **NOTE:** Your printer and computer must be connected and turned on.

**NOTE:** If you are scanning an original from the printer control panel or from your computer using a the HP printer software, the HP software provided with the printer must also be installed and running on your computer prior to scanning.

**NOTE:** If you are scanning a borderless original, load the original on the scanner glass, not the ADF.

---

- [Scan to a computer](#)
- [Scan to a memory card](#)

## Scan to a computer

### To scan an original to a computer from the printer control panel

Use these steps to scan from the control panel.

1. Load your original print-side down in the right-front corner of the glass or in the ADF. For more information, see [Load an original on the scanner glass](#) or [Load an original in the automatic document feeder \(ADF\)](#).
  2. Touch **Scan**, and then select **Computer**.
- 

 **NOTE:** Windows users: If your computer does not appear in the list of destinations, you will need to restart your HP software's scan function on the destination computer.

---

3. Touch **Document Type** to select the type of document you want to save. Make changes to scan options, if needed.
4. Touch **Start Scan**.

#### To scan an original from HP printer software

1. Load your original print-side down in the right-front corner of the glass or in the ADF. For more information, see [Load an original on the scanner glass](#) or [Load an original in the automatic document feeder \(ADF\)](#).
2. On the computer, open the HP scanning software:
  - **Windows:** From the computer desktop, click **Start**, select **Programs** or **All Programs**, select the folder for your HP printer, and then select **HP Scan**.
  - **Mac OS X:** Click the HP Utility icon in the Dock, click **Applications**, and then double-click **HP Scan 3**.
3. To start the scan, click **Scan**.

---

 **NOTE:** For more information, see the online Help provided with the scanning software.

---

## Scan to a memory card

#### To scan an original to a computer from the printer control panel

Use these steps to scan an original to a memory card.

1. Load your original print-side down in the right-front corner of the glass or in the ADF. For more information, see [Load an original on the scanner glass](#) or [Load an original in the automatic document feeder \(ADF\)](#).
2. Insert a memory card. For more information, see [Insert a memory card](#).
3. Touch **Scan**, and then select **Memory Device**.
4. Touch **Document Type** to select the type of document you want to save. Make changes to scan options, if needed.
5. Touch **Start Scan**.

## Scan a larger original (A3 or 11x17 inch)

You can scan a document that is larger than the scanner glass by scanning the document in two parts. After scanning the two parts, the printer joins them together, saving them as a single file.

---

 **NOTE:** TIFF black and PDF black are not supported for B-size scan.

The minimum top and bottom margin for your large original must match or exceed 6 mm (0.24 inch).

---

### To scan an original from the printer control panel

Use the following instructions to scan a large document.

1. Touch **Scan**, and then select the **Memory Device**.
2. Touch **Document Type** to choose the type of document you want to save. Make changes to scan options, if needed.
3. Touch **Paper Size** and select either **A3** or **Ledger (11X17 in.)** to choose the size of the original document
4. Touch **Settings** to rename the scan file name OR change the output quality.
5. Touch **Start Scan** to load the animation that shows how to place the A3/11x17 original on the scan glass.  
Load the original according to the animation, and then select **Scan**.

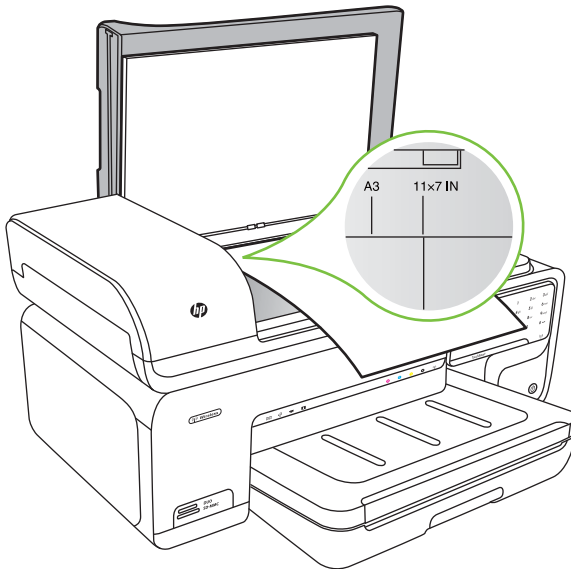

6. When prompted, select **Continue**.
7. Turn the paper around according to the animation, and then select **Scan**. The printer joins the two copies into one document.

### To scan an original from ArcSoft (Windows only)

1. Load your original print-side down in the right or left -back corner of the glass. For more information, see [Load an original on the scanner glass](#).
2. On the computer, open the scan software.  
From the computer desktop, click **Start**, select **Programs** or **All Programs**, select the folder for your HP printer, and then select **HP Scan**.
3. Touch **Size Original** to choose the size of the original document, and then select **A3** or **11 x 17 inch**.

## Scan using Webscan

Webscan is a feature of the embedded Web server that lets you scan photos and documents from your printer to your computer using a Web browser. This feature is available even if you did not install the printer software on your computer.

---

 **NOTE:** Webscan does not support scanning large documents.

For more information on the embedded Web server, see [Embedded Web server](#).

---

### To scan using Webscan

1. Load your original print-side down in the right-front corner of the glass or in the ADF. For more information, see [Load an original on the scanner glass](#) or [Load an original on the scanner glass](#) or [Load an original in the automatic document feeder \(ADF\)](#).
2. Open the embedded Web server. For more information, see [Embedded Web server](#).
3. Click the **Scan** tab, click **Webscan** in the left pane, make selections for options, and then click **Start Scan**.

## Scanning documents as editable text

When scanning documents, you can use the HP software to scan documents into a format that you can search, copy, paste, and edit. This allows you to edit letters, newspaper clippings, and many other documents.

To ensure that the software can convert your documents successfully, do the following:

- **Make sure the scanner glass or ADF window is clean.**  
When the printer scans the document, smudges or dust on the scanner glass or ADF window can be scanned, as well, and can prevent the software from converting the document to editable text.
- **Make sure the document is loaded correctly.**  
When scanning documents as editable text from the ADF, the original must be loaded into the ADF with the top forward and face up. When scanning from the scanner glass, the original must be loaded with the top facing the right edge of the scanner glass. Also, make sure the document is not skewed. For more information, see [Load an original on the scanner glass](#) or [Load an original in the automatic document feeder \(ADF\)](#).
- **Make sure the text on the document is clear.**  
To successfully convert the document to editable text, the original must be clear and of high quality. The following conditions can cause the software to not convert the document successfully:
  - The text on the original is faint or wrinkled.
  - The text is too small.
  - The structure of the document is too complex.

- The text is tightly spaced. For example, if the text that the software converts has missing or combined characters, "rn" might appear as "m."
- The text is on a colored background. Colored backgrounds can cause images in the foreground to blend too much.

---

# 4 Copy

You can produce high-quality color and grayscale copies on a variety of paper types and sizes.

---

 **NOTE:** If you are copying a document when a fax arrives, the fax is stored in the printer's memory until the copying finishes. This can reduce the number of fax pages stored in memory.

 **TIP:** If you have problems scanning documents, see [Solve copy problems](#).

---

This section contains the following topics:

- [Copy documents](#)
- [Change copy settings](#)

## Copy documents

You can make quality copies from the printer control panel.

### To copy documents

1. Make sure you have paper loaded in the main tray.
2. Load your original print-side down in the right-front corner of the glass or in the ADF. For more information, see [Load an original on the scanner glass](#) or [Load an original in the automatic document feeder \(ADF\)](#).

---

 **NOTE:** If you are copying a photo, place the photo on the scanner glass face down, as shown on the icon on the edge of the scanner glass.

---

3. Touch **Copy**.
4. Change any additional settings. For more information, see [Change copy settings](#)
5. To start the copy job, touch one of the following:
  - **Start Black:** To select a black-and-white copy job.
  - **Start Color :** To select a color copy job.

---

 **NOTE:** If you have a color original, selecting the **Black** function produces a black-and-white copy of the color original, while selecting the **Color** function produces a full-color copy of the color original.

---

### Copy a large original (A3 or 11x17 inch)

You can copy a document that is larger than the scanner glass by scanning the document in two scans, and then the printer prints the scans onto one sheet of paper.

---

 **NOTE:** The minimum top and bottom margin for your large original must match or exceed 6 mm (0.24 inch).

---

1. Make sure you have A3 or 11x17 inch paper loaded in the main tray.
2. Touch **Copy**.

3. Touch the A3/11x17 checkbox on the Copy screen, and then select **Settings** to change any other copy settings.
4. Select **Black** to make a black-and-white copy, or **Color** to make a color copy.
5. Select the size of the original.
6. Load the original according to the animation, and then select **Scan**.
7. When prompted, select **Continue**.
8. Turn the original around according to the animation, and then select **Scan**. The printer joins the two copies into one document and displays a preview.
9. Touch **Copy** to print the copy.

## Change copy settings

You can customize copy jobs using the various settings available from the printer's control panel, including the following:

- Number of copies
- Copy paper size
- Copy paper type
- Copy speed or quality
- Lighter/Darker settings
- Resizing originals to fit on different paper sizes

You can use these settings for single copy jobs, or you can save settings to be used as defaults for future jobs.

### To change copy settings for a single job

1. Touch **Copy**.
2. Select the copy function settings you want to change.
3. Touch **Start Black** or **Start Color**.

### To save the current settings as defaults for future jobs

1. Touch **Copy**.
2. Make any changes to the copy function settings, and then touch **Settings**.
3. Touch down arrow ▼, and then select **Set As New Defaults**.
4. Touch **Yes, change defaults**, and then select **Done**.

---

# 5 Fax

You can use the printer to send and receive faxes, including color faxes. You can schedule faxes to be sent at a later time and set up speed-dials to send faxes quickly and easily to frequently used numbers. From the printer control panel, you can also set a number of fax options, such as resolution and the contrast between lightness and darkness on the faxes you send.

---

 **NOTE:** Before you begin faxing, make sure you have set up the printer correctly for faxing. You might have already done this as part of the initial setup, by using either the control panel or the HP software provided with the printer. You can verify the fax is set up correctly by running the fax setup test from the control panel. For more information on the fax test, see [Test fax setup](#).

 **TIP:** If you have problems scanning documents, see [Solve fax problems](#).

---

This section contains the following topics:

- [Send a fax](#)
- [Receive a fax](#)
- [Set up speed-dial entries](#)
- [Change fax settings](#)
- [Fax and digital phone services](#)
- [Fax over Internet Protocol](#)
- [Use reports](#)

## Send a fax

You can send a fax in a variety of ways. Using the printer control panel, you can send a black-and-white or color fax. You can also send a fax manually from an attached phone. This allows you to speak with the recipient before sending the fax.

This section contains the following topics:

- [Send a standard fax](#)
- [Send a standard fax from the computer](#)
- [Send a fax manually from a phone](#)
- [Send a fax using monitor dialing](#)
- [Send a fax from memory](#)
- [Schedule a fax to send later](#)
- [Send a fax to multiple recipients](#)
- [Send a fax in Error Correction Mode](#)

### Send a standard fax

You can easily send a single- or multiple-page black-and-white or color fax by using the printer control panel.



---

 **NOTE:** If you need printed confirmation that your faxes were successfully sent, enable fax confirmation **before** sending any faxes.

 **TIP:** You can also send a fax manually from a phone or by using monitor dialing. These features allow you to control the pace of your dialing. They are also useful when you want to use a calling card to charge the call and you have to respond to tone prompts while dialing.

---

### To send a standard fax from the printer control panel

1. Load your original print-side down in the right-front corner of the glass or in the ADF. For more information, see [Load an original on the scanner glass](#) or [Load an original in the automatic document feeder \(ADF\)](#).

2. Touch **Fax**.

3. Enter the fax number by using the keypad.

 **TIP:** To add a pause in the fax number you are entering, touch \* repeatedly, until a dash (-) appears on the display.

---

4. Touch **Start Black** or **Start Color**.

**If the printer detects an original loaded in the automatic document feeder, it sends the document to the number you entered.**

 **TIP:** If the recipient reports issues with the quality of the fax you sent, you can try changing the resolution or contrast of your fax.

---

## Send a standard fax from the computer

You can send a document on your computer as a fax, without printing a copy and faxing it from the printer.

---

 **NOTE:** Faxes sent from your computer by this method use the printer's fax connection, not your Internet connection or computer modem. Therefore, make sure the printer is connected to a working telephone line and that the fax function is set up and functioning correctly.

---

To use this feature, you must install the printer software using the installation program provided on the HP software CD provided with the printer.

### Windows

1. Open the document on your computer that you want to fax.
2. On the **File** menu in your software application, click **Print**.
3. Make sure the printer you want to use is selected.

 **TIP:** Select the printer that has "**fax**" in the name.

---

4. To change settings (such as choosing to send the document as a black fax or a color fax), click the option that opens the printer **Properties** dialog box. Depending on your software application, this option might be called **Properties**, **Options**, **Printer Setup**, **Printer**, or **Preferences**.
5. After you have changed any settings, click **OK**.

6. Click **Print** or **OK**.
7. Enter the fax number and other information for the recipient, change any further settings for the fax, and then click **Send Fax**. The printer begins dialing the fax number and faxing the document.

### Mac OS X

1. Open the document on your computer that you want to fax.
2. From the **File** menu in your software application, click **Print**.
3. Make sure the printer you want to use is selected.

---

 **TIP:** Select the printer that has “**(Fax)**” in the name.

---

4. Select **Fax Recipients** from the pop-up menu below the **Orientation** setting.

---

 **NOTE:** Click the blue disclosure triangle next to the **Printer selection** to see the pop-up menu.

---

5. Type the fax number and other information in the boxes provided, and then click **Add to Recipients**.
6. Select the **Fax Mode** and any other fax options you want, and then click **Send Fax Now**. The printer begins dialing the fax number and faxing the document.

## Send a fax manually from a phone

Sending a fax manually allows you to make a phone call and talk with the recipient before you send the fax. This is useful if you want to inform the recipient that you are going to send them a fax before sending it. When you send a fax manually, you can hear the dial tones, telephone prompts, or other sounds through the handset on your telephone. This makes it easy for you to use a calling card to send your fax.

Depending on how the recipient has their fax machine set up, the recipient might answer the phone, or the fax machine might take the call. If a person answers the phone, you can speak with the recipient before sending the fax. If a fax machine answers the call, you can send the fax directly to the fax machine when you hear the fax tones from the receiving fax machine.

### To send a fax manually from an extension phone

1. Load your original print-side down in the right-front corner of the glass or in the ADF. For more information, see [Load an original on the scanner glass](#) or [Load an original in the automatic document feeder \(ADF\)](#).
2. Touch **Fax**.
3. Dial the number by using the keypad on the phone that is connected to the printer.

---

 **NOTE:** Do not use the keypad on the control panel of the printer when manually sending a fax. You must use the keypad on your phone to dial the recipient's number.

---

4. If the recipient answers the telephone, you can engage in a conversation before sending your fax.

---

 **NOTE:** If a fax machine answers the call, you will hear fax tones from the receiving fax machine. Proceed to the next step to transmit the fax.

---

5. When you are ready to send the fax, touch **Start Black** or **Start Color**.

---

 **NOTE:** If prompted, select **Send Fax**.

---

If you were speaking with the recipient before sending the fax, inform the recipient that they should press **Start** on their fax machine after they hear fax tones.

The telephone line is silent while the fax is transmitting. At this point, you can hang up the telephone. If you want to continue speaking with the recipient, remain on the line until the fax transmission is complete.

## Send a fax using monitor dialing

Monitor dialing allows you to dial a number from the printer control panel as you would dial a regular telephone. When you send a fax using monitor dialing, you can hear the dial tones, telephone prompts, or other sounds through the speakers on the printer. This enables you to respond to prompts while dialing, as well as control the pace of your dialing.

---

 **TIP:** If you are using a calling card and do not enter your PIN fast enough, the printer might start sending fax tones too soon and cause your PIN not to be recognized by the calling card service. If this is the case, you can create a speed dial entry to store the PIN for your calling card.



 **NOTE:** Make sure the volume is turned on, or you will not hear a dial tone.

---

### To send a fax using monitor dialing from the printer control panel

1. Load your originals. For additional information, see [Load an original on the scanner glass](#) or [Load an original in the automatic document feeder \(ADF\)](#).
2. Touch **Fax**, and then touch **Start Black** or **Start Color**.  
If the printer detects an original loaded in the automatic document feeder, you will hear a dial tone.
3. When you hear the dial tone, enter the number by using the keypad on the printer control panel.
4. Follow any prompts that might occur.

---

 **TIP:** If you are using a calling card to send a fax and you have your calling card PIN stored as a speed dial, when prompted to enter your PIN, touch  (Speed Dial) to select the speed dial entry where you have your PIN stored.

---

Your fax is sent when the receiving fax machine answers.

## Send a fax from memory

You can scan a black-and-white fax into memory and then send the fax from memory. This feature is useful if the fax number you are trying to reach is busy or temporarily unavailable. The printer scans the originals into memory and sends them once it is able to connect to the receiving fax machine. After the printer scans the pages into memory,



you can immediately remove the originals from the document feeder tray or scanner glass.

---

 **NOTE:** You can only send a black-and-white fax from memory.

---

### To send a fax from memory

1. Load your originals. For additional information, see [Load an original on the scanner glass](#) or [Load an original in the automatic document feeder \(ADF\)](#).
2. Touch **Fax**, and then touch **Fax Settings**.
3. Touch **Scan and Fax**.
4. Enter the fax number by using the keypad, touch  (Speed Dial) to select a speed dial, or touch  (Call History) to select a previously dialed or received number.
5. Touch **Start Fax**.  
The printer scans the originals into memory and sends the fax when the receiving fax machine is available.

### Schedule a fax to send later

You can schedule a black-and-white fax to be sent within the next 24 hours. This enables you to send a black-and-white fax late in the evening, when phone lines are not as busy or phone rates are lower, for example. The printer automatically sends your fax at the specified time.



You can only schedule one fax to be sent at a time. You can continue to send faxes normally, however, while a fax is scheduled.

---

 **NOTE:** You can only send faxes in black-and-white.

---

### To schedule a fax from the printer control panel

1. Load your originals. For additional information, see [Load an original on the scanner glass](#) or [Load an original in the automatic document feeder \(ADF\)](#).
2. Touch **Fax**, and then touch **Fax Settings**.
3. Touch **Send Fax Later**.
4. Enter the send time by using the numeric keypad, touch **AM** or **PM**, and then select **Done**.
5. Enter the fax number by using the keypad, touch  (Speed Dial) to select a speed dial, or touch  (Call History) to select a previously dialed or received number.
6. Touch **Start Fax**.  
The printer scans all pages and the scheduled time appears on the display. The fax is sent at the scheduled time.

### To cancel a scheduled fax

1. Touch the **Send Fax Later** message on the display.  
– OR –  
Touch **Fax**, and then select **Fax Settings**.
2. Touch **Cancel Scheduled Fax** .

## Send a fax to multiple recipients

You can send a fax to multiple recipients at once by grouping individual speed dial entries into group speed dial entries.

### To send a fax to multiple recipients using group speed dial

1. Load your originals. For additional information, see [Load an original on the scanner glass](#) or [Load an original in the automatic document feeder \(ADF\)](#).
2. Touch **Fax**, touch  (Speed Dial) to select a speed dial, and then select the group you want to fax to.
3. Touch **Start Black**.

If the printer detects an original loaded in the automatic document feeder, it sends the document to each number in the group speed dial entry.

---

 **NOTE:** You can only use group speed dial entries to send faxes in black-and-white. The printer scans the fax into memory then dials the first number. When a connection is made, it sends the fax and dials the next number. If a number is busy or not answering, the printer follows the settings for **Busy Redial** and **No Answer Redial**. If a connection cannot be made, the next number is dialed and an error report is generated.

---



## Send a fax in Error Correction Mode

**Error Correction Mode (ECM)** prevents loss of data due to poor phone lines by detecting errors that occur during transmission and automatically requesting retransmission of the erroneous portion. Phone charges are unaffected, or might even be reduced, on good phone lines. On poor phone lines, ECM increases sending time and phone charges, but sends the data much more reliably. The default setting is **On**. Turn ECM off only if it increases phone charges substantially, and if you can accept poorer quality in exchange for reduced charges.

Before turning the ECM setting off, consider the following. If you turn ECM off

- The quality and transmission speed of faxes you send and receive are affected.
- The **Fax Speed** is automatically set to **Medium**.
- You no longer send or receive faxes in color.

### To change the ECM setting from the control panel

1. From the Home screen, touch right arrow , and then select **Setup**.
2. Touch **Fax Setup** and then select **Advanced Fax Setup**.
3. Touch down arrow , and then select **Error Correction Mode**.
4. Select **On** or **Off**.

## Receive a fax

You can receive faxes automatically or manually. If you turn off the **Auto Answer** option, you must receive faxes manually. If you turn on the **Auto Answer** option (the default setting), the printer automatically answers incoming calls and receives faxes after the number of rings that are specified by the **Rings to Answer** setting. (The default **Rings to Answer** setting is five rings.)

If you receive a Legal-size or larger fax and the printer is not currently set to use Legal-size paper, the printer reduces the fax so that it fits on the paper that is loaded. If you have disabled the **Automatic Reduction** feature, the printer prints the fax on two pages.

---

 **NOTE:** If you are copying a document when a fax arrives, the fax is stored in the printer memory until the copying finishes. This can reduce the number of fax pages stored in memory.

---

- [Receive a fax manually](#)
- [Set up backup fax](#)
- [Reprint received faxes from memory](#)
- [Poll to receive a fax](#)
- [Forward faxes to another number](#)
- [Set the paper size for received faxes](#)
- [Set automatic reduction for incoming faxes](#)
- [Block unwanted fax numbers](#)
- [Receive faxes to your computer \(Fax to PC and Fax to Mac\)](#)

### Receive a fax manually

When you are on the phone, the person you are speaking with can send you a fax while you are still connected. This is referred to as manual faxing. Use the instructions in this section to receive a manual fax.

---

 **NOTE:** You can pick up the handset to talk or listen for fax tones.

---

You can receive faxes manually from a phone that is:

- Directly connected to the printer (on the 2-EXT port)
- On the same phone line, but not directly connected to the printer

#### To receive a fax manually

1. Make sure the printer is turned on and you have paper loaded in the main tray.
2. Remove any originals from the document feeder tray.
3. Set the **Rings to Answer** setting to a high number to allow you to answer the incoming call before the printer answers. Or, turn off the **Auto Answer** setting so that the printer does not automatically answer incoming calls.

4. If you are currently on the phone with the sender, instruct the sender to press **Start** on their fax machine.
5. When you hear fax tones from a sending fax machine, do the following:
  - a. Touch **Fax**, and then select **Start Black** or **Start Color**.
  - b. After the printer begins to receive the fax, you can hang up the phone or remain on the line. The phone line is silent during fax transmission.

## Set up backup fax

Depending on your preference and security requirements, you can set up the printer to store all the faxes it receives, only the faxes it receives while the printer is in an error condition, or none of the faxes it receives.

The following backup fax modes are available:

<b>On</b>	<p>The default setting. When backup fax is <b>On</b>, the printer stores all received faxes in memory. This enables you to reprint up to eight of the most recently printed faxes if they are still saved in memory.</p> <p><b>NOTE:</b> When printer memory is low, it overwrites the oldest, printed faxes as it receives new faxes. If the memory becomes full of unprinted faxes, the printer stops answering incoming fax calls.</p> <p><b>NOTE:</b> If you receive a fax that is too large, such as a very detailed color photo, it might not be stored in memory due to memory limitations.</p>
<b>On Error Only</b>	<p>Causes the printer to store faxes in memory only if an error condition exists that prevents the printer from printing the faxes (for example, if the printer runs out of paper). The printer continues to store incoming faxes as long as there is memory available. (If the memory becomes full, the printer stops answering incoming fax calls.) When the error condition is resolved, the faxes stored in memory print automatically, and then they are deleted from memory.</p>
<b>Off</b>	<p>Faxes are never stored in memory. For example, you might want to turn off backup fax for security purposes. If an error condition occurs that prevents the printer from printing (for example, the printer runs out of paper), the printer stops answering incoming fax calls.</p>

 **NOTE:** If backup fax is enabled and you turn off the printer, all faxes stored in memory are deleted, including any unprinted faxes that you might have received while the printer was in an error condition. You must contact the senders to ask them to resend any unprinted faxes. For a list of the faxes you have received, print the **Fax Log**. The **Fax Log** is not cleared when the printer is turned off.

### To set backup fax from the printer control panel

1. Touch right arrow , and then select **Setup**.
2. Touch **Fax Setup**, and then select **Advanced Fax Setup**.
3. Touch **Backup Fax Reception**.
4. Touch one of the options available.

## Reprint received faxes from memory

If you set the backup fax mode to **On**, the received faxes are stored in memory, whether the printer has an error condition or not.



---

 **NOTE:** After the memory becomes full, the oldest, printed faxes are overwritten as new faxes are received. If all the stored faxes are unprinted, the printer does not receive any fax calls until you print or delete the faxes from memory. You might also want to delete the faxes in memory for security or privacy purposes.

---

Depending on the sizes of the faxes in memory, you can reprint up to eight of the most recently printed faxes, if they are still in memory. For example, you might need to reprint your faxes if you lost the copy of your last printout.

#### To reprint faxes in memory from the printer control panel

1. Make sure you have paper loaded in the main tray.
2. Touch right arrow , and then select **Setup**.
3. Touch **Tools** , and then select **Reprint Faxes in Memory**.  
The faxes are printed in the reverse order from which they were received with the most recently received fax printed first, and so on.
4. If you want to stop reprinting the faxes in memory, touch  (Cancel button).

#### Poll to receive a fax

Polling allows the printer to ask another fax machine to send a fax that it has in its queue. When you use the **Poll to Receive** feature, the printer calls the designated fax machine and requests the fax from it. The designated fax machine must be set for polling and have a fax ready to send.

---

 **NOTE:** The printer does not support polling pass codes. Polling pass codes are a security feature that require the receiving fax machine to provide a pass code to the printer it is polling in order to receive the fax. Make sure the printer you are polling does not have a pass code set up (or has not changed the default pass code) or the printer cannot receive the fax.

---

#### To set up poll to receive a fax from the printer control panel



1. Touch **Fax**, and then select **Fax Settings**.
2. Touch **Poll to Receive**.
3. Enter the fax number of the other fax machine.
4. Touch **Start Fax**.

#### Forward faxes to another number

You can set up the printer to forward your faxes to another fax number. A received color fax is forwarded in black and white.

HP recommends that you verify the number you are forwarding to is a working fax line. Send a test fax to make sure the fax machine is able to receive your forwarded faxes.

#### To forward faxes from the printer control panel

1. Touch right arrow , and then select **Setup**.
2. Touch **Fax Setup**, and then select **Advanced Fax Setup**.
3. Touch down arrow , and then select **Fax Forwarding**.



4. Touch **On (Print and Forward)** to print and forward the fax, or select **On (Forward)** to forward the fax.

---

 **NOTE:** If the printer is not able to forward the fax to the designated fax machine (for example, if it is not turned on), the printer prints the fax. If you set up the printer to print error reports for received faxes, it also prints an error report.

---

5. At the prompt, enter the number of the fax machine intended to receive the forwarded faxes, and then touch **Done**. Repeat for each of the following prompts: start date, start time, end date, and end time.
6. Fax forwarding is activated. Touch **Ok** to confirm.  
If the printer loses power when **Fax Forwarding** is set up, it saves the **Fax Forwarding** setting and phone number. When the power is restored to the printer, the **Fax Forwarding** setting is still **On**.

---

 **NOTE:** You can cancel fax forwarding by selecting **Off** from the **Fax Forwarding** menu.

---

## Set the paper size for received faxes

You can select the paper size for received faxes. The paper size you select should match what is loaded in your main tray. Faxes can be printed on letter, A3, A4, or legal paper only.

---

 **NOTE:** If an incorrect paper size is loaded in the main tray when you receive a fax, the fax does not print and an error message appears on the display. Load Letter or A4 paper, and then touch **OK** to print the fax.

---

### To set the paper size for received faxes from the printer control panel

1. Touch right arrow , and then select **Setup**.
2. Touch **Fax Setup**, and then select **Basic Fax Setup**.
3. Touch **Fax Paper Size**, and then select an option.

## Set automatic reduction for incoming faxes

The **Automatic Reduction** setting determines what the printer does if it receives a fax that is too large for the default paper size. This setting is turned on by default, so the image of the incoming fax is reduced to fit on one page, if possible. If this feature is turned off, information that does not fit on the first page is printed on a second page. **Automatic Reduction** is useful when you receive a legal-size fax and letter-size paper is loaded in the main tray.

Automatic Reduction is useful when you receive a fax larger than A4/Letter-size and A4/Letter-size paper is loaded in the main tray

### To set automatic reduction from the printer control panel

1. Touch right arrow , and then select **Setup**.
2. Touch **Fax Setup**, and then select **Advanced Fax Setup**.
3. Touch **Automatic Reduction**, and then select **On** or **Off**.

## Block unwanted fax numbers

If you subscribe to a caller ID service through your phone provider, you can block specific fax numbers so the printer does not print faxes received from those numbers. When an incoming fax call is received, the printer compares the number to the list of unwanted fax numbers to determine if the call should be blocked. If the number matches a number in the blocked fax numbers list, the fax is not printed. (The maximum number of fax numbers you can block varies by model.)

---

 **NOTE:** This feature is not supported in all countries/regions. If it is not supported in your country/region, **Junk Fax Blocker** does not appear in the **Basic Fax Setup** menu.

**NOTE:** If no phone numbers are added in the Caller ID list, it is assumed that a Caller ID service has not been subscribed to with the phone company.



---

- [Add numbers to the junk fax list](#)
- [Remove numbers from the junk fax list](#)
- [Print a Junk Fax Report](#)

### Add numbers to the junk fax list

You can block specific numbers by adding them to the junk fax list.

#### To add a number to the junk fax list

1. Touch right arrow , and then select **Setup**.
2. Touch **Fax Setup**, and then select **Basic Fax Setup**.
3. Touch down arrow , and then select **Junk Fax Blocker**.
4. A message appears stating that Caller ID is required to block junk faxes. Touch **OK** to continue.
5. Touch **Add Numbers**.
6. To select a fax number to block from the caller ID list, touch **Select from Caller ID History**.  
- or -  
To manually enter a fax number to block, select **Enter new number**.
7. After entering a fax number to block, touch **Done**.

---



 **NOTE:** Make sure you enter the fax number as it appears on the control-panel display, and not the fax number that appears on the fax header of the received fax, as these numbers can be different.

---

### Remove numbers from the junk fax list

If you no longer want to block a fax number, you can remove a number from your junk fax list.

#### To remove numbers from the junk fax list



1. Touch right arrow , and then select **Setup**.
2. Touch **Fax Setup**, and then select **Basic Fax Setup**.
3. Touch down arrow , and then select **Junk Fax Blocker**.

4. Touch **Remove Numbers**.
5. Touch the number you want to remove, and then select **OK**.

### Print a Junk Fax Report

Use the following procedure to print a list of blocked junk fax numbers.

#### To print a Junk Fax Report

1. Touch right arrow , and then select **Setup**.
2. Touch **Fax Setup**, and then select **Basic Fax Setup**.
3. Touch down arrow , and then select **Junk Fax Blocker**.
4. Touch **Print Reports**, and then select **Junk Fax List**.

## Receive faxes to your computer (Fax to PC and Fax to Mac)

You can use Fax to PC and Fax to Mac to automatically receive faxes and save faxes directly to your computer. With Fax to PC and Fax to Mac, you can store digital copies of your faxes easily and also eliminate the hassle of dealing with bulky paper files.

Received faxes are saved as TIFF (Tagged Image File Format). Once the fax is received, you get an on-screen notification with a link to the folder where the fax is saved.

The files are named in the following method: XXXX\_YYYYYYYY\_ZZZZZZ.tif, where X is the sender's information, Y is the date, and Z is the time that the fax was received.

---

 **NOTE:** Fax to PC and Fax to Mac are available for receiving black-and-white faxes only. Color faxes are printed instead of being saved to the computer.

---

This section contains the following topics:

- [Fax to PC and Fax to Mac requirements](#)
- [Activate Fax to PC and Fax to Mac](#)
- [Modify Fax to PC or Fax to Mac settings](#)

### Fax to PC and Fax to Mac requirements

- The administrator computer, the computer that activated the Fax to PC or Fax to Mac feature, must be on at all times. Only one computer can act as the Fax to PC or Fax to Mac administrator computer.
- The destination folder's computer or server must be on at all times. The destination computer must also be awake, faxes will not be saved if the computer is asleep or in hibernate mode.
- Paper must be loaded in the input tray.

### Activate Fax to PC and Fax to Mac

On a computer running Windows, you can use the Digital Fax Setup Wizard to activate Fax to PC. On a Macintosh computer, you can use the HP Utility.

#### To set up Fax to PC (Windows)

1. Open the HP printer software. For more information, see [HP printer software \(Windows\)](#).
2. Double-click **Fax Actions**, and then double-click **Digital Fax Setup Wizard**.
3. Follow the onscreen instructions.

#### To set up Fax to Mac (Mac OS X)



1. Open the HP Utility. For more information, see [HP Utility \(Mac OS X\)](#).
2. Click the **Application** icon on the toolbar.
3. Double-click **HP Setup Assistant**, and then follow the onscreen instructions.

### Modify Fax to PC or Fax to Mac settings

You can update the Fax to PC settings from your computer at any time from the Digital Fax Setup Wizard. You can update the Fax to Mac settings from the HP Utility.

You can turn off Fax to PC or Fax to Mac and disable printing faxes from the printer's control panel.

#### To modify settings from the printer's control panel

1. Touch  (right arrow), and then select **Setup**.
  2. Touch **Fax Setup**, touch **Basic Fax Setup**, and then touch **Fax to PC**.
  3. Select the setting that you want to change. You can change the following settings:
    - **View PC hostname:** View the name of the computer that is set up to administer Fax to PC or Fax to Mac.
    - **Turn Off:** Turn off Fax to PC or Fax to Mac.
- 
-  **NOTE:** Use the HP software on your computer to turn on Fax to PC or Fax to Mac.
- 
- **Disable Fax Print:** Choose this option to print faxes as they are received. If you turn off printing, color faxes will still print.

#### To modify settings from the HP software (Windows)

1. Open the HP printer software. For more information, see [HP printer software \(Windows\)](#).
2. Double-click **Fax Actions**, and then double-click **Digital Fax Setup Wizard**.
3. Follow the onscreen instructions.

#### To modify settings from the HP software (Mac OS X)

1. Open the HP Utility. For more information, see [HP Utility \(Mac OS X\)](#).
2. Click the **Application** icon on the toolbar.
3. Double-click **HP Setup Assistant**, and then follow the onscreen instructions.

### Turn off Fax to PC or Fax to Mac

1. Touch , and then select **Setup**.
2. Touch **Fax Setup**, touch **Basic Fax Setup**, and then touch **Fax to PC**.
3. Touch **Turn Off**.

## Set up speed-dial entries

You can set up frequently used fax numbers as speed-dial entries. This lets you dial those numbers quickly by using the printer's control panel.

---

 **TIP:** In addition to creating and managing speed-dial entries from the printer's control panel, you can also use tools available on your computer, such as the HP software included with the printer and the printer's embedded Web server (EWS). For more information, see [Printer management tools](#).

---

This section contains the following topics:

- [Set up and change speed-dial entries](#)
- [Set up and change group speed-dial entries](#)
- [Delete speed-dial entries](#)
- [Print a list of speed-dial entries](#)

### Set up and change speed-dial entries

You can store fax numbers as speed-dial entries.

#### To set up speed-dial entries

1. On the printer's control panel, touch right arrow , and then touch **Setup**.
2. Touch **Fax Setup**, and then select **Speed Dial Setup**.
3. Touch **Add/Edit Speed Dial**, and then touch an unused entry number.
4. Type the fax number, and then touch **Next**.

---

 **NOTE:** Be sure to include any pauses or other required numbers, such as an area code, an access code for numbers outside a PBX system (usually a 9 or 0), or a long-distance prefix.

---

5. Type the name for the speed-dial entry, and then touch **Done**.

#### To change speed-dial entries

1. On the printer's control panel, touch right arrow , and then touch **Setup**.
2. Touch **Fax Setup**, and then select **Speed Dial Setup**.
3. Touch **Add/Edit Speed Dial**, and then touch the speed-dial entry you want to change.

4. If you want to change the fax number, type the new number, and then touch **Next**.



---

**NOTE:** Be sure to include any pauses or other required numbers, such as an area code, an access code for numbers outside a PBX system (usually a 9 or 0), or a long-distance prefix.

---

5. If you want to change the name of the speed-dial entry, type the new name, and then touch **Done**.

## Set up and change group speed-dial entries

You can store groups of fax numbers as group speed-dial entries.

### To set up group speed-dial entries



---

**NOTE:** Before you can create a group speed-dial entry, you must have already created at least one speed-dial entry.

---

1. On the printer's control panel, touch right arrow , and then touch **Setup**.
2. Touch **Fax Setup**, and then select **Speed Dial Setup**.
3. Touch **Group Speed Dial**, and then touch an unused entry number.
4. Touch the speed-dial entries you want to include in the group speed-dial entry, and then touch **OK**.
5. Type the name for the speed-dial entry, and then touch **Done**.

### To change group speed-dial entries

1. On the printer's control panel, touch right arrow , and then touch **Setup**.
2. Touch **Fax Setup**, and then select **Speed Dial Setup**.
3. Select **Group Speed Dial**, and then touch the entry you want to change.
4. If you want to add or remove speed-dial entries from the group, touch the speed-dial entries you want to include or those you want to remove, and then touch **OK**.
5. If you want to change the name of the group speed-dial, type the new name, and then touch **Done**.

## Delete speed-dial entries

To delete speed-dial entries or group speed-dial entries, complete the following steps:

1. On the printer's control panel, touch right arrow , and then touch **Setup**.
2. Touch **Fax Setup**, and then select **Speed Dial Setup**.
3. Touch **Delete Speed Dial**, touch the entry you want to delete, and then touch **Yes** to confirm.



---

**NOTE:** Deleting a group speed-dial entry does not delete the individual speed-dial entries.

---

## Print a list of speed-dial entries

To print a list of all of the speed-dial entries that have been set up, complete the following steps:

1. Load paper in the tray. For more information, see [Load media](#).
2. On the printer's control panel, touch right arrow , and then touch **Setup**.
3. Touch **Fax Setup**, and then select **Speed Dial Setup**.
4. Touch **Print Speed Dial List**.

## Change fax settings

After completing the steps in the getting started guide that came with the printer, use the following steps to change the initial settings or to configure other options for faxing.

- [Configure the fax header](#)
- [Set the answer mode \(Auto answer\)](#)
- [Set the number of rings before answering](#)
- [Change the answer ring pattern for distinctive ring](#)
- [Set the dial type](#)
- [Set the redial options](#)
- [Set the fax speed](#)
- [Set the fax sound volume](#)

## Configure the fax header

The fax header prints your name and fax number on the top of every fax you send. HP recommends that you set up the fax header by using the HP software provided with the printer. You can also set up the fax header from the printer control panel, as described here.

---

 **NOTE:** In some countries/regions, the fax header information is a legal requirement.

---

### To set or change the fax header

1. Touch right arrow , and then select **Setup**.
2. Touch **Fax Setup**, and then select **Basic Fax Setup**.
3. Touch **Fax Header**.
4. Enter your personal or company name, and then touch **Done**.
5. Enter your fax number, and then touch **Done**.

## Set the answer mode (Auto answer)

The answer mode determines whether the printer answers incoming calls.

- Turn on the **Auto Answer** setting if you want the printer to answer faxes **automatically**. The printer answers all incoming calls and faxes.
- Turn off the **Auto Answer** setting if you want to receive faxes **manually**. You must be available to respond in person to the incoming fax call or else the printer does not receive faxes.

### To set the answer mode

1. Touch right arrow , and then select **Setup**.
2. Touch **Fax Setup**, and then select **Basic Fax Setup**.
3. Touch **Auto Answer**, and then select **On** or **Off**.  
When **Auto Answer** is **On**, the printer answers calls automatically. When **Auto Answer** is **Off**, it does not answer calls.



### Set the number of rings before answering

If you turn on the **Auto Answer** setting, you can specify how many rings occur before incoming calls are automatically answered.

The **Rings to Answer** setting is important if you have an answering machine on the same phone line as the printer, because you want the answering machine to answer the phone before the printer does. The number of rings to answer for the printer should be greater than the number of rings to answer for the answering machine.

For example, set your answering machine to a low number of rings and the printer to answer in the maximum number of rings. (The maximum number of rings varies by country/region.) In this setup, the answering machine answers the call and the printer monitors the line. If the printer detects fax tones, it receives the fax. If the call is a voice call, the answering machine records the incoming message.

### To set the number of rings before answering

1. Touch right arrow , and then select **Setup**.
2. Touch **Fax Setup**, and then select **Basic Fax Setup**.
3. Touch **Rings to Answer**.
4. Touch up arrow  or down arrow  to change the number of rings.
5. Touch **Done** to accept the setting.

### Change the answer ring pattern for distinctive ring

Many phone companies offer a distinctive ring feature that allows you to have several phone numbers on one phone line. When you subscribe to this service, each number is assigned a different ring pattern. You can set up the printer to answer incoming calls that have a specific ring pattern.

If you connect the printer to a line with distinctive ring, have your telephone company assign one ring pattern to voice calls and another ring pattern to fax calls. HP recommends that you request double or triple rings for a fax number. When the printer detects the specified ring pattern, it answers the call and receives the fax.

---

 **TIP:** You can also use the Ring Pattern Detection feature in the printer's control panel to set distinctive ring. With this feature, the printer recognizes and records the ring pattern of an incoming call and, based on this call, automatically determines the distinctive ring pattern assigned by your telephone company to fax calls.

---

If you do not have a distinctive ring service, use the default ring pattern, which is **All Rings**.





**NOTE:** The printer cannot receive faxes when the main phone number is off the hook.

---

### To change the answer ring pattern for distinctive ring

1. Verify that the printer is set to answer fax calls automatically.
2. Touch right arrow , and then select **Setup**.
3. Touch **Fax Setup**, and then select **Advanced Fax Setup**.
4. Touch **Distinctive Ring**.
5. A message appears stating that this setting should not be changed unless you have multiple numbers on the same telephone line. Touch **Yes** to continue.
6. Do one of the following:
  - Touch the ring pattern assigned by your telephone company to fax calls.  
- Or -
  - Touch **Ring Pattern Detection**, and then follow the instructions on the printer's control panel.



**NOTE:** If the Ring Pattern Detection feature cannot detect the ring pattern or if you cancel the feature before it finishes, the ring pattern is automatically set to **All Rings**.

**NOTE:** If you are using either a PBX phone system that has different ring patterns for internal and external calls, you must call the fax number from an external number.

---

## Set the dial type



Use this procedure to set tone-dialing or pulse-dialing mode. The factory-set default is **Tone**. Do not change the setting unless you know that your phone line cannot use tone dialing.



**NOTE:** The pulse-dialing option is not available in all countries/regions.

---

### To set the dial type

1. Touch right arrow , and then select **Setup**.
2. Touch **Fax Setup**, and then select **Basic Fax Setup**.
3. Touch down arrow , and then select **Dial Type**.
4. Touch to select **Tone Dialing** or **Pulse Dialing**.

## Set the redial options

If the printer was unable to send a fax because the receiving fax machine did not answer or was busy, the printer attempts to redial based on the settings for the busy-redial and no-answer-redial options. Use the following procedure to turn the options on or off.

- **Busy redial:** If this option is turned on, the printer redials automatically if it receives a busy signal. The factory-set default for this option is **On**.
- **No answer redial:** If this option is turned on, the printer redials automatically if the receiving fax machine does not answer. The factory-set default for this option is **Off**.

### To set the redial options

1. Touch right arrow , and then select **Setup**.
2. Touch **Fax Setup**, and then select **Advanced Fax Setup**.
3. Touch to select the appropriate **Busy Redial** or **No Answer Redial** options.

## Set the fax speed

You can set the fax speed used to communicate between your printer and other fax machines when sending and receiving faxes.



If you use one of the following, setting the fax speed to a slower speed might be required:

- An Internet phone service
- A PBX system
- Fax over Internet Protocol (FoIP)
- An integrated services digital network (ISDN) service

If you experience problems sending and receiving faxes, try using a lower **Fax Speed**. The following table provides the available fax speed settings.

Fax speed setting	Fax speed
<b>Fast</b>	v.34 (33600 baud)
<b>Medium</b>	v.17 (14400 baud)
<b>Slow</b>	v.29 (9600 baud)



### To set the fax speed

1. Touch right arrow , and then select **Setup**.
2. Touch **Fax Setup**, and then touch **Advanced Fax Setup**.
3. Touch down arrow , and then select **Fax Speed**.
4. Touch to select the speed.

## Set the fax sound volume

Use this procedure to increase or decrease the volume of the fax sounds.

### To set the fax sound volume

1. Touch right arrow , and then select **Setup**.
2. Touch **Fax Setup**, and then select **Basic Fax Setup**.
3. Touch down arrow , and then select **Fax Sound Volume**.
4. Touch to select **Soft, Loud, or Off**.

## Fax and digital phone services

Many telephone companies provide their customers with digital phone services, such as the following:

- DSL: A Digital subscriber line (DSL) service through your telephone company. (DSL might be called ADSL in your country/region.)
- PBX : A private branch exchange (PBX) phone system
- ISDN: An integrated services digital network (ISDN) system.
- FoIP: A low-cost phone service that allows you to send and receive faxes with your printer by using the Internet. This method is called Fax over Internet Protocol (FoIP). For more information, see [Fax over Internet Protocol](#).

HP printers are designed specifically for use with traditional analog phone services. If you are in a digital phone environment (such as DSL/ADSL, PBX, or ISDN), you might need to use digital-to-analog filters or converters when setting up the printer for faxing.

---

 **NOTE:** HP does not guarantee that the printer will be compatible with all digital service lines or providers, in all digital environments, or with all digital-to-analog converters. It is always recommended that you discuss with the telephone company directly for the correct setup options based on their line services provided.

---

## Fax over Internet Protocol

You might be able to subscribe to a low cost phone service that allows you to send and receive faxes with your printer by using the Internet. This method is called Fax over Internet Protocol (FoIP).

You probably use a FoIP service (provided by your telephone company) when you:

- Dial a special access code along with the fax number, or
- Have an IP converter box that connects to the Internet and provides analog phone ports for the fax connection.

---

 **NOTE:** You can only send and receive faxes by connecting a phone cord to the port labeled "1-LINE" on the printer. This means that your connection to the Internet must be done either through a converter box (which supplies regular analog phone jacks for fax connections) or your telephone company.

 **TIP:** Support for traditional fax transmission over any Internet protocol telephone systems are often limited. If you experience problems faxing, try using a slower fax speed or disabling the fax error-correction mode (ECM). However, if you turn off ECM, you cannot send and receive color faxes. (For more information about changing the fax speed, see [Set the fax speed](#). For more information about using ECM, see [Send a fax in Error Correction Mode](#).)

---

If you have questions about Internet faxing, contact your Internet faxing services support department or your local service provider for further assistance.

## Use reports

You can set up the printer to print error reports and confirmation reports automatically for each fax you send and receive. You can also manually print system reports as required; these reports provide useful system information about the printer.

By default, the printer is set to print a report only if there is a problem sending or receiving a fax. A confirmation message that indicates whether a fax was successfully sent appears briefly on the control-panel display after each transaction.

 **NOTE:** If the reports are not legible, you can check the estimated ink levels from the control panel, the HP software (Windows), or HP Utility (Mac OS X). For more information, see [Printer management tools](#).

**NOTE:** Ink level alerts and indicators provide estimates for planning purposes only. When you receive a low-ink alert, consider having a replacement cartridge available to avoid possible printing delays. You do not need to replace the ink cartridges until print quality becomes unacceptable.

**NOTE:** Ensure that the printhead and ink cartridges are in good conditions and installed properly. For more information, see [Work with ink cartridges](#).

---

This section contains the following topics:

- [Print fax confirmation reports](#)
- [Print fax error reports](#)
- [Print and view the fax log](#)
- [Clear the fax log](#)
- [Print the details of the last fax transaction](#)
- [Print a Caller ID Report](#)
- [View the Call History](#)

### Print fax confirmation reports



If you require printed confirmation that your faxes were successfully sent, follow these instructions to enable fax confirmation **before** sending any faxes. Select either **On (Fax Send)** or **On (Send & Receive)**.

The default fax confirmation setting is **Off**. This means that a confirmation report is not printed for each fax sent or received. A confirmation message indicating whether a fax was successfully sent appears briefly on the control-panel display after each transaction.



**NOTE:** You can include an image of the first page of the fax on the Fax Sent Confirmation report if you choose **On (Fax Send)** or **On (Send and Receive)**, and if you scan the fax to send from memory.

### To enable fax confirmation

1. Touch right arrow , and then select **Setup**.
2. Touch **Fax Setup**, touch down arrow , and then select **Fax Reports**.
3. Touch **Fax Confirmation**.
4. Touch to select one of the following options.

<b>Off</b>	Does not print a fax confirmation report when you send and receive faxes successfully. This is the default setting.
<b>On (Fax Send)</b>	Prints a fax confirmation report for every fax you send.
<b>On (Fax Receive)</b>	Prints a fax confirmation report for every fax you receive.
<b>Send &amp; Receive</b>	Prints a fax confirmation report for every fax you send and receive.



### To include an image of the fax on the report

1. Touch right arrow , and then select **Setup**.
2. Touch **Print Report**, and then select **Fax Confirmation**.
3. Touch **On (Fax Send)** or **On (Send and Receive)**.
4. Touch **Fax Confirmation with image**.

## Print fax error reports

You can configure the printer so that it automatically prints a report when there is an error during transmission or reception.

### To set the printer to print fax error reports automatically



1. Touch right arrow , and then select **Setup**.
2. Touch **Fax Setup**, touch down arrow , and then select **Fax Reports**.
3. Touch **Fax Error Report**.
4. Touch to select one of the following.

On (Send & Receive)	Prints whenever a fax error occurs. This is the default setting.
Off	Does not print any fax error reports.
On (Fax Send)	Prints whenever a transmission error occurs.
On (Fax Receive)	Prints whenever a receiving error occurs.

## Print and view the fax log

You can print a log of faxes that have been received and sent by the printer.

### To print the fax log from the printer control panel

1. Touch right arrow , and then select **Setup**.
2. Touch **Fax Setup**, touch down arrow , and then select **Fax Reports**.
3. Touch **Fax Log**.

## Clear the fax log



Use the following steps to clear the fax log.

---

 **NOTE:** Clearing the fax log also deletes all faxes stored in memory.

---



### To clear the fax log via the printer control panel

1. Touch right arrow , and then select **Setup**.
2. Touch **Tools**.
3. Touch down arrow , and then select **Clear Fax Log**.

## Print the details of the last fax transaction

The Last Fax Transaction report prints the details of the last fax transaction to occur. Details include the fax number, number of pages, and the fax status.



### To print the Last Fax Transaction report

1. Touch right arrow , and then select **Setup**.
2. Touch **Fax Setup**, touch down arrow , and then select **Fax Reports**.
3. Touch **Last Transaction**.

## Print a Caller ID Report

Use the following procedure to print a list of Caller ID fax numbers.

### To print a Caller ID Report

1. Touch right arrow , and then select **Setup**.
2. Touch **Fax Setup**, touch down arrow , and then select **Fax Reports**.
3. Touch down arrow , and then select **Caller ID Report**.

## View the Call History



Use the following procedure to view a history of all the calls placed from the printer.

---

 **NOTE:** The call history cannot be printed. You can only view it from the printer's control panel display.

---

**To view the Call History**

1. Touch right arrow , and then select **Fax**.
2. Touch  (Call History).

---

# 6 Web

The printer offers innovative, Web-enabled solutions that can help you quickly access the Internet, obtain documents, and print them faster and with less hassle—and all without using a computer. In addition, you can use a Web service (Marketsplash by HP) to create and print professional-quality marketing materials.

---

 **NOTE:** To use these Web features, the printer must be connected to the Internet (either using an Ethernet cable or wireless connection). You cannot use these Web features if the printer is connected using a USB cable.

**NOTE:** In addition to these solutions, you can send print jobs to the printer remotely from mobile devices. With this service, called HP ePrint, you can print from email connected mobile phones, netbooks, or other mobile devices—anywhere, anytime. For more information, see [HP ePrint](#).

---

This section contains the following topics:

- [HP Apps](#)
- [Marketsplash by HP](#)

## HP Apps

HP Apps provide a quick and easy way to access, store, and print business information without a computer. Using HP Apps, you can gain access to content stored on the Web, such as business forms, news, archiving, and more—right from the printer's control-panel display.

To use HP Apps, the printer needs to be connected to the Internet (either using an Ethernet cable or wireless connection). Follow the instructions on the printer's control panel to enable and set up this service.

New Apps are periodically added, and you can select and download to the printer's control panel for use.

For more information, visit [www.hp.com/go/ePrintCenter](http://www.hp.com/go/ePrintCenter).

---

 **NOTE:** For a list of system requirements for this Web site, see [HP Web site specifications](#).

---



# Marketsplash by HP

Grow your business using online HP tools and services to create and print professional marketing materials. With Marketsplash, you can do the following:

- Quickly and easily create amazing, professional-quality brochures, flyers, business cards, and more. Choose from thousands of customizable templates created by award-winning business graphic designers.
- A variety of print options allow you to get exactly what you need, when you need it. For immediate, high-quality results, print on your printer. Other options are available online from HP and our partners. Achieve the professional quality you expect, while minimizing printing costs.
- Keep all of your marketing materials organized and readily accessible in your Marketsplash account, available from any computer and directly from the printer's control-panel display (on select models only).

To get started, select **Marketsplash by HP** in the HP printer software that came with your printer. Or for more information, visit [marketsplash.com](http://marketsplash.com).

---

 **NOTE:** For a list of system requirements for this Web site, see [HP Web site specifications](#).

**NOTE:** Not all Marketsplash tools and services are available in all countries, regions and languages. Visit [marketsplash.com](http://marketsplash.com) for the most current information.

---

---

# 7 Work with ink cartridges

To ensure the best print quality from the printer, you will need to perform some simple maintenance procedures. This section provides guidelines for handling the ink cartridges, instructions for replacing the ink cartridges, and aligning and cleaning the printhead.

---

 **TIP:** If you have problems scanning documents, see [Print quality troubleshooting](#)

---

This section contains the following topics:

- [Information on ink cartridges and the printhead](#)
- [Check the estimated ink levels](#)
- [Replace the ink cartridges](#)
- [Store printing supplies](#)
- [Usage information collection](#)

## Information on ink cartridges and the printhead

The following tips help maintain HP ink cartridges and ensure consistent print quality.

- The instructions in this user guide are for replacing ink cartridges, and are not intended for first time installation.
- If you need to replace an ink cartridge, wait until you have the new ink cartridge available to install before removing the old cartridge.

---

 **CAUTION:** Wait until you have a new ink cartridge available before removing the old ink cartridge. Do not leave the ink cartridge outside of the printer for an extended period of time. This can result in damage to both the printer and the ink cartridge.

---

- Keep all ink cartridges in the original sealed packages until they are needed.
- Store ink cartridges in the same orientation packages hang on store shelves or, if out of box, with label facing down.
- Be sure to turn off the printer properly. For more information, see [Turn off the printer](#).
- Store ink cartridges at room temperature (15-35° C or 59-95° F).
- You do not need to replace the cartridges until print quality becomes unacceptable, but a significant decrease in print quality may be the result of one or more depleted cartridges. It could also be caused by a clogged printhead. Possible solutions include checking the estimated ink levels remaining in the cartridges, and cleaning the printhead. Cleaning the printhead uses some ink.
- Do not clean the printhead unnecessarily. This wastes ink and shortens the life of the cartridges.

- Handle ink cartridges carefully. Dropping, jarring, or rough handling during installation can cause temporary printing problems.
- If you are transporting the printer, do the following to prevent ink leaking from the printer or other damage from occurring to the printer:
  - Make sure you turn off the printer by pressing **Power**. The printhead assembly should be parked on the right side of the printer, in the service station. For more information, see [Turn off the printer](#).
  - Make sure you leave the ink cartridges and printhead installed.
  - The printer must be transported sitting flat; it should not be placed on its side, back, front, or top.

#### Related topics

- [Check the estimated ink levels](#)
- [Printhead maintenance](#)

## Check the estimated ink levels

You can check the estimated ink levels from the printer software or the embedded Web server. For information about using these tools, see [Printer management tools](#). You can also print the Printer Status page to view this information (see [Understand the Printer Status Report](#)).

---

 **NOTE:** Ink level alerts and indicators provide estimates for planning purposes only. When you receive a low-ink alert, consider having a replacement cartridge available to avoid possible printing delays. You do not have to replace the cartridges until the print quality is unacceptable.

**NOTE:** If you have installed a refilled or remanufactured cartridge, or a cartridge that has been used in another printer, the ink level indicator might be inaccurate or unavailable.

**NOTE:** Ink from the cartridges is used in the printing process in a number of different ways, including in the initialization process, which prepares the printer and cartridges for printing, and in printhead servicing, which keeps print nozzles clear and ink flowing smoothly. In addition, some residual ink is left in the cartridge after it is used. For more information, see [www.hp.com/go/inkusage](http://www.hp.com/go/inkusage).

---

## Replace the ink cartridges

---

 **NOTE:** For information on recycling used ink supplies, see [HP inkjet supplies recycling program](#).

---

If you do not already have replacement ink cartridges for the printer, see [Order printing supplies online](#).

---

 **NOTE:** At this time, some portions of the HP Web site are available in English only.

 **CAUTION:** Wait until you have a new ink cartridge available before removing the old ink cartridge. Do not leave the ink cartridge outside of the printer for an extended period of time. This can result in damage to both the printer and the ink cartridge.

---

### To replace the ink cartridges

Use these steps to replace the ink cartridges.

1. Make sure the printer is turned on.
2. Open the print-carriage access door.

---

 **NOTE:** Wait until the print carriage stops moving before proceeding.

---

3. Press the tab on the front of the ink cartridge to release it, and then remove it from the slot.

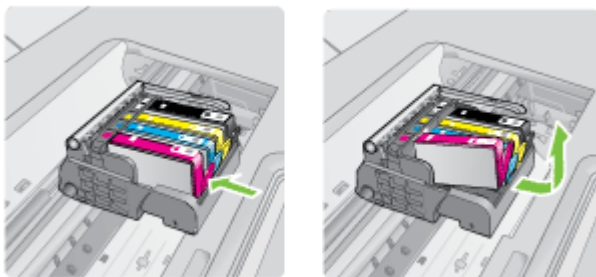

4. Remove the new ink cartridge from its packaging by pulling the orange pull-tab straight back to remove the plastic wrap from the ink cartridge.

---

 **NOTE:** Make sure you remove the plastic wrap from the ink cartridge before installing it in the printer, or printing fails.

---

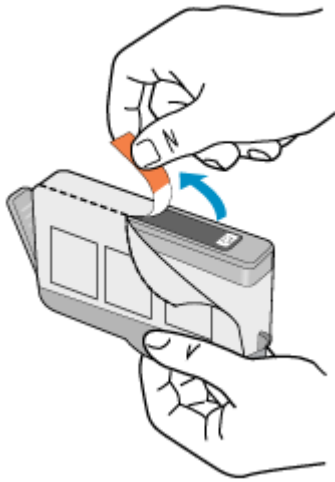

5. Twist the orange cap to snap it off.

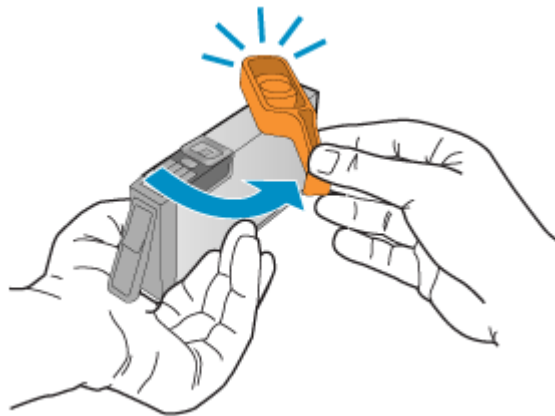

---

 **NOTE:** Make sure the plastic tab is entirely removed and that the label is slightly torn, revealing the vent channel.

---

6. Using the colored shaped icons for help, slide the ink cartridge into the empty slot until it clicks into place and is seated firmly in the slot.

 **CAUTION:** Do not lift the latch handle on the print carriage to install the ink cartridges. Doing so can result in incorrectly seated ink cartridges and printing problems. The latch must remain down in order to correctly install the ink cartridges.

---

Make sure that you insert the ink cartridge into the slot that has the same shaped icon and color as the one you are installing.

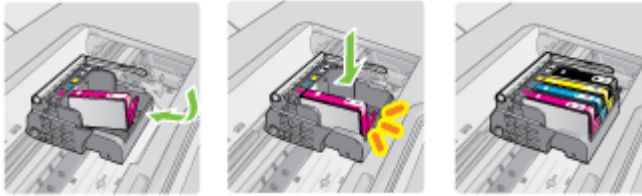

7. Repeat steps 3 through 6 for each ink cartridge you are replacing.
8. Close the print-carriage access door.

### Related topics

[Order printing supplies online](#)

## Store printing supplies

Ink cartridges can be left in the printer for extended periods of time. However, to assure optimal ink cartridge health, be sure to turn off the printer properly. For more information, see [Turn off the printer](#).

## Usage information collection

The HP cartridges used with this printer contain a memory chip that assists in the operation of the printer.

In addition, this memory chip collects a limited set of information about the usage of the printer, which might include the following: the date when the cartridge was first installed, the date when the cartridge was last used, the number of pages printed using the cartridge, the page coverage, the printing modes used, any printing errors that might have occurred, and the printer model. This information helps HP design future printers to meet our customers' printing needs.

The data collected from the cartridge memory chip does not contain information that can be used to identify a customer or user of the cartridge or their printer.

HP collects a sampling of the memory chips from cartridges returned to HP's free return and recycling program (HP Planet Partners: [www.hp.com/recycle](http://www.hp.com/recycle)). The memory chips from this sampling are read and studied in order to improve future HP printers. HP partners who assist in recycling this cartridge might have access to this data, as well.

Any third party possessing the cartridge might have access to the anonymous information on the memory chip. If you prefer to not allow access to this information, you can render the chip inoperable. However, after you render the memory chip inoperable, the cartridge cannot be used in an HP printer.

If you are concerned about providing this anonymous information, you can make this information inaccessible by turning off the memory chip's ability to collect the printer's usage information:

**To turn off usage information collection**

1. On the printer control panel, touch right arrow , and then touch **Setup**.
2. Select **Preferences**, and then select **Cartridge Chip Information**.
3. Touch **OK** to turn off usage information collection.



**NOTE:** If you turn off the memory chip's ability to collect the printer's usage information, you can still continue to use the cartridge in the HP printer.

---

---

# 8 Solve a problem

The information in this section suggests solutions to common problems. If your printer is not operating correctly and those suggestions did not solve your problem, try using one of the following support services to obtain assistance.

This section contains the following topics:

- [HP support](#)
- [General troubleshooting tips and resources](#)
- [Solve printing problems](#)
- [Print troubleshooting](#)
- [Print quality troubleshooting](#)
- [Solve paper-feed problems](#)
- [Solve copy problems](#)
- [Solve scan problems](#)
- [Solve fax problems](#)
- [Solve problems using HP Web sites and services](#)
- [Solve photo \(memory card\) problems](#)
- [Solve wired \(Ethernet\) network problems](#)
- [Solve wireless problems](#)
- [Configure your firewall to work with printers](#)
- [Solve printer management problems](#)
- [Troubleshoot installation issues](#)
- [Understand the Printer Status Report](#)
- [Understand the network configuration page](#)
- [Clear jams](#)

## HP support

### If you have a problem, follow these steps

1. Check the documentation that came with the printer.
2. Visit the HP online support Web site at [www.hp.com/support](http://www.hp.com/support). HP online support is available to all HP customers. It is the fastest source for up-to-date printer information and expert assistance and includes the following features:
  - Fast access to qualified online support specialists
  - Software and driver updates for the HP printer
  - Valuable troubleshooting information for common problems
  - Proactive printer updates, support alerts, and HP newsgrams that are available when you register the HP printerFor more information, see [Obtain electronic support](#).
3. Call HP support. Support options and availability vary by printer, country/region, and language. For more information, see [HP support by phone](#).



## Obtain electronic support

To find support and warranty information, go to the HP Web site at [www.hp.com/support](http://www.hp.com/support). If prompted, choose your country/region, and then click **Contact HP** for information on calling for technical support.

This Web site also offers technical support, drivers, supplies, ordering information and other options such as:

- Access online support pages.
- Send HP an e-mail message for answers to your questions.
- Connect with an HP technician by using online chat.
- Check for HP software updates.

You can also obtain support from the HP printer software (Windows) or HP Utility (Mac OS X), which provide easy, step-by-step solutions to common printing problems. For more information, see [Printer management tools](#).

Support options and availability vary by printer, country/region, and language.

## HP support by phone

The phone support numbers and associated costs listed here are those in effect at time of publication and are applicable only for calls made on a land line. Different rates may apply for mobile phones.

For the most current HP list of telephone support numbers and call costs information, see [www.hp.com/support](http://www.hp.com/support).

During the warranty period, you may obtain assistance from the HP Customer Care Center.

---

 **NOTE:** HP does not provide telephone support for Linux printing. All support is provided online at the following web site: <https://launchpad.net/hplip>. Click **Ask a question** to begin the support process.

The HPLIP Web site does not provide support for Windows or Mac OS X. If you are using these operating systems, see [www.hp.com/support](http://www.hp.com/support).

---

This section contains the following topics:

- [Before you call](#)
- [Phone support period](#)
- [Telephone support numbers](#)
- [After the phone support period](#)

### Before you call

Call HP support while you are in front of the computer and the printer. Be prepared to provide the following information:

- Model number (for more information, see [Finding the printer model number](#))
- Serial number (located on the back or bottom of the printer)

- Messages that appear when the situation occurs
- Answers to these questions:
  - Has this situation happened before?
  - Can you re-create it?
  - Did you add any new hardware or software to your computer at about the time that this situation began?
  - Did anything else occur prior to this situation (such as a thunderstorm or moving the printer)?

**Phone support period**

One year of phone support is available in North America, Asia Pacific, and Latin America (including Mexico).

**Telephone support numbers**

In many locations, HP provides toll free telephone support during the warranty period. However, some of the support numbers might not be toll free.

For the most current list of telephone support numbers, see [www.hp.com/support](http://www.hp.com/support).



[www.hp.com/support](http://www.hp.com/support)

Africa (English speaking)	+27 11 2345872	日本	03-3335-9800
Afrique (francophone)	+33 1 4993 9230	0800 222 47	الأردن
	021 672 280	الجزائر	한국
Algérie	021 67 22 80		1588-3003
Argentina (Buenos Aires)	54-11-4708-1600		Luxembourg (Français)
Argentina	0-800-555-5000		+352 900 40 006 0.15 €/min
Australia	1300 721 147		Luxemburg (Deutsch)
Australia (out-of-warranty)	1902 910 910		+352 900 40 007 0.15 €/Min
Österreich	+43 0820 87 4417 doppelter Ortstarif		Madagascar
	17212049	البحرين	262 262 51 21 21
België	+32 078 600 019 Peak Hours: 0,055 €/p/m Low Hours: 0,27 €/p/m		Magyarország
Belgique	+32 078 600 020 Peak Hours: 0,055 €/m Low Hours: 0,27 €/m		06 40 200 629 7,2 HUF/perc vezetékes telefonra
Brasil (Sao Paulo)	55-11-4004-7751		Malaysia
Brasil	0-800-709-7751		1800 88 8588
Canada	1-(800)-474-6836 (1-800 hp invent)		Mauritius
Central America & The Caribbean	<a href="http://www.hp.com/la/soporte">www.hp.com/la/soporte</a>		262 262 210 404
Chile	800-360-999		México (Ciudad de México)
中国	1068687980		55-5258-9922
中国	800-810-3888		México
Colombia (Bogotá)	571-606-9191		01-800-472-68368
Colombia	01-8000-51-4746-8368		Maroc
Costa Rica	0-800-011-1046		0801 005 010
Česká republika	810 222 222 1.53 CZN/min		Nederland
Danmark	+45 70 202 845 Opkald: 0,145 (kr. pr. min.) Pr. min. man-lør 08.00-19.30: 0,25 Pr. min. øvrige tidspunkter: 0,125		0.10 €/Min
Ecuador (Andinatel)	1-999-119 ☎ 800-711-2884		New Zealand
Ecuador (Pacifitel)	1-800-225-528 ☎ 800-711-2884		0800 441 147
	(02) 6910602	مصر	Nigeria
El Salvador	800-6160		(01) 271 2320
España	+34 902 010 059 0.94 €/p/m		Norge
France	+33 0969 320 435		+47 815 62 070 starter på 0,59 Kr per min., deretter 0,39 Kr per min. Fra mobiltelefon gjelder mobiltelfontakster.
Deutschland	+49 01805 652 180 0,14 €/Min aus dem deutschen Festnetz - bei Anrufen aus Mobilfunknetzen können andere Preise gelten		24791773
Ελλάδα	801-11-75400		عمان
Κύπρος	+800 9 2654		Panamá
Guatemala	1-800-711-2884		1-800-711-2884
香港特別行政區	(852) 2802 4098		Paraguay
India	1-800-425-7737		009 800 54 1 0006
India	91-80-28526900		Perú
Indonesia	+62 (21) 350 3408		0-800-10111
	+971 4 224 9189	العراق	Philippines
	+971 4 224 9189	الكويت	2 867 3551
	+971 4 224 9189	لبنان	Polska
	+971 4 224 9189	قطر	(22) 583 43 73 Koszt połączenia: - z tel. stacjonarnego jak za 1 impuls wg taryfy operatora - z tel. komórkowego wg taryfy operatora.
	+971 4 224 9189	اليمن	Portugal
Ireland	+353 1890 923 902 Calls cost Cost 5.1 cent peak / 1.3 cent off-peak per minute		+351 808 201 492 Custo: 8 cêntimos no primeiro minuto e 3 cêntimos restantes minutos
Italia	+39 848 800 871 costo telefonico locale		Puerto Rico
Jamaica	1-800-711-2884		1-877-232-0589
日本	0570-000511		República Dominicana
			1-800-711-2884
			Reunion
			0820 890 323
			România
			0801 033 390 (021 204 7090)
			Россия (Москва)
			495 777 3284
			Россия (Санкт-Петербург)
			812 332 4240
			800 897 1415
			السعودية
			Singapore
			+65 6272 5300
			Slovenská republika
			0850 111 256
			South Africa (RSA)
			0860 104 771
			Suomi
			+358 0 203 66 767
			Sverige
			+46 077 120 4765 0,23 kr/min
			Switzerland
			+41 0848 672 672 0,08 CHF/min.
			臺灣
			02-8722-8000
			ไทย
			+66 (2) 353 9000
			تونس
			071 891 391
			Trinidad & Tobago
			1-800-711-2884
			Tunisie
			23 926 000
			Türkiye (Istanbul, Ankara, İzmir & Bursa)
			0(212) 444 0307 Yerel numara: 444 0307
			Україна
			(044) 230-51-06
			الإمارات العربية المتحدة
			600 54 47 47
			United Kingdom
			0844 369 0369 0.50 £ p/m
			United States
			1-(800)-474-6836
			Uruguay
			0004-054-177
			Venezuela (Caracas)
			58-212-278-8666
			Venezuela
			0-800-474-68368
			Việt Nam
			+84 88234530

## After the phone support period

After the phone support period, help is available from HP at an additional cost. Help may also be available at the HP online support Web site: [www.hp.com/support](http://www.hp.com/support). Contact your HP dealer or call the support phone number for your country/region to learn more about support options.

## General troubleshooting tips and resources

---

 **NOTE:** Many of the steps below require HP software. If you did not install the HP software, you can install it using the HP software CD included with the printer, or you can download the software from the HP support Web site ([www.hp.com/support](http://www.hp.com/support)).

---

Try these when you begin troubleshooting a printing problem.

- For a paper jam, see [Clear paper jams](#).
- For paper-feed problems, such as the paper skew and paper pick, see [Solve paper-feed problems](#).
- Power light is on and not blinking. When the printer is turned on for the first time, it takes approximately 12 minutes to initialize it after the ink cartridges are installed.
- Power cord and other cables are working, and are firmly connected to the printer. Make sure the printer is connected firmly to a functioning alternating current (AC) power outlet, and is turned on. For voltage requirements, see [Electrical requirements](#).
- Media is loaded correctly in the input tray and is not jammed in the printer.
- All packing tapes and materials are removed.
- The printer is set as the current or default printer. For Windows, set it as the default in the Printers folder. For Mac OS X, set it as the default in the Print & Fax section of the System Preferences. See your computer's documentation for more information.
- **Pause Printing** is not selected if you are using a computer running Windows.
- You are not running too many programs when you are performing a task. Close programs that you are not using or restart the computer before attempting the task again.

### Troubleshooting topics

- [Solve printing problems](#)
- [Print troubleshooting](#)
- [Print quality troubleshooting](#)
- [Solve paper-feed problems](#)
- [Solve copy problems](#)
- [Solve scan problems](#)
- [Solve fax problems](#)
- [Solve wired \(Ethernet\) network problems](#)
- [Solve wireless problems](#)
- [Solve printer management problems](#)
- [Troubleshoot installation issues](#)

## Solve printing problems

This section contains the following topics:

- [The printer shuts down unexpectedly](#)
- [Alignment fails](#)
- [Printer takes a long time to print](#)
- [Something on the page is missing or incorrect](#)

### The printer shuts down unexpectedly

#### Check the power and power connections

Make sure the printer is connected firmly to a functioning alternating current (AC) power outlet. For voltage requirements, see [Electrical requirements](#).

### Alignment fails

If the alignment page appears to be only partially printed, or if it has light or white streaks, try cleaning the printhead.

If the alignment process fails, make sure you have loaded unused, plain white paper into the input tray. If you have colored paper loaded in the input tray when you align the ink cartridges, the alignment fails.

If the alignment process fails repeatedly, you might have a defective sensor or ink cartridge. Contact HP support. Go to [www.hp.com/support](http://www.hp.com/support). If prompted, select your country/region, and then click **Contact HP** for information on calling for technical support.

### Printer takes a long time to print

#### Check the system configuration and resources

Make sure the computer meets the minimum system requirements for the printer. For more information, see [System requirements](#).

#### Check the HP software settings

Print speed is slower when you select high print-quality settings. To increase the print speed, select different print settings in the printer driver. For more information, see [Print](#).

#### Check the ink cartridge levels

If a cartridge is completely out of ink, the printer may slow down to keep the printhead from overheating.

### Something on the page is missing or incorrect

#### Check the ink cartridges

Make sure the correct ink cartridges are installed and the ink cartridges are not low on ink. For more information, see [Check the estimated ink levels](#).

### Check the margin settings

Make sure the margin settings for the document do not exceed the printable area of the printer. For more information, see [Set minimum margins](#).

### Check the color print settings

Make sure **Print in Grayscale** is not selected in the printer driver.

### Check the printer location and length of USB cable

High electromagnetic fields (such as those generated by USB cables) can sometimes cause slight distortions to printouts. Move the printer away from the source of the electromagnetic fields. Also, it is recommended that you use a USB cable that is less than 3 meters (9.8 feet) long to minimize the effects of these electromagnetic fields.

## Print troubleshooting

Use this section to solve these printing problems:

- [Envelopes print incorrectly](#)
- [Borderless printing](#)
- [The printer is not responding or nothing happens when I try to print](#)
- [The printer prints meaningless characters](#)
- [Page order](#)
- [The margins are not printing as expected](#)
- [Text or graphics are cut off at the edge of the page](#)
- [A blank page came out while printing](#)
- [Paper is not picked up from the input tray](#)

### Envelopes print incorrectly

Try the following solutions to resolve the issue. Solutions are listed in order, with the most likely solution first. If the first solution does not solve the problem, continue trying the remaining solutions until the issue is resolved.

- [Solution 1: Load the stack of envelopes correctly](#)
- [Solution 2: Check the envelope type](#)
- [Solution 3: Tuck the flaps to avoid paper jams](#)

#### Solution 1: Load the stack of envelopes correctly

**Solution:** Load a stack of envelopes in the input tray according to the image below.

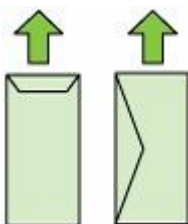

Make sure that you remove all paper from the input tray before loading the envelopes.

**Cause:** A stack of envelopes was loaded incorrectly.

If this did not solve the issue, try the next solution.

---

### **Solution 2: Check the envelope type**

**Solution:** Do not use shiny or embossed envelopes or envelopes that have clasps or windows.

**Cause:** The wrong type of envelope was loaded.

If this did not solve the issue, try the next solution.

---

### **Solution 3: Tuck the flaps to avoid paper jams**

**Solution:** To avoid paper jams, tuck the flaps inside the envelopes.

**Cause:** The flaps might get caught in the rollers.

---

## **Borderless printing**

- Borderless printing produces unexpected results

### **Borderless printing produces unexpected results**

**Solution:** Try printing the image from the photo imaging software that came with the printer.

**Cause:** Printing a borderless image from a non-HP software application produced unexpected results.

---

## **The printer is not responding or nothing happens when I try to print**

Try the following solutions to resolve the issue. Solutions are listed in order, with the most likely solution first. If the first solution does not solve the problem, continue trying the remaining solutions until the issue is resolved.

- Solution 1: Turn on the printer
- Solution 2: Load paper in the input tray
- Solution 3: Select the correct printer
- Solution 4: Check the printer driver status
- Solution 5: Wait until the printer completes the current operation
- Solution 6: Remove all cancelled print jobs from the queue
- Solution 7: Clear the paper jam
- Solution 8: Make sure the print carriage can move freely
- Solution 9: Check the connection from the printer to your computer
- Solution 10: Restart the printer



### **Solution 1: Turn on the printer**

**Solution:** Look at the **Power** light located on the printer. If it is not lit, the printer is turned off. Make sure the power cord is firmly connected to the printer and plugged into a power outlet. Press the **Power** button to turn on the printer.

**Cause:** The printer was turned off.

If this did not solve the issue, try the next solution.

---

### **Solution 2: Load paper in the input tray**

**Solution:** Load paper in the input tray.

For more information, see:

[Load media](#)

**Cause:** The printer was out of paper.

If this did not solve the issue, try the next solution.

---

### **Solution 3: Select the correct printer**

**Solution:** Make sure you have selected the correct printer in your software application.

 **TIP:** You can set the printer as the default printer to ensure that the printer is automatically selected when you select **Print** in the **File** menu of your different software applications.

---

**Cause:** The printer was not the selected printer.

If this did not solve the issue, try the next solution.

---

### **Solution 4: Check the printer driver status**

**Solution:** The printer driver status might have changed to either **offline** or **stop printing**.

**To check the printer driver status**

- **Windows:** In the HP printer software, click **Printer Actions**, and then click **See What's Printing**.
- **Mac OS:** Open **System Preferences**, and then click **Print & Fax**. Open the print queue for your printer.

**Cause:** The status of the printer driver had changed.

If this did not solve the issue, try the next solution.

---

### **Solution 5: Wait until the printer completes the current operation**

**Solution:** If the printer is performing another task your print job is delayed until the printer completes the current task.

Some documents take a long time to print. If nothing has printed several minutes after you sent a print job to the printer, check the printer's control panel to see if there are any errors.

**Cause:** The printer was busy with another task.

If this did not solve the issue, try the next solution.

---

### **Solution 6: Remove all cancelled print jobs from the queue**

**Solution:** A print job might remain in the queue after it has been cancelled. The cancelled print job jams the queue and prevents the next print job from printing.

From your computer, open the printer folder and see if the cancelled job remains in the print queue. Try to delete the job from the queue. If the print job remains in the queue, try one or both of the following:

- If the printer is connected with a USB cable, disconnect the cable from the printer, restart the computer, and then reconnect the USB cable to the printer.
- Shut down the printer, restart the computer, and then restart the printer.

**Cause:** A deleted print job was in the queue.

If this did not solve the issue, try the next solution.

---

### **Solution 7: Clear the paper jam**

**Solution:** Clear the paper jam and remove any torn paper that remains in the printer.

For more information, see:

[Clear jams](#)

**Cause:** The printer had a paper jam.

If this did not solve the issue, try the next solution.

---

### **Solution 8: Make sure the print carriage can move freely**

**Solution:** Unplug the power cable if it is not already unplugged. Check to see if the print carriage moves freely from one side of the printer to the other. Do not try to force it to move if it is hung up on something.

△ **CAUTION:** Be careful not to force the print carriage. If the carriage is stuck, forcing it to move damages the printer.

---

**Cause:** The print carriage had stalled.

If this did not solve the issue, try the next solution.

---

## **Solution 9: Check the connection from the printer to your computer**

**Solution:** Check the connection from the printer to your computer. Verify that the USB cable is securely plugged into the USB port on the back of the printer. Make sure the other end of the USB cable is plugged into a USB port on your computer. After the cable is connected, turn the printer off and then on again. If the printer is connected to the computer through a wired network, make sure that the respective connections are active and the printer is turned on.

If the connections are secure, and nothing has printed several minutes after you sent a print job to the printer, check the status of the printer.

To check the printer's status, complete the following steps:

### **Windows**

1. On the computer desktop, click **Start**, select **Settings**, and then click **Printers or Printers and Faxes**.  
- Or -  
Click **Start**, click **Control Panel**, and then double-click **Printers**.
2. If the printers on your computer are not being displayed in Details view, click the **View** menu, and then click **Details**.
3. Do one of the following, depending on the printer status:
  - a. If the printer is **Offline**, right-click the printer, and click **Use Printer Online**.
  - b. If the printer is **Paused**, right-click the printer, and click **Resume Printing**.
4. Try using the printer over the network.

### **Mac OS X**

1. Click **System Preferences** in the Dock, and then click **Print & Fax**.
2. Select the printer, and then click **Print Queue**.
3. If **Jobs Stopped** appears in the dialog box, click **Start Jobs**.

**Cause:** The computer was not communicating with the printer.

If this did not solve the issue, try the next solution.

---

## **Solution 10: Restart the printer**

### **Solution:**

1. Turn off the printer. For more information, see [Turn off the printer](#).
2. Unplug the power cord. Plug the power cord back in, and then press the **Power** button to turn on the printer.

**Cause:** The printer experienced an error.

---

## The printer prints meaningless characters

Try the following solutions to resolve the issue. Solutions are listed in order, with the most likely solution first. If the first solution does not solve the problem, continue trying the remaining solutions until the issue is resolved.

- [Solution 1: Restart the printer](#)
- [Solution 2: Print a previously saved version of the document](#)

### Solution 1: Restart the printer

**Solution:** Turn off the printer and your computer for 60 seconds, then turn them both on and try printing again. For more information, see [Turn off the printer](#).

**Cause:** There was no available memory in the printer.

If this did not solve the issue, try the next solution.

---

### Solution 2: Print a previously saved version of the document

**Solution:** Try printing another document from the same software application. If this works, then try printing a previously saved version of the document that is not corrupt.

**Cause:** The document was corrupt.

---

## Page order

Try the following solution to resolve the issue.

- [The pages in my document came out in the wrong order](#)

### The pages in my document came out in the wrong order

**Solution:** Print the document in reverse order. When the document finishes printing, the pages are in correct order.

**Cause:** The print settings were set to print the first page of your document first. Because of the way the paper feeds through the printer, the first page is print-side up at the bottom of the stack.

---

## The margins are not printing as expected

Try the following solutions to resolve the issue. Solutions are listed in order, with the most likely solution first. If the first solution does not solve the problem, continue trying the remaining solutions until the issue is resolved.

- [Solution 1: Check the printer margins](#)
- [Solution 2: Verify the paper size setting](#)
- [Solution 3: Load the stack of paper correctly](#)

### Solution 1: Check the printer margins

**Solution:** Check the printer margins.

Make sure the margin settings for the document do not exceed the printable area of the printer.

### To check your margin settings

1. Preview your print job before sending it to the printer.  
In most software applications, click the **File** menu, and then click **Print Preview**.
2. Check the margins.  
The printer uses the margins you have set in your software application, as long as they are greater than the minimum margins the printer supports. For more information about setting margins in your software application, see the documentation that came with the software.
3. Cancel the print job if the margins are not satisfactory, and then adjust the margins in your software application.

---

 **NOTE:** Margins for A3/11x17 pages, the margins on the top and bottom are larger than Letter-size pages.

---

**Cause:** The margins were not set correctly in your software application.

If this did not solve the issue, try the next solution.

---

### Solution 2: Verify the paper size setting

**Solution:** Verify that you have selected the correct paper size setting for your project. Make sure that you have loaded the correct paper size in the input tray.

**Cause:** The paper size setting might not have been set correctly for the project you were printing.

If this did not solve the issue, try the next solution.

---

### Solution 3: Load the stack of paper correctly

**Solution:** Remove the stack of paper from the input tray, reload the paper, and then slide the paper width guide inward until it stops at the edge of the paper.

For more information, see:

[Load media](#)

**Cause:** The paper guides were not positioned correctly.

---

### Text or graphics are cut off at the edge of the page

Try the following solutions to resolve the issue. Solutions are listed in order, with the most likely solution first. If the first solution does not solve the problem, continue trying the remaining solutions until the issue is resolved.

- [Solution 1: Check the margin settings](#)
- [Solution 2: Check the layout of the document](#)

- [Solution 3: Load the stack of papers correctly](#)
- [Solution 4: Try printing with borders](#)

### **Solution 1: Check the margin settings**

**Solution:** Check the printer margins.

Make sure the margin settings for the document do not exceed the printable area of the printer.

#### **To check your margin settings**

1. Preview your print job before sending it to the printer.  
In most software applications, click the **File** menu, and then click **Print Preview**.
2. Check the margins.  
The printer uses the margins you have set in your software application, as long as they are greater than the minimum margins the printer supports. For more information about setting margins in your software application, see the documentation that came with the software.
3. Cancel the print job if the margins are not satisfactory, and then adjust the margins in your software application.

**Cause:** The margins were not set correctly in your software application.

If this did not solve the issue, try the next solution.

---

### **Solution 2: Check the layout of the document**

**Solution:** Make sure the layout of the document you are trying to print fits on a paper size supported by the printer.

#### **To preview the print layout**

1. Load the correct paper size into the input tray.
2. Preview your print job before sending it to the printer.  
In most software applications, click the **File** menu, and then click **Print Preview**.
3. Check the graphics in the document to make sure that the current size fits within the printable area of the printer.
4. Cancel the print job if the graphics do not fit in the printable area of the page.

---

 **TIP:** Some software applications allow you to scale the document to fit the paper size currently selected. Additionally, you can scale the size of a document from the print **Properties** dialog box.

---

**Cause:** The size of the document you were printing was larger than the paper loaded in the input tray.

If this did not solve the issue, try the next solution.

---

### **Solution 3: Load the stack of papers correctly**

**Solution:** If the paper is misfeeding, it could cause parts of the document to cut off.

Remove the stack of paper from the input tray, and then reload the paper.

For more information, see:

[Load media](#)

**Cause:** The paper was loaded incorrectly.

If this did not solve the issue, try the next solution.

---

#### **Solution 4: Try printing with borders**

**Solution:** Try printing with borders by turning off the borderless option.

For more information, see:

[Print borderless documents](#)

**Cause:** Borderless printing was enabled. By selecting the **Borderless** option, your printed photo was enlarged and centered to fit the printable area of the page.

Depending on the relative sizes of the digital photo and the paper on which you are printing, this could result in some parts of the image being cropped.

---

### **A blank page came out while printing**

Try the following solutions to resolve the issue. Solutions are listed in order, with the most likely solution first. If the first solution does not solve the problem, continue trying the remaining solutions until the issue is resolved.

- [Solution 1: Remove any extra pages or lines at the end of the document](#)
- [Solution 2: Load paper in the input tray](#)
- [Solution 3: Check the ink levels](#)
- [Solution 4: Clean the printhead](#)
- [Solution 5: Load paper in the input tray](#)

#### **Solution 1: Remove any extra pages or lines at the end of the document**

**Solution:** Open the document file in your software application and remove any extra pages or lines at the end of the document.

**Cause:** The document you were printing contained an additional blank page.

If this did not solve the issue, try the next solution.

---

#### **Solution 2: Load paper in the input tray**

**Solution:** If the printer has only a few sheets remaining, load more paper in the input tray. If there is plenty of paper in the input tray, remove the paper, tap the stack of paper against a flat surface, and reload the paper into the input tray.

For more information, see:

[Load media](#)

**Cause:** The printer picked up two sheets of paper.

---

### Solution 3: Check the ink levels

**Solution:** The ink cartridges may be running low on ink.

**Cause:** Ink levels are too low.

---

### Solution 4: Clean the printhead

**Solution:** Complete the printhead cleaning procedure. For more information, see [Clean the printhead](#). The printhead may need to be cleaned if the printer was turned off incorrectly.

 **NOTE:** Turn off the printer by pressing the **Power** button located on the printer. Wait until the **Power** light turns off before unplugging the power cord or turning off a power strip. If you incorrectly turn off the printer, the print carriage might not return to the correct position causing problems with the ink cartridges and print quality issues.

---

**Cause:** The printhead was clogged.

---

### Solution 5: Load paper in the input tray

**Solution:** If the printer has only a few sheets remaining, load more paper in the input tray. If there is plenty of paper in the input tray, remove the paper, tap the stack of paper against a flat surface, and reload the paper into the input tray.

For more information, see:

[Load media](#)

**Cause:** The printer picked up two sheets of paper.

---

## Paper is not picked up from the input tray

Try the following solutions to resolve the issue. Solutions are listed in order, with the most likely solution first. If the first solution does not solve the problem, continue trying the remaining solutions until the issue is resolved.

- [Solution 1: Restart the printer](#)
- [Solution 2: Make sure the paper is loaded correctly](#)
- [Solution 3: Check the print settings](#)
- [Solution 4: Clean the rollers](#)
- [Solution 5: Check for a paper jam](#)
- [Solution 6: Service the printer](#)

### Solution 1: Restart the printer

**Solution:** Turn off the printer, and then unplug the power cord. Plug the power cord back in, and then press the **Power** button to turn on the printer.

**Cause:** The printer experienced an error.

If this did not solve the issue, try the next solution.

---



### **Solution 2: Make sure the paper is loaded correctly**

**Solution:** Make sure that the paper is loaded correctly in the input tray.

For more information, see:

[Load media](#)

**Cause:** The paper was not loaded correctly.

If this did not solve the issue, try the next solution.

---

### **Solution 3: Check the print settings**

**Solution:** Check the print settings.

- Check the paper type setting to make sure it matches the type of paper loaded in the input tray.
- Check the print quality setting and make sure it is not set too low.  
Print the image with a high print quality setting, such as **Best** or **Maximum dpi**.

**Cause:** The paper type or print quality settings were set incorrectly.

If this did not solve the issue, try the next solution.

---

### **Solution 4: Clean the rollers**

**Solution:** Clean the rollers.

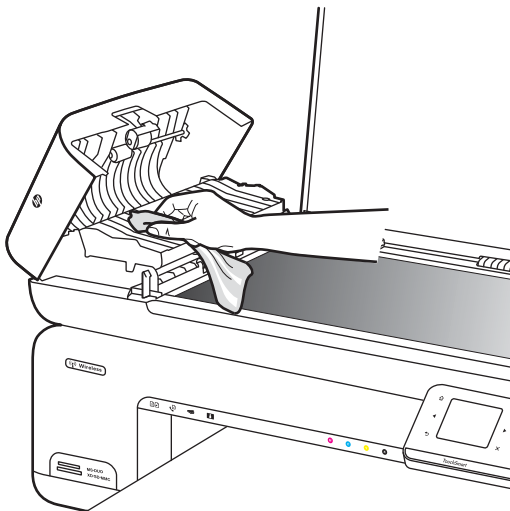

Make sure you have the following materials available:

- A lint-free cloth, or any soft material that will not come apart or leave fibers.
- Distilled, filtered, or bottled water (tap water might contain contaminants that can damage the ink cartridges).

**Cause:** The rollers were dirty and needed to be cleaned.

If this did not solve the issue, try the next solution.

---

### **Solution 5: Check for a paper jam**

**Solution:** Check for paper debris in the front of the printer. Remove any debris you find.

△ **CAUTION:** Trying to clear a paper jam from the front of the printer can damage the print mechanism. Always access and clear paper jams through the rear access panel.

**Cause:** Paper debris may be present, but not detected by the sensor.

---

### **Solution 6: Service the printer**

**Solution:** If you have completed all of the steps provided in the previous solutions, contact HP support for service.

Go to: [www.hp.com/support](http://www.hp.com/support).

If prompted, choose your country/region, and then click **Contact HP** for information on calling for technical support.

**Cause:** Your printer needs servicing.

---

## **Print quality troubleshooting**

Use this section to solve these print quality problems:

- [Wrong, inaccurate, or bleeding colors](#)
- [Ink is not filling the text or graphics completely](#)
- [The printout has a horizontal band of distortion near the bottom of a borderless print](#)
- [Printouts have horizontal streaks or lines](#)
- [Printouts are faded or have dull colors](#)
- [Printouts seem blurry or fuzzy](#)
- [Vertical streaks](#)
- [Printouts are slanted or skewed](#)
- [Ink streaks on the back of the paper](#)
- [Poor black text](#)
- [The printer prints slowly](#)
- [Printhead maintenance](#)

## Wrong, inaccurate, or bleeding colors

If your printout has one of the following print quality problems, try the solutions in this section for help.

- Colors look wrong  
For example, green was replaced with blue in your printout.
- Colors run into each other, or look like they are smeared on the page. The edges might have a feathering appearance instead of being sharp and defined.

Try the following solutions if the colors appear wrong, inaccurate, or bleed into each other.

- [Solution 1: Make sure you are using genuine HP ink cartridges](#)
- [Solution 2: Check the paper loaded in the input tray](#)
- [Solution 3: Check the paper type](#)
- [Solution 4: Check the ink levels](#)
- [Solution 5: Check the print settings](#)
- [Solution 6: Align the printhead](#)
- [Solution 7: Clean the printhead](#)
- [Solution 8: Contact HP support](#)

### Solution 1: Make sure you are using genuine HP ink cartridges

**Solution:** Check to see if your ink cartridges are genuine HP ink cartridges.

HP recommends that you use genuine HP ink cartridges. Genuine HP ink cartridges are designed and tested with HP printers to help you easily produce great results, time after time.

---

 **NOTE:** HP cannot guarantee the quality or reliability of non-HP supplies. Printer service or repairs required as a result of using a non-HP supply are not covered under warranty.

If you believe you purchased genuine HP ink cartridges, go to:

[www.hp.com/go/anticounterfeit](http://www.hp.com/go/anticounterfeit)

---

**Cause:** Non-HP ink cartridges were being used.

If this did not solve the issue, try the next solution.

---

### Solution 2: Check the paper loaded in the input tray

**Solution:** Make sure the paper is loaded correctly and that it is not wrinkled or too thick.

- Load paper with the side you want to print on facing down. For example, if you are loading glossy photo paper, load the paper with the glossy side down.
- Make sure the paper lays flat in the input tray and is not wrinkled. If the paper is too close to the printhead during printing, the ink might be smeared. This can happen if the paper is raised, wrinkled, or very thick, such as a mailing envelope.

For more information, see:

[Load media](#)

**Cause:** The paper was loaded incorrectly, or it was wrinkled or too thick.

If this did not solve the issue, try the next solution.

---

### **Solution 3: Check the paper type**

**Solution:** HP recommends that you use HP papers or any other paper type that is appropriate for the printer.

Always make sure the paper you are printing on is flat. For best results when printing images, use HP Advanced Photo Paper.

Store specialty media in its original packaging inside a resealable plastic bag on a flat surface in a cool, dry place. When you are ready to print, remove only the paper you plan to use immediately. When you have finished printing, return any unused photo paper to the plastic bag. This prevents the photo paper from curling.

---

 **NOTE:** For this issue, there is not a problem with your ink supplies. Therefore, replacing the ink cartridges or printhead is not necessary.

---

For more information, see:

[Select print media](#)

**Cause:** The wrong kind of paper was loaded in the input tray.

If this did not solve the issue, try the next solution.

---

### **Solution 4: Check the ink levels**

**Solution:** Check the estimated ink levels in the ink cartridges.

---

 **NOTE:** Ink level alerts and indicators provide estimates for planning purposes only. When you receive a low-ink alert, consider having a replacement cartridge available to avoid possible printing delays. You do not need to replace the ink cartridges until print quality becomes unacceptable.

---

For more information, see:

[Check the estimated ink levels](#)

**Cause:** The ink cartridges might have insufficient ink.

If this did not solve the issue, try the next solution.

---

## Solution 5: Check the print settings

**Solution:** Check the print settings.

- Check the print settings to see if the color settings are incorrect. For example, check to see if the document is set to print in grayscale. Or, check to see if advanced color settings such as saturation, brightness, or color tone, are set to modify the appearance of colors.
- Check the print quality setting and make sure it matches the type of paper loaded in the printer. You might need to choose a lower print quality setting if colors are running into each other. Or, choose a higher setting if you are printing a high-quality photo, and then make sure photo paper such as HP Advanced Photo Paper is loaded in the input tray.

---

 **NOTE:** On some computer screens, colors might appear differently than they do when printed on paper. In this case, there is nothing wrong with the printer, print settings, or ink cartridges. No further troubleshooting is required.

---

For more information, see:

[Select print media](#)

**Cause:** The print settings were set incorrectly.

If this did not solve the issue, try the next solution.

---

## Solution 6: Align the printhead

**Solution:** Align the printhead.

Aligning the printer can help ensure excellent print quality.

For more information, see:

[Align the printhead](#)

**Cause:** The printer needed to be aligned.

If this did not solve the issue, try the next solution.

---

## Solution 7: Clean the printhead

**Solution:** Check the following potential problems, and then clean the printhead.

- Check the orange pull tab on the ink cartridges. Make sure they were completely removed.
- Make sure all ink cartridges are correctly installed.
- Make sure you turn off the printer by using the **Power** button. This allows the printer to protect the printhead.

After cleaning the printhead, print a print quality report. Evaluate the print quality report to see if the print quality problem still exists.

For more information, see:

- [Printhead maintenance](#)
- [Print and evaluate a print quality report](#)

**Cause:** The printhead needed to be cleaned.

If this did not solve the issue, try the next solution.

---

### **Solution 8: Contact HP support**

**Solution:** Contact HP support for service.

Go to: [www.hp.com/support](http://www.hp.com/support).

If prompted, choose your country/region, and then click **Contact HP** for information on calling for technical support.

**Cause:** There was a problem with the printhead.

---

## **Ink is not filling the text or graphics completely**

Try the following solutions if the ink is not filling the text or image completely so that it appears that parts are missing or blank.

- [Solution 1: Make sure you are using genuine HP ink cartridges](#)
- [Solution 2: Check the ink levels](#)
- [Solution 3: Check the print settings](#)
- [Solution 4: Check the paper type](#)
- [Solution 5: Clean the printhead](#)
- [Solution 6: Contact HP support](#)

### **Solution 1: Make sure you are using genuine HP ink cartridges**

**Solution:** Check to see if your ink cartridges are genuine HP ink cartridges.

HP recommends that you use genuine HP ink cartridges. Genuine HP ink cartridges are designed and tested with HP printers to help you easily produce great results, time after time.

 **NOTE:** HP cannot guarantee the quality or reliability of non-HP supplies. Printer service or repairs required as a result of using a non-HP supply are not covered under warranty.

If you believe you purchased genuine HP ink cartridges, go to:

[www.hp.com/go/anticounterfeit](http://www.hp.com/go/anticounterfeit)

---

**Cause:** Non-HP ink cartridges were being used.

If this did not solve the issue, try the next solution.

---

## Solution 2: Check the ink levels

**Solution:** Check the estimated ink levels in the ink cartridges.

---

 **NOTE:** Ink level alerts and indicators provide estimates for planning purposes only. When you receive a low-ink alert, consider having a replacement cartridge available to avoid possible printing delays. You do not need to replace the ink cartridges until print quality becomes unacceptable.

---

For more information, see:

[Check the estimated ink levels](#)

**Cause:** The ink cartridges might have insufficient ink.

If this did not solve the issue, try the next solution.

---

## Solution 3: Check the print settings

**Solution:** Check the print settings.

- Check the paper type setting to make sure it matches the type of paper loaded in the input tray.
- Check the print quality setting and make sure it is not set too low. Print the image with a high print quality setting, such as **Best** or **Maximum dpi**.

**Cause:** The paper type or print quality settings were set incorrectly.

If this did not solve the issue, try the next solution.

---

## Solution 4: Check the paper type

**Solution:** HP recommends that you use HP papers or any other paper type that is appropriate for the printer.

Always make sure the paper you are printing on is flat. For best results when printing images, use HP Advanced Photo Paper.

Store specialty media in its original packaging inside a resealable plastic bag on a flat surface in a cool, dry place. When you are ready to print, remove only the paper you plan to use immediately. When you have finished printing, return any unused photo paper to the plastic bag. This prevents the photo paper from curling.

For more information, see:

[Select print media](#)

**Cause:** The wrong kind of paper was loaded in the input tray.

If this did not solve the issue, try the next solution.

---

## Solution 5: Clean the printhead

**Solution:** If the previous solutions did not resolve the issue, try cleaning the printhead.

After cleaning the printhead, print a print quality report. Evaluate the print quality report to see if the print quality problem still exists.

For more information, see:

- [Printhead maintenance](#)
- [Print and evaluate a print quality report](#)

**Cause:** The printhead needed to be cleaned.

If this did not solve the issue, try the next solution.

---

### **Solution 6: Contact HP support**

**Solution:** Contact HP support for service.

Go to: [www.hp.com/support](http://www.hp.com/support).

If prompted, choose your country/region, and then click **Contact HP** for information on calling for technical support.

**Cause:** There was a problem with the printhead.

---

## **The printout has a horizontal band of distortion near the bottom of a borderless print**

Try the following solutions if your borderless print has a blurry band or line on the bottom of it.

 **NOTE:** For this issue, there is not a problem with your ink supplies. Therefore, replacing the ink cartridges or printhead is not necessary.

---

- [Solution 1: Check the paper type](#)
- [Solution 2: Use a higher print quality setting](#)
- [Solution 3: Rotate the image](#)

### **Solution 1: Check the paper type**

**Solution:** HP recommends that you use HP papers or any other paper type that is appropriate for the printer.

Always make sure the paper you are printing on is flat. For best results when printing images, use HP Advanced Photo Paper.

Store photo media in its original packaging inside a resealable plastic bag on a flat surface in a cool, dry place. When you are ready to print, remove only the paper you plan to use immediately. When you have finished printing, return any unused photo paper to the plastic bag. This prevents the photo paper from curling.

For more information, see:

[Select print media](#)

**Cause:** The wrong kind of paper was loaded in the input tray.

If this did not solve the issue, try the next solution.

---



### **Solution 2: Use a higher print quality setting**

**Solution:** Check the print quality setting and make sure it is not set too low.  
Print the image with a high print quality setting, such as **Best** or **Maximum dpi**.

**Cause:** The print quality setting was set too low.  
If this did not solve the issue, try the next solution.

---

### **Solution 3: Rotate the image**

**Solution:** If the problem persists, use the HP software or another software application to rotate your image 180 degrees so that the light blue, gray, or brown hues in your image do not print at the bottom of the page.

**Cause:** The defect is more noticeable in areas of uniform light colors, so rotating the image may help.

---

## **Printouts have horizontal streaks or lines**

Horizontal streaks are streaks that are at right angles (or perpendicular) to the direction that the paper moved through the printer.

Try the following solutions if your printout has lines, streaks, or marks on it that run across the width of the page.

- [Solution 1: Make sure the paper is loaded correctly](#)
- [Solution 2: Check your print settings](#)
- [Solution 3: Check the ink levels](#)
- [Solution 4: Align the printhead](#)
- [Solution 5: Clean the printhead](#)
- [Solution 6: Contact HP support](#)

### **Solution 1: Make sure the paper is loaded correctly**

**Solution:** Make sure that the paper is loaded correctly in the input tray.

For more information, see:

[Load media](#)

**Cause:** The paper was not loaded correctly.  
If this did not solve the issue, try the next solution.

---

### **Solution 2: Check your print settings**

**Solution:** Check the print quality setting and make sure it is not set too low.  
Print the image with a high print quality setting, such as **Best** or **Maximum dpi**.

Check the media settings. Make sure the media selected matches the media loaded in the printer.

**Cause:** The print quality setting on the printer was set too low.

If this did not solve the issue, try the next solution.

---

### **Solution 3: Check the ink levels**

**Solution:** Check the estimated ink levels in the ink cartridges.

 **NOTE:** Ink level alerts and indicators provide estimates for planning purposes only. When you receive a low-ink alert, consider having a replacement cartridge available to avoid possible printing delays. You do not need to replace the ink cartridges until print quality becomes unacceptable.

---

For more information, see:

[Check the estimated ink levels](#)

**Cause:** The ink cartridges might have insufficient ink.

If this did not solve the issue, try the next solution.

---

### **Solution 4: Align the printhead**

**Solution:** Align the printhead.

Aligning the printer can help ensure excellent print quality.

For more information, see:

[Align the printhead](#)

**Cause:** The printer needed to be aligned.

If this did not solve the issue, try the next solution.

---

### **Solution 5: Clean the printhead**

**Solution:** Check the following potential problems, and then clean the printhead.

After cleaning the printhead, print a print quality report. Evaluate the print quality report to see if the print quality problem still exists.

For more information, see:

- [Printhead maintenance](#)
- [Print and evaluate a print quality report](#)

**Cause:** The printhead needed to be cleaned.

If this did not solve the issue, try the next solution.

---

### **Solution 6: Contact HP support**

**Solution:** Contact HP support for service.

Go to: [www.hp.com/support](http://www.hp.com/support).

If prompted, choose your country/region, and then click **Contact HP** for information on calling for technical support.

**Cause:** There was a problem with the printhead.

---

## Printouts are faded or have dull colors

Try the following solutions if the colors in your printout are not as bright and intense as you expected.

- [Solution 1: Check the print settings](#)
- [Solution 2: Check the paper type](#)
- [Solution 3: Check the ink levels](#)
- [Solution 4: Clean the printhead](#)
- [Solution 5: Contact HP support](#)

### Solution 1: Check the print settings

**Solution:** Check the print settings.

- Check the paper type setting to make sure it matches the type of paper loaded in the input tray.
- Check the print quality setting and make sure it is not set too low.  
Print the image with a high print quality setting, such as **Best** or **Maximum dpi**.

**Cause:** The paper type or print quality settings were set incorrectly.

If this did not solve the issue, try the next solution.

---

### Solution 2: Check the paper type

**Solution:** HP recommends that you use HP papers or any other paper type that is appropriate for the printer.

Always make sure the paper you are printing on is flat. For best results when printing images, use HP Advanced Photo Paper.

Store specialty media in its original packaging inside a resealable plastic bag on a flat surface in a cool, dry place. When you are ready to print, remove only the paper you plan to use immediately. When you have finished printing, return any unused photo paper to the plastic bag. This prevents the photo paper from curling.

For more information, see:

[Select print media](#)

**Cause:** The wrong kind of paper was loaded in the input tray.

If this did not solve the issue, try the next solution.

---

### Solution 3: Check the ink levels

**Solution:** Check the estimated ink levels in the ink cartridges.

---

 **NOTE:** Ink level alerts and indicators provide estimates for planning purposes only. When you receive a low-ink alert, consider having a replacement cartridge available to avoid possible printing delays. You do not need to replace the ink cartridges until print quality becomes unacceptable.

---

For more information, see:

[Check the estimated ink levels](#)

**Cause:** The ink cartridges might have insufficient ink.

If this did not solve the issue, try the next solution.

---

#### **Solution 4: Clean the printhead**

**Solution:** If the previous solutions did not resolve the issue, try cleaning the printhead.

After cleaning the printhead, print a print quality report. Evaluate the print quality report to see if the print quality problem still exists.

For more information, see:

- [Printhead maintenance](#)
- [Print and evaluate a print quality report](#)

**Cause:** The printhead needed to be cleaned.

If this did not solve the issue, try the next solution.

---

#### **Solution 5: Contact HP support**

**Solution:** Contact HP support for service.

Go to: [www.hp.com/support](http://www.hp.com/support).

If prompted, choose your country/region, and then click **Contact HP** for information on calling for technical support.

**Cause:** There was a problem with the printhead.

---

### **Printouts seem blurry or fuzzy**

Try the following solutions if your printout is not sharp or unclear.

---

 **NOTE:** For this issue, there is not a problem with your ink supplies. Therefore, replacing the ink cartridges or printhead is not necessary.

 **TIP:** After reviewing the solutions in this section, you can go to HP's Web site to see if there is additional troubleshooting help. For more information, go to: [www.hp.com/support](http://www.hp.com/support).

---

- [Solution 1: Check the print settings](#)
- [Solution 2: Use a higher quality image](#)

- [Solution 3: Print the image in a smaller size](#)
- [Solution 4: Align the printhead](#)

### **Solution 1: Check the print settings**

**Solution:** Check the print settings.

- Check the paper type setting to make sure it matches the type of paper loaded in the input tray.
- Check the print quality setting and make sure it is not set too low.  
Print the image with a high print quality setting, such as **Best** or **Maximum dpi**.

**Cause:** The paper type or print quality settings were set incorrectly.

If this did not solve the issue, try the next solution.

---

### **Solution 2: Use a higher quality image**

**Solution:** Use a higher resolution image.

If you print a photo or graphic and the resolution is too low, it appears blurry or fuzzy when printed.

If a digital photo or rasterized graphic has been resized, it might be blurry or fuzzy when printed.

**Cause:** The resolution of the image was low.

If this did not solve the issue, try the next solution.

---

### **Solution 3: Print the image in a smaller size**

**Solution:** Reduce the size of the image and then print it.

If you are printing a photo or graphic, and the print size is set too high, it appears blurry or fuzzy when printed.

If a digital photo or rasterized graphic has been resized, it can be blurry or fuzzy when printed.

**Cause:** The image was printed in a larger size.

If this did not solve the issue, try the next solution.

---

### **Solution 4: Align the printhead**

**Solution:** Align the printhead.

Aligning the printer can help ensure excellent print quality.

For more information, see:

[Align the printhead](#)

**Cause:** The printer needed to be aligned.

---

## Vertical streaks

- [Printouts have vertical streaks](#)

### Printouts have vertical streaks

Vertical Streaks are streaks that are parallel to the direction that the paper moved through the printer.

**Solution:** HP recommends that you use HP papers or any other paper type that is appropriate for the printer.

Always make sure the paper you are printing on is flat. For best results when printing images, use HP Advanced Photo Paper.

Store specialty media in its original packaging inside a resealable plastic bag on a flat surface in a cool, dry place. When you are ready to print, remove only the paper you plan to use immediately. When you have finished printing, return any unused photo paper to the plastic bag. This prevents the photo paper from curling.

---

 **NOTE:** For this issue, there is not a problem with your ink supplies. Therefore, replacing the ink cartridges or printhead is not necessary.

---

For more information, see:

[Select print media](#)

**Cause:** The wrong kind of paper was loaded in the input tray.

---

## Printouts are slanted or skewed

Try the following solutions if your printout does not appear straight on the page.

- [Solution 1: Make sure the paper is loaded correctly](#)
- [Solution 2: Make sure only one type of paper is loaded](#)
- [Solution 3: Ensure that the rear access panel is securely installed](#)

### Solution 1: Make sure the paper is loaded correctly

**Solution:** Make sure that the paper is loaded correctly in the input tray.

For more information, see:

[Load media](#)

**Cause:** The paper was not loaded correctly.

If this did not solve the issue, try the next solution.

---

### Solution 2: Make sure only one type of paper is loaded

**Solution:** Load only one type of paper at a time.

**Cause:** More than one type of paper was loaded in the input tray.

If this did not solve the issue, try the next solution.

---

### **Solution 3: Ensure that the rear access panel is securely installed**

**Solution:** Make sure that the rear door is securely installed.

If you removed the rear door to clear a paper jam, replace it. Gently push the door forward until it snaps into place.

**Cause:** The rear door was not securely installed.

---

## **Ink streaks on the back of the paper**

Try the following solutions if there is smeared ink on the back of your printout.

- [Solution 1: Print on a page of plain paper](#)
- [Solution 2: Wait while the ink dries](#)

### **Solution 1: Print on a page of plain paper**

**Solution:** Print one or several pages of plain paper to soak up any excess ink in the printer.

#### **To remove excess ink using plain paper**

1. Load several sheets of plain paper in the input tray.
2. Wait five minutes.
3. Print a document with little or no text.
4. Check the back of the paper for ink. If there is still ink on the back of the paper, try printing on another page of plain paper.

**Cause:** Ink accumulated inside the printer, where the back of the paper rests during printing.

If this did not solve the issue, try the next solution.

---

### **Solution 2: Wait while the ink dries**

**Solution:** Wait at least thirty minutes for the ink inside the printer to dry, then try the print job again.

**Cause:** The excess ink in the printer needed to dry out.

---

## **Poor black text**

Try the following solutions if the text in your printouts is not sharp and the edges are rough.

- [Solution 1: Wait before you attempt to reprint](#)
- [Solution 2: Use TrueType or OpenType fonts](#)
- [Solution 3: Align the printhead](#)
- [Solution 4: Clean the printhead](#)

### **Solution 1: Wait before you attempt to reprint**

**Solution:** If the black cartridge is new, allow time for automatic servicing to clear up the problem. Black print quality should start to improve in a few hours. If you do

not have time to wait, you can clean the printhead, but this uses more ink, and the poor black text may reoccur until automatic servicing is allowed to complete.

**Cause:** Many black print quality problems clear up when the automatic services are performed.

---

### **Solution 2: Use TrueType or OpenType fonts**

**Solution:** Use TrueType or OpenType fonts to ensure that the printer is able to print smooth fonts. When selecting a font, look for the TrueType or OpenType icon.



TrueType icon



OpenType icon

---

**Cause:** The font was a custom size.

Some software applications offer custom fonts that have jagged edges when enlarged or printed. Also, if you want to print bitmapped text, it might have jagged edges when enlarged or printed.

If this did not solve the issue, try the next solution.

---

### **Solution 3: Align the printhead**

**Solution:** Align the printhead.

Aligning the printer can help ensure excellent print quality.

For more information, see:

[Align the printhead](#)

**Cause:** The printer needed to be aligned.

If this did not solve the issue, try the next solution.

---

### **Solution 4: Clean the printhead**

**Solution:** If the previous solutions did not resolve the issue, try cleaning the printhead.

After cleaning the printhead, print a print quality report. Evaluate the print quality report to see if the print quality problem still exists.

For more information, see:

- [Printhead maintenance](#)
- [Print and evaluate a print quality report](#)

**Cause:** The printhead needed to be cleaned.

---



## The printer prints slowly

Try the following solutions if the printer is printing very slowly.

- [Solution 1: Use a lower print quality setting](#)
- [Solution 2: Check the ink levels](#)
- [Solution 3: Contact HP support](#)

### Solution 1: Use a lower print quality setting

**Solution:** Check the print quality setting. **Best** and **Maximum dpi** provide the best quality but are slower than **Normal** or **Draft**. **Draft** provides the fastest print speed.

**Cause:** The print quality was set to a high setting.

If this did not solve the issue, try the next solution.

---

### Solution 2: Check the ink levels

**Solution:** Check the estimated ink levels in the ink cartridges.

 **NOTE:** Ink level alerts and indicators provide estimates for planning purposes only. When you receive a low-ink alert, consider having a replacement cartridge available to avoid possible printing delays. You do not need to replace the ink cartridges until print quality becomes unacceptable.

---

For more information, see:

[Check the estimated ink levels](#)

**Cause:** The ink cartridges might have insufficient ink. Insufficient ink may cause the printhead to overheat. When the printhead overheats, the printer slows down to allow it to cool.

If this did not solve the issue, try the next solution.

---

### Solution 3: Contact HP support

**Solution:** Contact HP support for service.

Go to: [www.hp.com/support](http://www.hp.com/support).

If prompted, choose your country/region, and then click **Contact HP** for information on calling for technical support.

**Cause:** There was a problem with the printer.

---

## Printhead maintenance

If you are experiencing problems with printing, you might have a problem with the printhead. You should perform the procedures in the following sections only when directed to do so for resolving print quality issues.

Performing the aligning and cleaning procedures unnecessarily can waste ink and shorten the life of the cartridges.

This section contains the following topics:

- [Clean the printhead](#)
- [Align the printhead](#)
- [Print and evaluate a print quality report](#)
- [Advanced printhead maintenance](#)
- [Advanced ink cartridge maintenance](#)

### Clean the printhead

If your printed output is streaked or has any incorrect or missing colors, the printhead might need to be cleaned.

There are two stages of cleaning. Each stage lasts about two minutes, uses one sheet of paper, and uses an increasing amount of ink. After each stage, review the quality of the printed page. You should only initiate the next phase of cleaning if the print quality is poor.

If print quality still seems poor after you complete both stages of cleaning, try aligning the printer. If print quality problems persist after cleaning and aligning, contact HP support.

---

 **NOTE:** Cleaning uses ink, so clean the printheads only when necessary. The cleaning process takes a few minutes. Some noise might be generated in the process. Before cleaning the printheads, make sure you load paper. For more information, see [Load media](#).

Not turning the printer off correctly can cause print quality problems. For more information, see [Turn off the printer](#).

---

### To clean the printhead from the control panel

1. Load letter, A4, or legal unused plain white paper into the main input tray.
2. Touch right arrow , and then select **Setup**.
3. Touch **Tools**, and then select **Clean Printhead**.

### Align the printhead

The printer automatically aligns the printhead during the initial setup.

You might want to use this feature when the printer status page shows streaking or white lines through any of the blocks of color or if you are having print quality issues with your printouts.

### To align the printhead from the control panel

1. Load letter, A4, or legal unused plain white paper into the main input tray.
2. On the printer control panel, touch right arrow , and then touch **Setup**.
3. Touch **Tools**, and then select **Align Printer**.

### Print and evaluate a print quality report

Print quality problems can have many causes: software settings, a poor image file, or the printing system itself. If you are unhappy with the quality of your prints, a Print Quality Diagnostic page can help you determine if the printing system is working correctly.

This section includes the following topics:

- [To print a print quality report](#)
- [To evaluate the Print Quality Diagnostic Page](#)

### To print a print quality report

**Control panel:** Touch **Setup**, select **Print Report**, select **Printer Status** or **Self-Test**, and then click **OK**



### To evaluate the Print Quality Diagnostic Page

This section includes the following topics:

- [Ink Levels](#)
- [Good color bars](#)
- [Ragged, irregularly streaked, or faded bars](#)
- [Regular white streaks in the bars](#)
- [Bar colors are not uniform](#)
- [Large Black Font Text](#)
- [Alignment Patterns](#)
- [If you see no defects](#)

### Ink Levels



- ▲ Look at the Ink Level indicators in Line 21. If any of the bar level indicators are low, you may need to replace that ink cartridge.

**NOTE:** Ink level warnings and indicators provide estimates for planning purposes only. When you receive an ink alert message, consider having a replacement cartridge available to avoid possible printing delays. You do not need to replace cartridges until print quality becomes unacceptable.

### Good color bars



Example of Good Color Bars	All seven bars are solid, sharp-edged, and extend with uniform color all the way across the page - the printer is operating correctly.
----------------------------	--

- ▲ Look at the color bars in the middle of the page. There should be seven color bars. The color bars should have sharp edges. They should be solid (not streaked with white or other colors). They should be uniform in color throughout. The bars correspond to the ink cartridges in the printer as follows:

Item	Cartridge color
1	Black Ink Cartridge
2	Cyan Ink Cartridge
3	Magenta Ink Cartridge
4	Yellow Ink Cartridge

## Ragged, irregularly streaked, or faded bars



Example of Bad Color Bars	The top bar is irregularly streaked or fading.
---------------------------	--



Example of Bad Color Bars	The top black bar is ragged on one end.
---------------------------	---

If any of the bars are ragged, irregularly streaked, or faded, follow these steps:

1. Make sure the ink cartridges have ink.
2. Remove the cartridge corresponding to the streaked bar and make sure it is correctly vented. For more information, see [Replace the ink cartridges](#).
3. Reinstall the cartridge and make sure all the cartridges are correctly latched. For more information, see [Replace the ink cartridges](#).
4. Clean the printhead. For more information, see [Clean the printhead](#).
5. Try another print or reprint the Print Quality Diagnostic report. If the problem still occurs, but cleaning seems to have helped, clean again.
6. If cleaning does not solve the problem, replace the cartridge that corresponds to the ragged bar.
7. If replacing the ink cartridge does not help, contact HP - the printhead may need to be replaced.

### Preventing the problem that causes ragged bars on the Print Quality Diagnostic report:

- Avoid leaving opened ink cartridges outside of the printer for an extended period of time.
- Wait until a new cartridge is ready to be installed before removing an old ink cartridge.

### Regular white streaks in the bars

If any of the color bars show regular white streaks, follow these steps:



White streaks	The print quality bars have white streaks in them.
---------------	--

1. If the Print Quality Diagnostic report reads **PHA TTOE = 0**, align the printer. For more information, see [Align the printhead](#).
2. "If PHA TTOE is not 0," or aligning does not help, clean the printhead. For more information, see [Clean the printhead](#).
3. Print another Print Quality Diagnostic report. If the streaking is still there, but seems better, try another cleaning. If the streaking gets worse, contact HP - the printhead may need to be replaced.

### Bar colors are not uniform



Print quality bars are not uniform	The bars have lighter or darker portions in them.
------------------------------------	---

If the color of any of the bars is not uniform, follow these steps:

1. If the printer was recently transported at a high altitude, try a printhead cleaning.
2. If the printer was not recently transported, try printing another Print Quality Diagnostic report. This uses less ink than a printhead cleaning, but if it is not effective, try a cleaning.
3. Retry the Print Quality Diagnostic report. If the colors seem to be improving, continue cleaning. If the colors get worse, contact HP - the printhead may need to be replaced.

## Large Black Font Text

Look at the large-font text above the color blocks. **I ABCDEFG abcdefg** The type should be sharp and clear. If the type is jagged, try aligning the printer. If there are streaks or smears of ink, clean the printhead.

I ABCDEFG abcdefg

Example of good Large-Font Type	The letters are sharp and clear - the printer is operating correctly.
---------------------------------	---

I ABCDEFG abcdefg

Example of bad Large-Font Type	The letters are jagged - align the printer.
--------------------------------	---

I ABCDEFG abcdefg

Example of bad Large-Font Type	The letters are smeared - clean the printhead and check if the paper is curled. To avoid curl, store all paper flat in a resealable bag.
--------------------------------	--

I ABCDEFG abcdefg

Example of bad Large-Font Type	The letters are ragged on one end - clean the printhead. If this defect occurs right after a new black cartridge is installed, the printer's automatic servicing routines may solve the problem in a day or so, using less ink than a printhead cleaning.
--------------------------------	---

## Alignment Patterns

If the color bars and large font text look OK, and the ink cartridges are not empty, look at the alignment pattern directly above the color bars.

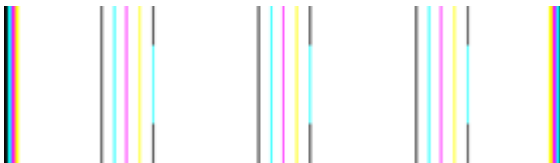

Example of a good alignment pattern	The lines are straight.
-------------------------------------	-------------------------

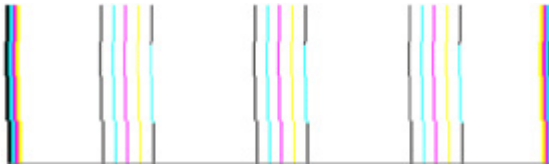

---

Examples of a bad alignment pattern	The lines are jagged - align the printer. If that does not work, contact HP.
-------------------------------------	--

---

### If you see no defects

If you do not see any defects on the print quality report, then the printing system is working correctly. There is no reason to replace supplies or have the printer serviced, because they are functioning correctly. If you still have a print quality problem, here are some other things you can check:

- Check the paper.
- Check the print settings.
- Make sure your image has sufficient resolution.
- If the problem seems confined to a band near the edge of your printout, use the HP software or another software application to rotate the image 180 degrees. The problem might not appear on the other end of the print.

### Advanced printhead maintenance

---

**⚠ WARNING!** Only reinstall the printhead as part of the procedure for **Printhead Problem** error messages

---

#### To reinstall the printhead

1. Make sure that the printer is turned on.
2. Open the ink cartridge door.

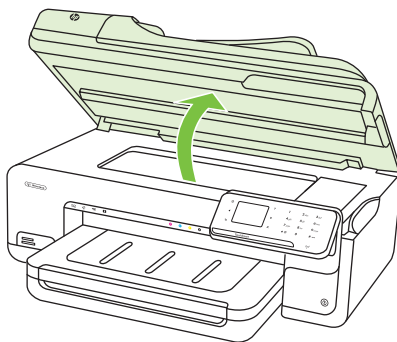



3. Remove all of the ink cartridges and place them on a piece of paper with the ink opening pointing up.

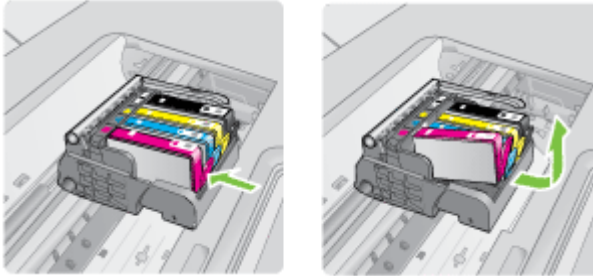

4. Lift the latch handle on the print carriage.



5. Remove the printhead by lifting it straight up.

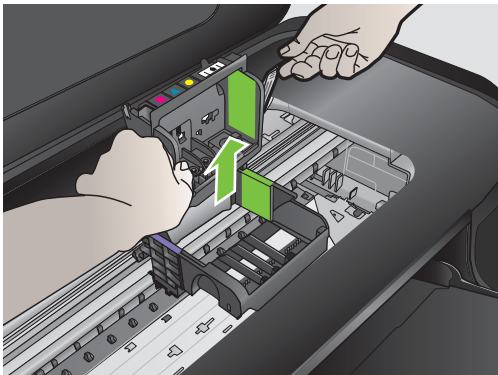

6. Clean the printhead.

There are three areas of the printhead that need to be cleaned: the plastic ramps on both sides of the ink nozzles, the edge between the nozzles and the electrical contacts, and the electrical contacts.

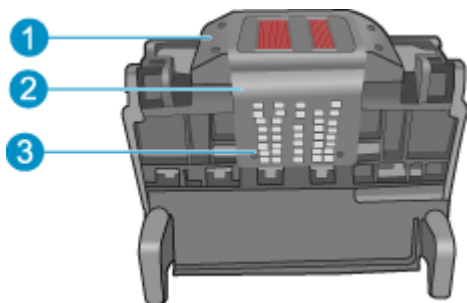

1	Plastic ramps on the sides of the nozzles
2	Edge between nozzles and contacts
3	Electrical contacts

△ **CAUTION:** Touch the nozzle and the electrical contact areas **only** with cleaning materials and not with your finger.

**To clean the printhead**

- a. Lightly dampen a clean, lint-free cloth and wipe the electrical contact area from the bottom to the top. Do not go past the edge between the nozzles and the electrical contacts. Clean until no new ink shows on the cloth.

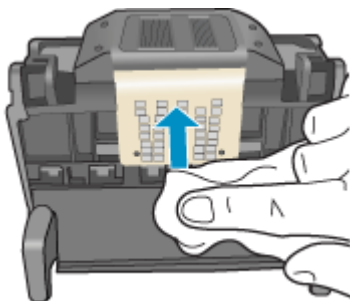

- b.** Use a fresh, lightly dampened, lint-free cloth to wipe any accumulated ink and debris from the edge between the nozzles and the contacts.

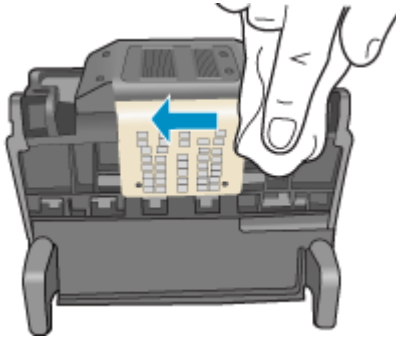

- c.** Use a fresh, lightly dampened, lint-free cloth to wipe the plastic ramps on both sides of the nozzles. Wipe away from the nozzles.

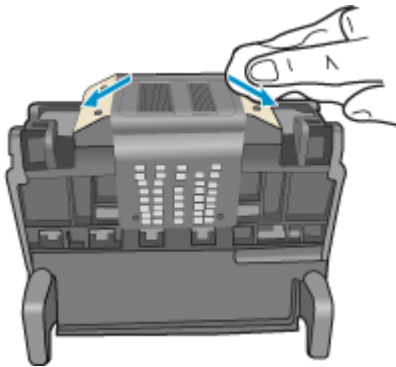

- d.** Wipe the previously cleaned areas dry with a dry lint-free cloth before proceeding to the next step.

7. Clean the electrical contacts inside the printer.

**To clean the electrical contacts in the printer**

- a. Lightly dampen a clean, lint-free cloth with bottled or distilled water.
- b. Clean the electrical contacts in the printer by wiping with the cloth from top to bottom. Use as many fresh, clean cloths as necessary. Clean until no ink shows on the cloth.

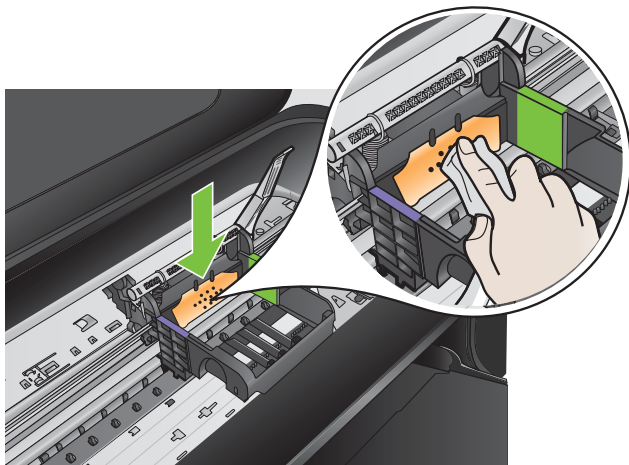

- c. Wipe the area dry with a dry lint-free cloth before proceeding to the next step.
8. Make sure the latch handle is raised, and then reinsert the printhead.

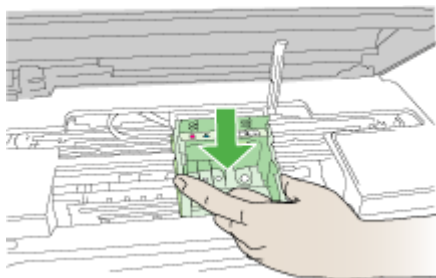

9. Carefully lower the latch handle.

---

 **NOTE:** Make sure you lower the latch handle before reinserting the ink cartridges. Leaving the latch handle raised can result in incorrectly seated ink cartridges and problems printing. The latch must remain down in order to correctly install the ink cartridges.

---

10. Using the colored shaped icons for help, slide the ink cartridge into the empty slot until it clicks into place and is seated firmly in the slot.

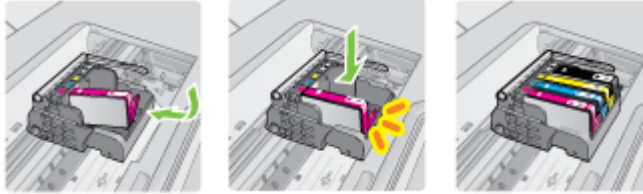

11. Close the ink cartridge door.

### Advanced ink cartridge maintenance

This section contains the following topics:

- Clean the sensor windows on the ink cartridges

#### Clean the sensor windows on the ink cartridges

If the problem is not resolved, printing can continue, but the ink system behavior might change.

- 
- △ **CAUTION:** The cleaning procedure should take only a few minutes. Make sure that the ink cartridges are reinstalled in the printer when instructed. Leaving them outside of the printer for an extended period of time can result in damage to the ink cartridges.
- 

#### To clean the sensor window on the ink cartridges

1. Gather swabs or a lint-free cloth to use for the cleaning procedure.
2. Make sure the printer is turned on.
3. Open the ink cartridge access door by lifting from the front right of the printer, until the door locks into place.

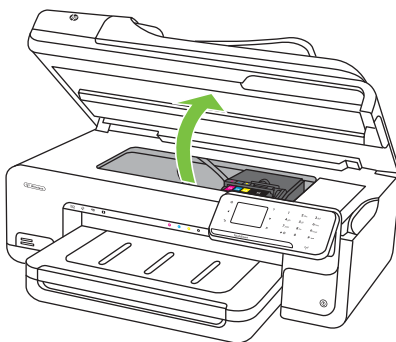

The print carriage moves to the center of the printer.

---

 **NOTE:** Wait until the print carriage stops moving before proceeding.

---

4. Remove all of the ink cartridges and place them on a piece of paper with the ink openings pointing up.

**To remove the ink cartridges**

- a. Press the tab on the ink cartridge to release it, and then remove it from the slot.

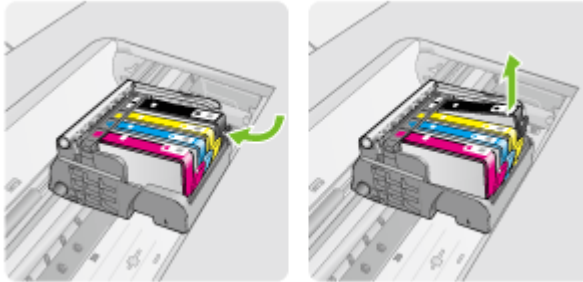

- b. Place the ink cartridge on a sheet of paper with the ink opening pointing up.

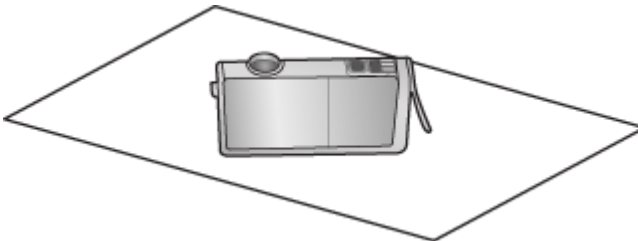

- c. Repeat steps a and b for each ink cartridge.
5. For each ink cartridge, wipe the sensor window with a dry swab or lint-free cloth. The sensor window is an area of clear plastic near the copper or gold-colored metal contacts on the bottom of the ink cartridge. Try not to touch the metal contacts.

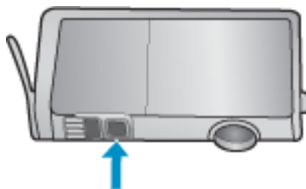

6. Install each ink cartridge in its slot. Press it down until the tab snaps into place. Match the color and icon on each ink cartridge label to the color and icon on the slot for that ink cartridge.

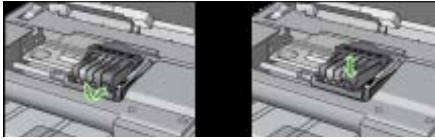

7. Close the ink cartridge access door, and check if the error has been resolved.
8. If you still receive the error message, turn the printer off, and then on again.

## Solve paper-feed problems

### **Media is not supported for the printer or tray**

Use only media that is supported for the printer and the tray being used. For more information, see [Media specifications](#).

### **Media is not picked up from a tray**

- Make sure media is loaded in the tray. For more information, see [Load media](#). Fan the media before loading.
- Make sure the paper guides are set to the correct markings in the tray for the media size you are loading. Also make sure the guides are snug, but not tight, against the stack.
- Make sure media in the tray is not curled. Uncurl paper by bending it in the opposite direction of the curl.
- When using thin special media, make sure that the tray is completely loaded. If you are using special media that is only available in small quantities, try placing the special media on top of other paper of the same size to help fill the tray. (Some media is picked up more easily if the tray is full.)
- If you are using thick special media (such as brochure paper), load media so that the tray is between 1/4 and 3/4 full. If necessary, place the media on top of other paper of the same size so that the stack height is within this range.

**Media is not coming out correctly**

- Make sure the output tray extender is fully extended; otherwise, printed pages may fall off the printer.

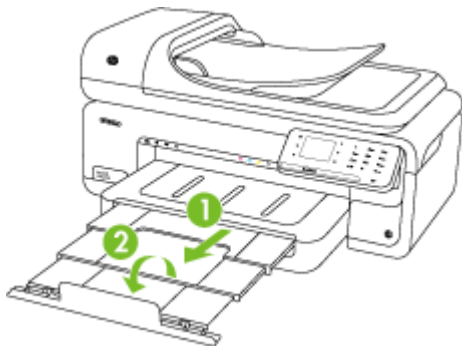

---

 **NOTE:** When printing documents larger than A3/11 x 17 inches, extend the output tray extender all the way and tilt the paper stopper.

---

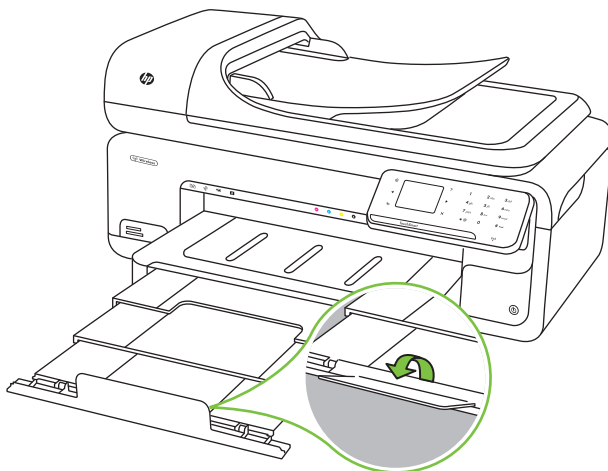

- Remove excess media from the output tray. There is a limit to the number of sheets the tray can hold.

**Pages are skewing**

- Make sure the media loaded in the trays is aligned to the paper guides. If needed, pull out the trays from the printer and reload the media correctly, making sure that the paper guides are correctly aligned.
- Load media into the printer only when it is not printing.



### Multiple pages are being picked up

- Fan the media before loading.
- Make sure the paper guides are set to the correct markings in the tray for the media size you are loading. Also make sure the guides are snug, but not tight, against the stack.
- Make sure the tray is not overloaded with paper.
- When using thin special media, make sure that the tray is completely loaded. If you are using special media that is only available in small quantities, try placing the special media on top of other paper of the same size to help fill the tray. (Some media is picked up more easily if the tray is full.)
- If you are using thick special media (such as brochure paper), load media so that the tray is between 1/4 and 3/4 full. If necessary, place the media on top of other paper of the same size so that the stack height is within this range.
- Use HP media for optimum performance and efficiency.

## Solve copy problems

If the following topics do not help, see [HP support](#) for information about HP support.

- [No copy came out](#)
- [Copies are blank](#)
- [Documents are missing or faded](#)
- [Size is reduced](#)
- [Copy quality is poor](#)
- [Copy defects are apparent](#)
- [The printer prints half a page, then ejects the paper](#)
- [Paper mismatch](#)
- [Copy A3/11x17 animation did not display](#)

### No copy came out

- **Check the power**  
Make sure that the power cord is securely connected, and the printer turned on.
- **Check the status of the printer**
  - The printer might be busy with another job. Check the control-panel display for information about the status of jobs. Wait for any job that is processing to finish.
  - The printer might be jammed. Check for jams. See [Clear paper jams](#).
- **Check the trays**  
Make sure that media is loaded. See [Load media](#) for more information.

## Copies are blank

- **Check the media**

The media might not meet Hewlett-Packard media specifications (for example, the media is too moist or too rough). See [Media specifications](#) for more information.
- **Check the settings**

The contrast setting might be set too light. On the printer control panel, touch **Copy**, touch **Lighter Darker**, and then use the arrows to create darker copies.
- **Check the trays**

If you are copying from the ADF, make sure that the originals have been loaded correctly. For more information, see [Load an original in the automatic document feeder \(ADF\)](#).

## Documents are missing or faded

- **Check the media**

The media might not meet Hewlett-Packard media specifications (for example, the media is too moist or too rough). See [Media specifications](#) for more information.
- **Check the settings**

The quality setting of **Fast** (which produces draft-quality copies) might be responsible for the missing or faded documents. Change to the **Normal** or **Best** setting.
- **Check the original**
  - The accuracy of the copy depends on the quality and size of the original. Use the **Copy** screen to adjust the brightness of the copy. If the original is too light, the copy might not be able to compensate, even if you adjust the contrast.
  - Colored backgrounds might cause images in the foreground to blend into the background, or the background might appear in a different shade.
  - If you are copying a borderless original, load the original on the scanner glass, not the ADF. For more information, see [Load an original on the scanner glass](#).
- If you are copying a photo, be sure to load it on the scanner glass as indicated by the icon on the scan bed.

## Size is reduced

- The reduce/enlarge or other copy feature might have been set from the printer control panel to reduce the scanned image. Check the settings for the copy job to make sure that they are for normal size.
- The HP software settings might be set to reduce the scanned image. Change the settings, if needed. See the onscreen Help for the HP software for more information.

## Copy quality is poor

- **Take steps to improve the copy quality**
  - Use quality originals.
  - Load the media correctly. If the media is loaded incorrectly, it might skew, causing unclear images. See [Media specifications](#) for more information.
  - Use or make a carrier sheet to protect your originals.
- **Check the printer**
  - The scanner lid might not be closed correctly.
  - The scanner glass or lid backing might need cleaning. See [Maintain the printer](#) for more information.
  - The automatic document feeder (ADF) might need cleaning. See [Maintain the printer](#) for more information.

## Copy defects are apparent

- **Vertical white or faded stripes**

The media might not meet Hewlett-Packard media specifications (for example, the media is too moist or too rough). See [Media specifications](#) for more information.
- **Too light or dark**

Try adjusting the contrast and copy-quality settings.
- **Unwanted lines**

The scanner glass, lid backing, or frame might need cleaning. See [Maintain the printer](#) for more information.
- **Black dots or streaks**

Ink, glue, correction fluid, or an unwanted substance might be on the scanner glass or lid backing. Try cleaning the printer. See [Maintain the printer](#) for more information.
- **Copy is slanted or skewed**

If you are using the automatic document feeder (ADF), check the following:

  - Make sure that the ADF input tray is not too full.
  - Make sure that the ADF width adjusters are snug against the sides of the media.
- **Unclear text**
  - Try adjusting the contrast and copy-quality settings.
  - The default enhancement setting might not be suitable for the job. Check the setting and change it to enhance text or photographs, if needed. For more information, see [Change copy settings](#).
- **Incompletely filled text or graphics**

Try adjusting the contrast and copy-quality settings.
- **Large, black typefaces look splotchy (not smooth)**

The default enhancement setting might not be suitable for the job. Check the setting and change it to enhance text or photographs, if needed. For more information, see [Change copy settings](#).
- **Horizontal grainy or white bands in light-gray to medium-gray areas**

The default enhancement setting might not be suitable for the job. Check the setting and change it to enhance text or photographs, if needed. For more information, see [Change copy settings](#).

## The printer prints half a page, then ejects the paper

### Check the ink cartridges

Make sure the correct ink cartridges are installed and the ink cartridges are not low on ink. For more information, see [Printer management tools](#) and [Check the estimated ink levels](#).

HP cannot guarantee the quality of non-HP ink cartridges.

## Paper mismatch

### Check the settings

Verify that the loaded media size and type matches the control panel settings.

## Copy A3/11x17 animation did not display

Make sure you touch the A3/11x17 box on the **Copy** screen.

## Solve scan problems

If the following topics do not help, see [HP support](#) for information about HP support.



**NOTE:** If you are starting the scan from a computer, see the software Help for troubleshooting information.

---

- [Scanner did nothing](#)
- [Scan takes too long](#)
- [Part of the document did not scan or text is missing](#)
- [Text cannot be edited](#)
- [Error messages appear](#)
- [Scanned image quality is poor](#)
- [Scan defects are apparent](#)
- [Scan A3/11x17 animation did not display](#)

## Scanner did nothing

- **Check the original**

Make sure that the original is placed on the scanner glass correctly. For more information, see [Load an original on the scanner glass](#).

- **Check the printer**

The printer might be coming out of PowerSave mode after a period of inactivity, which delays processing a short while. Wait until the printer displays the Home screen.

- **Check the HP software**

Make sure the HP software provided with the printer is correctly installed.

## Scan takes too long

- **Check the settings**
  - If you set the resolution too high, the scan job takes longer and results in larger files. To obtain good results when scanning or copying, do not use a resolution that is higher than needed. You can lower the resolution to scan more quickly.
  - If you acquire an image through TWAIN, you can change the settings so that the original scans in black and white. See the onscreen Help for the TWAIN program for information.
- **Check the status of the printer**

If you sent a print or copy job before you tried to scan, the scan starts if the scanner is not busy. However, the printing and scanning processes share memory, which means that the scan might be slower.

## Part of the document did not scan or text is missing

- **Check the original**
  - Make sure that you loaded the original correctly. For more information, see [Load an original on the scanner glass](#).
  - If you are copying a borderless original, load the original on the scanner glass, not the ADF. For more information, see [Load an original on the scanner glass](#).
  - Colored backgrounds can cause images in the foreground to blend into the background. Try adjusting the settings before you scan the original, or try enhancing the image after you scan the original.
- **Check the settings**
  - Make sure that the input media size is large enough for the original that you are scanning.
  - If you are using the HP software provided with the printer, the default settings in the HP software might be set to automatically perform a specific task other than the one that you are attempting. See the onscreen Help for the HP software for instructions about changing the properties.
  - If you have selected a picture scanning option, the HP software automatically crops the image. However, if you want to scan the entire page, complete the following steps:
    - Windows:** From the HP software, click **Scanner Actions**, click **Scan Properties**, and then select **Scan the entire glass**.
    - Mac OS X:** From the HP software, click **Scan**, select the **Pictures** scan profile, click **Profile Settings**, and then clear the **Crop** check box.

## Text cannot be edited

- **Check the settings**
  - When you scan the original, make sure that you select a document type that creates editable text. If text is classified as a graphic, it is not converted to text.
  - If you are using a separate OCR (optical character recognition) program, the OCR program might be linked to a word-processing program that does not perform OCR tasks. For more information, see the documentation provided with the OCR program.
  - Make sure you have selected an OCR language that corresponds to the language used for the document you are scanning. For more information, see the documentation provided with the OCR program.
- **Check the originals**
  - When scanning documents as editable text from the ADF, the original must be loaded into the ADF with the top forward and face up. When scanning from the scanner glass, the original must be loaded with the top facing the right edge of the scanner glass. Also, make sure the document is not skewed. For more information, see [Load an original on the scanner glass](#) or [Load an original in the automatic document feeder \(ADF\)](#).
  - The software might not recognize text that is tightly spaced. For example, if the text that the software converts has missing or combined characters, "rn" might appear as "m."
  - The accuracy of the software depends on the image quality, text size, and structure of the original and the quality of the scan itself. Make sure that your original has good image quality.
  - Colored backgrounds can cause images in the foreground to blend too much.

## Error messages appear

### "Unable to activate TWAIN source" or "An error occurred while acquiring the image"

- If you are acquiring an image from another device, such as a digital camera or another scanner, make sure that the other device is TWAIN-compliant. Devices that are not TWAIN-compliant do not work with the HP software.
- Make sure that you have connected the USB cable to the correct port on the back of your computer.
- Verify that the correct TWAIN source is selected. In the software, check the TWAIN source by selecting **Select Scanner** on the **File** menu.

## Scanned image quality is poor

### The original is a second-generation photo or picture

Reprinted photographs, such as those in newspapers or magazines, are printed by using tiny dots of ink that make an interpretation of the original photograph, which degrades the quality. Often, the ink dots form unwanted patterns that can be detected when the image

is scanned or printed or when the image appears on a screen. If the following suggestions do not solve the problem, you might need to use a better-quality version of the original.

- To eliminate the patterns, try reducing the size of the image after scanning.
- Print the scanned image to see if the quality is better.
- Make sure that the resolution and color settings are correct for the type of scan job.

#### **Text or images on the back of a two-sided original appear in the scan**

Two-sided originals can "bleed" text or images from the back side to the scan if the originals are printed on media that is too thin or too transparent.

#### **The scanned image is skewed (crooked)**

The original might have been placed incorrectly. Be sure to use the media guides when you place the original on the scanner glass. For more information, see [Load an original on the scanner glass](#).

#### **The image quality is better when printed**

The image that appears on the screen is not always an accurate representation of the quality of the scan.

- Try adjusting your computer monitor settings to use more colors (or levels of gray). On Windows computers, you typically make this adjustment by opening **Display** on the Windows control panel.
- Try adjusting the resolution and color settings.

#### **The scanned image shows blots, lines, vertical white stripes, or other defects**

- If the scanner glass is dirty, the image produced does not have optimum clarity. See [Maintain the printer](#) for cleaning instructions.
- The defects might be on the original and not a result of the scanning process.

#### **Graphics look different from the original**

The graphics settings might not be suitable for the type of scan job that you are performing. Try changing the graphics settings.

#### **Take steps to improve the scan quality**

- Use high-quality originals.
- Place the media correctly. If the media is placed incorrectly on the scanner glass, it might skew, which causes unclear images. For more information, see [Load an original on the scanner glass](#).
- Adjust the software settings according to how you plan to use the scanned page.
- Use or make a carrier sheet to protect your originals.
- Clean the scanner glass. See [Clean the scanner glass](#) for more information.

### **Scan defects are apparent**

#### **• Blank pages**

Make sure that the original document is placed correctly. Place the original document face down on the flatbed scanner with the top-left corner of the document located in the lower-right corner of the scanner glass.

#### **• Too light or dark**

- Try adjusting the settings. Be sure to use the correct resolution and color settings.
- The original image might be very light or dark or might be printed on colored paper.

- **Unwanted lines**

Ink, glue, correction fluid, or an unwanted substance might be on the scanner glass. Try cleaning the scanner glass. See [Maintain the printer](#) for more information.

- **Black dots or streaks**

- Ink, glue, correction fluid, or an unwanted substance might be on the scanner glass, the scanner glass might be dirty or scratched, or the lid backing might be dirty. Try cleaning the scanner glass and lid backing. See [Maintain the printer](#) for more information. If cleaning does not correct the problem, the scanner glass or lid backing might need to be replaced.
- The defects might be on the original and not a result of the scanning process.

- **Unclear text**

Try adjusting the settings. Make sure that the resolution and color settings are correct.

- **Size is reduced**

The HP software settings might be set to reduce the scanned image. See the HP software Help for more information about changing the settings.

## Scan A3/11x17 animation did not display

Make sure you touch the A3/11x17 box on the **Scan** screen.

## Solve fax problems

This section contains fax setup troubleshooting information for the printer. If the printer is not set up correctly for faxing, you might experience problems when sending faxes, receiving faxes, or both.

If you are having faxing problems, you can print a fax test report to check the status of the printer. The test will fail if the printer is not set up correctly for faxing. Perform this test after you have completed setting up the printer for faxing. For more information, see [Test fax setup](#).

If the test fails, review the report for information on how to fix any problems found. For more information, see [The fax test failed](#).

- [The fax test failed](#)
- [The display always shows Phone Off Hook](#)
- [The printer is having problems sending and receiving faxes](#)
- [The printer is having problems sending a manual fax](#)
- [The printer cannot receive faxes, but can send faxes](#)
- [The printer cannot send faxes, but can receive faxes](#)
- [Fax tones are recorded on my answering machine](#)
- [The phone cord that came with my printer is not long enough](#)
- [Color faxes do not print](#)
- [The computer cannot receive faxes \(Fax to PC and Fax to Mac\)](#)

### The fax test failed

If you ran a fax test and the test failed, review the report for basic information about the error. For more detailed information, check the report to see which part of the test failed, and then review the appropriate topic in this section for solutions to try.



This section contains the following topics:

- [The "Fax Hardware Test" failed](#)
- [The "Fax Connected to Active Telephone Wall Jack" test failed](#)
- [The "Phone Cord Connected to Correct Port on Fax" test failed](#)
- [The "Using Correct Type of Phone Cord with Fax" test failed](#)
- [The "Dial Tone Detection" test failed](#)
- [The "Fax Line Condition" test failed](#)

### The "Fax Hardware Test" failed

#### Solution:

- Turn off the printer by using the **Power** button located on the printer control panel and then unplug the power cord from the back of the printer. After a few seconds, plug the power cord in again, and then turn the power on. Run the test again. If the test fails again, continue reviewing the troubleshooting information in this section.
- Try to send or receive a test fax. If you can send or receive a fax successfully, there might not be a problem.
- If you are running the test from the **Fax Setup Wizard** (Windows) or **HP Setup Assistant** (Mac OS X), make sure the printer is not busy completing another task, such as receiving a fax or making a copy. Check the display for a message indicating that the printer is busy. If it is busy, wait until it is finished and in the idle state before running the test.
- Make sure you use the phone cord that came with the printer. If you do not use the supplied phone cord to connect from the telephone wall jack to the printer, you might not be able to send or receive faxes. After you plug in the phone cord that came with the printer, run the fax test again.
- If you are using a phone splitter, this can cause faxing problems. (A splitter is a two-cord connector that plugs into a telephone wall jack.) Try removing the splitter and connecting the printer directly to the telephone wall jack.

After you resolve any problems found, run the fax test again to make sure it passes and the printer is ready for faxing. If the **Fax Hardware Test** continues to fail and you experience problems faxing, contact HP support. Go to [www.hp.com/support](http://www.hp.com/support). If prompted, choose your country/region, and then click **Contact HP** for information on calling for technical support.

---

### The "Fax Connected to Active Telephone Wall Jack" test failed

#### Solution:

- Check the connection between the telephone wall jack and the printer to make sure the phone cord is secure.
- Make sure you use the phone cord that came with the printer. If you do not use the supplied phone cord to connect from the telephone wall jack to the printer, you might not be able to send or receive faxes. After you plug in the phone cord that came with the printer, run the fax test again.

- Make sure you have correctly connected the printer to the telephone wall jack. Using the phone cord supplied in the box with the printer, connect one end to your telephone wall jack, then connect the other end to the port labeled 1-LINE on the back of the printer. For more information on setting up the printer for faxing, see [Additional fax setup](#).
- If you are using a phone splitter, this can cause faxing problems. (A splitter is a two-cord connector that plugs into a telephone wall jack.) Try removing the splitter and connecting the printer directly to the telephone wall jack.
- Try connecting a working phone and phone cord to the telephone wall jack that you are using for the printer and check for a dial tone. If you do not hear a dial tone, contact your telephone company and have them check the line.
- Try to send or receive a test fax. If you can send or receive a fax successfully, there might not be a problem.

After you resolve any problems found, run the fax test again to make sure it passes and the printer is ready for faxing.

### The "Phone Cord Connected to Correct Port on Fax" test failed

**Solution:** Plug the phone cord into the correct port.

1. Using the phone cord supplied in the box with the printer, connect one end to your telephone wall jack, then connect the other end to the port labeled 1-LINE on the back of the printer.

 **NOTE:** If you use the 2-EXT port to connect to the telephone wall jack, you cannot send or receive faxes. The 2-EXT port should only be used to connect other equipment, such as an answering machine.

**Figure 8-1 Back view of the printer**

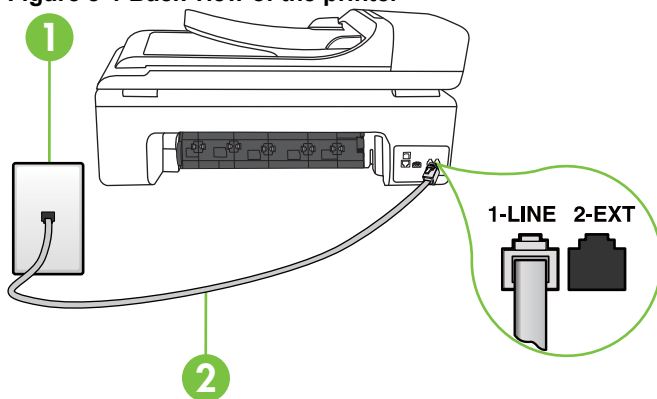

1	Telephone wall jack
2	Use the phone cord supplied in the box with the printer to connect to the "1-LINE" port

2. After you have connected the phone cord to the port labeled 1-LINE, run the fax test again to make sure it passes and the printer is ready for faxing.
3. Try to send or receive a test fax.
  - Make sure you use the phone cord that came with the printer. If you do not use the supplied phone cord to connect from the telephone wall jack to the printer, you might not be able to send or receive faxes. After you plug in the phone cord that came with the printer, run the fax test again.
  - If you are using a phone splitter, this can cause faxing problems. (A splitter is a two-cord connector that plugs into a telephone wall jack.) Try removing the splitter and connecting the printer directly to the telephone wall jack.

### The "Using Correct Type of Phone Cord with Fax" test failed

#### Solution:

- Make sure you used the phone cord supplied in the box with the printer to connect to the telephone wall jack. One end of the phone cord should be connected to the port labeled 1-LINE on the back of the printer, and the other end to your telephone wall jack.

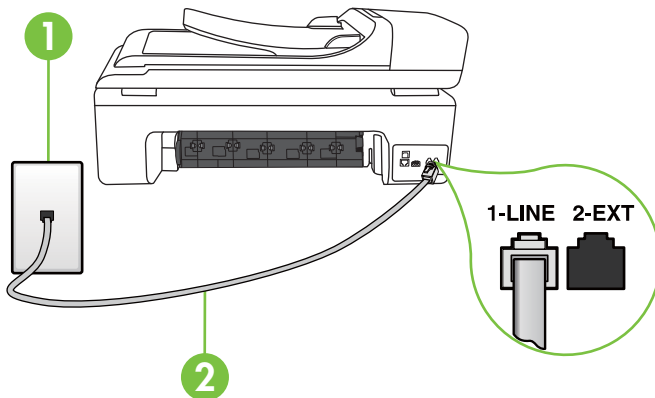

1	Telephone wall jack
2	Use the phone cord supplied in the box with the printer to connect to the "1-LINE" port

If the phone cord that came with the printer is not long enough, you can use a coupler to extend the length. You can purchase a coupler at an electronics store that carries phone accessories. You also need another phone cord, which can be a standard phone cord that you might already have in your home or office.

- Check the connection between the telephone wall jack and the printer to make sure the phone cord is secure.

- Make sure you use the phone cord that came with the printer. If you do not use the supplied phone cord to connect from the telephone wall jack to the printer, you might not be able to send or receive faxes. After you plug in the phone cord that came with the printer, run the fax test again.
  - If you are using a phone splitter, this can cause faxing problems. (A splitter is a two-cord connector that plugs into a telephone wall jack.) Try removing the splitter and connecting the printer directly to the telephone wall jack.
- 

### The "Dial Tone Detection" test failed

#### Solution:

- Other equipment, which uses the same phone line as the printer, might be causing the test to fail. To find out if other equipment is causing a problem, disconnect everything from the phone line, and then run the test again. If the **Dial Tone Detection Test** passes without the other equipment, then one or more pieces of the equipment is causing problems; try adding them back one at a time and rerunning the test each time, until you identify which piece of equipment is causing the problem.
- Try connecting a working phone and phone cord to the telephone wall jack that you are using for the printer and check for a dial tone. If you do not hear a dial tone, contact your telephone company and have them check the line.
- Make sure you have correctly connected the printer to the telephone wall jack. Using the phone cord supplied in the box with the printer, connect one end to your telephone wall jack, then connect the other end to the port labeled 1-LINE on the back of the printer.
- If you are using a phone splitter, this can cause faxing problems. (A splitter is a two-cord connector that plugs into a telephone wall jack.) Try removing the splitter and connecting the printer directly to the telephone wall jack.
- If your telephone system is not using a standard dial tone, such as some PBX systems, this might cause the test to fail. This does not cause a problem sending or receiving faxes. Try sending or receiving a test fax.
- Check to make sure the country/region setting is set appropriately for your country/region. If the country/region setting is not set or is set incorrectly, the test might fail and you might have problems sending and receiving faxes.
- Make sure you connect the printer to an analog phone line or you cannot send or receive faxes. To check if your phone line is digital, connect a regular analog phone to the line and listen for a dial tone. If you do not hear a normal sounding dial tone, it might be a phone line set up for digital phones. Connect the printer to an analog phone line and try sending or receiving a fax.
- Make sure you use the phone cord that came with the printer. If you do not use the supplied phone cord to connect from the telephone wall jack to the printer, you might not be able to send or receive faxes. After you plug in the phone cord that came with the printer, run the fax test again.

After you resolve any problems found, run the fax test again to make sure it passes and the printer is ready for faxing. If the **Dial Tone Detection** test continues to fail, contact your telephone company and have them check the phone line.

---

## The "Fax Line Condition" test failed

### **Solution:**

- Make sure you connect the printer to an analog phone line or you cannot send or receive faxes. To check if your phone line is digital, connect a regular analog phone to the line and listen for a dial tone. If you do not hear a normal sounding dial tone, it might be a phone line set up for digital phones. Connect the printer to an analog phone line and try sending or receiving a fax.
- Check the connection between the telephone wall jack and the printer to make sure the phone cord is secure.
- Make sure you have correctly connected the printer to the telephone wall jack. Using the phone cord supplied in the box with the printer, connect one end to your telephone wall jack, then connect the other end to the port labeled 1-LINE on the back of the printer.
- Other equipment, which uses the same phone line as the printer, might be causing the test to fail. To find out if other equipment is causing a problem, disconnect everything from the phone line, and then run the test again.
  - If the **Fax Line Condition Test** passes without the other equipment, then one or more pieces of the equipment is causing problems; try adding them back one at a time and rerunning the test each time, until you identify which piece of equipment is causing the problem.
  - If the **Fax Line Condition Test** fails without the other equipment, connect the printer to a working phone line and continue reviewing the troubleshooting information in this section.
- If you are using a phone splitter, this can cause faxing problems. (A splitter is a two-cord connector that plugs into a telephone wall jack.) Try removing the splitter and connecting the printer directly to the telephone wall jack.
- Make sure you use the phone cord that came with the printer. If you do not use the supplied phone cord to connect from the telephone wall jack to the printer, you might not be able to send or receive faxes. After you plug in the phone cord that came with the printer, run the fax test again.

After you resolve any problems found, run the fax test again to make sure it passes and the printer is ready for faxing. If the **Fax Line Condition** test continues to fail and you experience problems faxing, contact your telephone company and have them check the phone line.

---

## The display always shows Phone Off Hook

**Solution:** You are using the wrong type of phone cord. Make sure you are using the phone cord that came with the printer to connect the printer to your phone line. If the phone cord that came with the printer is not long enough, you can use a coupler to extend the length. You can purchase a coupler at an electronics store that carries phone accessories. You also need another phone cord, which can be a standard phone cord that you might already have in your home or office.

---

**Solution:** Other equipment that uses the same phone line as the printer might be in use. Make sure extension phones (phones on the same phone line, but not connected to the printer) or other equipment are not in use or off the hook. For

example, you cannot use the printer for faxing if an extension phone is off the hook, or if you are using a computer dial-up modem to send e-mail or access the Internet.

### The printer is having problems sending and receiving faxes

**Solution:** Make sure the printer is turned on. Look at the display on the printer. If the display is blank and the **Power** light is not lit, the printer is turned off. Make sure the power cord is firmly connected to the printer and plugged into a power outlet. Press the **Power** button to turn on the printer.

After turning on the printer, HP recommends you wait five minutes before sending or receiving a fax. The printer cannot send or receive faxes while it is initializing after being turned on.

**Solution:** If Fax to PC or Fax to Mac has been enabled, you may not be able to send or receive faxes if the fax memory is full (limited by printer memory).

#### Solution:

- Make sure you used the phone cord supplied in the box with the printer to connect to the telephone wall jack. One end of the phone cord should be connected to the port labeled 1-LINE on the back of the printer and the other end to your telephone wall jack, as shown below.

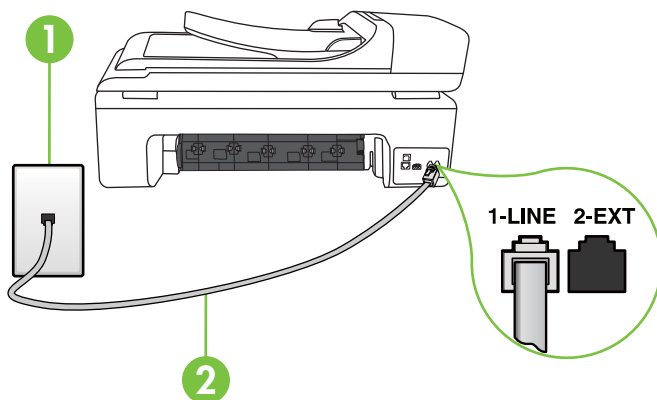

1	Telephone wall jack
2	Use the phone cord supplied in the box with the printer to connect to the "1-LINE" port

If the phone cord that came with the printer is not long enough, you can use a coupler to extend the length. You can purchase a coupler at an electronics store

that carries phone accessories. You also need another phone cord, which can be a standard phone cord that you might already have in your home or office.

- Try connecting a working phone and phone cord to the telephone wall jack that you are using for the printer and check for a dial tone. If you do not hear a dial tone, call your local telephone company for service.
- Other equipment, which uses the same phone line as the printer, might be in use. For example, you cannot use the printer for faxing if an extension phone is off the hook, or if you are using a computer dial-up modem to send an e-mail or access the Internet.
- Check to see if another process has caused an error. Check the display or your computer for an error message providing information about the problem and how to solve it. If there is an error, the printer does not send or receive a fax until the error condition is resolved.
- The phone line connection might be noisy. Phone lines with poor sound quality (noise) can cause faxing problems. Check the sound quality of the phone line by plugging a phone into the telephone wall jack and listening for static or other noise. If you hear noise, turn **Error Correction Mode (ECM)** off and try faxing again. For more information, see [Send a fax in Error Correction Mode](#).
- If you are using a digital subscriber line (DSL) service, make sure that you have a DSL filter connected or you cannot fax successfully. For more information, see [Case B: Set up the printer with DSL](#).
- Make sure the printer is not connected to a telephone wall jack that is set up for digital phones. To check if your phone line is digital, connect a regular analog phone to the line and listen for a dial tone. If you do not hear a normal sounding dial tone, it might be a phone line set up for digital phones.
- If you are using either a private branch exchange (PBX) or an integrated services digital network (ISDN) converter/terminal adapter, make sure the printer is connected to the correct port and the terminal adapter is set to the correct switch type for your country/region, if possible. For more information, see [Case C: Set up the printer with a PBX phone system or an ISDN line](#).
- If the printer shares the same phone line with a DSL service, the DSL modem might not be correctly grounded. If the DSL modem is not correctly grounded, it can create noise on the phone line. Phone lines with poor sound quality (noise) can cause faxing problems. You can check the sound quality of the phone line by plugging a phone into the telephone wall jack and listening for static or other noise. If you hear noise, turn off your DSL modem and completely remove power for at least 15 minutes. Turn the DSL modem back on and listen to the dial tone again.

---

 **NOTE:** You might notice static on the phone line again in the future. If the printer stops sending and receiving faxes, repeat this process.

---

If the phone line is still noisy, contact your telephone company. For information on turning your DSL modem off, contact your DSL provider for support.

- If you are using a phone splitter, this can cause faxing problems. (A splitter is a two-cord connector that plugs into a telephone wall jack.) Try removing the splitter and connecting the printer directly to the telephone wall jack.

## The printer is having problems sending a manual fax

### Solution:

 **NOTE:** This possible solution applies only in the countries/regions that receive a 2-wire phone cord in the box with the printer, including: Argentina, Australia, Brazil, Canada, Chile, China, Colombia, Greece, India, Indonesia, Ireland, Japan, Korea, Latin America, Malaysia, Mexico, Philippines, Poland, Portugal, Russia, Saudi Arabia, Singapore, Spain, Taiwan, Thailand, USA, Venezuela, and Vietnam.

- Make sure the telephone you use to initiate the fax call is connected directly to the printer. To send a fax manually, the telephone must be connected directly to the port labeled 2-EXT on the printer, as shown below.

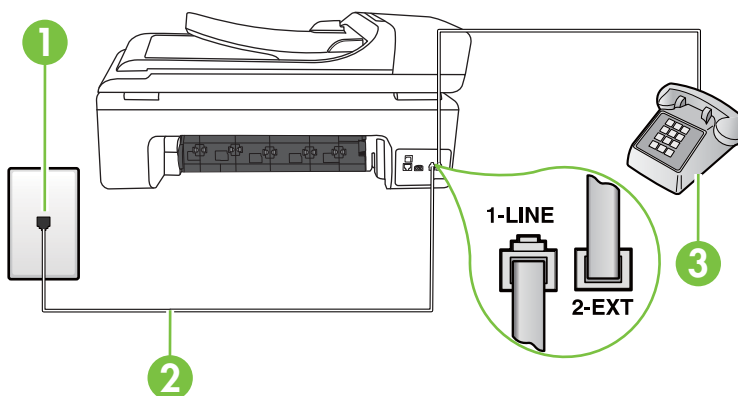

1	Telephone wall jack
2	Use the phone cord supplied in the box with the printer to connect to the "1-LINE" port
3	Telephone

- If you are sending a fax manually from your phone that is connected directly to the printer, you must use the keypad on the telephone to send the fax. You cannot use the keypad on the printer control panel.

 **NOTE:** If using a serial-type phone system, please connect your phone directly on top of the printer cable which has a wall plug attached to it.



## The printer cannot receive faxes, but can send faxes

### Solution:

- If you are not using a distinctive ring service, check to make sure that the **Distinctive Ring** feature on the printer is set to **All Rings**. For more information, see [Change the answer ring pattern for distinctive ring](#).
- If **Auto Answer** is set to **Off**, you need to receive faxes manually; otherwise, the printer does not receive the fax. For information on receiving faxes manually, see [Receive a fax manually](#).
- If you have a voice mail service at the same phone number you use for fax calls, you must receive faxes manually, not automatically. This means that you must be available to respond in person to incoming fax calls. For information on setting up the printer when you have a voice mail service, see [Case F: Shared voice/fax line with voice mail](#). For information on receiving faxes manually, see [Receive a fax manually](#).
- If you have a computer dial-up modem on the same phone line with the printer, check to make sure that the software that came with your modem is not set to receive faxes automatically. Modems that are set up to receive faxes automatically take over the phone line to receive all incoming faxes, which prevents the printer from receiving fax calls.
- If you have an answering machine on the same phone line with the printer, you might have one of the following problems:
  - Your answering machine might not be set up correctly with the printer.
  - Your outgoing message might be too long or too loud to allow the printer to detect fax tones, and the sending fax machine might disconnect.
  - Your answering machine might not have enough quiet time after your outgoing message to allow the printer to detect fax tones. This problem is most common with digital answering machines.

The following actions might help solve these problems:

- When you have an answering machine on the same phone line you use for fax calls, try connecting the answering machine directly to the printer as described in [Case I: Shared voice/fax line with answering machine](#).
- Make sure the printer is set to receive faxes automatically. For information on setting up the printer to receive faxes automatically, see [Receive a fax](#).
- Make sure the **Rings to Answer** setting is set to a greater number of rings than the answering machine. For more information, see [Set the number of rings before answering](#).

- Disconnect the answering machine and then try receiving a fax. If faxing is successful without the answering machine, the answering machine might be causing the problem.
- Reconnect the answering machine and record your outgoing message again. Record a message that is approximately 10 seconds in duration. Speak slowly and at a low volume when recording your message. Leave at least 5 seconds of silence at the end of the voice message. There should be no background noise when recording this silent time. Try to receive a fax again.



**NOTE:** Some digital answering machines might not retain the recorded silence at the end of your outgoing message. Play back your outgoing message to check.

---

- If the printer shares the same phone line with other types of phone equipment, such as an answering machine, a computer dial-up modem, or a multi-port switch box, the fax signal level might be reduced. The signal level can also be reduced if you use a splitter or connect extra cables to extend the length of your phone. A reduced fax signal can cause problems during fax reception.  
To find out if other equipment is causing a problem, disconnect everything except the printer from the phone line, and then try to receive a fax. If you can receive faxes successfully without the other equipment, one or more pieces of the other equipment is causing problems; try adding them back one at a time and receiving a fax each time, until you identify which equipment is causing the problem.
  - If you have a special ring pattern for your fax phone number (using a distinctive ring service through your telephone company), make sure that the **Distinctive Ring** feature on the printer is set to match. For more information, see [Change the answer ring pattern for distinctive ring](#).
- 

## The printer cannot send faxes, but can receive faxes

### Solution:

- The printer might be dialing too fast or too soon. You might need to insert some pauses in the number sequence. For example, if you need to access an outside line before dialing the phone number, insert a pause following the access number. If your number is 95555555, and 9 accesses an outside line, you might insert pauses as follows: 9-555-5555. To enter a pause in the fax number you are typing, touch **Space (#)** repeatedly, until a dash (-) appears on the display.  
You can also send the fax using monitor dialing. This enables you to listen to the phone line as you dial. You can set the pace of your dialing and respond to prompts as you dial. For more information, see [Send a fax using monitor dialing](#).
  - The number you entered when sending the fax is not in the correct format or the receiving fax machine is having problems. To check this, try calling the fax number from a telephone and listen for fax tones. If you cannot hear fax tones, the receiving fax machine might not be turned on or connected, or a voice mail service could be interfering with the recipient's phone line. You can also ask the recipient to check the receiving fax machine for any problems.
-

## Fax tones are recorded on my answering machine

### Solution:

- When you have an answering machine on the same phone line you use for fax calls, try connecting the answering machine directly to the printer as described in [Case I: Shared voice/fax line with answering machine](#). If you do not connect the answering machine as recommended, fax tones might be recorded on your answering machine.
  - Make sure the printer is set to receive faxes automatically and that the **Rings to Answer** setting is correct. The number of rings to answer for the printer should be greater than the number of rings to answer for the answering machine. If the answering machine and the printer are set to the same number of rings to answer, both devices answer the call and fax tones are recorded on the answering machine.
  - Set your answering machine to a low number of rings and the printer to answer in the maximum number of rings supported. (The maximum number of rings varies by country/region.) In this setup, the answering machine answers the call and the printer monitors the line. If the printer detects fax tones, the printer receives the fax. If the call is a voice call, the answering machine records the incoming message. For more information, see [Set the number of rings before answering](#).
- 

## The phone cord that came with my printer is not long enough

**Solution:** If the phone cord that came with the printer is not long enough, you can use a coupler to extend the length. You can purchase a coupler at an electronics store that carries phone accessories. You also need another phone cord, which can be a standard phone cord that you might already have in your home or office.

 **TIP:** If the printer came with a 2-wire phone cord adaptor, you can use it with a 4-wire phone cord to extend the length. For information on using the 2-wire phone cord adaptor, see the documentation that came with it.

---

### To extend your phone cord

1. Using the phone cord supplied in the box with the printer, connect one end to the coupler, then connect the other end to the port labeled 1-LINE on the back of the printer.
  2. Connect another phone cord to the open port on the coupler and to the telephone wall jack.
- 

## Color faxes do not print

**Cause:** The Incoming Fax Printing option is turned off.

**Solution:** To print color faxes, make sure that the Incoming Fax Printing option in the printer control panel is turned on.

---

### The computer cannot receive faxes (Fax to PC and Fax to Mac)

Check the following if you have set up Fax to PC or Fax to Mac and if the printer is connected to your computer using a USB cable.

**Cause:** The computer selected to receive faxes is turned off.

**Solution:** Make sure the computer selected to receive faxes is switched on at all times.

---

**Cause:** Different computers are configured for setup and receiving faxes and one of them may be switched off.

**Solution:** If the computer receiving faxes is different from the one used for setup, both computers should be switched on at all times.

---

**Cause:** Fax to PC or Fax to Mac is not activated or the computer is not configured to receive faxes.

**Solution:** Activate Fax to PC or Fax to Mac and make sure the computer is configured to receive faxes.

---

## Solve problems using HP Web sites and services

This section provides solutions to common problems using HP Web sites and services.

- [Solve problems using HP Web services](#)
- [Solve problems using HP Web sites](#)

### Solve problems using HP Web services

If you are having problems using the HP Apps or other Web services from the printer's control panel, check the following:

- Make sure the printer is connected to the Internet.

---

 **NOTE:** To use the printer's Web features, the printer must be connected to the Internet (either using an Ethernet cable or wireless connection). You cannot use these Web features if the printer is connected using a USB cable.

---

- Make sure the network hub, switch, or router is turned on and working correctly.
- If you are connecting the printer using an Ethernet cable, make sure you are not connecting the printer using a phone cord or a crossover cable to connect the printer to the network and that the Ethernet cable is securely connected to the printer. For more information, see [Solve wired \(Ethernet\) network problems](#).
- If you are connecting the printer using a wireless connection, make sure the wireless network is functioning properly. For more information, see [Solve wireless problems](#).

## Solve problems using HP Web sites

If you are having problems using HP Web sites from your computer, check the following:

- Make sure the computer that you are using is connected to the network.
- Make sure the Web browser meets the minimum system requirements. For more information, see [HP Web site specifications](#).
- If your Web browser uses any proxy settings to connect to the Internet, try turning off these settings. For more information, see the documentation available with your Web browser.

## Solve photo (memory card) problems

If the following topics do not help, see [Solve a problem](#) for information about HP support.



**NOTE:** If you are starting a memory card operation from a computer, see the software Help for troubleshooting information.

- [The printer cannot read the memory card](#)
- [The printer cannot read photos on the memory card](#)

### The printer cannot read the memory card

- **Check the memory card**
  - Make sure that the memory card is one of the supported types. For more information, see [Insert a memory card](#).
  - Some memory cards have a switch that controls how they can be used. Make sure that the switch is set so that the memory card can be read.
  - Inspect the ends of the memory card for dirt or material that closes a hole or spoils a metal contact. Clean the contacts with a lint-free cloth and small amounts of isopropyl alcohol.
  - Make sure that the memory card is working correctly by testing it with other devices.
- **Check the memory card slot**
  - Make sure that the memory card is fully inserted into the correct slot. For more information, see [Insert a memory card](#).
  - Remove the memory card (when the light is not blinking) and shine a flashlight into the empty slot. See if any of the small pins inside are bent. When the computer is off, you can straighten slightly bent pins by using the tip of a thin, retracted ballpoint pen. If a pin has bent in such a way that it touches another pin, replace the memory card reader or have the printer serviced. For more information, see [Solve a problem](#).
  - Make sure that only one memory card has been inserted at a time in the slots. An error message should appear on the control-panel display if more than one memory card is inserted.

### The printer cannot read photos on the memory card

#### Check the memory card

The memory card might be corrupt.

## Solve wired (Ethernet) network problems

If you are unable to connect the printer to your wired (Ethernet) network, perform one or more of the following tasks.



**NOTE:** After correcting any of the following, run the installation program again.

- [General network troubleshooting](#)
- [Network port created does not match printer IP address \(Windows\)](#)

### General network troubleshooting

If you are unable to install the HP software that came with the printer, verify that:

- All cable connections to the computer and the printer are secure.
- The network is operational and the network hub is turned on.
- All applications, including virus protection programs, spyware protection programs, and firewalls, are closed or disabled for computers running Windows
- The printer is installed on the same subnet as the computers that are using the printer.

If the installation program cannot discover the printer, print the network configuration page, and enter the IP address manually in the installation program. For more information, see [Understand the network configuration page](#).

Though it is not recommended that you assign the printer with a static IP address, you might resolve some installation problems (such as a conflict with a personal firewall) by doing so.

### Network port created does not match printer IP address (Windows)

If you are using a computer running Windows, make sure that the network ports created in the printer driver match the printer IP address:

1. Print the printer's network configuration page
2. On the computer desktop, click **Start**, select **Settings**, and then click **Printers** or **Printers and Faxes**.  
- or -  
Click **Start**, click **Control Panel**, and then double-click **Printers**.
3. Right-click the printer icon, click **Properties**, and then click the **Ports** tab.
4. Select the TCP/IP port for the printer, and then click **Configure Port**.
5. Compare the IP address listed in the dialog box and make sure it matches the IP address listed on the network configuration page. If the IP addresses are different, change the IP address in the dialog box to match the address on the network configuration page.
6. Click **OK** twice to save the settings and close the dialog boxes.

# Solve wireless problems

If the printer is unable to communicate with the network after completing the wireless setup and HP software installation, perform one or more of the following tasks in the order shown below.

- [Basic wireless troubleshooting](#)
- [Advanced wireless troubleshooting](#)

## Basic wireless troubleshooting

Perform the following steps in the order presented.

---

 **NOTE:** If this is the first time you are setting up the wireless connection, and you are using the HP software included with the printer, make sure that the USB cable is connected to the printer and the computer.

---

### Step 1 - Make sure the wireless (802.11) light is turned on

If the blue light near the printer's wireless button is not lit, the wireless capabilities might not have been turned on. To turn on wireless, touch right arrow , touch **Network**, touch **Wireless**, touch **Wireless Radio**, and then select **Yes**.

---

 **NOTE:** If your printer supports Ethernet networking, make sure that an Ethernet cable has not been connected to the printer. Connecting an Ethernet cable turns off the printer's wireless capabilities.

---

### Step 2 - Restart components of the wireless network

Turn off the router and the printer, and then turn them back on in this order: router first and then the printer. If you still are unable to connect, turn off the router, printer, and your computer. Sometimes, turning off the power and then turning it back on will recover a network communication issue.

### Step 3 - Run the Wireless Network Test

For wireless networking issues, run the Wireless Network Test. To print a Wireless Network Test page, touch right arrow , touch **Network**, touch **Wireless**, and then select **Wireless Network Test**. If a problem is detected, the printed test report will include recommendations that might help solve the problem.

## Advanced wireless troubleshooting

If you have tried the suggestions provided in the Basic troubleshooting section and are still unable to connect to your printer to the wireless network, try the following suggestions in the order presented:

- [Step 1: Make sure your computer is connected to your network](#)
- [Step 2: Make sure that the printer is connected to your network](#)
- [Step 3: Check to see if the firewall software is blocking communication](#)
- [Step 4: Make sure the printer is online and ready](#)

- Step 5: Make sure the wireless version of the printer is set as the default printer driver (Windows only)
- Step 6: Make sure the HP Network Devices Support service is running (Windows only)
- Step 7: Add hardware addresses to a wireless access point (WAP)

### Step 1: Make sure your computer is connected to your network

#### To check a wired (Ethernet) connection

- ▲ Many computers have indicator lights beside the port where the Ethernet cable from the router connects to your computer. Usually there are two indicator lights, one that is on and another that blinks. If your computer has indicator lights, check to see if the indicator lights are on. If the lights are not on, try reconnecting the Ethernet cable to the computer and the router. If you still do not see lights, there might be a problem with the router, the Ethernet cable, or your computer.

---

 **NOTE:** Macintosh computers do not have indicator lights. To check the Ethernet connection on a Macintosh computer, click **System Preferences** in the Dock, and then click **Network**. If the Ethernet connection is working correctly, **Built-in Ethernet** appears in the list of connections, along with the IP address and other status information. If **Built-in Ethernet** does not appear in the list, there might be a problem with the router, the Ethernet cable, or your computer. For more information, click Help in the window.

---

#### To check a wireless connection

1. Make sure that your computer's wireless has been turned on. (For more information, see the documentation that came with your computer.)
2. If you are not using a unique network name (SSID), then it is possible that your wireless computer could be connected to a nearby network that is not yours. The following steps can help you determine if your computer is connected to your network.

#### Windows

- a. On the computer desktop, click **Start**, click **Control Panel**, select **Network Connections**, click **View Network Status** and then click **Tasks**.  
or  
Click **Start**, select **Settings**, click **Control Panel**, double-click **Network Connections**, click the **View** menu, and then select **Details**.  
Leave the network dialog box open while you continue to the next step.
- b. Disconnect the power cord from the wireless router. The connection status of your computer should change to **Not Connected**.
- c. Reconnect the power cord to the wireless router. The connection status should change to **Connected**.



## Mac OS X

- ▲ Click the **AirPort** icon in the menu bar at the top of the screen. From the menu that appears, you can determine if the AirPort is turned on and which wireless network your computer is connected to.



**NOTE:** For more detailed information about your AirPort connection, click **System Preferences** in the Dock, and then click **Network**. If the wireless connection is working correctly, a green dot appears next to AirPort in the list of connections. For more information, click Help in the window.

If you are unable to get your computer connected to your network, contact the person who set up your network or the router manufacturer as there might be a hardware issue with either your router or computer.

If you are able to access the Internet and are using a computer running Windows, you can also access HP Network Assistant at [www.hp.com/sbso/wireless/tools-setup.html?jumpid=reg\\_R1002\\_USEN](http://www.hp.com/sbso/wireless/tools-setup.html?jumpid=reg_R1002_USEN) for help in setting up a network. (This Web site is only available in English.)

## Step 2: Make sure that the printer is connected to your network

If your printer is not connected to the same network as your computer, you cannot use the printer over the network. Follow the steps described in this section to find out if your printer is actively connected to the correct network.



**NOTE:** If your wireless router or Apple AirPort Base Station is using a hidden SSID, your printer does not automatically detect the network.

### A: Make sure the printer is on the network

1. If the printer supports Ethernet networking and is connected to an Ethernet network, make sure an Ethernet cable is not plugged into the back of the printer. If an Ethernet cable is plugged into the back, then wireless connectivity is disabled.
2. If the printer is connected to a wireless network, print the printer's Wireless Configuration page. For more information, see [Understand the network configuration page](#).
  - ▲ After the page has been printed, check the Network Status and URL:

<b>Network Status</b>	<ul style="list-style-type: none"><li>• If the Network Status is Ready, the printer is actively connected to a network.</li><li>• If the Network Status is Offline, the printer is not connected to a network. Run the Wireless Network Test (using the instructions at the beginning of this section) and follow any recommendations.</li></ul>
<b>URL</b>	The URL shown here is the network address assigned to the printer by your router. You need this to connect to the embedded Web server.

**B: Check to see if you can access the EWS**

- ▲ After you establish that the computer and the printer both have active connections to a network, you can verify if they are on the same network by accessing the printer's embedded Web server (EWS). For more information, see [Embedded Web server](#).

**To access the EWS**

- a. On your computer, open the Web browser you typically use to access the Internet (for example, Internet Explorer or Safari). In the address box, type the URL of the printer as it was shown on the network configuration page (for example, <http://192.168.1.101>).



**NOTE:** If you are using a proxy server in your browser, you might need to disable it to access the EWS.

---

- b. If you can access the EWS, try using the printer over the network (such as to print) to see if your network setup was successful.
- c. If you cannot access the EWS or are still having problems using the printer over the network, continue to the next section regarding firewalls.

**Step 3: Check to see if the firewall software is blocking communication**

If you cannot access the EWS and are sure both the computer and printer have active connections to the same network, the firewall security software might be blocking communication. Temporarily turn off any firewall security software running on your computer and then try to access the EWS again. If you can access the EWS, try using the printer (for printing).

If you are able to access the EWS and use your printer with the firewall turned off, you will need to reconfigure your firewall settings to allow the computer and printer to communicate with each other over the network. For more information, see [Configure your firewall to work with printers](#).

If you are able to access the EWS, but are still unable to use the printer even with the firewall turned off, try enabling the firewall software to recognize the printer.

**Step 4: Make sure the printer is online and ready**

If you have the HP software installed, you can check the printer's status from your computer to see if the printer is paused or offline, preventing you from using it.

To check the printer's status, complete the following steps:

**Windows**

1. On the computer desktop, click **Start**, select **Settings**, and then click **Printers or Printers and Faxes**.  
- Or -  
Click **Start**, click **Control Panel**, and then double-click **Printers**.
2. If the printers on your computer are not being displayed in Details view, click the **View** menu, and then click **Details**.

3. Do one of the following, depending on the printer status:
  - a. If the printer is **Offline**, right-click the printer, and click **Use Printer Online**.
  - b. If the printer is **Paused**, right-click the printer, and click **Resume Printing**.
4. Try using the printer over the network.

### Mac OS X

1. Click **System Preferences** in the Dock, and then click **Print & Fax**.
2. Select the printer, and then click **Print Queue**.
3. If **Jobs Stopped** appears in the dialog box, click **Start Jobs**.

If you can use the printer after performing the steps above but find that the symptoms persist as you continue to use the printer, your firewall might be interfering. If you still cannot use the printer over the network, continue to the next section for additional troubleshooting help.

### Step 5: Make sure the wireless version of the printer is set as the default printer driver (Windows only)

If you install the HP software again, the installer might create a second version of the printer driver in your **Printers** or **Printers and Faxes** folder. If you have difficulties printing or connecting to the printer, make sure the correct version of the printer driver is set as the default.

1. On the computer desktop, click **Start**, select **Settings**, and then click **Printers** or **Printers and Faxes**.  
- Or -  
Click **Start**, click **Control Panel**, and then double-click **Printers**.
2. Determine if the version of the printer driver in the **Printers** or **Printers and Faxes** folder is connected wirelessly:
  - a. Right-click the printer icon, and then click **Properties, Document Defaults, or Printing Preferences**.
  - b. On the **Ports** tab, look for a port in the list with a checkmark. The version of the printer driver that is connected wirelessly has **Standard TCP/IP Port** as the Port description, next to the checkmark.
3. Right-click the printer icon for the version of the printer driver that is connected wirelessly, and then click **Set as Default Printer**.

---

 **NOTE:** If there is more than one icon in the folder for the printer, right-click the printer icon for the version of the printer driver that is connected wirelessly, and then click **Set as Default Printer**.

---

### Step 6: Make sure the HP Network Devices Support service is running (Windows only)

#### To restart the HP Network Device Support service

1. Delete any print jobs currently in the print queue.
2. On the computer desktop, right-click **My Computer** or **Computer**, and then click **Manage**.
3. Double-click **Services and Applications**, and then click **Services**.

4. Scroll down the list of services, right click **HP Network Devices Support**, and then click **Restart**.
5. After the service restarts, try using the printer over the network again.

If you are able to use the printer over the network, your network setup was successful.

If you still cannot use the printer over the network or if you have to periodically perform this step in order to use your printer over the network, your firewall might be interfering.

If this still does not work, there might be a problem with your network configuration or router. Contact the person who set up your network or the router manufacturer for help.

### Step 7: Add hardware addresses to a wireless access point (WAP)

MAC filtering is a security feature in which a wireless access point (WAP) is configured with a list of MAC addresses (also called “hardware addresses”) of devices that are allowed to gain access to the network through the WAP. If the WAP does not have the hardware address of a device attempting to access the network, the WAP denies the device access to the network. If the WAP filters MAC addresses, then the printer’s MAC address must be added to the WAP’s list of accepted MAC addresses.

- Print the network configuration page. For more information, see [Understand the network configuration page](#).
- Open the WAP’s configuration utility, and add the printer’s hardware address to the list of accepted MAC addresses.

## Configure your firewall to work with printers

A personal firewall, which is security software running on your computer, can block network communication between your printer and your computer.

If you are having problems such as:

- Printer not found when installing HP software
- Unable to print, print job stuck in queue or printer goes offline
- Scan communication errors or scanner busy messages
- Unable to see printer status on your computer

The firewall might be preventing your printer from notifying computers on your network where it can be found. If the HP software cannot find the printer during installation (and you know the printer is on the network), or you have already successfully installed HP software and experience problems, try the following:

1. If you are using a computer running Windows, in the firewall configuration utility, look for an option to trust computers on the local subnet (sometimes called the “scope” or “zone”). By trusting all computers on the local subnet, computers and devices in your home or office can communicate with each other while still being protected from the internet. This is the easiest approach to use.
2. If you do not have the option to trust computers on the local subnet, add incoming UDP port 427 to your firewall’s list of allowed ports.



**NOTE:** Not all firewalls require you to differentiate between incoming and outgoing ports, but some do.

---

Another common problem is that HP software is not set as a trusted software by your firewall to access the network. This can happen if you answered “block” to any firewall dialog boxes that appeared when you installed the HP software.

If this occurs, and if you are using a computer running Windows, check that the following programs are in your firewall’s list of trusted applications; add any that are missing.

- **hpqkygrp.exe**, located in **C:\program files\HP\ digital imaging\bin**
- **hpqscnvw.exe**, located in **C:\program files\HP\ digital imaging\bin**  
- or -
- **hpiscnapp.exe**, located in **C:\program files\HP\ digital imaging\bin**
- **hpqste08.exe**, located in **C:\program files\HP\ digital imaging\bin**
- **hpqtra08.exe**, located in **C:\program files\HP\ digital imaging\bin**
- **hpqthb08.exe**, located in **C:\program files\HP\ digital imaging\bin**

---

 **NOTE:** Refer to your firewall documentation on how to configure the firewall port settings and how to add HP files to the “trusted” list.

Some firewalls continue to cause interference even after you disable them. If you continue to have problems after configuring the firewall as described above and if you are using a computer running Windows, you might need to uninstall the firewall software in order to use the printer over the network.

---

### **Advanced firewall information**

The following ports are also used by your printer and might need to be opened on your firewall configuration. Incoming ports (UDP) are destination ports on the computer while outgoing ports (TCP) are destination ports on the printer.

- **Incoming (UDP) ports:** 137, 138, 161, 427
- **Outgoing (TCP) ports:** 137, 139, 427, 9100, 9220, 9500

**The ports are used for the following functions:**

#### **Printing**

- **UDP ports:** 427, 137, 161
- **TCP port:** 9100

#### **Photo card upload**

- **UDP ports:** 137, 138, 427
- **TCP port:** 139

#### **Scanning**

- **UDP port:** 427
- **TCP ports:** 9220, 9500

#### **HP printer status**

**UDP port:** 161

### Faxing

- **UDP port:** 427
- **TCP port:** 9220

### HP printer installation

**UDP port:** 427

## Solve printer management problems

This section provides solutions to common problems that involve managing the printer. This section contains the following topic:

- [EWS cannot be opened](#)



---

**NOTE:** To use the EWS, the printer must be connected to a network using either an Ethernet or a wireless connection. You cannot use the EWS if the printer is connected to a computer with a USB cable.

---

### EWS cannot be opened

#### Check your network setup

- Make sure you are not using a phone cord or a crossover cable to connect the printer to the network.
- Make sure the network cable is securely connected to the printer.
- Make sure the network hub, switch, or router is turned on and working correctly.

#### Check the computer

Make sure the computer that you are using is connected to the network.



---

**NOTE:** To use the EWS, the printer must be connected to a network using either an Ethernet or a wireless connection. You cannot use the EWS if the printer is connected to a computer with a USB cable.

---

#### Check your Web browser

- Make sure the Web browser meets the minimum system requirements. For more information, see [System requirements](#).
- If your Web browser uses any proxy settings to connect to the Internet, try turning off these settings. For more information, see the documentation available with your Web browser.
- Make sure JavaScript and cookies are enabled in your Web browser. For more information, see the documentation available with your Web browser.

### Check the printer IP address

- To check the IP address of the printer, obtain the IP address by printing a network configuration page. Touch **right arrow**, select **Setup**, select **Network**, and then select **Print Network Settings**.

- Ping the printer using the IP address from the command prompt.

For example, if the IP address is 123.123.123.123, type the following at the MS-DOS prompt:

```
C:\Ping 123.123.123.123
```

- Open Terminal (available in the Applications > Utilities folder) and type the following: ping 123.123.123
- Open the Network Utility (available in the Applications > Utilities folder) and click the **Ping** tab.

If a reply appears, the IP address is correct. If a time-out response appears, the IP address is incorrect.

## Troubleshoot installation issues

If the following topics do not help, see [Solve a problem](#) for information about HP support.

- [Hardware installation suggestions](#)
- [HP software installation suggestions](#)
- [Solve network problems](#)

### Hardware installation suggestions

This section contains the following topics:

- [Hardware tips](#)
- [Make sure the ink cartridges are correctly installed](#)

#### Hardware tips

##### Check the printer

- Make sure that all packing tape and material have been removed from outside and inside the printer.
- Make sure that the printer is loaded with paper.
- Make sure that no lights are on or blinking except the Ready light, which should be on. If the Attention light is blinking, check for messages on the printer control panel.

##### Check the hardware connections

- Make sure that any cords and cables that you are using are in good working order.
- Make sure that the power cord is connected securely to both the printer and to a working power outlet.

**Check the printhead and ink cartridges**

- Make sure that the printhead and all ink cartridges are firmly installed in their correct, color-coded slot. Press down firmly on each one to ensure correct contact. The printer cannot work if they are not all installed.
- Make sure that all latches and covers are closed correctly.

**Make sure the ink cartridges are correctly installed**

1. Make sure the printer is turned on.
2. Open the ink cartridge access door by lifting from the front right of the printer, until the door locks into place.



**NOTE:** Wait until the print carriage stops moving before proceeding.

---

3. Make sure the ink cartridges are installed in the correct slots.  
Match the shape of the icon and color of the ink cartridge with the slot that has the same shaped icon and color.
4. Run your finger along the top of the ink cartridges to locate any cartridges that are not snapped completely down.
5. Press down on any cartridges that are sticking up.  
They should snap down into place.
6. If an ink cartridge was sticking up and you were able to snap it back down into place, close the ink cartridge access door and check if the error has gone away.
  - If the error has gone away, stop troubleshooting here. The error has been resolved.
  - If the error has not gone away, proceed to the next step.
  - If none of the ink cartridges were sticking up, proceed to the next step.
7. Locate the ink cartridge that is indicated in the error, and then press the tab on the ink cartridge to release it from the slot.
8. Press the ink cartridge back down into place.  
The tab should make a snapping noise when the ink cartridge is correctly seated. If the ink cartridge did not make a snapping noise, the tab might need to be readjusted.
9. Remove the ink cartridge from the slot.
10. Gently bend the tab away from the ink cartridge.

---

△ **CAUTION:** Be careful not to bend the tab more than about 1.27 cm (0.5 inches).

---

11. Reinstall the ink cartridge.  
It should now snap down into place.
12. Close the ink cartridge access door, and check if the error has gone away.
13. If you still receive the error, turn the printer off, and then on again.

**HP software installation suggestions****Check the computer system**

- Make sure that your computer is running one of the supported operating systems.
- Make sure that the computer meets at least the minimum system requirements.



- In the Windows Device Manager, make sure that the USB drivers have not been disabled.
- If you are using a computer running Windows, and the computer cannot detect the printer, run the uninstallation utility (util\ccc\uninstall.bat on the installation CD) to perform a clean uninstallation of the printer driver. Restart your computer, and reinstall the printer driver.

### Verify installation preliminaries

- Make sure to use the installation CD that contains the correct HP software for your operating system.
- Before installing HP software, make sure that all other programs are closed.
- If the computer does not recognize the path to the CD-ROM drive that you type, make sure that you are specifying the correct drive letter.
- If the computer cannot recognize the installation CD in the CD-ROM drive, inspect the installation CD for damage. You can download the printer driver from the HP Web site ([www.hp.com/support](http://www.hp.com/support)).

---

 **NOTE:** After correcting any problems, run the installation program again.

---

## Solve network problems



### General network troubleshooting

- If you are unable to install the HP software, verify that:
  - All cable connections to the computer and the printer are secure.
  - The network is operational and the network hub is turned on.
  - All applications, including virus protection programs, spyware protection programs, and firewalls, are closed or disabled for computers running Windows.
  - Make sure the printer is installed on the same subnet as the computers that will be using the printer.
  - If the installation program cannot discover the printer, print the network configuration page and enter the IP address manually in the installation program. For more information, see [Understand the network configuration page](#).
- If you are using a computer running Windows, make sure that the network ports created in the printer driver match the printer IP address:
  - Print the printer's network configuration page.
  - Click **Start**, then click **Printers** or **Printers and Faxes**.
  - Or -
  - Click **Start**, click **Control Panel**, and then double-click **Printers**.
  - Right-click the printer icon, click **Properties**, and then click the **Ports** tab.
  - Select the TCP/IP port for the printer, and then click **Configure Port**.
  - Compare the IP address listed in the dialog box and make sure it matches the IP address listed on the network configuration page. If the IP addresses are different, change the IP address in the dialog box to match the address on the network configuration page.
  - Click **OK** twice to save the settings and close the dialog boxes.

### Problems connecting to a wired network

- If the **Network** light on the printer control panel does not turn on, make sure that all of the “General network troubleshooting” conditions are met.
- Though it is not recommended that you assign the printer with a static IP address, you might resolve some installation problems (such as a conflict with a personal firewall) by doing so.

### To reset the printer's network settings

1. Touch right arrow , touch **Network**, touch **Restore Network Defaults**, and then select **Yes**. A message appears stating that the network defaults have been restored.
2. Touch right arrow , touch **Reports**, and then select **Print Network Configuration Page** to print the network configuration page and verify that the network settings have been reset.

## Understand the Printer Status Report

Use the Printer Status Report to:

- View current printer information and ink cartridge status
- Help troubleshoot problems

The Printer Status Report also contains a log of recent events.

If you need to call HP, it is often useful to print the Printer Status Report before calling.

### Printer Status Report



**Printer Status Report**

**1**

**Product Information**

- 1. Model Name: HP MFP
- 2. Model Number
- 3. Device Name: HP-Print-Device-1
- 4. Product Number: C8800A
- 5. Version: 01.0001
- 6. Printer (Job) ID: 1
- 7. Previous Version File: HP-Print-Device-1
- 8. Print Path: Local: 0
- 9. Country/Region: US +1
- 10. Expansion: Disabled
- 11. HP Number

**Print Usage Information**

- 12. Total Pages Printed: 0
- 13. Total High Capacity Pages Printed: 0
- 14. Remaining Pages Printed: 0

**Ink Delivery System Information**

- 15. Ink: All
- 16. Ink Levels
- 17. Estimated Ink Levels

	Pages	Type	Value	Unit
18. Ink: Cyan	0	Standard	0	Pages
19. Ink: Magenta	0	Standard	0	Pages
20. Ink: Yellow	0	Standard	0	Pages
21. Ink: All	0	Standard	0	Pages
22. Ink: Remaining Total	0	Standard	0	Pages
23. Ink: Number	0	Standard	0	Pages

**Connectivity Settings**

- 18. Network Status: Offline
- 19. Active Connection Type: None
- 20. IP: 192.168.1.10
- 21. Subnet Mask: 255.255.255.0
- 22. Gateway: 192.168.1.1
- 23. Active Protocol: IPv4

**Scan Settings**

- 24. Print From: Scanboard-Unit: 0
- 25. Scan From: Flatbed: 0

**Scan Usage Information**

- 26. Pages Scanned: 0
- 27. Scan From: HP: 0

**Fan Settings**

- 28. Fan Speed: Station: 10000
- 29. Backup Fan: Reception: 0
- 30. Fan Preheating: Off
- 31. Fan Postheating: Off
- 32. Sleep to: Idle: 0
- 33. Idle Mode: High: 0: Power
- 34. Idle Mode: Low: Connected Mode: 0
- 35. Fan to: FC: Off

**Fan Usage Information**

- 36. Power On: 0
- 37. Power Reserve: 0

**Additional Assistance**

The most information about how to change settings and diagnose problems, use the user documentation for your device. The documentation is available in your computer after you install the software, either from the HP Solution Center Software (Windows) or the Help Viewer (Mac OS).

**Find Troubleshooting**

To search for your problem in online resources for this, use the Find Troub. You can search the path from the device control panel or from the HP Solution Center Software.

**Wireless Network: Test**

To verify your wireless network connectivity for Windows, use the Wireless Network Test. You can search the path from the device control panel or from the HP Solution Center Software.

- 1. Printer Information:** Shows printer information (such as the printer name, model number, serial number, and firmware version number), as well as usage information printed from the tray.
- 2. Ink Delivery System Information:** Shows information about the ink cartridges, such as the estimated ink levels.

 **NOTE:** Ink level alerts and indicators provide estimates for planning purposes only. When you receive a low-ink alert, consider having a replacement cartridge available to avoid possible printing delays. You do not need to replace the ink cartridges until print quality becomes unacceptable.

- 3. Additional Assistance:** Provides information about available methods for finding more information about the printer, as well as information about diagnosing problems.

### To print the Printer Status Report

- ▲ Touch **Setup**, select **Reports**, select **Printer Status Report**.

## Understand the network configuration page

If the printer is connected to a network, you can print a network configuration page to view the network settings for the printer. You can use the network configuration page to help troubleshoot network connectivity problems. If you need to call HP, it is often useful to print this page before calling.

### Network Configuration Page



The screenshot shows the HP Network Configuration Page with the following sections and settings:

HP Network Configuration Page		
<b>General Information</b>		
Network Status	Office	Name
Network Connection Type	HP Jet Direct	Name
URL for Embedded Web Server	http://192.168.1.1	Name
Firmware Revision	000.000.000.000	Name
Manufacturer	HP	Name
Serial Number	HP1234567890123456	Name
Model Name	HP Jet Direct	Name
<b>IEEE 802.3 Wired</b>		
Hardware Address (MAC)	080020123456	Name
Link Configuration	Enabled	Name
<b>IEEE 802.11 Wireless</b>		
Hardware Address (MAC)	080020123456	Name
Status	Disconnected	Name
Communication Mode	Ad-hoc	Name
Network Name (SSID)	HP-xxxxxx-80211B	Name
<b>Port 9100</b>		
Status	Enabled	Name
<b>HTTP</b>		
Status	Enabled	Name
<b>Microsoft Web Services</b>		
WSD Discovery	Enabled	Name
Status	Enabled	Name
WSD Print	Enabled	Name
Status	Enabled	Name

1. **General Information:** Shows information about the current status and active connection type of the network, and other information, such as the URL of the embedded Web server.
2. **802.3 Wired:** Shows information about the active wired network connection, such as the IP address, subnet mask, default gateway, as well as the hardware address of the printer.
3. **802.11 Wireless:** Shows information about the active wireless network connection, such as the IP address, the communication mode, the network name, authentication type, and signal strength.
4. **mDNS:** Shows information about the active Multicast Domain Name System (mDNS) connection. mDNS services are typically used on small networks for IP address and name resolution (through UDP port 5353) where a conventional DNS server is not used.
5. **SLP:** Shows information about the current Service Location Protocol (SLP) connection. SLP is used by network management applications for printer management. The printer supports SNMPv1 protocol on IP networks.

### To print the network configuration page from the printer control panel

Touch **Setup**, select **Reports**, select **Network Configuration Page**.

## Clear jams

Occasionally, media becomes jammed during a job. Try the following remedies to reduce jams.

- Make sure that you are printing with media that meets specifications. For more information, see [Media specifications](#).
- Make sure that you are printing with media that is not wrinkled, folded, or damaged.
- Make sure that the printer is clean. For more information, see [Maintain the printer](#).
- Make sure that the trays are loaded correctly and are not too full. For more information, see [Load media](#).

This section contains the following topics:

- [Clear paper jams](#)
- [Avoid paper jams](#)

### Clear paper jams

If the paper was loaded in the main tray, you might need to clear the paper jam from the rear door.

Paper can also jam in the automatic document feeder (ADF). Several common actions can cause paper to jam the ADF:

- Placing too much paper in the ADF tray. For information on the maximum number of sheets allowed in the ADF, see [Load an original on the scanner glass](#).
- Using paper that is too thick or too thin for the printer.
- Trying to add paper to the ADF tray while the printer is feeding pages.

## To clear a paper jam from the rear door

Use these steps to clear a paper jam.

1. Press in the tab on the left side of the rear door to release the door. Remove the door by pulling it away from the printer.

---

△ **CAUTION:** Trying to clear a paper jam from the front of the printer can damage the print mechanism. Always access and clear paper jams through the rear door.

---

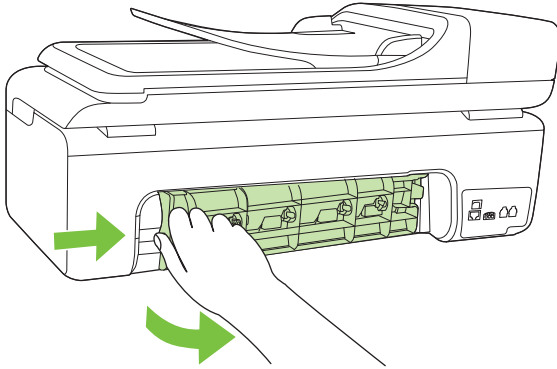

2. Gently pull the paper out of the rollers.

---

△ **CAUTION:** If the paper tears when you are removing it from the rollers, check the rollers and wheels for torn pieces of paper that might be remaining inside the printer. If you do not remove all the pieces of paper from the printer, more paper jams are likely to occur.

---

3. Replace the rear door. Gently push the door forward until it snaps into place.
4. Touch **OK** to continue the current job.

### To clear a paper jam in the automatic document feeder (ADF)

1. Lift the cover of the ADF.

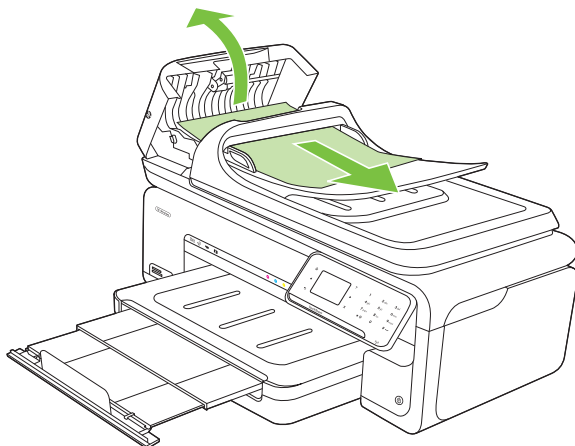

2. Gently pull the paper out of the rollers.

---

△ **CAUTION:** If the paper tears when you are removing it from the rollers, check the rollers and wheels for torn pieces of paper that might be remaining inside the printer. If you do not remove all the pieces of paper from the printer, more paper jams are likely to occur.

---

3. Close the cover of the ADF.

### Avoid paper jams

To help avoid paper jams, follow these guidelines.

- Remove printed papers from the output tray frequently.
- Prevent curled or wrinkled paper by storing all unused paper flat in a resealable bag.
- Ensure that paper loaded in the input tray lays flat and the edges are not bent or torn.
- Do not combine different paper types and paper sizes in the input tray; the entire stack of paper in the input tray must be the same size and type.
- Adjust the paper-width guide in the input tray to fit snugly against all paper. Make sure the paper-width guide does not bend the paper in the input tray.
- Do not force paper too far forward in the input tray.
- Use paper types that are recommended for the printer. For more information, see [Media specifications](#).

---

 **NOTE:** Humidity may cause paper to curl and hence paper jam.

---

---

# A Technical information

This section contains the following topics:

- [Warranty information](#)
- [Printer specifications](#)
- [Regulatory information](#)
- [Environmental product stewardship program](#)
- [Third-party licenses](#)

## Warranty information

This section contains the following topics:

- [Hewlett-Packard limited warranty statement](#)
- [Ink cartridge warranty information](#)

## Hewlett-Packard limited warranty statement

HP product	Duration of limited warranty
Software Media	90 days
Printer	1 year
Print or Ink cartridges	Until the HP ink is depleted or the "end of warranty" date printed on the cartridge has been reached, whichever occurs first. This warranty does not cover HP ink products that have been refilled, remanufactured, refurbished, misused, or tampered with.
Printheads (only applies to products with customer replaceable printheads)	1 year
Accessories	1 year unless otherwise stated

### A. Extent of limited warranty

- Hewlett-Packard (HP) warrants to the end-user customer that the HP products specified above will be free from defects in materials and workmanship for the duration specified above, which duration begins on the date of purchase by the customer.
- For software products, HP's limited warranty applies only to a failure to execute programming instructions. HP does not warrant that the operation of any product will be interrupted or error free.
- HP's limited warranty covers only those defects that arise as a result of normal use of the product, and does not cover any other problems, including those that arise as a result of:
  - Improper maintenance or modification;
  - Software, media, parts, or supplies not provided or supported by HP;
  - Operation outside the product's specifications;
  - Unauthorized modification or misuse.
- For HP printer products, the use of a non-HP cartridge or a refilled cartridge does not affect either the warranty to the customer or any HP support contract with the customer. However, if printer failure or damage is attributable to the use of a non-HP or refilled cartridge or an expired ink cartridge, HP will charge its standard time and materials charges to service the printer for the particular failure or damage.
- If HP receives, during the applicable warranty period, notice of a defect in any product which is covered by HP's warranty, HP shall either repair or replace the product, at HP's option.
- If HP is unable to repair or replace, as applicable, a defective product which is covered by HP's warranty, HP shall, within a reasonable time after being notified of the defect, refund the purchase price for the product.
- HP shall have no obligation to repair, replace, or refund until the customer returns the defective product to HP.
- Any replacement product may be either new or like-new, provided that it has functionality at least equal to that of the product being replaced.
- HP products may contain remanufactured parts, components, or materials equivalent to new in performance.
- HP's Limited Warranty Statement is valid in any country where the covered HP product is distributed by HP. Contracts for additional warranty services, such as on-site service, may be available from any authorized HP service facility in countries where the product is distributed by HP or by an authorized importer.

### B. Limitations of warranty

TO THE EXTENT ALLOWED BY LOCAL LAW, NEITHER HP NOR ITS THIRD PARTY SUPPLIERS MAKES ANY OTHER WARRANTY OR CONDITION OF ANY KIND, WHETHER EXPRESS OR IMPLIED WARRANTIES OR CONDITIONS OF MERCHANTABILITY, SATISFACTORY QUALITY, AND FITNESS FOR A PARTICULAR PURPOSE.

### C. Limitations of liability

- To the extent allowed by local law, the remedies provided in this Warranty Statement are the customer's sole and exclusive remedies.
- TO THE EXTENT ALLOWED BY LOCAL LAW, EXCEPT FOR THE OBLIGATIONS SPECIFICALLY SET FORTH IN THIS WARRANTY STATEMENT, IN NO EVENT SHALL HP OR ITS THIRD PARTY SUPPLIERS BE LIABLE FOR DIRECT, INDIRECT, SPECIAL, INCIDENTAL, OR CONSEQUENTIAL DAMAGES, WHETHER BASED ON CONTRACT, TORT, OR ANY OTHER LEGAL THEORY AND WHETHER ADVISED OF THE POSSIBILITY OF SUCH DAMAGES.

### D. Local law

- This Warranty Statement gives the customer specific legal rights. The customer may also have other rights which vary from state to state in the United States, from province to province in Canada, and from country to country elsewhere in the world.
- To the extent that this Warranty Statement is inconsistent with local law, this Warranty Statement shall be deemed modified to be consistent with such local law. Under such local law, certain disclaimers and limitations of this Warranty Statement may not apply to the customer. For example, some states in the United States, as well as some governments outside the United States (including provinces in Canada), may:
  - Preclude the disclaimers and limitations in this Warranty Statement from limiting the statutory rights of a consumer (e.g., the United Kingdom);
  - Otherwise restrict the ability of a manufacturer to enforce such disclaimers or limitations; or
  - Grant the customer additional warranty rights, specify the duration of implied warranties which the manufacturer cannot disclaim, or allow limitations on the duration of implied warranties.
- THE TERMS IN THIS WARRANTY STATEMENT, EXCEPT TO THE EXTENT LAWFULLY PERMITTED, DO NOT EXCLUDE, RESTRICT, OR MODIFY, AND ARE IN ADDITION TO, THE MANDATORY STATUTORY RIGHTS APPLICABLE TO THE SALE OF THE HP PRODUCTS TO SUCH CUSTOMERS.

#### HP Limited Warranty

Dear Customer,

You will find below the name and address of the HP entity responsible for the performance of the HP Limited Warranty in your country.

**You may have additional statutory rights against the seller based on your purchase agreement. Those rights are not in any way affected by this HP Limited Warranty.**

**Ireland:** Hewlett-Packard Ireland Limited, 63-74 Sir John Rogerson's Quay, Dublin 2

**United Kingdom:** Hewlett-Packard Ltd, Cain Road, Bracknell, GB-Berks RG12 1HN

**Malta:** Hewlett Packard International Trade BV, Branch 48, Sqaq Nru 2, Triq ix-Xatt, Pieta MSD08, Malta

**South Africa:** Hewlett-Packard South Africa Ltd, 12 Autumn Street, Rivonia, Sandton, 2128, Republic of South Africa



## Ink cartridge warranty information

The HP cartridge warranty is applicable when the product is used in its designated HP printing device. This warranty does not cover HP ink products that have been refilled, remanufactured, refurbished, misused, or tampered with.

During the warranty period the product is covered as long as the HP ink is not depleted and the end of warranty date has not been reached. The end of warranty date, in YYYY/MM format, may be found on the product as indicated:

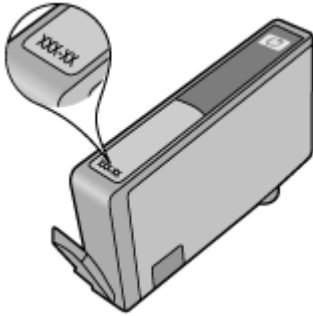

## Printer specifications

This section contains the following topics:

- [Physical specifications](#)
- [Printer features and capacities](#)
- [Processor and memory specifications](#)
- [System requirements](#)
- [Network protocol specifications](#)
- [Embedded Web server specifications](#)
- [Media specifications](#)
- [Print resolution](#)
- [Copy specifications](#)
- [Fax specifications](#)
- [Scan specifications](#)
- [HP Web site specifications](#)
- [Operating environment](#)
- [Electrical requirements](#)
- [Acoustic emission specification](#)
- [Memory card specifications](#)

### Physical specifications

#### Size (width x depth x height)

603 x 292 x 287.6 mm (23.7 x 11.5 x 11.3 inches)

#### Printer weight (does not include print supplies)

12 kg (26.5 lb)

### Printer features and capacities

Feature	Capacity
Connectivity	<ul style="list-style-type: none"> <li>• USB 2.0-compliant high speed device</li> <li>• Wired (Ethernet) network</li> <li>• Wireless 802.11n</li> </ul>
Ink cartridges	Four ink cartridges (black, yellow, magenta, cyan)
Supply yields	Visit <a href="http://www.hp.com/pageyield/">www.hp.com/pageyield/</a> for more information on estimated ink cartridge yields.
Printer languages	HP PCL 3 GUI
Duty cycle	Up to 7000 pages per month
Printer control panel language support Language availability varies by country/region.	Bulgarian, Croatian, Czech, Danish, Dutch, English, Finnish, French, German, Greek, Hungarian, Italian, Japanese, Korean, Norwegian, Polish, Portuguese, Romanian, Russian, Simplified Chinese, Slovak, Slovenian, Spanish, Swedish, Traditional Chinese, Turkish.

## Processor and memory specifications

Processor: 192 MHz ARM9 core

Memory: 128 MB DDR1

## System requirements



**NOTE:** For the most current information about supported operating systems and system requirements, visit [www.hp.com/support](http://www.hp.com/support).

### Operating system compatibility

- Windows XP Service Pack 2, Windows Vista, Windows 7
- Mac OS X (v10.5, v10.6)
- Linux (For more information, see <http://hplipopensource.com/hplip-web/index.html>).

### System requirements

- Microsoft Windows XP (32-bit) Service Pack 2: Intel Pentium II , Celeron® or compatible processor; 233 MHz or higher; 128 MB RAM, 750MB hard disk space, CD-ROM/DVD drive or internet connection, USB port
- Microsoft Windows Vista: 800 MHz 32-bit (x86) or 64-bit (x64) processor; 512 MB RAM, 2.0GB hard disk space, CD-ROM/DVD drive or internet connection, USB port
- Microsoft Windows 7: 1 GHz 32-bit (x86) or 64-bit (x64) processor; 1 GB (32-bit) or 2 GB (64-bit) RAM, 1.5GB hard disk space, CD-ROM/DVD drive or internet connection, USB port
- Mac OS X (v10.5.8, v10.6): PowerPC G4, G5, or Intel Core processor, 300 MB free hard disk space

## Network protocol specifications

### Network operating system compatibility

- Windows XP (32-bit) (Professional and Home Editions), Windows Vista 32-bit and 64-bit (Ultimate Edition, Enterprise Edition and Business Edition), Windows 7 (32-bit and 64-bit)
- Windows Small Business Server 2003 32-bit and 64-bit, Windows 2003 Server 32-bit and 64-bit, Windows 2003 Server R2 32-bit and 64-bit (Standard Edition, Enterprise Edition)
- Windows Small Business Server 2008 64-bit, Windows 2008 Server 32-bit and 64-bit, Windows 2008 Server R2 64-bit (Standard Edition, Enterprise Edition)
- Citrix XenDesktop 4
- Citrix XenServer 5.5
- Mac OS X v10.5, v10.6
- Microsoft Windows 2003 Server Terminal Services
- Microsoft Windows 2003 Server Terminal Services with Citrix Presentation Server 4.0
- Microsoft Windows 2003 Server Terminal Services with Citrix Presentation Server 4.5
- Microsoft Windows 2003 Server Terminal Services with Citrix XenApp 5.0
- Microsoft Windows 2003 Server Terminal Services with Citrix Metaframe XP with Feature Release 3
- Microsoft Windows 2003 Small Business Server Terminal Services
- Microsoft Windows Server 2008 Terminal Services
- Microsoft Windows Small Business Server 2008 Terminal Services
- Microsoft Windows 2008 Server Terminal Services with Citrix XenApp 5.0
- Novell Netware 6.5, Open Enterprise Server 2

### Compatible network protocols

TCP/IP

**Network management**

Embedded Web server

Features

Ability to remotely configure and manage network devices

**Embedded Web server specifications****Requirements**

- A TCP/IP-based network (IPX/SPX-based networks are not supported)
- A Web browser (either Microsoft Internet Explorer 7.0 or higher, Opera 8.0 or higher, Mozilla Firefox 1.0 or higher, Safari 1.2 or higher, or Google Chrome)
- A network connection (you cannot use the embedded Web server connected directly to a computer with a USB cable)
- An Internet connection (required for some features)



**NOTE:** You can open the embedded Web server without being connected to the Internet. However, some features are not available.

- It must be on the same side of a firewall as the printer.

**Media specifications**

Use the [Understand supported sizes](#) and [Understand supported media types and weights](#) tables to determine the correct media to use with your printer, and determine what features will work with your media. See the [Set minimum margins](#) section for information about the printing margins used by the printer, see the [Guidelines for two-sided \(duplex\) printing](#) section for guidelines that should be followed when printing on both side of a page.

**Understand specifications for supported media**

Always use the correct media-type setting in the printer driver, and configure the trays for the correct media type. HP recommends testing any paper before buying it in large quantities.

- [Understand supported sizes](#)
- [Understand supported media types and weights](#)

**Understand supported sizes**

Media size	Main tray	ADF
<b>Standard media sizes</b>		
U.S. Letter (216 x 279 mm; 8.5 x 11 inches) Also supports Borderless printing.	✓	✓
U.S. Legal (216 x 356 mm; 8.5 x 14 inches)	✓	✓
A4 (210 x 297 mm; 8.3 x 11.7 inches) Also supports Borderless printing.	✓	✓
U.S. Executive (184 x 267 mm; 7.25 x 10.5 inches)	✓	✓

(continued)

<b>Media size</b>	<b>Main tray</b>	<b>ADF</b>
B5 (JIS) (182 x 257 mm; 7.17 x 10.12 inches) Also supports Borderless printing.	✓	✓
B5 (ISO) (176 x 250 mm; 6.9 x 9.8 inches)	✓	
A5 (148 x 210 mm; 5.8 x 8.3 inches) Also supports Borderless printing.	✓	
A6 (105 x 148 mm; 4.13 x 5.83 inches) Also supports Borderless printing.	✓	
HV(101 x 180 mm; 4.0 x 7.1 inches) Also supports Borderless printing.	✓	
13 x 18 cm (5 x 7 inches) Also supports Borderless printing.	✓	
<b>B size</b>		
11 x 14 inches Also supports Borderless printing.	✓	
12 x 12 inches Also supports Borderless printing.	✓	
B4 (JIS) (257 x 364 mm)	✓	
Tabloid (11 x 17 inches) Also supports Borderless printing.	✓	
Super B (13 x 19 inches) Also supports Borderless printing.	✓	
A3 (297 x 420 mm; 11.69 x 16.54 inches) Also supports Borderless printing.	✓	
A3+ (330 x 483 mm; 12.99 x 18.98 inches) Also supports Borderless printing.	✓	

(continued)

Media size	Main tray	ADF
<b>Envelopes</b>		
U.S. #10 Envelope (105 x 241 mm; 4.12 x 9.5 inches)	✓	
C6 Envelope (114 x 162 mm; 4.5 x 6.4 inches)	✓	
Japanese Envelope Chou #3 (120 x 235 mm; 4.7 x 9.3 inches)	✓	
Japanese Envelope Chou #4 (90 x 205 mm; 3.5 x 8.1 inches)	✓	
Japanese Envelop Kaku #2 (240 x 332 mm; 9.45 x 13.07 inches)	✓	
Monarch Envelope (3.88 x 7.5 inches)	✓	
Card Envelope (111 x 162 mm; 4.4 x 6 inches)	✓	
No. 6 3/4 Envelope (91 x 165 mm; 3.6 x 6.5 inches)	✓	
<b>Cards</b>		
Index card (76.2 x 127 mm; 3 x 5 inches)	✓	
Index card (102 x 152 mm; 4 x 6 inches)	✓	
Index card (127 x 203 mm; 5 x 8 inches)	✓	
<b>Photo media</b>		
3 x 5 (76.2 x 180 mm; 3 x 5 inches) Also supports Borderless printing.		
4 x 6 (102 x 152 mm; 4 x 6 inches) Also supports Borderless printing.	✓	
5 x 7 (13 x 18 cm; 5 x 7 inches) Also supports Borderless printing.	✓	
8 x 10 (8 x 10 inches) Also supports Borderless printing.	✓	
10 x 15 cm	✓	

(continued)

<b>Media size</b>	<b>Main tray</b>	<b>ADF</b>
Also supports Borderless printing.		
10 x 15 cm tab Also supports Borderless printing.	✓	
Photo L (89 x 127 mm; 3.5 x 5 inches) Also supports Borderless printing.	✓	
2L (178 x 127 mm; 7.0 x 5.0 inches) Also supports Borderless printing.	✓	
4 x 6 tab (102 x 152 mm; 4 x 6 inches) Also supports Borderless printing.	✓	
Cabinet size (120 x 165 mm; 4.7 x 6.5 inches) Also supports Borderless printing.	✓	
<b>Other media</b>		
Ofuku hagaki** (200 x 148 mm; 7.9 x 5.8 inches)	✓	
Hagaki** (100 x 148 mm; 3.9 x 5.8 inches) Also supports Borderless printing.	✓	
Custom-size media between 76.2 to 330.2 mm wide and 127 to 1117 mm long (3 to 13 inches wide and 5 to 44 inches long) Custom size media is not supported in Windows.	✓	✓

\*\* The printer is compatible with plain and inkjet hagaki from Japan Post only. It is not compatible with photo hagaki from Japan Post.

**Understand supported media types and weights**

Location	Type	Weight	Capacity
Input tray	Paper	60 to 105 g/m <sup>2</sup> (16 to 28 lb bond)	Up to 150 sheets of plain paper (15 mm or 0.59 inch stacked)
	Transparencies		Up to 55 sheets (15 mm or 0.59 inch stacked)
	Photo media	280 g/m <sup>2</sup> (75 lb bond)	Up to 40 sheets (12 mm or 0.47 inch stacked)
	Labels		Up to 40 sheets (8 mm or 0.31 inch stacked)
	Envelopes	75 to 90 g/m <sup>2</sup> (20 to 24 lb bond envelope)	Up to 15 sheets (8 mm or 0.31 inch stacked)
	Cards	Up to 200 g/m <sup>2</sup> (110 lb index)	Up to 40 cards (8 mm or 0.31 inch stacked)
Output tray	All supported media		Up to 100 sheets of plain paper (text printing)
Automatic Document Feeder	Paper	60 to 75 g/m <sup>2</sup> (16 to 20 lb bond)	35 sheets

**Set minimum margins**

The document margins must match (or exceed) these margin settings in portrait orientation.

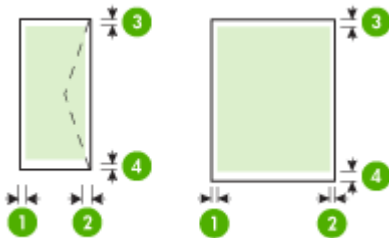



Media	(1) Left margin	(2) Right margin	(3) Top margin	(4) Bottom margin*
U.S. Letter	3.0 mm (0.125 inches)	3.0 mm (0.125 inches)	3.0 mm (0.125 inches)	3.0 mm (0.125 inches)
U.S. Legal				
A4				
U.S. Executive				
U.S. Statement				
B5				
A5				
Cards				
Custom-size media				
Photo media				
11x14in. Tabloid	5.0 mm (0.197 inches)	5.0 mm (0.197 inches)	20 mm (0.788 inches)	20 mm (0.788 inches)
12x12in. Tabloid				
B4 (JIS) Tabloid				
Tabloid				
Super B Tabloid				
A3 Tabloid				
A3+ (330x483mm Tabloid)				
Envelopes	3.0 mm (0.125 inches)	3.0 mm (0.125 inches)	3.0 mm (0.125 inches)	14.3 mm (0.563 inches)

 **NOTE:** Only Mac OS X supports custom paper sizes.

### Guidelines for two-sided (duplex) printing

- Always use media that conforms to the printer specifications. For more information, see [Media specifications](#).
- Do not print on both sides of transparencies, envelopes, photo paper, glossy media, or paper lighter than 16 lb bond (60 g/m<sup>2</sup>) or heavier than 28 lb bond (105 g/m<sup>2</sup>). Jams might occur with these media types.
- Several kinds of media require a specific orientation when you print on both sides of a page. These include letterhead, preprinted paper, and paper with watermarks and prepunched holes. When you print from a computer running Windows, the printer prints the first side of the media first. Load the media with the print side facing down.

### Print resolution

#### Black print resolution

Up to 1200 x 600 dpi black (when printing from a computer)

#### Color print resolution

Up to 4800 x 1200 optimized dpi color on select HP photo papers with 1200 input dpi. Photo papers include the following:

- HP Premium Plus Photo
- HP Premium Photo
- HP Advanced Photo

### Copy specifications

- Digital image processing
- ADF Input tray capacity: 35 sheet plain paper
- Digital zoom: from 25 to 400% (varies by model)
- Fit to page, Custom size, ID copy
- Copy speeds vary according to the complexity of the document
- ID Copy
- Up to 8 pages for copy collation

Refer to the following table to determine which paper type setting to choose based on the paper loaded in the main tray.

Paper type	Printer control panel setting
Plain paper	Plain Paper
HP Bright White Paper	Plain Paper
HP Premium Presentation Paper, Matte	Everyday Matte
Other inkjet papers	Everyday Matte
HP Premium Plus Photo Papers	Premium Photo Paper
HP Premium Photo Papers	Premium Photo Paper
HP Advanced Photo Paper	Premium Photo Paper
HP Everyday Photo Paper, Semi-gloss	Everyday Photo Paper
HP Everyday Photo Paper, Matte	Everyday Matte
Other photo papers	Photo Paper
HP Premium Inkjet Transparency	Transparency
HP Iron-on Transfer	Everyday Matte
HP Photo Cards	Premium Photo Paper
Other specialty papers	Everyday Matte
Glossy Greeting Card	Premium Photo Paper
Matte Greeting Card	Everyday Matte
HP Brochure & Flyer Paper, Glossy	Brochure Glossy
HP Brochure & Flyer Paper, Matte	Brochure Matte
Other Glossy Brochure	Brochure Glossy
Other Matte Brochure	Brochure Matte

### Fax specifications

- Walk-up black-and-white and color fax capability.
- Up to 99 speed dials (varies by model).

- Up to 100-page memory (varies by model, based on ITU-T Test Image #1 at standard resolution). More complicated pages or higher resolution takes longer and uses more memory. Also, other printer functions, such as copying, might affect the number of pages that can be stored in memory.
- Manual fax send and receive.
- Automatic busy redial up to five times (varies by model).
- Confirmation and activity reports.
- CCITT/ITU Group 3 fax with Error Correction Mode.
- 33.6 Kbps transmission.
- 3 seconds per page speed at 33.6 Kbps (based on ITU-T Test Image #1 at standard resolution). More complicated pages or higher resolution take longer and use more memory.
- Ring detect with automatic fax/answering machine switching.
- Junk fax blocker
- Digital fax
  - Paperless fax archive to PC or network
  - Paperless fax send from PC
- Non-volatile fax memory to retain faxes when out of paper

	Photo (dpi)	Very Fine (dpi)	Fine (dpi)	Standard (dpi)
Black	196 x 203 (8-bit grayscale)	300 x 300	196 x 203	196 x 98
Color	300 x 300	200 x 200	200 x 200	200 x 200

### Scan specifications

- Integrated OCR software automatically converts scanned text to editable text
- Scan speeds vary according to the complexity of the document
- Twain-compliant interface
- Resolution: 4800 x 4800 ppi optical
- Color: 24-bit per RGB color, 8-bit grayscale (256 levels of gray)
- Maximum scan size from glass: 216 x 355.6 mm (8.5 x 14 inches)
- Scan to memory card
- Scan to email for PDF and JPEG
- Scan to PC and network folder

### HP Web site specifications

The following Web-enabled features are available for this printer:

- [HP Apps](#)
- [Marketsplash by HP](#)
- [HP ePrint](#)

### Requirements

- A Web browser (either Microsoft Internet Explorer 6.0 or higher, Mozilla Firefox 2.0 or higher, Safari 3.2.3 or higher, or Google Chrome 3.0) with the Adobe Flash plug-in (version 10 or higher).
- An Internet connection

### Operating environment

#### Operating environment

Operating temperature: 5° to 40° C (41° to 104° F)

Recommended operating temperature: 15° to 32° C (59° to 90° F)

Recommended relative humidity: 20 to 80% noncondensing

**Storage environment**

Storage temperature: -40° to 60° C (-40° to 140° F)

Storage relative humidity: Up to 90% noncondensing at a temperature of 60° C (140° F)

**Electrical requirements**

**Power supply**

Universal power adapter (external)

**Power requirements**

Input voltage: 100 to 240 VAC (± 10%), 50/60 Hz (± 3Hz)

Output voltage: 32 Vdc at 1560 mA

**Power consumption**

28.4 watts printing (Fast Draft Mode); 32.5 watts copying (Fast Draft Mode)

**Acoustic emission specification**

Print in Draft mode, noise levels per ISO 7779

**Sound pressure (bystander position)**

LpAm 56 (dBA)

**Sound power**

LwAd 7.0 (BA)

**Memory card specifications**

- Maximum recommended number of files on a memory card: 1,000
- Maximum recommended individual file size: 12 megapixel maximum, 8 MB maximum
- Maximum recommended memory card size: 8 GB (solid state only)



**NOTE:** Approaching any of the recommended maximums on a memory card might cause the performance of the printer to be slower than expected.

---

**Supported memory card types**

- Secure Digital
- High Capacity Secure Digital
- Memory Stick
- MultiMediaCard (MMC)
- xD-Picture Card

## Regulatory information

The printer meets product requirements from regulatory agencies in your country/region.

This section contains the following topics:

- [FCC statement](#)
- [Notice to users in Korea](#)
- [VCCI \(Class B\) compliance statement for users in Japan](#)
- [Notice to users in Japan about the power cord](#)
- [Noise emission statement for Germany](#)
- [LED indicator statement](#)
- [Gloss of housing of peripheral devices for Germany](#)
- [Notice to users of the U.S. telephone network: FCC requirements](#)
- [Notice to users of the Canadian telephone network](#)
- [Notice to users in the European Economic Area](#)
- [Notice to users of the German telephone network](#)
- [Australia wired fax statement](#)
- [Regulatory information for wireless products](#)
- [Regulatory model number](#)
- [Declaration of conformity](#)

## FCC statement

### FCC statement

The United States Federal Communications Commission (in 47 CFR 15.105) has specified that the following notice be brought to the attention of users of this product.

This equipment has been tested and found to comply with the limits for a Class B digital device, pursuant to Part 15 of the FCC Rules. These limits are designed to provide reasonable protection against harmful interference in a residential installation. This equipment generates, uses and can radiate radio frequency energy and, if not installed and used in accordance with the instructions, may cause harmful interference to radio communications. However, there is no guarantee that interference will not occur in a particular installation. If this equipment does cause harmful interference to radio or television reception, which can be determined by turning the equipment off and on, the user is encouraged to try to correct the interference by one or more of the following measures:

- Reorient the receiving antenna.
- Increase the separation between the equipment and the receiver.
- Connect the equipment into an outlet on a circuit different from that to which the receiver is connected.
- Consult the dealer or an experienced radio/TV technician for help.

For further information, contact:

Manager of Corporate Product Regulations  
Hewlett-Packard Company  
3000 Hanover Street  
Palo Alto, Ca 94304  
(650) 857-1501

Modifications (part 15.21)

The FCC requires the user to be notified that any changes or modifications made to this device that are not expressly approved by HP may void the user's authority to operate the equipment.

This device complies with Part 15 of the FCC Rules. Operation is subject to the following two conditions: (1) this device may not cause harmful interference, and (2) this device must accept any interference received, including interference that may cause undesired operation.

## Notice to users in Korea

사용자 안내문(B급 기기)

이 기기는 비업무용으로 전자파 적합 등록을 받은 기기로서, 주거지역에서는 물론 모든 지역에서 사용할 수 있습니다.

## VCCI (Class B) compliance statement for users in Japan

この装置は、クラスB情報技術装置です。この装置は、家庭環境で使用することを目的としていますが、この装置がラジオやテレビジョン受信機に近接して使用されると、受信障害を引き起こすことがあります。取扱説明書に従って正しい取り扱いをして下さい。

VCCI-B

## Notice to users in Japan about the power cord

製品には、同梱された電源コードをお使い下さい。  
同梱された電源コードは、他の製品では使用出来ません。

## Noise emission statement for Germany

### **Geräuschemission**

LpA < 70 dB am Arbeitsplatz im Normalbetrieb nach DIN 45635 T. 19

## LED indicator statement

### **LED indicator statement**

The display LEDs meet the requirements of EN 60825-1.

## Gloss of housing of peripheral devices for Germany

Das Gerät ist nicht für die Benutzung im unmittelbaren Gesichtsfeld am Bildschirmarbeitsplatz vorgesehen. Um störende Reflexionen am Bildschirmarbeitsplatz zu vermeiden, darf dieses Produkt nicht im unmittelbaren Gesichtsfeld platziert werden.

## Notice to users of the U.S. telephone network: FCC requirements

### Notice to users of the U.S. telephone network: FCC requirements

This equipment complies with FCC rules, Part 68. On this equipment is a label that contains, among other information, the FCC Registration Number and Ringer Equivalent Number (REN) for this equipment. If requested, provide this information to your telephone company.

An FCC compliant telephone cord and modular plug is provided with this equipment. This equipment is designed to be connected to the telephone network or premises wiring using a compatible modular jack which is Part 68 compliant. This equipment connects to the telephone network through the following standard network interface jack: USOC RJ-11C.

The REN is useful to determine the quantity of devices you may connect to your telephone line and still have all of those devices ring when your number is called. Too many devices on one line might result in failure to ring in response to an incoming call. In most, but not all, areas the sum of the RENs of all devices should not exceed five (5). To be certain of the number of devices you may connect to your line, as determined by the REN, you should call your local telephone company to determine the maximum REN for your calling area.

If this equipment causes harm to the telephone network, your telephone company might discontinue your service temporarily. If possible, they will notify you in advance. If advance notice is not practical, you will be notified as soon as possible. You will also be advised of your right to file a complaint with the FCC. Your telephone company might make changes in its facilities, equipment, operations, or procedures that could affect the proper operation of your equipment. If they do, you will be given advance notice so you will have the opportunity to maintain uninterrupted service. If you experience trouble with this equipment, please contact the manufacturer, or look elsewhere in this manual, for warranty or repair information. Your telephone company might ask you to disconnect this equipment from the network until the problem has been corrected or until you are sure that the equipment is not malfunctioning.

This equipment may not be used on coin service provided by the telephone company.

Connection to party lines is subject to state tariffs. Contact your state public utility commission, public service commission, or corporation commission for more information.

This equipment includes automatic dialing capability. When programming and/or making test calls to emergency numbers:

- Remain on the line and explain to the dispatcher the reason for the call.
- Perform such activities in the off-peak hours, such as early morning or late evening.



**Note** The FCC hearing aid compatibility rules for telephones are not applicable to this equipment.

The Telephone Consumer Protection Act of 1991 makes it unlawful for any person to use a computer or other electronic device, including fax machines, to send any message unless such message clearly contains in a margin at the top or bottom of each transmitted page or on the first page of transmission, the date and time it is sent and an identification of the business, other entity, or other individual sending the message and the telephone number of the sending machine or such business, other entity, or individual. (The telephone number provided might not be a 900 number or any other number for which charges exceed local or long-distance transmission charges.) In order to program this information into your fax machine, you should complete the steps described in the software.



## Notice to users of the Canadian telephone network

### **Note à l'attention des utilisateurs du réseau téléphonique canadien/Notice to users of the Canadian telephone network**

Cet appareil est conforme aux spécifications techniques des équipements terminaux d'Industrie Canada. Le numéro d'enregistrement atteste de la conformité de l'appareil. L'abréviation IC qui précède le numéro d'enregistrement indique que l'enregistrement a été effectué dans le cadre d'une Déclaration de conformité stipulant que les spécifications techniques d'Industrie Canada ont été respectées. Néanmoins, cette abréviation ne signifie en aucun cas que l'appareil a été validé par Industrie Canada.

Pour leur propre sécurité, les utilisateurs doivent s'assurer que les prises électriques reliées à la terre de la source d'alimentation, des lignes téléphoniques et du circuit métallique d'alimentation en eau sont, le cas échéant, branchées les unes aux autres. Cette précaution est particulièrement importante dans les zones rurales.



**Remarque** Le numéro REN (Ringer Equivalence Number) attribué à chaque appareil terminal fournit une indication sur le nombre maximal de terminaux qui peuvent être connectés à une interface téléphonique. La terminaison d'une interface peut se composer de n'importe quelle combinaison d'appareils, à condition que le total des numéros REN ne dépasse pas 5.

Basé sur les résultats de tests FCC Partie 68, le numéro REN de ce produit est 0.0B.

This equipment meets the applicable Industry Canada Terminal Equipment Technical Specifications. This is confirmed by the registration number. The abbreviation IC before the registration number signifies that registration was performed based on a Declaration of Conformity indicating that Industry Canada technical specifications were met. It does not imply that Industry Canada approved the equipment.

Users should ensure for their own protection that the electrical ground connections of the power utility, telephone lines and internal metallic water pipe system, if present, are connected together. This precaution might be particularly important in rural areas.



**Note** The REN (Ringer Equivalence Number) assigned to each terminal device provides an indication of the maximum number of terminals allowed to be connected to a telephone interface. The termination on an interface might consist of any combination of devices subject only to the requirement that the sum of the Ringer Equivalence Numbers of all the devices does not exceed 5.

The REN for this product is 0.0B, based on FCC Part 68 test results.

## Notice to users in the European Economic Area

### Notice to users in the European Economic Area



This product is designed to be connected to the analog Switched Telecommunication Networks (PSTN) of the European Economic Area (EEA) countries/regions.

Network compatibility depends on customer selected settings, which must be reset to use the equipment on a telephone network in a country/region other than where the product was purchased. Contact the vendor or Hewlett-Packard Company if additional product support is necessary.

This equipment has been certified by the manufacturer in accordance with Directive 1999/5/EC (annex II) for Pan-European single-terminal connection to the public switched telephone network (PSTN). However, due to differences between the individual PSTNs provided in different countries, the approval does not, of itself, give an unconditional assurance of successful operation on every PSTN network termination point.

In the event of problems, you should contact your equipment supplier in the first instance.

This equipment is designed for DTMF tone dialing and loop disconnect dialing. In the unlikely event of problems with loop disconnect dialing, it is recommended to use this equipment only with the DTMF tone dial setting.

## Notice to users of the German telephone network

### Hinweis für Benutzer des deutschen Telefonnetzwerks

Dieses HP-Fax ist nur für den Anschluss eines analogen Public Switched Telephone Network (PSTN) gedacht. Schließen Sie den TAE N-Telefonstecker, der im Lieferumfang des HP All-in-One enthalten ist, an die Wandsteckdose (TAE 6) Code N an. Dieses HP-Fax kann als einzelnes Gerät und/oder in Verbindung (mit serielltem Anschluss) mit anderen zugelassenen Endgeräten verwendet werden.

## Australia wired fax statement

In Australia, the HP device must be connected to Telecommunication Network through a line cord which meets the requirements of the Technical Standard AS/ACIF S008.

## Regulatory information for wireless products

This section contains the following regulatory information pertaining to wireless products:

- [Exposure to radio frequency radiation](#)
- [Notice to users in Brazil](#)
- [Notice to users in Canada](#)
- [Notice to users in Taiwan](#)
- [European Union regulatory notice](#)

## Exposure to radio frequency radiation

### Exposure to radio frequency radiation



**Caution** The radiated output power of this device is far below the FCC radio frequency exposure limits. Nevertheless, the device shall be used in such a manner that the potential for human contact during normal operation is minimized. This product and any attached external antenna, if supported, shall be placed in such a manner to minimize the potential for human contact during normal operation. In order to avoid the possibility of exceeding the FCC radio frequency exposure limits, human proximity to the antenna shall not be less than 20 cm (8 inches) during normal operation.

## Notice to users in Brazil

### Aviso aos usuários no Brasil

Este equipamento opera em caráter secundário, isto é, não tem direito à proteção contra interferência prejudicial, mesmo de estações do mesmo tipo, e não pode causar interferência a sistemas operando em caráter primário. (Res. ANATEL 282/2001).

## Notice to users in Canada

### Notice to users in Canada/Note à l'attention des utilisateurs canadiens

**For Indoor Use.** This digital apparatus does not exceed the Class B limits for radio noise emissions from the digital apparatus set out in the Radio Interference Regulations of the Canadian Department of Communications. The internal wireless radio complies with RSS 210 and RSS GEN of Industry Canada.

**Utiliser à l'intérieur.** Le présent appareil numérique n'émet pas de bruit radioélectrique dépassant les limites applicables aux appareils numériques de la classe B prescrites dans le Règlement sur le brouillage radioélectrique édicté par le ministère des Communications du Canada. Le composant RF interne est conforme à la norme RSS-210 and RSS GEN d'Industrie Canada.

## Notice to users in Taiwan

### 低功率電波輻射性電機管理辦法

#### 第十二條

經型式認證合格之低功率射頻電機，非經許可，公司、商號或使用者均不得擅自變更頻率、加大功率或變更設計之特性及功能。

#### 第十四條

低功率射頻電機之使用不得影響飛航安全及干擾合法通信；經發現有干擾現象時，應立即停用，並改善至無干擾時方得繼續使用。

前項合法通信，指依電信法規定作業之無線電通信。低功率射頻電機須忍受合法通信或工業、科學及醫藥用電波輻射性電機設備之干擾。

## European Union regulatory notice

### European Union Regulatory Notice

Products bearing the CE marking comply with the following EU Directives:

- Low Voltage Directive 2006/95/EC
- EMC Directive 2004/108/EC

CE compliance of this product is valid only if powered with the correct CE-marked AC adapter provided by HP.

If this product has telecommunications functionality, it also complies with the essential requirements of the following EU Directive:

- R&TTE Directive 1999/5/EC

Compliance with these directives implies conformity to harmonized European standards (European Norms) that are listed in the EU Declaration of Conformity issued by HP for this product or product family. This compliance is indicated by the following conformity marking placed on the product.



The wireless telecommunications functionality of this product may be used in the following EU and EFTA countries:

Austria, Belgium, Bulgaria, Cyprus, Czech Republic, Denmark, Estonia, Finland, France, Germany, Greece, Hungary, Iceland, Ireland, Italy, Latvia, Liechtenstein, Lithuania, Luxembourg, Malta, Netherlands, Norway, Poland, Portugal, Romania, Slovak Republic, Slovenia, Spain, Sweden, Switzerland and United Kingdom.

#### Products with 2.4-GHz wireless LAN devices

##### France

For 2.4 GHz Wireless LAN operation of this product certain restrictions apply: This product may be used indoor for the entire 2400-2483.5 MHz frequency band (channels 1-13). For outdoor use, only 2400-2454 MHz frequency band (channels 1-9) may be used. For the latest requirements, see <http://www.art-telecom.fr>.



##### Italy

License required for use. Verify with your dealer or directly with the General Direction for Frequency Planning and Management (Direzione Generale Pianificazione e Gestione Frequenze).

### Regulatory model number

For regulatory identification purposes, your product is assigned a Regulatory Model Number. The Regulatory Model Number for your product is SNPRC-1005-01. This regulatory number should not be confused with the marketing name (HP Officejet 7500A (E910) Wide Format e-All-in-One) or product number.

## Declaration of conformity

		<b>DECLARATION OF CONFORMITY</b> according to ISO/IEC 17050-1 and EN 17050-1
<b>Supplier's Name:</b>	Hewlett-Packard Company	DoC#: SNPRC-1005-01-B
<b>Supplier's Address:</b>	138, Depot Road, #02-01, #04-01 Singapore 109683	
<b>declares, that the product</b>		
<b>Product Name and Model:</b>	HP Officejet 7500A Wide Format e-All-in-One Printer	
<b>Regulatory Model Number:<sup>1)</sup></b>	SNPRC-1005-01	
<b>Product Options:</b>	All	
<b>Radio Module</b>	SDGOB-0892	
<b>Power adaptor:</b>	0957-2271	
<b>conforms to the following Product Specifications and Regulations:</b>		
<b>SAFETY:</b>	IEC60950-1:2005 (2nd Edition) / EN60950-1:2006 EN 62311:2008	
<b>EMC:</b>	CISPR 22:2005 + A1:2005/EN55022:2006 + A1:2007 Class B EN 55024:1998 +A1:2001 + A2:2003 EN 61000-3-2:2006 EN 61000-3-3:1995 +A1: 2001 + A2:2005 FCC CFR 47, Part 15 Class B / ICES-003, Issue 4 Class B ETSI EN301 489-1 V1.8.1:2008-04, ETSI EN301 489-17 V1.3.2:2008-04	
<b>Telecom:</b>	TBR 21: 1998 <sup>3)</sup> FCC Rules and Regulations 47CFR Part 68 TIA-968-A-1+A-2+A-3+A-4+A-5 Telecommunications – Telephone Terminal Equipment CS-03, Part I, Issue 9, Feb 2005 EN 300 328 V1.7.1:2006	
<b>Energy Use:</b>	Regulation (EC) No. 1275/2008 ENERGY STAR ® Qualified Imaging Equipment Operational Mode (OM) Test Procedure Regulation (EC) No. 278/2009 Test Method for Calculating the Energy Efficiency of Single-Voltage External Ac-Dc and Ac-Ac Power Supplies	
<b>Supplementary Information:</b>		
<ol style="list-style-type: none"><li>1. This product is assigned a Regulatory Model Number which stays with the regulatory aspects of the design. The Regulatory Model Number is the main product identifier in the regulatory documentation and test reports, this number should not be confused with the marketing name or the product numbers.</li><li>2. This product complies with the requirements of the Low Voltage Directive 2006/95/EC, the EMC Directive 2004/108/EC, the EuP Directive 2005/32/EC &amp; the R&amp;TTE Directive 99/5/EC and carries the  marking accordingly. In addition, it complies with the WEEE Directive 2002/96/EC and RoHS Directive 2002/95/EC.</li><li>3. This product complies with TBR21:1998, except clause 4.7.1 (DC characteristic), which complies with ES 203 021-3, clause 4.7.1.</li><li>4. This Device complies with Part 15 of the FCC Rules. Operation is subject to the following two Conditions: (1) This device may not cause harmful interference, and (2) this device must accept any interference received, including interference that may cause undesired operation.</li><li>5. The product was tested in a typical configuration.</li></ol>		
<b>Singapore</b> <b>3 March 2010</b>		<hr/> <b>Yik Hou Meng</b> <b>Product Regulations Manager</b> <b>Customer Assurance, Business Printing Division</b>
<b>Local contact for regulatory topics only:</b> EMEA: Hewlett-Packard GmbH, HQ-TRE, Herrenberger Strasse 140, 71034 Boeblingen, Germany <a href="http://www.hp.com/go/certificates">www.hp.com/go/certificates</a> USA: Hewlett-Packard, 3000 Hanover St., Palo Alto 94304, U.S.A. 650-857-1501		

## Environmental product stewardship program

Hewlett-Packard is committed to providing quality products in an environmentally sound manner. Design for recycling has been incorporated into this product. The number of materials has been kept to a minimum while ensuring proper functionality and reliability. Dissimilar materials have been designed to separate easily. Fasteners and other connections are easy to locate, access, and remove using common tools. High priority parts have been designed to access quickly for efficient disassembly and repair.

For more information, visit HP's Commitment to the Environment Web site at:

[www.hp.com/hpinfo/globalcitizenship/environment/index.html](http://www.hp.com/hpinfo/globalcitizenship/environment/index.html)

This section contains the following topics:

- [Paper use](#)
- [Plastics](#)
- [Material safety data sheets](#)
- [Recycling program](#)
- [HP inkjet supplies recycling program](#)
- [Disposal of waste equipment by users in private households in the European Union](#)
- [Power consumption](#)
- [Chemical Substances](#)
- [RoHS notices \(China only\)](#)

### Paper use

This printer is suited for the use of recycled paper according to DIN 19309 and EN 12281:2002.

### Plastics

Plastic parts over 25 grams are marked according to international standards that enhance the ability to identify plastics for recycling purposes at the end of product life.

### Material safety data sheets

Material safety data sheets (MSDS) can be obtained from the HP Web site at:

[www.hp.com/go/msds](http://www.hp.com/go/msds)

### Recycling program

HP offers an increasing number of product return and recycling programs in many countries/regions, and partners with some of the largest electronic recycling centers throughout the world. HP conserves resources by reselling some of its most popular products. For more information regarding recycling of HP products, please visit:

[www.hp.com/hpinfo/globalcitizenship/environment/recycle/](http://www.hp.com/hpinfo/globalcitizenship/environment/recycle/)

### HP inkjet supplies recycling program

HP is committed to protecting the environment. The HP Inkjet Supplies Recycling Program is available in many countries/regions, and lets you recycle used print cartridges and ink cartridges free of charge. For more information, go to the following Web site:

[www.hp.com/hpinfo/globalcitizenship/environment/recycle/](http://www.hp.com/hpinfo/globalcitizenship/environment/recycle/)

# Disposal of waste equipment by users in private households in the European Union



## Disposal of Waste Equipment by Users in Private Households in the European Union

This symbol on the product or on its packaging indicates that this product must not be disposed of with your other household waste. Instead, it is your responsibility to dispose of your waste equipment by handing it over to a designated collection point for the recycling of waste electrical and electronic equipment. The separate collection and recycling of your waste equipment at the time of disposal will help to conserve natural resources and ensure that it is recycled in a manner that protects human health and the environment. For more information about where you can drop off your waste equipment for recycling, please contact your local city office, your household waste disposal service or the shop where you purchased the product.

## Evacuación de los equipos eléctricos y electrónicos usados por los usuarios domésticos en los hogares privados en la Unión Europea

La presencia de este símbolo en el producto o en su embalaje indica que este producto no puede ser desechado con los residuos domésticos. En su lugar, es su responsabilidad disponer de su equipo eléctrico y electrónico usando un punto de recogida designado para el reciclado de aparatos eléctricos y electrónicos. La recogida y el reciclado de su equipo eléctrico y electrónico al momento de su eliminación ayudará a preservar recursos naturales y a garantizar que el reciclaje proteja la salud y el medio ambiente. Si desea información adicional sobre los lugares donde puede dejar estos residuos para su reciclado, póngase en contacto con las autoridades locales de su ciudad, con el servicio de gestión de residuos domésticos o con la tienda donde adquirió el producto.

## Entsorgung von Elektrogeräten durch Benutzer in privaten Haushalten in der EU

Dieses Symbol auf dem Produkt oder dessen Verpackung gibt an, dass das Produkt nicht zusammen mit dem Restmüll entsorgt werden darf. Es obliegt daher Ihrer Verantwortung, das Gerät an einer entsprechenden Stelle für die Entsorgung oder Wiederverwertung von Elektrogeräten aller Art abzugeben (z.B. ein Wertstoffhof). Die separate Sammlung und das Recycling Ihrer alten Elektrogeräte zum Zeitpunkt Ihrer Entsorgung trägt zum Schutz der Umwelt bei und gewährleistet, dass sie auf eine Art und Weise recycelt werden, die keine Gefährdung für die Gesundheit des Menschen und der Umwelt darstellt. Weitere Informationen darüber, wo Sie alle Elektrogeräte zum Recyceln abgeben können, erhalten Sie bei den örtlichen Behörden, Wertschaffhöfen oder dort, wo Sie das Gerät erworben haben.

## Smaltimento di apparecchiature da rottamare da parte di privati nell'Unione Europea

Questo simbolo che appare sul prodotto o sulla confezione indica che il prodotto non deve essere smaltito assieme agli altri rifiuti domestici. Gli utenti devono provvedere allo smaltimento delle apparecchiature da rottamare in base al regolamento nazionale la conservazione delle risorse naturali e garantiscono che tali apparecchiature vengano rottamate nel rispetto dell'ambiente e della tutela della salute. Per ulteriori informazioni sui punti di raccolta delle apparecchiature da rottamare, contattare il proprio comune di residenza, il servizio di smaltimento dei rifiuti locali o il negozio presso il quale è stato acquistato il prodotto.

## Eliminación de residuos de aparatos eléctricos y electrónicos por parte de usuarios domésticos en la Unión Europea

Este símbolo en el producto o en el embalaje indica que no se puede deshechar el producto junto con los residuos domésticos. Por el contrario, si debe eliminar este tipo de residuos, es responsable del uso adecuado en un punto de recogida designado para el reciclado de aparatos eléctricos y electrónicos. El reciclaje y la recogida por separado de estos residuos en el momento de la eliminación ayudará a preservar recursos naturales y a garantizar que el reciclaje proteja la salud y el medio ambiente. Si desea información adicional sobre los lugares donde puede dejar estos residuos para su reciclado, póngase en contacto con las autoridades locales de su ciudad, con el servicio de gestión de residuos domésticos o con la tienda donde adquirió el producto.

## Likvidace vyloučeného zařízení užívatel v domácnosti v zemích EU

Tato značka na produktu nebo na jeho obalu označuje, že tento produkt nesmí být likvidován společně vyloučeného odpadu. Odpovědné za to, že vyloučené zařízení bude vyloučeno na určeném místě pro sběr odpadu, je uživatel. Správné odstranění a recyklace vyloučeného zařízení pomůže zachránit přírodní zdroje a zajistí, že recyklace proběhne způsobem chránícím lidské zdraví a životní prostředí. Další informace o tom, kam můžete vyloučené zařízení předat ke recyklaci, můžete získat od místní samosprávy, od společnosti provádějící svoz o likvidaci domovního odpadu nebo v obchodě, kde jste produkt zakoupili.

## Bortskaffelse af affaldsudstyr for brugere i private husholdninger i EU

Dette symbol på produktet eller på dets emballage indikerer, at produktet ikke må bortskaffes sammen med andet husholdningsaffald. Det er dit ansvar at bortskaffe affaldsudstyr ved at aflevere det på et designet indsamlingspunkt for genbrug af elektriske og elektroniske apparater. Den separate indsamling og genbrug af dit affaldsudstyr på indsamlingspunktet for bortskaffelse er med til at bevare naturlige ressourcer og sikre, at genbrug finder sted på en måde, der beskytter menneskers helbred samt miljøet. Hvis du vil vide mere om, hvor du kan aflevere dit affaldsudstyr til genbrug, kan du kontakte kommunen, den lokale myndighed eller den forretning, hvor du købte produktet.

## Afoer van afgedankte apparatuur door gebruikers in particuliere huishoudens in de Europese Unie

Dit symbool op het product of de verpakking geeft aan dat dit product niet mag worden afgevoerd met het huishoudelijk afval. Het is uw verantwoordelijkheid uw afgedankte apparatuur of de leverer op een aangewezen inzamelpunt voor de verwerking van afgedankte elektrische en elektronische apparatuur. De gescheiden inzameling en verwerking van uw afgedankte apparatuur draagt bij tot het sparen van natuurlijke hulpbronnen en tot het behoud van het milieu. Het recycling van afgedankte apparatuur helpt de gezondheid van de mens en het milieu te beschermen. Voor meer informatie over waar u uw afgedankte apparatuur kunt inleveren voor recycling kunt u contact opnemen met het gemeentebureau in uw woonplaats, de reinigingsdienst of de winkel waar u het product hebt aangekocht.

## Erasmopkõrgetes kasutatute kõrvaldamise teadmised käitlemise Euroopa Liidus

Täna lootele viia loote pakendil on see sümbol, et iga teie loode viiakse otse loote kogumispunkti. Teie loode on viia tarbeks muundatud seade selleks ettenahd elektrilise ja elektronika seadmete alaliseimiseks. Tähtsustatud teadmised seadmete eraldi kogumise ja käitlemise kohta aitavad kaasa loodevarude säästmisele ning loode, ja käitlemine toimib inimtervise ja keskkonnale ohult. Lisateadmised selle kohta, kuhu saate viia loode, saate küsida kohalikul omavalitsusel, otsekoostamise alustamispunktil või kaupluses, kust te seadme ostsite.

## Häivettävien laitteiden käsittely kotitalouksissa Euroopan unionin alueella

Tämä lootele viia loote pakendilla on tämä symboli, joka tarkoittaa, että kaikki teidän loote, on suoraan viettävä erilliselle keräyspaikalle. Häivettävien laitteiden erillinen keräys ja käsittely säästää luonnonvaroja. Näin toimimalla varmistetaan myös, että keräilytapahtumat toimivat, jotta suojelet ihmisten tervyyttä ja ympäristöä. Saat tarvittavia lisätietoja jätteen keräilypaikoista paikallisilta viranomaisilta, jätteenkielto- tai tuotteen jällemyyntiyhtiöltä.

## Αναρτίη άφρατων συσκευών στην Ευρωπαϊκή Ένωση

Το παρόν σύμβολο στον εξοπλισμό ή τη συσκευασία του υποδηλώνει ότι ο προϊόν αυτό δεν πρέπει να μεταβεί μαζί με άλλα οικιακά απορρίμματα. Αντιθέτως, εφόσον έχει είναι να απορριφτεί ως άφρατος οικιακός με τον καθορισμένο τρόπο, ο καθένας από εμάς έχει την ευθύνη να το παραδώσει σε ειδικό σημείο συλλογής απορριμμάτων για την ανακύκλωση ηλεκτρικού και ηλεκτρονικού εξοπλισμού. Η χωριστή συλλογή και ανακύκλωση των άφρατων οικιακών θα συμβάλει στη διατήρηση των φυσικών πόρων και στη διασφάλιση ότι θα ανακυκλωθούν με τρόπο τρόπο, ώστε να προστατευτεί η υγεία των ανθρώπων και το περιβάλλον. Για περισσότερες πληροφορίες σχετικά με το πού μπορείτε να απορρίψετε τις άφρατες συσκευές για ανακύκλωση, επικοινωνήστε με τις κατά τόπους αρχές, όπως ή με τον καταστήρα από το οποίο αγοράσθηκε το προϊόν.

## A hulladékanyagok kezelése a magánháztartásokban az Európai Unióban

Ez a szimbólum, amely a termék vagy annak csomagolásán van feltüntetve, azt jelzi, hogy a termék nem kezelhető egyúttal az egyéb háztartási hulladékkal. Az Ön feladata, hogy a készülék hulladékanyagait eljuttassa olyan kijelölt gyűjtőhelyre, amely az elektronikus hulladékokat és az elektronikus berendezések újrahuzáróanyagait foglalkozik. A hulladékanyagok elkülönült gyűjtése és újrahuzárása hozzájárul a természeti erőforrások megőrzéséhez, egyúttal azt a biztosítja, hogy a hulladék újrahuzárásának az egészséges és a környezetet nem ártalmas módon történjen. Ha többet szeretne tudni arról, hogy hol lehet a hulladékot elhelyezni, ahol lehetőséget újrahuzárásra a hulladékanyagokat, forduljon a helyi önkormányzatához, a háztartási hulladék begyűjtésével foglalkozó vállalatához vagy a termék forgalmazójához.

## Lietaisju atbrīvošana no nedrēģām ierīcēm Eiropas Savienības privātos mājās

Šis simbols uz ierīces vai tās iepakojuma norāda, ka šis ierīce nedrīkst iet kopā ar citiem mājokļa atkritumiem. Jūs esat atbildīgs par atbrīvošanu no nedrēģām ierīcēm, to nododot norādītajā savākšanas vieta, lai tiktu veikta nedrēģa elektriskā un elektroniskā aprīkojuma atbrīvošana pārstrādei. Speciāla nedrēģa ierīces savākšana un atbrīvošana pārstrāde palīdz tūpatērētājus resursus un nodrošina tūpatērētāju veselību, kas sagrā cilvēku veselību un apkārtni vidi. Lai iegūtu papildu informāciju par to, kur atbrīvojat ierīces, var noskaidrot nedrēģa ierīču, lauku, savienības ar vietējo pašvaldību, mājasinformācijas centrā vai veikalu, kurā iegādājāties šo ierīci.

## Eiropas Savienības vartotāji ir privāti namu ūķu atliekmas izņemšanas

Šis simbols arī produkta arba ir pakotnes marķē, kad produkts negatīvi iet kopā ar citiem mājokļa atkritumiem. Jūs privāto ierīci savā atliekmas izņemšanai atbildotāri ir jāatliekmas elektriskās un elektroniskās ierīces atbrīvošanas punktos. Jūs atliekmas izņemšana jānodrošina savā atbrīvošanas un pārstrādes, kas izņemšana no dabas resursiem un nodrošina cilvēku veselību un apkārtni vidi. Lai iegūtu papildu informāciju par to, kur atbrīvojat ierīces, var noskaidrot nedrēģa ierīču, lauku, savienības ar vietējo pašvaldību, mājasinformācijas centrā vai veikalu, kurā iegādājāties šo ierīci.

## Uytlyzēja zytēģe spryģezu pzyģez utzykownykh domowych w Unii Europejskiej

Symbol ten umieszczenie na produkcie lub opakowaniu oznacza, że tego produktu nie należy wyrzucać razem z innymi odpadami domowymi. Użytkownik jest odpowiedzialny za dostarczenie zużytego sprzętu do wyznaczonego punktu gromadzenia zużytych urządzeń elektrycznych i elektronicznych. Gromadzenie osobno i recykling tego typu odpadów przyczynia się do oszczędności zasobów naturalnych i gwarantuje, że recykling nie szkodzi zdrowiu i środowisku naturalnemu. Dodatkowe informacje na temat sposobu uytlyzēja zytēģe spryģezu w odpowiedzi na odpytywania ludzi lokalnych, w przedsiębiorstwach zajmującym się usuwaniem odpadów lub w miejscu zakupu produktu.

## Descarte de equipamentos por usuários em residências da União Europeia

Este símbolo no produto ou no embalagem indica que o produto não pode ser descartado junto com o lixo doméstico. No entanto, é sua responsabilidade levar os equipamentos a serem descartados a um ponto de coleta designado para o reciclagem de equipamentos eletro-eletrônicos. A coleta separada e o reciclagem dos equipamentos no momento do descarte ajudam na conservação dos recursos naturais e garantem que os equipamentos serão reciclados de forma a proteger a saúde das pessoas e o meio ambiente. Para obter mais informações sobre onde descartar equipamentos para reciclagem, entre em contato com o escritório local de sua cidade, o serviço de limpeza pública de seu bairro ou o loja em que adquiriu o produto.

## Postup používatelů v krajích Evropské unie při vyhadzování zařízení v domácnosti používaných do odpadu

Toto značka na produktu alebo na jeho obale označuje, že tento produkt nesmí být likvidován společně vyloučeného odpadu. Odpovědné za to, že vyloučené zařízení bude vyloučeno na určeném místě pro sběr odpadu, je uživatel. Správné odstranění a recyklace vyloučeného zařízení pomůže zachránit přírodní zdroje a zajistí, že recyklace proběhne způsobem chránícím lidské zdraví a životní prostředí. Další informace o tom, kam můžete vyloučené zařízení předat ke recyklaci, můžete získat od místní samosprávy, od společnosti provádějící svoz o likvidaci domovního odpadu nebo v obchodě, kde jste produkt zakoupili.

## Ravneje z odpadno opremo v gospodinjstvih znotraj Evropske unije

Ta značka na izdelku ali embalaži označuje, da ta izdelek ne smejo z drugimi gospodinjstvenimi odpadki. Odgovorno za to, da izdelek pride na določeno zbirno mesto za recikliranje odpadne električne in elektronske opreme, Z ločenim zbiranjem in recikliranjem odpadne opreme ob odlojanju boste pomagali ohraniti naravno vire in zagotoviti, v komunalnem podjetju ali trgovini, kjer ste izdelek kupili.

## Kassering av förbrukningsmaterial, för hem- och privat användare i EU

Produkt eller förbrukningsmaterial som den här symbolen har inte kasseras med vanlig hushållsavfall. I stället har du ansvar för att produkten lämnas till en inbörtnings- eller återvinningstjänst för hantering av el- och elektroniska produkter. Genom att lämna dina förbrukade produkter till en särskild samlingspunkt för återvinning av naturresurser, bidrar du till att minska miljöns belastning och säkerställa att återvinning sker på ett sätt som skyddar människors och miljön från produktens övriga rest. Komunal myndighet, sophanteringsföretag eller butik där varan köptes kan ge mer information om var du lämnar kasserade produkter för återvinning.

English  
Français  
Deutsch  
Italiano  
Español  
Čeština  
Dansk  
Nederlands  
Suomi  
Ελληνικά  
Magyar  
Lietuvių  
Latvian  
Slovenščina  
Polski  
Português  
Slovenčina  
Svenska

## Power consumption

Hewlett-Packard printing and imaging equipment marked with the ENERGY STAR® logo is qualified to the U.S. Environmental Protection Agency's ENERGY STAR specifications for imaging equipment. The following mark appears on ENERGY STAR qualified imaging products:



ENERGY STAR is a U.S. registered service mark of the U.S. EPA. As an ENERGY STAR partner, HP has determined that this product meets ENERGY STAR guidelines for energy efficiency.

Additional ENERGY STAR qualified imaging product model information is listed at:

[www.hp.com/go/energystar](http://www.hp.com/go/energystar)

## Chemical Substances

HP is committed to providing our customers with information about the chemical substances in our products as needed to comply with legal requirements such as REACH (*Regulation EC No 1907/2006 of the European Parliament and the Council*). A chemical information report for this product can be found at: [www.hp.com/go/reach](http://www.hp.com/go/reach)

## RoHS notices (China only)

### Toxic and hazardous substance table

有毒有害物质表						
根据中国《电子信息产品污染控制管理办法》						
零件描述	有毒有害化学物质和元素					
	铅	汞	镉	六价铬	多溴联苯	多溴联苯醚
外壳和托盘*	0	0	0	0	0	0
电线*	0	0	0	0	0	0
印刷电路板*	X	0	0	0	0	0
打印系统*	X	0	0	0	0	0
显示器*	X	0	0	0	0	0
喷墨打印机墨盒*	0	0	0	0	0	0
驱动光盘*	X	0	0	0	0	0
扫描仪*	X	X	0	0	0	0
网络配件*	X	0	0	0	0	0
电池板*	X	0	0	0	0	0
自动双面打印系统*	0	0	0	0	0	0
外部电源*	X	0	0	0	0	0

0: 指此部件的所有均一材质中包含的这种有毒有害化学物质, 含量低于SJ/T11363-2006 的限制  
X: 指此部件使用的均一材质中至少有一种包含的这种有毒有害化学物质, 含量高于SJ/T11363-2006 的限制  
注: 环保使用期限的参考标识取决于产品正常工作的温度和湿度等条件  
\*以上只适用于使用这些部件的产品



## Third-party licenses

This section contains the following topics:

- [HP Officejet 7500A \(E910\) e-All-in-One](#)

### HP Officejet 7500A (E910) e-All-in-One

#### LICENSE.aes-pubdom--crypto

```
/* rijndael-alg-fst.c
```

```
*
```

```
* @version 3.0 (December 2000)
```

```
*
```

```
* Optimised ANSI C code for the Rijndael cipher (now AES)
```

```
*
```

```
* @author Vincent Rijmen <vincent.rijmen@esat.kuleuven.ac.be>
```

```
* @author Antoon Bosselaers <antoon.bosselaers@esat.kuleuven.ac.be>
```

```
* @author Paulo Barreto <paulo.barreto@terra.com.br>
```

```
*
```

```
* This code is hereby placed in the public domain.
```

```
*
```

```
* THIS SOFTWARE IS PROVIDED BY THE AUTHORS "AS IS" AND ANY EXPRESS
```

```
* OR IMPLIED WARRANTIES, INCLUDING, BUT NOT LIMITED TO, THE IMPLIED
```

```
* WARRANTIES OF MERCHANTABILITY AND FITNESS FOR A PARTICULAR PURPOSE
```

```
* ARE DISCLAIMED. IN NO EVENT SHALL THE AUTHORS OR CONTRIBUTORS BE
```

```
* LIABLE FOR ANY DIRECT, INDIRECT, INCIDENTAL, SPECIAL, EXEMPLARY, OR
```

```
* CONSEQUENTIAL DAMAGES (INCLUDING, BUT NOT LIMITED TO, PROCUREMENT OF
```

```
* SUBSTITUTE GOODS OR SERVICES; LOSS OF USE, DATA, OR PROFITS; OR
```

```
* BUSINESS INTERRUPTION) HOWEVER CAUSED AND ON ANY THEORY OF LIABILITY,
```

```
* WHETHER IN CONTRACT, STRICT LIABILITY, OR TORT (INCLUDING NEGLIGENCE
```

```
* OR OTHERWISE) ARISING IN ANY WAY OUT OF THE USE OF THIS SOFTWARE,
```

```
* EVEN IF ADVISED OF THE POSSIBILITY OF SUCH DAMAGE.
```

```
*/
```

#### LICENSE.expats-mit--expat

Copyright (c) 1998, 1999, 2000 Thai Open Source Software Center Ltd

Permission is hereby granted, free of charge, to any person obtaining a copy of this software and associated documentation files (the "Software"), to deal in the Software without restriction, including without limitation the rights to use, copy, modify, merge, publish, distribute, sublicense, and/or sell copies of the Software, and to permit persons to whom the Software is furnished to do so, subject to the following conditions:

The above copyright notice and this permission notice shall be included in all copies or substantial portions of the Software.

THE SOFTWARE IS PROVIDED "AS IS", WITHOUT WARRANTY OF ANY KIND, EXPRESS OR IMPLIED, INCLUDING BUT NOT LIMITED TO THE WARRANTIES OF MERCHANTABILITY, FITNESS FOR A PARTICULAR PURPOSE AND NONINFRINGEMENT. IN NO EVENT SHALL THE AUTHORS OR COPYRIGHT HOLDERS BE LIABLE FOR ANY CLAIM, DAMAGES OR OTHER LIABILITY, WHETHER IN AN ACTION OF CONTRACT, TORT OR OTHERWISE, ARISING FROM, OUT OF OR IN CONNECTION WITH THE SOFTWARE OR THE USE OR OTHER DEALINGS IN THE SOFTWARE.

#### LICENSE.open\_ssl--open\_ssl

Copyright (C) 1995-1998 Eric Young (eay@cryptsoft.com)

All rights reserved.

This package is an SSL implementation written by Eric Young (eay@cryptsoft.com).

The implementation was written so as to conform with Netscapes SSL.

This library is free for commercial and non-commercial use as long as the following conditions are aheared to. The following conditions apply to all code found in this distribution, be it the RC4, RSA, lhash, DES, etc., code; not just the SSL code. The SSL documentation included with this distribution is covered by the same copyright terms except that the holder is Tim Hudson (tjh@cryptsoft.com).

Copyright remains Eric Young's, and as such any Copyright notices in the code are not to be removed.

If this package is used in a product, Eric Young should be given attribution as the author of the parts of the library used.

This can be in the form of a textual message at program startup or in documentation (online or textual) provided with the package.

Redistribution and use in source and binary forms, with or without modification, are permitted provided that the following conditions are met:

1. Redistributions of source code must retain the copyright notice, this list of conditions and the following disclaimer.
2. Redistributions in binary form must reproduce the above copyright notice, this list of conditions and the following disclaimer in the documentation and/or other materials provided with the distribution.
3. All advertising materials mentioning features or use of this software must display the following acknowledgement:  
 "This product includes cryptographic software written by Eric Young (eay@cryptsoft.com)" The word 'cryptographic' can be left out if the rouines from the library being used are not cryptographic related :-).
4. If you include any Windows specific code (or a derivative thereof) from the apps directory (application code) you must include an acknowledgement: "This product includes software written by Tim Hudson (tjh@cryptsoft.com)"

THIS SOFTWARE IS PROVIDED BY ERIC YOUNG ``AS IS" AND ANY EXPRESS OR IMPLIED WARRANTIES, INCLUDING, BUT NOT LIMITED TO, THE IMPLIED WARRANTIES OF MERCHANTABILITY AND FITNESS FOR A PARTICULAR PURPOSE ARE DISCLAIMED. IN NO EVENT SHALL THE AUTHOR OR CONTRIBUTORS BE LIABLE FOR ANY DIRECT, INDIRECT, INCIDENTAL, SPECIAL, EXEMPLARY, OR CONSEQUENTIAL DAMAGES (INCLUDING, BUT NOT LIMITED TO, PROCUREMENT OF SUBSTITUTE GOODS OR SERVICES; LOSS OF USE, DATA, OR PROFITS; OR BUSINESS INTERRUPTION) HOWEVER CAUSED AND ON ANY THEORY OF LIABILITY, WHETHER IN CONTRACT, STRICT LIABILITY, OR TORT (INCLUDING NEGLIGENCE OR OTHERWISE) ARISING IN ANY WAY OUT OF THE USE OF THIS SOFTWARE, EVEN IF ADVISED OF THE POSSIBILITY OF SUCH DAMAGE.

The licence and distribution terms for any publically available version or derivative of this code cannot be changed. i.e. this code cannot simply be copied and put under another distribution licence [including the GNU Public Licence.]

=====

Copyright (c) 1998-2001 The OpenSSL Project. All rights reserved.

Redistribution and use in source and binary forms, with or without modification, are permitted provided that the following conditions are met:

1. Redistributions of source code must retain the above copyright notice, this list of conditions and the following disclaimer.
2. Redistributions in binary form must reproduce the above copyright notice, this list of conditions and the following disclaimer in the documentation and/or other materials provided with the distribution.

3. All advertising materials mentioning features or use of this software must display the following acknowledgment:  
 "This product includes software developed by the OpenSSL Project for use in the OpenSSL Toolkit. (<http://www.openssl.org/>)"
4. The names "OpenSSL Toolkit" and "OpenSSL Project" must not be used to endorse or promote products derived from this software without prior written permission. For written permission, please contact [openssl-core@openssl.org](mailto:openssl-core@openssl.org).
5. Products derived from this software may not be called "OpenSSL" nor may "OpenSSL" appear in their names without prior written permission of the OpenSSL Project.
6. Redistributions of any form whatsoever must retain the following acknowledgment:  
 "This product includes software developed by the OpenSSL Project for use in the OpenSSL Toolkit (<http://www.openssl.org/>)"

THIS SOFTWARE IS PROVIDED BY THE OpenSSL PROJECT ``AS IS'' AND ANY EXPRESSED OR IMPLIED WARRANTIES, INCLUDING, BUT NOT LIMITED TO, THE IMPLIED WARRANTIES OF MERCHANTABILITY AND FITNESS FOR A PARTICULAR PURPOSE ARE DISCLAIMED. IN NO EVENT SHALL THE OpenSSL PROJECT OR ITS CONTRIBUTORS BE LIABLE FOR ANY DIRECT, INDIRECT, INCIDENTAL, SPECIAL, EXEMPLARY, OR CONSEQUENTIAL DAMAGES (INCLUDING, BUT NOT LIMITED TO, PROCUREMENT OF SUBSTITUTE GOODS OR SERVICES; LOSS OF USE, DATA, OR PROFITS; OR BUSINESS INTERRUPTION) HOWEVER CAUSED AND ON ANY THEORY OF LIABILITY, WHETHER IN CONTRACT, STRICT LIABILITY, OR TORT (INCLUDING NEGLIGENCE OR OTHERWISE) ARISING IN ANY WAY OUT OF THE USE OF THIS SOFTWARE, EVEN IF ADVISED OF THE POSSIBILITY OF SUCH DAMAGE.

=====

This product includes cryptographic software written by Eric Young ([eay@cryptsoft.com](mailto:eay@cryptsoft.com)). This product includes software written by Tim Hudson ([tjh@cryptsoft.com](mailto:tjh@cryptsoft.com)).

=====

Copyright (c) 1998-2006 The OpenSSL Project. All rights reserved.

Redistribution and use in source and binary forms, with or without modification, are permitted provided that the following conditions are met:

1. Redistributions of source code must retain the above copyright notice, this list of conditions and the following disclaimer.
2. Redistributions in binary form must reproduce the above copyright notice, this list of conditions and the following disclaimer in the documentation and/or other materials provided with the distribution.
3. All advertising materials mentioning features or use of this software must display the following acknowledgment:  
 "This product includes software developed by the OpenSSL Project for use in the OpenSSL Toolkit. (<http://www.openssl.org/>)"
4. The names "OpenSSL Toolkit" and "OpenSSL Project" must not be used to endorse or promote products derived from this software without prior written permission. For written permission, please contact [openssl-core@openssl.org](mailto:openssl-core@openssl.org).
5. Products derived from this software may not be called "OpenSSL" nor may "OpenSSL" appear in their names without prior written permission of the OpenSSL Project.
6. Redistributions of any form whatsoever must retain the following acknowledgment:  
 "This product includes software developed by the OpenSSL Project for use in the OpenSSL Toolkit (<http://www.openssl.org/>)"

THIS SOFTWARE IS PROVIDED BY THE OpenSSL PROJECT ``AS IS'' AND ANY EXPRESSED OR IMPLIED WARRANTIES, INCLUDING, BUT NOT LIMITED TO, THE IMPLIED WARRANTIES OF MERCHANTABILITY AND FITNESS FOR A PARTICULAR PURPOSE ARE DISCLAIMED. IN NO EVENT SHALL THE OpenSSL PROJECT OR ITS CONTRIBUTORS BE LIABLE FOR ANY DIRECT, INDIRECT, INCIDENTAL, SPECIAL, EXEMPLARY, OR CONSEQUENTIAL DAMAGES (INCLUDING, BUT NOT LIMITED TO, PROCUREMENT OF SUBSTITUTE GOODS OR

SERVICES; LOSS OF USE, DATA, OR PROFITS; OR BUSINESS INTERRUPTION) HOWEVER CAUSED AND ON ANY THEORY OF LIABILITY, WHETHER IN CONTRACT, STRICT LIABILITY, OR TORT (INCLUDING NEGLIGENCE OR OTHERWISE) ARISING IN ANY WAY OUT OF THE USE OF THIS SOFTWARE, EVEN IF ADVISED OF THE POSSIBILITY OF SUCH DAMAGE.

=====  
This product includes cryptographic software written by Eric Young (eay@cryptsoft.com). This product includes software written by Tim Hudson (tjh@cryptsoft.com).  
=====

Copyright 2002 Sun Microsystems, Inc. ALL RIGHTS RESERVED.

ECC cipher suite support in OpenSSL originally developed by SUN MICROSYSTEMS, INC., and contributed to the OpenSSL project.

**LICENSE.sha2-bsd--nos\_crypto**

/\* FIPS 180-2 SHA-224/256/384/512 implementation

\* Last update: 02/02/2007

\* Issue date: 04/30/2005

\*

\* Copyright (C) 2005, 2007 Olivier Gay <olivier.gay@a3.epfl.ch>

\* All rights reserved.

\*

\* Redistribution and use in source and binary forms, with or without

\* modification, are permitted provided that the following conditions

\* are met:

\* 1. Redistributions of source code must retain the above copyright

\* notice, this list of conditions and the following disclaimer.

\* 2. Redistributions in binary form must reproduce the above copyright

\* notice, this list of conditions and the following disclaimer in the

\* documentation and/or other materials provided with the distribution.

\* 3. Neither the name of the project nor the names of its contributors

\* may be used to endorse or promote products derived from this software

\* without specific prior written permission.

\*

\* THIS SOFTWARE IS PROVIDED BY THE PROJECT AND CONTRIBUTORS ``AS IS" AND

\* ANY EXPRESS OR IMPLIED WARRANTIES, INCLUDING, BUT NOT LIMITED TO, THE

\* IMPLIED WARRANTIES OF MERCHANTABILITY AND FITNESS FOR A PARTICULAR PURPOSE

\* ARE DISCLAIMED. IN NO EVENT SHALL THE PROJECT OR CONTRIBUTORS BE LIABLE

\* FOR ANY DIRECT, INDIRECT, INCIDENTAL, SPECIAL, EXEMPLARY, OR CONSEQUENTIAL

\* DAMAGES (INCLUDING, BUT NOT LIMITED TO, PROCUREMENT OF SUBSTITUTE GOODS

\* OR SERVICES; LOSS OF USE, DATA, OR PROFITS; OR BUSINESS INTERRUPTION)

\* HOWEVER CAUSED AND ON ANY THEORY OF LIABILITY, WHETHER IN CONTRACT, STRICT

\* LIABILITY, OR TORT (INCLUDING NEGLIGENCE OR OTHERWISE) ARISING IN ANY WAY

\* OUT OF THE USE OF THIS SOFTWARE, EVEN IF ADVISED OF THE POSSIBILITY OF

\* SUCH DAMAGE.

\*/

**LICENSE.zlib--zlib**

zlib.h -- interface of the 'zlib' general purpose compression library

version 1.2.3, July 18th, 2005

Copyright (C) 1995-2005 Jean-loup Gailly and Mark Adler

This software is provided 'as-is', without any express or implied warranty. In no event will the authors be held liable for any damages arising from the use of this software.

Permission is granted to anyone to use this software for any purpose, including commercial applications, and to alter it and redistribute it freely, subject to the following restrictions:

1. The origin of this software must not be misrepresented; you must not claim that you wrote the original software. If you use this software in a product, an acknowledgment in the product documentation would be appreciated but is not required.
2. Altered source versions must be plainly marked as such, and must not be misrepresented as being the original software.
3. This notice may not be removed or altered from any source distribution.

Jean-loup Gailly Mark Adler

jloup@gzip.org madler@alumni.caltech.edu

The data format used by the zlib library is described by RFCs (Request for Comments) 1950 to 1952 in the files <http://www.ietf.org/rfc/rfc1950.txt> (zlib format), [rfc1951.txt](http://www.ietf.org/rfc/rfc1951.txt) (deflate format) and [rfc1952.txt](http://www.ietf.org/rfc/rfc1952.txt) (gzip format).

---

# B HP supplies and accessories

This section provides information on HP supplies and accessories for the printer. The information is subject to changes, visit the HP Web site ([www.hpshopping.com](http://www.hpshopping.com)) for the latest updates. You may also make purchases through the Web site.

This section contains the following topics:

- [Order printing supplies online](#)
- [Supplies](#)

## Order printing supplies online

To order supplies online or create a printable shopping list, open the HP software that came with your printer and click **Shopping**. Select **Shop for Supplies Online**. The HP software uploads, with your permission, printer information, including model number, serial number, and estimated ink levels. The HP supplies that work in your printer are pre-selected. You can change quantities, add or remove items, and then print the list or purchase online at the HP Store or other online retailers (options differ by country/region). Cartridge information and links to online shopping also appear on ink alert messages.

You can also order online by visiting [www.hp.com/buy/supplies](http://www.hp.com/buy/supplies). If prompted, choose your country/region, follow the prompts to select your printer, and then the supplies you need.

---

 **NOTE:** Ordering cartridges online is not supported in all countries/regions. However, many countries have information on ordering by telephone, locating a local store and printing a shopping list. In addition, you can select the 'How to Buy' option at the top of the [www.hp.com/buy/supplies](http://www.hp.com/buy/supplies) page to obtain information about purchasing HP products in your country.

---

## Supplies

This section covers the following topics:

- [Ink cartridges](#)
- [HP media](#)

### Ink cartridges

Ordering cartridges online is not supported in all countries/regions. However, many countries have information on ordering by telephone, locating a local store and printing a shopping list. In addition, you can select the 'How to Buy' option at the top of the [www.hp.com/buy/supplies](http://www.hp.com/buy/supplies) page to obtain information about purchasing HP products in your country.

You can find the ink cartridge number in the following places:

- In the embedded Web server, by clicking the **Tools** tab, and then, under **Product Information** clicking **Ink Gauge**. For more information, see [Embedded Web server](#).
- On the label of the ink cartridge you are replacing.
- On the printer status page (see [Understand the Printer Status Report](#)).

---

 **NOTE:** Ink level warnings and indicators provide estimates for planning purposes only. When you receive a low-ink warning message, consider having a replacement cartridge available to avoid possible printing delays. You do not need to replace cartridges until prompted to do so.

---

## HP media

To order media such as HP Premium Paper, go to [www.hp.com](http://www.hp.com).



HP recommends plain papers with the ColorLok logo for printing everyday documents. All papers with the ColorLok logo are independently tested to meet high standards of reliability and print quality, and produce documents with crisp, vivid color, bolder blacks & dry faster than ordinary plain papers. Look for papers with the ColorLok logo in a variety of weights and sizes from major paper manufacturers.

# C Additional fax setup

After completing all the steps in the getting started guide, use the instructions in this section to complete your fax setup. Keep your getting started guide for later use.

In this section, you learn how to set up the printer so that faxing works successfully with equipment and services you might already have on the same phone line.

 **TIP:** You can also use the Fax Setup Wizard (Windows) or HP Setup Assistant (Mac OS X) to help you quickly set up some important fax settings such as the answer mode and fax header information. You can access these tools through the HP software you installed with the printer. After you run these tools, follow the procedures in this section to complete your fax setup.

This section contains the following topics:

- [Set up faxing \(parallel phone systems\)](#)
- [Serial-type fax setup](#)
- [Test fax setup](#)

## Set up faxing (parallel phone systems)

Before you begin setting up the printer for faxing, determine which kind of phone system your country/region uses. The instructions for fax setup differ depending on whether you have a serial- or parallel-type phone system.

- If you do not see your country/region listed in the table below, you might have a serial-type phone system. In a serial-type phone system, the connector type on your shared telephone equipment (modems, phones, and answering machines) does not allow a physical connection to the "2-EXT" port on the printer. Instead, all equipment must be connected at the telephone wall jack.

 **NOTE:** In some countries/regions that use serial-type phone systems, the phone cord that came with the printer might have an additional wall plug attached to it. This enables you to connect other telecom devices to the wall jack where you plug in the printer.

You might need to connect the supplied phone cord to the adapter provided for your country/region.

- If your country/region is listed in the table below, you might have a parallel-type telephone system. In a parallel-type phone system, you are able to connect shared telephone equipment to the phone line by using the "2-EXT" port on the back of the printer.

 **NOTE:** If you have a parallel-type phone system, HP recommends you use the 2-wire phone cord supplied with the printer to connect it to the telephone wall jack.

**Table C-1 Countries/regions with a parallel-type phone system**

Argentina	Australia	Brazil
Canada	Chile	China
Colombia	Greece	India
Indonesia	Ireland	Japan
Korea	Latin America	Malaysia
Mexico	Philippines	Poland



## Countries/regions with a parallel-type phone system (continued)

Portugal	Russia	Saudi Arabia
Singapore	Spain	Taiwan
Thailand	USA	Venezuela
Vietnam		

If you are unsure which kind of telephone system you have (serial or parallel), check with your telephone company.

This section contains the following topics:

- [Choose the correct fax setup for your home or office](#)
- [Case A: Separate fax line \(no voice calls received\)](#)
- [Case B: Set up the printer with DSL](#)
- [Case C: Set up the printer with a PBX phone system or an ISDN line](#)
- [Case D: Fax with a distinctive ring service on the same line](#)
- [Case E: Shared voice/fax line](#)
- [Case F: Shared voice/fax line with voice mail](#)
- [Case G: Fax line shared with computer modem \(no voice calls received\)](#)
- [Case H: Shared voice/fax line with computer modem](#)
- [Case I: Shared voice/fax line with answering machine](#)
- [Case J: Shared voice/fax line with computer modem and answering machine](#)
- [Case K: Shared voice/fax line with computer dial-up modem and voice mail](#)

### Choose the correct fax setup for your home or office

To fax successfully, you need to know what types of equipment and services (if any) share the same phone line with the printer. This is important because you might need to connect some of your existing office equipment directly to the printer, and you might also need to change some fax settings before you can fax successfully.

1. Determine if your telephone system is serial or parallel (see [Set up faxing \(parallel phone systems\)](#)).
  - a. Serial-type telephone system — See [Serial-type fax setup](#).
  - b. Parallel-type telephone system — Go to step 2.
2. Select the combination of equipment and services sharing your fax line.
  - DSL: A Digital subscriber line (DSL) service through your telephone company. (DSL might be called ADSL in your country/region.)
  - PBX: A private branch exchange (PBX) phone system or an integrated services digital network (ISDN) system.
  - Distinctive ring service: A distinctive ring service through your telephone company provides multiple telephone numbers with different ring patterns.
  - Voice calls: Voice calls are received at the same phone number you use for fax calls on the printer.
  - Computer dial-up modem: A computer dial-up modem is on the same phone line as the printer. If you answer Yes to any of the following questions, you are using a computer dial-up modem:
    - Do you send and receive faxes directly to and from your computer software applications through a dial-up connection?
    - Do you send and receive e-mail messages on your computer through a dial-up connection?
    - Do you access the Internet from your computer through a dial-up connection?

- Answering machine: An answering machine that answers voice calls at the same phone number you use for fax calls on the printer.
  - Voice mail service: A voice mail subscription through your telephone company at the same number you use for fax calls on the printer.
3. From the following table, choose the combination of equipment and services applicable to your home or office setting. Then look up the recommended fax setup. Step-by-step instructions are included for each case in the sections that follow.

 **NOTE:** If your home or office setup is not described in this section, set up the printer as you would a regular analog phone. Make sure you use the phone cord supplied in the box to connect one end to your telephone wall jack and the other end to the port labeled 1-LINE on the back of the printer. If you use another phone cord, you might experience problems sending and receiving faxes.

You might need to connect the supplied phone cord to the adapter provided for your country/region.

Other equipment or services sharing your fax line							Recommended fax setup
DSL	PBX	Distinctive ring service	Voice calls	Computer dial-up modem	Answering machine	Voice mail service	
							Case A: <u>Separate fax line (no voice calls received)</u>
✓							Case B: <u>Set up the printer with DSL</u>
	✓						Case C: <u>Set up the printer with a PBX phone system or an ISDN line</u>
		✓					Case D: <u>Fax with a distinctive ring service on the same line</u>
			✓				Case E: <u>Shared voice/fax line</u>
			✓			✓	Case F: <u>Shared voice/fax line with voice mail</u>
				✓			Case G: <u>Fax line shared with computer modem (no voice calls received)</u>
			✓	✓			Case H: <u>Shared voice/fax line with computer modem</u>
			✓		✓		Case I: <u>Shared voice/fax line with answering machine</u>

(continued)

Other equipment or services sharing your fax line							Recommended fax setup
DSL	PBX	Distinctive ring service	Voice calls	Computer dial-up modem	Answering machine	Voice mail service	
			✓	✓	✓		Case J: Shared voice/fax line with computer modem and answering machine
			✓	✓		✓	Case K: Shared voice/fax line with computer dial-up modem and voice mail

### Case A: Separate fax line (no voice calls received)

If you have a separate phone line on which you receive no voice calls, and you have no other equipment connected on this phone line, set up the printer as described in this section.

#### Back view of the printer

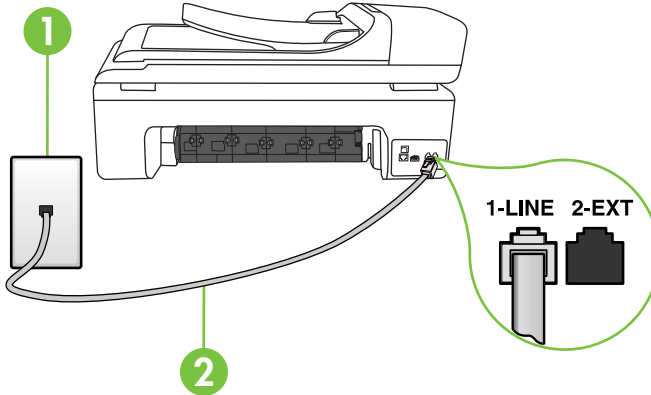

1	Telephone wall jack
2	Use the phone cord supplied in the box with the printer to connect to the 1-LINE port You might need to connect the supplied phone cord to the adapter provided for your country/region.

**To set up the printer with a separate fax line**

1. Using the phone cord supplied in the box with the printer, connect one end to your telephone wall jack, then connect the other end to the port labeled 1-LINE on the back of the printer.

 **NOTE:** You might need to connect the supplied phone cord to the adapter provided for your country/region.

If you do not use the supplied cord to connect from the telephone wall jack to the printer, you might not be able to fax successfully. This special phone cord is different from the phone cords you might already have in your home or office.

2. Turn on the **Auto Answer** setting.
3. (Optional) Change the **Rings to Answer** setting to the lowest setting (two rings).
4. Run a fax test.

When the phone rings, the printer answers automatically after the number of rings you set in the **Rings to Answer** setting. The printer begins emitting fax reception tones to the sending fax machine and receives the fax.

**Case B: Set up the printer with DSL**

If you have a DSL service through your telephone company, and do not connect any equipment to the printer, use the instructions in this section to connect a DSL filter between the telephone wall jack and the printer. The DSL filter removes the digital signal that can interfere with the printer, so the printer can communicate correctly with the phone line. (DSL might be called ADSL in your country/region.)

 **NOTE:** If you have a DSL line and you do not connect the DSL filter, you cannot send and receive faxes with the printer.

**Back view of the printer**

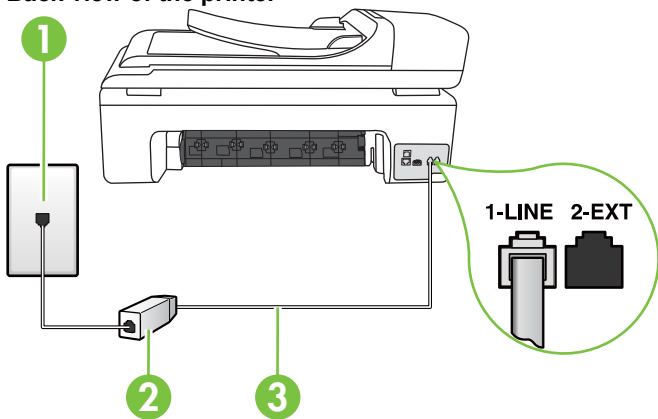

1	Telephone wall jack
2	DSL (or ADSL) filter and cord supplied by your DSL provider
3	Use the phone cord supplied in the box with the printer to connect to the 1-LINE port You might need to connect the supplied phone cord to the adapter provided for your country/region.

### To set up the printer with DSL

1. Obtain a DSL filter from your DSL provider.
2. Using the phone cord supplied in the box with the printer, connect one end to the open port on the DSL filter, and then connect the other end to the port labeled 1-LINE on the back of the printer.



**NOTE:** You might need to connect the supplied phone cord to the adapter provided for your country/region.

If you do not use the supplied cord to connect from the DSL filter to the printer, you might not be able to fax successfully. This special phone cord is different from the phone cords you might already have in your home or office.

As only one phone cord is supplied, you might need to obtain additional phone cords for this setup.

---

3. Connect an additional phone cord from the DSL filter to the telephone wall jack.
4. Run a fax test.

If you encounter problems setting up the printer with optional equipment, contact your local service provider or vendor for further assistance.

### Case C: Set up the printer with a PBX phone system or an ISDN line

If you are using either a PBX phone system or an ISDN converter/terminal adapter, make sure you do the following:

- If you are using either a PBX or an ISDN converter/terminal adaptor, connect the printer to the port that is designated for fax and phone use. Also, make sure that the terminal adapter is set to the correct switch type for your country/region, if possible.



**NOTE:** Some ISDN systems allow you to configure the ports for specific phone equipment. For example, you might have assigned one port for telephone and Group 3 fax and another port for multiple purposes. If you have problems when connected to the fax/phone port of your ISDN converter, try using the port designated for multiple purposes; it might be labeled "multi-combi" or something similar.

---

- If you are using a PBX phone system, set the call waiting tone to "off."



**NOTE:** Many digital PBX systems include a call-waiting tone that is set to "on" by default. The call waiting tone interferes with any fax transmission, and you cannot send or receive faxes with the printer. Refer to the documentation that came with your PBX phone system for instructions on how to turn off the call-waiting tone.

---

- If you are using a PBX phone system, dial the number for an outside line before dialing the fax number.
- Make sure you use the supplied cord to connect from the telephone wall jack to the printer. If you do not, you might not be able to fax successfully. This special phone cord is different from the phone cords you might already have in your home or office. If the supplied phone cord is too short, you can purchase a coupler from your local electronics store and extend it. You might need to connect the supplied phone cord to the adapter provided for your country/region.

If you encounter problems setting up the printer with optional equipment, contact your local service provider or vendor for further assistance.

### Case D: Fax with a distinctive ring service on the same line

If you subscribe to a distinctive ring service (through your telephone company) that allows you to have multiple phone numbers on one phone line, each with a different ring pattern, set up the printer as described in this section.

#### Back view of the printer

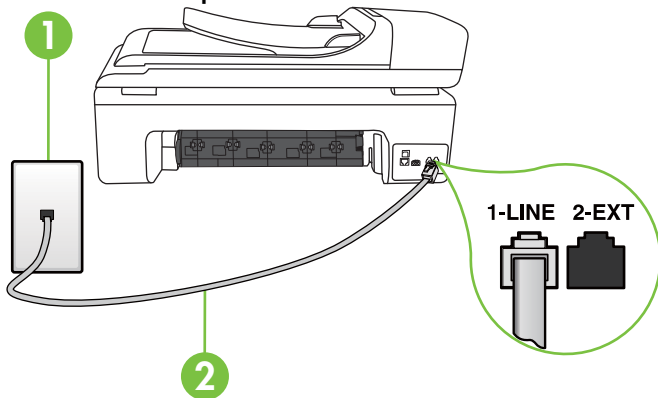

1	Telephone wall jack
2	Use the phone cord supplied in the box with the printer to connect to the 1-LINE port You might need to connect the supplied phone cord to the adapter provided for your country/region.

#### To set up the printer with a distinctive ring service

- Using the phone cord supplied in the box with the printer, connect one end to your telephone wall jack, then connect the other end to the port labeled 1-LINE on the back of the printer.

 **NOTE:** You might need to connect the supplied phone cord to the adapter provided for your country/region.  
If you do not use the supplied cord to connect from the telephone wall jack to the printer, you might not be able to fax successfully. This special phone cord is different from the phone cords you might already have in your home or office.

- Turn on the **Auto Answer** setting.
- Change the **Distinctive Ring** setting to match the pattern that the telephone company assigned to your fax number.

 **NOTE:** By default, the printer is set to answer all ring patterns. If you do not set the **Distinctive Ring** to match the ring pattern assigned to your fax number, the printer might answer both voice calls and fax calls or it might not answer at all.

 **TIP:** You can also use the Ring Pattern Detection feature in the printer's control panel to set distinctive ring. With this feature, the printer recognizes and records the ring pattern of an incoming call and, based on this call, automatically determines the distinctive ring pattern assigned by your telephone company to fax calls. For more information, see [Change the answer ring pattern for distinctive ring](#).

4. (Optional) Change the **Rings to Answer** setting to the lowest setting (two rings).
5. Run a fax test.

The printer automatically answers incoming calls that have the ring pattern you selected (**Distinctive Ring** setting) after the number of rings you selected (**Rings to Answer** setting). The printer begins emitting fax reception tones to the sending fax machine and receives the fax.

If you encounter problems setting up the printer with optional equipment, contact your local service provider or vendor for further assistance.

### Case E: Shared voice/fax line

If you receive both voice calls and fax calls at the same phone number, and you have no other office equipment (or voice mail) on this phone line, set up the printer as described in this section.

#### Back view of the printer

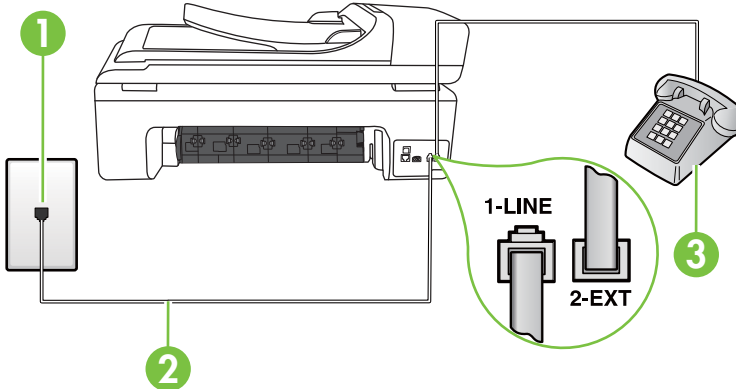

1	Telephone wall jack
2	Use the phone cord supplied in the box with the printer to connect to the 1-LINE port You might need to connect the supplied phone cord to the adapter provided for your country/region.
3	Telephone (optional)

#### To set up the printer with a shared voice/fax line

1. Using the phone cord supplied in the box with the printer, connect one end to your telephone wall jack, then connect the other end to the port labeled 1-LINE on the back of the printer.



**NOTE:** You might need to connect the supplied phone cord to the adapter provided for your country/region.

If you do not use the supplied cord to connect from the telephone wall jack to the printer, you might not be able to fax successfully. This special phone cord is different from the phone cords you might already have in your home or office.

2. Do one of the following:
  - If you have a parallel-type phone system, remove the white plug from the port labeled 2-EXT on the back of the printer, and then connect a phone to this port.
  - If you have a serial-type phone system, you might plug your phone directly on top of the printer cable which has a wall plug attached to it.

3. Now you need to decide how you want the printer to answer calls, automatically or manually:
  - If you set up the printer to answer calls **automatically**, it answers all incoming calls and receives faxes. The printer cannot distinguish between fax and voice calls in this case; if you suspect the call is a voice call, you must answer it before the printer answers the call. To set up the printer to answer calls automatically, turn on the **Auto Answer** setting.
  - If you set up the printer to answer faxes **manually**, you must be available to respond in person to incoming fax calls or the printer cannot receive faxes. To set up the printer to answer calls manually, turn off the **Auto Answer** setting.
4. Run a fax test.

If you pick up the phone before the printer answers the call and hear fax tones from a sending fax machine, you need to answer the fax call manually.

If you encounter problems setting up the printer with optional equipment, contact your local service provider or vendor for further assistance.

### Case F: Shared voice/fax line with voice mail

If you receive both voice calls and fax calls at the same phone number, and you also subscribe to a voice mail service through your telephone company, set up the printer as described in this section.

 **NOTE:** You cannot receive faxes automatically if you have a voice mail service at the same phone number you use for fax calls. You must receive faxes manually; this means you must be available to respond in person to incoming fax calls. If you want to receive faxes automatically instead, contact your telephone company to subscribe to a distinctive ring service, or to obtain a separate phone line for faxing.

#### Back view of the printer

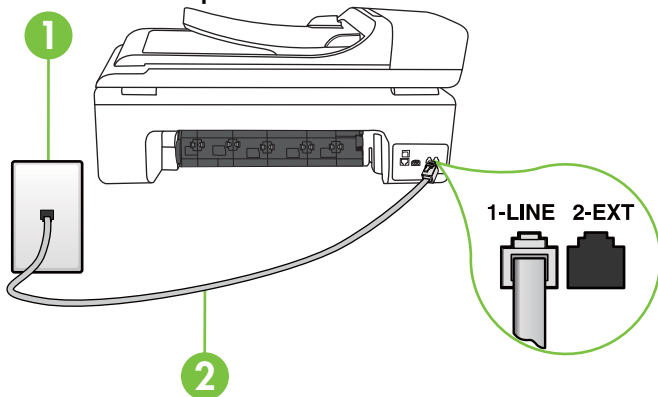

1	Telephone wall jack
2	Use the phone cord supplied in the box with the printer to connect to the "1-LINE" port You might need to connect the supplied phone cord to the adapter provided for your country/region.



### To set up the printer with voice mail

1. Using the phone cord supplied in the box with the printer, connect one end to your telephone wall jack, then connect the other end to the port labeled 1-LINE on the back of the printer.  
You might need to connect the supplied phone cord to the adapter provided for your country/region.



**NOTE:** You might need to connect the supplied phone cord to the adapter provided for your country/region.

If you do not use the supplied cord to connect from the telephone wall jack to the printer, you might not be able to fax successfully. This special phone cord is different from the phone cords you might already have in your home or office.

2. Turn off the **Auto Answer** setting.
3. Run a fax test.

You must be available to respond in person to incoming fax calls, or the printer cannot receive faxes. You must initiate the manual fax before voicemail picks up the line.

If you encounter problems setting up the printer with optional equipment, contact your local service provider or vendor for further assistance.

### Case G: Fax line shared with computer modem (no voice calls received)

If you have a fax line on which you receive no voice calls, and you also have a computer modem connected on this line, set up the printer as described in this section.



**NOTE:** If you have a computer dial-up modem, your computer dial-up modem shares the phone line with the printer. You cannot use both your modem and the printer simultaneously. For example, you cannot use the printer for faxing while you are using your computer dial-up modem to send an e-mail or access the Internet.

- [Set up the printer with a computer dial-up modem](#)
- [Set up the printer with a computer DSL/ADSL modem](#)

### Set up the printer with a computer dial-up modem

If you are using the same phone line for sending faxes and for a computer dial-up modem, follow these directions for setting up the printer.

#### Back view of the printer

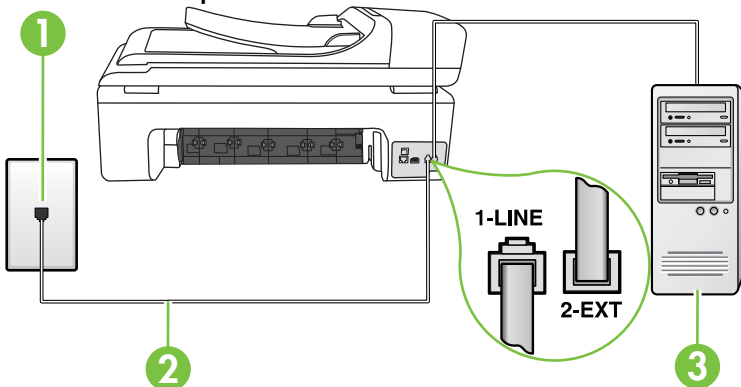

1	Telephone wall jack
2	Use the phone cord supplied in the box with the printer to connect to the "1-LINE" port You might need to connect the supplied phone cord to the adapter provided for your country/region.
3	Computer with modem

### To set up the printer with a computer dial-up modem

1. Remove the white plug from the port labeled 2-EXT on the back of the printer.
2. Find the phone cord that connects from the back of your computer (your computer dial-up modem) to a telephone wall jack. Disconnect the cord from the telephone wall jack and plug it into the port labeled 2-EXT on the back of the printer.
3. Using the phone cord supplied in the box with the printer, connect one end to your telephone wall jack, then connect the other end to the port labeled 1-LINE on the back of the printer.



**NOTE:** You might need to connect the supplied phone cord to the adapter provided for your country/region.

If you do not use the supplied cord to connect from the telephone wall jack to the printer, you might not be able to fax successfully. This special phone cord is different from the phone cords you might already have in your home or office.

4. If your modem software is set to receive faxes to your computer automatically, turn off that setting.



**NOTE:** If you do not turn off the automatic fax reception setting in your modem software, the printer cannot receive faxes.

5. Turn on the **Auto Answer** setting.
6. (Optional) Change the **Rings to Answer** setting to the lowest setting (two rings).
7. Run a fax test.

When the phone rings, the printer automatically answers after the number of rings you set in the **Rings to Answer** setting. The printer begins emitting fax reception tones to the sending fax machine and receives the fax.

If you encounter problems setting up the printer with optional equipment, contact your local service provider or vendor for further assistance.

## Set up the printer with a computer DSL/ADSL modem

If you have a DSL line and use that phone line to send faxes, follow these instructions to set up your fax.

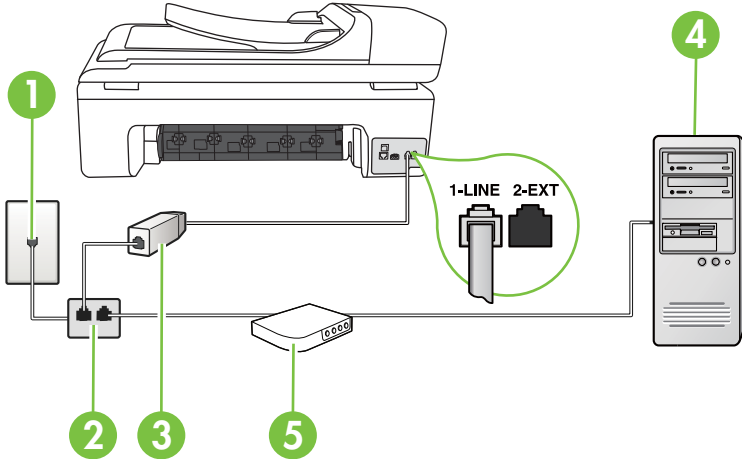

1	Telephone wall jack
2	Parallel splitter
3	DSL/ADSL filter Connect one end of the phone jack that was supplied with the printer to connect to the 1-LINE port on the back of the printer. Connect the other end of the cord to the DSL/ADSL filter. You might need to connect the supplied phone cord to the adapter provided for your country/region.
4	Computer
5	Computer DSL/ADSL modem

 **NOTE:** You need to purchase a parallel splitter. A parallel splitter has one RJ-11 port on the front and two RJ-11 ports on the back. Do not use a 2-line phone splitter, a serial splitter, or a parallel splitter which has two RJ-11 ports on the front and a plug on the back.

### Example of a parallel splitter



**To set up the printer with a computer DSL/ADSL modem**

1. Obtain a DSL filter from your DSL provider.
2. Using the phone cord provided in the box with the printer, connect one end to the DSL filter, and then connect the other end to the port labeled 1-LINE on the back of the printer.



---

**NOTE:** You might need to connect the supplied phone cord to the adapter provided for your country/region.

If you do not use the supplied cord to connect from the DSL filter to the back of the printer, you might not be able to fax successfully. This special phone cord is different from the phone cords you might already have in your home or office.

---

3. Connect the DSL filter to the parallel splitter.
4. Connect the DSL modem to the parallel splitter.
5. Connect the parallel splitter to the wall jack.
6. Run a fax test.

When the phone rings, the printer automatically answers after the number of rings you set in the **Rings to Answer** setting. The printer begins emitting fax reception tones to the sending fax machine and receives the fax.

If you encounter problems setting up the printer with optional equipment, contact your local service provider or vendor for further assistance.

**Case H: Shared voice/fax line with computer modem**

There are two different ways to set up the printer with your computer based on the number of phone ports on your computer. Before you begin, check your computer to see if it has one or two phone ports.



---

**NOTE:** If your computer has only one phone port, you need to purchase a parallel splitter (also called a coupler). (A parallel splitter has one RJ-11 port on the front and two RJ-11 ports on the back. Do not use a two-line phone splitter, a serial splitter, or a parallel splitter which has two RJ-11 ports on the front and a plug on the back.)

---

- [Shared voice/fax with computer dial-up modem](#)
- [Shared voice/fax with computer DSL/ADSL modem](#)

**Shared voice/fax with computer dial-up modem**

If you use your phone line for both fax and telephone calls, use these instructions to set up your fax. There are two different ways to set up the printer with your computer based on the number of phone ports on your computer. Before you begin, check your computer to see if it has one or two phone ports.



---

**NOTE:** If your computer has only one phone port, you need to purchase a parallel splitter (also called a coupler). (A parallel splitter has one RJ-11 port on the front and two RJ-11 ports on the back. Do not use a two-line phone splitter, a serial splitter, or a parallel splitter which has two RJ-11 ports on the front and a plug on the back.)

---

**Example of a parallel splitter**



## To set up the printer on the same phone line as a computer with two phone ports

### Back view of the printer

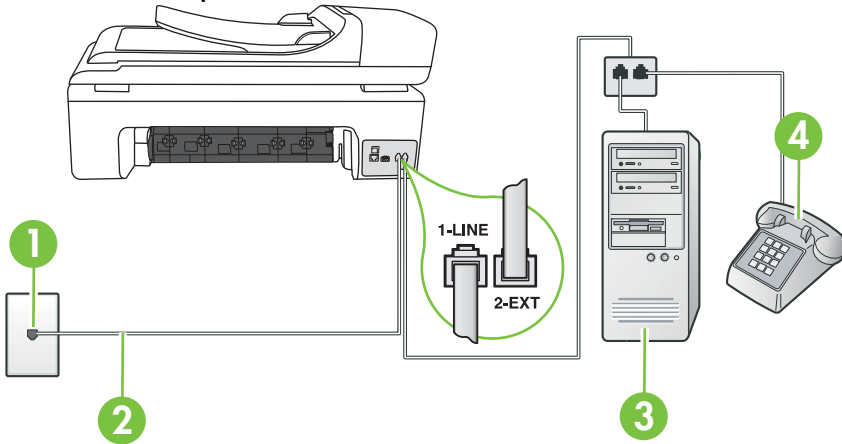

1	Telephone wall jack
2	Use the phone cord supplied in the box with the printer to connect to the 1-LINE port. You might need to connect the supplied phone cord to the adapter provided for your country/region.
3	Computer with modem
4	Telephone

1. Remove the white plug from the port labeled 2-EXT on the back of the printer.
2. Find the phone cord that connects from the back of your computer (your computer dial-up modem) to a telephone wall jack. Disconnect the cord from the telephone wall jack and plug it into the port labeled 2-EXT on the back of the printer.
3. Connect a phone to the "OUT" port on the back of your computer dial-up modem.
4. Using the phone cord supplied in the box with the printer, connect one end to your telephone wall jack, then connect the other end to the port labeled 1-LINE on the back of the printer.

 **NOTE:** You might need to connect the supplied phone cord to the adapter provided for your country/region.

If you do not use the supplied cord to connect from the telephone wall jack to the printer, you might not be able to fax successfully. This special phone cord is different from the phone cords you might already have in your home or office.

5. If your modem software is set to receive faxes to your computer automatically, turn off that setting.

 **NOTE:** If you do not turn off the automatic fax reception setting in your modem software, the printer cannot receive faxes.

6. Now you need to decide how you want the printer to answer calls, automatically or manually:
  - If you set up the printer to answer calls **automatically**, it answers all incoming calls and receives faxes. The printer cannot distinguish between fax and voice calls in this case; if you suspect the call is a voice call, you need to answer it before the printer answers the call. To set up the printer to answer calls automatically, turn on the **Auto Answer** setting.
  - If you set up the printer to answer faxes **manually**, you must be available to respond in person to incoming fax calls or the printer cannot receive faxes. To set up the printer to answer calls manually, turn off the **Auto Answer** setting.
7. Run a fax test.

If you pick up the phone before the printer answers the call and hear fax tones from a sending fax machine, you need to answer the fax call manually.

If you use your phone line for voice, fax, and your computer dial-up modem, follow these directions to set up your fax.

If you encounter problems setting up the printer with optional equipment, contact your local service provider or vendor for further assistance.

### Shared voice/fax with computer DSL/ADSL modem

Use these instructions if your computer has a DSL/ADSL modem

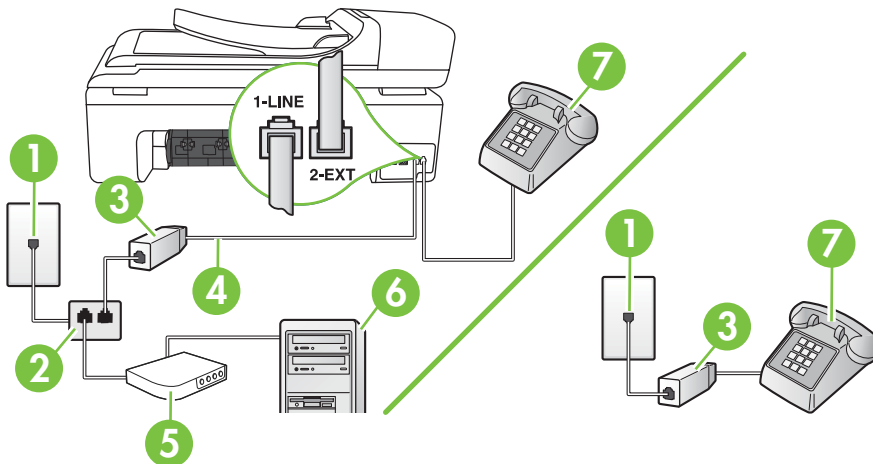

1	Telephone wall jack
2	Parallel splitter
3	DSL/ADSL filter
4	Phone cord supplied with the printer You might need to connect the supplied phone cord to the adapter provided for your country/region.
5	DSL/ADSL modem
6	Computer
7	Telephone



**NOTE:** You need to purchase a parallel splitter. A parallel splitter has one RJ-11 port on the front and two RJ-11 ports on the back. Do not use a 2-line phone splitter, a serial splitter, or a parallel splitter which has two RJ-11 ports on the front and a plug on the back.

---

### Example of a parallel splitter



#### To set up the printer with a computer DSL/ADSL modem

1. Obtain a DSL filter from your DSL provider.



**NOTE:** Phones in other parts of the home/office sharing the same phone number with DSL service must be connected to additional DSL filters to avoid noise when making voice calls.

---

2. Using the phone cord supplied in the box with the printers, connect one end to the DSL filter, then connect the other end to the port labeled 1-LINE on the back of the printer.



**NOTE:** You might need to connect the supplied phone cord to the adapter provided for your country/region.

If you do not use the supplied cord to connect from the DSL filter to the printer, you might not be able to fax successfully. This special phone cord is different from phone cords you might already have in your home or office.

---

3. If you have a parallel-type phone system, remove the white plug from the port labeled 2-EXT on the back of the printer, and then connect a phone to this port.
4. Connect the DSL filter to the parallel splitter.
5. Connect the DSL modem to the parallel splitter.
6. Connect the parallel splitter to the wall jack.
7. Run a fax test.

When the phone rings, the printer automatically answers after the number of rings you set in the **Rings to Answer** setting. The printer begins emitting fax reception tones to the sending fax machine and receives the fax.

If you encounter problems setting up the printer with optional equipment, contact your local service provider or vendor for further assistance.

### Case I: Shared voice/fax line with answering machine

If you receive both voice calls and fax calls at the same phone number, and you also have an answering machine that answers voice calls at this phone number, set up the printer as described in this section.

#### Back view of the printer

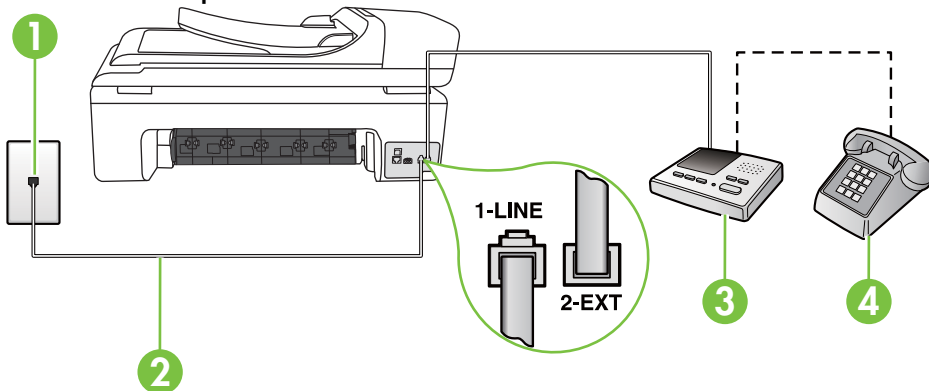

1	Telephone wall jack
2	Use the phone cord provided to connect to the 1-LINE port on the back of the printer You might need to connect the supplied phone cord to the adapter provided for your country/region.
3	Answering machine
4	Telephone (optional)

#### To set up the printer with a shared voice/fax line with answering machine

1. Remove the white plug from the port labeled 2-EXT on the back of the printer.
2. Unplug your answering machine from the telephone wall jack, and connect it to the port labeled 2-EXT on the back of the printer.

**NOTE:** If you do not connect your answering machine directly to the printer, fax tones from a sending fax machine might be recorded on your answering machine, and you cannot receive faxes with the printer.

3. Using the phone cord supplied in the box with the printer, connect one end to your telephone wall jack, then connect the other end to the port labeled 1-LINE on the back of the printer.

**NOTE:** You might need to connect the supplied phone cord to the adapter provided for your country/region.

If you do not use the supplied cord to connect from the telephone wall jack to the printer, you might not be able to fax successfully. This special phone cord is different from the phone cords you might already have in your home or office.



4. (Optional) If your answering machine does not have a built-in phone, for convenience you might want to connect a phone to the back of your answering machine at the "OUT" port.

---

 **NOTE:** If your answering machine does not let you connect an external phone, you can purchase and use a parallel splitter (also known as a coupler) to connect both the answering machine and telephone to the printer. You can use standard phone cords for these connections.

---

5. Turn on the **Auto Answer** setting.
6. Set your answering machine to answer after a low number of rings.
7. Change the **Rings to Answer** setting on the printer to the maximum number of rings supported by your printer. (The maximum number of rings varies by country/region.)
8. Run a fax test.

When the phone rings, your answering machine answers after the number of rings you have set, and then plays your recorded greeting. The printer monitors the call during this time, "listening" for fax tones. If incoming fax tones are detected, the printer emits fax reception tones and receives the fax; if there are no fax tones, the printer stops monitoring the line and your answering machine can record a voice message.

If you encounter problems setting up the printer with optional equipment, contact your local service provider or vendor for further assistance.

### Case J: Shared voice/fax line with computer modem and answering machine

If you receive both voice calls and fax calls at the same phone number, and you also have a computer modem and answering machine connected on this phone line, set up the printer as described in this section.

---

 **NOTE:** Since your computer dial-up modem shares the phone line with the printer, you cannot use both your modem and the printer simultaneously. For example, you cannot use the printer for faxing while you are using your computer dial-up modem to send an email or access the Internet.

---

- [Shared voice/fax line with computer dial-up modem and answering machine](#)
- [Shared voice/fax line with computer DSL/ADSL modem and answering machine](#)

### Shared voice/fax line with computer dial-up modem and answering machine

There are two different ways to set up the printer with your computer based on the number of phone ports on your computer. Before you begin, check your computer to see if it has one or two phone ports

---

 **NOTE:** If your computer has only one phone port, you must purchase a parallel splitter (also called a coupler), as shown below. (A parallel splitter has one RJ-11 port on the front and two RJ-11 ports on the back. Do not use a two-line phone splitter, a serial splitter, or a parallel splitter which has two RJ-11 ports on the front and a plug on the back.)

---

### Example of a parallel splitter



To set up the printer on the same phone line as a computer with two phone ports

Back view of the printer

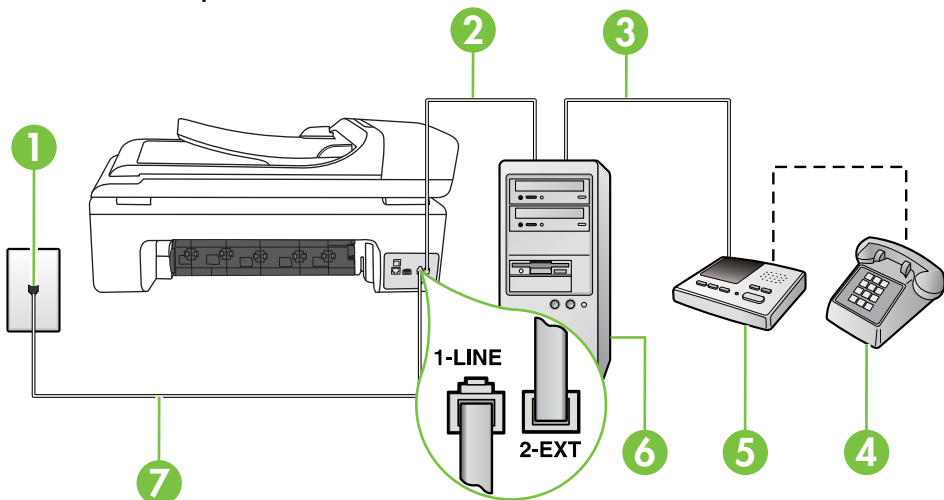

1	Telephone wall jack
2	"IN" phone port on your computer
3	"OUT" phone port on your computer
4	Telephone (optional)
5	Answering machine
6	Computer with modem
7	Use the phone cord supplied in the box with the printer to connect to the 1-LINE port. You might need to connect the supplied phone cord to the adapter provided for your country/region.

1. Remove the white plug from the port labeled 2-EXT on the back of the printer.
2. Find the phone cord that connects from the back of your computer (your computer dial-up modem) to a telephone wall jack. Disconnect the cord from the telephone wall jack and plug it into the port labeled 2-EXT on the back of the printer.
3. Unplug your answering machine from the telephone wall jack, and connect it to the port labeled "OUT" on the back of the computer (the computer dial-up modem).
4. Using the phone cord supplied in the box with the printer, connect one end to your telephone wall jack, then connect the other end to the port labeled 1-LINE on the back of the printer.



**NOTE:** You might need to connect the supplied phone cord to the adapter provided for your country/region.

If you do not use the supplied cord to connect from the telephone wall jack to the printer, you might not be able to fax successfully. This special phone cord is different from the phone cords you might already have in your home or office.

- (Optional) If your answering machine does not have a built-in phone, for convenience you might want to connect a phone to the back of your answering machine at the "OUT" port.

**NOTE:** If your answering machine does not let you connect an external phone, you can purchase and use a parallel splitter (also known as a coupler) to connect both the answering machine and telephone to the printer. You can use standard phone cords for these connections.

- If your modem software is set to receive faxes to your computer automatically, turn off that setting.

**NOTE:** If you do not turn off the automatic fax reception setting in your modem software, the printer cannot receive faxes.

- Turn on the **Auto Answer** setting.
- Set your answering machine to answer after a low number of rings.
- Change the **Rings to Answer** setting on the printer to the maximum number of rings supported by the product. (The maximum number of rings varies by country/region.)
- Run a fax test.

When the phone rings, your answering machine answers after the number of rings you have set, and then play your recorded greeting. The printer monitors the call during this time, "listening" for fax tones. If incoming fax tones are detected, the printer emits fax reception tones and receive the fax; if there are no fax tones, the printer stops monitoring the line and your answering machine records a voice message.

If you encounter problems setting up the printer with optional equipment, contact your local service provider or vendor for further assistance.

### Shared voice/fax line with computer DSL/ADSL modem and answering machine

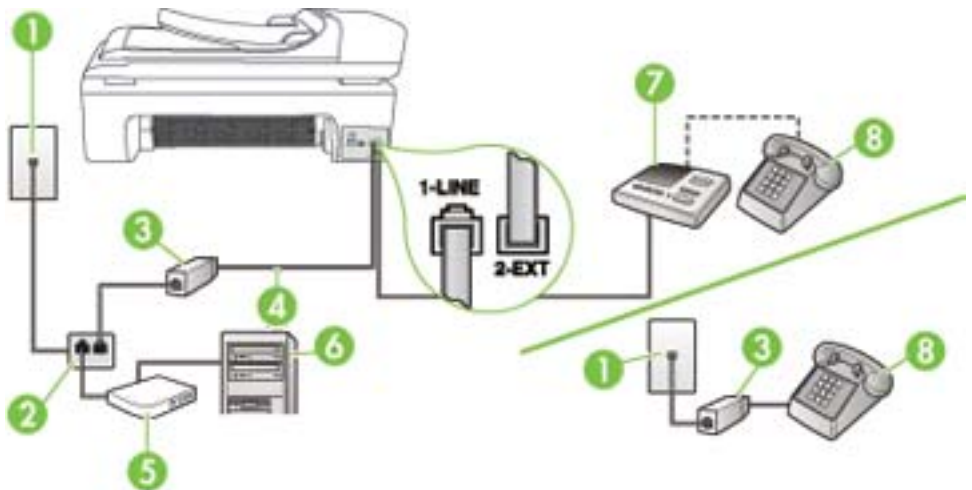

1	Telephone wall jack
2	Parallel splitter
3	DSL/ADSL filter

(continued)

4	Phone cord provided with the printer connected to the 1-LINE port on the back of the printer You might need to connect the supplied phone cord to the adapter provided for your country/region.
5	DSL/ADSL modem
6	Computer
7	Answering machine
8	Telephone (optional)

 **NOTE:** You must purchase a parallel splitter. A parallel splitter has one RJ-11 port on the front and two RJ-11 ports on the back. Do not use a 2-line phone splitter, a serial splitter, or a parallel splitter which has two RJ-11 ports on the front and a plug on the back.



### To set up the printer with a computer DSL/ADSL modem

1. Obtain a DSL/ADSL filter from your DSL/ADSL provider.

 **NOTE:** Phones in other parts of the home/office sharing the same phone number with DSL/ADSL service must be connected to additional DSL/ADSL filters; otherwise, noise occurs when making voice calls.

2. Using the phone cord supplied in the box with the printer, connect one end to the DSL/ADSL filter, then connect the other end to the port labeled 1-LINE on the back of the printer.

 **NOTE:** You might need to connect the supplied phone cord to the adapter provided for your country/region.

If you do not use the supplied cord to connect from the DSL/ADSL filter to the printer, you might not be able to fax successfully. This special phone cord is different from the phone cords you might already have in your home or office.

3. Connect the DSL/ADSL filter to the splitter.
4. Unplug the answering machine from the telephone wall jack, and connect it to the port labeled 2-EXT on the back of the printer.

 **NOTE:** If you do not connect your answering machine directly to the printer, fax tones from a sending fax machine might be recorded on your answering machine, and you might not receive faxes with the printer.

5. Connect the DSL modem to the parallel splitter.
6. Connect the parallel splitter to the wall jack.
7. Set your answering machine to answer after a low number of rings.
8. Change your **Rings to Answer** setting on the printer to the maximum number of rings supported by the printer.

 **NOTE:** The maximum number of rings varies by country/region.

9. Run a fax test.

When the phone rings, your answering machine answers after the number of rings you have set, and then play your recorded greeting. The printer monitors the call during this time, "listening" for

fax tones. If incoming fax tones are detected, the printer emits fax reception tones and receive the fax; if there are no fax tones, the printer stops monitoring the line and your answering machine can record a voice message.

If you use the same phone line for telephone, fax, and have a computer DSL modem, follow these instructions to set up your fax.

If you encounter problems setting up the printer with optional equipment, contact your local service provider or vendor for further assistance.

### Case K: Shared voice/fax line with computer dial-up modem and voice mail

If you receive both voice calls and fax calls at the same phone number, use a computer dial-up modem on the same phone line, and subscribe to a voice mail service through your telephone company, set up the printer as described in this section.

 **NOTE:** You cannot receive faxes automatically if you have a voice mail service at the same phone number you use for fax calls. You must receive faxes manually; this means you must be available to respond in person to incoming fax calls. If you want to receive faxes automatically instead, contact your telephone company to subscribe to a distinctive ring service, or to obtain a separate phone line for faxing.

Since your computer dial-up modem shares the phone line with the printer, you cannot use both your modem and the printer simultaneously. For example, you cannot use the printer for faxing if you are using your computer dial-up modem to send an email or access the Internet.

There are two different ways to set up the printer with your computer based on the number of phone ports on your computer. Before you begin, check your computer to see if it has one or two phone ports.

- If your computer has only one phone port, you must purchase a parallel splitter (also called a coupler), as shown below. (A parallel splitter has one RJ-11 port on the front and two RJ-11 ports on the back. Do not use a two-line phone splitter, a serial splitter, or a parallel splitter which has two RJ-11 ports on the front and a plug on the back.)

#### Example of a parallel splitter



- If your computer has two phone ports, set up the printer as described below.

#### Back view of the printer

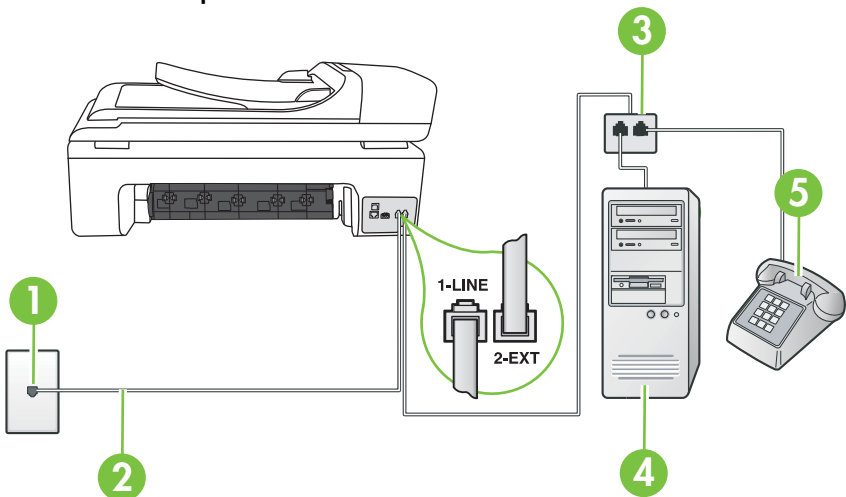

1	Telephone wall jack
2	Use the phone cord supplied in the box with the printer to connect to the 1-LINE port You might need to connect the supplied phone cord to the adapter provided for your country/region.
3	Parallel splitter
4	Computer with modem
5	Telephone

### To set up the printer on the same phone line as a computer with two phone ports

1. Remove the white plug from the port labeled 2-EXT on the back of the printer.
2. Find the phone cord that connects from the back of your computer (your computer dial-up modem) to a telephone wall jack. Disconnect the cord from the telephone wall jack and plug it into the port labeled 2-EXT on the back of the printer.
3. Connect a phone to the "OUT" port on the back of your computer dial-up modem.
4. Using the phone cord supplied in the box with the printer, connect one end to your telephone wall jack, then connect the other end to the port labeled 1-LINE on the back of the printer.



**NOTE:** You might need to connect the supplied phone cord to the adapter provided for your country/region.

If you do not use the supplied cord to connect from the telephone wall jack to the printer, you might not be able to fax successfully. This special phone cord is different from the phone cords you might already have in your home or office.

5. If your modem software is set to receive faxes to your computer automatically, turn off that setting.



**NOTE:** If you do not turn off the automatic fax reception setting in your modem software, the printer cannot receive faxes.

6. Turn off the **Auto Answer** setting.
7. Run a fax test.

You must be available to respond in person to incoming fax calls, or the printer cannot receive faxes. If you encounter problems setting up the printer with optional equipment, contact your local service provider or vendor for further assistance.

## Serial-type fax setup

For information on setting up the printer for faxing using a serial-type phone system, see the Fax Configuration Web site for your country/region.

Austria	<a href="http://www.hp.com/at/faxconfig">www.hp.com/at/faxconfig</a>
Germany	<a href="http://www.hp.com/de/faxconfig">www.hp.com/de/faxconfig</a>
Switzerland (French)	<a href="http://www.hp.com/ch/fr/faxconfig">www.hp.com/ch/fr/faxconfig</a>
Switzerland (German)	<a href="http://www.hp.com/ch/de/faxconfig">www.hp.com/ch/de/faxconfig</a>
United Kingdom	<a href="http://www.hp.com/uk/faxconfig">www.hp.com/uk/faxconfig</a>
Finland	<a href="http://www.hp.fi/faxconfig">www.hp.fi/faxconfig</a>

(continued)

Denmark	<a href="http://www.hp.dk/faxconfig">www.hp.dk/faxconfig</a>
Sweden	<a href="http://www.hp.se/faxconfig">www.hp.se/faxconfig</a>
Norway	<a href="http://www.hp.no/faxconfig">www.hp.no/faxconfig</a>
Netherlands	<a href="http://www.hp.nl/faxconfig">www.hp.nl/faxconfig</a>
Belgium (Dutch)	<a href="http://www.hp.be/nl/faxconfig">www.hp.be/nl/faxconfig</a>
Belgium (French)	<a href="http://www.hp.be/fr/faxconfig">www.hp.be/fr/faxconfig</a>
Portugal	<a href="http://www.hp.pt/faxconfig">www.hp.pt/faxconfig</a>
Spain	<a href="http://www.hp.es/faxconfig">www.hp.es/faxconfig</a>
France	<a href="http://www.hp.com/fr/faxconfig">www.hp.com/fr/faxconfig</a>
Ireland	<a href="http://www.hp.com/ie/faxconfig">www.hp.com/ie/faxconfig</a>
Italy	<a href="http://www.hp.com/it/faxconfig">www.hp.com/it/faxconfig</a>

## Test fax setup

You can test your fax setup to check the status of the printer and to make sure it is set up correctly for faxing. Perform this test after you have completed setting up the printer for faxing. The test does the following:

- Tests the fax hardware
- Verifies the correct type of phone cord is connected to the printer
- Checks that the phone cord is plugged into the correct port
- Checks for a dial tone
- Checks for an active phone line
- Tests the status of your phone line connection

The printer prints a report with the results of the test. If the test fails, review the report for information on how to fix the problem and rerun the test.

### To test fax setup via the printer control panel

1. Set up the printer for faxing according to your particular home or office setup instructions.
2. Make sure the ink cartridges are installed, and that full-size paper is loaded in the input tray before starting the test.
3. From the printer control panel, touch right arrow , and then select **Setup**.
4. Select **Tools**, and then select **Run Fax Test**.  
The printer displays the status of the test on the display and prints a report.
5. Review the report.
  - If the test passes and you are still having problems faxing, check the fax settings listed in the report to verify the settings are correct. A blank or incorrect fax setting can cause problems faxing.
  - If the test fails, review the report for more information on how to fix any problems found.

---

# D Network setup

You can manage network settings for the printer through the printer control panel as described in the next section. Additional advanced settings are available in the embedded Web server, a configuration and status tool you access from your Web browser using an existing network connection to the printer. For more information, see [Embedded Web server](#).

This section contains the following topics:

- [Change basic network settings](#)
- [Change advanced network settings](#)
- [Set up the printer for wireless communication](#)
- [Uninstall and reinstall the HP software](#)

## Change basic network settings

The control-panel options enable you to set up and manage a wireless connection and to perform a variety of network management tasks. This includes viewing the network settings, restoring the network defaults, turning the wireless radio on and off, and changing the network settings.

This section contains the following topics:

- [View and print network settings](#)
- [Turn the wireless radio on and off](#)

### View and print network settings

You can display a summary of the network settings on the printer control panel or the Network Toolbox. You can print a more detailed network configuration page which lists all of the important network settings such as the IP address, link speed, DNS, and mDNS. For more information on the network settings, see [Understand the network configuration page](#).

### Turn the wireless radio on and off

The wireless radio is on by default, as indicated by the blue light on the front of the printer. In order to stay connected to a wireless network, the radio must stay on. However, if your printer is connected to a wired network or you have a USB connection, the radio is not used. In this case you might want to turn the radio off.

1. Touch right arrow , and then select **Network**.
2. Touch **Wireless**, select **Wireless Radio**, and then select **On** to turn the radio on, or **Off** to turn the radio off.

## Change advanced network settings

The advanced network settings are provided for your convenience. However, unless you are an advanced user, you should not change any of these settings. The advanced settings include **Link Speed**, **IP Settings**, and **Default Gateway**.

This section contains the following topics:

- [Set link speed](#)
- [View IP settings](#)
- [Change IP settings](#)
- [Reset network settings](#)



## Set link speed

You can change the speed at which data is transmitted over the network. The default is **Automatic**.

1. Touch right arrow , and then select **Network**.
2. Select **Advanced Setup**, then select **Link Speed**.
3. Touch the number next to the link speed that matches your network hardware:
  - **1. Automatic**
  - **2. 10-Full**
  - **3. 10-Half**
  - **4. 100-Full**
  - **5. 100-Half**

## View IP settings

To view the IP address of the printer:

- Print the network configuration page. For more information, see [Understand the network configuration page](#).
- Or, open the Network Toolbox (Windows), click the **Network Settings** tab, click the **Wired** or **Wireless** tab (depending on the current connection), and then click **IP Settings**.

## Change IP settings

The default IP setting for the IP settings is **Automatic**, which sets the IP settings automatically. However, if you are an advanced user, you might want to manually change settings, such as the IP address, subnet mask, or the default gateway.

---

 **CAUTION:** Be careful when manually assigning an IP address. If you enter an invalid IP address during the installation, your network components cannot connect with the printer.

---

1. Touch right arrow , and then select **Network**.
2. Select **Advanced Setup**, and then select **IP Settings**.
3. A message appears warning that changing the IP address will remove the printer from the network. Touch **OK** to continue.
4. **Automatic** is selected by default. To change the settings manually, touch **Manual**.
5. Touch the IP setting:
  - **IP Address**
  - **Subnet Mask**
  - **Default Gateway**
6. Enter your changes, and then touch **Done**.

## Reset network settings

1. Touch right arrow , and then select **Network**.
2. Touch **Restore Network Defaults**, and then select **Yes**.

---

 **NOTE:** Print the network configuration page and verify that the network settings have been reset. For more information, see [Understand the network configuration page](#).  
By default, the network name (SSID) is "hpsetup" and the communication mode is "ad hoc."

---

## Set up the printer for wireless communication

You may set up the printer for wireless communication.



**NOTE:** If you encounter problems, see [Solve wireless problems](#).

Make sure the printer is not connected to the network using a network cable.

The sending device must have built-in 802.11 capabilities or an 802.11 wireless card installed.

The printer and the computers that use it must be on the same subnet.

Before installing the HP software, you might want to find out the settings of your network. Obtain the information from your system administrators, or complete the following tasks:

- Obtain your network's network name or Service Set Identifier (SSID) and communication mode (infrastructure or ad hoc) from the configuration utility for the network's wireless access point (WAP) or the computer's network card.
- Find out the type of encryption your network uses, such as Wired Equivalent Privacy (WEP).
- Find out the security password or encryption key of the wireless device.

This section contains the following topics:

- [To set up a wireless communication using the Wireless Setup Wizard](#)
- [Understand 802.11 wireless network settings](#)
- [Test the wireless connection](#)
- [Change the connection method](#)
- [Guidelines for ensuring wireless network security](#)
- [Guidelines for reducing interference on a wireless network](#)

## To set up a wireless communication using the Wireless Setup Wizard

The Wireless Setup Wizard provides an easy way to set up and manage a wireless connection (both infrastructure and ad hoc connections) to your printer.



**NOTE:** To connect to an infrastructure network, you must have a wireless network set up and running.

1. Set up the printer hardware. See the getting started guide or the setup poster that came with your printer.
2. On the printer control panel, touch right arrow , and then select **Network**.
3. Touch **Wireless**, select **Wireless Setup Wizard**, and then touch **OK**.
4. Follow the display instructions to complete the setup.



**NOTE:** If you cannot find the network name (SSID) and WPA key or WEP passphrase, contact your network administrator or the person who set up the wireless network..

**NOTE:** If you want to connect the printer using an ad hoc connection, connect your computer to the network name (SSID) "hpsetup". (This network name is the default, ad hoc network created by the printer.)

If your printer was previously configured for a different network, you can restore the network defaults to enable the printer to use "hpsetup". To restore the network defaults complete the following steps:

## Understand 802.11 wireless network settings

### Network name (SSID)

By default, the printer looks for the wireless network name or SSID named "hpsetup." Your network may have a different SSID.

### Communication mode

There are two communication mode options:

- **Ad hoc:** On an ad hoc network, the printer is set to ad hoc communication mode and communicates directly with other wireless devices without the use of a WAP. All devices on the ad hoc network must:
  - Be 802.11 compatible
  - Have ad hoc as the communication mode
  - Have the same network name (SSID)
  - Be on the same subnet and same channel
  - Have the same 802.11 security settings
- **Infrastructure (recommended):** On an infrastructure network, the printer is set to infrastructure communication mode and communicates with other devices on the network, whether the devices are wired or wireless, through a WAP. WAPs commonly act as routers or gateways on small networks.

### Security settings

- **Network authentication:** The printer's factory default setting is 'Open,' which does not require security for authorization or encryption. The other possible values are 'OpenThenShared,' 'Shared,' and 'WPA-PSK' (Wi-Fi® Protected Access Pre-Shared Key).

WPA increases the level of over-the-air data protection and access control on existing and future Wi-Fi networks. It addresses all known weaknesses of WEP, the original native security mechanism in the 802.11 standard.

WPA2 is the second generation of WPA security; it provides enterprise and consumer Wi-Fi users with a high level of assurance that only authorized users can access their wireless networks.

- **Data encryption:**
  - Wired Equivalent Privacy (WEP) provides security by encrypting data sent over radio waves from one wireless device to another wireless device. Devices on a WEP-enabled network use WEP keys to encode data. If your network uses WEP, you must know the WEP key(s) it uses.



**NOTE:** Shared WEP key encryption is not supported.

---

- WPA uses the Temporal Key Integrity Protocol (TKIP) for encryption and employs 802.1X authentication with one of the standard Extensible Authentication Protocol (EAP) types available today.
- WPA2 provides a new encryption scheme, the Advanced Encryption Standard (AES). AES is defined in counter cipher-block chaining mode (CCM) and supports the Independent Basic Service Set (IBSS) to enable security between client workstations operating in ad hoc mode.

### Test the wireless connection

Print the wireless test page for information about the printer's wireless connection. The wireless test page provides information about the printer's status, MAC address, and IP address. If the printer is connected to a network, the test page displays details about the network settings.

- ▲ **Printer control panel:** Touch right arrow , select **Network**, select **Wireless**, and then select **Wireless Network Test**.

### Change the connection method

#### To change the connection method (Windows)



**NOTE:** If you are changing to a wireless connection, make sure that an Ethernet cable has not been connected to the printer. Connecting an Ethernet cable turns off the printer's wireless capabilities.

---

1. On the computer desktop, click **Start**, select **Programs** or **All Programs**, click **HP**, select your printer name, and then click **Connect a New Printer**.
2. Follow the onscreen instructions.

#### **To change the connection method (Mac OS X)**

1. Open the HP Utility. For more information, see [HP Utility \(Mac OS X\)](#).
2. Click the **Application** icon on the toolbar.
3. Double-click **HP Setup Assistant**, and then follow the onscreen instructions.

### **Guidelines for ensuring wireless network security**

This section contains the following topics:

- [To add hardware addresses to a WAP](#)
- [Other guidelines](#)

#### **To add hardware addresses to a WAP**

MAC filtering is a security feature in which a WAP is configured with a list of MAC addresses (also called "hardware addresses") of devices that are allowed to gain access to the network through the WAP.

If the WAP does not have the hardware address of a device attempting to access the network, the WAP denies the device access to the network.

If the WAP filters MAC addresses, then the printer's MAC address must be added to the WAP's list of accepted MAC addresses.

1. Print the network configuration page. For information on the network configuration page, see [Understand the network configuration page](#).
2. Open the WAP's configuration utility, and add the printer's hardware address to the list of accepted MAC addresses.

#### **Other guidelines**

To keep the wireless network secure, follow these guidelines:

- Use a password with at least 20 random characters. You can use up to 64 characters in a WPA password.
- Avoid any common words or phrases, easy sequences of characters (such as all 1s), and personally-identifiable information for passwords. Always use random strings composed of uppercase and lowercase letters, numbers, and if allowed, special characters such as punctuation.
- Change the password periodically.
- Change the default password provided by the manufacturer for administrator access to the access point or wireless router. Some routers let you change the administrator name as well.
- Turn off administrative access over wireless if possible. If you do this, you need to connect to the router with a wired Ethernet connection when you want to make configuration changes.
- Turn off remote administrative access over the Internet on your router, if possible. You can use Remote Desktop to make an encrypted connection to a computer running behind your router and make configuration changes from the local computer you are accessing over the Internet.
- To avoid accidentally connecting to another party's wireless network, turn off the setting to automatically connect to non-preferred networks. This is disabled by default in Windows XP.

## Guidelines for reducing interference on a wireless network

The following tips will help reduce the chances for interference in a wireless network:

- Keep the wireless devices away from large metal objects, such as filing cabinets, and other electromagnetic devices, such as microwaves and cordless telephones, as these objects can disrupt radio signals.
- Keep the wireless devices away from large masonry structures and other building structures as these objects can absorb radio waves and lower signal strength.
- For an infrastructure network, position the WAP in a central location in line of sight with the wireless devices on the network.
- Keep all wireless devices on the network within range of one another.

## Uninstall and reinstall the HP software

If your installation is incomplete, or if you connected the USB cable to the computer before prompted by the HP software installation screen, you might need to uninstall and then reinstall the HP software that came with the printer. Do not simply delete the printer application files from your computer. Make sure to remove them correctly using the uninstall utility provided when you installed the HP software.

### To uninstall from a Windows computer, method 1

1. Disconnect the printer from your computer. Do not connect it to your computer until after you have reinstalled the HP software.
2. On the computer desktop, click **Start**, select **Programs** or **All Programs**, click **HP**, click the printer name, and then click **Uninstall**.
3. Follow the onscreen instructions.
4. If you are asked whether you would like to remove shared files, click **No**.  
Other programs that use these files might not work correctly if the files are deleted.
5. Restart your computer.
6. To reinstall the HP software, insert the HP software CD into your computer's CD drive and follow the onscreen instructions.
7. Connect the printer when the HP software prompts you to connect it to the computer.
8. Press the **Power** button to turn the printer on.  
After connecting and turning on the printer, you might have to wait several minutes for all of the Plug and Play events to complete.
9. Follow the onscreen instructions.

### To uninstall from a Windows computer, method 2

---

 **NOTE:** Use this method if **Uninstall** is not available in the Windows Start menu.

---

1. On the computer desktop, click **Start**, select **Settings**, click **Control Panel**, and then click **Add/Remove Programs**.  
- Or -  
Click **Start**, click **Control Panel**, and then double-click **Programs and Features**.
2. Select the printer name, and then click **Change/Remove** or **Uninstall/Change**.  
Follow the onscreen instructions.
3. Disconnect the printer from your computer.
4. Restart your computer.

---

 **NOTE:** It is important that you disconnect the printer before restarting your computer. Do not connect the printer to your computer until after you have reinstalled the HP software.

---

5. Insert the HP software CD into your computer's CD drive and then start the Setup program.
6. Follow the onscreen instructions.

**To uninstall from a Macintosh computer, method 1**

1. Open the HP Utility. For instructions, see [Open HP Utility](#).
2. Click the Application icon on the toolbar.
3. Double click **HP Uninstaller**.  
Follow the onscreen instructions.
4. After the HP software is uninstalled, restart your computer.
5. To reinstall the HP software, insert the HP software CD into your computer's CD drive.
6. On the desktop, open the CD, and then double-click **HP Installer**.
7. Follow the onscreen instructions.

**To uninstall from a Macintosh computer, method 2**

1. Open the Finder, select **Applications**, select **HP**, and then select your printer model.
2. Double-click **HP Uninstaller**.
3. Follow the onscreen instructions.

---

# E Printer management tools

This section contains the following topics:

- [HP printer software \(Windows\)](#)
- [HP Utility \(Mac OS X\)](#)
- [Embedded Web server](#)

## HP printer software (Windows)

The HP software provided with the printer provides maintenance information about the printer.

---

 **NOTE:** The HP printer software can be installed from the HP software CD if the computer meets the system requirements.

---

### Open the HP software

From the computer desktop, click **Start**, select **Programs** or **All Programs**, select **HP**, and then click your HP printer.

## HP Utility (Mac OS X)

The HP Utility contains tools to configure print settings, calibrate the printer, order supplies online, and find Web site support information.

---

 **NOTE:** On a Macintosh computer, the features available in the HP Utility vary depending on the selected printer.

Ink level warnings and indicators provide estimates for planning purposes only. When you receive an ink alert message, consider having a replacement cartridge available to avoid possible printing delays. You do not need to replace cartridges until print quality becomes unacceptable.

 **TIP:** When the HP Utility is opened, you can gain access to the Dock menu shortcuts by selecting and holding the mouse button over the appropriate icon for the HP Utility in the Dock.

---

### Open HP Utility

#### To open the HP Utility

- ▲ Click the HP Utility icon in the Dock.

---

 **NOTE:** If the icon does not appear in the Dock, click the Spotlight icon on the right side of the menu bar, type `HP Utility` in the box, and then click the **HP Utility** entry.

---

## Embedded Web server

When the printer is connected to a network, you can use the embedded Web server to view status information, change settings, and manage it from your computer.

---

 **NOTE:** For a list of system requirements for the embedded Web server, see [Embedded Web server specifications](#).

To view or change some settings, you might need a password.

You can open and use the embedded Web server without being connected to the Internet. However, some features are not available.

---

This section contains the following topics:

- [About cookies](#)
- [To open the embedded Web server](#)

### About cookies

The embedded Web server (EWS) places very small text files (cookies) on your hard drive when you are browsing. These files let the EWS recognize your computer the next time you visit. For example, if you have configured the EWS language, a cookie helps remember which language you have selected so that the next time you access the EWS, the pages are displayed in that language. Though some cookies are cleared at the end of each session (such as the cookie that stores the selected language), others (such as the cookie that stores customer-specific preferences) are stored on the computer until you clear them manually.

You can configure your browser to accept all cookies, or you can configure it to alert you every time a cookie is offered, which allows you to decide which cookies to accept or refuse. You can also use your browser to remove unwanted cookies.

---

 **NOTE:** Depending on your printer, if you disable cookies, you also disable one or more of the following features:

- Starting where you left the application (especially useful when using setup wizards)
- Remembering the EWS browser language setting
- Personalizing the EWS Home page

For information about how to change your privacy and cookie settings and how to view or delete cookies, see the documentation available with your Web browser.

### To open the embedded Web server

---

 **NOTE:** The printer must be on a network and must have an IP address. The IP address and hostname for the printer are listed on the status report. For more information, see [Understand the network configuration page](#).

In a supported Web browser on your computer, type the IP address or hostname that has been assigned to the printer.

For example, if the IP address is 123.123.123.123, type the following address into the Web browser: `http://123.123.123.123`.

---

 **TIP:** After opening the embedded Web server, you can bookmark it so that you can return to it quickly.

**TIP:** If you are using Safari on a Macintosh computer, you can also open the EWS by clicking the open-book toolbar button (located near the top of the browser window), clicking **Bonjour** in the **Collections** list, and then selecting the printer name.

---



---

# F How do I?

- [Get started](#)
- [Print](#)
- [Scan](#)
- [Copy](#)
- [Fax](#)
- [Work with ink cartridges](#)
- [Solve a problem](#)

---

# G Errors (Windows)

This list represents some of the errors you might see on your computer screen (Windows) and how to fix the errors.

- [Fax Memory Full](#)
- [Printer Disconnected](#)
- [Ink Alert](#)
- [Printhead Problem](#)
- [Cartridge Problem](#)
- [Paper Mismatch](#)
- [The cartridge cradle cannot move](#)
- [Paper Jam](#)
- [The printer is out of paper](#)
- [Printer Offline](#)
- [Printer Paused](#)
- [Document failed to print](#)
- [General printer error](#)
- [Door or cover open](#)
- [Previously used ink cartridge installed](#)

## Fax Memory Full

If Backup Fax Reception or HP Digital Fax (Fax to PC or Fax to Mac) is enabled and the product has a problem (such as a paper jam), the product saves incoming faxes to memory until the problem is resolved. However, the product's memory might fill up with faxes that have not been printed yet or transferred to the computer.

To solve this problem, resolve any problems with the product.

For more information, see [Solve fax problems](#).

## Printer Disconnected

The computer cannot communicate with the printer because one of the following events has occurred:

- The printer has been turned off.
- The cable connecting the printer - such as a USB cable or a network (Ethernet) cable - has been disconnected.
- If the printer is connected to a wireless network, the wireless connection has been broken.

To solve this problem, try the following solutions:

- Make sure the product is turned on and that the  (Power) light is on.
- Make sure the power cord and other cables are working and are firmly connected to the printer.
- Make sure the power cord is connected firmly to a functioning, alternating current (AC) power outlet.
- If the product is connected to a network, make sure the network is functioning properly. For more information, see [Solve wired \(Ethernet\) network problems](#).
- If the product is connected to a wireless network, make sure the wireless network is functioning properly. For more information, see [Solve wireless problems](#).

## Ink Alert

The ink cartridge identified in the message is low on ink.

Ink level warnings and indicators provide estimates for planning purposes only. When you receive a low-ink warning message, consider having a replacement cartridge available to avoid possible printing delays. You do not need to replace the ink cartridges until print quality becomes unacceptable.

For information about replacing ink cartridges, see [Replace the ink cartridges](#).

For information about ordering ink cartridges, see [HP supplies and accessories](#).

For information about recycling used ink supplies, see [HP inkjet supplies recycling program](#).

---

 **NOTE:** Ink from the cartridges is used in the printing process in a number of different ways, including in the initialization process, which prepares the printer and cartridges for printing. In addition, some residual ink is left in the cartridge after it is used. For more information see [www.hp.com/go/inkusage](http://www.hp.com/go/inkusage).

---

## Printhead Problem

The printhead identified in the message is missing, not detected, or incorrectly installed in the printer. To solve this problem, try the following solutions. Solutions are listed in order, with the most likely solution first. If the first solution does not solve the problem, continue trying the remaining solutions until the issue is resolved.

- [Solution 1: Turn the printer off and on](#)
- [Solution 2: Clean the electrical contacts](#)
- [Solution 3: Replace the printhead](#)

### **Solution 1: Turn the printer off and on**

Turn off the printer, and then turn it on again.

If the problem persists, try the next solution.

### **Solution 2: Clean the electrical contacts**

Clean the electrical contacts on the printhead. For more information, see [Advanced printhead maintenance](#).

If the problem persists, try the next solution.

### **Solution 3: Replace the printhead**

Replace the printhead. For more information, see [HP supplies and accessories](#).

---

 **NOTE:** If the printhead is still under warranty, contact HP support for service or replacement. For more information about the printhead warranty, see [HP support](#).

---

If the problem persists after you replace the cartridge, contact HP support. For more information, see [HP support](#).

## Cartridge Problem

The ink cartridge identified in the message is missing, damaged, or inserted into the wrong slot in the printer.

---

 **NOTE:** If the cartridge is identified in the message as incompatible, see [HP supplies and accessories](#) for information about obtaining cartridges for the printer.

---

To solve this problem, try the following solutions. Solutions are listed in order, with the most likely solution first. If the first solution does not solve the problem, continue trying the remaining solutions until the issue is resolved.

- [Solution 1: Turn the printer off and on](#)
- [Solution 2: Install the ink cartridges correctly](#)
- [Solution 3: Clean the electrical contacts](#)
- [Solution 4: Replace the ink cartridge](#)

### **Solution 1: Turn the printer off and on**

Turn off the printer, and then turn it on again.

If the problem persists, try the next solution.

### **Solution 2: Install the ink cartridges correctly**

Make sure all of the ink cartridges are properly installed:

1. Make sure the printer is turned on.
2. Open the print-carriage access door.



**NOTE:** Wait until the print carriage stops moving before proceeding.

---

3. Press the tab on the front of the ink cartridge to release it, and then remove it from the slot.
4. Slide the ink cartridge into the empty slot until it clicks into place and is seated firmly in the slot.



**CAUTION:** Do not lift the latch handle on the print carriage to install the ink cartridges. Doing so can result in incorrectly seated ink cartridges and printing problems. The latch must remain down in order to correctly install the ink cartridges.

---

5. Close the print-carriage access door and check if the error message has gone away.

If the problem persists, try the next solution.

### **Solution 3: Clean the electrical contacts**

Clean the electrical contacts on the ink cartridge.

1. Open the print-carriage access door and wait for the print carriage to stop moving.
2. Remove the cartridge and place it on a piece of paper with the nozzle plate facing up.
3. Dip a swab, or other soft, lint-free material that will not stick to the cartridges in distilled water, then squeeze it to remove most of the moisture. The swab should be only slightly damp.
4. Clean the ink cartridge contacts. Do not touch the nozzles.
5. Dry the electrical contracts with a new, clean swab.
6. Reinstall the ink cartridge, and then close the print-carriage access door.

If the problem persists, try the next solution.

### **Solution 4: Replace the ink cartridge**

Replace the indicated ink cartridge. For more information, see [HP supplies and accessories](#).



**NOTE:** If your cartridge is still under warranty, contact HP support for service or replacement. For more information about ink cartridge warranty, see [Ink cartridge warranty information](#). If the problem persists after you replace the cartridge, contact HP support. For more information, see [HP support](#).

---

## **Paper Mismatch**

The paper size or type selected in the printer driver does not match the paper loaded in the printer.

To solve this problem, try one of the following:

- Load the correct paper in the printer, and then press OK. For more information, see [Load media](#)
- Press the **X** (Cancel) button on the product's control panel, select a different paper size in the printer driver, and then print the document again.

## The cartridge cradle cannot move

Something is blocking the ink cartridge cradle (the part of the printer that holds the ink cartridges).

To clear the obstruction, press the  (Power) button to turn off the product, and then check the product for jams.

For more information, see [Clear jams](#).

## Paper Jam

Paper has become jammed in the printer.

Before you try to clear the jam, check the following:

- Make sure that you have loaded paper that meets specifications and is not wrinkled, folded, or damaged. For more information, see [Media specifications](#).
- Make sure that the printer is clean. For more information, see [Maintain the printer](#).
- Make sure that the trays are loaded correctly and are not too full. For more information, see [Load media](#).

For instructions on clearing jams, as well as more information about how to avoid jams, see [Clear jams](#).

## The printer is out of paper

The default tray is empty. Load more paper, and then press **OK**.

For more information, see [Load media](#).

## Printer Offline

The printer is currently offline. While offline, the printer cannot be used. To change the printer's status, complete the following steps:

1. Click **Start**, point to **Settings**, and then click **Printers** or **Printers and Faxes**.  
- Or -  
Click **Start**, click **Control Panel**, and then double-click **Printers**.
2. If the printers listed in the dialog box are not being displayed in **Details** view, click the **View** menu, and then click **Details**.
3. If the printer is **Offline**, right-click the printer, and click **Use Printer Online**.
4. Try using the printer again.

## Printer Paused

The printer is currently paused. While paused, new jobs are added to the queue but are not printed.

To change the printer's status, complete the following steps.

1. Click **Start**, point to **Settings**, and then click **Printers** or **Printers and Faxes**.  
- Or -  
Click **Start**, click **Control Panel**, and then double-click **Printers**.
2. If the printers listed in the dialog box are not being displayed in **Details** view, click the **View** menu, and then click **Details**.



3. If the printer is **Paused**, right-click the printer, and click **Resume Printing**.
4. Try using the printer again.

## Document failed to print

The printer could not print the document because a problem occurred in the printing system. For information about solving printing problems, see [Solve printing problems](#).

## General printer error

There was a problem with the printer. Usually, you can resolve such problems by completing the following steps:

1. Press the  (Power) button to turn off the printer.
2. Unplug the power cord, and then plug in the power cord again.
3. Press the  (Power) button to turn on the printer.

If this problem persists, write down the error code provided in the message, and then contact HP support. For more information about contacting HP support, see [HP support](#).

## Door or cover open

Before the printer can print documents, all doors and covers must be closed.

---

 **TIP:** When completely closed, most doors and covers snap into place. If the problem persists after you've securely closed all doors and covers, contact HP support. For more information, see [HP support](#).

---

## Previously used ink cartridge installed

The ink cartridge identified in the message was previously used in a different printer.

You can use ink cartridges in different printers, but if the cartridge was left outside of a printer for an extended period of time, the print quality of your documents might be affected. Also, if you use ink cartridges that have been used in a different printer, the ink level indicator might be inaccurate or unavailable.

If the print quality is unsatisfactory, try cleaning the printheads. For more information, see [Clean the printhead](#).

---

 **NOTE:** Ink from the cartridges is used in the printing process in a number of different ways, including in the initialization process, which prepares the printer and cartridges for printing, and in printhead servicing, which keeps print nozzles clear and ink flowing smoothly. In addition, some residual ink is left in the cartridge after it is used. For more information, see [www.hp.com/go/inkusage](http://www.hp.com/go/inkusage).

---

For more information about storing ink cartridges, see [Store printing supplies](#).

---

# Index

## Symbols/Numerics

(ADF) automatic document feeder  
clean 27  
feeding problems, troubleshoot 27

## A

accessibility 9  
accessories  
  Printer Status Report 163  
  warranty 168  
acoustic emissions 180  
ADF (automatic document feeder)  
  capacity 19  
  load originals 19  
ADSL, fax setup with  
  parallel phone systems 204  
after the support period 85  
align printhead 114  
answer ring pattern  
  change 64  
  parallel phone systems 206  
answering machine  
  fax tones recorded 147  
  set up with fax (parallel phone systems) 216  
  set up with fax and modem 217  
automatic document feeder (ADF)  
  capacity 19  
  clean 27  
  feeding problems, troubleshoot 27  
  load originals 19  
automatic fax reduction 57

## B

backup fax 55  
baud rate 66  
black and white pages  
  copy 46  
  fax 48

black dots or streaks, troubleshoot  
  copies 131  
  scan 136  
blank pages, troubleshoot  
  copy 130  
  scan 135  
blocked fax numbers  
  set up 58  
broadcast faxing  
  send 53  
buttons, control panel 12

## C

cameras  
  insert memory cards 25  
Cancel 12  
cancel  
  scheduled fax 53  
capacity  
  ADF 19  
  tray 176  
cards  
  sizes supported 174  
  tray supporting 176  
cartridges. *See* ink cartridges  
clean  
  automatic document feeder 27  
  exterior 27  
  printhead 114  
  scanner glass 26  
clear  
  fax logs 70  
color  
  dull 107  
color copy 46  
colored text, and OCR 44  
computer modem  
  shared with fax (parallel phone systems) 209  
  shared with fax and answering machine (parallel phone systems) 217

  shared with fax and voice line (parallel phone systems) 212  
  shared with fax and voice mail (parallel phone systems) 221  
Configure  
  firewall 156  
confirmation reports, fax 68  
connection type  
  change 227  
connectors, locating 11  
control panel  
  buttons 12  
  lights 12  
  status icons 13  
Copy 13  
copy  
  quality 131  
  settings 47  
  specifications 178  
  troubleshoot 129  
copy settings  
  copy 47  
correct port test, fax 138  
custom-size media  
  sizes supported 175  
custom-size paper  
  Mac OS 38  
  print on 37  
customer support  
  electronic 81  
  
**D**  
dark images, troubleshoot  
  copies 131  
  scans 135  
Declaration of Conformity (DOC) 189  
default settings  
  copy 47  
diagnostic page 114  
dial tone test, failure 140  
dial type, setting 65

- dial-up modem
  - shared with fax (parallel phone systems) 209
  - shared with fax and answering machine (parallel phone systems) 217
  - shared with fax and voice line (parallel phone systems) 212
  - shared with fax and voice mail (parallel phone systems) 221
- digital cameras
  - connect 37
  - insert memory cards 25
- distinctive ringing
  - change 64
  - parallel phone systems 206
- DOC 189
- dots or streaks, troubleshoot copies 131
- dots, troubleshoot scan 136
- driver
  - warranty 168
- DSL, fax setup with parallel phone systems 204
- duty cycle 170

**E**

- ECM. See error correction mode edit
  - text in OCR program 44
- electrical specifications 180
- embedded Web server
  - about 231
  - opening 232
  - system requirements 172
  - troubleshoot, cannot be opened 158
  - Webscan 44
- envelopes
  - sizes supported 174
  - tray supporting 176
- environmental specifications 179
- environmental sustainability program 190
- error correction mode 53
- error messages
  - unable to activate TWAIN source 134

- error reports, fax 69
- EWS. See embedded Web server

**F**

- faded copies 130
- faded stripes on copies, troubleshoot 131
- fax
  - answer mode 63
  - answering machine and modem, shared with (parallel phone systems) 217
  - answering machine troubleshoot 147
  - answering machine, set up (parallel phone systems) 216
  - auto answer 63
  - backup fax 55
  - blocking numbers 58
  - confirmation reports 68
  - dial tone test, failed 140
  - dial type, setting 65
  - distinctive ringing setup (parallel phone systems) 206
  - distinctive ringing, change pattern 64
  - DSL, set up (parallel phone systems) 204
  - error correction mode 53
  - error reports 69
  - forwarding 56
  - header 63
  - Internet Protocol, over 67
  - ISDN line, set up (parallel phone systems) 205
  - line condition test, failed 141
  - log, clear 70
  - log, print 70
  - manual receive 54
  - modem and answering machine, shared with (parallel phone systems) 217
  - modem and voice line, shared with (parallel phone systems) 212

- modem and voice mail, shared with (parallel phone systems) 221
- modem, shared with (parallel phone systems) 209
- monitor dialing 51, 53
- paper size 57
- parallel phone systems 200
- PBX system, set up (parallel phone systems) 205
- phone cord connection test, failed 138
- phone cord too short 147
- phone cord type test, failed 139
- poll to receive 56
- print last transaction details 70
- receive 54
- receive, troubleshoot 142, 145
- redial options 66
- reduction 57
- reports 68
- reprint 55
- rings to answer 64
- schedule 52
- send 48
- send, troubleshoot 142, 144, 146
- separate line setup (parallel phone systems) 203
- settings, change 63
- setup types 201
- shared phone line setup (parallel phone systems) 207
- sound volume 67
- specifications 178
- speed 66
- test failed 136
- test setup 223
- troubleshoot 136
- voice mail, set up (parallel phone systems) 208
- wall jack test, failed 137

Fax screen 13

Firewall

- configure 156

FoIP 67

forwarding faxes 56



**G**

- glass, scanner
  - clean 26
  - load originals 18
  - locating 10
- grainy or white bands on copies, troubleshoot 131
- graphics
  - incompletely filled on copies 131
  - look different from original scan 135

**H**

- hardware, fax setup test 137
- head 113
- header, fax 63
- Help 13
- Hewlett-Packard Company
  - notices 3
- HP software
  - uninstall from Mac OS X 230
  - uninstall from Windows 229
- HP Utility (Mac OS X)
  - opening 231
- humidity specifications 179

**I**

- ink
  - low 95
  - streaks on the back of paper 111
- ink cartridge 125
- ink cartridge door, locating 11
- ink cartridge latch, locating 11
- ink cartridges
  - check ink levels 75
  - locating 11
  - low ink 95
  - ordering online 198
  - part numbers 198
  - replace 75
  - supported 170
  - tips 74
  - warranty 168
  - yields 170
- ink level icons 13
- ink levels, check 75
- installation
  - hardware installation suggestions 159

- HP software installation
  - suggestions 160
  - troubleshooting issues 159

- Internet Protocol
  - fax, using 67
- IP address
  - checking for printer 159
- IP settings 225
- ISDN line, set up with fax
  - parallel phone systems 205

**J**

- jams
  - clear 164
  - media to avoid 18
  - paper 164, 166

**L**

- language, printer 170
- light images, troubleshoot
  - copies 131
  - scans 135
- lights, control panel 12
- line condition test, fax 141
- lines
  - copies, troubleshoot 131
  - scans, troubleshoot 135, 136
- link speed, setting 225
- load
  - photo 23, 24
  - tray 20, 22
- load cards 23, 24
- load envelopes 22
- load media 20
- load transparencies 24
- log, fax
  - print 70

**M**

- Mac OS
  - custom-size paper 38
  - Print borderless 39
  - Print photos 35
  - print settings 33
- Mac OS X
  - HP Utility 231
  - uninstall HP software 230
- maintain
  - ink cartridge 125
  - printhead 113

- maintenance
  - align printhead 114
  - check ink levels 75
  - clean printhead 114
  - diagnostic page 114
  - print quality report 114
  - printhead 113
  - replace ink cartridges 75
- manual faxing
  - receive 54
  - send 50, 51
- margins
  - incorrect 92
  - setting, specifications 176
  - text or graphic cut off 93
- media
  - ADF capacity 19
  - clear jams 164
  - load tray 20
  - print on custom-size 37
  - selecting 17
  - skewed pages 128
  - specifications 172
  - supported sizes 172
  - troubleshoot feeding 127
  - types and weights
    - supported 176
- memory
  - reprint faxes 55
  - save faxes 55
- memory cards
  - insert 25
  - print DPOF files 37
  - print files 36
  - specifications 180
  - troubleshoot 149
- missing or incorrect information, troubleshoot 86
- MMC memory card
  - insert 25
- model number 163
- modem
  - shared with fax (parallel phone systems) 209
  - shared with fax and answering machine (parallel phone systems) 217

- shared with fax and voice line (parallel phone systems) 212
- shared with fax and voice mail (parallel phone systems) 221
- monitor dialing 51, 53
- multi-feeds, troubleshoot 129

## N

- network port
  - address 150
- networks
  - advanced settings 224
  - connector illustration 11
  - IP settings 225
  - link speed 225
  - operating systems
    - supported 171
  - protocols supported 171
  - settings, change 224
  - solve problems 161
  - system requirements 172
  - view and printsettings 224
  - wireless communication
    - setup 225
  - wireless settings 163, 226
- noise information 180

## O

- OCR
  - edit scanned documents 44
  - troubleshoot 134
- operating environment
  - specifications 179
- operating systems
  - supported 171
- originals
  - scan 41
- output tray
  - locating 10
  - media supported 176

## P

- pages per month (duty cycle) 170
- paper
  - feed fails 96
  - jams 164, 166
  - ordering 199
  - size, set for fax 57

- paper-feed problems, troubleshoot 127
- parallel phone systems
  - answering machine
    - setup 216
  - countries/regions with 200
  - distinctive ringing setup 206
  - DSL setup 204
  - ISDN setup 205
  - modem and answering machine setup 217
  - modem and voice mail
    - setup 221
  - modem setup 209
  - modem shared with voice
    - line setup 212
  - PBX setup 205
  - separate line setup 203
  - setup types 201
  - shared line setup 207
- PBX system, set up with fax
  - parallel phone systems 205
- PCL 3 support 170
- phone cord
  - connected to correct port
    - test failed 138
  - correct type test failed 139
  - extend 147
- phone line, answer ring
  - pattern 64
- phone support 81
- phone support period
  - period for support 82
- phone, fax from
  - receive 54
  - send, 50
- photo media
  - sizes supported 174
- Photo screen 13
- photos
  - insert memory cards 25
  - print from DPOF files 37
  - print from memory cards 36
  - troubleshoot memory cards 149
- poll to receive fax 56
- poor printout quality 99
- ports, specifications 170
- power
  - specifications 180
  - troubleshoot 86
- power input, locating 11

## print

- blank printout 95
- borderless fails 88
- diagnostic page 114
- distorted printout 104
- envelopes print
  - incorrectly 87
- faded 107
- fax logs 70
- fax reports 68
- faxes 55
- last fax details 70
- margins incorrect 92, 93
- meaningless characters 92
- nothing happens 88
- photos from DPOF file 37
- photos from memory cards 36
- print quality report 114
- quality, troubleshoot 99, 102, 105, 108
- reversed page order 92
- slow 86
- troubleshoot 86
- troubleshooting 87
- vertical streaks 110
- Print borderless
  - Mac OS 39
  - Windows 39
- Print brochures
  - print 34
- print driver
  - warranty 168
- Print envelope 34
- Print envelopes
  - Mac OS 35
- Print photos
  - Mac OS 35
  - Windows 35
- print quality
  - smear ink 99
- print quality report 114
- print settings
  - print quality 98
- print-carriage access door, locating 11
- printer
  - no response 88
- printer control panel
  - locating 10
  - network settings 224
  - scan from 41
  - send faxes 49

## Index

- printer driver
    - warranty 168
  - printer software (Windows)
    - about 231
    - opening 231
  - Printer Status Report
    - information on 162
  - printhead
    - clean 114
  - printhead, align 114
  - printheads
    - ordering online 198
    - part numbers 198
  - printing
    - slow, troubleshoot 113
  - problems
    - print 87
  - processor specifications 171
  - pulse dialing 65
- Q**
- quality, troubleshoot
    - copy 131
    - scan 134
- R**
- radio interference
    - reducing 229
    - regulatory information 186
  - radio, turn off 224
  - rear access panel
    - clear jams 164
    - illustration 11
  - receive faxes
    - auto answer mode 63
    - automatically 54
    - blocking numbers 58
    - forwarding 56
    - manually 54
    - polling 56
    - rings to answer 64
    - troubleshoot 142, 145
  - recycle
    - print cartridges 190
  - redial options, setting 66
  - reduce fax 57
  - regulatory information 181, 186
  - regulatory model number 188
  - replace ink cartridges 75
  - report
    - wireless test 227
- reports**
- confirmation, fax 68
  - diagnostic 114
  - error, fax 69
  - fax test failed 136
  - print quality 114
  - printhead 113
- reprint**
- faxes from memory 55
- right navigation** 12
- rings to answer** 64
- S**
- save
    - faxes in memory 55
  - scan
    - error messages 134
    - from printer control panel 41
    - from Webscan 44
    - OCR 44
    - quality 134
    - Scan screen 13
    - scan specifications 179
    - slow 133
    - troubleshoot 132
  - Scan screen 13
  - scanner glass
    - clean 26
    - load originals 18
    - locating 10
  - schedule fax 52
  - Secure Digital memory card
    - insert 25
  - security
    - wireless
      - communication 228
      - wireless settings 227
  - send faxes
    - manually 50
    - memory, from 51
    - monitor dialing 51, 53
    - schedule 52
    - standard fax 48
    - troubleshoot 142, 144, 146
  - send scans
    - for OCR 44
    - troubleshoot 132
  - serial number 163
  - serial phone systems
    - countries/regions with 200
    - setup types 201
  - settings
    - copy 47
- network** 224
- speed, fax 66
  - volume, fax 67
- Setup** 13
- setup**
- answering machine (parallel phone systems) 216
  - answering machine and modem (parallel phone systems) 217
  - computer modem (parallel phone systems) 209
  - computer modem and answering machine (parallel phone systems) 217
  - computer modem and voice line (parallel phone systems) 212
  - computer modem and voice mail (parallel phone systems) 221
  - distinctive ringing 64
  - distinctive ringing (parallel phone systems) 206
  - DSL (parallel phone systems) 204
  - fax scenarios 201
  - fax, with parallel phone systems 200
  - ISDN line (parallel phone systems) 205
  - PBX system (parallel phone systems) 205
  - separate fax line (parallel phone systems) 203
  - shared phone line (parallel phone systems) 207
  - test fax 223
  - voice mail (parallel phone systems) 208
  - voice mail and computer modem (parallel phone systems) 221
- size**
- scans, troubleshoot 136
  - troubleshoot copy 130
- skew, troubleshoot**
- copy 131
  - print 128
  - scan 135
- slow print, troubleshoot** 86
- smear ink** 99

- software
    - OCR 44
    - warranty 168
    - Webscan 44
  - sound pressure 180
  - specifications
    - acoustic emissions 180
    - electrical 180
    - media 172
    - network protocols 171
    - operating environment 179
    - physical 170
    - processor and memory 171
    - storage environment 180
    - system requirements 171
  - speed
    - troubleshoot for
      - scanner 133
    - troubleshoot print 86
  - speed dial
    - send fax 48
  - status
    - network configuration
      - page 163
    - Printer Status Report 163
  - status icons 13
  - storage environment
    - specifications 180
  - streaks, troubleshoot
    - copies 131
    - scan 136
  - stripes on scans,
    - troubleshoot 135
  - subscriber identification
    - code 63
  - supplies
    - ordering online 198
    - Printer Status Report 163
    - yields 170
  - support 80
  - system requirements 171
- T**
- technical information
    - copy specifications 178
    - fax specifications 178
    - memory card
      - specifications 180
    - scan specifications 179
  - telephone line, answer ring
    - pattern 64
  - telephone wall jack, fax 137
  - telephone, fax from
    - receive 54
    - send 50
  - temperature specifications 179
  - tests, fax
    - dial tone, failed 140
    - failed 136
    - fax line condition 141
    - fax phone cord type test
      - failed 139
    - hardware, failed 137
    - port connection, failed 138
    - setup 223
    - telephone wall jack 137
  - text
    - cannot be edited after scan,
      - troubleshoot 134
    - cut off 93
    - incompletely filled on
      - copies 131
    - jagged 111
    - meaningless characters 92
    - missing from scan,
      - troubleshoot 133
    - not filled in 102
    - smooth fonts 111
    - splotchy on copies 131
    - unclear on copies,
      - troubleshoot 131
    - unclear scans 136
  - tone dialing 65
  - tray
    - capacity 176
    - media sizes supported 172
    - media types and weights
      - supported 176
  - trays
    - capacities 176
    - clear jams 164
    - load media 20
    - locating 10
    - media sizes supported 172
    - paper guides illustration 10
    - troubleshoot feeding 127
  - troubleshoot
    - answering machines 147
    - copy 129
    - copy quality 131
    - embedded Web server 158
    - fax 136
    - fax dial tone test failed 140
    - fax hardware test failed 137
    - fax line test failed 141
  - fax phone cord connection
    - test failed 138
  - fax phone cord type test
    - failed 139
  - fax tests 136
  - fax wall jack test, failed 137
  - jams, paper 166
  - media not picked up from
    - tray 127
  - memory cards 149
  - missing or incorrect
    - information 86
  - multiple pages are
    - picked 129
  - network configuration
    - page 163
  - paper-feed problems 127
  - power 86
  - print 86
  - print quality 99
  - Printer Status Report 162
  - receive faxes 142, 145
  - scan 132
  - scan quality 134
  - send faxes 142, 144, 146
  - skewed copies 131
  - skewed pages 128
  - slow print 86
  - tips 85
  - troubleshooting
    - general network
      - troubleshooting 150
    - hardware installation
      - suggestions 159
    - HP software installation
      - suggestions 160
    - installation issues 159
    - print 87
    - solve network problems 161
    - wired network 150
    - wireless problems 151
  - TWAIN
    - unable to activate
      - source 134
- U**
- uninstall HP software
    - Mac OS X 230
    - Windows 229
  - unwanted fax mode 58
  - USB connection
    - port, locating 10, 11
    - specifications 170

## Index

### V

vertical stripes on copies,  
troubleshoot 131

view

network settings 224

voice mail

set up with fax (parallel  
phone systems) 208

set up with fax and computer  
modem (parallel phone  
systems) 221

voltage specifications 180

volume

fax sounds 67

### W

wall jack test, fax 137

warranty 168

Web sites

accessibility information 9

customer support 81

environmental

programs 190

order supplies and

accessories 198

supply yield data sheet 170

Webscan 44

white bands or stripes,

troubleshoot

copies 131

scans 135

Windows

borderless 39

print brochures 33

Print photos 35

print settings 33

system requirements 171

uninstall HP software 229

wireless communication

advanced wireless

troubleshooting 151

basic wireless

troubleshooting 151

radio, turn off 224

reducing interference 229

regulatory information 186

security 228

set up 225

settings 226

wizard 226

wireless connection icons 13

wireless test report

print 227

### X

xD-Picture memory card

insert 25





© 2010 Hewlett-Packard Development Company, L.P.

[www.hp.com/support](http://www.hp.com/support)