



**SEW**  
**EURODRIVE**



## **DOP11B Operator Terminals**

Edition 11/2008

16666828 EN

# System Manual

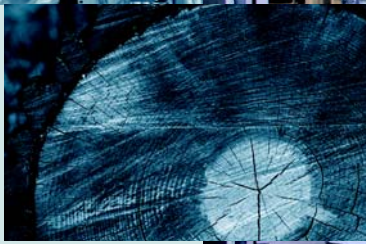
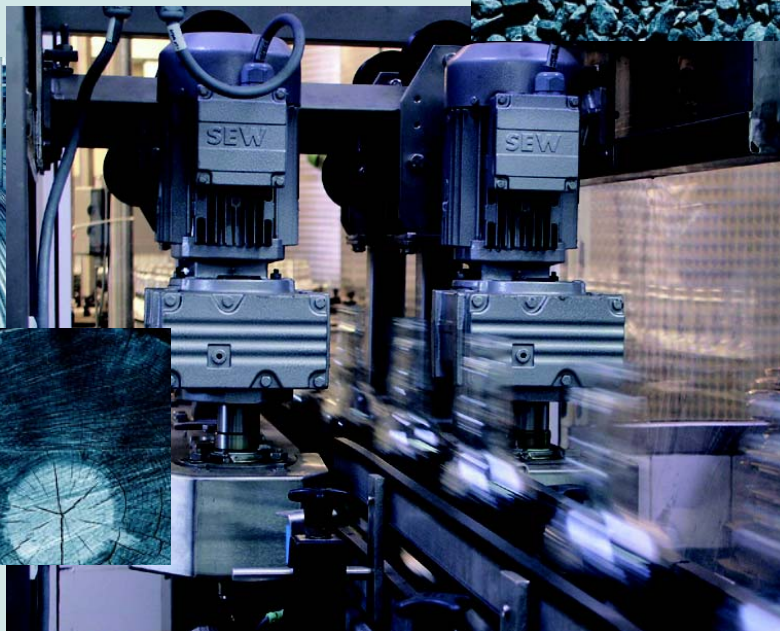



<b>1</b>	<b>General Information .....</b>	<b>5</b>
1.1	Using operating instructions.....	5
1.2	Structure of the safety notes .....	5
1.3	Right to claim under limited warranty .....	6
1.4	Exclusion of liability.....	6
1.5	Product names and trademarks .....	6
1.6	Copyright.....	6
1.7	Notes on terminology .....	6
1.8	Disassembly and waste disposal .....	6
<b>2</b>	<b>Safety Notes .....</b>	<b>7</b>
2.1	General information .....	7
2.2	Designated use .....	7
2.3	Installation and startup .....	8
2.4	Safety functions .....	8
2.5	Transportation/storage .....	9
2.6	Notes on operation.....	9
2.7	Service and maintenance .....	9
<b>3</b>	<b>Unit Information, Installation and Hardware.....</b>	<b>10</b>
3.1	Introduction .....	10
3.2	Unit designation, nameplates and scope of delivery .....	15
3.3	DOP11B-10 unit design .....	16
3.4	DOP11B-15 unit design .....	17
3.5	DOP11B-20 unit design .....	18
3.6	DOP11B-25 unit design .....	19
3.7	DOP11B-30 unit design .....	20
3.8	DOP11B-40 unit design .....	21
3.9	DOP11B-50 unit design .....	22
3.10	DOP11B-60 unit design .....	23
3.11	Accessories and options .....	24
<b>4</b>	<b>Installation .....</b>	<b>26</b>
4.1	Installation instructions for the basic unit .....	26
4.2	UL-compliant installation .....	27
4.3	Space required for installation.....	28
4.4	Installation procedure.....	29
4.5	Connecting basic units DOP11B-10 to DOP11B-60 .....	31
4.6	Connection to a PC.....	32
4.7	RS-485 connection .....	33
4.8	Connecting RS-485 to PCS21A .....	35
4.9	RS-232 connection via UWS11A .....	36
4.10	ETHERNET connection .....	37
4.11	Connection to a Siemens S7 .....	40
<b>5</b>	<b>Startup.....</b>	<b>42</b>
5.1	General startup instructions .....	42
5.2	Preliminary work and resources .....	43
5.3	Initial operation.....	44
5.4	Terminal functions.....	45
<b>6</b>	<b>Operation and Service .....</b>	<b>54</b>
6.1	Transferring projects with PC and HMI-Builder.....	54
6.2	Operating display at unit start .....	58
6.3	Error messages.....	59
6.4	SEW Electronics Service .....	61



<b>7</b>	<b>Programming</b>	<b>62</b>
7.1	Creating a project	62
7.2	Communication with MOVIDRIVE® and MOVITRAC®	69
7.3	Internal variables	82
7.4	Programming with the programming software	83
7.5	Graphic display and control	135
7.6	Text-based display and control	180
7.7	Transferring projects	185
7.8	Index addressing	195
<b>8</b>	<b>Unit Functions</b>	<b>199</b>
8.1	Message library	199
8.2	Alarm management	201
8.3	Recipe management	210
8.4	Passwords	222
8.5	Printing reports	225
8.6	Time control	229
8.7	Language management	230
8.8	LEDs	238
8.9	Function keys	238
8.10	Trends	242
8.11	Macros	246
8.12	System monitor	248
8.13	Data logger	249
<b>9</b>	<b>Network Functions and Communication</b>	<b>250</b>
9.1	Communication	250
9.2	Network communication	262
9.3	Network services	271
9.4	Network accounts	302
9.5	Accessing the network settings during runtime	303
<b>10</b>	<b>Technical Data and Dimension Drawings</b>	<b>304</b>
10.1	General technical data	304
10.2	Pin assignment	308
10.3	DOP11B-10	310
10.4	DOP11B-15	311
10.5	DOP11B-20	312
10.6	DOP11B-25 and -30	313
10.7	DOP11B-40	314
10.8	DOP11B-50	315
10.9	DOP11B-60	316
10.10	Label for DOP11B-10 to DOP11B-40	317
10.11	Label for DOP11B-50 and DOP11B-60	317
10.12	Cable	318
<b>11</b>	<b>Appendix</b>	<b>320</b>
11.1	Chemical resistance	320
11.2	Updating the operator terminal	323
11.3	Changing the battery	325
11.4	Troubleshooting	327
<b>12</b>	<b>Index</b>	<b>328</b>



# 1 General Information

## 1.1 Using operating instructions





Operating instructions are an integral part of the product and contain important information for operation and service. They are intended for staff responsible for the assembly, installation, startup and maintenance of the product.

The operating instructions must be legible and accessible at all times. Make sure that staff responsible for the plant and its operation, as well as persons who work independently on the unit, have read the operating instructions carefully and understood them. If you are unclear about any of the information in this documentation, or if you require further information, contact SEW-EURODRIVE.

## 1.2 Structure of the safety notes

The safety notes in these operating instructions are designed as follows:

<b>Pictogram</b>  	<b>! SIGNAL WORD</b>
	Type and source of danger. Possible consequence(s) if the safety notes are disregarded. <ul style="list-style-type: none"> <li>• Measure(s) to prevent the danger.</li> </ul>

Pictogram	Signal word	Meaning	Consequences if disregarded
Example:   General danger	<b>! DANGER</b>	Imminent danger	Severe or fatal injuries
 Specific danger, e.g. electric shock	<b>⚠ WARNING</b>	Possible dangerous situation	Severe or fatal injuries
	<b>⚠ CAUTION</b>	Possible dangerous situation	Minor injuries
	<b>STOP</b>	Possible damage to property	Damage to the drive system or its environment
	<b>NOTE</b>	Useful information or tip. Simplifies the handling of the drive system.	



#### 1.3 *Right to claim under limited warranty*

A requirement of fault-free operation and fulfillment of any rights to claim under limited warranty is that you adhere to the information in the operating instructions. Therefore, read the operating instructions before you start working with the unit!

Make sure that the operating instructions are available to staff responsible for the plant and its operation, as well as to persons who work independently on the unit. You must also ensure that the documentation is legible and accessible at all times.

#### 1.4 *Exclusion of liability*

You must comply with the information contained in these operating instructions to ensure safe operation of explosion-proof electric motors and to achieve the specified product characteristics and performance requirements. SEW-EURODRIVE assumes no liability for injury to persons or damage to equipment or property resulting from non-observance of the operating instructions. In such cases, any liability for defects is excluded.

#### 1.5 *Product names and trademarks*

The brands and product names in these operating instructions are trademarks or registered trademarks of the titleholders.

#### 1.6 *Copyright*

© 2008 – All rights reserved.

Unauthorized reproduction, copying, distribution or any other use of the whole or any part of this documentation is strictly prohibited.

#### 1.7 *Notes on terminology*

The operator terminals of the DOP11B series (Drive Operator Panel) can communicate with SEW frequency inverters and selected programmable logic controllers (PLC) via different communication paths at the same time.

For the sake of simplicity, **both units (PLC and inverter)** will be referred to as **controller** in this documentation.

#### 1.8 *Disassembly and waste disposal*

Complete or partial recycling of the operator terminal is subject to local regulations.

Note that the following components contain substances that may represent a health hazard and cause environmental pollution: Lithium battery, electrolyte capacitors and display.



## **2 Safety Notes**

### **2.1 General information**

- Read the safety notes carefully.
- Check the delivery for damage caused during transport on receipt. If damage is found, advise your supplier.
- The terminal fulfills the requirements of article 4 of the EMC Directive 89/336/EEC.
- Do not use the terminal in areas where there is a risk of explosion.
- SEW-EURODRIVE is not liable for modifications, changes, additions and/or alterations to the product.
- Use only spare parts and accessories manufactured according to SEW-EURODRIVE specifications.
- Read the installation and operating instructions carefully prior to installation, use or repair of the terminal.
- Never allow fluids to penetrate the slots or holes in the terminal. This may lead to a fire or cause the equipment to become live.
- Operation of the terminal is restricted to qualified personnel.

### **2.2 Designated use**

The operator terminals of the DOP11B series are intended for the operation and diagnosis of industrial and commercial systems.

A suitable response to communication errors between the DOP11B and the controller must be implemented for control. Suitable measures (e.g. limit switches, position monitoring) must be implemented to ensure that no damage occurs as a result of a communication error with DOP11B.

Do not start up the unit (take it into operation in the designated fashion) until you have established that the machine complies with the EMC Directive 2004/108/EC and that the conformity of the end product has been determined in accordance with the Machinery Directive 98/37/EC (with reference to EN 60204).



### 2.3 Installation and startup

- The terminal is designed for stationary installation.
- Place the terminal on a stable base during installation. The terminal may be damaged if it is dropped.
- Install the terminal according to the accompanying installation instructions.
- The unit must be grounded according to the accompanying installation instructions.
- The installation must be performed by qualified personnel.
- Route high-voltage cables, signal cables and supply cables separately from one another.
- Make sure that the voltage and polarity of the electrical power source are correct before you connect the terminal to the power supply.
- The openings in the housing are designed to allow air to circulate and must not be covered.
- Do not install the terminal in locations where it will be exposed to a powerful magnetic field.
- **Do not install or operate the terminal where it will be exposed to direct sunlight.**
- The peripheral equipment must be suitable for the application.
- On certain terminal models, the display glass is covered with a laminated foil to protect it from scratches. Pull off the foil carefully after installation to prevent static electricity causing damage to the terminal.

Make sure that **preventive measures** and **protection devices** correspond to the **applicable regulations** (e.g. EN 60204 or EN 50178).

Required preventive measures: Ground the unit

Required protection devices: Overcurrent protective devices

### 2.4 Safety functions

	<b>⚠ WARNING</b>
	<p>The operator terminals of the DOP11B series may not execute any safety functions without higher-level safety systems. Severe or fatal injuries.</p> <ul style="list-style-type: none"> <li>• Use higher-level safety systems to ensure protection of equipment and personnel.</li> </ul>





## **2.5 Transportation/storage**

Inspect the shipment for any damage that may have occurred in transit as soon as you receive the delivery. Inform the shipping company immediately. Do not operate the operator terminal if it is damaged.

Use suitable, sufficiently rated handling equipment if necessary.

Store the operator terminal in a dry, dust-free room if it is not to be installed straight away.

## **2.6 Notes on operation**

- Always keep the terminal clean.
- **Emergency stop and other safety functions should not be controlled from the operator terminal.**
- Do not touch the keys, display, etc. with sharp objects.
- Bear in mind that the terminal is ready for operation even if the backlighting is no longer illuminated, which means that entries made on the keyboard and touchscreen will still be registered.

## **2.7 Service and maintenance**

- The agreed limited warranty applies.
- Clean the display and front of the terminal with a soft cloth and mild detergent.
- Repairs must be performed by qualified personnel.



## 3 Unit Information, Installation and Hardware

### 3.1 Introduction

Requirements in modern industrial environments are steadily increasing and operator tasks at machines or on production lines are becoming increasingly more complex and involve more responsibility. The operator must be able to obtain information on the current status quickly and easily, and be able to influence the operation of the machine immediately. The functions in control systems are also increasing and becoming more advanced, enabling more complicated processes to be controlled efficiently. Operator terminals make human-machine communication simple and safe even for the most advanced processes.

Graphical operator terminals have been developed to meet the requirements for human-machine communication when controlling or monitoring different applications in the manufacturing and process industries, etc. They simplify the operator's work since they can easily be adapted to the working environment. This means operators can continue to use the concepts they are familiar with.

Projects can be built up as menu hierarchies or sequences in the terminal. A menu hierarchy consists of a main menu (with, for example, an overview) and a number of underlying menus with more detailed information on particular sections. The operator normally selects which menu is to be shown.

The menus in the operator terminals are called blocks.

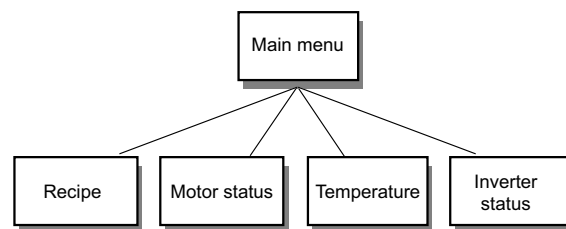

53717AEN



A sequence is also based on a main menu, from which the operator selects a sequence showing the blocks in a predetermined order. The program in the controller is usually used to control the block display.

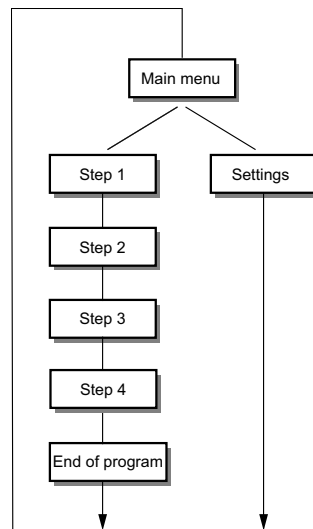

53719AEN

The functions of the operator terminals enable the process to be displayed as graphics or as text. There are also functions for

- Alarm handling
- Printing
- Trends
- Recipe management
- Time control

The functions are not only easy to use in the panel, they are also more cost-effective than conventional solutions with buttons, indicator lamps, time relays, preset counters and seven-day clocks. There are also functions to improve the application of the drive electronics.



#### 3.1.1 Programming

The operator terminals are programmed using a PC and the HMI-Builder software.

The operator terminal is largely object-oriented, i.e. an object is selected first and the function of the object is then assigned. All types of signals are defined on this principle.

The programmed project is stored in the operator terminal.

#### 3.1.2 Connecting the terminal to SEW frequency inverters

There are many advantages in connecting a terminal to a controller:

- The operator does not need to make any changes to the existing controller.
- The terminal does not block any of the inputs or outputs on the controller.
- The overview of the controller functions is optimized, e.g. time control and alarm handling.

#### 3.1.3 Status display and control

The operator is already familiar with the indicator lamps and the analog and digital status displays since these are used in the majority of applications today. The same applies to push buttons and rotary and thumbwheel switches for controlling a system. The terminal enables the operator to have all status displays and controls in one unit.

The operator can easily see and influence information in the controller. Moreover, it is possible to clearly see and influence all the signals affecting a specific object, e.g. a pump or a drive unit, which further simplifies the work.

This is possible due to the fact that all the information is exchanged through 'blocks' in the terminal. Blocks can be text blocks, with only text information, or graphic blocks, with full graphical presentation.

The operator terminals are equipped with function keys for direct control. These function keys are each assigned specific commands to enable control.

If several blocks are used, the operator can switch between the different blocks by using jump commands. This creates a menu hierarchy, which produces a structured application.



### 3.1.4 Setting up the operator terminal

The terminal should be set up close to the workplace to ensure maximum usability. This will enable the operator to receive all necessary information and work effectively. Set up the terminal at the correct height so that the user can see and operate it without problems. Visibility of the screen is influenced by distance, height, angle, light and color selection.

Monitoring, control and maintenance are remote functions and can be executed, for example, from a different position in the building or a different location. In such instances, communication can take place via LAN (Local Area Network), Internet or modem. In long production lines with many workplaces, several terminals can be connected to one or more controllers in the network.

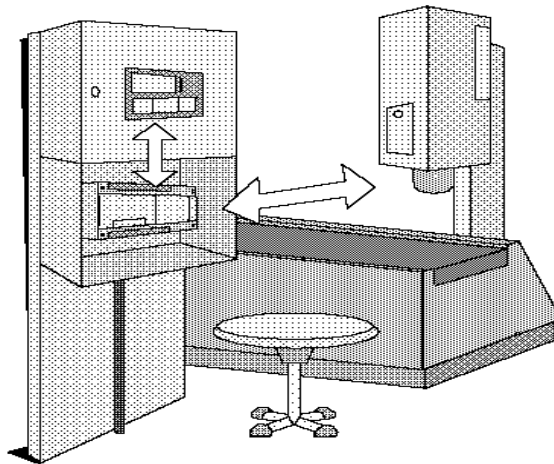

10553AXX



#### 3.1.5 Compact solutions

External units such as barcode scanners, weighing machines, modems, etc. can be connected via the terminal to the controller. The connection only requires an RS-232 interface and an ASCII communication protocol. Data entering the terminal is written directly to registers.

It is also possible to connect a unit working in parallel, such as an additional terminal or a PC with the MOVITOOLS® programming software for the inverter. As a result, you can simultaneously program the controller and communicate with it via the terminal.

When the PLC and inverter are connected to a terminal (two drivers in the terminal), data can be exchanged between the two units (analog and digital signals).

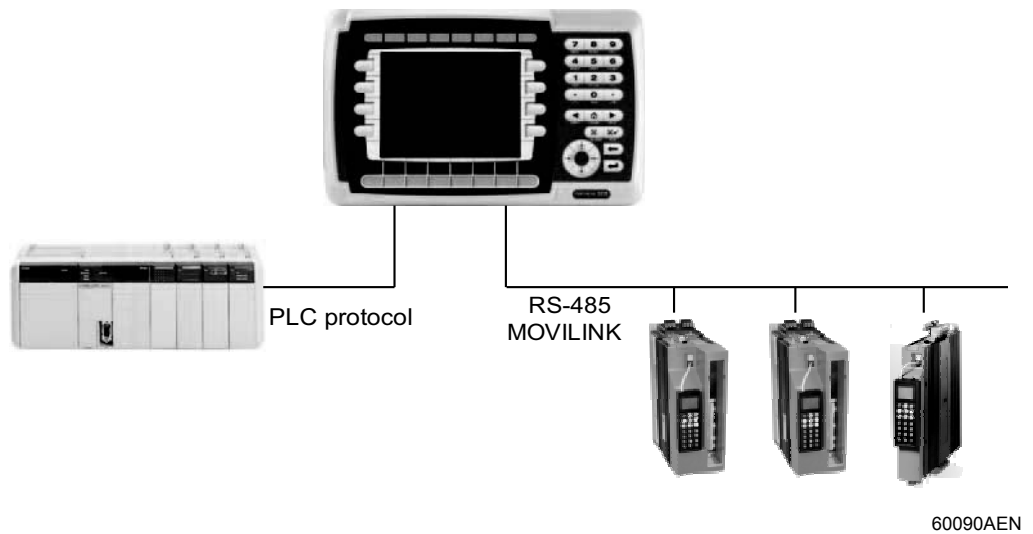



### 3.2 Unit designation, nameplates and scope of delivery

#### 3.2.1 Sample unit designation

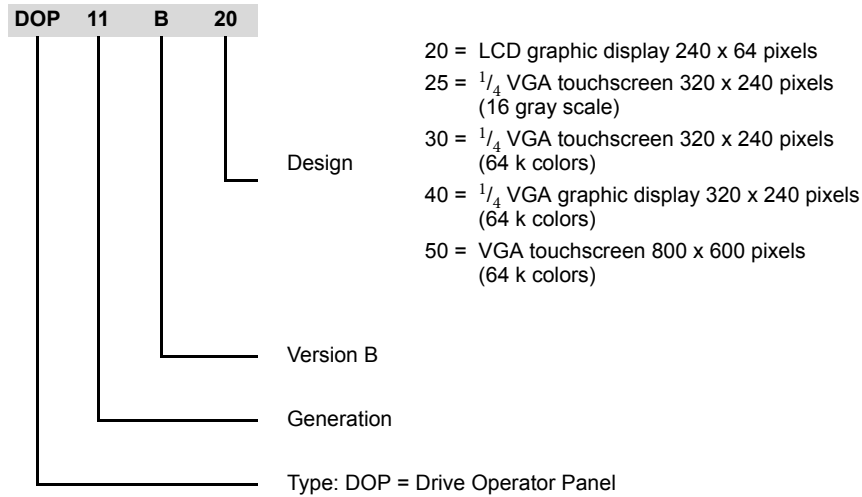

#### 3.2.2 Sample nameplate

The unit nameplate is attached to the side of the unit.

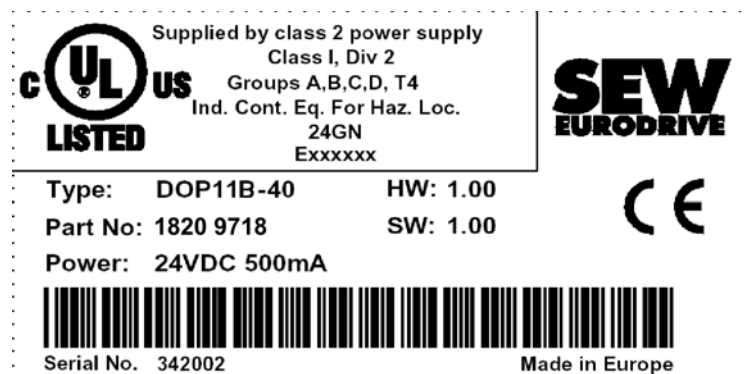

11596AXX

#### 3.2.3 Scope of delivery

Included in the scope of delivery:

- DOP11B operator terminal
- Installation equipment and installation template
- Quick reference guide with assembly and installation notes
- Phoenix COMBICON connector for DC 24 V, 5 mm, 3-pin



### 3.3 DOP11B-10 unit design

Part number: 1822 0266



63944AXX

- [1] Display
- [2] Function keys with inscription area
- [3] Numerical keys

- 160 x 32 pixel LCD graphic display (monochrome) with backlighting
- Voltage supply: DC 24 V, 100 mA
- 2 serial interfaces (RS-232 and RS-485 / RS-422); 2 can be used simultaneously
- IP66 membrane keypad with navigation keys, numeric keypad and 6 function keys
- 6 LEDs (two colors red / green)
- 1 expansion slot
- 512 KB application memory





### 3.4 DOP11B-15 unit design

Part number: 1822 0274



63945AXX

- [1] Display
- [2] Function keys with inscription area
- [3] Numerical keys
- [4] Navigation keys

- 240 x 64 pixel LCD graphic display (monochrome) with backlighting
- Voltage supply: DC 24 V, 100 mA
- 2 serial interfaces (RS-232 and RS-485 / RS-422); 2 can be used simultaneously
- IP66 membrane keypad with navigation keys, numeric keypad and 6 function keys
- 6 LEDs (two colors red / green)
- 1 expansion slot
- 512 KB application memory



#### 3.5 DOP11B-20 unit design

Part number: 1820 9661

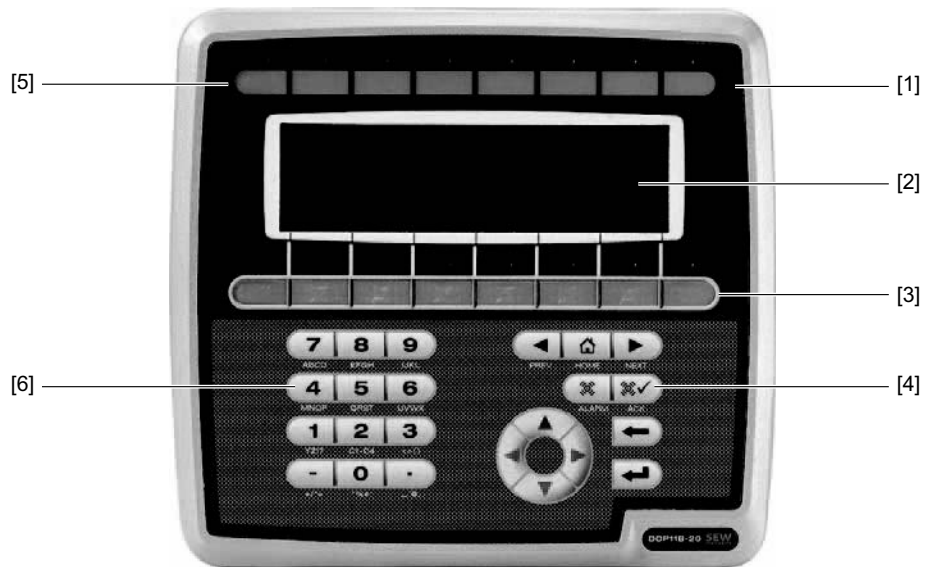

60091AXX

- [1] LEDs red / green
- [2] Display
- [3] Function keys
- [4] Navigation keys
- [5] Inscription areas
- [6] Numerical keys

- 240 x 64 pixel LCD graphic display (monochrome) with backlighting
- Voltage supply: DC 24 V, 350 mA
- 2 serial interfaces (RS-232 and RS-485 / RS-422); 2 can be used simultaneously
- 1 ETHERNET interface (RJ45 socket)
- 1 USB interface
- IP66 membrane keypad with navigation keys, numeric keypad and 8 function keys
- 16 LEDs (two colors red / green)
- 1 expansion slot
- 12 MB application memory



### 3.6 DOP11B-25 unit design

Part number: 1820 9688

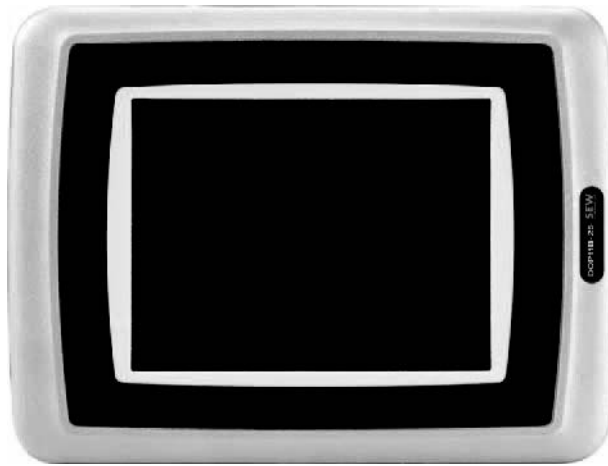

60065AXX

- 320 x 240 pixels,  $\frac{1}{4}$  VGA touchscreen (16 gray scale, STN, 5.7") with backlighting
- Voltage supply: DC 24 V, 450 mA
- 2 serial interfaces (RS-232, RS-485 / RS-422); 2 can be used simultaneously
- 1 ETHERNET interface (RJ45 socket)
- 1 USB interface
- IP66
- Horizontal or vertical installation
- 1 expansion slot
- 12 MB application memory



### 3.7 DOP11B-30 unit design

Part number: 1820 9696

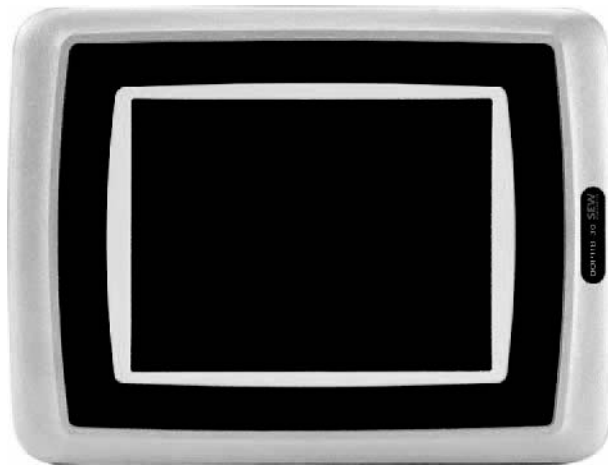

60066AXX

- 320 x 240 pixels,  $\frac{1}{4}$  VGA touchscreen (64 k colors, STN, 5.7") with backlighting
- Voltage supply: DC 24 V, 450 mA
- 2 serial interfaces (RS-232, RS-485 / RS-422); 2 can be used simultaneously
- 1 ETHERNET interface (RJ45 socket)
- 1 USB interface
- IP66
- Horizontal or vertical installation
- 1 expansion slot
- 12 MB application memory



### 3.8 DOP11B-40 unit design

Part number: 1820 9718

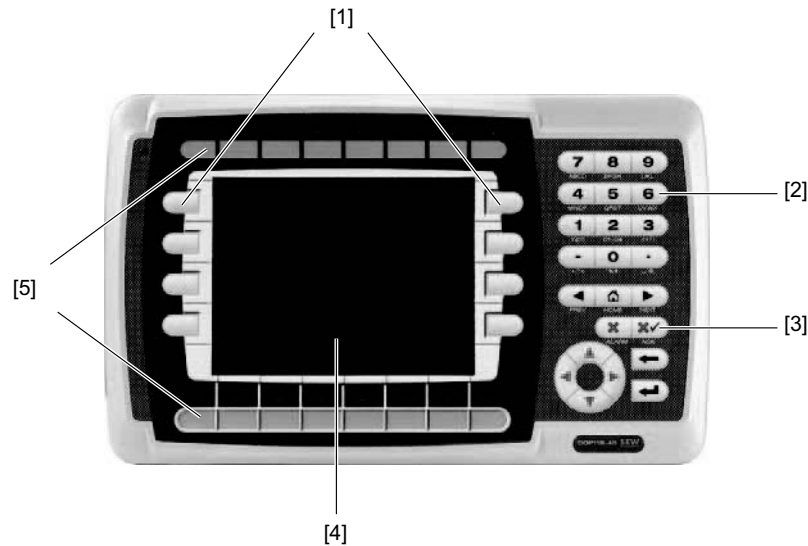

60092AXX

- [1] Function keys
- [2] Numerical keys
- [3] Navigation keys
- [4] Display
- [5] Inscription areas

- 320 x 240 pixels,  $\frac{1}{4}$  VGA graphic display (64 k colors, STN, 5.7") with backlighting
- Voltage supply: DC 24 V, 500 mA
- 2 serial interfaces (RS-232 and RS-485 / RS-422); 2 can be used simultaneously
- 1 ETHERNET interface (RJ45 socket)
- 1 USB interface
- IP66 membrane keypad with navigation keys, numeric keypad and 16 function keys
- 16 LEDs (two colors red / green)
- 1 expansion slot
- 12 MB application memory



#### 3.9 DOP11B-50 unit design

Part number: 1820 9726

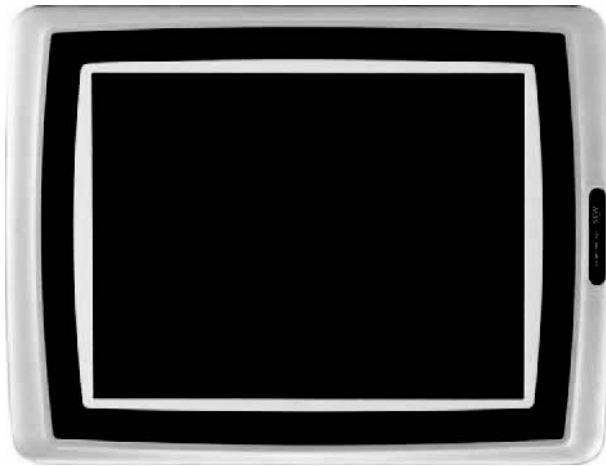

60068AXX

- 800 x 600 pixels, VGA touchscreen (64 k colors, 10.4") with backlighting
- Voltage supply: DC 24 V, 1.0 A
- 2 serial interfaces (RS-232 and RS-485 / RS-422); 2 can be used simultaneously
- 1 ETHERNET interface (RJ45 socket)
- 1 USB interface
- IP66
- Horizontal or vertical installation
- 1 expansion slot
- 12 MB application memory



### 3.10 DOP11B-60 unit design

Part number: 1822 0282

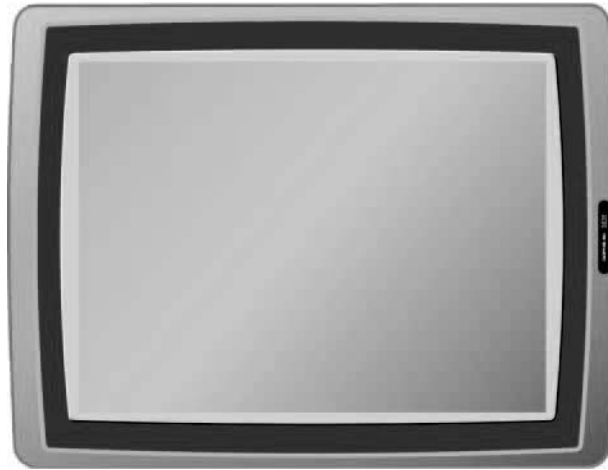

64006AXX

- 1024 x 768 pixels, VGA touchscreen (64 k colors, 15") with backlighting
- Voltage supply: DC 24 V, 1.2 A
- 2 serial interfaces (RS-232 and RS-485 / RS-422); 2 can be used simultaneously
- 1 ETHERNET interface (RJ45 socket)
- 1 USB interface
- IP66
- Horizontal or vertical installation
- 1 expansion slot
- 12 MB application memory



### 3.11 Accessories and options

Cables for programming the DOP11B operator terminal and for communication between the operator terminal and MOVIDRIVE®.

Option	Description	Part number
PCS11B (Panel Cable Serial)	Connection cable between operator terminal DOP11B (RS-232, max. 115.2 Kbit/s) and PC (RS-232) for programming the operator terminal. Fixed length of 3 m.	1821 1062
PCS21A (Panel Cable Serial)	Communication cable between the operator terminal (RS-485, max. 57.6 Kbit/s) and SEW frequency inverters (RS-485, RJ-10). Fixed length of 5 m.	1820 6328
PCS22A (Panel Cable Serial)	Communication cable from operator terminal (RS-485, max. 57.6 Kbit/s) to open cable end. Fixed length of 5 m.	1821 1054
Prefabricated cable D-SUB-9 PO	Communication cable between operator terminal (RS-232, max. 57.6 Kbit/s) and UWS11A or UWS21A (RS-232) interface converter. For communication with SEW frequency inverters. Fixed length of 1.8 m.	814 6144
PCM11A (Panel Cable MPI)	Communication cable between the operator terminal (RS-232, max. 57.6 Kbit/s) and SIMATIC S7 via MPI (max. 12 Mbit/s). Fixed length of 3 m.	824 8303



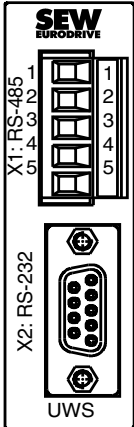
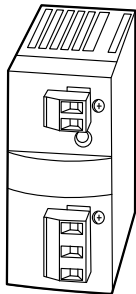

Option	Description	Part number
PFE11B (ETHERNET panel field-bus)	Option ETHERNET TCP/IP (10 Mbit/s)  To connect operator terminals DOP11B-10 and -15 to the customer's PC network. The ETHERNET option facilitates the following functions: <ul style="list-style-type: none"> <li>• Operation of the HMI-Builder software for programming the operator terminals via ETHERNET (projects can be uploaded and downloaded quickly).</li> <li>• Communication with PLC and drive technology via TCP/IP services (only suitable for DOP11B-10 and -15)</li> </ul> 	1822 2307
UWS11A	Interface adapter for DIN rail mounting RS-232 ↔ RS-485  	822 689X
UWU52A	Switched-mode power supply Input AC 100 ... 240 V Output DC 24 V, 2.5 A  	188 1817



## 4 Installation

### 4.1 Installation instructions for the basic unit

#### 4.1.1 Separate cable ducts

Route **power cables** and **electronics cables** in **separate cable ducts**.

#### 4.1.2 Cross sections

- Voltage supply: **Cross section according to rated input current.**
- Electronics cables:
  - 1 conductor per terminal 0.20 ... 0.75 mm<sup>2</sup> (AWG 20 ... 17)
  - 2 conductors per terminal 0.20 ... 0.75 mm<sup>2</sup> (AWG 20 ... 17)

#### 4.1.3 Shielding and grounding

- Use **shielded control cables** only.
- Apply the **shield by the shortest possible route and make sure it is grounded over a wide area at both ends**. You can ground one end of the shield via a suppression capacitor (220 nF / 50 V) to avoid ground loops. If using double-shielded cables, ground the outer shield on the controller end and the inner shield on the other end.

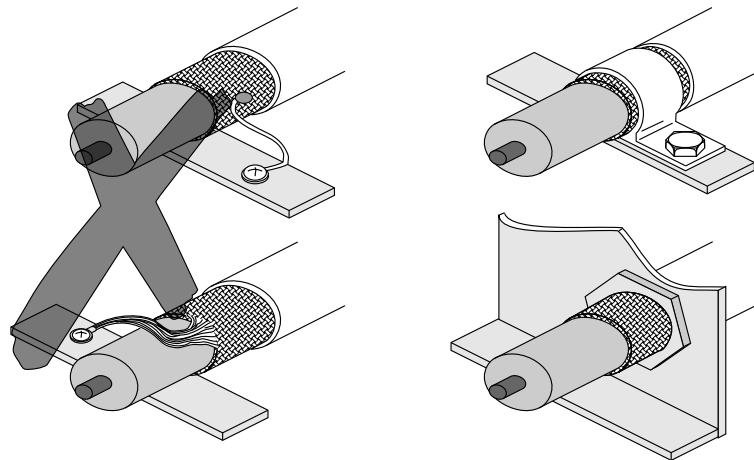

00755BXX  
Figure 1: Example of correct shield connection with metal clamp (shield clamp) or metal cable gland

- **Shielding** can also be achieved by laying the cables in **grounded sheet metal ducts or metal pipes**. In this case, the **power cables and control cables** should be **routed separately**.
- The unit is grounded via the connector for 24 V voltage supply.





## 4.2 UL-compliant installation

Note the following points for UL-compliant installation:

- This unit is designed exclusively for use in class 1, division 2, group A, B, C and D or in non-hazardous areas. Unit combinations in your system must be checked by the official inspection authority responsible at the time of installation.
- Use only copper conductors with a temperature range of 60 / 75 °C as connection cables.
- For horizontal installation, the maximum ambient temperature is 40 °C; for vertical installation the maximum temperature is 50 °C.

	<p><b>⚠ WARNING – RISK OF EXPLOSION!</b></p>
	<ul style="list-style-type: none"> <li>• Only disconnect the units when voltage is not applied or when it poses no danger to the area.</li> <li>• Exchanging components can impair suitability for class 1, division 2.</li> <li>• Only connect the following extension devices to the connection labeled "Extension": <ul style="list-style-type: none"> <li>– PFE11B, only for DOP11B-10 and -20.</li> </ul> </li> <li>• Only replace the extension device when voltage is not applied or when it poses no danger to the area.</li> <li>• This device includes a battery that may only be exchanged in a non-hazardous area. Use only the following battery type as a replacement: Lithium battery CR2450, 550 mAh.</li> <li>• The unit must be used on an even surface with protection 4X. Only for indoor use.</li> </ul>

	<p><b>NOTE</b></p>
	<p>Electrical connection must be made in line with the methods described in class 1, paragraph 2 (article 501-4(b) according to the National Electric Code NFPA70).</p>

	<p><b>STOP!</b></p>
	<p>Use only tested units with a <b>limited output voltage</b> (<math>V_{max} = DC\ 30\ V</math>) and <b>limited output current</b> (<math>I \leq 8\ A</math>) as an <b>external DC 24 V</b> voltage source.</p> <p>UL certification does not apply to operation in voltage supply systems with a non-grounded star point (IT systems).</p>



## Installation

### Space required for installation

#### 4.3 Space required for installation

- Thickness of mounting panel: 1.5 - 7.5 mm (0.06 - 0.3 in)
- Space required for installing the operator terminal:

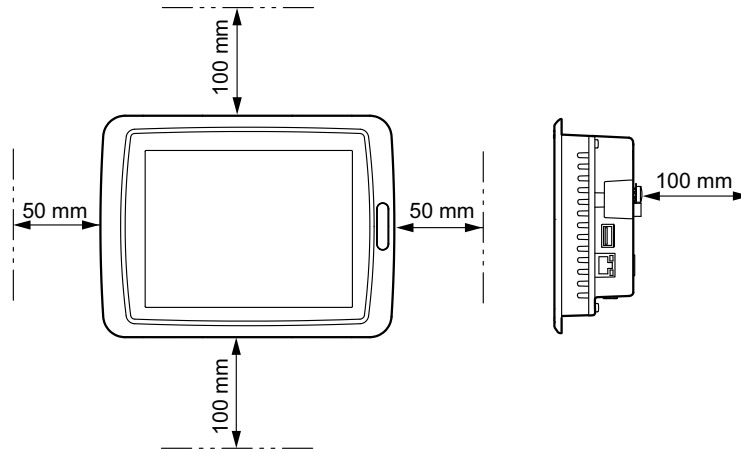

63788AXX



#### STOP

The openings in the housing are used for convection cooling and must not be covered.



#### 4.4 Installation procedure

1. Unpack the delivery and check it. Inform your supplier immediately if damage is found.

	<b>STOP</b>
	Place the operator terminal on a stable base during installation. If the unit falls down, it could be damaged.

2. Position the template where you want to install the operator terminal. Draw around the outer edge of the openings and cut out the markings.

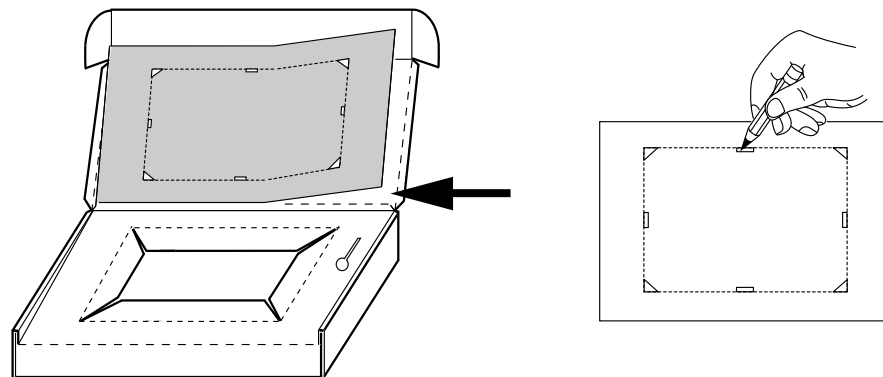

63789AXX

3. Use all the retaining bores and the brackets and screws supplied to fix the operator terminal in place.

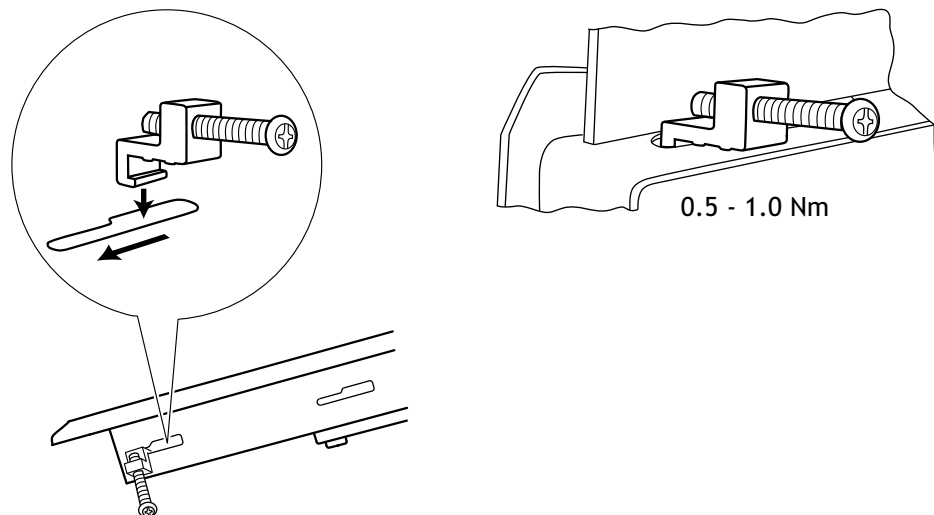

63827AXX

63825AXX



4. Connect the cables in the order indicated.

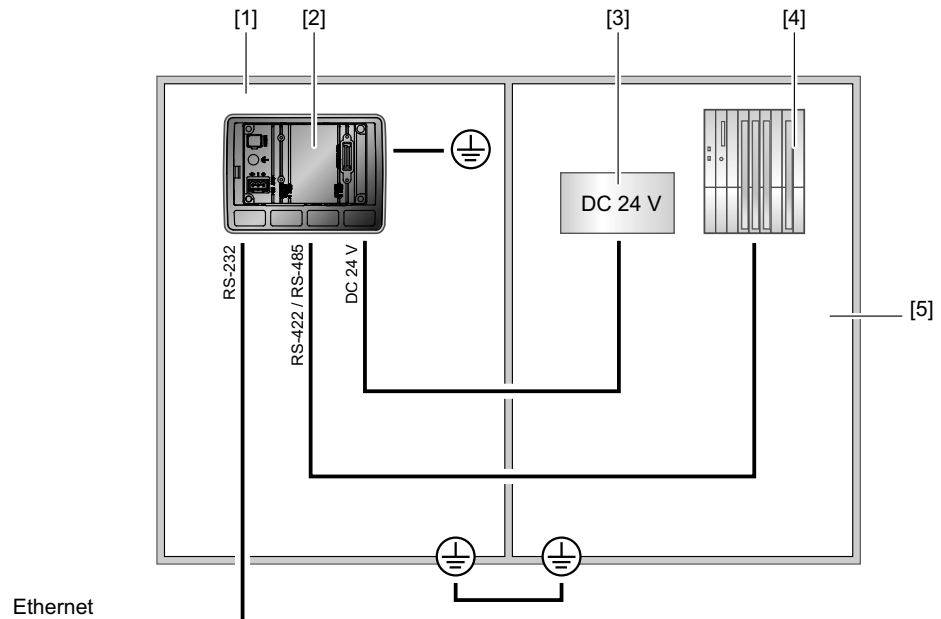

63822AXX

- [1] Make sure that the operator terminal and controller have the same electrical grounding (reference voltage value), as otherwise there may be problems with communication.
  - [2] Use an M5 screw and a PE conductor (as short as possible) with a minimum cross section of 2.5 mm<sup>2</sup>.
  - [3] Only use shielded communication cables.  
Route high-voltage cables separately from signal and supply cables.
  - [4] The operator terminal must adjust to the ambient temperature before it is taken into operation. If condensation builds up, you must ensure that the operator terminal is dry before connecting it to the power supply.  
Ensure that the voltage and polarity of the power source are correct.
  - [5] Control cabinet
5. Carefully remove the protective film from the display of the operator terminal to prevent damage from static electricity.



#### 4.5 Connecting basic units DOP11B-10 to DOP11B-60

##### 4.5.1 Voltage supply

	<b>STOP</b>
	Ensure correct polarity when connecting the terminal. Incorrect polarity will damage the unit.

	<b>NOTE</b>
	Make sure that the operator terminal and the controller system have the same electrical grounding (reference voltage value). Communication errors may occur if this is not the case.

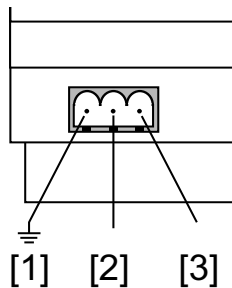

Figure 2: Voltage supply for DOP11B-10 to DOP11B-60 60059AXX

- [1] Ground
- [2] 0 V
- [3] +24 V



#### 4.6 Connection to a PC

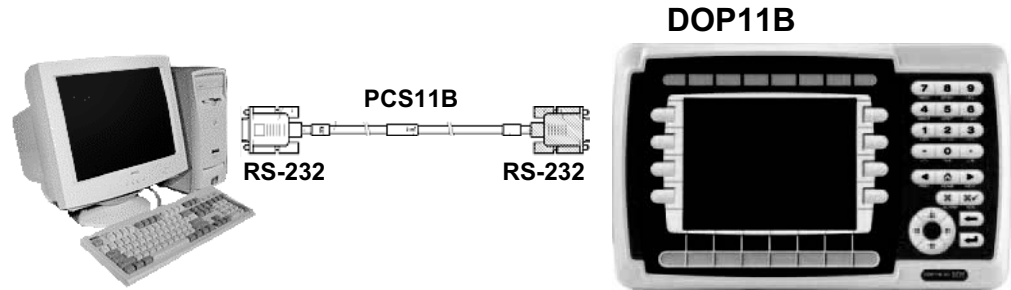

Figure 3: Connection to a PC

60060AXX

The operator terminal is programmed using the HMI-Builder software.  
The PCS11B communication cable is required to program the operator terminal.

	<p><b>NOTE</b></p> <p>Alternatively, the operator terminal can also be programmed via ETHERNET.</p>
	<p><b>STOP</b></p> <p>Possible damage to property The power must be switched off when connecting the units.</p>





### 4.7 RS-485 connection

You can connect up to 31 MOVIDRIVE® units to one operator terminal with the RS-485 interface.

The DOP11B can be connected directly to MOVIDRIVE® frequency inverters via the RS-485 interface using a 25-pin Sub-D connector.

#### 4.7.1 Wiring diagram: RS-485 interface

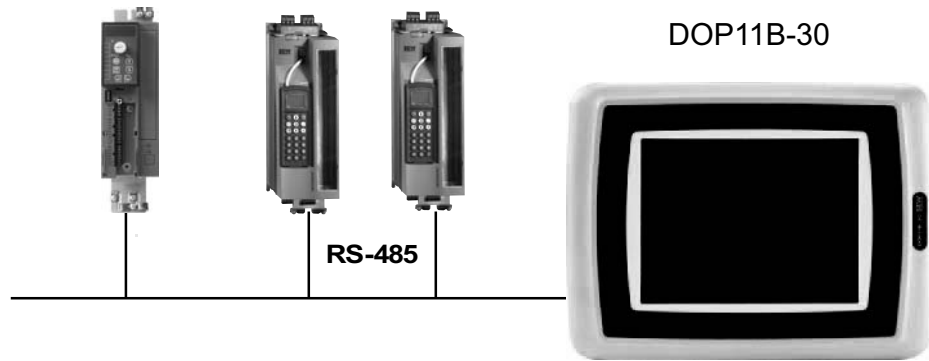

Figure 4: RS-485 connection

60093AXX

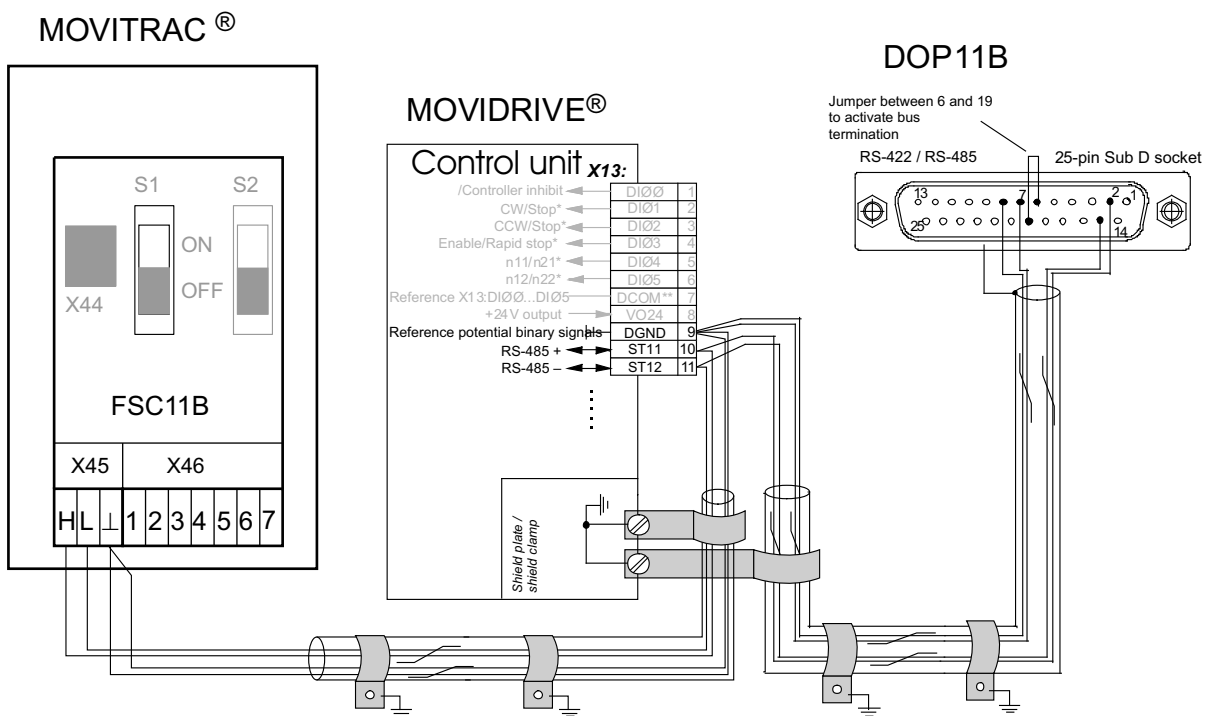

Figure 5: Pin assignment for DOP11B

60061AEN

	<b>NOTE</b>
	Alternatively, you can use the PCS22A cable.



## Installation

### RS-485 connection

#### Cable specification

Use a 2 x 2-core twisted and shielded copper cable (data transmission cable with braided copper shield). The cable must meet the following specifications:

- Core cross section 0.5 ... 0.75 mm<sup>2</sup> (AWG 20 ... 18)
- Cable resistance 100 ... 150 Ω at 1 MHz
- Capacitance per unit length ≤ 40 pF/m (12 pF/ft) at 1 kHz

For example, the following cable is suitable:

- Lappkabel, UNITRONIC® BUS CAN, 2 x 2 x 0.5 mm<sup>2</sup>.

#### Shielding

Apply the shield at both ends over large area at the controller electronics shield clamp and in the housing of the 25-pin Sub-D connector of the operator terminal.

	<b>STOP</b>
	<p>Bus controller may suffer irreparable damage as a result of a short circuit in the EMC decoupling between the electronics and ground.</p> <p><b>Never connect the shield ends to DGND!</b></p>

#### Cable length

The total permitted cable length is 200 m.

#### Terminating resistor

The controller and UWS11A interface adapter are equipped with dynamic terminating resistors. In this case, do not connect **any external terminating resistors!**

If the DOP11B operator terminal is connected to the frequency inverters via RS-485, activate the terminating resistor in the 25-pin Sub-D connector of the DOP11B (jumper between pin 6 and pin 19) if the operator terminal is the first or last station.

	<b>STOP</b>
	<p>There must not be any difference of potential between the units connected using the RS-485. Take suitable measures to avoid potential displacement, for example, by connecting the unit grounds (GND) with a separate cable, connecting the voltage supply (24 V) etc.</p>



## 4.8 Connecting RS-485 to PCS21A

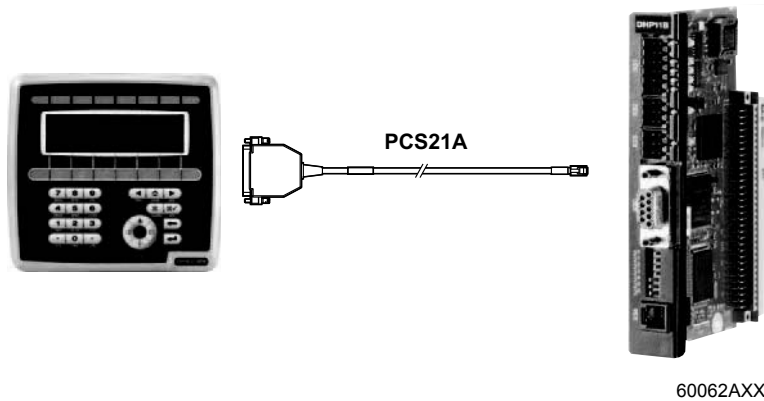

### 4.8.1 Shielding

Connect the shield to the electronics shield clamp of the controller and make sure it is connected over a wide area. The shielding is already connected in the housing of the 25-pin Sub-D connector of the PCS21A.

	<b>STOP</b>
	<p>The bus controller may suffer irreparable damage as a result of a short circuit in the EMC decoupling between the electronics and ground.</p> <p><b>Never connect the shield ends to DGND!</b></p>

### 4.8.2 Terminating resistor

The controller comes equipped with dynamic terminating resistors. Do not connect **any external terminating resistors!**

The terminating resistor in the 25-pin sub-D connector of the DOP11B is already activated by a jumper between pin 6 and pin 19.

	<b>STOP</b>
	<p>There must not be any difference of potential between the units connected using the RS-485. Take suitable measures to avoid potential displacement, for example, by connecting the unit grounds (GND) with a separate cable, connecting the voltage supply (24 V) etc.</p>



**4.9 RS-232 connection via UWS11A**

Connecting the DOP11B to a MOVIDRIVE® frequency inverter via UWS11A.

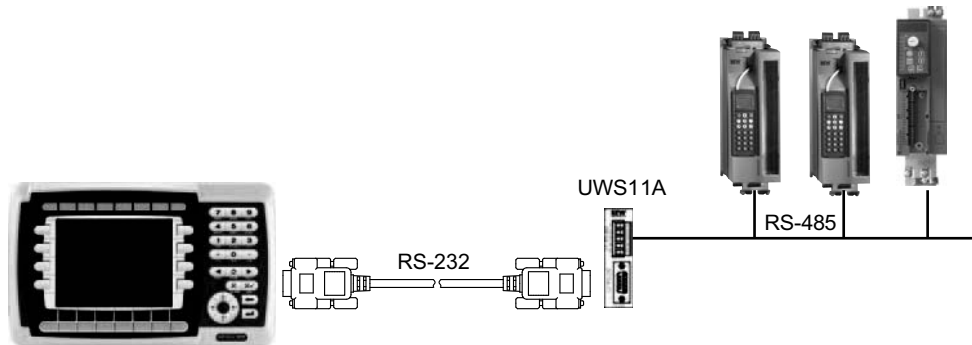

Figure 6: Connection via serial connection (UWS11A)

63841AXX

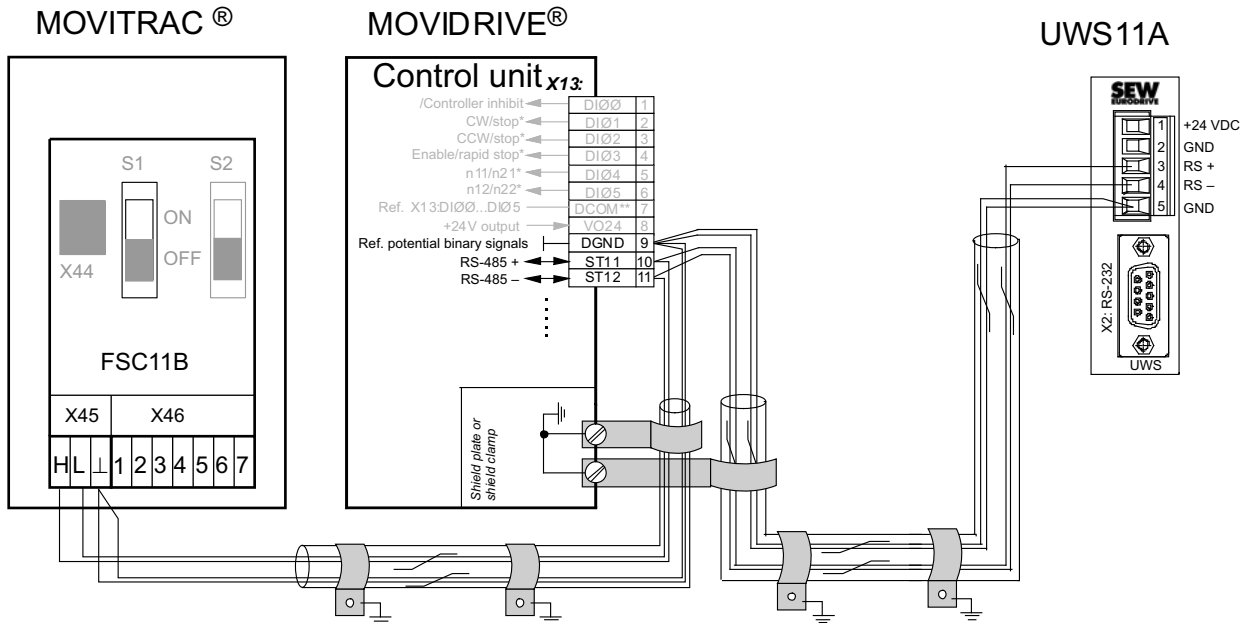

Figure 7: UWS11A terminal assignments

58787AEN



**NOTE**

Alternatively, you can use the D-SUB-9PO cable for the RS-232 connection (see the section "Accessories and options" on page 24).

**4.9.1 RS-485 connection**

See the section "RS-485 connection" on page 33 for the cable specification.



#### 4.10 ETHERNET connection

Connecting DOP11B to a PC for programming and remote maintenance via ETHERNET and TCP/IP.

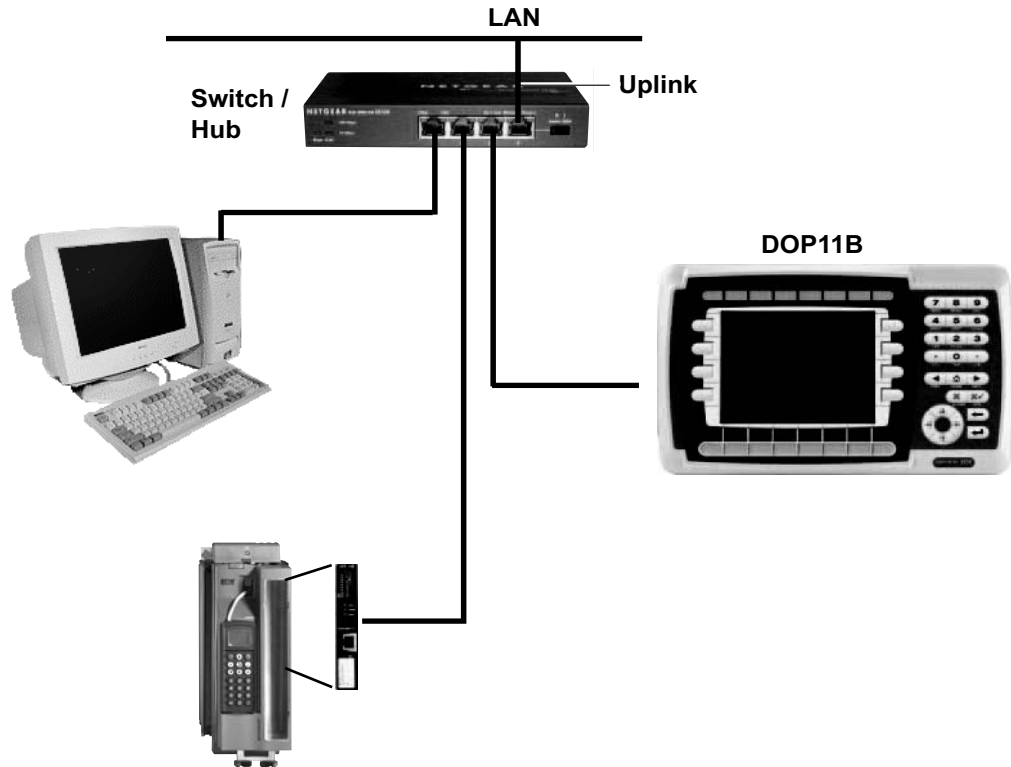

Figure 8: ETHERNET connection

60095AXX

##### 4.10.1 Cable specification

Use a standard shielded ETHERNET cable with shielded RJ45 connectors and cables according to the CAT5 specification. The maximum cable length is 100 m.

For example, the following cable is suitable:

- Lappkabel, UNITRONIC® LAN UTP BS flexible 4 x 2 x 26 AWG



#### NOTE

For a description of how to determine the ETHERNET (MAC) address of the option card, see the section "Configuration mode (SETUP)" on page 49 .



#### 4.10.2 ETHERNET interface in DOP11B-20 to -60

The DOP11B-20 to DOP11B-60 units are equipped as standard with an ETHERNET interface. Two LEDs are integrated into the RJ-45 socket.

The LEDs have the following functions:

Green LED	Illuminated	The ETHERNET cable is connected correctly.
	Flashing	Data is being sent or received.
Yellow LED	Illuminated	The setting 100 Mbit, full duplex is active.
	Flashing	The setting 100 Mbit, half duplex is active.

#### 4.10.3 PFE11B ETHERNET interface for DOP11B-10 and -15

##### Space requirements

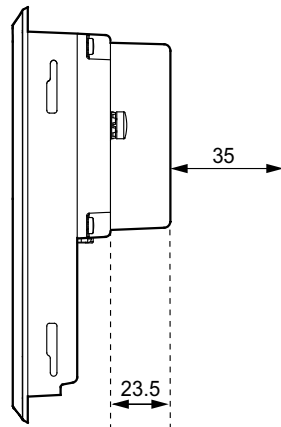

63798AXX

##### Installation

1. Unpack the delivery and check the contents for completeness and possible damage. Inform your supplier immediately if damage is found.

Scope of delivery:

- Expansion module
- 4 x M3x6
- 4 spacers



##### STOP

Place the terminal on a stable base during installation. If the unit falls down, it could be damaged.

2. Disconnect the operator terminal from the voltage supply.



- Remove the plastic cover from the expansion interface.

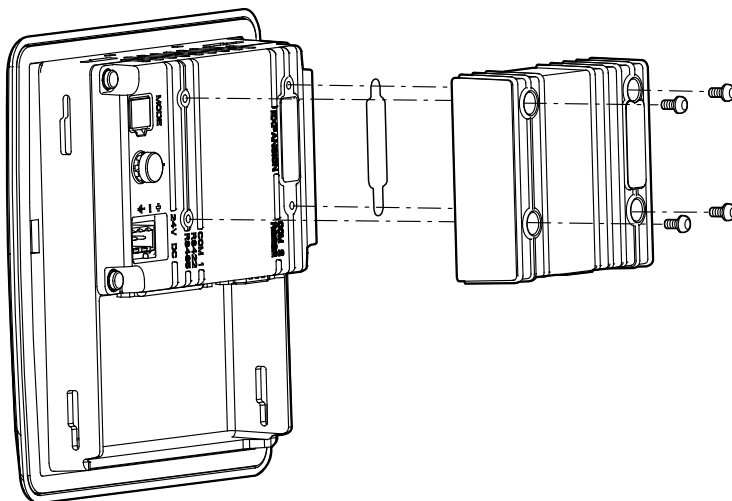

63799AXX

- Fix the expansion module in place using the screws supplied.
- Connect the operator terminal to the voltage supply.

### LEDs on PFE11B

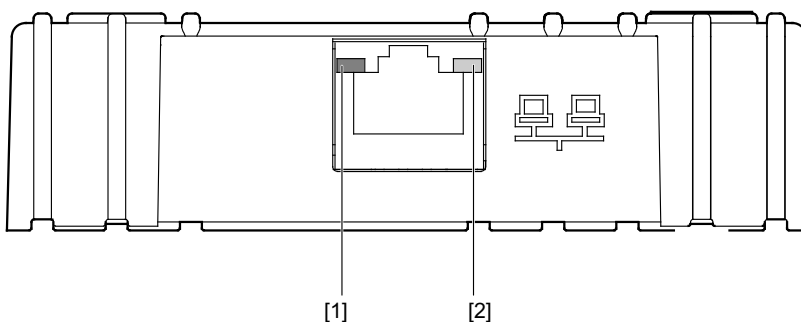

63810AXX

- [1] Green LED
- [2] Yellow LED

The expansion card has 2 LEDs with the following functions:

Green LED	Flashing	Data is being sent or received.
Yellow LED	Illuminated	The (twisted pair) ETHERNET cable is connected correctly.
TxD, YELLOW	LED is activated by ETHERNET transfer.	
RxD, YELLOW	LED is activated by ETHERNET reception.	
LINK, GREEN	LED is activated when the (twisted pair) ETHERNET cable is connected correctly.	



## Installation

### Connection to a Siemens S7

#### Settings in the configuration tool

Double-click on the [Peripherals] directory in the project manger in the configuration tool for the operator terminal. Click the right mouse button on [Expansion interface] and choose [EM-ETHERNET]. Then pull the controller with the corresponding driver or TCP/IP connection to the fieldbus symbol. To change the selected driver, choose [Properties] from the project menu. Additional information can be found in the driver documentation.

#### 4.11 Connection to a Siemens S7

##### 4.11.1 RS-485

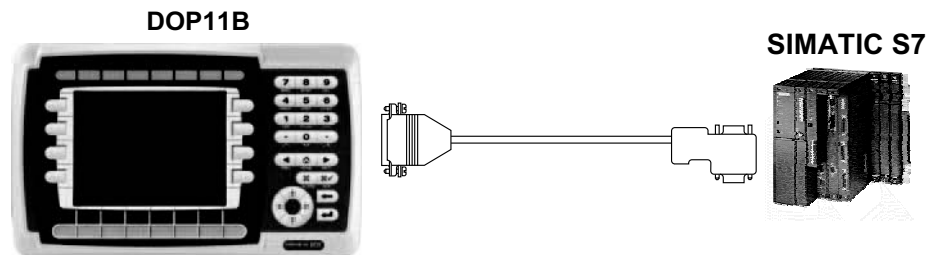

Figure 9: Connection to a Siemens S7 via MPI and RS-485

63682AXX

Use the driver "S7 MPI Direct".

##### 4.11.2 PCM11A

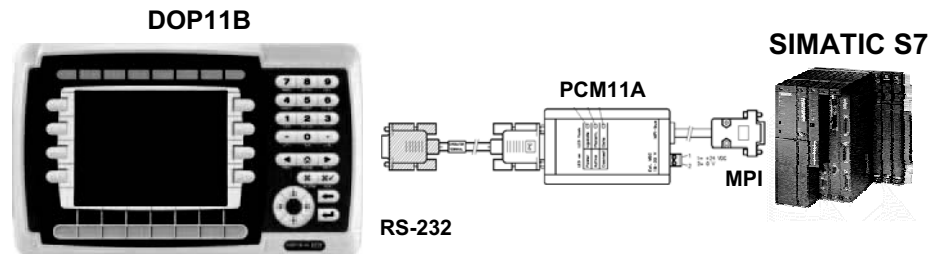

Figure 10: Connection to a Siemens S7 via MPI and PCM11A

60096AXX

Use the driver "S7 MPI (HMI adapter)".





4.11.3 ETHERNET

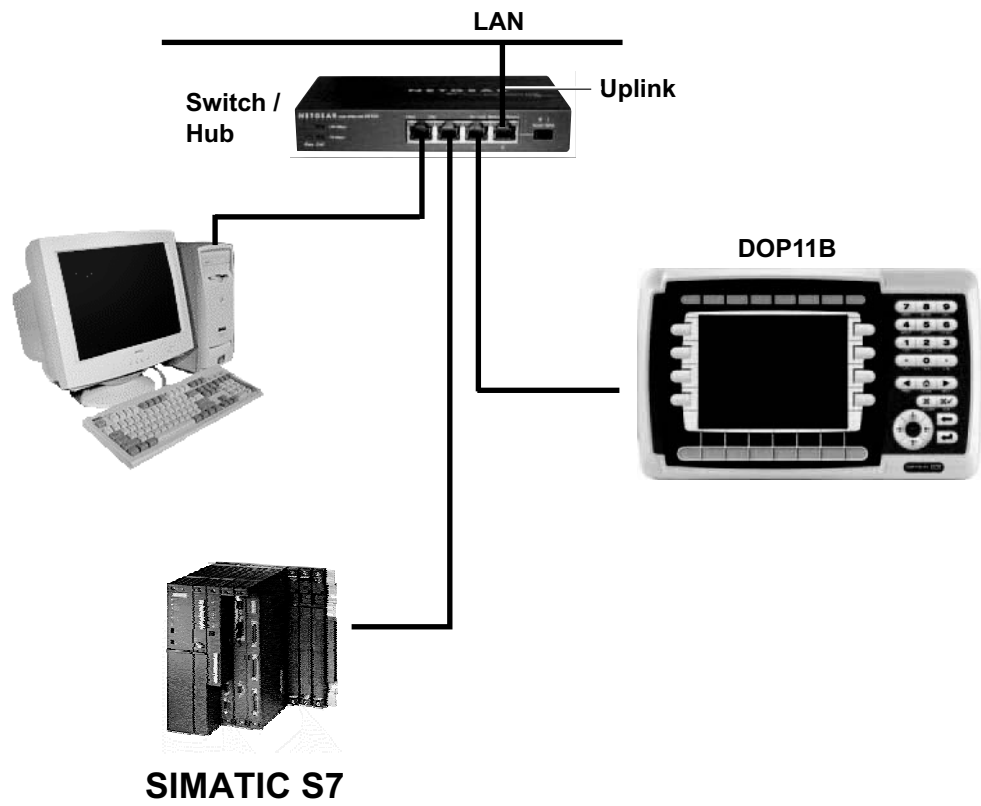

Figure 11: ETHERNET connection

64328AXX



## 5 Startup



### ! DANGER

Danger of electric shock.

**Severe or fatal injuries!**

- It is essential to comply with the safety notes in section 2 during installation.

### 5.1 General startup instructions

Requirement for successful startup is the correct electrical connection of the operator terminal.

The functions described in this section enable users to upload a project to the operator terminal and establish the unit in the necessary communication pathways.



### ! WARNING

Do not use the DOP11B operator terminals as safety devices for industrial applications.

Severe or fatal injuries.

- Use monitoring systems or mechanical protection devices to ensure the protection of personnel and equipment.



## 5.2 Preliminary work and resources

- Check the installation
- Take suitable measures to prevent the motor from starting up unintentionally via the connected frequency inverter.
  - Disconnect the electronics input X13.0/controller inhibit in MOVIDRIVE® or
  - Disconnect the supply voltage (24 V backup voltage must still be applied)
  - Disconnect the terminals "CW operation" and "Enable" on MOVITRAC®

Additional safety measures must be taken depending on the application to avoid injury to people and damage to machinery.

- Connect the operating terminal to MOVIDRIVE® or MOVITRAC® using an appropriate cable.



60093AXX

Figure 12: Connection between operator terminal and MOVIDRIVE® MDX60B/61B

- Connect the operator terminal to the PC using the PCS11B (RS-232) programming cable. Operator terminal and PC must be de-energized when you do this, otherwise undefined states may occur. Switch on the PC. If the HMI-Builder project planning software is not already installed on the PC, install it now and then start the software.

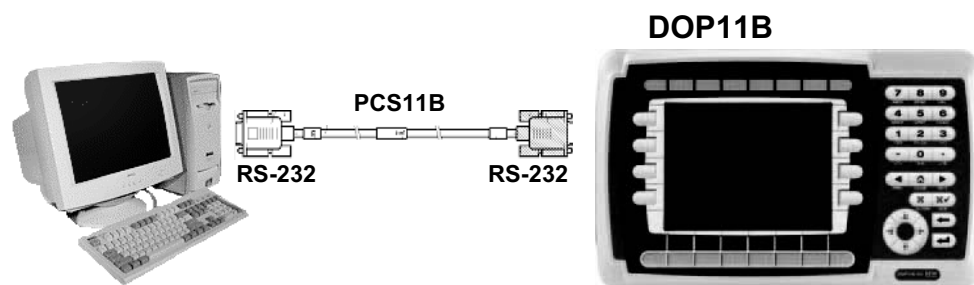

60060AXX

Figure 13: Connection between PC and operator terminal



- Switch on the supply (24 V) for the operator terminal and connected frequency inverters.



#### NOTE

Alternatively, DOP11B can also be programmed via ETHERNET (see page 189) and via USB (see page 190).

### 5.3 Initial operation



#### NOTE

Units are delivered without a loaded project.

Once the units are switched on, they will report the following information:



Figure 14: DOP11B-20 initial screen in delivery state

11597AXX



Figure 15: DOP11B-50 initial screen in delivery state

12076AXX



## 5.4 Terminal functions

This section describes the different modes in the operator terminal, the keyboard and the information page in the terminal.

### 5.4.1 Terminal keypad

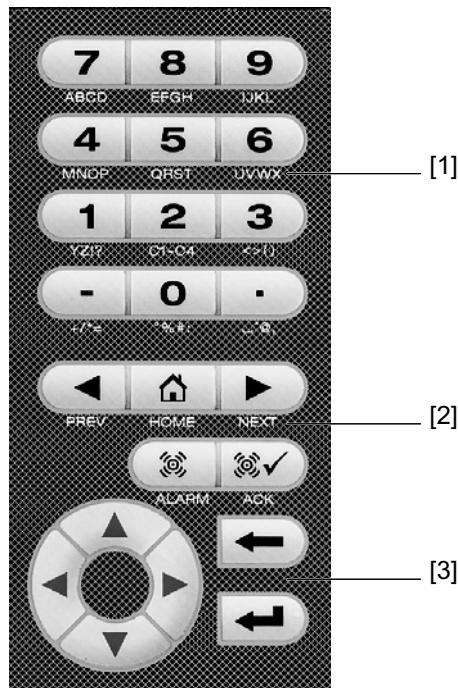

60097AXX

- [1] Integrated function keys
- [2] Arrow keys
- [3] Alphanumeric keys

#### **Alphanumeric keys**

You can use the alphanumeric keyboard to enter the following characters in dynamic text and numerical objects during run mode.

0-9

A-Z

a-z

! ? < > ( ) + / \* = ° % # : ' @

Country-specific characters



To enter numeric values, press the relevant key once.

To enter capital letters (A to Z), press the relevant key two to five times.

To enter lower case letters (a to z), press the relevant key six to nine times.

You can select the time interval between presses. If the key is not pressed within the specified time interval, the cursor moves to the next position.

Enter country-specific characters by pressing key <2> (C1C4) two to nine times. This option offers characters that are not included in the standard character set of the alpha-numeric terminal keyboard.



#### NOTE

You can use all characters of the selected character set in the HMI-Builder except those characters reserved for static text. To enter the required character, keep the key combination <ALT>+<0> (zero) pressed on the PC's keyboard, then enter the character code. You select the used character set in the HMI-Builder.

#### Reserved characters

The ASCII characters 0-32 (Hex 0-1F) and 127 are reserved for internal terminal functions and must not be used in projects or files in the terminal. The characters are used as control characters.

#### Arrow keys

Use the arrow keys to move the cursor in a menu or dialog box.

#### Integrated function keys

Not all the keys are available on all terminals.

Key	Description
Enter key	Use the ENTER key to confirm settings and to switch to the next line or level.
<PREV>	Use this key to return to the previous block.
<NEXT>	Use this key to go to the next block.
<ALARM>	Use this key to display the alarm list.
<ACK>	Use this key to acknowledge alarms in the alarm list.
<HOME>	Use this key to jump to block 0 in run mode.
<←>	Use this key to delete characters to the left of the cursor.



#### NOTE

If the main block (block number 0) has been displayed, the <PREV> key will not work since the block history is deleted when the main block is shown.

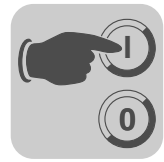

### 5.4.2 Switches on the DOP11B terminals

Four switches for selecting the operating mode (DIP switches) are located on the back of DOP11B operator terminals.

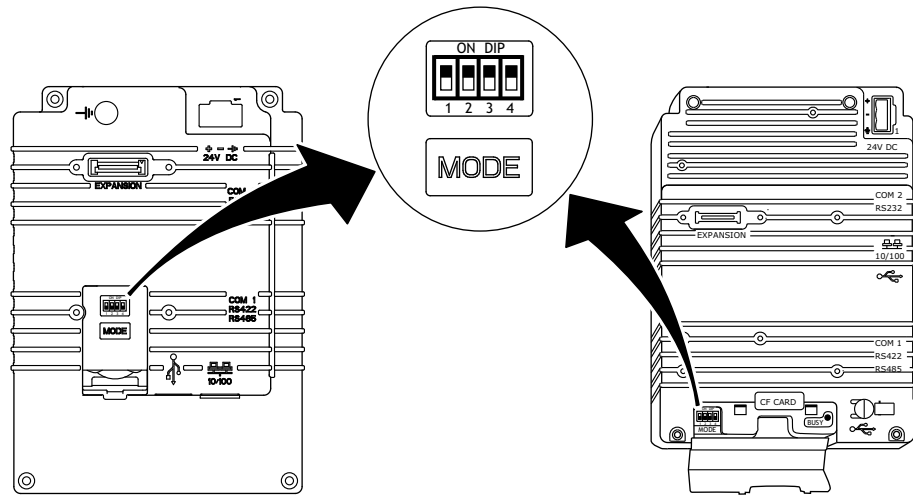

60855AXX

DIP switches have the following assignment:

**1 = ON, 0 = OFF**

You have to interrupt the power supply to the terminal to call up individual modes for DOP11B.

Turn the DIP switch on the side or back of the terminal to the position shown in the following table. You can now turn on the power supply again.

Switch position 1234	Function
0000	Run mode (RUN, standard operation)
0010	Reset system (delivery status)
0100	Sysload
1000	Configuration mode (SETUP)
1100	No function (RUN)
1110	Activate self-test function
XXX1	Hard reset



#### 5.4.3 Service menu

To call up the service menu, set the operating mode switches on the operator terminal to "1000". For information on the operating mode switches, see the section "Switches on the DOP11B terminals" on page 47.

The service menu includes the following options:

**Network settings** Choose this option to access the network menu.

**Network menu** The options in the network menu match the selection made in [Settings] / [Network] in the HMI-Builder. It includes the following entries:

Menu entry	Described in
TCP/IP settings	Network communication via ETHERNET (see page 263).
Accounts	Network accounts (see page 302).
Services	Network services (see page 271).

**Erase project memory** This option deletes the project memory.

**Load project from memory card** An empty operator terminal can be started using an existing information designer project from another terminal. To do so, you must first copy the project to a compact Flash memory card or USB stick using the function "Save project to memory card" (e.g. via a function key).

Insert the memory card into the empty operator terminal when it is off. Then choose the command "Load project from memory card" from the service menu and follow the instructions.

**Enter transfer mode** Enables manual access to the transfer mode which is required to download projects via a GSM modem. More information can be found in the section "Transfer via GSM modem" on page 194.

**Enter run mode** Enables manual access to the operating mode. More information can be found in the section "Transfer via GSM modem" on page 194.

**Update system program from memory card** Insert a compact Flash memory card or USB stick loaded with a new system program and follow the instructions. The system program can also be updated using configuration software for the operator terminals.

**Calibrate touch-screen** Follow the instructions on the screen to calibrate the touchscreen.



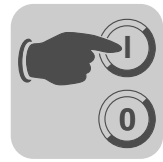

#### 5.4.4 Operating modes RUN and SETUP

The operator terminal has two operating modes.

- **Configuration mode (SETUP):** All basic settings are made in this mode, such as selection of the controller and menu language.
- **Run mode (RUN):** This mode is for running the application.

#### **Configuration mode (SETUP)**

This section contains a description of functions that cannot be carried out with the HMI-Builder.

#### **Erasing the memory**

The [setup] menu in the terminal includes the function [Erase Memory]. Use this function to erase the terminal's application memory. All blocks and definitions for alarms, time channels, function keys and system signals are erased.

Parameters	Description
Enter key	Memory is erased. The configuration menu is shown automatically when the erasure is completed.
<PREV>	Returns to previous level without erasing the memory.



#### **NOTE**

When the memory is erased, all the data stored on the terminal will be lost. The language selection parameter is not affected by this function. All other parameters will be erased or reset to their default values.

#### **Run mode (RUN)**

The application is executed in run mode. Block 0 will automatically be displayed on the screen when changing to run mode.

The integrated keyboard is used to highlight and change values in run mode.

If a communication error occurs between the terminal and controller, an error message will be shown on the screen. The terminal starts automatically once communication is reestablished. If you enter an I/O key combination while a communication error is active, the combination will be stored in the terminal buffer and transferred to the controller once communication resumes.

The terminal clock can continuously send data to a register in the controller to activate a monitoring function. The controller can use this monitoring function to detect a communication error. The controller checks whether the register has been updated. If it has not, an alarm indicating a communication error can be activated in the controller.

The functional principle of the individual objects and functions in operating mode will be explained in conjunction with the description of the respective objects and functions.



#### 5.4.5 Information page

The terminal contains an information page. The information page is activated by pressing the key combination <<-> and <PREV> simultaneously in run mode. A function or touch key can also be used or configured to call up the information page.

The current terminal, system program version and hardware version are shown at the top of the information page.

Parameters	Description
STARTS	Number of terminal starts
RUN	Number of terminal operating hours
CFL	Number of hours the backlighting has been switched on
32°C MIN: 21 MAX: 38 (example)	Current operating temperature, lowest and highest measured temperatures
DYNAMIC MEMORY	Available RAM memory (working memory) in bytes
FLASH MEM PROJ	Available Flash memory (project memory) in number of bytes
FLASH MEM BACK	Reserved
FLASH CACHEHITS	Percentage of block / allocation cache hits in the file system
FLASH ALLOCS	Maximum percentage of used or active allocations per block in the file system
DRIVER 1	Current driver and driver version
DIGITAL I/Os	The number of digital signals linked to controller 1 continuously monitored (STATIC) and the number in the current block (MONITOR)
ANALOG I/Os	The number of analog signals linked to controller 1 continuously monitored (STATIC) and the number in the current block (MONITOR)
I/O POLL	The time in ms between 2 readings of the same signal in controller 1
PKTS	The number of signals in each package transferred between the terminal and controller 1
TOUT1	The number of timeouts in communication with controller 1
CSUM1	The number of checksum errors in communication with controller 1
BYER	The number of byte errors in the communication
DRIVER 2	Current driver and driver version. The parameters for Driver 2 are only shown if controller 2 is defined in the project.
DIGITAL I/Os	The number of digital signals linked to controller 2 continuously monitored (STATIC) and the number in the current block (MONITOR).
ANALOG I/Os	The number of analog signals linked to controller 2 continuously monitored (STATIC) and the number in the current block (MONITOR)
I/O POLL	The time in ms between 2 readings of the same signal in controller 2
PKTS	The number of signals in each package transferred between the terminal and controller 2
TOUT2	The number of timeouts in communication with controller 2
CSUM2	The number of checksum errors in communication with controller 2
1 / 2 / 3	Current port for FRAME, OVERRUN and PARITY. 1 = RS-422 port, 2 = RS-232 port and 3 = RS-485 port.
FRAME	The number of frame errors in each port
OVERRUN	The number of overrun errors in each port
PARITY	The number of parity errors in each port



### 5.4.6 Joystick functions

Only applies to DOP11B-20 and DOP11B-40.

This function makes it possible to use the arrow keys as function keys. Enter the command "AK" and an address in the command line in the [System signals] window. Example: "AKH1" (command AK and memory cell H1).

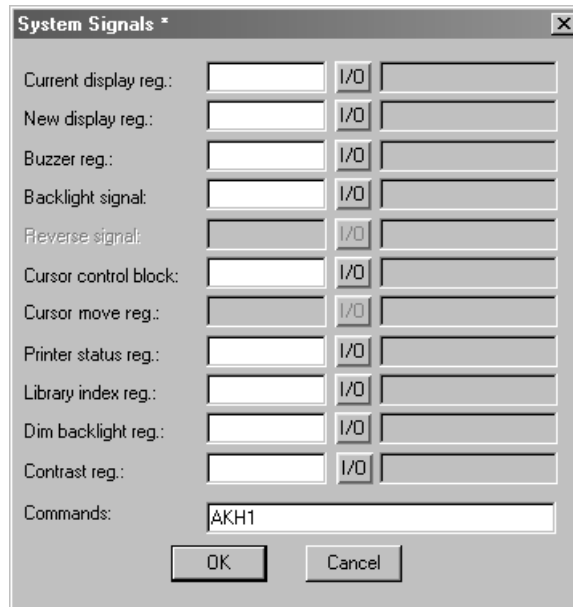

11486AEN

Figure 16: System signals

Memory cell H1 acts as the enable signal and the following four memory cells have functions according to the following control block:

Memory cell	Description
Hn0	Active = Joystick function. Disabled = Normal function.
Hn1	LEFT ARROW
Hn2	DOWN ARROW
Hn3	UP ARROW
Hn4	RIGHT ARROW

If you press an arrow when the enable signal is active, the memory cell corresponding to the key you press will be activated. When the enable signal is issued, the arrow keys will not perform their normal functions.



#### Example

The following example can be used to switch between the joystick function and normal function.

Perform the following steps:

- Use the SEW-MOVILINK (serial) Driveeffectier.
- Enter the text "AKH1" in [System signals] / [Commands].
- Generate a text block.
- Enter the static text "JOYSTICK."
- Create an object with the following settings:

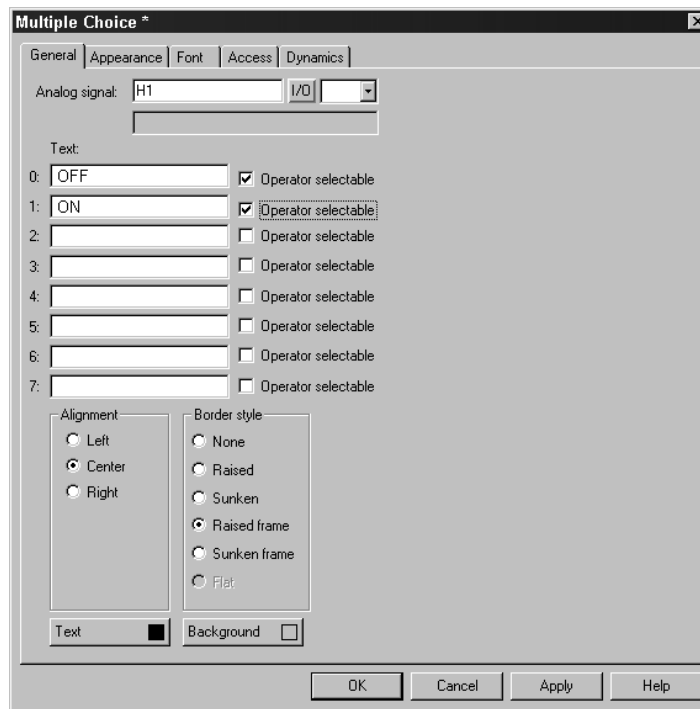



- Generate another four objects to monitor the memory content of H2, H3, H4 and H5.

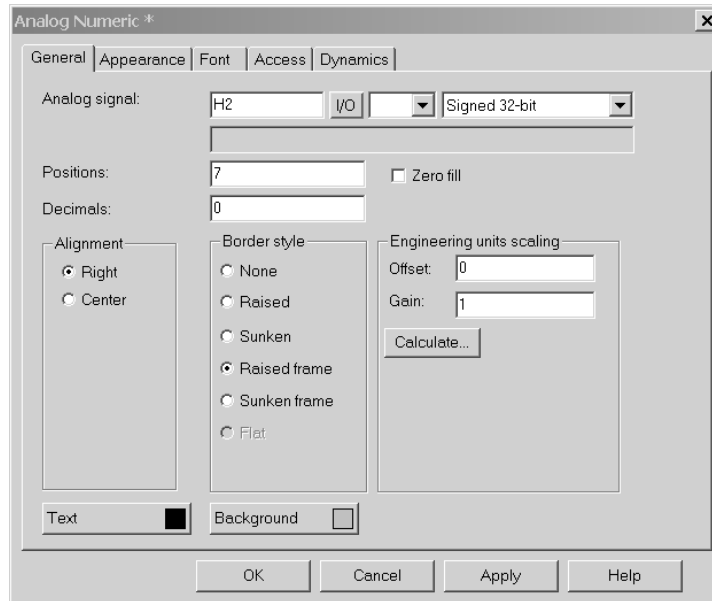

Appearance of the text block based on the sample settings:

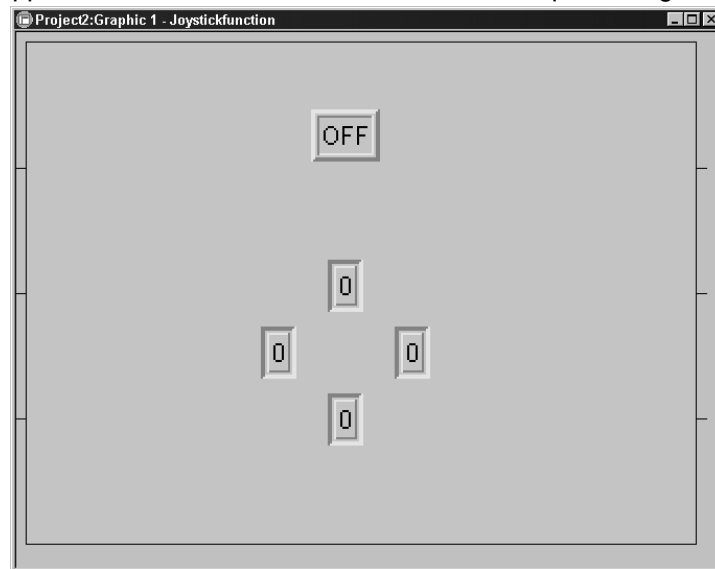



## 6 Operation and Service

### 6.1 Transferring projects with PC and HMI-Builder

You need the HMI-Builder software to start up the operator terminal with your PC.

1. Start the HMI-Builder program.
2. Select the language in the [Settings] / [Menu language] selection field.



11487AEN

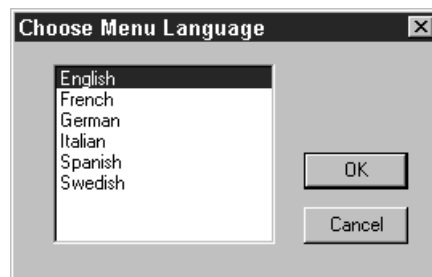

11244AEN



3. Use the [File] / [Open] function to open the project file you would like to transfer to the operator terminal.

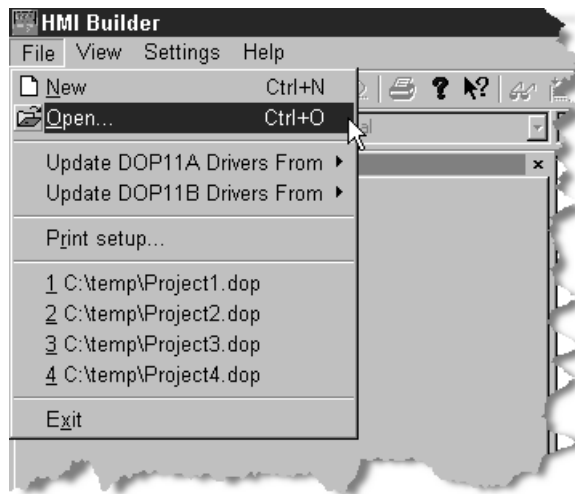

11488AEN

4. In the selection field [Transfer] / [Communication properties], select the communication connection [Use serial transfer] and enter the necessary parameters:

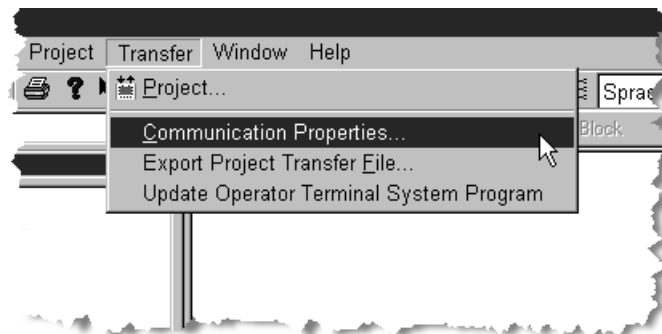

11489AEN



#### Serial transfer using the PCS11B programming cable.

Enter the following information:

- Communication port of the PC (e.g. Com1)
- Data transfer rate (default 152000)
- Timeout period (free entry, default 10,000 ms)
- Number of retries in case of communication problems (default 3)

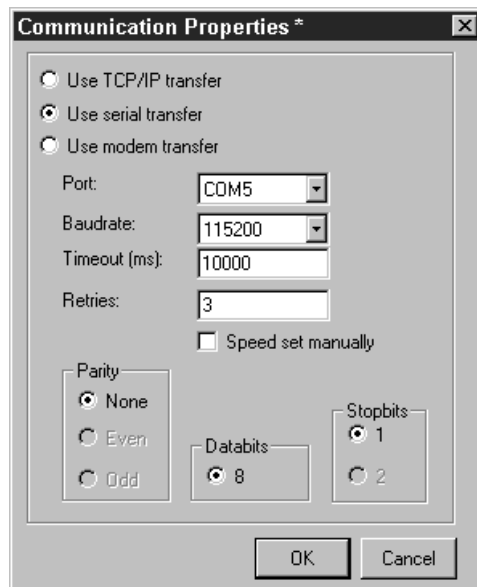

11490AEN

5. The project can now be transferred to the terminal by using the selection field [Transfer] / [Project].

The following functions are active as standard and must not be changed.

- Test project on send
- Send complete project
- Automatic terminal RUN/TRANSFER switching
- Check terminal version





Press the [Send] button to download the data.

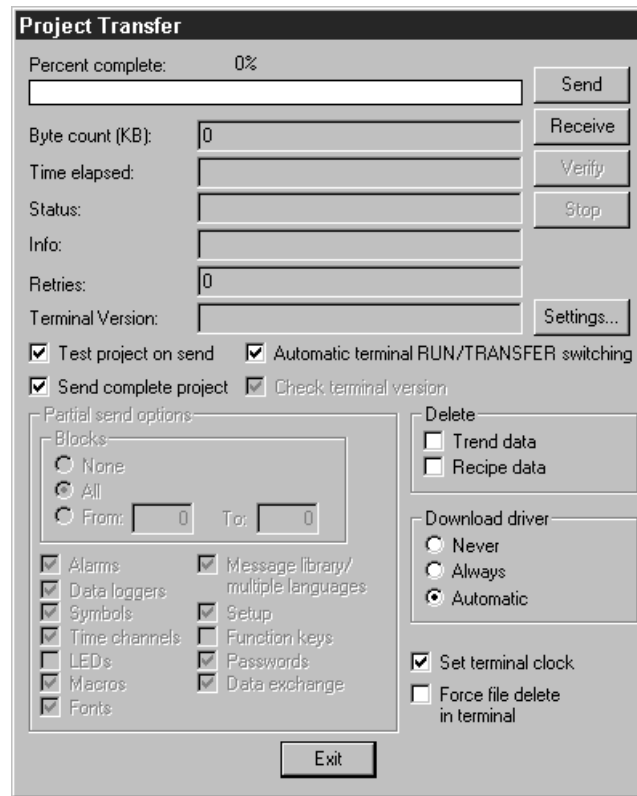

11247AEN

The following steps will be executed one after the other:

- Switch the terminal to transfer mode (TRANSFER)
- Transfer the communication driver for inverter and PLC
- Transfer project data
- Switch the terminal to RUN mode

The individual steps will be displayed in the terminal display during transfer.

Once transfer is completed, exit the dialog window using the [Exit] button and close the HMI-Builder.



#### 6.2 Operating display at unit start

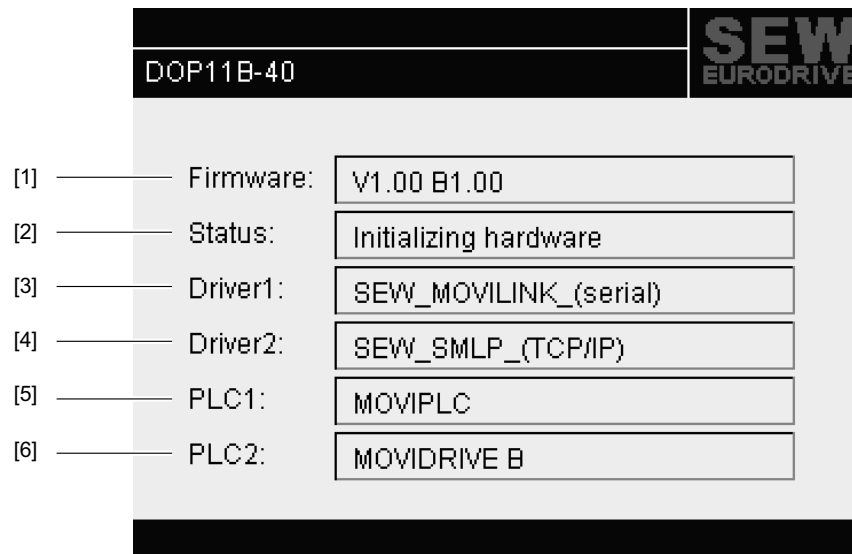

11592AXX

- [1] Firmware version of the operator terminal
- [2] Status of the boot process e.g.:  
 Initializing hardware  
 Loading comm. drivers  
 Init alarms  
 IP address: 192.168.1.1
- [3] Communication driver loaded in Controller 1  
 e.g.:  
 SEW\_MOVILINK\_(serial)  
 SEW\_SMLP\_(TCP/IP)  
 DEMO  
 ...
- [4] Communication driver loaded in Controller 2  
 e.g.:  
 SEW\_MOVILINK\_(serial)  
 SEW\_SMLP\_(TCP/IP)  
 DEMO  
 ...
- [5] Communication status of Controller 1  
 e.g.:  
 NO CONNECTION  
 MOVIPLC  
 MOVITRAC B  
 MOVIDRIVE B  
 ...
- [6] Communication status of Controller 2  
 e.g.:  
 NO CONNECTION  
 MOVIPLC  
 MOVITRAC B  
 MOVIDRIVE B  
 ...



### 6.3 Error messages

Errors in RUN mode will be displayed in the upper left hand corner of the display as error messages.

They are divided into two groups:

- Boot error (no inverter connected)
- Operation errors - Comm errors (error list)

#### 6.3.1 Boot error (no inverter found)

Boot error "1: Comm Error 254" means: no communication with connected inverters.

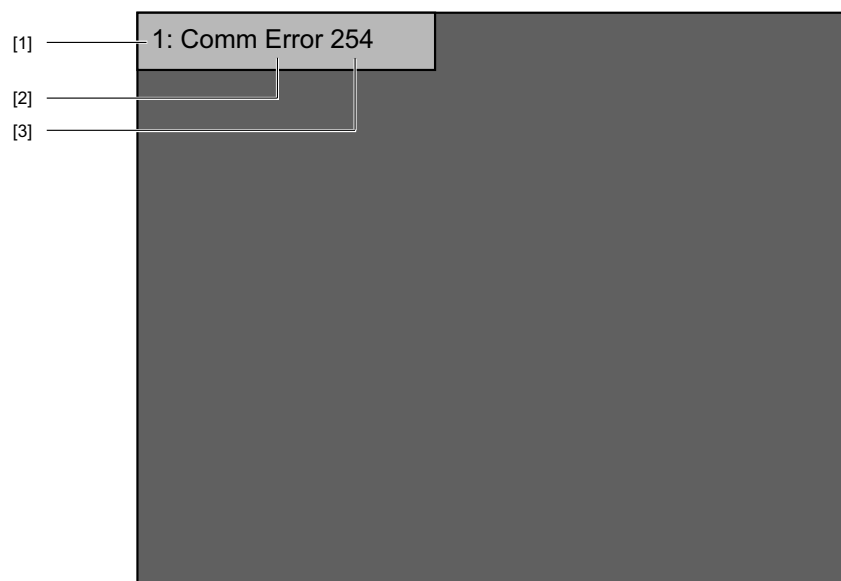

53590AXX

- [1] Controller in which the communication error occurs.  
e.g 1 or 2
- [2] Error type  
e.g. operation error - Comm Error
- [3] With address:  
e.g.  
01 - 99  
254 (= point to point!)



#### 6.3.2 Operating errors - Comm errors (error list)

Message from operator terminal	Error code	Description
no error	00 00	No error
invalid parameter	00 10	Illegal parameter index
fct. not implement	00 11	Function / parameter not implemented; <ul style="list-style-type: none"> <li>Controller does not recognize parameter addressed by the operator terminal. Check selection of MOVILINK<sup>®</sup> driver. Individual parameters of MOVITRAC<sup>®</sup> 07, MOVIDRIVE<sup>®</sup> A and MOVIDRIVE<sup>®</sup> B controllers are slightly different.</li> <li>The error may also be caused by the controller's firmware. Recently added parameters may not be included in older versions of the unit firmware.</li> </ul>
read only access	00 12	Read access only <ul style="list-style-type: none"> <li>No write access to addressed parameter. Deactivate the [Activate input] function in the operator terminal's project.</li> </ul>
param. lock active	00 13	Parameter lock is active <ul style="list-style-type: none"> <li>The [Parameter block] function was activated via parameter P803 in the addressed controller. Set parameter P803 to "OFF" by using the controller keypad or the MOVITOOLS<sup>®</sup> PC software to deactivate the parameter lock.</li> </ul>
fact. set active	00 14	Factory setting is active <ul style="list-style-type: none"> <li>Controller is performing a factory setting. Parameter change option is locked for a few seconds. Communication will be automatically reactivated once factory setting is complete.</li> </ul>
value too large	00 15	Value for parameter too large <ul style="list-style-type: none"> <li>Operator terminal is trying to write a value to a parameter that is not within the permitted value range. Adapt the minimum and maximum input values in the [Access] area in the project of the operator terminal. You will find the respective limit values in the controller's parameter list.</li> </ul>
value too small	00 16	Value for parameter too small <ul style="list-style-type: none"> <li>Operator terminal is trying to write a value to a parameter that is not within the permitted value range. Adapt the minimum and maximum input values in the [Access] area in the project of the operator terminal. You will find the respective limit values in the controller's parameter list.</li> </ul>
option missing	00 17	Required option card missing for this function / this parameter.
system error	00 18	Error in system software of controller <ul style="list-style-type: none"> <li>Contact SEW service.</li> </ul>
no RS485 access	00 19	Parameter access via RS-485 process interface on X13 only
no RS485 access	00 1A	Parameter access via RS-485 diagnostic interface only
access protected	00 1B	Parameter is access-protected <ul style="list-style-type: none"> <li>No read or write access to this parameter; parameter not suitable for use in operator terminal.</li> </ul>
inhibit required	00 1C	Controller inhibit required <ul style="list-style-type: none"> <li>The addressed parameter can only be altered when the controller is inhibited. Activate the controller inhibit status by removing the terminal X13.0 or via fieldbus (control word 1/2 basic block = 01hex).</li> </ul>
incorrect value	00 1D	Incorrect value <ul style="list-style-type: none"> <li>Some parameters can only be programmed to certain values. You will find the respective limit values in the parameter list of the controller.</li> </ul>
fact. set active	00 1E	Factory setting was activated.
not saved in EEPROM	00 1F	Parameter was not saved in EEPROM <ul style="list-style-type: none"> <li>Power-failure save failed.</li> </ul>
inhibit required	00 20	Parameter cannot be changed with enabled output stage <ul style="list-style-type: none"> <li>The addressed parameter can only be altered with inhibited inverter. Activate the controller inhibit status by removing the terminal X13.0 or via fieldbus (control word 1/2 basic block = 01hex).</li> </ul>

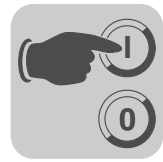

## 6.4 SEW Electronics Service

### 6.4.1 Send in for repair

Contact **SEW Electronics Service** if a fault cannot be rectified.

When contacting the SEW electronics service, always quote the digits of the unit designation so that our service staff can assist you more effectively.

#### **Provide the following information when sending the unit in for repair:**

- Serial number (→ nameplate)
- Unit designation
- Brief description of the application
- Nature of the error
- Accompanying circumstances
- Your own presumptions as to what has happened
- Any unusual events preceding the problem, etc.



## 7 Programming

### 7.1 Creating a project

#### 7.1.1 Basics

This section describes the system structure of the terminal and its basic functions. There is also an explanation of the general principles, object parameters and joint functions applicable in the terminal.

#### *Procedure for programming a project*

The graphical structure of the application in the terminal makes the monitoring tool easy to use. It is important to organize the application carefully and to consider which functions are necessary. Start with the overall view, and then work down to the detailed level. When programming a project, start with the functions in your application. Depending on the complexity, each function corresponds to one or more blocks. A project can contain both graphic and text blocks, and each block can contain static and dynamic objects. The blocks should be arranged in hierarchies to achieve a structured application, and to simplify procedures for the machine operator. The application can also be organized as a sequence control.

The application can be tested in full or in part prior to startup.

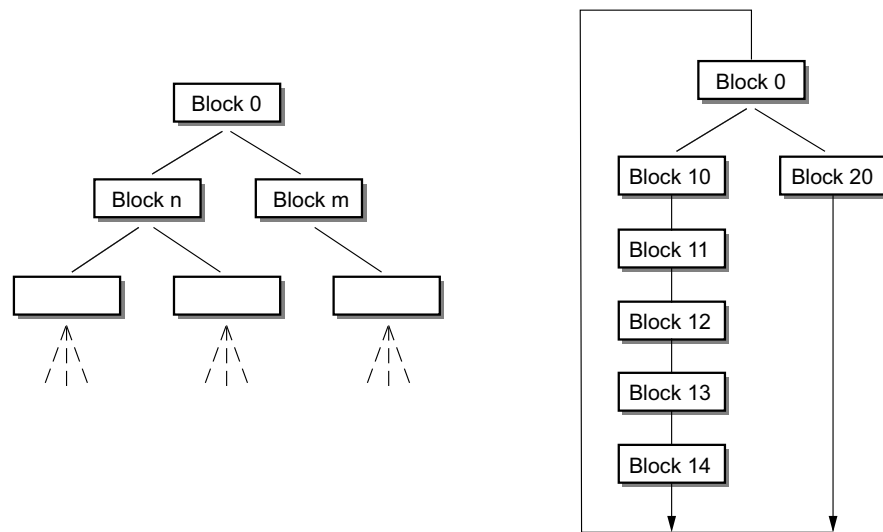

53375AXX

Figure 17: Block structure

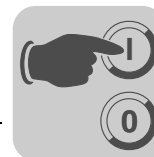

**Effective communication**

Read the following notes on signal transmission and optimization to ensure fast and effective communication between terminal and controller.

**Signals that influence the communication time**

Only signals for objects in the current block are read continuously. These include dynamic object signals. Signals for objects in other blocks will not be read. The number of blocks does not affect the communication time.

In addition to signals for objects in the current block, the terminal continuously receives the following signals from the controller:

- Display signals (block header)
- Block print signals (block header)
- LED register
- Alarm signals
- External confirmation signals for alarms and alarm groups
- Login signal (password)
- Logout signal (password)
- Trend curve register
- Register for column objects when min. / max. indicators are used
- New display register
- Buzzer register
- Backlighting signal
- Cursor control block
- Recipe control block
- Library index register
- Index register
- Register for PLC clock if it is used in terminal
- List erase signal (alarm settings)
- No protocol mode control register
- No protocol signal

**Signals that do not influence the communication time**

The following signals do not affect the communication time:

- Signals for function keys
- Time channels
- Objects in alarm texts



#### Optimize communication

##### *Grouping controller signals*

The signals from the controller (see list on page 63) are read fastest if they are bundled into one group, such as: If you have defined 100 signals you will reach the highest reading speed by grouping them (e. g. H0-H99). If the signal transfer takes place in individual steps (e.g. P104, H17, H45, etc.), then the update will take longer.

#### Effective block change

You will reach an optimum block change by using the block jump function of the function keys or by using jump objects. The display signal in the block header may only be used if the controller wants to enforce the opening of another block. If the controller is to change the display, you can use the new display register. This option affects the communication less then a larger number of display signals.

#### Signal packages

Transfer of signals between terminal and controller does not take place for all data at the same time. Instead, the information is separated into packages that each contain several signals. The number of signals in each package depends on the selected driver.

The number of packages must be kept to a minimum to speed up the communication. Grouped signals only require a minimum number of packages. Such programming is not possible in all cases. In such cases, there are spaces between two signals. A space represents the maximum distance between two signals that are part of the same package. The size of the space depends on the selected driver.

Signal	1	2	3	4	5	6	7	8	9	10
Use	X	X					X	X	X	

Space

53572AEN

#### User interface

Use graphic blocks for the user interface.

Text blocks are mainly for the printout of reports. They are slower and require more memory than graphic blocks.

Use 3D effects for an appealing user interface.

You can achieve an impressive visual design by combining objects with frames and 3D rectangles. Such a design simulates light incidence from top left. This creates shadow effects at the lower and right sides of raised objects as well as on the upper and left sides of lowered objects.





**Menu structure**

The terminal is divided into two operating modes: *configuration mode* and *run mode*. Each mode offers a number of different levels, depending on the function. Each level consists of a menu where you make a selection or enter parameters before going to the next level (menu).

An application is made up of blocks, graphic blocks and / or text blocks (primarily for report printouts). Values from the controller are shown and changed in the blocks. The programmer assigns each block a number between 0 and 989. Blocks 990-999 are reserved for special purposes. These are known as system blocks. The terminal is object oriented, which means that a block can contain all the signals linked to an object for the control and monitoring of, for example, a pump.

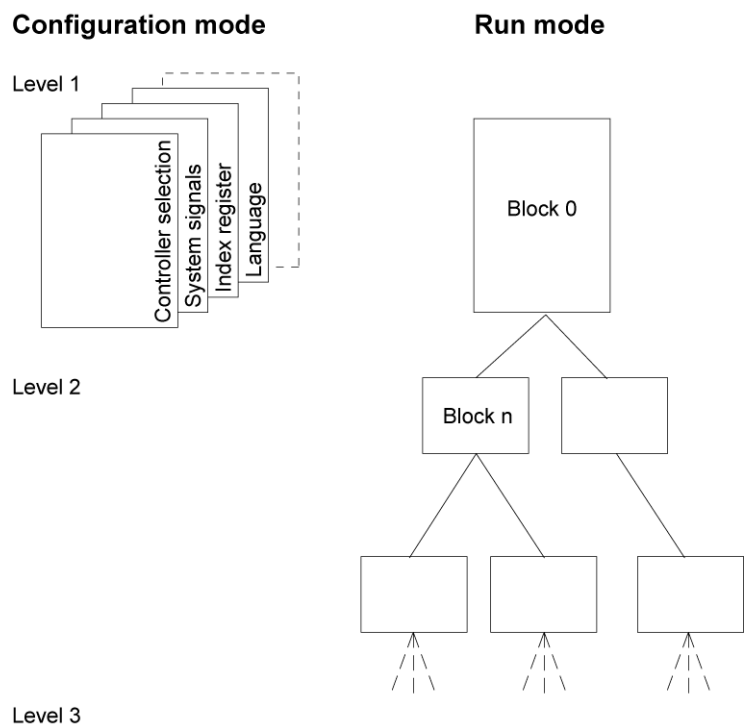

53376AEN

Figure 18: Configuration mode and run mode



#### Blocks

A block header is defined for each block. The header contains the block number, block type, status word, etc. The following functions can also be called as blocks:

- Alarms
- Time channels
- System monitor
- E-mail
- Contrast settings

These are known as system blocks. You can define up to 990 blocks.



#### NOTE

The block type cannot be changed for a defined block.

#### Signal formats

The following signal formats are available in the dialog for each object, provided that the selected driver supports the signal format.

Format type	Area
Signed 16-bit	-32768 ... +32767
Unsigned 16-bit	0 ... +65535
Signed 32-bit	-2147483648 ... +2147483647
Unsigned 32-bit	0 ... +4294967295
Floating-point number with exponent, 32-bit	$\pm 3.4E38$ , a number larger than 1000000 is shown with exponent (not with MOVILINK <sup>®</sup> driver).
Floating-point number without exponent, 32-bit	Parameter positions (including decimal point and characters) and decimals indicate the available area. For example, 8 positions and 3 decimals result in $\pm 999.999$ (not with MOVILINK <sup>®</sup> driver).
BCD floating point number	0 ... 9999.9999 (not with MOVILINK <sup>®</sup> driver)
BCD 16-bit	0 ... 9999 (not with MOVILINK <sup>®</sup> driver)
BCD 32-bit	0 ... 99999999 (not with MOVILINK <sup>®</sup> driver)
HEX 16-bit	0 ... FFFF
HEX 32-bit	0 ... FFFF FFFF
Seconds 16-bit	Analog numerical object that can be displayed in the time format. Syntax: <Hours:Minutes:Seconds> (not with MOVILINK <sup>®</sup> driver).
Seconds 32-bit	Analog numerical object that can be displayed in the time format. Syntax: <Hours:Minutes:Seconds> (not with MOVILINK <sup>®</sup> driver).
Character string	Character string that can be used in the [Dynamic for graphic objects] function in models DOP11B-20 to DOP11B-50. Example: In the objects Static symbol, Digital symbol and Multiple symbol, the dynamic property Symbol can be linked to a register with the Character string format.
16-bit array	Table format that can be used for an event in a dynamic function for graphic objects in models DOP11B-20 to DOP11B-50. Example: A group of registers is to be allocated different values when the value entered is equal to 99. The first value in the Value field will then be entered in register D21 in the field Signal. If the Value field appears as follows <1,2,3,4>, the value 2 will be entered in the next register (D22), etc.

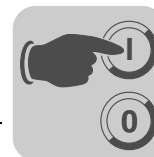

### 7.1.2 Installing the HMI-Builder

#### **Programming software**

The HMI-Builder programming software can be used to create projects for operator terminals in the DOP11B series. The functions in the HMI-Builder depend on the selected terminal.

We recommend using a mouse as the input device for the programming software. Refer to the Windows User's Guide for information on key combinations.

In the programming software, a project is created with graphic blocks and text blocks, which are then transferred to the operator terminal.

An online help is available for all functions. To call up the help text for each function, press the <F1> key. Information on the function is shown by pressing the help button in the toolbox and then clicking on a function.

#### **System prerequisites**

The configuration software runs on a PC with a minimum of 100 MB free memory and Microsoft Windows 2000 / XP Professional. The software can be used with a color or monochrome monitor screen. Microsoft Internet Explorer Version 5.0 upwards must be installed.

#### **Installing HMI-Builder**

The programming software is supplied on a CD. When you place the CD in your CD ROM drive the installation should start automatically. If it doesn't, select [Run] in the Start menu and enter the command D:/setup.exe (where D stands for the CD ROM drive). Install the programming software by clicking on the name and following the instructions.

The installation wizard creates an icon for the programming software in the program group of the programming software. To start the programming software, click on [Start] and select [Programs] / [Drive Operator Panels DOP] / [HMI-Builder]. The manual can be read directly from the CD by clicking on [Manuals].



#### Menu

The menu bar contains a number of drop-down menus.

Menu	Description
File	Contains functions that affect the entire project.
Edit	Includes the following functions: <ul style="list-style-type: none"> <li>• Cut</li> <li>• Copy</li> <li>• Paste</li> </ul>
View	The following menus can be called up: <ul style="list-style-type: none"> <li>• Block manager</li> <li>• Alarm management</li> <li>• Symbol manager</li> </ul>
Functions	In this menu you can configure the function keys, LEDs, passwords and macros. Alarm texts are entered and alarm groups are defined in this menu as well.
Setup	Here you set the basic configuration for the terminal.
Object	Is only available in the managers and holds all objects. The objects are also included in the toolbox.
Layout	Is only available in graphic block manager and includes functions for positioning objects in graphic blocks.
Block manager	Settings for visual representation of block manager
Transfer	The functions in the Transfer menu are used to transfer projects between the programming software and the terminal.
Window	Contains all general Windows functions. You can also make grid settings and define the search path to external programs, such as Paintbrush.
Help	Contains the help functions for the program.

#### Status bar

The status bar is located at the bottom of the HMI-Builder program window. In the [View] menu there is a function to show / hide the status bar.

The left part of the status bar describes the menu function selected in the menu. A short description of the function the cursor points to is shown for the functions in the toolbox.

The right part of the status bar indicates which of the following keys are activated:

**OVR** Overwrite (Paste key)

**CAP** Caps Lock

**NUM** Num Lock

Coordinates (line and column) in the block manager are also shown.



Figure 19: Status bar

53108AXX



## 7.2 Communication with MOVIDRIVE® and MOVITRAC®

This section describes the communication between operator terminals and frequency inverters MOVIDRIVE® and MOVITRAC®.

There is also an explanation of how parameters and variables can be addressed and read. Constellations with more than one inverter connected via RS-485 are also described.

### 7.2.1 Serial connection between operator terminal and inverter

Connect the inverter to the operator terminal as described in section 4.

Use the PCS11B cable to connect the PC to the operator terminal. The operator terminal is programmed via this cable.

#### **PCS11B programming cable**

Connection cable between operator terminal and PC for programming the operator terminal.

Fixed length of 3 m.

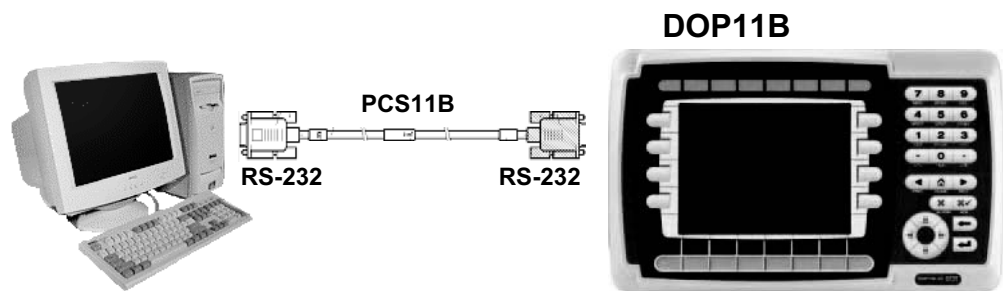

Figure 20: PCS11B programming cable

60060AXX



### 7.2.2 Communication settings in the HMI-Builder

#### Setting up communication between operator terminal and inverter

The settings for communication between the operator terminal and inverter are made in the HMI-Builder under [Setup] / [Peripherals].

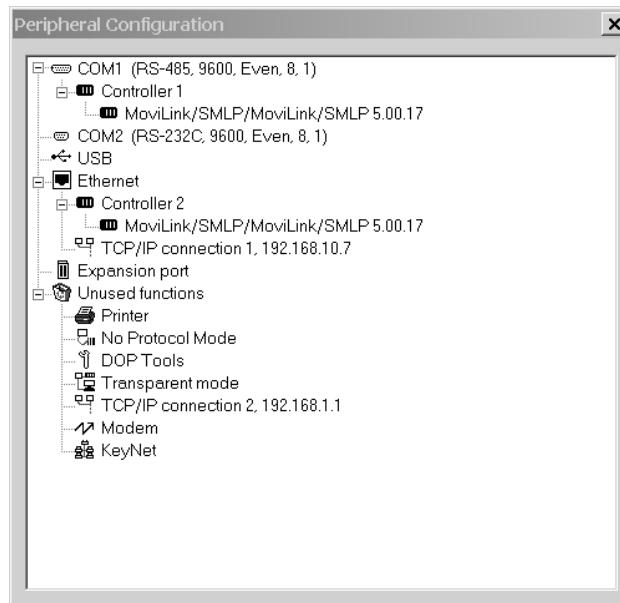

12077AEN

Figure 21: Communication settings

To change the communication port, select [Controller 1] (or [Controller 2]), press and hold down the left mouse button and drag the controller to the other communication port.

To enter communication parameters, press the right mouse button.



#### NOTE

The settings must correspond with the physical structure.



**MOVILINK® / SMLP driver (serial / ETHERNET)**

Settings

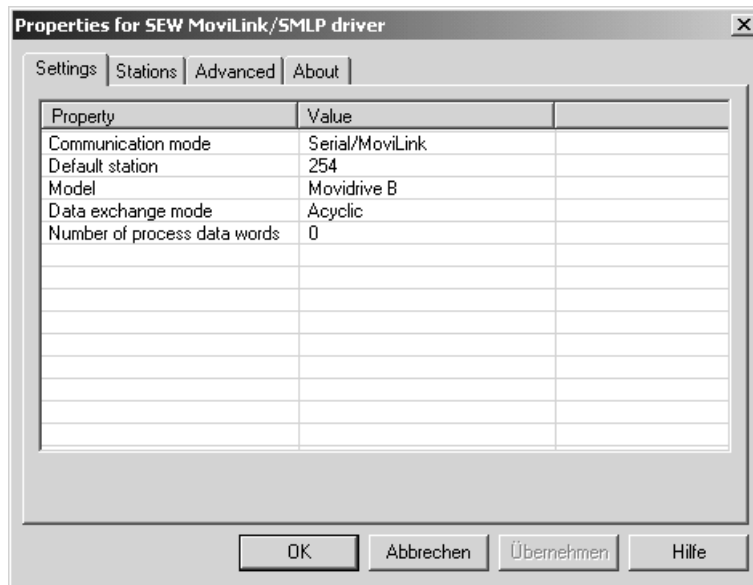

12068AXX

Figure 22: Properties for MOVILINK® / SMLP driver, Settings

Parameters	Description								
Communication mode	Specifies whether there is a serial or ETHERNET connection.								
Default station	<p>This address is always used if no other address is specified when defining the communication objects.</p> <p>Meaning when using the "ETHERNET/SMLP" communication mode: In ETHERNET communication mode, this number refers to the IP addresses defined under "Stations". To avoid communication errors, only use stations that have been defined.</p> <p>Meaning when using the "Serial/MOVILINK" communication mode:</p> <table border="1"> <tr> <td>0 – 99</td> <td>Individual inverter addresses</td> </tr> <tr> <td>100 – 199</td> <td>Group addresses</td> </tr> <tr> <td>254</td> <td>Peer-to-peer communication This address must not be used when several inverters are connected to the operator terminal.</td> </tr> <tr> <td>255</td> <td>Broadcast address All inverters connected to the RS-485 bus receive data but do not send a response to the operator terminal.</td> </tr> </table>	0 – 99	Individual inverter addresses	100 – 199	Group addresses	254	Peer-to-peer communication This address must not be used when several inverters are connected to the operator terminal.	255	Broadcast address All inverters connected to the RS-485 bus receive data but do not send a response to the operator terminal.
0 – 99	Individual inverter addresses								
100 – 199	Group addresses								
254	Peer-to-peer communication This address must not be used when several inverters are connected to the operator terminal.								
255	Broadcast address All inverters connected to the RS-485 bus receive data but do not send a response to the operator terminal.								
Model	Defines which inverter type is connected.								
Data exchange mode	Used to select cyclic or acyclic communication for the PDU type. This function is only available in the "Serial/MOVILINK" communication mode.								
Number of process data words	Defines the length of the telegram. 8-byte parameter channel and 0 – 3 process data words. This function is only available in the "Serial/MOVILINK" communication mode.								



Standard settings for using the "Serial/MOVILINK" communication mode:

Parameters	Description
Port	COM1, RS-485 COM2, RS-232 (with UWS11A)
Baud	9600
Data bits	8
Stop bits	1
Parity	Even

### Stations

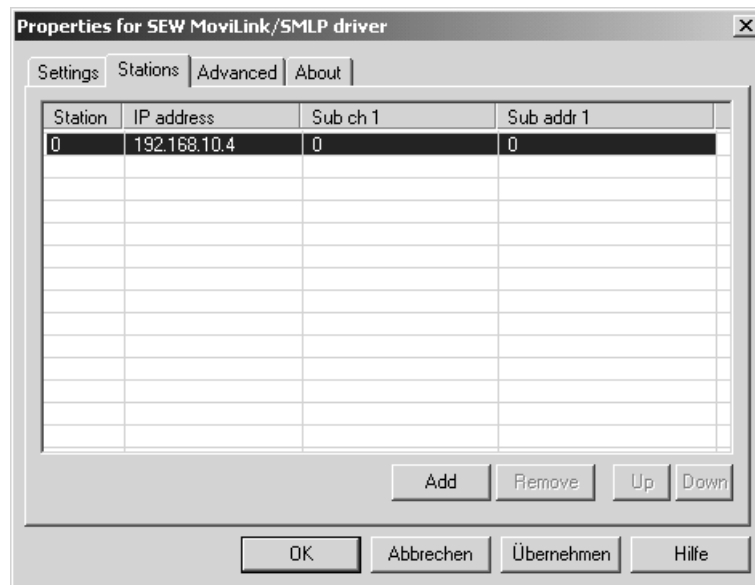

12069AXX

Figure 23: Properties for MOVILINK® / SMLP driver, Stations

Parameters	Description
Station	Station number via which the TCP/IP addresses can be addressed conveniently.
IP address	IP address During startup, the operator terminal establishes a connection to each IP address entered here.
Sub ch 1	Activates the routing to the subordinate bus system specified here, e.g. from fieldbus gateway DFE33B / UOH11B to the SBus. For information on the available subordinate bus systems, refer to the documentation of the respective device (gateway).
Sub add 1	Address of the inverters in the subordinate bus system.



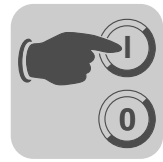

Standard settings for using the "Serial/MOVILINK" communication mode:

Parameters	Description
Port	COM1, RS-485 COM2, RS-232 (with UWS11A)
Baud	9600
Data bits	8
Stop bits	1
Parity	Even

Advanced

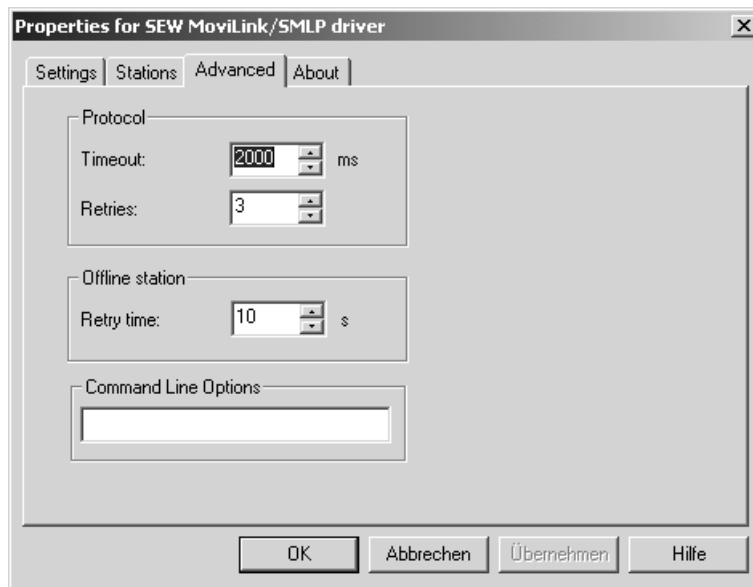

12070AXX

Figure 24: Properties for MOVILINK® / SMLP driver, Advanced

Parameters	Description
Timeout	Time in [ms] for repeat transmission.
Retries	Number of retries until a communication error is displayed.
Retry time	Wait time in [s] until a communication error is reset. Another attempt will be made to reestablish communication once this time has elapsed.
Command line options	No function.



Standard settings for using the "Serial/MOVILINK" communication mode:

Parameters	Description
Port	COM1, RS-485 COM2, RS-232 (with UWS11A)
Baud	9600
Data bits	8
Stop bits	1
Parity	Even

### Transparent mode

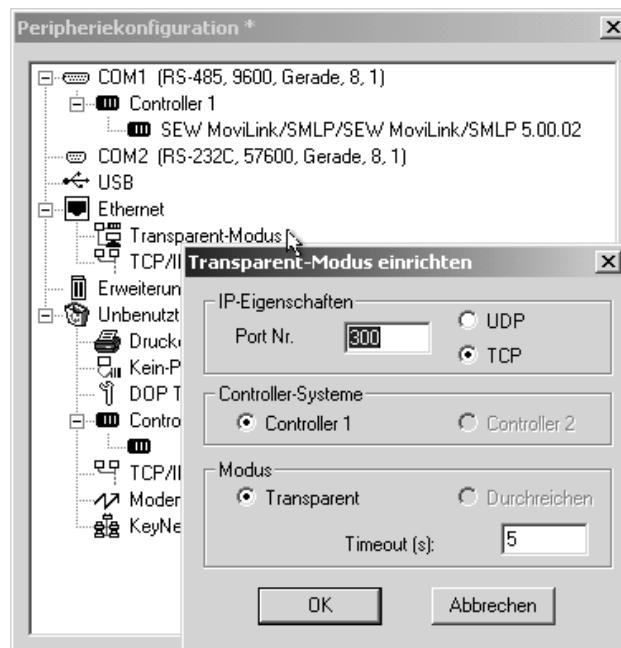

12071AXX

Figure 25: Properties for MOVILINK® / SMLP driver, Transparent mode

The driver supports a special transparent mode exclusive to the SEW driver.

If the driver is configured for serial communication and the transparent mode port is configured for the ETHERNET port with TCP and port number 300, special routing behavior is activated. This enables MOVITOOLS® MotionStudio to use an ETHERNET query to detect both the DOP11B units and the SEW devices connected via the DOP11B units' serial port.

These devices can be addressed as an ETHERNET gateway in MOVITOOLS® MotionStudio via ETHERNET and the DOP11B units.

Transparent mode does not work in any other configuration.

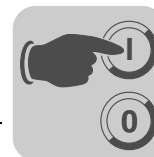

### 7.2.3 Addressing parameters and variables

#### Addressing

The MOVILINK® driver recognizes the following data formats:

P	For parameters (volatile writing)
NVP	For parameters (non-volatile writing)
X	For index (volatile writing)
NVX	For index (non-volatile writing)
H	For IPOS variables (volatile writing)
NVH	For IPOS variables (non-volatile writing)

Without the suffix NV, the data is written to the RAM of the inverter and is lost when the inverter is switched off.



#### NOTE

The suffix NV is required for non-volatile storage. In this case, the data is written to the EEPROM of the inverter. Note that only a limited number of write services can be executed on the EEPROM. Therefore, you should use the suffix NV carefully.

#### Digital data (bit-wise access)

Device	Minimum address	Maximum address	Comment
P <i>rr</i> . <i>bb</i>	P0.0	P999.31	Bit <i>bb</i> in register <i>rr</i>
NVP <i>rr</i> . <i>bb</i>	NVP0.0	NVP999.31	Bit <i>bb</i> in register
X <i>rr</i> . <i>bb</i>	X8192.0	X24575.31	Bit <i>bb</i> in register <i>rr</i>
NVX <i>rr</i> . <i>bb</i>	NVX8192.0	NVX24575.31	Bit <i>bb</i> in register <i>rr</i>
H <i>rr</i> . <i>bb</i>	H0.0	H511.31 (H1023.31 for MOVIDRIVE® B / H2048 for MOVI-PLC®)	Bit <i>bb</i> in register <i>rr</i>
NVH <i>rr</i> . <i>bb</i>	NVH0.0	NVH511.31 (NVH1023.31 for MOVIDRIVE® B / H2048 for MOVI-PLC®)	Bit <i>bb</i> in register <i>rr</i>

#### Analog signals

Device	Minimum address	Maximum address	Comment
P <i>rr</i>	P0	P999	Register <i>rr</i>
NVP <i>rr</i>	NVP0	NVP999	Register <i>rr</i>
X <i>rr</i>	X8192	X24575	Register <i>rr</i>
NVX <i>rr</i>	NVX8192	NVX24575	Register <i>rr</i>
H <i>rr</i>	H0	H511 (H1023 for MOVIDRIVE® B)	Register <i>rr</i>
NVH <i>rr</i>	NVH0	NVH511 (NVH1023 for MOVIDRIVE® B)	Register <i>rr</i>



#### NOTE

All parameters, variables and indices are 32-bit values.



### Analog signals (partial access)

For a number of the inverter parameters, several pieces of information are stored in one parameter. This means parameters P10, P11 and P12 are coded via index 8310. You can use the following notation to partially evaluate these parameters:

- H100.0-15 Low word of IPOS variable H100
- H100.16-32 High word of IPOS variable H100

Device	Minimum address	Maximum address	Comment
P rr . a-b	P0.0-1	P999.0-31	P rr . a-b a = Start bit b = Stop bit  <b>Example</b> H 100 . 7-14 Data is read from bit 7 up to and including bit 14.
NVP rr . a-b	NVP0.0-1	NVP999.0-31	
X rr . a-b	X8192.0-1	X24575.0-31	
NVX rr . a-b	NVX8192.0-1	NVX24575.0-31	
H rr . a-b	H0.0-1	H511.0-31 (H1023.0-31 for MOVIDRIVE® B)	
NVH rr . a-b	NVH0.0-1	NVH511.0-31 (NVH1023.0-31 for MOVIDRIVE® B)	

### Subindex

The subindex can only be used in conjunction with the index (X and NVX).

The notation is as follows: X8192/1, where 1 indicates access to subindex 1.

Other examples:

2:X8192/23.31 Address 2, index 8192, subindex 23, bit 31

7:X8192/9.0-15 Address 7, index 8192, subindex 9, bit 0 to bit15

### Communication with inverters in the RS-485 network

The following notation is used for addressing inverters with a defined RS-485 address:

#### Example

Default station RS-485 address 254 (peer-to-peer). Only to be used if only one inverter is connected to the operator terminal.

P100	Communication with parameter P100. The address that was entered in the [Default station] input field when configuring the driver is used as communication address.
2:P100	Communication with parameter P100 of the inverter with address 2
4:H102	Communication with IPOS variable H102 of the inverter with address 4

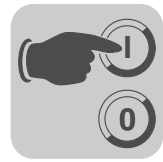

**Communication with inverters connected in the ETHERNET network**

While the operator terminal is starting up, communication is established with all TCP/IP address entered in the driver configuration.

The address in line 0 is also used when no other address is specified.

The following notation is used for addressing inverters with a defined TCP/IP address:

Example:

TCP/IP address in line 0 is 10.12.234.4, port 300.

TCP/IP address in line 1 is 10.12.234.5, port 300.

TCP/IP address in line 2 is 10.12.234.6, port 300.

TCP/IP address in line 3 is 10.12.234.7, port 300.

P100	Communication with parameter P100. The address that was entered in input field [1] when configuring the driver is used as the communication address (10.12.234.4).
1:P100	Communication with parameter P100 of the inverter with address 2 (10.12.234.5).
3:H102	Communication with IPOS variable H102 of the inverter with address 4 (10.12.234.7).



#### Process data

The MOVILINK® driver can operate 1 to 3 process data items per inverter depending on the setting.

A distinction is made between process output data (PO data from the PLC to the inverter) and process input data (PI data from the inverter to the PLC).

The number of process data items is set in the MOVILINK® driver *Dialog*. The inverter parameter P90 PD configuration must have the same value.

#### Bit-wise access to process data

Device	Minimum address	Maximum address	Comment
PO <i>rr</i> . <i>bb</i>	PO1.0	PO3.15	Bit <i>bb</i> in register <i>rr</i>
PI <i>rr</i> . <i>bb</i>	PI1.0	PI3.15	Bit <i>bb</i> in register

#### Word-by-word access to process data (16-bit)

Device	Minimum address	Maximum address	Comment
PO <i>rr</i>	PO1	PO3	Register <i>rr</i>
PI <i>rr</i>	PI1	PI3	Register <i>rr</i>



#### NOTE

The "ETHERNET/SMLP" communication mode does not support process data.



**Indexed communication with inverters in the RS-485 network**

In addition to directly specifying the RS-485 address, communication can also be performed via index. This means the RS-485 address is stored in a variable of the operator terminal and can be set by the operator.

This function is also available with the SMLP driver. In this case, the IP station is addressed instead of the RS-485- address.

**Example**

A project is created in which the operator can enter the RS-485 address of the inverter. This has the advantage that you do not have to know the actual address of the inverter when creating the DOP project. The user can enter and specify the address during system operation.

The actual speed of a drive should be indexed. The actual speed is displayed in parameter P000.

1. In the HMI-Builder under [View] / [Name list], define register D4096 (internal variables) in which the RS-485 address of the inverter to be addressed will be stored and define Parameter P000 as the symbolic name for the actual speed:

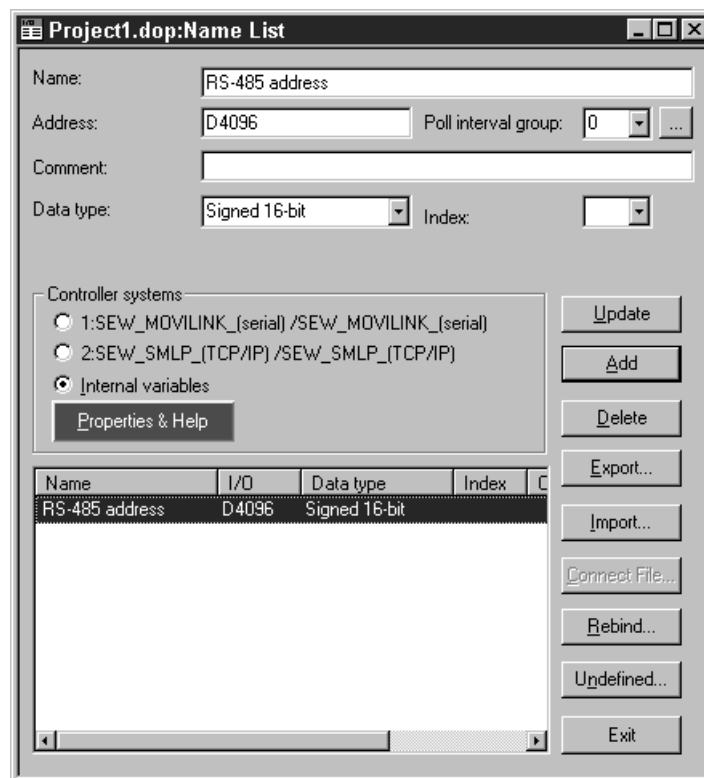

11494AEN



- Under [Setup] / [Index registers], link the pointer index register 1 to the variable D4096:

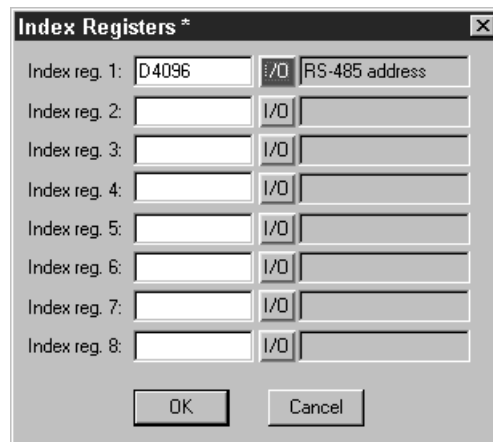

11495AEN

- Define the analog numeric object **Q3** to enable the user to enter the RS-485 address. Link this object to variable D4096 and select the 'Enable operator input' checkbox on the [Access] tab page.

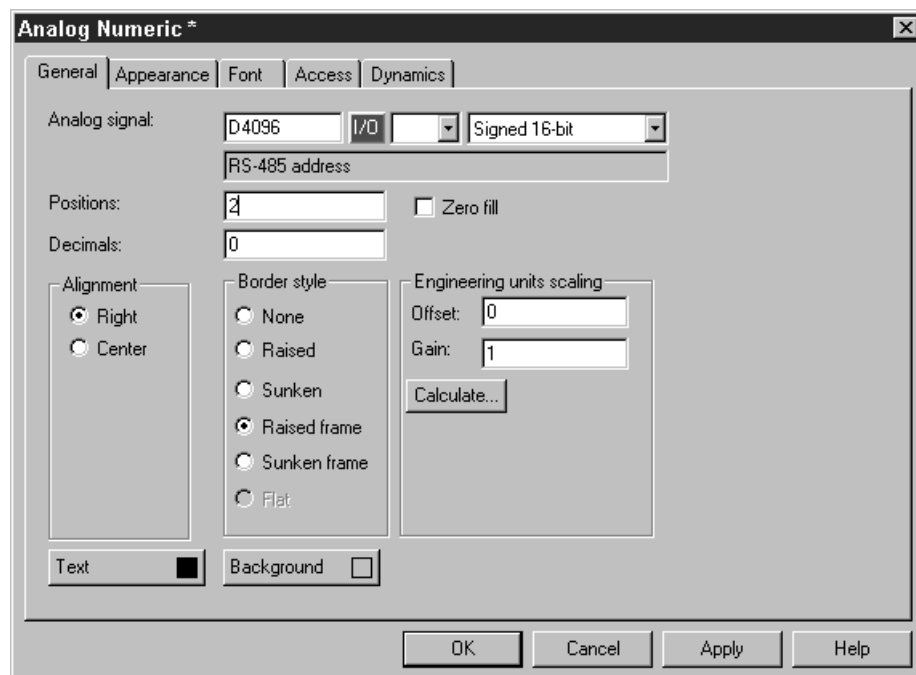

11496AEN



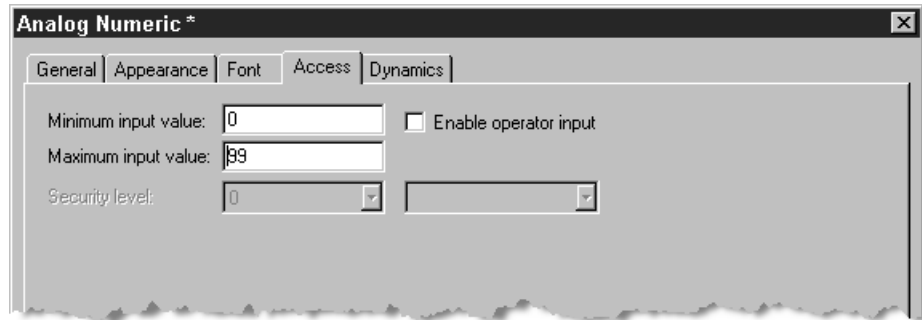

11497AEN

Note the minimum and maximum input values.

- Define another analog numeric object **03** to display the actual speed. Link this object with parameter P000 and enter the necessary scaling (0.001 in the example). The pointer I1 is now handled as a preset RS-485 address: I1:P000.

This ensures that the inverter address stored in the target of pointer I1 is the one that is addressed.

Enter a gain of 0.001 to display the actual speed in the unit [1/min].

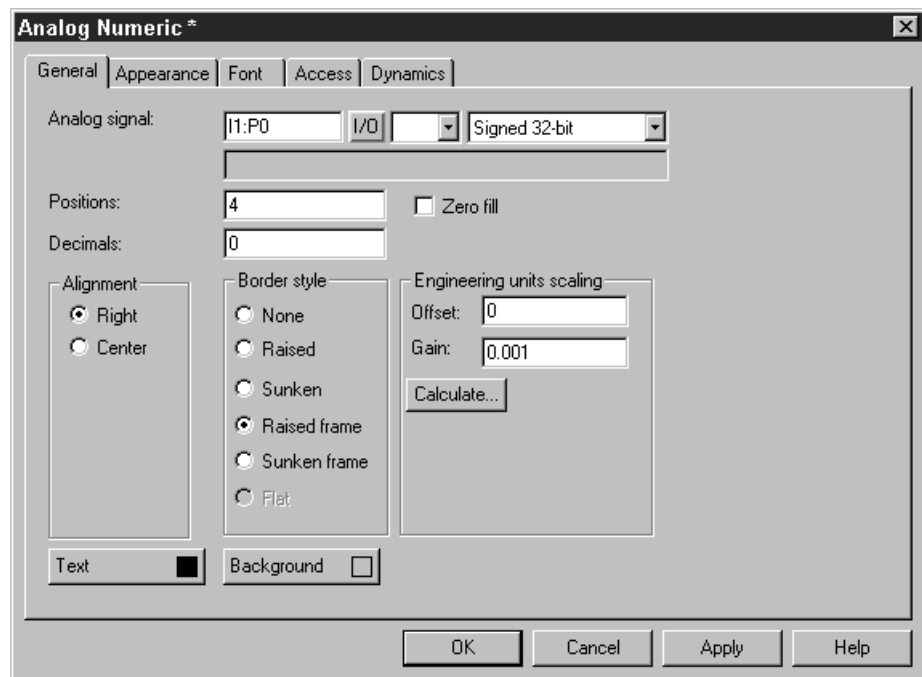

11498AEN



### 7.3 Internal variables

Internal variables are selected and used just like drivers. A series of volatile and non-volatile user-defined variables are available for selection. If a value is changed, the non-volatile variables are stored in the Flash memory. You can import them again the next time you start the unit. System variables cannot be changed. They are used to display query intervals and to switch functions. To access the window below, click in the I/O browser on [Properties & Help] or select [Functions] / [I/O configuration] / [Internal variables]

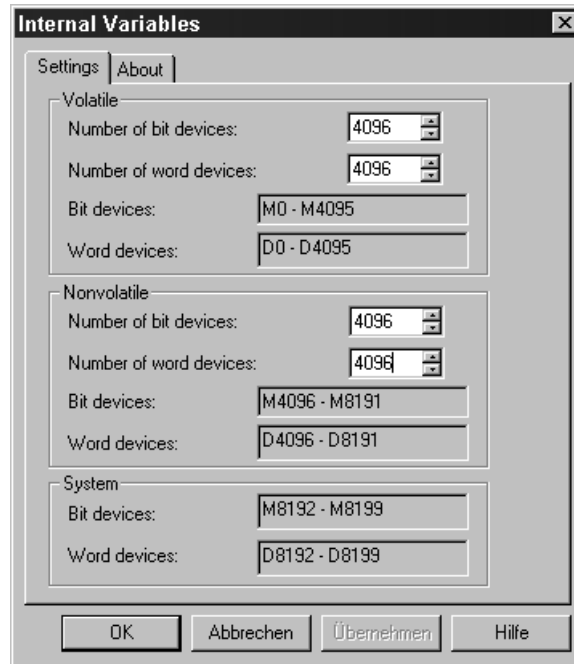

11605AXX

Variable type	Address range, bit	Address range, memory cell
Volatile	M0 ... M4095	D0 ... D4095
Non volatile	M4096 ... M8191	D4096 ... D8191
System	M8192 ... M8199	D8192 ... D8199



The system variables are assigned as follows:

Bit	Description
M8192	Always ON
M8193	Switches between OFF and ON every second
M8194	Switches between OFF and ON every 500 ms
M8195	Switches between OFF and ON every 200 ms
M8196	Communication error bit for driver 1. Value "0" indicates a communication error. Does not apply to slave drivers.
M8197	Communication error bit for driver 2. Value "0" indicates a communication error. Does not apply to slave drivers.
M8198 – M8199	Not assigned.

Memory cell	Description
D8192	Driver query interval 1 (ms)
D8193	Driver query interval 2 (ms)
D8195 ... D8199	Not used

## 7.4 Programming with the programming software

### 7.4.1 Starting the HMI-Builder

Click on [Start] / [Programs] / [Drive Operator Panels DOP] / [HMI-Builder] / [HMI-Builder].

The following menus are available to start the HMI-Builder without loading a project:

- File
- View
- Settings
- Help

Once you have created a project, all menus are available for selection.

File Edit View Functions Setup Project Transfer Window Help

11499AEN

### 7.4.2 Choosing a language

Choose the language for the user interface (including menu texts, object names, etc.) under [Settings] / [Menu language]. It is assumed in this manual that you have chosen *English*.



#### 7.4.3 Creating a project

To create a new project, select [File] / [New]. In the [Project properties] dialog box, you can select [Operator terminal], [Controller systems] and [Color scheme]. Not all options are available for all terminals. To create a new project, click on [OK].

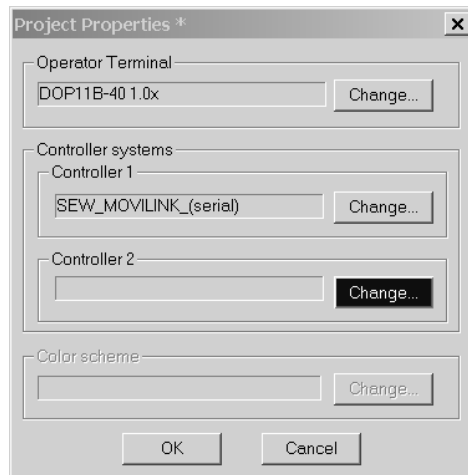

12072AEN

Figure 26: Project properties

#### Terminal

Click on [Change].

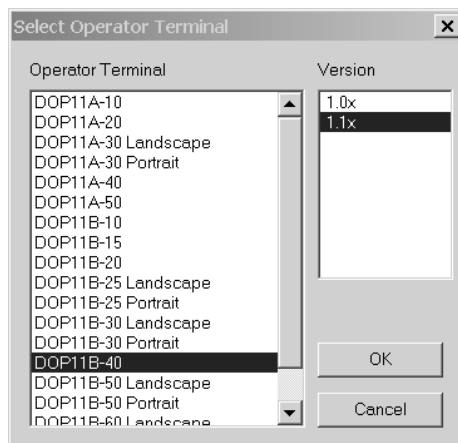

12073AEN

Figure 27: Select an operator terminal

Select a terminal and the version (system program) of the selected terminal type.



**Controller**

Here you define the controller to which the operator terminal will be connected. Clicking on the [Change] button opens the following dialog. The list shows all installed drivers. Select [Brand name] and [Protocol]. Click [OK] to confirm your selection. To cancel your selection, click [Cancel].

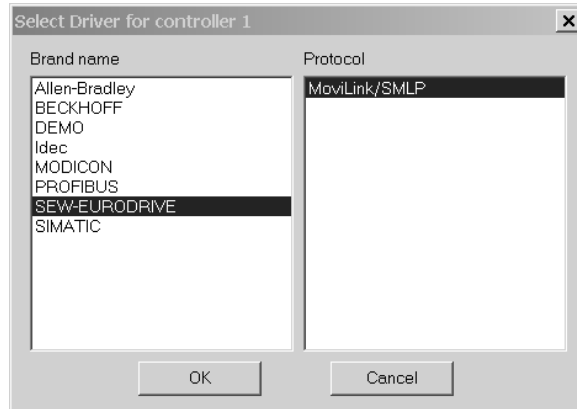

12074AEN

Figure 28: Controller

Two drivers can be used in a project (terminal). The driver for the second controller is selected in the same way as the first one.

For more detailed information on using two drivers in one terminal, refer to section "Communication with two controllers (two drivers)" on page 250.



#### 7.4.4 Updating drivers

**From the Internet** To update available drivers to the latest version or to install a new driver, select [File] / [Update terminal driver] / [Internet].

Close all projects before using this function. The computer must be connected to the Internet. A web browser is not required. After the connection is established, a list with all drivers that can be downloaded from the Internet will be displayed.

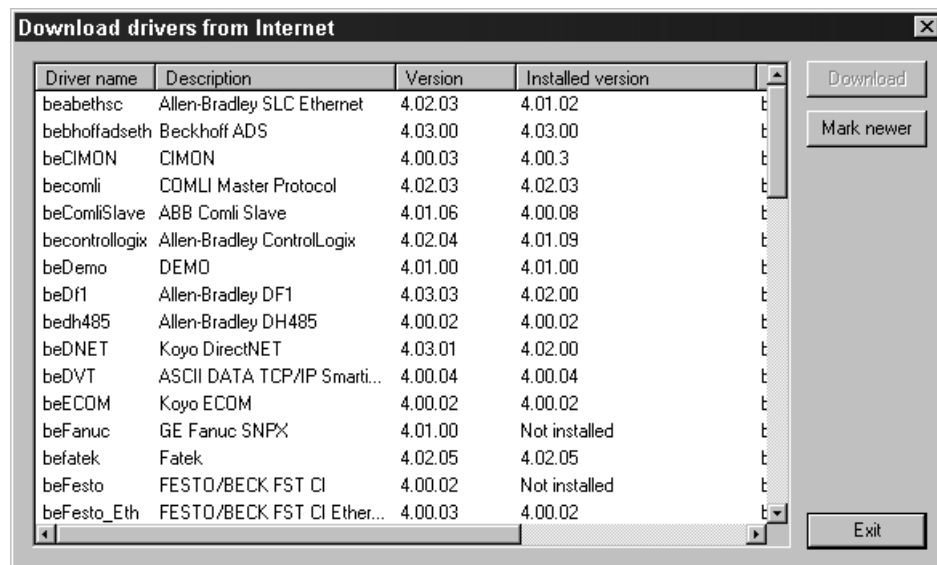

11503AXX

Figure 29: Downloading a driver from the Internet

The list shows the version numbers of available and already installed drivers. Select the driver(s) to be installed in the HMI-Builder. The function [Mark newer] highlights all drivers of a higher version that are not installed. Next, click [Download]. Each driver file size is about 500 kB and is ready to use directly after download.

#### From disk

To update existing drivers to the most recent version or install a new driver from a file, use the function [File] / [Update terminal driver] / [From data medium] in the HMI-Builder. Close all projects before you use this function. Open the uncompressed MPD file in the driver directory. A list opens with all drivers that can be installed.

The list shows the version numbers of available and already installed drivers. Select the driver(s) to be installed in the HMI-Builder. To continue, click [Install]. Once the installation is complete, click on [Close] to return to the HMI-Builder.



#### 7.4.5 Changing project settings

The selected terminal or controller can be changed for a project. To do so, choose [Project] / [Properties...] from the menu and click [Change] next to the parameter *Terminal* and/or *Controller*.

##### **Changing the terminal**

When updating the system program in the terminal, the terminal version must be adjusted accordingly in the [Project properties] menu. Otherwise, the scope of functions provided by the new terminal version will not be available.

##### **Changing the controller**

If you exchange the controller in a project for another controller with different signal names, then you also have to make a change for these signals. Use the internal name list for this purpose. See the section "Name list" on page 116.

1. Select [View] / [Name list] from the menu.
2. Click the [Undefined] button to add all I/Os used in the project to the name list.
3. Click [Export] to output the name list as a text file. Enter a name and click on [Save]. Define a separator for the text file.
4. Open the text file with an editor, such as Wordpad.
5. Change all I/Os into signals that will be used in the new controller. Save the file in a text format.
6. In the [Name list] dialog box, click the [Import] button and answer the question whether you are sure you want to delete all invalid I/Os with [No].
7. Click [Reconnect] to update all new I/Os in the project with the new name.
8. Select [Project] / [Properties...] from the menu and click [Change].
9. Select the new controller and double-click [OK].



#### Project manager

As soon as you create a project, the project manager is displayed with all the existing blocks and components. Click on the plus signs in the directory nodes to open the directories.

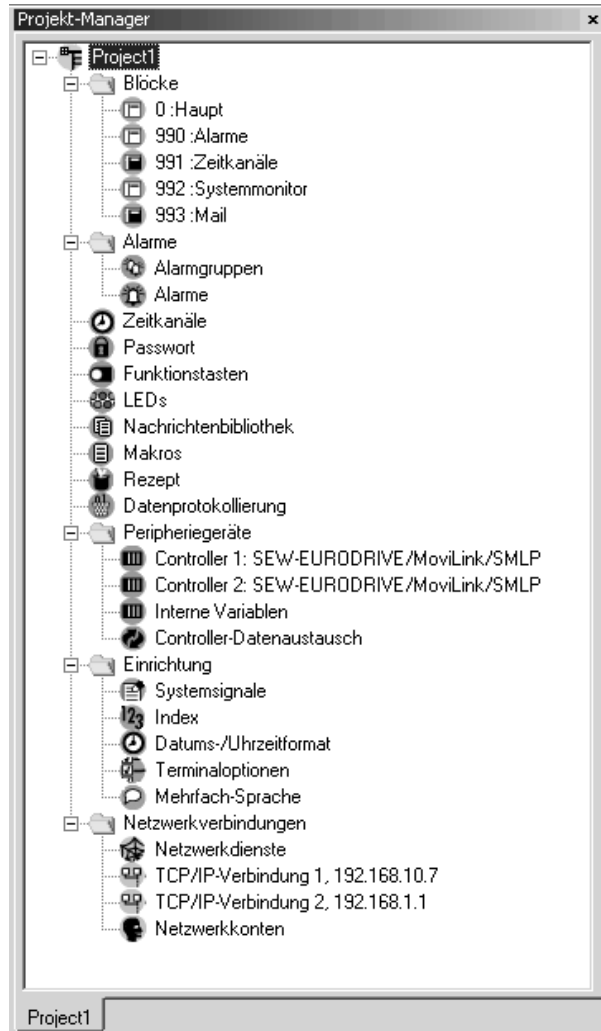

12075ADE

Figure 30: Project manager





7.4.6 Creating blocks with the block manager

Double-click on the directory [Blocks] to open the block manager. The block manager contains an overview of all the project blocks.

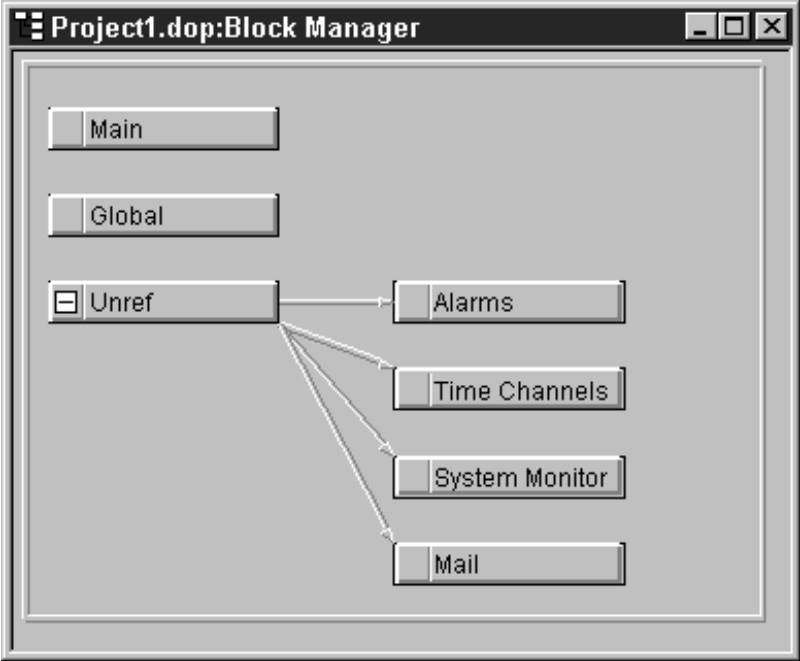

Figure 31: Creating blocks

10408AEN

When the block manager is displayed, the toolbars of the block manager and the zoom function are marked.

	<b>NOTE</b>
	The DOP11B-20 model does not have the [System monitor] block.



#### Defining blocks

Adding a block opens the following dialog box. The dialog box is a simplified representation of the complete block header. Click [OK] to open and display the created block.

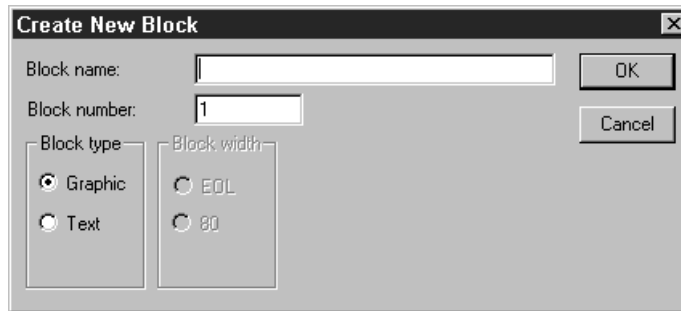

11505AEN

Figure 32: Creating a new block

Parameters	Description
Block name	You can enter a name for the block in this field. The block name will be displayed in the block manager and in the block list.
Block no.	The block number is specified in this field. If the number you enter is already assigned to a block, the defined values will appear automatically. Block 0 is automatically created at the start of the program and must exist in every project.
Block type	Select whether you want the block to be a graphic block or a text block.
Block width	Define the font size for a text block. The font size cannot be changed for a defined block.



**Block properties**

The [Block properties] menu contains basic parameters that apply to each individual block. The appearance of the block header depends on the selected block type. To define a complete block header, in the project manager or block manager click the right mouse button on a block and choose [Properties].

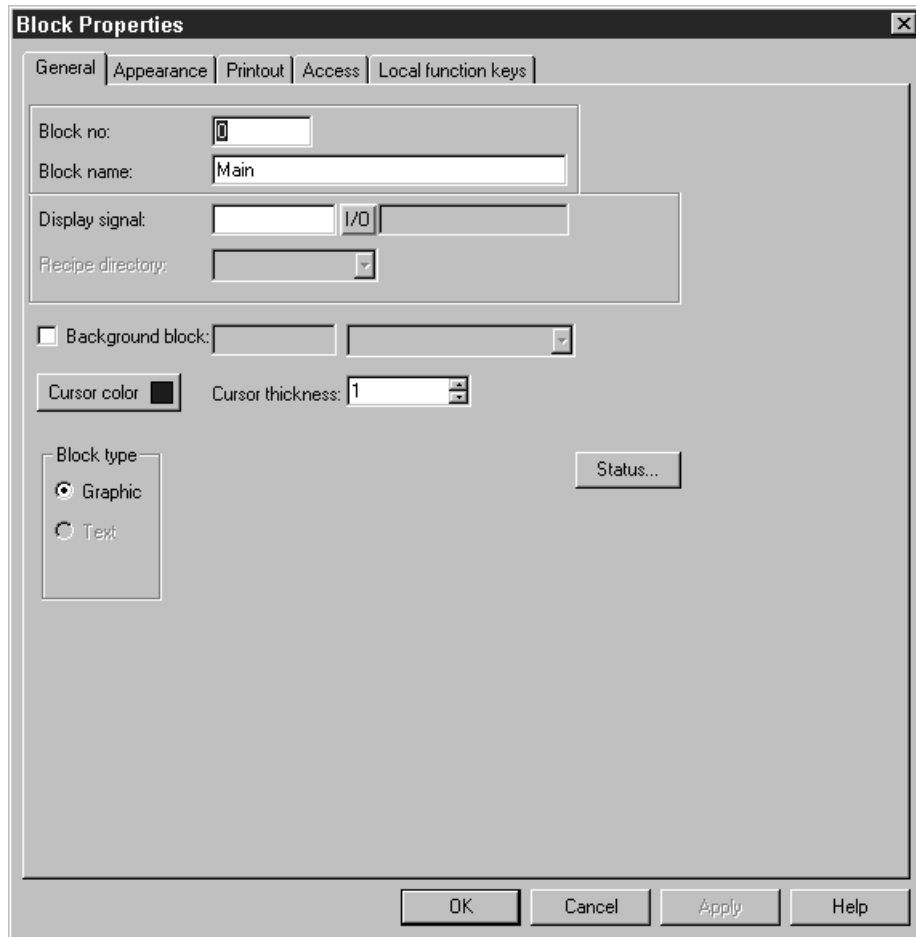

Figure 33: Block properties

11506AEN

In the project manager or the block manager, click the right mouse button on a block and choose [Properties] to enter detailed block information.



The terms used for defining the block header are explained below:

Tab page	Name	Description	
General information	Block number	The block number is specified in this field. If the number you enter is already assigned to a block, the defined values will appear automatically. Block number 0 is automatically created at the start and must exist in every project.	
	Block name	You can enter a name for the block in this field. The block name will be displayed in the block manager, in the project manager and in the block list.	
	Display signal	Digital signal that displays the selected block on the terminal screen. Use display signals in series to change blocks as quickly as possible. No entry is made in this field if you use another block changing method.	
	Recipe directory	Select a recipe directory where all recipes created in the block will be stored. See the section "Recipe management" on page 210.	
	Background block	Applies to graphic blocks only. You can select another block as the background block if, for example, several blocks are to be displayed with the same background color. When the graphic block manager is activated, you can define whether the background block is shown when editing the selected block using the [View] / [Options] / [Show background block] function.	
	Cursor color	Applies to graphic blocks only. Determines the color of the cursor in the operator terminal.	
	Cursor thickness	Applies to graphic blocks only. Determines the size of the cursor in the operator terminal.	
	Block type	The block type is defined when the block is created and cannot be changed here.	
	Status	When you click the [Status] button, the [Block options] dialog box is displayed. It shows the following status properties of the operator terminal screen. These properties do not affect the system blocks.	
		Parameters	Description
		Cursor off	Applies to text blocks only. Indicates whether the cursor is visible in the block in run mode.
		Place cursor on first manual object	Applies to text blocks only. Defines whether the cursor is to be positioned on the first maneuverable object in the block instead of in the top left hand corner.
		Deactivate <MAIN> key	Deactivates the <MAIN> key when the current block is displayed on the screen.
		Deactivate <LIST> key	Deactivates the <LIST> key when the current block is displayed on the screen.
Additional notes		Applies to text blocks only. Defines whether the [+] sign is to appear at the bottom and top right corner of the screen if the block contains more characters than can be displayed on the screen.	
Automatic data entry		Moves the cursor to the next maneuverable object after data has been entered. In this mode, the cursor can only point to maneuverable objects.	
Deactivate the <PREV> function key		Deactivates the <PREV> key and the function [Return to previous block] when the current block is displayed on the screen.	
Deactivate the <ENTER> function key	Only applies to digital objects. Deactivates the <ENTER> key when the current block is displayed on the screen.		



Tab page	Name	Description
Appearance		You can change the color and the color shading on the [Appearance] tab page.
Print	Print signal	Digital signal that sends the block to the connected printer. Display and print signals can be identical. Use print signals in series for fastest possible printing.
	End signal	Digital signal that is output by the terminal when the print process has been completed. The signal is enabled by default. Selecting the [Reset] option resets the signal when the print process has been completed.
E-mail		The [E-mail] tab page is only available for text blocks.
	Send e-mail signal	When the specified digital signal is enabled, the text block will be sent as an e-mail. The block name corresponds to the subject of the e-mail. Only text blocks can be sent as e-mail.
	E-mail end signal	Digital signal that is output by the operator terminal after an e-mail has been sent. The signal is enabled by default. Selecting the [Reset] option resets the signal when the e-mail has been sent.
	Send e-mail to address	The e-mail address of the recipient is entered in this field. Clicking the [...] button enables you to select up to eight recipients from a list. The address list is defined under [Setup] / [Network] / [Services] / [SMTP client]. See section "STMP client." on page 281.
	Append file	Enter the name of a trend or recipe file you want to attach to your mail. If a trend file and a recipe file have the same name, the trend file will be attached.
Access	Security level	Define the security level (0-8) for the block. If you enter a security level higher than "0", you will have to logon with a password that corresponds to the defined security level or higher.
Local function keys		You can define local function keys for the block on the [Local function keys] tab page. For more information, see the section "Function keys" on page 238.



### 7.4.7 Library

The library includes a series of catalogs with different symbol objects. You can also define catalogs created by the user. To do so, click the right mouse button on the library and choose [Directory] / [New].

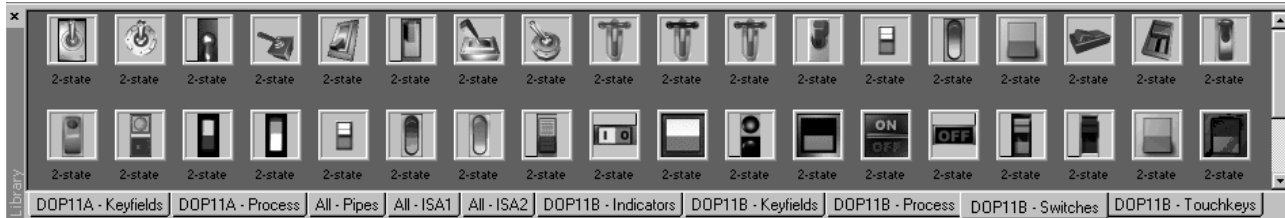

11507AEN

Figure 34: Library

Grouped objects and symbols can be saved in the library or in other projects. Objects and symbols stored in the library can be used again with other projects. Click the right mouse button on a grouped object or symbol in the work area, choose [Copy], click the right mouse button on the library and choose [Paste]. Library objects can be dragged from the library to the work area.

You can adjust the way the data is displayed by clicking the right mouse button on the library. To close the library catalog, click the right mouse button on the catalog and choose [Directory] / [Close].

You can hide the library by choosing [View] / [Toolbar] / [Library].

Symbol objects used in a project are stored in the project directory. These symbols can also be defined using the [Select symbol] dialog box.

#### ***Saving symbols in the library***

Use the cursor to select one or more objects (grouped or ungrouped) in the work area. Click with the right mouse button on the selection and choose [Copy]. Click the right mouse button in the library and choose [Paste].

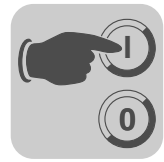

#### 7.4.8 Show terminal around the work area

The terminals have the menu entry [View] / [Options] / [Show terminal]. Selecting this option shows the current terminal around the work area of the active block. You can click on the function keys, LEDs and text fields of the terminal view.

##### **Defining function keys**

You can select whether you want to define a local or global function key by double-clicking a function key. The double-click opens the manager for the selected function. For further information on defining function keys, refer to the section "Function keys." on page 238.

##### **Defining LEDs**

Double-click an LED to open the manager for defining LEDs. For further information on defining LEDs, refer to the section "LEDs" on page 238.

##### **Creating text strips**

Double-clicking on a text strip field opens a dialog box where you can enter a text and define the orientation and font of a text. This function enables you to define text strips and print them out.



#### 7.4.9 I/O browser

When creating a local name list in your project, you can select I/O signals from this list when defining objects.

To do so, click on the [I/O] button. The [I/O] button is available in all fields in which an address can be entered. The [I/O browser] has an incremental search algorithm. This means a search is initiated by entering characters into the field for a name or signal. The I/O list is sorted by signals or names.

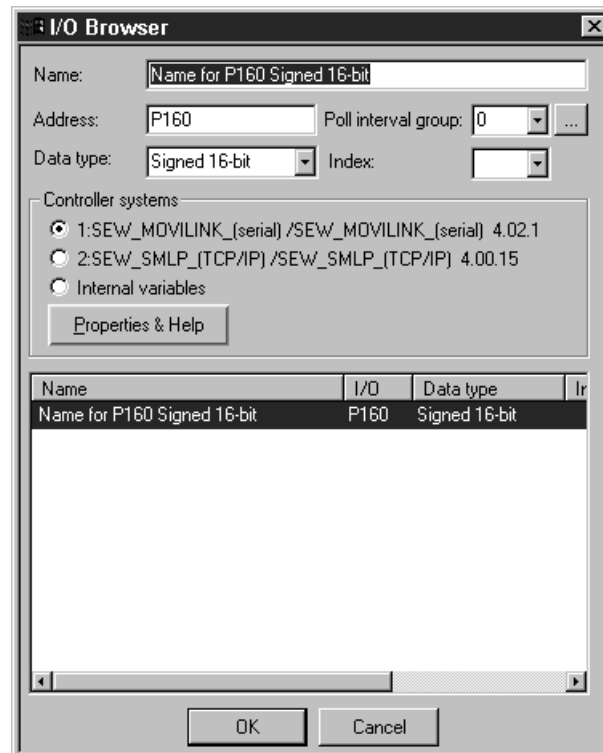

Figure 35: [I/O browser]

11508AEN





### 7.4.10 Programming blocks

Double-click the required block in the block manager. The double-click opens the work area for the block and the toolbox. The work area shows the graphic block or text block manager depending on whether you open a graphic block or a text block. The toolbox contains all objects that can be created in the block.

To select an object, click on the object in the toolbox and move the cursor to the position in the work area where you want to place the object. A mouse click activates the dialog box for the selected object. Enter the parameters into the dialog and click [OK]. The object now appears on the work area. Static text or graphics are displayed directly on the work area.

General object parameters are described in the section "Basics" on page 62 . Graphic and text objects are explained in the sections "Graphic display and control" (page 135) and "Text-based display and control" (page 180).

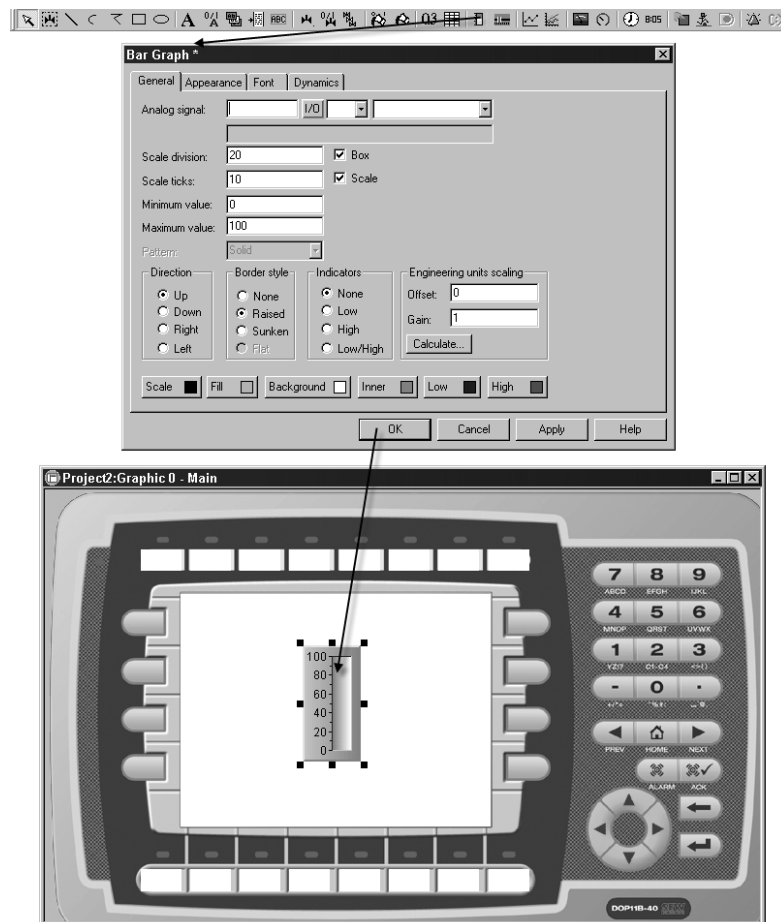

Figure 36: Programming blocks

11509AEN



### 7.4.11 Graphic block manager

This section describes the graphic block manager in the HMI-Builder. The method of operation and appearance are based on the Windows standard.

In the graphic block manager, graphic blocks are created using static and dynamic graphic elements.

#### **Opening the graphic block manager**

To open the [Graphic block manager] menu, double-click on a defined graphic block in the [block manager] or in the [Block list].

#### **Mouse, keys and cursor**

The following section explains what you can do with the mouse and keys in the graphic block manager and also explains the different cursor shapes.

#### **Use the mouse to perform the following actions:**

- Select objects from the toolbox
- Select objects by clicking on them
- Select several objects (by clicking next to the objects, keeping the left mouse button pressed down and drawing a selection rectangle around the required objects.)
- Move objects (by keeping the left mouse button pressed down while the cursor is positioned over an object and moving the mouse.)
- Resize object
- Open the parameter dialog box (by double-clicking on an object)

The figure below shows what a selected object looks like.

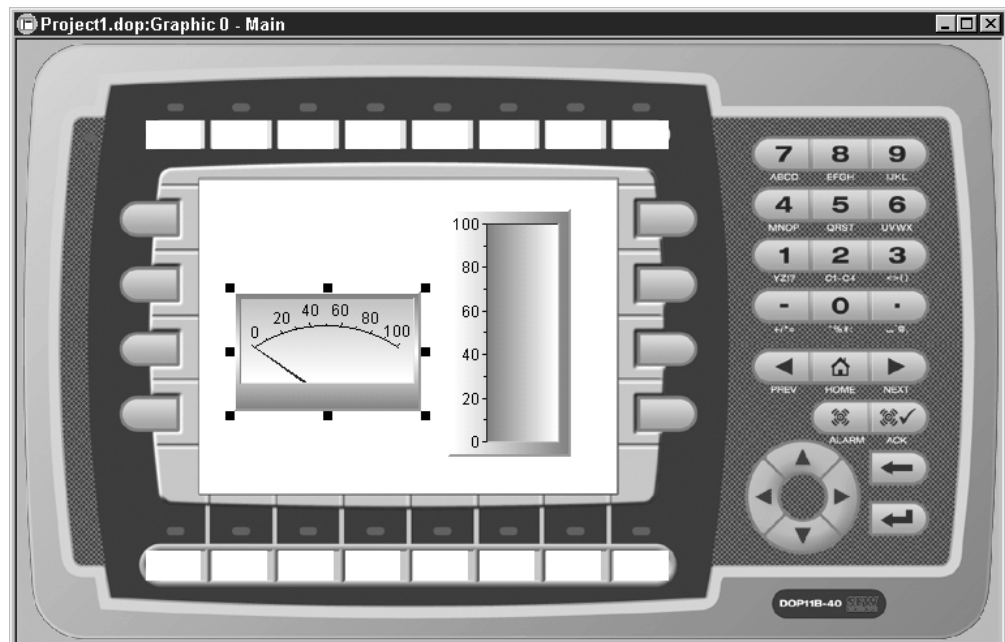

Figure 37: Selected object

11510AEN







**Use the keys to perform the following actions:**

- Create objects using the [Object] menu
- Use the arrow keys to move the cursor
- Move the cursor pixel-by-pixel (by pressing the key combination <Ctrl> + arrow key).
- Select or deselect an object (by positioning the cursor over the object and pressing the space bar)
- Select several objects (by selecting [Object] / [Pointer] from the menu and drawing a frame around the objects using the space bar and arrow keys)
- Move an object (by positioning the cursor over the object, keeping the space bar pressed down and pressing the arrow keys)
- Resize an object (by positioning the cursor over an object handle, keeping the space bar pressed down and pressing the arrow keys)
- Open the dialog box for a selected object (by pressing the Enter key)

**Cursor**

The cursor can take four different shapes:

	Within an object
	The size of the object can be changed
	In the graphic work area
	When selecting a function from the menu or the toolbox

**Creating objects**

Click on the required object in the toolbox and move the cursor to the position in the work area where you want to place the object. Click the mouse to position the object.

Static graphics are displayed by clicking on the work area. For dynamic objects, a dialog box opens for the current object. Click [OK] in the object dialog box to display the object on the screen.

Once the object is displayed it has handles and selection mode is active.

**Static graphic**

Static graphic objects comprise

- Line
- Curve
- Polylines
- Ellipsis
- Rectangle
- Symbol
- Text

They are used to draw background graphics. You can change static graphic objects into dynamic objects by linking them to the objects on the [Dynamic signals] tab page.

**Dynamic objects**

Dynamic objects are linked with signals to generate control and monitoring functions, etc. For more information on defining objects, refer to the section "Graphic display and control" on page 135.

**Selecting several objects**

There are two ways of selecting several objects in the graphic block manager.

- Press the left mouse button and keep it pressed down while drawing a selection rectangle around the required objects. The last object you have created will be displayed with filled handles.
- Select the pointer from the toolbox. Hold the shift key pressed while selecting the required objects. The last object you have selected will be displayed with filled handles.



*Positioning objects* The [Layout] menu offers several functions for positioning objects with ease:

- Align
- Make same size
- Space evenly
- Tile

You can also access these functions from a separate toolbox.

You can only access these functions when at least two objects have been selected. The functions perform their positioning calculations based on one or two reference objects.

The functions [Align], [Make same size] and [Tile] use the object that was last selected or created as the reference object. See the section "Selecting several objects" on page 100.

The function [Space evenly] takes the object furthest to the bottom/top or left/right as the reference object. The functions do not affect the reference object.

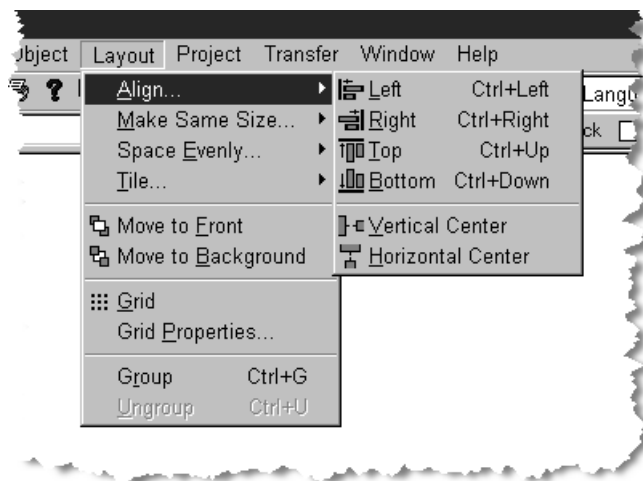

Figure 38: [Layout] menu

11511AEN



#### Align

The [Align] function offers six menu options for aligning objects vertically or horizontally.

Left	Aligns the selected objects flush left with the reference object.
Right	Aligns the selected objects flush right with the reference object.
Top	Aligns the selected objects flush with the top of the reference object.
Bottom	Aligns the selected objects flush with the bottom of the reference object.
Vertical center	Centers the selected objects vertically based on the reference object.
Horizontal center	Centers the selected objects horizontally based on the reference object.

#### Make same size

The [Make same size] option offers three functions to make selected objects the same size.

Width	Matches the width of the selected objects to that of the reference object.
Height	Matches the height of the selected objects to that of the reference object.
Both	Matches the size of the selected objects to that of the reference object.

#### Space evenly

The [Space evenly] option offers two functions to change the distance between two selected objects.

Vertical	Changes the position of the selected objects to an identical vertical distance. The objects closest to the top and bottom are not moved. At least three objects must have been selected.
Horizontal	Changes the position of the selected objects to an identical horizontal distance. The objects closest to the left and right side are not moved. At least three objects must have been selected.

#### Tile

The [Tile] option offers two functions that enable you to position two objects next to each other

Vertical	Changes the vertical position of the marked objects so that they are aligned with the reference object.
Horizontal	Changes the horizontal position of the marked objects so that they are aligned with the reference object.



*Grouping objects*

The [Layout] menu offers functions for grouping several objects. Select the required objects and choose [Layout] / [Group] from the menu. The group of objects will now be treated like a single object and you can resize the objects all at once. You can still define the color and font individually for each object in the group. Clicking an object in the group opens the edit dialog box for the corresponding object.

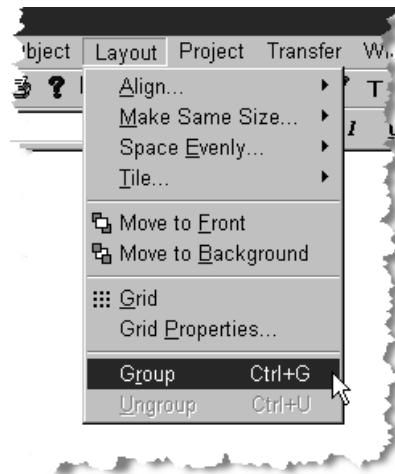

11512AEN

Figure 39: Grouping objects

The [Layout] / [Group] function... allows you to separate a group into individual objects.

**Saving and loading grouped objects**

You can save or load grouped objects by clicking the [Library] button in the toolbox in the graphic block manager.



## Creating tables

Object tables in a graphic block can be created as follows:

1. First, create two rows or columns with the same object.

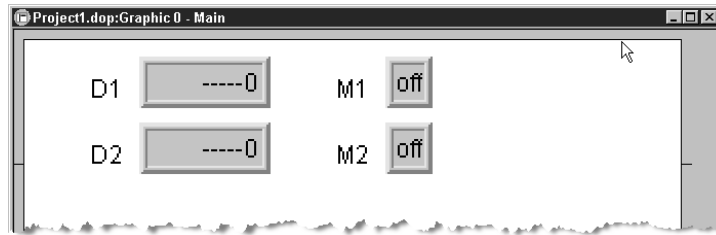
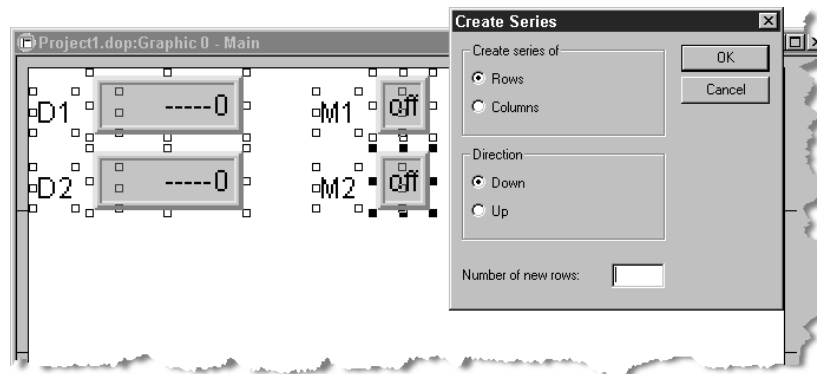

Figure 40: Object tables

10416AEN

2. Select the objects and choose [Object] / [Create series of] from the menu.



10417AEN

This opens a dialog box.

3. If you want to create a table, define the number of rows and columns and the direction into which you want to expand the table.

If you click [OK], the programming software creates a table with the defined number of rows or columns.

**NOTE**

The object alarm banner cannot be included in a table.



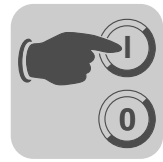

## Symbols



Symbols can be imported into the project. The bitmap library, which contains numerous buttons, pump symbols, etc., or graphic files on the PC can be used as the source.

Image files can be imported from other Windows applications (e.g. Paint) to the symbol library in the following formats:

- bmp
- jpg
- gif
- wmf

Symbol names can comprise a maximum of 30 characters. Umlauts are permitted.

### Adding a static symbol to a block

Click [Symbol] in the toolbox and move the cursor over the block in the work area where you want to place the symbol. Next, make a mouse click. Clicking on the work area opens the [Static symbol] dialog box.

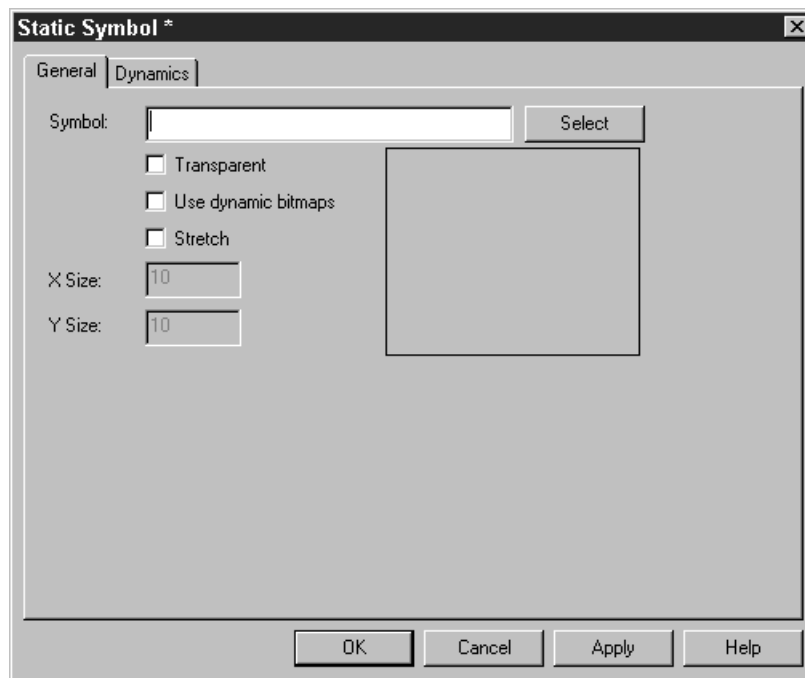

11473AEN

Enter the name of the symbol you want to add or click on [Select] to open the [Select symbol] dialog box.

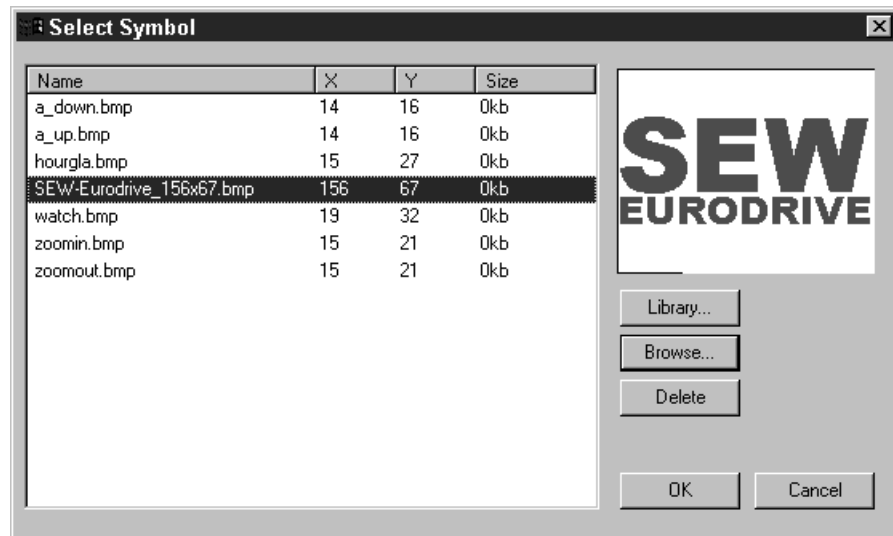

11474AEN

Click on [Library] to import a static symbol from the bitmap library. Alternatively, click on [Browse] to upload a graphic file from the PC.

The chosen symbol is displayed in the [Preview] window. BMP symbols are displayed as thumbnails in the preview window.

Click on [Open] and then [OK] to select a symbol. The symbol is now displayed in the [Static symbol] dialog box.



11475AEN



### [General] tab page

Parameters	Description
Symbol	Symbol of the name of the selected symbol.
Select	Button to select library symbols or external image files.
Transparent	Makes the symbol background transparent. The color of the upper left pixel is defined as the transparency color.
Stretch	When this option is enabled, you can change the x or y size of the object.

### [Dynamics] tab page

The functions on the [Dynamics] tab page are described in the section "General parameters" on page 135 .

### Copying a graphic from an application

Proceed as follows:

1. Copy an object in another application, e.g. Paint to the clipboard.
2. Open the graphic block manager in the programming software and select the [Paste] command.
3. Enter a name for the symbol. The name must not exceed 30 characters.
4. The symbol will then be saved in the symbol library under the specified name.

Graphics and symbols can be copied from one block to another and from one project to another in the HMI-Builder using the [Copy] and [Paste] functions.

**7.4.12 Text block manager**

Dialog fields and reports are created in the text block manager. A text block can consist of static text and dynamic objects. Static text is not changed during program execution whereas dynamic objects are linked with controller signals.

Eight dynamic object types are available:

- Digital text
- Multiple selection
- Message
- ASCII
- Analog numeric
- Bar chart
- Digital clock
- Jump

***Opening the text block manager***

To open the text block manager, double click on a defined text block in the block manager or in the block list. Select a defined block from the block list or create a new text block.

***Mouse and keys***

Click on the start of the text to be selected and drag the cursor over the text. To select text using keys, hold down the shift key and select the text using the arrow keys.

Selected text is deleted using the [Cut] function.

To view an object's properties, double-click an object and press the <F4> key.





**Toolbox**

The text block manager provides a toolbox with the following functions.

- Maximize
- Minimize
- OEM mark

All functions are also available from the menus. For further information on defining and using the different objects in text blocks, see the section "Text-based display and control" on page 180.

	Maximize
	Minimize
	ASCII selection list. For selecting characters that cannot be entered directly on the keyboard.

**Defining text blocks**

**Static text**

The text block manager is a text manager for entering static text. The Windows functions [Copy] and [Paste] can be used to copy and paste text in a block from one block to another or from one program to another (e.g. Microsoft Word). This function can be used to document applications quickly and easily.

**Dynamic objects**

Dynamic objects can be defined at any text position. Select the object type from the toolbox or the [Object] menu. This opens a dialog where you can define the object.

The dynamic object is marked with a hash key (#) followed by one or more hyphens (-) depending on the position. For more information on defining dynamic objects, see the section "Text-based display and control" on page 180.



#### 7.4.13 I/O change

The [I/O change] function enables you to change I/Os or move an entire I/O range. I/O changes can be made for the entire project or only for selected objects.

The function can be used in the following areas:

- Blocks in the block list
- Objects in graphic and text blocks
- Lines in the alarm list
- Lines in the function key manager
- Lines in the LED manager
- Lines in the cross reference list

Select [Edit] / [I/O change] from the menu.

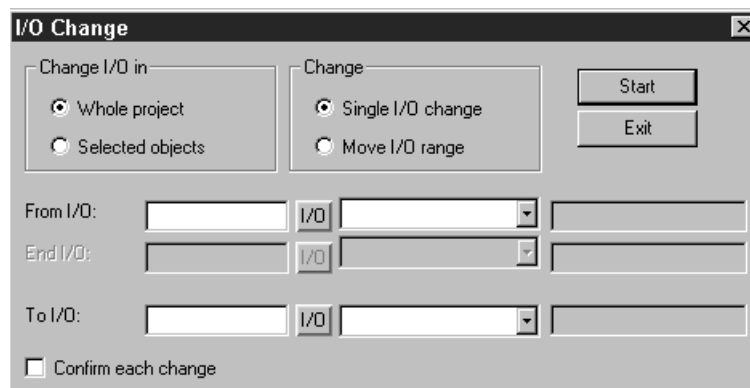

11269AEN

Figure 41: I/O change

Parameters	Description
Change I/Os in	Specify whether I/Os should be changed in the entire project or for selected objects.
Change	Choose whether an individual I/O is to be changed or an entire I/O area is to be moved.
From I/O, End I/O, To I/O	Enter the I/O to be changed and define the I/O area that a move is to be made for/into.
Confirm each change	Select this checkbox if you want to confirm each I/O change for an object.



#### 7.4.14 BDTP station change

This function enables you to change the index numbering for a BDTP client project in a BDTP network, e.g. from station 1 to station 3. Select [Edit] / [BDTP station change] from the menu.

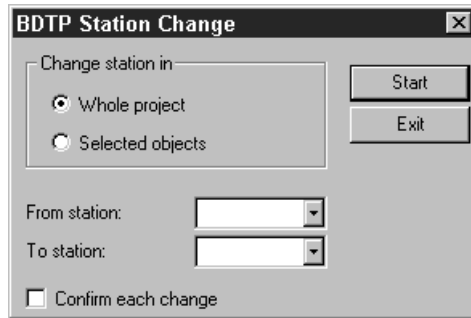

11513AEN

Figure 42: BDTP station change

Parameters	Description
Change station in	Specify whether the index numbering is to be changed in the entire project or for selected objects.
From station, to station	Specify the index number to be changed as well as the BDTP station index number in this field.
Confirm each change	Enable this checkbox if you want to confirm each BDTP station change for an object.

#### 7.4.15 I/O cross reference

The [I/O cross reference] function is used to document I/Os clearly. Select this function via [View] / [I/O cross reference].

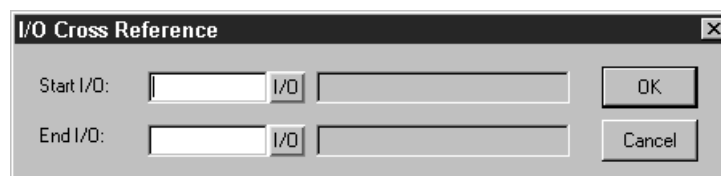

11270AEN

Figure 43: [I/O cross reference]

Enter [Start I/O] and [End I/O] in the dialog box that opens. If you leave the field [Start I/O] empty, all I/Os up to the value in the field [End I/O] are included. If you leave the field [End I/O] empty, all I/Os up to the value in the field [Start I/O] are included. If you do not enter a value in any field, all I/Os will be included in the list.



#### Display

The results output by this function will be displayed in a list with two levels. The first level lists the available I/Os and the number of objects belonging to each IO. To open the second level, click the plus symbol on the left of the I/O. This displays all the objects that are included in the selected I/O. The plus symbol then changes to a minus symbol.

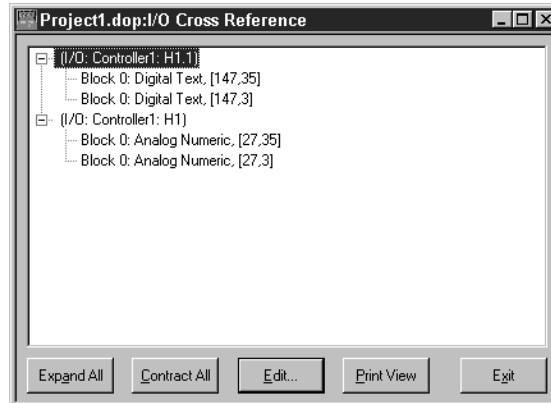

10425AEN

Figure 44: [I/O cross reference] display

You can select a row in the list and copy it to the clipboard from where you can paste it, for example, into a Microsoft Word document.

#### 7.4.16 Other managers

The HMI-Builder also includes managers for handling:

- Function keys
- LEDs
- Alarms
- Alarm groups
- Passwords
- Time channels
- Message library
- Macros
- Data exchange
- Name list

These managers are called up from the [Functions] menus and are used in the same way. The parameters in the respective manager are described in the corresponding sections.

The definitions for function keys, LEDs, alarms, alarm groups, time channels, message library, macros and data exchange are listed in the relevant manager. New definitions can be inserted using the [Append] or [Insert] functions.





To change a definition, select the definition you want to change, make the change and click [Update]. To change several definitions with ease, click [Update] or [Append] only once and then confirm each change with the Enter key.

The [Append] and [Update] functions remain active until another function is called. Use the [Delete] function to delete a selected definition. To close the manager, click [Close]. The following example applies to the alarm manager.

#### 7.4.17 [File] menu

The [File] menu includes functions for creating, opening, saving and closing projects. These functions are available in the standard toolbar. The print options can also be accessed using this menu. You can use the [Update driver] function to download new drivers from the Internet or install them from a disk.

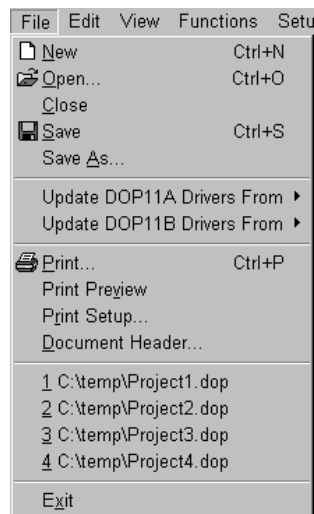

11514AEN

Figure 45: [File] menu



#### 7.4.18 [Edit] menu

The [Edit] menu comprises the following functions:

- Cut
- Copy
- Paste
- Undo
- Select all

The [Find] function is available for editing texts in different languages. The menu also includes the functions [I/O change], [BDTP station change] and the options [Standard controller] and [Font templates].

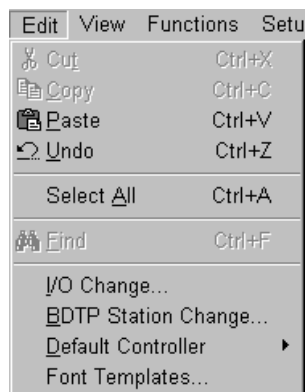

11515AEN

Figure 46: [Edit] menu



### 7.4.19 [View] menu

The [View] menu includes

- Block manager
- I/O cross reference
- Name list
- Project manager

The menu also provides functions for setting various display modes in the program. Some functions appear in Windows applications as standard, others are specific to HMI-Builder. A description of the functions specific to HMI-Builder are given below.

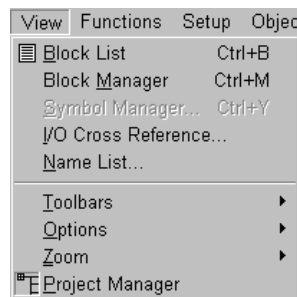

11516AEN

### Block list

The [Block list] menu shows the blocks belonging to the application. To create a new block, click on [New] in the block list. To open an existing block, click on [Open]. Clicking the [New] button opens the [Create new block] dialog box. Here you can define basic parameters for the block. To open the [Create new block] dialog box for a selected block in the list, click on the [Properties] button. To delete a selected block, click [Delete].

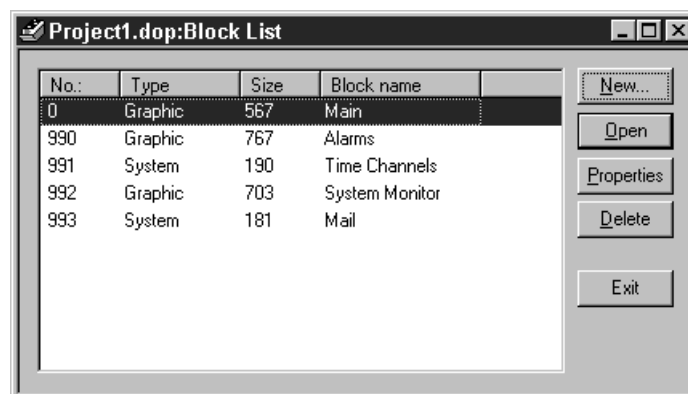

11517AEN



#### Block manager

In the [Block manager] menu, all blocks in an application are presented graphically. Using this menu, you can create new blocks, define the block header and define jumps via toolbox functions.

#### I/O cross reference

The [I/O cross reference] menu item can be used to display a list of the I/Os.

#### Name list

The [Name list] menu enables you to define a local name list for the signals used. Signals in the project that do not have a name can be added to the name list using the [Undefined] function. You can insert new signals or edit and update existing ones. Use the [Update] function to update the project with the changes you have made in the name list.

You can export a name list to a text file. You can also import a text file into a name list. Tab, semicolon, comma or blank can be used as separators for the file contents. You can sort an internal name list. The text file must not contain special country-specific characters, such as Ä, Ö and Ü.

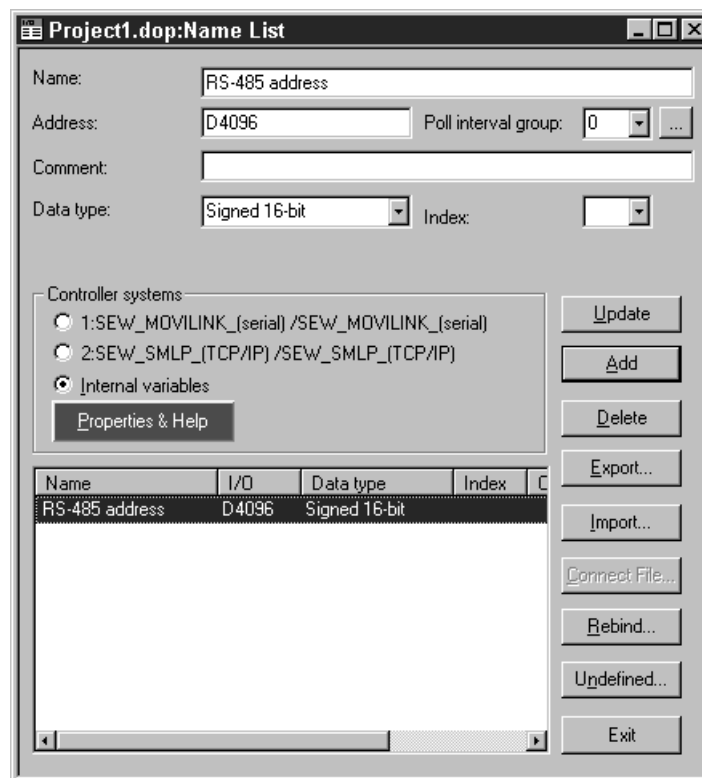



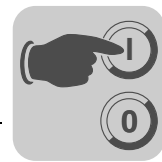





11494AEN

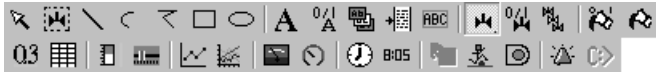

**Toolbars**

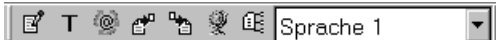

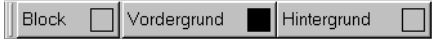

You can show and hide all the HMI-Builder toolbars using the [Tool bars] menu item.

Parameters	Description
Standard layout	Selecting this option resets all the toolbars to their default settings.
Standard	
Status bar	 <p>The status bar is located at the bottom of the configuration software window. The left area of the status bar includes a description of the selected menu or a brief description of the object that the cursor is pointing to in the toolbar. It also displays the coordinates (lines and column) in the block manager. The right area of the status bar displays the terminal model and driver version of the current project and the available terminal memory once the project has been transferred. OVR indicates that the overwrite button has been pressed.</p>
Block manager	See the section "[View] menu" on page 115.
Object	 <p>To choose objects, select them in the object bar and move them to the work area. Click on an object to display its properties dialog box. Enter the parameters and click [OK]. The object now appears in the work area. Static text or graphics are displayed directly in the work area. The static graphic objects line, curve, ellipsis, rectangle, symbol and text are used to draw background graphics. If you choose the [Dynamic] tab page when creating static graphic objects, you can link signals with the objects, thus transforming them into dynamic objects. Dynamic objects are linked with signals to create, among other things, control and monitoring functions. The general object parameters are described in the section "Basics" (page 62). Graphic and text objects are explained in the sections "Graphic display and control" (page 135) and "Text-based display and control" (page 180). Next to the objects there is a button for selecting symbols and a pointer (far left in the toolbar). See also the section "Static / dynamic graphic objects" (page 144).</p>
Font	 <p>You can use the font toolbar to select a predefined text style or to create a user-defined style. The text style is defined for the selected object. If you select a different font type, size or style for an object, a new text style is created and displayed in the list field.</p>
Controller	 <p>The driver for the current object can be selected using the controller toolbar. Click the  symbol to select the internal variables.</p>
Language	
Alignment	 <p>The alignment toolbar makes it easier to align objects on the screen. Objects can be aligned vertically and horizontally and changed in size based on the object that was most recently created (reference object). You can use the buttons in the toolbar to distribute objects evenly over the screen or tile them next to one another. When you move the cursor over a button in the toolbar, a brief description of the button is displayed. A more detailed description is given in the status bar (bottom left).</p>
Line width	 <p>In this toolbar you can select the line thickness for straight lines, curves, polygons, rectangles and circles. The line thickness can also be specified in the object's properties dialog box.</p>
Color	 <p>The color toolbar shows the foreground and background color of the current object and the block color. Click on the buttons to select a different color from the palette.</p>

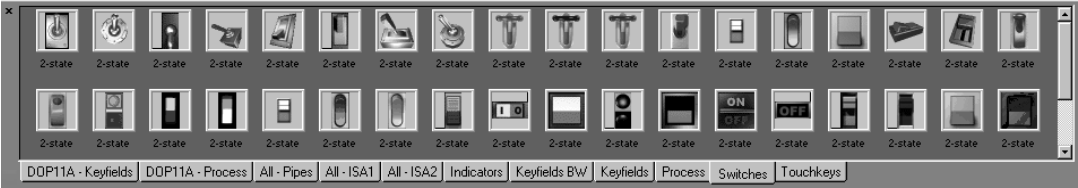

## Programming

### Programming with the programming software

Parameters	Description
Layout	 <p>You can use the buttons in the layout toolbar to move objects in front of or behind other objects and to hide or show a grid.</p>
Zoom	 <p>The buttons in the zoom toolbar are used to increase or decrease the size of the work area or the block manager.</p>
Library	 <p>See the section "Library" (page 94).</p>
Execute	 <p>You can use the simulator to execute a project on a PC. Save the project and choose [Project] / [Execute]. A window that can be used as a virtual operator terminal is displayed. Press &lt;ESC&gt; to close the simulator and return to the configuration software.</p>

### Options

Parameters	Description
Show terminal	Selecting this option displays a terminal around the work area in the graphic manager. You can use the terminal display to call up the managers for LEDs, function keys and text strips. Double-clicking on a function (e.g. a function key) opens the corresponding edit dialog box.
Show background block	Applies to graphic blocks only. With this option, you can display the background block when working in the graphic block manager.
Show language index	For multi-language support only. Shows the index number for the text in the application.
Quick info	Quick info is displayed for a function when the cursor is moved over the corresponding button.
Use terminal font	Here, you can select whether the text you have entered in the dialog boxes should be displayed by the program in the terminal font.
Choose Unicode font	Select a Unicode font from the dialog box. This font will be used in the programming software for multi-language support.



### 7.4.20 [Functions] menu

The [Functions] menu includes managers for:



11518AEN

Function	Description
Function keys	Here you can define global and local function keys. See the section "Function keys" on page 238.
LED	With this option you can define functions for the LEDs. See the section "LEDs" on page 238.
Alarm groups	With this option, you can group alarms (e. g. by severity levels) to detect and remedy them more efficiently. See the section "Alarm management" on page 201.
Alarms	With this option you can define alarm messages and signals that trigger an alarm. See the section "Alarm management" on page 201.
Time channels	With this option you can define time channels that control events in processes at a certain time. See the section "Time control" on page 229.
Passwords	With this option you can define passwords for the various security levels in the application. See the section "Passwords" on page 222.
Message library	With this option you can create message tables where values between 0 and 65535 are linked with texts. See the section "Message library" on page 199.
Macros	With this option you can create events that affect all function and touch keys. See the section "Macros" on page 246.
Data exchange	With this option you can define the conditions for data exchange between the selected controllers.
Data logger	Data can be logged and saved in a file. The data is saved at defined intervals or when values are changed.
I/O configuration	To display the properties of the controller driver and internal variables, select [I/O configuration].



#### 7.4.21 [Setup] menu

The [Setup] menu includes functions for configuring the terminal.

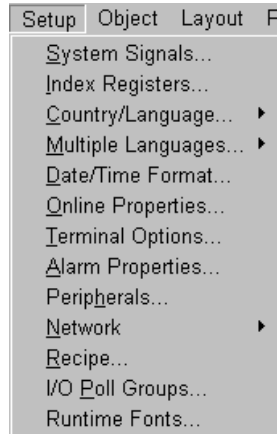

11519AEN

#### **System signals**

With this option you can define handshake signals between the terminal and controller.

#### **Register current display**

Data register in the controller that contains the number of the block (in run mode) to be displayed on the screen. The data register is automatically updated when the block is changed. This register does not affect block selection.

#### **Register new display**

Data register in the controller that defines which block will be displayed on the screen.

#### **Buzzer register**

The value of this register defines the buzzer tone. Tones and scales are given in the table below. When the value is 0, no sound is issued. All values in the table are given in Hz.

	C	D	E	F	G	A	H
Small	–	–	–	–	–	220	247
One	262	294	330	349	392	440	494
Two	523	587	659	698	784	880	988
Three	1046	1174	1318	1397	1568	1760	1975
Four	2093	2348	2636	2794	3136	3520	3950
Five	4186	–	–	–	–	–	–





### Backlighting signal

Digital signal that activates or deactivates the backlighting.

### Cursor control block

The start register for a control block is specified in the terminal. The start register writes the current cursor position in the graphic block to the data register in the controller.

Register	Description
0	Current graphic cursor position X (in pixels): 0-239 for DOP11B-20 and 0-319 for DOP11B-40.
1	Current graphic cursor position Y (in pixels): 0-63 for DOP11B-20 and 0-239 for DOP11B-40.
2	Status register
0	Normal
1	The user attempts to move the cursor downward but there is no object at the selected position.
2	The user attempts to move the cursor upward but there is no object at the selected position.
3	The user attempts to move the cursor to the left but there is no object at the selected position.
4	The user attempts to move the cursor to the right but there is no object at the selected position.

The following table applies only to models with touchscreen.

The cursor control block is the start register in a control block that writes the current pointer position in the graphic block to the controller's data register.

Register	Description
0	x-coordinate (in pixels): 0-319
1	y-coordinate (in pixels): 0-239
2	Status register: 0 Not pressed, 1 Pressed

### Cursor movement register

The position of the cursor in a graphic block can be controlled via a register. The meaning of the register values is described below. Value 0 must be assigned to the register between the same command for the movement. We recommend that you also use the [Cursor control block] option to optimize this function.

Register value	Description
1	Moves the cursor to the first maneuverable object.
2	Moves the cursor to the next maneuverable object.
3	Moves the cursor up one step.
4	Moves the cursor down one step.
5	Moves the cursor left one step.
6	Moves the cursor right one step.



#### Print status register

Not relevant for the DOP11B series.

#### Library index register

This register is used for indexing the message library. The library number from which the texts are to be retrieved is indicated in the message object.

When defining an index register, its contents is added to the number specified in the object. This means a register can control from which library the texts are to be retrieved.

#### Commands

One or more of the following commands can be entered in the command line. Commands are separated by spaces. All commands are capitalized.

Command	Description
ABUPx	Enables alarms to be saved on an external memory card by specifying the bit device "x".
AKx	Activates the joystick function. See the section "Joystick function " on page 51.
AUCR	Register [AlwaysUpdateCurrentRecipe]. Updates the recipe of the current recipe register on saving. The recipe does not have to be loaded again.
ALDR	Enables 2 alarm lines to be used per alarm. See the section "Operator terminal alarms" on page 208.
ALOFx	AlarmListOverflow The bit device "x" shows when active alarms are to be deleted from the alarm list.
AMBn	Enables several alarm backup files to be saved on an external memory card. "n" stands for the number of backup files that can be saved.
AUCR	Register "AlwaysUpdateCurrentRecipe". Updates the recipe of the current recipe register on saving. The recipe does not have to be loaded again.
BCTO	Displays the error message "BDTG comm. Error" the first time a BDTP client attempts to reestablish a connection with a BDTP server.
BFF	Block Form Feed. Adds a page break after each block during printing.
BTIMx	BDTP response timeout, where "x" stands for the number of seconds. For more information, see the section "BDTP" on page 272.
DBAF	Deactivates the query for creating a backup file structure when a USB Flash drive is connected.
DBKL	Unlocks keyboard and touchscreen when the backlighting needs to be replaced. The default locks the keyboard and touchscreen when the backlighting is not active.
DD	Disable Delete. Deactivates the deletion of alarms from the alarm list. When this command is issued, inactive or acknowledged alarms are not deleted from the alarm list.
DGP	Removes the alarm group from alarm printouts.
DNBW	Deactivates the warning "No block x". If this warning is not deactivated, it is issued, for example, when a block jump has not been configured for an existing block number or when the function [New display register] is used in order to use the data registers in the controller to specify which block is to be displayed on the screen.



Command	Description
FLIP	Turns the screen display in portrait or landscape format by 180° to allow reverse assembly.
FTNO	Deletes the line with the OFF indicators in trend files when using FTP.
LOBx	Activates the digital signal <b>x</b> when the battery of the real-time clock needs to be replaced. For example, <b>LOBM0</b> activates M0 when the battery needs to be replaced.
MClx	MemCardInserted Activates the digital signal <b>x</b> when a memory card is inserted.
MCRD#	Enables individual recipes to be stored on an external memory card. See the section "Storing individual recipes on an external memory card during operation" on page 221.
NHD	This command allows for printing graphic blocks without block header (which includes block name, block number, date and time) on a laser printer.
NMAN	Activates the warning "Not maneuverable" for operator terminals with touchscreen.
NTx	Timeout in <b>x</b> ms for a message in no protocol mode.
Rx	Maximum number of transmission attempts, <b>x</b> = number of attempts. Applies to communication with the controller. Example: R5@2 applies to controller 2.
Tx	Global timeout in <b>x</b> ms. Applies to communication with the controller. Example: T10000@1 applies to the timeout for controller 1.
PDxxxxxxx	Password protecting access to the [Transfer] menu. More information can be found in the section "Passwords" on page 222.
PSxxxxxxx	Password that has priority over all other password levels. Used, for example, for support and maintenance. More information can be found in the section "Passwords" on page 222.
PSCE	Calculates the size of the project and displays the result on the diagnostics page and in the file info.txt. Using this command in projects with numerous trend curves slows the loading process and the use of FTP functions considerably. See also the section "FTP server" on page 276.
PWDF	Activates the use of a password for a USB Flash drive.
SCRR	Limits the number of characters for recipe names and recipe directories that can be stored in the controller to 8. See also the section "Limit the length of recipe names and directories that can be stored in the controller" on page 215.
SJAFx	Displays the text "Remote access" in the top right corner when a VNC client is connected. <b>x</b> = Character size.
TBS	A sign must be entered after the command to show which trends or data logs should be copied to the external memory card. On activation of the "TBUP" signal, only the trends or data logs starting with this sign are copied over. See the section "Trends" on page 242.
TBUP	Used to backup trend files. More information can be found in the section "Creating backup copies for trend data" on page 245.
TCFx	Value to set the temperature compensation for the terminal contrast. The standard value is determined based on test results. However, in areas with wide and frequent temperature fluctuations, this value may have to be adapted. To lower the temperature compensation, increase the value "x". Enter the value "0" to deactivate the temperature compensation.
TESOSn	Saves a sample trend. See the section "Creating backup copies for trend data" on page 245.
TMBx	Trend Multi Backup. See the section "Creating backup copies for trend data" on page 245.
VNCD	VNC Disconnect. Disconnects the current VNC session when the bit device "x" is set.

**Index register**

Index addressing of dynamic objects. For more information, see the section "Index addressing" (page 195).



## Programming

### Programming with the programming software

#### Country / Language

##### Character set

The selected character set determines which character table will be used in the terminal and which special country-specific characters will be available.

##### System language

Menu language selection: British English, German, Swedish or American English. By default, the menu texts in the terminal are set to British English.

#### Multi-lingual functions

Menu	Description
New language	Starts the wizard for creating multi-lingual applications.
Edit	With this option you can edit or translate texts in the application.
Setup	This function displays the tree structure for the languages in the application. For more information on possible settings, see the section "Language management" on page 230.
Export	This function exports the application languages to a Unicode text file. Choose this function to export user texts. The dialog box [Export multi-lingual texts] is displayed. Enter the destination and the format of the file to be saved.
Import	This function imports a language for use in the terminal. Choose this function to import user texts. The dialog box [Import multi-lingual texts] is displayed. Enter the name of the text file to be imported.
Display index	This function displays the index in objects instead of texts. You can also enter text for the index display. In this way, the new text is assigned a new index.
Cross reference	Displays a cross reference list with the indices for the application blocks.
Reuse index	If this function is active when copying an object, a new object will be created with the same index.
Choose Unicode font	Choose a Unicode font for use in the programming software.



**Date / time format** Setting the date and time format.

Menu	Description	
Date format	The following date formats are possible: <ul style="list-style-type: none"> <li>• YY-MM-DD</li> <li>• YYMMDD</li> <li>• DD.MM.YY</li> <li>• DD/MM/YY</li> <li>• DD/MM/YY</li> </ul> Y=year, M=month, D=day.	
Time format	The following time formats are possible: <ul style="list-style-type: none"> <li>• HH:MM:SS</li> <li>• HH:MM</li> </ul> H=hours, M=minutes, S=seconds.	
Activate clock	Select this checkbox to activate the clock in the terminal. When controller 1 or 2 is selected, the clock refers to the clock in controller 1 or 2.	
Clock → controller 1/2	Select this option if you want to transfer the data of the terminal clock to a data register in controller 1 or 2. If the controller has an activated real-time clock and the terminal clock sends data to the same data register, the controller clock will have priority.	
Update interval	Here you can define how often the terminal sends clock data to the controller. Enter the value in seconds. The recommended value is 60 seconds. Shorter update intervals slow down the communication between terminal and controller.	
Controller register	Enter the start address for saving the date and time in the controller. If you use this function, the terminal clock will be written to 7 successive registers (see table below).	
	<b>Controller register CR</b>	<b>Time segment</b>
	CR	Seconds
	CR+1	Minutes
	CR+2	Hours
	CR+3	Day
	CR+4	Month
	CR+5	Year
CR+6	Day of the week (1 ... 7; 1 = Sunday)	
Daylight saving time	Here you can specify dates for the start and end of daylight saving time. Enter the day of week, week of month, month, hour and setting. You can choose between Europe and U.S. standard time. To deactivate daylight saving time, leave both month fields blank.	

**Online properties** Enables selected functions to be changed on the operator terminal.



#### Terminal options

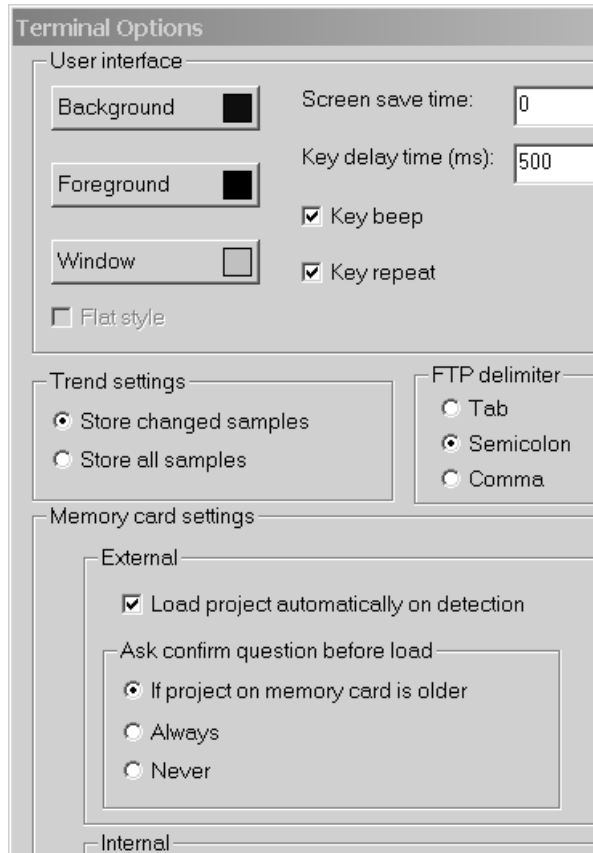

11987AXX

Figure 47: Terminal options

Option	Description
Background	Defines the background color for the terminal.
Foreground	Defines the text color for the terminal.
Window	Defines the window color for the terminal.
Screen saver time (min)	Enter the screen saver activation time in minutes. The default setting is 0 which means the screen saver is disabled. A screen saver extends the life of your monitor.
Key delay (ms)	Time interval in milliseconds between 2 hits of the same key before the cursor automatically moves to the next position. Is used when ASCII characters (A-Z, etc.) are entered. See the section "Alphanumeric keys" on page 45.
Key beep	Defines whether the terminal produces a signal tone when a key is pressed.
Key repeat	Specifies whether a function is repeated as long as a key is being pressed. This does not apply to function keys and the entry of alphanumeric characters (A-Z, etc.).
Trend settings	General trend settings are made in this field.



Option	Description
Save changed samples	Saves changed samples in trends only if the value has changed since the last measurement.
Save all samples	Saves all samples in trends, even if the value has not changed since the last measurement. These parameters affect all defined trends.
FTP delimiter	The terminal can save the transferred files locally. Access is enabled via FTP or external memory card. The content of recipe or trend files, for example, can be delimited using the separators tab, semicolon or comma. When the FTP delimiter is changed, the separators of all internally saved recipes are checked and, if necessary, adapted. For more information, see the section "FTP server" on page 276.

**Memory card settings**

Here you can make settings for external memory cards.

External	You can connect either a compact Flash card (only for DOP11B-50) or a USB Flash drive externally. The external memory can be used to back up projects or store recipe files. This option cannot be used to extend the project memory. DOP11B-50 does not support the use of 2 external storage devices at the same time. If two storage devices are connected, the compact Flash card has priority over the USB drive.
Internal	Applies only to DOP11B-50. If an internal compact Flash memory card is used to extend the project memory, you must specify its size here.

**Alarm properties**

General properties for alarm management. For more information, see the section "Alarm management" on page 201.



### Peripherals

All communication settings are made under [Setup] / [Peripherals] or by double-clicking on the [Peripherals] directory in the project manager. Devices can be moved using the mouse.

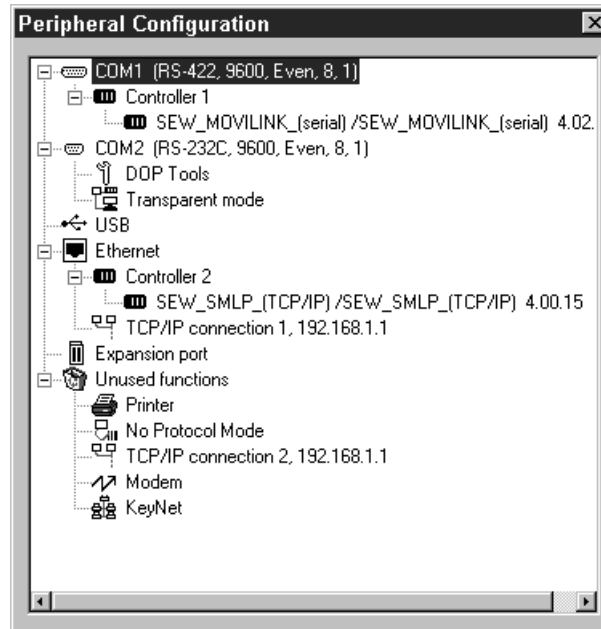

11491AEN

### Port properties

Click the right mouse button on a connection to display or change the current configuration.

### COM2:RS-232C

Select the [RS-232C] COM2 port and click the right mouse button. The following dialog box opens.

Assign the following parameters to the port:

- Baud rate
- Parity
- Data bits
- Stop bits

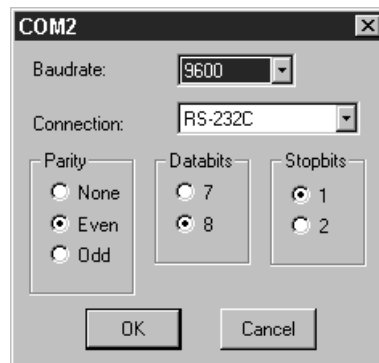

10481AEN





**COM1:RS-485 / RS-422**

Select the [RS-485 / RS-422] COM1 port and click the right mouse button. The following dialog box opens.

Assign the following parameters to the port:

- Baud rate
- Parity
- Data bits
- Stop bits

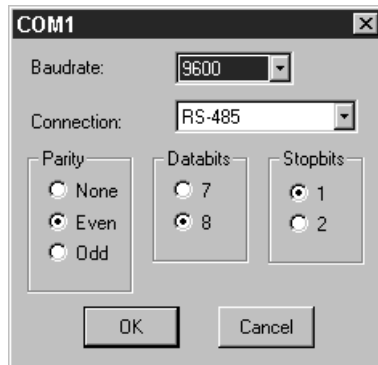

10482AEN

For communication with MOVIDRIVE®, choose 9600, RS-485, even, 8, 1.

**USB**

You can use the USB host connection to connect external devices, such as a USB hub, Flash drive, mouse, or keyboard.

**ETHERNET**

The operator terminal has an ETHERNET connection for connection with a TCP/IP network.

**Printer**

Right-click on the option [Printer] to open the dialog box for the printer properties. For more information, see the section "Printing reports" on page 225.

Parameters	Description
No protocol mode	The no protocol mode is described in the section "Communication" (page 250).
Controller 1 and Controller 2	Right-click on [Controller 1] or [Controller 2] and choose [Properties] to change the selected protocol.
TCP/IP connection 1 and TCP/IP connection 2	Right-click on [TCP/IP connection 1] or [TCP/IP connection 2] and choose [Properties] to enter the TCP/IP settings.
Modem	For more information, see the section "Communication" on page 250.
Transparent mode	For more information, see the section "Transparent mode" on page 252.



#### Network

The network properties are explained in the following sections:

- "Network services" (page 271)
- "Network accounts" (page 302)
- "Network communication via ETHERNET (TCP/IP connections)" (page 263)

#### Recipe

Here you can enter the properties for recipe management. See the section "Recipe management" (page 210).

#### I/O query groups

The I/O query interval groups define the query intervals for signal groups in ms. You can enter values from 0 to 65535 ms. If a signal is not assigned an I/O query interval group, the signal is queried continuously. The I/O query interval group for a signal is assigned during the object definition using the I/O button. The I/O button is available in all dialog boxes in which a signal can be entered. See the section "I/O browser" (page 96).

#### Runtime fonts

Runtime fonts are font attributes and effects for menus (e.g. system texts) and dialog boxes (virtual keyboard models for touchscreen) on the operator terminal. The DOP11B series cannot process formulas.

#### 7.4.22 [Block manager] menu

The [Block manager] menu comprises functions for programming blocks.

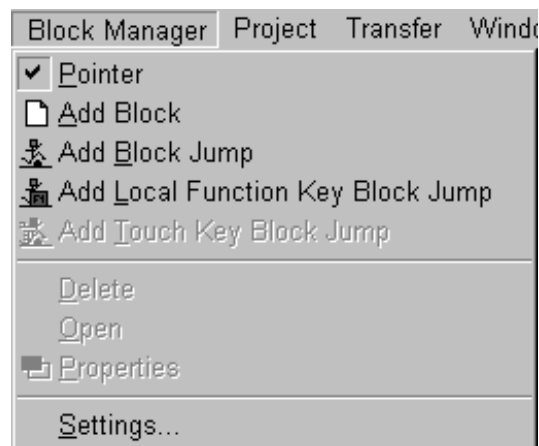

11594AEN



**Settings for the  
block manager**

The block manager display is configured under [Block manager] / [Settings].

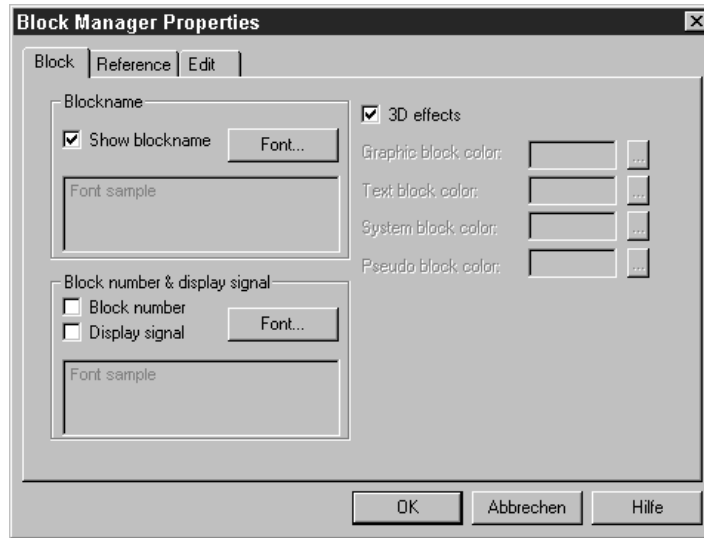

10442AEN

Tab page	Description
Block	Define the appearance of data for the block in the block manager.
Reference	You can set the overview for the block manager here.
Edit	This tab page includes special functions for the display in the block manager.



#### 7.4.23 [Object] menu

The [Object] menu lists all objects available in the program. The number of objects depends on the terminal type. For a description of the objects, see the sections "Graphic display and control" (page 135) and "Text-based display and control" (page 180).

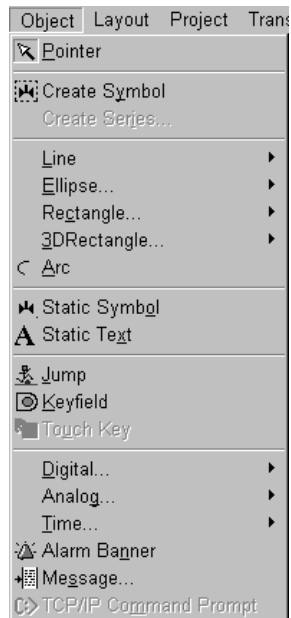

11520AEN



#### 7.4.24 [Layout] menu

The [Layout] menu provides functions for aligning and adjusting several objects. These functions are described in the section "Positioning objects" on page 101 .

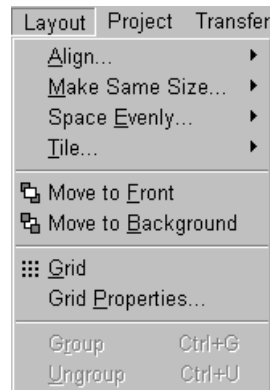

11521AEN

#### 7.4.25 [Project] menu

The [Project] menu includes functions for testing projects, changing project properties and simulating projects.

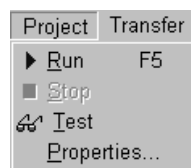

11601AEN

#### **Simulator**

You can use the simulator to execute a project on a PC. Save the project and choose [Project] / [Execute]. A window that can be used as a virtual operator terminal is displayed. Press <Esc> to close the simulator and return to the configuration software.



#### 7.4.26 [Transfer] menu

The [Transfer] menu provides functions for transferring projects, selected blocks and communication settings between the PC and terminal. See the section "Transferring projects" on page 185.

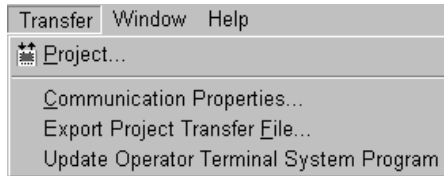

11522AEN



#### NOTE

The communication settings for the programming software and terminal must be identical.

#### 7.4.27 [Window] menu

Here, you can define the appearance of the program windows in the configuration software.

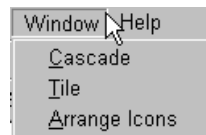

11523AEN

#### 7.4.28 [Help] menu

The [Help] menu is used to call up the online help for the configuration software or the controller. The menu also includes information on the version number and allows you to activate/deactivate the Tip of the Day.



11524AEN

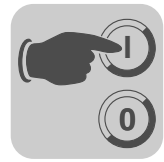

## 7.5 Graphic display and control

This section lists all the graphic objects in tables and explains each in detail. This section only applies to terminals that support graphic display.

### 7.5.1 General parameters

To call up the [Properties] dialog box for an object, double-click on the object in the work area.

#### General

The properties displayed in the [General] tab page are object-specific. They are described for each object.

All dynamic objects can be connected to a digital or analog signal.

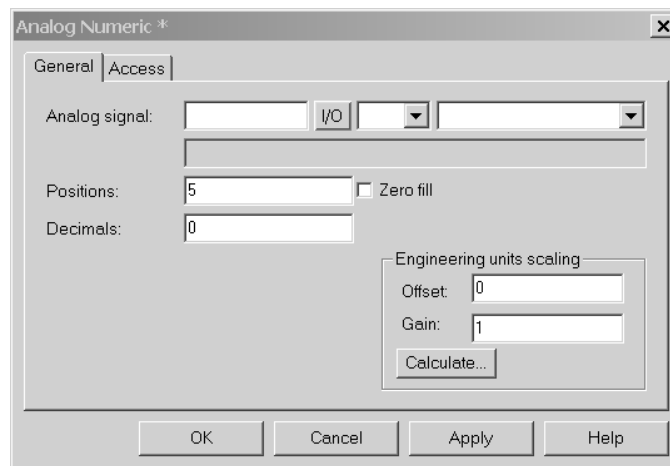

11988AEN

Figure 48: [General] tab page



#### Scaling for technical units

The *offset* and *gain* parameters are used to scale the register value to a display value according to the following formula.

$$\text{Display value} = \text{offset} + \text{gain} \times \text{register value}$$

If you change a value for an object in run mode using the terminal, the display value will be scaled according to the following formula:

$$\text{Register value} = (\text{display value} - \text{offset}) / \text{gain}$$

The scaling affects neither the defined maximum/minimum values nor the number of decimal places.



#### NOTE

The functions for increasing/decreasing values affect the register value for the maneuverable object but not the display value.

#### Calculating technical units

The [offset/gain calculation] function serves as a tool for calculating the parameters *offset* and *gain*. Enter the value for the *offset* and *gain* of the object on the [General] tab page and click on [Calculate]. The following dialog box opens:

Input		Lower	Upper
Controller value range:		-32768	32767
Panel value range:		-32768	32767

  

Output	
Calculated offset:	0
Calculated gain:	1

10591AEN

Enter the range for the controller and terminal values. The function determines the correct values for the *offset* and *gain* parameters.



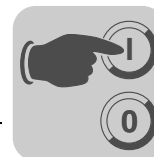

## Appearance

The properties of the [Appearance] tab page are object-specific.

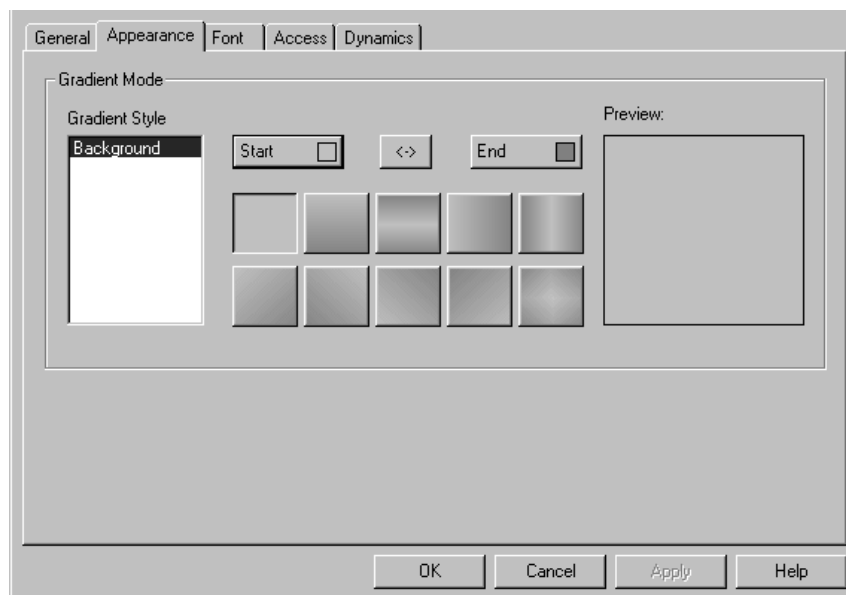

11602AEN

The operator terminals with color display support object and bitmap images with 65536 colors. DOP11B-25 supports 16 greyscales. The DOP11B-20 has a black-and-white display.

The use of colors facilitates the creation of more realistic objects with 3D effect and shading. You can choose the foreground and background colors for blocks and the color gradient styles for objects. You can also select the colors for scales, curves, etc. in graphic objects.

Use the buttons [Start] and [End] to call up the color palette in order to define your own colors. Click the button <-> to reverse the current color gradient. You can click several color gradient style buttons until you have found the style you require.

The result is displayed in the [Preview] window.



#### Font

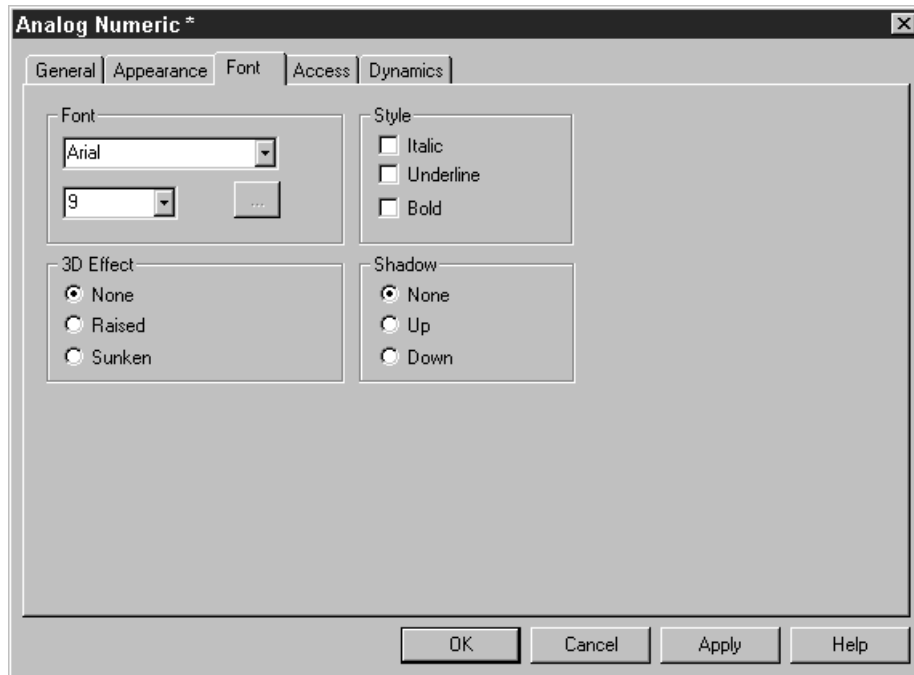

11525AEN

Parameters	Description
Font	Choose a font and font size from the drop-down lists. Click the [...] button to select a font from the Windows dialog box.
Style	Text can be displayed in italics, underlined or bold. If you do not select one of the checkboxes, standard text is used.
3D effect	Here you can assign 3D effects to texts.
Shadow	Texts can be displayed with a shadow effect.



## Access

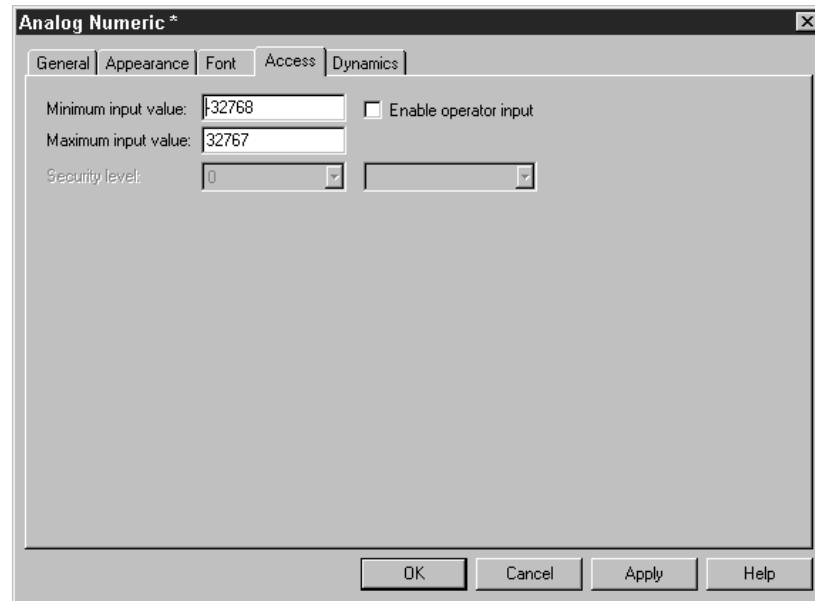

11526AEN

On the [Access] tab page you define whether you want the object to be a maneuverable object. Enter the [Minimum input value] and [Maximum input value] for the object (and the access). You can also specify the security level for the object. You define security levels under [Functions] / [Passwords].



#### Dynamics

This section describes the functions on the [Dynamics] tab page.

#### Property

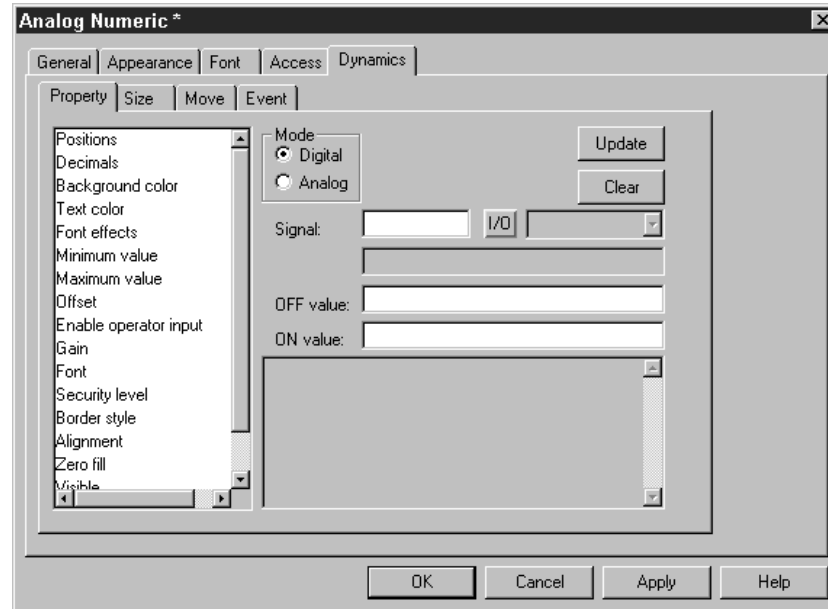

11527AEN

On the [Property] tab page, you can specify which signal a property should control. You can choose between digital and analog control.

- Choose the property to be controlled by the controller from the list. The property can only be used once per object / signal.
- A property being used is marked red.
- Enter a signal or click on the [I/O] button to select a signal using the I/O browser.

The values "OFF" and "ON" are permitted for digital signals. If you do not specify OFF / ON values, the OFF value is set to 0 and the ON value to 1 by default.

You can use the "Character string" format type to define the length of analog signals.



#### NOTE

Connect the servomotor only as shown in the following wiring diagram, which is included with the servomotor.

If analog control is selected for a property that can only be assigned the values OFF and ON, the property remains ON for as long as the signal is assigned a value other than 0.

The *offset* / *gain* of an object can only be changed when the *offset* / *gain* for the object is not 0 or 1.

The *Visible* property must not be used simultaneously with the *Positions* property.

Dynamic texts are not converted into Unicode format. Instead, a question mark will appear.



**Size**

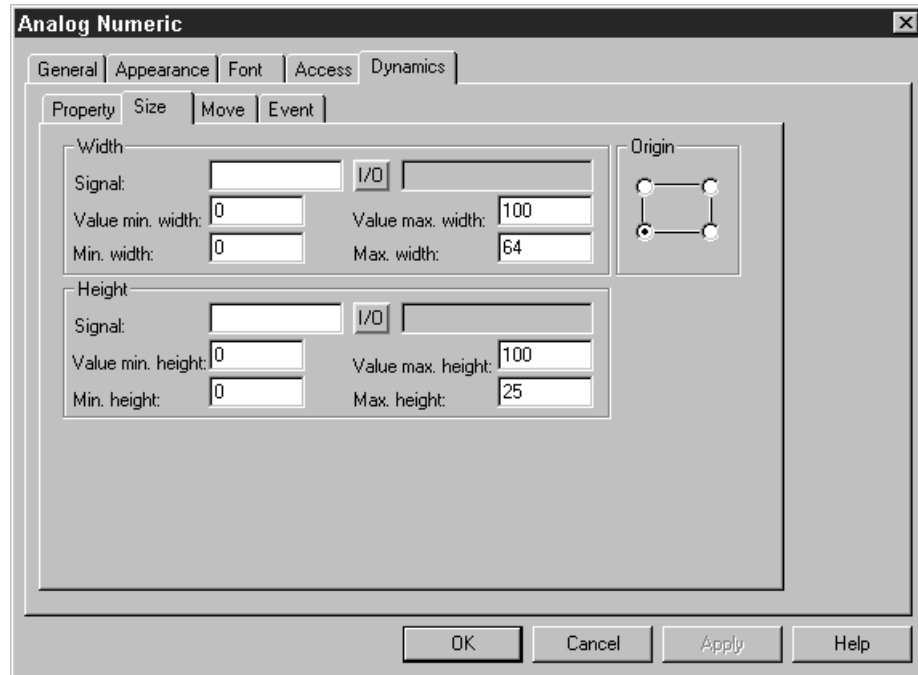

11528AEN

On the [Size] tab page you can define the values for [Width], [Height] and [Origin]. Define 2 analog signals for which the signal values determine the size of the object relating to the x-axis (width) or the y-axis (height).



**NOTE**

If you enter an invalid value, for example a value that does not enable the object to be displayed on the screen, the value will be ignored.

Parameters	Description
Signal	Enter an analog signal.
Value min. width / height	Enter the minimum value of the analog signal.
Value max. width / height	Enter the maximum value of the analog signal.
Min. width / height	Enter the minimum value for the width / height of the object in pixels at which the minimum value corresponds to the defined value.
Max. width / height	Enter the maximum value for the width / height of the object in pixels at which the maximum value corresponds to the defined value.
Origin	Select the starting position of the object for display on the screen.



#### Move

11529AEN

On the [Move] tab page, enter two analog signals whose values determine the x (width) and y (height) coordinates of the object.



#### NOTE

If you enter an invalid value, for example a value that does not enable the object to be displayed on the screen, the value will be ignored.

Parameters	Description
Signal	Enter an analog signal.
Value from	Enter the minimum value of the analog signal.
Value to	Enter the maximum value of the analog signal.
From x / y position	Enter the x and y coordinates of the object, i.e. the pixel value on the screen at which the value of the parameter <i>corresponds with the value of the defined value.</i>
To x / y position	Enter the x and y coordinates of the object, i.e. the pixel value on the screen at which the value of the parameter <i>corresponds with the value of the defined value.</i>



**Event**

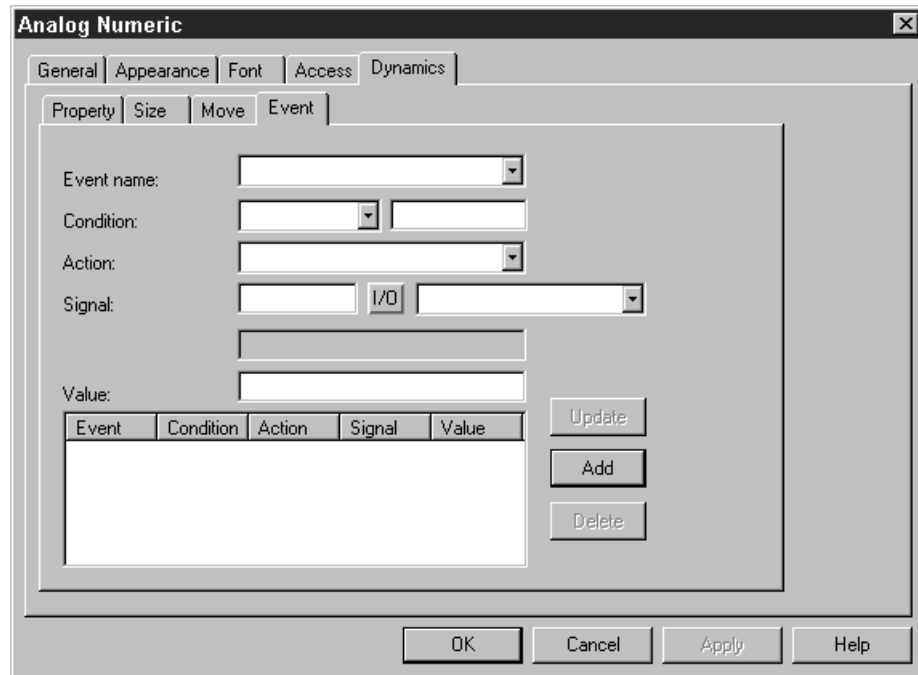

11530AEN

On the [Event] tab page you can define the parameters described below. You can update existing events, add new events or delete events by clicking the corresponding buttons in the dialog box.

Parameters	Description	
Event name	Enter a name for the event or select an entry from the list.	
Condition	Select a condition from the list. You can choose between four conditions:	
	Equal to	The signal reports an event when the object value matches the parameter value. The value has to be entered by the user.
	Not equal to	The signal reports an event when the object value <b>does not</b> match the parameter value. The value has to be entered by the user.
	Greater than	The signal reports an event when the object value is greater than the parameter value. The value has to be entered by the user.
	Lower than	The signal reports an event when the object value is lower than the parameter value. The value has to be entered by the user.
Action	Select one of the following options: <ul style="list-style-type: none"> <li>• Digital signal</li> <li>• Analog signal</li> <li>• Macro</li> </ul>	
Signal	Select the signal that should be influenced when the condition is fulfilled.	
Value	Enter the value that the signal in question should take on if the condition is fulfilled.	



#### 7.5.2 Graphic objects









##### *Static / dynamic graphic objects*

Static graphic objects are used for creating graphics. On the [Dynamics] tab page, you can assign dynamic properties to graphic objects.



#### NOTE

In the display, static objects are always placed behind dynamic objects.

Symbol	Object
	Line
	Curve
	Rectangle
	Symbol
	Static text
	Ellipsis
	Keypad object
	Polygon line
	Touch button





***Dynamic bitmap management***

If you activate the [Use dynamic bitmaps] checkbox for a static symbol object, the terminal will call up the specified bitmap file (namn.bmp) from the [IMAGES] library in the terminal file system. The bitmap graphic is displayed on the terminal screen in run mode. The graphic to be displayed must be transferred to the [IMAGES] library in the terminal via FTP. You can add, exchange or delete dynamic bitmap graphics via FTP. This is done by overwriting, saving or deleting BMP files in the [IMAGES] library. The image for a dynamic bitmap graphic object is displayed on the terminal in run mode only. The bitmap graphics in the library are not available in the programming software and can therefore not be displayed.

***Dynamic digital graphic objects***

Digital graphic objects are linked to signals in the controller.

Symbol	Object	Description
	Digital text	Toggles between two texts depending on the state of a digital signal.
	Digital symbol	Changes between two symbols depending on the state of the digital signal.
	Digital fill	Used for filling a framed area with one of 2 colors. The color depends on the state of the digital signal.



#### **Dynamic analog graphic objects**

Analog graphic objects are linked to registers in the controller.

Symbol	Object	Description
	Analog numeric	Input and display of numerical values.
	Bar	Displays a value in the form of a bar chart.
	Diagram	Used for drawing an x / y diagram that corresponds to the data register content.
	VU-meter	Creates a graphic VU-meter on the screen.
	ASCII	Controls ASCII character strings in graphic blocks.
	Slider	Allows for increasing or decreasing the value for an analog signal.
	Trend	Displays the values retrieved from data registers in the form of a curve.
	Speedometer	Creates a graphic speedometer on the screen.
	Analog fill	Used for filling a framed area with one of 16 colors. The color depends on the register value.
	Multiple symbol	Shows one of up to eight symbols. The symbol depends on the data register value. Allows you to move symbols on the screen.
	Multiple selection	Linked to a data register that can have up to eight different states. A text with up to 30 characters can be assigned to each state.
	Message	Object that displays texts from a message library.
	Analog numeric table	Creates a table with numeric objects.



**Other objects**

Symbol	Object	Description
	Jump	Jump to another block.
	Alarm banner	Used to display a line from the alarm list.
	Analog clock	Object to display an analog clock.
	Digital clock	Object to display a digital clock.
	TCP/IP command entry	Object for transferring a TCP/IP command to other units. Only applies for terminals that are connected to a TCP/IP network.

**Digital text**



Text object used for switching between two entered texts depending on the state of a digital signal. The text can have up to 30 characters.

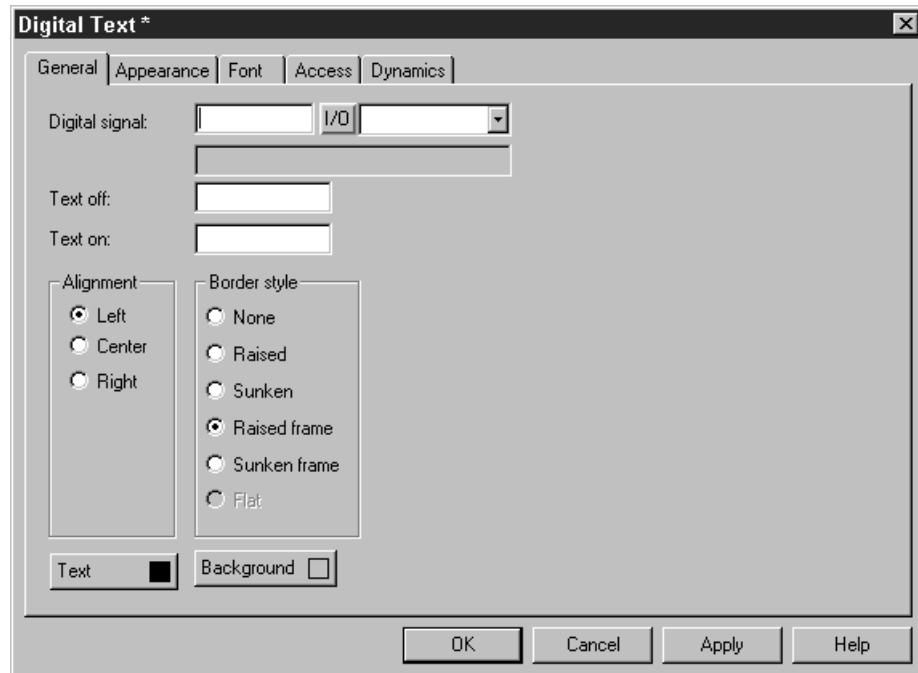

11531AEN



#### [General] tab page

Parameters	Description
Digital signal	Address of the digital signal.
Text Off	Text that is to be displayed when the signal state is 0.
Text On	Text that is to be displayed when the signal state is 1.
Alignment	Specify whether you want the text left-justified, centered or right-justified.
Border style	Specify whether you want the object to be displayed with a border.
Text	Choose a text color for the object.
Background	Choose a background color for the object.

#### Other tab pages

The functions on the [Appearance], [Font], [Access] and [Dynamics] tab pages are described in the section [General parameters] on page 135 .

#### Digital symbol



Object that is used to change between two selected symbols depending on the state of the digital signal.

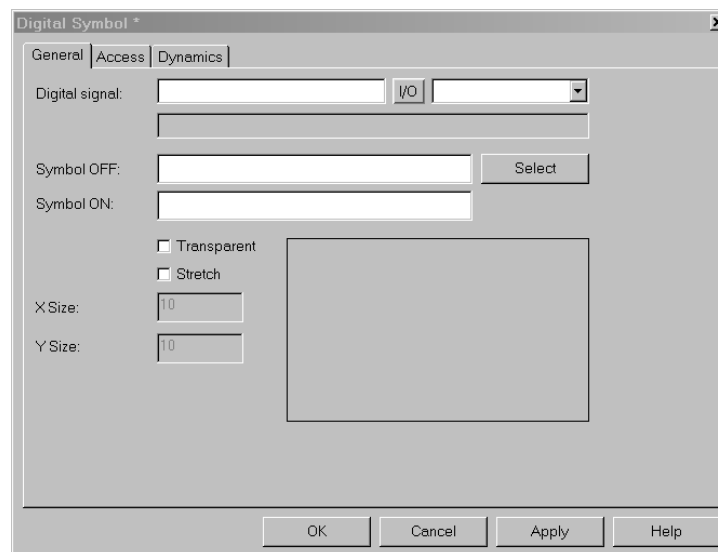

11532AEN



**[General] tab page**

Parameters	Description
Digital signal	Signal address
Symbol OFF	Select the symbol you want to have displayed when the signal state is 0.
Symbol ON	Select the symbol you want to have displayed when the signal state is 1.
Transparent	If you select this option, the symbol will be transparent. The color of the upper left pixel is defined as the transparency color.
Stretch	If you select this option, the object's x and y dimensions can be adapted using the x and y fields or by moving the cursor in the work area.

**Other tab pages**

The functions on the [Appearance], [Access] and [Dynamics] tab pages are explained in section "General parameters" on page 135 .

**Digital fill**



Object used for filling a framed area with any color.

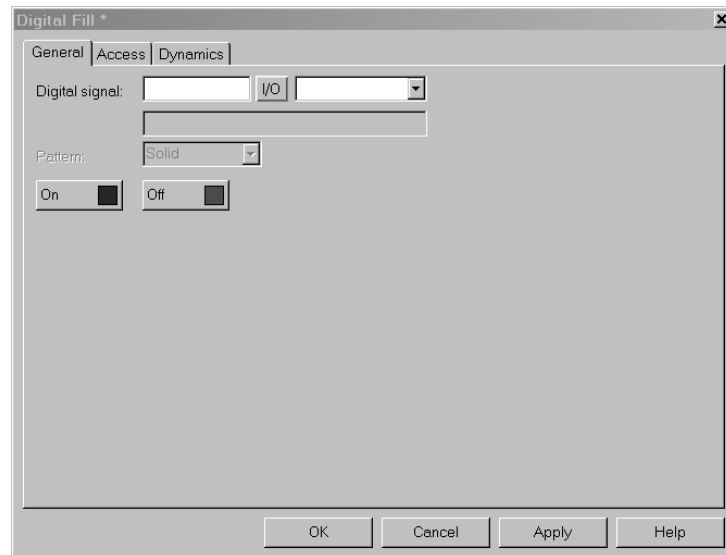

11533AEN



**NOTE**

Filling very irregular areas may lead to system errors during operation. In certain cases, the filling process will slow down the loading time of images.



#### [General] tab page

Parameter	Description
Digital signal	Address of the digital signal
On	Defines the object color for signal value 1.
Off	Defines the object color for signal value 0.

#### Other tab pages

The functions on the [Access] and [Dynamics] tab pages are explained in section "General parameters" on page 135 .

#### Object positioning

The program calculates which area will be filled. The object must therefore be positioned correctly. Incorrectly positioned objects may cause application errors during operation. The area to be filled is only limited by static objects and static parts of dynamic objects. Filled objects can be replaced by digital symbol objects or multiple symbol objects to increase efficiency within a project.

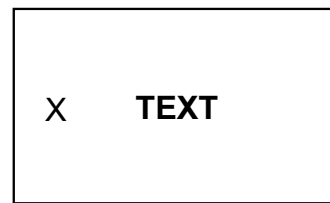
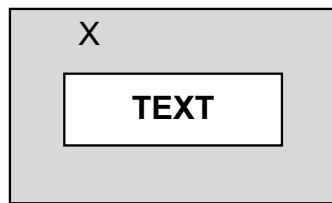

53958AXX

X = Object positioning

Correct: Draw a frame around the text in the area to be filled to speed up image loading.

Incorrect: Image loading is slowed down because the program must perform extensive calculations to fill the area between the letters.



**Jump**



Object used for jumping to another object. This object enables a menu tree to be created in the project. You can go back to the previous block (up to nine levels back) by pressing the <PREV> button on the terminal. See the section "Function keys" on page 238.

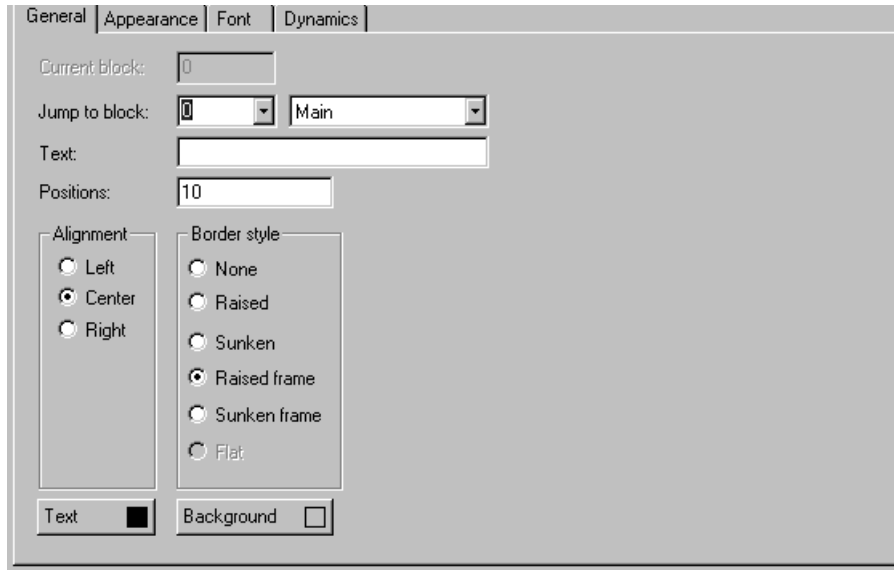

11534AEN

Figure 49: Jump to another block

**[General] tab page**

Parameters	Description
Current block	The number of the current block is displayed in this field. This number cannot be changed.
Jump to block	Enter the number or the name of the block to which you want the program to jump to.
Text	Enter any text you want to appear in the object.
Positions	Number of positions for the text
Alignment	Specify whether you want the text left-justified, centered or right-justified.
Border style	Specify whether you want the object to be displayed with a border.
Text	Choose a color for the text in the object.
Background	Choose a background color for the object.



**NOTE**

If a jump to a block that does not exist is initiated during operation, an error message will appear.

**Other tab pages**

The functions on the [Appearance], [Font] and [Dynamics] tab pages are explained in section "General parameters" on page 135 .



#### Analog numeric

03

Object for entering and displaying numerical values. This object is used, for example, for creating input fields.

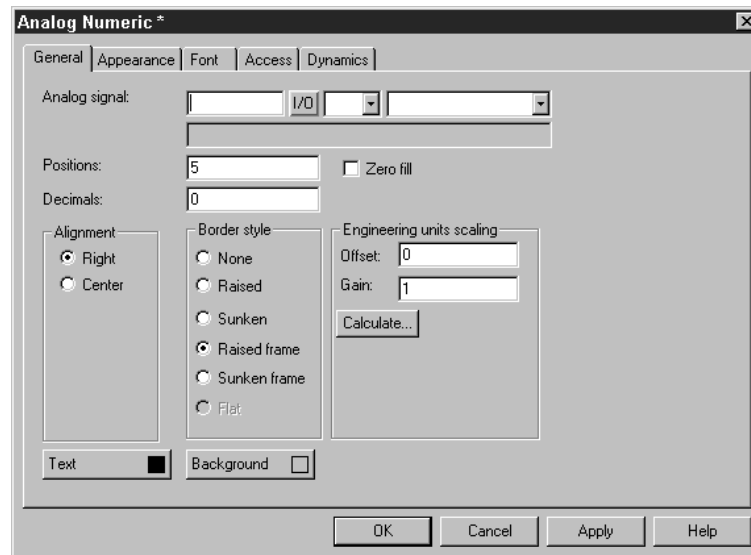

11535AEN

#### [General] tab page

Parameters	Description
Analog signal	Signal address
Positions	Number of positions for displaying the entered value including comma and minus sign.
Zero fill	Specify whether you want empty positions to be filled with zeros.
Decimals	Number of decimal places for displaying the entered value.
Alignment	Specify whether you want the input field to be formatted right-justified or centered.
Border style	Specify whether you want the object to be displayed with a border.
Engineering units scaling	These fields are used for scaling the register value. See the section "General parameters" on page 135.
Text	Choose a color for the text in the object.
Background	Choose a background color for the object.

#### Other tab pages

The functions on the [Appearance], [Font], [Access] and [Dynamics] tab pages are described in the section [General parameters] on page 135 .





**Bar chart**

Object that displays integers or floating point numbers in the form of bar charts.

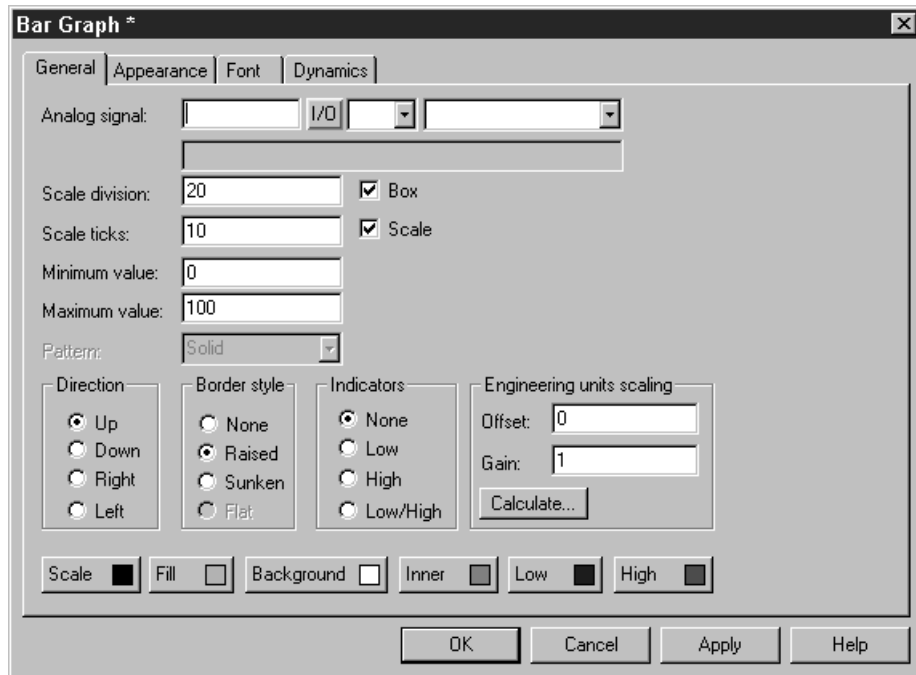

11536AEN

**[General] tab page**

Parameters	Description
Analog signal	Signal address
Scale division	Specify the scale division that should be used.
Box	Specify whether a box should be drawn around the bar.
Scale ticks	Specify the interval between the displayed scale ticks.
Scale	Select whether a scale should be displayed on the chart.
Minimum value	Specify the permitted minimum value for the signal.
Maximum value	Specify the permitted maximum value for the signal.
Direction	Specify whether you want the border to appear on the top, bottom, right, or left.
Pattern	Specify whether you want the graph to be filled completely or dot-wise.
Border style	Specify whether you want the object to be displayed with a border.
Indicators	Specify whether the highest and/ or lowest signal value should be entered on the axis. The indicators are reset when the operator terminal is started. This reset can also be performed on the operator terminal by selecting the bar chart and pressing the <Enter> key. (Point to the chart if your terminal has a touchscreen.) The indicators support 16-bit characters only (signed).
Engineering units scaling	Used for scaling the register value. See the section "General parameters" on page 135.
Scale	Choose a color for the scale in the object.
Fill	Choose a fill color.
Background	Choose a background color for the object.
Inner	Specify the color of the bar that is not filled in.
Low	Select a color for low.
High	Select a color for high.



#### Other tab pages

The functions on the [Appearance], [Font], [Access] and [Dynamics] tab pages are described in the section [General parameters] on page 135 .

#### Diagram



Object used for creating an x / y diagram that corresponds to the register content in the controller. This function is a realtime function. The object is usually used for time-independent displays. A time-dependent display with an update cycle of < 1 s is possible if the controller records the data. In the following example, the value in register 0 serves as the first x-coordinate and the value in register 10 as the first y-coordinate. There are 4 register pairs. The table and figure are provided to illustrate the example.

x-coordinate	Register	Value	y-coordinate	Register	Value
X0	0	0	Y0	10	11
X1	1	41	Y1	11	40
X2	2	51	Y2	12	85
X3	3	92	Y3	13	62

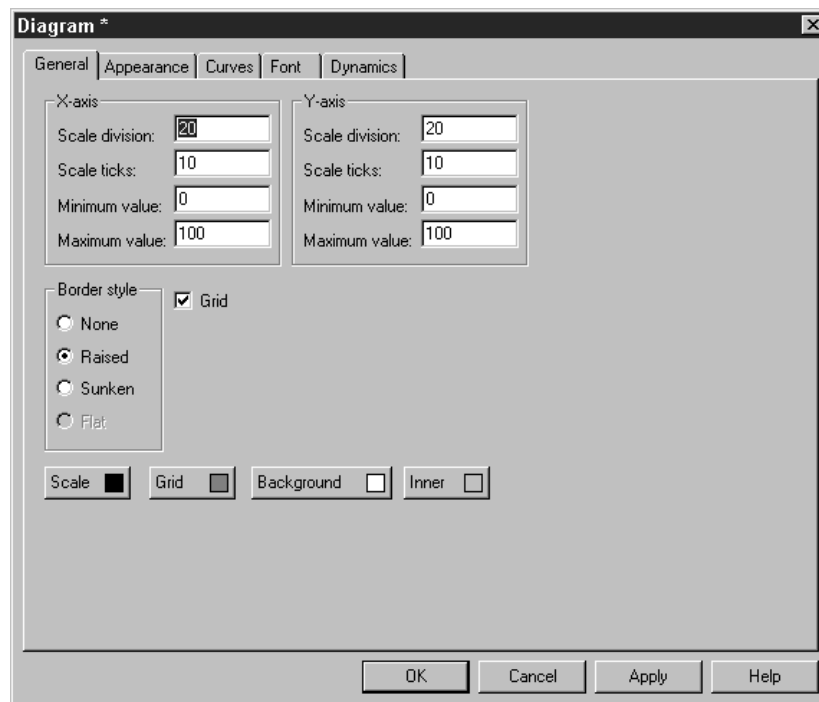

11537AEN



**[General] tab page**

Parameters	Description
Scale division	Interval between the numerical scale marks on the x and y axes.
Scale ticks	Interval between the scale ticks displayed on the x and y axes.
Minimum value	Minimum value for the x and y coordinates.
Maximum value	Maximum value for the x and y coordinates.
Border style	Specify whether you want the object to be displayed with a border.
Grid (checkbox)	Select this checkbox to display a grid in the diagram.
Scale	Choose a color for the scale in the diagram.
Grid	Choose a color for the grid in the diagram.
Background	Choose a background color for the object.
Inside	Choose a color for the inside of the object.

**[Curves] tab page**

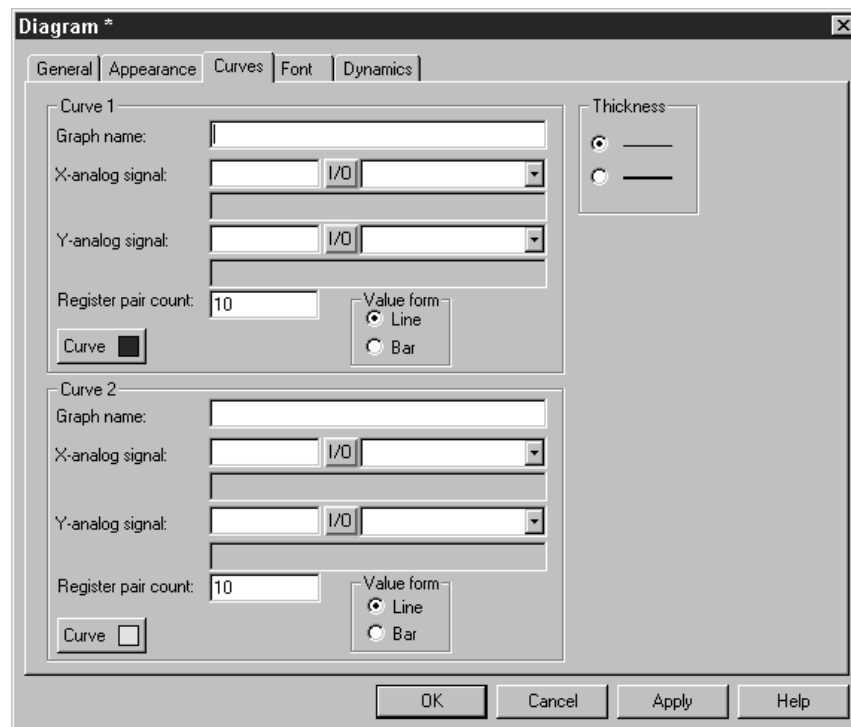

11538AEN

Parameters	Description
Graph name	Enter a name for the respective curve in this field.
X analog signal	Data register that contains the first x coordinate for the corresponding curve.
Y analog signal	Data register that contains the first y coordinate for the corresponding curve.
Register pair count	Number of register pairs to be drawn (as points or bar). A total of 49 register pairs can be used.
Value form	Specify whether you want the diagram to appear as a bar chart or line diagram. In a bar chart, a bar is drawn for each register pair. In a line diagram, the x / y coordinates are displayed as points connected with a line.
Curve	Choose a color for the corresponding curve.
Thickness	Specify the line thickness for the curve.



#### Other tab pages

The functions on the [Appearance], [Font], [Access] and [Dynamics] tab pages are described in the section [General parameters] on page 135 .

#### VU-meter



Object used for creating a graphic VU-meter on the screen.

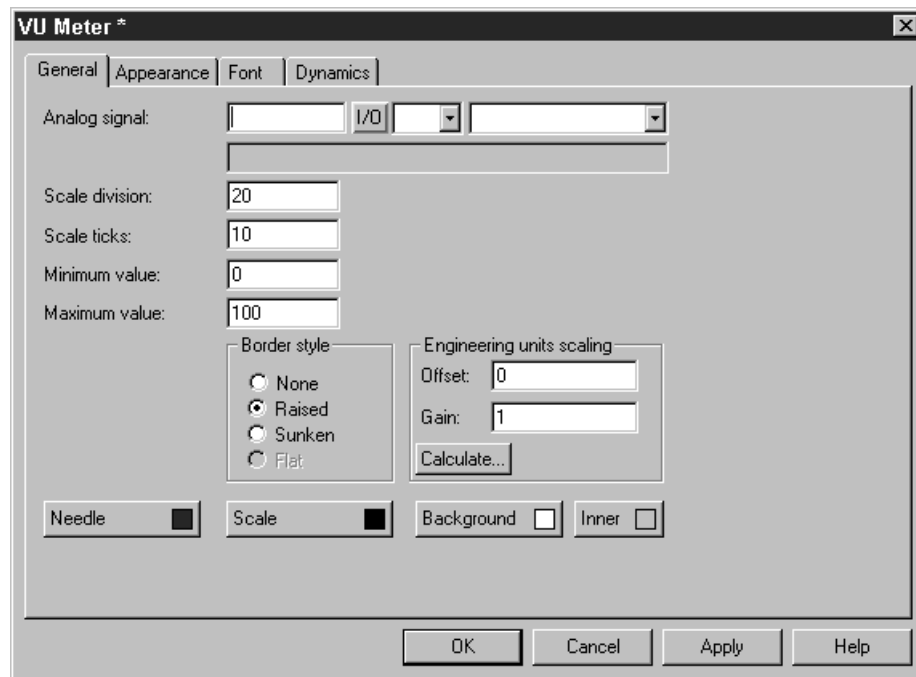

11539AEN

#### [General] tab page

Parameters	Description
Analog signal	Signal address
Scale division	Specify the scale division that should be used.
Scale ticks	Specify the interval between the displayed scale ticks.
Minimum value	Specify the permitted minimum value for the signal.
Maximum value	Specify the permitted maximum value for the signal.
Border style	Specify whether you want the object to be displayed with a border.
Engineering units scaling	Used for scaling the register value. See the section "General parameters" on page 135.
Needle	Choose a color for the pointer needle in the object.
Scale	Choose a color for the scale in the object.
Background	Choose a background color for the object.
Inner	Choose a color for the inside of the object.

#### Other tab pages

The functions on the [Appearance], [Font], [Access] and [Dynamics] tab pages are described in the section [General parameters] on page 135 .



**ASCII**



The ASCII object processes ASCII character strings. Text stored in the controller's data register can be displayed. The texts must be available in expanded IBM ASCII format. The texts can be changed in run mode from the operator terminal. To do so, open and close the input field by pressing the Enter key.

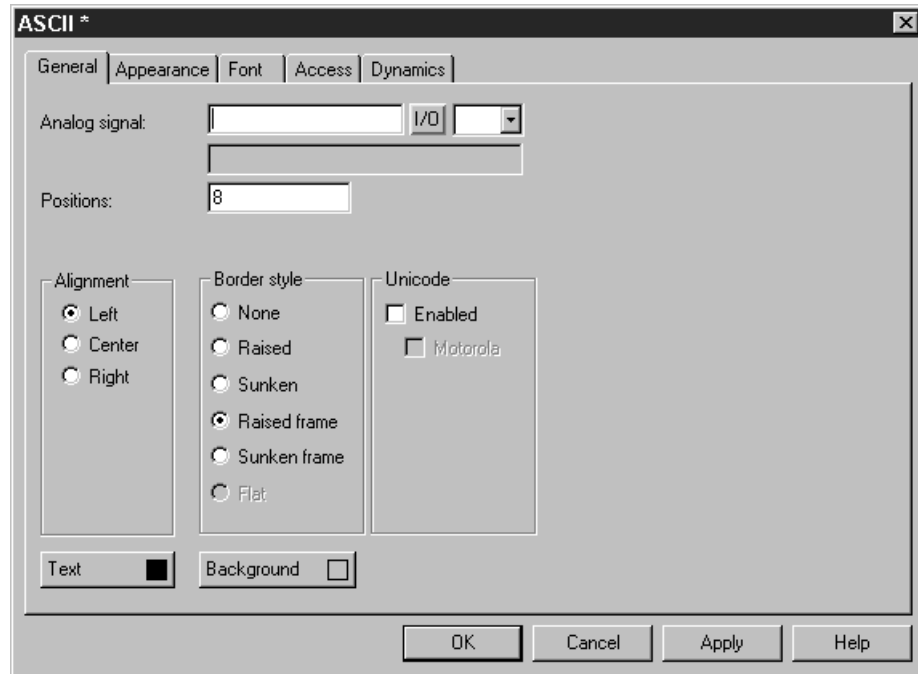

11540AEN

**[General] tab page**

Parameters	Description
Analog signal	Specify the data register where you want to store the text for the first position.
Positions	Specify the number of positions for the text on the screen.
Alignment	Specify whether you want the text left-justified, centered or right-justified.
Border style	Specify whether you want the object to be displayed with a border.
Text	Choose a color for the text in the object.
Background	Choose a background color for the object.

**Other tab pages**

The functions on the [Appearance], [Font], [Access] and [Dynamics] tab pages are described in the section [General parameters] on page 135 .



#### Slider



Object that displays the value for an analog signal in a slider and enables the value for the analog signal to be increased and decreased.

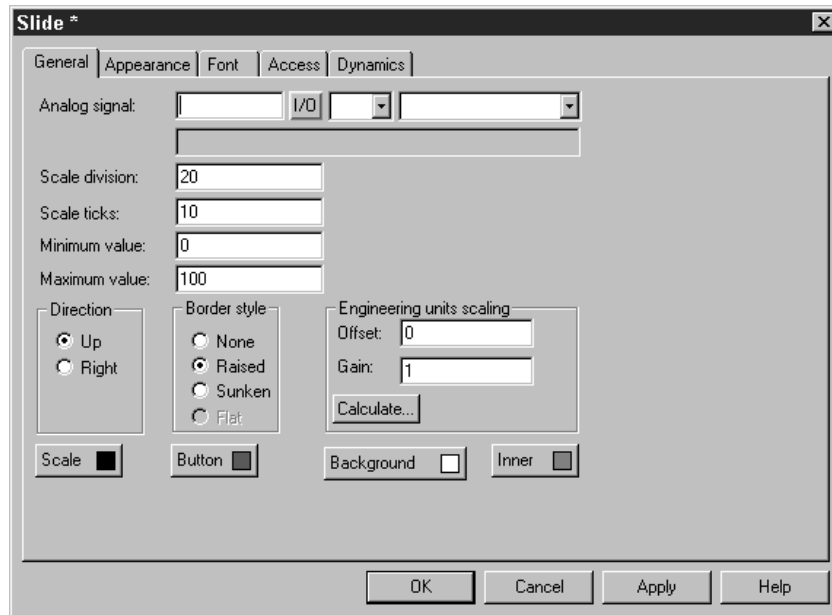

11541AEN

#### [General] tab page

Parameters	Description
Analog signal	Signal address
Scale division	Specify the scale division that should be used.
Scale ticks	Specify the interval between the displayed scale ticks.
Minimum value	Specify the permitted minimum value for the object.
Maximum value	Specify the permitted maximum value for the object.
Direction	Specify whether you want the object to be displayed vertically or horizontally.
Border style	Specify whether you want the object to be displayed with a border.
Engineering units scaling	These fields are used for scaling the register value. See the section "General parameters" on page 135.
Scale	Choose a color for the scale in the object.
Button	Choose a color for the display button in the object.
Background	Choose a background color for the slider.
Inner	Choose a color for the inside of the slider.



#### NOTE

The file format BCD floating point number without exponent cannot be used for SEW communication drivers.

#### Other tab pages

The functions on the [Appearance], [Font], [Access] and [Dynamics] tab pages are described in the section [General parameters] on page 135 .



**Trend**



Object that displays values recorded by analog signals.

You can define the following parameters for the trend object. Under [Setup] / [Terminal options], you can define whether you want to save only changed trends or all of them.

11542AEN

**[General] tab page**

Parameters	Description
Name	Enter a name for the trend object. Each object must be assigned an unambiguous name. The object name must not exceed eight characters. The characters A ... Z, 0 ... 9 and _ are permitted. The parameter is mandatory.
Sample interval	Enter a time interval for recording data. The minimum value is 1 s.
Sample count	Enter the number of values to be stored. The maximum number of values is 65534.
Sample full limit	Enter the number of samples at which the 'Sample full limit' should be activated.
Sample full signal	Specify a digital signal that should be activated when the number of samples under 'Sample full limit' has been reached.
Enable sample signal	Enter the digital signal that, if enabled, should start the process of data acquisition. Acquisition stops when the signal is reset. Parameters need not be specified.
Erase sample signal	Specify a digital signal that, if enabled, deletes all trend data in the history.



Parameters	Description
y scale	Specify whether you want the y scale to be hidden, appear left, right, or on both sides.
Minimum value	Enter a minimum value for the y axis. This value is called up by the specified register.
Maximum value	Enter a maximum value for the y axis. This value is called up by the specified controller register.
Scale division	Specify which scale division should be used on the y axis.
Scale ticks	Specify the interval between the displayed scale ticks.
Time scale	
Time range	Enter the time range that should be displayed in the trend diagram.
Scale division	Specify which scale division should be used on the x axis.
Scale ticks	Specify the interval between the displayed scale ticks.
Border style	Specify whether you want the object to be displayed with a border.
Grid	Specify whether you want to display a grid in the object.
Scale	Choose a color for the scale in the object.
Grid	Choose an appropriate color for the grid.
Background	Choose a background color for the object.

#### [Curves] tab page

11543AEN

Parameters	Description
Analog signal	Analog signals that the object records and for which the values should be displayed. Only 16-bit numbers may be used.
Color	Choose the color for the corresponding curve. For DOP11B-20, you can also choose between <i>Dotted</i> or <i>Continuous</i> curves.
Offset and gain	Used for scaling the register value. See the section "General parameters" on page 135.





### Other tab pages

The functions on the [Appearance], [Font], [Access] and [Dynamics] tab pages are described in the section [General parameters] on page 135 .



### NOTE

If you copy a block with trend data, you will have to rename the trend object. Do not use the same name for two trend objects.

### Speedometer



Object for creating a graphic speedometer on the screen.

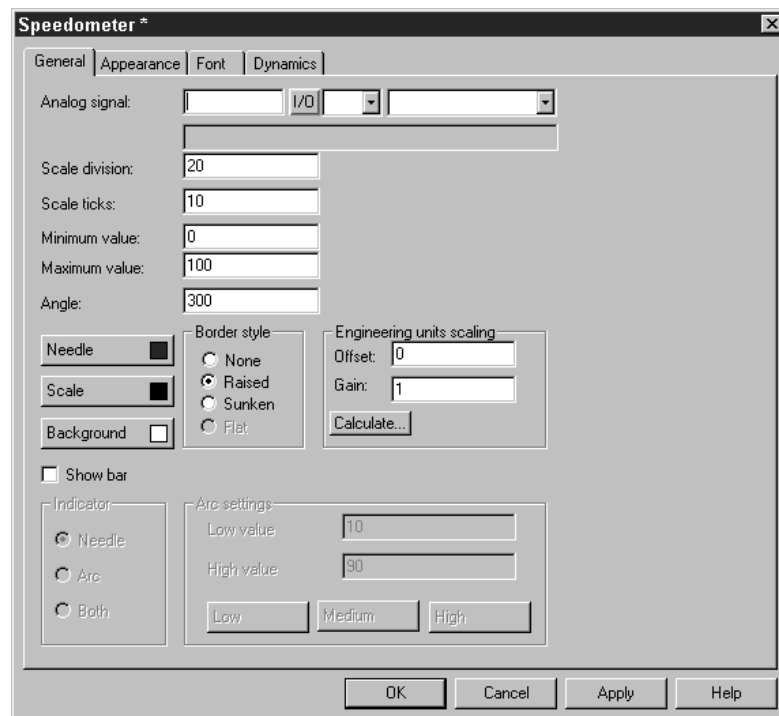

11544AEN



#### [General] tab page

Parameters	Description
Analog signal	Signal address
Scale division	Specify the scale division that should be used.
Scale ticks	Specify the interval between the displayed scale ticks.
Minimum value	Specify the minimum value that the speedometer can display.
Maximum value	Specify the maximum value that the speedometer can display.
Angle	Specify an angle (work area for the object) between 10 and 360 degrees.
Scaling for technical units	These fields are used for scaling the register value. See the section "General parameters" on page 135.
Border style	Specify whether you want the speedometer to be displayed with a border.
Needle	Choose a color for the pointer needle in the speedometer.
Scale	Choose a color for the scale.
Background	Choose a background color for the speedometer.
Show bar	Select this checkbox to show a bar for the speedometer. Activating this option means the associated configuration options are available.
Pointer	Choose <i>Needle</i> , <i>Arc</i> or <i>Both</i> .
Arc settings	Define minimum and maximum values and the colors for the different ranges.

#### Other tab pages

The functions on the [Appearance], [Font], [Access] and [Dynamics] tab pages are described in the section [General parameters] on page 135 .



**Alarm banner**

Object used for displaying a line in the alarm list.

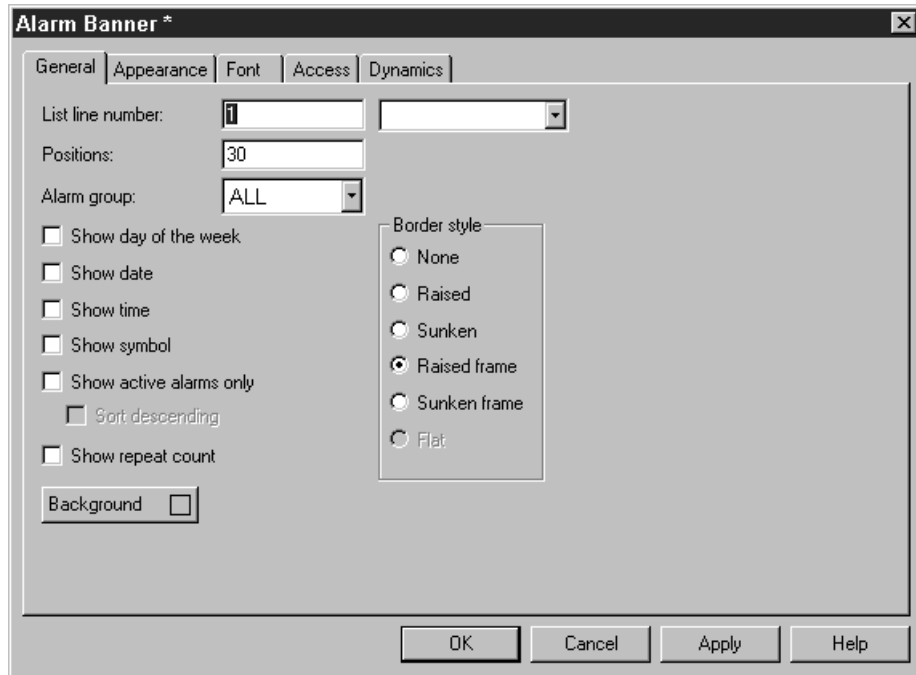

11545AEN

**[General] tab page**

Parameters	Description
Line number	Enter the line number in the alarm list from which you want to retrieve information (1=first line, 2=second line, etc.) when the specified alarm group is shown in the alarm list.
Positions	Enter the number of positions to be displayed. The maximum length (date, time and alarm text) is 101 characters.
Alarm group	Specify the alarm group you want to display. The object is shown in the color defined for the alarm group.
Show day of the week	Select whether you want the week day to be displayed.
Show date	Select whether you want the date to be displayed.
Show time	Select whether you want the time to be displayed.
Show symbol	Select whether you want alarm symbols to be displayed. See the section "Alarm management " on page 201.
Show active alarms only	Choose whether only active alarms should be displayed in the alarm banner. If no active alarm has been triggered, the alarm banner remains empty. An alarm does not have to be acknowledged, just inactive, so that the next alarm can be displayed in the alarm banner.
Sort descending	Display the active alarms in descending order, i.e. the most recent active alarm is displayed. Only possible if you have selected <i>Show active alarms only</i> .
Show repeat count	Select whether you want the repeat counter to be displayed. The repeat counter indicates how often the alarm has been repeated. See the section "Alarm management " on page 201.
Border style	Specify whether you want the alarm banner to be displayed with a border.
Background	Choose a background color for the alarm banner.



#### NOTE

To acknowledge an alarm in the alarm banner, you must activate the [Enable acknowledge] checkbox on the [Access] tab page.

The foreground color for the alarm text is specified by the color defined for the alarm group.

#### Other tab pages

The functions on the [Appearance], [Font], [Access] and [Dynamics] tab pages are described in the section [General parameters] on page 135.

See also the section "Alarm management" on page 201.

#### Analog fill



The analog fill object fills a box with color. The color depends on the register value (see table below).

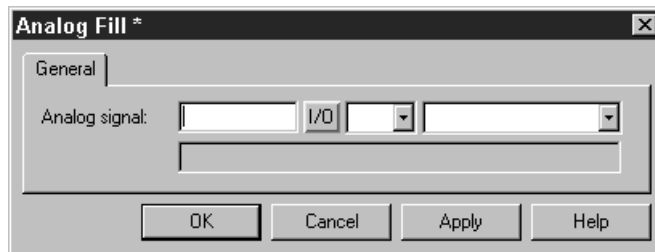

11546AEN

Parameters	Description
Analog signal	Enter the data register whose content controls the object color. See the table below.

Register content	Color	Register content	Color
0	Black	8	Gray
1	Blue	9	Light blue
2	Green	10	Light green
3	Cyan	11	Light cyan
4	Red	12	Light red
5	Magenta	13	Light magenta
6	Yellow	14	Light yellow
7	Light gray	15	White

For limitations and information on object positioning, see the section "Digital fill" on page 149.



**Analog clock**

Time object for displaying an analog clock.

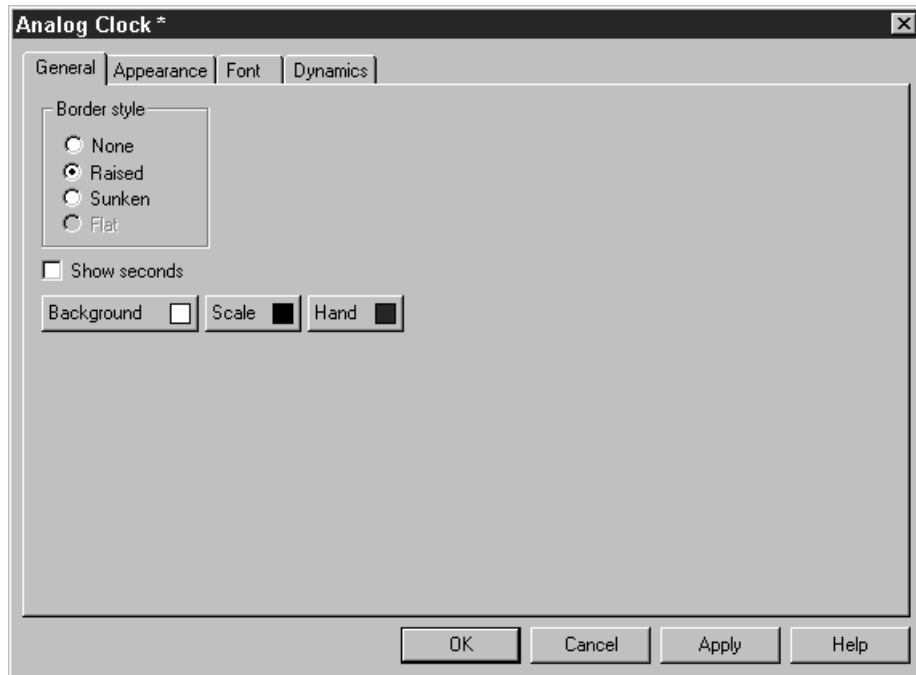

11547AEN

**[General] tab page**

Parameters	Description
Border style	Specify whether you want the clock to appear with a border.
Show seconds	Select whether you want a second hand to be displayed.
Background	Choose a background color for the clock.
Scale	Choose a color for the scale in the object.
Hand	Choose a color for the hand in the object.



**NOTE**

You have to specify a maneuverable date / time object (digital clock) to set the clock in run mode.

**Other tab pages**

The functions on the [Appearance], [Font] and [Dynamics] tab pages are explained in section "General parameters" on page 135 .



**NOTE**

Further setting options are available under [Setup] / [Date/time format].



#### Digital clock



Time object for displaying the digital clock, week day and date.

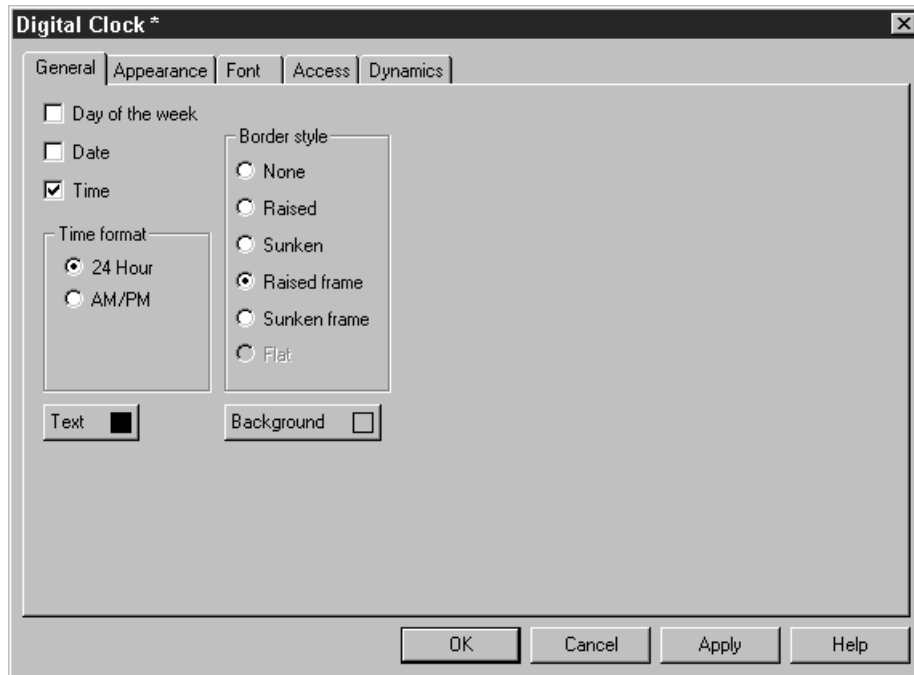

11548AEN

#### [General] tab page

Parameters	Description
Day of the week	Select whether you want the week day to be displayed.
Date	Select whether you want the date to be displayed.
Time	Select whether you want the time to be displayed.
Time format	Choose whether the time should be displayed in 12 or 24 hour mode.
Border style	Specify whether you want the object to be displayed with a border.
Text	Choose a color for the text in the object.
Background	Choose a background color.



#### NOTE

You have to specify a maneuverable date / time object (digital clock) to set the clock in run mode.



**Other tab pages**

The functions on the [Appearance], [Font], [Access] and [Dynamics] tab pages are described in the section [General parameters] on page 135 .

	<b>NOTE</b>
	Further setting options are available under [Setup] / [Date/time format].

**Multiple symbol**



Object that can display one of up to 16 symbols. The symbol depends on the data register value.

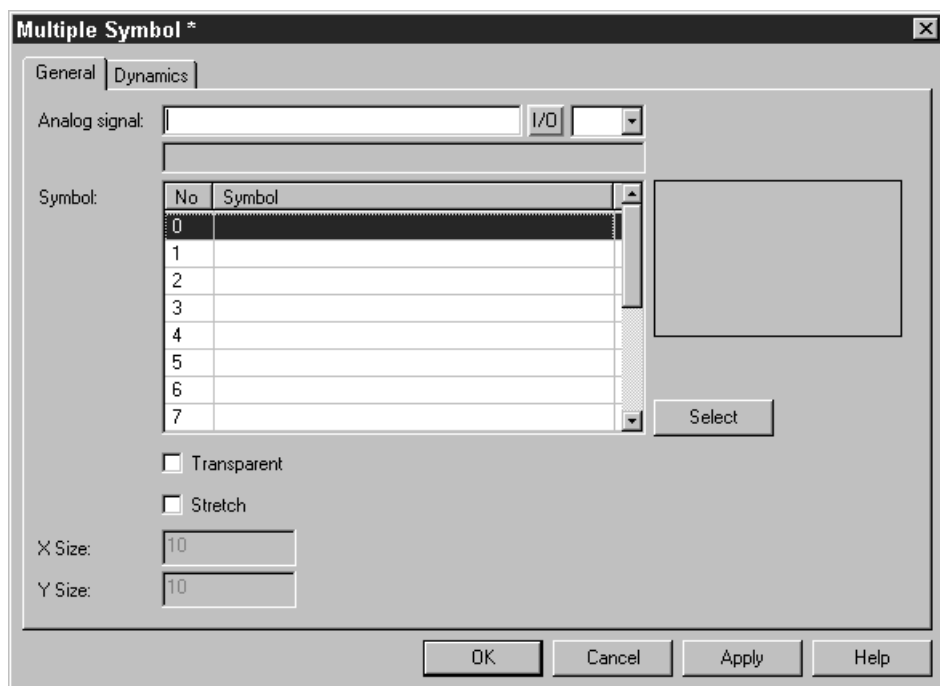

11549AEN

**[General] tab page**

Parameters	Description
Analog signal	Data register that controls the symbol to be displayed. If the register value is 1, symbol 1 will be displayed, etc.
Symbol 0 ... 15	Select the symbol you want to display. If the register value is 0, symbol 0 will be displayed, etc.

**[Dynamics] tab page**

The functions on this tab page are explained in the section "General parameters" on page 135 .



#### Multiple selection



Object that can exist in several states. The object is linked to a data register that can have up to eight different states. A text with up to 30 characters can be assigned to each state.

11550AEN

#### [General] tab page

Parameters	Description
Analog signal	Data register that controls the text to be displayed. If the register value is 1, text 1 will be displayed, etc.
Text 0 ... 7	Enter the texts that should be displayed for each object status.
Activate input 0 ... 7	Activate the corresponding checkbox to maneuver the object to this status from the terminal in run mode.
Alignment	Specify whether you want the text left-justified, centered or right-justified.
Border style	Specify whether you want the object to be displayed with a border.
Text	Choose a color for the text in the object.
Background	Choose a background color for the object.

#### Other tab pages

The functions on the [Appearance], [Font], [Access] and [Dynamics] tab pages are described in the section [General parameters] on page 135 .

#### Touch key



Only applies to DOP11B-25, -30 and -50. See the sections "Using touchscreen" on page 177 and "Function keys" on page 238.

This object creates a touch-sensitive surface that corresponds to a function key. It can





be used to change the display, control memory cells, etc.

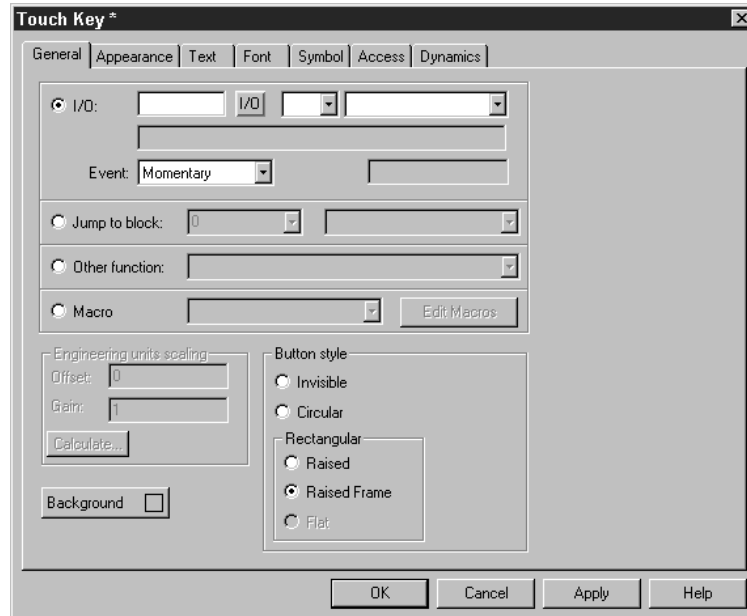

11551AEN

**[General] tab page**

Parameters	Description
I/O	Signal type influenced by the object. For a description of the predefined functions, see the section "Function keys" on page 238.
Event	Choose how the object should affect the signal. Use the option <i>Set</i> to activate the signal when the object is triggered.
Set	Press the touch key to set the signal to high.
Grouped	All signals belonging to a touch key with current group number are reset. The group number is specified under <i>Group no.</i> A group comprises a maximum of eight touch keys.
Decrease analog	In this field, the analog signal linked to the function key is decreased by the value entered under <i>value</i> .
Temporary	The signal is activated as long as the object is pressed.
Reset	The signal is reset when the object is pressed.
Specify analog	In this field, the analog signal linked to the function key is assigned the value defined under <i>value</i> .
Toggle	The signal is activated and reset alternately when the object is pressed.
Increase analog	The analog signal linked to the function key is increased by the value defined under <i>value</i> .
Set analog	Can be used to influence an analog object. A screen keyboard appears that can be used to enter a value.



Parameters	Description
Jump to block	Jumps to a different block when the object is influenced. Enter the number or name of the block to which you want the program to jump.
Other functions	For a description of the functions, see the section "Function keys" on page 238.
Macro	For a description of the function, see the section "Macros" on page 246.
Button style	Choose the required button style: Round, rectangular or invisible.
Background	Choose a background color for the object.
Text	You can enter up to 5 lines of text. You can set the position of the text. The font size remains the same, even if the size of the touch key is changed.
Symbol	You can label the touch key with a symbol. You can set the position of the symbol. If you activate the option <i>Stretch</i> on the [Symbol] tab page, the symbol covers the entire touch key.

You can use an invisible touch-sensitive area to define areas that make it possible to jump between blocks in an overview (e. g. for a machine). The detailed views are linked to invisible touch-sensitive areas that are positioned at certain parts of the machine. Pressing one of these areas will display the corresponding detailed view.

#### Other tab pages

The functions on the [Appearance], [Font], [Access] and [Dynamics] tab pages are described in the section [General parameters] on page 135 .



**Message**



Object that displays texts from a message library.

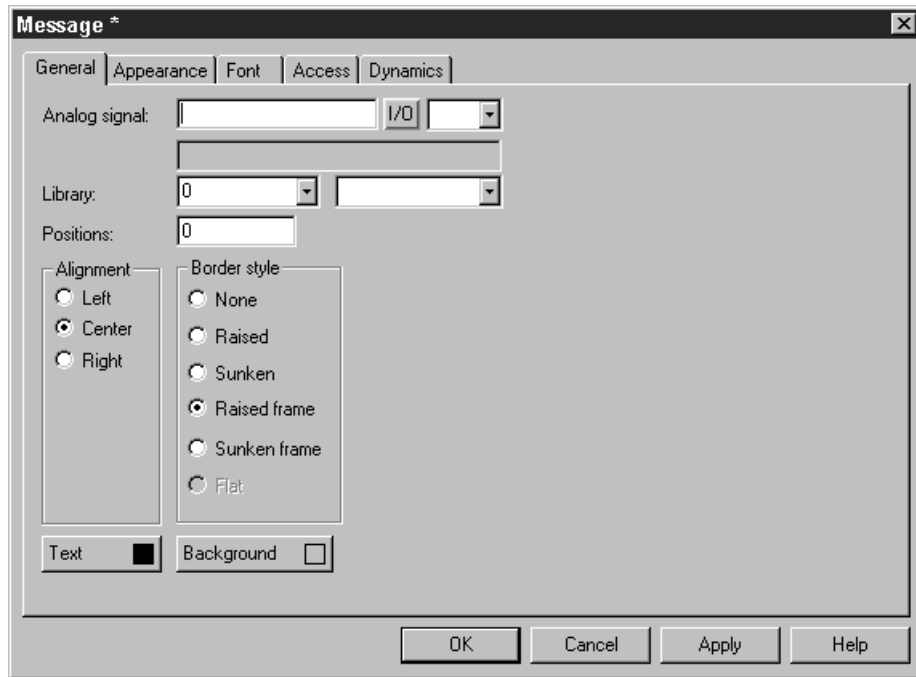

11552AEN

**[General] tab page**

Parameters	Description
Analog signal	Analog signal that controls which text from the selected message library is displayed.
Library	Select the number of the required message library. It is defined under [Functions] / [Message library].
Positions	Specify the number of positions for displaying text; 0=automatic length adjustment.
Alignment	Specify whether you want the text left-justified, centered or right-justified.
Border style	Specify whether you want the object to be displayed with a border.
Text	Choose a color for the text.
Background	Choose a background color for the object.



**NOTE**

When using the function for an indexed message library, the number of positions must not be 0, otherwise automatic length adjustment will not work.  
For more information, see the section "Message library" on page 199.



#### [Access] tab page

The required maneuvering range is set on the [Access] tab page. An area with a maximum of 64 texts can be maneuvered in run mode. Enter the number of the first and last texts in the area.

#### Other tab pages

The functions on the [Appearance], [Font], [Access] and [Dynamics] tab pages are described in the section [General parameters] on page 135 .

#### Analog numeric table



Object used for creating a table with analog numeric objects.

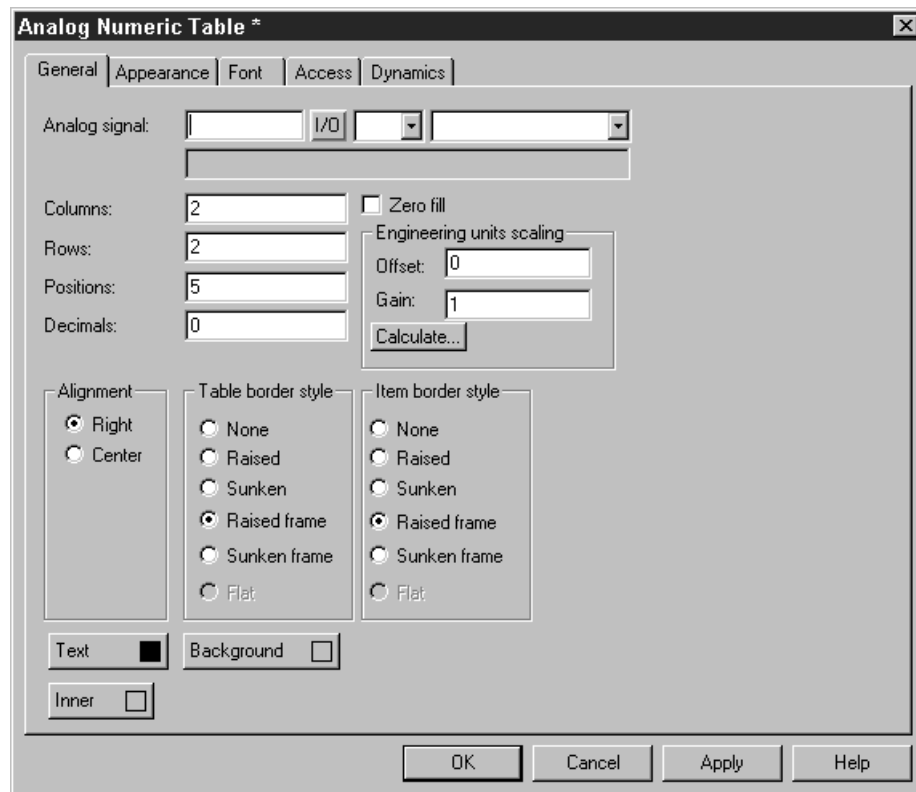

11553AEN

#### [General] tab page

Parameters	Description
Analog signal	The first signal that appears in the table. Only 16-bit registers are supported.
X size	Specify the number of table columns.
Zero fill	Specify whether you want empty positions to be filled with zeros.
Y size	Specify the number of table rows.
Positions	Specify the number of positions that should be used to display the entered value.
Decimals	Specify the number of decimal points that should be used to display the entered value.

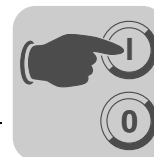

Parameters	Description
Alignment	Specify whether you want the input field to be formatted right-justified or centered.
Table border style	Specify whether you want the table to appear with a border.
Item border style	Specify whether you want each table cell to be displayed with a border.
Text	Choose a color for the text in the object.
Background	Choose a background color for the table.
Inside	Choose an inside color for the table.
Engineering units scaling	These fields are used for scaling the register value. See the section "General parameters" on page 135.

#### [Access] tab page

Enter the table orientation in the [Access] tab page. The table signals are calculated according to the chosen orientation.

#### Other tab pages

The functions on the [Appearance], [Font] and [Dynamics] tab pages are explained in section "General parameters" on page 135 .

	<b>NOTE</b>
	Minimum and maximum values are only used when the object is a maneuverable object.



#### 7.5.3 Operating graphic blocks

Not applicable for DOP11B-25, -30 and -50.

Press the arrow keys to switch between maneuverable objects. A selected object is identified by a flashing border.

##### **Selecting maneuverable objects**

Press the arrow keys to change between maneuverable objects. The objects are selected according to the following principle:

The cursor is positioned in the middle of a cross. Pressing the right arrow key selects the first object located in area "A" (see figure). If the system cannot find an object in the narrow strip on the right, it searches area "a". Press the down arrow key to search for objects in areas "B" and "b". Press the left arrow key to search in areas "C" and "c". Press the up arrow key to search objects in areas "D" and "d".

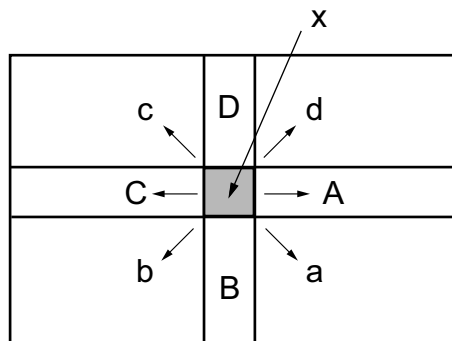

53964AXX

x = cursor position

##### **Digital objects**

Digital objects, text objects, symbol objects and filled objects change their state when the Enter key is pressed. If the functions for increasing and decreasing are linked to function keys, the signal linked to the object with these keys will be enabled or reset.

##### **Analog objects**

###### **ASCII objects**

Move the cursor over the object and press the Enter key. Enter the required text and confirm the entry by pressing the Enter key.

###### **Message objects**

Move the cursor over the object and press the Enter key. A selection list with all available states opens. Select the required state and press the Enter key. This way, you define the analog signal linked to the object.



### Multiple selection objects

Move the cursor over the object and press the Enter key. A selection list with all available states opens. Select the required state and press the Enter key. This way, you define the analog signal linked to the object.

### Numeric objects

To control a numeric object, enter a value and press the Enter key. If the value entered is too high or too low, the minimum or maximum value for the object will be displayed. This information will also be issued if you press the Enter key while the object is maneuverable.

### Numeric table objects

If a table object is highlighted, press the Enter key to select the first table row. You can now move the cursor over the cells using the arrow keys. Change the value of a selected cell and press the Enter key.

### Slider objects

You control the object using the arrow keys by moving the cursor over the object and pressing the Enter key. You can now increase or decrease the value using the arrow keys. Confirm your entry by pressing the Enter key. The value increases or decreases by the number that corresponds to the object setting under scale ticks. Complete the process by pressing the Enter key.

This object can also be increased and decreased using the functions. To do so, the object must be linked to function keys. See the section "Function keys" on page 238.

### Bar objects

To change (reset) the minimum and maximum indicators for a specific value in bar objects, place the cursor on the object and press the Enter key.

In terminals with a touchscreen, you can reset the minimum and maximum indicators by touching the bar.



#### Trend objects

In run mode, trend curves can display ongoing values. Select the required trend object and press the Enter key. This opens a dialog box. Select a time interval and date for the data to be displayed. "History" is displayed at the bottom of the dialog box. To go back to real-time display, press the Enter key again. The trend data is stored in files. You specify the name when defining the trend object.



10657AXX

#### Other objects

#### Digital clock

The digital clock (real-time clock) is set by selecting the object and entering the required time. To complete the process, press the Enter key.



#### NOTE

If you use the controller clock, you have to set the time in run mode.

#### Jump objects

Select the required object and press the Enter key.





#### 7.5.4 Using the touchscreen

This section refers only to DOP11B-25, -30 and -50.

Terminals with a touchscreen do not have a built-in keyboard. The system is controlled using the touchscreen functions only. You should always touch only one spot on the touch-sensitive screen. If you touch two spots at the same time, the spot between the two spots you have touched will be chosen.

	<b>NOTE</b>
	<p>When using terminals with a touchscreen, objects CANNOT be controlled in the text block.</p> <p>If you touch a non-maneuverable object, the message "Not maneuverable" will appear. If you touch a password protected object, the message "Access denied" will appear.</p>

#### **Digital objects**

Digital objects, text objects, symbol objects and filled objects change their state when you touch them with your finger.

#### **Analog objects**

##### **ASCII objects**

Touch the object with your finger. This displays an alphanumeric keyboard on the screen. Enter the required text by touching the keyboard. Complete your entry by pressing the Enter key.

##### **Multiple selection objects**

Touch the object with your finger to open a selection list. To choose an object from the list, touch it with your finger.

##### **Numeric objects**

Touch the object with your finger. The numeric keyboard will be displayed. Enter the required value by touching the keyboard. Complete your entry by pressing the Enter key.

##### **Numeric table objects**

Touch a cell in the table object with your finger. The numeric keyboard will be displayed. Enter the required value by touching the keyboard. Complete your entry by pressing the Enter key.

##### **Slider objects**

Control the object by touching and dragging the buttons.



#### Bar chart objects

Press the bars to reset the minimum/maximum indicators.

#### Trend objects

In run mode, trend curves can display ongoing values. Touch the object with your finger. A button toolbar is shown below the trend.

Double arrow	Scrolls the trend horizontally by one screen
Single arrow	Scrolls the trend horizontally by half a screen
-	Maximizes the trend display
+	Minimizes the trend display
^	Returns to the basic setting

To go back to real-time display, click on the object again.



10658AXX

#### Other objects

##### Digital clock

Touch the object with your finger. The numeric keyboard will be displayed. Enter the required time by touching the keyboard. Complete your entry by pressing the Enter key.

##### Jump objects

Touch the object with your finger to perform a jump.



**Alphanumeric keypad**

The alphanumeric keypad appears, for example, when controlling an ASCII object.

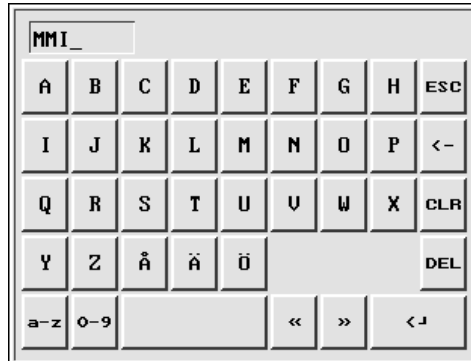

10659AXX

Key	Description
A-Z	These keys are used for entering the required text.
ESC	Hides the keyboard and returns to the previous menu.
<-	Deletes one character left of the current position.
CLR	Clears all characters you entered.
DEL	Deletes the character where the cursor is currently positioned.
	Confirms the setting made and hides the keyboard.
@	Used to type the @ character.
>>	Moves the cursor to the right.
<<	Moves the cursor to the left.
a-z	Toggles between upper and lower case.
0-9	Toggles between letters, numbers, and special characters.
SPC	Opens a selection list with special characters.
MAIL	Opens a list with e-mail addresses.

**Selection lists**

Selection lists are displayed in addition to alphanumeric and numeric keyboards.

Use the arrows in the selection list to view the top or bottom entry. To close the list without selecting any entry, press [CANCEL].



10660AXX

**7.6 Text-based display and control**

Text blocks are only used for printouts and reports. With the exception of DOP11B-20 (which can display text blocks), they cannot be displayed by operator terminals in the DOP11B series.

The text display is used to create different types of report printouts and e-mails e.g. daily reports, status reports, etc.

Reports consist of text blocks, which can include both static and dynamic text. The structure of a report is described in the section "Printing reports" (page 225).

This section describes the text objects.

**NOTE**

Text-based printouts are not supported when using Unicode.

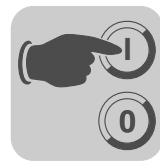

### 7.6.1 General parameters

#### Scaling for technical units

The *offset* and *gain* parameters are used to scale the register value to a display value according to the following formula.

$$\text{Display value} = \text{offset} + \text{gain} \times \text{register value}$$

If you alter the value for an object via the terminal in run mode, the display value will be scaled according to the following formula.

$$\text{Register value} = (\text{display value} - \text{offset}) / \text{gain}$$

The scaling affects neither the defined maximum/minimum values nor the number of decimal places.

	<b>NOTE</b>
	The functions for increasing/decreasing values affect the register value for the maneuverable object but not the display value.

#### Calculating technical units

The [offset/gain calculation] function serves as a tool for calculating the parameters *offset* and *gain*. Enter the value for the *offset* and *gain* of the object on the [General] tab page and click on [Calculate]. The following dialog box opens.

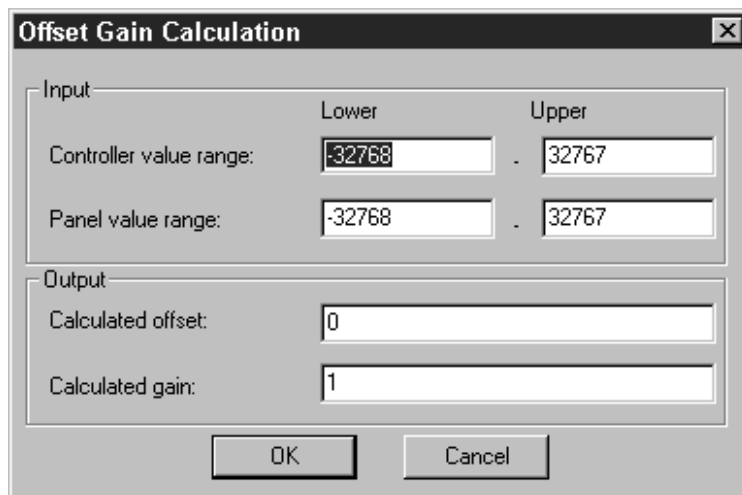

10591AEN

Enter the range for the controller and terminal values. The function determines the correct values for the *offset* and *gain* parameters.



#### Access

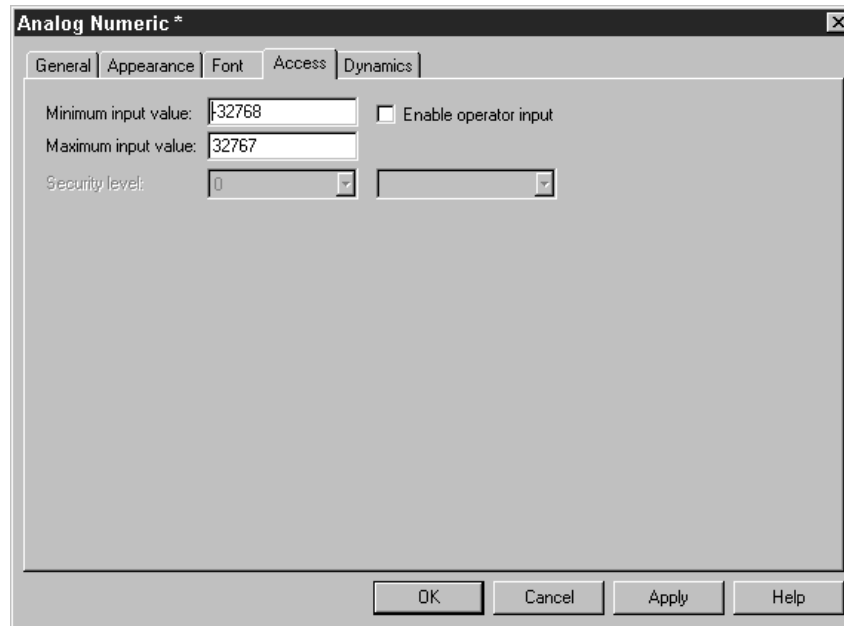

11526AEN

Under [Access], define whether the object should be maneuverable. Enter the minimum and maximum values. You can also specify the security level for the object. Security levels are defined under [Functions] / [Passwords]. See the section "Passwords" (page 222).

#### Message

The [Message] dialog box looks as follows:

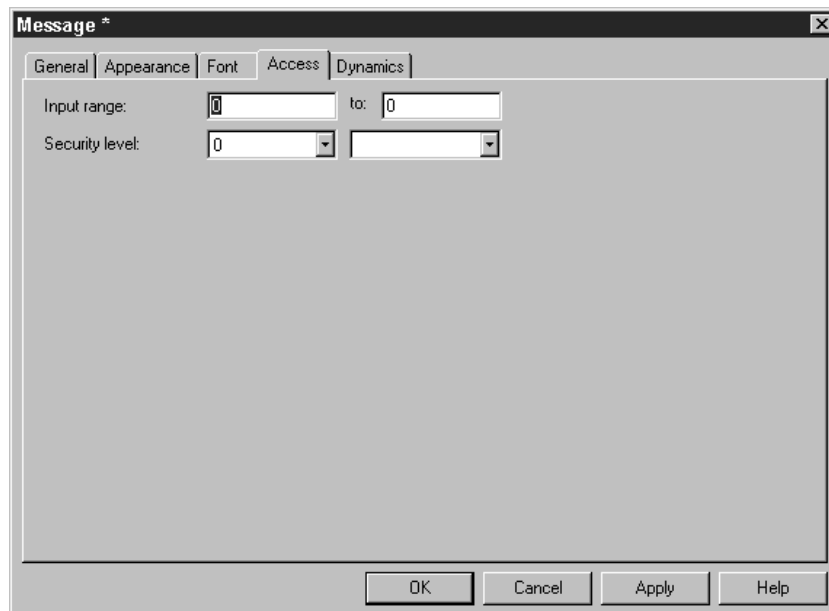

11555AEN

Enter the [Input range] for the first and last text in the area. An area with a maximum of 64 texts can be maneuvered in run mode.

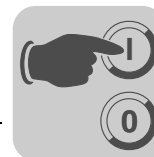

## 7.6.2 Text objects

### *Dynamic text objects*

Symbol	Object	Description
	Analog numeric	Displays the value in numerical form.
	Digital clock	Set date and time.
	Digital text	Toggles between two texts depending on the state of a digital signal.
	Multiple selection	Linked to a data register that can have up to eight different states. A text with up to 30 characters can be assigned to each state.
	Jump	Jump to another block.
	Bar chart	Displays values in the form of a bar chart.
	ASCII	Controls ASCII character strings.
	Message	Object that displays text from a message library.



#### 7.6.3 Operating text blocks

A text block consists of rows of text with static and dynamic objects. The dynamic objects indicate the current state of signals to which the objects are linked. Certain dynamic objects can be maneuvered. Their status can be changed in run mode.

To change a maneuverable object, use the arrow keys and move the cursor over the object you want to change. Text blocks can be scrolled vertically but not horizontally.

	<b>NOTE</b>
	Objects in text blocks cannot be controlled when using terminals with a touchscreen.

#### **Digital objects**

Digital objects are operated by selecting the required object. Press the Enter key to change the object status.

#### **Analog objects**

##### **Analog objects and date / time objects**

To operate these objects, move the cursor over the required object. Enter the new value. Complete your entry by pressing the Enter key. You can reject any changes you make before you press the Enter key. To do so, exit the field using the [↑] or [↓] key. The original value will be retained.

##### **Text objects**

To operate a text object, select it and press the Enter key. This opens an input field. The input field will appear in the first or last line depending on the position of the object on the screen. If the text is longer than the width of your screen, the input field will be scrolled. Press the Enter key to confirm your entry.

##### **Message objects**

To operate a message object, use the arrow keys to move the cursor to the required object and press the Enter key. A selection list with all available states is displayed on the screen. Select the required state and press the Enter key. The analog signal linked to the object will be changed.



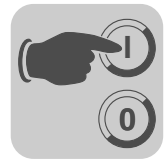

### Multiple selection objects

To operate a multiple selection object, use the arrow keys to move the cursor to the required object and press the Enter key. A selection list with all available states is displayed on the screen. Select the required state and press the Enter key. The analog signal linked to the object will be changed.

### Jump objects

Select the required object and press the Enter key.

### Bar objects

You can set the indicators for the minimum and maximum values to the current value for the bar object. To do so, select the object and press the Enter key.

## 7.7 Transferring projects

Before a project can be used on the operator terminal, it must be transferred from the PC to the terminal.

Connect the PC with the configuration software to the operator terminal via the PCS11B cable (see page 32) or ETHERNET (see page 37).

### 7.7.1 Setting up your terminal

You do not usually have to make any settings in the terminal. The project transfer process is controlled by the HMI-Builder. If required, you can set the transfer parameters in the terminal in configuration mode under [Setup] / [Port parameters] / [HMI-Builder].



#### NOTE

The communication settings for the HMI-Builder and terminal must match.



#### 7.7.2 Transfer properties

The transfer is controlled from the HMI-Builder. In the HMI-Builder, you can set transfer properties under [Transfer] / [Project].

11247AEN

Parameters	Description
Percent complete	Progress indicator that displays the upload status in percentage completed.
Byte counter (kB)	Indicates how many kB have already been uploaded.
Time elapsed	Indicates how much time has elapsed since the send, receive, or verify functions were performed.
Status	Indicates the transfer status and the project section that is currently being transferred, such as properties, individual blocks, alarm groups, individual symbols and function keys.
Information	Displays the driver that is to be loaded to the terminal.
Retries	If problems occur during the upload, the HMI-Builder will retry the upload several times before aborting the process.
Terminal version	Displays the current terminal type and version number of the system program after the connection with the terminal is established.
Test project on send	Using this option automatically verifies the project before transfer.
Automatic terminal RUN / TRANSFER switching	If this checkbox is enabled, the terminal will automatically switch to transfer mode. The terminal will return to the previous state once the transfer is complete.
Check terminal version	If this option is enabled, the system program version of the terminal will be compared with the project version set in the HMI-Builder.
Send complete project	Specify whether you want to send the complete project.



Parameters	Description	
Partial send options	Block	
	No	No blocks are transferred to the terminal.
	All	All blocks are transferred to the terminal.
	From To	Specify the block sequence to be transferred to the terminal.
	Alarms	Specify whether you want to transfer alarms to the terminal.
	Data logger	Specify whether you want to transfer data protocols to the terminal.
	Symbols	Specify whether you want to transfer symbols to the terminal.
	Time channels	Specify whether you want to transfer time channels to the terminal.
	LEDs	Specify whether you want to transfer LEDs to the terminal.
	Macros	Specify whether you want to transfer macros to the terminal.
	Fonts	Specify whether you want to transfer fonts to the terminal.
	Message library	Specify whether you want to transfer the message library to the terminal.
	Setup	Specify whether you want to transfer the configuration (under <i>Properties</i> ) to the terminal.
	Function keys	Specify whether you want to transfer the function keys to the terminal.
Passwords	Specify whether you want to transfer passwords to the terminal.	
Data exchange	Specify whether you want to transfer data exchange to the terminal.	
Delete	Trend data	Choose this option if all the trend data saved on the terminal should be deleted.
	Recipe data	Choose this option if all the recipe data saved on the terminal should be deleted.
Download driver	No	Choose this option when drivers should never be downloaded.
	Always	Choose this option when drivers should always be downloaded.
	Automatic	Choose this option when the driver should be transferred automatically to the terminal, when the drivers in the terminal and in the current project do not match or are the same version.
Set terminal clock	Choose this option when the PC time setting should be transferred to the terminal.	
Enforce file deletion in the terminal	Choose this option when all files on the operator terminal should be deleted and overwritten by new files (e.g. a complete new file structure).	
Send	Click on this button to send the project to the terminal with the specified settings.	
Receive	Click this button to load the project present in the terminal. This means the active project in the HMI-Builder will be overwritten. There must be an active project in the HMI-Builder to be able to load a project from the terminal.	
Stop	Click this button to cancel the transfer.	
Settings	Configure the transfer parameters here. The transfer values must match the values in the terminal.	



You can call up the communication parameters under [Transfer] / [Communication properties] or by clicking the [Settings] button in the [Project Transfer] dialog box.

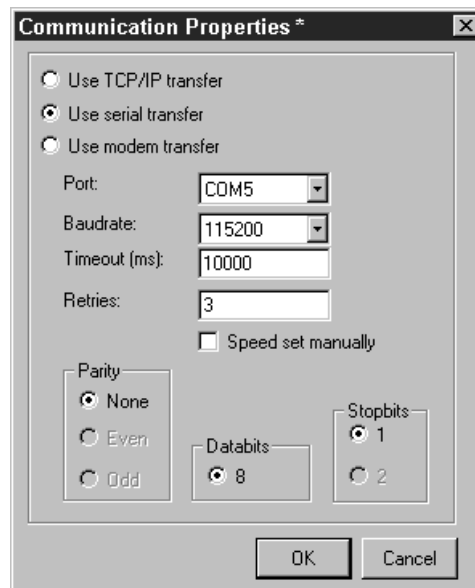

11490AEN

#### Settings in the communication parameters dialog box.

Parameters	Description
TCP/IP transfer	Specify whether you want to transfer the project using TCP/IP. See the section "TCP/IP transfer" on page 189.
Use serial transfer	Specify whether you want to transfer the project using serial transfer. See the section "Serial transfer" on page 190.
Use modem transfer	Specify whether you want to transfer the project using the modem. See the section "Modem transfer" on page 192.
Port	Select a communication port for the PC.
Baud rate	Specify the transfer speed (bps).
Timeout (ms)	Specify the number of milliseconds between two transfer attempts.
Quantity	Enter the number of transfer attempts before transfer interrupted.
Speed set manually	Only required for older terminal versions with modem communication. The transfer speed must be set manually to the same value in the terminal and the HMI-Builder. The terminal must be switched to transfer mode manually.
Parity	Select the type of parity check.
Data bits	Number of data bits for the transfer. The value must be 8.
Stop bits	Select the number of stop bits used for transfer.



**NOTE**

Communication errors may occur if other Windows applications are running while the project is being transferred. Close all other programs to eliminate this error source.  
Existing links to symbols are taken into account when blocks are transferred.

**7.7.3 TCP/IP transfer**

To transfer a project via TCP/IP, select the [Use TCP/IP transfer] option from the [Transfer] / [Communication properties] menu. Clicking the [Send] button in the [Project transfer] dialog box opens the following window:

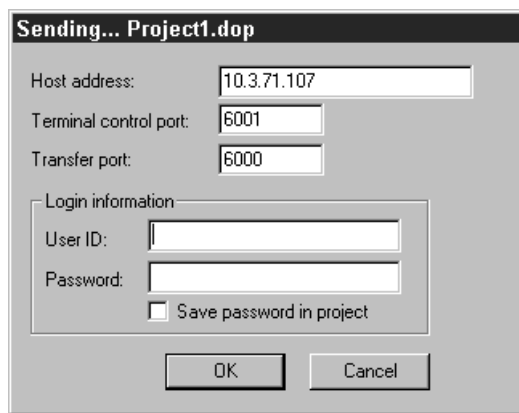

11566AEN

Parameters	Description
Host address	Enter the IP address for the target terminal.
Terminal control port	Specifies the TCP/IP port number for the changeover from RUN to transfer mode. This value usually need not be changed. The default setting is 6001.
Transfer port	Specifies the TCP/IP port number for the transfer (project transfer server). This value usually need not be changed. The default setting is 6000.
User ID	Enter the user name that is used to check the changeover from RUN to transfer mode. It is not used when the terminal is already in transfer mode.
Password	Enter the password that is used for checking the changeover from RUN to transfer mode. It is not used when the terminal is already in transfer mode. You only have to make this setting when the authorization check under [Setup] / [Network] / [Services] / [Terminal controller] is activated and the users are defined under [Setup] / [Network] / [Accounts].
Save password in project	Select this checkbox if you want to save your password and user ID. You will then not be prompted for them anymore.



#### 7.7.4 Serial transfer

For serial transfer, select the [Use serial transfer] option under [Transfer] / [Communication properties]. To transfer the project to the terminal, click the [Send] button in the [Project Transfer] dialog box.

#### 7.7.5 Update projects with an external memory card

To copy a project to a compact Flash memory card or a USB drive, choose [Transfer] / [Export project transfer file] in the HMI-Builder.



#### NOTE

- The USB drive must support the standard **USB Storage Class driver**. DOP11B does not support manufacturer-specific USB drivers.
- The USB storage medium must be formatted in FAT or FAT 32.
- Compact Flash memory cards are only supported by DOP11B-50.

#### **Recommended USB storage medium for DOP11B**

Our engineers have tested a range of USB storage media. The storage media listed below are recommended for use with the DOP11B operator terminals:

Brand and type of USB storage medium	Size
Scandisk Cruzer Micro USB 2.0	1 GB Flash memory
Corsair Flash Readout USB 2.0	1 GB
Kingston Datatraveler II, Pocket Memory, USB 2.0	1 GB
Pendrive, USB 2.0	256 MB
Verbatim Store-N-Go, Hi-speed, USB	1 GB
Scandisk Cruzer Mini, USB 2.0	1 GB Flash memory
Beijer Electronics, USB	256 MB

Our recommendations refer only to the types and sizes listed here.

#### **Load project from memory card**

Save the project in the "BACKUP/PROJECTS" library on the external memory card. The file structure is created automatically when the card is formatted in the operator terminal. If there is no operator terminal available, the library structure must be created manually.

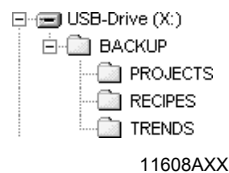



**Load project automatically on recognition**

Save the project file in the master directory of the external memory card. There must only be one project in the master directory at a time, otherwise automatic project recognition and automatic loading of the project does not work. Settings for transferring the project to the operator terminal are made under [Setup] / [Terminal options]

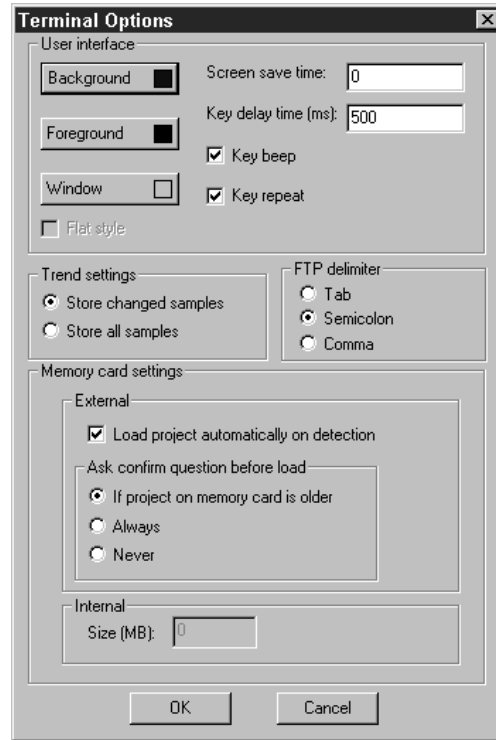

11604AEN

**Memory card settings**

Setting	Description
Confirmation prompt before loading	Specify whether, and if so, when a confirmation prompt should appear when loading a project to the operator terminal.
If project on memory card is older	The confirmation prompt is issued when the project is older than the project already available on the operator terminal.
Always	The confirmation prompt is always issued as soon as a project is found in the external memory card.
Never	The project on the external memory card is transferred automatically to the operator terminal without a confirmation prompt.



#### 7.7.6 Modem transfer

For transfer via modem, select the [Use modem transfer] option under [Transfer] / [Communication properties]. To transfer the project to the terminal, click the [Send] button in the [Project transfer] dialog box.

#### **Modem settings**

Make the following settings for a modem connected to the operator terminal:

```
AT &F &D0 &K0 &C1 E0 Q0 V1 S0=1 &W
```

Use the following settings for a modem connected to the PC:

```
AT &F &D0 &K0 &C1 E0 Q0 V1 S0=1 &W
```

The modem commands are described in the following table.

Command	Description
AT	Informs the modem about signal input. AT precedes all commands.
&F	Resets the modem to factory defaults.
&E0	Deactivates echo.
Q1	Result codes are not returned.
&D0	Modem ignores DTR.
&K0	No flow control.
&W	Saves settings.



#### **NOTE**

The modem must be set to "autoanswer" to enable transfer.





**Communication settings**

1. Configure the modem.
2. Make the communication settings in the HMI-Builder under [Transfer] / [Communication properties]. Select [Use modem transfer].

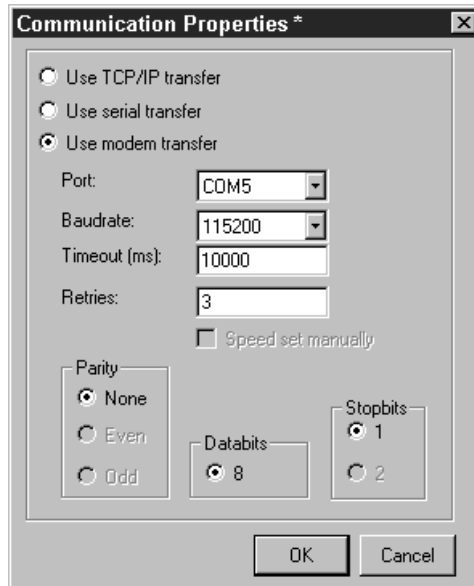

11567AEN

3. Specify a port and set the [Baud rate], [Parity] and [Stop bits].
4. Use the program [DOP Tools] / [DOP Modem Connect] to establish the connection.
5. Next, select [Transfer] from the HMI-Builder menu.

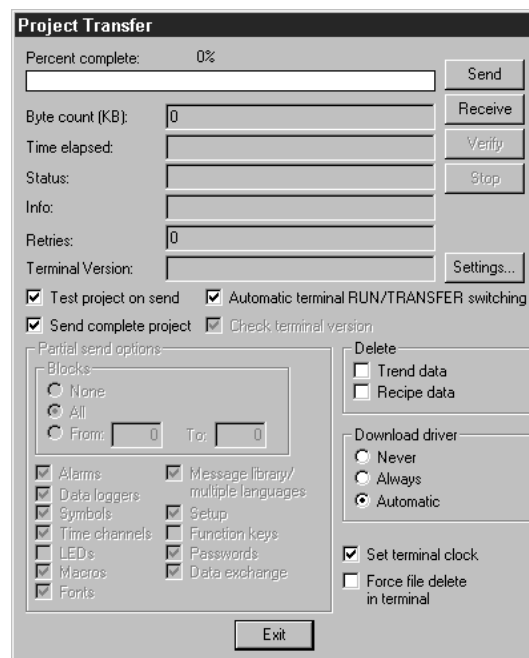

11247AEN

6. Select [Automatic RUN/TRANSFER switching] and press [Send].



#### 7.7.7 Transfer via GSM modem

A special procedure is required for transfer via GSM modem. The operator terminal must be switched to transfer and run mode manually.

Select the communication properties for the modem transfer in the Information Designer (see the description in the previous section).

In the operator terminal, call up the service menu by setting the operating mode switch on the back of the operator terminal to 1000. For information on the operating mode switches, refer to the hardware and installation manual for the operator terminal.



#### NOTE

The service menu is also displayed (without changing the operating mode switch) when an empty operator terminal is switched on.

Choose 'Enter Transfer Mode' from the service menu. Switch off the operator terminal, set the mode switch to 0000 and switch the operator terminal back on again. The operator terminal is now started in transfer mode.

Transfer the project to the operator terminal by clicking on [Send] in the Project transfer dialog box in the Information Designer

Call up the service menu again by setting the mode switch to "1000".

Choose "Enter Run Mode" from the service menu.

Switch off the operator terminal, set the mode switch to "0000" and switch the operator terminal back on again. The operator terminal is now started in run mode.

The downloaded project is now executed on the operator terminal.



## 7.8 Index addressing

Without index addressing, an object is always linked to the same register (IPOS variable or parameter number). Consequently, only the value of this register can be displayed in the object.

Index addressing enables you to choose in run mode from which register you want an object to import the display value. For this purpose, the value in the index register can be added to the address for the register that displays an analog signal in the object. The following applies:

**Display value = content in register (object address + content in index register)**

If the index register content is 2 and the address of the register specified in the object is 100, the value displayed in the object will be retrieved from register 102. If the value in the index register is changed to 3, the value for the object will be retrieved from register 103 instead.

The index register is defined in the individual projects. This setting is made under [Setup] / [Index register]. Up to eight index registers can be used in each project. Each index register can be used for more than one object.

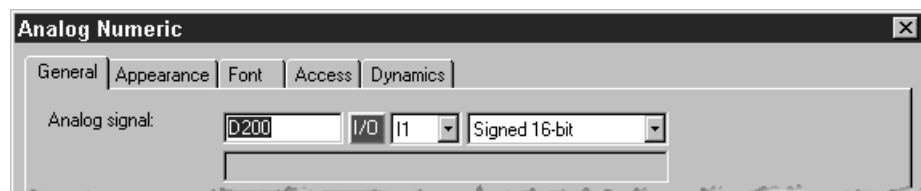

The objects used in the project specify whether index addressing is used and which register acts as the index register. To do so, select I1 to I8 in the dialog box for the object to the right of the specified analog signal.



11569AEN

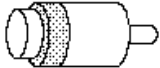

The following example shows how to control three motors from one block. The motor parameters for torque and speed are stored in six different registers. One of the motors is selected in a block. The current torque and speed for the selected motor are displayed in the block. When selecting another motor, the current torque and speed of the other motor should be displayed instead. Index addressing is used for this purpose.

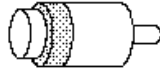
Motor 1	Motor 2	Motor 3
		
Torque in register D101 Speed in register D201	Torque in register D102 Speed in register D202	Torque in register D103 Speed in register D203

Register D0 is defined as [Index register 1] under [Setup] / [Index register]. The value in the register is used to determine the motor for which the torque and speed are to be displayed.

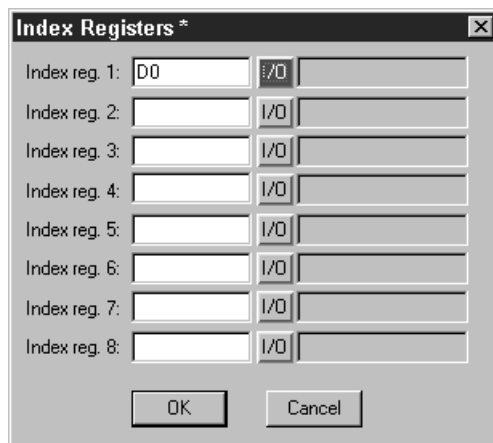

11570AEN



If the value in D0 is 1, then the torque and speed of motor 1 are to be displayed. If the value is 2 or 3, then the parameters for motor 2 or 3 are to be displayed. The value in register D0 is controlled by a multiple selection object in which the texts motor 1, motor 2, and motor 3 appear. In addition, these three options are created as maneuverable.

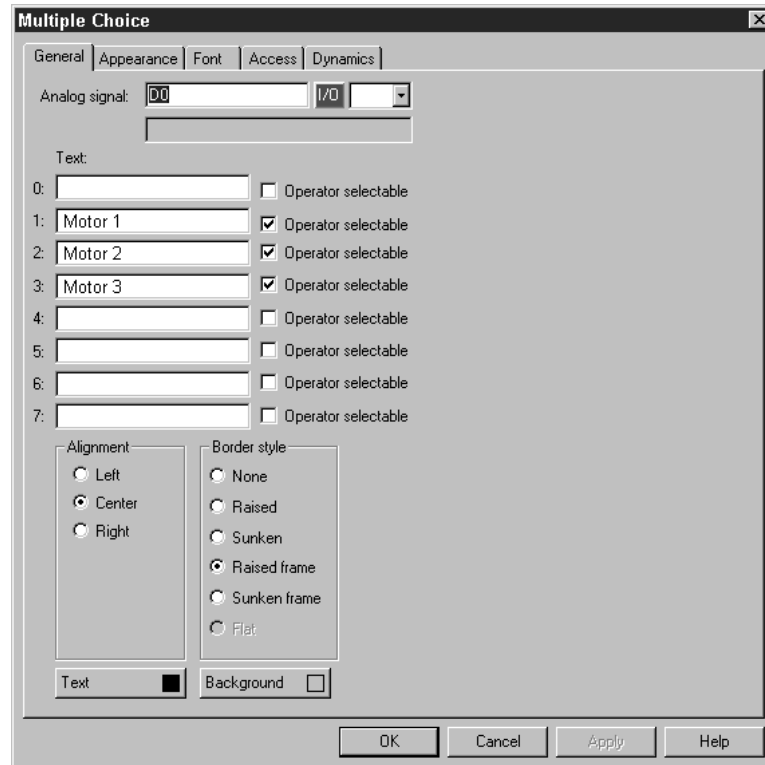

11571AEN

Torque and speed are displayed in the form of two numeric objects. In the object for the torque, "D100" is defined as the analog signal and "I1" as the index register.

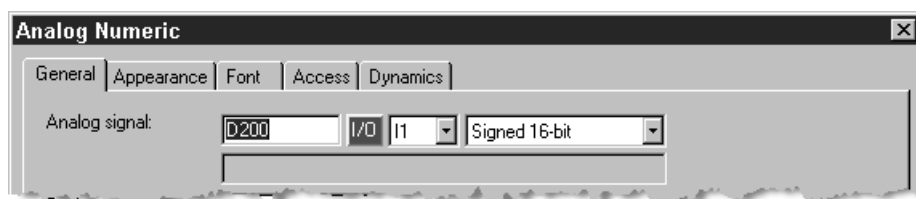

11569AEN



In the object for the speed, D200 is defined as the analog signal and I1 as the index register. The maneuverable multiple selection object enables the options motor 1, motor 2, and motor 3 to be called up in run mode. Depending on the selection, one of the values 1, 2 or 3 is stored in register D0. The value in register D0 is added to the addresses of the objects that display torque and speed. Consequently, these can display the values in register D101, D102 or D103, or register D201, D202 or D203.



10452AXX

- [1] Multiple selection objects - analog signal D0  
 [2] Numeric object - analog signal D100, index register D0  
 [3] Numeric object - analog signal D200, index register D0



#### NOTE

Other suffixes can be specified in addition to index registers. The index register is not counted twice when using 32-bit registers.

If you connect the terminal to a BDTP network, you have to specify the same index register both in the server and the client, as indexing takes place in the server driver.



## 8 Unit Functions

### 8.1 Message library

The [Message library] function enables you to create text tables where values between 0 and 65535 are linked with texts. One of the uses of the [Message library] function is to display each sequence step in a sequence control. The function can also be used to display error codes. An analog signal creates error codes that are linked with texts in a text block. The function is also used for assigning specific values to analog signals depending on the selected text.

The message library consists of one or more text tables, each with up to 512 text character strings. Each text string can have up to 40 characters. Activate this option under [Functions] / [Message library].

Parameters	Description
Library	Specify a number for the message library.
Name	Enter a name for the message library.

You can edit a message library by selecting the library and clicking [Edit]. Several edit windows can be opened at the same time.

Parameters	Description
Text no.	Enter a number for the text (0 - 65535).
Text	A text that is called up once the current signal assumes the text number for the text.

#### Example

A simple example is given below to explain the function. Each sequence step in our sequence control is displayed by a text.

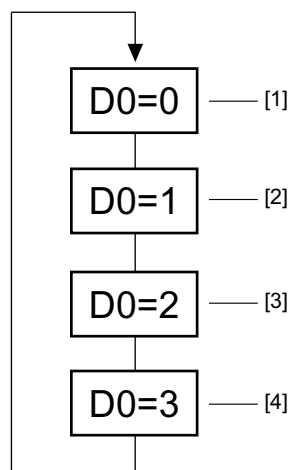

54131AXX

- [1] The object is placed onto the conveyor belt.
- [2] Mount tool X
- [3] Mount tool Y
- [4] Remove object from the conveyor belt



Begin by creating a message library with the name "Maskin2."

1. Select [Functions] / [Message library] from the menu.
2. Assign a number (in this case "2") and a name ("Maskin2") to the library.
3. Click on [Add].

You have now created a message library with the name "Maskin2." Next, you have to define the various texts in the library.

4. Select the library and click [Edit].

Enter the text number and text in this dialog box. The text number represents the value for the analog signal linked to the message object. The [Text] button can be used to display the text in the message object.

Once you have completed the message library, you have to create a message object in the application. You can create the message library in the text block or in the graphic block.

5. To do so, select the [Message] object from the toolbox. Move the pointer to where you want to position the object and click the mouse.
6. Define the analog signal that controls the text display.
7. In the [Library] field, you can select the message library from which the text is to be retrieved.
8. Select whether the object should be maneuverable and between which texts it should be able to switch during operation.





## 8.2 Alarm management

This section describes the process of alarm management. It makes the user aware of operating states that require an immediate response. Alarms can be divided into groups based on priority. Alarm lines can display texts and dynamic data in alarm management. The *Alarm banner* object can indicate an alarm in any application block.

### 8.2.1 Alarm groups

In the operator terminal, alarms can be divided into different groups, e.g. according to priority. Depending on the size of the font, up to 16 groups can be created. Different colors can be assigned to each group. Alarms can be sorted by groups in the alarm block. Alarm groups need not be defined.

#### Defining alarm groups

Alarm groups are defined in the project manager in the [Alarm] directory under [Alarm groups]. The properties of the alarm group are defined in following dialog box.

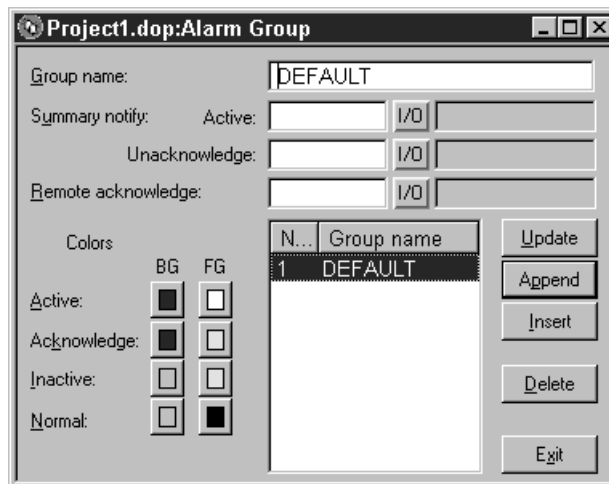

11573AEN

Parameters	Description	
Group name	User defined name for the alarm group	
Summary notification	Active	Digital signal that is set to 1 when an alarm is activated in the group.
	Unacknowledged	Digital signal that is set to 1 when alarms in the group are not acknowledged.
	Remote acknowledge	Digital signal that, if enabled, acknowledges all alarms in the group at the same time.
Colors	Define the colors for active, acknowledged and inactive alarms as well as for alarms in normal state.	



#### 8.2.2 Alarms

Alarm messages are defined in the project manager in the [Alarms] directory under [Alarms].

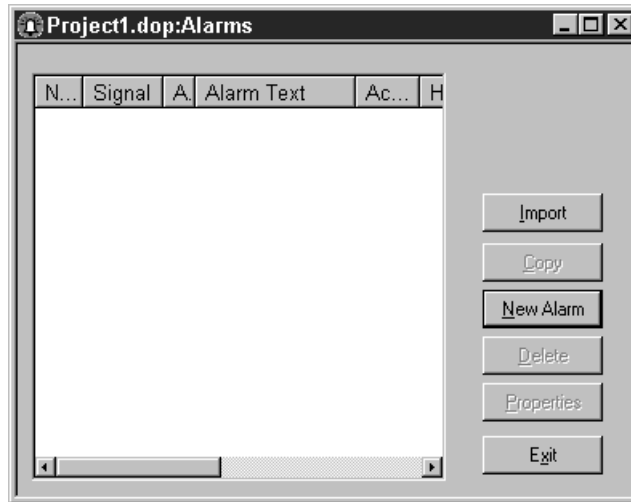

11574AEN

Button	Description
Import	See the section "Alarm import" on page 207.
Copy	Copy alarm
New alarm	Define a new alarm
Delete	Delete an alarm
Properties	Display the properties of individual alarms



**Defining alarms**

Click on [New alarm] in the [Alarms] dialog box to define a new alarm. A maximum of 300 alarms is recommended.

11575AEN

Parameters	Description		
Alarm text		Digital text	Clicking this button adds a digital text object to the alarm text. The text that corresponds to the current value of the digital signal when the alarm is activated is displayed.
		Analog numeric	Clicking this button adds an analog numeric object to the alarm text. The analog value present when the alarm is activated is displayed.
		ASCII	Clicking this button adds an ASCII object to the alarm text. The ASCII text present when the alarm is activated is displayed.
Signal	Specifies the signal (digital or analog) that triggers the alarm when it changes to the defined state.		
Trigger alarm if	Digital signal is:		
	On / Off	Select [On] if an alarm is to be issued when the signal is enabled. Select [Off] if an alarm is to be issued when the signal is disabled.	
	Analog signal is:		
	Equal to	An alarm will be issued if the value of the specified analog signal is equal to the value entered in the following field.	
	Not equal to	An alarm will be issued if the value of the specified analog signal is not equal to the value entered in the following field.	
	Lower than	An alarm will be issued if the value of the specified analog signal is lower than the value entered in the following field.	
Greater than	An alarm will be issued if the value of the specified analog signal is greater than the value entered in the following field.		



## Unit Functions

### Alarm management

Parameters	Description
Acknowledge notify	Digital signal that is influenced when the alarm is acknowledged. Usually, the signal is set to 1.
Reset	Selecting the [Reset] checkbox disables the above mentioned signal when an alarm is acknowledged.
Remote acknowledge	Digital signal which acknowledges the alarm if enabled.
Alarm group	Specifies the alarm group for the definition (alarm).
Info block	A block number or a block name for a text or graphic block is entered in this field. It displays a help text for the user that contains e.g. information on alarms and relevant remedial measures. If no entries are made in the field, no block will be linked to an alarm. See the sections "Operator terminal alarms" (page 208) and "STMP client" (page 281).
Mail to address	Alarms can be sent as an e-mail to a predefined recipient. This mail contains the alarm text. See the section "Alarm properties" (page 205) and "STMP client" (page 281).
Acknowledgement required	Indicates whether the alarm needs to be acknowledged or not. The alarm must be acknowledged when the checkbox is activated. If the checkbox is deactivated, the alarm will only serve as an event alarm, i.e. information.
History	Indicates when the alarm should be deleted from the alarm list. An activated checkbox means the alarm remains in the alarm list until the list is full. If the checkbox is activated, the alarm is deleted from the list as soon as it has been acknowledged and is no longer active. If the [Acknowledgment required] checkbox is not selected, the alarm will be deleted from the list once it is no longer active.
To printer	If this checkbox is selected, the alarm message is output on the printer as soon as the alarm status changes.
Repeat counter	If this checkbox is activated, a counter for the alarm will be displayed in alarm management to record the frequency of an alarm. The alarm must be acknowledged to enable the alarm to appear in the list as a new alarm message.

#### NOTE



The value defined for an analog alarm signal cannot be controlled via register. An alarm is logged with a fixed value. Logging in intervals is not possible. Only 16-bit values are supported.



### 8.2.3 Alarm properties

Click the right mouse button in the project manager on the [Alarms] directory and select [Properties] to make general settings for alarms and alarm lists. The space required by alarms in the alarm lists depends on the length of the alarm text and the number of objects. The space required by an alarm can be calculated using the following formula

$$S = 42 + NC$$

S = Number of bytes

NC = Number of characters in the alarm text

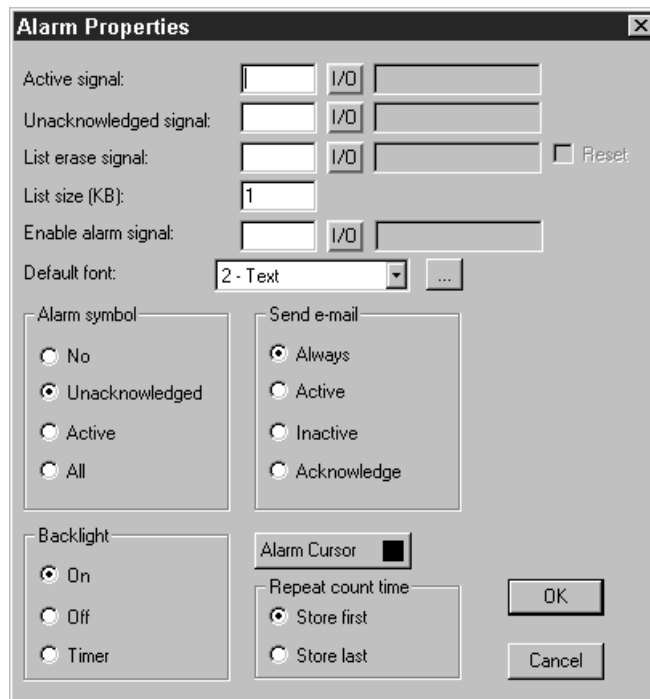

11576AEN

Parameters	Description
Active signal	Specifies the digital signal that will be issued by the terminal if the alarm is active.
Unacknowledged signal	Specifies the digital signal that will be issued by the terminal when the alarm is not acknowledged.
List erase signal	Specifies the activated digital signal that deletes deactivated alarms from the alarm list if it is set to 1.
Reset	If this checkbox is activated, the signal entered in the field [List erase signal] is reset when alarm management is deleted.
List size (KB)	Provides information on the size of the list in KB. Note: If the system assigns the same amount of memory as is indicated for the list size, the list size will double. If the list size exceeds 10 KB, the performance of the project will be influenced negatively.



Parameters	Description	
Enable alarm signal	Digital signal that, if enabled, invokes alarm handling in the terminal. This parameter enables the activation or deactivation of alarm management in the terminal. Do not use this parameter if you want alarm management to be active permanently.	
Default font	Specifies the default font size for the alarm list. The standard font size in the alarm list is always displayed after a start or restart and when switching between operating modes.	
Alarm symbol	Specifies when the alarm symbol is to be displayed. "ALARM" is displayed in the text block and a bell is shown in the graphic block at the top right corner of the screen.	
	No	The alarm symbol is never displayed.
	Unacknowledged	The alarm symbol is displayed when the alarm list includes unacknowledged alarms.
	Active	The alarm symbol is displayed when the alarm list includes active alarms.
	All	The alarm symbol is displayed when the alarm list includes active and/or unacknowledged alarms.
Send e-mail	Specifies when alarm messages should be sent by e-mail.	
	Always	An alarm is always sent as an e-mail when its status changes.
	Active	An alarm is sent as an e-mail when it is activated.
	Inactive	An alarm is sent as an e-mail when it is deactivated.
	Acknowledge	An alarm is sent as an e-mail when it is acknowledged.
Backlight	Specify whether the backlighting should change when an alarm is activated.	
	On	Means that the lighting will be switched on when the alarm symbol is displayed (default setting).
	Off	The background lighting is not affected by the alarm.
	Timer	The lighting is switched on when a new alarm is activated. The lighting is switched off when the screen saver time has elapsed.
Alarm cursor	Specify the cursor color in the alarm list.	
Repeat count time	Save first	When the alarm is acknowledged, the time that the first alarm was activated is saved in alarm management.
	Save last	When the alarm is acknowledged, the time that the last alarm was activated is saved in alarm management.

The alarm list is rewritten when it is full. 25% of the alarms are deleted from the list when it is rewritten. This means 75% of the previous content will be retained.

#### Example:

The length of the alarm text is 38 characters. This means each alarm requires 80 bytes in the alarm list. The result is  $1024 \text{ (list size = 1 KB)} / 80 = \text{maximum 12 alarms}$  in the alarm list. When the 13th alarm is issued, the alarm list will be rewritten and only includes the last nine alarms.



### 8.2.4 Importing alarms

Alarm texts can be imported from name lists that were created for the controller using the HMI-Builder configuration software. Before importing alarms, the project in HMI-Builder must be linked to a name list. Select the corresponding name file under [View] / [Name list]. Double-click in the project manager on the [Alarms] directory and click the button [Import] to define the alarm import.

11989AEN

Parameters	Description
Start I/O	Enter the address for the start I/O when importing alarms from the name file. The start I/O can be either an analog or a digital signal.
End I/O	Enter the address for the end I/O when importing alarms from the name file. The end I/O must match the start I/O.
Alarm properties	The properties for all alarms (start I/O to end I/O) that can be imported by clicking on the [Import] button are defined in the alarm properties. For a description of the individual parameters, see the section "Alarms" on page 202. The parameters <i>Signal type</i> , <i>Analog/Digital</i> and <i>Alarm group</i> must be entered before the alarm is imported.



#### 8.2.5 Alarm banner

	<b>NOTE</b>
	Information on the <i>Alarm banner</i> object can be found in the section "Graphic display and control" (page 163).

#### 8.2.6 Alarms in the operator terminal

In the graphic block, an alarm is indicated by a flashing bell in the top right corner of the screen. This display can be deactivated by right-clicking on the [Alarms] directory and making the appropriate selection from [Properties] in the project manager.

Alarms are displayed in an alarm list with predefined alarm texts. The alarm list includes the last triggered alarms and is sorted by the defined alarm groups. The alarm triggered last is displayed first in the list. The list can be sorted in descending order. More information can be found in the section "Alarm banner" on page 208. To define the size of the alarm list, right click in the project manager on the [Alarms] directory and then select [Properties]. Jumping to the alarm block (system block no. 990) will display the alarm management.

The following information is displayed for each alarm: Number of times the alarm is triggered (if selected), alarm status, and the time it was triggered, deactivated or acknowledged in the selected display format.

The counter for the alarm in alarm management is displayed in accordance with the following table, provided that the checkbox [Repeat counter] has been activated for the alarm in the [Alarms] dialog box.

Display format	Description
(12)	Means the alarm was issued twelve times. The alarm must be acknowledged to enable the alarm to appear in the list as a new alarm message.
>999)	Means the alarm was issued more than 999 times without having been acknowledged. The counter can contain a maximum of 999 alarms.

Alarms can assume the following statuses:

Symbol	Status
*	Not active, not acknowledged
\$	Inactive, not acknowledged
–	Active, acknowledged
<empty>	Not active, acknowledged

Alarm times can be displayed in the following formats:

Display format	Description
S	Time when the alarm was activated. If alarms occur repeatedly, the time when the alarm was activated first will be displayed.
E	Time when the alarm became inactive. If alarms occur repeatedly, the time when the alarm was deactivated last will be displayed.
A	Time when the alarm was acknowledged.



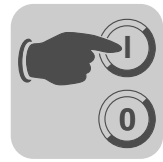

To go to the alarm block, either define a jump to system block 990 in a block, press <LIST> or have the controller retrieve the list for block 990 via the display signal.

To acknowledge an alarm, move the cursor over the corresponding alarm line in the list and press <ACK> or use a function key.

When a printer is connected, the alarm can be output directly according to the order or status change. This setting can be specified in the alarm definition.

The alarm is printed with the following information:

- Frequency of occurrence
- Date
- Time
- Status
- Alarm text

To delete inactive acknowledged alarms from the history, press <←> (back button). To deactivate the function, enter the command "DD" in the command line (in the project manager, double-click on [System signals] in the [Setup] directory)

To return to the previous block, press <PREV> on the terminal or <ESC> on the touch-screen.

When the print signal is output for block 990, the respective alarm list contents can be printed.

**Linking blocks  
with alarms**

Text or graphic blocks can be linked with alarms. Choose <INFO> for an alarm in the alarm list to display the block with which the alarm is linked. This block can contain information on the alarm and the corresponding handling recommendations. The <INFO> button is only available when the relevant alarm is linked with a block. To return to the alarm list, press <PREV>.



#### 8.2.7 Graphic alarm page

The page is displayed graphically and can be edited by the user. You can assign functions to function keys or touch keys to maximize or minimize alarm page text and to browse through the pages. You can also select which date and time stamp should be displayed. Alarms can be sorted by groups and the required group can be displayed.

The status is indicated by the colors defined when setting the alarm group.

	<b>NOTE</b>
	The graphic alarm page (alarm list) is printed in text form.

### 8.3 Recipe management

The [Recipe management] function enables the user to save all the dynamic data of one or more blocks (i.e. signals and their values) in a file in run mode.

The user can transfer the file to the controller, where the loaded values are further processed. The recipe management function makes it possible to reuse comprehensive parameter configurations. Consequently, users can set up a recipe directory with files offering different parameter settings. This function makes for an efficient design of production runs with tight schedules that require a fast product change, such as in the production of identical products in different colors.

Recipe files can be created on a terminal, controller or PC using the *DOP Tools* software.

The recipe files are stored in the terminal. To use the recipe management function, the functions for saving, loading, deleting and adding recipes have to be linked with function or touch keys. See the section "Function keys" on page 238.

You can send recipe files as attachments from terminals using the e-mail function.



The following figure illustrates the principle of recipe management.

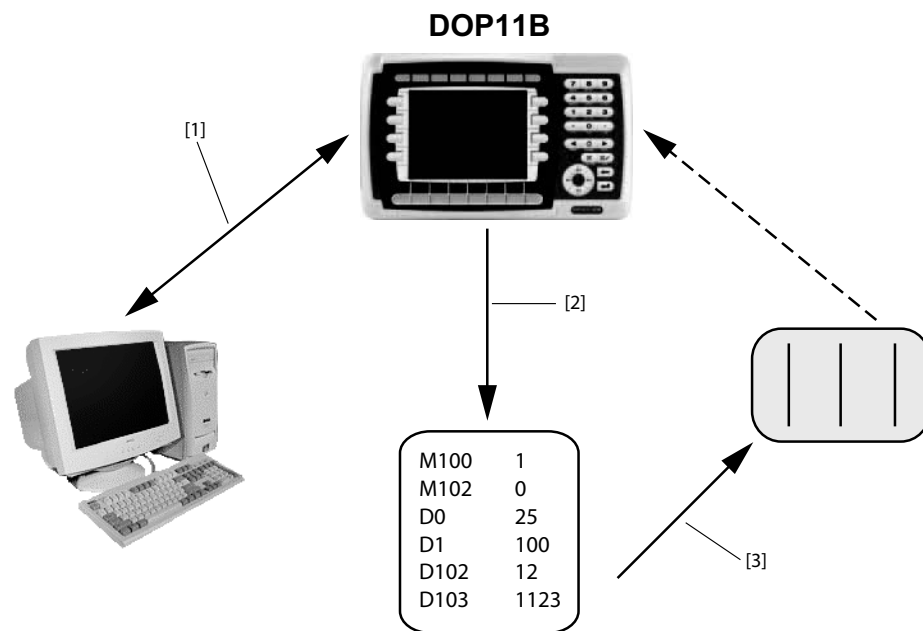

63685AXX

- [1] The PC is used to program the operator terminal. The FTP program makes it possible to use the PC to back up recipes or create new ones.
- [2] Save the recipe files using the function [Save recipe].
- [3] Transfer the recipe to the controller using the function [Load recipe].



#### 8.3.1 Calculating the recipe size

The following formula is used to calculate the size of the recipe in the project memory. (The formula does not always provide exact results due to the complexity of the file system).

$$S = \Sigma (IOW \times 10)$$

S = Number of bytes. If the calculated value **S** is less than 360, the value 360 must be set for **S**.

$\Sigma$  = Number of I/O series

IOW = Number of words in each I/O series. A word memory is calculated for values less than 16 bit.



#### NOTE

If you use the function [Create and transfer recipes using the controller program], the maximum number of I/Os in a recipe is limited to 1000.

If you use the function [Create recipes on the terminal], the maximum number of I/Os is only limited by the memory available in the operator terminal.

#### Example

Our recipe consists of 3 I/O series H0-H109 (=110 double words) and H200-H299 (=100 double words) and H600.0 to H609.0 (=10 words).

This results in the following calculation:

$$S = ((110 \times 2) \times 10) + ((100 \times 2) \times 10) + (10 \times 10)$$

$$S = 4300 \text{ bytes (per recipe)}$$

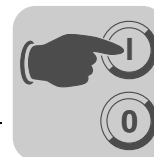

### 8.3.2 Recipe properties and recipe directories

In the project manager, double-click on [Recipe] to define the settings for recipe management and to create, edit and delete recipe directories.

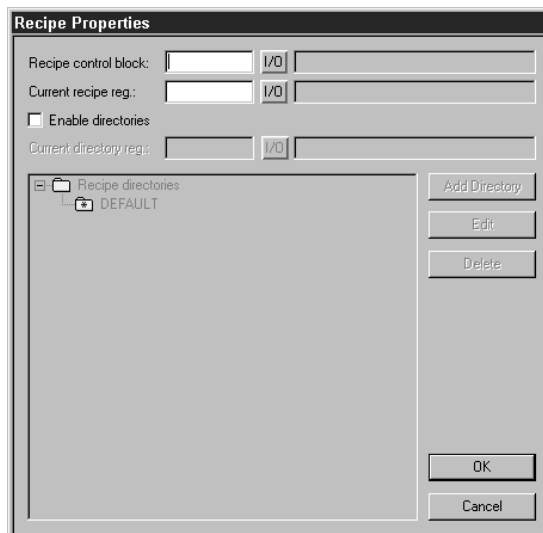

11577AEN

Parameters	Description
Recipe control block	Control block for saving, reading, and deleting recipes via the controller. See the section "Creating and transferring recipes using the controller program" on page 218.
Current recipe register	Enter the first of four or 16 16-bit registers where the terminal stores the name of the recipe that was last loaded to the controller. This name can then be represented as an ASCII object. The function occupies either 4 registers (8 characters) or 16 registers (32 characters).
Enable directories	Selecting this option enables you to create recipe directories in the terminal. See the section "Recipe directory" on page 214.
Current directory register	Enter the first of four or 16 16-bit registers where the terminal stores the name of the recipe directory that was specified for the block. This name can then be represented as an ASCII object. The function occupies either 4 registers (8 characters) or 16 registers (32 characters).



#### **Recipe directory**

You can use the function [Save recipe on memory card], which is called up via a function key or touch key, to save files on a compact Flash card or a USB Flash drive. Using recipe directories makes for a clearer structure and easier recipe management in applications with many recipes. Thirty-two recipe directories can be created for each level.

Recipe directories are created in the master directory of the terminal memory in the [RECIPE] directory. A recipe directory is linked with one or more blocks under [Block properties]. All recipes created in a block are stored in the selected recipe directory.

See the section "Store individual recipes on an external memory card during operation" on page 221 for information on storing individual recipes on an external memory card.

Recipe directories are created, edited and deleted in the project manager. To do so, double-click on [Set up recipe signals]. Defined recipe directories are displayed in a list that corresponds to the library structure. You can add new recipe directories by clicking the [Add directory] button. The name of the recipe directory must comprise between 1 and 32 characters. The first character must be a letter or a number. The characters A ... Z, 0 ... 9 and \_ (underscore) are permitted. The symbol # can also be entered using the command *MCRD#*.

See the section "Store individual recipes on an external memory card during operation" on page 221.

To change a recipe directory, select it and click [Edit]. Choose [Delete] to delete the selected recipe directory.

#### **Recipe directory in run mode**

You can create and delete recipe directories in run mode using the [Create recipe directory] and [Delete recipe directory] functions. The functions are linked with function keys or touch keys.

You can change and select recipe directories for the current block in run mode using the [Change recipe settings] function for function keys or touch keys. Pressing the function key or touch key for [Change recipe directory] opens a pick-list with a number of recipe directories. Select a file and press the Enter key. The recipes in the block are then stored in the selected recipe directory. See the section "Function keys" on page 238.



#### **NOTE**

Recipe directories created in HMI-Builder cannot be deleted using the function or touch key linked with the [Delete recipe directory] function. Recipe directories created in the terminal are not included in the terminal project when a project is transferred from the terminal to HMI-Builder (via receive function in the [Project transfer] dialog box).

Recipe management between terminal and PC takes place using the applications [DOP Tools] / [DOP File Transfer] and [DOP Tools] / [DOP FTP Transfer]. See the section "Using recipes in the PC" on page 217.



### 8.3.3 Creating recipes on the terminal

When programming the application, you can specify which block(s) can be used to save the recipe. The [Append recipe] function is also available in run mode. All signals to be included in the recipe are defined in the recipe block. All dynamic values of the block are saved in a recipe file. Apart from trend objects, you can use all digital and analog objects as recipe parameters.

In run mode, a jump is performed to the block containing the recipe parameters. Enter the required values in the dynamic objects and press the function or touch key that is linked with [Save recipe]. The name may have up to 32 characters. The first character must be a letter or a number. The characters A ... Z, 0 ... 9 and \_ (underscore) are permitted for the name. Otherwise, the same file name conventions apply as for MS-DOS.

The recipe file is stored in the terminal; either in the recipe directory specified for the block or in the same recipe directory unless you have created specific recipe directories under [Setup] / [Recipe settings].

#### ***Limiting the length of recipe names and directories stored in the controller***

Some controller programs are configured to support a maximum of 8 characters when saving recipe names and directories in the controller. If names of up to 32 characters are used by mistake, they may overwrite important information in the controller. You can use the command SCRR (SchortCurrentRecipeRegister) to prevent this. To do so, choose [Setup] / [System signals] and enter "SCCR" in the command line.

When this command is entered, no more than 8 characters can be entered in the operator terminal for recipe names and directories.



#### 8.3.4 Appending recipes

You can link the [Append recipe] function to function or touch keys. This function makes it possible to add signals and the associated values of the current block to an existing recipe in run mode. This way, you can store signals and the associated values of different blocks in a common recipe. New signals are appended in this process. Already existing signals are updated when the function is executed.

When pressing the function or touch key for [Append recipe], you have to specify the name of the recipe to which you want to add the current block signals and the associated values. If no recipe is stored in the terminal when the function is executed, a new recipe will be created in the terminal. A new recipe will also be created if you have not specified the same recipe directory for the blocks.

The same or no recipe directory must be specified to add signals from another block to a recipe.



#### NOTE

If a new character string is added to an already existing recipe with character strings, you have to separate the character strings using address separators. Otherwise, the already existing character string will be expanded by the new one.

#### 8.3.5 Transferring recipes to the controller

In run mode, the recipe is transferred to the controller using the [Load recipe] function. This function transfers the signals and values saved in the files to the controller. Pressing the function or touch key for [Load recipe] opens a pick-list with available recipe files. Select a file and press the Enter key. The controller now runs with the loaded values.

#### 8.3.6 Deleting recipes

In run mode, the specified recipe can be deleted from the terminal memory using the [Delete recipe] function. Press the function or touch key linked with [Delete recipe]. Doing so opens a pick-list with available recipe files. Select the file you want to delete and press the Enter key. To confirm that you want to delete the file, press Enter. To cancel the action, press <PREV>.



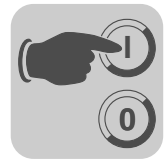

### 8.3.7 Using recipes in the PC

The [DOP Tools File Transfer] program (icon in the DOP Tools program group) installed on your PC makes it possible to address the terminal like a PC drive. This means the PC can be used to create backup copies of terminal files (e.g. recipe files). This way, new recipes can be created in the PC and transferred to the terminal.

The recipe file is saved in SKV format on the PC and can be called up in Excel. The files can be edited in Excel and then used again. Complete the file with the "END" command.

**Example**

```
P100;3
P102;0
H50;12
END
```

You can also transfer recipe files between the terminal and PC via FTP. Use the [DOP Tools] / [DOP FTP Transfer] (standard FTP client) program for this purpose.

	<b>NOTE</b>
	Restrictions apply to recipe files in SKV format when using Unicode.



#### 8.3.8 Creating and transferring recipes using the controller program

Recipe data can be created, transferred and deleted via a control block in the controller. The files created with the controller program are compatible with the recipe files of the terminal. Consequently, the terminal can receive files created by the controller program and vice versa.

The control block looks as follows:

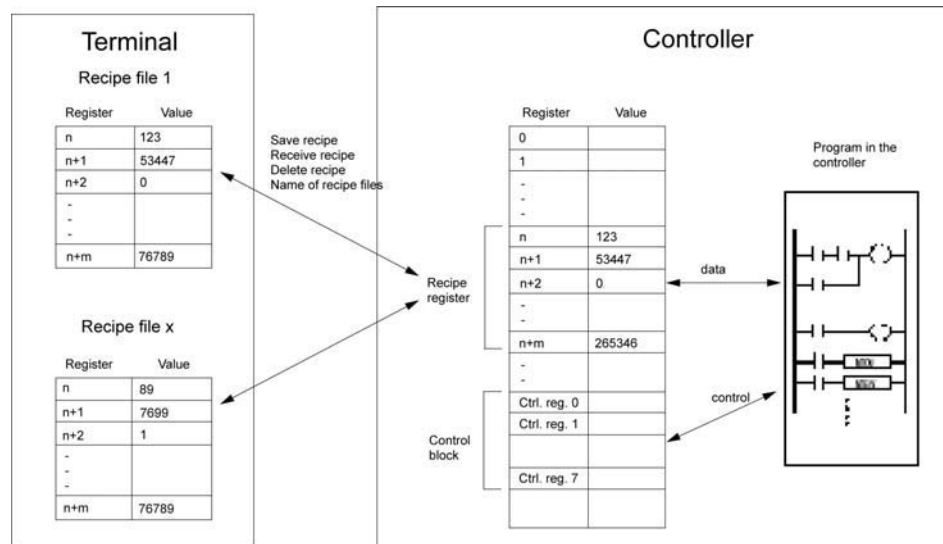

54249AEN



#### NOTE

The function only processes 16-bit values. No other formats can be used. Only the low word of each variable is stored when you create a recipe using the control block.



**Using recipe names with up to 8 characters**

Double-click on [Recipe] in the project manager to define the first control register under [Recipe control block]. This register and the seven subsequent registers are used as control registers. The control block is described in the following table.

Register	Content	Description
Control register 0	Command	The command register is defined by the controller. Available commands: 0. No command 1. Save recipe in terminal 2. Recipe received by terminal 3. Delete recipe in the terminal 4. Create recipe directory 5. Change recipe directory 6. Delete recipe directory
Control register 1	Handshake	Handshake register defined by the terminal 0. Ready for new command 1. OK 2. Write error in the recipe file 3. Recipe file not found
Control register 2	File name characters 1-2	Name of the recipe file or recipe directory in the terminal.
Control register 3	File name characters 3-4	
Control register 4	File name characters 5-6	
Control register 5	File name characters 7-8	
Control register 6	Start data register	First data register that is loaded from the recipe file or is to be saved in the recipe file.
Control register 7	Number of registers	Number of registers to be loaded from or saved to the recipe file.



## Unit Functions

### Recipe management

#### **Using recipe names with up to 32 characters**

Double-click on [Recipe] in the project manager to define the first control register under [Recipe control block]. This register and the 15 subsequent registers are used as control registers. The control block is described in the following table.

Register	Content	Description
Control register 0	Command	The command register is defined by the controller. Available commands: 10. No command 11. Save recipe in terminal 12. Recipe received by terminal 13. Delete recipe in the terminal 14. Create recipe directory 15. Change recipe directory 16. Delete recipe directory
Control register 1	Handshake	Handshake register defined by the terminal 0. Ready for new command 1. OK 2. Write error in the recipe file 3. Recipe file not found
Control register 2	File name characters 1-2	Name of the recipe file or recipe directory in the terminal.
Control register 3	File name characters 3-4	
Control register 4	File name characters 5-6	
Control register 5	File name characters 7-8	
Control register 6	File name characters 9-10	
Control register 7	File name characters 11-12	
Control register 8	File name characters 13-14	
Control register 9	File name characters 15-16	
Control register 10	File name characters 17-18	
Control register 11	File name characters 19-20	
Control register 12	File name characters 21-22	
Control register 13	File name characters 23-24	
Control register 14	File name characters 25-26	
Control register 15	File name characters 27-28	
Control register 16	File name characters 29-30	
Control register 17	File name characters 31-32	
Control register 18	Start data register	First data register that is loaded from the recipe file or is to be saved in the recipe file.
Control register 19	Number of registers	Number of registers to be loaded from or saved to the recipe file.

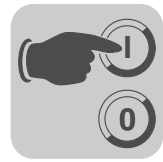

**Procedure**

1. The result code register must be 0. If it is not, set the command register to 0 or 10.
2. Set the command in the command register (e.g. 11).
3. Wait for the ready signal or the error code in the result code register.
4. Set the command register to 0 or 10. The terminal will then set the result register to 0.

	<b>NOTE</b>
	Recipe directories that were created in the HMI-Builder programming software cannot be deleted in run mode.

**Limitations**

Recipes created in the controller can contain a maximum of 1000 registers. Only word units can be saved.

The recipe name may contain the characters A ... Z, 0 ... 9 and \_ (underscore). The symbol # can also be entered using the command *MCRD#*.

**8.3.9 Storing individual recipes on the external memory card during operation**

You can use the function [Save recipe on memory card], which is called up via a function key or touch key, to save files on a compact Flash card or a USB Flash drive. The whole recipe directory in the operator terminal is transferred to the memory card.

In some cases, you may only want to store some of the recipes on an external memory card. To do so, use the command *MCRD#*. The process of storing individual recipes on an external memory card is described below.

**Settings in the HMI-Builder**

1. Choose [Setup] / [System signals] and enter the command line *MCRD#*. Click [OK].
2. In the [Recipe properties] dialog box, select the checkbox [Activate directories]. Click [OK].

**Settings in the operator terminal**

1. Create a folder using the command [Create recipe directory], e.g. *#RECIPES\_EXTERNAL*. The # symbol must be placed before the directory name.
2. Use the command [Change recipe directory] to go to the new folder.
3. For example, if you press a touch key with the function [Save recipe], the recipes in the *RECIPES\_EXTERNAL* directory will be transferred to the external memory card.



## 8.4 Passwords

This function can be used to create a security system for the machine. Users can in this way be easily assigned specific authorizations for the system.

A security level can be assigned to the following objects:

- Blocks
- Function keys
- Touch keys
- Maneuverable objects

Each security level is protected by a password. To gain access to the individual levels, the user must register with a password for the current level or a higher security level. This function is optional.

### 8.4.1 Defining security levels

In the dialog box for the object called up from the [Access] tab page, specify a security level (0-8) when the input is active. Security level 0 means all users can access the object. In this case, you will not be prompted for a password.



### 8.4.2 Defining passwords

The passwords for security levels 1-8 are defined under [Functions] / [Passwords].

Parameters	Description
Password 1-8	Enter the password for security levels 1-8.
Confirm question 1-8	Enter a security question with a maximum of 20 characters that is to be answered by the user before being able to access an object with a certain security level. This function is not available if you have defined a security level for a function or touch key.
Comment 1-8	Enter a comment or description for the password or security level. This parameter is optional.
Login signal	This parameter specifies the digital signal that creates an input field for login when enabled. You can also link the login input field with a function or touch key.
Logout signal	This parameter specifies a digital signal that logs out the current user when enabled. This function can also be linked with a function or touch key. See the section "Function keys" on page 238.
Login level reg.	Here, users can specify a register in the controller that executes the control of the security level. The register controls the security level for all objects to which a security level (password) has been assigned. The register value determines the current security level: Value 0 = no security level, 1 = security level 1, etc.
Current level reg.	This parameter specifies a register from which the terminal can retrieve data for displaying the corresponding security level (0-8).
Login timeout	This parameter specifies the amount of idle time for a terminal in minutes after which a user is automatically logged out. If the value 0 is entered, the user will not be logged off automatically.
Password RUN / PROG	Here you can enter a password that is mandatory when changing manually from RUN to PROG mode. This function does not apply to the transition from PROG to RUN or when an automatic terminal switchover RUN / TRANSFER is used in the HMI-Builder.
Automatic login	This parameter specifies whether the login screen opens automatically when password-protected blocks, objects or keys are accessed. This function only applies to terminals with a touchscreen and to function keys on all other terminals, because the cursor cannot be positioned on password-protected objects without already being logged in with security level access corresponding to the object.

### 8.4.3 Login

If the [Automatic login] checkbox under [Functions] / [Passwords] is not activated, login takes place either via function key or touch key, or via a digital signal from the controller (login signal). To open the login input field, press the function key that is linked to the [Login to specified security level] function on the defined security level or activate the digital signal. Enter the password here. The password is linked to a security level. See the section "Defining security levels" on page 222.



#### 8.4.4 Passwords for transferring projects

In the command line under [Setup] / [System signals], enter the command "PDxxxxxxx". This command prompts a password (xxxxxxx) to enable the user to access the functions in the terminal menu [Transfer]. This password must be entered in the terminal when transferring a project from the HMI-Builder to the terminal.

#### 8.4.5 Multi-access passwords

In the command line under [Setup] / [System signals], enter the command "PSxxxxxxx". This password (xxxxxxx) grants access to all terminal functions. This command is used, for example, for support and maintenance. Only capital letters can be entered in the command line.

#### 8.4.6 Changing passwords during operation

The [Change login password] function allows users to change passwords for function or touch keys during operation. Pressing the function or touch key linked to [Change login password] opens a dialog box where you can change the password for the relevant security level. See the section "Function keys" on page 238.



#### NOTE

No security level can be entered for block [0].

After logoff, the <PREV> key and the [Return to previous block] function are disabled for function and touch keys to prevent unauthorized users from accessing password-protected blocks.





## 8.5 Printing reports

A number of reports (such as daily reports or event reports) can be created with ease for tracking the production process. The figure below shows the principle for creating daily reports.

### 8.5.1 Printer connection

The printer must have either a serial or USB connection. Serial printers must support the IBM character set (850). USB printers must support the USB printer class and at least PCL 5. For printing via ETHERNET, the network printer must use the Windows network services. You make the printer settings under [Setup] / [Peripherals]. For information on the printer configuration, refer to the printer manual.

Possible printers:

Serial printer	= Panasonic KX-P1092
USB printer	= HP Laser Inkjet
	= HP Laser Deskjet

### 8.5.2 Printing projects

To print a project, select [File] / [Print] from the menu. Select the corresponding check-boxes to define which parts of the project will be printed. Click [Setup] to configure the printer. Click [Preview] to open a print preview.

### 8.5.3 Printing text blocks

Reports are created as text block with static and dynamic text. The maximum width of the report is 150 characters. You can enter any text in the text block, e.g. the table header or another static text that should always be printed out. To output process values, dynamic objects have to be defined that represent the value for the signal to which the object is linked.

The time when the report is to be printed can be selected, for example, via time channels.

	<b>NOTE</b>
	Text blocks cannot be printed with Unicode.



#### 8.5.4 Printing graphic blocks

Graphic blocks can be printed using a PC server via ETHERNET. It is also possible to connect a printer with a USB connection to the operator terminal. The USB printer must support the following printer languages: HP PCL5, PCL5C, PCL6. Graphic blocks can only be printed when they are displayed on the screen. Commands can be entered in the command line. To do so, in the project manager double-click on [System signals] in the [Setup] folder.

If you enter the command *NHD* in the command line, the laser printer will print the graphic block without a header (with block name, block number, date and time).

	<b>NOTE</b>
	<p>The printer buffer must contain at least 5 MB to print graphic blocks.</p> <p>The alarm block, i.e. the graphic block with the alarm list, is printed in text form.</p>

#### 8.5.5 Defining printouts

The printout is defined in the [Block properties] dialog box on the [Printout] tab page. To open the dialog box, right-click on the block and choose [Properties]. The *Print signal* parameter specifies which digital signal triggers the print process for the block. The digital end signal that is activated by the operator terminal when printing is finished is also entered here. Choose [Reset] to reset the signal.



8.5.6 Printer properties

To define printer properties, open the project manager and double-click on the entry [Peripherals]. Then right-click on [Printer] and choose [Properties]. More information on the printer can be found in the printer manual. The printer must support the expanded IMB-ASCII character set. To print graphic blocks, the printer must support the graphic functions HP PCL5, HP PCL5C or HP PCL6.

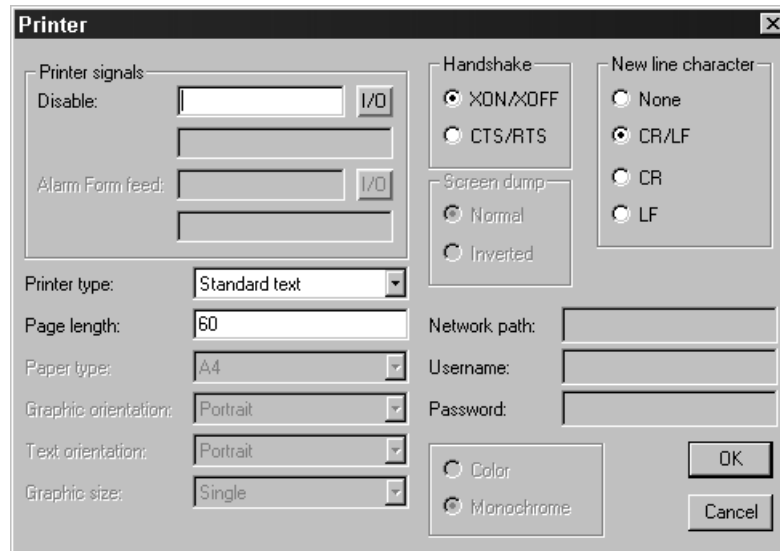

11578AEN

Parameters	Description	
Printer signals	Deactivate	Digital signal that cancels printing if enabled. This enables the printer port to be used for another form of data transfer (e.g. transparent mode).
	Page break alarm	Signal that sends a page break command to the printer. When the alarm command <i>To printer</i> is used, the page break signal is only sent at the end of a page (i.e. not after each alarm). Only for laser and inkjet printers.
Printer type	Choose a standard text printer or the installed printer (PCL inkjet printer or PCL laser printer).	
Page length	Here, you define the number of lines before a page break. No page break is created when the page length is set to 0.	
Paper type	Choose the paper type matching the installed printer.	
Graphic orientation	This parameter specifies whether the graphic is printed in portrait or landscape format.	
Text orientation	Specify whether you want to print the report on a PCL5 printer in portrait or landscape format.	
Network path	Specifies the search path for the network printer.	
User name	User name on the print server.	
Password	Password on the print server.	
Handshake	Specify whether the handshake between printer and terminal takes place via XON / OFF or CTS / RTS.	
New line character	Specify the end of line character: CR/LF, CR, LF or none.	
Color / monochrome	Specify whether the printout should be in color or black-and-white.	



#### NOTE

The printer settings apply for parameters such as the character table, font size and borders.

More information on printers can be found in the printer manual.

### 8.5.7 Setting up a communication port

To select the communication port for the connected printer, go to [Setup] / [Peripherals], right-click on [Printer], and choose [Connection]. You can now select the communication port to which the printer is connected. For information on the correct setup for the communication port and the connected printer, refer to the printer manual for the respective printer.

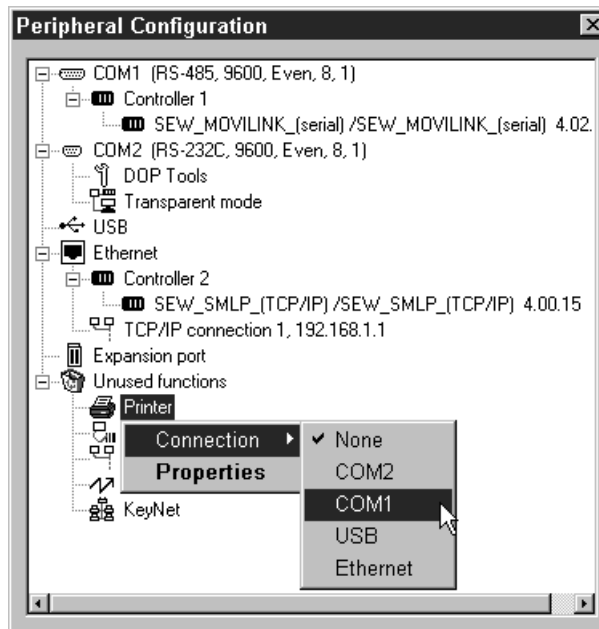

11579AEN

Parameters	Description
Baud rate	Define the communication speed (in baud). The speed must correspond with the baud rate of the external units.
Parity	Specify the parity. The parity must correspond with the parity of the external units.
Data bits	Specify the number of data bits. The number of data bits must correspond with that of the external units.
Stop bits	Specify the number of stop bits. The number of stop bits must correspond with that of the external units.



### 8.5.8 Control codes for the printer

Enter the control codes for the printer in a text block. Type "%%" and add a number between 1 and 31. The numbers 1 to 31 represent the control codes for the printer. Type "%%12" for example. This entry refers to the page break. For a description of the control codes, refer to the printer manual. A command must be followed by a space. The page break ("%%12") must be entered at the end of the line. The "%%" character is not permitted in the text. Several commands are permitted in a line.

### 8.5.9 Printer status

The status of the connected printer can be read using a printer register. This register is specified under [Setup] / [System signals].

## 8.6 Time control

The [Time control] function allows for enabling and disabling digital signals depending on the realtime clock. You can use this function to control events in the process (e.g. switching motors on and off) at specified times via the terminal. Time channels replace time relays and 7-day time switches.

### 8.6.1 Defining time channels

Time channels are defined under [Functions] / [Time channels].

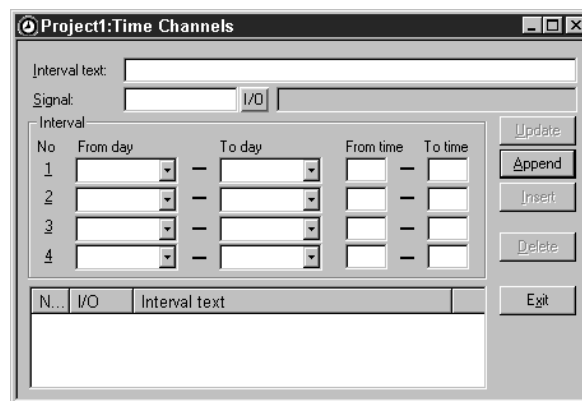

11580AEN

Parameters	Description
Interval text	Enter any text for the time channel.
Signal	Define a digital signal that will be activated at the specified time intervals.
Interval	Specify days and times for the interval. You can define four different intervals for each time channel.



#### 8.6.2 Run mode display

The page with the time channels is displayed when system block 991 is activated. The system block is either activated by a jump object or a digital signal that is linked to the block. Time channel values can be read and changed. The [Time channels] option under [Setup] / [Online properties] must be selected to modify time channel values in run mode.

To read or change the values for a time channel, move the cursor to the required line and press the Enter key. You can also touch the required line if the terminal has a touchscreen. Press [OK] to conclude the time channel definition. Close the time channel menu by clicking <PREV> or pressing <Cancel> if the terminal has a touchscreen. Doing so displays the block from which the time channel block was activated.

### 8.7 Language management

The programming software supports multi-language applications for operator terminals in the DOP series. We recommend that you create the entire application in one language using the programming software. Multilingual support enables you to translate all the texts in an application into other languages. The translation can be carried out directly in the programming software. You can also export all texts in the form of a text file and translate them in another software. The translated file can then be reimported into the programming software. A maximum of 10 languages can be created per application.

An index is assigned to each text in the application. To optimize the function and minimize the amount of text, you can copy and paste text that is frequently used in the application. These texts are linked to the same index.

The application language also contains user texts and is linked with a system language that contains system texts. User texts are texts that are entered when programming the project. System texts are texts that already exist when a new project is created and texts in the system program of the terminal.



#### NOTE

Some fonts, particularly Asian fonts, require a lot of space in the memory. This reduces the amount of memory available for the project itself and must be taken into account when projects are to be translated. The entire storage space for a project and accompanying fonts amounts to 12 MB.

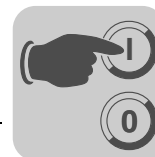

### 8.7.1 Unicode on the operator terminal

Unicode is a global character coding standard that uses 16-bit values for displaying the characters of many languages. The DOP11B operator terminals only support Unicode character sets. Unicode characters can be used in projects and system texts.

The Microsoft Windows XP and Windows 2000 operating systems support Unicode.

HMI-Builder uses a Unicode character set to display Unicode characters in the dialog boxes.

### 8.7.2 Creating several application languages

Choose [Setup] / [Multi language] / [New language]. This function calls up a wizard for creating several application languages. Follow the instructions in the dialog box and select or enter the required parameter values or names



11990AEN



## Unit Functions

### Language management

Specify whether you want to have all texts copied from an existing language (i.e. one that has already been created). Language 1 is the language in which the application was created (basic language).

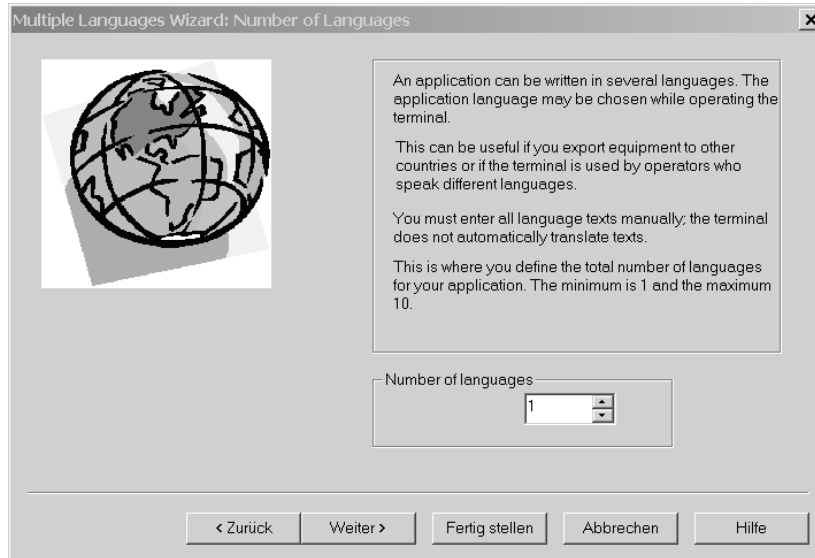

11991AEN

Choose how many languages should be used in the application. Click [Next] to continue.

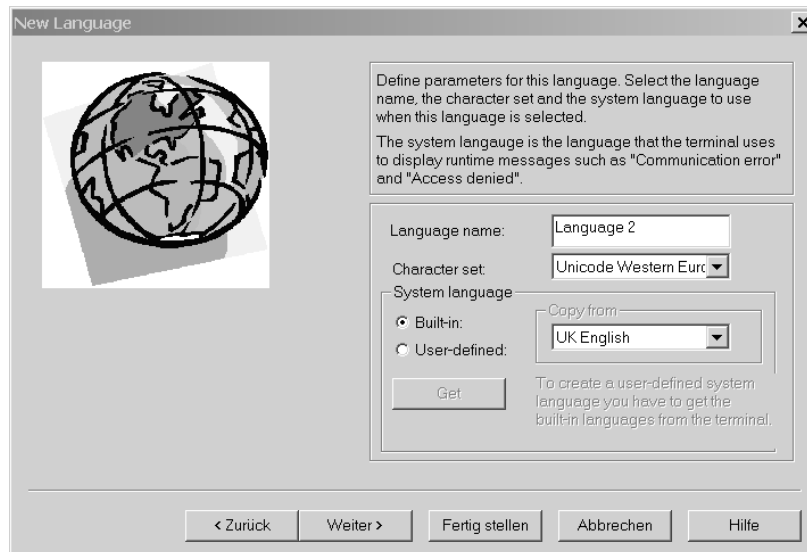

11992AEN

The software suggests language names. You can change these names.

Under [Character set], select the character set that should be used in the terminal and any special country-specific characters. See the section "Country/language" on page 124.





Under [System language], you can choose between [Integrated] or [User defined]. Selecting [Integrated] will display the system texts in the terminal in the selected language. Selecting [User defined] enables you to translate an integrated system language and link it with the system language for the application language (terminal needs to be connected to a PC).



11993AEN

The language control register is defined here. Its value (0 ... 9) specifies which application language (0 ... 9) should be used for the terminal.

Click [End] to exit the wizard. This opens a directory tree with all languages you have created.



#### 8.7.3 Translating and editing texts in the programming software

Choose [Setup] / [Multi language] / [Edit].

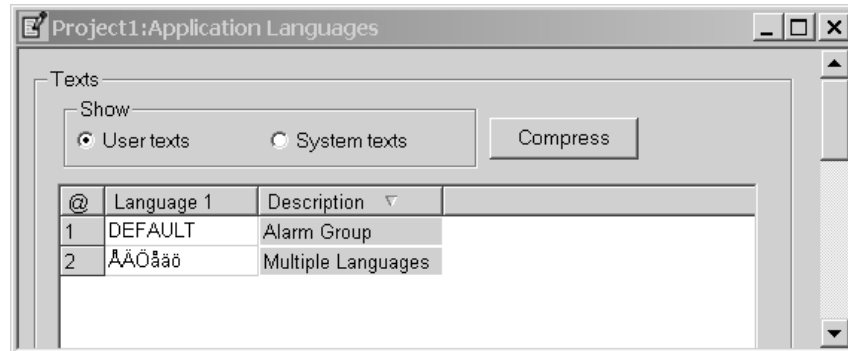

11994AEN

Enter the translation for the respective language in a table cell. Use the arrow keys to move the cursor through rows and columns. Browse the text list via [Edit] / [Find].

You can also export application languages as text files and translate them in another program (e.g. Excel or Notepad). The text file will then be reimported into the application. See the sections "Export" and "Import" on page 236.



### 8.7.4 Properties of the application language

Choose [Setup] / [Multi language] / [Setup].

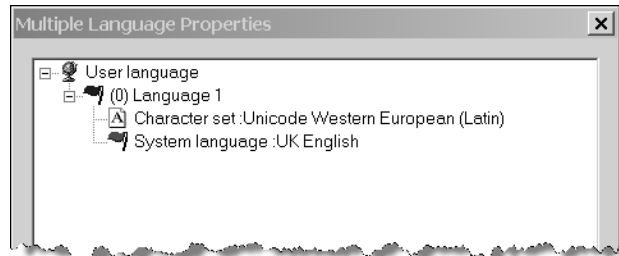

11995AEN

Right-click on [User language] and choose [Properties] to change the register for controlling the language display.

You can make the following settings by right clicking the language name:

Parameters	Description
New language	Use selected language
Character set	Select / change character set
System language	Select / change system language
Delete language	Delete current language
Rename	Rename the current language
Properties	Define the data registers that determine the value for the language display

To change the character set for the language, right-click on [Character set].

Right-click on [System language] to change the selected system language.

### 8.7.5 User-defined system language

To create a user-defined system language, select [User defined], choose the source language and click [Receive]. The [Language transfer] dialog box opens. Click [Load] to load the integrated system languages from the terminal. In this way, you can also edit system texts under [Setup] / [Multi Language] / [Edit]. You can also export texts as text file and edit the text in another program.

All system texts in the terminal (passwords, time channels, etc.) support multilingual applications. You can either use the predefined system languages or create your own (new) languages. All characters in the selected character set are available for the application languages. A text character sequence can be linked to several objects. The maximum number of text character sequences for each language depends on the available project memory in the terminal.

The bottom left area of the application language dialog box provides information on the memory size for the selected language (language file). The information is displayed in X/Y format, where X stands for the occupied memory and Y for the free memory available for each language, e. g. size 7/128.



#### 8.7.6 Exporting

Languages can be exported, e.g. to Excel, where they can be translated and reimported to the programming software.

Choose [Setup] / [Multi language] / [Export]. Choose user texts (or system texts). Enter the name of the export file into the dialog box that opens and select Unicode as the format.

#### 8.7.7 Importing

Choose [Setup] / [Multi language] / [Import] or click on the button [Import] in the language toolbar.

Next, select [User texts] (or [System texts]). The dialog box [Import multi-lingual texts] is displayed. Enter the name of the text file to be imported. The project language is in Unicode format.

#### 8.7.8 Displaying index numbers

Each object that represents text in an application with multi-lingual support is linked to an index. An index can be linked to various objects containing the same text. To display the index numbers for the object texts, select [Setup] / [Multi Language] / [Show index].

#### 8.7.9 Cross reference

Choose [Setup] / [Multi language] / [Cross reference]. In the cross reference list that opens, you can edit objects by right-clicking them. The cross reference list supports the incremental search when entering index numbers.

#### 8.7.10 Reusing an index

Choose [Setup] / [Multi language] / [Reuse index]. If the [Reuse index] function is active while copying an object, the same index will be assigned to the copy. This way, objects with the same index need only be translated once. Changes made to a text affect all texts with the same index number.



#### NOTE

If you delete an object that has copies with the same index number, only the selected object will be deleted.



### 8.7.11 Choosing Unicode font

Here you choose a Unicode font if an expanded character set is required for creating the application language.

### 8.7.12 Application languages in run mode

The application language can be changed in the terminal in run mode. To do so, change the value (0-9) in the specified language control register. Note that the terminal updates the entire block when a new language is selected in run mode. If the terminal has a cursor, it will be positioned on the first maneuverable object in the current block after having performed the change.

### 8.7.13 Font templates

You can use the font templates to determine which font is assigned to the text objects and languages. Choose [Edit] / [Font templates] to call up a list of the fonts used in the project. If you use a language that contains characters not included in the Windows TrueType fonts such as Arial or Times New Roman, the font must be assigned to the language. Changes made to the font template affect all the text objects linked to the corresponding font.

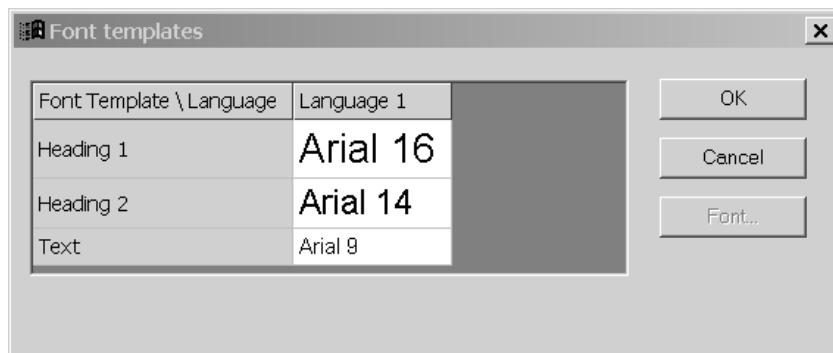

11996AEN



#### NOTE

The size of the font files is taken into account when determining the occupied project memory.



#### 8.8 LEDs

Only applies to operator terminals with LEDs.

The operator terminal has integrated LEDs that are linked to a register. The LEDs are defined under [Functions] / [LED]. The register content determines the color and, if required, the flashing frequency of the LED as shown in the table below.

Register value (Hex)	Register value (Dec)	Flashing frequency (Hz)	Color
00	0	-	No
01	1	-	Green
02	2	-	Red
11	17	5	Green
12	18	5	Red
21	33	2,5	Green
22	34	2,5	Red
31	49	1,2	Green
32	50	1,2	Red
41	65	0,6	Green
42	66	0,6	Red

#### 8.9 Function keys

You link a function key to a signal by entering the signal's address according to the relevant key or by choosing the corresponding function from the selection list. The function key linked to a signal will be activated according to the function you have specified when defining the function key.



#### NOTE

Only two function keys linked to signals can be activated at the same time. If more than two function keys are pressed simultaneously, only the two signals that were triggered first will be activated.

The number of function keys depends on the terminal type.



### 8.9.1 Defining function keys

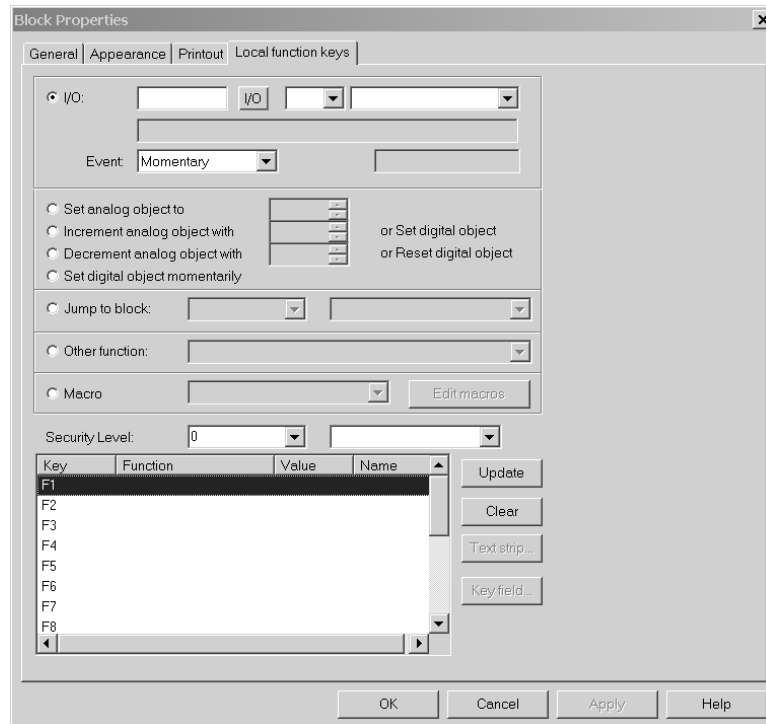

11997AEN

You can define function keys in two ways:

- Globally
- Locally

#### Global definition

- Global function keys are defined and used in the entire application and apply to all blocks.
- A global definition is always available in run mode, as long as the block displayed on the screen does not have any local definitions for the current function key.
- Global definitions are made under [Functions] / [Function keys].

#### Local definition

- Local function keys are defined and used for a block.
- Local definitions have a higher priority than global definitions.
- Local function keys are defined in the block's 'Properties' dialog box on the [Local function keys] tab page.



## Unit Functions

### Function keys

Function	Description	
IO	Signal that is activated by the function key. (The subsequent field is used for specifying possible index registers and signal formats.)	
Event	The IO event function serves for defining the effect of the function key on the specified signal. The Event function provides the following options:	
	Temporary	The signal is active as long as the key is pressed.
	Toggle	The signal is set or reset when the key is pressed.
	Set	The signal is set when the key is pressed and remains in this state.
	Reset	The signal is reset when the key is pressed and remains in this state.
	Grouped	All signals that are linked to a function key with the current group number are reset. The group number is entered in the [Group no.] field. A group comprises a maximum of eight function keys.
	Set analog	In the [Set analog] option, the analog signal linked to the function key is assigned the value defined in the [Value] field.
	Inc. analog	The analog signal linked to the function key is increased by the value defined in the [value] field.
	Dec. analog	The analog signal linked to the function key is decreased by the value defined in the [value] field.
Set analog object to	Assigns the entered value to the maneuverable analog object selected with the cursor.	
Increase analog object by or set digital object	Increases the value of the selected maneuverable analog object by the value specified or activates a selected maneuverable digital object.	
Decrease analog object by or reset digital object	Decreases the value of a maneuverable analog object by the value specified or resets a selected maneuverable digital object.	
Set digital object temporarily	Activates a selected digital object as long as the key is pressed.	
Jump to block	Jumps to the block with the selected name or number.	
Other functions	Function or touch keys are linked to the functions in the selection list. See the separate table "Other functions of function keys and touch keys" on page 241.	
Macro	The selected macro is executed. You can change the name of the selected macro or change the macro event for the selected event by clicking the [Edit macro] button.	
Security level	You can define security levels for function keys. The operator must login with a password for this or another security level to being able to use the function key.	





**Other functions of function keys and touch keys**

Function	Description
Load recipe	Retrieves the recipe from the memory of the operator terminal.
Save recipe	Saves the recipe in the memory of the operator terminal.
Delete recipe	Deletes the recipe from the memory of the operator terminal.
Append recipe	Appends signals and their values from the current block to an existing recipe. See the section "Recipe management" on page 210.
Login to specified security level	Login. See the section "Passwords" on page 222.
Logoff	Logoff.
Changes login password	Changes the password.
Scrolls one page up	Scrolls one page up in alarm management.
Scrolls one page down	Scrolls one page down in alarm management.
Maximizes text	Maximize text size in alarm management.
Minimizes text	Minimize text size in alarm management.
Saves recipe to memory card	Saves the recipe to the memory card selected for backup.
Loads recipe from memory card	Loads the recipe from the memory card selected for backup.
Deletes recipe on memory card	Deletes the recipe from the memory card selected for backup.
Loads project from memory card	Loads the project from the memory card selected for backup.
Acknowledges alarm	Acknowledge alarm in the alarm list.
Displays alarm list	Display alarm management (block 990).
Jumps to info block connected to the alarm	Jumps to the info block connected to the alarm. Refers to the current alarm line or alarm management.
List alarm groups	Specifies the alarm group from which the alarm is to be displayed in alarm management.
Returns to the previous block	Shows the previous block. You can go back up to nine levels. When block 0 is displayed, this function will not execute a jump to the previous block. This function does not perform block jumps if you have to login to a higher security level than the one you have.
Displays object info	Shows the minimum and maximum values for analog objects in the text block in run mode.
Input	Corresponds to pressing the Enter key.
Displays the diagnostics page	Displays the information window of the operator terminal.
Connect TCP/IP	Establishes the connection for serial TCP/IP communication.
Disconnect TCP/IP	Disconnects the serial TCP/IP connection.
Changes recipe directory	Edit recipe directory in the terminal.
Creates recipe directory	Create recipe directory in the terminal.
Deletes recipe directory	Delete recipe directory in the terminal.



#### 8.9.2 Using function keys to jump to block

This function enables the user to jump to blocks using function keys without using a display signal. Choose [Jump to block] from the selection list when defining the keys (locally or globally).

Changing to a block can be performed easiest using function keys. A digital signal is not assigned in the controller.

### 8.10 Trends

#### 8.10.1 Development trend

With this function, the controller constantly acquires analog values and displays them in a trend object during operation. The values are displayed in curves. The recorded values are stored in the operator terminal's project memory.

Several independent trend curves can either be displayed in the same block or in different blocks. The number of curves is restricted by the size and capacity of the project memory.

The trend object displays, for example, the time interval between the data recordings and the number of values.

#### **Calculating the trend data size**

Use the following formula to calculate the trend data size in the project memory:

$$S = TOG + AK (28 + (645 \times ((AS / 100) + 1)))$$

TOG	Trend object size (If all the parameters are changed for a trend object, the value of the TOG = 320 Bytes.)
AK	Number of curves defined in the trend object
AS	Number of samples that are rounded off to the next hundredth
S	Number of bytes



#### **NOTE**

The RAM memory can also limit the number of trends in an object. This limitation depends on other objects and functions used in the project.

Trend objects can be specified as signed and unsigned 32-bit values. Trend curves in the 32-bit format require more memory space than those in the 16-bit format.



**Display in run mode**

In run mode, trend curves can display ongoing values. Select the required trend object and press the Enter key. This opens a dialog box. Select a time interval and date for the data to be displayed. "History" is displayed at the bottom of the dialog box. To go back to real-time display, press the Enter key again. The trend data is stored in files. You specify the name when defining the trend object.

**8.10.2 Defining trend objects**

You can define trend objects in a block exactly like other dynamic objects. The object can be linked with up to 6 analog signals.

Unlike other objects, the trend object name must be specified using 1-8 characters. The first character must either be a letter or a number. A-Z, 0-9 are permitted characters for the trend name. Otherwise, the same file name conventions apply as for MS-DOS.

You can define the following parameters for the trend object. Under [Setup] / [Terminal options], you can define whether you want to save only changed trends or all of them.

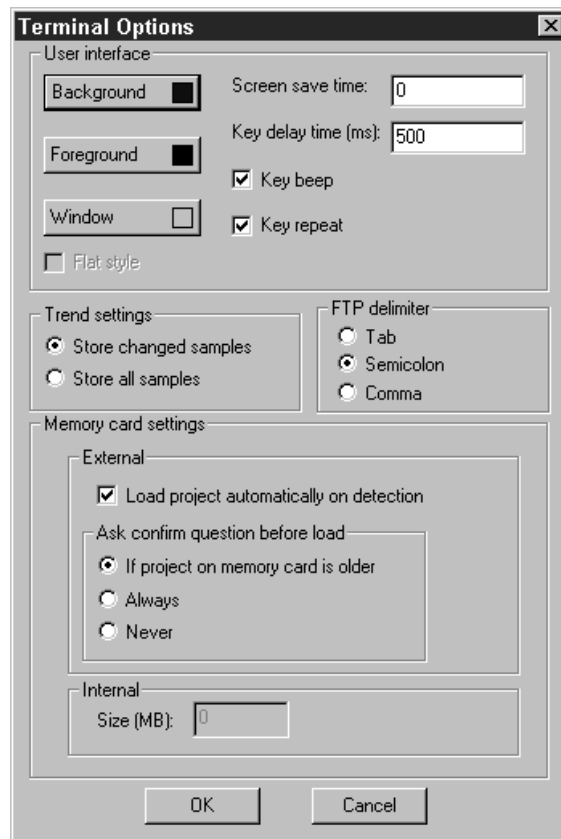

11604AEN

	<b>NOTE</b>
	More information on trend objects can be found in the section "Graphic display and control" (page 159).



#### 8.10.3 Transferring trend data

If the [DOP Tools] \ [DOP File Transfer] program is installed on your PC, you will be able to transfer trend data, recipes and alarm lists to and from the PC for statistical calculations, display or for storage purposes.

You can also transfer the following data between PC and terminal using FTP:

- Trend data
- Recipes
- Alarm lists
- HTML files
- Bitmap graphics

An FTP client must be installed on the PC for this purpose. The *DOP Tools* program group includes the *DOP FTP Client* application that acts as the standard FTP client.

You can directly open trend files for statistical calculations, e.g. in Excel.

#### **Trend files**

The name for each trend file is specified when defining the trend object. The suffix SKV is assigned to the file.

Line format of the trend file:

DDDD;TTTT;AAAA;BBBB;CCCC;DDDD;EEEE;FFFF:

Format	Description
DDDD	Date format defined under Setup.
TTTT	Time format defined under Setup.
AAAA	Trend curve 1
BBBB	Trend curve 2 (if defined)
CCCC	Trend curve 3 (if defined)
DDDD	Trend curve 4 (if defined)
EEEE	Trend curve 5 (if defined)
FFFF	Trend curve 6 (if defined)

The oldest value is displayed in the first file line, the newest in the last line. The SKV format can be directly exported to Microsoft Excel. The diagram wizard in Excel is used for creating statistical diagrams. You cannot change files and send them to the terminal.



8.10.4 Backing up trend data

Files containing trend data can be copied from the normal project memory in the operator terminal to an external memory card inserted into the terminal. The memory card in the operator terminal must be formatted as a backup card. It can be inserted into any operator terminal. The data on the card can then be transferred via FTP to a PC and processed there. Trend files for which a backup copy has been created are located on the operator terminal in the (library) directory 'Backup'. To transfer trend data files between the terminal and a PC, an FTP client must be installed on the PC (DOP FTP client).

The command TBUP and a memory cell specified in the command line of the configuration software are used to create backup copies for trend data from the operator terminal's project memory to the external memory card in the terminal. In the project manager, double-click on [System signals] in the [Setup] directory.

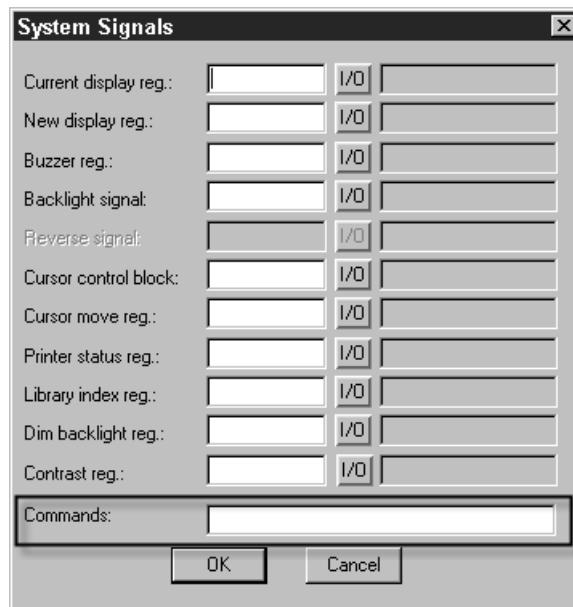

11582AEN

Parameters	Description
TBUP	Trend backup. Used to create backup copies of trend files on external memory cards.
TESOSn	When the [Activate] signal is enabled, only a trend sample is saved. When n=*, the setting applies to all trend objects. When n=T, the setting only applies to trend objects beginning with T.
TMBx	Trend multi backup. Used in conjunction with the system command TBUP to create several backup libraries on one memory card. (x is the number of libraries with backup files on the card. When this number is exceeded, the oldest library is overwritten automatically. The default value is 1.)



Enter the command *TBUP* followed by a digital signal (e.g. M10). This digital signal can also be linked to a function key or touch key. When the digital signal is activated by the push of a button, all the trend files from the operator terminal's project memory are backed up on the external memory card. Once the backup process is complete, the operator terminal deactivates the digital signal entered in the command line.



#### NOTE

On an external memory card, it is possible to save only one version of a trend in each library. When a backup is created for a trend already saved, the earlier version is overwritten. The command *TMBx* can be used to create several libraries.

## 8.11 Macros

A macro combines several events in the terminal into a single command. If you frequently call up certain commands or settings in the terminal, you can automate these processes by creating a macro. A macro is triggered via local or global function keys or touch keys. You call up the [Macros] function under [Functions] / [Macros].

### 8.11.1 Adding a macro

Clicking on the [Add macro] button opens the selection dialog box.

11998AEN

Enter a name for the macro in the dialog box. The name must be unique. Click [OK] to display the macro in the list under the name you have defined.

The number of user-definable macros is unlimited.



8.11.2 Insert event / Add event

Clicking on the [Insert event] or [Add event] button opens the following selection dialog box:

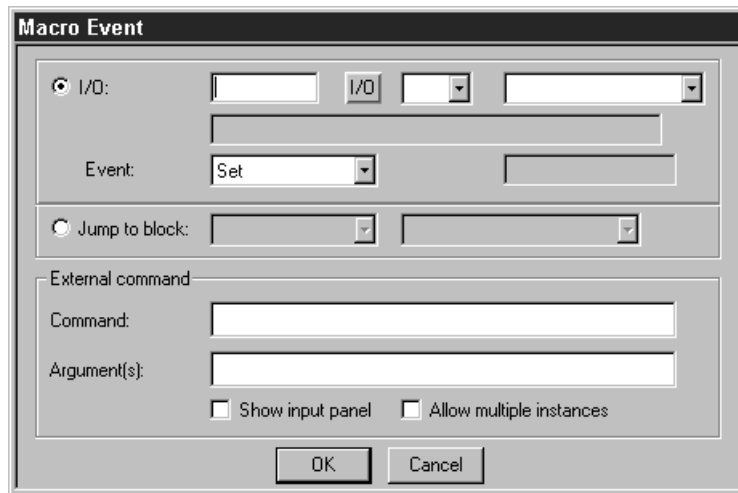

11583AEN

Each macro can include a maximum of eight different events (lines).

Parameters	Description	
I/O	With this parameter you define the signal to be linked to an event in the macro. In the [Event] field, select the event to be linked to the signal in the macro. You can choose from the following events:	
	Set	The digital signal is activated when the macro key is pressed and remains in this state.
	Decrease analog	Activating the macro by pressing a key will decrease the analog signal by the value defined in the [value] field.
	Reset	The digital signal is deactivated when the macro key is pressed and remains in this state.
	Set analog	Activating the macro by pressing a key will assign the value defined in the [value] field to the analog signal.
	Toggle	The digital signal is activated and deactivated alternately by pressing the macro key.
	Increase analog	Activating the macro by pressing a key will increase the analog signal by the value defined in the [Value] field.
Jump to block	Enter the number or name of the block you want to jump to when pressing the macro key. A block jump can only be the last event in a macro because it completes the macro.	
Command	Command to be activated. You can choose from the following commands:	
	IPCONFIG	Retrieves and displays the terminal's current IP address.
	PING	Checks whether a host is available.
	ROUTE	Used to display, add and delete files.
Argument	Text field with the command parameter, e.g. 192.168.1.1 for the command PING.	
Show input panel	Yes / No (only for touch keys). Determines whether an input area should be displayed when the program is in operation	
Allow multiple instances	Yes / No Determines whether several instances of the program may run simultaneously.	



### 8.11.3 Editing

Click on [Edit] to change the name of the current macro or the macro event of the current event. Alternatively, double-click directly on the macro or macro event to edit it.

### 8.11.4 Activating macros

You activate a macro using function or touch keys. Each key (global or local) can be linked to a macro. You select the macro for the corresponding key in the dialog boxes for local and global function keys and touch keys.

## 8.12 System monitor

The system monitor is a block used for displaying and changing control signal values when the operator terminal is switched on. The values are displayed as decimal, hexadecimal and ASCII values. The system monitor is always available on the operator terminal. To use the system monitor when the operator terminal is switched on, create a block jump from another block to the system monitor block. To add control signals, for example, you must call up the edit field. It appears as soon as you press the Enter key or click on the button [NEW] when the system monitor is active.





### 8.13 Data logger

Data can be logged and, like trend data (but without the terminal display), stored in a file. Data can be logged at different intervals or when values are changed. Each data logger supports 16 signals and can log 16-bit, 32-bit and real (floating point) values. The logging process occupies system power and memory space.

In the project manager, double-click on [Data logging]. Then right-click on [Data logging] and choose [Add]. Double-clicking on [Data logger] calls up the following dialog box.

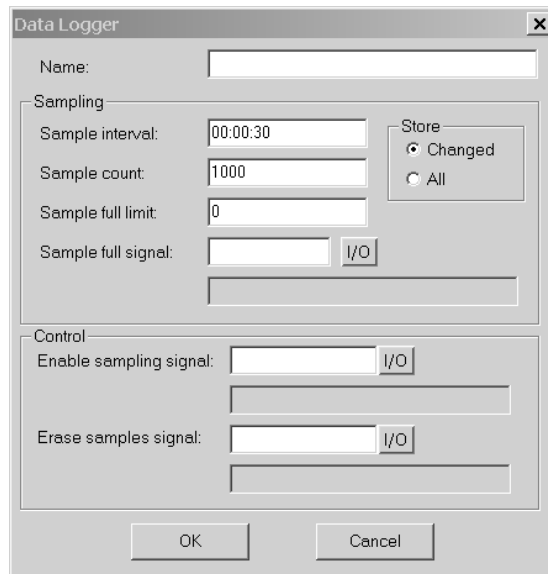

11999AEN

Parameters	Description
Name	Enter a name (file name) for the data logger. This name, which can only be entered once for each logger, may contain a maximum of 8 characters. Only the characters A - Z, 0 - 9 and _ are permitted.
Sample interval	Enter an interval for logging the data. The minimum value is 1 s.
Sample counter	Enter the number of values to be saved. The maximum value is 65534. Once the maximum value has been exceeded, the oldest entry is overwritten with each new sample.



## 9 Network Functions and Communication

### 9.1 Communication

#### 9.1.1 Communication with two controllers (two drivers)

You can activate two different drivers in the terminal. This means the terminal is capable of communicating with two different controllers simultaneously.

The controllers can be connected with the serial terminal interface or via an ETHERNET connection.

Signal addressing to the controller takes place according to the usual procedure for the respective controller (see driver documentation for more details).

- Choose [Project] / [Properties] from the menu in HMI-Builder.
- Select the controller by clicking [Change] for controller 1 or controller 2. If the driver selected for controller 1 does not support two drivers, then you cannot select a driver for controller 2.
- Click [OK].
- Choose [Setup] / [Peripherals].
- Drag [Controller 1] and [Controller 2] to the connection ports to which the respective controller is connected. The interfaces RS-232C, RS-422 / RS-485 and ETHERNET are available for this purpose.

Refer to the driver documentation for more details on how to connect the controller and terminal.

#### **Addressing**

Signal addressing to the controller takes place according to the usual procedure for the respective controller (see driver documentation for more details). To define the controller to which a created object should be linked, click the button for the required controller ([1] or [2]) in the tool bar in HMI-Builder.

Controller 1 is set by default when you create or open a project.

Clicking the [1] button links the signal of an object to be created with controller 1. Clicking the [2] button links the signal of an object to be created with controller 2.

Alternatively, you can click the [I/O] button in the object to be created and use the I/O browser to select the controller to be used for linking to the object.

To address a signal in controller 2 when controller 1 is preset, add "@2" to the signal (or vice versa "@1" for controller 1 if controller 2 is preset).

#### **Example**

Controller 1 is preset. Register D0 in controller 2 is to be linked to a slider. Enter "D0@2" under analog signal in the slider dialog box.



**I/O cross reference**

The [I/O cross reference] function for displaying an overview of I/Os can be used both for controller 1 and controller 2. The cross reference displays the preset controller.

**Name list**

Controller 1 and controller 2 support the name list with all associated functions.

	<b>NOTE</b>	
	<p>If communication with one controller is interrupted, the terminal will continue communication with the other controller. The terminal tries to reestablish the interrupted controller connection every 10 seconds. This process can impair communication with the connected system. The interval can be changed in the driver properties in the offline status parameter.</p>	

**9.1.2 Data exchange between controllers**

When a terminal is connected to two controllers (two drivers in the terminal), data can be exchanged between the controllers (analog and digital signals). You can also connect two controllers via separate terminals in a BDTP network.

The signal type need not be identical in the two controllers. Data is exchanged between controller 1 and controller 2 via a virtual data channel. You can define eight different data channels. Data exchange can be time-controlled or based on events. You define the conditions for the exchange of data and the signal intervals for each data channel under [Functions] / [Data exchange].

Parameters	Description	
Area	Start I/O 1	Start address for the data channel for controller 1. (The subsequent field is used for specifying possible index registers and signal formats.)
	Start I/O 2	Start address for the data channel for controller 2. (The subsequent field is used for specifying possible index registers and signal formats.)
Mode	Specify whether the signals for the data channel are analog or digital signals.	
Size	Specify the number of signals to be transferred in the data channel (start address + subsequent). The maximum number of signals for a data channel is 255.	
Flow 1 → 2	Trigger signal	Digital trigger signal that controls the data exchange for the data channel from controller 1 to controller 2. Meaning of the signal status:
		0   Inactive
		1   Transfer The terminal deactivates the signal after successful transfer.
	Interval	Shows the time in seconds that elapses between cyclic transfers in the data channel. Set the interval parameter to zero if there is no cyclic transfer. When the value is higher than zero (1), the parameter has priority over the trigger signal. In this case, a trigger signal will not be able to initiate a transfer. The maximum number of seconds is 65535.



Parameters	Description	
Flow 2 → 1	Trigger signal	Digital trigger signal that controls the data exchange for the data channel from controller 2 to controller 1. Meaning of the signal status:
		0   Inactive
	1   Transfer The terminal deactivates the signal after successful transfer.	
	Interval	Indicates the time in seconds that elapses between cyclic transfers in the data channel. Set the interval parameter to zero if there is no cyclic transfer. When the value is higher than zero (1), the parameter has priority over the trigger signal. In this case, a trigger signal will not be able to initiate a transfer. The maximum number of seconds is 65535.

When you have completed your data channel settings, click [Add].

	NOTE
	<p>The [Data exchange] function has the same priority as all other terminal functions. Example: If the terminal is working at full capacity (because other functions are being executed), when you request a data exchange, the data transfer time between the controllers will increase.</p>

### 9.1.3 Transparent mode

In transparent mode, you can use a communication port (programming / printer port) on the terminal that is not connected with the controller to connect other parallel units to the controller. Such units can be terminals, a PC with programming tools for the controller or a higher-level operator system.

Refer to the driver manual for information on whether the connected controller supports transparent mode.

#### **Connecting PCs or other com- puter systems**

PCs with a programming tool or another computer system are connected directly to a communication port (in this case programming/ printer port) of the terminal.

The MOVILINK® / SMLP driver supports a special transparent mode exclusive to the SEW driver.

If the driver is configured for serial communication and the transparent mode port is configured for the ETHERNET port with TCP and port number 300, special routing behavior is activated. This enables MOVITOOLS® MotionStudio to use an ETHERNET query to detect both the DOP11B units and the SEW devices connected via the DOP11B units' serial port.

These devices can be addressed as an ETHERNET gateway in MOVITOOLS® MotionStudio via ETHERNET and the DOP11B units.

Transparent mode does not work in any other configuration.



**Terminal and PC settings**

Make the following PC and terminal settings to enable transparent mode. Make the communication settings in the terminal project in HMI-Builder under [Setup] / [Peripherals].

- Drag the [Transparent mode] element to the required communication port (i.e. the port to which the PC is connected with the terminal).
- Right-click the element to configure transparent mode (if supported by the driver, see the driver manual for details).

The settings for the port to which the PC is connected must be identical with the settings in the PC program (programming software for the controller).

Parameters	Description
IP properties	This parameter is only used for communication in transparent / pass-through mode via ETHERNET. The transparent mode unit must be connected with a TCP/IP port for this purpose. Port number 6004 usually need not be changed. Select the required protocol: UDP or TCP.
Controller systems	This parameter is only used for communication in transparent / pass-through mode via ETHERNET. The transparent mode unit must be connected with a TCP/IP port for this purpose. Define whether you want the transparent / pass-through mode to apply to controller 1 or 2.
Mode	Select transparent or pass-through mode as communication type. Timeout – Enter a time interval in seconds after which the terminal will change from pass-through mode back to run mode if no pass-through communication has taken place.

**Connecting two terminals in transparent mode**

You can connect several terminals to the same computer in transparent mode. The following section explains how to connect two terminals. Several terminals can be connected in the same way.

	<b>NOTE</b>
	The SEW communication drivers do not support transparent mode.

**Cable connections**

When connecting two terminals to one controller, the first terminal is connected as described in the installation manual. The two terminals are connected with a cable. The cable connects to the free port of the first terminal and the corresponding port of the second terminal. If the communication distance via RS-232 ports exceeds 15 m, you will require a signal amplifier.

**Setting up the first terminal**

Make the communication settings in HMI-Builder under [Setup] / [Peripherals]. Make the settings for the port connected to the controller as usual. The settings for the port connected to the second terminal can be defined by the user.



#### Setting up the second terminal

Make the communication settings in HMI-Builder under [Setup] / [Peripherals]. The controller must be connected to the port provided for connecting the second terminal to the first terminal. The settings on this port correspond to those of the port of the first terminal to which the second terminal is connected.

#### Baud rate

The baud rate is between 600 and 115,200 baud. We recommend you use the highest baud rate between the terminals for optimum performance. The communication speed decreases as the number of connected terminals increases (see the following table).

#### Access time to the controller

Terminals	Terminal 1	Terminal 2	Terminal 3	Terminal 4
1	100 %	–	–	–
2	50 %	50 %	–	–
3	50 %	25 %	25 %	–
4	50 %	25 %	12.5 %	12.5 %

#### Connecting three terminals in pass-through mode

You can connect a third terminal to terminal two in the network using a cable. Setup is the same as for the second terminal.

#### 9.1.4 Pass-through mode

The [pass-through mode] function makes it possible to set the terminal in such a way that communication can take place between the PC programming software (in this case MOVITOOLS<sup>®</sup>) of the connected controller and the controller itself (MOVIDRIVE<sup>®</sup> or MOVITRAC<sup>®</sup> 07) via the operator terminal.

The function is analog to the transparent mode function and also only supports one controller. Consequently, transparent or pass-through mode can only be performed on one communication port of the terminal.

If pass-through mode is active and the PC communicates with the controller via the terminal, the communication between the terminal and connected controller will be interrupted. This is the difference between pass-through mode and transparent mode. A terminal on which communication in pass-through mode is taking place will be locked for the operator. An empty screen is displayed with a reference to the pass-through mode.

Pass-through mode for one of the connected controllers is activated or deactivated using the [DOP Tools] / [DOP Modem Connect] program. The program is available as an icon in the [DOP Tools] program group.



#### NOTE

The MOVILINK<sup>®</sup> driver for MOVIDRIVE<sup>®</sup> and MOVITRAC<sup>®</sup> 07 units only supports pass-through mode. Transparent mode is not supported.



**Properties of the operator terminal and PC**

The following PC and terminal settings are required to enable pass-through mode:

Make the communication settings in the terminal project in HMI-Builder under [Setup] / [Peripherals]. Drag the [Transparent mode] element to the required communication port (i.e. the port to which the PC is connected with the terminal).

To configure pass-through mode, right-click the element. The settings for the port to which the PC is connected must match the settings in the PC program (programming software for the controller).

Parameter	Description
IP properties	This parameter is only used for communication in transparent / pass-through mode via ETHERNET. The transparent mode unit must be connected with a TCP/IP port for this purpose. Port number 6004 usually need not be changed. Select the required protocol: UDP or TCP.
Controller systems	This parameter is only used for communication in transparent / pass-through mode via ETHERNET. The transparent mode unit must be connected with a TCP/IP port for this purpose. Define whether you want the transparent / pass-through mode to apply to controller 1 or 2.
Mode	Select transparent or pass-through mode as communication type. Timeout – Enter a time interval in seconds after which the terminal will change from pass-through mode back to run mode if no pass-through communication has taken place.

You can use pass-through mode for serial communication as well as for connection via ETHERNET.



#### 9.1.5 Using the terminal as communication interface (no protocol mode)

The no protocol mode is used for connecting different controllers or for connecting external devices (e.g. barcode scanners or balances) to the controller. The controller monitors data transfer with the communication port. The data arriving at the communication port is stored in registers. Communication takes place by transferring the data register range that corresponds to the following control block.

Click the right mouse button on [No protocol mode] under [Setup] / [Peripherals].

Register	Description
Control register 0	Start register for send data buffer <ul style="list-style-type: none"> <li>The first register in the buffer area contains the total number of bytes to be transferred.</li> <li>The subsequent registers contain the transfer data.</li> <li>The maximum buffer size is 127 registers = 254 bytes.</li> </ul>
Control register 1	Command register for transfer <ul style="list-style-type: none"> <li>Set to 1 by the controller if transfer is requested.</li> <li>Set to 0 by the terminal after successful transfer.</li> </ul>
Control register 2	Start register for receive data buffer <ul style="list-style-type: none"> <li>The first register in the buffer area contains the total number of bytes received.</li> <li>The subsequent registers contain the received data.</li> <li>The maximum buffer size is 127 registers = 254 bytes.</li> </ul>
Control register 3	Command register for reception <ul style="list-style-type: none"> <li>Set to 0 by the controller if the controller is ready to receive data.</li> <li>Set to 1 by the terminal when the message is available.</li> <li>Set to -1 (FFFF) if the message is faulty (e.g. too short).</li> <li>Set to 2 by the controller when the connection buffer is to be cleared.</li> <li>Set to 3 by the controller when the connection buffer has been cleared.</li> </ul> <p>The connection buffer is automatically cleared when starting the unit and when changing between transparent mode and no protocol mode. The register is assigned the value 3.</p>
Control register 4	End code (1 or 2 bytes) in the received message.
Control register 5	Length of the received message. The end code is used if the register content is 0.





**No protocol signal**

Digital signal for switching between no protocol mode and transparent mode, e.g. for selecting a computer and sending a message.

Under [Setup] / [Peripherals], drag the unit to the required communication connection. Click the right mouse button on [No protocol mode] and choose [Properties] to determine which register is the first control register in the transfer area. This register and the five subsequent registers will be used as control registers.

In run mode, the inverter / PLC can change between no protocol mode and transparent mode. To do so, enter a digital signal in the dialog box in the *No protocol signal* parameter.

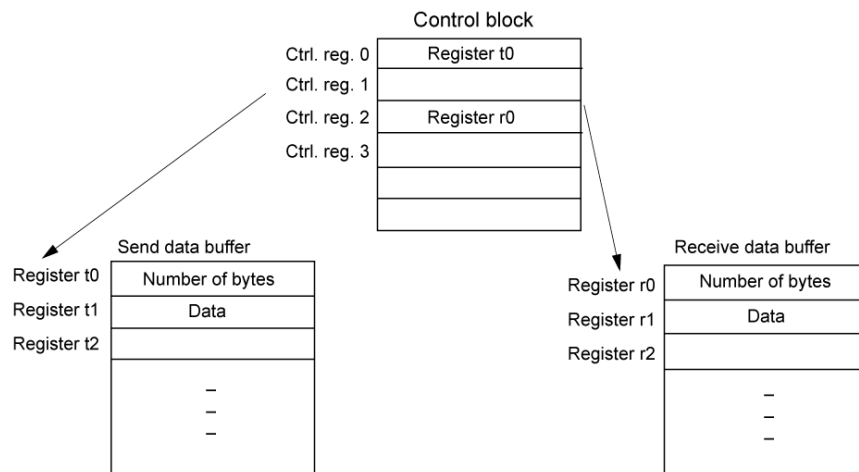

54250AEN



#### Example of using the no protocol mode

The following example describes the use of the no protocol mode using a MOVILINK<sup>®</sup> read command.

A MOVIDRIVE<sup>®</sup> unit is connected to RS-232 and RS-485 respectively on the DOP11B-30. The MOVIDRIVE<sup>®</sup> unit connected to the RS-485 interface is controlled as usual using the MOVILINK<sup>®</sup> driver.

The MOVIDRIVE<sup>®</sup> unit connected to the RS-232 interface should, for example, simulate a barcode scanner. It has the RS-232 address 2. In this case, the terminal acts as the master for the MOVIDRIVE<sup>®</sup> unit.

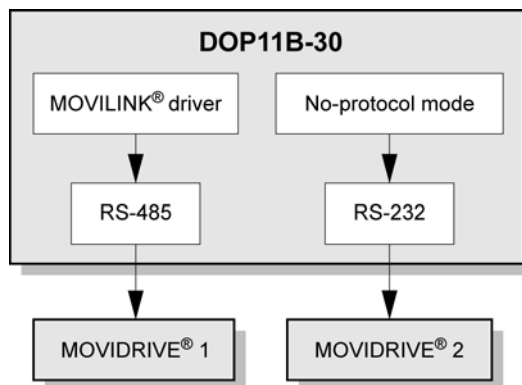

60110AEN

Make the following settings:

1. Under [Setup] / [Peripherals], drag the [No protocol mode] unit to the required communication port.

Example:

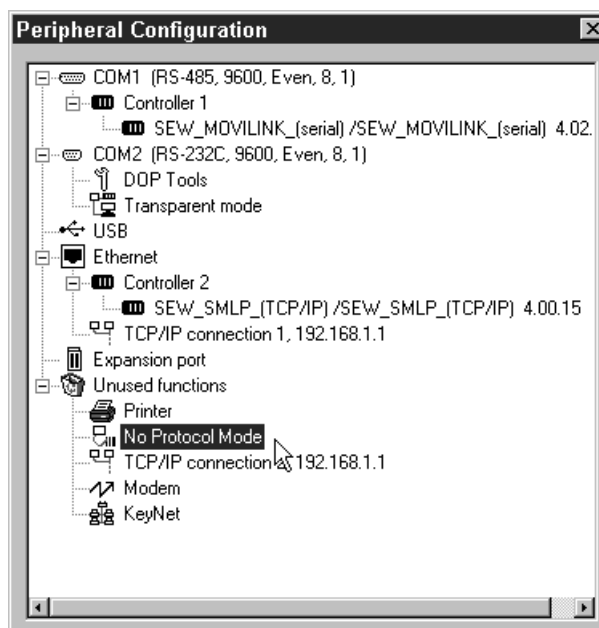

11584AEN



- Click the right mouse button on [No protocol mode] / [Properties] to define the first control register.

**Example**

- No protocol control reg.: H50(controller 1)
- No protocol at signal: H56.0(controller 1)

Index 8489 from RS-485 address 2 should be read. The relevant telegram is given as follows in hexadecimal code:

02 02 86 31 00 21 29 00 00 00 00 BF

The control block is defined as H50 to H55 (see above).

At bit H56.0, the program changes to no-protocol mode (see above).

The send data buffer should be H60 to H66.

The receive data buffer should be H80 to H86.

Make the following settings in HEX:

*Control block*

Variable	Hex	Dec	Description
H50:	00 3C;	60	Send buffer from H60
H51:	00 00;		
H52:	00 50;	80	Receive buffer from H80
H53:	00 00;		
H54:	00 00;		
H55:	00 0C	12	Telegram length 12 bytes

*Send data buffer*

Variable	Hex	Dec	Description
H60:	00 0C;	12	12 bytes to be sent
H61:	02 02;	MOVILINK® request: 02 02 86 31 00 21 29 00 00 00 00 BF  (See the "MOVIDRIVE® Serial Communication" manual)	
H62:	86 31;		
H63:	00 21;		
H64:	29 00;		
H65:	00 00		
H66:	00 BF		

Set H56.0 = 1 to activate the no protocol mode.

When H51 = 00 01, the telegram defined from H60 is sent.

H53 is set to 3 by the terminal. When it is reset to 0, the sent telegram is only written from H80 for a parity check, if applicable. H53 is then set to 1 automatically by the terminal.

When H53 is set to 00 00 again, the received response is stored from H80. For confirmation, H53 is reset to 1.



The response should look as follows or similar:

Variable	Hex	Dec	Description
H80:	00 0C;	12	12 bytes to be received
H81:	1D 02;		MOVILINK® response: 1D 02 86 31 00 21 29 00 02 49 F0 1B  (See the "MOVIDRIVE® Serial Communication" manual)
H82:	86 31;		
H83:	00 21;		
H84:	29 00;		
H85:	02 49		
H86:	F0 1B		

In this process, index 8489 was read once. It can be started again by setting H51 to 00 01.

### Connecting a modem

A modem is used for establishing a connection with a PC. You make the connection settings under [Setup] / [Peripherals]. Call up the dialog box by selecting [Modem] and clicking the right mouse button to select [Properties].

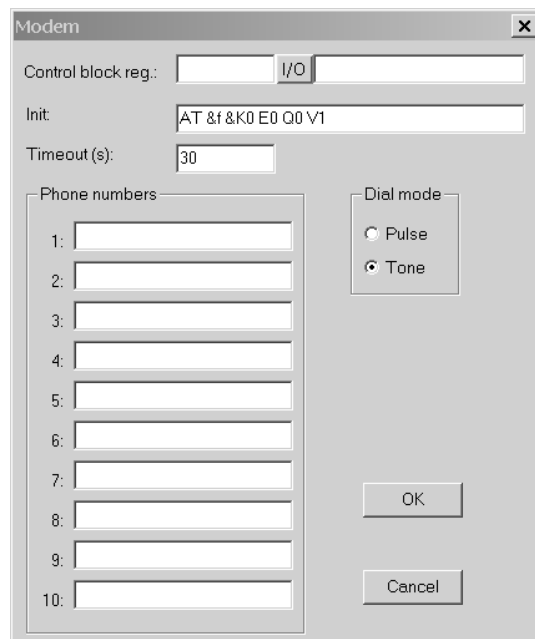

12000AEN



### Control block register

Communication is established with three control registers from the control block. The first register in the control block is defined in the [Control block register] dialog box. The functions of the control register are described in the following table.

Register	Description	
Control register 0	Contains the command that describes how the controller establishes a connection and communication.	
	0	Wait for command
	1 ... 10	Establish a connection using the phone number entered in the [Phone no. 1 - 10] field. Maximum 40 characters are permitted.
	11	Establish a connection using a phone number stored in the controller. The phone number is stored as an ASCII character string that begins in the third control register and in the subsequent registers. The character string must not exceed 40 characters, i.e. 20 registers are permitted. Not all registers must be used. The last register to be read must contain the ASCII code 0.
	101 ... 110	An initialization character string is transferred to the modem. Enter the Hayes modem command in the [Phone no. 1 - 10] field. Command 101 sends the character string entered in the [Phone no. 1] field etc.
	111	An initialization string stored in the controller is sent to the modem. Enter the Hayes modem command that begins in the third control register. See command 11 for more details.
	255	Disconnect connection
Control register 1	The second control register is used as the status register. It contains the result of the modem commands. The status register can include the following:	
	Status codes	
	0	Command was executed correctly
	1	A connection is being established
	2	Modem has established a connection
	3	Modem has received a dial tone
	Error codes	
	101	No connection
	102	Modem carrier signal lost
	103	Unknown modem error
	104	Modem does not receive a dial tone
	105	Busy while establishing a connection
	106	No response while establishing a connection
	107	No response from the modem
	255	Unknown fault / status
Control register 2	The operator terminal can establish a connection using a phone number stored in the controller. The phone number is stored as an ASCII character string that begins in the third control register and in the subsequent registers. The character string must not exceed 40 characters, i.e. 20 registers. Not all registers must be used. The last register to be read must contain the ASCII code 0.	

**Init**

Initialization string for the modem.

**Timeout (ms)**

Number of seconds after which an inactive line is interrupted. The predefined value is 30 s. You can enter a time between 5 and 600 s.

**Dial method**

Pulse or touch-tone dialing.

**Phone number 1-10**

Complete phone number for establishing a connection.

## 9.2 Network communication

Network communication takes place using TCP/IP (Transmission Control Protocol / Internet Protocol). TCP/IP refers to a group of standard protocols for exchanging data between systems and units. Operator terminals can be integrated into the network via ETHERNET or a serial connection.

The ETHERNET connection of the operator terminal supports TCP/IP connections. The connection takes place in line with the ETHERNET standard.

The terminal network is a client/server network. Only clients can access data in the network. The data is provided by servers. An operator terminal can function simultaneously as a client and a server, i.e. it can provide data and receive data from other terminals at the same time. Up to 20 clients can retrieve data from the same server. One client can access data from up to 16 different servers.

All operator terminals must have an IP address. IP addresses from 192.168.0.0 to 192.168.254.254 are recommended for local networks.

Standard Internet tools, such as web browsers, mail servers, FTP clients and VNC clients, can be used for working on the operator terminal. Web pages can be created on the PC and transferred to the operator terminal. The web pages can contain real-time data from the controller or terminal. Browsers and scripts are used to change values, create signals and confirm alarms. The VNC client can be used to enable remote control and remote access to the operator terminal.

The operator terminal can also send e-mails when certain events occur (e.g. alarms and status reports).



### 9.2.1 Network communication via ETHERNET

In the project manager, double click on [Peripherals] to call up the dialog box [Peripheral configuration].

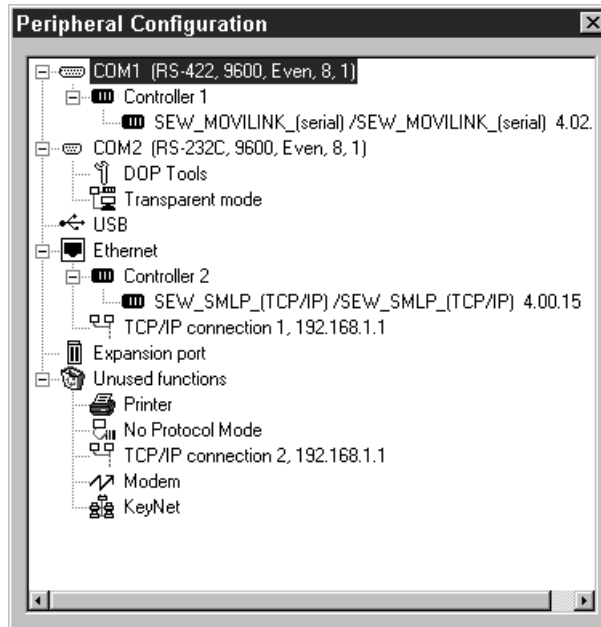

11491AEN



#### Properties

Right-click on [TCP/IP connection 1] and choose [Properties] to define the properties of the TCP/IP network.

11585AEN

Parameters	Description
Connection name	Enter a name for the connection. You do not have to enter any parameters.
Host configuration	If [Manual] is selected, the settings made in the [TCP/IP properties] dialog box will be used. Choose another setting when the operator terminal receives one or more TCP/IP parameters from the server.
IP address and subnet mask	Enter the network ID for the node (terminal). The network connection takes place according to ETHERNET standard. For a local terminal network, IP addresses between 192.168.0.0 and 192.168.254.254 are recommended.
Gateway	Specify which network device can identify other networks in the local network.
Primary DNS and secondary DNS	Enter the DNS server(s).





**ETHERNET connections**

The following section gives two examples of ETHERNET connections.

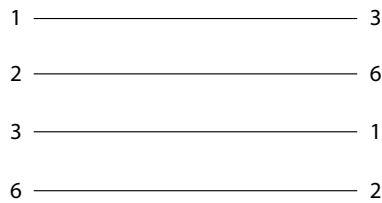

60456AXX

- [1] Node 1
- [2] Node 2

**Connection between two operator terminals with twisted-pair cable (TP)**

The cables have RJ45 connectors. The cable is a shielded or unshielded twisted pair (crossed) CAT5 cable. The distance between operator terminals must not exceed 100 m.



**NOTE**

If data exchange does not function properly and the green LED (Link) is not illuminated, you have probably mixed up connections 3 and 6.



TCP/IP settings in the nodes

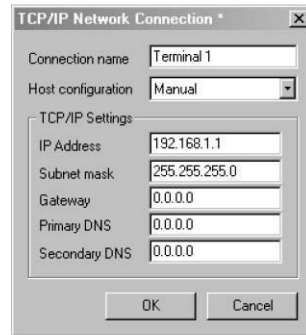

[Setup] / [Network] / [TCP/IP-Connections]

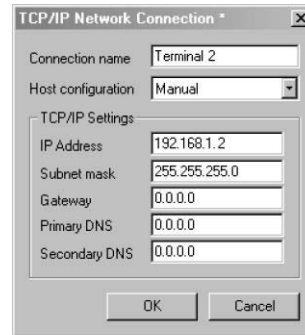

[Setup] / [Network] / [TCP/IP-Connections]

54327AEN

**Connection between more than two operator terminals with twisted-pair cable (TP)**

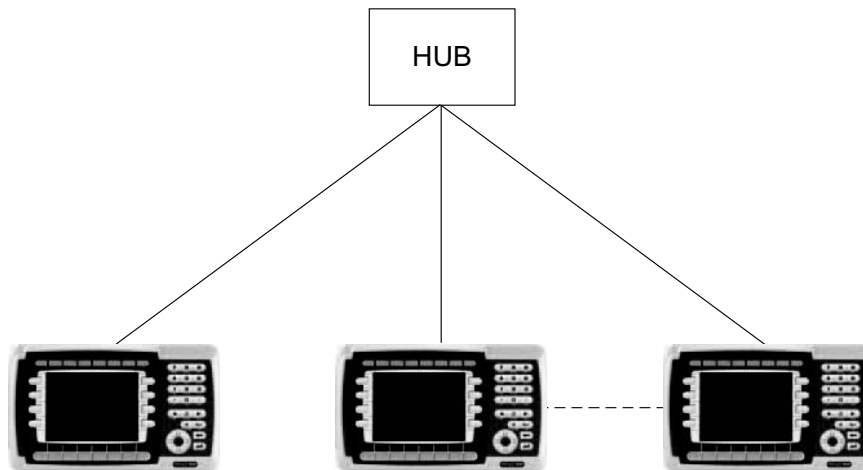

- 1 ————— 3
- 2 ————— 6
- 3 ————— 1
- 6 ————— 2

60457AEN

The maximum length between operator terminal and hub is 100 m. The maximum number of nodes per hub depends on the number of connections on the hub. The cables have RJ45 connectors. The cable is a shielded or unshielded twisted pair CAT5 cable.



9.2.2 Serial network communication / PPP

**Making the connection**

Choose [Setup] / [Peripherals] from the menu. In the [Peripheral configuration] dialog box, select a TCP/IP connection and keep the left mouse button pressed. Drag the mouse to the [COM1] or [COM2] entry and release the mouse button. TCP/IP connection 1 must be used before TCP/IP connection 2 becomes available.



**NOTE**

The parity on the port for the TCP/IP connection must be set to "None".

**Setup**

Right-click on [TCP/IP connection 2] and choose [Properties] to define the properties of the TCP/IP network.

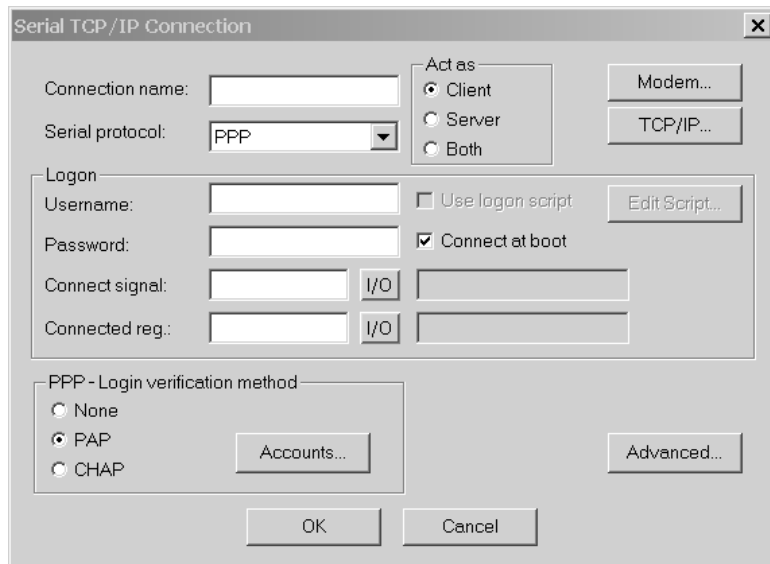

12001AEN

Parameter	Description												
Connection name	Enter a name for the connection. You do not have to enter any parameters.												
Serial protocol	The PPP protocol is used for serial communication.												
User name	User name to log in to the remote network.												
Password	Password to log in to the remote network.												
Connect signal	Digital signal to activate (1) or disconnect (0) the connection.												
Connected register	Analog register that can have one of the following states:												
	<table border="1"> <thead> <tr> <th>Register</th> <th>Description</th> </tr> </thead> <tbody> <tr> <td>0</td> <td>Disconnected (PPP client)</td> </tr> <tr> <td>1</td> <td>Wait for connection (PPP server)</td> </tr> <tr> <td>2</td> <td>Connected as PPP client</td> </tr> <tr> <td>3</td> <td>Connected as PPP server</td> </tr> <tr> <td>7</td> <td>Connection error</td> </tr> </tbody> </table>	Register	Description	0	Disconnected (PPP client)	1	Wait for connection (PPP server)	2	Connected as PPP client	3	Connected as PPP server	7	Connection error
	Register	Description											
	0	Disconnected (PPP client)											
	1	Wait for connection (PPP server)											
	2	Connected as PPP client											
3	Connected as PPP server												
7	Connection error												



Parameter	Description	
Connect at boot	With a PPP connection, the terminal can be connected automatically to another terminal or PC at startup.	
PPP login validation method	Choose a method for validating the user ID. This value usually need not be changed.	
Accounts	Determines who has access to the services.	
Act as	Determines whether the operator terminal should act as a PPP client and / or a PPP server, i.e. whether it should establish a remote data transmission connection or whether another host should dial into the operator terminal.	
Modem	The parameters under [Modem] are only relevant for modem connections. The modem is connected to a commercially available modem cable.	
	Parameter	Description
	Enable modem	The unit checks whether a modem is connected.
	Disconnect if idle (min)	Interrupts the connection if it has been idle for the specified number of seconds. Entering 0 means the connection will never be interrupted.
	Phone number	Enter the remote data transmission number to be dialed.
	Control code for modem	Character string for modem initialization. Refer to the modem manual for more information.
TCP/IP	TCP/IP connection parameters. When the operator terminal is connected to a remote host, the parameters <i>IP address</i> , <i>Subnet mask</i> and <i>Gateway</i> are overwritten by the settings under [Advanced].	
	Parameter	Description
	Host configuration	If [Manual] is selected, the settings made in the [TCP/IP properties] dialog box will be used. Choose another setting when the operator terminal receives one or more TCP/IP parameters from the server.
	IP address and subnet mask	Enter the network ID for the node (terminal). The network connection takes place according to the ETHERNET standard. IP addresses in the range of 192.168.0.0 and 192.168.254.254 are recommended for a local network that only consists of terminals.
	Gateway	Enter the network unit in the local network that is capable of identifying the other networks in the Internet.
	Primary DNS and secondary DNS	Enter the DNS servers here.



Parameter	Description										
Advanced	Choose [Advanced] to define additional parameters.										
	<table border="1"> <thead> <tr> <th>Parameter</th> <th>Description</th> </tr> </thead> <tbody> <tr> <td>Use VJ compression for IP headers</td> <td>Compression of the IP header. This value usually need not be changed.</td> </tr> <tr> <td>Supply / Request remote address</td> <td>The local IP address is requested and provided. Should be set to 0.0.0.0 if the IP address is to be assigned by the remote node.</td> </tr> <tr> <td>Use remote address as gateway</td> <td>Activate this option if you want to use the IP address of the remote node as gateway (connection port to another network). The option is disabled by default. Note: Data transfer is not possible if the [Use remote address as gateway] checkbox is disabled and you are using a subnetwork. In this case, you cannot send e-mails from the operator terminal either, but other units can log into the operator terminal using an FTP client or browser.</td> </tr> <tr> <td>Supply / Request local address</td> <td>The IP address for the remote node is requested and provided. Should be set to 0.0.0.0 if the IP address is to be assigned by the remote node.</td> </tr> </tbody> </table>	Parameter	Description	Use VJ compression for IP headers	Compression of the IP header. This value usually need not be changed.	Supply / Request remote address	The local IP address is requested and provided. Should be set to 0.0.0.0 if the IP address is to be assigned by the remote node.	Use remote address as gateway	Activate this option if you want to use the IP address of the remote node as gateway (connection port to another network). The option is disabled by default. Note: Data transfer is not possible if the [Use remote address as gateway] checkbox is disabled and you are using a subnetwork. In this case, you cannot send e-mails from the operator terminal either, but other units can log into the operator terminal using an FTP client or browser.	Supply / Request local address	The IP address for the remote node is requested and provided. Should be set to 0.0.0.0 if the IP address is to be assigned by the remote node.
Parameter	Description										
Use VJ compression for IP headers	Compression of the IP header. This value usually need not be changed.										
Supply / Request remote address	The local IP address is requested and provided. Should be set to 0.0.0.0 if the IP address is to be assigned by the remote node.										
Use remote address as gateway	Activate this option if you want to use the IP address of the remote node as gateway (connection port to another network). The option is disabled by default. Note: Data transfer is not possible if the [Use remote address as gateway] checkbox is disabled and you are using a subnetwork. In this case, you cannot send e-mails from the operator terminal either, but other units can log into the operator terminal using an FTP client or browser.										
Supply / Request local address	The IP address for the remote node is requested and provided. Should be set to 0.0.0.0 if the IP address is to be assigned by the remote node.										
	<p>The diagram illustrates a network configuration between two nodes. Node 1 is on the left and has a Remote IP of 192.168.1.2 and a Local IP of 192.168.1.1. Node 2 is on the right and has a Remote IP of 0.0.0.0 and a Local IP of 0.0.0.0. Two arrows connect the nodes: one from Node 1's Remote IP to Node 2's Local IP, and another from Node 2's Remote IP to Node 1's Local IP, representing a bidirectional connection.</p>										



Serial connection

**PPP connection between operator terminal and PC**

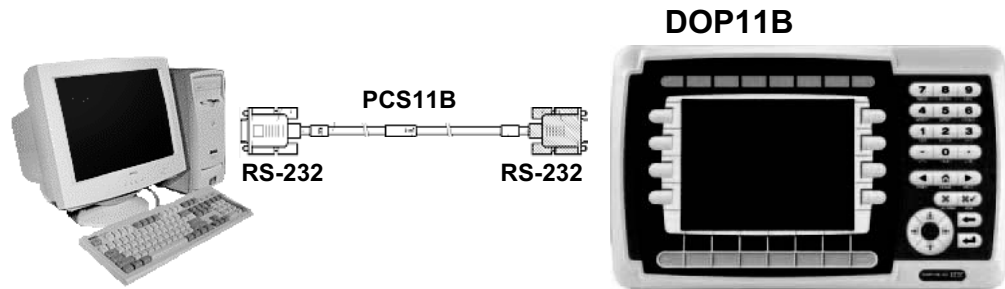

60060AXX

**Properties in the operator terminal**

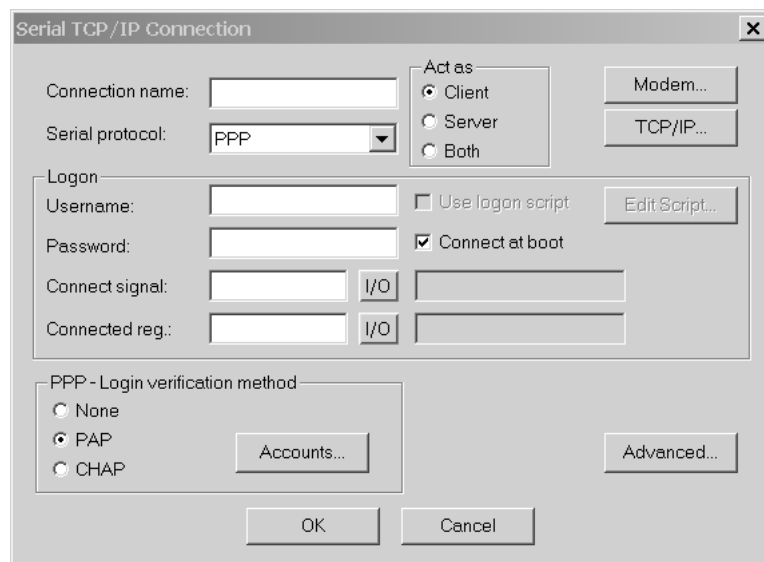

12001AEN

Choose the TCP/IP connection for the serial connection.

The properties under TCP/IP (IP address, subnet mask and gateway) are not relevant in this case. The PPP is responsible for changing parameters.



**NOTE**

More information can be found in the PC operating system manual.



### 9.3 Network services

In the project manager, double-click on the directory [Network connections] and choose [Network services]. Select the services that the operator terminal should provide in the network. Select the checkbox to activate a service. To change the properties of a service, choose [Edit].

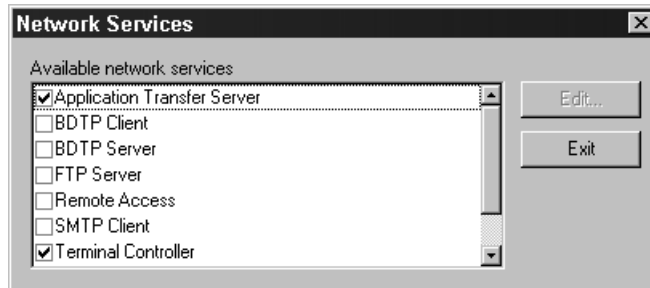

11586AEN

#### 9.3.1 Project transfer server

Projects are transferred using TCP/IP. From the list, choose the option [Project transfer server] and click on [Edit] to enter the number of the port that should be used for the transfer. This value usually need not be changed.



**9.3.2 BDTP**

BDTP is a protocol that uses client/server communication. A client requests information and obtains this information from the server. The BDTP server can receive I/O requests from the BDTP clients. The operator terminal can be a server, a client, or both at the same time. A client can request data from a maximum of 16 servers. The IP addresses of the server are specified in the BDTP client. Each server can supply up to 20 clients with information. Network communication via BDTP is used to connect two or more operator terminals with one or two controllers, or several terminals with two or more controllers at the same performance level. Example: Production lines with one operator terminal at each work station. If the BDTP server fails, the client will continue to use the existing system connection. The client does not perform a restart to establish a server connection. When the server is active, BDTP communication takes place as before.

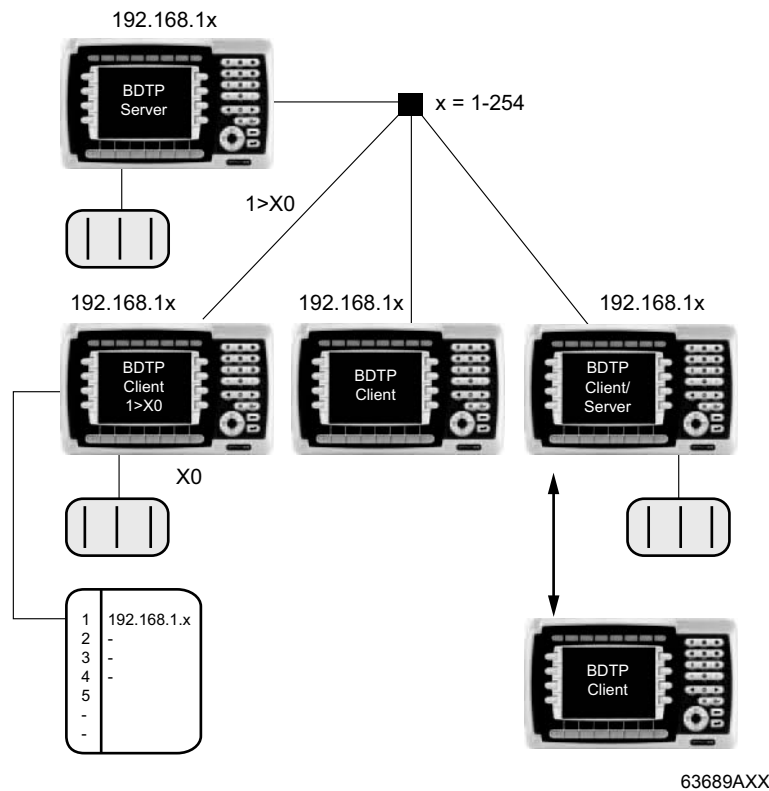





### 9.3.3 BDTP client

For the BDTP client network service, IP addresses are defined for the BDTP server in the network from which the client will request information. From the list, choose the option [BDTP client] and click on [Edit] to select the properties.

11587AEN

**BDTP server port** Enter the communication port to which the BDTP server or the network is connected. This value usually need not be changed.

**Standard BDTP server** You can specify a standard server which will be used by default. If no other entry is made for I/O, the signals will be requested from this server.



**Data register**

The values in the data register can be transferred between a client and various servers in the network. The first register in the register block of the client that is to be transferred to or from the specified server is defined under Data register. The register type must be the same for client and server.

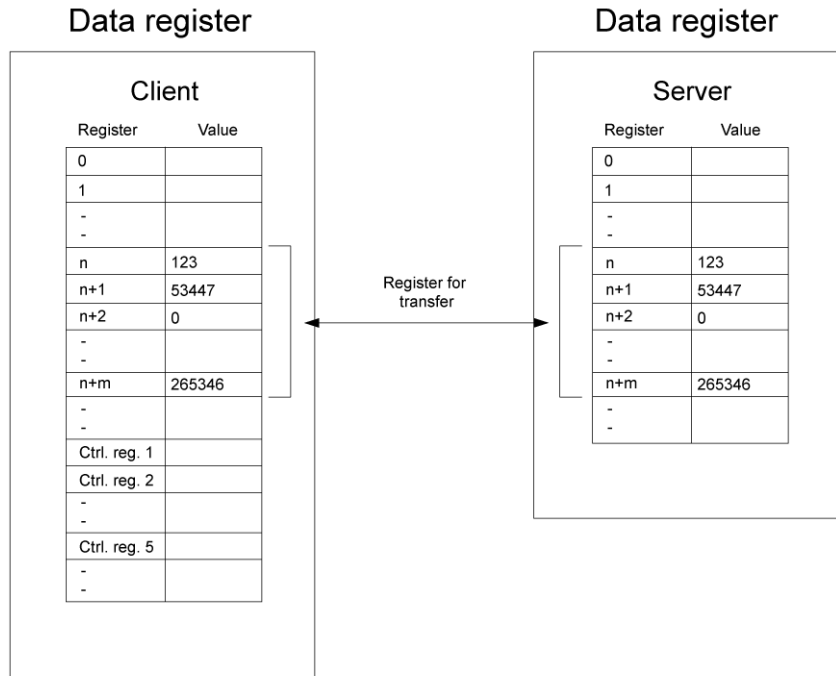

54652AEN

**Control block**

The control block specifies the first register in the control block of the client, which occupies a total of five registers.

Register	Content	Description
Control register 1	Command	Command register defined in the client.
		Available commands:
		0   No command
		1   Transfers the register values from the client to the server specified in control register 3. 2   Transfers the register values from the server, which is specified in control register 3, to the client.
Control register 2	Result code	Result code register defined by the client.
		Available commands:
		0   Ready for new command
		1   OK 2   Transfer error
Control register 3	Server index	Number of the server in the network with which data is exchanged.
Control register 4	Index register	The value in the index register is added to the address of the register specified under <i>Data register</i> . When a zero is entered, the register block starts for the address specified in the <i>Data register</i> .
Control register 5	Number of registers	Number of registers whose values are to be transferred from or to the specified server.



The following procedure must be followed for transfer:

1. The result code register must be 0. If it is not, set the command register to 0.
2. Enter the command in the command register.
3. Wait for the ready signal or the error code in the result code register.
4. Set the command register to 0. The operator terminal will then set the result code register to 0.

**Synchronize  
clock with server**

Specify whether you want the clock in the client to be synchronized with a certain server (terminal). To do so, enter the number of the required server in the selection field. If the clock in the client is changed locally, the new data will also be transferred to the server.

**BDTP server  
address**

Enter the IP address for the server from which the client is to request data. The addresses are indexed in the order they are entered.

When programming the object, it is essential to specify the server from which the address is to be requested. In the address field of the object dialog boxes, enter the text "Server index>device."

For example, if you enter "2>D15" in the address field, the value for the object from register D15 on the server will be retrieved using index 2.

You can change the server index in a client project using the [BDTP station change function].



**NOTE**

If no controller is connected to the BDTP client (operator terminal), the inverter/PLC 1 and inverter/PLC 2 units must be dragged from the RS-232C / RS-422 / RS-485 interfaces to "Unused functions" in the [Peripheral configuration] dialog box. Call up this dialog box from [Setup] / [Peripherals].



#### 9.3.4 BDTP server

The BDTP server handles queries from clients and supplies clients (terminals) with information after a request from a client (terminal). From the list, choose the option [BDTP server] and click on [Edit] to select the properties.

Parameter	Description
Server port	Communication port for the BDTP server. Usually need not be changed.
Max. clients	Maximum number of BDTP clients (terminals) in the network.
Data register	The values in the data register can be transferred between a server and various clients in a network. The first register in the register block of the server that is to be transferred to or from the specified client is defined under [Data register]. The register type must be the same for client and server. Data transfer can only be controlled from the clients. More information on data transfer can be found in the section "BDTP client" on page 273.
Clock server	Specify whether you want all other clients in the network to be synchronized to the current server clock. See also the section "BDTP client" on page 273.

#### 9.3.5 FTP server

FTP (File Transport Protocol) is a standard Internet protocol and the easiest way of exchanging files between computers on the Internet. FTP is an application protocol using the TCP/IP Internet protocol. FTP is usually used to transfer web sites from the computer where they were created to a server connected to the Internet. FTP can also be used for downloading programs and other files from another server (terminal) to your computer. Files can be transferred from or to the terminal when the terminal acts as FTP server. An FTP client must be installed on the PC for file transfer, such as DOP Tools, Internet Explorer, Windows Commander or another FTP standard software.

Files with a length of 0 are displayed in certain libraries. The reason for this is that these files contain dynamic data, which means that their size changes. This means a file of the length 0 is not necessarily empty. The terminal does not work with the file date. Therefore, the date values displayed are not relevant. The terminal can save the contents of all files that can be accessed via FTP using various separators. You can use the following characters as separators for the file contents: Tab (→), semicolon (;) or colon (:).

Make the FTP separator setting in HMI-Builder under [Setup] / [Terminal options]. The file name must not contain national special characters, such as, Ä, Ö and Ü. The FTP server of the terminal can process up to three connected clients simultaneously.



**NOTE**

The files in the individual libraries increase the project memory load. For information on the available project memory, see the file `info.txt` in the master directory [Root].

This function facilitates data transfer from a PC to and from the terminal. The FTP server in the terminal supports data transfer in passive mode (PASV). The passive mode should be used if the terminal is **not** connected using PPP connection. This is necessary because it is not possible to determine in advance which components are connected between client and server, e.g. router-based firewalls or gateways.

Using passive mode eliminates several errors. Web browsers use this mode as standard. Passive mode can also be used with PPP connections. Special country-specific characters in file names are not supported. The terminals do not evaluate the dates of files.

To make the settings for this function, select the entry [FTP server] from [Setup] / [Network / [Services] and click [Edit].

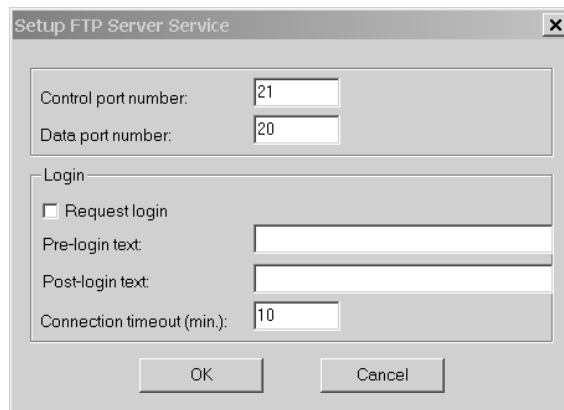

12002AEN

Parameter	Description
Control port number	The standard value is 21 and should not be changed.
Data port number	The standard value is 20 and should not be changed.
Request login	Here you specify whether the user has to log in to gain access to the FTP server (terminal). Make the user definition under [Setup] / [Network] / [Accounts]. See the section "Network accounts" on page 302. If you do not activate this option, all users will have unlimited access right to the FTP server.
Pre login text	Text that appears before the login prompt: e.g. "You have to log in to the terminal. Enter the login data."
Post login text	Text that appears after the login: e.g. "You are logged in."
Connection timeout (min)	Permitted idle time for the FTP connection before the FTP server (terminal) will disconnect the connection. The standard value is 10 minutes.



#### Master directory

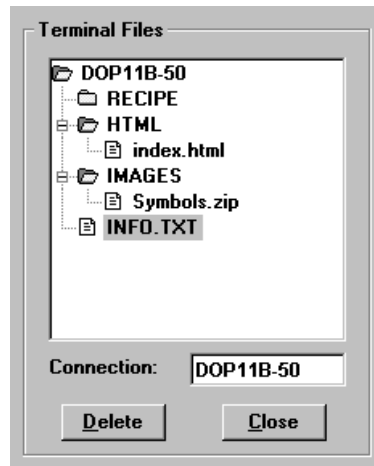

11593AXX

The master directory (current terminal name) comprises the following directories:

- ALARMS
- HTML
- RECIPE
- TRENDS
- IMAGES

Only directories for which the user has access rights (per account) are shown. The info.txt file containing information on the terminal is also stored here.

#### info.txt file

The info.txt file contains the following information on the terminal:

##### **DOP11B-40**

Firmware version: V1.20

Build number: 89

Driver1: SEW\_MDR 4.01.00

Driver2: MODBUS Master 4.00.06

Dynamic memory: 20328448 bytes free (bytes unoccupied)

Project memory: 1077586 byte used (bytes occupied)

IP address: 10.3.71.2

No files can be deleted from the master directory even if the user has write access. Deleting the [HTML], [RECIPE] or [IMAGES] directories deletes the contents of the respective directory. The directory itself will not be deleted.



**[ALARMS] directory**

This directory is only shown if alarms have been defined in the terminal and the terminal is in run mode. The alarm groups are displayed as SKV files with a length of 0. This does not necessarily mean that there are no alarms. They are read-only files.

Each alarm is stored in a line ending with a carriage return and a line feed .

**File format**

A semicolon (;) is used as separator.

Status;Activation date;Activation time;Deactivation date;Deactivation time;Acknowledgement date;Acknowledgement time;Alarm text

All fields are always available. The date and time fields of unacknowledged alarms are empty.

The file is completed with "END" (carriage return, line feed).

**[HTML] directory**

This directory contains files that are managed by the web server. You can create sub-libraries. The start file (HTML page shown as the start page in the web browser) must always have the name index.htm.

The file format depends on the file type. Standard file formats such as HTML are used.

**[RECIPE] directory**

The individual recipes in the respective recipe directories are displayed as SKV files with a length of 0. This does not mean the recipe is empty. Read and write access is available for files in this library.

Each recipe value is stored in a line ending with a carriage return and a line feed .

**File format**

A semicolon (;) is used as separator.

e.g. signal;value;date type;length

The file is completed with

"END" (carriage return, line feed).

If the file is of the "Array" (AR) type, each line contains a value. The first line looks as described above. All subsequent lines only have the following entry:

;value



#### Data types for analog signals

Type	Description
Unoccupied	16-bit character
+	No 16-bit character
L	32-bit character
L+	No 32-bit character
RB	BCD float format
RF	Floating point number with exponent
SB	16-bit BCD format
LB	32-bit BCD format
SH	16-bit hexadecimal
LH	32-bit hexadecimal
RD	Floating point number
AR	16-bit array (signed)
ST	Character string
BI	Bit 0 or 1

#### [TRENDS] library

This directory is only available if trends have been defined in the terminal and the terminal is in run mode. The various trend objects are displayed as SKV files with a length of 0. They are read-only files. Curve 1 must be used to make sure a trend is valid. Each measured value is stored in a line ending with a carriage return and a line feed .

#### File format

A semicolon (;) is used as separator.

e.g. Date;time;value1;value2;value3;value4;value5;value6;OFF

The file is completed with

"END" (carriage return, line feed).

Only the number of curves available in the trend (no empty fields) will be transferred.

In the following cases, "OFF" is included in the measured values and indicates an interruption in the capture process.

- When the terminal changes to run mode, a copy of the latest sample will be saved. The copy is marked with "OFF". As soon as the terminal has received the valid value, the new values will be saved without the "OFF" mark.
- When the signal for trend activation is output, a copy is marked with "OFF." When the signal is output, a new value is saved without the "OFF" mark.
- When the stored value is transferred using FTP or HMI-Tools, a sample will be saved marked with "OFF". After the transfer is complete, a new value will be saved without the "OFF" mark.





**[IMAGES]  
directory**

You can save graphics in BMP format in this directory. Bitmap graphics can be displayed in static symbol objects when the terminal is in run mode.

Files in this directory can be written, overwritten and deleted. It is not possible to create new sub-libraries. If you activate the [Use dynamic bitmaps] checkbox for a static symbol object, the terminal will call up the specified bitmap file (namn.bmp) from the [IMAGES] directory in the terminal file system. In run mode, the bitmap graphic will be displayed on the terminal screen.

The graphic to be displayed must be transferred to the directory via FTP. You can add, exchange or delete dynamic bitmap graphics via FTP. This is done by overwriting, saving or deleting BMP files in the [IMAGES] directory. The image for a dynamic bitmap graphic object is only displayed on the terminal in run mode.

The bitmap graphics in the directory are not available in HMI-Builder and can therefore not be displayed.

	<p><b>NOTE</b></p> <p>Use the same X and Y size for the BMP graphic in the library and for the symbol object defined in HMI-Builder.</p> <p>Files cannot be accessed from the [IMAGES] directory.</p> <p>When a BMP file is sent to the [IMAGES] directory, transfer is stopped briefly for the time it takes the terminal to convert the standard BMP format into the terminal's special BMP format.</p>
--	---

**9.3.6 STMP client**

SMTP (Simple Mail Transfer Protocol) is a TCP/IP protocol used for sending and receiving e-mails. SMTP is usually used together with one or two other protocols (POP3 or IMAP) as SMTP only provides limited functions for saving received messages. These protocols allow the user to save messages in a server mailbox and retrieve them later. This means SMTP is used for sending e-mails and POP3 or IMAP are used for retrieving e-mails from the local server.

The terminals can act as SMTP client (send e-mails). A mail server is required for using the SMTP client function.

You can use the mail server of your Internet service provider for this purpose. You can also use a local mail server.

This function makes it possible to send e-mails from the operator terminal. You need a mail server to use the SMTP client function so that the operator terminal can send mails. The recipient can access the mails from the mail server. You can use the mail server of your Internet service provider or a local mail server. You can attach trend and recipe files to an e-mail. The attached files can only be read using DOP Tools. Up to a maximum of 20 messages can be sent simultaneously.



Under [Setup] / [Network] / [Services], select the entry [SMTP client] and click [Edit].  
Make the following settings here:

12003AEN

Parameter	Description
Server port	The default port number 25 usually need not be changed.
Mail server	IP address for the mail server or alias name (DNS server) for the SMTP mail server. If you enter an alias name, you have to enter the IP address for the DNS server under [Setup] / [Network] / [TCP/IP connections].
Authentication	Used when the mail server requires SMTP authentication. With SMTP authentication, the user must log on before he can access mails. User name: User names for SMTP authentication Password: Password for SMTP authentication
My e-mail address	Enter your e-mail address. The recipient will see this name as sender. If possible, enter an e-mail address to which the mail server can send back error messages in case of an error.
Send via connection	Specify the TCP/IP connection to be used for sending the e-mail. Note that TCP/IP connection 1 must be used before TCP/IP connection 2 is available.
Predefined recipients	Predefined list with a maximum of 16 recipients (e-mail addresses) to which the terminal will send messages. The maximum length for a recipient address is 60 characters.



**Sending alarms  
by e-mail**

Alarms can not only be printed but can also be sent by e-mail. You can transfer the entire alarm list by sending block 990 (see the section "Sending reports by e-mail" on page 284).

Each alarm can be linked to one or more e-mail addresses in the configuration of the STMP client. You can make a general setting for the status of alarms being sent by e-mail under [Setup] / [Alarm settings]. See the section "Alarm management" on page 301.

11575AEN

Parameter	Description
Info block	If an info block (text block) is specified, it will be included in the e-mail. See the section "Alarm management" on page 301.
Send e-mail to address	Specify the mail recipient. You can choose up to eight recipients from the predefined list in the [Setup STMP client service] dialog box.



#### **Sending reports by e-mail**

Text blocks can not only be printed but can also be sent by e-mail. Alarm block 990 can also be sent as an e-mail.



#### **NOTE**

Only text blocks can be sent. Alarm block 990 is the only system block that can be sent as e-mail. Trend and recipe files can be sent as attachment to the e-mail message.

11589AEN

Parameter	Description
Send mail signal	An e-mail will be sent when the specified digital signal is activated.
Mail completion signal	Digital signal that is output by the terminal after an e-mail has been sent. The signal is usually activated by the terminal. Selecting the [Reset] option will reset the signal once the e-mail has been sent.
Mail to address	The e-mail address of the recipient is entered in this field. Clicking the [...] button enables you to select up to eight recipients from a list. The list with e-mail addresses is created under [Setup] / [Network] / [Services] in the [Set up SMTP Client Service] dialog box.
Attach file	Enter the name of a trend or recipe file you want to attach to your mail. If a trend file and a recipe file have the same name, the trend file will be attached. The file name must not contain national special characters, such as, Å, Ö and Ü.



**Sending e-mails via system block**

A block jump to the [E-mail] system block (993) enables you to create and send messages in run mode.

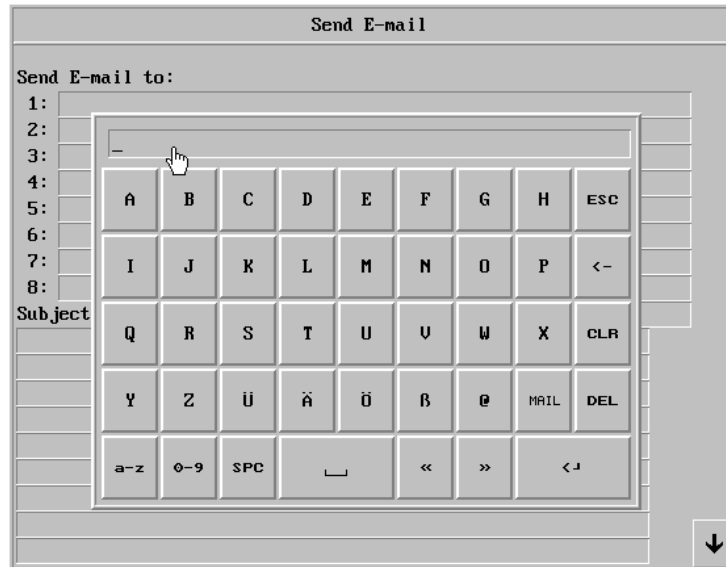

10810AEN

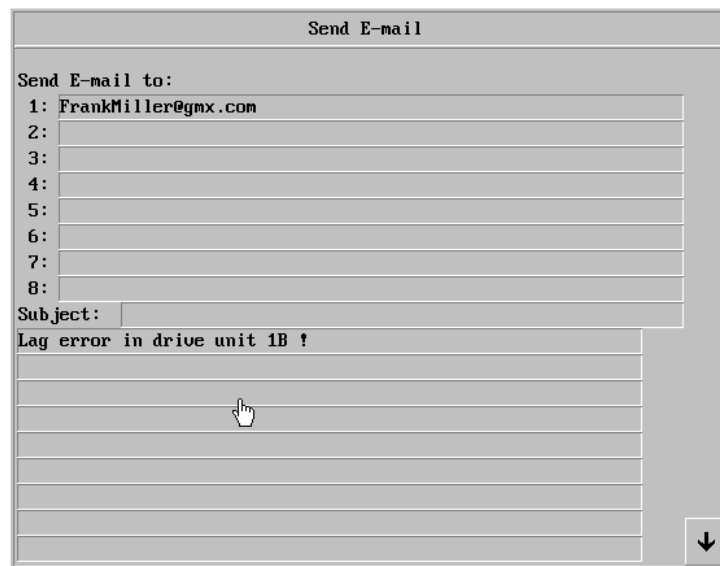

10811AEN

Parameter	Description
Send e-mail to	Enter the recipient in this field. You can type an address or select an entry from the global list. To display the global list, press the <LIST> key on terminals with a keyboard, or the <MAIL> key on terminals with a touchscreen.
Subject	Enter the subject of your message. The subject length is limited to 50 characters. The message text is limited to 10 lines with 50 characters each.



#### 9.3.7 Terminal controller

The terminal controller is used to change from RUN to TRANSFER via TCP/IP. Click on [Edit] and enter the port number for the transfer. The port number usually need not be changed. Activate the [Authentication required] option if the user name and password should be specified before transfer. Users are defined under [Setup] / [Network] / [Accounts].



12004ADE

#### 9.3.8 Transparent mode

Transparent mode is used for communication in transparent / pass-through mode in the terminal network via ETHERNET (see also sections "Communication" on page 250 and "Network services" on page 271). To make the settings for this function, select the entry [Transparent mode] from [Setup] / [Network] / [Services] and click [Edit].

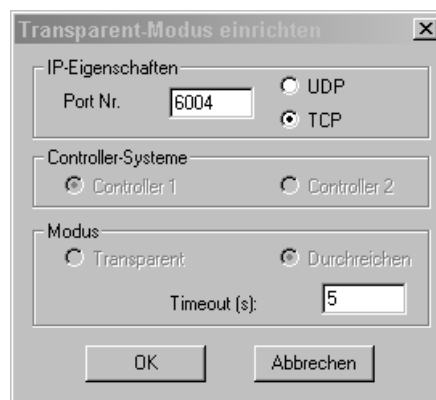

12005ADE

Parameter	Description
IP properties	Port number 6004 usually need not be changed. Select the required protocol: UDP or TCP.
Control systems	Define whether you want the transparent / pass-through mode to apply to controller 1 or 2.
Mode	Select transparent or pass-through mode as communication type. Enter a time interval in seconds under [Timeout] after which the terminal will change from pass-through mode back to run mode if no pass-through communication took place.



9.3.9 Web server

A web server prepares files so that they can be displayed in a browser (e.g. Internet Explorer). PCs that provide websites must run as web servers.

(WWW server) is a program that uses the client / server model and the Hypertext Transfer Protocol (HTTP) to transfer files that form the web sites of Internet users (with computers with HTTP clients). A web server program must also be installed on all PCs or terminals in the Internet that contain a web site.

You can configure the web server in the terminal with this function. A web server is a program based on a client/server model that uses Hypertext Transfer Protocol (HTTP). Web servers process files into websites or web pages that can be displayed by HTTP clients.

See also the section "Network services" on page 271.

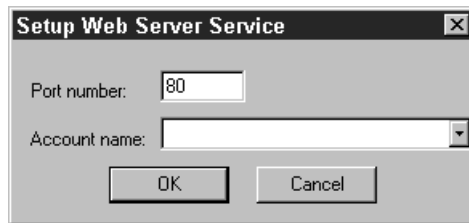

11591AEN

Parameter	Description
Port no.	The standard value 80 does not usually have to be changed.
Account name	Defining an account name protects HTML pages in the operator terminal with passwords. Accounts are defined under [Setup] / [Network] / [Accounts].

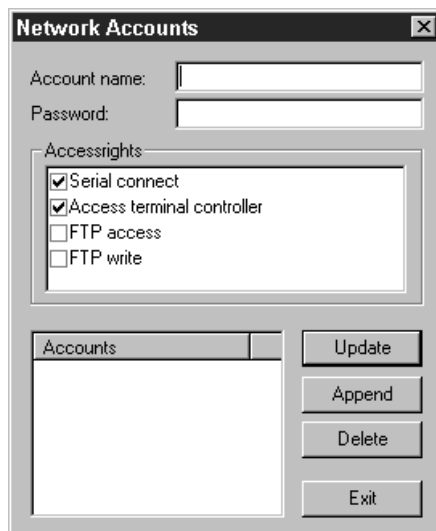

11590AEN



Parameter	Description
Account name	The account name that was specified in the previous dialog box is displayed here. Accounts are defined under [Setup] / [Network] / [Accounts].
Password	Enter a password. All HTML pages are protected with this account name and password. To protect an individual page with another account name and password, add the following code to the HTML header: <pre>&lt;HTML&gt;   &lt;HEAD&gt;     &lt;META name="superuser"<sup>1)</sup> content="12345"&gt;   &lt;/HEAD&gt;   Contains the remaining HTML code. &lt;/HTML&gt;</pre>

1) "superuser" stands for the account name and "12345" for the password.



#### NOTE

The header must contain the above mentioned code. The *Name* and *Content* parameters must have an account name and a password.





**SSI script**

An SSI (Server-Side Include) is a variable value (e.g. a file) that a server can add to an HTML file before sending it. Process as follows to insert an SSI into an HTML file when creating a web site:

```
<!--#echo var="LAST_MODIFIED"-->
```

The following SSI scripts are supported for displaying terminal values in HTML pages:

Name	Parameter	Description	Example
get_ipaddr.fn	None	Shows the IP address of the web server. Used in the CGI script.	<!--#exec cgi="get_ipaddr.fn"-->
get_domainname.fn	None	Shows the domain name of the web server.	<!--#exe cgi="get_domainname.fn"-->
get_date.fn	Date format e.g. MM/DD/YY or YY-MM-DD. If not specified, the terminal settings will be used.	Shows the terminal date.	<!--#exec cgi="/get_date.fn MM/DD/YY"-->
get_time.fn	Time format e.g. HH:MM:SS or HH:MM. If not specified, the terminal settings will be used.	Shows the terminal time.	<!--#exec cgi="/get_time.fn HH:MM"-->
get_device.fn	X, Y, Z X = device Y = display format (see separate table) Z = length (see following table)	Shows the device value (signal value) of the controller.	<!--#exec cgi="/get_device.fn D5"--> <!--#exec cgi="/get_device.fn D5LH"--> <!--#exec cgi="/get_device.fn M7"--> <!--#exec cgi="/get_device.fn D9ST,30"--> <!--#exec cgi="/get_device.fn D0AR,10"-->
get_diag.fn	None	Shows the diagnostics window of the terminal.	<!--#exec cgi="/get_diag.fn"-->
get_mode.fn	None	Shows the operating mode of the terminal: [RUN] / [PROG] / [SETUP] / [TRANSFER]	<!--#exec cgi="/get_mode.fn"-->



#### Display format for get\_device.fn

Name	Length	Description	Example
None	None	Shows the value in signed 16-bit format.	<!--#exec cgi=/get_device.fn D1-->
+	None	Shows the value in unsigned 16-bit format.	<!--#exec cgi=/get_device.fn D3+-->
L	None	Shows the value in signed 32-bit format.	<!--#exec cgi=/get_device.fn D7L-->
L+	None	Shows the value in unsigned 32-bit format.	<!--#exec cgi=/get_device.fn D2L+-->
RB	None	Shows the value as 32-bit BCD float (SIMATIC).	<!--#exec cgi=/get_device.fn D10RB-->
RF	None	Shows the value as 32-bit IEEE float.	<!--#exec cgi=/get_device.fn D8RF-->
RD	None	Shows the value as 32-bit IEEE float without exponent.	<!--#exec cgi=/get_device.fn D1RD-->
SB	None	Shows the value in 16-bit BCD format.	<!--#exec cgi=/get_device.fn D3SB-->
LB	None	Shows the value in 32-bit BCD format.	<!--#exec cgi=/get_device.fn D7LB-->
SH	None	Shows the value in 16-bit HEX format.	<!--#exec cgi=/get_device.fn D2SH-->
LH	None	Shows the value in 32-bit HEX format.	<!--#exec cgi=/get_device.fn D1LH-->
AR	None	Shows the number of values in signed 16-bit format.	<!--#exec cgi=/get_device.fn D5AR,10-->
ST	None	Shows the number of registers as a character string.	<!--#exec cgi=/get_device.fn D9ST,30-->

#### Automatic refresh

The HTML page is usually not automatically refreshed. Adding the following code to the HTML page will enable automatic refresh.

```
<meta http-equiv="Refresh"CONTENT="5">
```

CONTENT specifies how often the page should be refreshed (in seconds).

#### Example of an HTML page with SSI script

```
<HTML>
<HEAD>
<meta http-equiv="Refresh"CONTENT="5">
</HEAD>
<!--#exec cgi="/get_ipaddr.fn"--><BR>
<!--#exec cgi="/get_domainname.fn"--><BR>
<BR>
One IO:<BR>
<!--#exec cgi="/get_date.fn MM/DD/YY"--><BR>
<!--#exec cgi="/get_time.fn HH:MM"--><BR>
D5 = <!--#exec cgi="/get_device.fn D5"--><BR>
M7=<!--#exec cgi="/get_device.fn M7"--><BR>
D9 (string) = <!--#exec cgi="/get_device.fn D9ST,30"--><BR>
D0-D9 =<!--#exec cgi="/get_device.fn D0AR, 10"--><BR>
D8013 = <!--#exec cgi="/get_device.fn D8013"--><BR>
</HTML>
```



**CGI script**

The CGI (Common Gateway Interface) is a standard method for a web server to manage data for and from the user. When the user opens a website (by clicking a link or entering an address in the web browser) the server sends back the required page. If you fill in and send a form on a website, it is usually received by an application program. The server returns a confirmation. The procedure for data transfer between server and application is referred to as CGI and belongs to the HTTP protocol.

The following CGI scripts are supported to enable values to be changed in the terminal:

Name	Parameter	Description	Example
set_date.fn	Date format, e. g. MM/DD/YY or YY-MM-DD. If not specified, the terminal settings will be used.	Is used with FORM to set the date in the terminal.	<pre>&lt;FORM ACTION="http://&lt;!--#exec cgi="/get_ipaddr.fn"--&gt;/ set_date.fn" METHOD="POST"&gt; &lt;INPUT SIZE=10 MAXLENGTH=10 NAME="YY:MM:DD"&gt; &lt;INPUT TYPE="submit" VALUE="Submit"&gt; &lt;/FORM&gt;</pre>
set_time.fn	Time format, e. g. HH:MM:SS or HH:MM. If not specified, the terminal settings will be used.	Is used with FORM to set the time in the terminal.	<pre>&lt;FORM ACTION="http://&lt;!--#exec cgi="/get_ipaddr.fn"--&gt;/ set_time.fn" METHOD="POST"&gt; &lt;INPUT SIZE=10 MAXLENGTH=10 NAME="HH:MM:SS"&gt; &lt;INPUT TYPE="submit" VALUE="Submit"&gt; &lt;/FORM&gt;</pre>
set_device.fn	XY X = device Y= display format (see separate table) e. g. D0L + D5SH	Is used with FORM to set a device (signal) in the controller.	<pre>&lt;FORM ACTION="http://&lt;!--#exec cgi="/get_ipaddr.fn"--&gt;/ set_device.fn" METHOD="POST"&gt; &lt;INPUT SIZE=10 MAXLENGTH=10 NAME="D0L"&gt; &lt;INPUT TYPE="submit" VALUE="Submit"&gt; &lt;/FORM&gt;</pre>
set_mode.fn	RUN PROG SETUP TRANSFER	Is used with FORM to change the operating mode of the terminal.	<pre>&lt;FORM ACTION="http://&lt;!--#exec cgi="/get_ipaddr.fn"--&gt;/ set_mode.fn" METHOD="POST"&gt; &lt;SELECT NAME="MODE"&gt; &lt;OPTION VALUE="RUN"&gt;Run &lt;OPTION VALUE="PROG"&gt;Prog &lt;OPTION VALUE="SETUP"&gt;Setup &lt;OPTION VALUE="TRANSFER"&gt;Transfer &lt;/SELECT&gt; &lt;INPUT TYPE="submit" VALUE="Submit"&gt; &lt;/FORM&gt;</pre>
push_key.fn	(see separate table)	Used to simulate the activation of a terminal key.	<pre>&lt;FORM ACTION="http://&lt;!--#exec cgi="/get_ipaddr.fn"--&gt;/ push_key.fn" METHOD="POST"&gt; &lt;SELECT NAME="F2"&gt; &lt;OPTION VALUE="SET"&gt;Set &lt;OPTION VALUE="RESET"&gt;Reset &lt;OPTION VALUE="TOGGLE"&gt;Toggle &lt;/SELECT&gt; &lt;INPUT TYPE="submit" VALUE="Submit"&gt; &lt;/FORM&gt; &lt;FORM ACTION="http://&lt;!--#exec cgi="/get_ipaddr.fn"--&gt;/ push_key.fn" METHOD="POST"&gt; &lt;INPUT SIZE=1 MAXLENGTH=1 NAME="Key"&gt; &lt;INPUT TYPE="submit" VALUE="Submit"&gt; &lt;/FORM&gt;</pre>



#### Display format for set\_device.fn

Name	Description
None	Shows the value in signed 16-bit format.
+	Shows the value in unsigned 16-bit format.
L	Shows the value in signed 32-bit format.
L+	Shows the value in unsigned 32-bit format.
RB	Shows the value as 32-bit BCD float.
RF	Shows the value as 32-bit IEEE float.
RD	Shows the value as 32-bit IEEE float without exponent.
SB	Shows the value in 16-bit BCD format.
LB	Shows the value in 32-bit BCD format.
SH	Shows the value in 16-bit HEX format.
LH	Shows the value in 32-bit HEX format.
ST	Shows the number of registers as a character string.



Parameters for push\_key.fn

Parameter	Description	Example
KEY	Can assume the following values: A-Z 0-9 ACK LIST MAIN PREV BACKSPACE ENTER UP DOWN LEFT RIGHT	<FORM ACTION="http://<!--#exec cgi="/get_ipaddr.fn"-->/push_key.fn" METHOD="POST"> Key = <SELECT NAME="Key"> <OPTION VALUE="ENTER">Enter <OPTION VALUE="A">A <OPTION VALUE="B">B <OPTION VALUE="1">1 <OPTION VALUE="2">2 <OPTION VALUE="3">3 <OPTION VALUE="UP">Up <OPTION VALUE="DOWN">Down <OPTION VALUE="LEFT">Left <OPTION VALUE="RIGHT">Right <OPTION VALUE="PREV">Prev </SELECT> <INPUT TYPE="submit" VALUE="Submit"> <P> </FORM>
F1-F22	Can assume the following values: SET RESET TOGGLE	<FORM ACTION="http://<!--#exec cgi="/get_ipaddr.fn"-->/push_key.fn" METHOD="POST"> <SELECT NAME="F2"> <OPTION VALUE="SET">Set <OPTION VALUE="RESET">Reset <OPTION VALUE="TOGGLE">Toggle </SELECT> <INPUT TYPE="submit" VALUE="Submit"> </FORM>

**Example of an HTML page with SSI and CGI script**

```
<HTML>
<FORM ACTION="http://<!--#exec cgi="/get_ipaddr.fn"-->/ set_date.fn"
METHOD="POST">
Set date here (YY:MM:DD):
<INPUT SIZE=10
    MAXLENGTH=10
    NAME="YY:MM:DD"
    VALUE="<!--#exec cgi="/get_date.fn"-->">
<INPUT TYPE="submit" VALUE="Submit"> <P>
</FORM>
<FORM ACTION="http://<!--#exec cgi="/get_ipaddr.fn"-->/ set_time.fn"
METHOD="POST">
Set time here (HH:MM:SS):
<INPUT SIZE=10
    MAXLENGTH=10
    NAME="HH:MM:SS"
    VALUE="<!--#exec cgi="/get_time.fn"-->">
<INPUT TYPE="submit" VALUE="Submit"> <P>
</FORM>
<FORM ACTION="http://<!--#exec cgi="/get_ipaddr.fn"-->/ set_device.fn"
METHOD="POST">
D0 =
<INPUT SIZE=10
    MAXLENGTH=10
    NAME="D0"
    VALUE="<!--#exec cgi="/get_device.fn D0"-->">
<INPUT TYPE="submit" VALUE="Submit">
</FORM>
</HTML>
```



#### **Saving HTML files via FTP**

An FTP standard client, such as [DOP Tools] \ [DOP FTP Client], is used for transferring and saving HTML files to and on the terminal.

See the section "FTP server" on page 276.

The files are transferred to the HTML directory of the operator terminal.

File names must be assigned in DOS format (8.3). The length of the file name is limited to eight characters. HTM is used as the suffix.



#### **NOTE**

The file INDEX.HTM must always be available.

#### **9.3.10 Remote access**

This function enables access to and mirroring and control for an operator terminal from a PC using the free VNC client Remote Access Viewer and the VNC server integrated in the operator terminal.

Remote Access Viewer is a program for remote access and control of the DOP11B operator terminals. The VNC (Virtual Network Computing) client program Remote Access Viewer in conjunction with the integrated VNC server can be used to access, view and control the remote access function in the operator terminal from a PC.

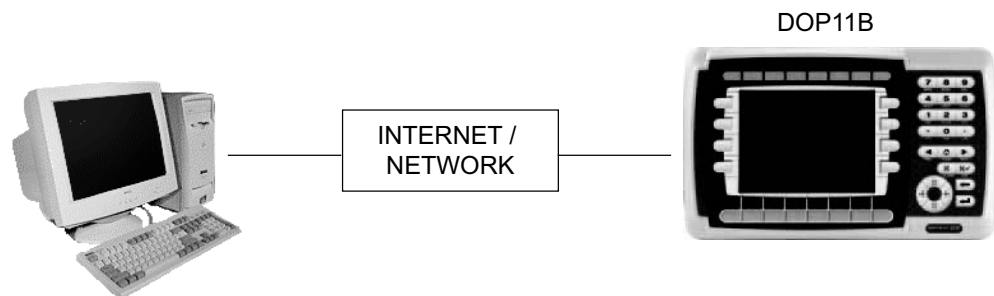

60680AXX

You can use the VNC technology to access an operator terminal connected to a PC via ETHERNET as long as it is connected to the same network. When the PC and operator terminal are connected to the Internet, you can access the operator terminal from any PC with Internet connection from anywhere in the world. The remote access functionality for operator terminals is particularly important for remote customer support, remote control, and troubleshooting.



**Settings in the operator terminal**

The operator terminal has a built-in VNC server. The remote access function must be activated in the project application in the operator terminal. A more detailed description of the configuration tool can be found in the configuration tool manual.

**Settings in the configuration tool**

1. Open the operator terminal project in the configuration tool.
2. Choose [Setup] / [Network] / [Services].

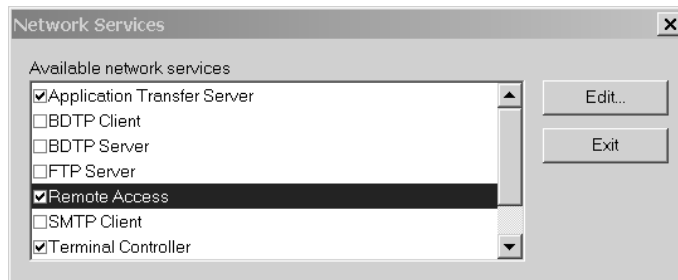

12006AEN

3. Select [Remote access] and click [Edit].

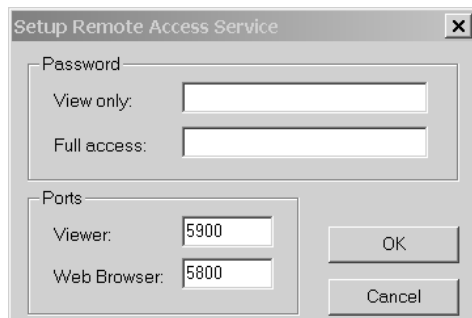

12007AEN

**Password**

View only	Enter a password for read-only access to the operator terminal in the Remote Access Viewer. A Remote Access Viewer / web browser user that logs on with the view-only password cannot make any changes in the operator terminal.
Full access	Enter a password for full access to the operator terminal in the Remote Access Viewer. A Remote Access Viewer / web browser user that logs on with the password for full access can operate the terminal as if he were standing in front of it.



**NOTE**

If the same password is used for the view-only mode and full access, the Remote Access Viewer / web browser users have full access to the operator terminal.



#### Ports

Viewer (5900)	TCP (Transmission Control Protocol) connection for the Remote Access Viewer; does not usually have to be changed.
Full access (5800)	TCP connection for HTTP (Hypertext Transfer Protocol) connections; does not usually have to be changed.

To end the program, choose OK and Exit. Save the project and transfer it to the operator terminal. The VNC server is now running in the operator terminal.

#### Command to show whether the VNC client is connected

In the configuration tool, enter the command "SJAFx" in the 'Commands' line under [Setup] / [System signals] to display the text "Remote access" in the top right-hand corner of the operator terminal when a VNC client (Remote Access Viewer or web browser) is connected with the VNC server in the operator terminal. "x" is an index for the font size to be displayed; available font sizes are shown in the field "Menus" in the window [Runtime fonts] ([Setup] / [Runtime fonts]).

Signal Name	Address	I/O	Menu
Current display reg.:	<input type="text"/>	<input type="text"/>	<input type="text"/>
New display reg.:	<input type="text"/>	<input type="text"/>	<input type="text"/>
Buzzer reg.:	<input type="text"/>	<input type="text"/>	<input type="text"/>
Backlight signal:	<input type="text"/>	<input type="text"/>	<input type="text"/>
Reverse signal:	<input type="text"/>	<input type="text"/>	<input type="text"/>
Cursor control block:	<input type="text"/>	<input type="text"/>	<input type="text"/>
Cursor move reg.:	<input type="text"/>	<input type="text"/>	<input type="text"/>
Printer status reg.:	<input type="text"/>	<input type="text"/>	<input type="text"/>
Library index reg.:	<input type="text"/>	<input type="text"/>	<input type="text"/>
Dim backlight reg.:	<input type="text"/>	<input type="text"/>	<input type="text"/>
Contrast reg.:	<input type="text"/>	<input type="text"/>	<input type="text"/>
Commands:	<input type="text"/>		

OK Cancel

12008AEN





**Connection to the operator terminal**

The VNC server detects HTTP (Hypertext Transfer Protocol) connections on the TCP (Transmission Control Protocol) port 5800 as set in the operator terminal for the remote access function (see page 295).

Enter the IP address of the operator terminal followed by a ":" (colon) and the TCP port number 5800 in the web browser's address field. If the IP address of the operator terminal were 10.3.71.22, for example, you would enter **http://10.3.71.22:5800**.



12019AEN

Remote Access Viewer displays an image of the operator terminal on the PC screen. The image in the Remote Access Viewer can be updated on request or at regular intervals. The remote access function fulfills the same function as the actual operator terminal.



11599AXX



The VNC server integrated in the operator terminal also includes a small VNC applet. You can connect an operator terminal to a web browser that supports Java applets, e.g. Microsoft Internet Explorer.

If you use a web browser, the image of the operator terminal frame is not displayed.



11600AXX

#### **VNC authentication**

- The web browser asks for a password as soon as the connection is established.
- Enter the password set in the operator terminal.
- The operator terminal should now be displayed in the web browser on your PC.



**Controlling the operator terminal**

An operator terminal with keyboard is controlled using the PC keyboard. The following keys on your PC keyboard match the keys on the operator terminal.

PC keyboard	Operator terminal keyboard
Pos1	MAIN
Shift + F11	LIST
Shift + F12	ACK
Screen ↑	PREV
Screen ↓	NEXT
F1 to F12	F1 to F12
Shift + F1 to F12	F13 to F22
Enter key	ENTER
Arrow keys	Arrow keys

If the terminal has a touchscreen, you can touch the screen directly.

	<b>NOTE</b>
	Connection to the operator terminal via proxy is <b>not</b> recommended.

**9.3.11 Recommendations and limitations for network communication**

Optimal signal transfer is required for fast and efficient communication between terminals and controller in a terminal network (BDTP network). Read the section "Effective communication" on page 63 and follow the instructions for optimizing network functionality in the terminals. A maximum of 3000 signals can be transferred in a terminal network.

**Example 1**

A terminal network consists of three clients and a server. Each client can access 1000 signals. This means the server has to transfer 3000 signals to the individual clients. This is also the case if the address ranges for the signals in the clients are identical. This ensures that the signal transfer in the network operates to full capacity.

**Example 2**

The server should retrieve the addresses requested by the clients. The server then queries the controller status and sends it to the relevant client.

**Example**

A terminal network (BDTP network) consists of a server and five clients. Each terminal contains 50 alarms with the same address. For the server, this means that 50 addresses must be queried by the controller. In addition, the server must send 50 alarms to the respective client (5 x 50). Consequently, the server must distribute 250 alarms in the network.



#### **Transparent mode via ETHERNET**

The following prerequisites must be fulfilled before the [Transparent mode] via ETHERNET communication (TCP/IP protocol) function can be used:

- Driver and programming tools must support communication in transparent mode. (For more information, refer to the driver or controller manual.)
- If the configuration software for the controller does not support TCP/IP project transfer, a program simulating the COM connection in a TCP/IP environment must be installed on the PC. This program communicates with the controller in transparent mode via the TCP/IP network.

#### **Pass-through mode via ETHERNET**

Communication in pass-through mode is only possible if the drivers support this mode. See the section "Communication" on page 250.

The following prerequisite must be fulfilled before pass-through mode via ETHERNET communication (TCP/IP protocol) can be used:

- You will have to use a program for conversion from COM port to TCP/IP if the programming software for the controller does not support project transfer via TCP/IP. This program communicates with the controller in transparent mode via the TCP/IP network. (For more detailed information, refer to the driver or controller manual.)

#### **No protocol mode**

The [No protocol mode] function, which is used when one or more terminals act as the communication interface (see also the section "Communication" on page 250), is not recommended for larger terminal network (BDTP networks).

A large network is a BDTP network with a high number of signals between server and clients. Control registers and control signals are transferred when the terminal acts as communication interface. These have a negative influence on communication speed and reduce network performance. See the section "Effective communication" on page 63.

#### **Signal packages**

Optimal signal transfer is key for fast and efficient communication between terminals and controller (e.g. in a network). Read the section "Effective communication" on page 63 and follow the instructions for optimizing network functionality in the terminals. These requirements apply to all stations in the terminal network. The refresh time may increase if signals are not transferred in packages.



**Alarm  
management**

The terminal network is a client/server network. The server stores data (e.g. alarm signals) that is retrieved by the clients. The simultaneous transfer of different signals has a negative impact on the transfer time between operator terminals and controllers. The number of signals should therefore be limited. For more information, refer to the section "Efficient communication" on page 63.

The number of alarm signals in the network must not exceed the number of signals the server is capable of processing in the entire network. A server can process up to 300 alarms depending on the application and the operator terminal. Consequently, a network must not contain more than 300 alarms.

**Index in the  
network client**

In run mode, index addressing helps to specify the register from which an object should retrieve the displayed value. Index addressing cannot be used in terminals that act as BDTP clients. BDTP clients exclusively use the index register of the BDTP server.

However, if a terminal that acts as a BDTP client also has a local controller, the normal rules apply when using index addressing.



#### 9.4 Network accounts

Under [Setup] / [Network] / [Accounts], you can define who may access terminal services that require login. This function creates an authorization check. This means a user name and password are created for various users with access to different services in the network. Special country-specific characters are not permitted in account names and passwords.

11590AEN

According to the figure, the account with the name "Superuser" is authorized to access all network functions requiring login. The buttons enable you to update, add and delete accounts in the list.

Parameter	Description
Account name	Enter an account name.
Password	Enter a password for the account.

##### 9.4.1 Access rights

Parameter	Description
Serial connection	The user can establish a serial connection (PPP). This option should be activated.
Access terminal controller	The terminal controller is used to change from RUN to TRANSFER via TCP/IP. This option should be activated.
FTP Access	The user has read access on the FTP server (terminal).
FTP Write	The user has write access on the FTP server. This also requires FTP access.



### 9.5 *Accessing the network settings during runtime*

The operator terminal's unique hardware number - its MAC (Media Access Control) address - can be accessed during runtime using a macro with the command "IP-CONFIG" and the argument "/ALL".

The IP configuration is displayed with the MAC address in a Windows CE console.



**NOTE**

More information can be found in the section "Insert event / Add event" (page 247).

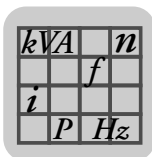

## 10 Technical Data and Dimension Drawings

### 10.1 General technical data

#### 10.1.1 Display

	DOP11B-10	DOP11B-15	DOP11B-20	DOP11B-25
Graphics resolution (pixels)	160 x 32	240 x 64	240 x 64	320 x 240
Line x characters text	Graphic			
Active screen size, W x H	89.6 x 17.9 mm	90.2 x 24 mm	127.0 x 33.8 mm	115.2 x 86.4 mm
Backlighting	LED, can be dimmed >50,000 h at an ambient temperature of +25 °C.	LED, can be dimmed >50,000 h at an ambient temperature of +25 °C.	LED, can be dimmed >50,000 h at an ambient temperature of +25 °C.	CCFL, can be dimmed >45,000 h at an ambient temperature of +25 °C.
Contrast setting	Via system variable			
Screen	FSTN-LCD screen (liquid crystal), monochrome	FSTN-LCD screen (liquid crystal), monochrome	FSTN-LCD screen (liquid crystal), monochrome	FSTN-LCD screen (liquid crystal), 16 gray scale

	DOP11B-30	DOP11B-40	DOP11B-50	DOP11B-60
Graphics resolution (pixels)	320 x 240	320 x 240	800 x 600	1024 x 768
Line x characters text	Graphic			
Active screen size, W x H	115.2 x 86.4 mm	115.2 x 86.4 mm	211.2 x 158.4 mm	304.1 x 228.1 mm
Backlighting	CCFL, can be dimmed >60,000 h at an ambient temperature of +25°C.		CCFL, can be dimmed >50,000 h at an ambient temperature of +25°C.	CCFL, can be dimmed >35,000 h at an ambient temperature of +25°C.
Contrast setting	Via system variable			
Screen	CSTN-LCD screen (liquid crystal), 64 k colors		TFT-LCD screen (liquid crystal), 64 k colors	TFT-LCD screen (liquid crystal), 64 k colors



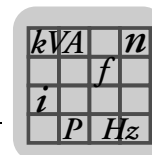

10.1.2 Technical data

	DOP11B-10	DOP11B-15	DOP11B-20	DOP11B-25
Keyboard	<ul style="list-style-type: none"> <li>Numeric keypad</li> <li>Navigation keypad</li> <li>6 function keys</li> <li>6 LEDs (red / green)</li> </ul>	<ul style="list-style-type: none"> <li>Numeric keypad</li> <li>Navigation keypad</li> <li>6 function keys</li> <li>6 LEDs (red / green)</li> </ul>	<ul style="list-style-type: none"> <li>Numeric keypad</li> <li>Navigation keypad</li> <li>8 function keys</li> <li>16 LEDs</li> </ul>	Touch resistive
Keyboard material / Material for unit front	Membrane keyboard with metal end caps. Overlay autotex F207 with back print, 1 million operations		Membrane keyboard with metal caps. Overlay autotex F157 with back print, 1 million operations	Touchscreen Polymeer (Autotex F250) on glass, 1 million operations
Additional memory	None		Via USB memory	
Graphical objects	Yes			
Real-time clock	$\pm 20$ PPM + error display through ambient temperature and supply voltage. Max. total error display: 1 minute/month at +25 °C = 12 minutes/year. The real-time clock battery has a rating life of 3 years. Temperature coefficient: 0.004 ppm/°C <sup>2</sup>			
Supply voltage	DC 24 V (DC 20 ... 30 V), 3-pin terminal contact CE: The voltage supply must meet requirements for SELV or PELV in line with IEC 950 or IEC 742. UL: Supply voltage in line with guidelines for voltage supply class 2.			
Current consumption at operating voltage	Normal: 0.1 A Maximum: 0.3 A	Normal: 0.15 A Maximum: 0.35 A	Normal: 0.25 A Maximum: 0.45 A	
Fuse	Internal DC fuse, 1.0 A time-lag, 5 x 20 mm		Internal DC fuse, 2.0 A time-lag, 5 x 20 mm	
Ambient temperature	Vertical installation: 0 °C ... +50 °C Horizontal installation: 0 °C ... +40 °C			
Storage temperature	-20 to +70 °C			
Humidity	5 ... 85 % (non-condensing)			
Front dimensions W x H x D	155.2 x 113.6 x 6 mm	155.2 x 155.2 x 6 mm	202 x 187 x 6 mm	201 x 152 x 6 mm
Installation depth	43 mm	44 mm	56.9 mm	56.8 mm
Enclosure front	IP66			
Enclosure back	IP20			
Protection material back	Powder-coated aluminum			
Weight	0.4 kg	0.5 kg	0.875 kg	0.87 kg
Memory	512 kB (incl. fonts)	512 kB (incl. fonts)	12 MB (incl. fonts)	
EMC tests on terminal	Tested according to: EN 61000-6-3 (emission) and EN 61000-2-2 (interference immunity).			
UL approval	UL 1604 (Class I, Div 2) / UL 508 / UL 50 4x indoor use only			
DNV approval	In preparation			
NEMA	4x indoor use only			

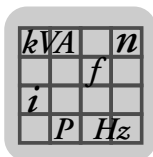

	DOP11B-30	DOP11B-40	DOP11B-50	DOP11B-60
Keyboard	Touch resistive	<ul style="list-style-type: none"> <li>Numeric keypad</li> <li>Navigation keypad</li> <li>16 function keys</li> <li>16 LEDs (red / green)</li> </ul>	Touch resistive	
Keyboard material / Material for unit front	Touchscreen Polymeer (Autotex) on glass, 1 million operations	Membrane keyboard with metal caps. Overlay autotex F157 with back print, 1 million operations	Touchscreen Polymeer (Autotex F250) on glass, 1 million operations	
Additional memory	Via USB memory		Via USB memory or compact Flash card	
Graphical objects	Yes			
Real-time clock	$\pm 20$ PPM + error display through ambient temperature and supply voltage. Max. total error display: 1 minute/month at +25 °C = 12 minutes/year. The real-time clock battery has a rating life of 3 years. Temperature coefficient: 0.004 ppm/°C <sup>2</sup>			
Supply voltage	DC 24 V (DC 20 ... 30 V), 3-pin terminal contact			
	CE: The voltage supply must meet requirements for SELV or PELV in line with IEC 950 or IEC 742. UL: Supply voltage in line with guidelines for voltage supply class 2.			
Current consumption at operating voltage	Normal: 0.25 A Maximum: 0.45 A	Normal: 0.3 A Maximum: 0.5 A	Normal: 0.5 A Maximum: 1.0 A	Normal: 1.2 A Maximum: 1.7 A
Fuse	Internal DC fuse, 2.0 A time-lag, 5 x 20 mm		Internal DC fuse, 3.15 A time-lag, 5 x 20 mm	
Ambient temperature	Vertical installation: 0 °C ... +50 °C Horizontal installation: 0 °C ... +40 °C			
Storage temperature	-20 to +70 °C			
Humidity	5 ... 85 % (non-condensed)			
Front dimensions W x H x D	201 x 152 x 6 mm	275 x 168 x 6 mm	302 x 228 x 6 mm	398 x 304 x 6 mm
Installation depth	56.8 mm	57.3 mm	58 mm	
Enclosure front	IP66			
Enclosure back	IP20			
Protection material back	Powder-coated aluminum			
Weight	0.87 kg	1.11 kg	2.0 kg	3.7 kg
Memory	12 MB (incl. fonts)			
EMC tests on terminal	Tested according to: EN 61000-6-3 (emission) and EN 61000-2-2 (interference immunity).			
UL approval	UL 1604 (Class I, Div 2) / UL 508 / UL 50 4x indoor use only			
DNV approval	In preparation		Yes	
NEMA	4x indoor use only			

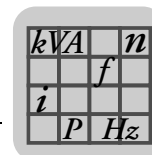

### 10.1.3 Functions

	DOP11B-10	DOP11B-15	DOP11B-20	DOP11B-25	DOP11B-30	DOP11B-40	DOP11B-50	DOP11B-60
Network functions	No		E-mails / web server / remote access / FTP server					
Dual driver with data exchange	Yes							
Pass-through mode	Yes (depending on driver)							
No protocol mode	Yes							
Multilingual capability	Yes, up to 10 languages in one project							
Standard Windows fonts	No		Yes					
Internal variables	Yes, volatile and non-volatile							
Trend recording	Yes							
Recipe management	Yes							
Alarm management	Yes, up to 16 groups							
Time channels	Yes							
I/O poll groups	Yes							
Passwords	Yes, up to 8 groups							
Message library	Yes							
Macros	Yes							
Printer function	Yes							

### 10.1.4 Communication

	DOP11B-10	DOP11B-15	DOP11B-20	DOP11B-25	DOP11B-30	DOP11B-40	DOP11B-50	DOP11B-60
Serial interface RS-232	9-pin sub D connector, installed plug with retaining screws 4-40 UNC, can be set up to 115200 Baud.							
Serial interface RS-422	25-pin sub D connector, installed socket with retaining screws 4-40 UNC, can be set up to 115200 Baud.							
ETHERNET	As an option		As an option		Shielded RJ45 socket, 10/100 MBit - full duplex			
USB	No		Host type A (USB1.1), max. output current 500 mA				Host type A (USB1.1), max. output current 500 mA, device type B (USB1.1)	

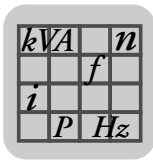

### 10.2 Pin assignment

#### 10.2.1 RS-232

D-sub 9-pin connector	Terminal no.	Designation	Signal direction operator terminal ↔ XXX
	1	DCD	←
	2	RD	←
	3	TD	→
	4	DTR	→
	5	SG	–
	6	DSR	←
	7	RTS	→
	8	CTS	←
	9	RI	←

#### 10.2.2 RS-422 / RS-485

D-sub 25-pin socket	Terminal no.	RS-422		RS-485	
		Designation	Signal direction operator terminal ↔ XXX	Designation	Signal direction operator terminal ↔ XXX
	2	TxD+	→	Tx / Rx+	↔
	15	TxD-	→	Tx / Rx-	↔
	3	RxD+	←	–	–
	16	RxD-	←	–	–
	4	RTS+	→	–	–
	17	RTS-	→	–	–
	5	CTS+	←	–	–
	18	CTS-	←	–	–
	20	1)	–	–	–
	21	1)	–	–	–
	6	Do not assign	–	Bus terminator <sup>2)</sup>	Connect to pin 19 for the bus terminator <sup>3)</sup>
	19	Do not assign	–	Bus terminator <sup>4)</sup>	–
	7,8	0 V	–	0V	–
	14	+ 5 V < 100 mA	→	+5 V < 100 mA	→

1) Pin 20 connected to pin 21 in the terminal

2) Connected directly to pin 2 internally (Tx / Rx+)

3) Note: Only the first and last bus stations should have a bus terminator.

4) Connected internally to pin 15 (Tx / Rx-) via 120 Ohm 1/4 resistor.

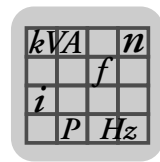

10.2.3 ETHERNET

RJ45 socket	Terminal no.	Designation	Signal direction operator terminal ↔ XXX
	1	Tx+	→
	2	Tx-	→
	3	Rx+	←
	6	Rx-	←
	4, 5, 7, 8	GND	-

10.2.4 USB

USB socket	Terminal no.	Designation	Signal direction operator terminal ↔ XXX
USB-A 	1	VBUS	-
	2	D -	↔
	3	D +	↔
	4	GND	-
USB-B 	1	VBUS	-
	2	D -	↔
	3	D +	↔
	4	GND	-

10.2.5 PCS21A

RJ10 4-pin connector	Terminal no.	Designation	Signal direction operator terminal ↔ XXX
	1	Do not assign	Reserved
	2	Tx/Rx+	↔
	3	Tx/Rx-	↔
	4	y	

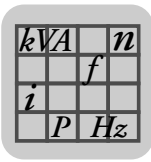

10.3 DOP11B-10

10.3.1 Text strips for DOP11B-10

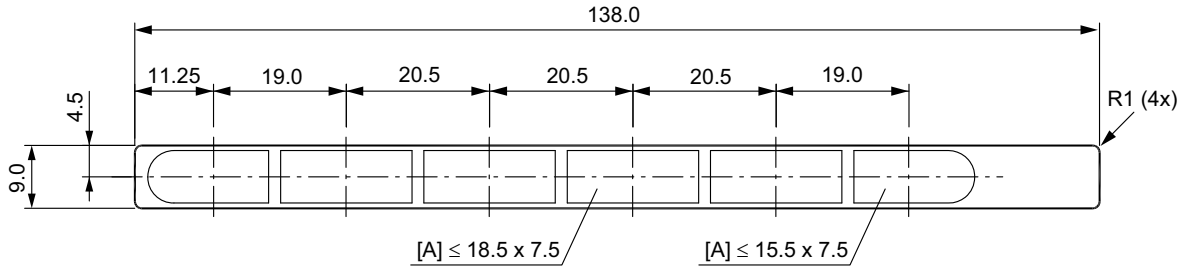

63783AXX

[A] Maximum area for texts in mm.

10.3.2 Dimension drawing for DOP11B-10

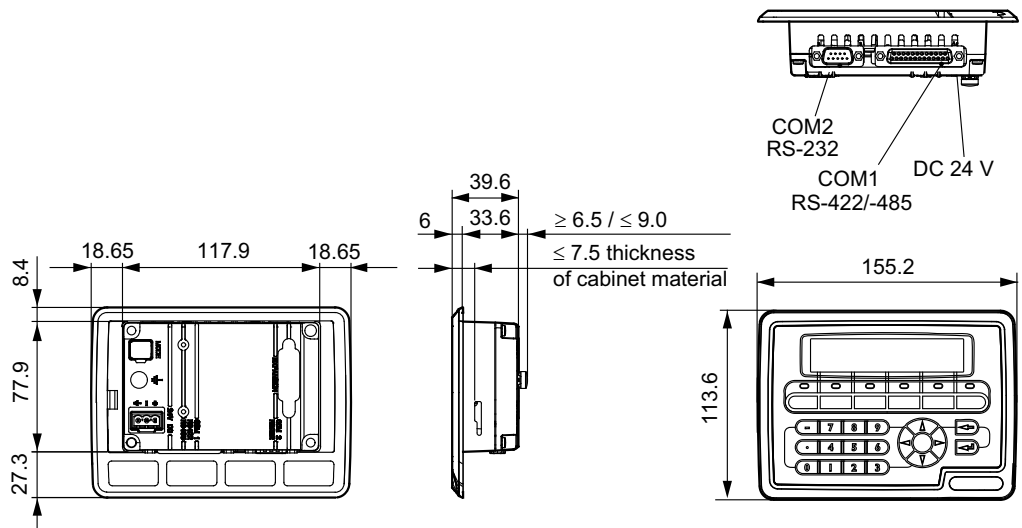

63779AEN

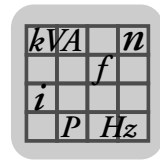

10.4 DOP11B-15

10.4.1 Text strips for DOP11B-15

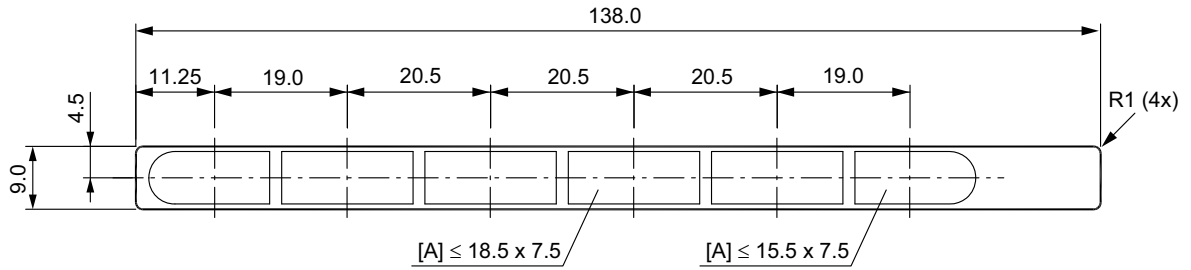

63783AXX

[A] Maximum area for texts in mm.

10.4.2 Dimension drawing for DOP11B-15

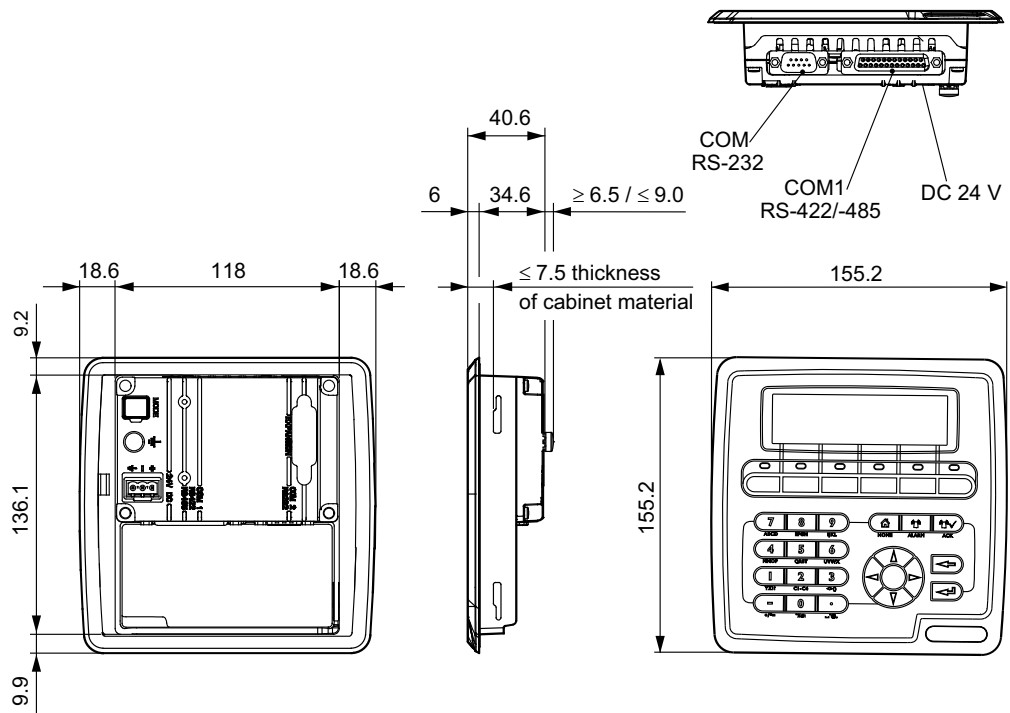

63780AEN

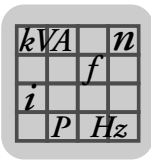

10.5 DOP11B-20

10.5.1 Text strips for DOP11B-20

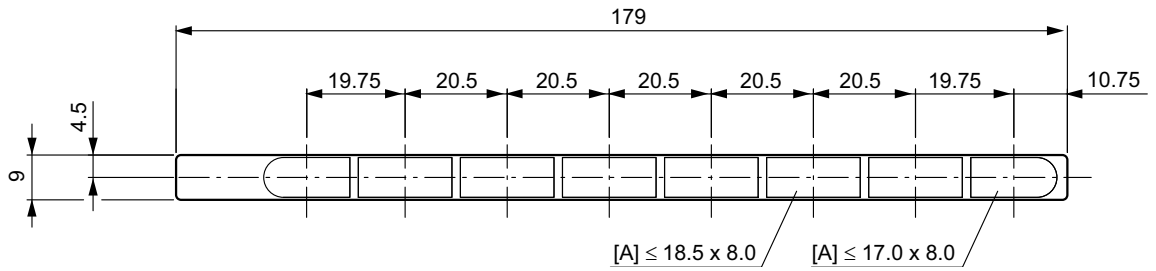

63784AXX

[A] Maximum area for texts in mm.

10.5.2 Dimension drawing for DOP11B-20

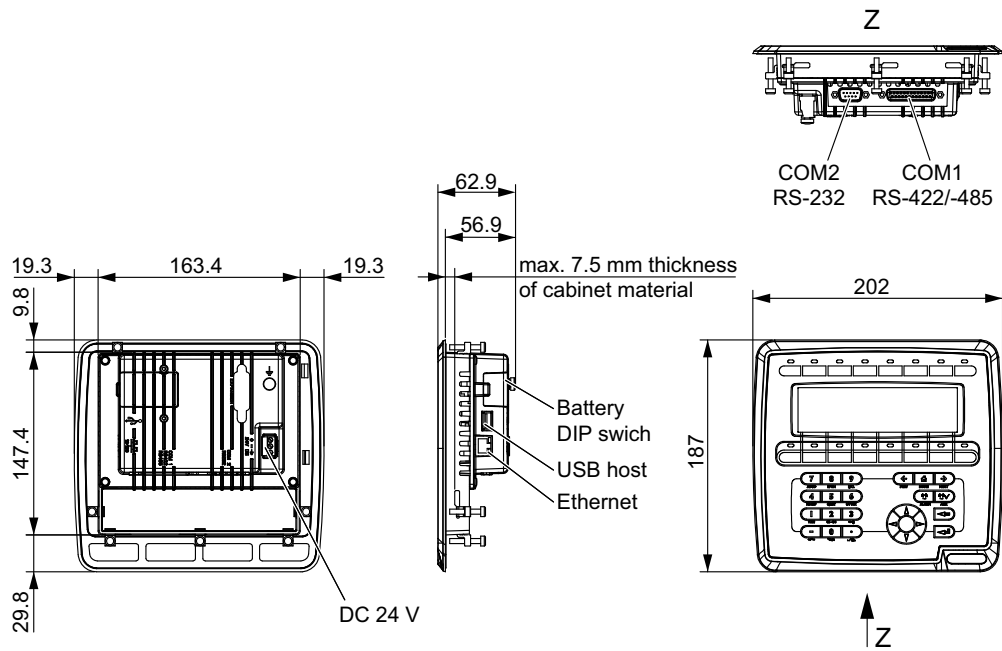

60742AEN



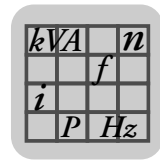

10.6 DOP11B-25 and -30

10.6.1 Dimension drawing for DOP11B-25 and -30

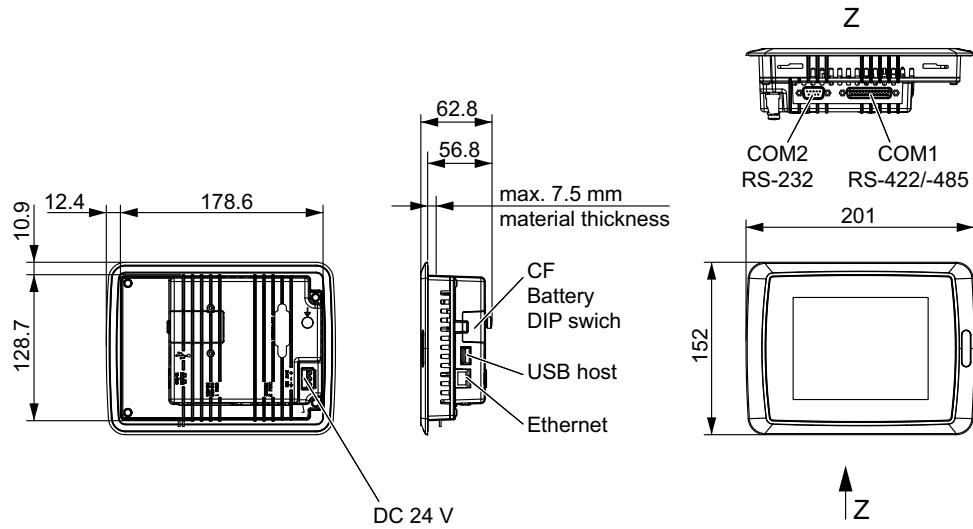

60741AEN

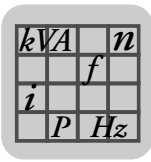

10.7 DOP11B-40

10.7.1 Text strips for DOP11B-40

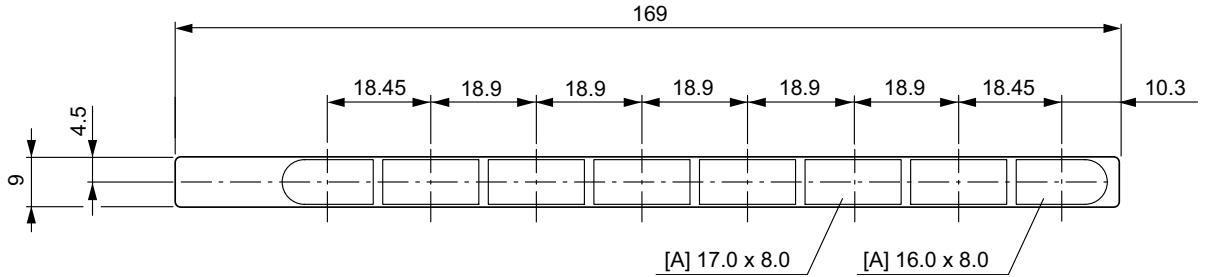

63817AXX

[A] Maximum area for texts in mm.

10.7.2 Dimension drawing for DOP11B-40

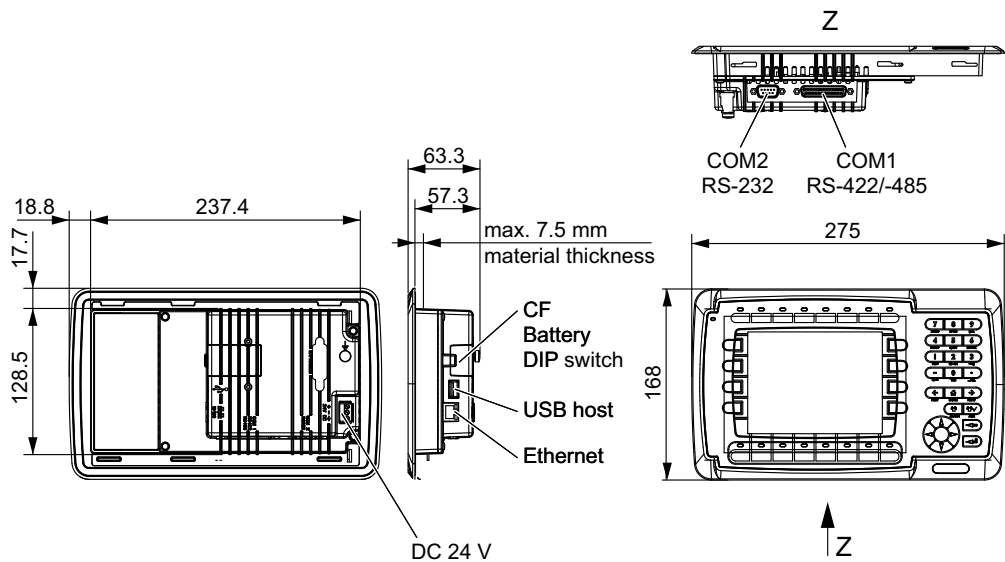

60740AEN

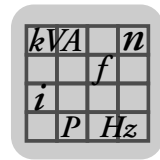

10.8 DOP11B-50

10.8.1 Dimension drawing for DOP11B-50

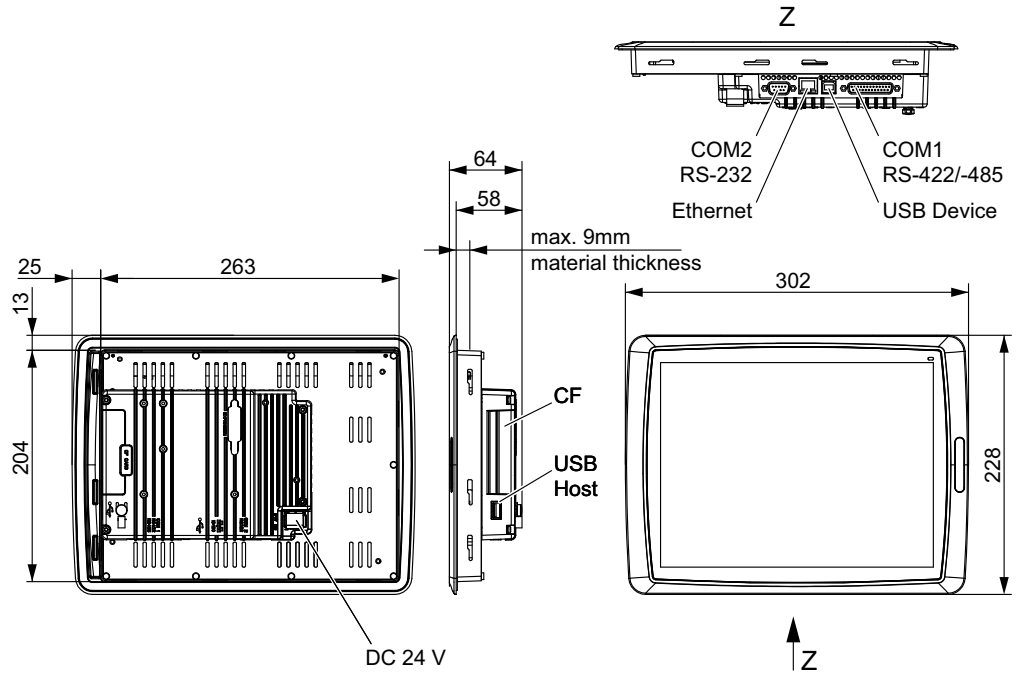

60739AEN

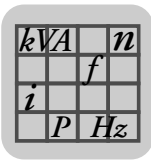

10.9 DOP11B-60

10.9.1 Dimension drawing for DOP11B-60

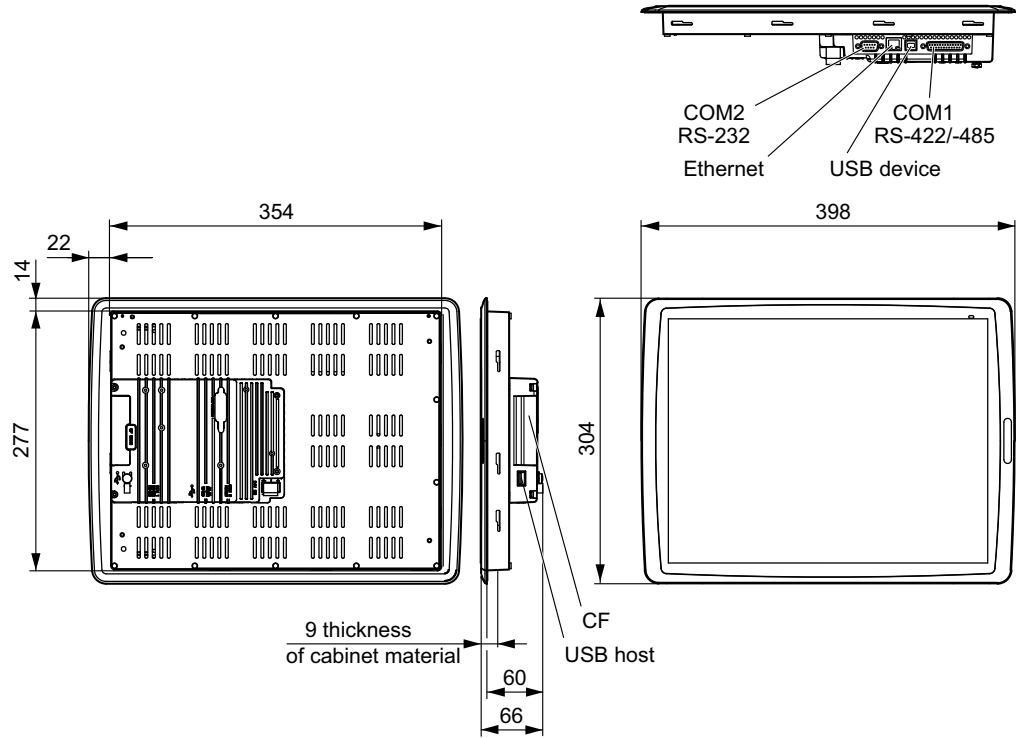

63781AEN

$kVA$	$n$
$i$	$f$
$P$	$Hz$

**10.10 Label for DOP11B-10 to DOP11B-40**

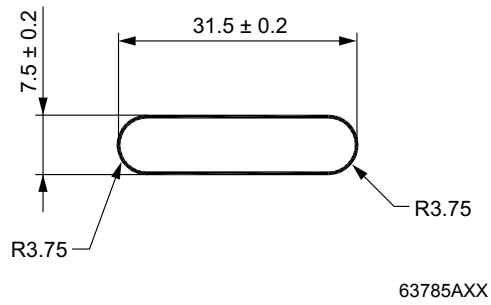

**10.11 Label for DOP11B-50 and DOP11B-60**

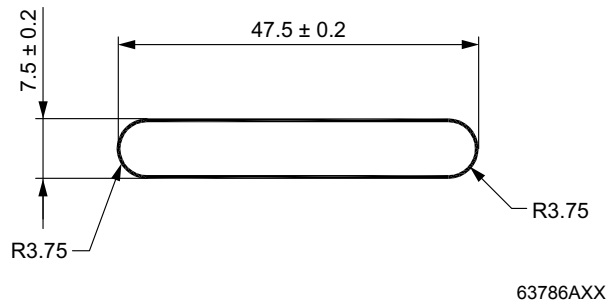

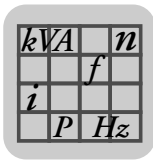

10.12 Cable

10.12.1 PCS11B

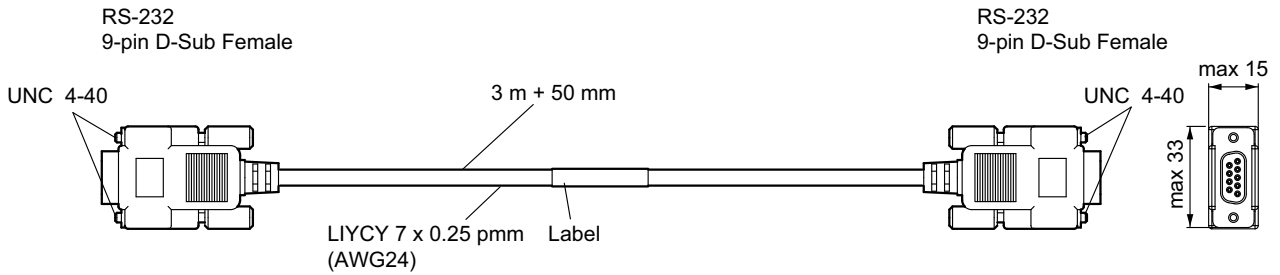
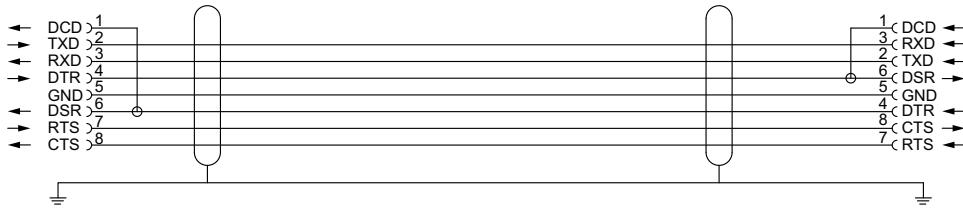

63833AXX

10.12.2 PCS21A

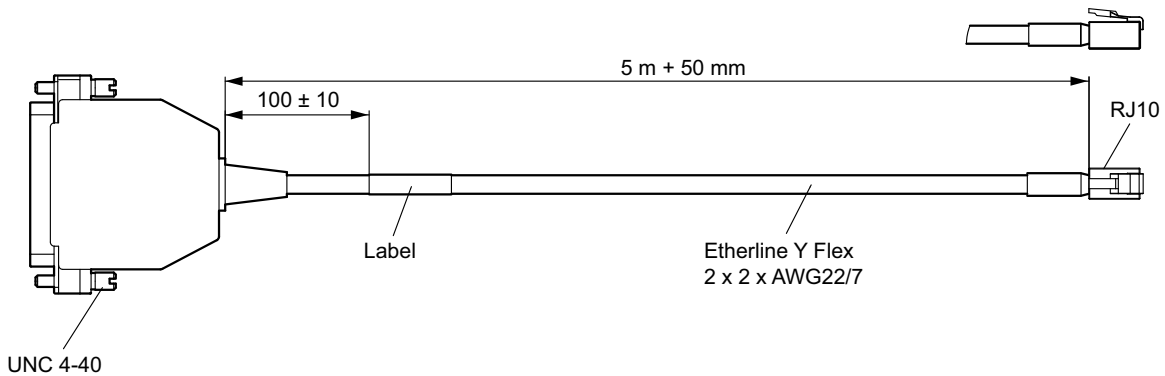
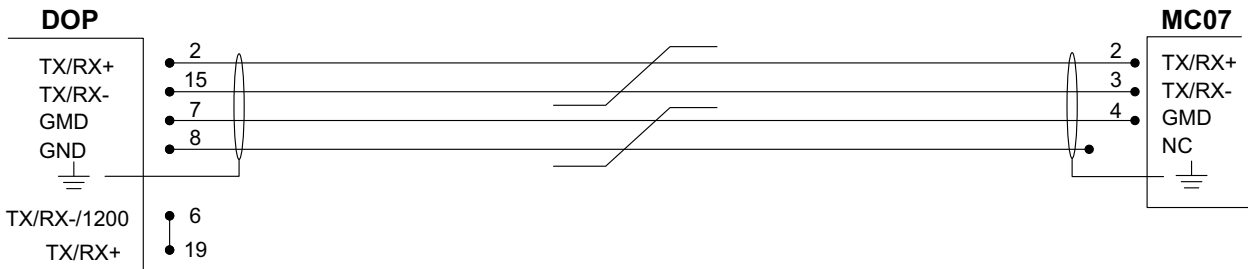

63840AXX

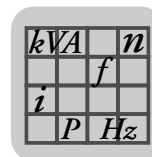

10.12.3 PCS22A

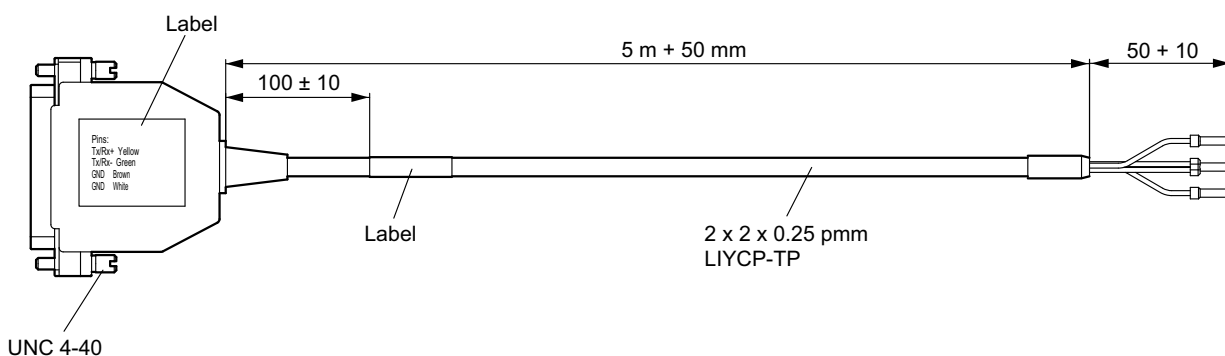
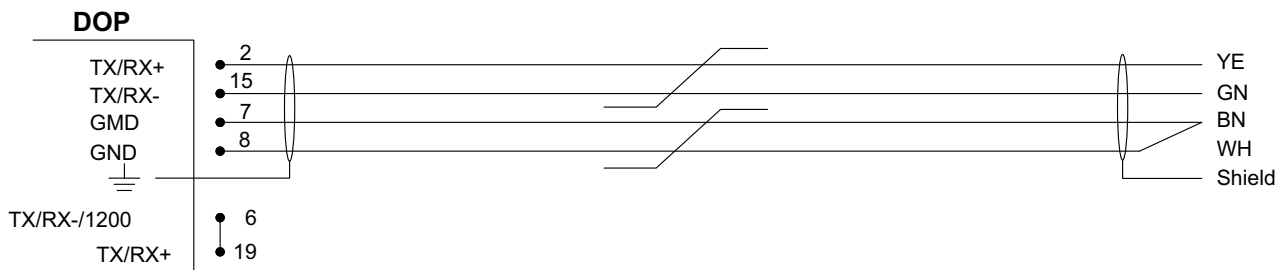

63835AXX

10.12.4 RS-232 communication cable (prefabricated cable D-SUB 9PO)

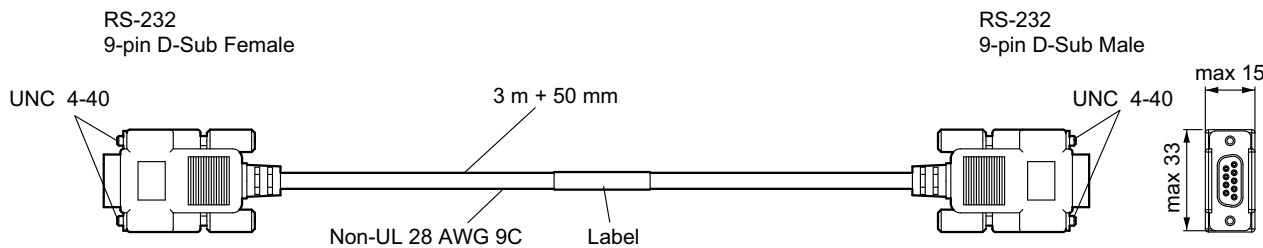
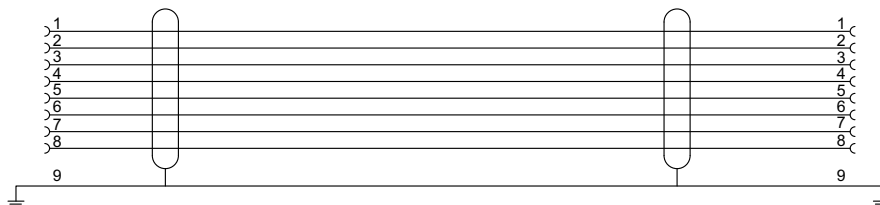

64007AXX



## 11 Appendix

### 11.1 Chemical resistance

#### 11.1.1 Metal housing

The frame and housing are made of powder-coated aluminum. This powder coating can be exposed to the following substances for more than 24 hours without any visible changes:

Alcohol 95%	Tap water
Aluminum cleaner	Ligroin
Ammonia	Lactic acid
Butanol	Sodium carbonate 10%
Chloric acid 10%	Sodium dichromate, saturated
Diesel oil	Sodium hypochlorite solution
De-ionized water	Sodium hydroxide
Acetic acid	Paraffin oil
Ethanol 99.5%, denatured	Phosphoric acid
FAM engine gasoline	Nitric acid
Glycol	Sulfuric acid
Urea, saturated	Cooking oil
Hydroperoxide	Turpentine
Isoproponal	Washing liquid
Common salt 20%	Citric acid
Cooling agent	–

#### 11.1.2 Keyboard and display

##### **Solvent resistance for the display surface**

This surface of the display can be exposed to the following substances for more than 24 hours without any visible changes:

2-ethylene-hexane acid	Kerosene
Acetone	Methanol
Ammonia solution (relative density 0.9)	Sodium carbonate <20 %
Ammonia solution <10 %	Sodium hypochlorite <10 %
Cotton seed oil	Sodium hydroxide <48 %
Benzol	Olive oil
Hydrochloric acid <35 %	Oleic acid
Distilled water	Nitric acid (specific density 1.42)
Dichloromethane	Nitric acid <40%
Diethyl ether	Salt water
Diisobutylene	Sulfuric acid (specific density 1.84)
Dimethylformamide	Sulfuric acid <30 %
Pure acetic acid (relative density 1.05)	Tetrachloromethane
Acetic acid	Toluene
Ethyl acetate	Hydrogen peroxide <28 %
Ethanol	Citric acid
Isoproponal	–





**Solvent  
resistance for  
Autotex F157**

Autotex F157 is used to cover the membrane keypad.

**Compatible substances**

In accordance with DIN 42 115 part 2, Autotex F157 can be exposed to the following substances for more than 24 hours without any visible changes:

1.1.1. Trichloroethane (Genklene)	Isophorone
Acetaldehyde	Isopropanol
Acetone	Potassium ferrocyanide / Ferrocyanide
Acetonitrile	Potassium hydroxide <30 %
Aliphatic hydrocarbon	Potassium carbonate
Alkali carbonate	Linseed oil
Formic acid <50 %	Hydrogen peroxide
Ammonia <40 %	Methanol
Amyl acetate	Methyl ethyl ketone
Gasoline	MIBK
Bichromate	Sodium bisulphate
Butyl cellosolve	Sodium carbonate
Hydrochloric acid <36 %	Sodium hypochlorite <20 % (bleach)
Cyclohexanol	Sodium hydroxide <40 %
Cyclohexanone	n-butyl acetate
Decontaminated	Paraffin oil
Diacetone alcohol	Phosphoric acid <30 %
Dibutyl phthalate	Nitric acid <10 %
Diesel oil	Salt water
Diethyl ether	Cutting oil
Diocetyl phthalate	Sulfuric acid <10 %
Dioxan	Silicone oil
Dowanol DRM / PM	Teepol
Ferric chloride	White spirit
Ferrous chlorine	Test gasoline
Acetic acid	Toluene
Ethanol	Triacetin
Ether	Trichloroacetic acid <50 %
Ethyl acetate	Universal brake fluid
Aviation gasoline	Washing powder
Formaldehyde 37 % ... 42 %	Water
Blown castor oil	Fabric softener
Glycerin	Xylol
Glycol	–

Autotex did not show any noticeable changes after being exposed to pure acetic acid for less than one hour in accordance with DIN 42 115 part 2.

**Harmful substances**

	<b>STOP</b>
	<p>Autotex is not resistant against high pressure vapor higher than 100 °C or against the following substances:</p> <ul style="list-style-type: none"> <li>• Benzyl alcohol</li> <li>• Dichloromethane</li> <li>• Concentrated alkaline solutions</li> <li>• Concentrated mineral acids</li> </ul>

**Substances that do not change colors**

The following substances do not cause materials to change color during exposure over a 24 hour period at a temperature of 50°C:

Ajax	Lenor
Ariel (laundry detergent)	Milk
Domestos	Persil (laundry detergent)
Downey	Top Job
Fantastic	Grape juice
Formula 409	Vim (cleansing agent)
Gumption	Vortex
Jet Dry	Windex
Coffee	Wisk

**Substances that may change colors**

Closer examination showed slight discolorations due to contact with the following substances:

Mustard
Ketchup
Tomato juice
Lemon juice

	<b>NOTE</b>
	<p>As with all polyester-based films, Autotex F157 is not suited for use in direct sunlight for longer periods.</p>



## 11.2 Updating the operator terminal

The operator terminal is equipped with a system program (operating system) stored in the terminal memory.

This system program can be replaced by a newer version via PC or external memory card. Not available for DOP11B-10 and -15. See also the section "Downloading system programs in DOP11B-10 and -15" on page 324.

### 11.2.1 Downloading the system program via PC

HMI-Builder is used to download system programs to the operator terminal via a PC. The transfer can take place via serial interface or ETHERNET. A PCS11B cable should be used as the serial connection. A crossed CAT5 cable can be used as the ETHERNET connection.

The following prerequisites must be fulfilled when transferring the system program to the operator terminal via PC:

PC with HMI-Builder

Connection cable between PC and operator terminal

File containing the new system program (OPSys\_b\*.cab)



#### NOTE

Ensure that the power supply is not interrupted during the transfer.

#### Preparation

##### Via serial connection

1. Connect the PCS11B connection cable to the PC and operator terminal.
2. Open a project or create a new one with the required operator terminal type.
3. Choose [Transfer] / [Update operator terminal system program].

No settings are required in the operator terminal.

Under [Options] / [Communication properties], enter the port for the data transfer and the transfer speed.

##### Via ETHERNET

1. Connect the PC and operator terminal using the connection cable.
2. Enter a valid IP address for the operator terminal.
3. Open a project or create a new one with the required operator terminal type.
4. Choose [Transfer] / [Update operator terminal system program].
5. Choose [Settings] / [Use TCP/IP transfer].



#### 11.2.2 Downloading a system program via an external memory card

1. Save the system program file (OPSys\_b\*.cab) in the master directory of the external compact Flash memory card or the USB Flash drive.
2. Insert the memory card into the operator terminal or connect the USB Flash drive and start the operator terminal to update the system program automatically.

	<b>NOTE</b>
	Compact Flash cards are only supported by DOP11B-50.

#### 11.2.3 Downloading system programs in DOP11B-10 und -15

The Software Image Loader is used to download system programs to the operator terminal via a PC. Image Loader is available to download on the website. Transfer takes place via PCS11B cable using the serial interface.

The following items are required to update the system program on the operator terminal:

- A PC with the "Image Loader" software
- A PCS11B cable

#### **Preparation**

1. Double-click the EXE file Image Loader to run it. Proceed as follows:
2. Connect the PCS11B connection cable to the PC and operator terminal.
3. Disconnect the power supply to the operator terminal.
4. Set the operator terminal to the image load mode by switching the operating mode switch 2 to ON.
5. Switch the supply voltage back on.
6. All operator terminals connected to the PC with COM connections and in image load mode are displayed in a drop-down list. Choose the operator terminal that you want to update using the MAC address (hex).
7. Click on Upgrade (update).
8. Once the update is complete, disconnect the power supply to the operator terminal again. Return operating mode switch 2 to the OFF position.
9. Switch the power supply to the operator terminal back on.



### 11.3 Changing the battery

	<b>NOTE</b>
	<ul style="list-style-type: none"> <li>• Make sure there is sufficient ESD protection.</li> <li>• Make a backup copy of the operator terminal project; see the section "Transfer properties" on page 186.</li> </ul>

#### 11.3.1 DOP11B-20, -25, -30 and -40

You require:

- Lithium battery, CR2450, 550 mAh

#### Procedure

1. Disconnect the operator terminal.
2. Open the battery compartment.

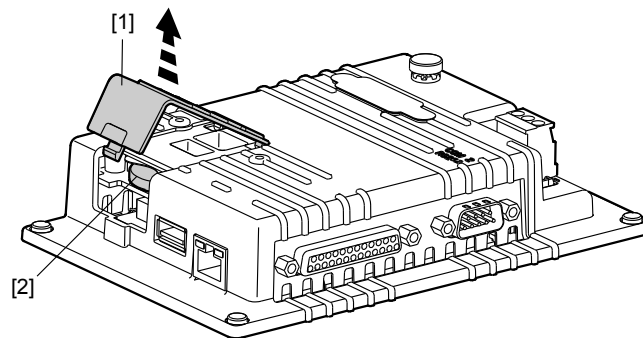

63847AXX

- [1] Battery compartment  
[2] Battery

3. Do not use conductive tongs to remove the battery.
4. Insert a new battery.
5. Close the battery compartment.

	<b>NOTE</b>
	<p>You should recycle the lithium battery.</p>



#### 11.3.2 DOP11B-50 and -60

You require:

- Lithium battery, CR2450, 550 mAh
- Hot-melt gun: Jet-Melt TCQ, manufacturer: 3M
- Hot-melt adhesive: 3748 V-O, manufacturer: 3M

#### Procedure

1. Disconnect the operator terminal.
2. Remove the rear cover of the operator terminal by loosening the four Torx screws.

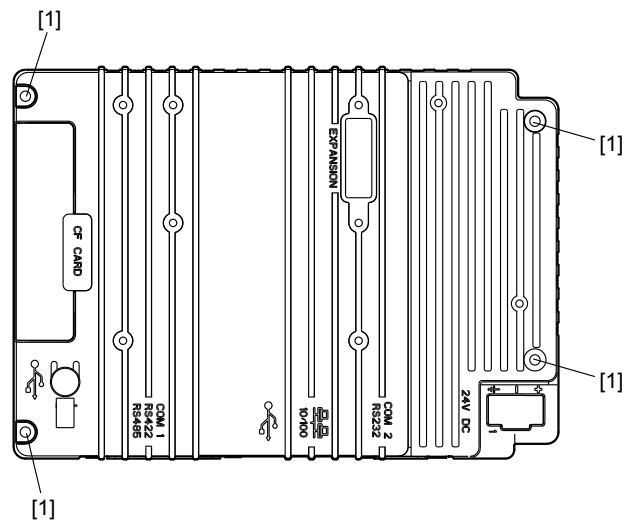

63848AXX

[1] Torx screws

3. Turn the cover over (the CPU board and battery are located on the rear).

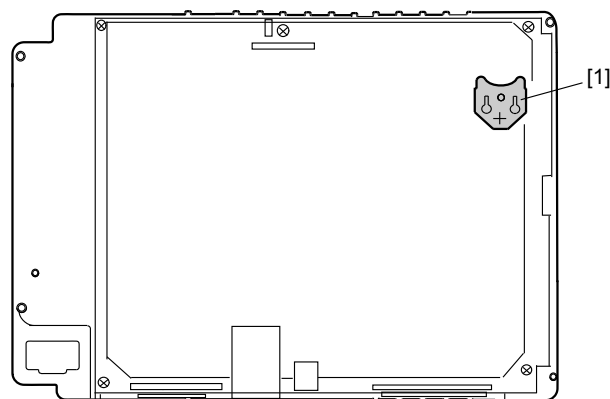

63849AXX

[1] Battery holder



4. If the battery is fixed in place with a hot-melt adhesive, remove it before removing the battery carefully from the battery holder.
5. Carefully insert a new battery into the battery holder. The plus sign on the battery must be aligned with the plus sign on the holder.
6. Fix the battery in place using a hot-melt adhesive.
7. Reassemble the operator terminal in the reverse order.

	<b>NOTE</b>
	You should recycle the lithium battery.

## 11.4 Troubleshooting

The following error list will help you diagnose errors that occur in the operator terminal.

Scenario	Error diagnosis
<ul style="list-style-type: none"> <li>• The operator terminal is not working properly.</li> <li>• The operation LED is not illuminated.</li> </ul>	<ol style="list-style-type: none"> <li>1. Check the voltage</li> <li>2. Is enough current being supplied?</li> <li>3. Check the fuse</li> <li>4. Check the power card</li> <li>5. Is the power card installed correctly?</li> </ol>
No communication between operator terminal and controller.	<ol style="list-style-type: none"> <li>1. Check the communication cable between the devices.</li> <li>2. Check whether the operator terminal has downloaded a controller driver.</li> <li>3. Check whether the right controller driver is being used.</li> <li>4. Check the communication connections on the CPU board.</li> </ol>
The operator terminal is in operation, but the backlighting does not work.	<ol style="list-style-type: none"> <li>1. Check the attenuation of the backlighting.</li> <li>2. Check whether the backlighting is connected to the power card.</li> <li>3. Replace the backlighting</li> <li>4. Check DC / AC on the power card.</li> </ol>
The operator terminal is not working, the backlighting is off, but the operation LED is illuminated.	<ol style="list-style-type: none"> <li>1. Check the attenuation of the backlighting.</li> <li>2. Check the CPU board for scorched components.</li> <li>3. Download new firmware to the operator terminal.</li> </ol>
The operator terminal is not equipped with the latest firmware.	<ol style="list-style-type: none"> <li>1. Check the version used by the operator terminal.</li> <li>2. Save a copy of the project on the computer.</li> <li>3. Use the Image Loader to download an update and follow the instructions.</li> </ol>
The operator terminal is in operation, but one or more keys do not work.	<ol style="list-style-type: none"> <li>1. Check whether the power cable is connected correctly.</li> <li>2. Replace front section.</li> </ol>
The touchscreen works either poorly or not at all.	<ol style="list-style-type: none"> <li>1. Reset the touchscreen.</li> <li>2. Check whether the power cable is connected correctly.</li> <li>3. Replace the display screen of the operator terminal.</li> <li>4. Check the touchscreen interface on the power card.</li> </ol>
Lines on the display panel are the wrong color or the display is displaced.	<ol style="list-style-type: none"> <li>1. Check whether the display panel has a wide vertical or horizontal area. It should be at least 2-3 cm wide and gray or black.</li> <li>2. Check whether the cable for the display panel is connected correctly.</li> <li>3. The display panel cable should not be bent or damaged in any way. If it shows signs of damage, it must be replaced.</li> </ol>
The operator terminal does not start after a component has been replaced.	Remove the battery and replace it (applies only to DOP11B-20 to -40).
Battery is weak / no battery	<ol style="list-style-type: none"> <li>1. Check whether the battery is sitting correctly in the battery holder.</li> <li>2. If the battery is weak / empty, it must be replaced (see the section "Changing the battery" on page 325.)</li> </ol>



## A

Access.....	139, 182
Accessories.....	24
Activate .....	248
Addressing parameters and variables.....	75
Alarm	
<i>Alarm banner</i> .....	208
<i>Management</i> .....	201
Alarm banner.....	163
Alarm import.....	207
Alarm management.....	201, 301
Alarm properties.....	205
ALARMS .....	279
Alarms	
<i>Alarm groups</i> .....	201
<i>Alarms</i> .....	202
<i>Defining alarm groups</i> .....	201
<i>Graphic alarm page</i> .....	210
<i>Import</i> .....	207
<i>Properties</i> .....	205
<i>Send by e-mail</i> .....	283
Alphanumeric keypad.....	179
Alphanumeric keys.....	45
Analog clock graphic objects.....	165
Analog fill graphic objects .....	164
Analog graphic objects.....	146
Analog numeric object.....	152
Analog numeric table graphic object.....	172
Append recipes .....	216
Application language.....	235
Application languages in run mode.....	237
Arrow keys .....	46
ASCII objects .....	157
Assembly.....	13

## B

Bar chart graphic object .....	153
Basic unit connection .....	31
BDTP.....	272
BDTP client.....	273
BDTP server.....	275, 276
BDTP station change .....	111
Block .....	66
<i>Create (using the block manager)</i> .....	89
<i>Define</i> .....	90
<i>Program</i> .....	97
<i>Properties</i> .....	91
Block list.....	115
Block manager .....	116, 130
<i>Settings</i> .....	131
Boot error .....	59

## C

Cable.....	318
<i>PCS11B</i> .....	318
<i>PCS22A</i> .....	319

## Cable specification

<i>ETHERNET</i> .....	37
<i>RS-485</i> .....	34
Calculate recipe size .....	212
Calculating technical units.....	136, 181
Calculating the trend data size .....	242
CGI script .....	291
Change project settings .....	87
Change the controller.....	87
Change the terminal.....	87
Changing the battery.....	325
Choose language .....	83
Communication with 2 controllers .....	250
Communication with MOVIDRIVE® and MOVITRAC® 07.....	69
<i>Addressing parameters and variables</i> .....	75
<i>Communication settings in the     HMI-Builder</i> .....	70
<i>Communication with inverters     in the RS-485 network</i> .....	76
<i>Indexed communication with     inverters in the RS-485 network</i> ..	79
<i>Serial connection between o     perator terminal and inverter</i> .....	69
Communication, effective .....	63
Configuration mode (SETUP) .....	49
Configuration tool .....	295
Connection to a PC .....	32
Connection to SEW frequency inverters .....	12
Connection, ETHERNET.....	265
Connection, serial .....	69
Control.....	12
Control codes for the printer.....	229
Control, graphic.....	135
Copyright .....	6
Country settings .....	124
Create a project.....	62
Create and transfer recipes using the controller program .....	218
Create recipes on the terminal .....	215
Creating projects	
<i>Blocks</i> .....	66
<i>Effective communication</i> .....	63
<i>Menu structure</i> .....	65
<i>Programming a project</i> .....	62
<i>Signal formats</i> .....	66

## D

Data exchange between controllers .....	251
Data logger.....	249
Define printouts .....	226
Define time channels.....	229
Defining security levels .....	222
Delete recipes .....	216
Diagram graphic object .....	154
Digital clock graphic object.....	166
Digital fill graphic object .....	149





Digital graphic objects .....	145	Graphic block manager .....	98
Digital symbol graphic object .....	148	<i>Create objects</i> .....	100
Digital text graphic object .....	147	<i>Create tables</i> .....	104
Dimension drawing		<i>Cursor</i> .....	98
<i>DOP11B-10</i> .....	310	<i>Group objects</i> .....	103
<i>DOP11B-15</i> .....	311	<i>Keys</i> .....	98
<i>DOP11B-20</i> .....	312	<i>Mouse</i> .....	98
<i>DOP11B-25</i> .....	313	<i>Open</i> .....	98
<i>DOP11B-30</i> .....	313	<i>Position objects</i> .....	101
<i>DOP11B-40</i> .....	314	<i>Select several objects</i> .....	100
<i>DOP11B-50</i> .....	315	<i>Symbols</i> .....	105
<i>DOP11B-60</i> .....	316	Graphic display and control .....	135
Directory		Graphic objects .....	144
<i>ALARMS</i> .....	279	<i>Alarm banner</i> .....	163
<i>HTML</i> .....	279	<i>Analog clock</i> .....	165
<i>IMAGES</i> .....	281	<i>Analog fill</i> .....	164
<i>TRENDS</i> .....	280	<i>Analog numeric</i> .....	152
Display .....	304	<i>Analog numeric table</i> .....	172
Display, graphic .....	135	<i>ASCII</i> .....	157
DOP11B-10, unit design .....	16	<i>Bar chart</i> .....	153
DOP11B-15, unit design .....	17	<i>Diagram</i> .....	154
DOP11B-20, unit design .....	18	<i>Digital clock</i> .....	166
DOP11B-25, unit design .....	19	<i>Digital fill</i> .....	149
DOP11B-30, unit design .....	20	<i>Digital symbol</i> .....	148
DOP11B-40, unit design .....	21	<i>Digital text</i> .....	147
DOP11B-50, unit design .....	22	<i>Dynamic analog</i> .....	146
DOP11B-60, unit design .....	23	<i>Dynamic bitmap management</i> .....	145
Driver update		<i>Dynamic digital</i> .....	145
<i>From disk</i> .....	86	<i>Jump</i> .....	151
Dynamic text objects .....	183	<i>Message</i> .....	171
Dynamics .....	140	<i>Multiple selection</i> .....	168
<b>E</b>		<i>Multiple symbol</i> .....	167
Error list .....	60	<i>Slider</i> .....	158
Error messages .....	59	<i>Speedometer</i> .....	161
ETHERNET .....	41	<i>Static / dynamic</i> .....	144
ETHERNET 10 Base T (option card) .....	309	<i>Touch key</i> .....	168
ETHERNET connection .....	37	<i>Trend</i> .....	159
ETHERNET connections .....	265	<i>VU-meter</i> .....	156
ETHERNET, Network communication .....	263	<b>H</b>	
Exclusion of liability .....	6	HMI-Builder	
<b>F</b>		<i>Choose a language</i> .....	83
Fault information .....	59	<i>Communication settings</i> .....	70
Font .....	138	<i>Create a project</i> .....	84
Frequency inverter, connection .....	12	<i>Description</i> .....	67
FTP server .....	276	<i>Installation</i> .....	67
Function keys .....	238	<i>Menu</i> .....	68
<i>Define</i> .....	95, 239	<i>Start</i> .....	83
<i>Global</i> .....	239	<i>Status bar</i> .....	68
<i>Integrated</i> .....	46	<i>System prerequisites</i> .....	67
<i>Jump to block</i> .....	242	<i>Update driver</i> .....	86
<i>Local</i> .....	239	HTML directory .....	279
Functions, terminal .....	45	<b>I</b>	
<b>G</b>		I/O browser .....	96
General parameters .....	135, 181	I/O change .....	110
		I/O cross reference .....	111



IMAGES directory .....	281	<i>Layout</i> .....	133
Index addressing .....	195	<i>Name list</i> .....	116
Index in the network client .....	301	<i>Object</i> .....	132
Initial operation .....	44	<i>Setup</i> .....	120
Installation .....	26	<i>Transfer</i> .....	134
<i>UL-compliant</i> .....	27	<i>View</i> .....	115
Installation, HMI-Builder .....	67	<i>Window</i> .....	134
Installing drivers .....	86	Message graphic object .....	171
Integrated function keys .....	46	Message library .....	199
Introduction .....	10	Modem	
Inverter		<i>Connect</i> .....	260
<i>Communication in the RS-485 network</i> ...	76	<i>Settings</i> .....	192
<i>Indexed communication in the</i>		<i>Transfer</i> .....	192
<i>RS-485 network</i> .....	79	Multi-lingual functions .....	124
<b>J</b>		Multiple selection graphic object .....	168
Joystick functions .....	51	Multiple symbol graphic object .....	167
Jump object .....	151	<b>N</b>	
<b>L</b>		Name list .....	116
Label		Nameplate .....	15
<i>DOP11B-10 to DOP11B-40</i> .....	317	Network accounts .....	302
<i>DOP11B-50 and DOP11B-60</i> .....	317	Network communication .....	262
Language index .....	236	<i>FTP server</i> .....	276
Language management .....	230	<i>Limitations</i> .....	299
<i>Application</i> .....	231	<i>Recommendations</i> .....	299
<i>Cross reference</i> .....	236	<i>Serial</i> .....	267
<i>Display index</i> .....	236	<i>SMTP client</i> .....	281
<i>Reuse index</i> .....	236	<i>Via ETHERNET</i> .....	263
<i>Unicode</i> .....	237	Network services .....	271
LEDs .....	238	Network settings .....	303
<i>Define</i> .....	95	No protocol mode .....	256, 300
Library		<b>O</b>	
<i>Master library</i> .....	278	Operate graphic blocks .....	174
<i>RECIPE</i> .....	279	Operate text blocks .....	184
Linking blocks with alarms .....	209	Operating display at unit start .....	58
Login .....	223	Operating errors .....	60
<b>M</b>		Operating modes (RUN and SETUP) .....	49
Macros .....	246, 248	Option card	
<i>Add</i> .....	246	<i>ETHERNET 10 Base T</i> .....	309
<i>Edit</i> .....	248	Options .....	24
Maneuverable objects .....	174	Options, Terminal .....	126
<i>Analog objects</i> .....	174	<b>P</b>	
<i>Digital objects</i> .....	174	Pass-through mode .....	254
<i>Select</i> .....	174	Pass-through mode via ETHERNET .....	300
Master library .....	278	Passwords .....	222
Membrane keyboard .....	320	<i>Change during operation</i> .....	224
Memory card .....	190	<i>Define</i> .....	223
Menu		<i>For transferring projects</i> .....	224
<i>Block list</i> .....	115	<i>Multi-access</i> .....	224
<i>Block manager</i> .....	116, 130	PCM11A .....	40
<i>Edit</i> .....	114	PCS11B .....	318
<i>File</i> .....	113	PCS22A .....	319
<i>Functions</i> .....	119	Peripherals .....	128
<i>Help</i> .....	134		
<i>I/O cross reference</i> .....	116		



Pin assignment.....	308	Run mode (RUN) .....	49
<i>RS-232</i> .....	308	<b>S</b>	
<i>RS-422</i> .....	308	Safety functions.....	8
<i>RS-485</i> .....	308	Safety notes .....	7
Ports.....	296	Saving HTML files via FTP .....	294
Printer		Scaling for technical units .....	136, 181
<i>Connection</i> .....	225	Scope of delivery.....	15
<i>Control codes</i> .....	229	Send alarms by e-mail .....	283
<i>Properties</i> .....	227	Send e-mails via system block.....	285
<i>Status</i> .....	229	Send reports by e-mail .....	284
Printer connection .....	225	Serial connection.....	69
Printer properties.....	227	Serial network communication .....	267
Printer status.....	229	Serial transfer .....	190
Printing graphic blocks .....	226	Service .....	61
Printing projects .....	225	Set up a communication port .....	228
Printing text blocks .....	225	Setting up the operator terminal .....	13
Programming.....	12, 62	Show terminal .....	95
Programming software		Siemens S7 connection via MPI .....	40
<i>Choose language</i> .....	83	Signal formats .....	66
<i>Create a project</i> .....	84	Signal packages .....	300
<i>Description</i> .....	67	Slider graphic object.....	158
<i>Installation</i> .....	67	SMTP client.....	281
<i>Menu</i> .....	68	Speedometer graphic object .....	161
<i>Starting the HMI-Builder</i> .....	83	SSI script.....	289
<i>Status bar</i> .....	68	Startup.....	42
<i>Update driver</i> .....	86	Status display.....	12
Project		Switches .....	47
<i>Change settings</i> .....	87	Symbols	
<i>Create</i> .....	84	<i>Create</i> .....	105
<i>Print</i> .....	225	System monitor .....	248
<i>Transfer</i> .....	54, 185	System signals .....	120
Projekt erstellen		<b>T</b>	
<i>Effektive Kommunikation</i> .....	63	TCP/IP transfer .....	189
Properties, block .....	91	Technical data .....	304
<b>R</b>		<i>Communication</i> .....	307
Recipe directory .....	214	<i>Display</i> .....	304
<i>In run mode</i> .....	214	<i>Functions</i> .....	307
Recipe library RECIPE.....	279	<i>General</i> .....	305
Recipe management.....	210	Terminal controller .....	286
<i>Append</i> .....	216	Terminal keypad.....	45
<i>Calculate recipe size</i> .....	212	Terminal options.....	126
<i>Create</i> .....	215	Text	
<i>Delete</i> .....	216	<i>Digital text object</i> .....	147
<i>Per controller program</i> .....	218	Text block manager	
<i>Transfer</i> .....	216	<i>Define</i> .....	109
Recipe settings.....	213	<i>Keys</i> .....	108
Remote access .....	294	<i>Mouse</i> .....	108
Repair.....	61	<i>Open</i> .....	108
Reserved characters .....	46	<i>Toolbox</i> .....	109
Right to claim under limited warranty .....	6	Text objects, dynamic .....	183
RS-232 connection.....	36		
RS-485			
<i>Communication with inverters</i> .....	76		
<i>Indexed communication with inverters</i> ....	79		
RS-485 / MPI.....	40		
RS-485 connection.....	33		



Text strips	
<i>DOP11B-10</i> .....	310
<i>DOP11B-15</i> .....	311
<i>DOP11B-20</i> .....	312
<i>DOP11B-40</i> .....	314
Text-based display and control .....	180
Time control .....	229
Toolbox	
<i>Text block manager</i> .....	109
Touch key graphic object .....	168
Touchscreen .....	177
Transfer project .....	54
Transfer properties, Projects .....	186
Transfer recipes to the controller .....	216
Transfer trend data .....	244
Transfer, Modem .....	192
Transfer, Serial .....	190
Transfer, TCP/IP .....	189
Transferring projects .....	185
<i>Transfer properties</i> .....	186
Transparent mode .....	252, 286
Transparent mode via ETHERNET .....	300
Trends .....	242
<i>Calculating the trend data size</i> .....	242
<i>Development</i> .....	242
<i>Trend files</i> .....	244
<i>Trend objects</i> .....	159, 243
TRENDS directory .....	280
Troubleshooting .....	327
Two drivers .....	250
<b>U</b>	
UL-compliant installation .....	27
Unit designation .....	15
Update the system program .....	323
Updating drivers	
<i>From the Internet</i> .....	86
User-defined system language .....	235
Using dynamic bitmaps .....	145
Using the terminal as a communication interface	
256	
UWS11A connection .....	36
<b>V</b>	
Voltage supply .....	31
VU-meter graphic object .....	156
<b>W</b>	
Waste disposal .....	6
Web server .....	287



## Address List

Germany				
<b>Headquarters Production Sales</b>	<b>Bruchsal</b>	SEW-EURODRIVE GmbH & Co KG Ernst-Blickle-Straße 42 D-76646 Bruchsal P.O. Box Postfach 3023 • D-76642 Bruchsal	Tel. +49 7251 75-0 Fax +49 7251 75-1970 <a href="http://www.sew-eurodrive.de">http://www.sew-eurodrive.de</a> <a href="mailto:sew@sew-eurodrive.de">sew@sew-eurodrive.de</a>	
<b>Service Competence Center</b>	<b>Central</b>	SEW-EURODRIVE GmbH & Co KG Ernst-Blickle-Straße 1 D-76676 Graben-Neudorf	Tel. +49 7251 75-1710 Fax +49 7251 75-1711 <a href="mailto:sc-mitte@sew-eurodrive.de">sc-mitte@sew-eurodrive.de</a>	
	<b>North</b>	SEW-EURODRIVE GmbH & Co KG Alte Ricklinger Straße 40-42 D-30823 Garbsen (near Hannover)	Tel. +49 5137 8798-30 Fax +49 5137 8798-55 <a href="mailto:sc-nord@sew-eurodrive.de">sc-nord@sew-eurodrive.de</a>	
	<b>East</b>	SEW-EURODRIVE GmbH & Co KG Dänkritzter Weg 1 D-08393 Meerane (near Zwickau)	Tel. +49 3764 7606-0 Fax +49 3764 7606-30 <a href="mailto:sc-ost@sew-eurodrive.de">sc-ost@sew-eurodrive.de</a>	
	<b>South</b>	SEW-EURODRIVE GmbH & Co KG Domagkstraße 5 D-85551 Kirchheim (near München)	Tel. +49 89 909552-10 Fax +49 89 909552-50 <a href="mailto:sc-sued@sew-eurodrive.de">sc-sued@sew-eurodrive.de</a>	
	<b>West</b>	SEW-EURODRIVE GmbH & Co KG Siemensstraße 1 D-40764 Langenfeld (near Düsseldorf)	Tel. +49 2173 8507-30 Fax +49 2173 8507-55 <a href="mailto:sc-west@sew-eurodrive.de">sc-west@sew-eurodrive.de</a>	
	<b>Electronics</b>	SEW-EURODRIVE GmbH & Co KG Ernst-Blickle-Straße 42 D-76646 Bruchsal	Tel. +49 7251 75-1780 Fax +49 7251 75-1769 <a href="mailto:sc-elektronik@sew-eurodrive.de">sc-elektronik@sew-eurodrive.de</a>	
	<b>Drive Service Hotline / 24 Hour Service</b>			+49 180 5 SEWHELP +49 180 5 7394357
	Additional addresses for service in Germany provided on request!			
France				
<b>Production Sales Service</b>	<b>Hagenau</b>	SEW-USOCOME 48-54, route de Soufflenheim B. P. 20185 F-67506 Hagenau Cedex	Tel. +33 3 88 73 67 00 Fax +33 3 88 73 66 00 <a href="http://www.usocome.com">http://www.usocome.com</a> <a href="mailto:sew@usocome.com">sew@usocome.com</a>	
<b>Production</b>	<b>Forbach</b>	SEW-EUROCOME Zone Industrielle Technopôle Forbach Sud B. P. 30269 F-57604 Forbach Cedex	Tel. +33 3 87 29 38 00	
<b>Assembly Sales Service</b>	<b>Bordeaux</b>	SEW-USOCOME Parc d'activités de Magellan 62, avenue de Magellan - B. P. 182 F-33607 Pessac Cedex	Tel. +33 5 57 26 39 00 Fax +33 5 57 26 39 09	
	<b>Lyon</b>	SEW-USOCOME Parc d'Affaires Roosevelt Rue Jacques Tati F-69120 Vaulx en Velin	Tel. +33 4 72 15 37 00 Fax +33 4 72 15 37 15	
	<b>Paris</b>	SEW-USOCOME Zone industrielle 2, rue Denis Papin F-77390 Verneuil l'Etang	Tel. +33 1 64 42 40 80 Fax +33 1 64 42 40 88	
Additional addresses for service in France provided on request!				



## Address List

Algeria			
<b>Sales</b>	<b>Alger</b>	Réducom 16, rue des Frères Zagnoun Bellevue El-Harrach 16200 Alger	Tel. +213 21 8222-84 Fax +213 21 8222-84 reducom_sew@yahoo.fr
Argentina			
<b>Assembly Sales Service</b>	<b>Buenos Aires</b>	SEW EURODRIVE ARGENTINA S.A. Centro Industrial Garin, Lote 35 Ruta Panamericana Km 37,5 1619 Garin	Tel. +54 3327 4572-84 Fax +54 3327 4572-21 sewar@sew-eurodrive.com.ar http://www.sew-eurodrive.com.ar
Australia			
<b>Assembly Sales Service</b>	<b>Melbourne</b>	SEW-EURODRIVE PTY. LTD. 27 Beverage Drive Tullamarine, Victoria 3043	Tel. +61 3 9933-1000 Fax +61 3 9933-1003 http://www.sew-eurodrive.com.au enquires@sew-eurodrive.com.au
	<b>Sydney</b>	SEW-EURODRIVE PTY. LTD. 9, Sleigh Place, Wetherill Park New South Wales, 2164	Tel. +61 2 9725-9900 Fax +61 2 9725-9905 enquires@sew-eurodrive.com.au
Austria			
<b>Assembly Sales Service</b>	<b>Wien</b>	SEW-EURODRIVE Ges.m.b.H. Richard-Strauss-Strasse 24 A-1230 Wien	Tel. +43 1 617 55 00-0 Fax +43 1 617 55 00-30 http://sew-eurodrive.at sew@sew-eurodrive.at
Belarus			
<b>Sales</b>	<b>Minsk</b>	SEW-EURODRIVE BY RybalkoStr. 26 BY-220033 Minsk	Tel.+375 (17) 298 38 50 Fax +375 (17) 29838 50 sales@sew.by
Belgium			
<b>Assembly Sales Service</b>	<b>Brüssel</b>	<b>SEW Caron-Vector</b> Avenue Eiffel 5 B-1300 Wavre	Tel. +32 10 231-311 Fax +32 10 231-336 http://www.sew-eurodrive.be info@caron-vector.be
<b>Service Competence Center</b>	<b>Industrial Gears</b>	<b>SEW Caron-Vector</b> Rue de Parc Industriel, 31 BE-6900 Marche-en-Famenne	Tel. +32 84 219-878 Fax +32 84 219-879 http://www.sew-eurodrive.be service-wallonie@sew-eurodrive.be
	<b>Antwerp</b>	<b>SEW Caron-Vector</b> Glasstraat, 19 BE-2170 Merksem	Tel. +32 3 64 19 333 Fax +32 3 64 19 336 http://www.sew-eurodrive.be service-antwerpen@sew-eurodrive.be
Brazil			
<b>Production Sales Service</b>	<b>Sao Paulo</b>	SEW-EURODRIVE Brasil Ltda. Avenida Amâncio Gaiolli, 152 - Rodovia Presidente Dutra Km 208 Guarulhos - 07251-250 - SP SAT - SEW ATENDE - 0800 7700496	Tel. +55 11 2489-9133 Fax +55 11 2480-3328 http://www.sew-eurodrive.com.br sew@sew.com.br
Additional addresses for service in Brazil provided on request!			
Bulgaria			
<b>Sales</b>	<b>Sofia</b>	BEVER-DRIVE GmbH Bogdanovetz Str.1 BG-1606 Sofia	Tel. +359 2 9151160 Fax +359 2 9151166 bever@fastbg.net



Cameroon			
<b>Sales</b>	<b>Douala</b>	Electro-Services Rue Drouot Akwa B.P. 2024 Douala	Tel. +237 33 431137 Fax +237 33 431137
Canada			
<b>Assembly Sales Service</b>	<b>Toronto</b>	SEW-EURODRIVE CO. OF CANADA LTD. 210 Walker Drive Bramalea, Ontario L6T3W1	Tel. +1 905 791-1553 Fax +1 905 791-2999 <a href="http://www.sew-eurodrive.ca">http://www.sew-eurodrive.ca</a> <a href="mailto:marketing@sew-eurodrive.ca">marketing@sew-eurodrive.ca</a>
	<b>Vancouver</b>	SEW-EURODRIVE CO. OF CANADA LTD. 7188 Honeyman Street Delta. B.C. V4G 1 E2	Tel. +1 604 946-5535 Fax +1 604 946-2513 <a href="mailto:marketing@sew-eurodrive.ca">marketing@sew-eurodrive.ca</a>
	<b>Montreal</b>	SEW-EURODRIVE CO. OF CANADA LTD. 2555 Rue Leger LaSalle, Quebec H8N 2V9	Tel. +1 514 367-1124 Fax +1 514 367-3677 <a href="mailto:marketing@sew-eurodrive.ca">marketing@sew-eurodrive.ca</a>
Additional addresses for service in Canada provided on request!			
Chile			
<b>Assembly Sales Service</b>	<b>Santiago de Chile</b>	SEW-EURODRIVE CHILE LTDA. Las Encinas 1295 Parque Industrial Valle Grande LAMP RCH-Santiago de Chile P.O. Box Casilla 23 Correo Quilicura - Santiago - Chile	Tel. +56 2 75770-00 Fax +56 2 75770-01 <a href="http://www.sew-eurodrive.cl">http://www.sew-eurodrive.cl</a> <a href="mailto:ventas@sew-eurodrive.cl">ventas@sew-eurodrive.cl</a>
China			
<b>Production Assembly Sales Service</b>	<b>Tianjin</b>	SEW-EURODRIVE (Tianjin) Co., Ltd. No. 46, 7th Avenue, TEDA Tianjin 300457	Tel. +86 22 25322612 Fax +86 22 25322611 <a href="mailto:info@sew-eurodrive.cn">info@sew-eurodrive.cn</a> <a href="http://www.sew-eurodrive.cn">http://www.sew-eurodrive.cn</a>
	<b>Suzhou</b>	SEW-EURODRIVE (Suzhou) Co., Ltd. 333, Suhong Middle Road Suzhou Industrial Park Jiangsu Province, 215021	Tel. +86 512 62581781 Fax +86 512 62581783 <a href="mailto:suzhou@sew-eurodrive.cn">suzhou@sew-eurodrive.cn</a>
	<b>Guangzhou</b>	SEW-EURODRIVE (Guangzhou) Co., Ltd. No. 9, JunDa Road East Section of GETDD Guangzhou 510530	Tel. +86 20 82267890 Fax +86 20 82267891 <a href="mailto:guangzhou@sew-eurodrive.cn">guangzhou@sew-eurodrive.cn</a>
	<b>Shenyang</b>	SEW-EURODRIVE (Shenyang) Co., Ltd. 10A-2, 6th Road Shenyang Economic Technological Development Area Shenyang, 110141	Tel. +86 24 25382538 Fax +86 24 25382580 <a href="mailto:shenyang@sew-eurodrive.cn">shenyang@sew-eurodrive.cn</a>
	<b>Wuhan</b>	SEW-EURODRIVE (Wuhan) Co., Ltd. 10A-2, 6th Road No. 59, the 4th Quanli Road, WEDA 430056 Wuhan	Tel. +86 27 84478398 Fax +86 27 84478388
Additional addresses for service in China provided on request!			
Colombia			
<b>Assembly Sales Service</b>	<b>Bogotá</b>	SEW-EURODRIVE COLOMBIA LTDA. Calle 22 No. 132-60 Bodega 6, Manzana B Santafé de Bogotá	Tel. +57 1 54750-50 Fax +57 1 54750-44 <a href="http://www.sew-eurodrive.com.co">http://www.sew-eurodrive.com.co</a> <a href="mailto:sewcol@sew-eurodrive.com.co">sewcol@sew-eurodrive.com.co</a>



## Address List

Croatia			
<b>Sales Service</b>	<b>Zagreb</b>	KOMPEKS d. o. o. PIT Erdödy 4 II HR 10 000 Zagreb	Tel. +385 1 4613-158 Fax +385 1 4613-158 kompeks@inet.hr
Czech Republic			
<b>Sales</b>	<b>Praha</b>	SEW-EURODRIVE CZ S.R.O. Business Centrum Praha Lužná 591 CZ-16000 Praha 6 - Vokovice	Tel. +420 255 709 601 Fax +420 220 121 237 <a href="http://www.sew-eurodrive.cz">http://www.sew-eurodrive.cz</a> sew@sew-eurodrive.cz
Denmark			
<b>Assembly Sales Service</b>	<b>Kopenhagen</b>	SEW-EURODRIVEA/S Geminivej 28-30 DK-2670 Greve	Tel. +45 43 9585-00 Fax +45 43 9585-09 <a href="http://www.sew-eurodrive.dk">http://www.sew-eurodrive.dk</a> sew@sew-eurodrive.dk
Egypt			
<b>Sales Service</b>	<b>Cairo</b>	Copam Egypt for Engineering & Agencies 33 El Hegaz ST, Heliopolis, Cairo	Tel. +20 2 22566-299 + 1 23143088 Fax +20 2 22594-757 <a href="http://www.copam-egypt.com/">http://www.copam-egypt.com/</a> copam@datum.com.eg
<b>Service</b>	<b>Sharjah</b>	Copam Middle East (FZC) Sharjah Airport International Free Zone P.O. Box 120709 Sharjah <b>United Arab Emirates</b>	Tel. +971 6 5578-488 Fax +971 6 5578-499 copam_me@eim.ae
Estonia			
<b>Sales</b>	<b>Tallin</b>	ALAS-KUUL AS Reti tee 4 EE-75301 Peetri küla, Rae vald, Harjumaa	Tel. +372 6593230 Fax +372 6593231 veiko.soots@alas-kuul.ee
Finland			
<b>Assembly Sales Service</b>	<b>Lahti</b>	SEW-EURODRIVE OY Vesimäentie 4 FIN-15860 Hollola 2	Tel. +358 201 589-300 Fax +358 3 780-6211 sew@sew.fi <a href="http://www.sew-eurodrive.fi">http://www.sew-eurodrive.fi</a>
<b>Production Assembly Service</b>	<b>Karkkila</b>	SEW Industrial Gears Oy Valurinkatu 6, PL 8 FI-03600 Karkkila, 03601 Karkkila	Tel. +358 201 589-300 Fax +358 201 589-310 sew@sew.fi <a href="http://www.sew-eurodrive.fi">http://www.sew-eurodrive.fi</a>
Gabon			
<b>Sales</b>	<b>Libreville</b>	ESG Electro Services Gabun Feu Rouge Lalala 1889 Libreville Gabun	Tel. +241 741059 Fax +241 741059
Great Britain			
<b>Assembly Sales Service</b>	<b>Normanton</b>	SEW-EURODRIVE Ltd. Beckbridge Industrial Estate P.O. Box No.1 GB-Normanton, West- Yorkshire WF6 1QR	Tel. +44 1924 893-855 Fax +44 1924 893-702 <a href="http://www.sew-eurodrive.co.uk">http://www.sew-eurodrive.co.uk</a> info@sew-eurodrive.co.uk
Greece			
<b>Sales Service</b>	<b>Athen</b>	Christ. Boznos & Son S.A. 12, Mavromichali Street P.O. Box 80136, GR-18545 Piraeus	Tel. +30 2 1042 251-34 Fax +30 2 1042 251-59 <a href="http://www.boznos.gr">http://www.boznos.gr</a> info@boznos.gr





Hong Kong			
<b>Assembly Sales Service</b>	<b>Hong Kong</b>	SEW-EURODRIVE LTD. Unit No. 801-806, 8th Floor Hong Leong Industrial Complex No. 4, Wang Kwong Road Kowloon, Hong Kong	Tel. +852 36902200 Fax +852 36902211 contact@sew-eurodrive.hk
Hungary			
<b>Sales Service</b>	<b>Budapest</b>	SEW-EURODRIVE Kft. H-1037 Budapest Kunigunda u. 18	Tel. +36 1 437 06-58 Fax +36 1 437 06-50 office@sew-eurodrive.hu
India			
<b>Registered Office Assembly Sales Service</b>	<b>Vadodara</b>	SEW-EURODRIVE India Private Limited Plot No. 4, GIDC POR Ramangamdi • Vadodara - 391 243 Gujarat	Tel. +91 265 2831086 Fax +91 265 2831087 <a href="http://www.seweurodriveindia.com">http://www.seweurodriveindia.com</a> sales@seweurodriveindia.com subodh.ladwa@seweurodriveindia.com
<b>Assembly Sales Service</b>	<b>Chennai</b>	SEW-EURODRIVE India Private Limited Plot No. K3/1, Sipcot Industrial Park Phase II Mambakkam Village Sriperumbudur - 602105 Kancheepuram Dist, Tamil Nadu	Tel. +91 44 37188888 Fax +91 44 37188811 c.v.shivkumar@seweurodriveindia.com
Ireland			
<b>Sales Service</b>	<b>Dublin</b>	Alperton Engineering Ltd. 48 Moyle Road Dublin Industrial Estate Glasnevin, Dublin 11	Tel. +353 1 830-6277 Fax +353 1 830-6458 info@alperton.ie <a href="http://www.alperton.ie">http://www.alperton.ie</a>
Israel			
<b>Sales</b>	<b>Tel-Aviv</b>	Liraz Handasa Ltd. Ahofer Str 34B / 228 58858 Holon	Tel. +972 3 5599511 Fax +972 3 5599512 <a href="http://www.liraz-handasa.co.il">http://www.liraz-handasa.co.il</a> office@liraz-handasa.co.il
Italy			
<b>Assembly Sales Service</b>	<b>Milano</b>	SEW-EURODRIVE di R. Blickle & Co.s.a.s. Via Bernini, 14 I-20020 Solaro (Milano)	Tel. +39 02 96 9801 Fax +39 02 96 799781 <a href="http://www.sew-eurodrive.it">http://www.sew-eurodrive.it</a> sewit@sew-eurodrive.it
Ivory Coast			
<b>Sales</b>	<b>Abidjan</b>	SICA Ste industrielle et commerciale pour l'Afrique 165, Bld de Marseille B.P. 2323, Abidjan 08	Tel. +225 2579-44 Fax +225 2584-36
Japan			
<b>Assembly Sales Service</b>	<b>Iwata</b>	SEW-EURODRIVE JAPAN CO., LTD 250-1, Shimoman-no, Iwata Shizuoka 438-0818	Tel. +81 538 373811 Fax +81 538 373814 <a href="http://www.sew-eurodrive.co.jp">http://www.sew-eurodrive.co.jp</a> sewjapan@sew-eurodrive.co.jp
Korea			
<b>Assembly Sales Service</b>	<b>Ansan-City</b>	SEW-EURODRIVE KOREA CO., LTD. B 601-4, Banweol Industrial Estate 1048-4, Shingil-Dong Ansan 425-120	Tel. +82 31 492-8051 Fax +82 31 492-8056 <a href="http://www.sew-korea.co.kr">http://www.sew-korea.co.kr</a> master@sew-korea.co.kr



## Address List

Korea			
	<b>Busan</b>	SEW-EURODRIVE KOREA Co., Ltd. No. 1720 - 11, Songjeong - dong Gangseo-ku Busan 618-270	Tel. +82 51 832-0204 Fax +82 51 832-0230 master@sew-korea.co.kr
Latvia			
<b>Sales</b>	<b>Riga</b>	SIA Alas-Kuul Katlakalna 11C LV-1073 Riga	Tel. +371 7139253 Fax +371 7139386 http://www.alas-kuul.com info@alas-kuul.com
Lebanon			
<b>Sales</b>	<b>Beirut</b>	Gabriel Acar & Fils sarl B. P. 80484 Bourj Hammoud, Beirut	Tel. +961 1 4947-86 +961 1 4982-72 +961 3 2745-39 Fax +961 1 4949-71 ssacar@inco.com.lb
Lithuania			
<b>Sales</b>	<b>Alytus</b>	UAB Irseva Naujoji 19 LT-62175 Alytus	Tel. +370 315 79204 Fax +370 315 56175 info@irseva.lt http://www.sew-eurodrive.lt
Luxembourg			
<b>Assembly Sales Service</b>	<b>Brüssel</b>	CARON-VECTOR S.A. Avenue Eiffel 5 B-1300 Wavre	Tel. +32 10 231-311 Fax +32 10 231-336 http://www.sew-eurodrive.lu info@caron-vector.be
Malaysia			
<b>Assembly Sales Service</b>	<b>Johore</b>	SEW-EURODRIVE SDN BHD No. 95, Jalan Seroja 39, Taman Johor Jaya 81000 Johor Bahru, Johor West Malaysia	Tel. +60 7 3549409 Fax +60 7 3541404 sales@sew-eurodrive.com.my
Mexico			
<b>Assembly Sales Service</b>	<b>Quéretaro</b>	SEW-EURODRIVE MEXICO SA DE CV SEM-981118-M93 Tequisquiapan No. 102 Parque Industrial Quéretaro C.P. 76220 Quéretaro, México	Tel. +52 442 1030-300 Fax +52 442 1030-301 http://www.sew-eurodrive.com.mx scmexico@seweurodrive.com.mx
Morocco			
<b>Sales</b>	<b>Casablanca</b>	Afit 5, rue Emir Abdelkader MA 20300 Casablanca	Tel. +212 22618372 Fax +212 22618351 ali.alami@premium.net.ma
Netherlands			
<b>Assembly Sales Service</b>	<b>Rotterdam</b>	VECTOR Aandrijftechniek B.V. Industrieweg 175 NL-3044 AS Rotterdam Postbus 10085 NL-3004 AB Rotterdam	Tel. +31 10 4463-700 Fax +31 10 4155-552 http://www.vector.nu info@vector.nu



New Zealand			
<b>Assembly Sales Service</b>	<b>Auckland</b>	SEW-EURODRIVE NEW ZEALAND LTD. P.O. Box 58-428 82 Greenmount drive East Tamaki Auckland	Tel. +64 9 2745627 Fax +64 9 2740165 <a href="http://www.sew-eurodrive.co.nz">http://www.sew-eurodrive.co.nz</a> sales@sew-eurodrive.co.nz
	<b>Christchurch</b>	SEW-EURODRIVE NEW ZEALAND LTD. 10 Settlers Crescent, Ferrymead Christchurch	Tel. +64 3 384-6251 Fax +64 3 384-6455 sales@sew-eurodrive.co.nz
Norway			
<b>Assembly Sales Service</b>	<b>Moss</b>	SEW-EURODRIVE A/S Solgaard skog 71 N-1599 Moss	Tel. +47 69 24 10 20 Fax +47 69 24 10 40 <a href="http://www.sew-eurodrive.no">http://www.sew-eurodrive.no</a> sew@sew-eurodrive.no
Peru			
<b>Assembly Sales Service</b>	<b>Lima</b>	SEW DEL PERU MOTORES REDUCTORES S.A.C. Los Calderos, 120-124 Urbanizacion Industrial Vulcano, ATE, Lima	Tel. +51 1 3495280 Fax +51 1 3493002 <a href="http://www.sew-eurodrive.com.pe">http://www.sew-eurodrive.com.pe</a> sewperu@sew-eurodrive.com.pe
Poland			
<b>Assembly Sales Service</b>	<b>Lodz</b>	SEW-EURODRIVE Polska Sp.z.o.o. ul. Techniczna 5 PL-92-518 Łódź	Tel. +48 42 676 53 00 Fax +48 42 676 53 45 <a href="http://www.sew-eurodrive.pl">http://www.sew-eurodrive.pl</a> sew@sew-eurodrive.pl
		<b>24 Hour Service</b>	Tel. +48 602 739 739 (+48 602 SEW SEW) sewis@sew-eurodrive.pl
Portugal			
<b>Assembly Sales Service</b>	<b>Coimbra</b>	SEW-EURODRIVE, LDA. Apartado 15 P-3050-901 Mealhada	Tel. +351 231 20 9670 Fax +351 231 20 3685 <a href="http://www.sew-eurodrive.pt">http://www.sew-eurodrive.pt</a> infosew@sew-eurodrive.pt
Romania			
<b>Sales Service</b>	<b>București</b>	Sialco Trading SRL str. Madrid nr.4 011785 Bucuresti	Tel. +40 21 230-1328 Fax +40 21 230-7170 sialco@sialco.ro
Russia			
<b>Assembly Sales Service</b>	<b>St. Petersburg</b>	ZAO SEW-EURODRIVE P.O. Box 36 195220 St. Petersburg Russia	Tel. +7 812 3332522 +7 812 5357142 Fax +7 812 3332523 <a href="http://www.sew-eurodrive.ru">http://www.sew-eurodrive.ru</a> sew@sew-eurodrive.ru
Senegal			
<b>Sales</b>	<b>Dakar</b>	SENEMECA Mécanique Générale Km 8, Route de Rufisque B.P. 3251, Dakar	Tel. +221 338 494 770 Fax +221 338 494 771 senemeca@sentoosn
Serbia			
<b>Sales</b>	<b>Beograd</b>	DIPAR d.o.o. Ustanicka 128a PC Košum, IV floor SCG-11000 Beograd	Tel. +381 11 347 3244 / +381 11 288 0393 Fax +381 11 347 1337 office@dipar.co.yu



## Address List

Singapore			
<b>Assembly Sales Service</b>	<b>Singapore</b>	SEW-EURODRIVE PTE. LTD. No 9, Tuas Drive 2 Jurong Industrial Estate Singapore 638644	Tel. +65 68621701 Fax +65 68612827 <a href="http://www.sew-eurodrive.com.sg">http://www.sew-eurodrive.com.sg</a> <a href="mailto:sewsingapore@sew-eurodrive.com">sewsingapore@sew-eurodrive.com</a>
Slovakia			
<b>Sales</b>	<b>Bratislava</b>	SEW-Eurodrive SK s.r.o. Rybničná 40 SK-831 06 Bratislava	Tel. +421 2 33595 202 Fax +421 2 33595 200 <a href="mailto:sew@sew-eurodrive.sk">sew@sew-eurodrive.sk</a> <a href="http://www.sew-eurodrive.sk">http://www.sew-eurodrive.sk</a>
	<b>Žilina</b>	SEW-Eurodrive SK s.r.o. Industry Park - PChZ ulica M.R.Štefánika 71 SK-010 01 Žilina	Tel. +421 41 700 2513 Fax +421 41 700 2514 <a href="mailto:sew@sew-eurodrive.sk">sew@sew-eurodrive.sk</a>
	<b>Banská Bystrica</b>	SEW-Eurodrive SK s.r.o. Rudlovska cesta 85 SK-974 11 Banská Bystrica	Tel. +421 48 414 6564 Fax +421 48 414 6566 <a href="mailto:sew@sew-eurodrive.sk">sew@sew-eurodrive.sk</a>
	<b>Košice</b>	SEW-Eurodrive SK s.r.o. Slovenská ulica 26 SK-040 01 Košice	Tel. +421 55 671 2245 Fax +421 55 671 2254 <a href="mailto:sew@sew-eurodrive.sk">sew@sew-eurodrive.sk</a>
Slovenia			
<b>Sales Service</b>	<b>Celje</b>	Pakman - Pogonska Tehnika d.o.o. Ul. XIV. divizije 14 SLO - 3000 Celje	Tel. +386 3 490 83-20 Fax +386 3 490 83-21 <a href="mailto:pakman@siol.net">pakman@siol.net</a>
South Africa			
<b>Assembly Sales Service</b>	<b>Johannesburg</b>	SEW-EURODRIVE (PROPRIETARY) LIMITED Eurodrive House Cnr. Adcock Ingram and Aerodrome Roads Aeroton Ext. 2 Johannesburg 2013 P.O.Box 90004 Bertsham 2013	Tel. +27 11 248-7000 Fax +27 11 494-3104 <a href="http://www.sew.co.za">http://www.sew.co.za</a> <a href="mailto:info@sew.co.za">info@sew.co.za</a>
	<b>Cape Town</b>	SEW-EURODRIVE (PROPRIETARY) LIMITED Rainbow Park Cnr. Racecourse & Omuramba Road Montague Gardens Cape Town P.O.Box 36556 Chempet 7442 Cape Town	Tel. +27 21 552-9820 Fax +27 21 552-9830 Telex 576 062 <a href="mailto:cfoster@sew.co.za">cfoster@sew.co.za</a>
	<b>Durban</b>	SEW-EURODRIVE (PROPRIETARY) LIMITED 2 Monaco Place Pinetown Durban P.O. Box 10433, Ashwood 3605	Tel. +27 31 700-3451 Fax +27 31 700-3847 <a href="mailto:cdejager@sew.co.za">cdejager@sew.co.za</a>
Spain			
<b>Assembly Sales Service</b>	<b>Bilbao</b>	SEW-EURODRIVE ESPAÑA, S.L. Parque Tecnológico, Edificio, 302 E-48170 Zamudio (Vizcaya)	Tel. +34 94 43184-70 Fax +34 94 43184-71 <a href="http://www.sew-eurodrive.es">http://www.sew-eurodrive.es</a> <a href="mailto:sew.spain@sew-eurodrive.es">sew.spain@sew-eurodrive.es</a>



Sweden			
<b>Assembly</b>	<b>Jönköping</b>	SEW-EURODRIVE AB	Tel. +46 36 3442 00
<b>Sales</b>		Gnejsvägen 6-8	Fax +46 36 3442 80
<b>Service</b>		S-55303 Jönköping Box 3100 S-55003 Jönköping	<a href="http://www.sew-eurodrive.se">http://www.sew-eurodrive.se</a> jonkoping@sew.se
Switzerland			
<b>Assembly</b>	<b>Basel</b>	Alfred Imhof A.G.	Tel. +41 61 417 1717
<b>Sales</b>		Jurastrasse 10	Fax +41 61 417 1700
<b>Service</b>		CH-4142 Münchenstein bei Basel	<a href="http://www.imhof-sew.ch">http://www.imhof-sew.ch</a> info@imhof-sew.ch
Thailand			
<b>Assembly</b>	<b>Chonburi</b>	SEW-EURODRIVE (Thailand) Ltd.	Tel. +66 38 454281
<b>Sales</b>		700/456, Moo.7, Donhuaroh	Fax +66 38 454288
<b>Service</b>		Muang Chonburi 20000	<a href="mailto:sewthailand@sew-eurodrive.com">sewthailand@sew-eurodrive.com</a>
Tunisia			
<b>Sales</b>	<b>Tunis</b>	T. M.S. Technic Marketing Service Zone Industrielle Mghira 2 Lot No. 39 2082 Fouchana	Tel. +216 71 4340-64 + 71 4320-29 Fax +216 71 4329-76 <a href="mailto:tms@tms.com.tn">tms@tms.com.tn</a>
Turkey			
<b>Assembly</b>	<b>Istanbul</b>	SEW-EURODRIVE	Tel. +90 216 4419164, 3838014, 3738015
<b>Sales</b>		Hareket Sistemleri San. ve Tic. Ltd. Sti.	Fax +90 216 3055867
<b>Service</b>		Bagdat Cad. Koruma Cikmazi No. 3 TR-34846 Maltepe ISTANBUL	<a href="http://www.sew-eurodrive.com.tr">http://www.sew-eurodrive.com.tr</a> <a href="mailto:sew@sew-eurodrive.com.tr">sew@sew-eurodrive.com.tr</a>
Ukraine			
<b>Sales</b>	<b>Dnepropetrovsk</b>	SEW-EURODRIVE	Tel. +380 56 370 3211
<b>Service</b>		Str. Rabochaja 23-B, Office 409 49008 Dnepropetrovsk	Fax +380 56 372 2078 <a href="http://www.sew-eurodrive.ua">http://www.sew-eurodrive.ua</a> <a href="mailto:sew@sew-eurodrive.ua">sew@sew-eurodrive.ua</a>
USA			
<b>Production</b>	<b>Southeast Region</b>	SEW-EURODRIVE INC.	Tel. +1 864 439-7537
<b>Assembly</b>		1295 Old Spartanburg Highway	Fax Sales +1 864 439-7830
<b>Sales</b>		P.O. Box 518	Fax Manufacturing +1 864 439-9948
<b>Service</b>		Lyman, S.C. 29365	Fax Assembly +1 864 439-0566
<b>Corporate Offices</b>			Fax Confidential/HR +1 864 949-5557 <a href="http://www.seweurodrive.com">http://www.seweurodrive.com</a> <a href="mailto:cslyman@seweurodrive.com">cslyman@seweurodrive.com</a>
<b>Assembly</b>	<b>Northeast Region</b>	SEW-EURODRIVE INC.	Tel. +1 856 467-2277
<b>Sales</b>		Pureland Ind. Complex	Fax +1 856 845-3179
<b>Service</b>		2107 High Hill Road, P.O. Box 481 Bridgeport, New Jersey 08014	<a href="mailto:csbridgeport@seweurodrive.com">csbridgeport@seweurodrive.com</a>
	<b>Midwest Region</b>	SEW-EURODRIVE INC.	Tel. +1 937 335-0036
		2001 West Main Street	Fax +1 937 440-3799
		Troy, Ohio 45373	<a href="mailto:cstroy@seweurodrive.com">cstroy@seweurodrive.com</a>
	<b>Southwest Region</b>	SEW-EURODRIVE INC.	Tel. +1 214 330-4824
		3950 Platinum Way	Fax +1 214 330-4724
		Dallas, Texas 75237	<a href="mailto:csdallas@seweurodrive.com">csdallas@seweurodrive.com</a>
	<b>Western Region</b>	SEW-EURODRIVE INC.	Tel. +1 510 487-3560
		30599 San Antonio St.	Fax +1 510 487-6433
		Hayward, CA 94544	<a href="mailto:cshayward@seweurodrive.com">cshayward@seweurodrive.com</a>
Additional addresses for service in the USA provided on request!			



## Address List

---

Venezuela			
<b>Assembly</b>	<b>Valencia</b>	SEW-EURODRIVE Venezuela S.A.	Tel. +58 241 832-9804
<b>Sales</b>		Av. Norte Sur No. 3, Galpon 84-319	Fax +58 241 838-6275
<b>Service</b>		Zona Industrial Municipal Norte	<a href="http://www.sew-eurodrive.com.ve">http://www.sew-eurodrive.com.ve</a>
		Valencia, Estado Carabobo	<a href="mailto:ventas@sew-eurodrive.com.ve">ventas@sew-eurodrive.com.ve</a>
			<a href="mailto:sewfinanzas@cantv.net">sewfinanzas@cantv.net</a>



## How we're driving the world

With people who think fast and develop the future with you.

With a worldwide service network that is always close at hand.

With drives and controls that automatically improve your productivity.

With comprehensive knowledge in virtually every branch of industry today.

With uncompromising quality that reduces the cost and complexity of daily operations.

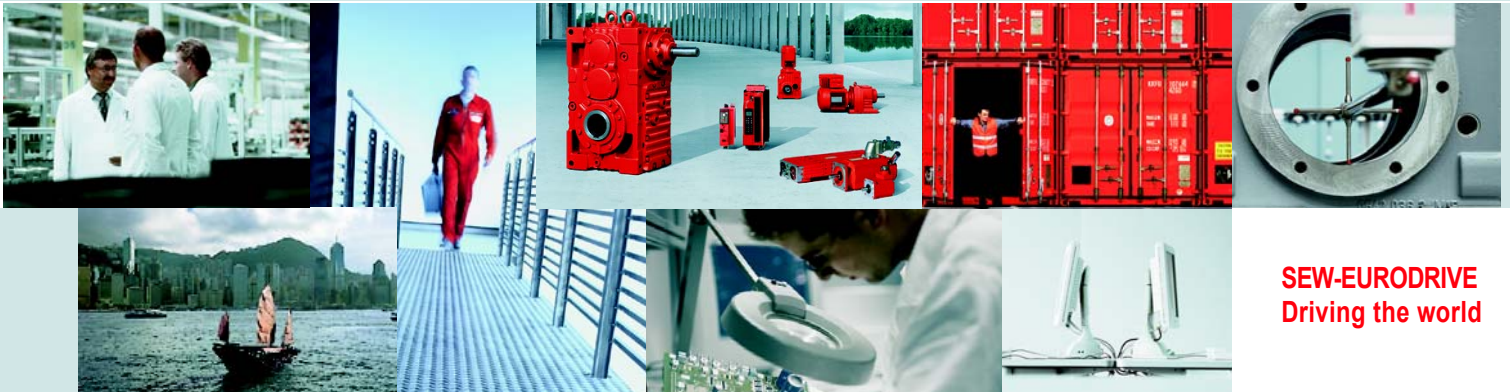

**SEW-EURODRIVE**  
Driving the world

With a global presence that offers responsive and reliable solutions. Anywhere.

With innovative technology that solves tomorrow's problems today.

With online information and software updates, via the Internet, available around the clock.

**SEW**  
**EURODRIVE**

SEW-EURODRIVE GmbH & Co KG  
P.O. Box 3023 · D-76642 Bruchsal / Germany  
Phone +49 7251 75-0 · Fax +49 7251 75-1970  
sew@sew-eurodrive.com

→ [www.sew-eurodrive.com](http://www.sew-eurodrive.com)