

DRIVING CENTRIFUGAL COMPRESSOR TECHNOLOGY

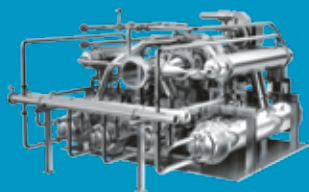

Atlas Copco Gas and Process Solutions

Atlas Copco





Driving Centrifugal Compressor Technology

Over the past century, Atlas Copco has built close relationships with customers around the globe. In doing so, we have pursued one goal: providing our customers with sustainable productivity, regardless of process, application, or market. Integral Gear Technology – the concept that drives our centrifugal compressors – is what allows us to consistently achieve this goal.

The Entire Range of Solutions

Integral Gear Technology is the forward-looking expertise that makes our turbocompressors first-in-class. It's a market-leading innovation and the result of decades of development.

A uniquely versatile and cost-efficient solution, this technology allows for multi-staging, enabling up to eight stages to be included on one gearbox.

And that's not all. We also offer a complete range of multi-stage expander / compressor / generator solutions. Moreover, our compressor design supports API specifications.

Compact Design, Efficient Operation

Our centrifugal compressors feature a very compact design. This greatly reduces your on-site footprint, especially in marine and offshore settings.

By providing a range of customization possibilities, we can also focus on your precise needs. Our options include diverse impeller designs and variable diffusers, to name just a few.

Energy efficiency – with a focus on power optimization – is a key area we emphasize. The goal: to ensure an optimum process for you.

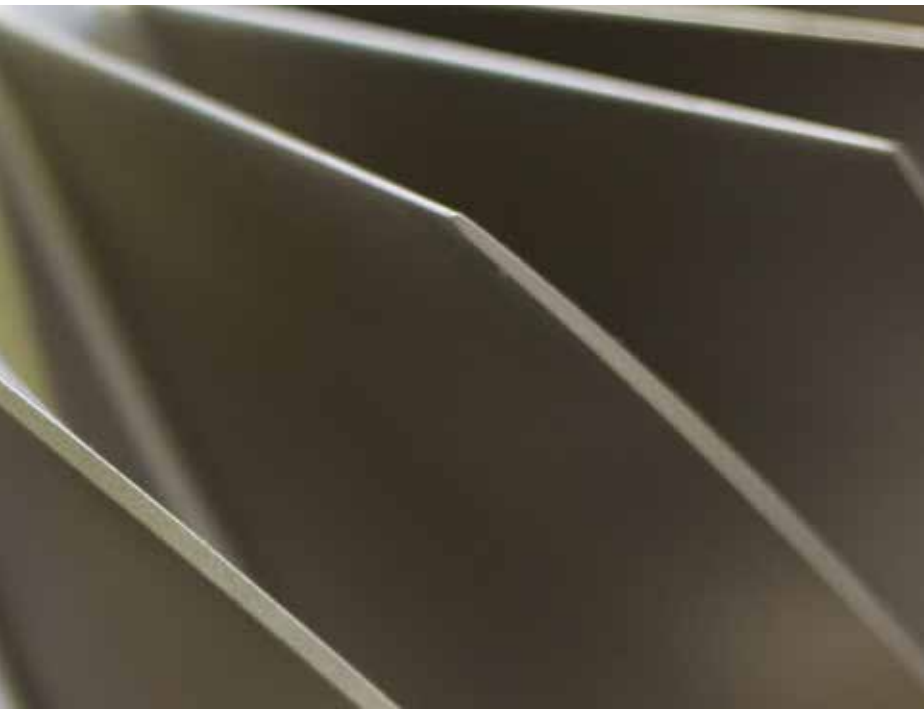

Integral Gear Technology offers you:

- Customization options that improve your process
- Shorter installation and commissioning times
- Maximum compressor efficiency
- Maximum reliability
- Power savings
- Compact and lean design

Our Compressor Range

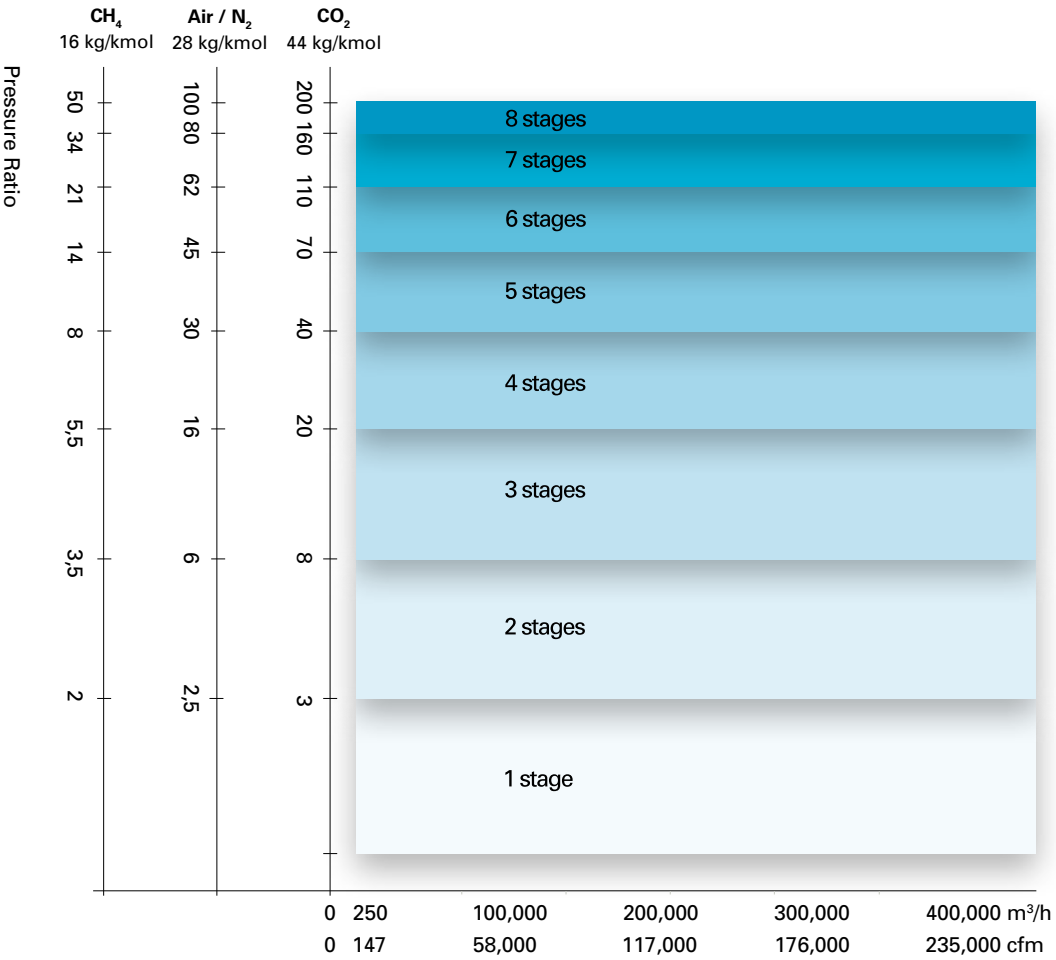

For a detailed performance range, please see pgs. 46–51.

Effective Inlet Volume



Industrial Gases

Industrial-gas technology may have originated over a century ago, but it remains a key growth market in many of today's global industries. That's precisely where Atlas Copco air compressors can be found – providing a whole host of solutions for the industrial gas industry.

Carbon Capture Storage (CCS)

Atlas Copco turbocompressors are employed in Carbon capture storage (CCS), a new and promising technology. Integrated into different processes (such as Oxyfuel), CCS allows CO₂ to be captured directly at the source instead of being released into the atmosphere.

The CO₂ is then transported to a predetermined location – either underground or underwater – where it is safely stored.

Air Separation

We offer a range of customer-centric products, including Main Air, Booster Air / N₂ and oxygen compressors, as well as our expansion turbine options.

Atlas Copco Gas and Process machines serve air-separation applications in numerous sectors, such as the steel, chemical / petrochemical, electronics, Gas to Liquid (GTL) / Syngas / CO, and microprocessor industries.

Thanks to our wide range of options, we can customize the industrial-gas compressor you choose to meet your precise needs.

Industrial Gas Applications

Application	No. of stages	Discharge pressure bar (PSI)	Effective inlet flow m ³ /h (cfm)
Air compressor	2 - 6	35 (507)	3,500 - 400,000 (2,100 - 235,000)
Booster Air	1 - 6	80 (1,160)	2,500 - 80,000 (1,500 - 47,000)
Booster N ₂	1 - 6	80 (1,160)	2,500 - 80,000 (1,500 - 47,000)
Recycle N ₂ + feed	2 - 4 + 2 (6 stages)	80 (1,160)	2,500 - 80,000 (1,500 - 47,000) 1,000 - 40,000 (600 - 24,000)
Oxygen	1 - 5	32 (464)	3,000 - 16,000 (1,800 - 9,000)
Main Air +	3+3	8 (116)	30,000 - 250,000 (18,000 - 147,000)
Booster combined	4+2	80 (1,160)	3,000 - 60,000 (1,800 - 35,000)



CO₂ gas compressors are used in pipeline applications.



Atlas Copco builds air compressors up to 400,000 m³/h.



The steel industry is a main market for air-separation applications.

Oil and Gas

Atlas Copco Gas and Process equipment reliably supports every process in the industry – upstream, midstream, and downstream, on land and at sea.

In an industry that spans oceans and continents, performance and reliability are the name of the game. Atlas Copco Gas and Process offers customized and standardized machinery that supports every link in the value chain, maximizing performance without sacrificing dependability.

Upstream

The beginning of the petroleum process involves the exploration and production of crude oil and natural gas. It covers all applications from the well to the product-transportation system.

Within this segment, gas processing, gas treatment, and Liquefied Petroleum Gas (LPG) applications rely on Atlas Copco Gas and Process turbomachinery.

Midstream

Once crude oil or natural gas have been located and produced, they enter the crucial midstream sector – pipeline transportation, storage, and processing.

From transportation to storage, we offer decades of experience and expertise in Liquefied Natural Gas (LNG), including the reliquefaction of boil-off gas that occurs aboard LNG vessels.

Downstream

Perhaps the most complex market within the oil-and-gas industry, downstream refers to the refining and marketing processes, as well as all other subsequent measures of transforming and processing hydrocarbon products further down the value chain.

Atlas Copco Gas and Process machines support down-stream applications such as petrochemical, aromatics, anorganics, as well as refinery and power-generation processes.

Well



- Gas processing
- Gas treatment
- Liquefied Petroleum Gas (LPG)
- Regeneration gas

LNG Transportation



- LNG reliquefaction
- Fuel Gas Supply

Storage Regasification



- LNG onshore
- Gas storage
- Gas pipeline

Chemical Petrochemical

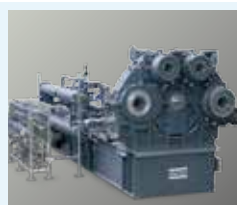

- Fertilizer
- Refineries
- Gas to Liquid (GTL)
- Combustion-air blowing
- Plant and instrument air

Power Generation



- Fuel Gas Boosting (FGB) applications
- Flue Gas Desulfurization (FGD)
- Soot-blowing Air

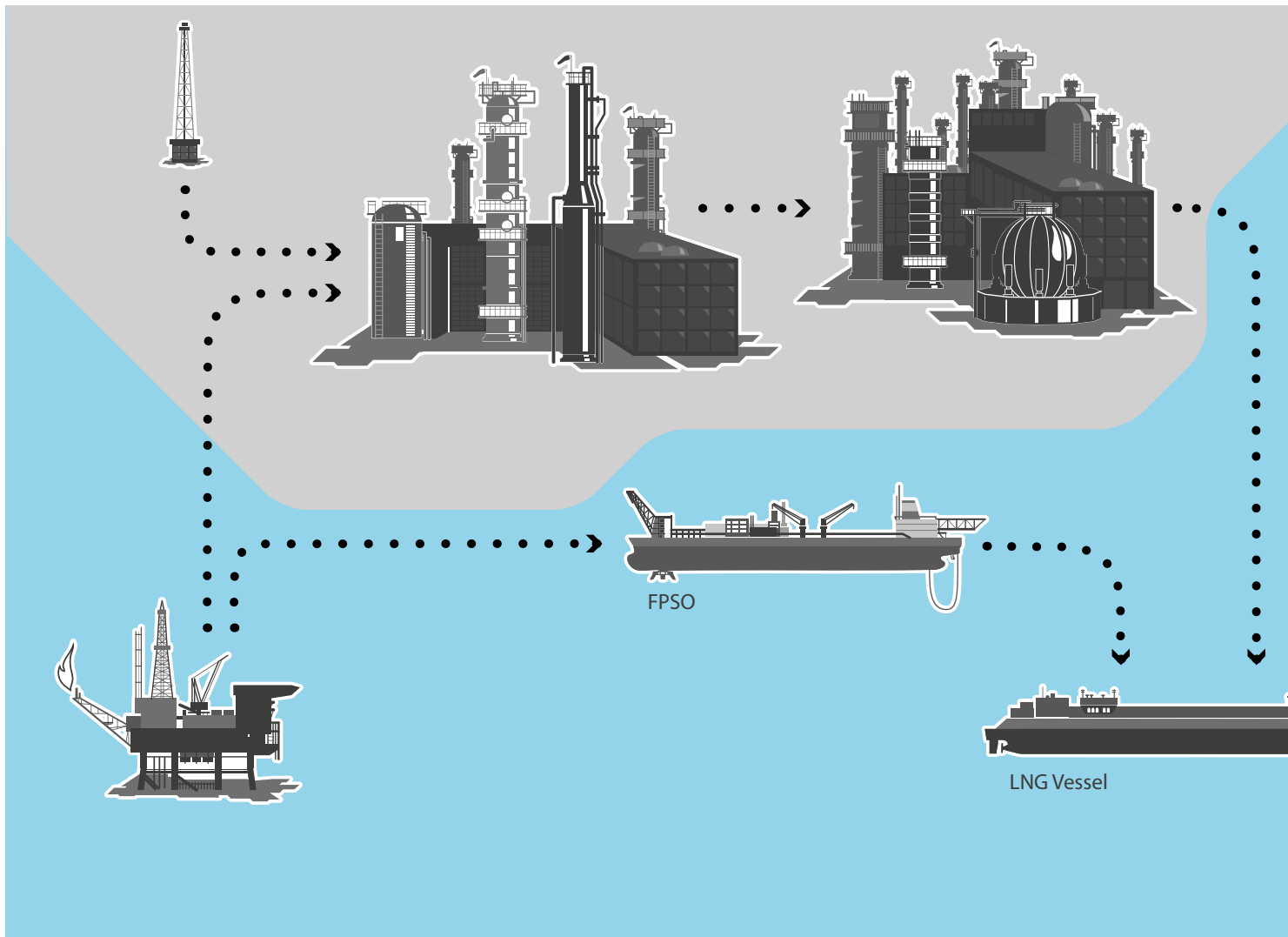

Designed using a wealth of experience, our turbocompressors support each link in the oil and gas value chain. Most of all, they're built to ensure your process remains productive over the long term. See above where we can support your process.

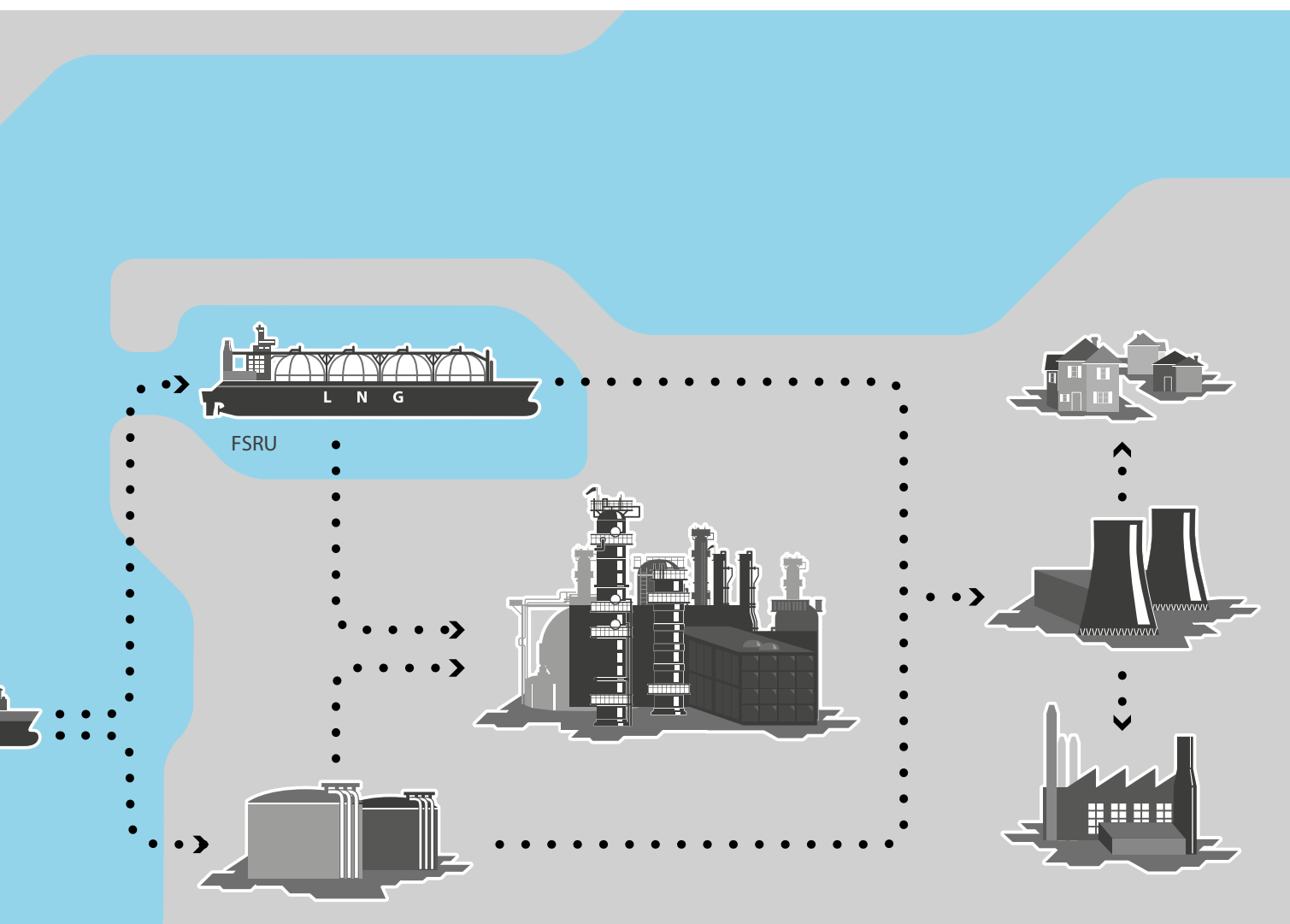

“At Atlas Copco, we’re committed to promoting reliability and innovation within the oil and gas industry.”



Picture source: Statoil
Photo: Dag Myrestrand

Your Application



Photo: BASF.

Chemical / Petrochemical

Chemical / Petrochemical is a key downstream segment. This is where added value is generated as hydrocarbons are processed and refined. Thanks to our extensive experience, we're a reliable, trusted partner in this crucial sector.

The chemical / petrochemical segment is one of the most complex industries. Given its demanding processes, reliability and safety are all-important.

Those are only two of the concerns we focus on as we supply centrifugal gas and air compressor solutions to a broad range of chemical / petrochemical processes – everything from traditional applications, such as ethylene and propylene manufacturing, to the production of aromatics and inorganics, to refinery operations.

Plant Air: A Vital Driver

As in other sectors, a reliable supply of air to plant equipment is vital if Chemical/Petrochemical players are to operate successfully.

Their equipment must work well, first and foremost. In addition, it must comply with any and all industrial standards, like those of the American Petroleum Institute (API).

That's a demanding range of challenges. And we're proud to help our customers meet them – by providing proven, sustainable solutions.

Chemical / petrochemical applications at a glance:

- Aromatics (e.g., PTA, phenol, caprolactam, maleic anhydride)
- Inorganics (e.g., hydrogen, CO, ammonia, etc.)
- Refineries (e.g., MTBE, FCC, etc.)
- Coal to Liquid (CTL), Gas to Liquid (GTL)

“We supply sustainable turbocompressor solutions for the complex chemical / petrochemical market.”



Inside an ethylene-oxide plant



A centrifugal gas compressor for CO compression

Power Generation

Energy-market players are constantly striving for new solutions that minimize environmental impact. Conversely, they want to maximize productivity while generating a reliable supply of energy. Atlas Copco Gas and Process can meet those market needs, and others, thanks to our extensive experience and recognized know-how.

The market for natural-gas driven applications within the power-generation industry is growing rapidly all over the world.

Regardless of location, an efficient delivery of gas to the plant's turbines is instrumental if productivity is to be maintained in this process.

Our centrifugal gas compressors are a reliable solution for meeting this challenge. They can be easily maintained, with minimum downtime. Our customers rely on them for a number of applications, including fuel-gas boosting.

In addition, every plant has different pressure and flow needs. Identifying the right compressor and components for each customer site is therefore a task of critical importance. Needless to say, it's a process we focus on in detail.



An Atlas Copco fuel-gas booster

Power Industry

Centrifugal air compressors can also help coal-fired power plants reduce their environmental impact. By deploying them in flue-gas desulfurization and sootblowing operations, customers can decrease their carbon footprint without sacrificing plant efficiency.

Power-generation and power-industry applications:

- Fuel-gas boosting
- Flue-gas desulfurization
- Sootblowing air
- Plant and process air
- Atomizing air compressors for gas turbines



Driving natural-gas power plants



Further Markets

Customers in other markets often have highly specific demands, and meeting them requires even greater dedication – not to mention an eye for innovation and the drive to get the job done. Long known as a “can-do” company, we’re always up to the task.

Mechanical Vapor Compression

Our turbocompressors have proven highly effective in the process of mechanical vapor compression. In this application, compressors are used to compact the vapor generated by a “mother liquid,” raising both the vapor’s pressure and temperature.

Deployed as a source of heat, the compressed vapor then aids in the evaporation of the mother liquid. Two sectors that make use of this technology are the seawater-desalination and pulp and paper industries.

The Atlas Copco turbocompressors used in this complex, energy-efficient process are just one more example of our efforts to promote innovative, forward-looking technologies.

Wastewater Oxygen Compression

Wastewater treatment doesn’t work without oxygen: The microorganisms used to purify wastewater need to “breathe” to be able to break down organic materials. To work effectively, the oxygen must be supplied at a specified pressure. That’s where our compressors come into play: They are being employed at wastewater-treatment facilities in several large metropolitan areas around the globe.



Atlas Copco compressors help supply oxygen to the wastewater-treatment process.



Our compressors play a big role in paper and pulp production.



This vapor compressor is used in a facility in Chile.



The salt industry uses vapor-compression applications.

The Extra Edge for Your Process: Integral Gear Technology

Based on decades of process-oriented and engineering know-how, Integral Gear Technology is an innovative approach well-suited to each customer's equipment requirements.

Developed in constant interaction with our customers, Integral Gear Technology provides long-term answers to today's application challenges. Even better, it does so in one compact, customizable package.

To give just one example: The rotor is an integral part of the gearbox, meaning the impeller is mounted on the high-speed pinion.

This allows the impeller to run at its specific optimum speed with the best efficiency.

Our Integral Gear Technology offers you:

- Improved efficiency
- Compact design
- Multi-speed capability for optimal speed in each stage
- Easy inspection and maintenance
- Combined service operation

That's not all: Our compressors with Integral Gear Technology meet standards API 617, chapter 3, and API 672. They also meet other relevant quality standards, such as AGMA Q13 and ISO 1328, grade 4.

More and more customers around the world are choosing Integral Gear Technology – testimony to the effectiveness of this productivity-boosting approach.

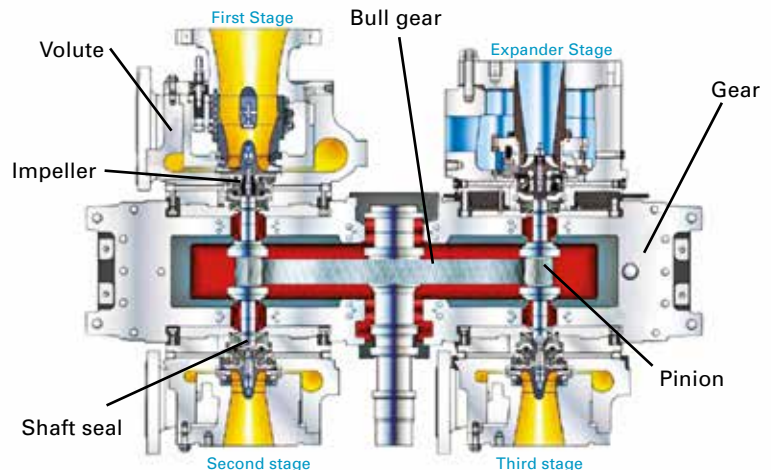

How it works: an inside look at the integral-gear concept.

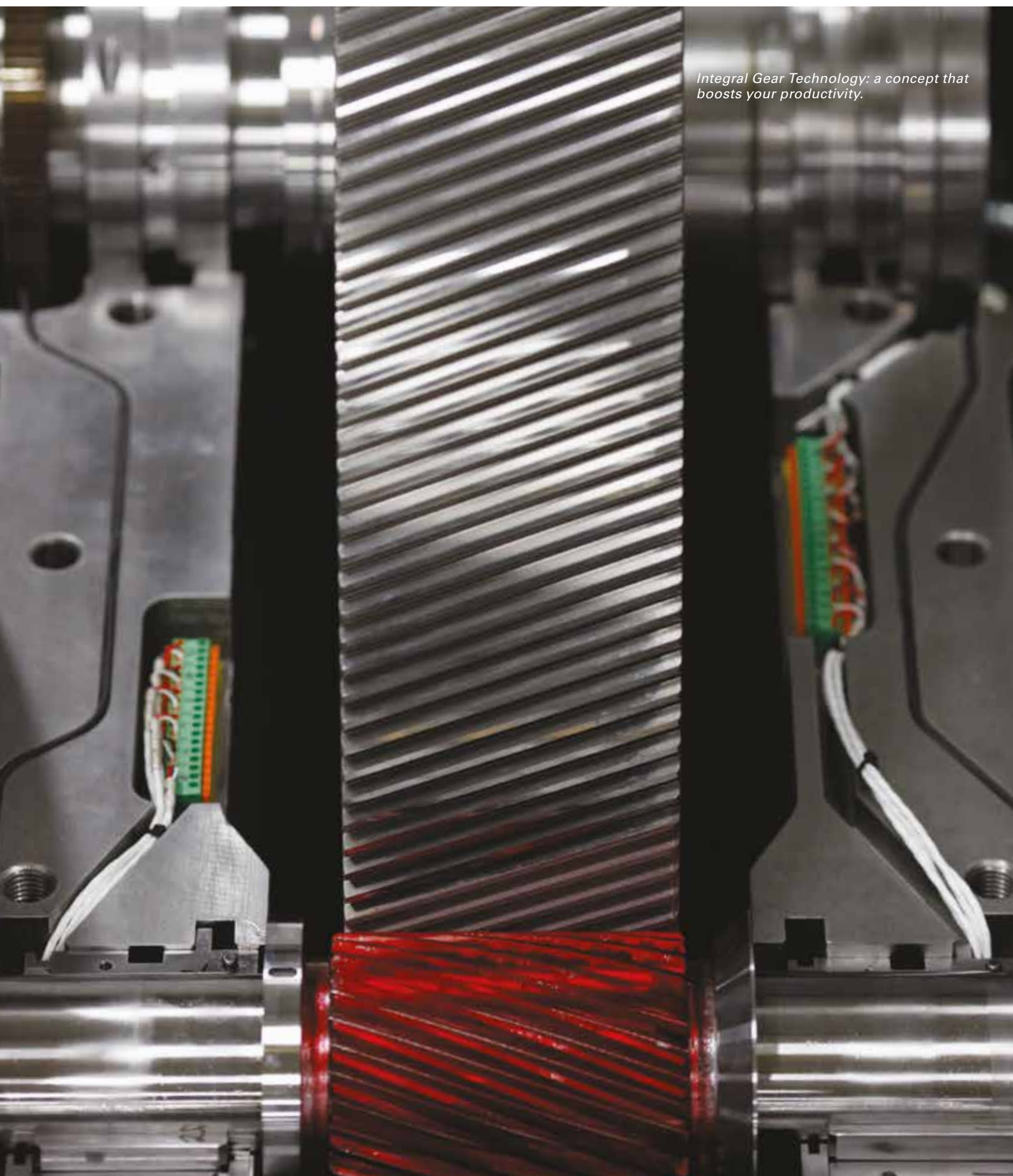

Integral Gear Technology: a concept that boosts your productivity.

Technical Features



Finding the right balance for your machine: high-speed balancing.

“Integral Gear Technology provides answers to today’s application challenges in one compact, customizable package.”

Inside the technology

Atlas Copco integral speed-increasing gears are driven by high-quality helical gearing with precise mesh geometry.

This ensures:

- Reliable performance
- Smooth operation
- High mechanical efficiency

The technology’s design offers a number of key advantages. First, its multiple-speed capability allows each stage to run at optimum pace, resulting in the highest-possible efficiencies.

In addition, thrust collars or axial bearings in the pinion gear ensure a high level of efficiency. This decreases losses while increasing mechanical rotor stability and reliability.

Tilting-pad bearings are used on the high-speed shaft, while sleeve bearings are used on the low-speed shaft.

Split horizontally, the gearbox design also facilitates easy inspection and maintenance of gears and bearings, without the need to disconnect the system’s piping.

Finally, to ensure optimum efficiency, sensing probes can be mounted on the pinions to monitor shaft vibration. In addition, sensors are installed in the bearings to keep track of temperature changes and shaft vibration.



A radial-axial bearing



A radial bearing



Driving Your Process: Our Impellers

Atlas Copco Gas and Process employs superior design features in its impellers. They are at the heart of an aerodynamic stage design that drives your process.



*Quality in the making:
milling an impeller.*

Our turbocompressors feature an aerodynamic stage design, and the impeller is a key part of it. This design is based on decades of experience and ongoing development.

Having built thousands of compressor stages, we know what to expect. The result: impellers that meet your exact flow and pressure requirements.

In addition, Atlas Copco Gas and Process has years of experience creating compressors that can be used with corrosive and challenging gases.

Unsurprisingly, our extensive experience and technological know-how have also produced something else: many satisfied customers.

Our impellers:

- Provide optimum efficiency and reliability
- Have a strong track record for use with corrosive and challenging gases
- Are individually designed for your process requirements
- Are performance tested
- Cover a broad range of use

Technical Features

Inside the technology

When selecting impellers, we use software that calculates the design optimally reflecting your process.



Up close: micro spline.

Thanks to the unique flow coefficients of each impeller group, our turbocompressors can meet a range of diverse requirements.

Key benefits:

- Our impellers are available in open or closed configuration
- All geometries are tested by R&D
- Impellers are mounted on the pinion shaft using Hirth serration or micro spline
- Their design ensures easy assembly and high reliability



It's all in the details: Hirth serration.

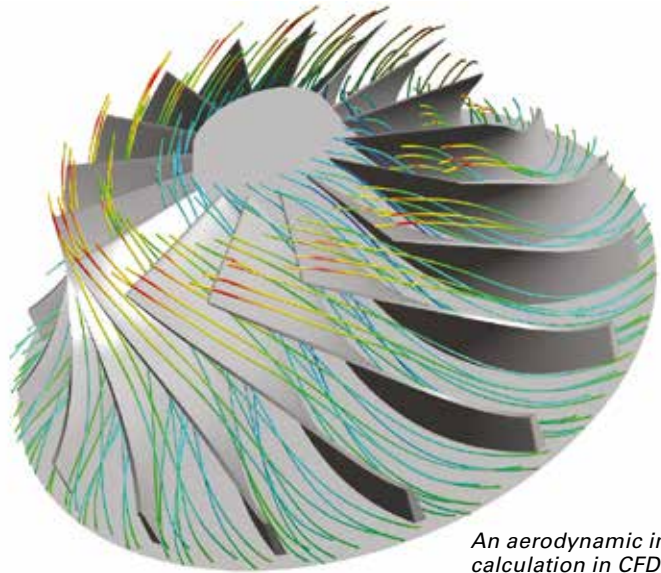

An aerodynamic impeller calculation in CFD

“We’ve built thousands and thousands of compressors – experience that results in superior impeller design.”



A closed impeller



Each impeller is custom-designed to meet your needs.



Controlling Your Capacity: Our IGV and DGV Options

Our turbocompressors are designed to be an integral part of your process and your plant as a whole. To maximize their effectiveness, they can be equipped with different capacity-control options, which can adapt to changing process conditions such as discharge pressure and volume.

Our control options include **inlet-guide vanes (IGV)**, **diffuser-guide vanes (DGV)**, and **combined IGV and DGV configurations**, as well as a speed-control capability using steam turbines or VFD.

The bottom line: Our capacity-control options ensure your process is as flexible and efficient as possible.

IGV Control

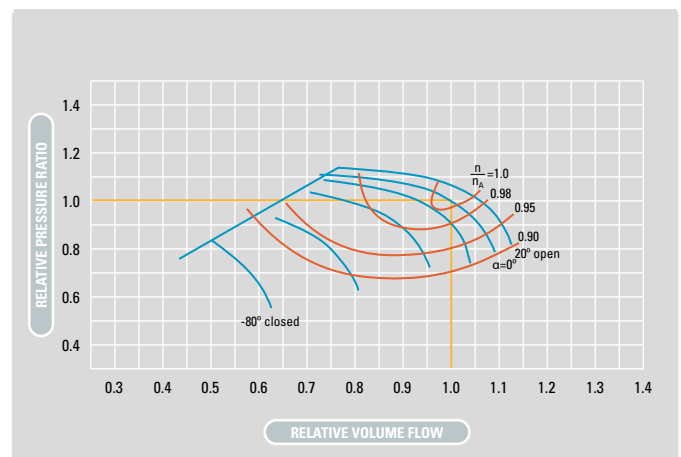



A typical Inlet Guide Vane (IGV)

Atlas Copco Gas and Process capacity-control options offer you:

- Optimum control range
- Maximum efficiency in all parts of your operation
- Vast range of regulation capabilities and excellent partial performance
- DGVs capable of large turndown
- Combined configuration to ensure maximum control flexibility

Inside the technology

Our **variable IGVs** offer a wide operating range and excellent partial-load performance.

In addition, our **variable DGVs** ensure an excellent control range in both single and multi-stage applications.

Finally, our **speed control** is just the feature you need when volume turndown at a lower pressure ratio is required.



A variable diffuser-guide vane (DGV)

DGV Control

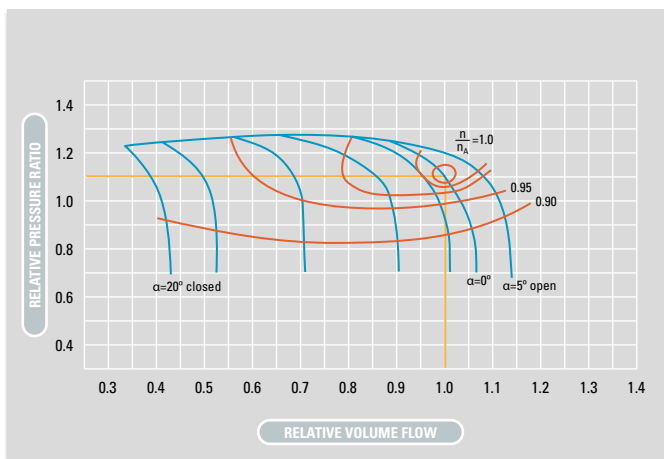

Speed Control

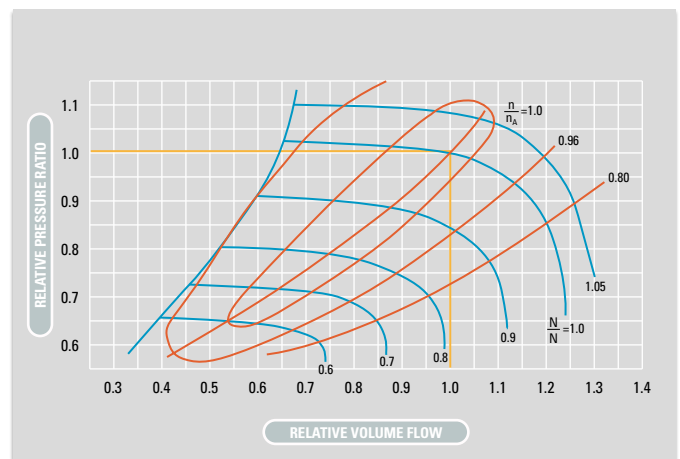



Shielding Your Process: Our Seal Options

Our Gas and Process turbocompressors are equipped with state-of-the-art shaft seals – to ensure your process remains a closed, efficient system.

Shaft seals minimize or eliminate the leakage of gas while preventing air intrusion into the compressor case.

Because every application requires a different solution, Atlas Copco Gas and Process offers a wide variety of seals. Our customers rely on them in any number of challenging settings, such as those that involve corrosive, toxic, and flammable gases.

With multiple options available, finding the right solution is the key. Drawing on decades of know-how and engineering expertise, our experts will be glad to help you identify the seal that meets your precise needs.

Our seal-gas systems comply with API 614 / 617.

Inside the technology

Our **dry-gas seals** can be applied in single, tandem or double-acting configurations. Dynamic dry-gas seals, for example, offer an alternative to oil-lubricated seals for minimum leakage applications.

In addition, **shaft seals** such as **floating carbon ring seals** or precision-engineered **labyrinth seals** are ideal for minimum-leakage situations. They can also be combined with two to five chambers to allow the injection of buffer gas.

For example, when leakage into the atmosphere is permissible, **labyrinth seals** are an effective choice. The number of labyrinths and clearances is determined by the customer's application.



What Atlas Copco Gas and Process offers you:

All of our seals provide one universal advantage: maximum efficiency.

Other benefits include:

- Superior reliability
- Optimized shaft-seal selection and configuration
- Minimized process-gas leakage
- Minimized seal-gas consumption

Dynamic dry-gas seals

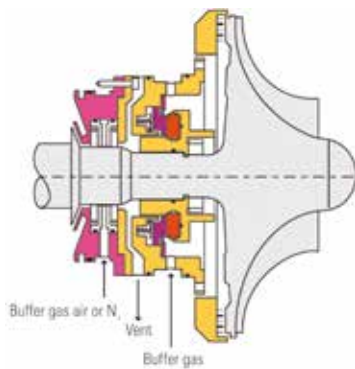

Oil-lubricated seals



Floating carbon seals

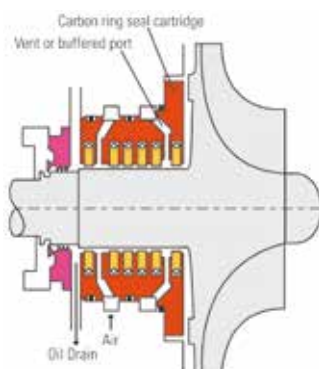

Labyrinth seals

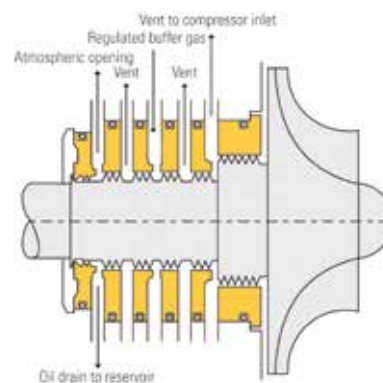

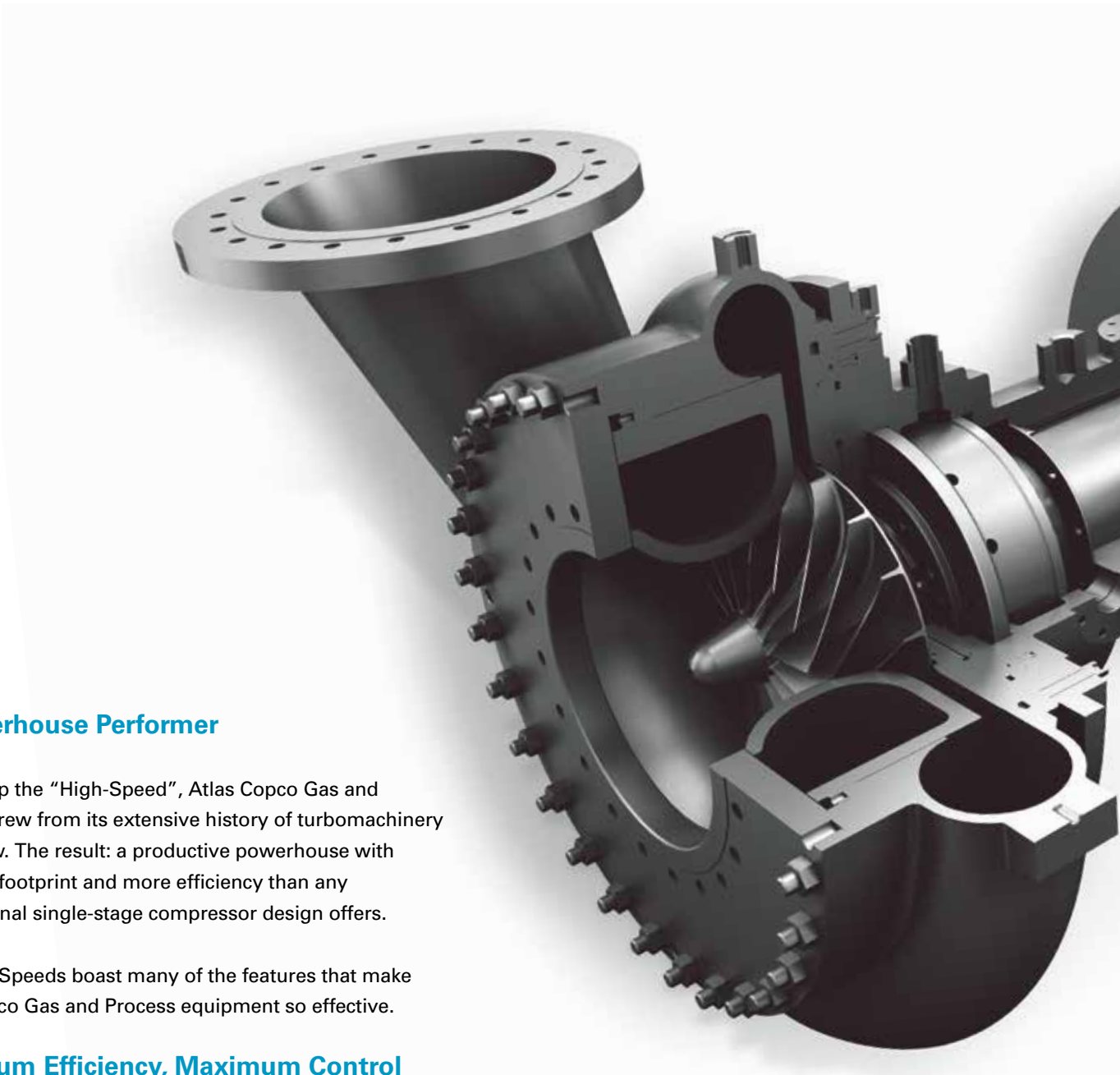

A Powerhouse Performer

To develop the “High-Speed”, Atlas Copco Gas and Process drew from its extensive history of turbomachinery know-how. The result: a productive powerhouse with a smaller footprint and more efficiency than any conventional single-stage compressor design offers.

Our High-Speeds boast many of the features that make Atlas Copco Gas and Process equipment so effective.

Maximum Efficiency, Maximum Control

An ultra-compact permanent magnet motor offers high speeds while reducing energy losses. At the same time, contactless active magnetic bearings (AMB) dynamically align the rotor shaft, prevent wear and tear, and eliminate the need for lubrication.

Because our High-Speeds feature hermetically-sealed EExd housing, no complex seal-gas system is required – not even in applications involving explosive gases. Consequently, costs and power consumption decrease while reliability gets a boost.

“The High-Speed is ideal for meeting high demands, at the lowest operational cost.”

Powering Your Performance: Our High-Speed Turbochargers

Originally developed for the LNG market, our High-Speed turbochargers now boost productivity across applications. Pure energy contained in a compact package, they offer oil-free efficiency at maximum velocity.



Less Is More

Innovative features are not the only benefit that sets Atlas Copco's High-Speed apart. On the contrary: It's what's lacking from the system that really boosts productivity and speed.

The High-Speed does not include a gearbox, any oil system, oil bearing, or speed-increasing gears, coupling or coupling guard. Because it is outfitted with speed control, it also requires no inlet-guide vanes.

Its reduced weight and small footprint mean the High-Speed is perfect for applications such as marine and offshore, where optimal use of space is key, as well as small power units and single-stage applications.

The new High-Speed provides customers a host of benefits:

- No gearbox and 100% oil-free
- Ready for offshore installation
- Smallest footprint
- Designed for cryogenic gas applications (-140°C)
- No current peaks during start-up
- Speed control
- No-contact bearings eliminate wear and tear
- Minimal maintenance costs

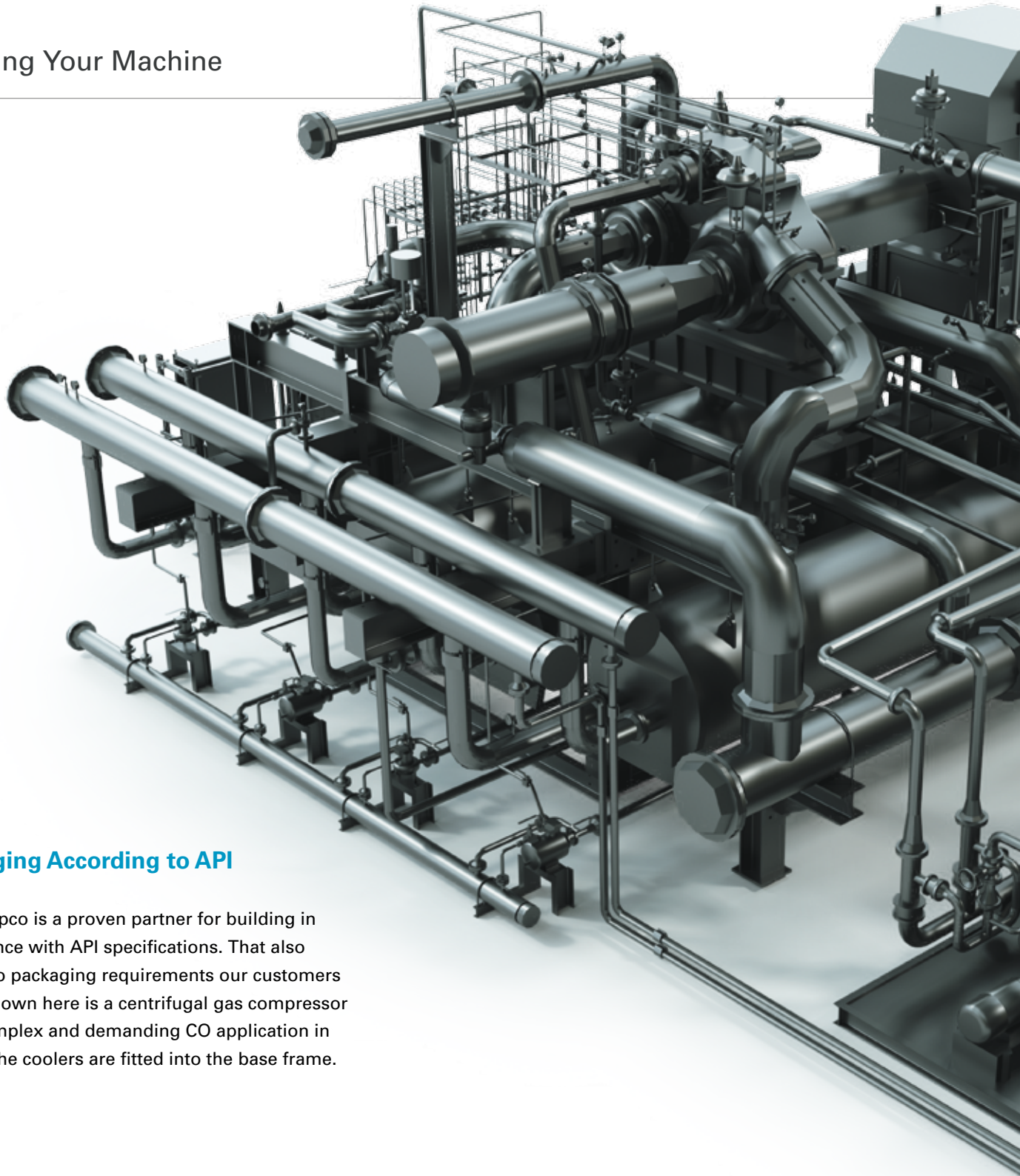

Packaging According to API

Atlas Copco is a proven partner for building in accordance with API specifications. That also relates to packaging requirements our customers have. Shown here is a centrifugal gas compressor for a complex and demanding CO application in China. The coolers are fitted into the base frame.

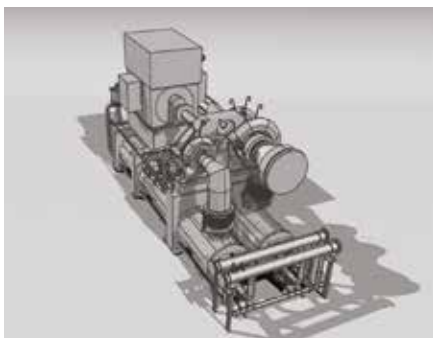

Full-package arrangement



Semi-package arrangement

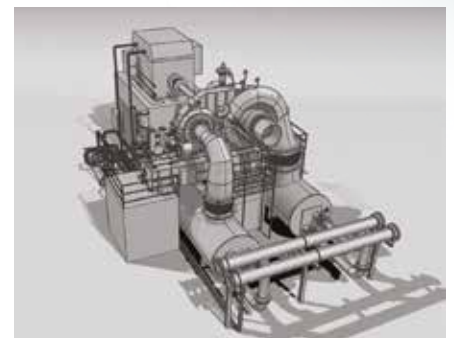

Free arrangement



Our Packaging Options

Markets are becoming increasingly globalized and dynamic, which has a direct impact on our customers. To respond optimally to their needs, we offer flexible options when delivering centrifugal compressors for air or gas compressors, as well as highly specified packaging solutions in line with API.

Full-Packaging

Dating back to the early days of the turbocompressor, full-packaging is the most compact approach. It means the entire machine – from the core unit to the coolers and piping – is assembled and shipped to the customer in one skid (unit).

This option is best suited for machines with a flow volume of up to 52,000 m³/h, and when quick installation and operations are needed.

Semi-Packaging

This option is suitable for heavier machines (approx. 80 tons, flow volumes up to 120,000 m³/h) that cannot feasibly be transported as one unit. Select components such as the motor or foundation are produced and installed separately, instead.

Free Arrangement

A modern variation of semi-packaging, our free-arrangement option takes advantage of the possibilities for sourcing components locally, thus reducing transport costs and times.

This option was developed because turbocompressors have grown in size. Often sourced locally, the components are delivered separately and installed as one unit on site.

Thanks to our systematic planning procedures and global infrastructure, this approach is ideal for customers who operate larger compressors and this need a customized solution.

“Thanks to our extensive know-how and innovative planning, we can offer each customer a fully customized packaging solution.”

Committed to Sustainable Quality

By producing consistently high-quality products, Atlas Copco Gas and Process has established itself as an industry frontrunner. Our commitment to excellent quality has also earned us an outstanding reputation – and loyal customers around the globe.

Your Partner From Start to Finish – and Beyond



*Front-end engineering & design / **Engineering/procurement/construction

Our focus on quality means that all of our equipment is designed and constructed for a minimum service life of **20 years** and at least **three years of uninterrupted operation**.

Because we're active in numerous markets, we also adhere to a range of standards, including **ISO, ASME, DIN, and CENELEC**.

This includes national and regional standards (such as those used in Australia, Russia and Japan), as well as the Marine Standard.

Finally, all our global facilities are subject to quality-assurance programs certified to the **ISO 9001** standard and registered by Lloyds Register Quality Assurance, Ltd.

Our quality promise to you:

- A lifelong service-responsibility guarantee for your machine
- Adherence to the applicable standards
- Global quality management according to ISO 9001
- Compliance with marine-relevant specifications (where required)
- Support of electric standards (where required)
- Documentation in your own language
- Compliance with ISO14001 and OHSAS 18001



It's all about precision.

Proven Engineering Expertise

Extensive process know-how, automated workflows, integrated quality protocols – these are just some of the engineering resources we draw on to provide our customers with first-in-class products.

Our Tools for Boosting Your Productivity

Aerodynamics	Mechanics	Design
<ul style="list-style-type: none">• OEM* software• Experimental measurements• CFD analysis: ANSYS• Gas programs: HYSYS, FRG, GPA	<ul style="list-style-type: none">• OEM* software• Rotor dynamics: SR3• Rotor dynamics & bearings: Madyn• Torsional analysis: DRESP• FEA: ANSYS• FVA workbench: RICOR, ST-Plus	<ul style="list-style-type: none">• 3D-CAD: ProE, MEDUSA/MPDS, Autodesk, Inventor• 2D-CAD: MEDUSA• Process design: HYSYS• Component design: OEM* software

*Original Equipment Manufacturer
Different programs for aero design and selection of compressor and turbine components.

Quality Benchmarks

The Atlas Copco Gas and Process engineering department has set standards in the areas of aerodynamics, rotor design, controlling technology, lubrication systems, pressure vessels, instrumentation, and piping.

In addition to product excellence, the result of our applied expertise is our position as an industry leader and a roster of satisfied customers.



Talking about your machine: Constant interaction helps develop our engineering competence.



Production Know-How Around the Globe

From Cologne to Upstate New York to China, when manufacturing our products we focus on one goal: helping our customers stay productive over the long term. With our many years of experience in markets around the world, we have the in-house knowledge to make it happen.



The right tools: Atlas Copco Gas and Process has an automated tool supply.

Among other benefits, we offer you:

- Local packaging, and local sourcing for peripheral components
- In-house packaging of key components ensures premier quality and delivery times

Key components in our engineering toolkit:

- State-of-the-art production machinery (including milling, balancing and spinning equipment)
- Modern production infrastructure fit for the global stage – and your process needs
- Constant product-performance review
- Strict quality assurance

Inside our Production Facilities

Working with the appropriate tools and processes, we use our extensive engineering know-how to create innovative, first-in-class products. Our skill set, moreover, is something we continue to invest in.



Balancing machines



Spinning machinery



Inside the multi-skill machine: the milling process

Testing Your Machine

At our Gas and Process testing facilities, your machine is thoroughly checked before leaving the plant. We have the ability to simulate all relevant operating conditions you are facing, so we know when your equipment is ready to roll.

For example, as a standard quality-assurance measure, we perform mechanical test runs on your machine, with performance testing carried out when required.

To ensure nothing is left to chance, our tests fully comply with all relevant standards, including DIN, ISO, VDI 2045, ASME, PTC10 and API 617 / 672.

In testing the machines we sell, we also work closely with our customers in order to achieve our final goal: delivering the best product possible.

Ultimately, it's about making sure you have the quality, efficiency, and sustainability you need to carry out your processes.





A bird's eye view of the test bed

Reaching Our Customers Worldwide

From California to Cologne to China:
With a tight service network and our
production facilities for turbocompressors
and expansion turbines we span the globe.

- Production plant
- Service center

**Application Center and
Manufacturing Plant
Atlas Copco Mafi-Trench**
Location: Santa Maria (CA)
Core competence:
Turboexpanders for
hydrocarbon applications
and geothermal.



**Application Center and
Manufacturing Plant USA**
Atlas Copco Comptec

Location: Voorheesville (NY)

Core competence:

Centrifugal compressors for air separation and various hydrocarbon applications, including power generation.



**Application Center and
Manufacturing Plant Europe**

Location: Cologne (Germany)

Core competence:

Centrifugal compressors and turboexpanders for all applications.



**Application Center and
Packaging Facility India**

Location: Pune (India)

Core competence:

Packaging for centrifugal compressors, primarily for air-separation applications.



**Application Center and
Manufacturing Plant Far East**

Location: Shanghai (China)

Core competence:

Packaging of turbocompressor and expander products.



The Right Components for You



Building to API Specifications

Our experts can help you choose the right components for your process, before we build them to meet current international industry standards.



Equipment used in the petrochemical industry must meet rigorous standards.

Customizing to Your Requirements

Industries and applications such as chemical / petrochemical or oil and gas depend on equipment that operates with maximum efficiency and reliability and meets internationally set standards.

At Atlas Copco Gas and Process, we offer customers the unique combination of technical know-how and manufacturing expertise needed to transform every challenge into a success.

Depending on your process, we can customize your equipment to match the rigorous standards set by the American Petroleum Institute (API), which help improve efficiency of equipment and processes, comply with legislative and regulatory requirements, and increase the safety of operations.

The Right Components for You

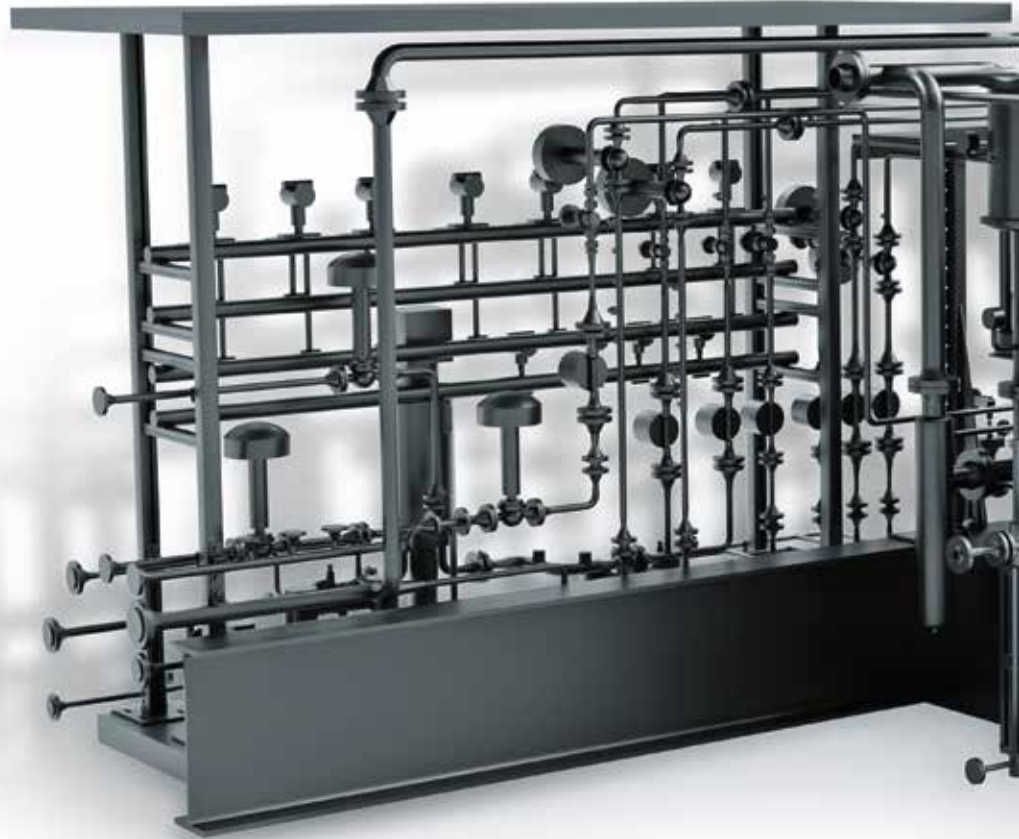

Always Up to Standard

Atlas Copco Gas and Process builds compressors to meet API 617, chapter 3 (gas) and API 672 (air) requirements, including oil systems that reflect API 614. In fact, our know-how helps set industry standards.

After all, Atlas Copco Gas and Process engineers participated in the development of API 617, 7th edition, as well as API 672, 4th edition.

Atlas Copco Gas and Process also builds compressors that meet both API and DIN standards.



*GT032 T1D1 compressor
built to comply with API 617*

“At Atlas Copco, we build our integrally geared compressors according to recognized industry standards, including API 617, chapter 3.”

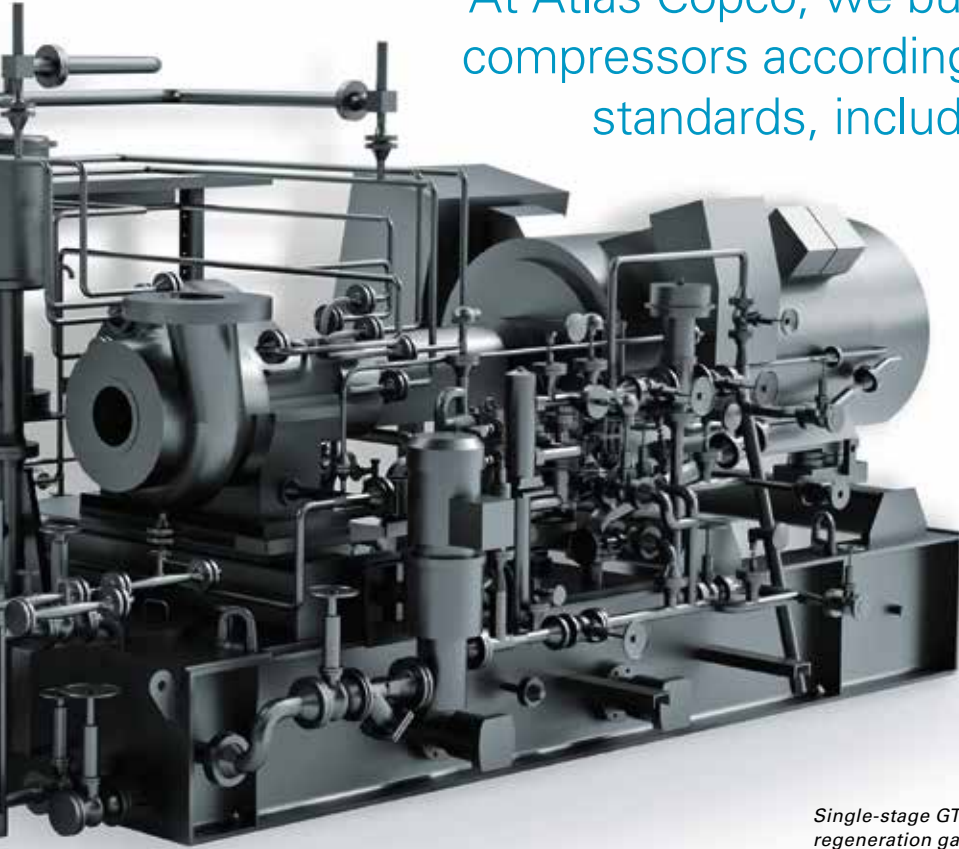

Single-stage GT026 centrifugal compressor for regeneration gas built according to API specifications

Atlas Copco Gas and Process combines innovative, standard-setting turbomachinery with long-term project experience in extreme locations. Our equipment stays reliable, efficient, and safe in the cold of the Siberian tundra, in the heat of the desert, and in the corrosive, windswept waters of coastal regions.



Today, Atlas Copco is the market leader for centrifugal turbocompressors built to support offshore applications.

Atlas Copco Gas and Process and API:

- We are a member of API and actively participate in standards development
- We focus on and are committed to serving the gas and process industry
- We have extensive experience meeting API standards
- We are proud to be a leading supplier of custom-built solutions
- Our track record includes 100-plus integrally-geared units built according to API 617, chapter 3





Features of Our Turbocompressor Products

This overview provides you with an in-depth look into our turbocompressor products – and how they differ technically.

	H	SC
		
Suction pressure (max.)	1.4 bar(a) (8 bar)*	70 bar(a)
Discharge pressure (max.)	30 bar(a)	70 bar(a)
Suction temperature	-40 to 50°C	-40 to +200°C
Effective inlet-flow range	3,500–42,500 (85,000**) m ³ /h	250–110,000 m ³ /h
Maximum No. of stages	1–4	1
Gases handled	Air, nitrogen	All gases
Impeller types	Open	Open
Shaft / impeller connection	Microspline	Microspline
Seals		
Labyrinth	●	●
Carbon ring	●	●
Dry-gas seal		●
Capacity / pressure control		
Variable inlet-guide vanes (IGV)	●	●
Variable diffuser-guide vanes (DGV)	●**	●
Variable speed		●
Inlet throttle	●	●
API	672	672 / 617
Axial thrust compensation	High-speed axial bearings	High-speed axial bearings
Oil system	Manufacturer's standard or API 614	Manufacturer's standard or API 614
Coupling	Dry	Dry
Test code	VDI2045 / ASME PTC10	VDI2045 / ASME PTC10

* H-booster or request

** for single-stage H

TP	GT	T	HST
			
50 bar(a)	80 bar(a)	40 bar(a)	4 bar(a)
70 bar(a)	200 bar(a)	40 bar(a)	10 bar(a)
-40 to +200°C	-200 to +200°C	-40 to +150°C	-160 to +50°C
250–20,000 m ³ /h	250–400,000 m ³ /h	15,000–50,000 m ³ /h	Up to 50,000 m ³ /h
2–5	1–8	1	1
All gases	All gases	Polyethylene, polypropylene	Natural gas
Open	Open / closed	Open	Open
Microspline	Hirth serration	Hirth serration	Hirth serration
•	•		•
•	•		•
•	•	•	Hermetically sealed
•	•	•	•
	•		•
•	•	•	•
•	•		•
672 / 617	672 / 617	617	
High-speed axial bearings	High-speed axial bearings or thrust collar	High-speed axial bearings	Active magnetic bearings
Manufacturer's standard or API 614	Manufacturer's standard or API 614	API 614	N / A
Dry	Dry	Dry	N / A
VDI2045 / ASME PTC10	VDI2045 / ASME PTC10	VDI2045 / ASME PTC10	VDI2045 / ASME PTC10

Products and Applications at a Glance

Industrial Gases

Main Air Compressor

This turbocompressor feeds an oxygen plant inside a Chinese steel mill.

Type: Three-stage GT153
Inlet pressure: 0.99 bar(a)
Outlet pressure: 6.4 bar(a)
Inlet temperature: 30 °C
Flow: 380,000 m³/h



Industrial Gases

Booster Air Compressor / N₂ Recycle Compressor

This combined service machine is at the heart of a steel and iron mill.

Type: Six-stage combined-service GT040
Inlet pressure: 5.6 bar(a)
Outlet pressure: 62 bar(a)
Inlet temperature: 22 °C
Flow: 8,800 m³/h



Industrial Gases

Recycled Feed Main Air / Booster Air Compressor

This MAC-BAC compressor supplies dry nitrogen.

Type: Four-stage combined-service GT050 / GT032
Inlet pressure: 5.3 bar(a)
Outlet pressure: 29.1 bar(a)
Inlet temperature: 24 °C
Flow: 20,000 m³/h

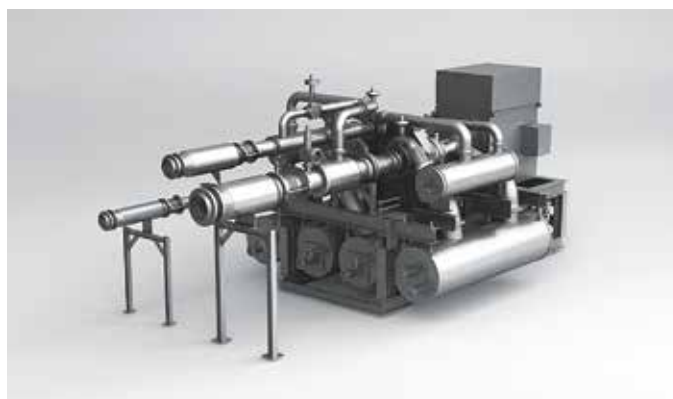

Industrial Gases

Air Compressor for Membrane N₂ Generation

This machine is used in an LNG-regasification application.

Type: Three-stage H16000
Inlet pressure: 0.993 bar(a)
Outlet pressure: 13.9 bar(a)
Inlet temperature: 42 °C
Flow: 19,000 m³/h



Booster Air Compressor

This is a two-stage H-Series compressor.

Type: Two-stage H26000
Inlet pressure: 6 bar(a)
Outlet pressure: 26 bar(a)
Inlet temperature: 30 °C
Flow: 6,600 m³/h

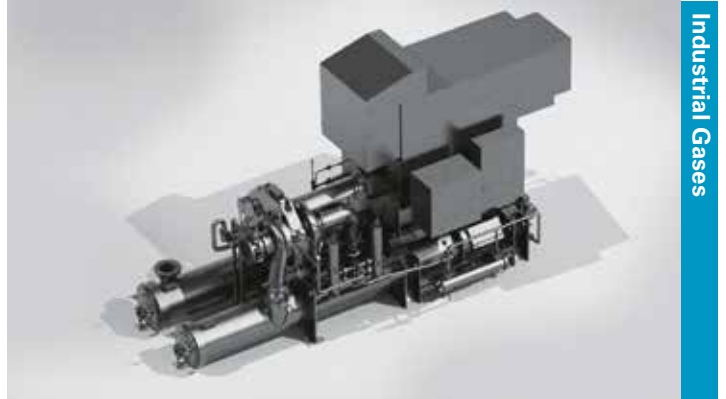

Industrial Gases

Centrifugal Gas Compressor for Power Generation

Close-up of one of our fuel-gas boosters.

Type: Single-stage SC-series
Inlet pressure: 27 bar(a)
Outlet pressure: 42 bar(a)
Inlet temperature: 12 °C
Flow: 2,900 m³/h



Oil and Gas

Centrifugal Gas Compressor for Power Generation

This fuel-gas booster is used inside a Russian natural-gas driven power plant.

Type: Six-stage GT050
Inlet pressure: 5.7 bar(a)
Outlet pressure: 48.3 bar(a)
Inlet temperature: 13 °C
Flow: 14,300 m³/h

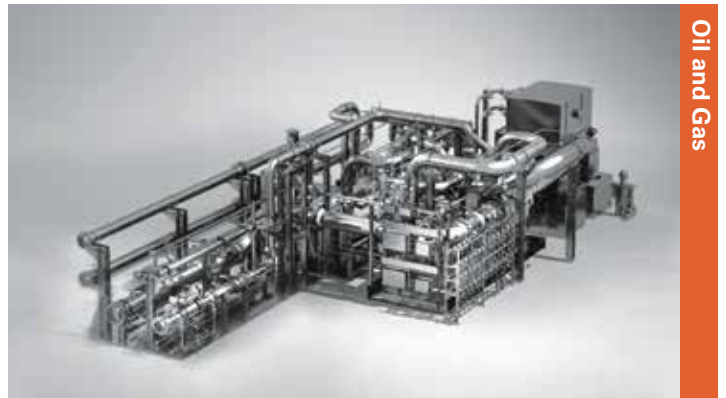

Oil and Gas

Centrifugal Gas Compressor for Power Generation

This fuel-gas booster is used in a combined-cycle power plant.

Type: Single-stage GT026
Inlet pressure: 23.5 bar(a)
Outlet pressure: 35 bar(a)
Inlet temperature: 15 °C
Flow: 3,700 m³/h

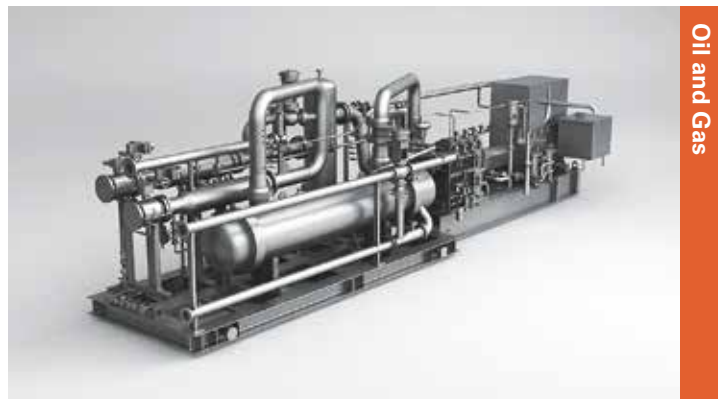

Oil and Gas

Products and Applications at a Glance

Oil and Gas

Centrifugal Compressor for Regeneration Gas

Used in the United Arab Emirates, this regeneration-gas compressor is built to fully support API requirements.

Type: Single-stage GT026
Inlet pressure: 67.35 bar(a)
Outlet pressure: 74.30 bar(a)
Inlet temperature: 62 °C
Flow: 2,500 m³/h

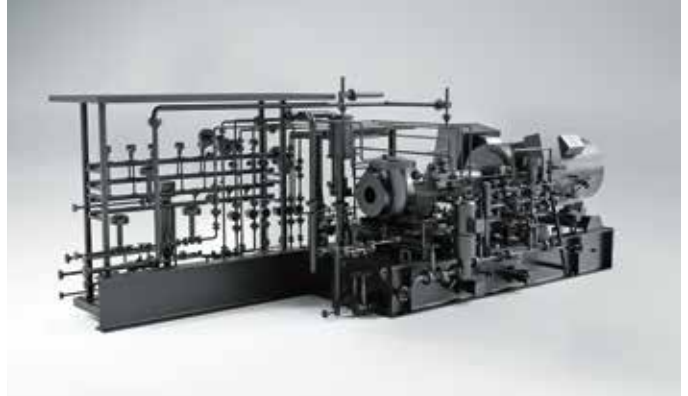

Oil and Gas

Comander for Liquefied Natural Gas (LNG)

The comander's expander stage is an essential component in an on-board LNG reliquefaction plant.

Type: Three-stage GT 032 N3D0 /
Single-stage ETG 150 MS
Inlet Pressure: 56.35 bar(a)
Inlet Temperature: -110 °C
Flow: 94,400 Nm³/h
Expander Cold Production: 1,096 kW (1,469 HP)

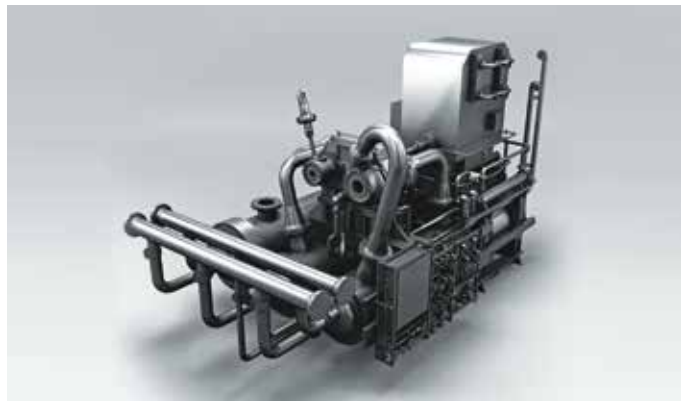

Oil and Gas

Comander for Chemical

The comander is deployed in a Belgian hydrogen-peroxide-to-propylene-oxide (HPPO) plant.

Type: Three-stage GT056/ETI300NS
Inlet pressure: 1.1 bar(a)
Outlet pressure: 8.7 bar(a)
Inlet temperature: 20 °C
Flow: 37,500 m³/h



Oil and Gas

Centrifugal Gas Compressor for Petrochem

This compressor is deployed in a methanol application.

Type: Four-stage GT026
Inlet pressure: 6.40 bar(a)
Outlet pressure: 38.90 bar(a)
Inlet temperature: 38 °C
Flow: 2,500 m³/h

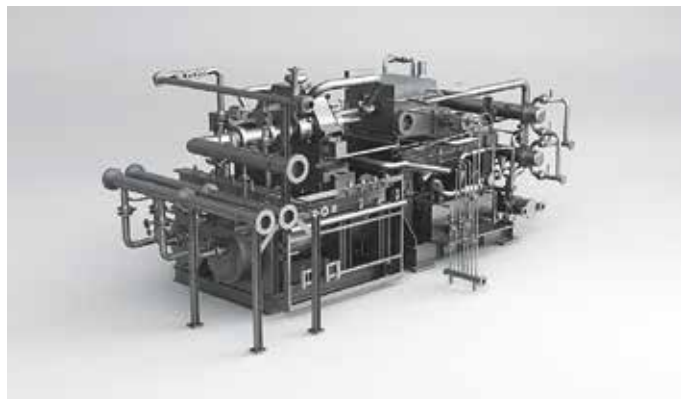

Centrifugal Gas Compressor for Ethylene

This compressor used inside a polyethylene plant.

Type: Four-stage GT021
Inlet pressure: 18.5 bar(a)
Outlet pressure: 74.5 bar(a)
Inlet temperature: 33 °C
Flow: 2,200 m³/h



Oil and Gas

Centrifugal Gas Compressor for Coal Gasification

This five-stage machine is used in a CO application in China.

Type: Five-stage GT070
Inlet pressure: 1.1 bar(a)
Outlet pressure: 83.4 bar(a)
Inlet temperature: 12 °C
Flow: 43,000 m³/h



Oil and Gas

Centrifugal Gas Compressor for Petrochemical

This compressor for a Chinese petrochemical plant had to meet complex requirements.

Type: Five-stage GT032
Inlet pressure: 1.8 bar(a)
Outlet pressure: 37.9 bar(a)
Inlet temperature: 27 °C
Flow: 30,000 m³/h



Oil and Gas

Centrifugal Gas Compressor for Gas Pipeline

This compressor for CO₂ is used in a gas-pipeline application in the Netherlands.

Type: Four-stage GT032
Inlet pressure: 1.06 bar(a)
Outlet pressure: 31 bar(a)
Inlet temperature: 31 °C
Flow: 10,800 m³/h

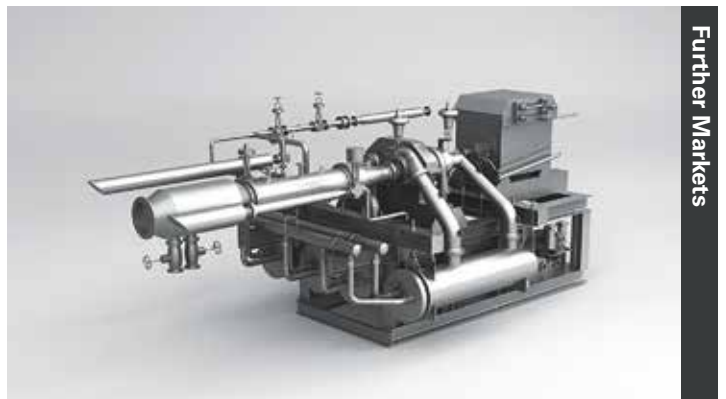

Further Markets

Our Products for Your Market

Market Applications	Centrifugal Gas Compressor			Centrifugal Air Compressor	
	GT	T	SC/TP	H	GT
Industrial Gas					
Main air	●			●	●
Booster air / N ₂	●		●	●	
Oxygen compression			●		
Steel	●	●	●	●	●
Electronics	●		●	●	●
GTL / Syngas / CO	●	●	●		●
N ₂ recycle – feed	●		●	●	
Carbon capture storage (CCS)	●				●
Oil and Gas					
Gas processing – upstream	●	●	●		
Gas treatment – upstream	●	●	●		
Liquefied petroleum gas (LPG) – upstream	●	●	●		
LNG transportation – midstream	●				
LNG reliquefaction – midstream	●	●	●		
LNG onshore – midstream	●	●	●		
Gas storage – midstream	●	●	●		
Gas pipeline – midstream	●	●	●		
Petrochemical – downstream	●	●	●		
Fertilizer – downstream	●	●	●		
Refineries – downstream	●	●	●		
Gas to liquid – downstream	●	●	●		
Gas aromatics – downstream	●				
Power generation – downstream	●	●	●	●	●
Further Markets					
Mechanical vapor compression	●		●		
Wastewater treatment				●	
Flue-gas desulfurization (FGD)				●	
Pharmaceutical food				●	
Automotive				●	
Glass				●	
Plant & industrial air				●	
Process air			●	●	●
Sootblowing air				●	



COMMITTED TO SUSTAINABLE PRODUCTIVITY

We stand by our responsibilities towards our customers, towards the environment and the people around us. Our renewable energy services are one of the ways we put this commitment into action. Find out more on our website or by contacting your local Atlas Copco sales specialist.

Atlas Copco Gas and Process Division
Schlehenweg 15, 50999 Cologne, Germany
www.atlascopco-gap.com

Atlas Copco