

# Safety Recall

## Code: 20BM



<b>Subject</b>	<b>Fuel Pressure Damper</b>
<b>Release Date</b>	February 12, 2019
<b>Affected Vehicles</b>	<b>U.S.A. &amp; CANADA: Certain 2013-2016 MY Audi S8 &amp; A8</b> <i>Check Campaigns/Actions screen in Elsa on the day of repair to verify that a VIN qualifies for repair under this action. Elsa is the <u>only</u> valid campaign inquiry &amp; verification source.</i> <ul style="list-style-type: none"><li>✓ Campaign status must show "open."</li><li>✓ If Elsa shows other open action(s), inform your customer so that the work can also be completed at the same time the vehicle is in the workshop for this campaign.</li></ul>
<b>Problem Description</b>	Over time, the fuel supply line for the high pressure fuel pump may become porous, resulting in a fuel odor or a fuel leak. Leaking fuel, in the presence of an ignition source, may result in a fire.
<b>Corrective Action</b>	A fuel pressure damper will be installed in the low pressure fuel supply located inside the fuel tank.
<b>Important Repair Scheduling Information</b>	Fuel Level on Day of Repair (Customer Vehicles) To help facilitate this repair, please advise customers to have the fuel level in the vehicle at one-quarter tank or less on the day of repair if at all possible.
<b>Precautions</b>	Customers who notice a fuel odor in the vehicle are advised to contact an authorized Audi dealer without delay and arrange to have the vehicle inspected.
<b>Parts Information</b>	Parts will be allocated prior to owner notification. If allocated parts have been used and your dealership is at the weekly Upper Order Limit, please submit the backordered sales document number to <a href="mailto:upperorderlimits@audi.com">upperorderlimits@audi.com</a> to have additional parts released.
<b>Code Visibility</b>	On or about February 12, 2019, affected vehicles will be listed on the Inventory Vehicle Open Campaign Action report under My Dealership Reports (found on <a href="http://www.accessaudi.com">www.accessaudi.com</a> & OMD Web). A list will not be posted for dealers who do not have any affected vehicles. On or about February 12, 2019, this campaign code will show open on affected vehicles in Elsa. On or about February 12, 2019, affected vehicles will be identified with this campaign code in the VIN Lookup tool at <a href="http://www.audiusa.com">www.audiusa.com</a> and on the NHTSA VIN lookup tool at <a href="http://www.safercar.gov">www.safercar.gov</a> .
<b>Owner Notification</b>	Owner notification will take place in February 2019. Owner letter examples are included in this bulletin for your reference.
<b>Additional Information</b>	<b>Please alert everyone in your dealership about this action, including Sales, Service, Parts and Accounting personnel. Contact Warranty if you have any questions.</b> <b>IMPORTANT REMINDER ON VEHICLES AFFECTED BY SAFETY &amp; COMPLIANCE RECALLS</b> <b><u>New Vehicles in Dealer Inventory:</u> It is a violation of federal law for a dealer to deliver a new motor vehicle or any new or used item of motor vehicle equipment (including a tire) covered by this notification under a sale or lease until the defect or noncompliance is remedied. By law, dealers must correct, prior to delivery for sale or lease, any vehicle that fails to comply</b>

with an applicable Federal Motor Vehicle Safety Standard or that contains a defect relating to motor vehicle safety.

**Pre-Owned Vehicles in Dealer Inventory: Dealers should not deliver any pre-owned vehicles in their inventory which are involved in a safety or compliance recall until the defect has been remedied.**

Dealers must ensure that every affected inventory vehicle has this campaign completed before delivery to consumers.

### Claim Entry Instructions

After campaign has been completed, enter claim as soon as possible to help prevent work from being duplicated elsewhere. Attach the Elsa screen print showing action open on the day of repair to the repair order.

If customer refused campaign work:

- ✓ U.S. dealers: Submit the request through Audi Warranty Online under the Campaigns/Update option.
- ✓ Canada dealers: Upload the repair order [signed by customer] to Audi WIN/Operations/Campaign Closure.

<b>Service Number</b>	20BM																								
<b>Damage Code</b>	0099																								
<b>Parts Vendor Code</b>	002																								
<b>Claim Type</b>	Sold vehicle: 7 10 Unsold vehicle: 7 90																								
<b>Causal Indicator</b>	Mark pressure damper as causal part*																								
<b>Vehicle Wash/Loaner</b>	Do not claim wash/loaner under this action																								
<b>Criteria I.D.</b>	01 or 02																								
	<p>Install fuel pressure damper and replace fuel pressure regulator</p> <p>Labor operation: 2057 23 99 140 T.U.</p> <table border="1"> <thead> <tr> <th>Quantity</th> <th>Part Number</th> <th>Description</th> </tr> </thead> <tbody> <tr> <td>1.00</td> <td>4H0201574</td> <td>Pressure damper*</td> </tr> <tr> <td>1.00</td> <td>4H0201559F</td> <td>In-tank regulator</td> </tr> <tr> <td>1.00</td> <td>4H0201284E</td> <td>Cover and hose kit</td> </tr> <tr> <td>1.00</td> <td>1J0919133B</td> <td>Seal ring</td> </tr> </tbody> </table> <p>-AND- (ONLY if vehicle is equipped with rear bucket seats)</p> <table border="1"> <thead> <tr> <th>Quantity</th> <th>Part Number</th> <th>Description</th> </tr> </thead> <tbody> <tr> <td>2.00</td> <td>4E0885196</td> <td>Seat mounting clip</td> </tr> </tbody> </table>	Quantity	Part Number	Description	1.00	4H0201574	Pressure damper*	1.00	4H0201559F	In-tank regulator	1.00	4H0201284E	Cover and hose kit	1.00	1J0919133B	Seal ring	Quantity	Part Number	Description	2.00	4E0885196	Seat mounting clip			
Quantity	Part Number	Description																							
1.00	4H0201574	Pressure damper*																							
1.00	4H0201559F	In-tank regulator																							
1.00	4H0201284E	Cover and hose kit																							
1.00	1J0919133B	Seal ring																							
Quantity	Part Number	Description																							
2.00	4E0885196	Seat mounting clip																							
<b>Criteria I.D.</b>	03																								
	<p>Install fuel pressure damper, replace fuel pressure regulator and replace external fuel line</p> <p>Labor operation: 2057 24 99 180 T.U.</p> <table border="1"> <thead> <tr> <th>Quantity</th> <th>Part Number</th> <th>Description</th> </tr> </thead> <tbody> <tr> <td>1.00</td> <td>4H0201574</td> <td>Pressure damper*</td> </tr> <tr> <td>1.00</td> <td>4H0201559F</td> <td>In-tank regulator</td> </tr> <tr> <td>1.00</td> <td>4H0201284E</td> <td>Cover and hose kit</td> </tr> <tr> <td>1.00</td> <td>1J0919133B</td> <td>Seal ring</td> </tr> <tr> <td>1.00</td> <td>4H0201220G</td> <td>Fuel line</td> </tr> </tbody> </table> <p>-AND- (ONLY if vehicle is equipped with rear bucket seats)</p> <table border="1"> <thead> <tr> <th>Quantity</th> <th>Part Number</th> <th>Description</th> </tr> </thead> <tbody> <tr> <td>2.00</td> <td>4E0885196</td> <td>Seat mounting clip</td> </tr> </tbody> </table>	Quantity	Part Number	Description	1.00	4H0201574	Pressure damper*	1.00	4H0201559F	In-tank regulator	1.00	4H0201284E	Cover and hose kit	1.00	1J0919133B	Seal ring	1.00	4H0201220G	Fuel line	Quantity	Part Number	Description	2.00	4E0885196	Seat mounting clip
Quantity	Part Number	Description																							
1.00	4H0201574	Pressure damper*																							
1.00	4H0201559F	In-tank regulator																							
1.00	4H0201284E	Cover and hose kit																							
1.00	1J0919133B	Seal ring																							
1.00	4H0201220G	Fuel line																							
Quantity	Part Number	Description																							
2.00	4E0885196	Seat mounting clip																							

The repair information in this document is intended for use only by skilled technicians who have the proper tools, equipment and training to correctly and safely maintain your vehicle. These procedures are not intended to be attempted by "do-it-yourselfers," and you should not assume this document applies to your vehicle, or that your vehicle has the condition described. To determine whether this information applies, contact an authorized Audi dealer. ©2019 Audi of America, Inc. and Audi Canada. All Rights Reserved.

## Customer Letter Example (U.S.A.)

<MONTH YEAR>

<CUSTOMER NAME>

<CUSTOMER ADDRESS>

<CUSTOMER CITY STATE ZIPCODE>

**This notice applies to your vehicle:** <VIN>

**NHTSA:** 19V057

**Subject: Safety Recall 20BM – Fuel Pressure Damper  
Certain 2013-2016 Model Year Audi S8 & A8 Vehicles**

Dear Audi Owner,

This notice is sent to you in accordance with the National Traffic and Motor Vehicle Safety Act. Audi has decided that a defect, which relates to motor vehicle safety, exists in certain 2013-2016 model year Audi S8 and A8 vehicles. Our records show that you are the owner of a vehicle affected by this action.

- What is the issue?** Over time, the fuel supply line for the high pressure fuel pump may become porous, resulting in a fuel odor or a fuel leak. Leaking fuel, in the presence of an ignition source, may result in a fire.
- What will we do?** To correct this defect, your authorized Audi dealer will install a fuel pressure damper in the low pressure fuel supply located inside the fuel tank. This work will take up to two (2) hours to complete and will be performed for you free of charge. Please keep in mind that your dealer may need additional time for the preparation of the repair, as well as to accommodate their daily workshop schedule.
- What should you do?** Please contact your authorized Audi dealer without delay to schedule this recall repair. For your convenience, you can also visit [www.audiusa.com](http://www.audiusa.com) and click on the "Find a Dealer" link to locate a dealer near you and schedule this service.
- To help facilitate this repair, if possible please have the fuel level in your vehicle at one-quarter tank or less on the day of repair.
- Precautions you should take** Customers who notice a fuel odor in the vehicle are advised to contact an authorized Audi dealer without delay and arrange to have the vehicle inspected.
- Lease vehicles and address changes** If you are the lessor and registered owner of the vehicle identified in this action, the law requires you to forward this letter immediately via first-class mail to the lessee within ten (10) days of receipt. If you have changed your address or sold the vehicle, please fill out the enclosed prepaid Owner Reply card and mail it to us so we can update our records.
- Reimbursement of Expenses** If you have previously paid for repairs relating to the condition described in this letter, the enclosed form explains how to request reimbursement. We would be pleased to review your reimbursement request.
- Can we assist you further?** If your authorized Audi dealer fails or is unable to complete this work free of charge within a reasonable time, please contact Audi Customer Experience at 1-800-253-2834 or via our "Contact Us" page at [www.audiusa.com](http://www.audiusa.com).
- Checking your vehicle for open Recalls and Service Campaigns** To check your vehicle's eligibility for repair under this or any other recall/service campaign, please visit the **Recall/Service Campaign Lookup** tool at [www.audiusa.com](http://www.audiusa.com) and enter your Vehicle Identification Number (VIN).

If you still cannot obtain satisfaction, you may file a complaint with: The Administrator, National Highway Traffic Safety Administration, 1200 New Jersey Avenue, SE., Washington, DC 20590; or call the toll-free Vehicle Safety Hotline at 1-888-327-4236 (TTY: 1-800-424-9153); or go to <http://www.safercar.gov>.

We apologize for any inconvenience this matter may cause; however we are taking this action to help ensure your safety and continued satisfaction with your vehicle.

Sincerely,

Audi Customer Protection

## Customer Letter Example (CANADA)

<MONTH YEAR>

<CUSTOMER NAME>

<CUSTOMER ADDRESS>

<CUSTOMER CITY STATE ZIPCODE>

**This notice applies to your vehicle:** <VIN>

**Subject: Safety Recall 20BM – Fuel Pressure Damper  
Certain 2013-2016 Model Year Audi S8 & A8 Vehicles**

Dear Audi Owner,

This notice is sent to you in accordance with the requirements of the Motor Vehicle Safety Act. Audi has decided that a defect, which relates to motor vehicle safety, exists in certain 2013-2016 model year Audi S8 and A8 vehicles. Our records show that you are the owner of a vehicle affected by this action.

**What is the issue?** Over time, the fuel supply line for the high pressure fuel pump may become porous, resulting in a fuel odor or a fuel leak. Leaking fuel, in the presence of an ignition source, may result in a fire.

**What will we do?** To correct this defect, your authorized Audi dealer will install a fuel pressure damper in the low pressure fuel supply located inside the fuel tank. This work will take up to two (2) hours to complete and will be performed for you free of charge. Please keep in mind that your dealer may need additional time for the preparation of the repair, as well as to accommodate their daily workshop schedule.

**What should you do?** Please contact your authorized Audi dealer without delay to schedule this recall repair. To help facilitate this repair, if possible please have the fuel level in your vehicle at one-quarter tank or less on the day of repair.

**Precautions you should take** Customers who notice a fuel odor in the vehicle are advised to contact an authorized Audi dealer without delay and arrange to have the vehicle inspected.

**Lease vehicles and address changes** If you are the lessor and registered owner of the vehicle identified in this action, the law requires you to forward this letter immediately via first-class mail to the lessee within ten (10) days of receipt. If you have changed your address or sold the vehicle, please fill out the enclosed prepaid Owner Reply card and mail it to us so we can update our records.

**Reimbursement of Expenses** If you have previously paid for repairs relating to the condition described in this letter, the enclosed form explains how to request reimbursement. We would be pleased to review your reimbursement request.

**Can we assist you further?** If your authorized Audi dealer fails or is unable to complete this work free of charge within a reasonable time, please contact Audi Customer Relations Monday through Friday from 8AM to 8PM EST at 1-800-822-2834 or via our "Contact Audi Canada" page at [www.audi.ca](http://www.audi.ca).

We apologize for any inconvenience this matter may cause; however we are taking this action to help ensure your safety and continued satisfaction with your vehicle.

Sincerely,

Audi Customer Protection

**Repair Overview**

**NOTE**

- These repair instructions may differ from the labor operations and labor times listed in ELSA.
- Damages resulting from improper repair or failure to follow these work instructions are the dealer's responsibility and are not eligible for reimbursement under this action.
- This procedure must be read in its entirety prior to performing the repair.
- Due to variations in vehicle equipment and options, the steps/illustrations in this work procedure may not identically match all affected vehicles.
- Diagnosis and repair of pre-existing conditions in the vehicle are not covered under this action.
- When working during extreme temperatures, it is recommended that the vehicle be allowed to acclimate inside the shop to avoid temperature-related component damage/breakage.

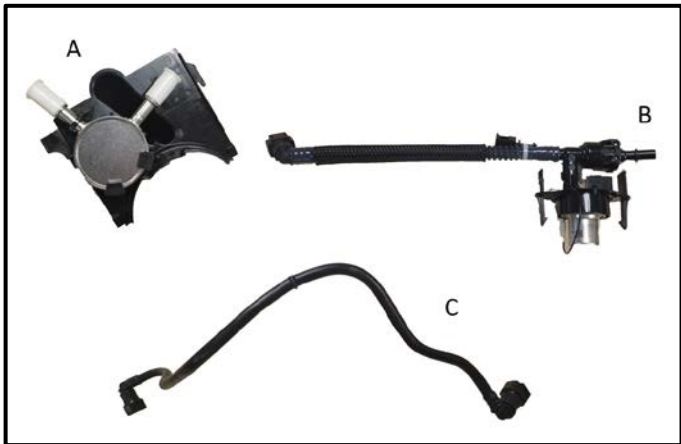

- Criteria 01 and 02 vehicles:
  - Install in-tank fuel pressure damper <A>.
  - Replace in-tank fuel pressure regulator <B>.
- Criteria 03 vehicles:
  - Install in-tank fuel pressure damper <A>.
  - Replace in-tank fuel pressure regulator <B>.
  - Remove external fuel pressure damper and install a new fuel line <C>.

## Required Parts

<u>Criteria</u>	<u>Quantity</u>	<u>Part Number</u>	<u>Part Description</u>
01 or 02 or 03	1	4H0.201.559.F	In-tank regulator
	1	4H0.201.574	Pressure damper
	1	4H0.201.284.E	Cover and hose kit
	1	1J0.919.133.B	Seal ring
03 only	1	4H0.201.220.G	Fuel line

### ! NOTE

The specified part numbers reflect the status at the start of this recall. Interim updates made in ETKA can cause a listed part number to become unavailable. In this case, the new part number specified in ETKA should be used.

## Required Tools

	<p>Fuel Extracting Device -VAS5190A- (or equivalent)</p>		<p>Adapter -VAS5190/4- (or equivalent from Adapter set -VAS5190/10-) (or equivalent)</p>
	<p>Torque Wrench 5-50Nm -VAG1331- (or equivalent)</p>		<p>Torque Wrench 40 - 200 Nm -VAG1332- (or equivalent)</p>
	<p>Wrench - Fuel Sending Unit -T10202-</p>		<p>Pry lever -80-200- (or equivalent)</p>

## Repair Instruction

### Section A - Check for Previous Repair

Applicable criteria ID(s)	Campaign/Action Status
01 ← <b>2</b>	Open ← <b>1</b>

**EXAMPLE**

- Enter the VIN in Elsa and proceed to the “Campaign/Action” screen.

#### TIP

On the date of repair, print this screen and keep a copy with the repair order.

- Confirm the Campaign/Action is open <arrow 1>. If the status is closed, no further work is required.
- Note the Applicable Criteria ID <arrow 2> for use in determining the correct work to be done and corresponding parts associated.
- **Proceed to Section B**



## Section B – Install In-tank Fuel Pressure Damper and Replace Pressure Regulator

### **⚠ WARNING**

Risk of injury. Refer to “Warning and Safety Precautions”, found in **Appendix A** at the end of this document.



#### **Record fuel level:**

- Check the vehicle fuel level displayed on the instrument cluster <1>.
- Record the vehicle fuel level on the repair order.

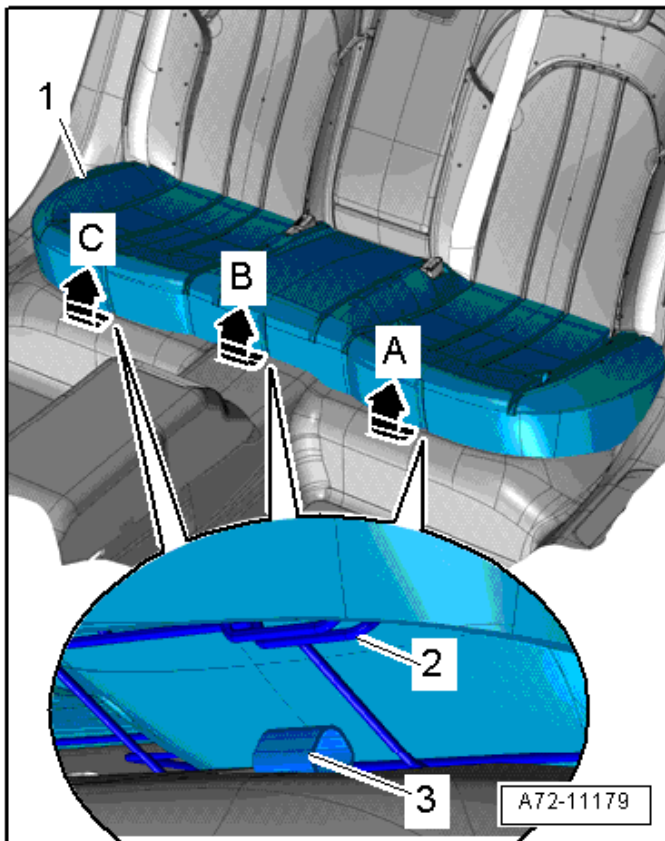

#### **Remove rear seat bench (vehicles without rear bucket seats):**

- Move the front seats all the way forward.
- Gently pull upward on the rear seat bench <1> to the same height as one of the mounts <3> (apply some initial tension) in the direction of <arrow A>.
- Use the Pry Lever -80-200- to pry the seat frame <2> for the rear seat bench from its mount <3>, making sure not to bend or twist the seat frame.
- Repeat the procedure in the center and on the opposite side of the rear seat bench in the direction of <arrows B, C>.
- Vehicles with seat heating: disconnect the seat heating connector
- Remove rear seat bench from the vehicle.

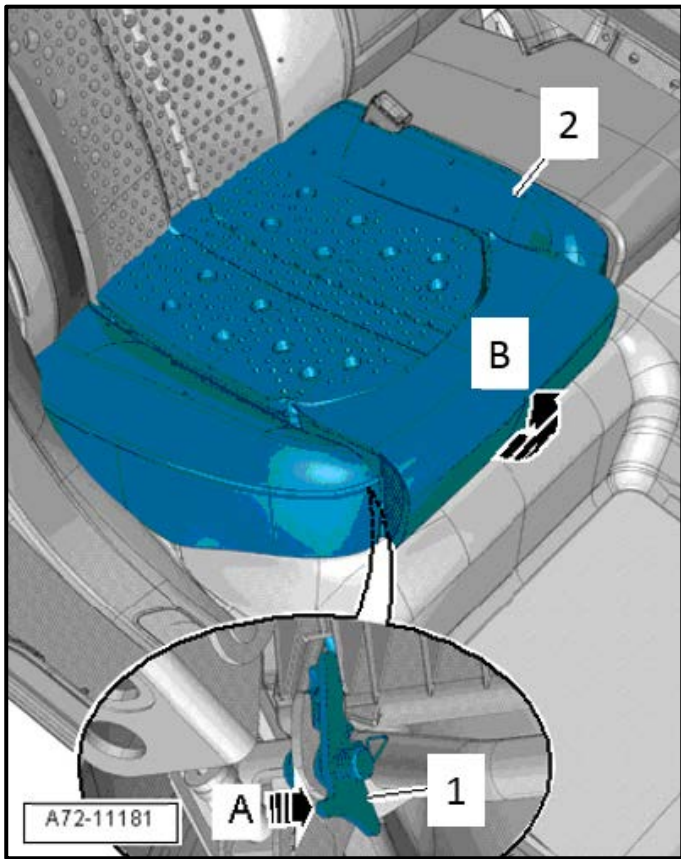

**Remove passenger rear seat pan (vehicles with rear bucket seats):**

- Move individual power rear seat into the rearmost, highest position.
- Grab under the side of the seat frame toward the front and press release lever <1> in the direction of <arrow A>.
- Simultaneously, pull seat pan <2> up with the other hand in the direction of <arrow B>, so the seat pan disengages from the mount.
- Disconnect the connectors and remove seat pan from the vehicle.

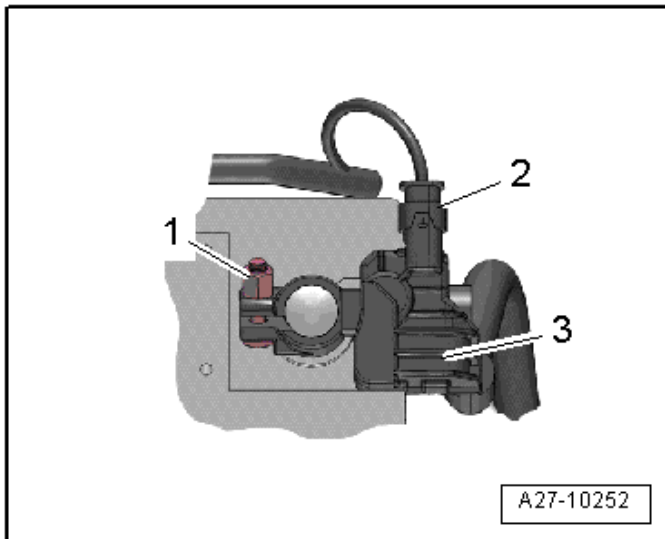

**Disconnect battery:**

- Access the battery.
- Disconnect and isolate battery ground cable <3>.

**IMPORTANT REPAIR STEP**

**STOP! STOP!**

**IMPORTANT!**

These fuel line coupling disconnect instructions must be followed in order, so damage to the fuel couplings does not occur:

- Counter-hold the component (i.e. fuel pump flange or fuel pressure regulator).
- Push the fuel coupling toward the component.
- Push and hold the release buttons only after the coupling has been pushed toward the component.
- Remove fuel coupling from the component.

**CAUTION**

**RISK OF NONPAYMENT!**

- The above instructions must be followed, otherwise the fuel coupling will not disengage.
- DO NOT use pliers or other tools or damage to the coupling may occur.
- Damage to any fuel coupling or fuel line/hose due to improper removal/installation may cause a leak.
- **A damaged fuel coupling requires replacement of the fuel line/hose. Consequential damage resulting from improper removal/installation of a fuel coupling is not covered under this campaign.**

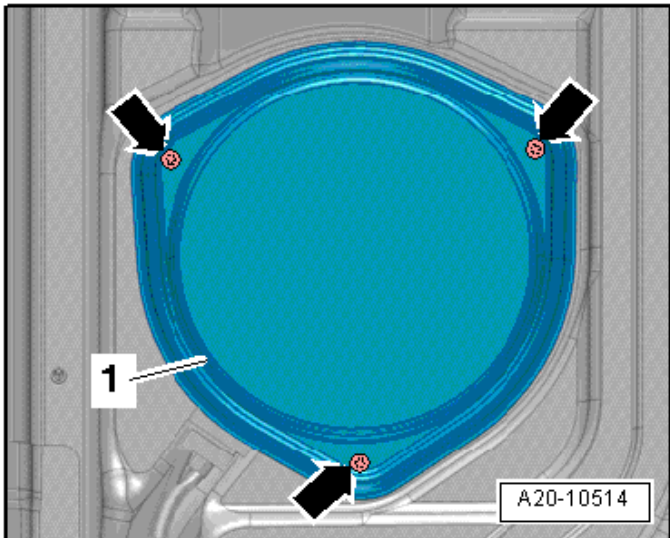

**Remove flange cover:**

- Position carpet so the sealing cover can be accessed.
- Remove the bolts <arrows> and remove the sealing flange cover <1>.

**TIP**

The carpet may have to be cut along the perforations in order to access the sealing flange cover.

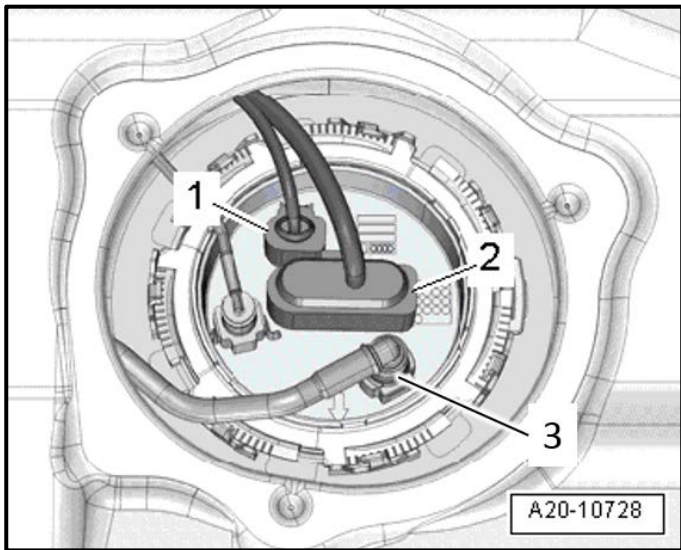

- Disconnect the connectors <1 and 2> on the sealing flange by releasing the connector safety catch.

**⚠ WARNING**

**Risk of injury because the fuel is under pressure.**

To reduce pressure in fuel system, lay a clean cloth around the coupling and carefully remove the coupling.

- Disconnect fuel line <3> from the sealing flange.

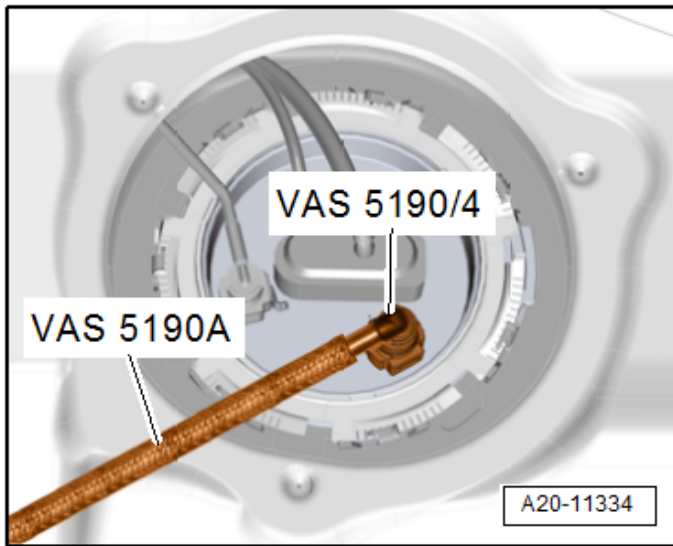

**Drain fuel tank:**

- Connect the hose from the fuel extraction device to the fuel supply connection on the sealing flange (VAS5190A with VAS5190/4 shown).
- Drain all the fuel from the fuel tank.

**⚠ WARNING**

**Danger due to escaping fuel.**

To prevent large quantities of fuel from leaking from the fuel delivery unit when removing, the fuel tank should be completely empty.

- Record how much fuel is drained.

**! NOTE**

Accurately record the amount of fuel in liters removed from the vehicle.

It is required to fill the fuel tank precisely with the amount of fuel removed. Failure to do so may result in fuel sending unit faults.

- Remove suction hose from the sealing flange.

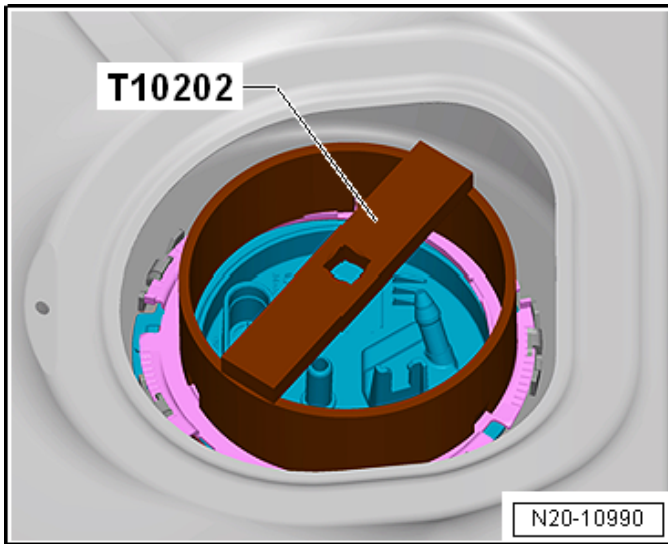

**Remove sealing flange:**

- Remove the locking ring using the -T10202-.

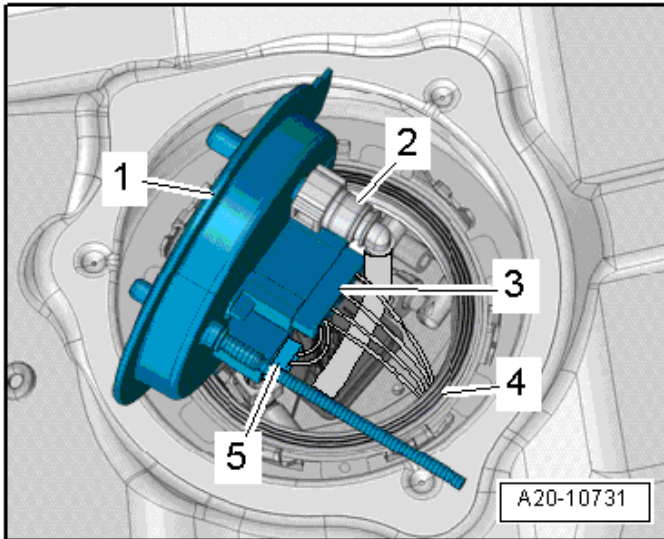

- Place absorbent mats around fuel tank opening to catch any dripping fuel.
- Remove sealing flange <1> from the fuel tank.
- Remove the seal <4> through the opening in the fuel tank.
- Press the release button and disconnect the fuel line <2> from the sealing flange.
- Release the connector safety catch and disconnect the connectors <3 and 5>.

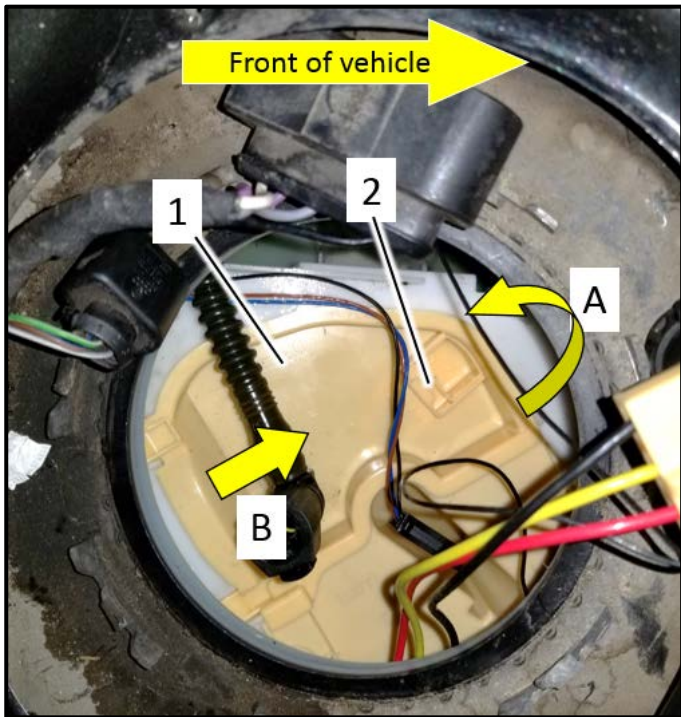

**Remove first cover <1>:**

- Release locking tab <2>.
- Lift cover in direction of <arrow A>.
- Remove cover in direction of <arrow B>.

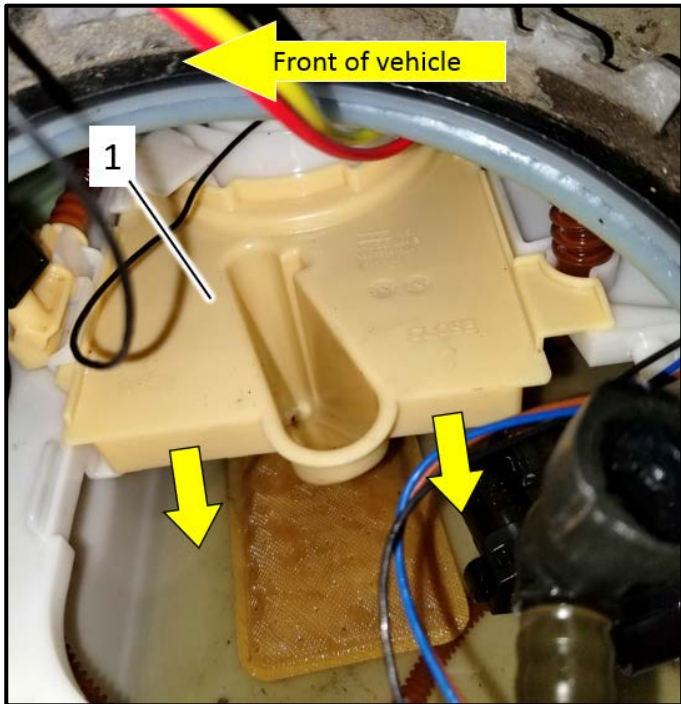

**Remove and discard second cover <1>:**

- Pull second cover <1> off in direction of <arrows>.
- Discard cover.

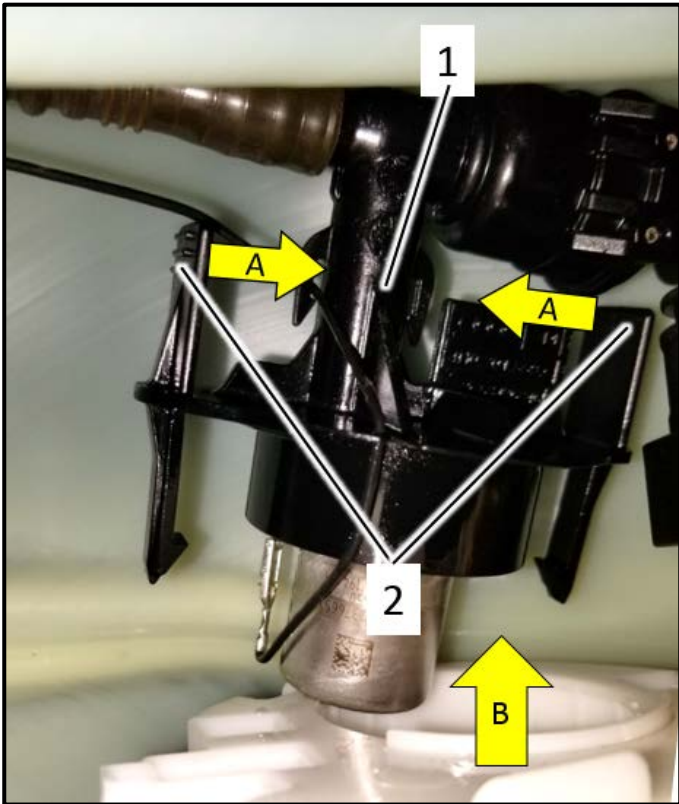

#### Release fuel pressure regulator <1> from fuel tank:

- Reach into the fuel tank opening and toward the front of the vehicle.
- Press locking release tabs <2> in direction of <arrows A>.
- Remove pressure regulator <1> in direction of <arrow B>.

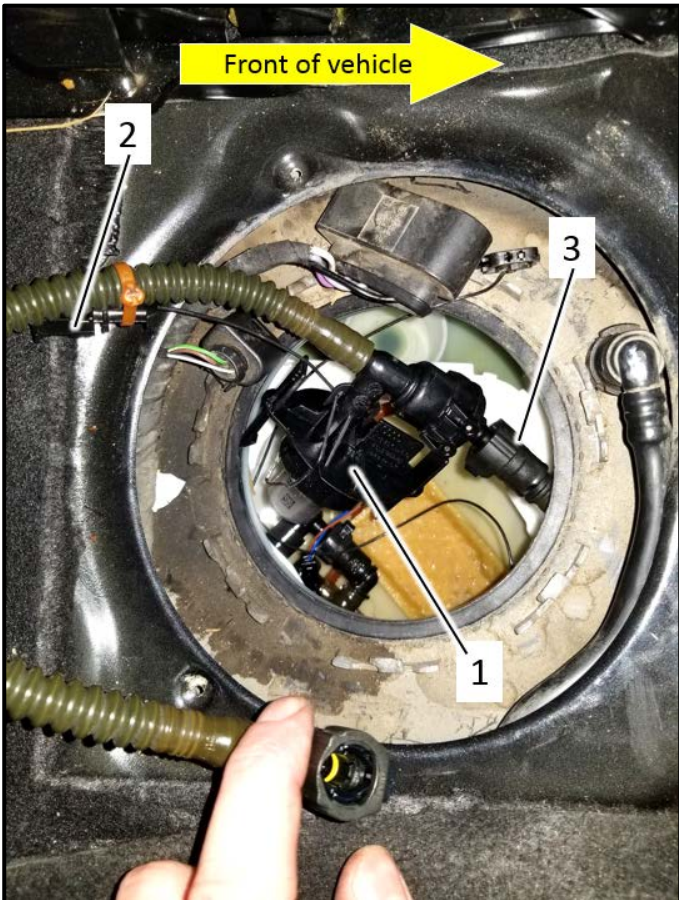

#### Remove fuel pressure regulator <1> from the fuel tank:

- Pull fuel pressure regulator <1> with hoses attached slightly out of the fuel tank.
  - Fuel pressure regulator has to be rotated as shown in order to be removed.
- Disconnect ground wire connector <2>.
- Disconnect fuel hose coupling <3>.
- Remove fuel pressure regulator <1>.

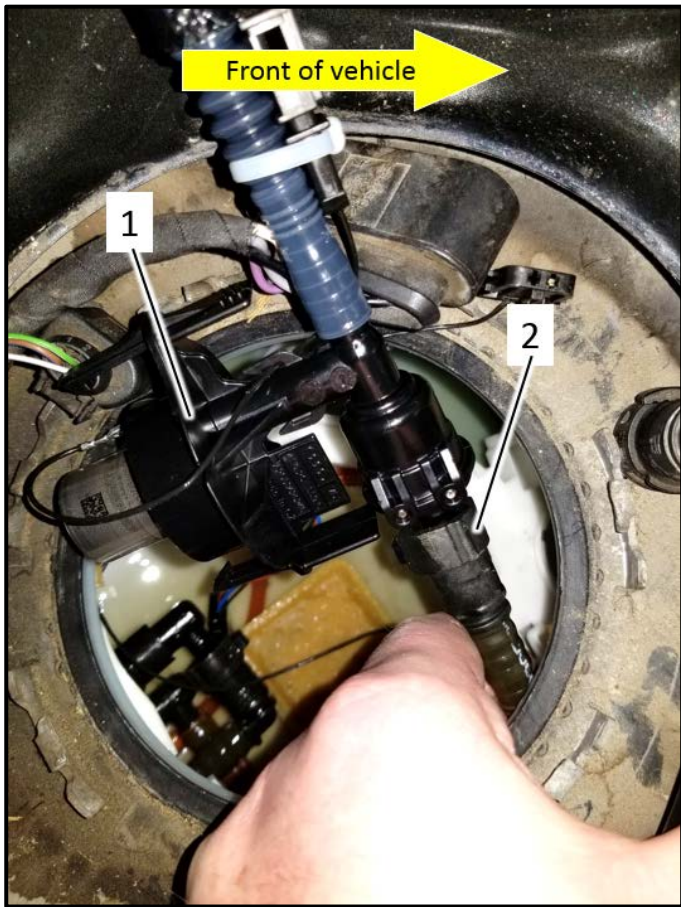

**Install new fuel pressure regulator:**

- Connect fuel line coupling <2> to new fuel pressure regulator <1> until it audibly locks.

Part Number	Part Description
4H0.201.559.F	Fuel pressure regulator

- Gently pull on coupling <2> to verify that it is locked properly in place.
- Install fuel pressure regulator <1> into fuel tank.



- Connect ground wire connector <1>.
- Install fuel pressure regulator <1> into fuel tank.





- Lock fuel pressure regulator <1> into place.

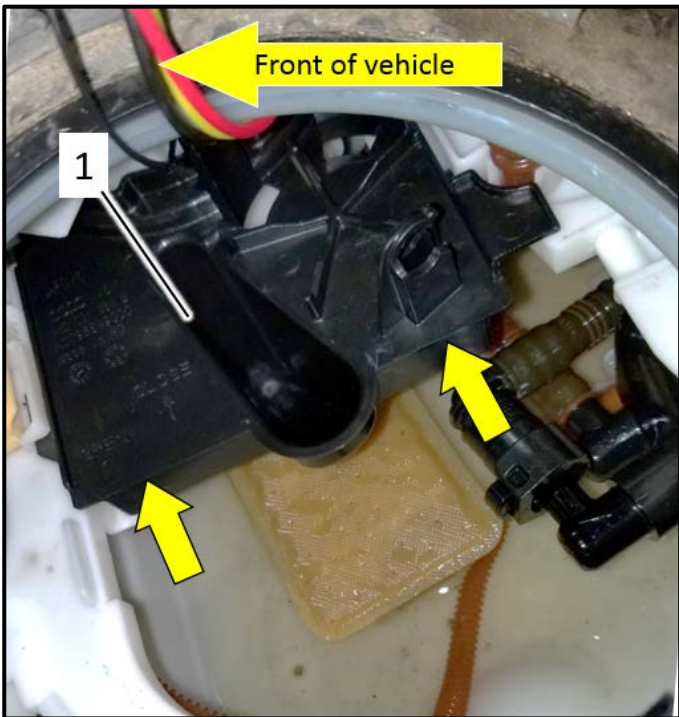

**Install new cover <1>:**

- Install new cover <1> in direction of <arrows> until it audibly locks into place.

** TIP**

The new cover is included in cover and hose kit, part number 4H0.201.284.E

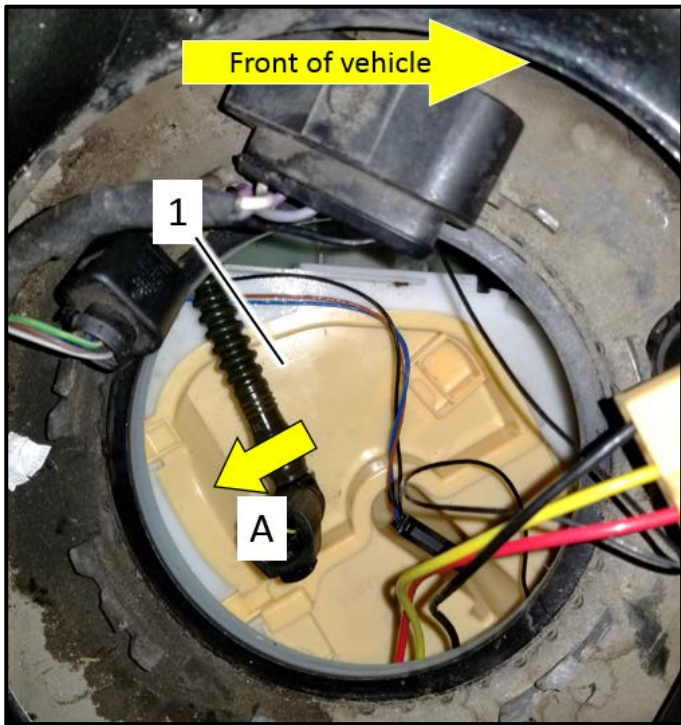

**Install cover <1>:**

- Install cover <1> in direction of <arrow A> until it locks onto the hinge pins.
- Fold cover down until it locks into place.

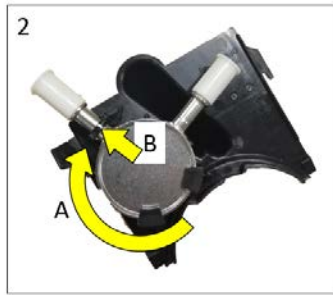

### Install fuel pressure damper <1>:

- Install new fuel pressure damper into cover.

Part Number	Part Description
4H0.201.574	Pressure damper

- Rotate damper in direction of <arrow A> until damper is locked into place <arrow B>.

### NOTE

Photos <1 and 2> show cover removed for clarity.

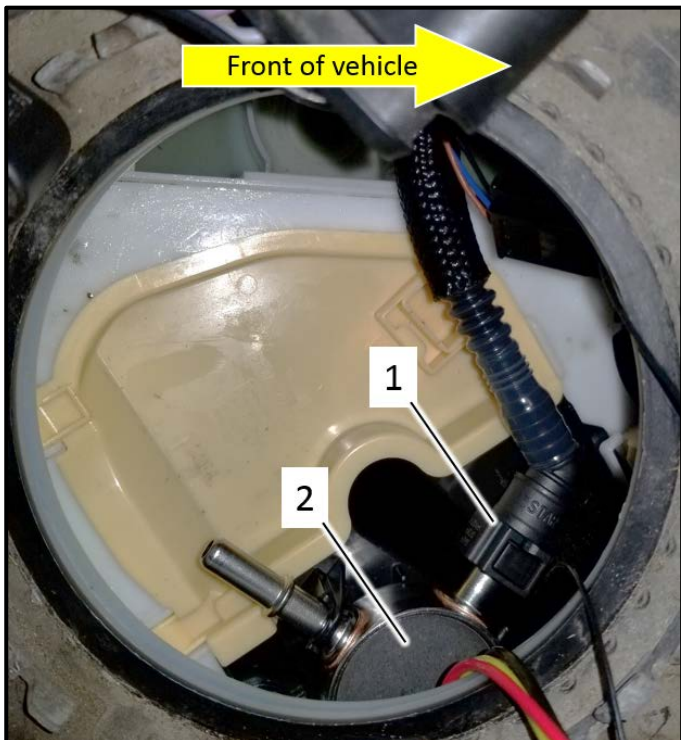
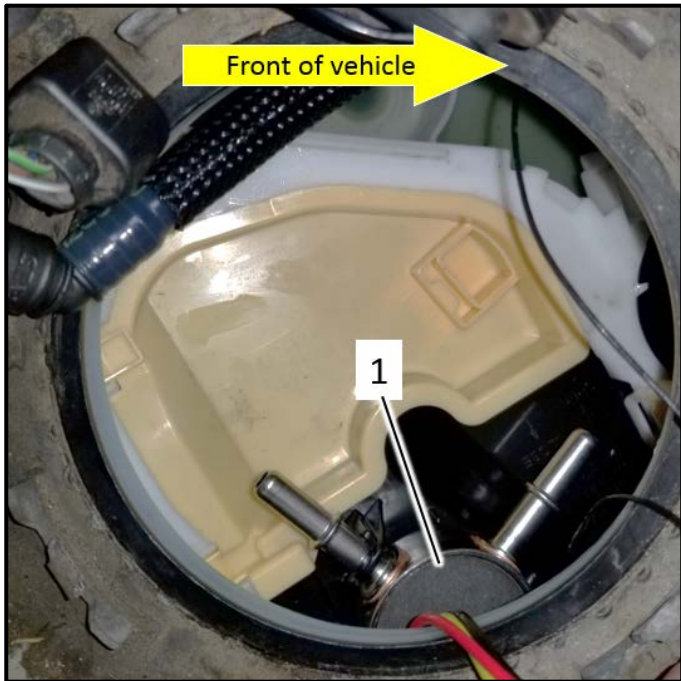

### Connect fuel line from fuel pressure regulator to fuel pressure damper:

- Install fuel line coupling <1> onto fuel pressure damper <2> until it audibly locks.
- Gently pull on coupling <1> to verify that it is locked properly in place.



### Connect new fuel line to fuel pressure damper:

- Fitting <a> connects to the fuel pump flange.
- Fitting <b> connects to the pressure damper.

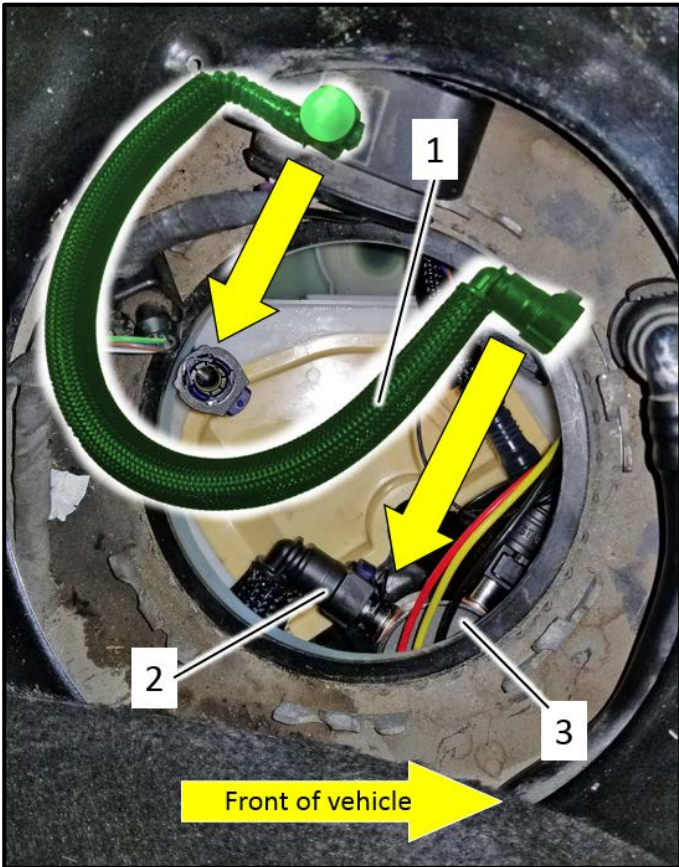

- Bend new fuel hose <1> as shown and install into fuel tank in direction of <arrows>.
- Install fuel line coupling <2> onto fuel pressure damper <3> until it audibly locks.
- Gently pull on coupling <2> to verify that it is locked properly in place.

### TIP

The new hose is included in cover and hose kit, part number 4H0.201.284.E

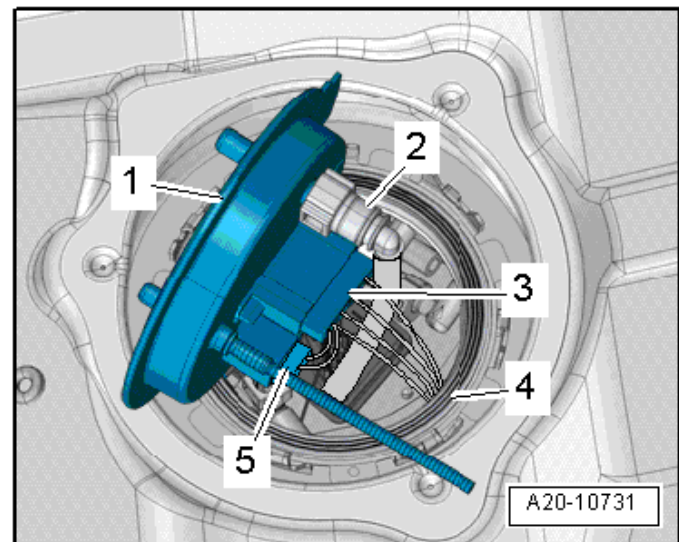

### Install sealing flange:

- Connect fuel line coupling <2> until it audibly locks.
- Gently pull on coupling <2> to verify that it is locked properly in place.
- Install electrical connectors <3 and 5>.
- Install new seal ring <4> dry onto fuel tank.

Part Number	Part Description
1J0.919.133.B	Seal ring

- Press sealing flange <1> into fuel tank.

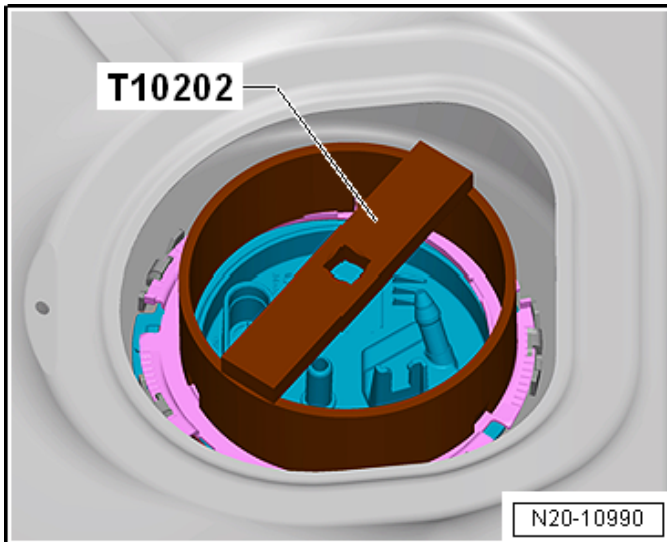

**Install locking ring:**

- Install locking ring and torque to 120 Nm using the -T10202-.

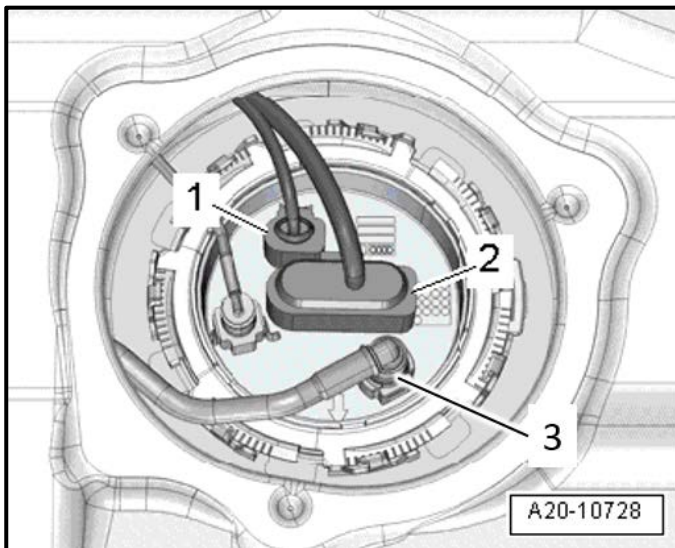

**Connect electrical connectors and fuel line (if necessary):**

- Install and lock electrical connectors <1 and 2>.
- **Criteria 03 vehicles:**
  - Vehicle requires new fuel supply line.
  - Do not connect fuel line coupling <3>.
  - Proceed to Section C (External fuel pressure damper replacement).
- **Criteria 01 and 02 vehicles:**
  - Vehicle does not require new fuel supply line.
  - Install fuel line coupling <3> until it audibly engages.
  - Gently pull on coupling <3> to verify that it is locked properly in place.
  - Proceed to Section D (Vehicle reassembly).

## Section C – External Fuel Pressure Damper Replacement

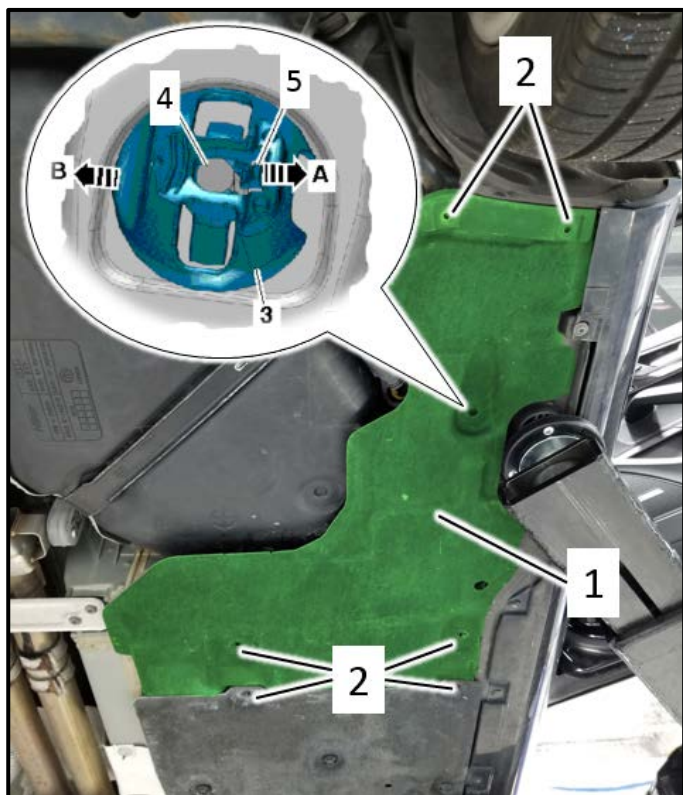

### Remove right rear noise insulation:

- Remove nuts <2>.
- Remove clip <3>:
  - Unlock the release lever <5> with needle nose pliers in direction of <arrow A> and push it off the pin <4> in direction of <arrow B>.

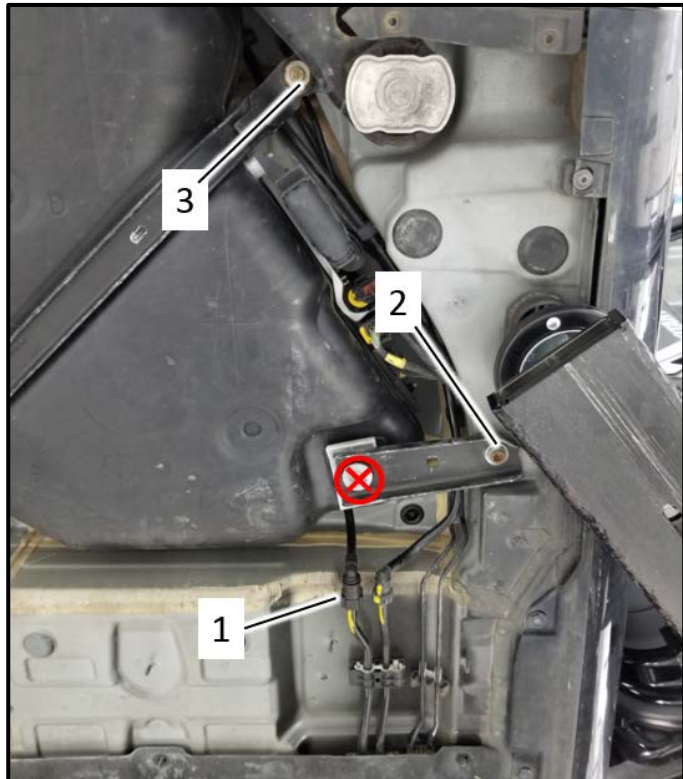

### Disconnect fuel line and lower fuel tank:

- Place a drip tray under the fuel line coupling <1>.
- Disconnect fuel line coupling <1>.
- Remove bolts <2 and 3>.
- DO NOT remove nut holding bracket to fuel tank.
- Fuel tank will drop slightly.

#### TIP

The fuel tank does not have to be supported when lowering since the fuel will be drained.

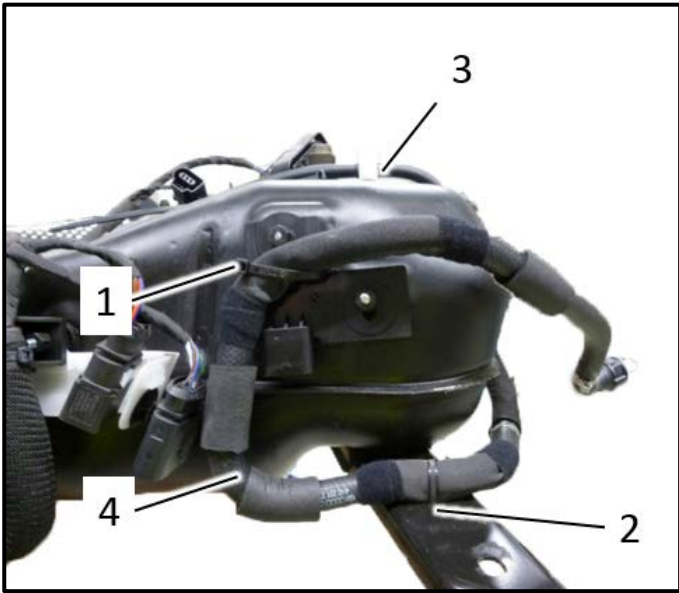

**Remove and discard external fuel pressure damper:**

- Cut tie wraps <1 and 2>.
- Disengage fuel line from support <3>.
- Remove and discard external fuel pressure damper <4>.

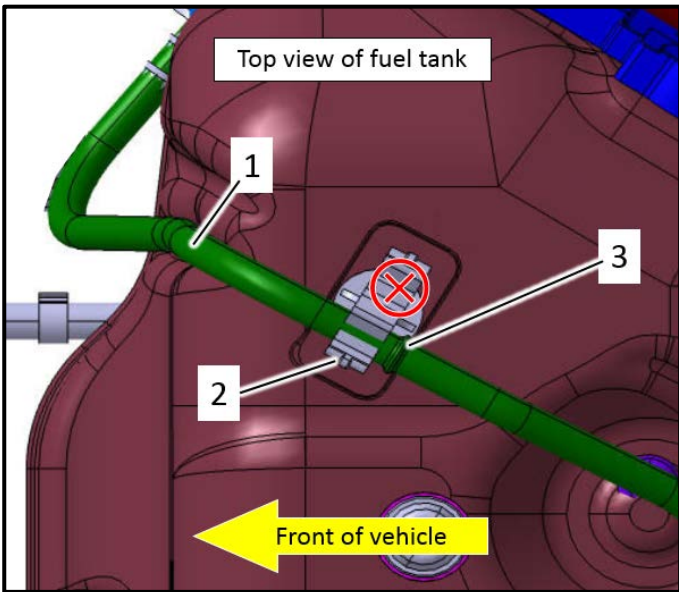

**Install new fuel supply line:**

Part Number	Part Description
4H0.201.220.G	Fuel line

- Install new fuel supply line <1> and note the following:
  - Install fuel line into securing bracket <2> first.
  - The fuel line must be installed in the securing bracket position as shown.
  - The bulge <3> on the line will go behind the securing bracket <2>.

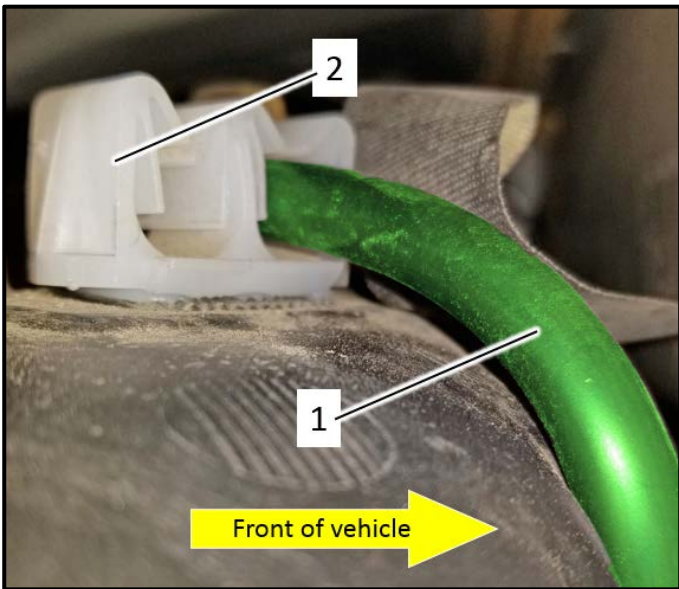

**NOTE**

View from the right side of fuel tank showing fuel supply line <1> installed in securing bracket <2>.

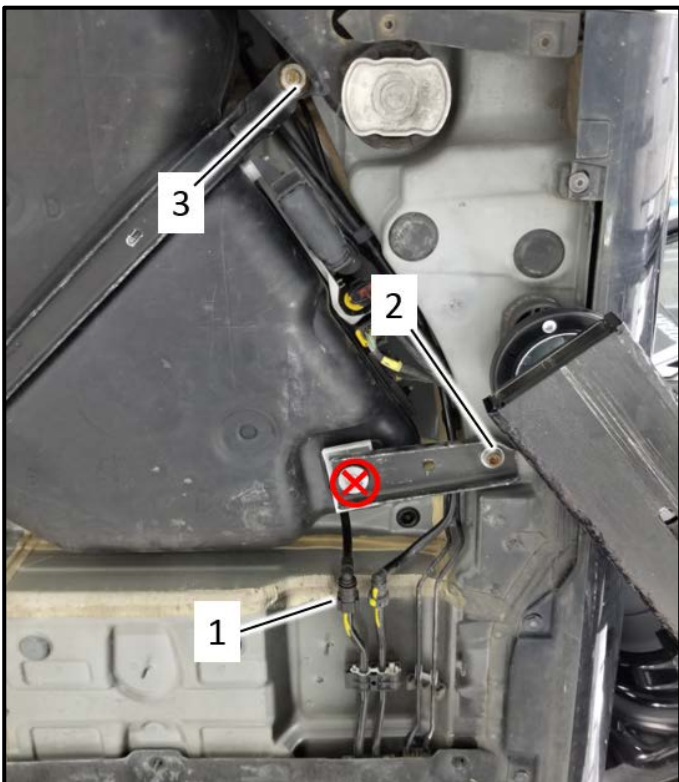

**Reinstall fuel tank and connect fuel line:**

- Raise fuel tank.
- Install bolts <2 and 3> and torque to 23 Nm.
- Install fuel line coupling <1> until it audibly locks.
- Gently pull on coupling <1> to verify that it is locked properly in place.
- Install noise insulation and torque fasteners to 2 Nm.



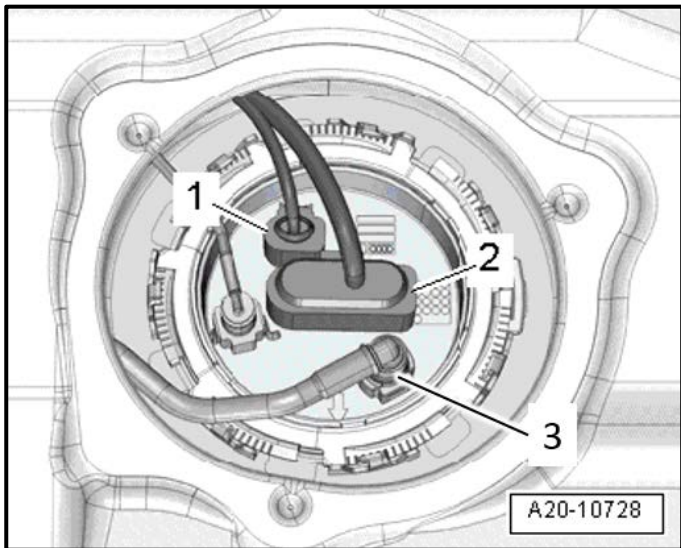

**Connect fuel line at sealing flange:**

- Install fuel line coupling <3> until it audibly engages.
- Gently pull on coupling <3> to verify that it is locked properly in place.

**Proceed to Section D.**

**Section D – Vehicle Reassembly**

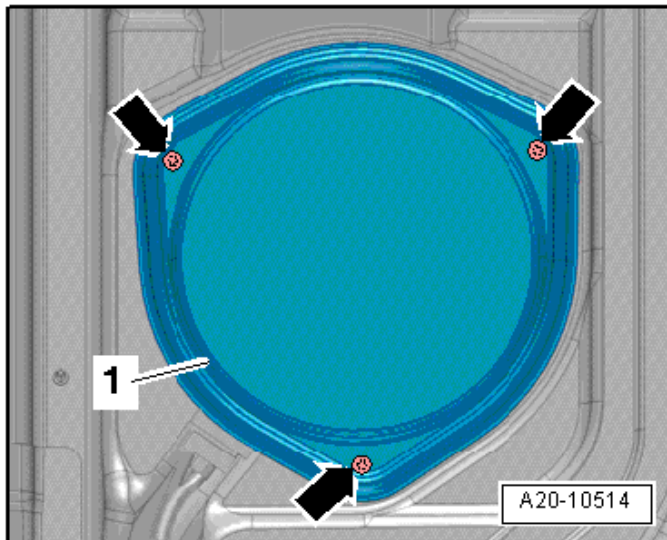

**Install fuel pump cover:**

- Install fuel pump cover <1> and tighten screws <arrows> by hand.
- Reposition carpet over cover.

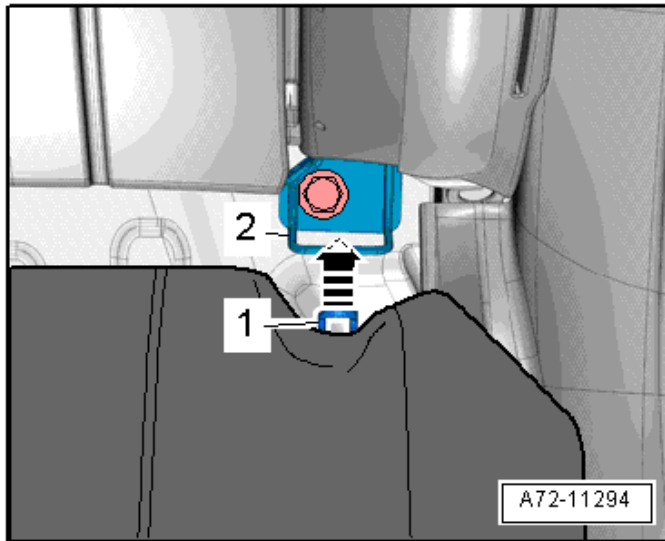

### Install rear seat bench (vehicles without rear bucket seats):

- Install rear seat bench in the vehicle.
- Connect electrical connectors (if equipped).
- Position the seat belt latch in the seat padding.
- Attach wire bracket <1> for the rear seat bench to the bracket <2> on the backrest frame in the direction of <arrow> and rear seat bench until it engages audibly in the mount.

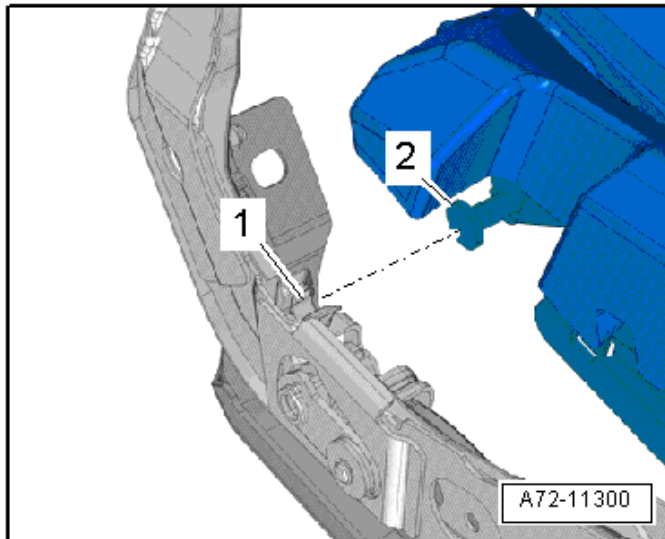

### Install passenger rear seat pan (rear bucket seats):

- Insert seat pan in the vehicle and connect harness connectors.
- Replace plastic mounts <1>.

Part Number	Part Description
4E0.885.196	Seat mounting clip (x2)

- Install mounting pins <2> at the rear of the seat pan in the mounts <1> and press down seat pan until it latches.

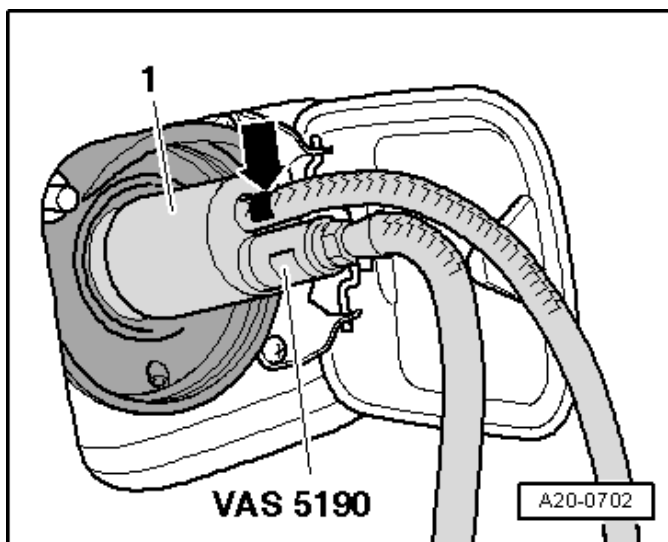

### Refill fuel tank:

- Refill the fuel tank with the same amount of fuel that was removed.

### **CAUTION**

Refer to the previously recorded fuel measurement. Be certain to refill the vehicle fuel tank with the same amount of fuel that was originally extracted from the vehicle or fuel sending unit faults may occur.

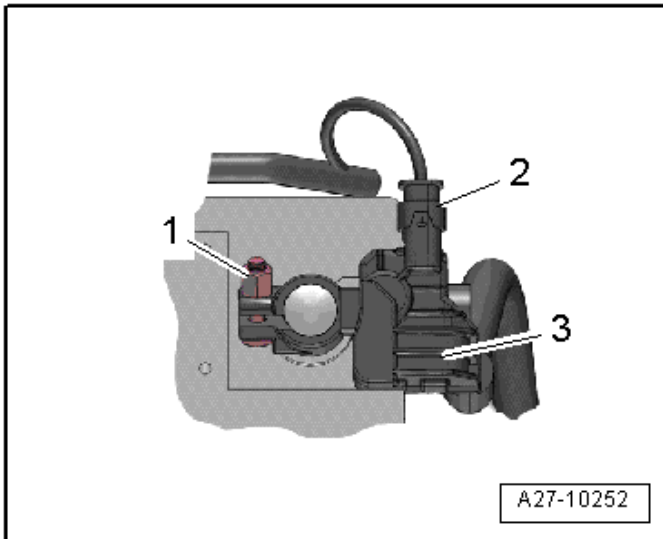

#### Reconnect battery:

- Disconnect the connector <2> from the Battery Monitoring Control Module -J367- <3>.
- Attach the battery ground cable clamp by hand to the battery negative terminal and torque the nut <1> to 6 Nm.
- Reconnect the connector to the Battery Monitoring Control Module -J367-.
- If equipped, install the vehicle tool kit.
- Set clock to local time (if necessary).
- Activate the convenience one-touch open/close functions.

**Proceed to Section E.**

## Section E – Campaign Completion Stamp

I certify that this campaign  
has been performed in strict  
accordance with the applicable  
Audi repair procedure.

SAGA Code: \_\_\_\_\_  
Technician: \_\_\_\_\_  
Date: \_\_\_\_\_

Item#: AUD4927ENG

-OR-

Je certifie que cette  
campagne de rappel a été  
exécutée suivant les strictes  
directives de réparation  
d'Audi

Code de SAGA: \_\_\_\_\_  
Technicien: \_\_\_\_\_  
Date: \_\_\_\_\_

Item # AUD4927FRE

- Once the campaign has been completed, the technician should stamp the repair order.
- Stamps are available for ordering through the Compliance Label Ordering Portal.
- **Proceed to Section F.**

## Section F - Parts Return/Disposal

Properly store (retain), destroy or dispose of removed parts in accordance with all state/province and local requirements, unless otherwise indicated and/or requested through the Warranty Parts Portal (WPP) for U.S. and the Part Destruction and Core Disposition Report for Canada.

## Appendix A – Warning and Safety Precautions

### WARNING

#### Note the Following When Working on the Fuel System:

- There is a risk of injury because the fuel is under very high pressure.
- Fuel pressure in high pressure pipe can be up to 120 bar (1740 psi)! Always follow the safety precautions when reducing the pressure in the high pressure area.
- The fuel supply line is under pressure. To prevent injuries and skin contact, wear protective goggles and protective clothing. Wrap a clean cloth around the connection before loosening hose connections. Remove the hose connection carefully to release the pressure.
- Fuel coming into contact with skin poses a health risk.
- Do not let fuel come in contact with bare skin. Wear fuel-resistant gloves.
- Leaking fuel poses a risk of burns.
- For safety reasons, switch off the current to the fuel pump before opening the fuel system. Otherwise, the fuel pump will activate when the driver door is opened.
- Disconnect the power supply by removing the fuse for the Fuel Pump Control Module / fuel delivery unit, or by disconnecting the battery.
- Danger of explosion due to cell phones. Keep cell phones out of reach in the work space area.