

Marman®

Standard Tube Size and Variable Diameter V-Band Couplings

- Simplified Stock
- Long Life
- Vibration Proof
- Numerous Sizes
- Corrosion Resistant



EATON

Powering Business Worldwide

V-Band Couplings

Standard Tube Size and Variable Diameter V-Band Couplings

Eaton's Marman V-Band couplings and flanges connect and seal all types of tubing, piping, ducts and containers. Assembly or disassembly of the compact coupling is a simple operation requiring only a few seconds. A selection of

three standard latch styles offers the best choice for any application.

V-Band couplings eliminate use of heavy bolted flanges, yet offer high strength and light weight. Standard flanges are available for pressure and structural applications at temperatures to 800°F (427°C).

Six V-Retainer cross sections are available in standard tube O.D. sizes to meet any operating conditions. The material gauge and configuration of the retainer determines the operating performance of the coupling.

Use performance rating charts shown on page 5 for the selection of the appropriate V-Band couplings and flanges in

standard tube O.D. sizes to provide minimum weight with maximum strength for specific application requirements.

Eight additional cross-sections shown on pages 12 and 13 can be ordered in any increment from the minimum diameter shown with each part number to twenty inches. Performance ratings are listed on page 15.



T-Bolt Latch Coupling

For use for higher strength semi-permanent applications or where frequent assembly and disassembly is not required.



Quick-Coupler Latch Coupling

For applications requiring frequent assembly or disassembly, Quick-Coupler Latch can be connected or disconnected without removal of nut.

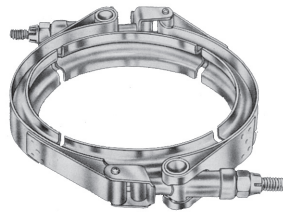

Multiple Latch, Quick-Coupler and T-Bolt

For larger size (6" and over) applications, equal distribution of band tension is provided with the two latches.

Gasket

The flat gasket used with Flange P/Ns 4550 and 4560 may be rubber, metal, or a combination of these materials. The gasket must be designed to compress to a .060 minimum thickness for proper coupling assembly.

The O-Ring gasket used with Flange P/Ns 4560 and 4570 may be of any rubber or silicone compound depending on the application. Standard gaskets of the series AN123851 through AN124050 may be used for all sizes. For tube sizes over

5 inches, standard O-Rings of the next smaller size than the flange cavity diameter may be purchased and stretched into position during assembly. These O-Rings can be obtained from local sources. The cavity area of the flanges has been designed to permit this application.

Flanges are available for V-Band coupling P/Ns 4563, 4573, 4583, 4564, 4574, 4584, 4565, 4575 and 4585. The same female flange is used for both O-Ring sealed flanges and gasketed flat-faced flanges.

Flange P/Ns 4550 and 4560 are used to make a joint using a flat gasket of rubber or metal.

Flange Part Numbers 4560 and 4570 are used for O-Ring applications. The O-Rings used are the series AN123851 and AN124050. This same set of flanges 4560 and 4570 may be used for structural applications by omitting the O-Ring.

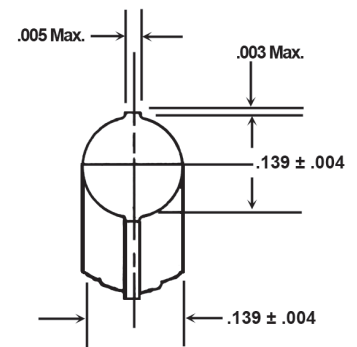

O-Ring Gasket

Approximate Weights

To determine the weight of a coupling, select the K_1 and K_2 values from the table below and insert them in the following formula:

$$W = K_1 + (K_2D)$$

D = Nominal Diameter of coupling, inches.

Example: Coupling No. NE102788-0948AM

$$K_1 = .233$$

$$K_2 = .086$$

$$D = 9.48$$

$$W = K_1 + (K_2D)$$

$$= .233 + (.086 \times 9.48)$$

$$= 1.048 \text{ lbs.}$$

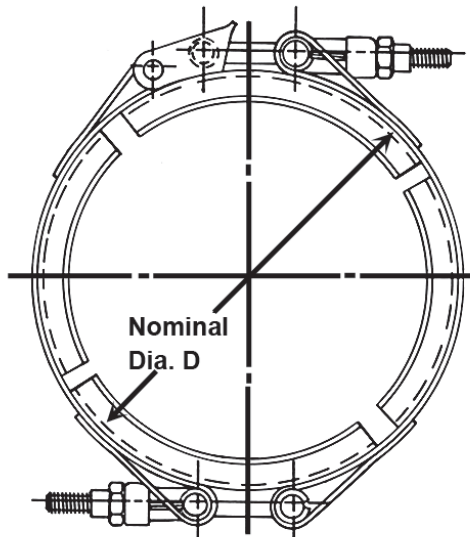

Part Number	K_1	K_2	Part Number	K_1	K_2
NE102142	.112	.035	NE102665	.065	.035
NE102145	.233	.055	NE102666	.134	.050
NE102148	.266	.116	NE102667	.133	.116
NE102151	.227	.068	NE102668	.137	.086
NE102157	.242	.083	NE102669	.115	.064
NE102658	.044	.035	NE102670	.140	.079
NE102659	.089	.050	NE102671	.340	.159
NE102660	.110	.116	NE102788	.233	.086
NE102661	.088	.086	NE102789	.631	.159
NE102662	.071	.068	NE102790	.624	.136
NE102663	.094	.083	NE102791	.254	.136
NE102664	.248	.159	NE102820	.336	.136

Material Specifications

Item	Material	Specifications	Commercial
			AISI Number
Retainer	Corrosion & Heat Resisting Steel	AMS 5512 Comp Ti	321
Strap	Corrosion & Heat Resisting Steel	AMS 551 Comp 301 1/4 H	301 1/4 H
T-Bolt	Corrosion & Heat Resisting Steel	AMS 5732 or AMS 5737	A286
T-Bolt	Alloy Steel	AMS 6322	8740
T-Bolt	Corrosion & Heat Resisting Steel	MILS-18732	431ANL

Selection of correct V-Band Couplings and Flanges

To select V-Band couplings and flanges, the following factors must be known. These include loading, temperature, desired safety factor and tube O.D. Loading may consist of internal pressure, bending moment and/or axial tension. Ratings are based on the maximum load, which will not produce structural yield of any component part.

Please follow these steps to select the correct V-Band couplings and flanges.

Step 1. Pressure Load. If an internal pressure load exists, use Chart 1. Locate a point representing the proof pressure (twice operating pressure) on the left-hand scale. Draw a horizontal line from this point to the diagonal line representing the tube O.D. From the intersection of these two lines, draw a vertical line to the bottom scale to determine N_p .

Step 2. Bending Moment If a bending moment load exists, use Chart 2. Locate a point representing the bending moment (in inch-pounds) on the left-hand scale. Draw a horizontal line from this point to the diagonal line representing the tube O.D. From the intersection of these two lines draw a vertical line to the bottom scale to determine N_B .

Step 3. Axial Tension. If an axial tension load exists (other than pressure), this can be calculated by dividing the axial load in pounds by the circumference at the flange O.D. in inches to determine N_A .

Step 4. The total load intensity (N) is found by adding N_p , N_B and N_A as determined in Steps 1, 2 and 3.

Step 5. Temperature Strength Conversion. If the environmental operating temperature is above 100°F (38°C), a correction for temperature is necessary. Multiply the load intensity (N) obtained from Step 4 by the temperature correction factor. Please note that there are temperature correction factors shown below for both aluminum and stainless steel. Aluminum flanges should not be used above 500°F (260°C).

Step 6. Safety Factor. To calculate a specific safety factor, multiply N (with temperature correction, if applicable) by this safety factor.

Step 7. Using the rating Chart 3, draw a horizontal line from the tube O.D. on the left-hand scale to intersect a vertical line from N (as corrected in Steps 5 and 6, if applicable) on the bottom scale. All curves to the right of this intersection point represent components which may be used. See coupling part numbers and flange material codes under Chart 3. If no curves are to the right of the intersection, consult your Eaton representative for special flange materials or configuration.

Step 8. See flange specifications and dimensions on pages 13 and 14 and coupling specifications and dimensions on pages 6–11.

To select a V-Band coupling for special flanges using Chart 4, follow the same procedure utilizing Charts 1 and 2 to determine N, applying correction and safety factors.

After determining the proper coupling to meet exact operating conditions, select the choice of latch style from the three offered as shown on each of the following Dimension and Specification pages. A separate part number is designated for each latch style for each of the V-Retainer cross sections shown.

Example: A V-Band coupling with flanges is required for the following conditions:

Tubing	3.00 in. dia. stainless steel
Proof Pressure	300 psi
Bending Moment	2000 pound-inches
Axial Load	1000 pounds
Temperature	600°F (315°C)
Safety Factor	1.1

Step 1. Pressure Load. (Follow dotted line on charts) Draw a horizontal line from 300 on the proof pressure scale to the diagonal line labeled 3.00 (tube O.D.). The intersection point is directly above 240 on the N_p scale at the bottom.

Step 2. Bending Moment. Draw a horizontal line from 2000 on the bending moment scale to the diagonal line labeled 3.00 (tube O.D.). Directly below the intersection point, we find N_B equal to 190.

Step 3. Axial Tension. Flange O.D. for 3.00 – 3.78 (see page 14). Dividing 1000 by $\pi \times 3.78$ results in $N_A=80$.

Step 4. N equals $240 + 190 + 80 = 510$

Step 5. Temperature Strength Conversion. Multiply 510×1.30 (temperature correction for stainless steel at 600°F) = 663.

Step 6. Safety Factor. Draw a horizontal line from 3.00 on the tube O.D. scale (Chart 3) and a vertical line from 730 on the bottom scale (N) and determine the intersection point. If, the solid red line curve (stainless steel flanges) and the white line curve (V-Band couplings part numbers 4565, 4575 and 4585) fall to the right of this point indicating these components are suitable.

Step 7. See flange specifications and dimensions on page 14 and coupling specifications and dimensions on pages 6–11.

Explanation of Symbols

Symbol	Meaning	Units	Formula
N_p	Load Intensity Due to Pressure	inch-pounds	$N_p = \frac{P(D_S)^2}{4D_F}$
N_B	Load Intensity Due to Bending Moment	inch-pounds	
N_A	Load Intensity Due to Axial Tension	inch-pounds	$N_B = \frac{4M}{\pi(D_F)^2}$
N	Total Load Intensity	inch-pounds	
D_S	Sealing Diameter	inches	$N_A = \frac{A}{\pi D_F}$
D_F	Flange Outside Diameter	inches	
P	Pressure	psi	$N = N_p + N_B + N_A$
M	Bending Moment	inch-pounds	
A	Axial Tension	pounds	

Temperature Correction Factors

Flanges	Aluminum	Stainless Steel	All Couplings
200°	1.10	1.05	1.10
400°	2.40	1.10	1.20
500°	10.00	—	—
600°	—	1.30	1.25
800°	—	1.50	1.30

Standard Tube Size and Variable Diameter V-Band Couplings

Ratings are based on the maximum load which will not produce structural yield of any component part.

CHART 1 (STEP 1)

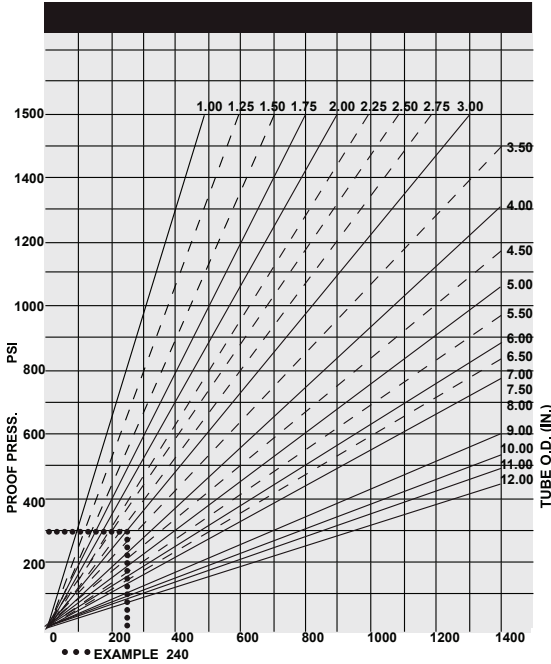

CHART 2 (STEP 2)

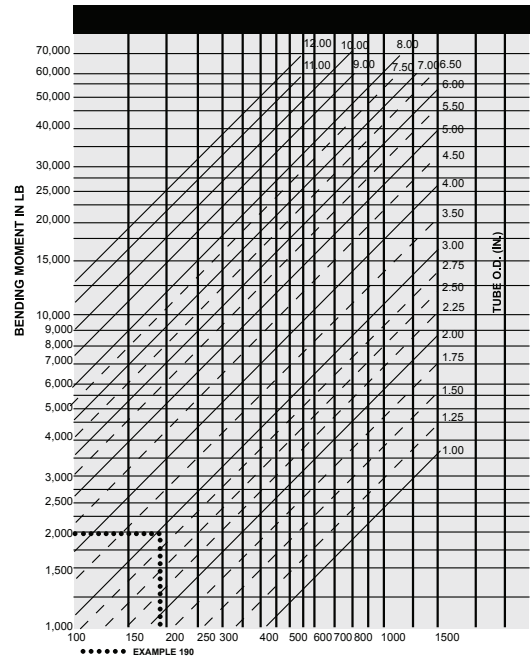

CHART 3 (STEP 7)

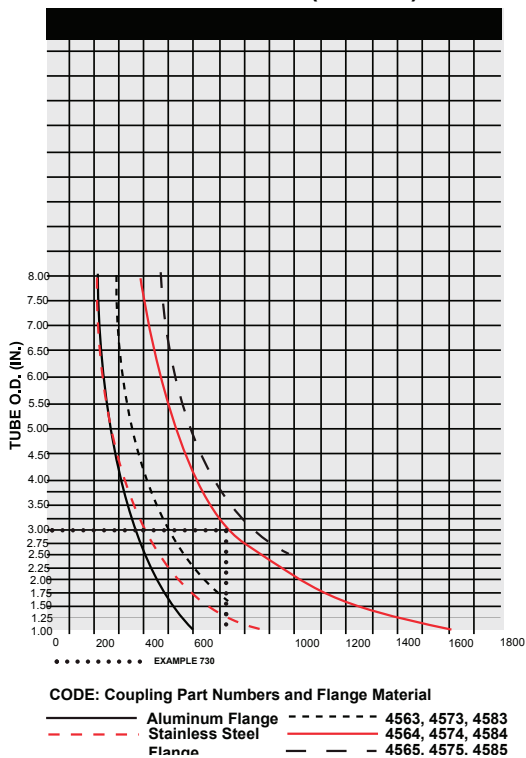
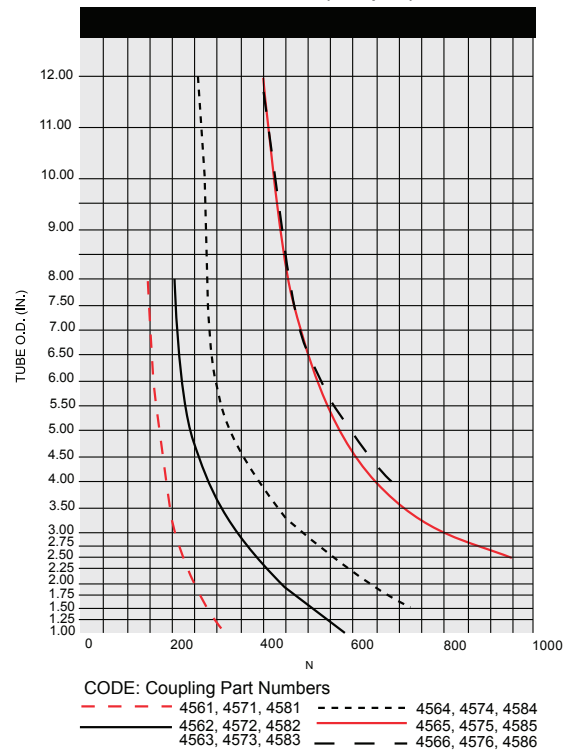
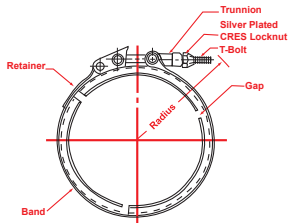

Chart 4 (Step 8)



Standard tube size V-Band Couplings

Part numbers 4561, 4571, 4581



Quick Coupler Latch Couplings
1 Latch - 3 Segments

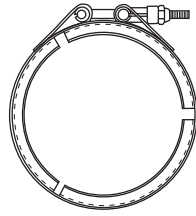

T-Bolt Coupling
1 Latch - 3 Segments

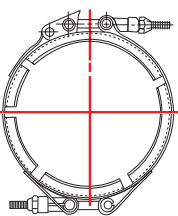

Multiple Latch Coupling
2 Latches - 4 Segments

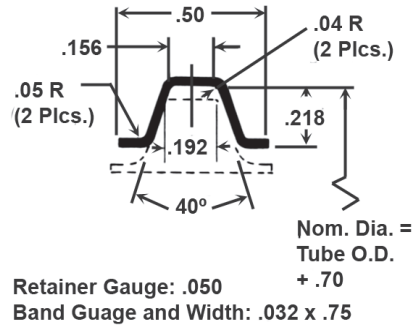

Tube Size O.D.	Part Number	Weight Lbs.	Part Number	Weight Lbs.	Part Number	Weight Lbs.	Flange to be used with these couplings	Radius Max.	431 Heat Treated CRES T-Bolt*		Recommended Torque Inch/Lb.**		
									Part Number	Thread			
1.00	4561-100	.16	4571-100	.14	Not Available Under 6.00		A to A A to B (see below)	1.72	18446-50-200	.190-32 UNJF-3A	25		
1.25	4561-125	.17	4571-125	.15				1.78	18446-50-200		25		
1.50	4561-150	.19	4571-150	.17				2.12	18277-50-200		30		
1.75	4561-175	.20	4571-175	.18				2.22	18277-50-200		30		
2.00	4561-200	.21	4571-200	.19				2.31	18277-50-200		35		
2.25	4561-225	.23	4571-225	.21				2.41	18277-50-200		35		
2.50	4561-250	.24	4571-250	.22				2.50	18277-50-200		35		
2.75	4561-275	.25	4571-275	.23				2.62	18277-50-200		35		
3.00	4561-300	.27	4571-300	.25				2.72	18277-50-200		40		
3.50	4561-350	.30	4571-350	.28				2.91	18277-50-225		40		
4.00	4561-400	.33	4571-400	.31				3.22	18277-50-225		40		
4.50	4561-450	.36	4571-450	.34				3.44	18277-50-225		40		
5.00	4561-500	.39	4571-500	.37				3.66	18277-50-225		40		
5.50	4561-550	.42	4571-550	.40				3.88	18277-50-225		40		
6.00	4561-600	.44	4571-600	.42				4581-600	.49		4.12	18277-50-225	40
6.50	4561-650	.47	4571-650	.45				4581-650	.52		4.34	18277-50-225	45
7.00	4561-700	.50	4571-700	.48				4581-700	.55		4.56	18277-50-225	50
7.50	4561-750	.53	4571-750	.51	4581-750	.58	4.78	18277-50-225	50				
8.00	4561-800	.55	4571-800	.53	4581-800	.60	5.03	18277-50-225	50				

All dimensions in inches.

NOTE: To facilitate assembly of smaller diameter couplings, the T-Bolt is curved and the retainer gap is rotated under the latch.

Order by Part Number — see page 9
Separate numbers are designated for each latch style.
T-Bolt and nut are furnished with coupling.

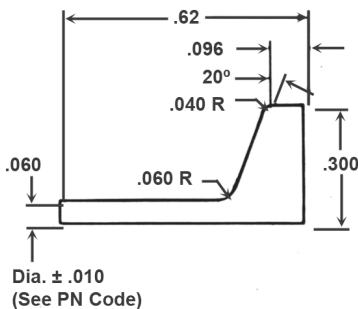

A NK102124

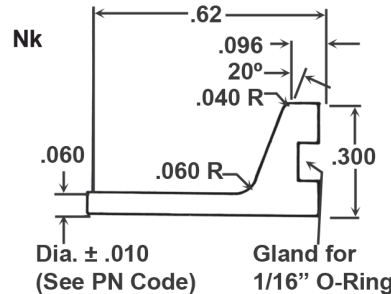

B NK102125

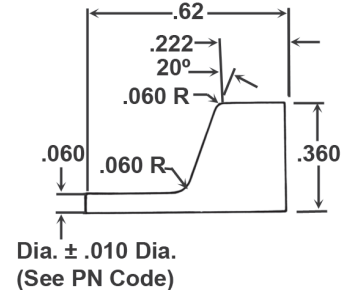

C NK102126

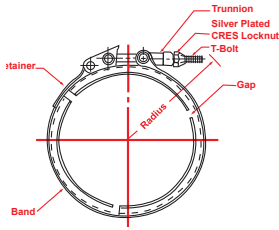

Quick Coupler Latch Couplings
1 Latch - 3 Segments

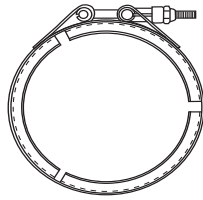

T-Bolt Coupling
1 Latch - 3 Segments

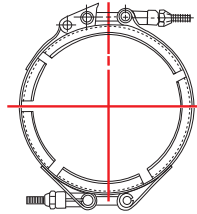

Multiple Latch Coupling
2 Latches - 4 Segments

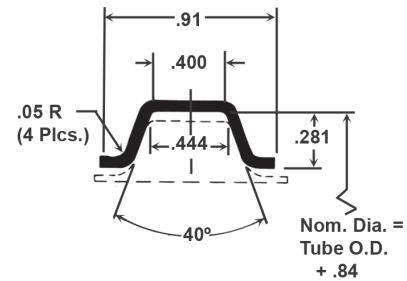

Retainer Gauge: .050
Band Gauge and Width: .032 x 1.00

Tube Size O.D.	Part Number	Weight Lbs.	Part Number	Weight Lbs.	Part Number	Weight Lbs.	Flange to be used with these couplings	Radius Max.	431 Heat Treated CREST-Bolt*		Recommended Torque Inch/Lb.**																																																																	
									Part Number	Thread																																																																		
1.00	4562-100	.29	4572-100	.24	Not Available Under 6.00		C to C C to D (see below)	2.03	18462-75-225	.250-28 UNJF-3A	30																																																																	
1.25	4562-125	.31	4572-125	.26								4582-600	.92	2.22	18462-75-225	30																																																												
1.50	4562-150	.33	4572-150	.28													4582-650	.96	2.38	18289-75-225	35																																																							
1.75	4562-175	.35	4572-175	.30																		4582-700	1.00	2.47	18289-75-225	35																																																		
2.00	4562-200	.37	4572-200	.32																							4582-750	1.04	2.56	18289-75-225	40																																													
2.25	4562-225	.39	4572-225	.34																												4582-800	1.08	2.66	18289-75-225	40																																								
2.50	4562-250	.41	4572-250	.36																																	4582-850	1.08	2.75	18289-75-225	45																																			
2.75	4562-275	.43	4572-275	.38																																						4582-900	1.08	2.84	18289-75-225	45																														
3.00	4562-300	.46	4572-300	.41																																											4582-950	1.08	2.94	18289-75-225	50																									
3.50	4562-350	.54	4572-350	.49																																																4582-1000	1.08	3.44	18289-75-275	50																				
4.00	4562-400	.58	4572-400	.53																																																					4582-1050	1.08	3.63	18289-75-275	55															
4.50	4562-450	.62	4572-450	.57																																																										4582-1100	1.08	3.81	18289-75-275	60										
5.00	4562-500	.66	4572-500	.61																																																															4582-1150	1.08	4.03	18289-75-275	65					
5.50	4562-550	.73	4572-550	.68																																																																				4582-1200	1.08	4.38	18289-75-300	70
6.00	4562-600	.77	4572-600	.72																																																																								
6.50	4562-650	.81	4572-650	.76	4582-1300	1.08	4.81	18289-75-300	80																																																																			
7.00	4562-700	.85	4572-700	.80						4582-1350	1.08	5.03	18289-75-300	85																																																														
7.50	4562-750	.89	4572-750	.84											4582-1400	1.08	5.22	18289-75-300	90																																																									
8.00	4562-800	.93	4572-800	.89																4582-1450	1.08	5.47	18289-75-300	95																																																				

All dimensions in inches.

* Replacement T-Bolts can be ordered for Quick Coupler Latches only. They can not be replaced on T-Bolt latches. Last dash number indicates T-Bolt length in hundredths inches.

** Tolerances on recommended torque are ± 10%.

NOTE: To facilitate assembly of smaller diameter couplings, the T-Bolt is curved and the retainer gap is rotated under the latch.

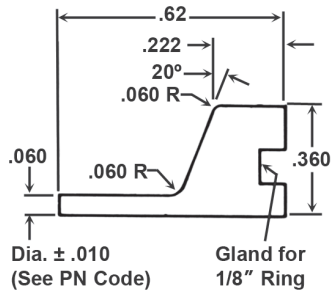

D NK102127

Order Flanges Separately by Part No.

Flange Part No. Code: **NK102124-0000 XX**
 Drawing no. _____
 Dia. in hundredths inches (0100 = 1 inch) _____

Material Code _____
 AC = 6061-T6 Aluminum Alloy
 BA = Low Carbon Steel
 SA = 304 Stainless Steel
 SF = 316 Stainless Steel

Standard tube size V-Band Couplings

Part numbers 4563, 4573, 4583

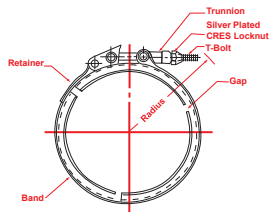

Quick Coupler Latch Couplings
1 Latch - 3 Segments

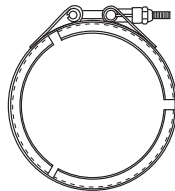

T-Bolt Coupling
1 Latch - 3 Segments

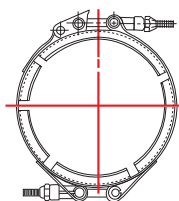

Multiple Latch Coupling
2 Latches - 4 Segments

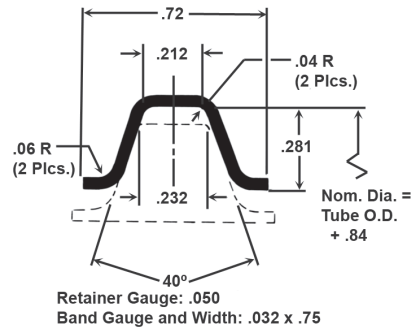

Tube Size O.D.	Part Number	Weight Lbs.	Part Number	Weight Lbs.	Part Number	Weight Lbs.	Flange to be used with these couplings	Radius Max.	431 Heat Treated CRES T-Bolt*		Recommended Torque Inch/Lb.**																																																													
									Part Number	Thread																																																														
1.00	4563-100	.25	4573-100	.20	Not Available Under 6.00		Use Flange Part Numbers 4550, 4560, 4570, shown on page 14.	2.03	18462-75-225	.250-28 UNJF-3A	30																																																													
1.25	4563-125	.27	4573-125	.22								4583-600	.79	2.22	18462-75-225	30																																																								
1.50	4563-150	.29	4573-150	.24													.82	2.38	18289-75-225	35																																																				
1.75	4563-175	.30	4573-175	.25																	.86	2.47	18289-75-225	35																																																
2.00	4563-200	.32	4573-200	.27																					.89	2.56	18289-75-225	40																																												
2.25	4563-225	.34	4573-225	.29																									.93	2.66	18289-75-225	40																																								
2.50	4563-250	.36	4573-250	.31																													4.81	2.75	18289-75-225	45																																				
2.75	4563-275	.38	4573-275	.33																																	4.81	2.84	18289-75-225	45																																
3.00	4563-300	.40	4573-300	.35																																					4.81	2.94	18289-75-225	50																												
3.50	4563-350	.46	4573-350	.41																																									4.81	3.44	18289-75-275	50																								
4.00	4563-400	.49	4573-400	.44																																													4.81	3.63	18289-75-275	55																				
4.50	4563-450	.53	4573-450	.48																																																	4.81	3.81	18289-75-275	60																
5.00	4563-500	.56	4573-500	.51																																																					4.81	4.03	18289-75-275	65												
5.50	4563-550	.62	4573-550	.57																																																									4.81	4.38	18289-75-300	70								
6.00	4563-600	.65	4573-600	.60																																																													4.81	4.59	18289-75-300	75				
6.50	4563-650	.68	4573-650	.63																																																																	4.81	4.81	18289-75-300	80
7.00	4563-700	.72	4573-700	.67																																																																				
7.50	4563-750	.75	4573-750	.70	4.81	5.22	18289-75-300	90																																																																
8.00	4563-800	.79	4573-800	.74					4.81	5.47	18289-75-300	95																																																												

All Dimensions in Inches

NOTE: To facilitate assembly on smaller diameter couplings, the T-Bolt is curved and the retainer gap is located under the latch.

*Replacement T-Bolts can be ordered for Quick Coupler Latches only. They can not be replaced on the T-Bolt latches. Last dash number indicates T-Bolt length in hundredths inches.

** Tolerances on recommended torque are ± 10%

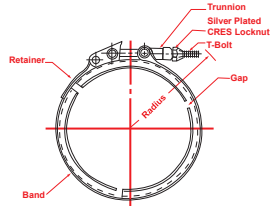

Quick Coupler Latch Couplings
1 Latch - 3 Segments

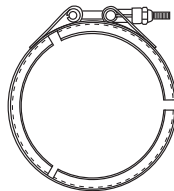

T-Bolt Coupling
1 Latch - 3 Segments

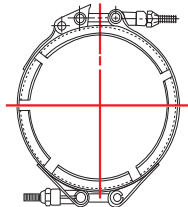

Multiple Latch Coupling
2 Latches - 4 Segments

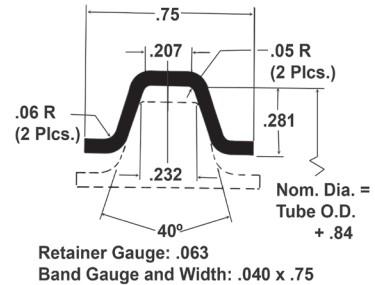

Tube Size O.D.	Part Number	Weight Lbs.	Part Number	Weight Lbs.	Part Number	Weight Lbs.		
1.50	4564-150	.33	4574-150	.28	Not Available Under 6.00			
1.75	4564-175	.35	4574-175	.30				
2.00	4564-200	.37	4574-200	.32				
2.25	4564-225	.39	4574-225	.34				
2.50	4564-250	.42	4574-250	.37				
2.75	4564-275	.44	4574-275	.39				
3.00	4564-300	.46	4574-300	.41				
3.50	4564-350	.53	4574-350	.48				
4.00	4564-400	.57	4574-400	.52				
4.50	4564-450	.62	4574-450	.57				
5.00	4564-500	.66	4574-500	.61				
5.50	4564-550	.72	4574-550	.67				
6.00	4564-600	.77	4574-600	.72			4584-600	.91
6.50	4564-650	.81	4574-650	.76			4584-650	.95
7.00	4564-700	.85	4574-700	.80	4584-700	.99		
7.50	4564-750	.90	4574-750	.85	4584-750	1.04		
8.00	4564-800	.94	4574-800	.89	4584-800	1.08		

Flange to be used with these couplings	Radius Max.	431 Heat Treated CREST-T-Bolt*		Recommended Torque Inch/Lb.**
		Part Number	Thread	
Use Flange Part Numbers 4550, 4560, 4570, shown on page 14.	2.38	18289-75-225	.250-28 UNJF-3A	40
	2.47	18289-75-225		45
	2.56	18289-75-225		50
	2.66	18289-75-225		55
	2.75	18289-75-225		60
	2.84	18289-75-225		65
	2.94	18289-75-225		70
	3.47	18289-75-275		75
	3.63	18289-75-275		80
	3.84	18289-75-275		85
	4.03	18289-75-275		90
	4.41	18289-75-300		95
	4.59	18289-75-300		100
	4.81	18289-75-300		105
	5.03	18289-75-300		110
	5.25	18289-75-300		115
5.47	18289-75-300	120		

All dimensions in Inches
NOTE: To facilitate assembly of smaller diameter couplings, the T-Bolt is curved and the retainer gap is rotated under the latch.

How to Order

Order by Part Number

Separate part numbers are designated for each latch style. T-Bolt and nut are furnished with coupling.

4564-250



Standard tube size V-Band Couplings

Part numbers 4565, 4575, 4585

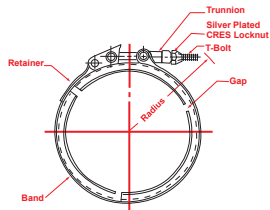

Quick Coupler Latch Couplings
1 Latch - 3 Segments

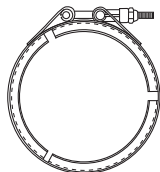

T-Bolt Coupling
1 Latch - 3 Segments

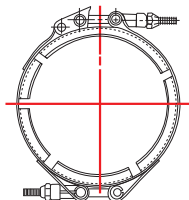

Multiple Latch Coupling
2 Latches - 4 Segments

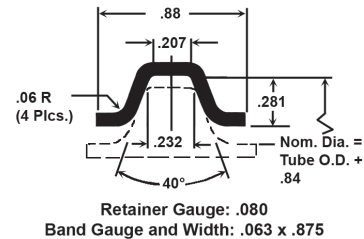

Tube Size O.D.	Part Number	Weight Lbs.	Part Number	Weight Lbs.	Part Number	Weight Lbs.		
2.50	4565-250	.71	4575-250	.61	Not Available Under 6.00			
2.75	4565-275	.73	4575-275	.63				
3.00	4565-300	.76	4575-300	.66				
3.50	4565-350	.82	4575-350	.72				
4.00	4565-400	.88	4575-400	.78				
4.50	4565-450	.97	4575-450	.87				
5.00	4565-500	1.04	4575-500	.94				
5.50	4565-550	1.10	4575-550	1.00				
6.00	4565-600	1.16	4575-600	1.06			4585-600	1.37
6.50	4565-650	1.22	4575-650	1.12			4585-650	1.43
7.00	4565-700	1.28	4575-700	1.18	4585-700	1.49		
7.50	4565-750	1.35	4575-750	1.25	4585-750	1.56		
8.00	4565-800	1.41	4575-800	1.37	4585-800	1.63		

Flange to be used with these couplings	Radius Max.	431 Heat Treated CREST-Bolt*		Recommended Torque Inch/Lb.**
		Part Number	Thread	
Use Flange Part Numbers 4550, 4560, 4570, shown on page 14.	3.25	18448-88-300	.3125-24 UNJF-3A	80
	3.31	18448-88-300		85
	3.41	18448-88-300		90
	3.59	18448-88-300		95
	3.78	18448-88-300		100
	4.31	18448-88-350		105
	4.50	18448-88-350		110
	4.69	18448-88-350		120
	4.91	18448-88-350		130
	5.09	18448-88-350		140
	5.31	18448-88-350		150
	5.53	18448-88-350		160
	5.72	18448-88-350		180

All dimensions in inches.

Note: To facilitate assembly of smaller diameter couplings, the retainer gap is rotated under the latch.

ORDER BY PART NUMBER: See page 9

Separate numbers are designated for each latch style. T-Bolt and nut are furnished with coupling.

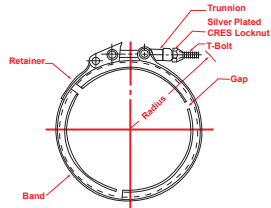

Quick Coupler Latch Couplings
1 Latch - 3 Segments

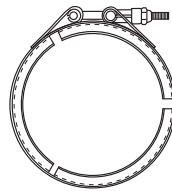

T-bolt Coupling
1 Latch - 3 Segments

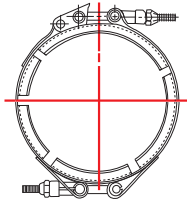

Multiple Latch Coupling
2 Latches - 4 Segments

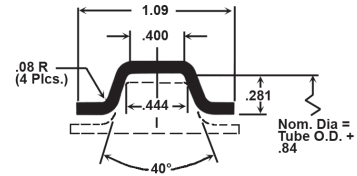

Retainer Gauge: .080
Band Gauge and Width: .063 x 1.000

Tube Size O.D.	Part Number	Weight Lbs.	Part Number	Weight Lbs.	Part Number		Weight Lbs.	Flange to be used with these couplings	Radius Max.	431 Heat Treated CRES T-Bolt*		Recommended Torque Inch/Lb.**
										Part Number	Thread	
4.00	4566-400	.95	4576-400	.86	Not Available Under 6.00			C to C C to D See page 6 and 7	3.78	18448-88-300	.3125-24 UNJF-3A	100
4.50	4566-450	1.05	4576-450	.96					4.31	18448-88-350		105
5.00	4566-500	1.12	4576-500	1.03					4.51	18448-88-350		110
5.50	4566-550	1.19	4576-550	1.10					4.69	18448-88-350		120
6.00	4566-600	1.26	4576-600	1.17					4586-600	1.46		4.91
6.50	4566-650	1.33	4576-650	1.24	4586-650	1.53		5.09	18448-88-350	140		
7.00	4566-700	1.40	4576-700	1.31	4586-700	1.60		5.31	18448-88-350	150		
7.50	4566-750	1.47	4576-750	1.38	4586-750	1.67		5.53	18448-88-350	160		
8.00	4566-800	1.55	4576-800	1.46	4586-800	1.75		5.72	18448-88-350	180		
9.00	Not Available Over 8.00	Not Available Over 8.00			4586-900	1.92		6.19	18448-88-350	200		
1.00					4586-1000	2.07		6.88	18448-88-400	220		
11.00					4586-1100	2.22		7.31	18448-88-400	240		
12.00					4586-1200	2.37		7.75	18448-88-400	260		

All dimensions in inches.

Note: To facilitate assembly of smaller diameter couplings, the retainer gap is rotated under the latch.

* Replacement T-Bolts can be ordered for Quick Coupler Latches only. They cannot be replaced on T-Bolt latches. Last dash number indicates T-Bolt length in hundredths inches.

** Tolerances on recommended torque are ± 10%.

Variable Diameter V-Band Retainer Couplings

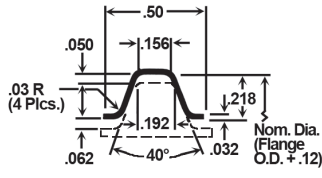
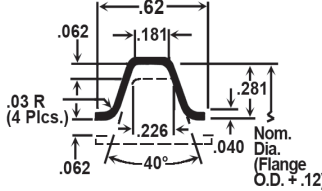
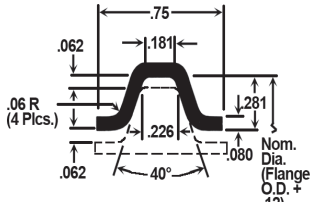
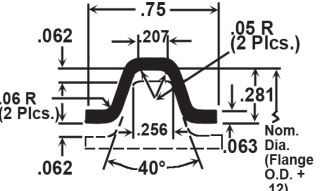
Retainers	Basic Part Number	Minimum Diameter	Latch Style (See page 15)	Band Material	Band Width	Flange	Bolt Size	Performance*
 <p>Retainer Gauge: .032</p>	NE102142	4.00	3	.025 301 1/4 H CRES	.62	NK102125 & NK102124	.190-32 UNJF	A
	NE102658		1					
	NE102665	2.00	2					
 <p>Retainer Gauge: .040</p>	NE102145	6.00	3	.032 301 1/4 H CRES	.75	NK102129 & NK102128	.250-28 UNJF	A
	NE102659		1	.025 301 1/4 H CRES				
	NE102666	2.00	2	.025 301 1/2 H CRES				
 <p>Retainer Gauge: .080</p>	NE102148	6.00	3	.050 301 1/4 H CRES	1.00	NK102129 & NK102128	.250-28 UNJF	D
	NE102660		1					
	NE102667	3.80	2					
 <p>Retainer Gauge: .063</p>	NE102788	6.00	3	.040 301 1/4 H CRES	.75	NK102167 & NK102166	.250-28 UNJF	C
	NE102661		1					
	NE102668	3.00	2					

All dimensions in inches
* See Performance Chart on page 15.

How to Order Variable Diameter V-Bands and Flanges

Typical Part Number

Basic Part No. _____ **NE102142-0670 A M**

Nom. Diameter in hundredths inches _____
(0100 = 1 inch)

T-Bolt (see T-Bolt code on page 14) _____

Nut (See Nut Code- Page 14) _____

Order Flanges Separately By Part Number

Basic Flange Part No. _____ **NK102124-0800 SA**

Dia. in hundredths inches (0100 = 1 inch) _____

Material Code _____
AC = 6061-T6 Aluminum Alloy
BA = Low Carbon Steel
SA = 304 Stainless Steel
SF = 316 Stainless Steel

Note: Order V-Bands by Nominal Diameter, not Basic Tube Sizes

Retainers	Basic Part Number	Minimum Diameter	Latch Style (See page 15)	Band Material	Band Width	Flange	Bolt Size	Performance*
<p>Retainer Gauge: .080</p>	NE102791	3.80	1	.063 301 1/4 H CRES	.88	NK1102166 & NK102167	.3125-24 UNJF	D
	NE102820		2					
	NE102790	6.00	3					
<p>Retainer Gauge: .050</p>	NE102151	6.00	3	.032 301 1/4 H CRES	.75	NK102166 & NK102167	.250-28 UNJF	B
	NE102662	3.00	1					
	NE102669		2					
<p>Retainer Gauge: .050</p>	NE102157	6.00	3	.032 301 1/4 H CRES	1.00	NK102126 & NK102127	.250-28 UNJF	B
	NE102663	3.00	1					
	NE102670		2					
<p>Retainer Gauge: .080</p>	NE102789	6.00	3	.063 301 1/4 H CRES	1.00	NK102126 & NK102127	.3125-24 UNJF	D
	NE102664	4.00	1					
	NE102671		2					

All dimensions in inches
 * See Performance Chart on page 15.

Flanges for V-Band/Retainers on these two pages

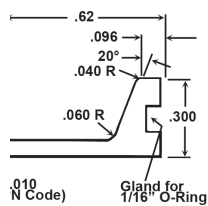

NK102125

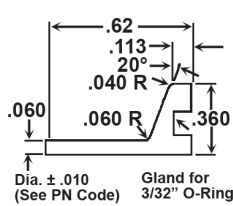

NK102129

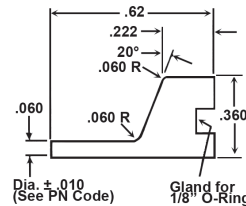

NK102127

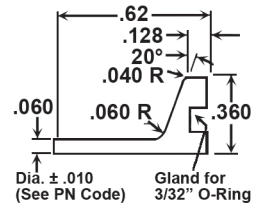

NK102167

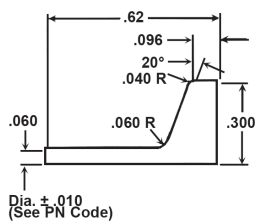

NK102124

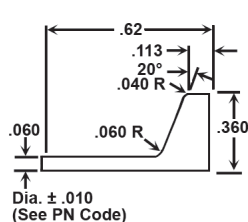

NK102128

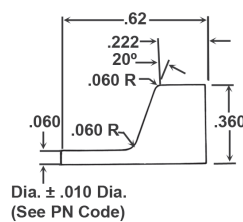

NK102126

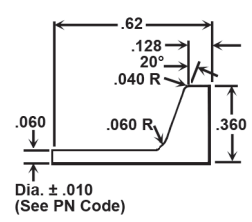

NK102166

Flange Specifications & Dimensions for Tube Size V-Bands

Part numbers 4550, 4560, 4570, Flanges/Sizes 1" Thru 8" For Retainers on Pages 8, 9, 10

Gasketed Flat Faced Flanges for High Temperature Applications

O-Ring Sealed Flanges for Low Temperature and Structural Applications

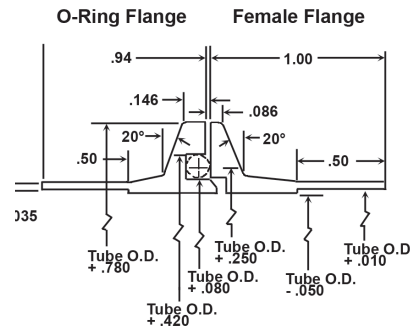
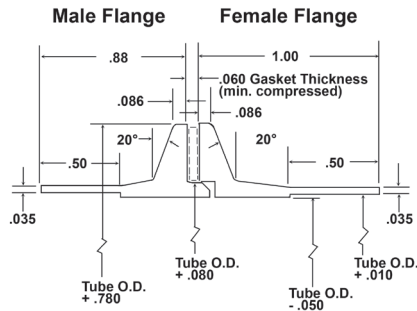

Tube Size O.D.	Male Flange		Weight Lbs.		Female Flange		Weight Lbs.		O-Ring Flange		Weight Lbs.	
	Part Number	Material Code (Specify One)	Aluminum	Stainless Steel	Part Number	Material Code (Specify One)	Aluminum	Stainless Steel	Part Number	Material Code (Specify One)	Aluminum	Stainless Steel
1.00	4550-100	- A - S	.039	.116	4560-100	- A - S	.037	.111	4570-100	- A - S	.045	.133
1.25	4550-125	- A - S	.047	.140	4560-125	- A - S	.045	.133	4570-125	- A - S	.054	.160
1.50	4550-150	- A - S	.056	.164	4560-150	- A - S	.053	.156	4570-150	- A - S	.063	.186
1.75	4550-175	- A - S	.064	.188	4560-175	- A - S	.060	.179	4570-175	- A - S	.072	.213
2.00	4550-200	- A - S	.072	.212	4560-200	- A - S	.068	.201	4570-200	- A - S	.081	.239
2.25	4550-225	- A - S	.080	.237	4560-225	- A - S	.076	.224	4570-225	- A - S	.090	.266
2.50	4550-250	- A - S	.088	.261	4560-250	- A - S	.085	.247	4570-250	- A - S	.099	.292
2.75	4550-275	- A - S	.096	.285	4560-275	- A - S	.091	.270	4570-275	- A - S	.108	.328
3.00	4550-300	- A - S	.104	.309	4560-300	- A - S	.099	.294	4570-300	- A - S	.117	.345
3.50	4550-350	- A - S	.121	.357	4560-350	- A - S	.114	.338	4570-350	- A - S	.134	.398
4.00	4550-400	- A - S	.137	.405	4560-400	- A - S	.130	.384	4570-400	- A - S	.152	.451
4.50	4550-450	- A - S	.153	.453	4560-450	- A - S	.145	.429	4570-450	- A - S	.170	.503
5.00	4550-500	- A - S	.170	.501	4560-500	- A - S	.160	.474	4570-500	- A - S	.188	.556
5.50	4550-550	- A - S	.186	.550	4560-550	- A - S	.176	.520	4570-550	- A - S	.206	.609
6.00	4550-600	- A - S	.202	.598	4560-600	- A - S	.191	.565	4570-600	- A - S	.224	.663
6.50	4550-650	- A - S	.218	.645	4560-650	- A - S	.206	.611	4570-650	- A - S	.242	.715
7.00	4550-700	- A - S	.234	.694	4560-700	- A - S	.222	.656	4570-700	- A - S	.260	.768
7.50	4550-750	- A - S	.251	.742	4560-750	- A - S	.237	.702	4570-750	- A - S	.277	.821
8.00	4550-800	- A - S	.267	.791	4560-800	- A - S	.252	.747	4570-800	- A - S	.295	.875

All dimensions in inches.

HOW TO ORDER

Typical Part Number

4560-600-S

Flange Part No. _____

Diameter in hundredths of inches (100 = 1 inch) _____

Material Code _____

Order by Component Part Number:

Material code must be added to complete the Flange Part Number.

Sample Part Number:

4560-600-S (six inch diameter female flange with stainless steel material).

Material	Temperature	Material Ordering Code
6061-TB Aluminum	500° F	— A
321 or 347 CRES	800° F	— S

Variable Diameter V-Band Latch Style Couplings

Couplings on pages 12 and 13 can be ordered in any size from the minimum diameter as shown with each part number to a maximum diameter of 20 inches.

See material specifications on page 3.

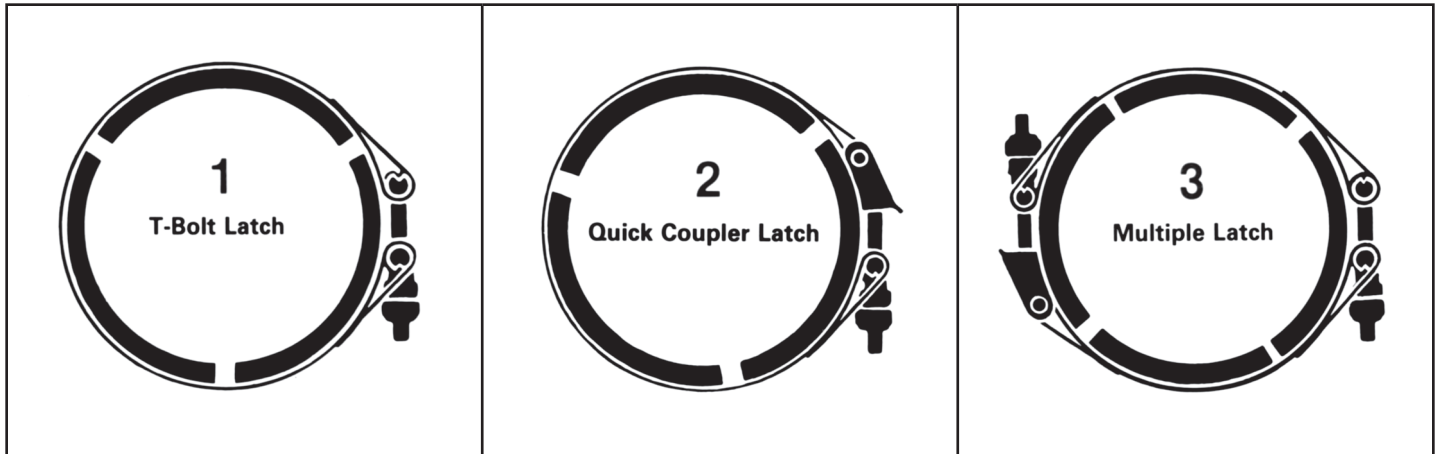

Performance Chart for Variable Nom. Dia. Couplings

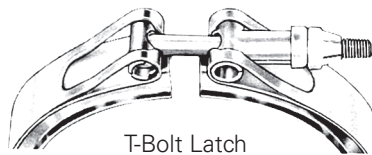
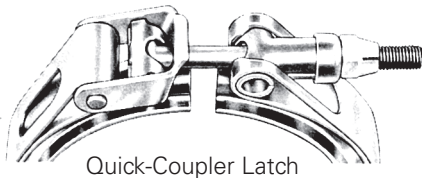
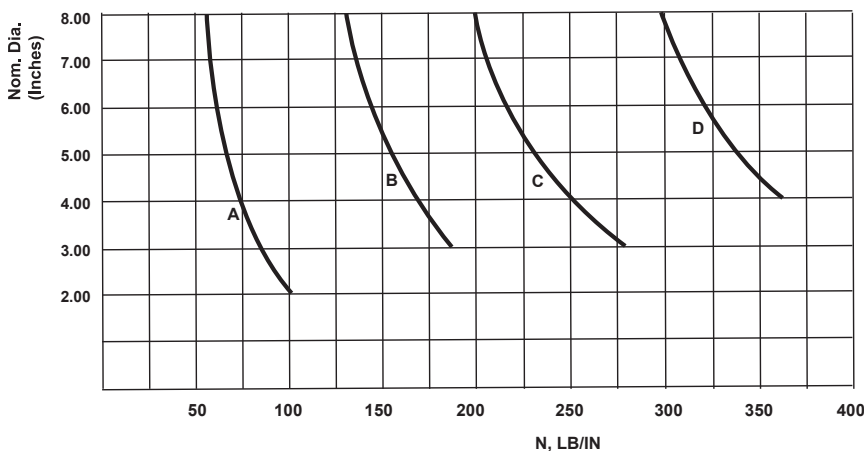

Ratings are based on the maximum load which will not produce structural yield of any component part (Proof)



T-Bolt Codes

	T-Bolt	Code
	A286 CRES	A
Not Available on a 5/16	Alloy Steel Plate	B
Not Available on 5/16	431 ANL CRES	C

Nut Codes

	Nut	Code
	Self-locking Nut, High Temperature Silver-Plated CRES. Max. Temp. 1200°F	M
	Plain Hexagon Nut, Silver Plated CRES with Lockwire hole. Max. Temp. 800°F	D
	Self Locking Nut, Cadmium Plated Steel. Max. Temp. 450°F	S

Eaton
Aerospace Group
Fluid & Electrical Distribution Division
90 Clary Connector
Eastanollee, Georgia 30538
Phone: (706) 779 3351
Fax: (706) 779 2638



Eaton
Aerospace Group
9650 Jeronimo Road
Irvine, California 92618
Phone: (949) 452 9500
Fax: (949) 452 9555
www.eaton.com/aerospace

Copyright © 2015 Eaton
All Rights Reserved
Copying or Editing is Forbidden
Form No. TF100-32C
(Supersedes AEB258)
May 2015