



Parkrimp 2
Model 83C-081 / 83C-082
Technical Manual
Bulletin 4480-T25-US



ENGINEERING YOUR SUCCESS.

Safety Notices

- Read the entire Technical Manual prior to mounting and operating this crimper.
- There are Parkrimp training videos available to view online at: <http://solutions.parker.com/hpd-product-videos>

WARNING — When using this machine, always exercise basic safety precautions, including the following:

1. Use this machine only for its intended purpose: to fabricate Parker hose assemblies.
2. Parker Hannifin will not accept responsibility for any incidental, consequential or special damages of any kind or nature whatsoever that result from any subsequent alterations to any Parkrimp machine. Parker Hannifin disclaims any warranties on items altered after leaving the Parker Hannifin facility.
3. This machine must be properly installed and located in accordance with the installation instructions before it is used.

To minimize the possibility of injury:

1. The power unit must be connected to a grounded properly rated, protected and sized power-supply circuit to prevent electrical shock and to avoid electrical overload; Never use an extension cord to connect this machine or any other Parker machine to the electrical outlet.
2. DO NOT OPERATE OVER MAXIMUM RATED WORKING PRESSURE; AND
3. CHECK FOR SAFE SYSTEM SETUPS.

Make sure that the valve, connecting hoses, etc. are protected from any external source of damage, such as: excessive heat, flame, moving machine parts, sharp edges, falling objects, corrosive chemicals, etc.

IMPORTANT SAFETY NOTICE

THIS INFORMATION IS INTENDED FOR USE BY INDIVIDUALS POSSESSING ADEQUATE BACKGROUNDS OF ELECTRICAL, ELECTRONIC AND MECHANICAL EXPERIENCE. ANY ATTEMPT TO REPAIR THIS MACHINE MAY RESULT IN PERSONAL INJURY AND PROPERTY DAMAGE.
THE MANUFACTURER OR SELLER CANNOT BE RESPONSIBLE FOR THE INTERPRETATION OF THIS INFORMATION, NOR CAN IT ASSUME ANY LIABILITY IN CONNECTION WITH ITS USE.

DISCONNECT ANY POWER CORD BEFORE SERVICING
IMPORTANT - RECONNECT ALL GROUNDING DEVICES



Parker Safety Guide for Selecting and Using Hose, Tubing, Fittings and Related Accessories
Publication No. 4400-B.1
Revised: August 2007

WARNING: Failure or improper selection or improper use of hose, tubing, assemblies, fittings, quick action couplings or related accessories ("Products") can cause death, personal injury and property damage. Possible consequences of failure or improper selection or improper use of these Products include but are not limited to:

- Fittings thrown off at high speed.
- High velocity fluid discharge.
- Explosion or burning of the conveyed fluid.
- Electrocutation from high voltage electric power lines.
- Contact with suddenly moving or falling objects that are controlled by the conveyed fluid.
- Injections by high-pressure fluid discharge.
- Dangerously whipping hose.
- Contact with conveyed fluids that may be hot, cold, toxic, or otherwise injurious.
- Sparking or explosion caused by static electricity buildup or other sources of electricity.
- Sparking or explosion while spraying paint or flammable liquids.
- Injuries resulting from inhalation, ingestion or exposure to fluids.

Before selecting or using any of these Products, it is important that you read and follow the instructions below. Only Hose from Parker's Stratoflex Products Division is approved for in-flight aerospace applications.

Offer of Sale

The items described in this document are hereby offered for sale by Parker Hannifin Corporation, its subsidiaries or its authorized distributors. This offer and its acceptance are governed by the provisions stated in the "Offer of Sale".



Table of Contents

Safety Notice	2
Specifications.....	4
Installation & Operating Instructions.....	5-6
Electrical Requirements	6
Die Part Numbers	7
Tooling	8
Tool Selection Chart.....	9
Crimping Instructions	10-11
Assembly Details and Parts Lists	12-17
Maintenance	18
Trouble Shooting Guide.....	19-20
Safety Guide (Parker Publication 4400-B.1).....	21-24
Offer of Sale.....	25

Help us help you ...

Read this guide carefully.

It is designed to help you operate and maintain your Parkrimp 2. If you don't understand something or need more help, call:

Technical Service Department
Parker Hannifin Corporation
Hose Products Division
Phone: (440) 943-5700
Fax: (440) 943-3129

Write down the Model and Serial Numbers:

83C-

Serial Number (See page 17, item 2.34 for location)

Use these numbers in any correspondence or service calls.

RECEIVING INSTRUCTIONS: UNPACKING – Remove all documents and components from shipping containers.

INSPECTION – Visually inspect all components for shipping damage. If any shipping damage is found, notify the carrier at once. Shipping damage is not covered by the Parker warranty. The carrier is responsible for all repair and replacement costs resulting from such damage.





Capability

- Up to 2" ID 2 wire braided hose
- Up to 2" ID 4/6 wire spiral hose*

Features

- Easy to use vertical design
- Crimps full range of Parker hoses from 1/4" through 2" I.D.*
- Crimps both steel and stainless steel fittings*
- For use with 25, 26, 43, 70, 71, 73, 76, 77, 78, 79, 81, S6 and HY Series fittings

Specifications

- Dimensions: 31" wide, 24" deep, 77" high
- Weight: 842 lbs (Head is 558 lbs and base is 284 lbs)
- Rating: 125 ton force @ 5,000 psi maximum
- Full Cycle Time: 30 seconds without adapter bowl
20 seconds with adapter bowl
- Hydraulic oil: Enerpac oil

Standard Equipment

Part Number		Description	Individual Part Number
83C-081	83C-082		
●	●	Parkrimp 2 Crimper Head Assembly	83C-080
●		Parkrimp 2 Stand Assembly with 230/460 volt, 3 phase, 50/60 Hz power unit (wired for 230 volt)	83C-S40
	●	Parkrimp 2 Stand Assembly with 230 volt, 1 phase, 50/60 Hz power unit	83C-S20
●	●	Adapter Bowl	83C-OCB
●	●	Spacer Ring	83C-R02
●	●	Spacer Plate	83C-R02H

*Can crimp 77 Series stainless steel fittings up to 1-1/2"

Optional Tooling

- Die Kit PK2-KDA (Includes 43 Series dies in sizes 1/4", 3/8", 1/2", 3/4", 1", 1-1/4" and 77 Series dies in sizes 1/2", 5/8", 3/4", 1", 1-1/4", 1-1/2" and 2" only)
- Die Kit 77K-KDA (Includes 77 Series dies in sizes 1/2", 5/8", 3/4", 1", 1-1/4", 1-1/2" and 2" only)

Installation & Operating Instructions

Installing the Parkrimp 2 Crimper

The Parkrimp 2 is shipped in two crates. One crate contains the crimp head (83C-080), and the second contains the stand assembly (83C-S20 or 83C-S40). See previous page for weight of each.

Check to make sure you have received the following items:

Qty.	Part Number	
1	83C-080	Crimp Head Assembly Includes:
1	83C-OCB	Adapter Bowl Assembly
1	83C-R02	Spacer Ring
1	83C-R02H	Spacer Plate
1	83C-R12	Split Die Ring (Front Half)
4	832180-5	1/2-13 x 2-1/2" Hex Head Bolt
4	832180-6	1/2" Lockwasher
4	832180-7	1/2" Hex Nut
1	832181	Hoist Ring
1	842205	Grease
1	4480-T25-US	Technical Manual
1	83C-S20 or 83C-S40	Stand Assembly Includes:
1	881612-13 or 881612-14	Receptacle
2		Hose Assemblies

1. Remove crate top and sides from shipping pallets. Unbolt stand from pallet and move to final location for assembly.
2. The crimp head (83C-080) may have been shipped with mounting bracket (832156) rotated to fit crate. Reposition and install 5/8" x 1" bolts with lockwashers. Torque the bolts to 100-125 lb-ft.
3. Carefully lift the crimp head from shipping pallet and position on stand. Align four holes in mounting bracket with holes in stand top. Bolt the crimp head to stand with 1/2" x 2 1/2" hex head bolts, lockwashers and nuts provided. Torque the nuts to 85-110 lb-ft.
4. Install provided hose assemblies, remove eye bolt and reinstall cylinder guard.
5. Remove the reservoir breather shipping plug.
6. Attach the enclosed breather cap to the reservoir.
7. The crimper has been filled with oil and cycled. Check the oil level in the reservoir prior to start-up. The oil level should be visible in the Sight Gage. Add Enterpac oil if filling is required.
8. Wire the machine in accordance with the requirements of the National Electrical Code.

Caution: Check for proper motor rotation.

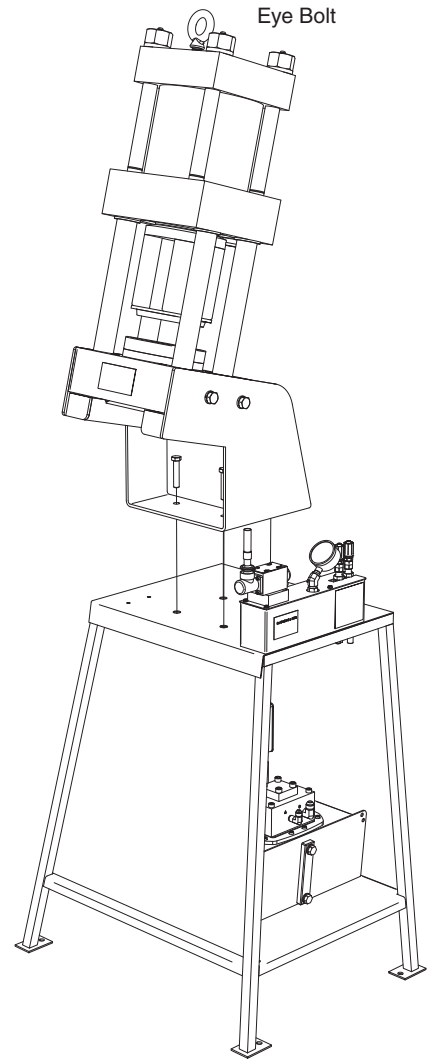

Figure 2: Use eye bolt for lifting crimp head

Installation & Operating Instructions

Removal of Air from the Parkrimp 2 Hydraulic Circuit

The hydraulic system, when connected for the first time, will have air in the system. The air must be removed for safety and proper operation. Air can generally be removed from the system by fully advancing and retracting the hydraulic cylinder several times. When the trapped air is removed from the hydraulic circuit, the cylinder will advance and retract smoothly. Sluggish cylinder action is usually the first sign of air in the system.

To Test and Operate the Parkrimp 2 Crimper

1. Place adapter bowl and spilt die ring(both halves) in machine.
2. Start motor by depressing on button
3. Pull valve handle toward you to lower cylinder. Pressurize system to 2,000 psi and check for any leaks
4. Pull valve handle toward you and fully pressurize system. Gauge pressure should be 5,000 to 5,300 psi. Push valve handle to raise cylinder.

Electrical Requirements

IMPORTANT SAFETY NOTICE

THIS INFORMATION IS INTENDED FOR USE BY INDIVIDUALS POSSESSING ADEQUATE BACKGROUNDS OF ELECTRICAL, ELECTRONIC AND MECHANICAL EXPERIENCE. ANY ATTEMPT TO REPAIR THIS MACHINE MAY RESULT IN PERSONAL INJURY AND PROPERTY DAMAGE.

THE MANUFACTURER OR SELLER CANNOT BE RESPONSIBLE FOR THE INTERPRETATION OF THIS INFORMATION, NOR CAN IT ASSUME ANY LIABILITY IN CONNECTION WITH ITS USE.

DISCONNECT POWER CORD BEFORE SERVICING

IMPORTANT — RECONNECT ALL GROUNDING DEVICES

Model No:	83C-081	83C-082
Voltage:	208-230/460 V	115/208-230 V
Amperage:	4.6-4.8/2.4 FLA	14.0/7.0-6.8 FLA
Phase:	3 PH	1 PH
Cycle:	50/60 HZ	50/60 HZ
Factory Wired For:	208-230 Volt, 3 PH, 60 Hz	208-230 Volt, 1 PH, 60 Hz

The power supply should be brought to a separate branch circuit, single-grounded receptacle. The Parkrimp 2 has been shipped with power cord, plug and a receptacle. The outlet box should be within reach of provided cord. We strongly recommend against the use of an extension cord.

Motor rotation - always check motor rotation upon first start-up, or if machine is relocated. Jog the motor once and verify that the motor rotation is the same as arrow decal located on motor.

Both model crimpers have dual voltage motors and can be rewired to operate at higher or lower voltage. This requires rewiring in the electric motor conduit box, adjusting or replacing the on/off power switch for overload protection rating and possibly new wire cable to handle additional amperage loads. Contact Parker Hannifin Hose Products Division Technical Service for additional information. Any electrical modification on these machines may void the warranty.

Both models are suitable to operate at 50 hertz voltages as listed on the motor nameplates. Operating at 50 hertz will reduce the motor RPM. The resulting pump output oil flow and cylinder speed will be reduced by approximately 15-18%. The output pressure will be the same.

Die Part Numbers

The following dies are available from Hose Products Division for use on the Parkrimp 2 machine.

Fitting Series	-4 RED	-5 PUR	-6 YEL	-8 BLU	-10 ORG	-12 GRN	-16 BLK	-20 WHT	-24 RED	-32 GRN
Die Part Number	80C-A04	80C-A05	80C-A06	80C-A08	80C-A10	80C-A12	80C-A16 83C-A16H	80C-A20 83C-A20H	83C-A24	83C-A32
43 Series										
Die Part Number			83C-D06	83C-D08	83C-D10	83C-D12	83C-D16 83C-D16H	83C-D20 83C-D20H	83C-D24	83C-D32
71 Series										
Die Part Number				80C-CS08	80C-CS10	80C-CS12	83C-CS16	83C-CS20	83C-CS24	83C-CS32
77 Series										
Die Part Number			80C-Y06	80C-Y08						
25 Series										
Die Part Number	80C-E04	80C-E05	80C-E06	80C-E08	80C-E10	80C-E12	80C-E16	83C-E20	83C-E24	83C-E32
26 Series										
Die Part Number						80C-V12	80C-V16	80C-V20	83C-V24	83C-V32
81 Series										
Die Part Number	80C-H595			80C-H735	80C-H860	80C-H1015	80C-H1170	80C-H1365		
HY Series 611HT, 801, 836 Hose										

Tooling

The following tooling is used for crimping

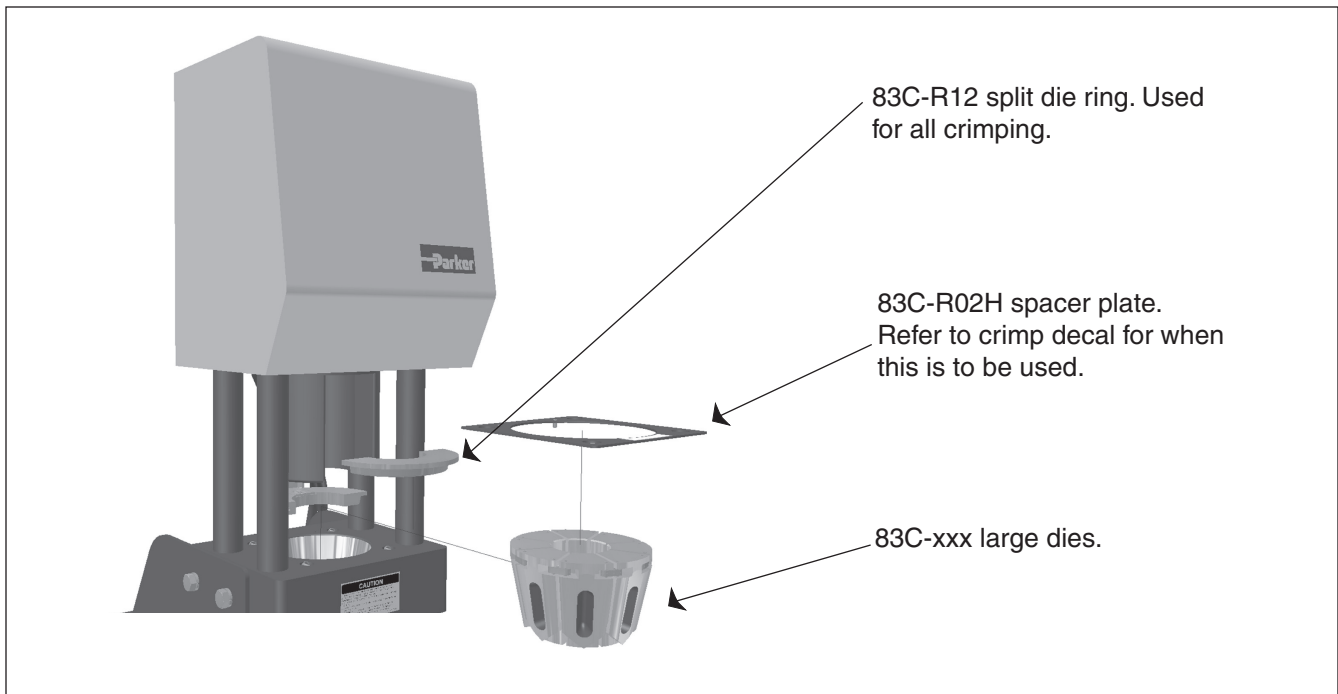
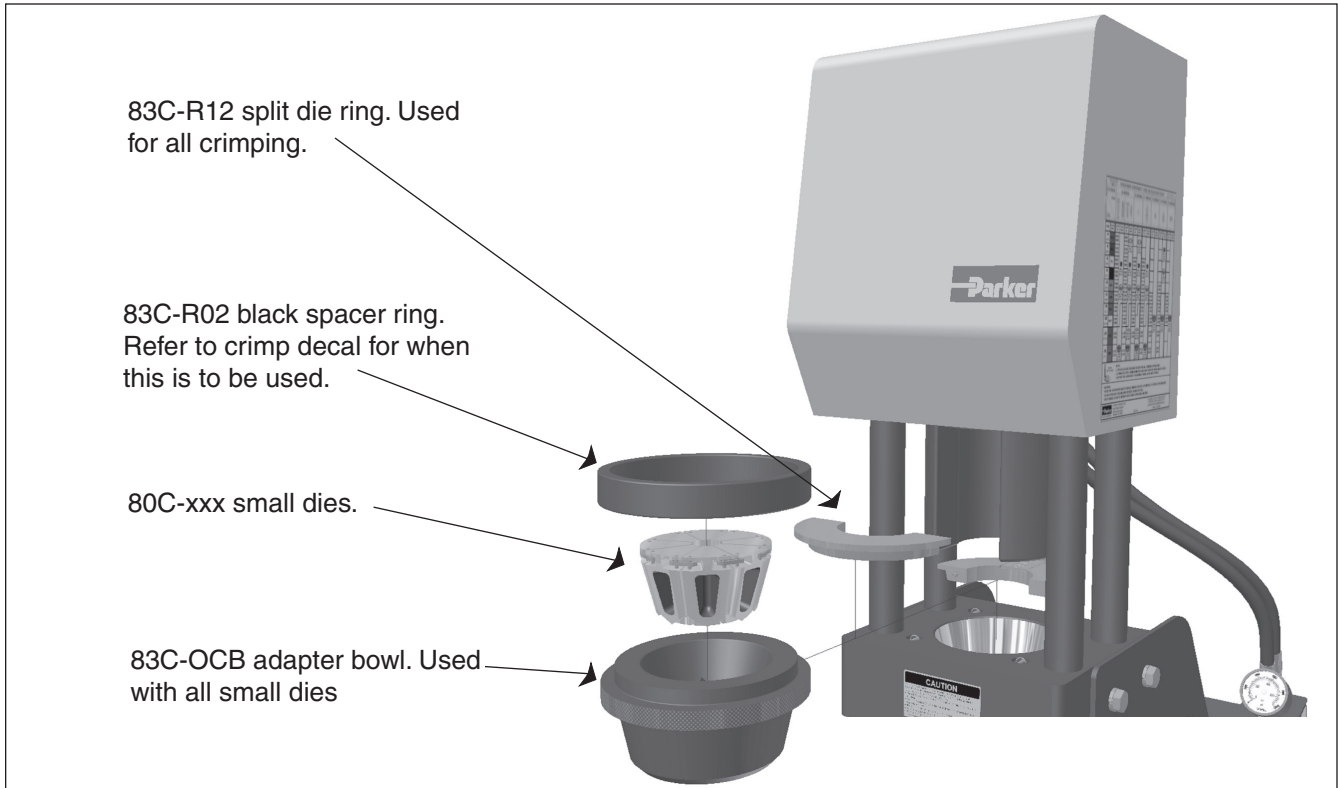

Tool Selection Chart

Parker		Parker Hannifin Corporation Hose Products Division 90240 Lakeland Blvd. Wickliffe, Ohio 44092		Parkrimp 2 Hose Die Selection Chart											
Finishing Series	HOSE	-4 RED	-5 PUR	-6 YEL	-8 BLU	-10 ORG	-12 GRN	-16 BLK	-20 WHT	-24 RED	-32 GRN				
40 Series	Die Part Number	80C-A04	80C-A05	80C-A06	80C-A08	80C-A10	80C-A12	80C-A16	80C-A20	80C-A24	80C-A32				
	GLOBAL CORE	187/187ST/TC (-8 THRU -32) 387/387ST/TC (-4 THRU -16) 487/487ST/TC (-4 THRU -12) 787/787ST/TC (-4 AND -6) 797/797ST/TC (-4 AND -6)	0.645 0.665	0.710 0.730	0.825 0.845	0.945 0.965	1.060 1.080	1.245 1.265	1.590 1.610	1.970 1.990	2.290 2.310	2.735 2.755			
40 Series	351ST/TC 422 426 431 436 451ST/TC 471ST/TC 472TC/LT 482ST/TC														
	Tooling Required														
40 Series	GLOBAL CORE	387/387ST/TC (-20 ONLY) 487/487ST/TC (-16 ONLY) 722/722ST/TC (-6 THRU -16) 722LT (-6 THRU -20) 722ST/TC (-20 ONLY)	0.685 0.705	0.750 0.770	0.865 0.885	0.985 1.005	1.100 1.120	1.285 1.305	1.630 1.650	2.010 2.030	2.330 2.350	2.775 2.795			
	302 421WC 881														
71 Series	Die Part Number	80C-D06 80C-D08 80C-D10 80C-D12 80C-D16 80C-D20 80C-D24 80C-D32													
	721/721ST/TC 722/722ST/TC/LT (-24 AND -32 ONLY)	0.950 0.970	1.100 1.120	1.220 1.240	1.355 1.375	1.695 1.715	2.025 2.045	2.290 2.310	2.775 2.795						
77 Series	Die Part Number	80C-C06 80C-C10 80C-C12 80C-C16 80C-C20 80C-C24 80C-C32													
	GLOBAL CORE 387/387ST/TC (-20 THRU -32) 487/487ST/TC (-20 THRU -32) 787/787ST/TC 797/797ST/TC	0.930 0.950	1.057 1.077	1.245 1.265	1.541 1.561	1.970 1.990	2.320 2.340	2.865 2.885							
25 Series	Die Part Number	80C-Y06 80C-Y08													
	271	0.680 0.700	0.825 0.845												
26 Series	Die Part Number	80C-E04 80C-E06 80C-E08 80C-E10 80C-E12 80C-E16 80C-E20 80C-E24 80C-E32													
	213 285 293	0.460 0.480	0.520 0.540	0.575 0.595	0.670 0.690	0.805 0.825	0.915 0.935	1.175 1.195	1.420 1.440	1.670 1.690	2.160 2.180				
26 Series	201 225 266 206 226 SS2SUL 221FR 244	0.500 0.520	0.560 0.580	0.615 0.635	0.710 0.730	0.845 0.865	0.955 0.975	1.215 1.235	1.460 1.480	1.710 1.730	2.200 2.220				
	Tooling Required														
81 Series	Die Part Number	80C-V18 80C-V16 80C-V20 80C-V24 80C-V32													
	811 811HT 881	1.155 1.175	1.450 1.470	1.740 1.760	2.010 2.030	2.430 2.450									
14Y Series	Die Part Number	80C-H55 80C-H1015 80C-H1170 80C-H1365													
	801 611HT (-4 THRU -12) 836	0.575 0.595				0.995 1.015	1.140 1.160	1.350 1.370							
14Y Series	Die Part Number	80C-H735 80C-H860													
	801 611HT 836	0.775 0.775	0.890 0.910												
<p>Caution: Read the operations and technical manual before attempting to operate this machine. Do not operate this machine without guard in place. Keep hands clear of moving parts when operating machine.</p> <p>Note: Stainless steel crimp diameters may be up to 0.010" greater than table listings. Do not use lubricant to assemble spiral hose and fittings.</p>															
83C-R12 Split Die ring is used for all crimping operations		83C-xxx Small dies and 83C-OCB adapter bowl used on sizes 4 thru -20		83C-R02 Spacer Ring used with adapter bowl when called out above		83C-xxx Large dies used on sizes -16 thru -32		83C-R02H Spacer Plate used when called out above							
Information on this decal is subject to change without notice. For the most current crimp specifications, please visit Crimpsource at www.parker.com/crimpsource . New decals can be ordered at Parker website https://parker.cp.imtco.com/Account/Login .												Decal Part Number: 83C-CRIMPDECAL REV. K			

For Reference Only

Notes:

This chart is displayed on the yellow crimper cover of the Parkrimp 2 machine.

For a complete selection of hose and fittings, see Catalog 4400.

Caution: To ensure consistent quality, crimp diameters must be checked —

1. After first assembly.
2. At regular intervals during the production, such as first, last and every 50th assembly.

If you find your crimp diameters out of tolerance, inspect each assembly made. **Never allow hose assemblies with an incorrect crimp diameter to be used.** Use the appropriate Parker Machine Trouble Shooting Guide to determine the cause. If you are unable to determine the cause of the problem, call our Hose Products Division Technical Service Department, (440) 943-5700, for assistance.

Additional Hose Die Selection Charts are available upon request from your Parker supplier.



Crimping Instructions

Crimping instructions when the Adapter Bowl IS NOT required.

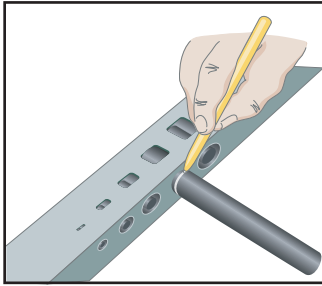

1. Mark the hose insertion depth and push hose into fitting until the mark on the hose is even with the end of the shell. Lubricate hose if necessary, however, **DO NOT lubricate if using spiral hose.** (See Catalog 4400 or CrimpSource online for Hose Insertion Depth table.)

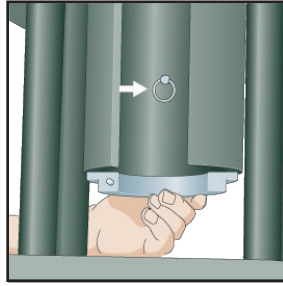

2. With the pusher in the full up position, lift the back half of the split die ring. Lock it in the up position by pushing the slide pin in. (The slide pin is inside the pusher at the back.) Lubricate Die Bowl using a premium quality lithium base grease.

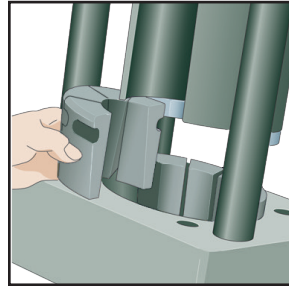

3. Insert the proper size and series die set into the die bowl. (The die sets are in two halves of four dies each. Place one half in the back and one half in the front to facilitate removal of bent tube fittings.) See decal on side of crimper for proper tool selection.

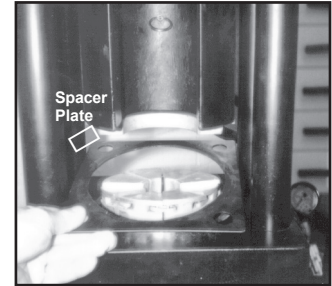

3b. If required, place spacer plate around dies.

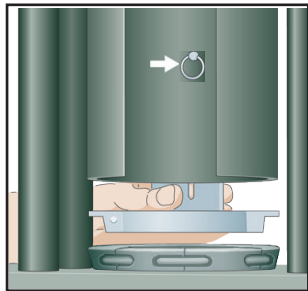

4. Lower the back half of the split die ring onto the dies by pulling the slide pin forward.

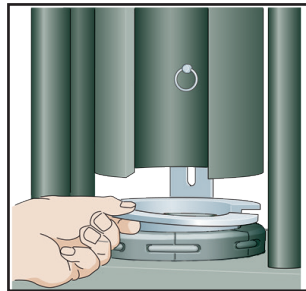

5. Insert the front half of the split die ring aligning the pins in the back half with the hole in the front half.

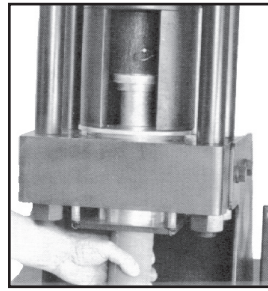

6a. Position hose in dies from below.

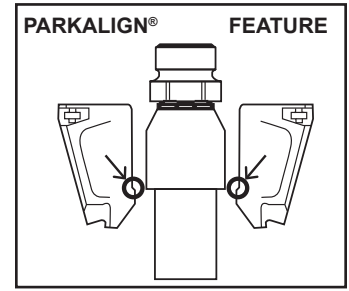

6b. Rest bottom of coupling on die step using PARKALIGN® feature.

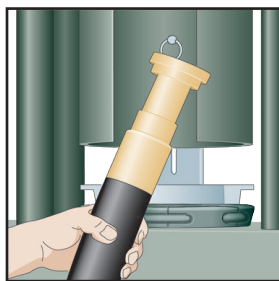

7. Turn on the pump by depressing the "ON" switch. Pull the valve handle forward to bring the pusher down for crimping. When the split die ring contacts the base plate, the crimp is complete. Push the valve handle back to lift the pusher, open the dies, and release the finished assembly.

8. You do not have to remove any tooling to remove or insert straight fittings. The front half of the split die ring and the front die train must be removed to insert and remove bent tube fittings.

Note: See Hose/Die Selection chart on side of machine, or Crimpsource® online, for crimp diameters.

Note: Hose assemblies must be inspected for cleanliness and free of all foreign particles.

Note: Parker will not accept responsibility for the operation of, provide warranty coverage for, a crimper that is operated by a power unit other than equipment supplied by Parker Hannifin for the express purpose of operating the crimper.

Crimping Instructions

Crimping Instructions when the Adapter Bowl IS required.

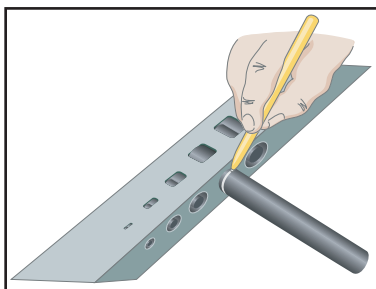

1. Mark the hose insertion depth and push hose into fitting until the mark on the hose is even with the end of the shell. Lubricate hose if necessary, however, **DO NOT lubricate if using spiral hose.** (See Catalog 4400 or CrimpSource online for Hose Insertion Depth table.)

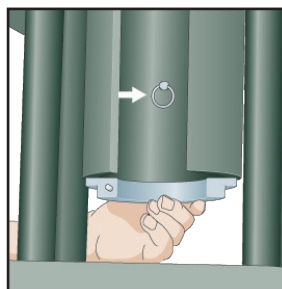

2. With the pusher in the full up position, lift the back half of the split die ring. Lock it in the up position by pushing the slide pin in. (The slide pin is located inside the pusher at the back.)

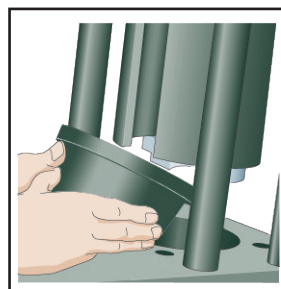

3. Lubricate Die Bowl using a premium quality lithium base grease. Carefully insert the adapter bowl, 83C-OCB, into the base bowl. The adapter bowl must be tilted toward the back of the crimper during insertion. See decal on side of crimper for proper tool selection.

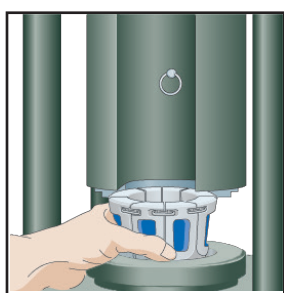

4. Lubricate Die Bowl using a premium quality lithium base grease. Place unitized die-train into the adapter bowl. See decal on crimper for proper die set.
Note: Die sets have color coded cavities indicating size and have the fitting series and dash size stamped on the top.

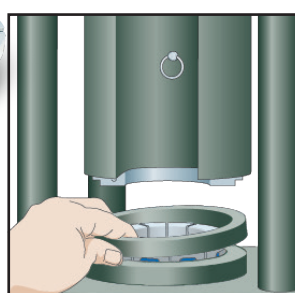

5. If required, place spacer ring on locating step of adapter bowl. Reference hose/die selection chart for usage.

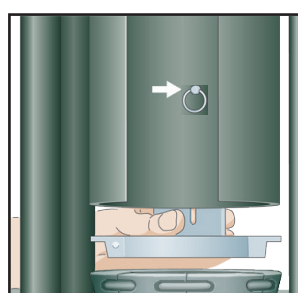

6. Lower the back half of the split die ring onto the dies by pulling the slide pin forward.

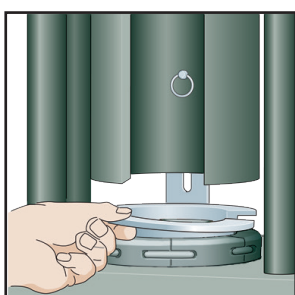

7. Insert the front half of the split die ring aligning the pin in the back half with the hole in the front half.

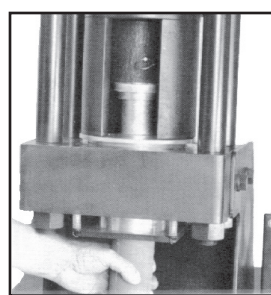

8a. Position hose in dies from below.

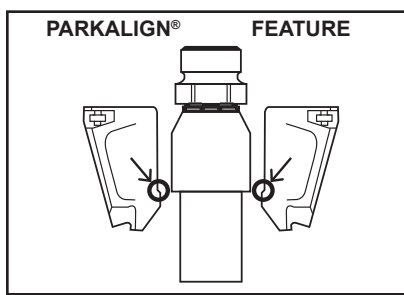

8b. Rest bottom of coupling on die step using PARKALIGN® feature. **Once positioned, go to Step 7 on page 10.**

Note: See Hose/Die Selection chart on side of machine, or CrimpSource® online for crimp diameters.

Note: Hose assemblies must be inspected for cleanliness and free of all foreign particles.

Note: Parker Hannifin will not accept responsibility for the operation of, or provide warranty coverage for, a crimper that is operated by a power unit other than equipment supplied by Parker Hannifin for the express purpose of operating the crimper.

Assembly Detail & Parts List

The Parkrimp 2 power unit is supplied to Parker by Enerpac. For warranty or repair on these pumps, contact Parker Technical Service Department at (440) 943-5700 and you will be put into contact with an approved Enerpac Service Center.

ENERPAC Warranty Policy

For those ENERPAC items sold as part of the Parker product offering, the following warranty applies.

ENERPAC products are warranted to be free of defects in materials and workmanship under normal use for as long as they are owned by the original purchaser, subject to the exclusions and limitations described below. This warranty does not cover ordinary wear and tear, overloading, alterations, (including repairs or attempted repairs by parties other than ENERPAC or its authorized service representatives), improper fluid, use in a manner for which they are not intended or use which is contrary to instructions for the products.

THIS WARRANTY IS LIMITED TO NEW PRODUCTS SOLD THROUGH ENERPAC AUTHORIZED DISTRIBUTORS, ORIGINAL EQUIPMENT MANUFACTURERS OR OTHER DESIGNATED CHANNELS OF DISTRIBUTION. NO AGENT, EMPLOYEE, OR OTHER REPRESENTATIVE OF ENERPAC HAS THE AUTHORITY TO IN ANY WAY CHANGE OR AMEND THIS WARRANTY.

Electronic products and components are warranted against defects in material and workmanship for a period of two years from the date of purchase.

The following items supplied with ENERPAC products are excluded from this warranty:

- Components not manufactured by ENERPAC, including air motors, electric motors, gasoline engines, and diesel engines. Such items are warranted to the extent of the warranty provided by the manufacturers of such items.

If the customer believes a product is defective, the product must be delivered, or shipped freight prepaid, to the nearest ENERPAC Authorized Service Center. The customer should contact ENERPAC to locate an Authorized Service Center in the customer's area. Products that do not conform to this

warranty will be returned by ground transportation, freight prepaid.

THE FOREGOING WARRANT IS EXCLUSIVE AND IS IN LIEU OF ALL OTHER EXPRESS AND IMPLIED WARRANTIES, INCLUDING BUT NOT LIMITED TO THE IMPLIED WARRANTIES OF MERCHANTABILITY AND FITNESS FOR A PARTICULAR PURPOSE.

The remedy of repair, replacement or refund is customer's exclusive remedy in the event of breach of this warranty.

SELLER SHALL NOT BE SUBJECT TO AND DISCLAIMS:

(a) ANY OTHER OBLIGATIONS OR LIABILITIES ARISING OUT OF BREACH OF CONTRACT OR OF WARRANTY,

(b) ANY OBLIGATIONS WHATSOEVER ARISING FROM TORT CLAIMS (INCLUDING NEGLIGENCE AND STRICT LIABILITY) OR ARISING UNDER THEORIES OF LAW WITH RESPECT TO PRODUCTS SOLD OR SERVICES RENDERED BY SELLER OR ANY UNDERTAKINGS, ACTS OR OMISSIONS RELATING THERETO, AND

(c) ALL CONSEQUENTIAL, INCIDENTAL AND CONTINGENT DAMAGES WHATSOEVER.

ENERPAC's liability in all cases is limited to, and shall not exceed, the purchase price paid.

For the nearest authorized ENERPAC SERVICE CENTER, please call ENERPAC at 800-558-0530 or visit the ENERPAC WEB SITE at www.Enerpac.com.

Assembly Detail & Parts List

Crimper

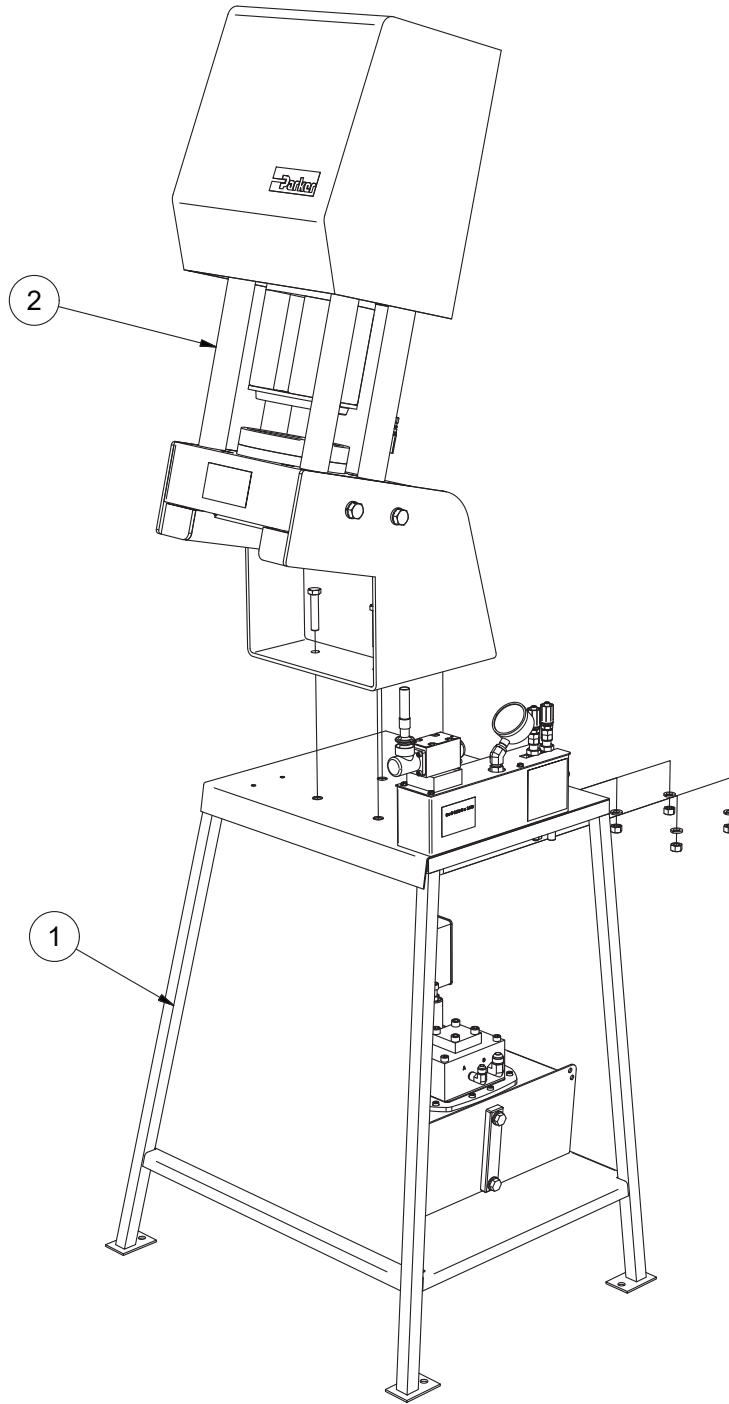

ITEM	DESCRIPTION	PART NUMBER	QTY.
1	Stand Assembly	83C-S20/83C-S40	1
2	Crimp Head Assembly	83C-080	1

Assembly Detail & Parts List

83C-080 Crimp Head

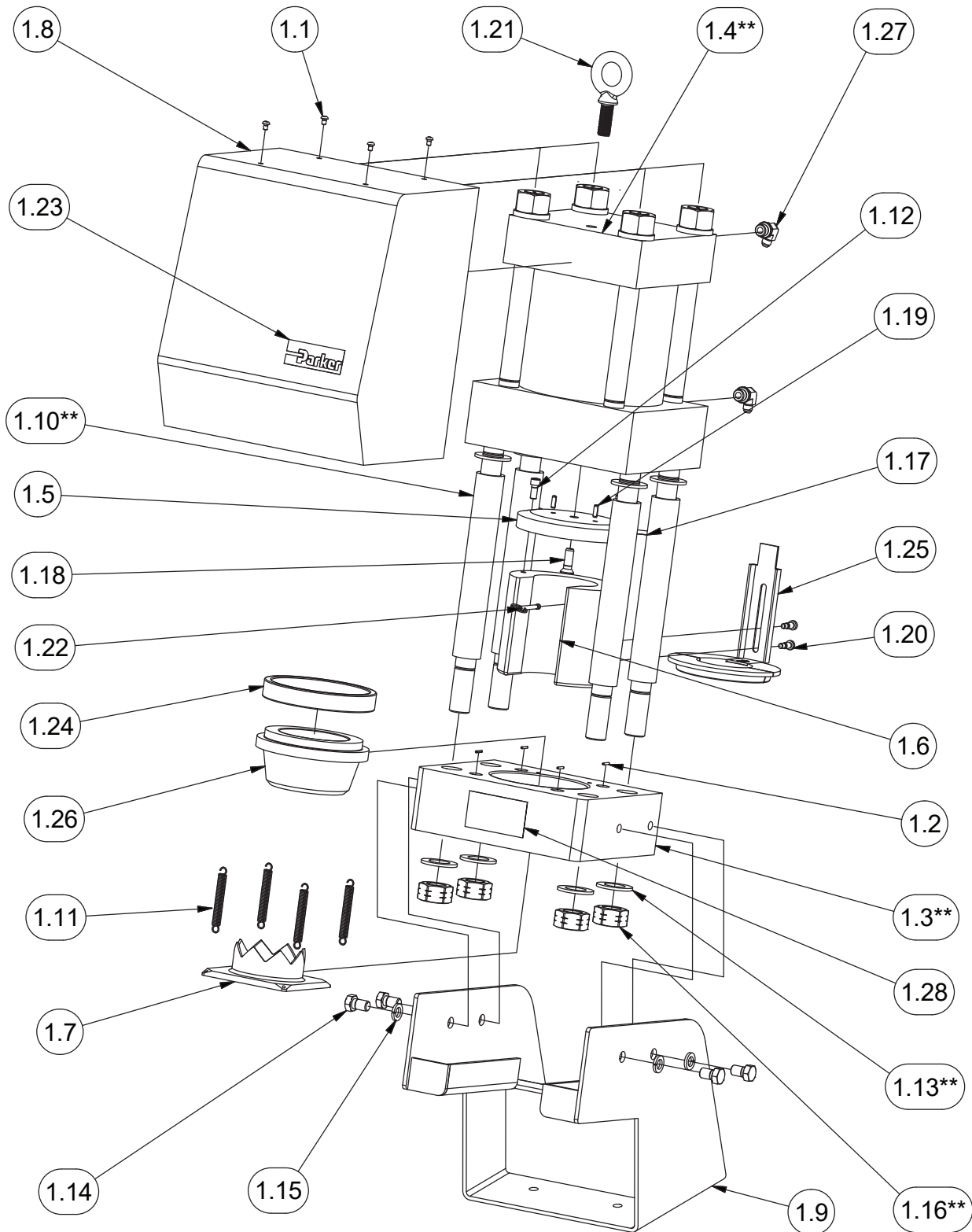

Assembly Detail & Parts List

83C-080 Crimp Head

ITEM	DESCRIPTION	PART NUMBER	QTY.
1.1	1/4-20 X 3/8" BCHS	802001	4
1.2	1/8" X 3/4" SPRING PIN	832001	4
1.3**	BASE PLATE	832092	1
1.4**	HYDRAULIC CYLINDER	832093	1
1.5	PUSHER PLATE	832094	1
1.6	PUSHER	832098	1
1.7	LARGE DIE SEPARATOR	832151	1
1.8	GUARD	832155	1
1.9	BRACKET MOUNT	83C-BRK	1
1.10**	COMPRESSION SLEEVE	832165	4
1.11	DIE SEPARATOR SPRING	832166	4
1.12	3/8-16 X 7/8" SHCS	832180-1	2
1.13**	2-1/4" X 1-1/4" X 5/32" FLAT WASHER	832180-2	8
1.14	5/8-11 X 1" HEX HEAD BOLT	832180-3	4
1.15	5/8" SPRING LOCK WASHER	832180-4	4
1.16**	1-1/4-12 GRADE 8 HEX NUT	832180-8	4
1.17	1/4" x 3" SPRING PIN	832180-11	2
1.18	1/2-13 x 1-1/2 FHCS	832180-12	1
1.19	1/4" X 3/4" SPRING PIN	832180-13	2
1.20	3/8" X 3/8" SHOULDER BOLT	832180-15	2
1.21	HOIST RING	832181	1
1.22	SLIDE PIN ASSEMBLY	832195	1
1.23	PARKER LOGO DECAL	892036	1
1.24	SPACER RING	83C-R02	1
1.25	SPLIT DIE RING ASSEMBLY	83C-R12	1
1.26	ADAPTER BOWL ASSEMBLY	83C-0CB	1
1.27	TUBE FITTING ADAPTER	6-8_C50X (2503-8-6)	2
1.28	CRIMP CAUTION DECAL	DEC-CAUTION	1
1.29	CRIMP DECAL	83C-CRIMPDECAL	1
1.31	1/2-13 X 2-1/2" HEX HEAD BOLT	832180-5	4
1.32	1/2" LOCKWASHER	832180-6	4
1.33	1/2" HEX NUT	832180-7	4
1.34	SPACER PLATE	83C-R02H	1

NOTES:

1. Items marked ** are not sold individually, contact your Parker Products supplier.

Assembly Detail & Parts List

83C-S20/83C-S40 Stand Assembly

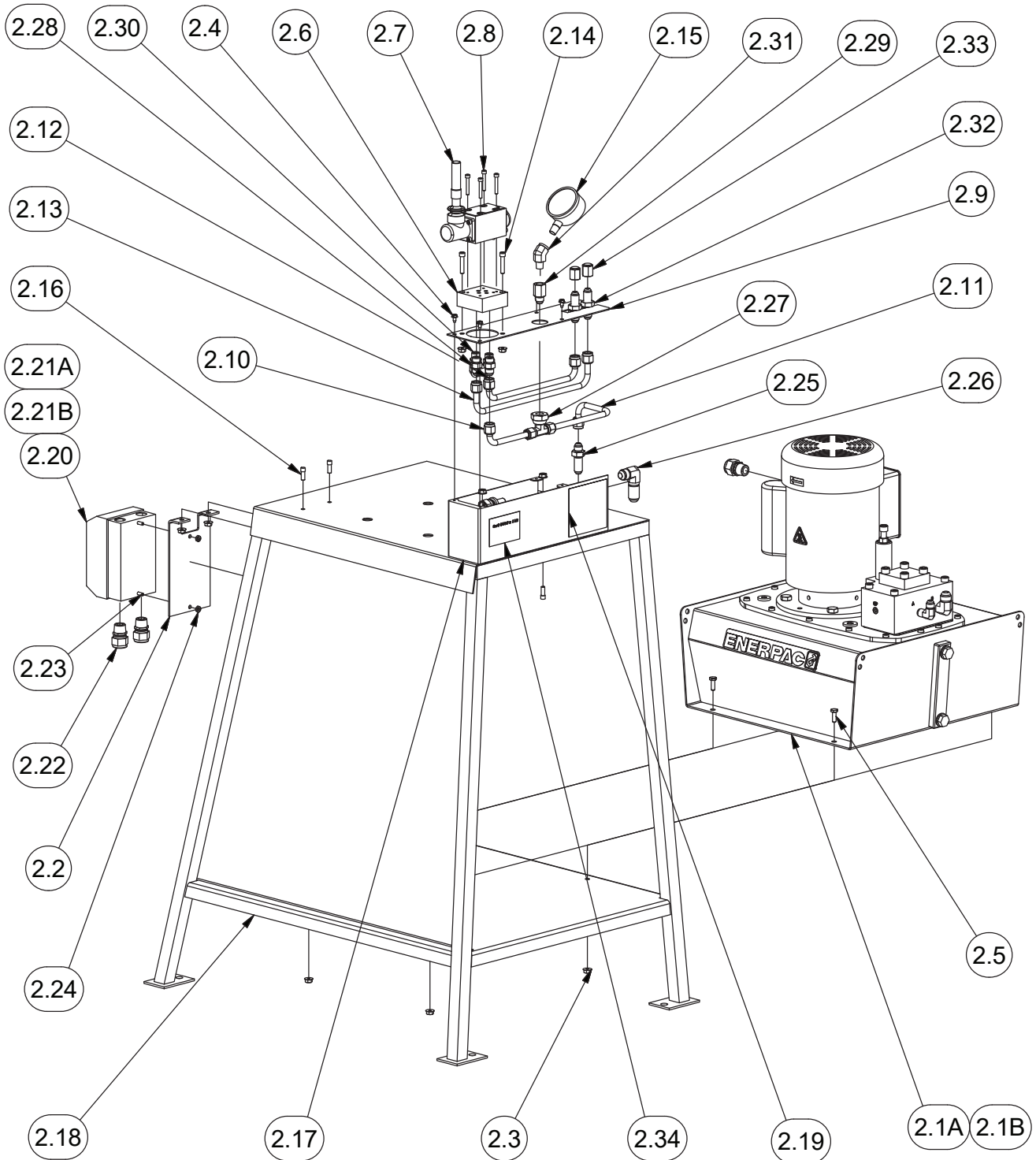

Assembly Detail & Parts List

83C-S20/83C-S40 Stand Assembly

ITEM	DESCRIPTION	PART NUMBER	QTY.
2.1A	1 PHASE POWER UNIT FOR 83C-S20	83C-PWR-1PHV3	1
2.1B	3 PHASE POWER UNIT FOR 83C-S40	83C-PWR-3PHV3	1
2.2	MOTOR STARTER MOUNT	83C-SMT	1
2.3	1/4-20 HEX NUT	802015	10
2.4	10-24 X 3/8 TYPE F TAPPING SCREW	832205-10	4
2.5	1/4-20 X 3/4" HEX HEAD SCREW	832205-D	4
2.6	VALVE SUBPLATE	881605	1
2.7	PARKER VALVE	881606-1	1
2.8	10-24 X 1-1/4 SOCKET HEAD CAP SCREW	881606-2	4
2.9	MOUNTING BRACKET	881610	1
2.10	TUBE ASSEMBLY	881611-1	1
2.11	TUBE ASSEMBLY	881611-2	1
2.12	TUBE ASSEMBLY	881611-3	1
2.13	TUBE ASSEMBLY	881611-4	1
2.14	1/4-20 X 1-1/4 SOCKET HEAD CAP SCREW	881612-1	2
2.15	PRESSURE GAUGE	881612-2	1
2.16	PEM STUD	881612-22	4
2.17	VALVE MOUNTING BOX	881615	1
2.18	STAND	881616	1
2.19	DECAL	881618	1
2.20	MOTOR STARTER BOX #GV2-MC01	TH18-400-78	1
2.21A	1 PHASE MOTOR STARTER FOR 83C-S20	TH18-400-77	1
2.21B	3 PHASE MOTOR STARTER FOR 83C-S40	TH18-400-108	1
2.22	STRAIGHT CORD GRIP FITTING	TH18-400-105	3
2.23	10-24 X 1/2" SOCKET HEAD CAP SCREW	TH18-B-46	2
2.24	10-24 HEX NUT	TH18-N-2	2
2.25	TUBE FITTING ADAPTER	6 WTX-S (0353-6-6)	3
2.26	TUBE FITTING ADAPTER	8 WETX-S (2353-8-8)	1
2.27	TUBE FITTING ADAPTER	6 S6X-S (393T-6-6)	1
2.28	TUBE FITTING ADAPTER	6 F50X-S (0503-6-6)	3
2.29	TUBE FITTING ADAPTER	6 GTX (0203-4-6)	1
2.30	TUBE FITTING ADAPTER	8-6 C50X-S (2503-6-8)	1
2.31	TUBE FITTING ADAPTER	1/4 CD45-S (3102-4-4)	1
2.32	TUBE FITTING ADAPTER	6 WLN-S (53-6N)	2
2.33	TUBE FITTING ADAPTER	6 FNTX-S (06CP-6)	2
2.34	SERIAL NUMBER DECAL	DEC-SNBR	1
2.35	PARKER HOSE FITTING (NOT SHOWN)	30682-8-8	4
2.36	PARKER HOSE FITTING (NOT SHOWN)	10643-6-6	2
2.37	PARKER HOSE (NOT SHOWN)	801-8-GRA	4 ft.
2.38	PARKER HOSE (NOT SHOWN)	381-6	7 ft.
2.39A	1 PHASE PLUG FOR 83C-S20 (NOT SHOWN)	881612-9	1
2.39B	3 PHASE PLUG FOR 83C-S40 (NOT SHOWN)	881612-10	1
2.40A	1 PHASE POWER CABLE FOR 83C-S20 (NOT SHOWN)	881612-11	10 ft.
2.40B	3 PHASE POWER CABLE FOR 83C-S40 (NOT SHOWN)	881612-12	10 ft.
2.41A	1 PHASE RECEPTACLE FOR 83C-S20 (NOT SHOWN)	881612-13	1
2.41B	3 PHASE RECEPTACLE FOR 83C-S40 (NOT SHOWN)	881612-14	1

Maintenance

Maintenance

- Frequently inspect all system components (e.g., crimp bowls, dies, die rings, pusher, hoses, electrical cords) for signs of excessive wear, leakage or damage. Replace any worn or damaged component immediately. Any electrical repair or replacement may only be performed by a qualified electrician, adhering to all applicable local and national codes.

DO NOT CONTINUE TO USE MACHINE WITH DAMAGED COMPONENTS.

- Check hydraulic fluid level every 40 hours of operation. Oil should be visible in the reservoir sight glass. Add Enerpac HF oil if necessary by removing the fill port cap. Always be sure the cylinder is fully retracted before adding fluid to the reservoir.
- Completely drain and clean the reservoir, reservoir magnet and pick-up screen every 1000 hours of use or more frequently if machine is used in dirty environments. Refill the reservoir with Enerpac HF oil. The reservoir is full when visible in the sight glass.
- Turn the machine off when not in use. Allowing the machine to run continuously when not in use, may cause overheating. If oil temperature rises to 140°F, turn machine off and let cool to 120°F.
- Clean the crimp bowls of old grease on a weekly basis. Re-grease the crimp bowls after the bowl has been cleaned.
- Apply approved MOLY-GRADE lithium grease such as Citgo Lithoplex MP2, Dow Corning Molykote GN Assembly Paste or equivalent to the dies and crimp bowl each time the dies are changed. If dies are not changed through a day's operation, grease should be applied twice a day.
- In addition to the above preventative maintenance, it is strongly recommended that the machine crimp head be inspected and serviced every 5-6 years.
Contact Parker Hose Products Division Technical Services department for crimper service information.

Trouble Shooting Guide

If you have a problem with your Parkrimp 2 machine:

- First check that the proper tooling, hose and fitting combinations are being used as identified in the Parker Catalog 4400.
- Then check the following recommendations. If after the following suggested remedy, the problem persists, call our Technical Service Department at (440) 943-5700.

Symptoms	Possible Causes	What To Do
Power unit does not operate	Blown fuse(s) Low voltage at motor On-off switch faulty Motor or pump assembly faulty	Replace with time-delay fuse(s) or circuit breaker(s) and check for the cause of the overload. Call a qualified electrician. Disconnect power. Replace off-on switch. See Enerpac instructions on page 12
Power unit stalls before pusher bottoms out	Low voltage at motor Lack of lubrication between dies and die cavity Wrong fitting, hose or die ring combination	Call a qualified electrician. Lubricate die cavity with approved MOLY-GRADE lithium grease such as Citgo Lithoplex MP2, Dow Corning Molykote GN Assembly Paste or equivalent. Use correct combination. See Catalog No. 4400.
Motor vibrates or is excessively noisy	High voltage Motor fan loose, damaged, or out of balance	Call a qualified electrician. With power disconnected, remove motor fan guard. Tighten fan screw(s), or repair fan or fan guard by straightening. If problem continues, call Enerpac.
Power unit runs but cylinder does not move up or down when valve handle is actuated.	Low oil supply Incorrect motor rotation.	Refill oil reservoir with Enerpac hydraulic oil only. Tank capacity is 5 gallons. Verify proper motor rotation with arrow on side

Trouble Shooting Guide

Symptoms	Possible Causes	What To Do
Valve leaks	Valve hold down bolts loose O-rings at valve	Tighten hold down bolts to 50-60 inch pounds. Replace O-rings.
Coupling crimp diameter above or below specification.	Wrong fitting style being used Wrong hose being used. Wrong die ring being used Pusher is not being bottomed out on die ring and base plate (usually inconsistent crimp diameters) Relief valve set too low High or low voltage Worn, damaged or faulty die ring Low on oil Crimp dies or die rings damaged, worn or faulty Die cavity in base plate or adapter bowl worn or faulty	Only approved fittings can be used with the Parkrimp 2 machine. For a complete selection and correct combinations of hose and fittings, see Parker Catalog 4400. Use only Parker No-Skive hose. For a complete selection of hose and fittings, see Parker Catalog 4400. See crimper decal or Parker Catalog 4400 for correct die ring. Lubricate die cavity with approved MOLY-GRADE lithium grease such as Citgo Lithoplex MP2, Dow Corning Molykote GN Assembly Paste or equivalent. Bottom out pusher on the die ring completely. When bottomed, you will hear the relief valve open. The pressure gauge should read 5,000-5,300 psi. Relief valve setting should be 5000 psi. Relief valve can only be set at factory. Call a qualified electrician. Replace die ring. Refill oil reservoir with Enerpac oil only. Tank capacity is 5 gallons. Visually inspect all wear surfaces for raised metal dent or gouges. Replace damaged die sets or die rings. Worn or faulty die sets will crimp above or below specification by the same amount with both the silver and black die rings. Replace worn or faulty die sets. Lubricate the die cavity in base plate frequently to prevent wear. Check crimp diameter of several different sizes of die sets with both the silver and black die rings. If all crimp diameters are out of specification by the same amount, the die cavity in the base plate or adapter bowl may be out of specification. Contact Technical Service Department for repair. Lubricate the die cavity in the bowls frequently to prevent wear.



Parker Safety Guide for Selecting and Using Hose, Tubing, Fittings, Connectors, Conductors, Valves and Related Accessories

Parker Publication No. 4400-B.1

WARNING: Failure or improper selection or improper use of hose, tubing, fittings, assemblies, valves, connectors, conductors or related accessories (“Products”) can cause death, personal injury and property damage. Possible consequences of failure or improper selection or improper use of these Products include but are not limited to:

- Fittings thrown off at high speed.
- High velocity fluid discharge.
- Explosion or burning of the conveyed fluid.
- Electrocutation from high voltage electric powerlines.
- Contact with suddenly moving or falling objects that are controlled by the conveyed fluid.
- Injections by high-pressure fluid discharge.
- Dangerously whipping Hose.
- Tube or pipe burst.
- Weld joint fracture.
- Contact with conveyed fluids that may be hot, cold, toxic or otherwise injurious.
- Sparking or explosion caused by static electricity buildup or other sources of electricity.
- Sparking or explosion while spraying paint or flammable liquids.
- Injuries resulting from inhalation, ingestion or exposure to fluids.

Before selecting or using any of these Products, it is important that you read and follow the instructions below. No product from any division in Parker Fluid Connectors Group is approved for in-flight aerospace applications. For hoses and fittings used in in-flight aerospace applications, please contact Parker Aerospace Group.

1.0 GENERAL INSTRUCTIONS

1.1 Scope: This safety guide provides instructions for selecting and using (including assembling, installing, and maintaining) these Products. For convenience, all rubber and/or thermoplastic products commonly called “hose” or “tubing” are called “Hose” in this safety guide. Metallic tube or pipe are called “tube”. All assemblies made with Hose are called “Hose Assemblies”. All assemblies made with Tube are called “Tube Assemblies”. All products commonly called “fittings”, “couplings” or “adapters” are called “Fittings”. Valves are fluid system components that control the passage of fluid. Related accessories are ancillary devices that enhance or monitor performance including crimping, flaring, flanging, presetting, bending, cutting, deburring, swaging machines, sensors, tags, lockout handles, spring guards and associated tooling. This safety guide is a supplement to and is to be used with the specific Parker publications for the specific Hose, Fittings and Related Accessories that are being considered for use. Parker publications are available at www.parker.com. SAE J1273 (www.sae.org) and ISO 17165-2 (www.ansi.org) also provide recommended practices for hydraulic Hose Assemblies, and should be followed.

1.2 Fail-Safe: Hose, Hose Assemblies, Tube, Tube Assemblies and Fittings can and do fail without warning for many reasons. Design all systems and equipment in a fail-safe mode, so that failure of the Hose, Hose Assembly, Tube, Tube Assembly or Fitting will not endanger persons or property.

1.3 Distribution: Provide a copy of this safety guide to each person responsible for selecting or using Hose, Tube and Fitting products. Do not select or use Parker Hose, Tube or Fittings without thoroughly reading and understanding this safety guide as well as the specific Parker publications for the Products.

1.4 User Responsibility: Due to the wide variety of operating conditions and applications for Hose, Tube and Fittings. Parker does not represent or warrant that any particular Hose, Tube or Fitting is suitable for any specific end use system. This safety guide does not analyze all technical parameters that must be considered in selecting a product. The user, through its own analysis and testing, is solely responsible for:

- Making the final selection of the Products.
- Assuring that the user’s requirements are met and that the application presents no health or safety hazards.
- Following the safety guide for Related Accessories and being trained to operate Related Accessories.
- Providing all appropriate health and safety warnings on the equipment on which the Products are used.
- Assuring compliance with all applicable government and industry standards.

1.5 Additional Questions: Call the appropriate Parker technical service department if you have any questions or require any additional information. See the Parker publication for the Products being considered or used, or call 1-800-CPARKER, or go to www.parker.com, for telephone numbers of the appropriate technical service department.

2.0 HOSE, TUBE AND FITTINGS SELECTION INSTRUCTIONS

2.1 Electrical Conductivity: Certain applications require that the Hose be nonconductive to prevent electrical current flow. Other applications require the Hose and the Fittings and the Hose/Fitting interface to be sufficiently conductive to drain off static electricity. Extreme care must be exercised when selecting Hose, Tube and Fittings for these or any other applications in which electrical conductivity or nonconductivity is a factor.

The electrical conductivity or nonconductivity of Hose, Tube and Fittings is dependent upon many factors and may be susceptible to change. These factors include but are not limited to the various materials used to make the Hose and the Fittings, Fitting finish (some Fitting finishes are electrically conductive while others are nonconductive), manufacturing methods (including moisture control), how the Fittings contact the Hose, age and amount of deterioration or damage or other changes, moisture content of the Hose at any particular time, and other factors.

The following are considerations for electrically nonconductive and conductive Hose. For other applications consult the individual catalog pages and the appropriate industry or regulatory standards for proper selection.

2.1.1 Electrically Nonconductive Hose: Certain applications require that the Hose be nonconductive to prevent electrical current flow or to maintain electrical isolation. For applications that require Hose to be electrically nonconductive, including but not limited to applications near high voltage electric lines, only special nonconductive Hose can be used. The manufacturer of the equipment in which the nonconductive Hose is to be used must be consulted to be certain that the Hose, Tube and Fittings that are selected are proper for the application. Do not use any Parker Hose or Fittings for any such application requiring nonconductive Hose, including but not limited to applications near high voltage electric lines or dense magnetic fields, unless (i) the application is expressly approved in the Parker technical publication for the product, (ii) the Hose is marked “nonconductive”, and (iii) the manufacturer of the equipment on which the Hose is to be used specifically approves the particular Parker Hose, Tube and Fittings for such use.

2.1.2 Electrically Conductive Hose: Parker manufactures special Hose for certain applications that require electrically conductive Hose. Parker manufactures special Hose for conveying paint in airless paint spraying applications. This Hose is labeled “Electrically Conductive Airless Paint Spray Hose” on its lay-line and packaging. This Hose must be properly connected to the appropriate Parker Fittings and properly grounded in order to dissipate dangerous static charge buildup, which occurs in all airless paint spraying applications. Do not use any other Hose for airless paint spraying, even if electrically conductive. Use of any other Hose or failure to properly connect the Hose can cause a fire or an explosion resulting in death, personal injury, and property damage. All hoses that convey fuels must be grounded.

Parker manufactures a special Hose for certain compressed natural gas (“CNG”) applications where static electricity buildup may occur. Parker CNG Hose assemblies comply with the requirements of ANSI/IAS NGV 4.2; CSA 12.52, “Hoses for Natural Gas Vehicles and Dispensing Systems” (www.ansi.org). This Hose is labeled “Electrically Conductive for CNG Use”

on its layline and packaging. This Hose must be properly connected to the appropriate Parker Fittings and properly grounded in order to dissipate dangerous static charge buildup, which occurs in, for example, high velocity CNG dispensing or transfer. Do not use any other Hose for CNG applications where static charge buildup may occur, even if electrically conductive. Use of other Hoses in CNG applications or failure to properly connect or ground this Hose can cause a fire or an explosion resulting in death, personal injury, and property damage. Care must also be taken to protect against CNG permeation through the Hose wall. See section 2.6, Permeation, for more information. Parker CNG Hose is intended for dispenser and vehicle use within the specified temperature range. Parker CNG Hose should not be used in confined spaces or unventilated areas or areas exceeding the specified temperature range. Final assemblies must be tested for leaks. CNG Hose Assemblies should be tested on a monthly basis for conductivity per ANSI/IAS NGV 4.2; CSA 12.52.

Parker manufactures special Hose for aerospace in-flight applications. Aerospace in-flight applications employing Hose to transmit fuel, lubricating fluids and hydraulic fluids require a special Hose with a conductive inner tube. This Hose for in-flight applications is available only from Parker's Stratoflex Products Division. Do not use any other Parker Hose for in-flight applications, even if electrically conductive. Use of other Hoses for in-flight applications or failure to properly connect or ground this Hose can cause a fire or an explosion resulting in death, personal injury and property damage. These Hose assemblies for in-flight applications must meet all applicable aerospace industry, aircraft engine and aircraft requirements.

- 2.2 Pressure:** Hose, Tube and Fitting selection must be made so that the published maximum working pressure of the Hose, Tube and Fittings are equal to or greater than the maximum system pressure. The maximum working pressure of a Hose, or Tube Assembly is the lower of the respective published maximum working pressures of the Hose, Tube and the Fittings used. Surge pressures or peak transient pressures in the system must be below the published maximum working pressure for the Hose, Tube and Fitting. Surge pressures and peak pressures can usually only be determined by sensitive electrical instrumentation that measures and indicates pressures at millisecond intervals. Mechanical pressure gauges indicate only average pressures and cannot be used to determine surge pressures or peak transient pressures. Published burst pressure ratings for Hose is for manufacturing test purposes only and is no indication that the Product can be used in applications at the burst pressure or otherwise above the published maximum recommended working pressure.
- 2.3 Suction:** Hoses used for suction applications must be selected to insure that the Hose will withstand the vacuum and pressure of the system. Improperly selected Hose may collapse in suction application.
- 2.4 Temperature:** Be certain that fluid and ambient temperatures, both steady and transient, do not exceed the limitations of the Hose, Tube, Fitting and Seals. Temperatures below and above the recommended limit can degrade Hose, Tube, Fittings and Seals to a point where a failure may occur and release fluid. Tube and Fittings performances are normally degraded at elevated temperature. Material compatibility can also change at temperatures outside of the rated range. Properly insulate and protect the Hose Assembly when routing near hot objects (e.g. manifolds). Do not use any Hose in any application where failure of the Hose could result in the conveyed fluids (or vapors or mist from the conveyed fluids) contacting any open flame, molten metal, or other potential fire ignition source that could cause burning or explosion of the conveyed fluids or vapors.
- 2.5 Fluid Compatibility:** Hose, and Tube Assembly selection must assure compatibility of the Hose tube, cover, reinforcement, Tube, Plating and Seals with the fluid media used. See the fluid compatibility chart in the Parker publication for the product being considered or used. This information is offered only as a guide. Actual service life can only be determined by the end user by testing under all extreme conditions and other analysis.
- Hose, and Tube that is chemically compatible with a particular fluid must be assembled using Fittings and adapters containing likewise compatible seals. Flange or flare processes can change Tube material properties that may not be compatible with certain requirements such as NACE
- 2.6 Permeation:** Permeation (that is, seepage through the Hose or Seal) will occur from inside the Hose or Fitting to outside when Hose or Fitting is used with gases, liquid and gas fuels, and refrigerants (including but not limited to such materials as helium, diesel fuel, gasoline, natural gas, phosphate esters, Skydrol, or LPG). This permeation may result in high concentrations of vapors which are potentially flammable, explosive, or toxic, and in loss of fluid. Dangerous explosions, fires, and other hazards can result when using the wrong Hose for such applications. The system designer must take into account the fact that this permeation
- will take place and must not use Hose or Fitting if this permeation could be hazardous. The system designer must take into account all legal, government, insurance, or any other special regulations which govern the use of fuels and refrigerants. Never use a Hose or Fitting even though the fluid compatibility is acceptable without considering the potential hazardous effects that can result from permeation through the Hose or Tube Assembly.
- Permeation of moisture from outside the Hose or Fitting to inside the Hose or Fitting will also occur in Hose or Tube assemblies, regardless of internal pressure. If this moisture permeation would have detrimental effects (particularly, but not limited to refrigeration and air conditioning systems), incorporation of sufficient drying capacity in the system or other appropriate system safeguards should be selected and used. The sudden pressure release of highly pressurized gas could also result in Explosive Decompression failure of permeated Seals and Hoses.
- 2.7 Size:** Transmission of power by means of pressurized fluid varies with pressure and rate of flow. The size of the components must be adequate to keep pressure losses to a minimum and avoid damage due to heat generation or excessive fluid velocity.
- 2.8 Routing:** Attention must be given to optimum routing to minimize inherent problems (kinking or flow restriction due to Hose collapse, twisting of the Hose, proximity to hot objects or heat sources). For additional routing recommendations see SAE J1273 and ISO 17165-2. Hose Assemblies have a finite life and should be installed in a manner that allows for ease of inspection and future replacement. Hose because of its relative short life, should not be used in residential and commercial buildings inside of inaccessible walls or floors, unless specifically allowed in the product literature. Always review all product literature for proper installation and routing instructions.
- 2.9 Environment:** Care must be taken to insure that the Hose, Tube and Fittings are either compatible with or protected from the environment (that is, surrounding conditions) to which they are exposed. Environmental conditions including but not limited to ultraviolet radiation, sunlight, heat, ozone, moisture, water, salt water, chemicals and air pollutants can cause degradation and premature failure.
- 2.10 Mechanical Loads:** External forces can significantly reduce Hose, Tube and Fitting life or cause failure. Mechanical loads which must be considered include excessive flexing, twist, kinking, tensile or side loads, bend radius, and vibration. Use of swivel type Fittings or adapters may be required to insure no twist is put into the Hose. Use of proper Hose or Tube clamps may also be required to reduce external mechanical loads. Unusual applications may require special testing prior to Hose selection.
- 2.11 Physical Damage:** Care must be taken to protect Hose from wear, snagging, kinking, bending smaller than minimum bend radius and cutting, any of which can cause premature Hose failure. Any Hose that has been kinked or bent to a radius smaller than the minimum bend radius, and any Hose that has been cut or is cracked or is otherwise damaged should be removed and discarded. Fittings with damages such as scratches on sealing surfaces and deformation should be replaced.
- 2.12 Proper End Fitting:** See instructions 3.2 through 3.5. These recommendations may be substantiated by testing to industry standards such as SAE J517 for hydraulic applications, or MIL-A-5070, AS1339, or AS3517 for Hoses from Parker's Stratoflex Products Division for aerospace applications.
- 2.13 Length:** When determining the proper Hose or Tube length of an assembly, be aware of Hose length change due to pressure, Tube length change due to thermal expansion or contraction, and Hose or Tube and machine tolerances and movement must be considered. When routing short hose assemblies, it is recommended that the minimum free hose length is always used. Consult the hose manufacturer for their minimum free hose length recommendations. Hose assemblies should be installed in such a way that any motion or flexing occurs within the same plane.
- 2.14 Specifications and Standards:** When selecting Hose, Tube and Fittings, government, industry, and Parker specifications and recommendations must be reviewed and followed as applicable.
- 2.15 Hose Cleanliness:** Hose and Tube components may vary in cleanliness levels. Care must be taken to insure that the Hose and Tube Assembly selected has an adequate level of cleanliness for the application.
- 2.16 Fire Resistant Fluids:** Some fire resistant fluids that are to be conveyed by Hose or Tube require use of the same type of Hose or Tube as used with petroleum base fluids. Some such fluids require a special Hose, Tube, Fitting and Seal, while a few fluids will not work with any Hose at all. See instructions 2.5 and 1.5. The wrong Hose, Tube, Fitting or Seal may fail after a very short service. In addition, all liquids but pure water may burn fiercely under certain conditions, and even pure water leakage may be hazardous.

- 2.17 Radiant Heat:** Hose and Seals can be heated to destruction without contact by such nearby items as hot manifolds or molten metal. The same heat source may then initiate a fire. This can occur despite the presence of cool air around the Hose or Seal. Performance of Tube and Fitting subjected to the heat could be degraded.
- 2.18 Welding or Brazing:** When using a torch or arc welder in close proximity to hydraulic lines, the hydraulic lines should be removed or shielded with appropriate fire resistant materials. Flame or weld spatter could burn through the Hose or Seal and possibly ignite escaping fluid resulting in a catastrophic failure. Heating of plated parts, including Hose Fittings and adapters, above 450°F (232°C) such as during welding, brazing or soldering may emit deadly gases. Any elastomer seal on fittings shall be removed prior to welding or brazing, any metallic surfaces shall be protected after brazing or welding when necessary. Welding and brazing filler material shall be compatible with the Tube and Fitting that are joined.
- 2.19 Atomic Radiation:** Atomic radiation affects all materials used in Hose and Tube assemblies. Since the long-term effects may be unknown, do not expose Hose or Tube assemblies to atomic radiation. Nuclear applications may require special Tube and Fittings.
- 2.20 Aerospace Applications:** The only Hose, Tube and Fittings that may be used for in-flight aerospace applications are those available from Parker's Stratoflex Products Division. Do not use any other Hose or Fittings for in-flight applications. Do not use any Hose or Fittings from Parker's Stratoflex Products Division with any other Hose or Fittings, unless expressly approved in writing by the engineering manager or chief engineer of Stratoflex Products Division and verified by the user's own testing and inspection to aerospace industry standards.
- 2.21 Unlocking Couplings:** Ball locking couplings or other Fittings with quick disconnect ability can unintentionally disconnect if they are dragged over obstructions, or if the sleeve or other disconnect member, is bumped or moved enough to cause disconnect. Threaded Fittings should be considered where there is a potential for accidental uncoupling.
- 3.0 HOSE AND FITTINGS ASSEMBLY AND INSTALLATION INSTRUCTIONS**
- 3.1 Component Inspection:** Prior to assembly, a careful examination of the Hose and Fittings must be performed. All components must be checked for correct style, size, catalog number, and length. The Hose must be examined for cleanliness, obstructions, blisters, cover looseness, kinks, cracks, cuts or any other visible defects. Inspect the Fitting and sealing surfaces for burrs, nicks, corrosion or other imperfections. Do NOT use any component that displays any signs of nonconformance.
- 3.2 Hose and Fitting Assembly:** Do not assemble a Parker Fitting on a Parker Hose that is not specifically listed by Parker for that Fitting, unless authorized in writing by the engineering manager or chief engineer of the appropriate Parker division. Do not assemble a Parker Fitting on another manufacturer's Hose or a Parker Hose on another manufacturer's Fitting unless (i) the engineering manager or chief engineer of the appropriate Parker division approves the Assembly in writing or that combination is expressly approved in the appropriate Parker literature for the specific Parker product, and (ii) the user verifies the Assembly and the application through analysis and testing. For Parker Hose that does not specify a Parker Fitting, the user is solely responsible for the selection of the proper Fitting and Hose Assembly procedures. See instruction 1.4.
- To prevent the possibility of problems such as leakage at the Fitting or system contamination, it is important to completely remove all debris from the cutting operation before installation of the Fittings. The Parker published instructions must be followed for assembling the Fittings on the Hose. These instructions are provided in the Parker Fitting catalog for the specific Parker Fitting being used, or by calling 1-800-CPARKER, or at www.parker.com.
- 3.3 Related Accessories:** Do not crimp or swage any Parker Hose or Fitting with anything but the listed swage or crimp machine and dies in accordance with Parker published instructions. Do not crimp or swage another manufacturer's Fitting with a Parker crimp or swage die unless authorized in writing by the engineering manager or chief engineer of the appropriate Parker division.
- 3.4 Parts:** Do not use any Parker Fitting part (including but not limited to socket, shell, nipple, or insert) except with the correct Parker mating parts, in accordance with Parker published instructions, unless authorized in writing by the engineering manager or chief engineer of the appropriate Parker division.
- 3.5 Field Attachable/Permanent:** Do not reuse any field attachable Hose Fitting that has blown or pulled off a Hose. Do not reuse a Parker permanent Hose

Fitting (crimped or swaged) or any part thereof. Complete Hose Assemblies may only be reused after proper inspection under section 4.0. Do not assemble Fittings to any previously used hydraulic Hose that was in service, for use in a fluid power application.

- 3.6 Pre-Installation Inspection:** Prior to installation, a careful examination of the Hose Assembly must be performed. Inspect the Hose Assembly for any damage or defects. DO NOT use any Hose Assembly that displays any signs of nonconformance.
- 3.7 Minimum Bend Radius:** Installation of a Hose at less than the minimum listed bend radius may significantly reduce the Hose life. Particular attention must be given to preclude sharp bending at the Hose to Fitting juncture. Any bending during installation at less than the minimum bend radius must be avoided. If any Hose is kinked during installation, the Hose must be discarded.
- 3.8 Twist Angle and Orientation:** Hose Assembly installation must be such that relative motion of machine components does not produce twisting.
- 3.9 Securement:** In many applications, it may be necessary to restrain, protect, or guide the Hose to protect it from damage by unnecessary flexing, pressure surges, and contact with other mechanical components. Care must be taken to insure such restraints do not introduce additional stress or wear points.
- 3.10 Proper Connection of Ports:** Proper physical installation of the Hose Assembly requires a correctly installed port connection insuring that no twist or torque is transferred to the Hose when the Fittings are being tightened or otherwise during use.
- 3.11 External Damage:** Proper installation is not complete without insuring that tensile loads, side loads, kinking, flattening, potential abrasion, thread damage or damage to sealing surfaces are corrected or eliminated. See instruction 2.10.
- 3.12 System Checkout:** All air entrapment must be eliminated and the system pressurized to the maximum system pressure (at or below the Hose maximum working pressure) and checked for proper function and freedom from leaks. Personnel must stay out of potential hazardous areas while testing and using.
- 3.13 Routing:** The Hose Assembly should be routed in such a manner so if a failure does occur, the escaping media will not cause personal injury or property damage. In addition, if fluid media comes in contact with hot surfaces, open flame or sparks, a fire or explosion may occur. See section 2.4.
- 3.14 Ground Fault Equipment Protection Devices (GFEPDs): WARNING! Fire and Shock Hazard.** To minimize the danger of fire if the heating cable of a Multitube bundle is damaged or improperly installed, use a Ground Fault Equipment Protection Device. Electrical fault currents may be insufficient to trip a conventional circuit breaker.
- For ground fault protection, the IEEE 515:** (www.ansi.org) standard for heating cables recommends the use of GFEPDs with a nominal 30 milliampere trip level for "piping systems in classified areas, those areas requiring a high degree of maintenance, or which may be exposed to physical abuse or corrosive atmospheres".
- 4.0 TUBE AND FITTINGS ASSEMBLY AND INSTALLATION INSTRUCTIONS**
- 4.1 Component Inspection:** Prior to assembly, a careful examination of the Tube and Fittings must be performed. All components must be checked for correct style, size, material, seal, and length. Inspect the Fitting and sealing surfaces for burrs, nicks, corrosion, missing seal or other imperfections. Do NOT use any component that displays any signs of nonconformance.
- 4.2 Tube and Fitting Assembly:** Do not assemble a Parker Fitting with a Tube that is not specifically listed by Parker for that Fitting, unless authorized in writing by the engineering manager or chief engineer of the appropriate Parker division. The Tube must meet the requirements specified to the Fitting.
- The Parker published instructions must be followed for assembling the Fittings to a Tube. These instructions are provided in the Parker Fitting catalog for the specific Parker Fitting being used, or by calling 1-800-CPARKER, or at www.parker.com.
- 4.3 Related Accessories:** Do not preset or flange Parker Fitting components using another manufacturer's equipment or procedures unless authorized in writing by the engineering manager or chief engineer of the appropriate Parker division. Tube, Fitting component and tooling must be checked for correct style, size and material. Operation and maintenance of Related Accessories must be in accordance with the operation manual for the designated Accessory.
- 4.4 Securement:** In many applications, it may be necessary to restrain, protect, or guide the Tube to protect it from damage by unnecessary flexing, pressure surges, vibration, and contact with other mechanical components. Care must be taken to insure such restraints do not introduce additional stress or wear points.

Safety Guide

- 4.5 **Proper Connection of Ports:** Proper physical installation of the Tube Assembly requires a correctly installed port connection insuring that no torque is transferred to the Tube when the Fittings are being tightened or otherwise during use.
- 4.6 **External Damage:** Proper installation is not complete without insuring that tensile loads, side loads, flattening, potential abrasion, thread damage or damage to sealing surfaces are corrected or eliminated. See instruction 2.10.
- 4.7 **System Checkout:** All air entrapment must be eliminated and the system pressurized to the maximum system pressure (at or below the Tube Assembly maximum working pressure) and checked for proper function and freedom from leaks. Personnel must stay out of potential hazardous areas while testing and using.
- 4.8 **Routing:** The Tube Assembly should be routed in such a manner so if a failure does occur, the escaping media will not cause personal injury or property damage. In addition, if fluid media comes in contact with hot surfaces, open flame or sparks, a fire or explosion may occur. See section 2.4.
- 5.0 **HOSE AND FITTING MAINTENANCE AND REPLACEMENT INSTRUCTIONS**
- 5.1 Even with proper selection and installation, Hose life may be significantly reduced without a continuing maintenance program. The severity of the application, risk potential from a possible Hose failure, and experience with any Hose failures in the application or in similar applications should determine the frequency of the inspection and the replacement for the Products so that Products are replaced before any failure occurs. Certain products require maintenance and inspection per industry requirements. Failure to adhere to these requirements may lead to premature failure. A maintenance program must be established and followed by the user and, at minimum, must include instructions 5.2 through 5.7
- 5.2 **Visual Inspection Hose/Fitting:** Any of the following conditions require immediate shut down and replacement of the Hose Assembly:
 - Fitting slippage on Hose;
 - Damaged, cracked, cut or abraded cover (any reinforcement exposed);
 - Hard, stiff, heat cracked, or charred Hose;
 - Cracked, damaged, or badly corroded Fittings;
 - Leaks at Fitting or in Hose;
 - Kinked, crushed, flattened or twisted Hose; and
 - Blistered, soft, degraded, or loose cover.
- 5.3 **Visual Inspection All Other:** The following items must be tightened, repaired, corrected or replaced as required:
 - Leaking port conditions;
 - Excess dirt buildup;/
 - Worn clamps, guards or shields; and
 - System fluid level, fluid type, and any air entrapment.
- 5.4 **Functional Test:** Operate the system at maximum operating pressure and check for possible malfunctions and leaks. Personnel must avoid potential hazardous areas while testing and using the system. See section 2.2.
- 5.5 **Replacement Intervals:** Hose assemblies and elastomeric seals used on Hose Fittings and adapters will eventually age, harden, wear and deteriorate under thermal cycling and compression set. Hose Assemblies and elastomeric seals should be inspected and replaced at specific replacement intervals, based on previous service life, government or industry recommendations, or when failures could result in unacceptable downtime, damage, or injury risk. See section 1.2. Hose and Fittings may be subjected to internal mechanical and/or chemical wear from the conveying fluid and may fail without warning. The user must determine the product life under such circumstances by testing. Also see section 2.5.
- 5.6 **Hose Inspection and Failure:** Hydraulic power is accomplished by utilizing high pressure fluids to transfer energy and do work. Hoses, Fittings and Hose Assemblies all contribute to this by transmitting fluids at high pressures. Fluids under pressure can be dangerous and potentially lethal and, therefore, extreme caution must be exercised when working with fluids under pressure and handling the Hoses transporting the fluids. From time to time, Hose

Assemblies will fail if they are not replaced at proper time intervals. Usually these failures are the result of some form of misapplication, abuse, wear or failure to perform proper maintenance. When Hoses fail, generally the high pressure fluids inside escape in a stream which may or may not be visible to the user. Under no circumstances should the user attempt to locate the leak by "feeling" with their hands or any other part of their body. High pressure fluids can and will penetrate the skin and cause severe tissue damage and possibly loss of limb. Even seemingly minor hydraulic fluid injection injuries must be treated immediately by a physician with knowledge of the tissue damaging properties of hydraulic fluid.

If a Hose failure occurs, immediately shut down the equipment and leave the area until pressure has been completely released from the Hose Assembly. Simply shutting down the hydraulic pump may or may not eliminate the pressure in the Hose Assembly. Many times check valves, etc., are employed in a system and can cause pressure to remain in a Hose Assembly even when pumps or equipment are not operating. Tiny holes in the Hose, commonly known as pinholes, can eject small, dangerously powerful but hard to see streams of hydraulic fluid. It may take several minutes or even hours for the pressure to be relieved so that the Hose Assembly may be examined safely.

Once the pressure has been reduced to zero, the Hose Assembly may be taken off the equipment and examined. It must always be replaced if a failure has occurred. Never attempt to patch or repair a Hose Assembly that has failed. Consult the nearest Parker distributor or the appropriate Parker division for Hose Assembly replacement information.

Never touch or examine a failed Hose Assembly unless it is obvious that the Hose no longer contains fluid under pressure. The high pressure fluid is extremely dangerous and can cause serious and potentially fatal injury.

- 5.7 **Elastomeric seals:** Elastomeric seals will eventually age, harden, wear and deteriorate under thermal cycling and compression set. Elastomeric seals should be inspected and replaced.
- 5.8 **Refrigerant gases:** Special care should be taken when working with refrigeration systems. Sudden escape of refrigerant gases can cause blindness if the escaping gases contact the eye and can cause freezing or other severe injuries if it contacts any other portion of the body.
- 5.9 **Compressed natural gas (CNG):** Parker CNG Hose Assemblies should be tested after installation and before use, and at least on a monthly basis per instructions provided on the Hose Assembly tag. The recommended procedure is to pressurize the Hose and check for leaks and to visually inspect the Hose for damage and to perform an electrical resistance test.
 - Caution:** Matches, candles, open flame or other sources of ignition shall not be used for Hose inspection. Leak check solutions should be rinsed off after use.
- 6.0 **HOSE STORAGE**
- 6.1 **Age Control:** Hose and Hose Assemblies must be stored in a manner that facilitates age control and first-in and first-out usage based on manufacturing date of the Hose and Hose Assemblies. Unless otherwise specified by the manufacturer or defined by local laws and regulations:
 - 6.1.1 The shelf life of rubber hose in bulk form or hose made from two or more materials is 28 quarters (7 years) from the date of manufacture, with an extension of 12 quarters (3 years), if stored in accordance with ISO 2230;
 - 6.1.2 The shelf life of thermoplastic and polytetrafluoroethylene hose is considered to be unlimited;
 - 6.1.3 Hose assemblies that pass visual inspection and proof test shall not be stored for longer than 2 years.
 - 6.1.4 **Storage:** Stored Hose and Hose Assemblies must not be subjected to damage that could reduce their expected service life and must be placed in a cool, dark and dry area with the ends capped. Stored Hose and Hose Assemblies must not be exposed to temperature extremes, ozone, oils, corrosive liquids or fumes, solvents, high humidity, rodents, insects, ultraviolet light, electromagnetic fields or radioactive materials.

Issue Date 24-SEP-2015	ECO Number: XXXXXX	Revision Letter: A	Revision Date: 30-OCT-2015	Specification FC-Safety Guide
----------------------------------	------------------------------	------------------------------	--------------------------------------	-----------------------------------------

THIS DOCUMENT CONTAINS INFORMATION THAT IS CONFIDENTIAL AND PROPRIETARY TO PARKER HANNIFIN. THIS DOCUMENT IS FURNISHED ON THE UNDERSTANDING THAT THE DOCUMENT AND THE INFORMATION IT CONTAINS WILL NOT BE COPIED OR DISCLOSED TO OTHERS EXCEPT WITH THE WRITTEN CONSENT OF PARKER, WILL NOT BE USED FOR ANY PURPOSE OTHER THAN CONDUCTING BUSINESS WITH PARKER, AND WILL BE RETURNED AND ALL FURTHER USE DISCONTINUED UPON REQUEST BY PARKER. COPYRIGHT PARKER. YEAR OF COPYRIGHT IS FIRST YEAR INDICATED ON THIS DOCUMENT. ALL RIGHTS RESERVED



Offer of Sale

Offer of Sale

1. **Definitions.** As used herein, the following terms have the meanings indicated.
- Buyer: means any customer receiving a Quote for Products from Seller.
- Goods: means any tangible part, system or component to be supplied by the Seller.
- Products: means the Goods, Services and/or Software as described in a Quote provided by the Seller.
- Quote: means the offer or proposal made by Seller to Buyer for the supply of Products.
- Seller: means Parker-Hannifin Corporation, including all divisions and businesses thereof.
- Services: means any services to be supplied by the Seller.
- Software: means any software related to the Products, whether embedded or separately downloaded.
- Terms: means the terms and conditions of this Offer of Sale or any newer version of the same as published by Seller electronically at www.parker.com/saleterms.
2. **Terms.** All sales of Products by Seller are contingent upon, and will be governed by, these Terms and, these Terms are incorporated into any Quote provided by Seller to any Buyer. Buyer's order for any Products whether communicated to Seller verbally, in writing, by electronic data interface or other electronic commerce, shall constitute acceptance of these Terms. Seller objects to any contrary or additional terms or conditions of Buyer. Reference in Seller's order acknowledgement to Buyer's purchase order or purchase order number shall in no way constitute an acceptance of any of Buyer's terms of purchase. No modification to these Terms will be binding on Seller unless agreed to in writing and signed by an authorized representative of Seller.
3. **Price: Payment.** The Products set forth in Seller's Quote are offered for sale at the prices indicated in Seller's Quote. Unless otherwise specifically stated in Seller's Quote, prices are valid for thirty (30) days and do not include any sales, use, or other taxes or duties. Seller reserves the right to modify prices at any time to adjust for any raw material price fluctuations. Unless otherwise specified by Seller, all prices are F.C.A. Seller's facility (INCOTERMS 2010). All sales are contingent upon credit approval and payment for all purchases is due thirty (30) days from the date of invoice (or such date as may be specified in the Quote). Unpaid invoices beyond the specified payment date incur interest at the rate of 1.5% per month or the maximum allowable rate under applicable law.
4. **Shipment: Delivery: Title and Risk of Loss.** All delivery dates are approximate. Seller is not responsible for damages resulting from any delay. Regardless of the manner of shipment, delivery occurs and title and risk of loss or damage pass to Buyer, upon placement of the Products with the shipment carrier at Seller's facility. Unless otherwise agreed, Seller may exercise its judgment in choosing the carrier and means of delivery. No deferment of shipment at Buyers' request beyond the respective indicated shipping date will be made except on terms that will indemnify, defend and hold Seller harmless against all loss and additional expense. Buyer shall be responsible for any additional shipping charges incurred by Seller due to Buyer's acts or omissions.
5. **Warranty.** The warranty related to the Products is as follows: (i) Goods are warranted against defects in material or workmanship for a period of twelve (12) months from the date of delivery or 2,000 hours of use, whichever occurs first; (ii) Services shall be performed in accordance with generally accepted practices and using the degree of care and skill that is ordinarily exercised and customary in the field to which the Services pertain and are warranted for a period of six (6) months from the completion of the Services by Seller; and (iii) Software is only warranted to perform in accordance with applicable specifications provided by Seller to Buyer for ninety (90) days from the date of delivery or, when downloaded by a Buyer or end-user, from the date of the initial download. All prices are based upon the exclusive limited warranty stated above, and upon the following disclaimer:
DISCLAIMER OF WARRANTY: THIS WARRANTY IS THE SOLE AND ENTIRE WARRANTY PERTAINING TO PRODUCTS. SELLER DISCLAIMS ALL OTHER WARRANTIES, EXPRESS AND IMPLIED, INCLUDING DESIGN, NONINFRINGEMENT, MERCHANTABILITY, AND FITNESS FOR A PARTICULAR PURPOSE. SELLER DOES NOT WARRANT THAT THE SOFTWARE IS ERROR-FREE OR FAULT-TOLERANT, OR THAT BUYER'S USE THEREOF WILL BE SECURE OR UNINTERRUPTED. BUYER AGREES AND ACKNOWLEDGES THAT UNLESS OTHERWISE AUTHORIZED IN WRITING BY SELLER THE SOFTWARE SHALL NOT BE USED IN CONNECTION WITH HAZARDOUS OR HIGH RISK ACTIVITIES OR ENVIRONMENTS. EXCEPT AS EXPRESSLY STATED HEREIN, ALL PRODUCTS ARE PROVIDED "AS IS".
6. **Claims: Commencement of Actions.** Buyer shall promptly inspect all Products upon receipt. No claims for shortages will be allowed unless reported to the Seller within ten (10) days of delivery. Buyer shall notify Seller of any alleged breach of warranty within thirty (30) days after the date the non-conformance is or should have been discovered by Buyer. Any claim or action against Seller based upon breach of contract or any other theory, including tort, negligence, or otherwise must be commenced within twelve (12) months from the date of the alleged breach or other alleged event, without regard to the date of discovery.
7. **LIMITATION OF LIABILITY.** IN THE EVENT OF A BREACH OF WARRANTY, SELLER WILL, AT ITS OPTION, REPAIR OR REPLACE THE NON-CONFORMING PRODUCT, RE-PERFORM THE SERVICES, OR REFUND THE PURCHASE PRICE PAID WITHIN A REASONABLE PERIOD OF TIME. **IN NO EVENT IS SELLER LIABLE FOR ANY SPECIAL, INDIRECT, INCIDENTAL OR CONSEQUENTIAL DAMAGES ARISING OUT OF, OR AS THE RESULT OF, THE SALE, DELIVERY, NON-DELIVERY, SERVICING, NON-COMPLETION OF SERVICES, USE, LOSS OF USE OF, OR INABILITY TO USE THE PRODUCTS OR ANY PART THEREOF, LOSS OF DATA, IDENTITY, PRIVACY, OR CONFIDENTIALITY, OR FOR ANY CHARGES OR EXPENSES OF ANY NATURE INCURRED WITHOUT SELLER'S WRITTEN CONSENT, WHETHER BASED IN CONTRACT, TORT OR OTHER LEGAL THEORY. IN NO EVENT SHALL SELLER'S LIABILITY UNDER ANY CLAIM MADE BY BUYER EXCEED THE PURCHASE PRICE PAID FOR THE PRODUCTS.**
8. **Loss to Buyer's Property.** Any designs, tools, patterns, materials, drawings, confidential information or equipment furnished by Buyer or any other items which are or become Buyer's property, will be considered obsolete and may be destroyed by Seller after two (2) consecutive years have elapsed without Buyer ordering the Products manufactured using such property. Seller shall not be responsible for any loss or damage to such property while it is in Seller's possession or control.
9. **Special Tooling.** Special Tooling includes but is not limited to tooling, jigs, fixtures and associated manufacturing equipment acquired or necessary to manufacture Products. A tooling charge may be imposed for any Special Tooling. Such Special Tooling shall be and remain Seller's property notwithstanding payment of any charges by Buyer. In no event will Buyer acquire any interest in Special Tooling belonging to Seller that is utilized in the manufacture of the Products, even if such Special Tooling has been specially converted or adapted for such manufacture and notwithstanding any charges paid by Buyer. Unless otherwise agreed, Seller has the right to alter, discard or otherwise dispose of any Special Tooling or other property in its sole discretion at any time.
10. **Security Interest.** To secure payment of all sums due, Seller retains a security interest in all Products delivered to Buyer and, Buyer's acceptance of these Terms is deemed to be a Security Agreement under the Uniform Commercial Code. Buyer authorizes Seller as its attorney to execute and file on Buyer's behalf all documents Seller deems necessary to perfect its security interest.
11. **User Responsibility.** The Buyer through its own analysis and testing, is solely responsible for making the final selection of the Products and assuring that all performance, endurance, maintenance, safety and warning requirements of the application of the Products are met. The Buyer must analyze all aspects of the application and follow applicable industry standards, specifications, and other technical information provided with the Product. If Seller provides Product options based upon data or specifications provided by the Buyer, the Buyer is responsible for determining that such data and specifications are suitable and sufficient for all applications and reasonably foreseeable uses of the Products. In the event the Buyer is not the end-user, Buyer will ensure such end-user complies with this paragraph.
12. **Use of Products, Indemnity by Buyer.** Buyer shall comply with all instructions, guides and specifications provided by Seller with the Products. **Unauthorized Uses.** If Buyer uses or resells the Products for any uses prohibited in Seller's instructions, guides or specifications, or Buyer otherwise fails to comply with Seller's instructions, guides and specifications, Buyer acknowledges that any such use, resale, or non-compliance is at Buyer's sole risk. Buyer shall indemnify, defend, and hold Seller harmless from any losses, claims, liabilities, damages, lawsuits, judgments and costs (including attorney fees and defense costs), whether for personal injury, property damage, intellectual property infringement or any other claim, brought by or incurred by Buyer, Buyer's employees, or any other person, arising out of: (a) improper selection, application, design, specification or other misuse of Products provided by Seller; (b) any act or omission, negligent or otherwise,

of Buyer; (c) Seller's use of patterns, tooling, equipment, plans, drawings, designs or specifications or other information or things furnished by Buyer; (d) damage to the Products from an external cause, repair or attempted repair by anyone other than Seller, failure to follow instructions, guides and specifications provided by Seller, use with goods not provided by Seller, or opening, modifying, deconstructing or tampering with the Products for any reason; or (e) Buyer's failure to comply with these Terms. Seller shall not indemnify Buyer under any circumstance except as otherwise provided in these Terms.

13. **Cancellations and Changes.** Buyer may not cancel or modify any order for any reason, except with Seller's written consent and upon terms that will indemnify, defend and hold Seller harmless against all direct, incidental and consequential loss or damage. Seller, at any time, may change Product features, specifications, designs and availability.
14. **Limitation on Assignment.** Buyer may not assign its rights or obligations without the prior written consent of Seller.
15. **Force Majeure.** Seller does not assume the risk and is not liable for delay or failure to perform any of Seller's obligations by reason of events or circumstances beyond its reasonable control ("Events of Force Majeure"). Events of Force Majeure shall include without limitation: accidents, strikes or labor disputes, acts of any government or government agency, acts of nature, delays or failures in delivery from carriers or suppliers, shortages of materials, or any other cause beyond Seller's reasonable control.
16. **Waiver and Severability.** Failure to enforce any provision of these Terms will not invalidate that provision; nor will any such failure prejudice Seller's right to enforce that provision in the future. Invalidation of any provision of these Terms by legislation or other rule of law shall not invalidate any other provision herein and, the remaining provisions will remain in full force and effect.
17. **Termination.** Seller may terminate any agreement governed by or arising from these Terms for any reason and at any time by giving Buyer thirty (30) days prior written notice. Seller may immediately terminate, in writing, if Buyer: (a) breaches any provision of these Terms (b) appoints a trustee, receiver or custodian for all or any part of Buyer's property (c) files a petition for relief in bankruptcy on its own behalf, or one if filed by a third party (d) makes an assignment for the benefit of creditors; or (e) dissolves its business or liquidates all or a majority of its assets.
18. **Ownership of Software.** Seller retains ownership of all Software supplied to Buyer hereunder. In no event shall Buyer obtain any greater right in and to the Software than a right in the nature of a license limited to the use thereof and subject to compliance with any other terms provided with the Software.
19. **Indemnity for Infringement of Intellectual Property Rights.** Seller is not liable for infringement of any patents, trademarks, copyrights, trade dress, trade secrets or similar rights ("Intellectual Property Rights") except as provided in this Section. Seller will defend at its expense and will pay the cost of any settlement or damages awarded in an action brought against Buyer based on a third party claim that one or more of the Products sold hereunder infringes the Intellectual Property Rights of a third party in the country of delivery of the Products by the Seller to the Buyer. Seller's obligation to defend and indemnify Buyer is contingent on Buyer notifying Seller within ten (10) days after Buyer becomes aware of any such claim, and Seller having sole control over the defense of the claim including all negotiations for settlement or compromise. If one or more Products sold hereunder is subject to such a claim, Seller may, at its sole expense and option, procure for Buyer the right to continue using the Products, replace or modify the Products so as to render them non-infringing, or offer to accept return of the Products and refund the purchase price less a reasonable allowance for depreciation. Seller has no obligation or liability for any claim of infringement: (i) arising from information provided by Buyer; or (ii) directed to any Products provided hereunder for which the designs are specified in whole or part by Buyer; or (iii) resulting from the modification, combination or use in a system of any Products provided hereunder. The foregoing provisions of this Section constitute Seller's sole and exclusive liability and Buyer's sole and exclusive remedy for such claims of infringement of Intellectual Property Rights.
20. **Governing Law.** These Terms and the sale and delivery of all Products are deemed to have taken place in, and shall be governed and construed in accordance with, the laws of the State of Ohio, as applicable to contracts executed and wholly performed therein and without regard to conflicts of laws principles. Buyer irrevocably agrees and consents to the exclusive jurisdiction and venue of the courts of Cuyahoga County, Ohio with respect to any dispute, controversy or claim arising out of or relating to the sale and delivery of the Products.
21. **Entire Agreement.** These Terms, along with the terms set forth in the main body of any Quote, forms the entire agreement between the Buyer and Seller and constitutes the final, complete and exclusive expression of the terms of sale. In the event of a conflict between any term set forth in the main body of a

Quote and these Terms, the terms set forth in the main body of the Quote shall prevail. All prior or contemporaneous written or oral agreements or negotiations with respect to the subject matter shall have no effect. These Terms may not be modified unless in writing and signed by an authorized representative of Seller.

22. **Compliance with Laws.** Buyer agrees to comply with all applicable laws, regulations, and industry and professional standards, including those of the United States of America, and the country or countries in which Buyer may operate, including without limitation the U.S. Foreign Corrupt Practices Act ("FCPA"), the U.S. Anti-Kickback Act ("Anti-Kickback Act"), U.S. and E.U. export control and sanctions laws ("Export Laws"), the U.S. Food Drug and Cosmetic Act ("FDCA"), and the rules and regulations promulgated by the U.S. Food and Drug Administration ("FDA"), each as currently amended. Buyer agrees to indemnify, defend, and hold harmless Seller from the consequences of any violation of such laws, regulations and standards by Buyer, its employees or agents. Buyer acknowledges that it is familiar with all applicable provisions of the FCPA, the Anti-Kickback Act, Export Laws, the FDCA and the FDA and certifies that Buyer will adhere to the requirements thereof and not take any action that would make Seller violate such requirements. Buyer represents and agrees that Buyer will not make any payment or give anything of value, directly or indirectly, to any governmental official, foreign political party or official thereof, candidate for foreign political office, or commercial entity or person, for any improper purpose, including the purpose of influencing such person to purchase Products or otherwise benefit the business of Seller. Buyer further represents and agrees that it will not receive, use, service, transfer or ship any Product from Seller in a manner or for a purpose that violates Export Laws or would cause Seller to be in violation of Export Laws.

Notes

Parker Fluid Connectors Group

North American Divisions & Distribution Service Centers

Your complete source for quality tube fittings, hose & hose fittings, brass & composite fittings, quick-disconnect couplings, valves and assembly tools, locally available from a worldwide network of authorized distributors.

Fittings:

Available in inch and metric sizes covering SAE, BSP, DIN, GAZ, JIS and ISO thread configurations, manufactured from steel, stainless steel, brass, aluminum, nylon and thermoplastic.

Hose, Tubing and Bundles:

Available in a wide variety of sizes and materials including rubber, wire-reinforced, thermoplastic, hybrid and custom compounds.

Worldwide Availability:

Parker operates Fluid Connectors manufacturing locations and sales offices throughout North America, South America, Europe and Asia-Pacific.

For information, call toll free...

1-800-C-PARKER
(1-800-272-7537)

North American Divisions

Fluid System Connectors Division

Otsego, MI
phone 269 694 9411
fax 269 694 4614

Hose Products Division

Wickliffe, OH
phone 440 943 5700
fax 440 943 3129

Parflex Division

Ravenna, OH
phone 330 296 2871
fax 330 296 8433

Quick Coupling Division

Minneapolis, MN
phone 763 544 7781
fax 763 544 3418

Tube Fittings Division

Columbus, OH
phone 614 279 7070
fax 614 279 7685

Distribution Service Centers

Buena Park, CA

phone 714 522 8840
fax 714 994 1183

Conyers, GA

phone 770 929 0330
fax 770 929 0230

Louisville, KY

phone 502 937 1322
fax 502 937 4180

Portland, OR

phone 503 283 1020
fax 503 283 2201

Toledo, OH

phone 419 878 7000
fax 419 878 7001
fax 419 878 7420
(FCG Kit Operations)

Canada

Milton, ONT

phone 905 693 3000
fax 905 876 1958
(Contact Milton for other Service Center locations.)

Mexico

Toluca, MEX

phone (52) 722 2754 200
fax (52) 722 2722 168



Parker Hannifin Corporation
Hose Products Division
30240 Lakeland Boulevard
Wickliffe, OH 44092
phone 440 943 5700
fax 440 943 3129
e-mail hpdorders@parker.com
www.parkerhose.com