

NEWLIFE[®]

Oxygen Concentrator Service Manual

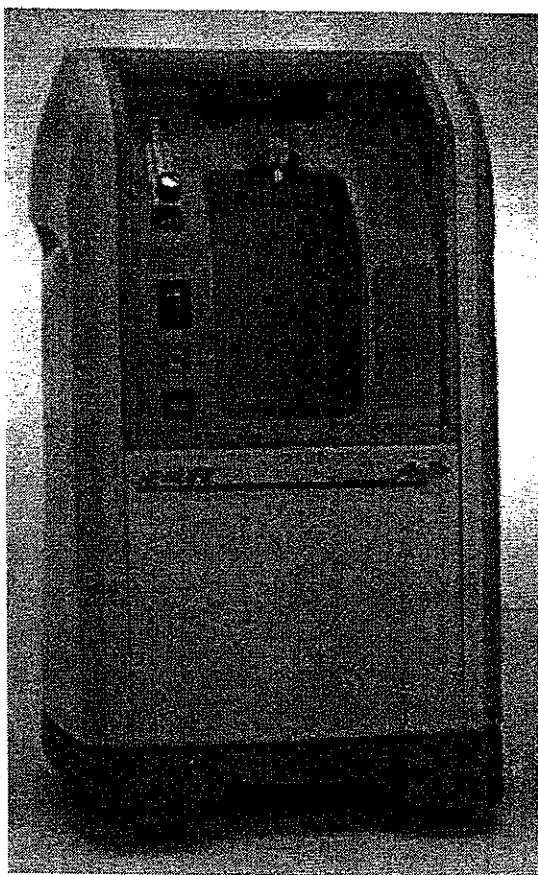

MN016-1

AIRSEP[®]

AirSep Corporation • 401 Creekside Drive • Buffalo, NY 14228-2085 USA

Telephone: (716) 691-0202 • 24-Hour Fax: (716) 691-4141

AirSep is a registered trademark of AirSep Corporation.



NewLife is a registered trademark of AirSep Corporation.



EcoCheck is a trademark of AirSep Corporation.

MBL

Table of Contents

Section 1.0

Introduction

1.1	Equipment Provider Responsibility	1-1
1.2	Safety Guidelines and Important Notices	1-2
1.3	Safety Rules	1-3
1.4	NewLife Product Warranty	1-4
1.5	How to Use This Service Manual	1-5
1.6	General Information	1-6
1.7	Functional Specifications	1-7

Section 2.0

Handling Procedures

2.1	Unpacking	2-1
2.2	NewLife Operation Check	2-2
2.2.1	Oxygen Purity Test	2-4
2.2.2	Analyzer Calibration	2-6
2.3	Conditions & Procedure for Returning a NewLife Unit	2-7
2.4	Packing for Shipment	2-7

Section 3.0

Patient Instructions

3.1	General Instructions	3-1
3.2	Routine Maintenance by the Patient	3-1
3.2.1	Cleaning the Air Intake Gross Particle Filter	3-1
3.2.2	Checking the Alarm System Battery	3-2

Section 4.0

Operation

4.1	Description of Operation	4-1
4.2	Exterior Parts	4-2
4.3	Start-Up	4-6
4.4	Alarm System	4-7
4.4.1	Battery Test	4-7
4.4.2	Power Failure Alarm Test	4-7
4.4.3	Low Pressure Alarm Test	4-7

Section 5.0

Service

4.4.4	High Pressure Alarm Test	4-8
4.4.5	EcoCheck Oxygen Monitor Verification Test	4-10
5.1	Components	5-1
5.2	Cabinet Removal	5-1
5.2.1	Removing Side Panel(s)	5-1
5.2.2	Removing Back Panel	5-2
5.2.3	Removing Lower Front Cover	5-3
5.2.4	Removing Control Panel	5-3
5.2.5	Superstructure	5-3
5.2.6	Caster Replacement	5-4
5.3	Compressor	5-5
5.3.1	Compressor Maintenance	5-6
5.3.2	Compressor Assembly Replacement	5-6
5.3.3	Vibration Mount Replacement	5-9
5.3.4	Capacitor Replacement	5-10
5.3.5	Compressor Rebuild Kit Installation	5-11
5.4	Solenoid Valves	5-14
5.4.1	Feed or Waste Valve Rebuilding	5-15
5.4.2	Feed or Waste Valve Reassembly	5-16
5.4.3	Equalization (EQ) Valve Rebuilding	5-17
5.4.4	Equalization (EQ) Valve Reassembly	5-18
5.4.5	Solenoid Valve Coil Replacement	5-18
5.4.6	Valve Cleaning	5-19
5.5	Sieve Bed Replacement	5-19
5.5.1	Sieve Bed Removal	5-19
5.5.2	Sieve Bed Installation	5-21
5.6	Cabinet Fan Replacement	5-21
5.7	Circuit Board Replacement	5-23
5.7.1	Circuit Board Removal	5-25
5.7.2	Circuit Board Installation	5-26
5.8	Product Regulator Check and Setting	5-26
5.8.1	Setting Product Regulator for Normal Operation	5-27
5.8.2	Product Regulator Lockout	5-28
5.8.3	Back Pressure Correction at 5 LPM	5-29
5.8.4	Product Regulator Cleaning or Rebuilding	5-30

5.9	High or Low Pressure Switch Replacement	5-33
5.10	Circuit Breaker Replacement	5-34
5.10.1	Circuit Breaker Removal	5-34
5.10.2	Circuit Breaker Installation	5-36
5.11	ON/OFF Power Switch Replacement	5-36
5.11.1	ON/OFF Power Switch Removal	5-36
5.11.2	ON/OFF Power Switch Installation	5-37
5.12	Buzzer Replacement	5-37
5.13	Hour Meter Replacement	5-38
5.14	Flowmeter Pilot Light Bulb Replacement	5-40
5.15	Flowmeter Replacement	5-41
5.15.1	Flowmeter Removal (Pediatric or 5 LPM Scale)	5-41
5.15.2	Flowmeter Installation (Pediatric or 5 LPM Scale)	5-42
5.16	Control Panel Replacement (Single or Dual Flowmeter Option)	5-42
5.16.1	Control Panel Removal (Single or Dual Flowmeter Option)	5-44
5.16.2	Control Panel Installation (Single to Dual Flowmeter Option)	5-46
5.17	Power Cord Replacement	5-48
5.18	EcoCheck Oxygen Monitor Installation	5-50
5.19	Air Outlet Option	5-55
5.19.1	Setting the Air Outlet Pressure Regulator	5-56
5.19.2	Air Outlet Pressure Regulator Cleaning	5-56
5.20	Operating Pressure Test	5-58
5.20.1	High Operating Pressure	5-59
5.20.2	Low Operating Pressure	5-59
5.21	Leak Test Procedure	5-60
5.22	EcoCheck Valve Cleaning	5-62

Section 6.0

Maintenance

6.1	Routine Maintenance	6-1
6.1.1	Air Intake Gross Particle Filter/GPF	6-1
6.1.2	Bacteria Filter Replacement	6-1
6.1.3	Battery Replacement	6-3
6.1.4	Recording Maintenance	6-4
6.2	Cleaning and Infection Control	6-7
6.2.1	Preparing for New Patient Use	6-7

List of Illustrations

Section 2.0

Figure 2.1	Unpacking the Unit	2-1
Figure 2.2	Flowmeter Set to Maximum Flow	2-3
Figure 2.3	Removal of Humidifier Bottle	2-4
Figure 2.4	Analyzer Connected to Oxygen Outlet	2-5
Figure 2.5	NewLife with Packing Materials	2-8

Section 3.0

Figure 3.1	Cleaning Air Intake Gross Particle Filter	3-2
------------	-------------------------------------------	-----

Section 4.0

Figure 4.1	Process Schematic	4-1
Figure 4.2	NewLife – Exterior Front	4-3
Figure 4.3	NewLife – Exterior Back	4-5
Figure 4.4	Oxygen Monitor Light Indicates Low Purity	4-6
Figure 4.5	Compressor Lead Disconnected from Strip	4-8
Figure 4.6	Lead Disconnected from Right Waste Solenoid Valve	4-9
Figure 4.7	EcoCheck Valve Set to ECONOMY Mode	4-10
Figure 4.8	EcoCheck Valve Set for 5 LPM Capability	4-11

Section 5.0

Figure 5.1	Removal of Side Panel(s)	5-2
Figure 5.2	Removal of Back Panel	5-2
Figure 5.3	Removal of Lower Front Cover	5-3
Figure 5.4	Caster Removal	5-4
Figure 5.5	Disconnection of Suction Tube	5-7
Figure 5.6	Disconnection of Compression Fitting	5-7
Figure 5.7	Removal of Compressor from Unit	5-7
Figure 5.8	Disconnection of Capacitor Leads	5-7

Section 7.0

Tool Kit
and Pressure
Test Gauge

7-1

Section 8.0

Spare Parts

8.1	Spare Parts Kits	8-1
8.1.1	N5 Kit	8-1
8.1.2	N25 Kit	8-1

Section 9.0

Troubleshooting

9-1

Appendix A

■	Wiring Schematics	
	NewLife Basic Unit	A-1
	NewLife with Oxygen Monitor	A-2
■	Exploded Drawings	
	Control Panel Assembly	A-3
	Main Structure Assembly	A-4
	Base and Cabinet Components	A-5
	Test Block Assembly	A-6
	Valve Block Assembly	A-7
	Compressor Assembly	A-8
	Adsorption Bed Assembly	A-9

Appendix B

■	Molecular Sieve	B-1
■	Efficiency and Power Formula	B-3
■	Rain-Out in Oxygen Concentrators	B-4
■	Path of Particles Within the NewLife	B-6
■	EcoCheck Oxygen Monitor	B-7

Figure 5.9	Discharging Capacitor for Removal of Compressor Assembly	5-8
Figure 5.10	Vibration Mount Removal	5-9
Figure 5.11	Disconnection of Leads for Capacitor Replacement	5-11
Figure 5.12	Valve Plate Assembly	5-12
Figure 5.13	Lighting Matrix	5-14
Figure 5.14	Removal of Red Cap from Right Feed Valve	5-15
Figure 5.15	Solenoid Valve Assembly	5-16
Figure 5.16	Removal of Solenoid Base	5-16
Figure 5.17	Removal of Red Cap from Equalization Valve	5-17
Figure 5.18	Removal of Solenoid Coil	5-17
Figure 5.19	EQ Valve – Removal of Solenoid Base	5-18
Figure 5.20	Disconnection of Product Tubes	5-20
Figure 5.21	Disconnection of Equalization Tubes	5-20
Figure 5.22	Sieve Beds	5-21
Figure 5.23	Location of Cabinet Fan	5-22
Figure 5.24	Connections of Leads to Cabinet Fan	5-23
Figure 5.25	Valve Lighting Sequence Label	5-23
Figure 5.26a	Performance Specification Label – 5 lpm	5-24
Figure 5.26b	Performance Specification Label – 6 lpm	5-24
Figure 5.27	Circuit Board Removal	5-25
Figure 5.28	Flowmeter Indicates 5.5 LPM for Normal Regulator Setting	5-26
Figure 5.29	Adjustment of Regulator Knob	5-27
Figure 5.30	Reset of Regulator Knob	5-27
Figure 5.31	Connection of Oxygen Accessories	5-28
Figure 5.32	Removal of Product Regulator Bonnet	5-31
Figure 5.33	Product Regulator Assembly	5-32
Figure 5.34	Location of Pressure Switches	5-33
Figure 5.35	Disconnection of Leads to High Pressure Switch	5-34
Figure 5.36	Removal of Circuit Breaker Leads	5-35
Figure 5.37	Removal of Circuit Breaker	5-35
Figure 5.38	Disconnection of Leads for ON/OFF Power Switch Removal	5-36
Figure 5.39	ON/OFF Power Switch Removal	5-37
Figure 5.40	Replacement of Buzzer Leads	5-38
Figure 5.41	Disconnection of Hour Meter Leads	5-39
Figure 5.42	Installation of Hour Meter	5-39
Figure 5.43	Removal of Pilot Light Bulb	5-40

Figure 5.44	Insertion of New Pilot Light Bulb	5-41
Figure 5.45	Removal of Flowmeter Nuts	5-42
Figure 5.46	Control Panel Displays Dual Flow Unit	5-43
Figure 5.47	Location of Control Panel Screws	5-44
Figure 5.48	Removal of Oxygen Tubing at Product Regulator	5-45
Figure 5.49	Disconnection of Tubing from Product Tank	5-46
Figure 5.50	Removal of Brass Elbow for Dual Flow Option	5-47
Figure 5.51	Installation of New Brass Elbow	5-47
Figure 5.52	Removal of Power Cord Twist Clamps	5-48
Figure 5.53	Disconnection of Push-On Connectors	5-49
Figure 5.54	Removal of Phillips-Head Screws	5-49
Figure 5.55	Removal of Power Cord Receptacle	5-49
Figure 5.56	Removal of Strain Relief	5-49
Figure 5.57	Positioning of Strain Relief	5-50
Figure 5.58	Monitor Label Affixes to Control Panel	5-51
Figure 5.59	Oxygen Monitor Assembly	5-52
Figure 5.60	Location of Slots with Circuit Board Support Tabs Inserted	5-53
Figure 5.61	Oxygen Monitor Circuit Board	5-53
Figure 5.62	Air Outlet Option	5-55
Figure 5.63	Air Outlet Valve in Closed Position	5-55
Figure 5.64	Air Outlet Valve in Open Position	5-55
Figure 5.65	Adjustment of Air Outlet Regulator	5-56
Figure 5.66	Air Outlet Pressure Regulator Assembly	5-57
Figure 5.67	Location of Pressure Test Port	5-58
Figure 5.68	Pressure Test Gauge Connects to Test Port	5-59
Figure 5.69	Leak Test – Compressor Fittings	5-61
Figure 5.70	Leak Test – Heat Exchanger Fittings	5-61
Figure 5.71	EcoCheck Valve Assembly	5-62

Section 6.0

Figure 6.1	Removal of Bacteria Filter	6-1
Figure 6.2	Removal of Battery from Holder	6-3
Figure 6.3	History Record Card	6-4
Figure 6.4a	Maintenance Check Form	6-5
Figure 6.4b	Maintenance Check Record Explanation	6-6

Section 7.0

Figure 7.1	Contents of Tool Kit	7-1
Figure 7.2	Pressure Test Gauge	7-2

Appendix A

Figure A.1	NewLife Basic Unit – Wiring Schematic	A-1
Figure A.2	NewLife with Oxygen Monitor – Wiring Schematic	A-2
Figure A.3	Control Panel Assembly	A-3
Figure A.4	Main Structure Assembly	A-4
Figure A.5	Base and Cabinet Components	A-5
Figure A.6	Test Block Assembly	A-6
Figure A.7	Valve Block Assembly	A-7
Figure A.8	Compressor Assembly	A-8
Figure A.9	Adsorption Bed Assembly	A-9

Appendix B

Figure B.1	Sieve Bed Assembly	B-2
------------	--------------------	-----

1.0 Introduction

1.1 Equipment Provider Responsibility

All Home Care Equipment Providers of the NewLife® Oxygen Concentrator must assume responsibilities for handling, operational check-out, patient instruction, maintenance, repair, and parts replacement. These responsibilities are outlined below and throughout this manual.



NewLife units must not be used for or with any life-supporting applications. Geriatric, pediatric, or any other patients unable to communicate discomfort while using this machine may require additional monitoring. Advise patients to immediately notify their Equipment Providers and/or physicians in case of an alarm or any discomfort.

As an Equipment Provider, you must do all of the following:



- Inspect the condition of each NewLife unit immediately upon delivery to your business location. Note any sign of damage, external or internal, on the delivery receipt, and report it directly to both the freight company and AirSep Corporation immediately.
- Check the operation of each NewLife before delivery to a patient. Always operate the unit for a reasonable length of time (minimum 45 minutes), and check that the oxygen purity level is within specifications. (Test the alarm system as described in Section 4.4 of this manual.)
- Deliver NewLife units only to patients authorized by a physician's prescription. The NewLife must not be used as a life-supporting device. A backup supply of oxygen must be available.
- Instruct patients how to use the NewLife in conjunction with the Patient Manual.
- Instruct patients to notify their physicians and/or Equipment Providers if they experience any signs of discomfort.
- Instruct each patient how to perform routine maintenance of the air intake gross particle filter and how to check the alarm system battery. (Refer to Section 3.2.)

- Replace the bacteria filter after every 10,000 hours.
- Perform a test of oxygen purity on the NewLife unit. (Refer to Section 2.2.1.)
- Be available to service each patient at any time.
- Repair components and replace parts only as outlined in this manual. Use only AirSep parts for replacement in NewLife Oxygen Concentrators.
- Refer to the NewLife Product Warranty if parts replacement is required within the warranty period.
- Return a NewLife unit ONLY as described in the "Conditions and Procedure for Returning a NewLife" section of this manual. (Refer to Section 2.3.)

1.2 Safety Guidelines and Important Notices

To ensure safe operation and proper unit maintenance, AirSep Corporation recommends that you keep this service manual readily available for reference.

As you read the manual, pay special attention to the WARNING, CAUTION and NOTE messages. They identify safety guidelines or other important information as follows:

 WARNING	Describes a hazard or unsafe practice that can result in severe bodily injury or death.
 CAUTION	Describes a hazard or unsafe practice that can result in minor bodily injury or property damage.
 NOTE	Provides information important enough to emphasize or repeat.

1.3 Safety Rules

Carefully review and familiarize yourself with the following important safety information about the NewLife Oxygen Concentrator.



This device manufactures high purity oxygen, which promotes rapid burning. Allow no smoking by anyone (including the patient) or any open flames within five feet of this device or the oxygen carrying tubing. Use no oil, grease, or petroleum-based products on or near the unit. Disconnect the power cord before you clean or service it.



Electrical shock hazard. Do not remove covers while the unit is plugged in. Allow only a qualified service technician to remove the covers. Do not use extension cords with this unit.

1.4 NewLife Product Warranty

AirSep Corporation warrants the NewLife Oxygen Concentrator to be free from defect in parts and workmanship for one, three, five, or seven years (as specified on the original invoice provided) from the date of delivery to the original purchaser, under normal use and operation. AirSep Corporation's obligations under this warranty are limited to the repair or replacement of any such item of equipment (or part thereof) shown to be defective or, at AirSep Corporation's option, to refunding the purchase price of any such defective item of equipment.

Each item of equipment for which a warranty claim is asserted shall, at the request of AirSep Corporation, be returned on a prepaid basis with proof of purchase date to the AirSep factory at the expense of the purchaser. Replacement parts shall be warranted as stated above for the unexpired portion of the original (one-, three-, five-, or seven-) year parts warranty (as specified on the original invoice provided). This warranty does not extend to any item or part subjected to misuse, accident, improper maintenance, or application, or which has been repaired or altered outside of the AirSep Corporation Factory without the express prior written authorization of AirSep Corporation.

The foregoing warranty is in lieu of any other warranty, expressed or implied, in fact or in law, including without limitation the warranty of merchantability or the warranty of fitness for particular purpose. It is expressly understood that purchaser's sole and exclusive remedy for defect in parts is limited to enforcement of AirSep Corporation's obligation as set forth above, and AirSep Corporation shall not be liable to purchaser or others for loss of use of the equipment or for other special, indirect, incidental, or consequential damages.

Notwithstanding anything to the contrary contained herein, during the parts warranty period, as specified above, AirSep will pay the cost of return freight charges to the customer. For warranty repair during the first 90 days from the date of invoice, AirSep will pay freight both ways. After the parts warranty has expired, the customer is responsible for freight both ways.

1.5 How to Use This Service Manual

This manual specifically details for you, the Equipment Provider, the procedures to service the AirSep NewLife Oxygen Concentrator.



NOTE

This manual provides instruction for Equipment Providers only. This is not a manual for NewLife patient use. Provide patients with the NewLife Patient Manual.

To prevent unauthorized use, do not leave your NewLife Service Manual or any reproduced pages at a patient location.

This manual includes complete sections in the following areas:

Introduction.....	(1.0)
Handling Procedures.....	(2.0)
Returning the NewLife for Factory Service (RGA).....	(2.3)
Maintenance Performed by the Patient	(3.2)
Operation of the NewLife	(4.0)
Service	(5.0)
Maintenance Performed by the Equipment Provider	(6.0)
Troubleshooting	(9.0)

All section titles and subject subtitles are listed in the Table of Contents on the first pages of this manual. A separate troubleshooting chart is located in the last section of this manual.

Appendix A provides wiring schematics and exploded drawings for your reference.

Appendix B includes supplemental material about rain-out, molecular sieve, the oxygen monitor, and the path of particles within the concentrator as well as information on features relevant to the responsible care practitioner and the service technician.

Appendix C provides CSA-approved specifications for the NewLife Oxygen Concentrator and a list of symbols referenced on the unit.



When requesting parts or service, provide the unit's model, serial number, hour meter reading, oxygen purity level, and operating pressure. Check that all part numbers are listed correctly. Complete and accurate information helps to expedite your request.

1.6 General Information

This manual provides the information needed by Equipment Providers to perform periodic maintenance, to repair components, and to replace parts of the NewLife Oxygen Concentrator. The NewLife Oxygen Concentrator is a self-contained air separation device that can supply up to 5 liters per minute (lpm) of high purity oxygen. This device is intended for use by patients who require supplemental oxygen therapy as prescribed by their physicians.

The NewLife unit uses a pressure swing adsorption (PSA) process to separate oxygen from room air. This process uses two sieve beds (canisters) filled with a molecular sieve material called zeolite. As room air enters the first sieve bed, the nitrogen in the air attaches (adsorbs) to the zeolite while the oxygen passes freely through the material and out of the bed for the patient's use. When the bed reaches its capacity to hold nitrogen, the process switches to the other bed, while the first bed is purged (cleaned) of the nitrogen. One bed makes oxygen while the other bed is purged of the nitrogen for the next cycle. The sieve material is completely regenerative and lasts indefinitely under normal conditions.



The design of the NewLife Oxygen Concentrator allows for home patient therapy under the direction of a qualified, licensed physician. An alternate source of oxygen must be available if a power failure or equipment malfunction occurs. Instruct patients to consult their physicians or Equipment Providers for the type of backup system required.



This unit must not be used for or with any life-support applications. Geriatric, pediatric, or any other patients unable to communicate discomfort while using this machine may require additional monitoring. Advise patients to immediately notify their Equipment Providers and/or physicians in case of an alarm or any discomfort.

1.7 Functional Specifications

Dimensions: 28.5 in. high, 15.7 in. wide, 14.5 in. deep
(72.4 cm high, 40.0 cm wide, 36.8 cm deep)

Weight: 54.0 lb; shipping weight - 64.0 lb
(24.5 kg; shipping weight - 29.0 kg)

Electrical Requirements: 120 VAC, 60 Hz, 4 amps, 350 watts

Capacity: 5 liters per minute at 90% oxygen
(Based on an atmospheric pressure of 14.7 psia at 70°F (21°C))

Accuracy: Flowmeter $\pm 5\%$ full scale. (Based on precalibrated analysis.)

Concentration: 1-3 liters per minute at 95% $\pm 3\%$
4 liters per minute at 92% $\pm 3\%$
5 liters per minute at 90% $\pm 3\%$

Response Time: 5 minutes to attain maximum purity following initial start-up or after an extended shutdown.

Positioning: Locate the back of the unit a minimum of 12 inches from the wall and clear of any obstruction. Operate the unit in an upright position.

2.0 Handling Procedures

2.1 Unpacking

- 1** Open and inspect all cartons (that contain units) upon delivery. If the exterior of a unit's carton is damaged, note it on the freight bill signed by the driver.
- 2** Unpack the unit at once. To remove the NewLife from its carton, gently tip the carton on an angle, or place it on its side, and pull the unit out. (See Figure 2.1.)

Tip Carton
with NewLife
Unit on an
Angle for
Easy
Removal

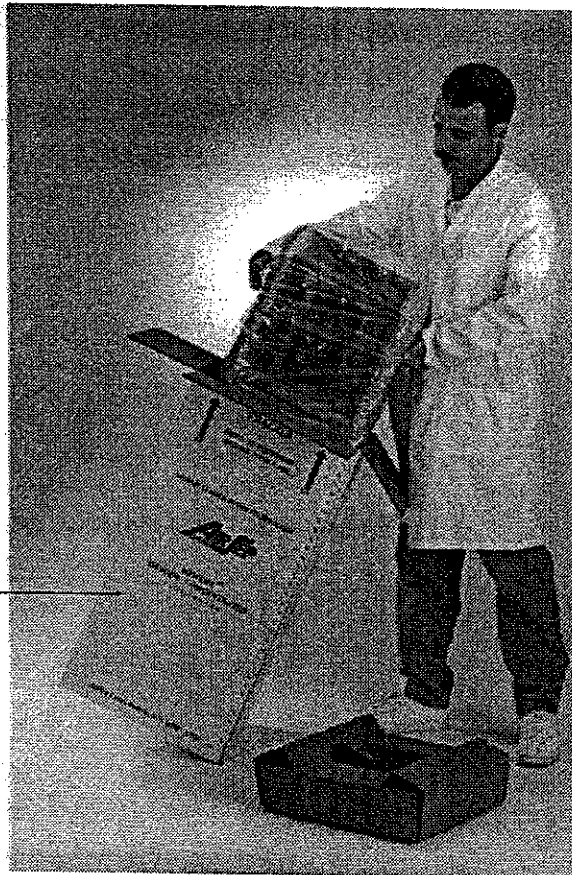

Figure 2.1: Unpacking the Unit

- 3** Inspect the cabinet exterior thoroughly for damage.
- 4** Remove the cabinet, as explained in Section 5.2 of this manual, and inspect the interior for damage.
- 5** If you find any concealed damage, do not discard the shipping carton. Call the freight company who made the delivery, and file a concealed damage claim.



Damage must be reported within 24 hours of delivery. Only the consignee can file a damage claim.



Save the shipping carton and packing inserts in case you need to ship the NewLife unit.

2.2 NewLife Operation Check

AirSep tests every NewLife Oxygen Concentrator thoroughly after manufacture. You must perform the following test to ensure that no damage occurred in shipping or handling. (Refer to Section 4.2 for the location of parts on the NewLife unit.)



Always uncoil the power cord *completely* from its holder before you plug in the NewLife unit.

- 1** Plug in the power cord of the unit, and set the ON/OFF switch to the ON position. Check to see that the following occurs:
 - a. A continuous alarm loudly sounds for approximately five seconds. See the troubleshooting chart in Section 9.0 of this manual for possible causes if either (A) the alarm fails to sound at all, (B) the alarm fails to shut off, or (C) it sounds after 35 seconds.

- 3** Inspect the cabinet exterior thoroughly for damage.
- 4** Remove the cabinet, as explained in Section 5.2 of this manual, and inspect the interior for damage.
- 5** If you find any concealed damage, do not discard the shipping carton. Call the freight company who made the delivery, and file a concealed damage claim.



Damage must be reported within 24 hours of delivery. Only the consignee can file a damage claim.



Save the shipping carton and packing inserts in case you need to ship the NewLife unit.

2.2 NewLife Operation Check

AirSep tests every NewLife Oxygen Concentrator thoroughly after manufacture. You must perform the following test to ensure that no damage occurred in shipping or handling. (Refer to Section 4.2 for the location of parts on the NewLife unit.)



Always uncoil the power cord *completely* from its holder before you plug in the NewLife unit.

- 1** Plug in the power cord of the unit, and set the ON/OFF switch to the ON position. Check to see that the following occurs:
 - a. A continuous alarm loudly sounds for approximately five seconds. See the troubleshooting chart in Section 9.0 of this manual for possible causes if either (A) the alarm fails to sound at all, (B) the alarm fails to shut off, or (C) it sounds after 35 seconds.

- b. The flowmeter pilot light illuminates.
- c. The compressor runs. Listen for the sound.
- d. Exhaust air flows out of the bottom of the unit.

2 Turn the flowmeter adjustment knob counterclockwise until it stops (wide open).

As Figure 2.2 shows, the maximum flow should register 5.5 lpm (the 5.5 lpm line should appear to split the middle of the flowmeter ball) with no connections at the oxygen outlet. If not, refer to Section 5.8.1 to set the product regulator.

3 Perform an oxygen purity test as described in Section 2.2.1.

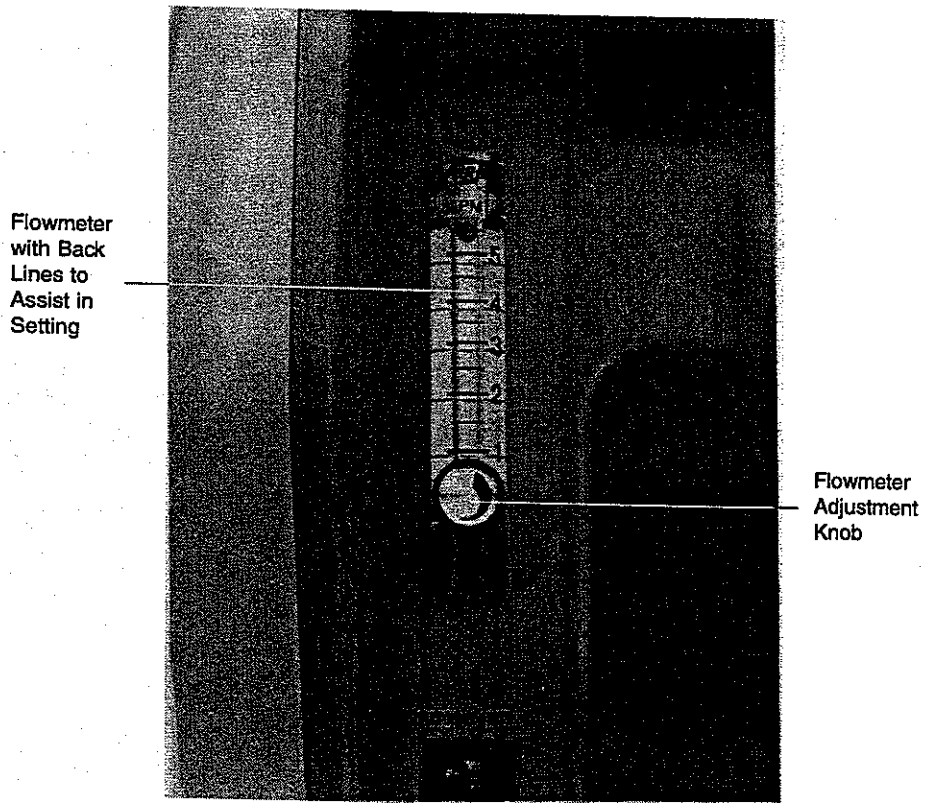

Figure 2.2: Flowmeter Set to Maximum Flow

2.2.1 Oxygen Purity Test

To ensure that the unit's output of oxygen is within specification, you must perform an oxygen purity test regularly. Test the unit upon delivery to a patient and at periodic intervals (Home care providers, based on their expertise and documentation, may establish and implement their own protocol for intervals required to check oxygen concentrator purity. The interval established may be longer or shorter than 90 days, which is AirSep's default time period for providers who do not choose to establish their own protocol.)

- 1** If an oxygen humidifier bottle is used, remove it from the oxygen outlet. (See Figure 2.3).

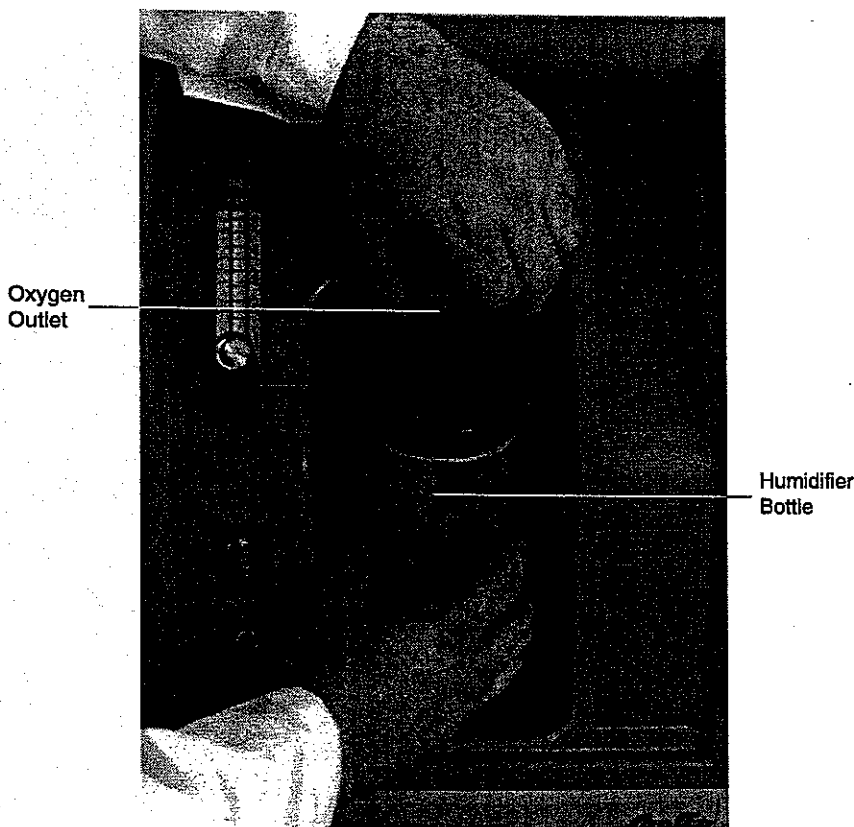

Figure 2.3: Removal of Humidifier Bottle

- 2** Attach a calibrated oxygen purity analyzer to the oxygen outlet. (See Figure 2.4.) If the analyzer requires calibration, refer to Section 2.2.2 for the calibration procedure.

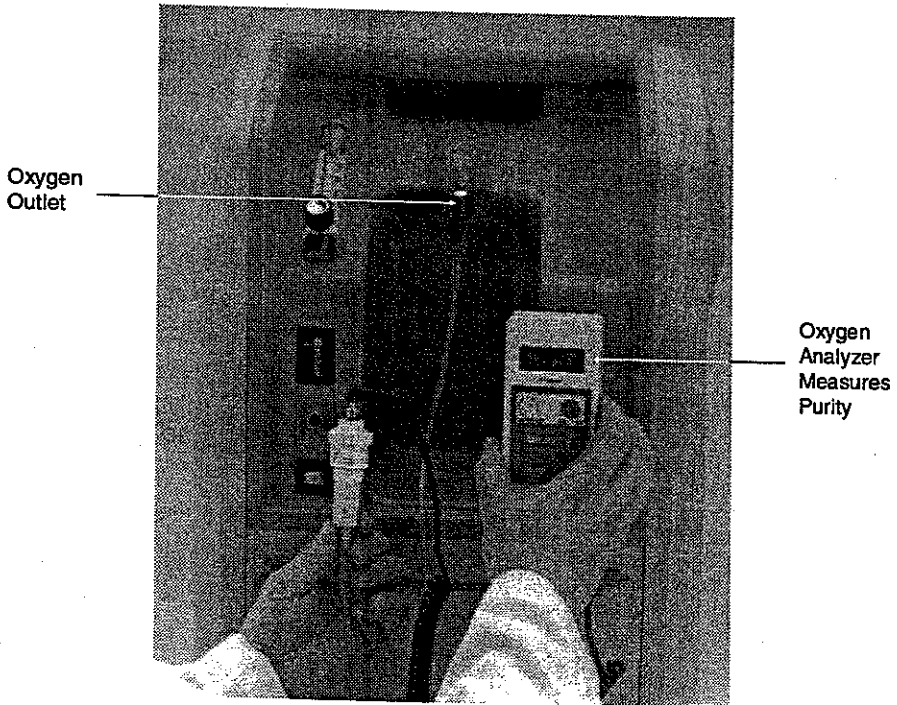

Figure 2.4: Analyzer Connected to Oxygen Outlet

- 3** Verify that the product flow rate delivered by the unit matches the patient's prescription.
The flow rate should not exceed 5 lpm.
- 4** Set the unit's ON/OFF power switch to the ON position. (It takes approximately five minutes for the oxygen purity to stabilize.) Take oxygen purity readings every 30 seconds until the analyzer shows that two consecutive readings are the same.
- 5** Disconnect the oxygen analyzer, and reconnect the humidifier bottle (if used) and any other equipment/accessories that may be required.
- 6** Adjust the flowmeter adjustment knob to the prescribed level.



Do not measure oxygen purity output after the product stream passes through a humidifier bottle, or erroneous readings will result.

2.2.2 Analyzer Calibration

Follow the manufacturer's instruction manual to calibrate the oxygen purity analyzer.

General Instructions to Calibrate an Oxygen Purity Analyzer:

- 1** Connect the oxygen analyzer to a tank that contains 100% oxygen, and open the flow control valve so that the liter flow rate equals the flow rate of the concentrator you will be checking.
- 2** Wait until the analyzer reading stabilizes, then adjust the analyzer calibration knob until the meter registers 100%.
- 3** Close the flow control valve, and disconnect the analyzer from the 100% oxygen tank.
- 4** Expose the analyzer inlet to ambient air.

The reading should fall to 21%. If not, the analyzer may be defective. Refer to the analyzer's instruction manual for calibration and accuracy specifications.



Check and calibrate all analyzers before they leave your business location (i.e., for service calls, etc.). Also, recalibrate any analyzer used to test units at patient locations before you perform each purity test.

2.3 Conditions & Procedure for Returning a NewLife Unit

If you need to return a unit for repair, you must obtain **PRIOR APPROVAL**, in the form of a Return Goods Authorization (RGA) number from AirSep Corporation.

Write the RGA number clearly on the outside of the shipping carton. To obtain an RGA number, call either the Customer or Technical Service Department at (716) 691-0202 with the serial number and hour meter reading on the unit.

- Return each NewLife unit in its original packaging.
- Be certain to insure merchandise, and properly pack it for shipping. AirSep assumes no responsibility for damage that occurs in transit.
- UPS returns of a NewLife unit must have a minimum of \$1,000 in declared value.
- You must prepay shipping charges on all returns.



NOTE

Do not return any unit to AirSep without an RGA. AirSep refuses any unauthorized returns.



NOTE

If you need to call for service assistance, have the Model, Serial Number, Hour Meter Readings, Oxygen Purity Level, and Operating Pressures readily available.

2.4 Packing for Shipment

It is very important to properly pack the NewLife unit for shipment, as shown in Figure 2.5. This helps to prevent shipping damage. Follow the steps below:

- 1** Remove the humidifier bottle if attached.
- 2** Be sure the side panels are fastened.
- 3** Wrap the power cord onto the power cord holder or around the base. (See Figure 2.5.)

- 4** Place the unit into its original shipping carton with bottom insert.
- 5** Make sure the caster wheels are suspended by the bottom insert.



When the handles of the NewLife line up with the cutout hand grips of the box, the unit is in the box properly.

- 6** Place the top insert on the unit.
- 7** Close and tape the carton.
- 8** Write the Return Goods Authorization (RGA) number on the outside of the shipping carton.



Figure 2.5: NewLife With Packing Materials

3.0 Patient Instructions

3.1 General Instructions

It is important that patients thoroughly understand how to operate the AirSep NewLife unit. This enables proper treatment as prescribed by a qualified, licensed physician. You must explain that the purpose of this therapy is to alleviate symptoms. If patients experience any discomfort or the unit alarms, they must notify their Equipment Provider and/or physician immediately.

You, as the Equipment Provider, are responsible to see that each patient receives the Patient Manual. Locate the Patient Manual in the pocket on the back of each unit. Explain each step in the operation of the unit to the patient in reference to this manual. (Spanish and French versions of the Patient Manual are available upon request.)

3.2 Routine Maintenance by the Patient

To ensure accurate output and efficient operation of the unit, the patient must perform two simple routine maintenance tasks:

- Clean the air intake gross particle filter
- Check the alarm system battery

3.2.1 Cleaning the Air Intake Gross Particle Filter



NOTE

The patient must clean this filter weekly, as described below. The filter may require daily cleaning if the NewLife unit operates in a harsh environment such as a house heated by wood, kerosene, or oil, or one with excessive cigarette smoke.

- 1** Remove the dirty air intake gross particle filter from the back of the NewLife unit, and install the clean filter stored in the pocket on the back of the unit.
- 2** Wash the dirty filter in warm soapy water, and rinse. (See Figure 3.1.)
- 3** Use a soft absorbent towel to remove excess water.
- 4** Place the clean air intake gross particle filter in the pocket on the back of the unit.

Air Intake
Gross
Particle
Filter

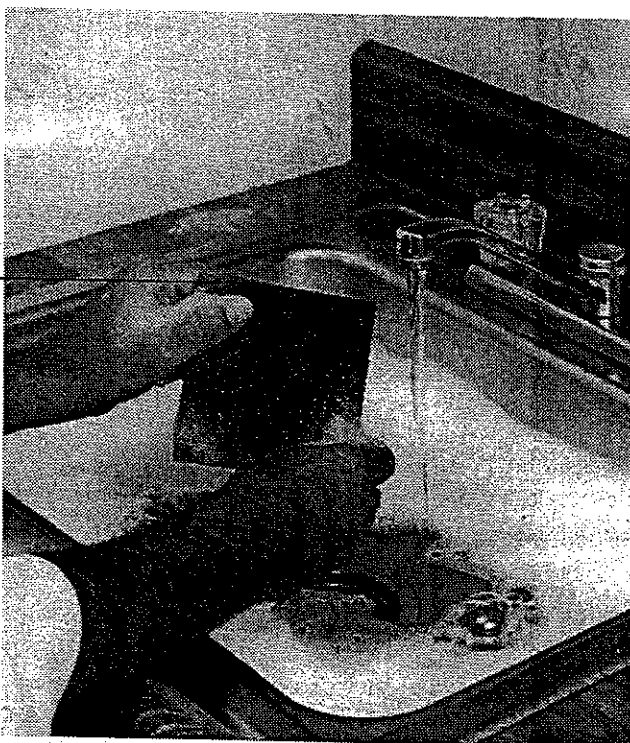

Figure 3.1: Cleaning Air Intake Gross Particle Filter

3.2.2 Checking the Alarm System Battery

The alarm system battery is tested each time the ON/OFF switch is set to the ON position. A continuous alarm sounds for approximately five seconds to indicate a good battery. If the alarm sounds weak, or no alarm sounds at all, instruct the patient to call the Equipment Provider immediately. Refer to Section 5.1.3 for the battery replacement procedure.

4.0 Operation

4.1 Description of Operation

Figure 4.1 shows the normal flow of air through the NewLife Oxygen Concentrator. Air is drawn into the NewLife cabinet through an external air intake gross particle filter. This filtered air enters the compressor via a suction resonator, which helps quiet the compressor's suction sound. Pressurized air then exits the compressor and passes through a heat exchanger. The heat exchanger reduces the temperature of the compressed air. Next, a two-way solenoid feed valve directs the air into one of two sieve beds that contain molecular sieve. The unique property of air passes through this material, thus producing high purity oxygen.

There are two sieve beds: while one produces high purity oxygen, the other is purged of the nitrogen it adsorbed (collected) while it made oxygen. Each adsorber produces oxygen for approximately eight seconds and delivers it to the product tank. Oxygen exits the product tank through a pressure regulator, flow control valve, flowmeter, and bacteria filter. The flow control valve, which is part of the flowmeter, controls the amount of oxygen delivered to the patient. The NewLife unit delivers up to 95% pure oxygen at flow rates from 1-5 lpm.

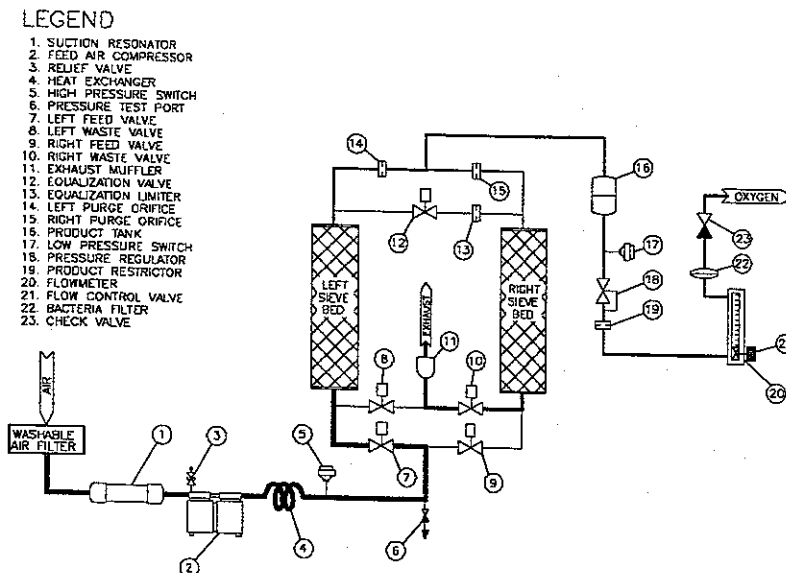

Figure 4.1: Process Schematic

4.2 Exterior Parts

Refer to Figures 4.2 and 4.3 for the location of the exterior parts described below.

Exterior Cabinet

Constructed of ABS plastic for maximum strength and durability.

- (2) Side Panels (SB-ME-046)
- Lower Front Panel (SB-ME-045)
- Control Panel (SB-ME-044)
- Back Panel (SB-ME-043)
- Base (CA-01-005)

Illuminated Flowmeter/Control (FL-01-05-02)

Displays and controls the oxygen flow rate. Back lines enable easy viewing.

Serial Number Label (LA-ME-21-01)

Shows the serial number of the unit.

Hour Meter (EL-HM-60-02)

Displays the total number of hours of operation for the unit.

Circuit Breaker (EL-CB-04)

Used to reset the unit after an electrical overload shutdown.

ON/OFF Power Switch (SB-ME-041)

Starts and stops the operation of the unit. The green color indicates the *ON* position; black indicates the *OFF* position.

Oxygen Outlet

Connection port for optional humidifier.

Adapter (PH-42-04-BF)

Connects to oxygen outlet to allow connection of the humidifier or oxygen tubing.

Operating Instruction Label (LA-ME-30-02)

Displays the unit's operating instructions for easy reference by the patient.

Equipment Provider Label (LA-ME-30-03)

Allows you to display your company name and emergency phone number on a matching label.

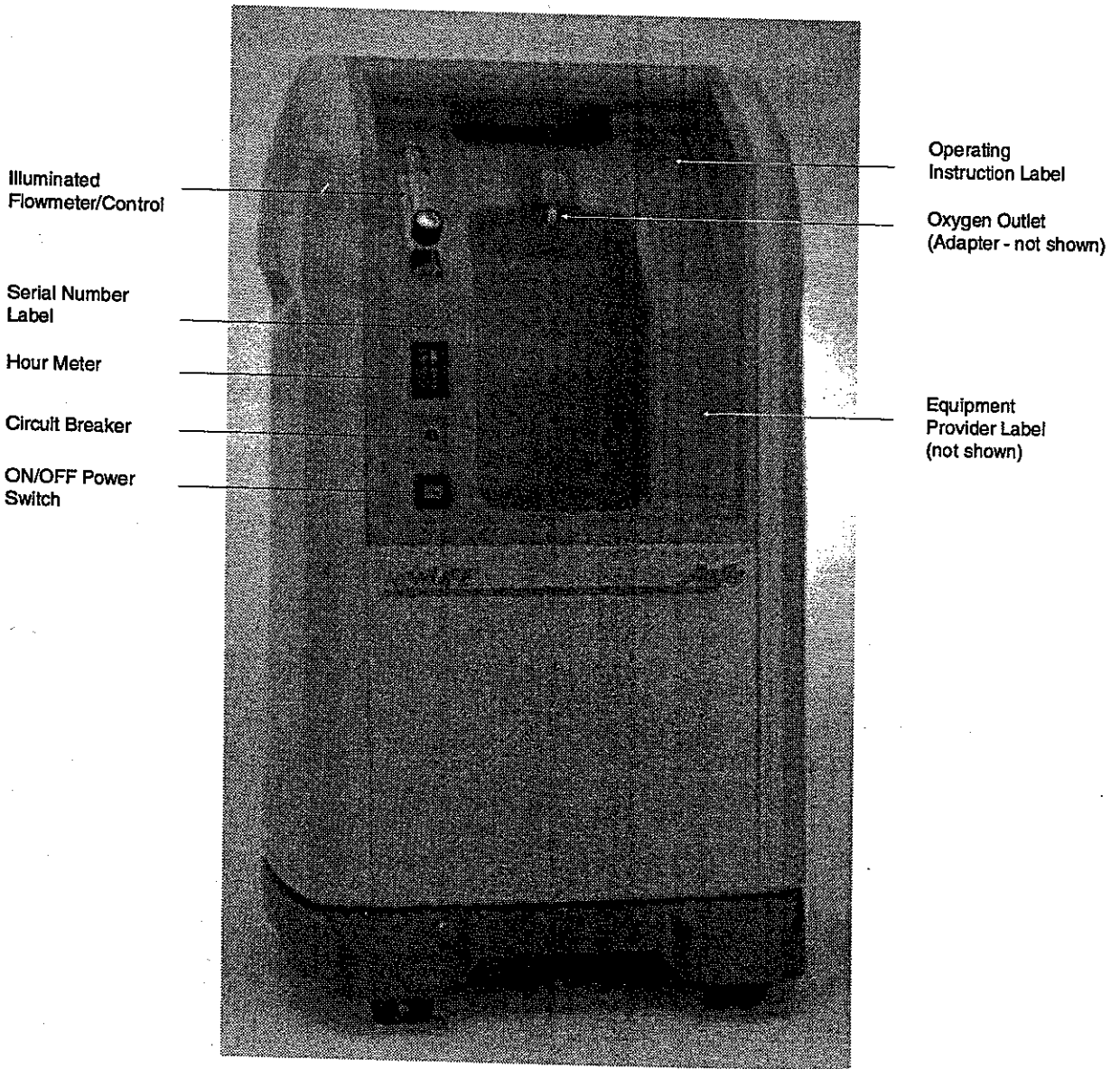

Figure 4.2: NewLife — Exterior Front

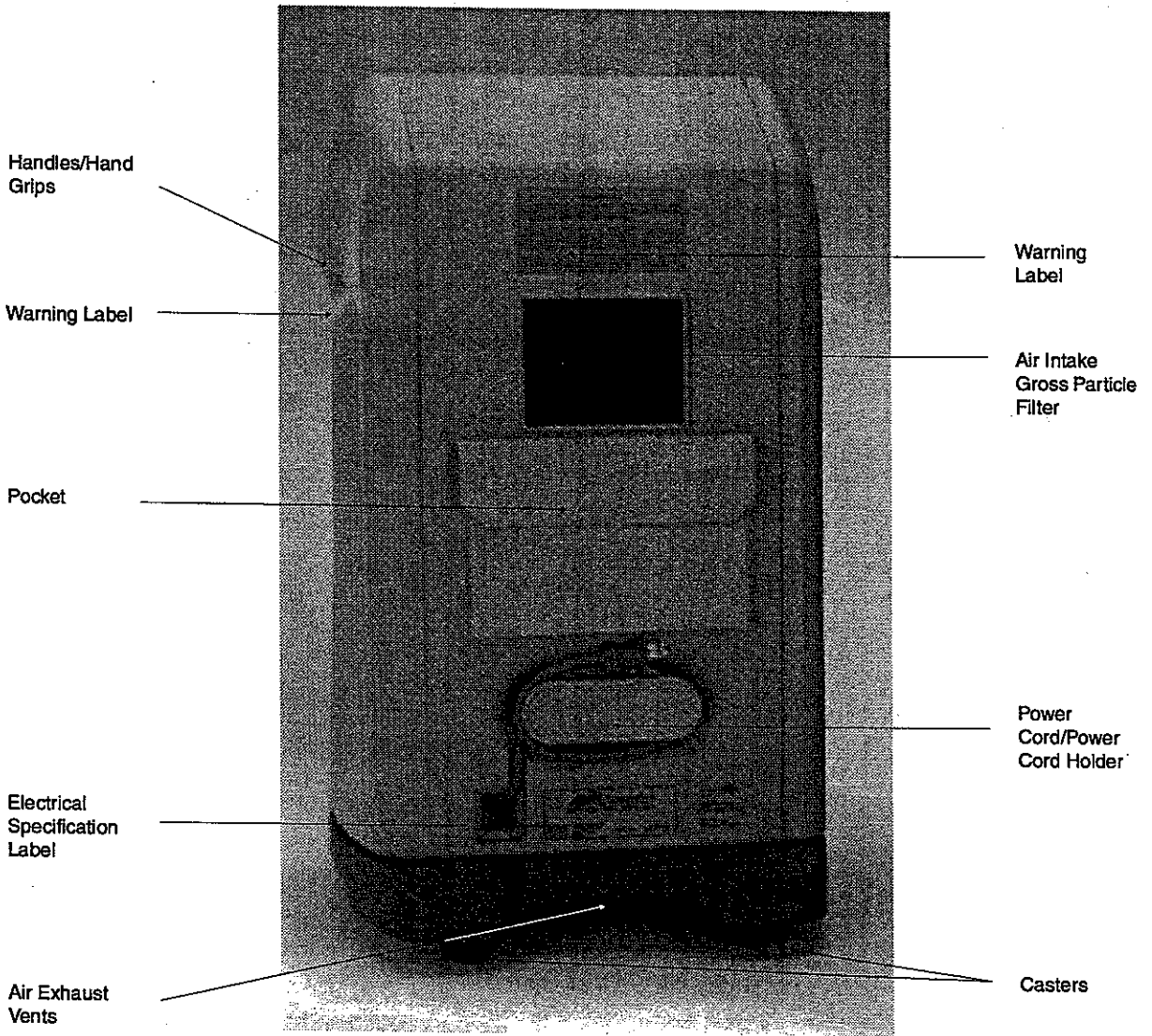
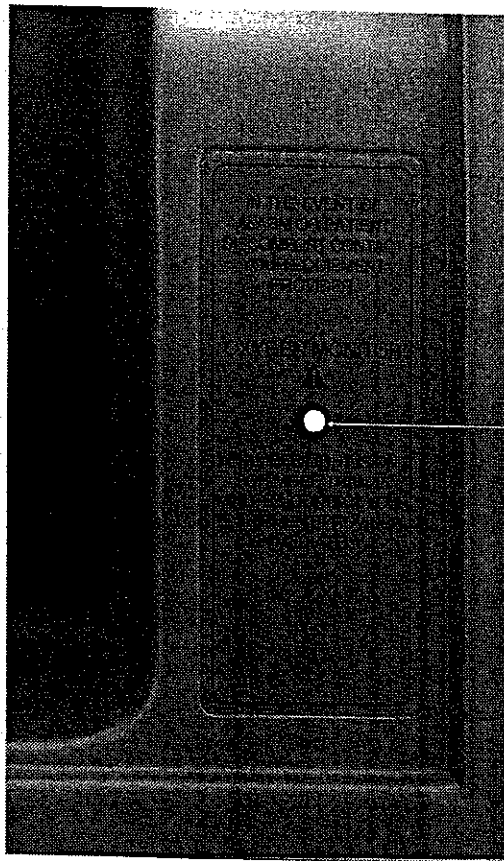

Figure 4.3: NewLife — Exterior Back

4.3 Start-Up

The AirSep NewLife Oxygen Concentrator accepts household electrical power.

- 1** Uncoil the power cord *completely* from its holder before use, and plug in the unit.
- 2** Set the ON/OFF switch to the *ON* position, and observe the following:
 - The audible alarm sounds loudly for five seconds. This indicates the battery for the alarm is good.
 - **OPTIONAL:** The Oxygen Monitor's amber light (See Figure 4.4.) remains on until the oxygen purity reaches $85\% \pm 3\%$ (approximately two minutes).



Oxygen Monitor's
Amber Light
Illuminates When
Oxygen Purity is
Below 85%

Figure 4.4:
Oxygen Monitor Light Indicates Low Purity

4.4 Alarm System

The NewLife Oxygen Concentrator is equipped with a battery-powered alarm system, which sounds a continuous and loud alarm when a power failure occurs. It sounds an intermittent alarm if the high or low pressure switches are activated or if the optional oxygen monitor detects lower than therapeutic levels of oxygen purity. The alarm remains on until you correct the alarm condition or you set the ON/OFF switch to the *OFF* position. Refer to Section 9.0 for a list of probable alarm causes.

4.4.1 Battery Test

When the NewLife unit is turned on, a five-second audible alarm sounds to indicate the condition of the battery.



The audio alarm must sound loudly for approximately five seconds each time the unit is turned to *ON* to indicate the battery is in good condition.

4.4.2 Power Failure Alarm Test

To test the power failure alarm, take the following step:

Unplug the unit, and set the ON/OFF switch to the *ON* position.

This should immediately activate the audio alarm. If it does not, refer to the troubleshooting chart in Section 9.0 of this manual.

4.4.3 Low Pressure Alarm Test

To test the low pressure alarm, take the following steps :

- 1** Set the ON/OFF switch to the *OFF* position, and unplug the power cord.
- 2** Remove the left side panel, and disconnect the blue compressor lead from the terminal strip. (See Figure 4.5.)

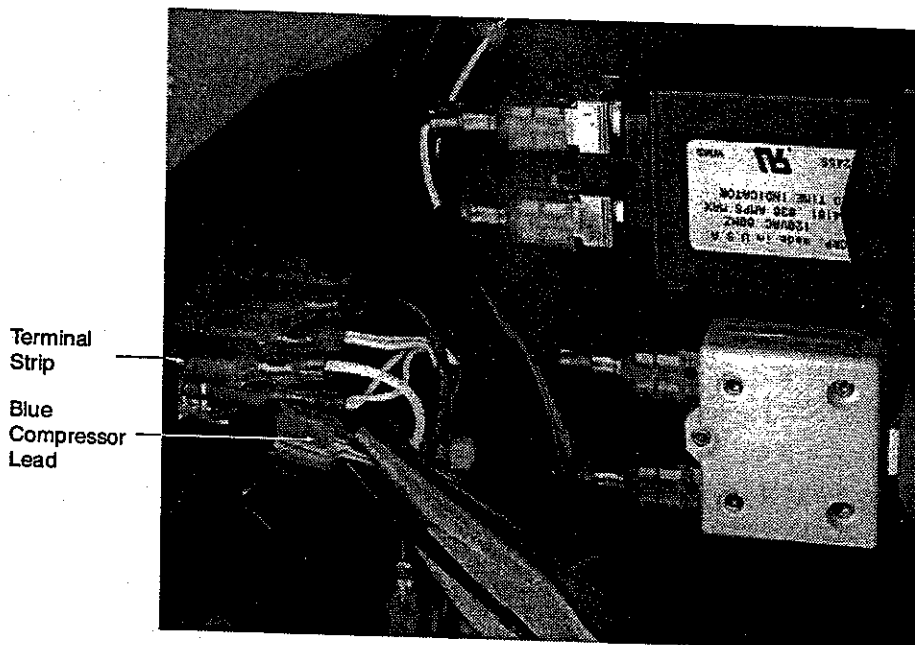

Figure 4.5:
Compressor Lead Disconnected from Strip

- 3** Plug in the unit, and set the ON/OFF switch to the ON position.

The alarm sounds loudly at start-up for approximately five seconds. After approximately 35 seconds, the low pressure alarm should sound intermittently.

If the alarm does not sound, refer to the item titled "Alarm does not sound" in the troubleshooting chart in Section 9.0 of this manual.

- 4** Set the ON/OFF switch to the OFF position, and unplug the power cord.
- 5** Reconnect the compressor lead at the terminal strip.
- 6** Reconnect the side panel.

4.4.4 High Pressure Alarm Test

To test the high pressure alarm, take the following steps:

- 1** Set the ON/OFF switch to the OFF position, and unplug the power cord.

- 2 Remove the side and back panels, and disconnect one lead from the right waste solenoid valve. (See Figure 4.6.)
- 3 Plug in the unit, and set the ON/OFF power switch to the ON position.

The audio alarm sounds loudly at start-up for approximately five seconds. After approximately 35 seconds, the high pressure alarm should sound intermittently. If the alarm does not sound, refer to the item titled "Alarm does not sound" in the troubleshooting chart in Section 9.0 of this manual.

- 4 Set the ON/OFF switch to the OFF position, and unplug the power cord.
- 5 Reconnect the lead to the right waste solenoid valve.
- 6 Reconnect the back and side panels.



Do not run the NewLife unit longer than three minutes with the leads to the right waste solenoid valve disconnected. Damage to the unit can occur.

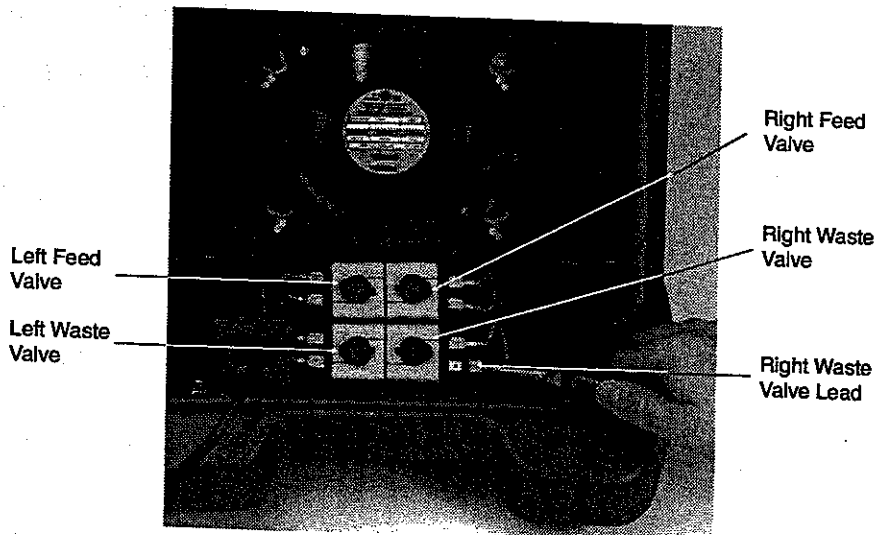

Figure 4.6: Lead Disconnected from Right Waste Solenoid Valve

4.4.5 EcoCheck Oxygen Monitor Verification Test

To test the optional EcoCheck oxygen monitor, take the following steps:

- 1** Uncoil the power cord *completely* from its holder before use, and plug in the unit.
- 2** Set the ON/OFF switch to the ON position.

Allow purity to build until the (amber) OXYGEN MONITOR light turns off.

- 3** Connect, with less than six feet of tubing, a calibrated oxygen analyzer to the NewLife oxygen outlet.
- 4** With the NewLife EcoCheck valve set for ECoNomy mode (See Figure 4.7.), set the flowmeter above 4 lpm.

Observe that the (amber) OXYGEN MONITOR light turns on at $85\% \pm 3\%$.

EcoCheck
Valve in
Horizontal
Position
Limits Flow
to 3 lpm

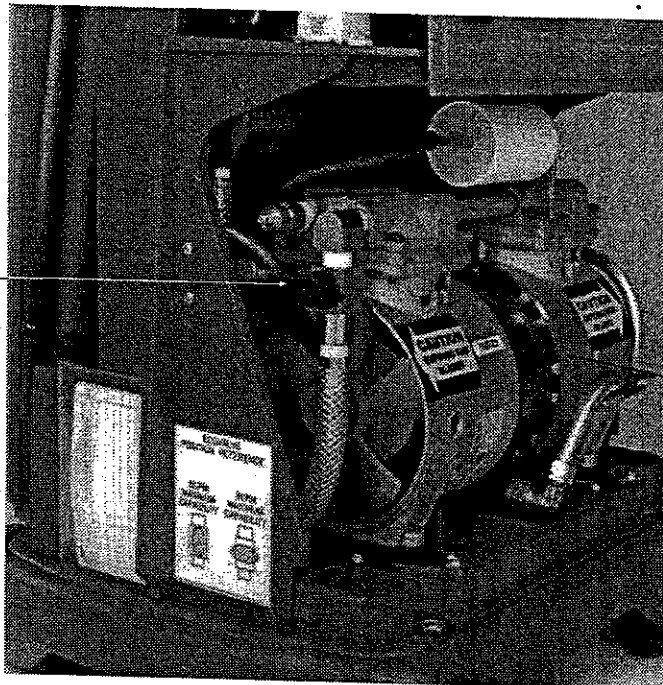

Compressor

Figure 4.7: EcoCheck Valve Set to ECoNomy Mode

- 5 Set the flowmeter to 3 lpm, and observe that the (amber) OXYGEN MONITOR light turns off at $85\% \pm 3\%$.
- 6 Set the flowmeter to the patient's prescription.



NOTE

If the prescription is greater than 3 lpm, you must position the Eco-Check valve vertically, as shown in Figure 4.8, to restore the 5 lpm capability.

EcoCheck
Valve in
Vertical
Position
Enables
Flow to 5
lpm

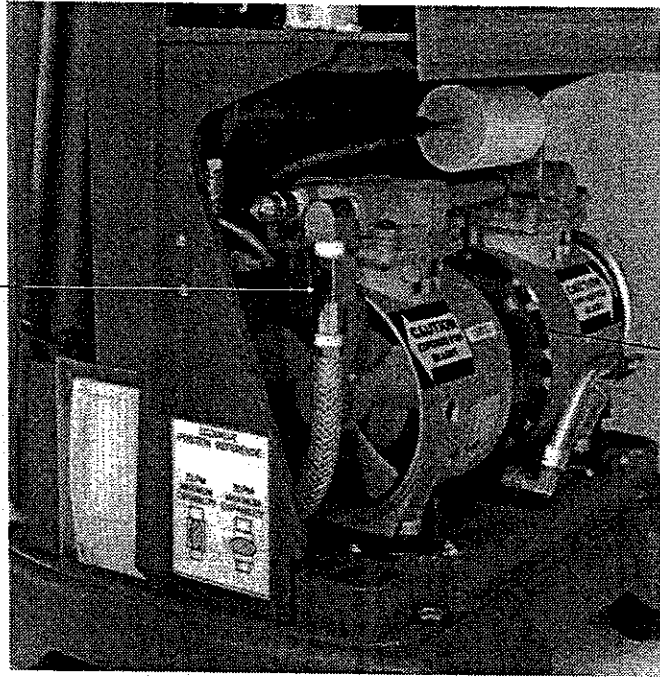

Compressor

Figure 4.8: EcoCheck Valve Set for 5 LPM Capability



NOTE

Depending on the specific oxygen analyzer used, its responsiveness may be different from the NewLife EcoCheck oxygen monitor.

5.0 Service

5.1 Components

The design of the AirSep NewLife Oxygen Concentrator, including the compressor, valves, circuit board, sieve beds, cooling fan, and filter, enables easy access. This allows you to perform scheduled maintenance, repair, and replacement of parts with minimal time and effort.



CAUTION

For your safety, be sure to set the ON/OFF switch to the *OFF* position and unplug the power cord of the unit before you service the NewLife Oxygen Concentrator.



NOTE

Record all scheduled maintenance. (Refer to Section 6.0.)

5.2 Cabinet Removal

5.2.1 Removing Side Panel(s)

To remove one or both side panels, unscrew the 1/4 turn fastener(s) and remove the panel(s). (See Figure 5.1.)

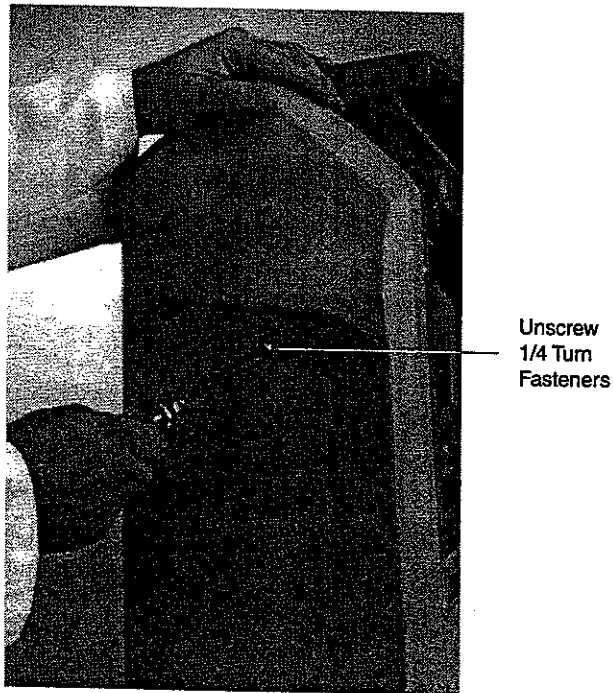

Figure 5.1: Removal of Side Panel(s)

5.2.2 Removing Back Panel

Remove both side panels, and lift off the back panel. Make sure the power cord can pass freely through the power cord cutout. (See Figure 5.2.)

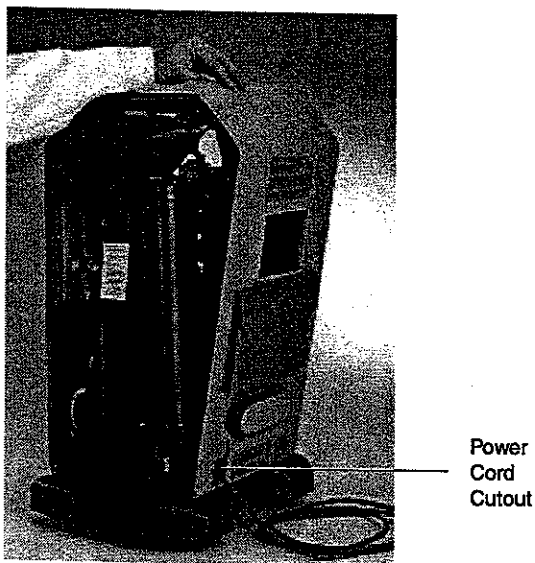

Figure 5.2: Removal of Back Panel

5.2.3 Removing Lower Front Cover

Firmly grasp panel with both hands, and slightly bow panel outward to remove. (See Figure 5.3.)



Figure 5.3: Removal of Lower Front Cover

5.2.4 Removing Control Panel

Four screws hold the control panel in place. Remove them and the control panel to install the optional dual flowmeter control panel. (Refer to Section 5.16.)

5.2.5 Superstructure

The weight and forces of the internal components rest solely on three foamed ABS parts: the superstructure, compressor plate, and the base. These parts were specially designed and formed. They should never require replacement under normal use.

5.2.6 Caster Replacement

- 1** Remove the cabinet panels to expose the caster nut.
- 2** Remove the caster nut with a 9/16-inch socket.
(See Figure 5.4.)
Use an extension for the two front caster nut removals.
- 3** Install the new caster and washer, and tighten the nut.
- 4** Reconnect the cabinet panels.

Remove
Caster
Nut with
9/16-inch
Socket



Figure 5.4: Caster Removal

5.3 Compressor

The compressor is the "pump" within the oxygen concentrator that pushes the room air into the bottom of the sieve beds. This allows oxygen to flow out of the top.

Two different aspects of the compressor cause concern: the output and the sound level.

■ Output

Compressor output refers to how much compressed air the compressor can produce. The model of the compressor, the stroke of the piston, and the condition of the cup seals determine this. The NewLife uses the Thomas double WOB-L twin piston compressor Model 2619 with a .38" stroke. Stroke refers to how far the piston moves. In the NewLife unit, the piston moves only 38/100 of an inch, requiring less electricity to operate than other comparable models. (See Appendix B for the power formula of the oxygen concentrator.)

The cup seals form the seal between the piston and the cylinder wall. As the cup seals wear, the compressor's output begins to gradually decrease. This reduction in compressor output results in less air for the sieve beds. Therefore, the production of oxygen decreases.

This drop in oxygen production occurs over a long time period. You can detect it first at 5 lpm, then 4 lpm, then 3 lpm, etc. You can continue a patient's therapy on the NewLife unit as long as that unit's oxygen purity level at the prescribed liter flow rate meets AirSep's specifications. See the following chart:

AirSep NewLife Purity Specifications			
Liter Flow	Spec	In Spec	Out of Spec
1-3 lpm	95% \pm 3%	92%	91%
4 lpm	92% \pm 3%	89%	88%
5 lpm	90% \pm 3%	87%	86%

For example: If the NewLife is in use at 2 lpm, the concentrator would not require servicing until the purity is below 92%.

■ Sound Level

The condition of the compressor's bearings mainly determine its sound level.

There are four bearings located within the compressor that allow the inner components of the compressor to rotate. These sealed bearings are sensitive to high temperatures, which can cause the lubricant to leak out. If the bearings wear to the point that they become noisy, the compressor becomes noticeably loud and needs servicing.

5.3.1 Compressor Maintenance

Preventative maintenance on the compressor is not required. You do not need to perform any maintenance on the compressor as long as the NewLife is within AirSep's specifications at the desired liter flow rate. (Refer to Section 5.3 for the AirSep NewLife Purity Specification chart.)

5.3.2 Compressor Assembly Replacement

To simplify and speed the replacement of the compressor, AirSep supplies a rebuilt compressor already mounted to a compressor plate. This includes the heat exchanger, pressure relief valve, and vibration mounts as an assembly. To maximize the time period between compressor exchanges, each rebuilt compressor includes compression, compressor bearings, a new heat exchanger, and new vibration mounts.

Compressor Assembly Removal

To remove the compressor assembly for exchange, follow the steps listed below:

- 1** Set the unit's ON/OFF switch to the *OFF* position, and unplug the power cord.
- 2** Remove the side and lower front panels.
- 3** Disconnect the suction tube, as shown in Figure 5.5.

- 4** Disconnect the blue compressor lead at the terminal strip and the brown lead at the temperature switch.
- 5** Disconnect the compression fitting for the heat exchanger located at the bottom center of the compressor. (See Figure 5.6.)
- 6** Remove the two screws that connect the compressor plate to the base of the unit, and slide out the compressor assembly. (See Figure 5.7.)
- 7** Disconnect the two leads to the capacitor, and remove the screw that secures the capacitor mounting bracket to the compressor to remove the capacitor and the capacitor bracket. (See Figure 5.8.)

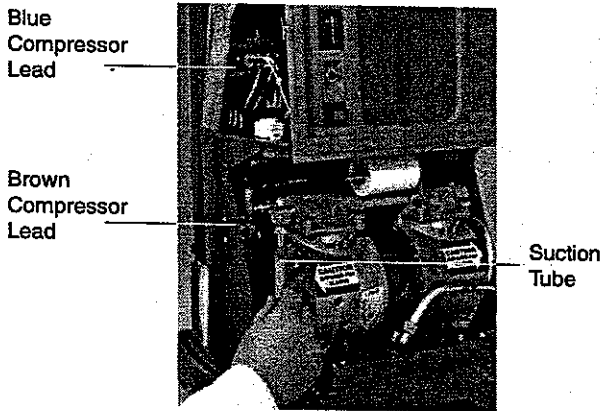

Figure 5.5: Disconnection of Suction Tube

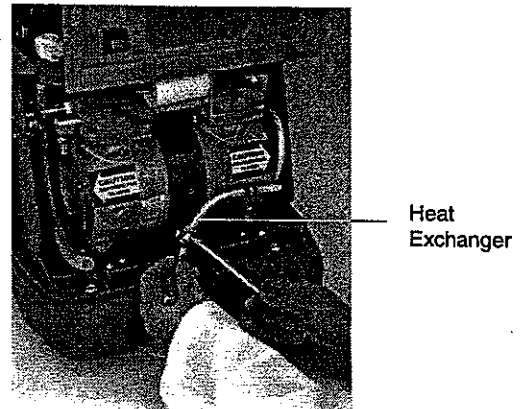

Figure 5.6: Disconnection of Compression Fitting

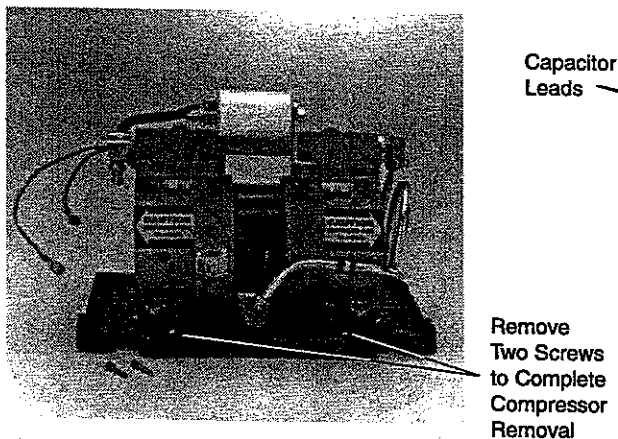

Figure 5.7: Removal of Compressor from Unit

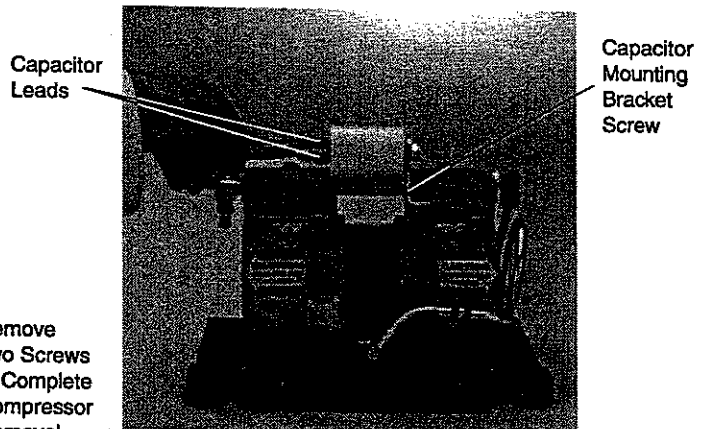

Figure 5.8: Disconnection of Capacitor Leads



With the unit turned off and unplugged, simultaneously touch both spades of the capacitor with an insulated screwdriver as a precaution to eliminate any charge the capacitor may be storing. (See Figure 5.9.)

Touch Both Capacitor Spades with an Insulated Screwdriver to Eliminate any Charge the Capacitor May be Storing

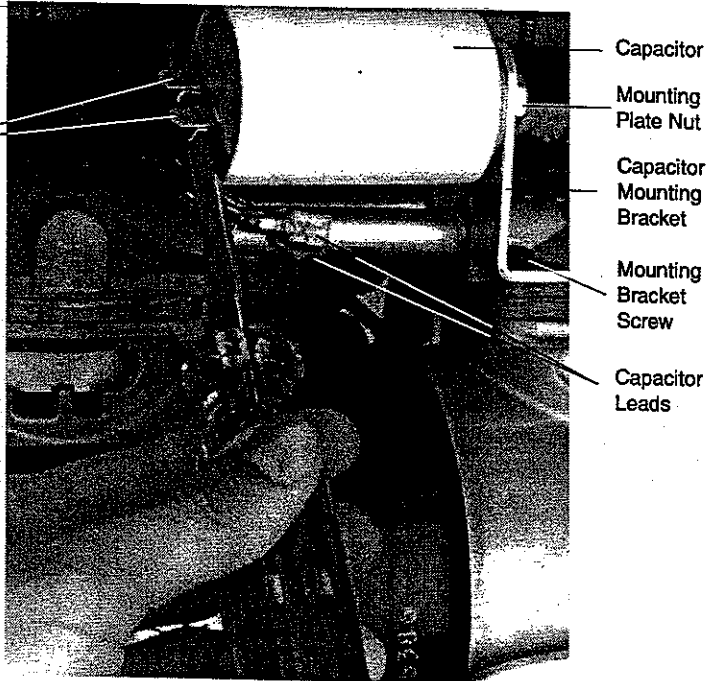

Figure 5.9: Discharging Capacitor for Removal of Compressor Assembly

Compressor Assembly Installation

To install the rebuilt compressor assembly, follow the steps listed below:

- 1** Perform the compressor removal procedure in reverse order.
- 2** Make sure to position the compressor's lead wires behind the braided suction tube.
- 3** Leak test all connections as outlined in the leak test procedure in Section 5.21.

**NOTE**

For compressor assembly installation:
When you tighten the compression fitting for the heat exchanger (See Figure 5.6.) for the first time, push the heat exchanger all the way into the elbow compression fitting, and tighten the nut exactly one full turn past the hand-tight position. This crimps the ferrule. For an already crimped ferrule, tighten the nut only 1/8 turn past the hand-tight position.

5.3.3 Vibration Mount Replacement

The vibration mounts are six-pound neoprene mounts used to reduce the vibration and sound of the compressor. AirSep supplies them with each rebuilt compressor assembly.

If you need to replace the vibration mounts for a compressor assembly that is not supplied by AirSep, use the following procedures.

Vibration Mount Removal

- 1** Complete steps 1–6 of the compressor removal procedure. (See Figures 5.5–5.7.)
- 2** Remove the compressor from the compressor plate by removing the four 1/4-inch x 1 1/4-inch screws in the center of the vibration mounts. (See Figure 5.10.)
- 3** Remove the two screws that secure the vibration mount to the compressor plate.

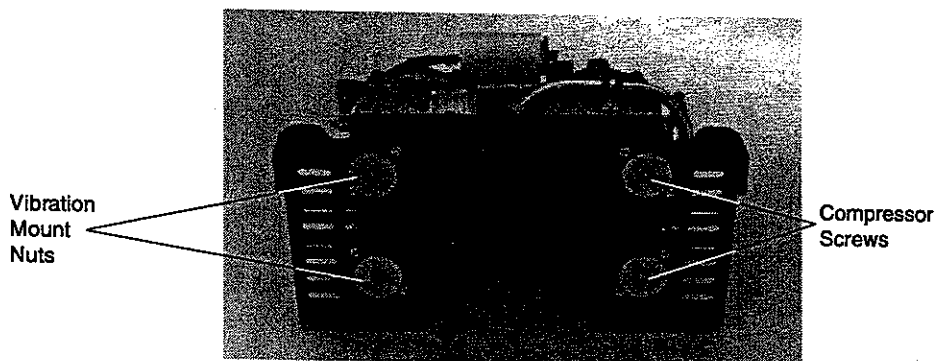

Figure 5.10: Vibration Mount Removal

Vibration Mount Installation

To install the vibration mounts, follow the vibration mount removal procedure in reverse order.

5.3.4 Capacitor Replacement

The capacitor starts the compressor. If the compressor cannot start, the capacitor may be defective and require replacement.

To replace the capacitor, take the following steps:

- 1** Set the unit's ON/OFF switch to the *OFF* position, and unplug the power cord.
- 2** Remove the side and lower front panels.



With an insulated screwdriver, simultaneously touch both spades of the capacitor as a precaution to eliminate any possible charge the capacitor may be storing. (See Figure 5.9.)

- 3** Disconnect the two leads to the capacitor, loosen the mounting plate nut, and lift the capacitor off its mounting plate. (See Figure 5.11.)
- 4** To install the new capacitor, connect the leads, slide the capacitor onto the mounting plate, and tighten the mounting plate nut.

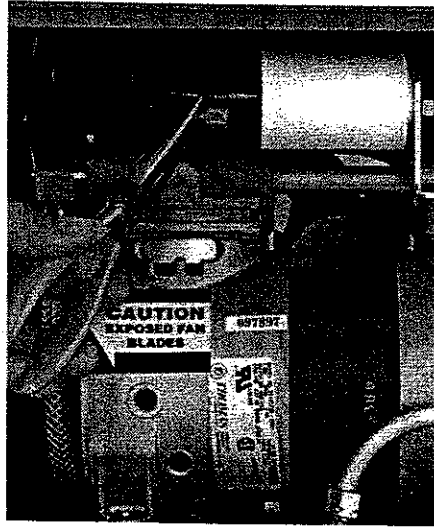

Figure 5.11: Disconnection of Leads for Capacitor Replacement

5.3.5 Compressor Rebuild Kit Installation (SB-ME-036R)

AirSep's compressor exchange includes a completely rebuilt compressor (compression and bearings). It eliminates the need for you to rebuild the NewLife compressor. For your reference, the compressor rebuilding procedure is included in this manual.

Tools required:

- Phillips-head screwdriver
- Slotted-head screwdriver

Disassembly of Compressor

- 1** Remove four screws off each head of the compressor (total eight) with the slotted-head screwdriver.
- 2** Remove and retain both compressor heads.
- 3** Separate the two valve plate assemblies from the compressor heads.
- 4** Remove and discard two cylinder O-rings from the valve plate.
- 5** Remove and discard from each valve plate: (2) flapper screws, (2) valve keepers, (1) valve restraint, (2) valve flappers, and (1) O-ring gasket. (See Figure 5.12.)

- 6** Remove and discard two cylinder sleeves.
- 7** Use a Phillips-head screwdriver to remove four retainer screws from the top of each piston.
- 8** Lift off the piston plate. Remove and discard the piston cup seal.
- 9** Wipe clean the valve plates, heads, piston plates, and the housing as necessary.



Do not use a wire wheel to clean any residue from these parts. Clean parts with denatured alcohol and lint-free rags.

- 10** Inspect for any visible damage.

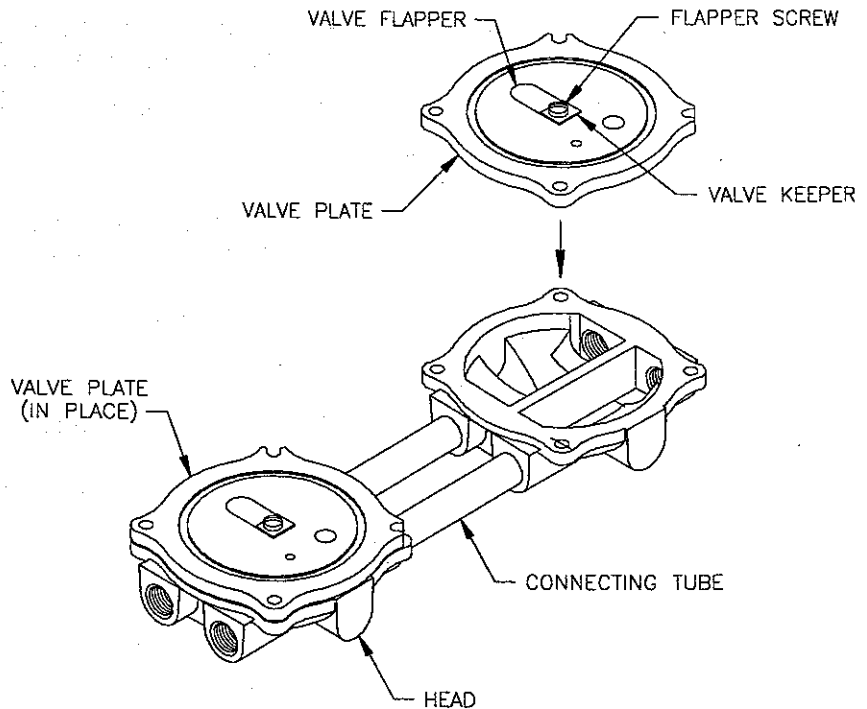

Figure 5.12: Valve Plate Assembly

Assembly of Rebuilt Compressor

- 1** Assemble to each valve plate: (2) new valve flappers, (1) valve restraint, (2) valve keepers, and (2) valve flapper screws. Assemble the valve restraint to the exhaust valve only, located on the side opposite the cylinder O-ring groove. (See Figure 5.12.)
- 2** Install the new cylinder sleeve around the piston.
- 3** Place the new piston cup seal along groove on the bottom of piston plate.
- 4** Assemble the piston plate to the top of the connecting rod. Tighten down with four retaining screws using an "X" pattern.
- 5** Repeat steps 2 through 4 for the other side of the compressor.
- 6** Place two new cylinder O-rings into the groove of each valve plate. Place the valve plates on top of the housing groove with the O-ring in place, fitting over the cylinder sleeve.
- 7** View the compressor from the front, and observe that the open corners on the valve plate face right.
- 8** Place two O-ring gaskets into the bottom groove of each head.
- 9** Assemble heads to the compressor with connecting tubes to the compressor. Use eight head screws to fasten to the unit. Tighten to 30-in. lbs using an "X" pattern.

Parts included in compressor rebuild kit:

Quantity	Description
2	Piston Cup
2	Cylinder Sleeve
8	Screw Retainer
4	Valve Keeper
2	Valve Restraint
4	Valve Flapper
4	Screw Flapper
2	O-ring (Sleeve)
2	O-ring (Head Gasket)
8	Head Screw
2	Screw-Connecting Tube

5.4 Solenoid Valves

The NewLife uses 5 two-way solenoid valves: two feed, two waste, and one equalization. Each valve has an open (energized) and closed (de-energized) position. As the NewLife operates, two valves are always energized.

The solenoid valves of the NewLife unit require no scheduled maintenance. If a valve becomes noisy, you can easily replace the internal valve parts. To identify the noisy valve, observe which green circuit board light illuminates at the time of the noise. The lighting matrix on the circuit board corresponds to the valve location. (See Figure 5.13.)

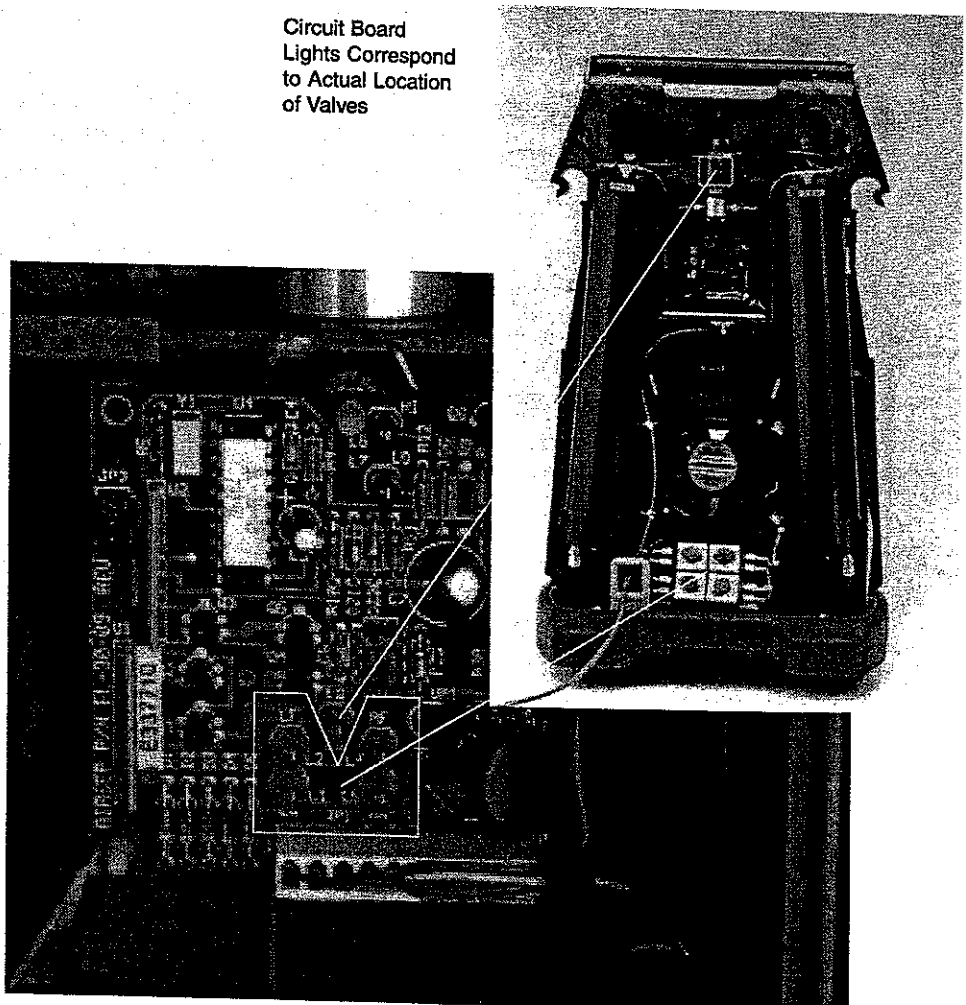

Figure 5.13: Lighting Matrix

5.4.1 Feed or Waste Valve Rebuilding

The two feed valves and two waste valves are located on the unified valve block. This valve block does not require removal to rebuild a feed or waste valve.

- 1** Set the ON/OFF switch to the *OFF* position, and unplug the power cord.
- 2** Remove the side and back panels.
- 3** Remove the red cap from the appropriate valve with a slotted-head screwdriver. (See Figure 5.14.)
- 4** Lift off the solenoid coil.

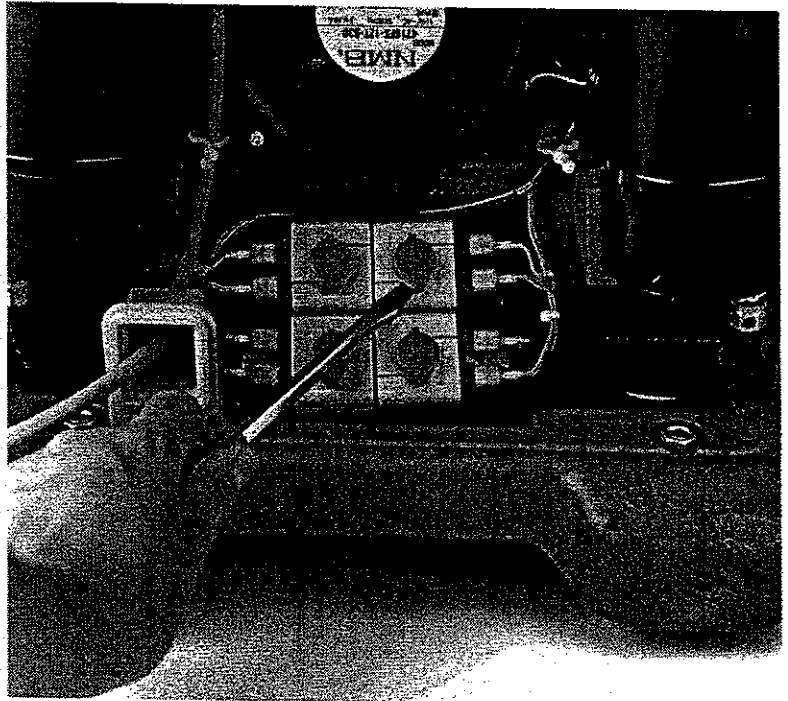

Figure 5.14: Removal of Red Cap from Right Feed Valve



NOTE

Correct direction of spring is required for proper valve function. (See Figure 5.15.)

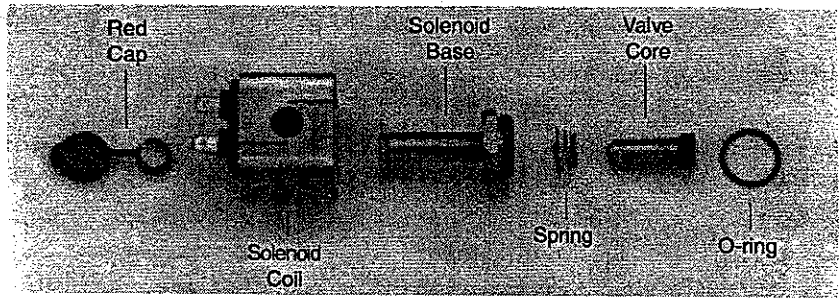

Figure 5.15: Solenoid Valve Assembly

- 5** Loosen and remove the solenoid base with a one-inch deep well socket. (See Figure 5.16.)
- 6** Install the rebuild kit, which contains all parts of the solenoid assembly except the solenoid coil.

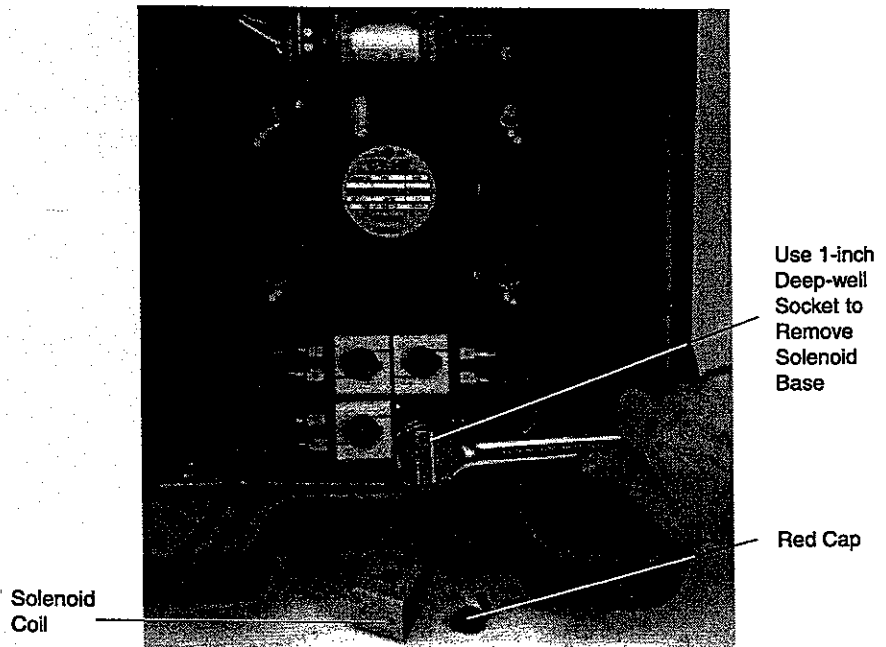

Figure 5.16: Removal of Solenoid Base

5.4.2 Feed or Waste Valve Reassembly

To reassemble the feed or waste valves, follow the feed or waste valve rebuilding procedure in reverse order, and test for leaks.

5.4.3 Equalization (EQ) Valve Rebuilding

- 1** Set the unit's ON/OFF switch to the *OFF* position, and unplug the power cord.
- 2** Remove the side and back panels.
- 3** Remove the red cap from the EQ valve with a slotted-head screwdriver. (See Figure 5.17.)
- 4** Lift off the solenoid coil. (See Figure 5.18.)
- 5** Secure the EQ plate with pliers or channel locks.
- 6** Loosen and remove the solenoid base with an 8-inch adjustable wrench. (See Figure 5.19.)
- 7** Install the rebuild kit, which contains all parts of the solenoid valve assembly except the solenoid coil.

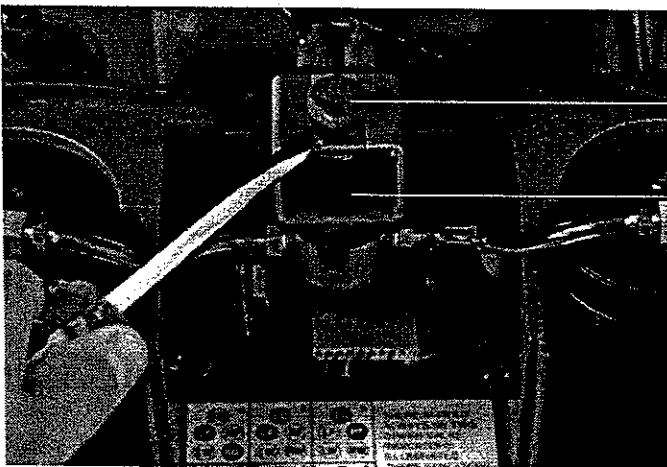

Use Slotted-head
Screwdriver to
Remove Red Cap

Equalization Valve
Solenoid Coil

**Figure 5.17: Removal of Red Cap
from Equalization Valve**

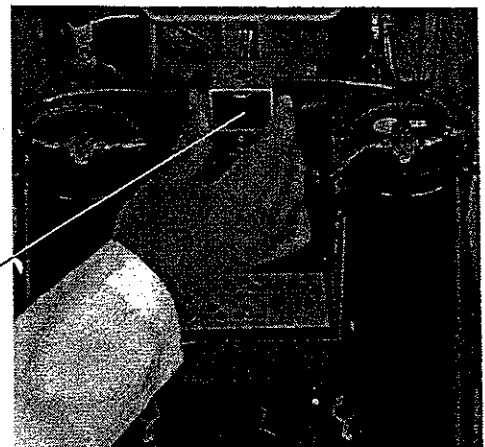

Equalization
Valve
Solenoid Coil

Figure 5.18: Removal of Solenoid Coil

Use Pliers to
Secure the
Equalization
Valve Plate

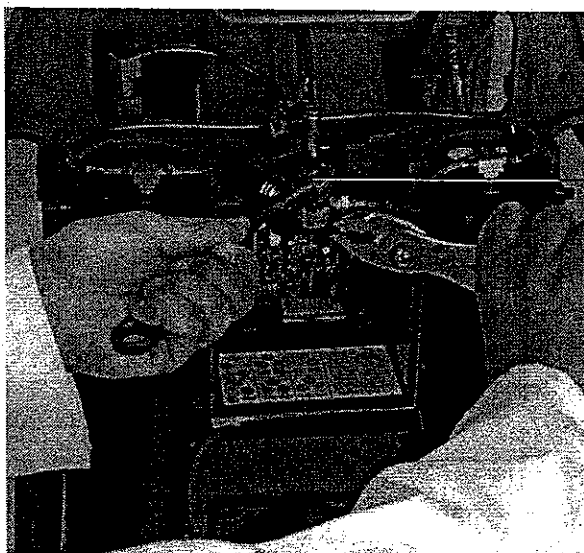

Equalization
Valve
Solenoid
Base

Figure 5.19: EQ Valve – Removal of Solenoid Base

5.4.4 Equalization (EQ) Valve Reassembly

To reassemble the EQ valve, follow the EQ valve rebuilding procedure in reverse order, and test for leaks.

5.4.5 Solenoid Valve Coil Replacement

If a solenoid valve coil does not operate, its corresponding green light on the circuit board does not illuminate.

- 1** Set the ON/OFF switch to the *OFF* position, and unplug the power cord.
- 2** Remove the side and back panels.
- 3** Remove the red cap with a slotted-head screwdriver. (See Figure 5.17.)
- 4** Disconnect the solenoid leads, and lift off the solenoid coil. (See Figure 5.18.)
- 5** Replace with the new coil.
- 6** Press the red cap back on top of the coil, and reconnect the solenoid leads.
- 7** Reconnect the back and side panels.

5.4.6 Valve Cleaning

Clean any of the feed or waste valves by first removing the solenoid coil from the valve block assembly, as described in Section 5.4.5. Then firmly tap it on a hard surface such as a table to dislodge any debris that may be inside the solenoid coil.

5.5 Sieve Bed Replacement



Do not expose molecular sieve (contents of bed) to air for an extended period of time. Prolonged exposure of molecular sieve to the moisture in room air results in contamination and permanent damage to the sieve material. Keep all openings to the sieve beds sealed.



If replacement is necessary, you must replace both sieve beds at the same time.

5.5.1 Sieve Bed Removal

- 1** Set the unit's ON/OFF switch to the *OFF* position, and unplug the power cord.
- 2** Remove the side and back panels.
- 3** Cut the green tie-wraps at the brass "T" fitting, and disconnect the green 1/4-inch product tubes. (See Figure 5.20.)

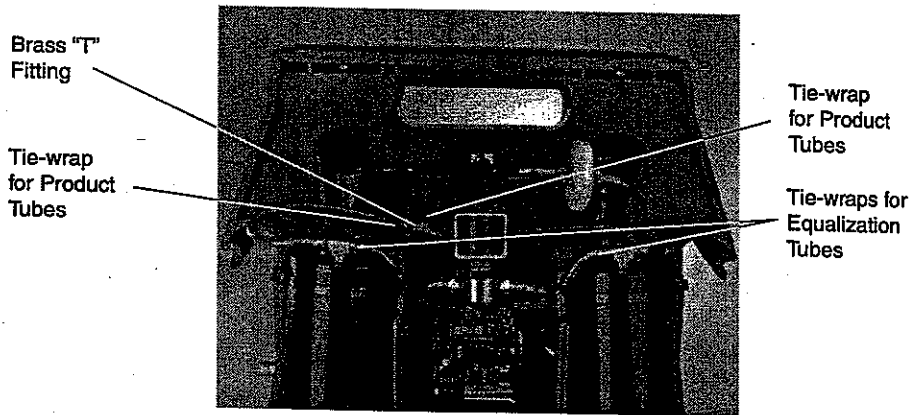

Figure 5.20: Disconnection of Product Tubes

- 4** Cut the green tie-wraps at the top of the sieve beds, and disconnect the green 1/4-inch equalization tubes. (See Figure 5.21.)
- 5** Remove the 9/16-inch compression fitting on the bottom of each sieve bed.
- 6** Cut the black tie-wraps, and remove the sieve beds.
Proper removal of the sieve beds includes the product tubes. (See Figure 5.22.)
- 7** Plug the opening on the top and bottom of the sieve beds.

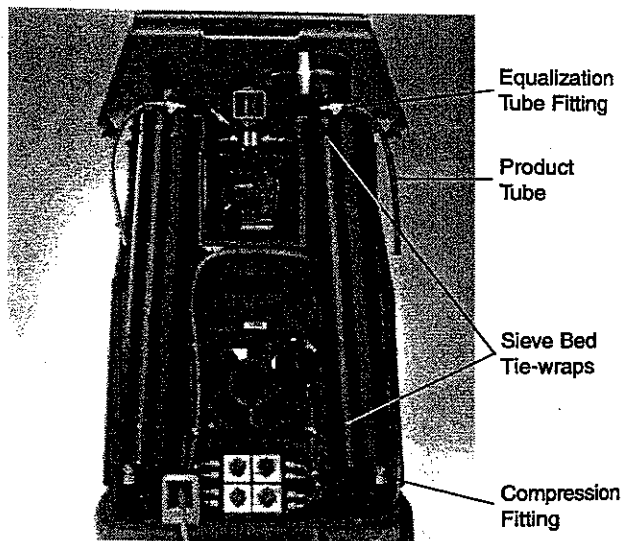

Figure 5.21: Disconnection of Equalization Tubes

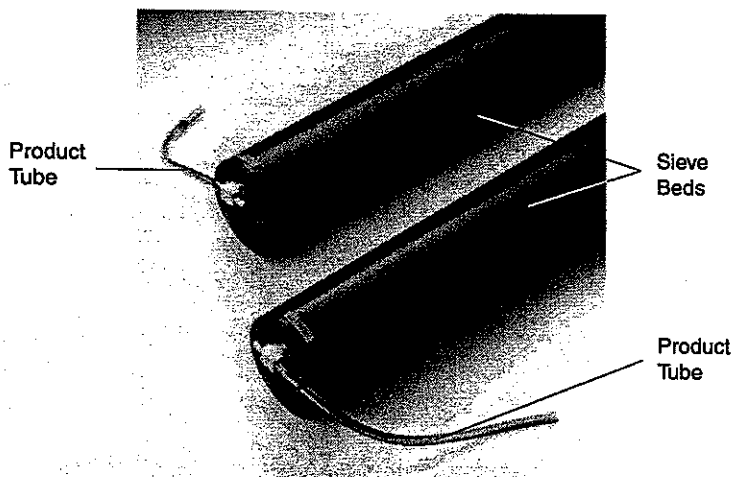

Figure 5.22: Sieve Beds

5.5.2 Sieve Bed Installation

To install the sieve beds, follow the sieve bed removal procedure in reverse order. It is very important to tighten all tubes to eliminate leaks. However, do not over tighten.

To check for leaks, take the following steps:

- 1** Uncoil the power cord *completely* from its holder before use, and plug in the unit.
- 2** Set the unit's ON/OFF switch to *ON* for three minutes with the flowmeter closed to pressurize the system.
- 3** Set the unit's ON/OFF switch to *OFF*, and unplug the power cord.
- 4** Apply soapy water around the sieve bed tube connections, and check for leaks.



Leaks can be so small in air loss that purity is not affected immediately. The sieve material can become contaminated gradually. Careful leak testing is important. (Refer to Section 5.21.)

5.6 Cabinet Fan Replacement (FA-00-01)

The cabinet fan for the NewLife is located in the back of the unit. (See Figure 5.23.) Refer to the troubleshooting chart in Section 9.0 of this manual for instances where replacement of the fan may be required.

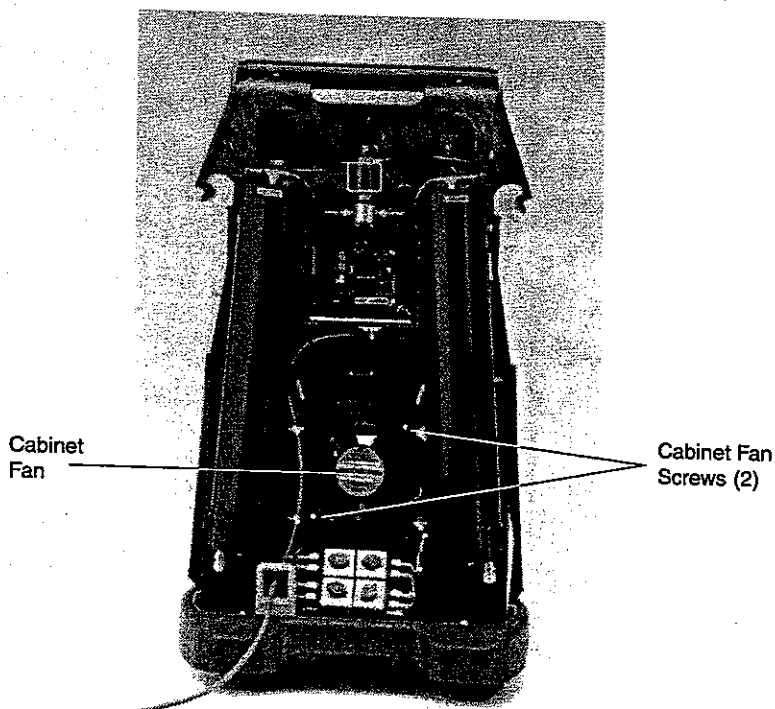

Figure 5.23: Location of Cabinet Fan

To replace the cabinet fan in the NewLife unit, take the following steps:

- 1** Set the unit's ON/OFF switch to the OFF position, and unplug the power cord.
- 2** Remove the side and back panels.
- 3** Remove the two screws that hold the fan to the superstructure, and remove the fan.
- 4** Disconnect the fan leads.
- 5** Position the new cabinet fan so that the air flow arrow points toward the compressor and the electrical connections are in the bottom right corner.
- 6** Connect the fan leads (See Figure 5.24.), and install the cabinet fan screws.
- 7** Reconnect the back and side panels.

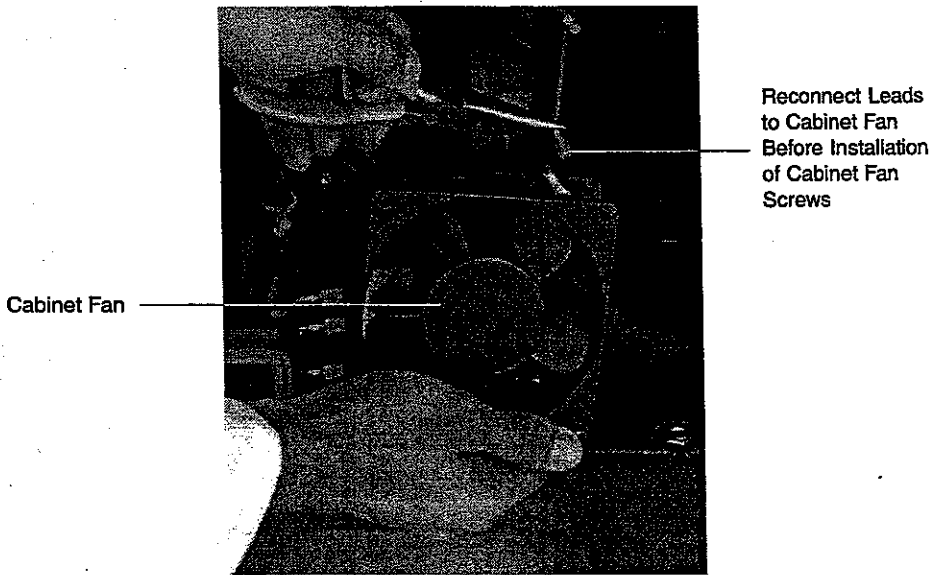

Figure 5.24: Connection of Leads to Cabinet Fan

5.7 Circuit Board Replacement (EL-30-09)

The solid-state printed circuit board controls the sequential timing operation of the five solenoid valves and the alarm system functions (low and high pressure alarms and power failure alarm). The five-green-light matrix corresponds to the valve configuration of the NewLife unit.

Two green lights should always illuminate during normal operation. See Figure 5.25 for the lighting sequence.

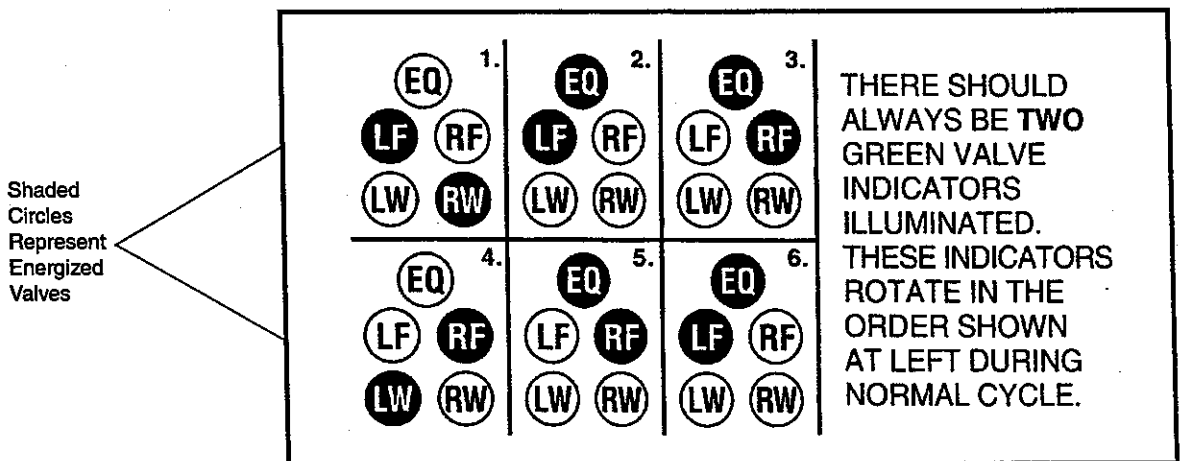

Figure 5.25: Valve Lighting Sequence Label

See Figure 5.26a and 5.26b for the valve configuration and alarm indicator specification label. A green light that fails to illuminate indicates a disconnected or faulty solenoid coil or an electrical malfunction in that valve circuit. The two vertical red lights indicate high and low pressure. Consult the troubleshooting chart in Section 9.0 to determine when to replace the printed circuit board.

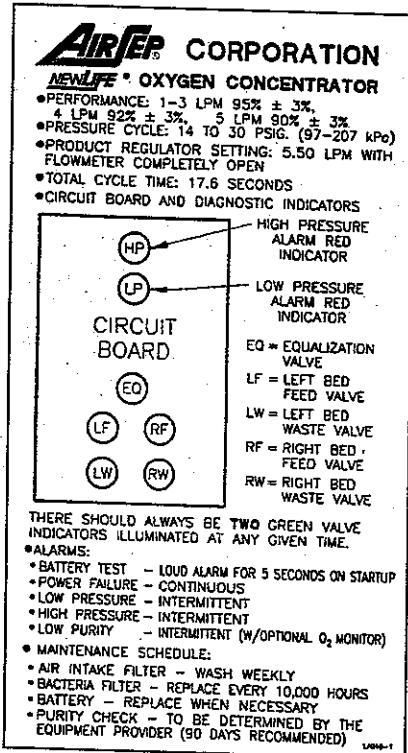

Figure 5.26a: Performance Specification Label - 5 LPM

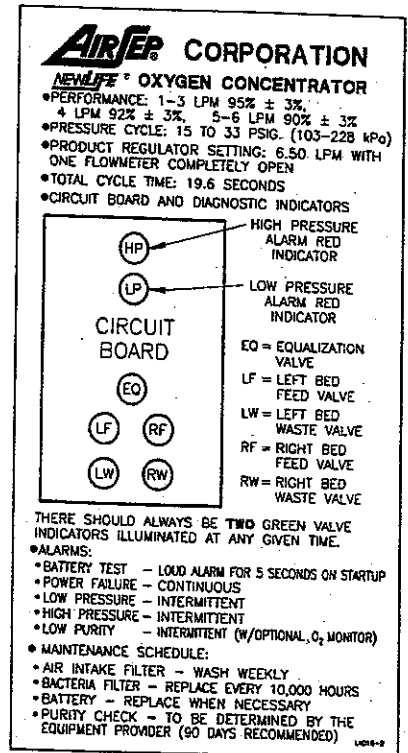



Figure 5.26b: Performance Specification Label - 6 LPM



CAUTION

The Printed Circuit Boards (PCBs) contain components that are sensitive to electrostatic discharge (ESD) and can damage the board if not handled properly. As when handling any ESD-sensitive PCB, observe standard ESD safety procedures. These procedures include the following:

- Handle the PCB by the edges only.
- Work on a grounded ESD mat.
- Wear a grounded wrist strap.
- Store PCBs only in anti-static bags.

5.7.1 Circuit Board Removal

- 1** Set the unit's ON/OFF switch to the *OFF* position, and unplug the power cord.
- 2** Remove the side and back panels.
- 3** Disconnect the main power 10-pin connector from the circuit board. (See Figure 5.27.)
- 4** Push in on the locking tab to the alarm 6-pin connector to disconnect it.
- 5** With a slotted screwdriver, push in on the board support tabs, while you lift each corner of the circuit board.
- 6** Remove the circuit board.

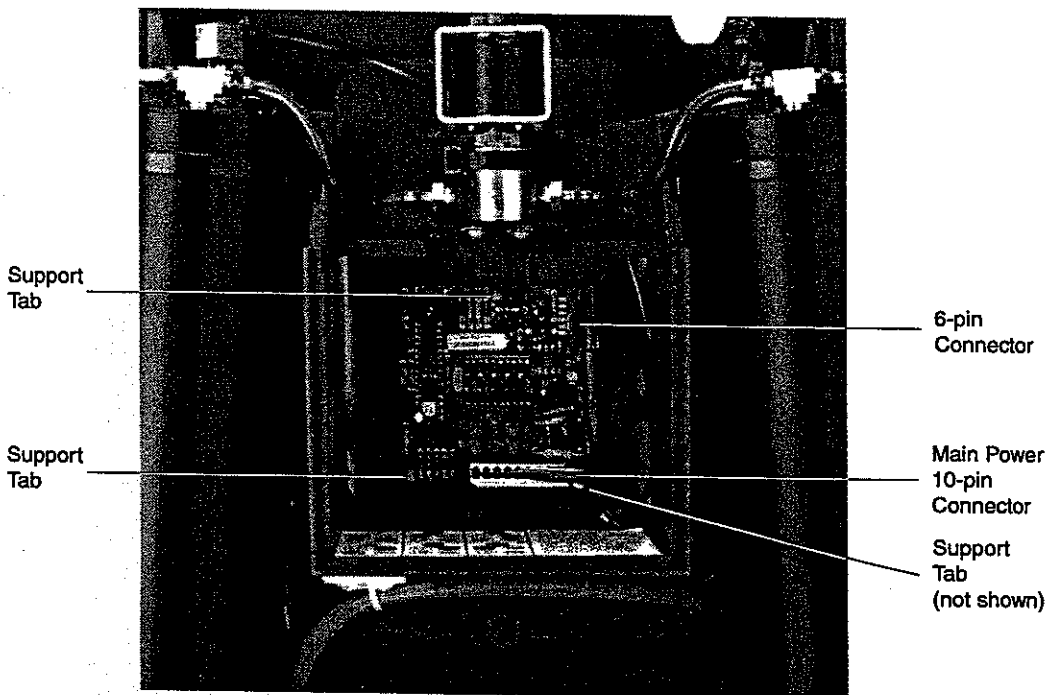

Figure 5.27: Circuit Board Removal



Handle the new circuit board only by the edges to prevent electrostatic damage to the unit.

5.7.2 Circuit Board Installation

- 1** Push the circuit board on to the support tabs.
- 2** Firmly plug in the 6-pin connector to the circuit board so that the connector's locking tab locks against the circuit board.
- 3** Plug in the 10-pin connector.
- 4** Reconnect the back and side panels.

5.8 Product Regulator Check and Setting

The product regulator enables you to set the maximum flow of oxygen output by the NewLife unit. To check for proper adjustment of the product regulator, take the following steps:

- 1** Set the ON/OFF switch to the ON position.
- 2** Allow the unit to run for three minutes.
- 3** Turn the flowmeter adjustment knob counterclockwise until it stops (wide open). (See Figure 5.28.)
- 4** The flowmeter ball centers itself on the 5.5 lpm line. If not, the product regulator needs to be reset.

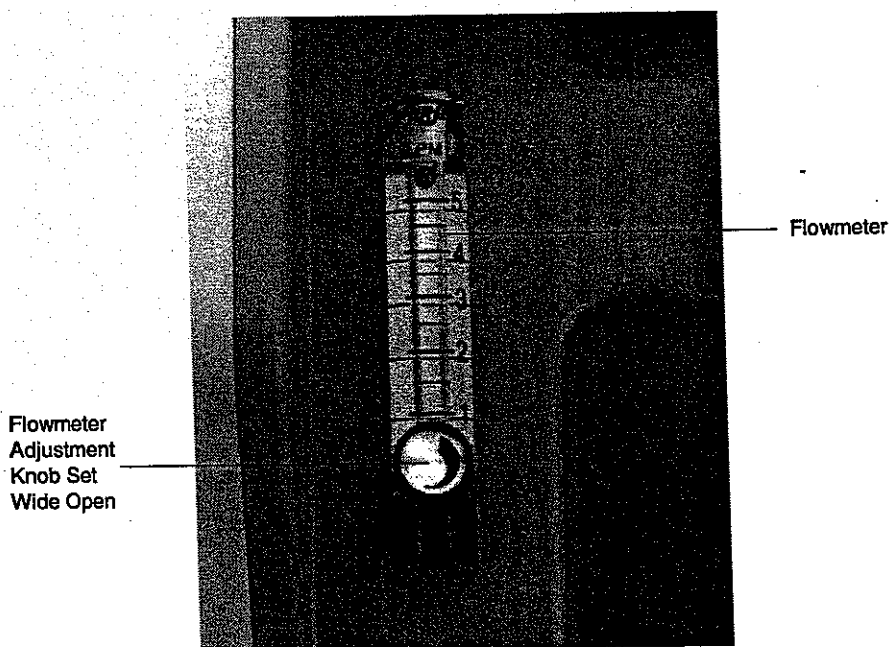

Figure 5.28: Flowmeter Indicates 5.5 LPM for Normal Regulator Setting

5.8.1 Setting Product Regulator for Normal Operation

Use the following procedure to reset the product regulator:

- 1 Uncoil the power cord *completely* from its holder before use, and plug in the unit.
- 2 Set the unit's ON/OFF switch to the ON position, and allow the unit to run at least three minutes to build up pressure.
- 3 Disconnect the humidifier bottle, if used, and the tubing from the oxygen outlet.
- 4 Remove the right side panel.
- 5 Turn the flowmeter adjustment knob counterclockwise until it stops (wide open). (See Figure 5.28.)
- 6 Pull outward on the regulator knob to unlock it. (See Figure 5.29.)

Earlier NewLife models used a red regulator locking ring that must be pulled outward for regulator adjustment.

- 7 Turn the regulator knob until the flowmeter ball centers on the 5.5 lpm line (clockwise to increase).
- 8 Push in the regulator knob to lock it. (See Figure 5.30.)
- 9 Reconnect the side panel.

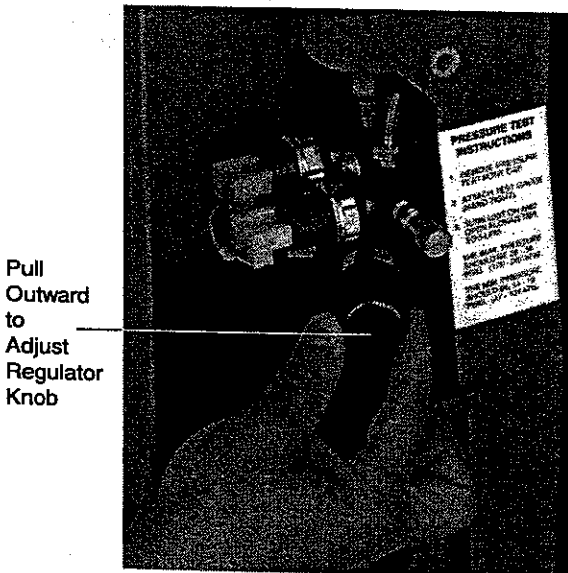

Figure 5.29: Adjustment of Regulator Knob

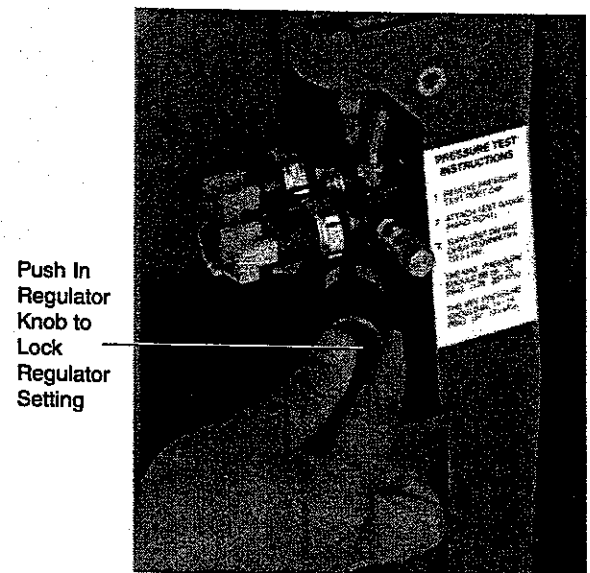

Figure 5.30: Reset of Regulator Knob

5.8.2 Product Regulator Lockout

Take the following steps to limit the maximum flow of oxygen below 5 lpm:



It may be desirable to provide one additional liter of flow if you use the lockout feature.

- 1** Uncoil the power cord *completely* from its holder before use, and plug in the unit.
- 2** Set the unit's ON/OFF switch to the ON position, and allow the unit to run at least three minutes to build up pressure.
- 3** If used, connect the humidifier bottle, oxygen tubing, and cannula to the oxygen outlet. (See Figure 5.31.)
- 4** Remove the right side panel.

Connect
Oxygen
Accessories to
Oxygen Outlet
Before Setting
Regulator
Lockout

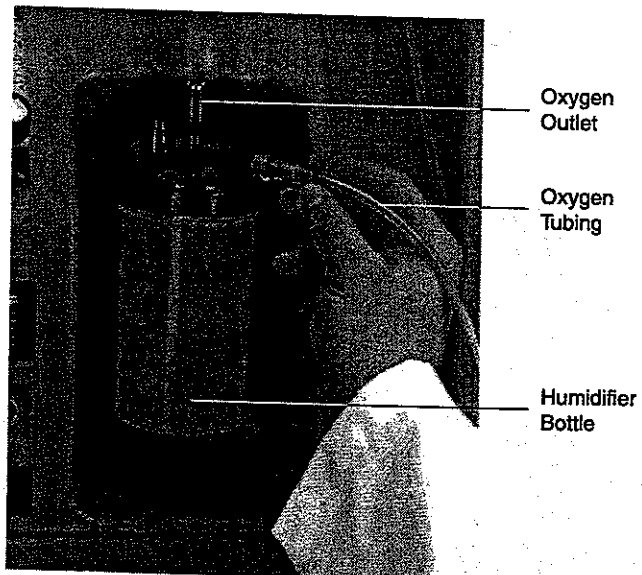

**Figure 5.31: Connection of
Oxygen Accessories**

- 5 Turn the flowmeter adjustment knob counterclockwise until it stops (wide open). (See Figure 5.28.)
- 6 Pull outward on the regulator knob to unlock it. (See Figure 5.29.)



When this lockout feature is no longer required, follow the normal regulator setting procedure, as described in Section 5.8.1.

- 7 Turn the regulator knob counterclockwise to decrease the setting until the flowmeter registers the maximum flow desired.
- 8 Push in the regulator knob to lock the setting. (See Figure 5.30.)
- 9 Reconnect the side panel.

5.8.3 Back Pressure Correction at 5 LPM

In some cases, additional lengths of oxygen tubing with a humidifier bottle can increase back pressure and limit oxygen flow below 5 lpm.

To achieve 5 lpm, use the following procedure:

- 1 Uncoil the power cord *completely* from its holder before use, and plug in the unit.
- 2 Set the ON/OFF switch to the ON position, and allow the unit to run at least three minutes to build up pressure.
- 3 Connect the humidifier bottle, oxygen tubing, and cannula to the oxygen outlet. (See Figure 5.31.)
- 4 Remove the right side panel.
- 5 Turn the flowmeter adjustment knob counterclockwise until it stops (wide open). (See Figure 5.28.)
- 6 Pull outward on the regulator knob to unlock it. (See Figure 5.29.)

- 7** Turn the regulator knob clockwise until the flowmeter ball centers on the 5.5 lpm line.
- 8** Push in the regulator knob to lock the setting. (See Figure 5.30.)
- 9** Turn the flowmeter adjustment knob clockwise until the flowmeter indicates 5 lpm.
- 10** Reconnect the side panel.

**NOTE**

When this back pressure correction at 5 lpm is no longer required, follow the normal regulator setting procedure as described in Section 5.8.1.

5.8.4 Product Regulator Cleaning or Rebuilding

Clean or rebuild the product regulator if the flowmeter ball fluctuates more than 1/4 of a liter or if the regulator cannot be adjusted for lockout.

Earlier NewLife models used a product regulator with a red locking ring.

- 1** Set the unit's ON/OFF switch to the *OFF* position, and unplug the power cord.
- 2** Remove the right side panel.
- 3** Use large pliers to unscrew the bonnet of the product regulator, which contains a large spring. (See Figure 5.32.)

**NOTE**

Adjust the product regulator fully counterclockwise to unload the spring. This makes disassembly and reassembly easier.

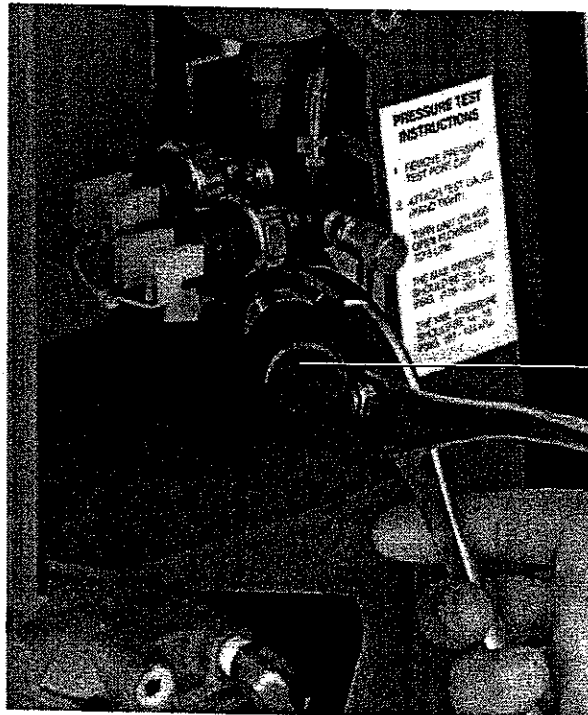

Use
Large
Pliers to
Remove
Product
Regulator
Bonnet

Figure 5.32: Removal of Product Regulator Bonnet

- 4** Remove the diaphragm. (Clean or replace it.) (See Figure 5.33.)
- 5** Use a Phillips-head screwdriver to unscrew the diaphragm stem guide located in the center of the regulator body to gain access to the seat.
- 6** Remove the seat. Be careful not to lose the spring located behind the seat.
- 7** Clean or replace the seat.
- 8** With the spring behind the seat, screw the diaphragm stem guide back into the body of the regulator. (Do not over tighten.)
- 9** Install a clean or replacement diaphragm.
- 10** Put the large spring and slip ring into the bonnet, and screw the bonnet onto the regulator body.
- 11** Reset the product regulator as described in Section 5.8.1.

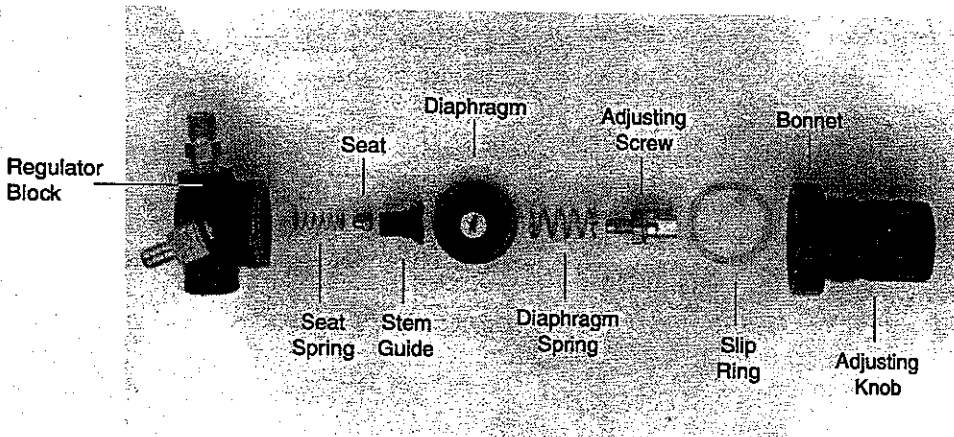

Figure 5.33: Product Regulator Assembly

Note the following part numbers to order the appropriate regulator rebuild kit:

RE-MI-KT-01 — Regulator rebuild kit

RE-MI-KT-02 — Regulator rebuild kit (red locking ring)

5.9 High or Low Pressure Switch Replacement

The high pressure switch is located closer than the low pressure switch to the pressure test port. Remove it first to gain access to the low pressure switch. (See Figure 5.34.)

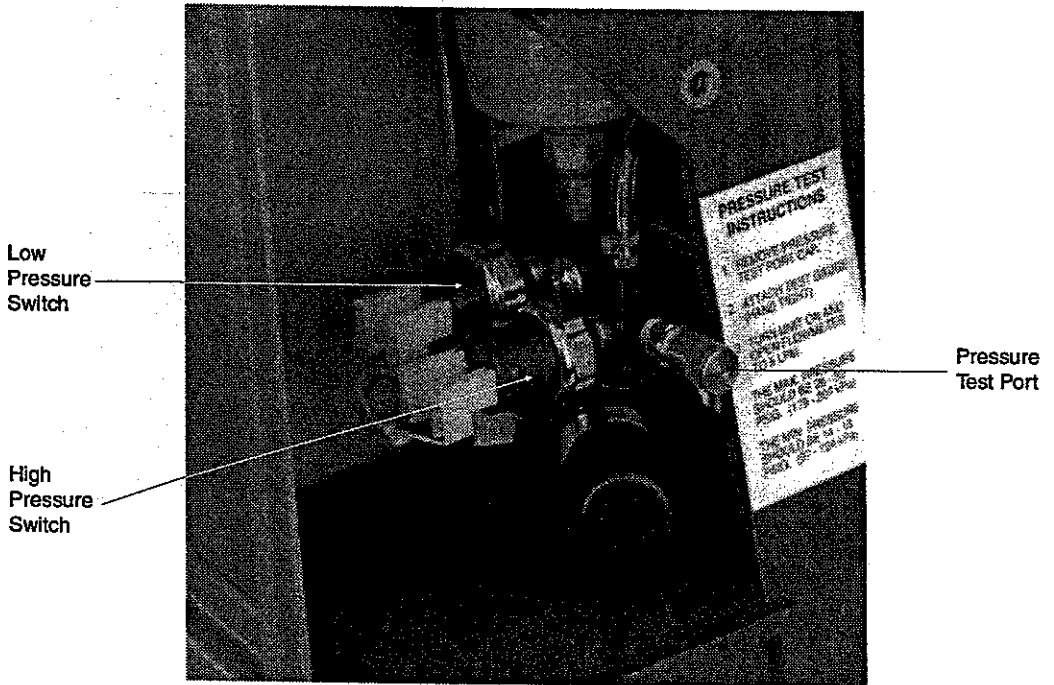

Figure 5.34: Location of Pressure Switches

- 1 Set the unit's ON/OFF switch to the OFF position, and unplug the power cord.
- 2 Remove the right side panel.
- 3 Disconnect the leads to the pressure switch. (See Figure 5.35.)
- 4 Unscrew the pressure switch from the pressure test block.
- 5 Install the new pressure switch, connect the leads, and leak test as described in Section 5.21.
- 6 Test the alarm system, as described in Section 4.4.
- 7 Reconnect the side panel.

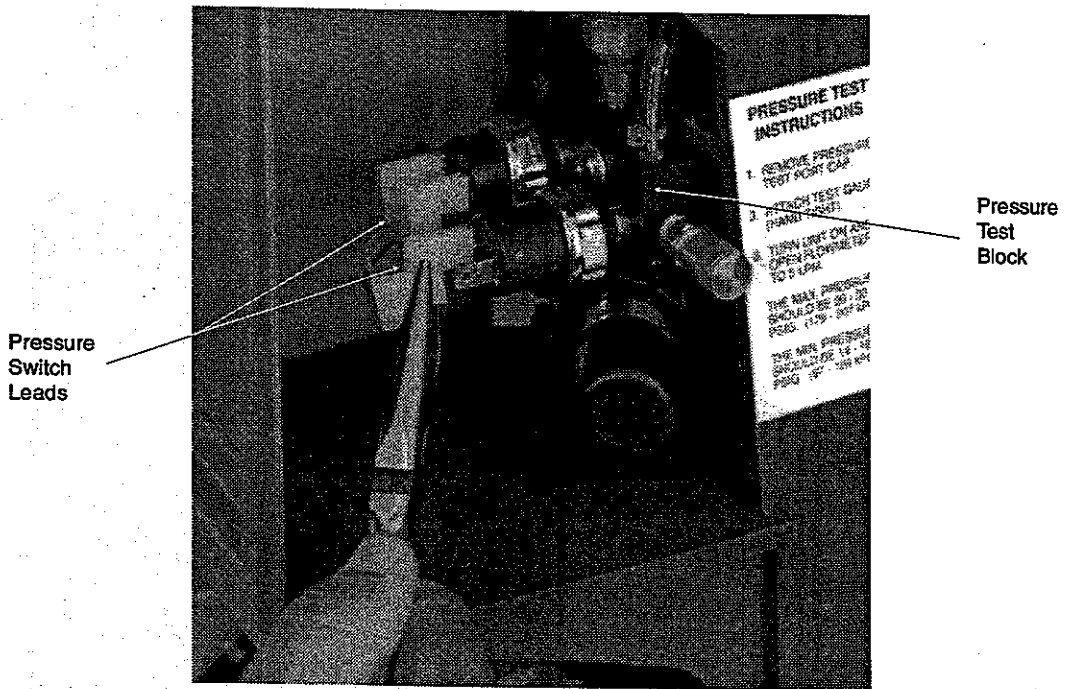

Figure 5.35: Disconnection of Leads to High Pressure Switch

5.10 Circuit Breaker Replacement

5.10.1 Circuit Breaker Removal

- 1** Set the unit's ON/OFF switch to the OFF position, and unplug the power cord.
- 2** Remove the left side panel.
- 3** Disconnect the circuit breaker leads. (See Figure 5.36.)
- 4** Unscrew the circuit breaker while you apply pressure to the circuit breaker retaining ring. (See Figure 5.37.)

Circuit
Breaker
Leads

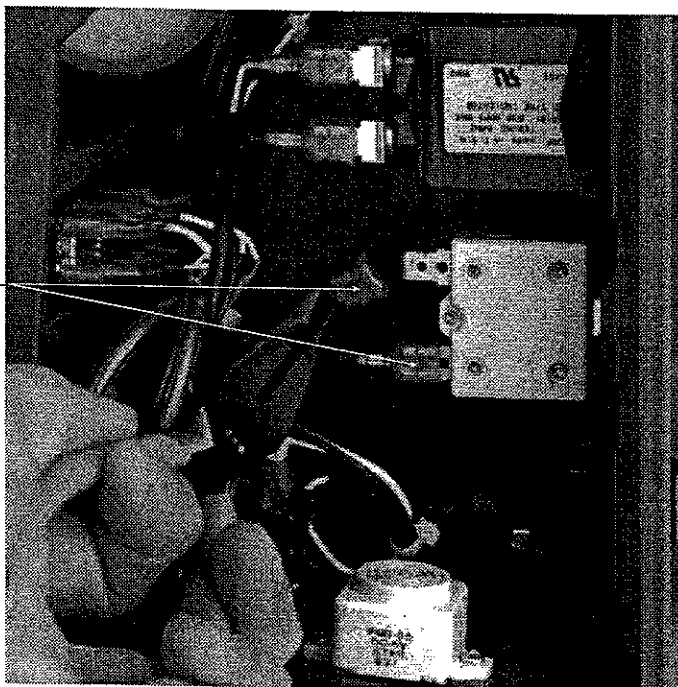

**Figure 5.36: Removal of
Circuit Breaker Leads**

Circuit
Breaker

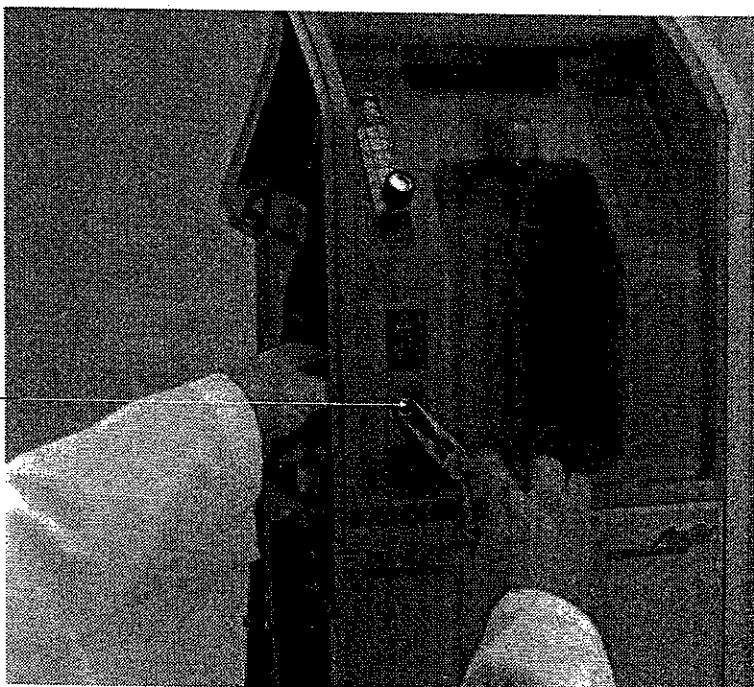

Apply
Pressure to
Retaining
Ring to
Remove
Circuit
Breaker

Figure 5.37: Removal of Circuit Breaker

5.10.2 Circuit Breaker Installation

Follow the removal procedure for the circuit breaker in reverse order to install the new circuit breaker.

5.11 ON/OFF Power Switch Replacement

5.11.1 ON/OFF Power Switch Removal

- 1** Set the unit's ON/OFF switch to the *OFF* position, and unplug the power cord.
- 2** Remove both side panels, the lower front panel, and the back cover.
- 3** Unscrew the four Phillips-head screws that hold the control panel to the superstructure.
- 4** Cut off the two white tie-wraps from the terminal strip leads. (See Figure 5.38.)
- 5** Disconnect the two-pin alarm connector and the ON/OFF switch leads from the terminal strip, power cord, and circuit breaker.

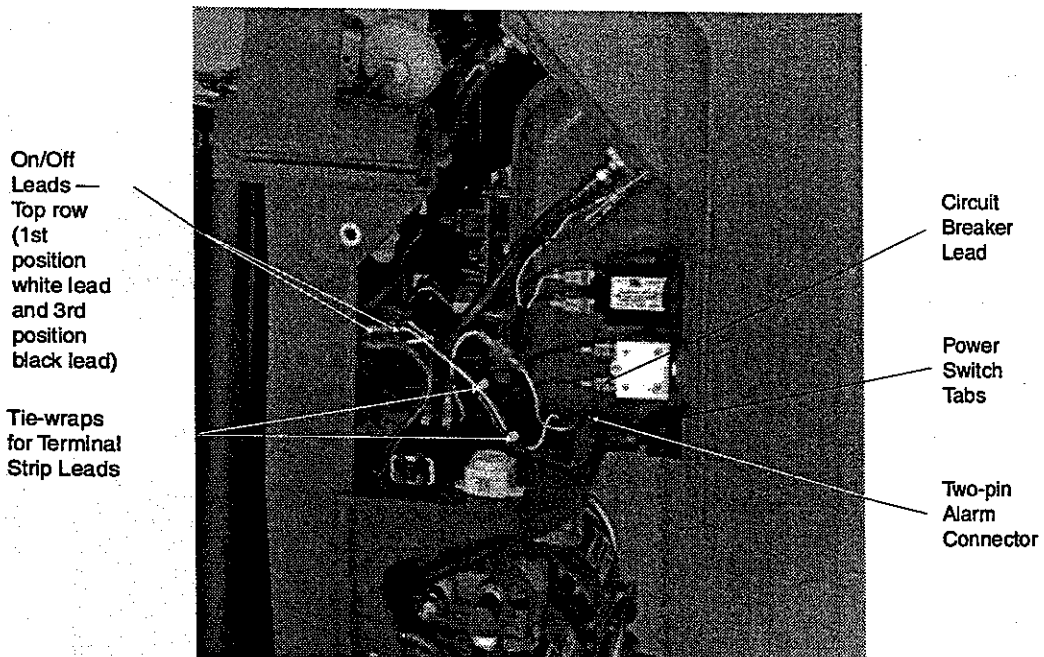
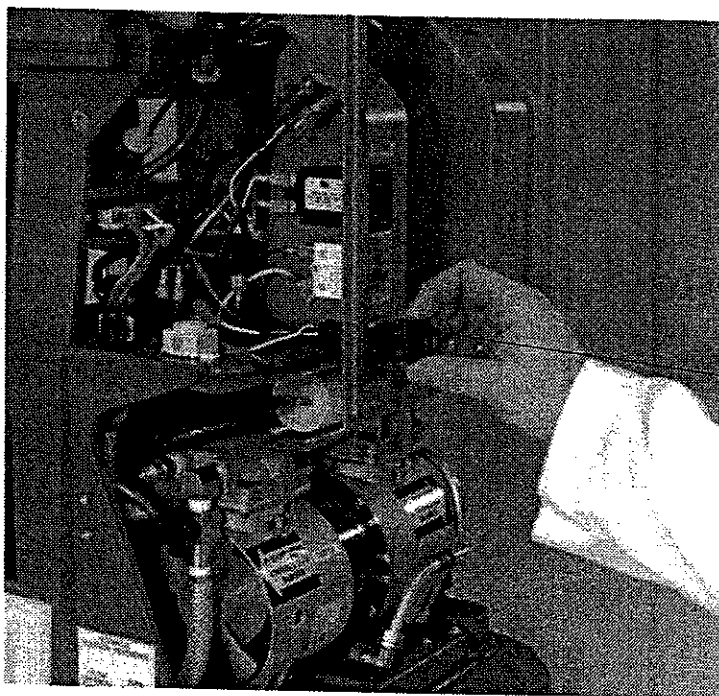

Figure 5.38: Disconnection of Leads for ON/OFF Power Switch Removal

- 6 Press in all eight tabs in the back of the power switch, and remove the switch through the front panel. (See Figure 5.39.)

Remove Power
Switch Through
Front of Unit



Power Switch

Figure 5.39: ON/OFF Power Switch Removal

5.11.2 ON/OFF Power Switch Installation

Follow the removal procedure for the ON/OFF power switch in reverse order to install a new power switch. Make sure the soldered wires and terminals on the new power switch face upward.

5.12 Buzzer Replacement

- 1 Set the unit's ON/OFF switch to the OFF position, and unplug the power cord.
- 2 Remove the left side panel.
- 3 Unscrew the two Phillips-head screws that hold the buzzer to the superstructure, and solder if necessary to disconnect the buzzer leads. (See Figure 5.40.)
- 4 Solder the leads to the new buzzer, and screw the buzzer to the superstructure.
- 5 Reconnect the side panel.

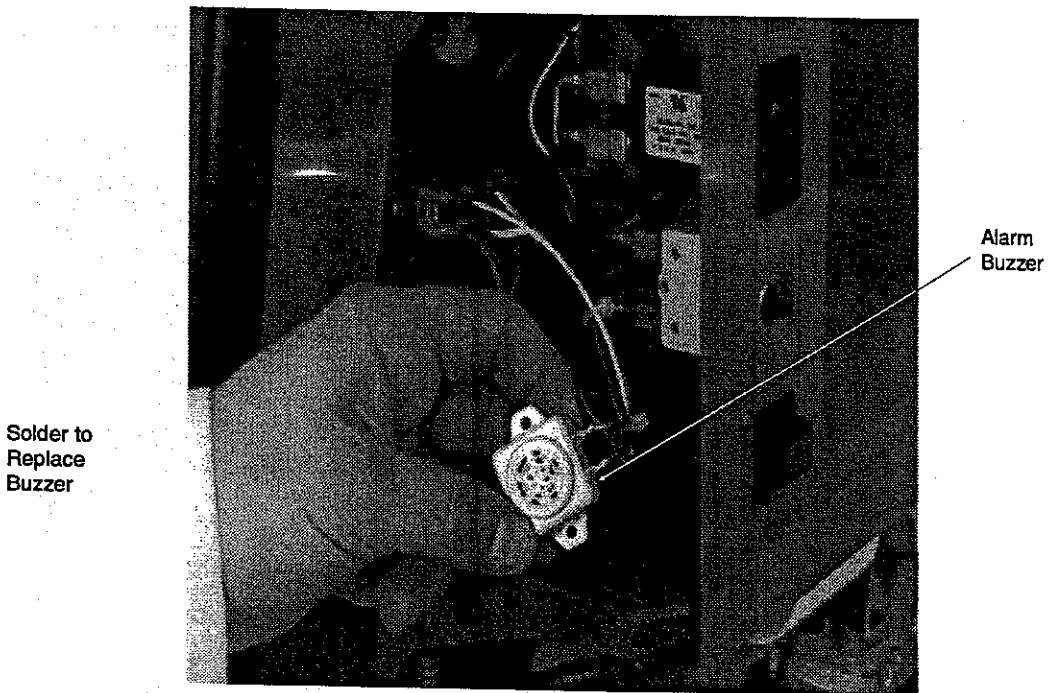

Figure 5.40: Replacement of Buzzer Leads

5.13 Hour Meter Replacement

- 1** Set the unit's ON/OFF switch to the *OFF* position, and unplug the power cord.
- 2** Remove the left side panel.
- 3** Disconnect the hour meter leads. (See Figure 5.41.)
- 4** Push both hour meter mounting bracket tabs away from the hour meter and move the bracket to the left.
- 5** Remove the hour meter through the control panel.
- 6** Install the new hour meter into the control panel, and push the mounting bracket on to the new hour meter to secure it.
Make sure that the 1/10-hour increment displays on top. (See Figure 5.42.)
- 7** Reconnect the hour meter leads.
- 8** Reconnect the side panel.

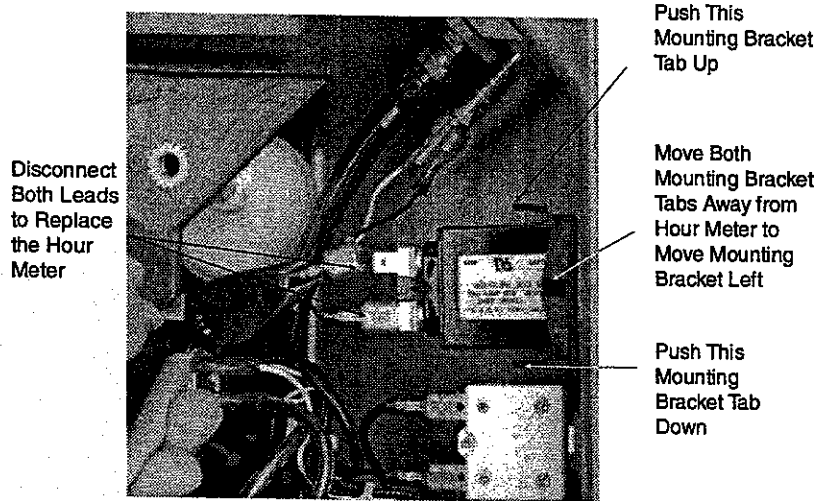

Figure 5.41: Disconnection of Hour Meter Leads

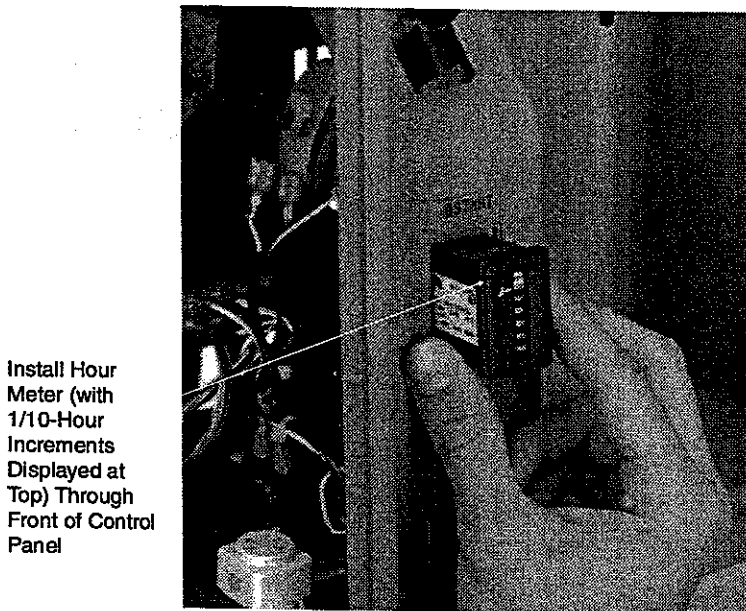

Figure 5.42: Installation of Hour Meter

5.14 Flowmeter Pilot Light Bulb Replacement

- 1** Set the unit's ON/OFF switch to the *OFF* position, and unplug the power cord.
- 2** Remove the left side panel.
- 3** Pull the pilot light bulb out of the flowmeter, and disconnect the bulb leads. (See Figure 5.43.)

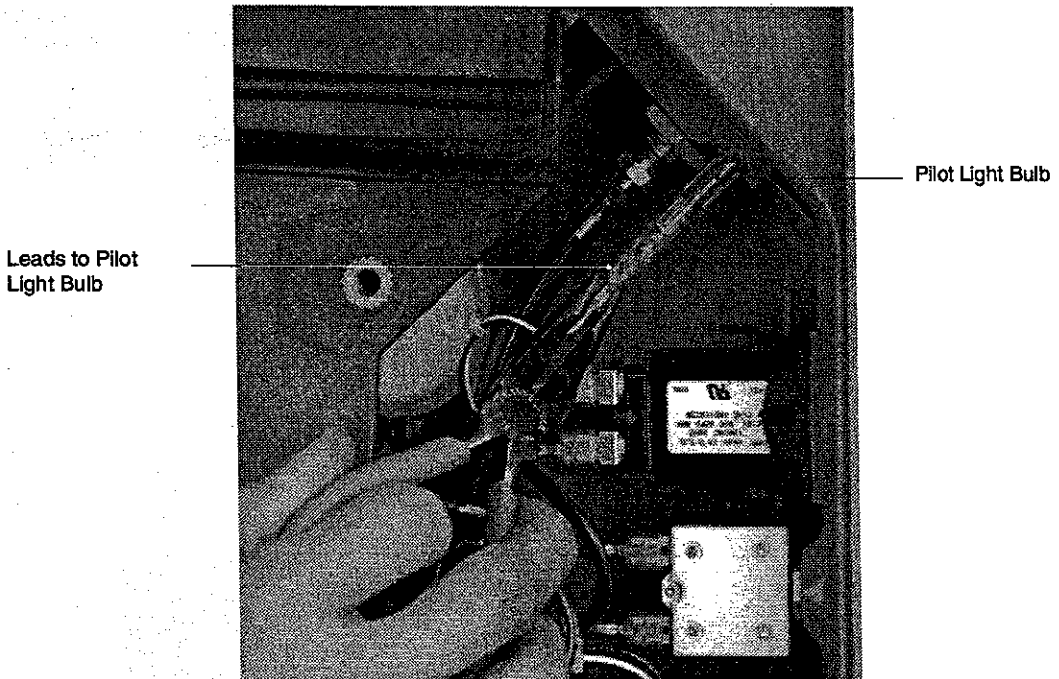

Figure 5.43: Removal of Pilot Light Bulb

- 4** Insert the new bulb into the pilot light hole in the flowmeter. (See Figure 5.44.)
- 5** Reconnect the pilot light bulb leads.
- 6** Reconnect the side panel.

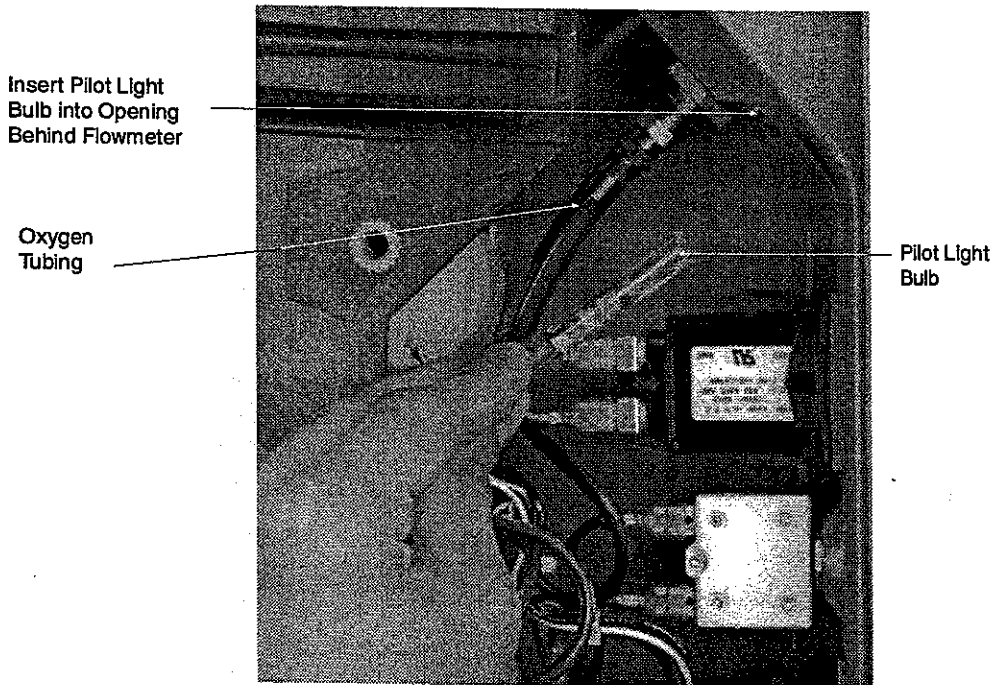

Figure 5.44: Insertion of New Pilot Light Bulb

5.15 Flowmeter Replacement

5.15.1 Flowmeter Removal (Pediatric or 5 LPM Scale)

- 1** Set the unit's ON/OFF switch to the *OFF* position, and unplug the power cord.
- 2** Remove the left side panel.
- 3** Remove the pilot light bulb. (See Figure 5.43.)
- 4** Cut the green tie-wraps, and remove the 3/8-inch green oxygen tubing from the flowmeter fittings.
- 5** Unscrew the flowmeter nuts with a wrench. (See Figure 5.45.)
- 6** Remove the flowmeter through the control panel.

Unscrew Flowmeter
Nuts with a Crescent
Wrench

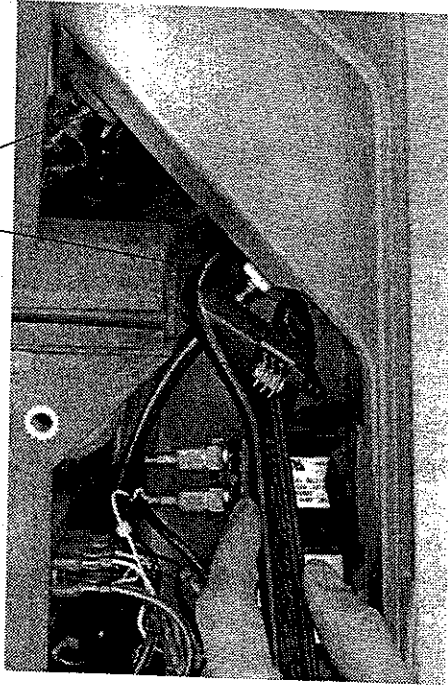

Figure 5.45: Removal of Flowmeter Nuts

5.15.2 Flowmeter Installation (Pediatric or 5 LPM Scale)

To install a new flowmeter, follow the flowmeter removal procedure in reverse order. Then perform a leak test on the connections as described in Section 5.21.

5.16 Control Panel Replacement (Single or Dual Flowmeter Option)

Figure 5.46 shows the NewLife unit with the dual flowmeter option.

The contents of the dual flow conversion kit (Part No. SB-ME-049) are listed below:

Qty	Part No.	Description
1	SL-02	Slug (pressed into elbow)
1	BB-27-03-02	Elbow (drilled with #70 drill bit - 5 holes)
4	MI-MO-00-01	Adhesive Tie-Wrap Mount
4	MI-TI-04	Tie-Wrap (White)
1	EL-3-22-1302	22-Gauge White Wire

Qty	Part No.	Description
1	EL-2-22-1301	22-Gauge Black Wire
2	EL-C51-266	.250 Blue Push-on Connector
2	EL-C51-122	.110 Pink Push-on Connector
1		Flowmeter (type to be determined)

The following are also required to complete a dual flow conversion:

Qty	Part No.	Description
1	EL-HM-60-02	Hour Meter with Bracket
1	EL-101-15	On/Off Switch with Harness
1	EL-CB-04	Circuit Breaker
1	PH-42-04-BF	Female NPT Swivel Adapter

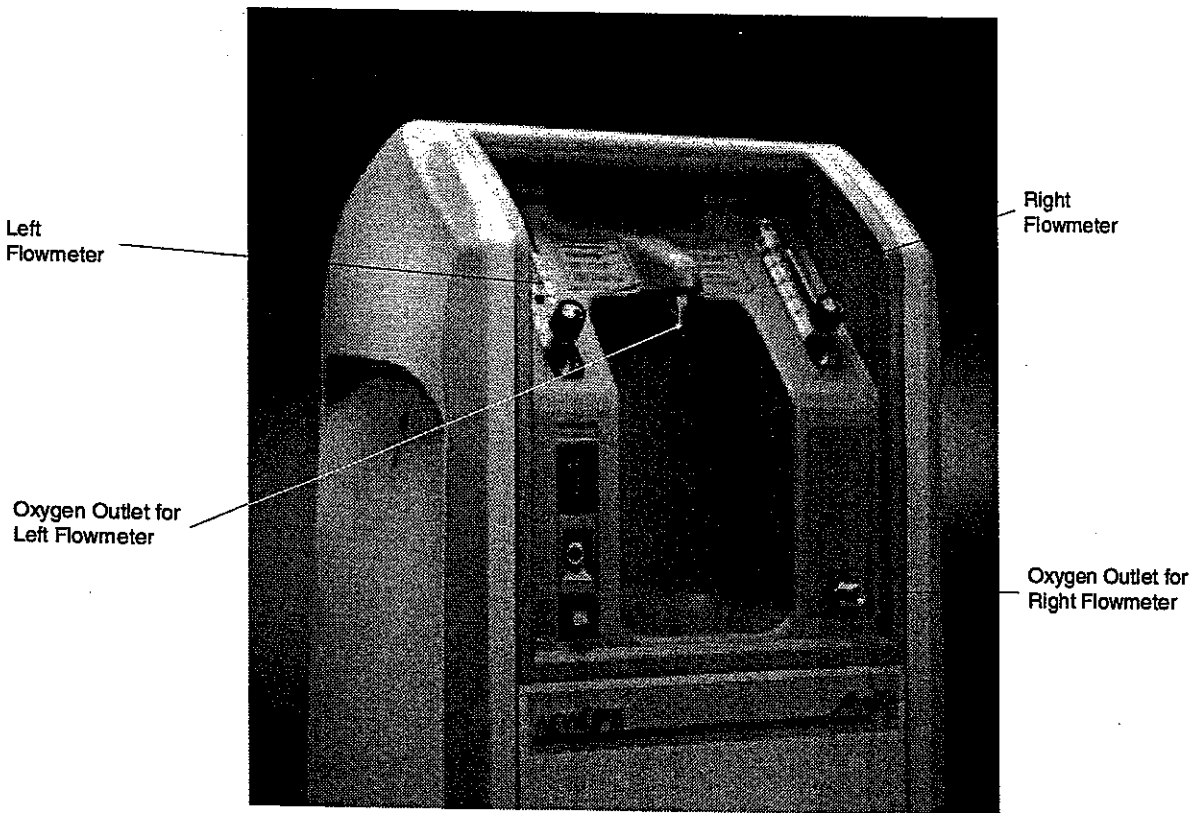

Figure 5.46: Control Panel Displays Dual Flow Unit

5.16.1 Control Panel Removal (Single or Dual Flowmeter Option)

- 1** Set the unit's ON/OFF switch to the *OFF* position, and unplug the power cord.
- 2** Remove the side, back, and lower front panels.
- 3** Push in the board support tabs with a slotted-head screwdriver while you lift each corner of the board to remove the circuit board from the circuit board supports. (See Figure 5.27.)
- 4** Unscrew the four Phillips-head screws that hold the control panel to the superstructure. (See Figure 5.47.)
- 5** Disconnect the hour meter leads, and remove the hour meter.
- 6** Remove the flowmeter pilot light.

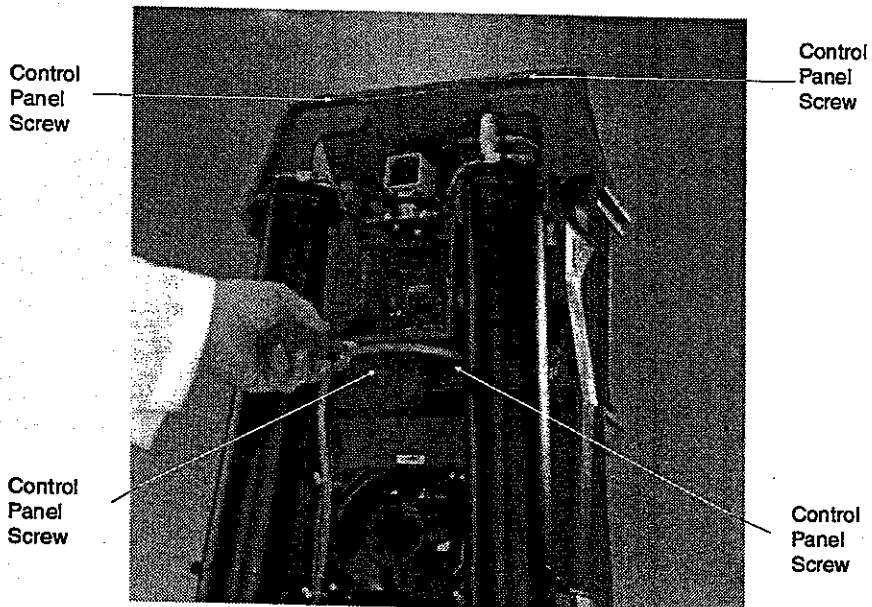

Figure 5.47: Location of Control Panel Screws



Installation of a dual flowmeter cover requires a second pilot light for the right side flowmeter. The white wire lead of the pilot light connects to the top of the hour meter spade, and the black wire lead connects to the bottom hour meter spade. If the hour meter has single spade connections, replace them with the dual spade connections included with the kit.

- 7** Disconnect the power switch two-pin alarm connector.
- 8** Disconnect the two power switch leads at the top of the terminal strip. (See Figure 5.38.)
- 9** Disconnect the white power cord lead at the spade connection.
- 10** Disconnect the black power cord lead from the circuit breaker.
- 11** Cut the green tie-wrap and the 3/8-inch green oxygen tubing at the product regulator. (See Figure 5.48.)
- 12** Remove the control panel.

Cut Tie-wrap to Remove Green Oxygen Tubing (not shown)

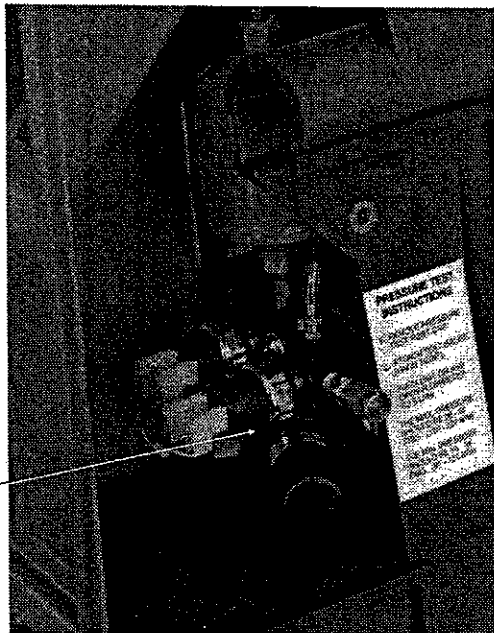

Figure 5.48: Removal of Oxygen Tubing at Product Regulator

5.16.2 Control Panel Installation (Single to Dual Flowmeter Option)

To install a dual flow control panel, you must replace the brass elbow fitting at the top of the product tank with a shorter fitting. Follow the instructions below to make this replacement:

- 1** Cut the green tie-wrap, and disconnect the 1/4-inch green tubing from the top of the gray product tank. (See Figure 5.49.)

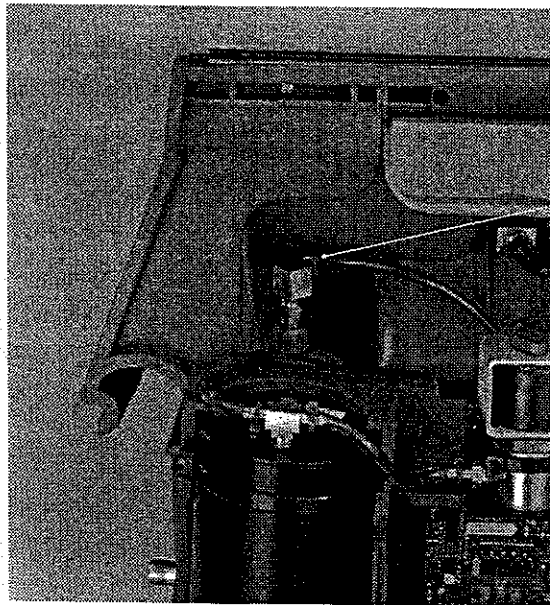

Figure 5.49: Disconnection of Tubing
from Product Tank

- 2** Carefully support the product tank using a 5/8-inch open-end wrench while you remove the brass elbow with a 7/16-inch open-end wrench. (See Figure 5.50.)
- 3** Install the shorter elbow while you support the product tank. (See Figures 5.50 and 5.51.)
- 4** Reconnect the 1/4-inch green oxygen tube, and secure it with a green tie-wrap.



Figure 5.50: Removal of Brass Elbow for Dual Flow Option

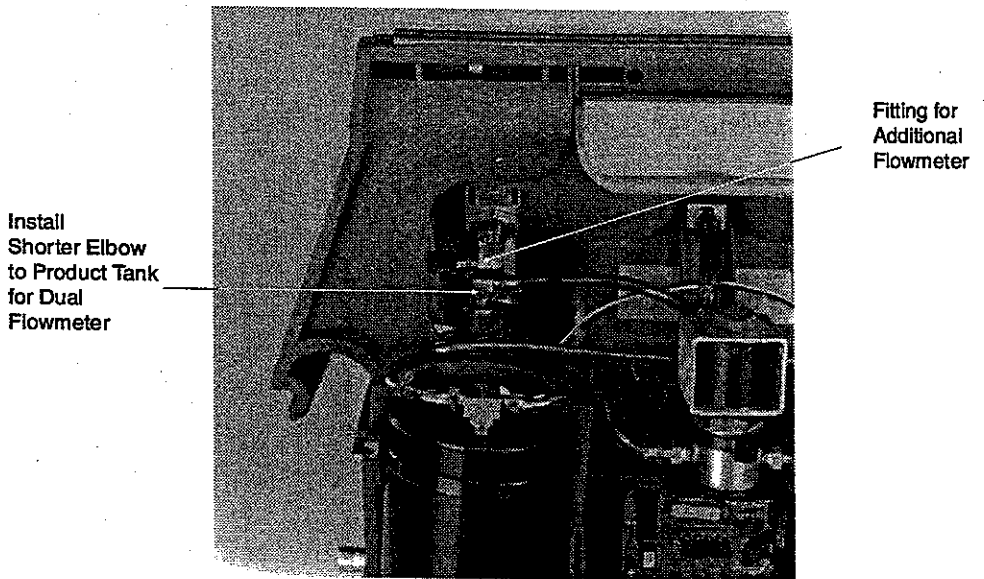

Figure 5.51: Installation of New Brass Elbow

To install a new control panel, follow the control panel removal procedure in reverse order. Then leak test the connections as described in Section 5.21.

5.17 Power Cord Replacement

- 1** Set the unit's ON/OFF switch to the *OFF* position, and unplug the power cord.
- 2** Remove the side and back panels.
- 3** Open the plastic twist clamps. (See Figure 5.52.)

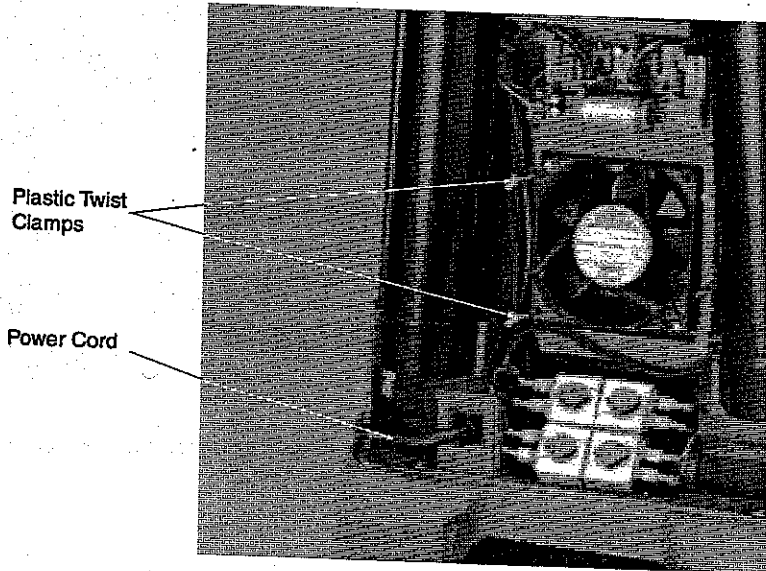

Figure 5.52: Removal of Power Cord Twist Clamps

- 4** Cut the tie-wraps (located under the valve sequencing label and near the power cord push-on connectors).
- 5** Disconnect the white power cord lead from the ON/OFF switch lead. (See Figure 5.53.)
Make sure to grip the larger ON/OFF switch push-on connector firmly with needle-nose pliers while you use another pair of needle-nose pliers to gently wiggle out the smaller power cord lead push-on connector.
- 6** Disconnect the black power cord lead from the top terminal on the circuit breaker.
- 7** Lay the unit face down, and unscrew the two Phillips-head screws that secure the power cord receptacle. (See Figure 5.54.)

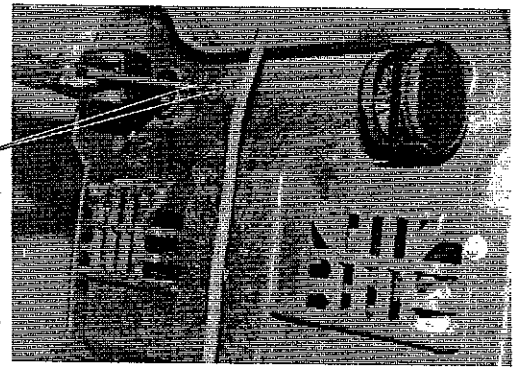
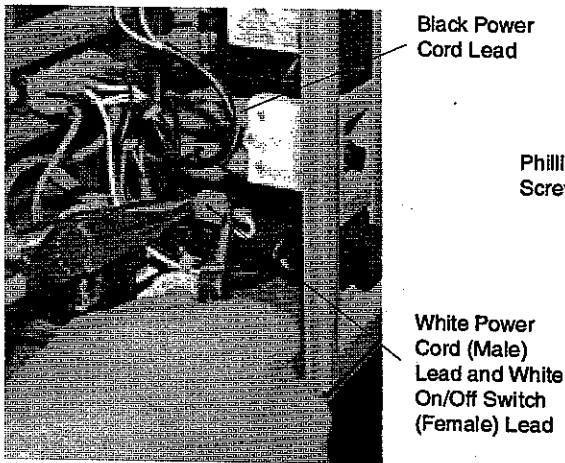

Figure 5.54: Removal of Phillips-head Screws

Figure 5.53: Disconnection of Push-on Connectors

- 8** Use a slotted-head screwdriver to break the receptacle seal. (See Figure 5.55.)
- 9** Pull the receptacle forward until the back of the strain relief is visible.
- 10** Press both ends of the strain relief together with needle-nose pliers to remove and save it for reuse. (See Figure 5.56.)

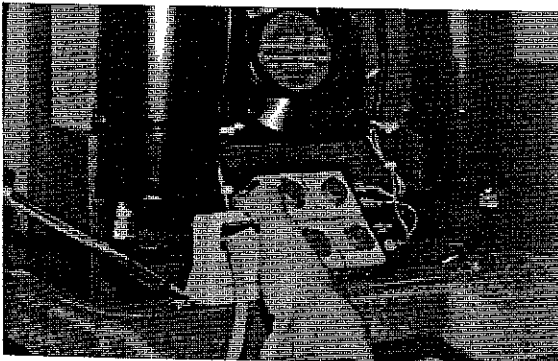

Figure 5.55: Removal of Power Cord Receptacle

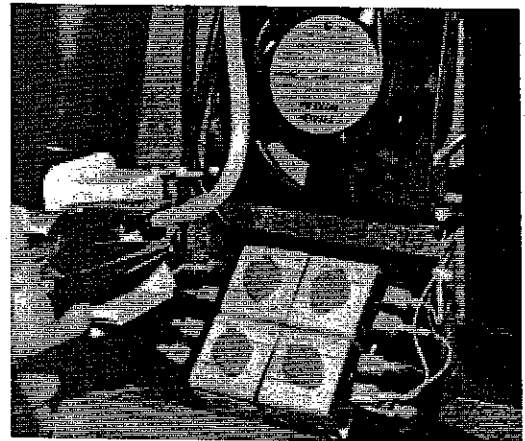
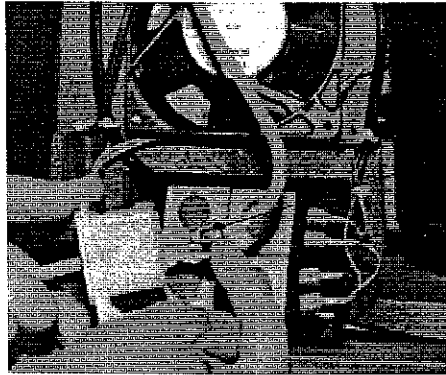

Figure 5.56: Removal of Strain Relief

- 11** Pull the power cord through the opening on the power cord receptacle.

- 12** Slide the strain relief onto the new power cord with the lip of the strain relief facing the ends of the power cord leads. (See Figure 5.57.)



Correctly
Position Lip of
Strain Relief

Figure 5.57: Positioning of Strain Relief

- 13** Insert the new power cord through the opening on the receptacle by squeezing the strain relief together with pliers.
- 14** Position the strain relief upward, and push it into the rear of the power cord opening on the receptacle.
- 15** Reconnect the power cord leads, close the plastic twist clamps, and reattach the tie-wraps.
- 16** Reconnect the power cord receptacle to the base of the unit with the two Phillips-head screws.
- 17** Reconnect the side and back panels.

5.18 EcoCheck™ Oxygen Monitor Installation

Take the following steps to install the optional EcoCheck Oxygen Monitor:

- 1** Set the unit's ON/OFF switch to the *OFF* position, and unplug the power cord.
- 2** Remove the side, back, and lower front panels.
- 3** Unscrew the four Phillips-head screws that hold the control panel to the superstructure. (See Figure 5.47.)

- 4** Hold (do not apply) the monitor front label over the right side of the control panel, and trace the opening for the amber light indicator.
- 5** Use a 1/4-inch drill bit to drill a hole for the light.
- 6** Apply the monitor label to the right side of the control panel. (See Figure 5.58.)

Match Position
of Label's
Opening to
Drilled Hole,
and Apply
Monitor Label
to Control
Panel

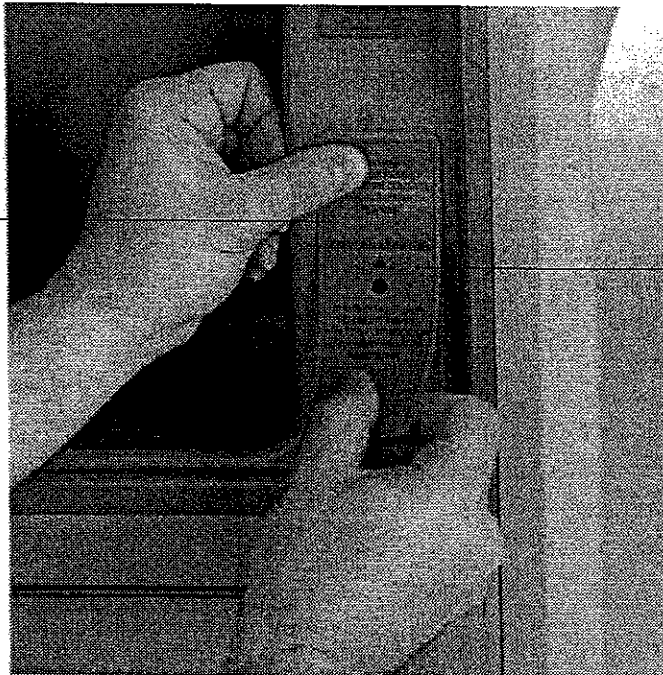

Oxygen
Monitor Label

**Figure 5.58: Monitor Label
Affixes to Control Panel**

- 7** Insert the retainer ring (bezel) for the light. (See Figure 5.59.)

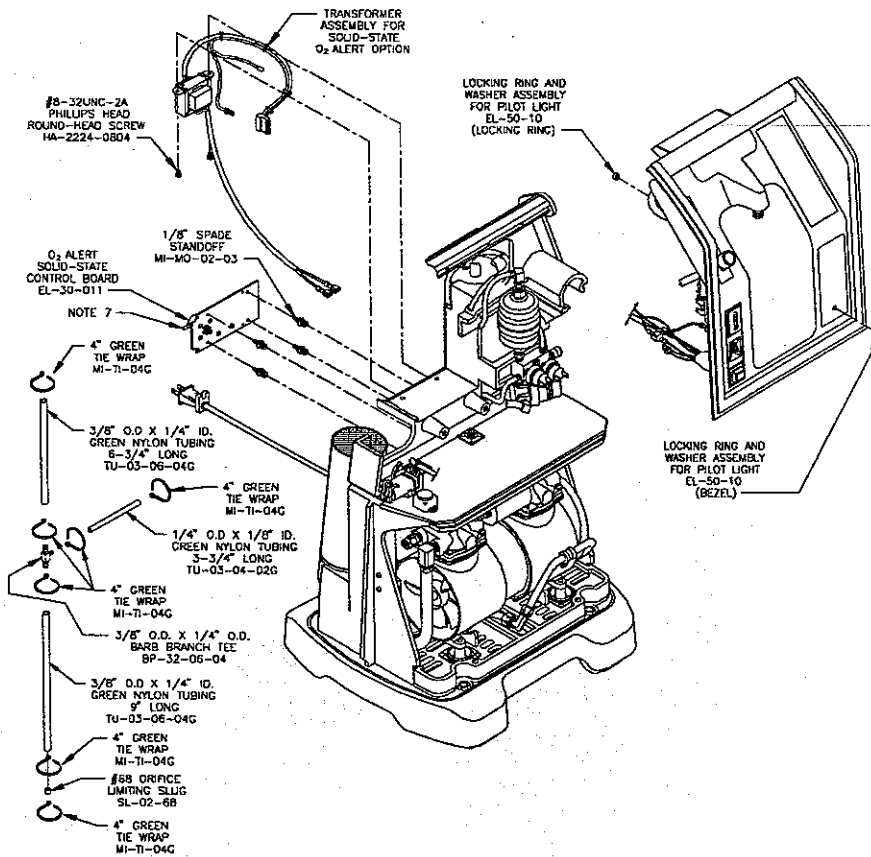

Figure 5.59: Oxygen Monitor Assembly

- 8** Push four plastic board support mounts into the slots located above the cabinet fan on the superstructure. (See Figure 5.60.)
- 9** Push the monitor circuit board on to the support tabs so that the white sensor is located in the bottom right corner. (See Figure 5.61.)

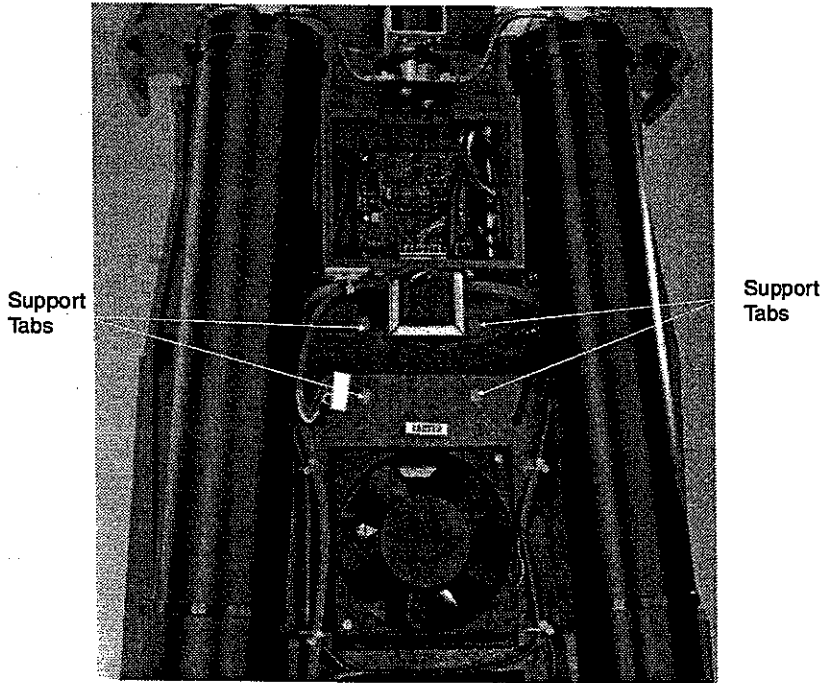

Figure 5.60: Location of Slots with Circuit Board Support Tabs Inserted

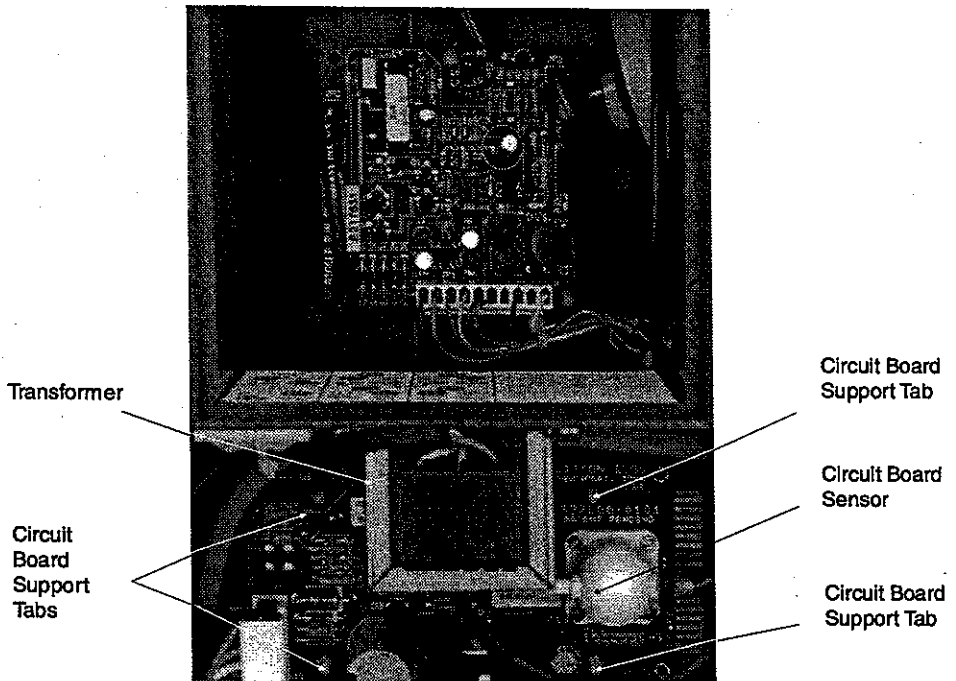

Figure 5.61: Oxygen Monitor Circuit Board

- 10** Cut the two green tie-wraps, and disconnect and remove the green product tube that connects the regulator and bottom flowmeter fitting.
- 11** Install the green product tube to the regulator, bottom flowmeter fitting, and the monitor's white sensor (on the right barb). Secure the tube to the fittings with tie-wraps.
- 12** Screw the transformer to the superstructure on the underside where the circuit board sequence label is located. (See Figure 5.61.)
If the superstructure does not have inserts, drill these holes with a 7/32-inch drill bit.
- 13** Plug the red, blue, and white terminal wire connectors into the monitor's circuit board.
- 14** Place the slip ring on the monitor's amber light indicator, and push it into the retainer on the control panel. Push the slip ring over the retainer. (See Figure 5.59.)
- 15** Attach the two-pin connector from the monitor's circuit board to the NewLife's circuit board at the top left corner.
- 16** Attach the transformer power wires to the hour meter spades. If necessary, replace single spades with double spades.
- 17** Leak test the connections, and verify the monitor's performance with the verification test procedure. (Refer to Section 4.4.5.)

**NOTE**

For units equipped with the Air Outlet and EcoCheck Oxygen Monitor options: Make sure the Air Outlet option is used only with the NewLife unit in the normal 5 lpm mode. It is not possible for a patient to receive proper nebulizer treatment when the unit operates with the EcoCheck valve in the ECONomy mode.

5.19 Air Outlet Option

The Air Outlet option enables the NewLife unit to serve as a source of compressed air for patients who require a medication nebulizer.

The air outlet valve and adapter on the unit's control panel allows for an easy connection to the patient's hand held nebulizer tubing. (See Figure 5.62.)

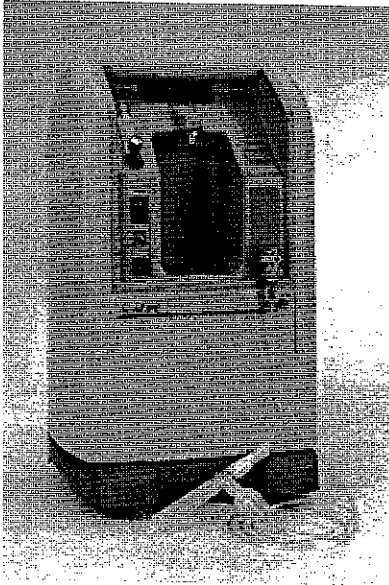
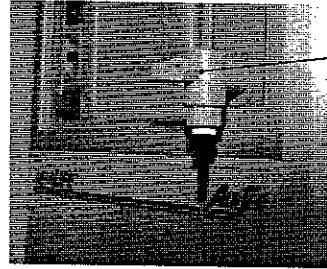
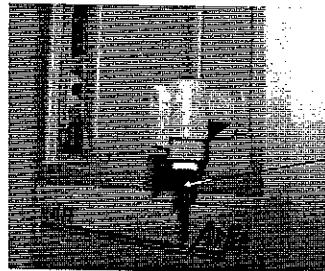

Figure 5.62: Air Outlet Option
Part No. SB-ME-052A



Air Valve Part
No. VA-44-04

**Figure 5.63: Air Outlet
Valve in Closed Position**



Air Outlet Barb
Fitting Part No.
PH-41-03-04

**Figure 5.64: Air Outlet
Valve in Open Position**



With a nebulizer attached to the air outlet, oxygen purity can fall as much as 5%. If the air valve remains open with no nebulizer attached, purity will fall to approximately 60%.

5.19.1 Setting the Air Outlet Pressure Regulator

- 1** Attach the pressure test gauge (Part No. SB-ME-058-Test Kit) to the barb fitting on the air outlet.
- 2** Adjust the air outlet pressure regulator to a maximum of 12 psig ± 2 . (See Figure 5.65.)

The gauge assembly contains a #71 orifice, which limits air flow to 6 lpm.

For a maximum pressure setting of 12 psig, minimum air outlet pressure should not fall below 9 psig.

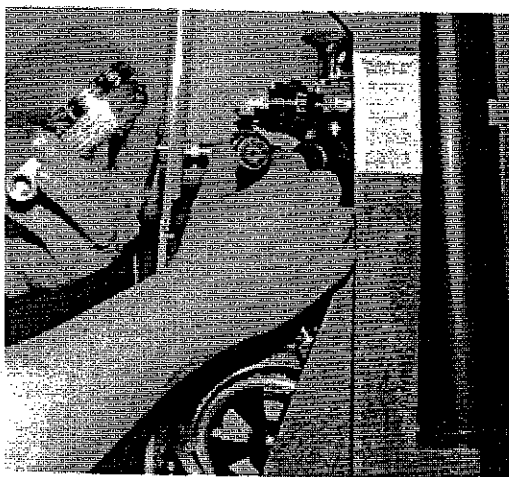

Connect
Pressure Test
Gauge to Air
Outlet Valve

Figure 5.65: Adjustment of Air Outlet Regulator

5.19.2 Air Outlet Pressure Regulator Cleaning

Clean the air outlet pressure regulator in the same way in which you clean the product regulator. Refer to Section 5.8.4 for instructions on removal of the product regulator. See Figure 5.66 for an exploded view of the Air Outlet Pressure Regulator Assembly.

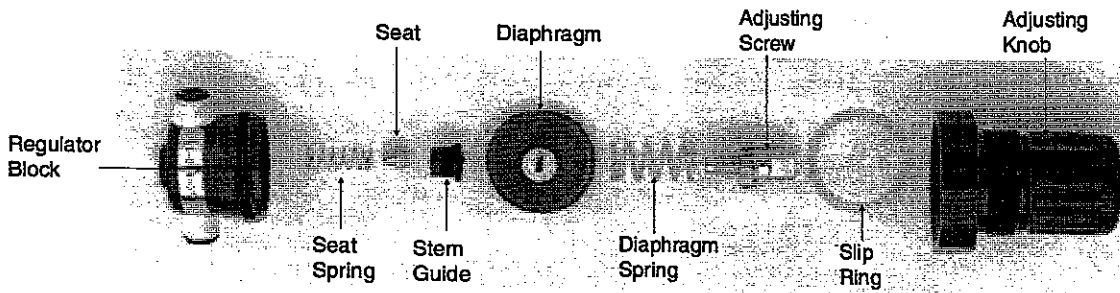

Figure 5.66: Air Outlet Pressure Regulator Assembly



NOTE

In high humidity environments or during extended periods on non-use, disconnect the nebulizer and open the air valve completely to purge/flush the system.



NOTE

For units equipped with both the Air Outlet and the EcoCheck Oxygen Monitor options, you may occasionally detect a slight surging of mist and the oxygen monitor light may illuminate.

5.20 Operating Pressure Test

Use the following procedure to test the operating pressure of the unit.

- 1** Set the unit's ON/OFF switch to the OFF position, and unplug the power cord.
- 2** Remove the right side panel.
- 3** Remove the test port cap. (See Figure 5.67.)

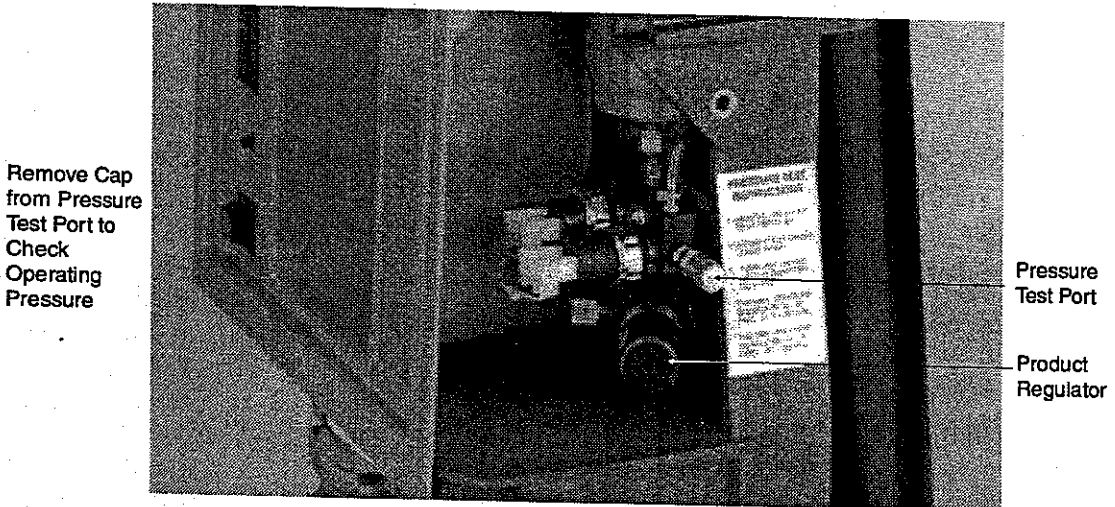

Figure 5.67: Location of Pressure Test Port

- 4** Connect the pressure test gauge to the test port. (See Figure 5.68.)
- 5** Hand tighten the knurled swivel.
- 6** Plug in the power cord, and set the unit's ON/OFF power switch to the ON position. Set the flowmeter to 5 lpm, and allow the unit to run at least five minutes.
- 7** Observe the maximum and minimum readings on the pressure test gauge.

The maximum reading should indicate 26-30 psig (179-207 kPa).
The minimum reading should indicate 14-18 psig (97-124 kPa).



NOTE

When you turn the unit on, the system pressure always registers higher than normal for the first few minutes of operation.

Connect
Pressure Test
Gauge to Port
to Check
Operating
Pressure



Knurled Swivel
on Pressure
Test Gauge

**Figure 5.68: Pressure Test Gauge
Connects to Test Port**

5.20.1 High Operating Pressure

Higher than normal operating pressure may indicate any of the following:

- A restrictive blowdown muffler, which does not allow the waste (purge) gas to exit the system freely.
Operate the unit with the blowdown muffler disconnected to see if the operating pressure returns to normal.
- An improperly operating circuit board or solenoid valve.
Confirm that the circuit board and solenoid valves function properly.
- Contaminated sieve beds.
Change the sieve beds.

5.20.2 Low Operating Pressure

Lower than normal operating pressure may indicate any of the following:

- A restriction in the suction resonator, which limits the amount of room air available to the compressor.

Disconnect the braided suction tube at the compressor, and allow the unit to operate without the suction resonator to see if normal operating pressure returns.

- An improperly operating circuit board or solenoid valve.
Confirm that the circuit board and solenoid valves function properly.
- A leak in the unit, which allows system pressure to escape.
Leak test the unit.
- A compressor with reduced output.
Ensure that the purity level at the desired liter flow is within AirSep's specifications. If it is below specifications, replace or repair the compressor.
- An obstructed or vertically positioned (ECONomy mode) EcoCheck valve.
For the optional EcoCheck feature: confirm that the EcoCheck valve is not obstructed or in the ECONomy mode. (Refer to Section 4.4.5.)

5.21 Leak Test Procedure

When you service the NewLife unit, thoroughly leak test it as outlined below. Use a leak indicating solution or liquid soap and water, which creates bubbles in the presence of a leak.

A solution of one teaspoon of liquid soap per quart of water is sufficient.

- 1** Uncoil the power cord *completely* from its holder before use, and plug in the unit.
- 2** Set the unit's ON/OFF switch to the *ON* position, and close the flowmeter.
Allow the unit to run for approximately three minutes.
- 3** Set the ON/OFF switch to the *OFF* position, and unplug the power cord.
- 4** Remove the side, back, and lower front panels.
- 5** In the compressor compartment, apply the solution to the heat exchanger connections and fittings on the compressor. (See Figures 5.69 and 5.70.)

Apply Solution
or Soapy Water
to Leak Test
Compressor
Fittings

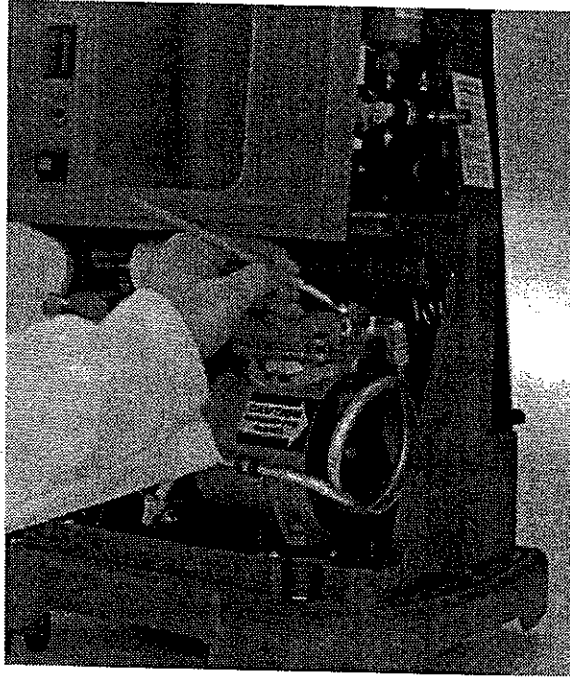
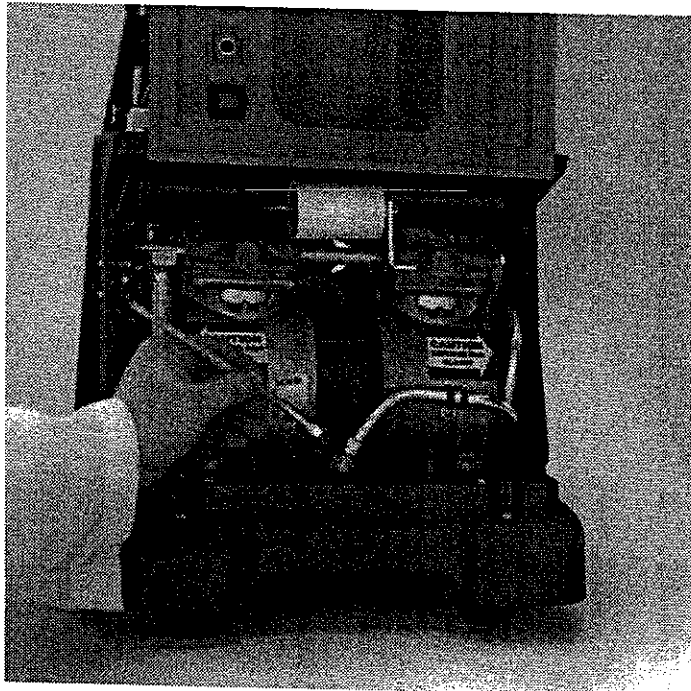

Figure 5.69: Leak Test – Compressor Fittings



Apply Solution
or Soapy Water
to Leak Test
Heat
Exchanger
Fittings

Figure 5.70: Leak Test — Heat Exchanger Fittings

- 6** On the right side, apply the solution to the regulator, pressure test block fittings and the product tank.
- 7** On the back, apply the solution to the unified valve block fittings, sieve bed fittings (top and bottom), and EQ valve fittings.



When you leak test, be sure to wipe off any excess water and protect all electrical components from the solution.

5.22 EcoCheck Valve Cleaning



Observe the original position of the EcoCheck valve in Figure 5.71. Reinstall the valve body and valve handle to this position after cleaning.

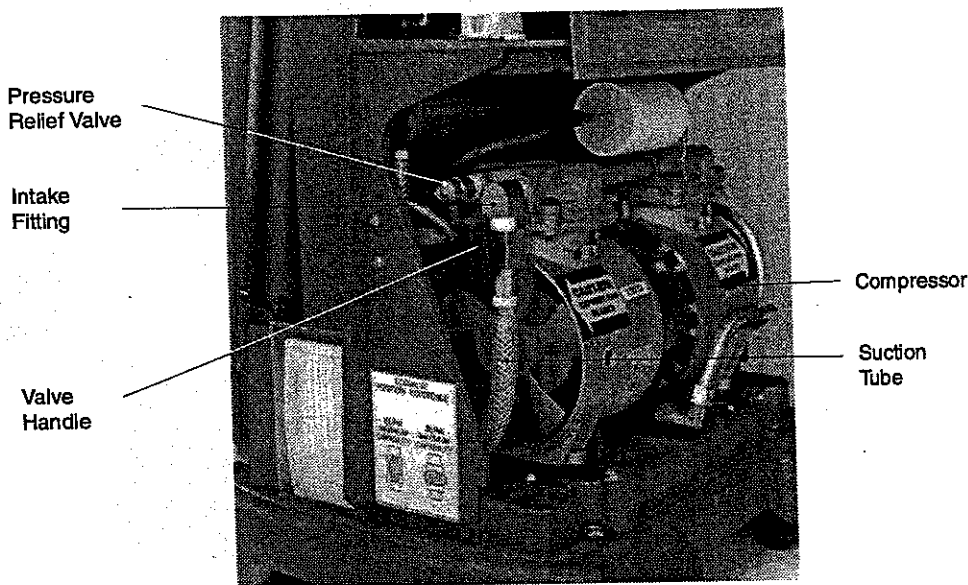
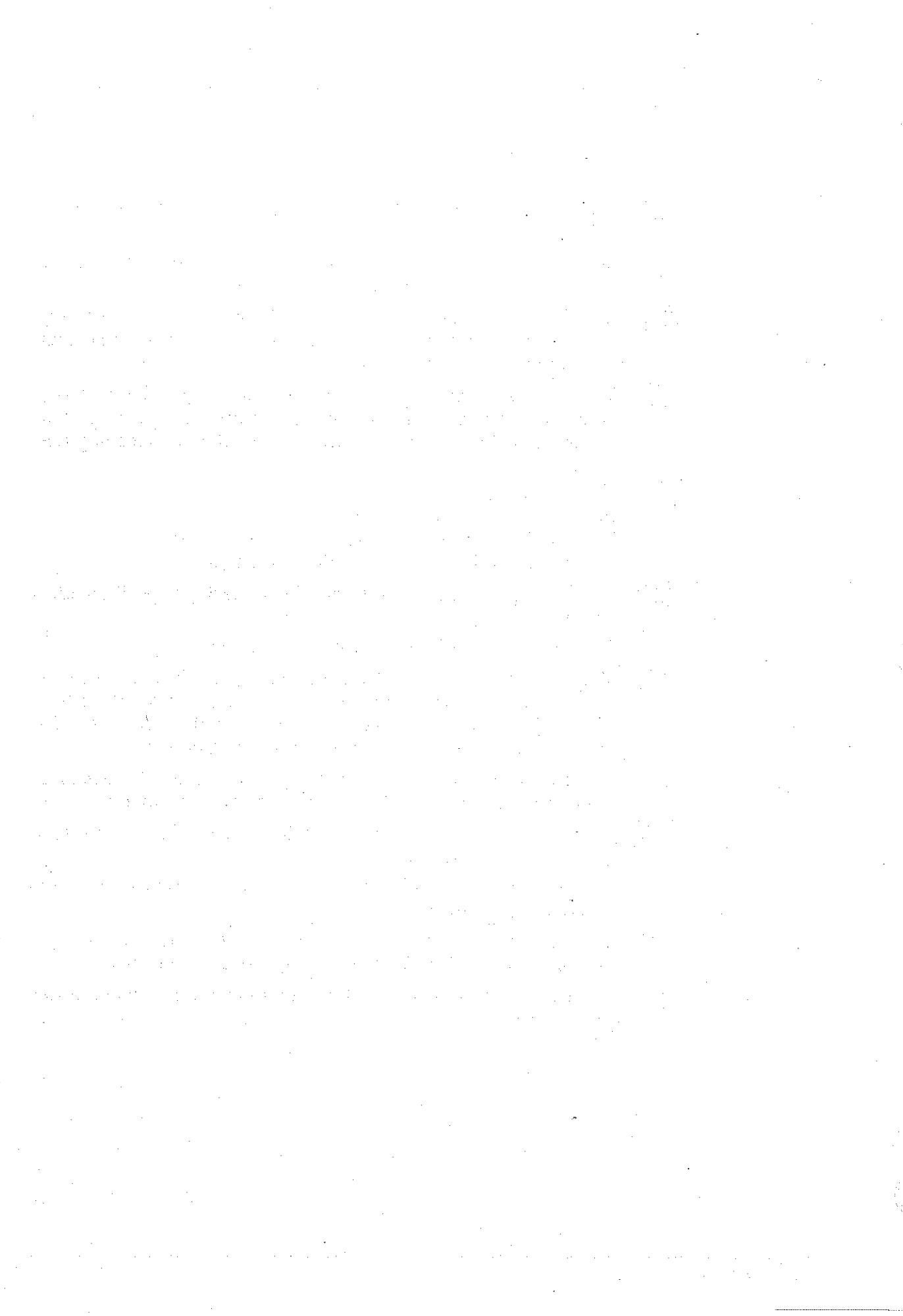

Figure 5.71: EcoCheck Valve Assembly

- 1** Follow steps 1–6 of the compressor removal procedure in Section 5.3.2.
- 2** Remove the pressure relief valve with a 9/16-inch combination or adjustable wrench. (See Figure 5.71.)
- 3** Remove the intake fitting and the valve body (as an assembly) with an adjustable wrench. (For the proper angle, grasp this fitting from the top.)
- 4** With the valve handle in the 5 lpm position (See Figure 4.8.), clean both openings of the valve assembly by pushing in a back-and-forth motion with any of the following cleaning devices:
 - pipe cleaner
 - non-cotton swab
 - 9/32-inch or smaller wooden or plastic dowel
 - shank of a 9/32-inch drill bit (.281-inch dia)
- 5** Repeat step 4 with the valve handle in the 3 lpm position. (See Figure 4.7.)

Use a shank end of a # 34-inch drill bit if necessary.
- 6** If compressed air is available, blow air through both openings of the valve body alternately with the valve in both the 5 lpm and the 3 lpm position. If compressed air is not available, tap the valve firmly on a hard surface to loosen any debris.
- 7** If a buildup of debris is visible along the inside rim of the suction tube, use the edge of a slotted screwdriver to remove it.
- 8** Thread the EcoCheck valve into the front (right) compressor port, and tighten securely.

Make sure the assembly is in the same position as before removal. (See Figure 5.71.)
- 9** Reseal the pressure relief valve with teflon tape, thread the valve into the back (left) compressor port, and tighten securely.
- 10** Reinstall the compressor in the NewLife unit in the reverse order of removal.



6.0 Maintenance

6.1 Routine Maintenance

The NewLife unit has two filters and a 9-volt battery that require scheduled maintenance and replacement.

In addition, you must perform a test of purity concentration on the unit. (Refer to Section 2.2.1.)

AirSep does not require preventative maintenance on the compressor. You do not need to perform any compressor maintenance as long as the NewLife unit remains within specifications at the desired flow rate.

6.1.1 Air Intake Gross Particle Filter/GPF (FI-50-08-05)

The external air intake gross particle filter is located on the back of the unit. (See Figure 4.3 in Section 4.2.) You can easily remove it by hand. Instruct the patient to clean this filter weekly. (Refer to Section 3.2.1.)



The filter may require daily cleaning if the NewLife unit operates in a harsh environment such as a house heated by wood, kerosene, or oil, or one with excessive cooking or cigarette smoke.

6.1.2 Bacteria Filter Replacement (FI-30-03)

The bacteria filter must be replaced after every 10,000 hours of use.

- 1** Set the unit's ON/OFF switch to the *OFF* position, and unplug the power cord.
- 2** Remove the side panels to locate the bacteria filter.



Observe the position of the filter before removal (green dot on outlet side).

- 3** Cut the tie-wraps, and separate the green tubing from both sides of the filter. (See Figure 6.1.)

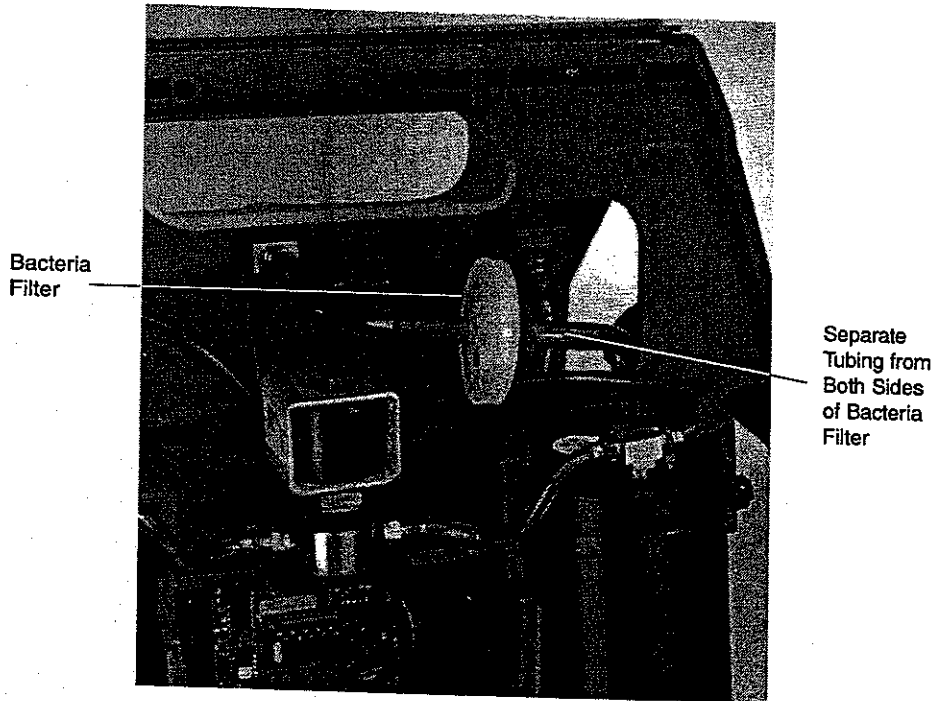

Figure 6.1: Removal of Bacteria Filter

- 4** Install the new filter with the inlet side in the same position as before. Push the tubing together so that the tubing overlaps the bacteria filter connections, and secure it with the tie-wraps.
- 5** Record information about the bacteria filter replacement on the History Record card, which is discussed in Section 6.1.4.
- 6** Reconnect the back and side panels.

6.1.3 Battery Replacement

Each time the NewLife unit is turned on, the alarm must sound loudly for a five-second test to indicate a good battery. An alarm that sounds faint during the five-second start-up test indicates a weak battery. If the unit fails to alarm or sounds faint during the start-up test, the battery requires replacement.

To replace the battery, take the following steps:

- 1** Set the unit's ON/OFF switch to the *OFF* position, and unplug the power cord.
- 2** Remove the left side panel.
- 3** Release the Velcro strap, and lift the battery out of the battery holder. (See Figure 6.2.)

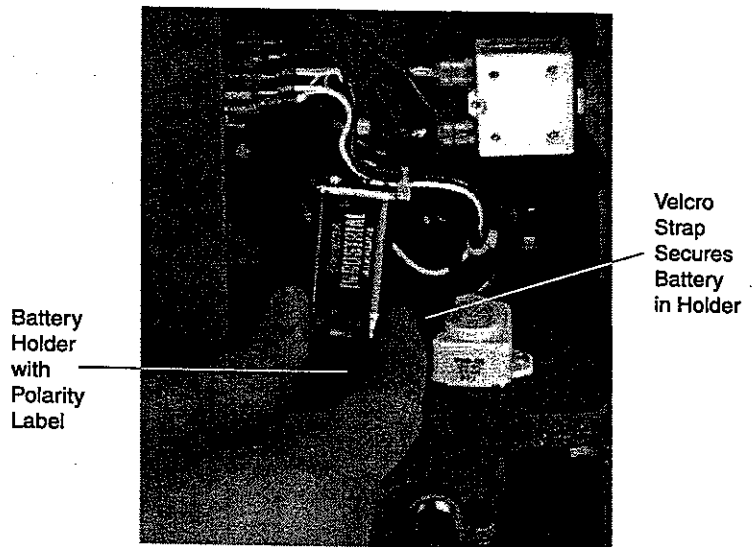

Figure 6.2: Removal of Battery from Holder

- 4** Install the new battery maintaining proper polarity, and secure it with the Velcro strap.
- 5** Set the ON/OFF switch to the *ON* position to test the alarm.
- 6** Record the battery replacement information on the History Record card.
- 7** Reconnect the side panel.

Explanation of Maintenance Record

- (a) **Date:** Record date of maintenance, set-up, or pick-up.
- (b) **Hours:** Record current reading of hour meter.
- (c) **Set-Up:** Indicate with a ✓ that the NewLife® is delivered to patient.
- (d) **Pick-Up:** Indicate with a ✓ that the NewLife is picked up from patient.
- (e) **Prescribed LPM:** Record patient's prescribed lpm (liters per minute) flow rate. Maximum rated flow capacity is 5 lpm for the standard NewLife unit.
- (f) **O₂% Concentration:** Record result of oxygen analyzer purity test at patient's prescribed lpm flow rate.
- (g) **Power Failure Alarm:** Indicate with a ✓ that the power failure alarm is operational by disconnecting power cord when power switch is in "on" position.
- (h) **Replace Battery:** Indicate with a ✓ only when replacing battery. When installing battery, ALWAYS test for battery alarm. If alarm does not sound, battery may not be installed properly or may be defective.
- (i) **Wash GPF:** Indicate with a ✓ that the air intake gross particle filter is cleaned.
- (j) **Clean Unit:** Indicate with a ✓ that the machine's exterior is cleaned.
- (k) **Replace Bacteria Filter:** Indicate with a ✓ only when changing bacteria filter at 10,000 hours.
- (l) **Additional Information:** Record other services performed or any relevant observations.
- (m) **Initials:** Record servicing personnel's initials.



AirSep Corporation • 401 Creekside Drive • Buffalo, NY 14228-2085 USA
USA/Canada Toll-Free: 800-874-0202 • Tel: 716-691-0202 • Fax: 716-691-4141

MN004-1

CG 13 08/97

Figure 6.4b: Maintenance Check Record Explanation

6.2 Cleaning and Infection Control

With the growing concern about possible cross infection from home oxygen equipment (i.e., oxygen concentrators) from one home care patient to another, a clarification on this topic is necessary.

The organisms of most concern are M. Tuberculosis, HIV, and Viral Hepatitis. These are potentially pathogenic.

Tuberculosis can survive outside of the human body, but its mode of transmission is by droplet nuclei. When infected individuals cough, they release droplet nuclei into the air, and these carry the Tuberculosis organism. These droplet nuclei may be breathed in by another person, but prolonged exposure to the infected person is usually necessary for infection to occur.

HIV and Viral Hepatitis are both viruses, which are not living cells themselves but which can duplicate when in a living "host" cell. Both of these organisms are usually passed on by person-to-person contact, and both need to be in the human body to survive. Once outside the body, viruses do not survive.

6.2.1 Preparing for New Patient Use

When you remove the NewLife from a patient's home, always dispose of the used nasal cannula and humidifier bottle. Clean the exterior of the NewLife with a soapy water solution or commercial cleaner to remove any gross debris, organic or otherwise. Be careful not to get any liquid into the interior of the unit.

Next, clean the exterior with either a common chemical disinfectant or a bleach solution* before other patients use the unit. For the bleach solution, wear eye and skin protection to prevent exposure to the chlorine. Allow the NewLife to air dry, and then retest it before you return it to inventory.

Clean the air inlet gross particle filter with warm soapy water between each patient's use. Clean this filter at least once per week, depending on the environment, during normal operation.

Change the bacteria filter after 10,000 hours of use. It is not necessary to change this filter between patients even if the previous patient had a communicable disease or infection.

*Make the bleach solution a 1:100 dilution of 5.25% sodium hypochlorite. Mix one part household bleach (e.g., Clorox) with 99 parts cold tap water. To measure the solution easily, take 1/4 cup of household bleach, and mix it with a gallon of cold tap water. Allow the mixture to sit on potentially contaminated surfaces for 10 minutes.

7.0 Tool Kit and Pressure Test Gauge

The tools needed for you to properly service the NewLife unit are shown in Figure 7.1 below. AirSep offers these tools as part of a kit available for purchase (Part No. MI-TL-01).

In addition, channel locks and a small slotted-head screwdriver may be recommended for some service procedures.

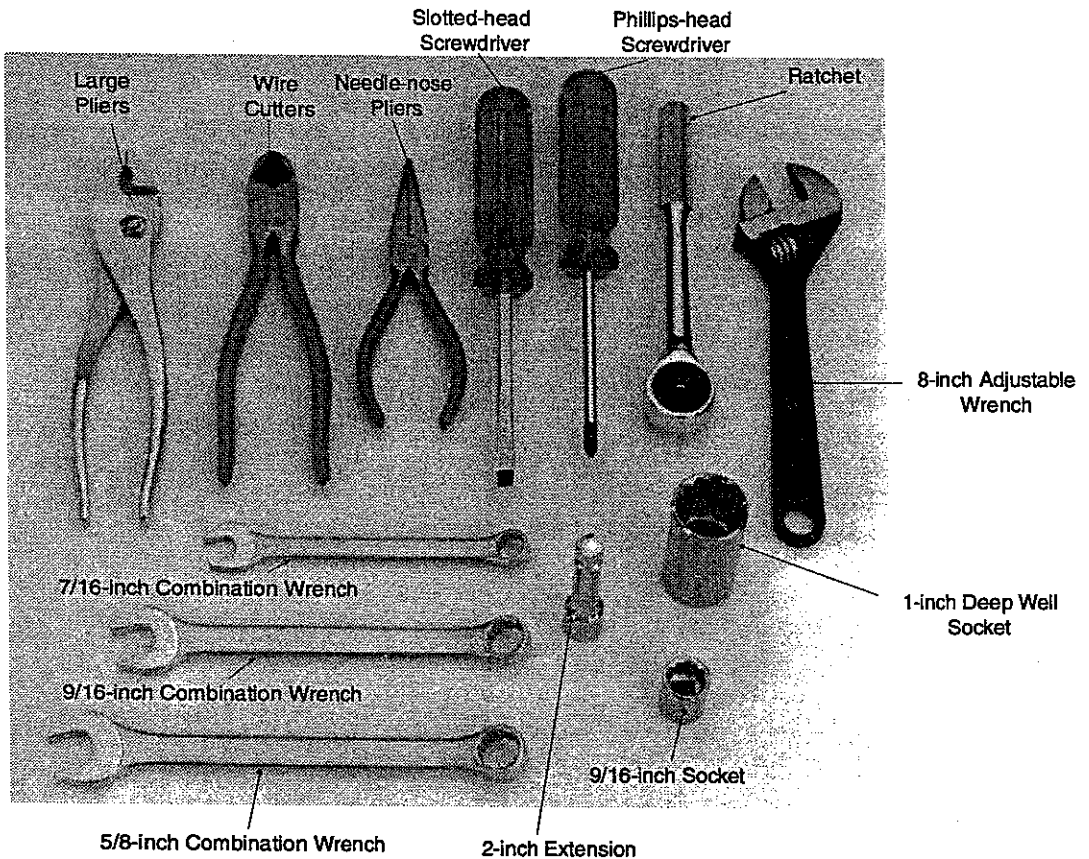

Figure 7.1: Contents of Tool Kit

A pressure test gauge (Part No. GA-KT-01) to take both high and low pressure readings on the NewLife unit should be kept available at all times. This gauge, as shown in Figure 7.2, connects to the pressure test port on the pressure test block.

Refer to Section 5.20 for the proper use of the pressure test gauge.

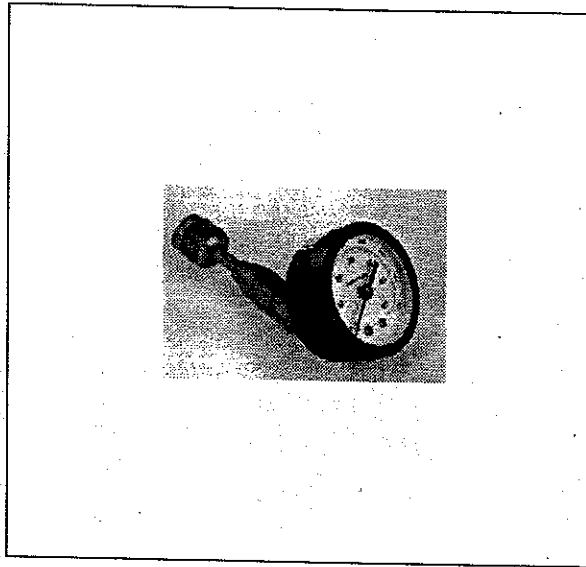

Figure 7.2: Pressure Test Gauge

8.0 Spare Parts

8.1 Spare Parts Kits

AirSep recommends the purchase of the N5 or N25 Kit for spare parts. The contents of each kit are listed below.

8.1.1 N5 Kit (AS-00-K21)

Quantity	Part Number	Description
1	EL-11-1-12	Power Cord
1	EL-30-09	Circuit Board
2	EL-50-07	Pilot Light (Flowmeter)
1	EL-CB-04	Circuit Breaker
1	EL-CP-03	Capacitor
1	FA-00-01	Cabinet Fan
1	FI-30-03	Bacteria Filter
4	MI-VM-06	Vibration Mount
1	SB-ME-041	ON/OFF Switch Assembly

8.1.2 N25 Kit (AS-00-K22)

Quantity	Part Number	Description
4	BC-9-05	Compression Nut and Ferrule 5/16-in.
4	BC-9-06	Compression Nut and Ferrule 3/8-in.
1	EL-11-1-12	Power Cord
1	EL-30-09	Circuit Board
3	EL-50-07	Pilot Light (Flowmeter)
1	EL-BZ-02	Buzzer
1	EL-CB-04	Circuit Breaker
1	EL-CP-03	Capacitor
8	EL-C51-166	Push-On (Pink)

N25 Kit (AS-00-K22) Continued

Quantity	Part Number	Description
8	EL-C51-266	Push-On (Blue)
1	FA-00-01	Cabinet Fan
3	FI-30-03	Bacteria Filter
1	GA-KT-01	Pressure Test Gauge
4	MI-CA-07	Caster
4	MI-MO-02-03	Circuit Board Supports
10	MI-TI-04A	Tie-Wrap, Small (Blue)
10	MI-TI-04B	Tie-Wrap, Small (Black)
10	MI-TI-04G	Tie-Wrap, Small (Green)
4	MI-TI-13B	Tie-Wrap, Large (Black)
8	MI-VM-06	Vibration Mount
2	PH-42-04-BF	Oxygen Adapter
1	SB-ME-041	On/Off Switch Assembly
3 ft	TU-02-05-04B	Tubing, Nylon (5/16-inch Black)
3 ft	TU-02-06-04B	Tubing, Nylon (3/8-inch Black)
4 ft	TU-03-04-02A	Tubing, Vinyl (1/4-inch Blue)
4 ft	TU-03-04-02B	Tubing, Vinyl (1/4-inch Black)
4 ft	TU-03-04-02G	Tubing, Vinyl (1/4-inch Green)
4 ft	TU-03-06-04G	Tubing, Vinyl (3/8-inch Green)
1	VA-12-00-01	Feed or Waste Valve

9.0 Troubleshooting

Problem	Probable Cause	Solution
Compressor does not run. Constant audio alarm with ON/OFF power switch in ON position.	No power to unit.	Check wall outlet for power.
	Unit circuit breaker tripped or faulty.	Reset or replace circuit breaker.
	Faulty electrical connections.	Check electrical connections.
	Defective ON/OFF power switch.	Replace ON/OFF power switch.
	Defective circuit board.	Check circuit board for two-light rotation/replace circuit board.
Compressor runs with intermittent alarm. Purity at 5 lpm is within specifications.	Defective high or low pressure switch.	Replace and retest pressure switch.
	Defective circuit board.	Replace circuit board.
Compressor shuts down intermittently.	Restricted air flow through unit.	Clean inlet filter, or remove obstruction.
	Defective cabinet fan.	Replace cabinet fan.
	Defective capacitor.	Replace capacitor.
	Defective compressor.	Replace compressor.
	Defective high temperature switch.	Replace high temperature switch.

Problem	Probable Cause	Solution
Compressor does not start. ON/OFF power switch in ON position, intermittent alarm, and cabinet fan turns.	Extreme cold start.	Allow unit to reach room temperature.
	Compressor thermally cut off due to excessive heat. NOTE: It will not restart until it cools down.	Blocked air intake or defective cabinet fan/clear obstruction, or replace cabinet fan.
	Defective capacitor.	Replace capacitor.
	Defective circuit board.	Check circuit board for two-light rotation/replace circuit board.
	Faulty electrical connection for compressor.	Check electrical connections for compressor.
	Defective compressor.	Replace compressor.
	Defective high temperature switch.	Replace high temperature switch.
Compressor runs with intermittent alarm and low purity.	Leak.	Leak test and repair leak.
	Defective circuit board.	Check circuit board for two-light rotation/replace circuit board.
	Defective sieve beds.	Replace sieve beds.
	Faulty solenoid valve.	Repair or replace solenoid.
	Restriction in exhaust muffler.	Replace or clean muffler.

Problem	Probable Cause	Solution
Compressor relief valve releases (popping sound).	Defective circuit board.	Check circuit board for two-light rotation/replace circuit board.
	Defective solenoid valve.	Repair or replace solenoid valve.
	Contaminated sieve beds.	Replace sieve beds.
	Defective relief valve.	Replace relief valve.
	Faulty electrical connection.	Repair electrical connection.
Constant alarm with ON/OFF switch in ON position. Circuit breaker repeatedly trips.	Defective circuit breaker.	Replace circuit breaker.
	Defective capacitor.	Replace capacitor.
	Defective compressor.	Replace compressor.
	Defective circuit board.	Check circuit board for two-light rotation/replace circuit board.
	Faulty electrical connection.	Repair electrical connection.
Alarm does not sound.	Dead battery.	Replace battery.
	Incorrectly installed battery.	Reinstall battery with correct polarity.
	Defective ON/OFF switch.	Replace ON/OFF switch.
	Defective buzzer.	Replace buzzer.
	Faulty electrical connection.	Repair electrical connection.
	Defective pressure switch.	Replace and test pressure switch.

Problem	Probable Cause	Solution
Flowmeter fluctuates.	Improperly set or faulty product regulator.	Check regulator setting clean, repair, or replace regulator.
	Leak.	Leak test.
	Defective circuit board.	Check circuit board for two-light rotation/replace circuit board.
	Defective solenoid valve.	Repair or replace solenoid valve.
Cabinet fan does not turn.	Defective cabinet fan.	Replace cabinet fan.
	Defective electrical connections.	Check electrical connections.
Discharge of water from the oxygen outlet when unit is turned on.	Unit was transported with humidifier attached.	Remove humidifier when transporting unit.
	Defective check valve.	Replace check valve.
Water develops and collects in the oxygen tubing when humidifier is used.	Back of unit is located against wall or surface.	Allow 12 inches of clearance at back of unit.
	Rain-out conditions exist.	See Appendix B for rain-out causes and solutions.
Limited or low flow.	Restriction in humidifier or tubing.	Replace humidifier or tubing.
	Product regulator set too low.	Adjust regulator setting.
	Leak.	Leak test and repair leak.
	Weak compressor.	Check system pressure and rebuild or exchange compressor.
	Defective solenoid valve.	Repair or replace solenoid valve.
	Reduced air intake (suction).	Check suction resonator and suction tube for obstruction.

Problem	Probable Cause	Solution
Low purity.	Leak.	Leak test and repair leak.
	Weak compressor.	Check system pressure, and rebuild or replace compressor.
	Unit's temperature too high.	Blocked air intake or defective cabinet fan.
	Defective circuit board.	Check circuit board for two-light rotation/replace circuit board.
	Contaminated sieve beds.	Replace sieve beds.
	Defective solenoid valve.	Repair or replace solenoid valve.
	Restriction in exhaust muffler.	Replace or clean exhaust muffler.
	Restriction in suction resonator.	Check suction resonator and suction tube for obstruction and remove.
Restriction in EcoCheck valve.	Clean EcoCheck valve.	

Appendix A

- **Wiring Schematics**

- NewLife Basic Unit — Wiring Schematic

- NewLife with Oxygen Monitor — Wiring Schematic

- **Exploded Drawings**

- Control Panel Assembly

- Main Structure Assembly

- Base and Cabinet Components

- Test Block Assembly

- Valve Block Assembly

- Compressor Assembly

- Adsorption Bed Assembly

CONNECT TO
120 VAC/60Hz
GROUNDED
POWER OUTLET

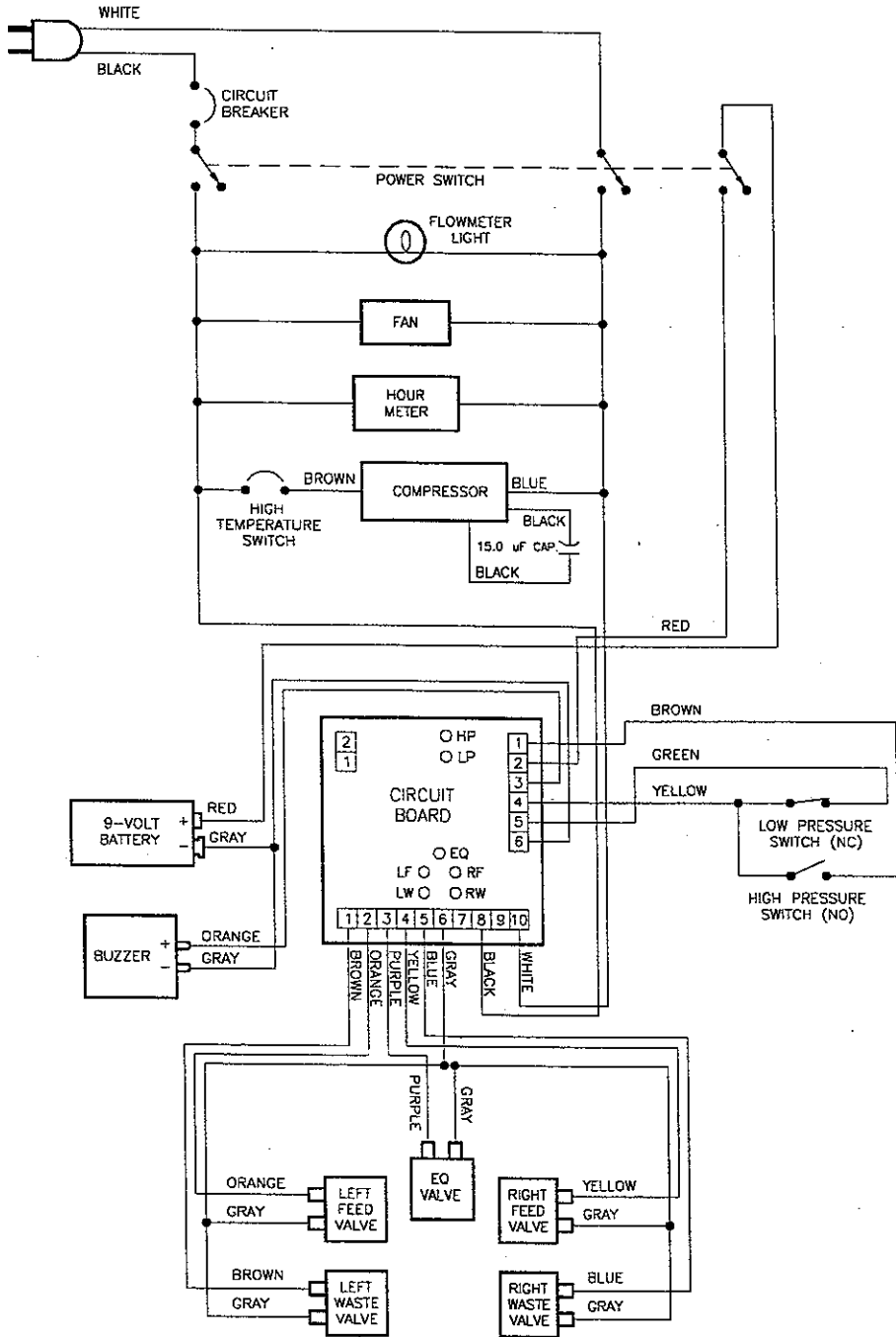

Figure A.1: NewLife Basic Unit – Wiring Schematic

CONNECT TO
120 VAC/60Hz
GROUNDED
POWER OUTLET

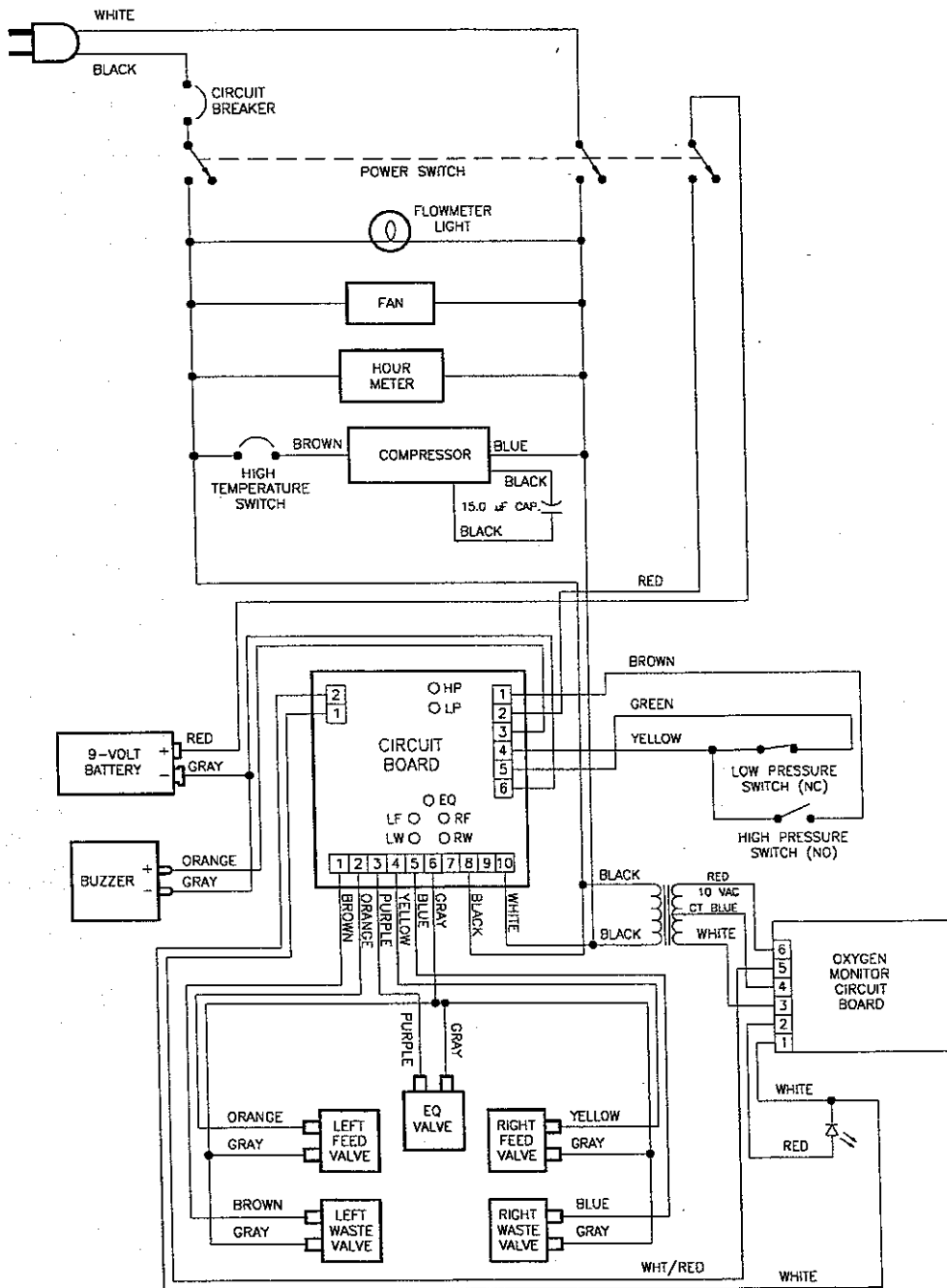

Figure A.2: NewLife with Oxygen Monitor – Wiring Schematic

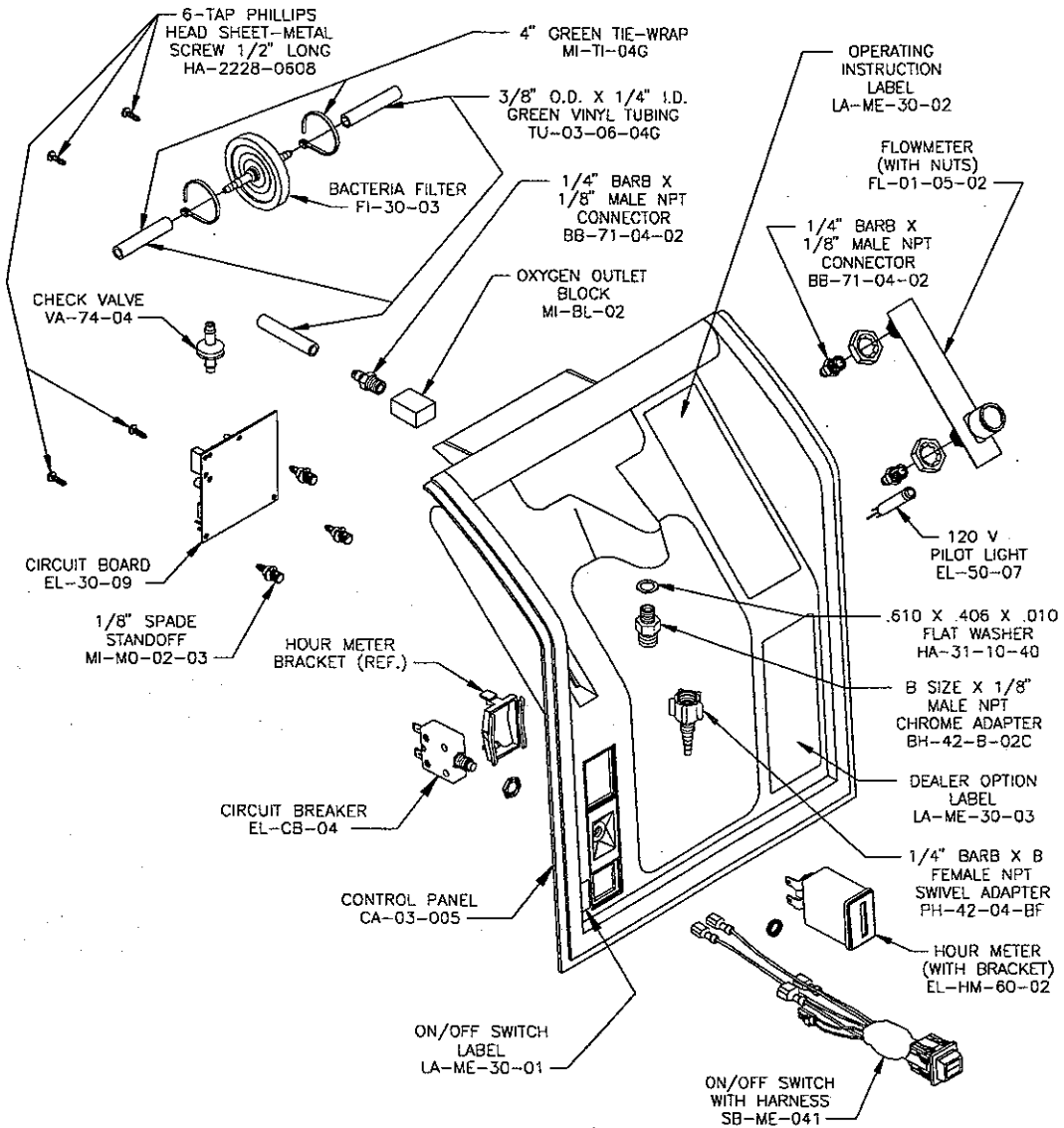
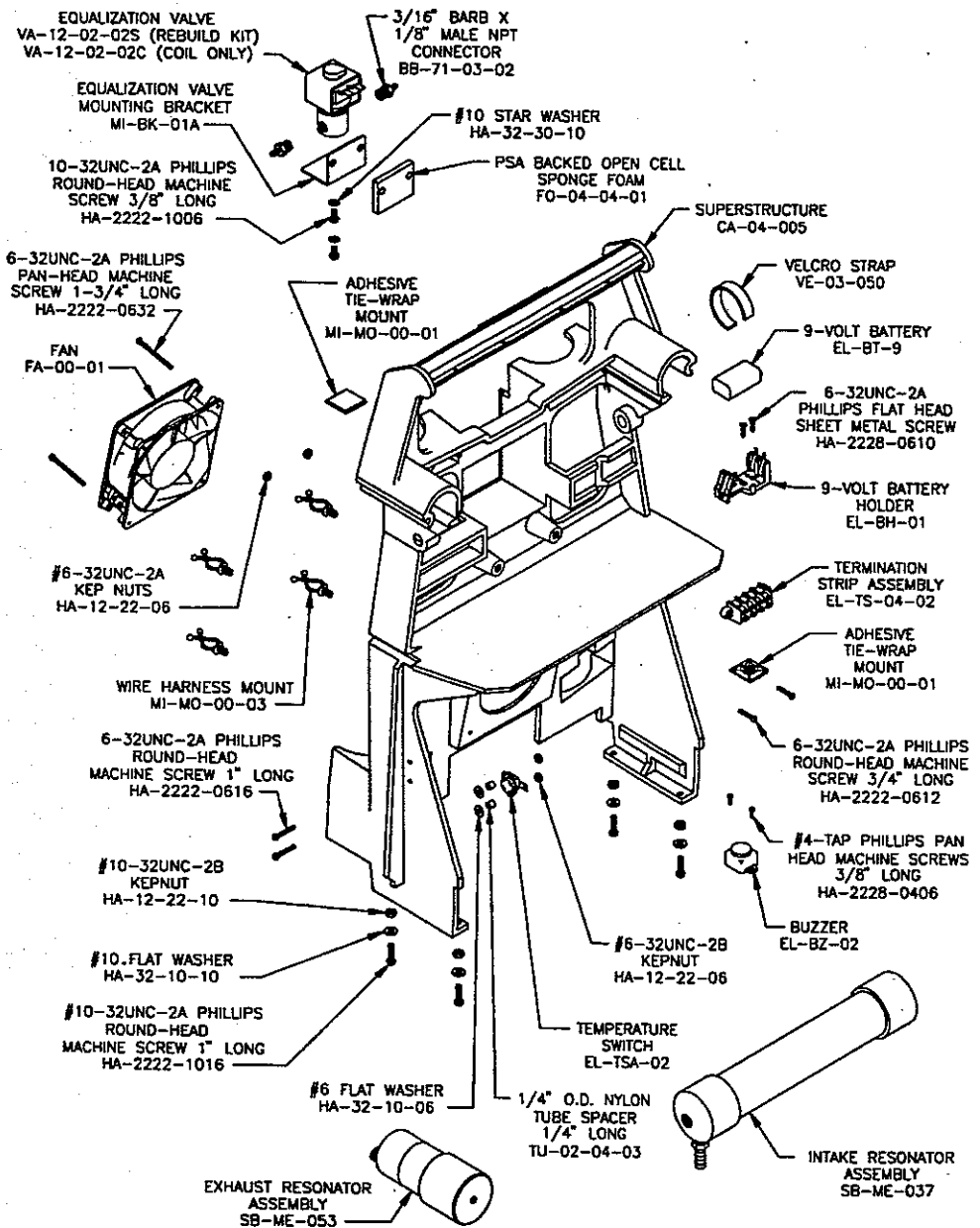
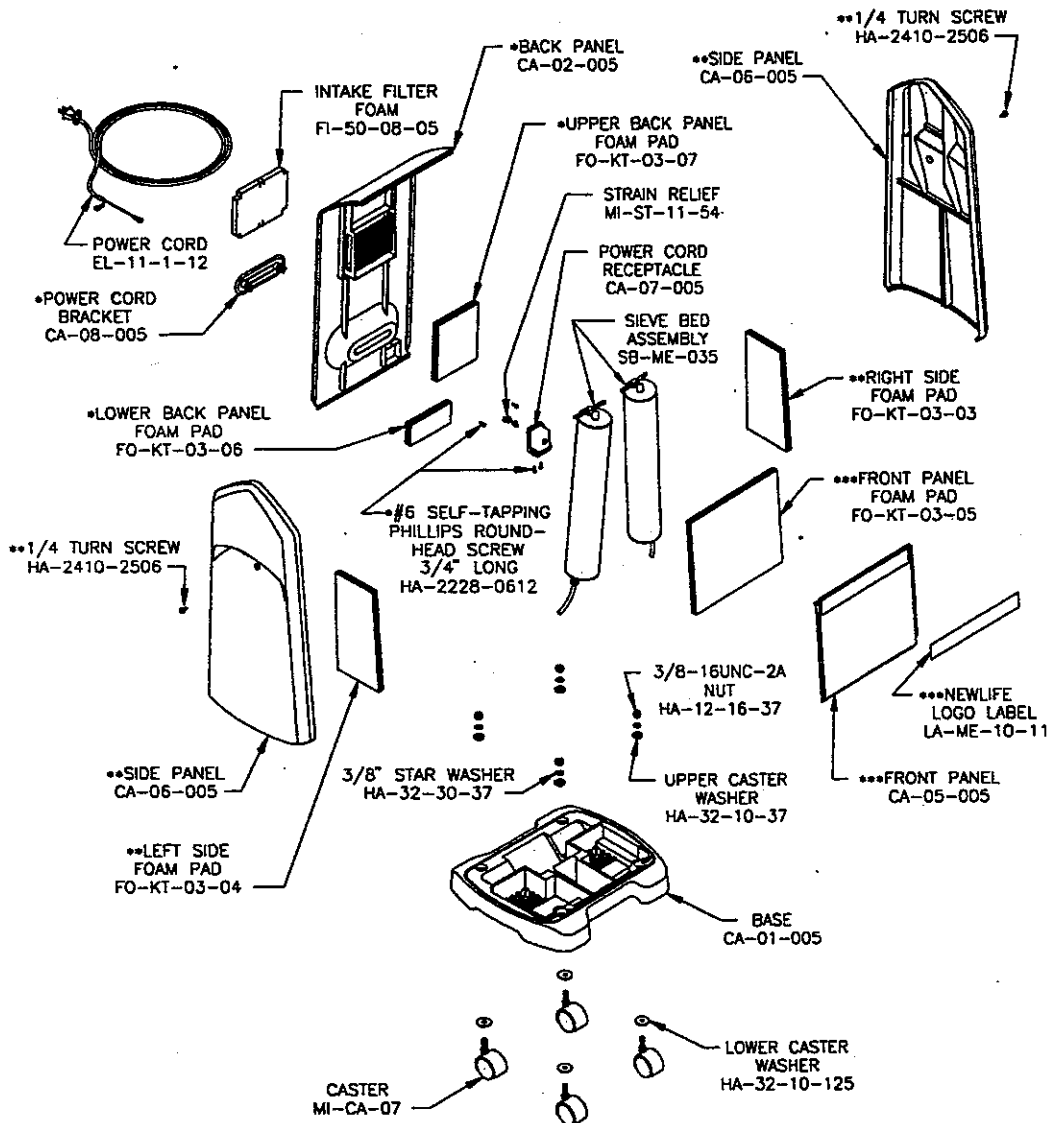

Figure A.3: Control Panel Assembly



NewLife 120VAC, 60 Hz Model Main Structure Assembly

Figure A.4: Main Structure Assembly



- *AVAILABLE AS BACK PANEL ASSEMBLY, AIRSEP PART NO. SB-ME-043.
(TOTAL FOUR HA-2228-0608 SHOWN; TWO ARE INCLUDED IN BACK PANEL.)
- **AVAILABLE AS SIDE PANEL ASSEMBLY, AIRSEP PART NO. SB-ME-046.
- ***AVAILABLE AS FRONT PANEL ASSEMBLY, AIRSEP PART NO. SB-ME-045.

Figure A.5: Base and Cabinet Components

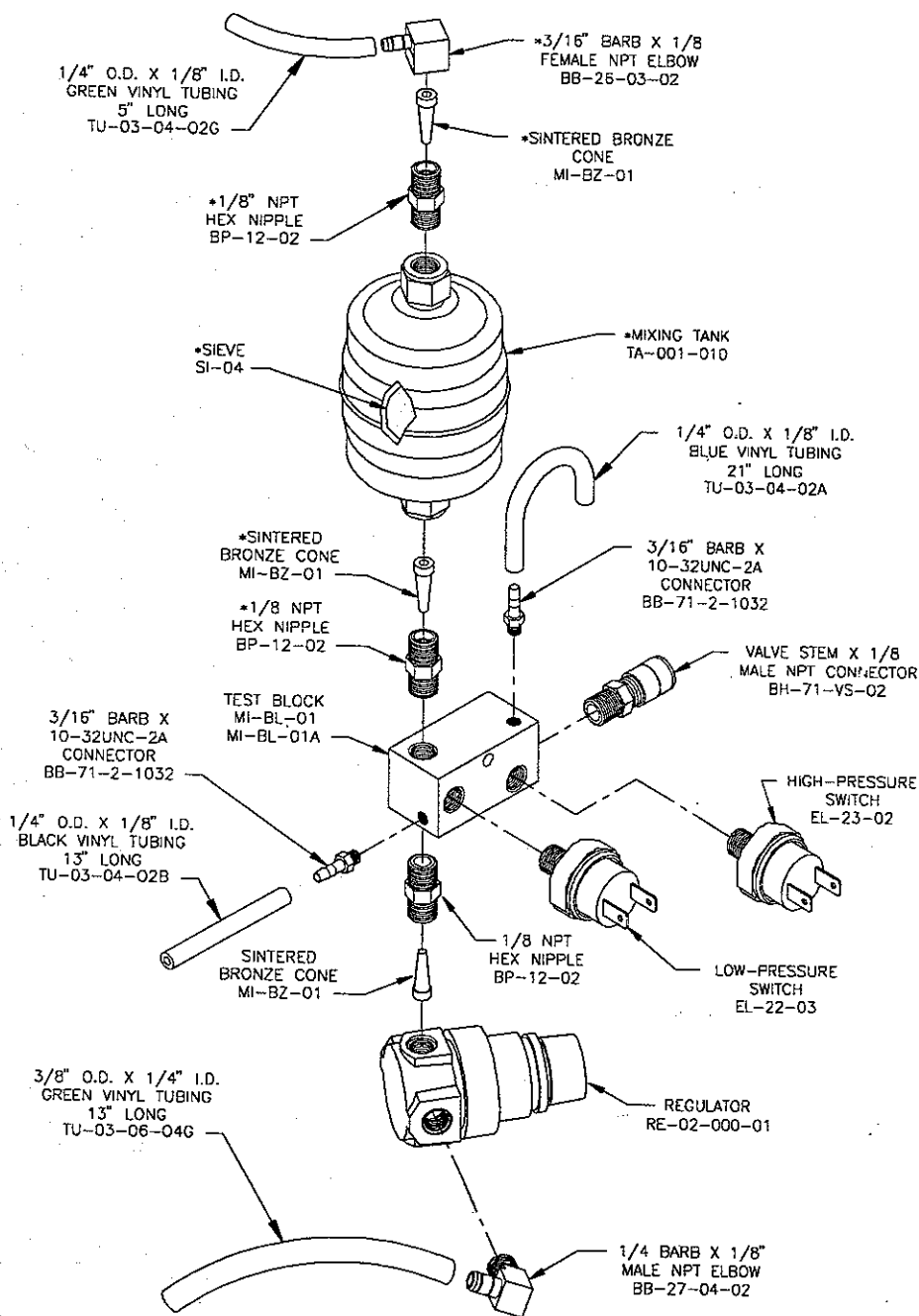

* PART INCLUDED IN MIXING TANK ASSEMBLY, AIRSEP PART NO. SB-ME-038

Figure A.6: Test Block Assembly

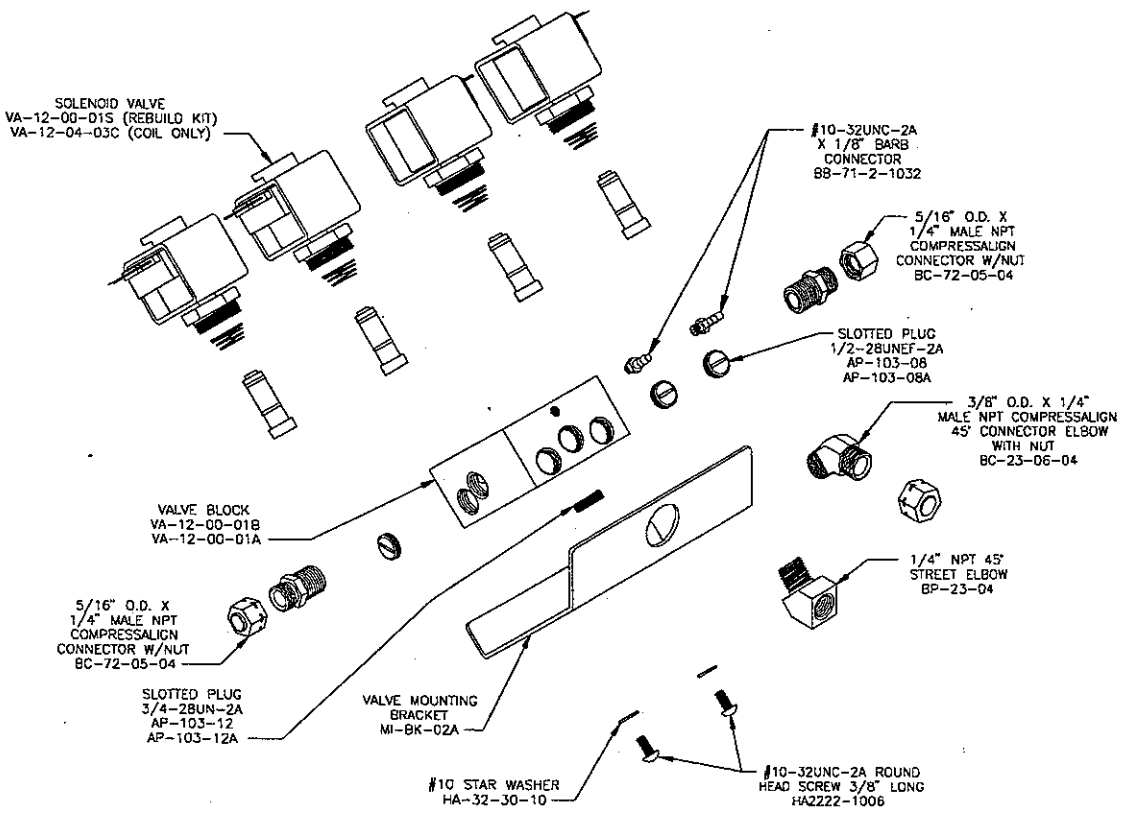
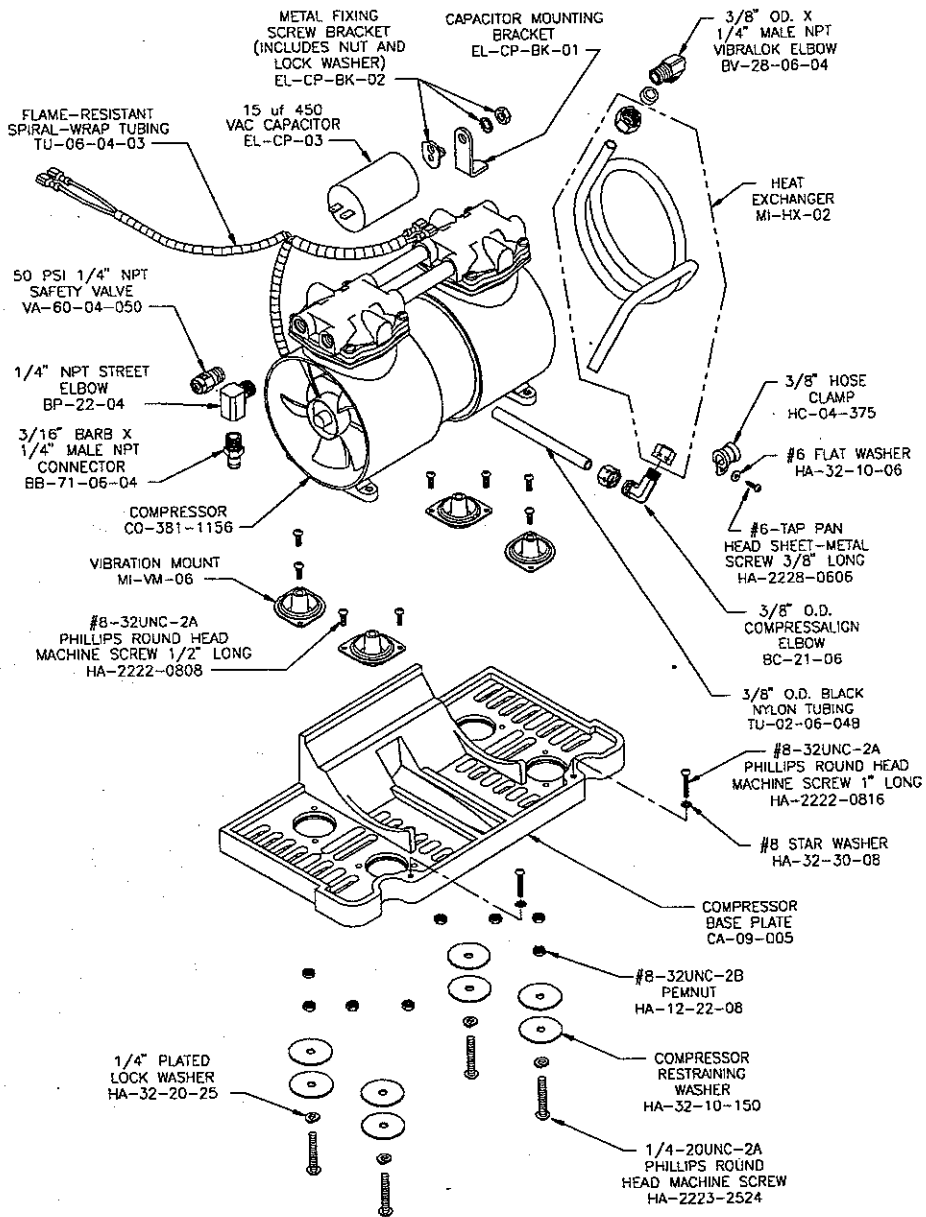

Figure A.7: Valve Block Assembly



NOTE: COMPRESSION ASSEMBLY AVAILABLE AS PART NO. SB-ME-036. CAPACITOR NOT INCLUDED.

Figure A.8: Compression Assembly

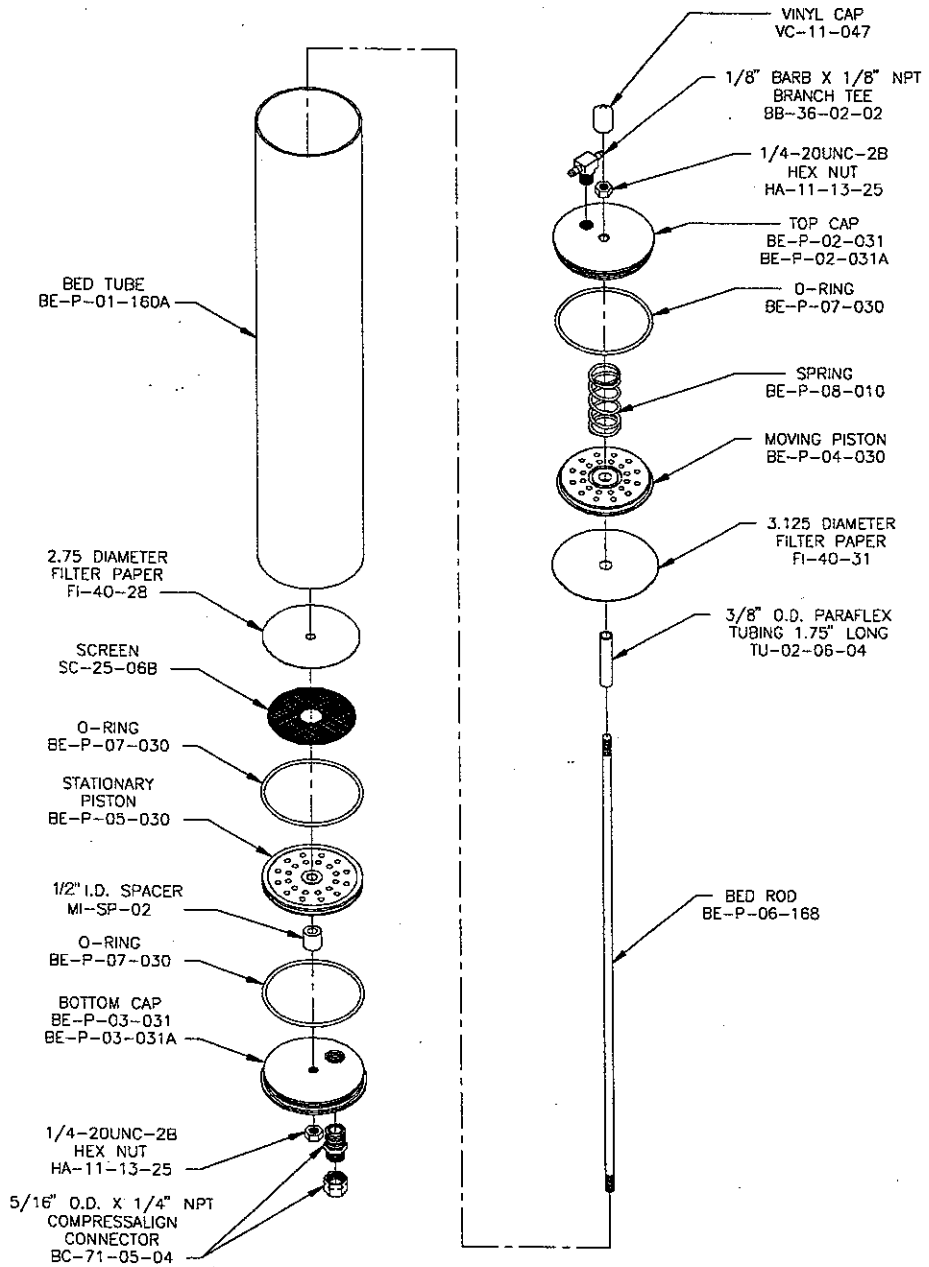

Figure A.9: Adsorption Bed Assembly

Appendix B

- **Molecular Sieve**
- **Efficiency and Power Formula**
- **Rain-Out In Oxygen Concentrators**
- **Path of Particles Within the NewLife**
- **EcoCheck Oxygen Monitor**
- **Features for the Respiratory Care Practitioner**
- **Features for the Service Technician**

Molecular Sieve

Approximately three pounds of tiny beads of molecular sieve fill each sieve bed. The sieve material, zeolite, has active sites that hold nitrogen molecules under pressure. As the NewLife unit pressurizes and directs room air into the bed, the nitrogen attaches (adsorbs) to the sieve material. This is due to a physical attraction between the active sites and nitrogen molecules. The oxygen and trace argon move freely through the sieve material and out of the bed to the product tank for the patient's use. The sieve material holds back the nitrogen until it is full saturated and then requires purging (regeneration).

The purge process includes depressurizing the bed by opening the waste valve, which allows the nitrogen to exit via an exhaust muffler. Oxygen then back flushes the purging bed. This back flush action drives all of the nitrogen from the sieve material. The cycle switches between beds, which allows one bed to produce oxygen while the other bed goes through the purge process to prepare for the next cycle.

The sieve material is completely regenerative and lasts indefinitely under normal conditions.

Contaminated or inactive sieve refers to sieve material that can no longer attract nitrogen and produce high purity oxygen. Sieve material becomes contaminated when water molecules bond to the active sites. Contaminated sieve cannot be regenerated within the concentrator. Therefore, you must replace the beds. Sieve material can become contaminated in three ways - a leak, a cycle failure, or sieve migration.

- A leak — When the unit is in operation, a leak allows pressurized air or oxygen to escape, which results

in a reduction of purity. When the unit is not in operation, the leak provides the water molecules in room air access to reach the active sites of the sieve material and contaminate it.



NOTE

The potential for sieve contamination explains why you must carefully leak-test all units when serviced. Leak test the NewLife using the leak test procedure in Section 5.21.

- Cycle failure — Oxygen concentrators are designed to operate with a certain quantity of water molecules, which are always present in room air (humidity). In a properly functioning concentrator, the water molecules, directed into the sieve bed, are captured within the first inch of sieve material. Because this first inch of sieve is exposed to water molecules, it is rendered inactive and is unable to attach nitrogen molecules for gas separation.

When the cycle switches to purge the bed, the water molecules exhaust from the bed along with the nitrogen. All sieve beds within functioning concentrators contain both a small contaminated zone of sieve to hold and release water molecules and a large active zone of sieve to hold and release nitrogen molecules. The contaminated zone within the bed is the water zone or moisture zone.

The cycle of pressurization (feed) and purge (blow-down) must remain intact for the sieve beds to last indefinitely. If the concentrator malfunctions and causes one sieve bed to receive room air for a longer period than designed, the moisture zone increases. Active sieve needed for gas separation becomes contaminated due to the additional water molecules that enter the bed because of this malfunction.

A cycle failure that prevents the sieve beds from being pressurized and then purged as intended

leads to contaminated sieve beds, which require replacement.

- **Sieve Migration** — Sieve migration is the movement of sieve material within the sieve bed. All sieve beds have a contamination zone. If this zone migrates, it then introduces contaminated sieve into the active part

of the sieve bed. The active sieve in turn moves into the bottom of the bed where it becomes contaminated by the water molecules entering the bed. This movement can also cause the bead-like sieve particles to wear down and create a fine dust. To prevent sieve migration, the NewLife sieve beds are spring-loaded. (See Figure B.1.)

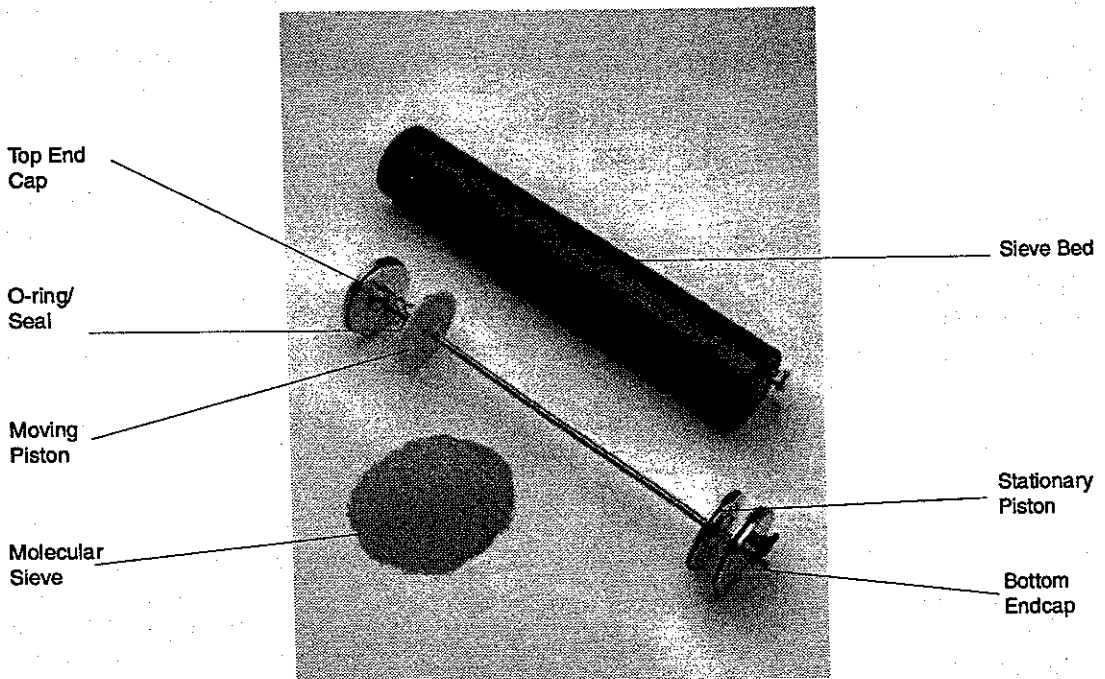

Figure B.1: Sieve Bed Assembly

Efficiency and Power Formula

Electrical efficiency of an oxygen concentrator refers to the ratio of power cost to oxygen production. The NewLife® uses only 350 watts to produce 5 lpm of therapeutic oxygen. The average power consumption for a 5 lpm unit is 450 watts, or 28% more electricity than the NewLife uses. The NewLife's more efficient design requires less compressed air (feed air) to make 5 lpm of oxygen. This allows for the use of a shorter stroke compressor. The NewLife uses the same double WOB L Model 2619 compressor from Thomas Industries as other manufacturers, yet its smaller stroke uses less power. (The stroke refers to how far the piston moves.)

In the NewLife, the piston moves only 38/100 of an inch, while most other brands utilize a piston that travels 16% farther, or 44/100 of an inch. A large stroke compressor requires more power and generates more heat as it operates. Because the compressor is the main source of power consumption and heat generation within the concentrator, the NewLife costs less to operate while producing less heat. Also the Teflon cup seals will last longer because of the smaller stroke and lower operating temperature.

High Purity with Low Power

AirSep demonstrates its technical superiority through high purity levels at 5 lpm on the NewLife (average 93%) with a power consumption of only 350 watts. Inform patients that AirSep provides the most efficient oxygen concentrator on the market. Use the following formula for calculating the monthly power cost for the AirSep NewLife versus other brands:

Example: 350 watts ÷ 1,000 = .35 kW x .12 cents/kWh x 24 hours/day x 30 days/month = \$30.24 per month for continuous use in most areas of the Northeast U.S.

$$\text{Watts} \div 1,000 = \text{kilowatts}$$

$$\text{kilowatts} \times \text{kilowatt rate} \times 24 \text{ hours/day} \times 30 \text{ days/month} = \text{total power cost}$$

Cost Savings

Most concentrators require 450 watts, which calculates to \$38.88 per month. The patient who uses the NewLife can save over \$100 per year.

Nursing Home Savings with Dual Flow NewLife

Some Equipment Providers have combined the NewLife's power savings and the dual flow option into very successful presentations for institutions.

If a nursing home uses 10 of our competitor's oxygen concentrators, the electrical cost to operate them at the facility could total \$388.80 per month. If the facility doubles up patients on five NewLife units with dual flow options, the facility's power cost would drop to \$151.20. The facility could save \$237.60 a month by converting to NewLife Oxygen Concentrators.

Additional Savings With EcoCheck™ Monitors

NewLife with EcoCheck monitors have an economy mode of operation, which reduces the power consumption from 350 to 280 watts. This feature can be utilized on patients using 3 lpm or less for additional power savings, as illustrated in the sample chart below:

	Watts	Rate	Usage	Cost	Savings per Month	Savings per Year
Average Concentrator	450 W	.12/kW	Cont.	\$38.88/month		
NewLife	350 W	.12/kW	Cont.	\$30.24/month	\$8.64	\$103.68
NewLife Economy Mode	280 W	.12/kW	Cont.	\$24.19/month	\$14.69	\$176.28

Rain-Out In Oxygen Concentrators

Rain-out refers to the condensation that develops and collects in the oxygen tubing when a humidifier is used with an oxygen concentrator. If this condensation progresses to the point that it makes its way out of the tubing and into the patient's nose, it can cause discomfort.

The best way to prevent rain-out is to eliminate the humidifier, but with certain patients and referral sources, that solution is not always feasible. As an Equipment Provider, you need to consider the causes and potential solutions for reducing and eliminating rain-out.

Causes of Rain-Out

First, rain-out can occur when the delivery gas temperature is at ambient. For example, even with an oxygen cylinder, rain-out can occur as a result of the floor temperature. The room may be 70°F, but the floor could be quite a bit cooler depending on the type of floor and other conditions. Ceramic tile and hardwood floors are colder than carpeted floors. Floors above crawl spaces rather than basements, and floors that have air conditioning ducts are all examples of why a floor can be quite a bit cooler than its room.

The length of tubing has an effect as well. Fifty feet of tubing allows oxygen to come in contact with the cold surface for a longer period of time than 25 feet of tubing. Therefore, the longer the tubing and the colder the floor, the more likely rain-out will occur even if the oxygen delivery temperature is at ambient.

The second main factor that contributes to rain-out occurs when the oxygen traveling through the tubing on the floor is warmer than the ambient air. This is the main reason why some concentrators

experience more rain-out than other models. Some units run warmer internally (because of higher power consumption and differences in airflow design), which may cause the oxygen delivery temperature to be higher than ambient temperature. This would allow the oxygen, at several degrees warmer than ambient air, to accumulate more moisture from the humidifier bottle. As oxygen travels in the tubing on the floor and cools down, the moisture changes into condensation.

The NewLife unit has the lowest outlet gas temperature of any other concentrator because it uses less power (only 350 watts, or 280 watts in ECONomy mode) and benefits from an effective cabinet airflow design. To ensure the outlet gas temperature is within 1°F of ambient, you need to provide adequate ventilation for the NewLife unit. Make certain to place the unit at least 12 inches on all sides from a wall or other obstruction.

The location of a concentrator can have a compounding effect on rain-out. For instance, if a unit operates in a small room (i.e., closet area or storage room) it can raise the temperature of that room. When oxygen exits the concentrator, it cools down as it travels through the tubing on the floor, which produces rain-out. A good example is when a patient puts a unit in a bathroom or a closet, and although the patient's home may be 70°F, the concentrator heats the bathroom or closet up to 80°F. Additionally, a concentrator can run warmer than normal because its air intake or exhaust vents are partially blocked, or the concentrator is located where it pulls in warm air from a heating source. Both factors also contribute to rain-out.

Other Causes and Solutions

Following are some other possible causes and corrective actions to lessen the occurrences of rain-out:

- Examine the location of the concentrator to make sure the air intake gross particle filter is kept clean, the unit is adequately ventilated at the air intake and exhaust vents, and there is not a build up of heat from the sun or other heating source.

An afternoon sun "baking" the concentrator can cause rain-out. Relocate the concentrator to a shaded, larger, and more ventilated area, or turn the concentrator 90° to facilitate better circulation.

- If the concentrator is a bottom-venting unit and the carpeting is plush, you can use a low pile carpet sample on top of the existing carpeting to create a lower pile surface. Some providers report good results when they turn over the carpet sample and run the concentrator on the back side of the sample.
- If the humidifier bottle is overfilled, it can cause water to spew into the tubing and result in rain-out. The design of a humidifier bottle can also have an effect. Some providers achieve better results by converting from the flat-top humidifier bottle to a dome-top bottle such as Salter's. With a flat-top bottle, water droplets can form directly above the outlet port and be pushed into the oxygen tubing. With the dome-top bottle, water droplets are diverted down the sides of the bottle and away from the outlet port.
- Bottles stored in a warm place, cleaned in hot water or even filled with warm water, all contribute to rain-out. Instruct patients to fill the humidifier bottle with room temperature, or better yet, cool water. Some providers suggest that their patients purchased distilled water, store it in the refrigerator, and actually use the cold water in the humidifier bottle. Other providers recommend that patients put ice cubes in the bottle if they use tap water.
- Additionally, rain-out can occur when the tubing is cold, i.e., if a provider brings in tubing from a cold vehicle in the wintertime. As the humidified oxygen comes through the tubing, it may rain-out. In the summertime, if a unit is stored in a warm place when delivered, it may create more rain-out.
- Shorten the length of tubing or elevate the tubing from cold floor surfaces to reduce rain-out.
- Another common way to eliminate rain-out is with an in-line water trap. This device is basically a chamber that can accumulate the water and prevent it from reaching the patient. Locate it in the tubing near the patient for maximum effectiveness. To locate it closer to the concentrator itself defeats its purpose.

Path Of Particles Within the NewLife

The NewLife's air intake gross particle filter removes large particles present in room air. Smaller particles flow through the compressor and join the particles the compressor expels as it wears. These

particles pass through the feed valves during the feed cycle and are temporarily stopped at the bottom barrier of each bed. During the blowdown cycle, the particles pass through the waste valves and exit the concentrator via the exhaust muffler.

EcoCheck Oxygen Monitor

Description of the Sensing Technology

The EcoCheck™ oxygen monitor utilizes a solid-state, ceramic-sensing technology. A specially prepared ceramic material demonstrates different electrical conductivity based on the oxygen concentration of the sample gas. When voltage is applied across the element, the current generated relates to the number of oxygen ions moving across the ceramic material. The current generated therefore relates to the oxygen content of the sample gas. The on-board microcontroller analyzes this current to provide continuous oxygen monitoring. This natural occurrence allows the sensor to perform as a highly accurate, long life, and drift-free oxygen sensor with no expendable or consumable materials. The purity set point of the AirSep oxygen monitor when installed in the NewLife Oxygen Concentrator is $85\% \pm 3\%$.

Background

The sensing technology on the AirSep oxygen monitor was developed by Litton Industries to monitor the performance of PSA oxygen concentrators aboard military aircraft.

First installed aboard U.S. Air Force F-15s, these monitors have demonstrated excellent reliability for over five years. Testing included vibration, acceleration, temperature variations, deep cycling, dielectric strength, insulation resistance, and voltage variations to ensure these monitors met the rigorous military specifications for combat aircraft. More recent installations include Navy T-45 trainers, F-18 Hornets, F-14 Tom Cats, and AV-8B Harrier Jump Jets. In addition to the aircraft applications, this sensing technology is used in a variety of test and

ground support equipment, including Army and Navy mobile hospital PSA oxygen systems.

Principle of Operation for ECONOMY Mode

The AirSep NewLife Oxygen Concentrator uses a compressor to pump room air through the two sieve beds that separate and concentrate oxygen. Normal compressor output is sufficient to produce a flow of 5 lpm at a therapeutic level of oxygen concentration.

With the economy valve, located on the suction side of the compressor, positioned in ECONOMY mode, the amount of air available to the compressor is reduced. This results in a reduction in the total amount of oxygen produced. The ECONOMY mode of operation reduces the NewLife's production of therapeutic oxygen to a maximum of 3 lpm.

Refer to Section 4.4.5 of the manual for the procedure to position the economy valve.

The reduction of air to the compressor creates the desirable effects of reduced power consumption, lower internal temperatures, and quieter operation. Full 5 lpm capacity can be restored by repositioning the economy valve to full capacity.

Performance in ECONOMY Mode:

LPM	Concentration*
1-2	95%
3	90%

Oxygen concentration $\pm 3\%$

*Based on an atmospheric pressure of 14.7 P.S.I.A. (101 kPa) at 70°F (21°C)

Exclusive Power Savings – ECONomy Mode of Operation

Features

- Allows the concentrator to adapt to patients using 3 lpm or less of oxygen. Full 5 lpm capability can easily be restored by simply repositioning the economy valve.
- Reduces electrical consumption of the NewLife by 20% (from 350 watts to 280 watts).
- Extends compressor and other component life by reducing internal temperatures.
- Enables quieter operation.
- The NewLife locking flow prevents the use of more than 3 lpm of oxygen when in the ECONomy mode.

Specifications for EcoCheck Oxygen Monitor

Size:	4.7 in. L x 2.4 in. W x 1.1 in. D 11.9 cm L x 6.1 cm W x 2.8 cm D
-------	----------------------------------------------------------------------

Weight:	30.0 oz 85 grams
---------	---------------------

Power:	6.5 watts
--------	-----------

Accuracy:	Alarms at 85%, oxygen purity \pm 3%
-----------	------------------------------------------

Audio Alarm Delay:	15 minutes
--------------------	------------

Ordering Information:

Part Nos. SB-ME-040B
(120 VAC, 60 Hz Model)

SB-ME-040E
(220/230/240 VAC, 50 Hz Models - oxygen
monitor only)

Features for the Respiratory Care Practitioner

- **Extremely Quiet Operation**
Ensures an acceptable sound level for all patients — even with NewLife units placed next to their beds.
- **High Reliability**
Uses proven design and industrial componentry.
- **Aesthetically Pleasing Colors and Streamline Design**
Create a non-medical look.
- **Double-Insulated ABS Plastic Cabinet**
Provides electrical safety, durability, and strength.
- **Handles, Hand Grips, and Built-In, Protected Wheels**
Enable the patient to move the concentrator more easily.
- **Long Power Cord with Two-Prong Plug and Cord Holder**
Allows patients flexibility in relocating their concentrators.
- **Reinforced Metal Oxygen Outlet**
Eliminates the oxygen elbow or adapter for humidifier use, and will not break, spin, or kink.
- **Oxygen Adapter**
Comes packed with each NewLife, and can be stored in the rear pocket of the concentrator.
- **Back-Lined Illuminated Flowmeter**
For easy viewing and setting.
- **Metal Flowmeter Fittings**
Eliminate potential leaks.
- **Locking Flow Feature**
Protects CO₂-retaining patients from the dangers of higher liter flows.
- **Flow Restrictor**
Prevents patients from overdrawing the concentrator.
- **Back Pressure Adjustment**
Allows longer tubing set-ups.
- **Lowest Power Consumption**
Saves patients money on their power bills.
- **Cool Running**
Reduces patients' concerns about heat exhausted into their rooms.
- **Near-Ambient Oxygen Delivery Temperature**
Reduces rain-out associated with humidification and long tubing set-ups.
- **Humidifier Protection**
Prevents breakage, and the design accepts most humidifier bottles.
- **Circuit Breaker**
Eliminates fuses, and is easily located and reset by the patient.
- **Green/Black Indicator in Power Switch**
Eliminates a pilot light bulb, yet patient can easily verify on/off position.
- **Purity Assurance**
Alarms to indicate high and low pressure.
- **Alarm Distinction**
Helps eliminate service calls by using a constant alarm to identify the most common alarm — power disconnect.
- **Straight Line Purity**
Eliminates purity drop associated with dirty intake filters.
- **Easy Reference Patient Manual**
Located in rear pocket of the concentrator. (Also available in Spanish and French.)
- **Extra Air Intake Gross Particle Filter**
Located in rear pocket of the concentrator.
- **Optional Pediatric Flowmeter**
For low flow applications.

- **Optional Dual Flowmeter**
Enables dual patient use in the home, extended care facility, hospital, or physician's waiting room.
- **Optional EcoCheck**
Oxygen monitor with exclusive economy mode of operation and verification test. The EcoCheck monitor uses state-of-the-art ceramic oxygen-sensing technology initially developed for military applications.
- **Cabinet Coloring**
Reduces scratch visibility by providing gray coloring throughout the textured plastic.
- **Low-Cost Replacement Panels**
Keep equipment looking new indefinitely.
- **Contoured Interlocking Panels**
Make a secure fit, and can be cleaned and disinfected easily and quickly.
- **90-Day Check Sheet**
Clearly defines concentrator maintenance procedures through a dated check-log.
- **Easy Access for All Maintenance**
Allows for complete access with the turn of two screws.
- **History Record Card**
Fits inside each NewLife to record maintenance performed.
- **Matching Dealer Labels**
Allow dealer's name and emergency telephone number to be clearly visible on the front of the concentrator.

Features for the Service Technician

- **High Reliability**
Uses proven design and industrial components.
- **Superior Serviceability**
Turn of two screws allows direct access to all components for quick replacement. Unit is self-supporting, and can be handled and operated with all panels off.
- **Lowest Power Consumption**
Results in lower operating temperature within the cabinet, extending the life of internal components such as tubing, foam, vibration mounts, and compressor bearings.
- **Lowest Replacement Parts Cost**
Always makes the repair of the NewLife more cost-effective than replacing it.
- **Double-Insulated ABS Plastic Cabinet for Safety**
Eliminates sharp edges and is extremely durable.
- **Base, Superstructure, and Compressor Plate (the three structural parts) are Foamed ABS Plastic**
For maximum strength.
- **Cabinet Coloring**
Reduces scratch visibility by providing gray coloring throughout the textured plastic.
- **Contoured Interlocking Panels**
Make a secure fit and can be cleaned, and disinfected easily and quickly.
- **Low-Cost Replacement Panels (side panels are interchangeable)**
Help to keep equipment looking new indefinitely.
- **Power Cord Holder**
Helps prevent damage to cord, which is easily replaced if necessary.
- **Built-in, Single-Post Wheels**
Receive protection by the base; thick washers spread the forces where the wheels attach to the reinforced base.
- **Reinforced Metal Oxygen Outlet**
Eliminates the O₂ elbow or adapter for humidifier use and will not break, spin, or kink.
- **Flow Restrictor**
Prevents overdrawing the concentrator and eventual sieve bed contamination.
- **Green/Black Indicator in Power Switch**
Requires no pilot light, thus eliminating potential service calls due to a flickering bulb.
- **Long Life Flowmeter Bulb (25,000 hrs.)**
Replaces easily.

Component Features

Compressor:

- **Requires no scheduled maintenance**
Component is completely covered during the entire parts warranty (one, three, five, or seven years).
- **Exchange made easy and simple**
Completely rebuilt compressor (including bearings) arrives already mounted to the compressor plate, with vibration mounts, heat exchange, and relief valve.
- **Fast Removal**
Achieved in less than five minutes by two screws and one compression fitting.
- **.38 Stroke Compressor**
Requires less power and produces less heat for a longer compressor life.

- **Additional Temperature Switch**
Helps prevent heat damage by shutting off the compressor significantly below (approximately 100°F) the compressor's internal thermal cut-out switch.
- **Limited Movement**
Prevents stressing the vibration mounts. (The washers limit upward movement while the cradle limits downward movement.)

Circuit Board:

- **Circuit Board Light Matrix**
Matches valve configuration for fast identification.
- **Diagnostic Lighting System**
Indicates inoperative solenoid coil or faulty circuit board and is visible through the air intake opening.
- **Internal Lighting Diagram**
Illustrates rotating two-light sequence for easy referencing.
- **High/Low Pressure LED Indicators**
Aids with troubleshooting.

Valves:

- **High Reliability Valves**
Includes industrial, two-way valves with a 10-year plus life expectancy and a proven reputation for reliability.
- **Unified Valve Block**
Incorporates two feed and two waste valves into a single body. This unique design simplifies the valve assembly by eliminating fittings, is easy to diagnose, and allows for easy access.

Sieve Beds:

- **Refillable Aluminum Sieve Beds**
Provides reliability and low replacement cost.
- **Anodized**
Prevents oxidation stains and is easy to clean.

- **Spring Loaded**
Prevents sieve migration.
- **Internal O-rings**
Seal more reliably than external O-rings.

Other Features:

- **Cabinet Foam has Mylar Shield**
Makes cleaning easier and helps prevent the foam from absorbing odors and dust.
- **Color-Coded Tubing**
Ensures easier identification.
- **Specification Labels Inside**
Assist with performance and diagnostic referencing.
- **History Record Card**
Provides a maintenance record thus eliminating duplicate replacement of bacteria filters and batteries.
- **Service Manual**
Instructs Equipment Providers with comprehensive yet easy-to-follow procedures.
- **Service Video Tape**
Covers the removal of all components with a 25-minute tape with on-screen clock for quick reference.
- **Toll-Free Telephone Number**
Accesses factory service technicians.
- **Quick-Connecting Test Gauge**
Indicates system operating pressures.
- **Parts Warranty**
Covers all parts regardless of hours in use.
- **Lifetime Labor Warranty**
Provides five-day factory turnaround.
- **Lowest Maintenance Costs**
Requires only two filters and a 9-volt battery.
- **Factory Service Centers**
Located in Buffalo, NY; Kansas City, KS; St. Petersburg, FL; Phoenix, AZ; Toronto, ONT, Canada; and throughout North America.

Appendix C

■ Specifications

Classification

Symbols

Classification

Type of protection against electric shock:

Class II Protection from electric shock is achieved by DOUBLE INSULATION. Protective earthing or reliance upon installation conditions are not required.

Degree of protection against electric shock:

Type B Equipment providing a particular degree of protection against electric shock, particularly regarding:

- 1) allowable leakage current;
- 2) reliability of protective earth connection (if present).

Not intended for direct cardiac application.

Degree of protection against harmful ingress of water:

Drip-proof equipment - IPX1

Equipment provided with an enclosure preventing entry of such an amount of falling liquid as might interfere with the satisfactory and safe operation of the equipment.

Method of cleaning and infection control allowed:

Please refer to the Maintenance section in the NewLife Service Manual.

Degree of safety of application in the presence of flammable anesthetic gases:

Equipment not suitable for such application.







Mode of operation:

Continuous duty.

Symbols

Symbols are frequently used on equipment in preference to words with the intention of obviating language differences and permitting easier comprehension of a marking or indication, sometimes in a restricted space.

The following table is a list of symbols and definitions used with the NewLife Oxygen Concentrator. These symbols are taken from the appropriate International Electrotechnical Commission (IEC) standards:

Symbol	IEC Publication	Description
	878-02-02	Type B Equipment
	348	Attention, consult ACCOMPANYING DOCUMENTS
	417-5008	Off (power: disconnection from the mains)
	417-5007	On (power: connection to the mains)
	417-5032	Alternating current
	417-5172	Class II Equipment
IPX1	529	Protected against dripping water

