

PASSENGER ELEVATORS

# NEXIEZ -MR



2nd Edition



Utilizing its technological prowess and extensive experience, Mitsubishi Electric has remained a leader in the vertical transportation market since entering the business in 1931. The Company's creative, innovative spirit, represented by production of the world's first spiral escalator and elevator group-control systems that use artificial-intelligence technologies, continues to receive high evaluations industry-wide. Our products and systems are renowned for their high levels of quality, reliability and safety; and it is this sense of security and trust fostered with building owners and end-users alike that has led to the global expansion of our elevator/escalator business and the after-sales network to service it.

We understand responsibilities as a good corporate citizen, and continue to implement measures for protecting the environment and ensuring a sustainable society for future generations. A number of original technologies are being introduced to ensure more efficient products, systems and manufacturing operations, thereby enhancing productivity, reducing energy consumption and providing smoother, faster and more comfortable vertical transportation systems.

三菱電機  
**SOLWE**

# Principle

Based on our policy, "Quality in Motion", we provide elevators and escalators that will satisfy our customers with high levels of comfort, efficiency, ecology and safety.



Comfort

Efficiency

Ecology

Safety

Mitsubishi Electric elevators, escalators and building management systems are always evolving, helping achieve our goal of being the No.1 brand in quality. In order to satisfy customers in all aspects of comfort, efficiency and safety while realizing a sustainable society, quality must be of the highest level in all products and business activities, while priority is placed on consideration for the environment. As the times change, Mitsubishi Electric promises to utilize the collective strengths of its advanced and environmental technologies to offer its customers safe and reliable products while contributing to society.

**We strive to be green in all of our business activities.**

We take every action to reduce environmental burden during each process of our elevators' and escalators' lifecycle.



## Contents

Introduction	5-6
Ecology	7-8
Efficiency	9-11
Safety and Comfort	12-14
Standard Design	15
Features	16-18
Basic Specifications	19-24
Important Information on Elevator Planning	25

## Application

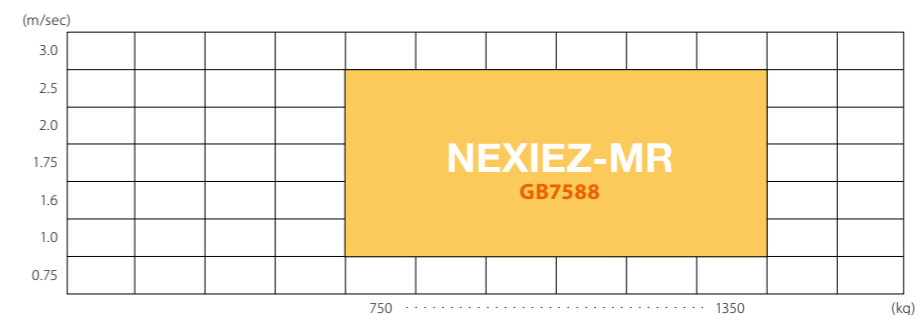
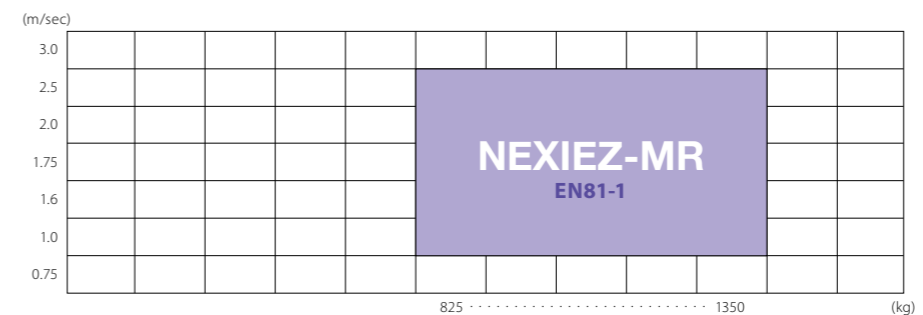
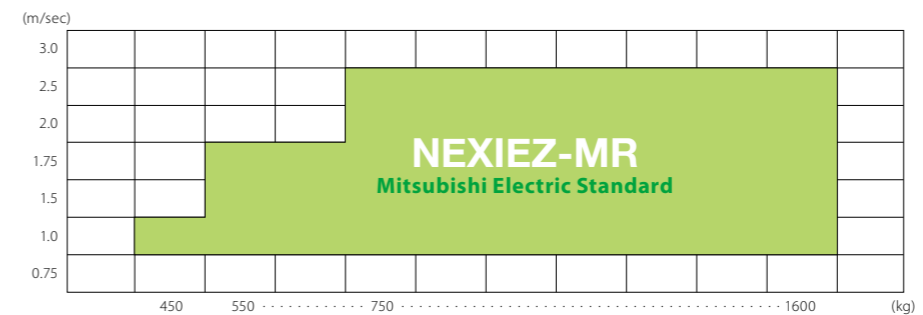

# Welcome to a New Era in Vertical Transportation Introducing the NEXIEZ...

... technologically advanced elevators that consume less power, have minimal impact on the global environment and harmoniously serve people and buildings with smooth, seamless operation. The refined design produces a high-quality atmosphere that reassures passengers of the superior safety and comfort synonymous with Mitsubishi Electric products. Regardless of the use or purpose, the NEXIEZ is a best match solution for virtually any elevator installation.





# Ecology

## Using Energy Wisely

Our long-term commitment to developing energy-efficient elevators has created systems and functions that make intelligent use of power.

### Milestones of Energy-saving Technologies in Elevator Development

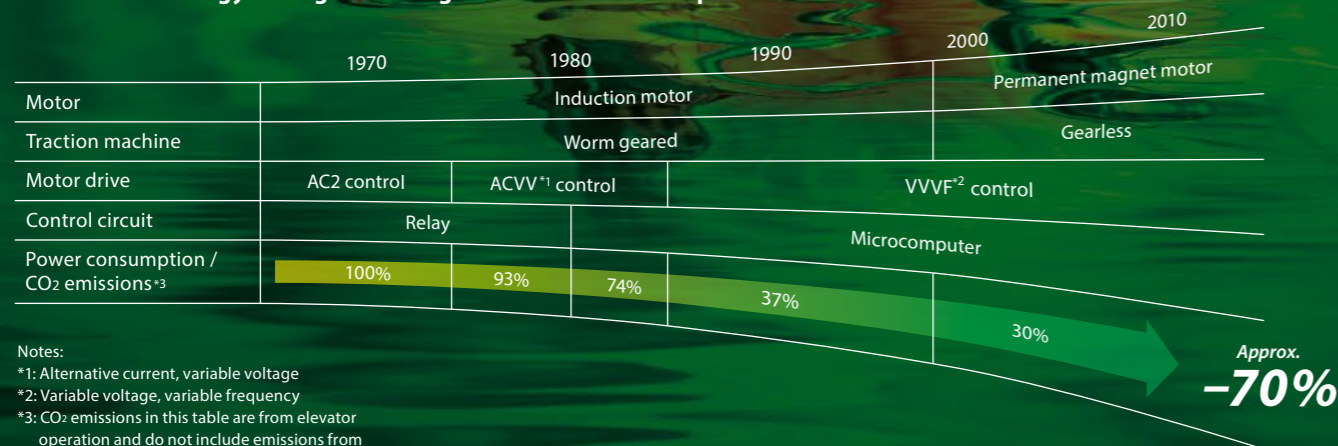

Notes:  
 \*1: Alternative current, variable voltage  
 \*2: Variable voltage, variable frequency  
 \*3: CO<sub>2</sub> emissions in this table are from elevator operation and do not include emissions from manufacturing, transportation and other processes.

## Reusing Energy

### Regenerative Converter: PCNV (Optional)

Elevators usually travel using power from a power supply (powered operation); however, when they travel down with a heavy car load or up with a light car load (regenerative operation), the traction machine functions as a power generator. Although the power generated during traction machine operation is usually dissipated as heat, the regenerative converter transmits the power back to the distribution transformer and feeds into the electrical network in the building along with electricity from the power supply. Compared to the same type of elevator without a regenerative converter, this system provides an energy-saving effect of approximately 35%.\* In addition, the Regenerative Converter has the effect of decreasing harmonic currents.

Note: \* The value is a reference datum and may increase or decrease in accordance with actual conditions of use and elevator specifications.

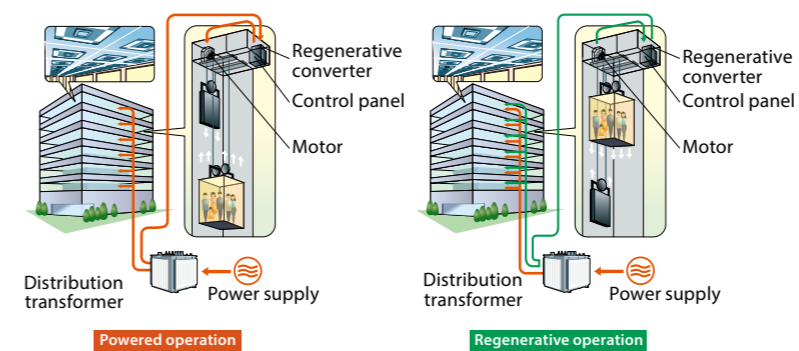

## Enhancing Energy Efficiency

### Traction Machine with PM Motor (PM motor: Permanent magnet motor)

The joint-lapped core built in the PM motor of the traction machine features flexible joints. The iron core can be like a hinge, which allows coils to be wound around the core more densely, resulting in improved motor efficiency and compactness. High-density magnetic field is produced, enabling lower use of energy and resources and reduced CO<sub>2</sub> emissions. In addition, we have adopted a 2:1 (single-wrap) roping system, which lessens load on the traction machine, and allows further reductions in traction machine size.

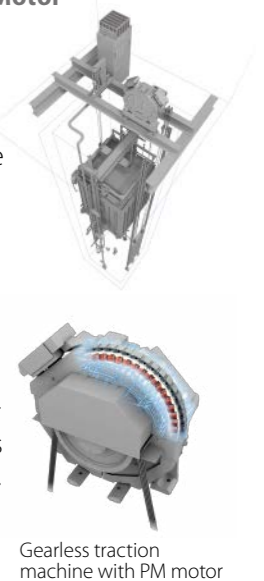

## Devices that Use Less Energy

### LED Lighting (Optional)

Energy-efficient LEDs consume less power than conventional lamps. Used for ceiling lights and hall lanterns, LEDs boost the overall energy performance of the building. Furthermore, the long service life eliminates the need for frequent lamp replacement.

#### Advantage of LEDs

Ceiling: L210S			
Service life (hr)		Power consumption (W)	
LED	25000	LED	32.5
Incandescent lamp	2000	Incandescent lamp	132
Approximately 12.5 times longer		Approximately 75% reduction	



Ceiling: L210S LED downlights (yellow-orange)

## Energy-saving Features

Mitsubishi Electric offers features that help to reduce the energy consumption of elevators.

### Energy-saving Operation – Number of Cars: ESO-N (Optional for ΣAI-22)

The number of service cars is automatically reduced to some extent without affecting passenger waiting time.

### Energy-saving Operation – Allocation Control: ESO-W (ΣAI-2200C only)

Based on each elevator's potential energy consumption, the system selects the elevator that best balances operational efficiency and energy consumption. Please refer to page 10 for details.

### Car Light/Fan Shut Off – Automatic: CFO-A/CLO-A

The car lighting/ventilation fan is automatically turned off if there are no calls for a specified period.

## Smooth Mobility through Efficient Group Control

When a building is expected to have heavy traffic, optimum car allocation suited for every condition makes a big difference in preventing congestion at a lobby floor and reducing long waits.

**Group Control Systems: ΣAI-22 and ΣAI-2200C**  
ΣAI-22 and ΣAI-2200C control multiple elevators optimally according to the building size.

Improving of traffic efficiency can alleviate the passengers' irritation. Applying the new allocation algorithm, the average waiting time and long waits are reduced.

Group control systems	Suitable building size	Number of cars in a group
ΣAI-22 system	Small to medium	3 to 4 cars
ΣAI-2200C system	Large (Especially buildings with dynamic traffic conditions)	3 to 8 cars

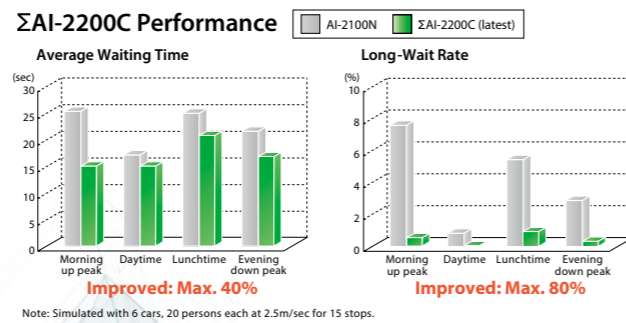

## Forecasting a Near-Future Hall Call to Reduce Long Waits

### Cooperative Optimization Assignment (ΣAI-2200C)

When a hall call is registered, the algorithm assumes a near-future call that could require long waits. Through evaluation of the registered hall call and the forecasted call, the best car is assigned. All cars work cooperatively for optimum operation.

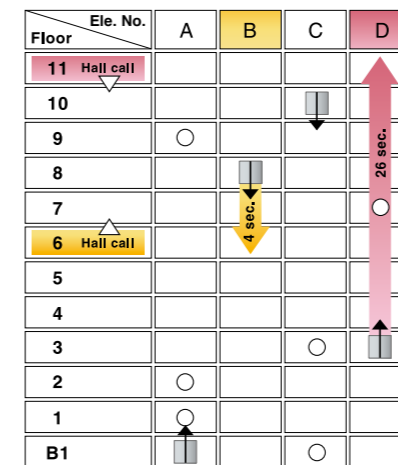
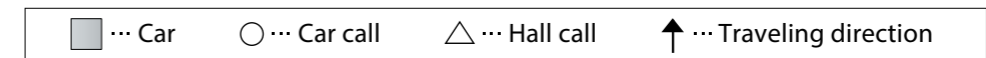

**AI-2100N**  
 [A hall call is registered at 6th Fl.]  
 Allocates the closest car B.  
 [Another hall call is soon registered at 11th Fl.]  
 Allocates D, resulting in long wait of 26 sec.

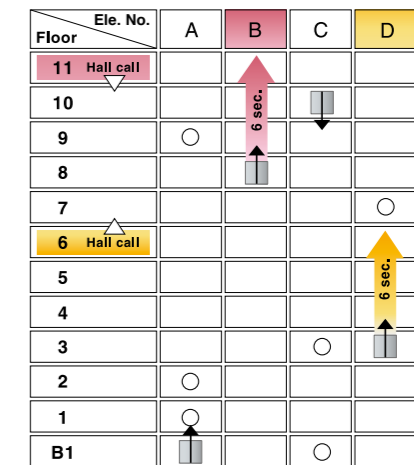

**ΣAI-2200C (Latest)**  
 [A hall call is registered at 6th Fl.]  
 Allocates D, which is moving upward.  
 [Another hall call is soon registered at 11th Fl.]  
 Allocates B, which immediately arrives at the floor.

## Maximizing Operational Efficiency and Minimizing Energy Consumption

### Energy-saving Operation — Allocation Control: ESO-W (ΣAI-2200C)

This system selects the elevator in a group that best balances operational efficiency and energy consumption. Priority is given to operational efficiency during peak hours and energy efficiency during non-peak hours.

Car allocation that maximizes operational efficiency does not necessarily translate to energy efficiency. A car uses energy efficiently when it travels down with a heavy load, or up with a light load. Accordingly, if multiple cars have the same traveling distance, this system chooses the car that requires the least energy.

Through a maximum 10% reduction in energy consumption compared to our conventional system, this system allows building owners to cut energy costs without sacrificing passenger convenience.

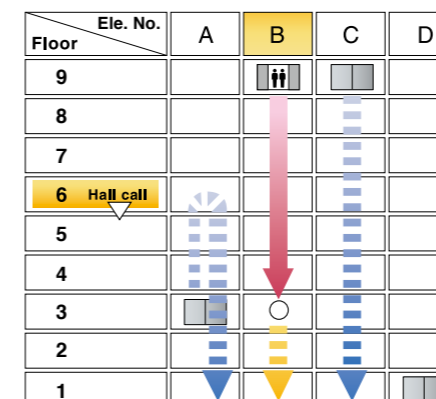

#### Initial conditions: non-peak period

- Car A:** Parked at the 3rd floor
- Car B:** About to leave the 9th floor with several passengers
- Car C:** Parked at the 9th floor.
- Car D:** Parked at the 1st floor

Under the conditions above, when a hall call is registered at the 6th floor to go to the 1st floor, waiting time and traveling distance will be the same regardless of whether car A, B or C responds to the call.

#### In response to the call, the cars will operate in the following ways:

- Car A will travel up with no passengers and then down with only one passenger (requires more energy than car B).
- Car B will travel down with more passengers than car A (requires the least energy).
- Car C will travel down with no passengers and then down with only one passenger (requires the most energy).

#### Car selection

During non-peak hours when energy efficiency is prioritized, car B is selected.

## Selecting Optimum Car Allocation through Rule-set Simulations

### Dynamic Rule-set Optimizer (ΣAI-2200C)

Based on real traffic data, passenger traffic is predicted every few minutes. According to the prediction, real-time simulation selects the best rule-set (multiple rules have been set as car allocation patterns), which optimizes transport efficiency.

## Allocating Passengers to Cars Depending on Destination Floors

### Destination Oriented Allocation System: DOAS (Optional for ΣAI-2200C)

When a passenger enters a destination floor at a hall, the hall operating panel immediately indicates which car will serve the floor. Because the destination floor is already registered, the passenger does not need to press a button in the car. Furthermore, dispersing passengers by destination prevents congestion in cars and minimizes their waiting and traveling time.

### Standard arrangement of hall fixtures (No hall lantern\* is provided.)

Cars receive destination information from all floors to provide the best service for more complex traffic conditions throughout the day.

#### Example of hall arrangement

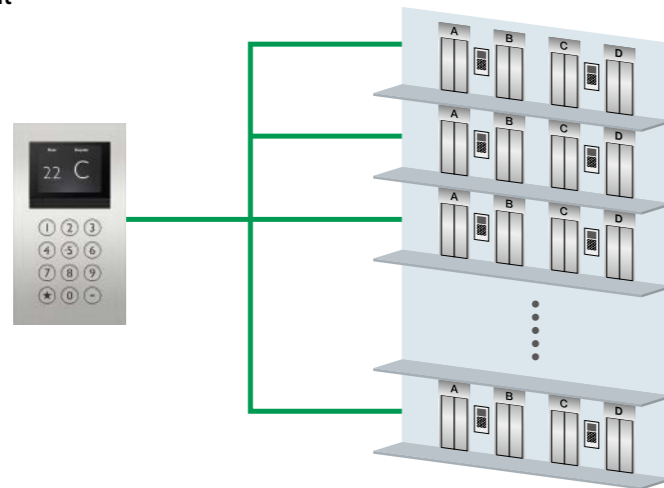

Note:  
\*Hall lanterns are available as optional.

## Providing a Safe, Comfortable Ride

Whether the user is elderly or a person with special need, our elevators deliver every passenger to the destination floor safely and comfortably.

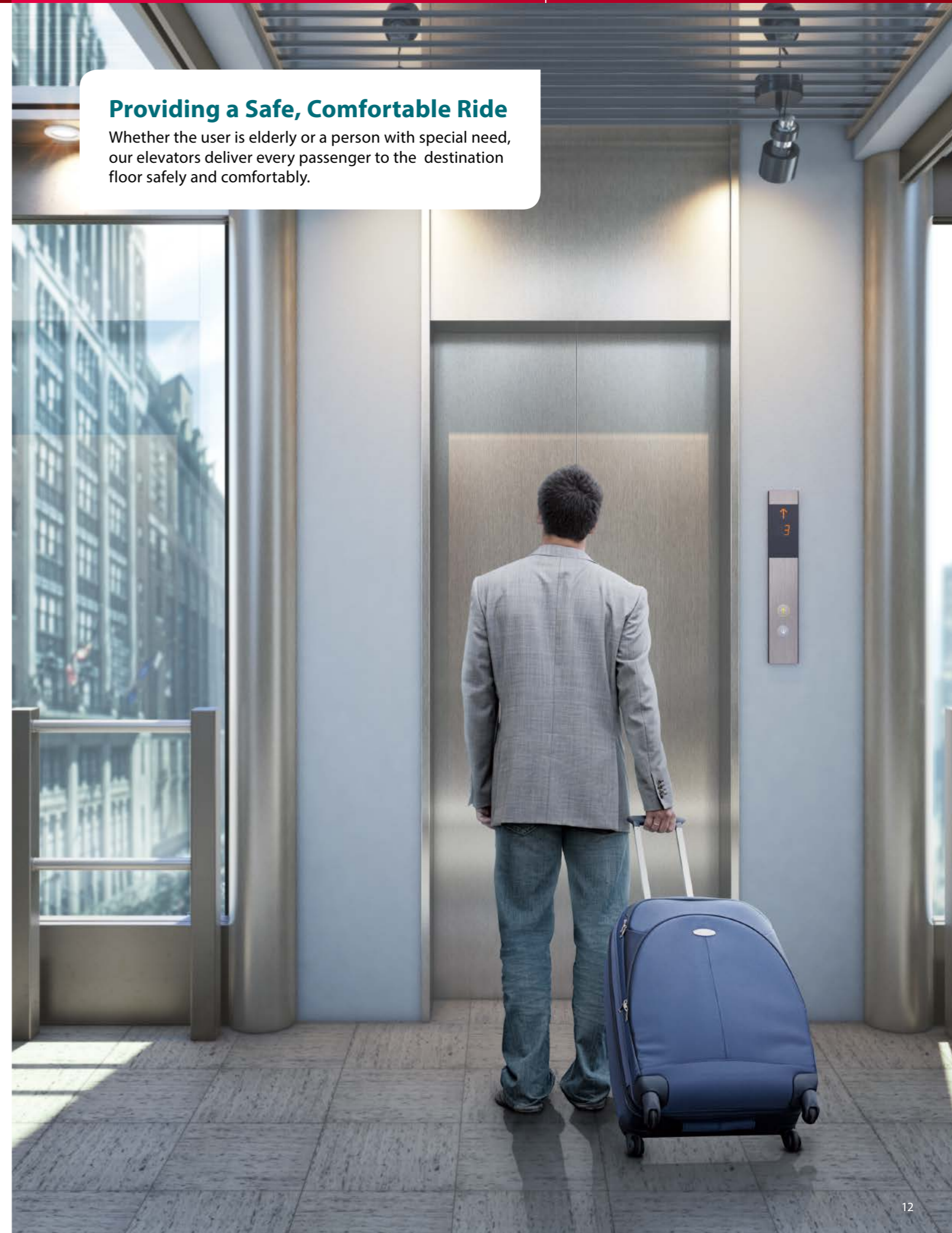

## Emergency Situations

### Emergency operations\*

Enhance safety by adding emergency operation features which quickly respond to a power failure, fire or earthquake.

Power failure	<b>Mitsubishi Emergency Landing Device: MELD (Optional)</b> Upon power failure, a car automatically moves to the nearest floor using a rechargeable battery to facilitate the safe evacuation of passengers.
	<b>Operation by Emergency Power Source — Automatic/Manual: OEPS (Optional)</b> Upon power failure, predetermined car(s) use a building's emergency power supply to move to a specified floor and open the doors for passengers to evacuate. After all cars have arrived, predetermined car(s) will resume normal operation.
Fire	<b>Fire Emergency Return: FER (Optional)</b> When a key switch or a building's fire sensors are activated, all cars immediately return to a specified floor and open the doors to facilitate the safe evacuation of passengers.
	<b>Firefighters' Emergency Operation: FE (Optional)</b> When the fire operation switch is activated, the car immediately returns to a predetermined floor. The car then responds only to car calls which facilitate fire-fighting and rescue operations.
Earthquake	<b>Earthquake Emergency Return: EER-P/EER-S (Optional)</b> When a primary and/or secondary wave seismic sensor is activated, all cars stop at the nearest floor and park there with the doors open to facilitate the safe evacuation of passengers.

Note:  
\*Please refer to page 16 for details.

## For Safe Boarding

### Door safety devices

Our reliable safety device ensures that the doors are clear to open and close. Depending on the type of sensor, the detection area differs.



Hall Motion Sensor: HMS  
(Optional)



Multi-beam Door Sensor  
(Optional)

## For Comfortable Use

### User-oriented Design

Great care is taken in the design and manufacture of each and every elevator part to ensure a comfortable, user-friendly ride.

### Clear Font

The font for indicators and buttons is highly visible. On tactile buttons in particular, the font makes letters/numbers easy for visually-impaired passengers to distinguish.

1 2 3 4 5 6 7 8 9 0

### LCD Position Indicators: Car/hall (Optional)

Clear, bright LCD indicators deliver information clearly and effectively.

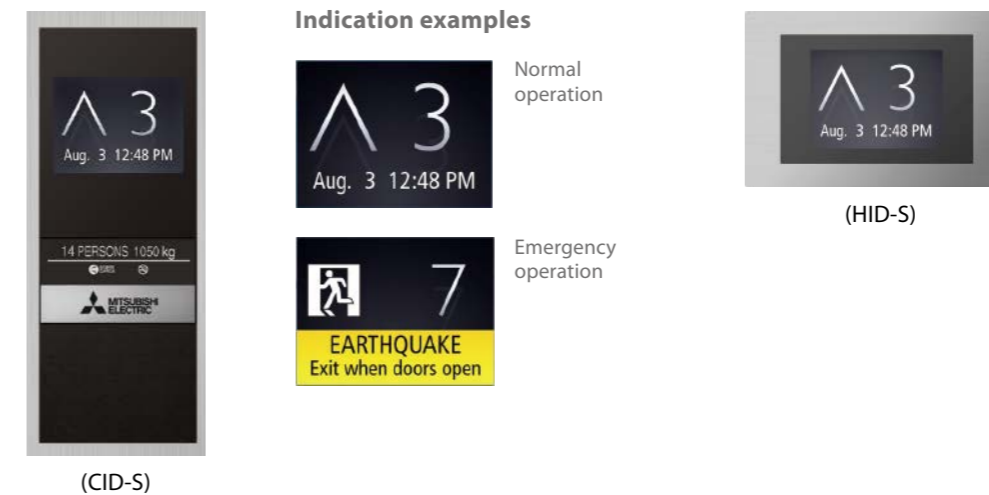

### LCD Information Display\*: 10.4- or 15-inch, for car/hall (Optional)

The cutting-edge LCD display delivers elevator information with stereoscopic direction arrows and animated pictures.



Urban black

\*Please consult our local agents for the production terms, etc.

### Colors

Select the best color from our five popular and eye-catching background colors.



Modern White

Elegance Brown



## Car

Ceiling: S00



### Car Design Example

- Walls ——— SUS-HL
- Transom panel ——— SUS-HL
- Doors ——— SUS-HL
- Front return panels — SUS-HL
- Kickplate ——— Aluminum
- Flooring ——— PR803: Gray
- Car operating panel — CBV1-C760



Ceiling: Painted steel sheet (Y033) with a milky white resin lighting cover  
Lighting: Central lighting

### Car operating panel



CBV1-C760\*1  
Segment LED indicators\*2  
Tactile button with yellow-orange lighting

## Hall

Narrow Jamb: E-102



### Hall Design Example

- Jamb ——— SUS-HL
- Doors ——— SUS-HL
- Hall position indicator and button — PIV1-A1010N Boxless

### Hall position indicators and buttons

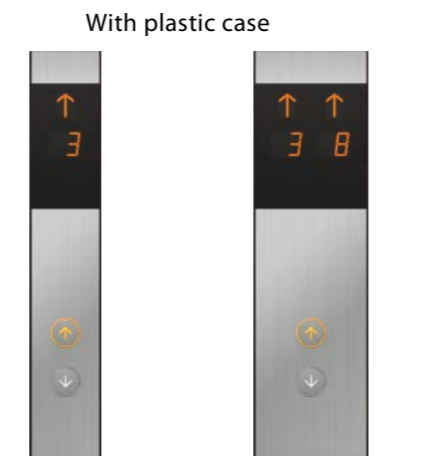

PIV1-A1010N Boxless PIV1-A1020N Boxless  
Segment LED indicators\*2  
Tactile button with yellow-orange lighting

Feature	Abbreviation	Description	1C to 2C 2BC	3C to 4C ΣAI-22	3C to 8C ΣAI-2200C
<b>EMERGENCY OPERATIONS AND FEATURES</b>					
Building Management System — GateWay	BMS-GW	Each elevator's status and operation can be monitored and controlled using a building management system which manages various facilities in the building via the interface for the elevator system.	⊙	⊙	⊙
Earthquake Emergency Return	EER-P EER-S	Upon activation of primary and/or secondary wave seismic sensors, all cars stop at the nearest floor, and park there with the doors open to facilitate the safe evacuation of passengers.	⊙	⊙	⊙
Emergency Car Lighting	ECL	Car lighting which turns on immediately when power fails, providing a minimum level of lighting within the car. (Choice of dry-cell battery or trickle-charge battery)	⊙	⊙	⊙
Fire Emergency Return	FER	Upon activation of a key switch or a building's fire alarm, all calls are canceled, all cars immediately return to a specified evacuation floor and the doors open to facilitate the safe evacuation of passengers.	⊙	⊙	⊙
Firefighters' Emergency Operation	FE	During a fire, when the fire operation switch is activated, the car calls of a specified car and all hall calls are canceled and the car immediately returns to a predetermined floor. The car then responds only to car calls which facilitate fire-fighting and rescue operation.	⊙	⊙	⊙
MelEye Mitsubishi Elevators & Escalators Monitoring and Control System	WP-W	Each elevator's status and operation can be monitored and controlled using an advanced Webbased technology which provides an interface through personal computers. Special optional features such as preparation of traffic statistics and analysis are also available.	⊙	⊙	⊙
Mitsubishi Emergency Landing Device	MELD	Upon power failure, a car equipped with this function automatically moves and stops at the nearest floor using a rechargeable battery, and the doors open to facilitate the safe evacuation of passengers. (Maximum allowable floor-to-floor distance is 11 meters.)	⊙	⊙	⊙
Operation by Emergency Power Source — Automatic/Manual	OEPS	Upon power failure, predetermined car(s) uses the building's emergency power supply to move to a specified floor, where the doors then open to facilitate the safe evacuation of passengers. After all cars have arrived, the predetermined car(s) resume normal operation.	⊙	⊙	⊙
Supervisory Panel	WP	Each elevator's status and operation can be remotely monitored and controlled through a panel installed in a building's supervisory room, etc.	⊙	⊙	⊙ <sup>#1</sup>

### DOOR OPERATION FEATURES

Automatic Door-open Time Adjustment	DOT	The time doors are open will automatically be adjusted depending on whether the stop was called from the hall or the car, to allow smooth boarding of passengers or loading of baggage.	—	—	Ⓢ
Automatic Door Speed Control	DSAC	Door load on each floor, which can depend on the type of hall doors, is monitored to adjust the door speed, thereby making the door speed consistent throughout all floors.	Ⓢ	Ⓢ	Ⓢ
Door Load Detector	DLD	When excessive door load has been detected while opening or closing, the doors immediately reverse.	Ⓢ	Ⓢ	Ⓢ
Door Nudging Feature — With Buzzer	NDG	A buzzer sounds and the doors slowly close when they have remained open for longer than the preset period. With the AAN-B or AAN-G feature, a beep and voice guidance sound instead of the buzzer.	Ⓢ	Ⓢ	Ⓢ
Door Sensor Self-diagnosis	DODA	Failure of non-contact door sensors is checked automatically, and if a problem is diagnosed, the door-close timing is delayed and the closing speed is reduced to maintain elevator service and ensure passenger safety.	Ⓢ	Ⓢ	Ⓢ
Electronic Doorman	EDM	Door open time is minimized using the SR or Multi-beam Door Sensor feature that detects passengers boarding or exiting.	⊙	⊙	⊙
Extended Door-open Button	DKO-TB	When the button inside a car is pressed, the doors will remain open longer to allow loading and unloading of baggage, a stretcher, etc.	⊙	⊙	—
Hall Motion Sensor	HMS	Infrared-light is used to scan a 3D area near the open doors to detect passengers or objects.	⊙	⊙	⊙
Multi-beam Door Sensor	—	Multiple infrared-light beams cover some height of the doors to detect passengers or objects as the doors close. (Cannot be combined with the SR feature.)	⊙	⊙	⊙
Reopen with Hall Button	ROHB	Closing doors can be reopened by pressing the hall button corresponding to the traveling direction of the car.	Ⓢ	Ⓢ	Ⓢ
Repeated Door-close	RDC	Should an obstacle prevent the doors from closing, the doors will repeatedly open and close until the obstacle is cleared from the doorway.	Ⓢ	Ⓢ	Ⓢ
Safety Door Edge	SDE	The sensitive door edge detects passengers or objects during door closing.	⊙	⊙	⊙
Safety Ray	SR	1-beam	Ⓢ	Ⓢ	Ⓢ
		2-beam			

Notes: 1C-2BC (1-car selective collective) - Standard, 2C-2BC (2-car group control system) - Optional, ΣAI-22 (3- to 4-car group control system) - Optional, ΣAI-2200C (3- to 8-car group control system) - Optional  
Ⓢ = Standard ⊙ = Optional † = Not applicable — = Not applicable  
#1: Please consult our local agents for the production terms, etc.

Notes:

\*1: Maximum number of floors: 22 floors

\*2: Some letters of the alphabets are not available. Please consult our local agents for details.

Actual colors may differ slightly from those shown.  
Please refer to the design guide for details and other designs.

# Features (2/2)

Feature	Abbreviation	Description	1C to 2C 2BC	3C to 4C ΣAI-22	3C to 8C ΣAI-2200C
<b>■ OPERATIONAL AND SERVICE FEATURES</b>					
Attendant Service	AS	Exclusive operation where an elevator can be operated using the buttons and switches located in the car operating panel, allowing smooth boarding of passengers or loading of baggage.	⊙	⊙	⊙
Automatic Bypass	ABP	A fully-loaded car bypasses hall calls in order to maintain maximum operational efficiency.	⊙ <sup>#3</sup>	⊙	⊙
Automatic Hall Call Registration	FSAT	If one car cannot carry all waiting passengers because it is full, another car will automatically be assigned for the remaining passengers.	⊙	⊙	⊙
Backup Operation for Group Control Microprocessor	GCBK	An operation by car controllers which automatically maintains elevator operation in the event that a microprocessor or transmission line in the group controller has failed.	⊙ <sup>†</sup>	⊙	⊙
Car Call Canceling	CCC	When a car has responded to the final car call in one direction, the system regards remaining calls in the other direction as mistakes and clears them from the memory.	⊙	⊙	⊙
Car Fan Shut Off — Automatic	CFO-A	If there are no calls for a specified period, the car ventilation fan will automatically turn off to conserve energy.	⊙	⊙	⊙
Car Light Shut Off — Automatic	CLO-A	If there are no calls for a specified period, the car lighting will automatically turn off to conserve energy.	⊙	⊙	⊙
Continuity of Service	COS	A car which is experiencing trouble is automatically withdrawn from group control operation to maintain overall group performance.	⊙ <sup>†</sup>	⊙	⊙
Elevator and Security System Interface	EL-SCA/ EL-SC	Personal authentication by building's security devices can trigger predetermined elevator operation such as permission of access to private floors, automatic registration of a hall call and a destination floor, and priority service.	⊙ <sup>#1</sup>	⊙	⊙
False Call Canceling — Automatic	FCC-A	If the number of registered car calls does not correspond to the car load, all calls are canceled to avoid unnecessary stops.	⊙	⊙	⊙
False Call Canceling — Car Button Type	FCC-P	If a wrong car button is pressed, it can be canceled by quickly pressing the same button again twice.	⊙	⊙	⊙
Independent Service	IND	Exclusive operation where a car is withdrawn from group control operation for independent use, such as maintenance or repair, and responds only to car calls.	⊙	⊙	⊙
Next Landing	NXL	If the elevator doors do not open fully at a destination floor, the doors close, and the car automatically moves to the next or nearest floor where the doors open.	⊙	⊙	⊙
Non-service to Specific Floors — Car Button Type	NS-CB	To enhance security, service to specific floors can be disabled using the car operating panel. This function is automatically deactivated during emergency operation.	⊙	⊙	⊙
Non-service to Specific Floors — Switch/Timer Type	NS NS-T	To enhance security, service to specific floors can be disabled using a manual or timer switch. This function is automatically deactivated during emergency operation.	⊙ <sup>#1</sup>	⊙	⊙
Non-service Temporary Release for Car Call — Card Reader Type	NSCR-C	To enhance security, car calls for desired floors can be registered only by placing a card over a card reader. This function is automatically deactivated during emergency operation.	⊙	⊙	⊙
Out-of-service by Hall Key Switch	HOS HOS-T	For maintenance or energy-saving measures, a car can be taken out of service temporarily with a key switch (with or without a timer) mounted in a specified hall.	⊙	⊙	⊙
Out-of-service — Remote	RCS	With a key switch on the supervisory panel, etc., a car can be called to a specified floor after responding to all car calls, and then automatically be taken out of service.	⊙	⊙	⊙
Overload Holding Stop	OLH	A buzzer sounds to alert the passengers that the car is overloaded. The doors remain open and the car will not leave that floor until enough passengers exit the car.	⊙	⊙	⊙
Regenerative Converter	PCNV	For energy conservation, power regenerated by a traction machine can be used by other electrical systems in the building.	⊙	⊙	⊙
Return Operation	RET	Using a key switch on the supervisory panel, a car can be withdrawn from group control operation and called to a specified floor. The car will park on that floor with the doors open, and not accept any calls until independent operations begin.	⊙	⊙	⊙
Safe Landing	SFL	If a car has stopped between floors due to some equipment malfunction, the controller checks the cause, and if it is considered safe to move the car, the car will move to the nearest floor at a low speed and the doors will open.	⊙	⊙	⊙
Secret Call Service	SCS-B	To enhance security, car calls for desired floors can be registered only by entering secret codes using the car buttons on the car operating panel. This function is automatically deactivated during emergency operation.	⊙	⊙	⊙
<b>■ GROUP CONTROL FEATURES</b>					
Bank-separation Operation	BSO	Hall buttons and the cars called by each button can be divided into several groups for independent group control operation to serve special needs or different floors.	⊙ <sup>†,#2</sup>	⊙	⊙
Closest-car Priority Service	CNPS	A function to give priority allocation to the car closest to the floor where a hall call button has been pressed, or to reverse the closing doors of the car closest to the pressed hall call button on that floor. (Cannot be combined with hall position indicators.)	—	⊙ <sup>#2</sup>	⊙
Congested-floor Service	CFS	The timing of car allocation and the number of cars to be allocated to floors where meeting rooms or ballrooms exist and the traffic intensifies for short periods of time are controlled according to the detected traffic density data for those floors.	—	⊙	⊙
Destination Oriented Allocation System	DOAS	When a passenger enters a destination floor at a hall, the hall operating panel indicates which car will serve the floor. The passenger does not need to press a button in the car. Dispersing passengers by destination prevents congestion in the cars and minimizes waiting and traveling time.	—	—	⊙ <sup>#4</sup>

Feature	Abbreviation	Description	1C to 2C 2BC	3C to 4C ΣAI-22	3C to 8C ΣAI-2200C
Down Peak Service	DPS	Controls the number of cars to be allocated and the timing of car allocation in order to meet increased demands for downward travel during office leaving time, hotel check-out time, etc. to minimize passenger waiting time.	—	⊙	⊙
Elevator Call System with Smartphone	ELCS-SP	Using a smartphone equipped with the application, users can change the call setting for their elevator and check the status of the elevator assigned to them. Once inside the secure area, users can call an elevator remotely from anywhere.	—	—	⊙ <sup>#2</sup>
Energy-saving Operation — Number of Cars	ESO-N	To save energy, the number of service cars is automatically reduced to some extent, but not so much that it adversely affects passenger waiting time.	—	⊙	⊙
Forced Floor Stop	FFS	All cars in a bank automatically make a stop at a predetermined floor on every trip without being called.	⊙	⊙	⊙
Intense Up Peak	IUP	To maximize transport efficiency, an elevator bank is divided into two groups of cars to serve upper and lower floors separately during up peak. In addition, the number of cars to be allocated, the timing of car allocation to the lobby floor, the timing of door closing, etc. are controlled based on predicted traffic data.	—	—	⊙
Light-load Car Priority Service	UCPS	When traffic is light, empty or lightly-loaded cars are given higher priority to respond to hall calls in order to minimize passenger travel time. (Cannot be combined with hall position indicators.)	—	⊙ <sup>#2</sup>	⊙
Lunchtime Service	LTS	During the first half of lunchtime, calls for a restaurant floor are served with higher priority, and during the latter half, the number of cars allocated to the restaurant floor, the allocation timing for each car and the door opening and closing timing are all controlled based on predicted data.	—	⊙	⊙
Main Floor Changeover Operation	TFS	This feature is effective for buildings with two main (lobby) floors. The floor designated as the "main floor" in a group control operation can be changed as necessary using a manual switch.	⊙	⊙	⊙
Main Floor Parking	MFP	An available car always parks on the main (lobby) floor with the doors open (or closed only in China).	⊙	⊙	⊙
Special Car Priority Service	SCPS	Special cars, such as observation elevators and elevators with basement service, are given higher priority to respond to hall calls. (Cannot be combined with hall position indicators.)	—	⊙ <sup>#2</sup>	⊙
Special Floor Priority Service	SFPS	Special floors, such as floors with VIP rooms or executive rooms, are given higher priority for car allocation when a call is made on those floors. (Cannot be combined with hall position indicators.)	—	⊙ <sup>#2</sup>	⊙
Up Peak Service	UPS	Controls the number of cars to be allocated to the lobby floor, as well as the car allocation timing, in order to meet increased demands for upward travel from the lobby floor during office starting time, hotel check-in time, etc., and minimize passenger waiting time.	—	⊙	⊙
VIP Operation	VIP-S	A specified car is withdrawn from group control operation for VIP service operation. When activated, the car responds only to existing car calls, moves to a specified floor and parks there with the doors open. The car then responds only to car calls.	⊙ <sup>†,#2</sup>	⊙	⊙
<b>■ SIGNAL AND DISPLAY FEATURES</b>					
Auxiliary Car Operating Panel	ACS	An additional car control panel which can be installed for large-capacity elevators, heavy-traffic elevators, etc.	⊙	⊙	⊙
Basic Announcement	AAN-B	A synthetic voice (and/or buzzer) alerts passengers inside a car that elevator operation has been temporarily interrupted by overloading or a similar cause. (Available in limited languages.)	⊙	⊙	⊙
Car Arrival Chime	AECC (car)	Electronic chimes sound to indicate that a car will soon arrive. (The chimes are mounted either on Car Arrival Chime the top and bottom of the car, or in each hall.)	⊙	⊙	—
	AECH (hall)		⊙	⊙	⊙
Car Information Display	CID	This 10.4- or 15-inch LCD for car front return panels shows the date and time, car position, travel direction and elevator status messages. In addition, customized video images can be displayed in full-screen or partial-screen formats.	⊙	⊙	⊙
Car LCD Position Indicator	CID-S	This 5.7-inch LCD for car operating panels shows the date and time, car position, travel direction and elevator status messages.	⊙	⊙	⊙
Flashing Hall Lantern	FHL	A hall lantern, which corresponds to a car's service direction, flashes to indicate that the car will soon arrive.	⊙	⊙	⊙
Hall Information Display	HID	This 10.4- or 15-inch LCD for elevator halls shows the date and time, car position, travel direction and elevator status messages. In addition, customized video images can be displayed in full-screen or partial-screen formats.	⊙	⊙	—
Hall LCD Position Indicator	HID-S	This 5.7-inch LCD for elevator halls shows the date and time, car position, travel direction and elevator status messages.	⊙	⊙	—
Immediate Prediction Indication	AIL	When a passenger has registered a hall call, the best car to respond to that call is immediately selected, the corresponding hall lantern lights up and a chime sounds once to indicate which doors will open.	—	⊙	⊙
Intercommunication System	ITP	A system which allows communication between passengers inside a car and the building personnel.	⊙	⊙	⊙
Second Car Prediction	TCP	When a hall is crowded to the extent that one car cannot accommodate all waiting passengers, the hall lantern of the next car to serve the hall will light up.	—	—	⊙
Sonic Car Button — Click Type	ACB	A click-type car button which emits electronic beep sounds when pressed to indicate that the call has been registered.	⊙	⊙	⊙
Voice Guidance System	AAN-G	Information on elevator service such as the current floor or service direction is given to the passengers inside a car.	⊙	⊙	⊙

Notes: 1C-2BC (1-car selective collective) - Standard, 2C-2BC (2-car group control system) - Optional, ΣAI-22 (3- to 4-car group control system) - Optional, ΣAI-2200C (3- to 8-car group control system) - Optional  
 ⊙ = Standard ⊙ = Optional † = Not applicable to 1C-2BC — = Not applicable  
 #1: When 2C-2BC, please consult our local agents.  
 #2: Please consult our local agents for the production terms, etc.  
 #3: Optional when the operation system is 1C-2BC.  
 #4: • When the DOAS is applied, AECC is ⊙ and the Safety Ray (SR) or Multi-beam Door Sensor feature should be installed.  
 • The DOAS cannot be combined with some features. Please refer to the ΣAI-2200C brochure for those features.

## Horizontal Dimensions

Mitsubishi Electric Standard									
Code number	Number of persons	Rated capacity (kg)	Rated speed (m/sec)	Door type	Entrance width (mm) JJ	Car internal dimensions (mm) AA×BB	Counterweight position	Minimum hoistway dimensions (mm) AH×BH/car*	Minimum machine room dimensions (mm) AM×BM/car
P6	6	450	1.0	CO	800	1400×850	Rear	1750×1400	1850×2700
P8	8	550	1.0				Side	2100×1200	2100×1900
P9	9	600				1.5	Rear	1750×1590	1850×2900
P10	10	700	Side				2100×1380	2100×2000	
P11	11	750	1.75			Rear	1750×1660	1850×2950	
						Side	2100×1450	2100×2050	
P13	13	900			Rear	1750×1810	1850×3100		
					Side	2100×1600	2100×2050		
P15	15	1000			Rear	1750×1910	1850×3200		
					Side	2100×1700	2100×2100		
P17	17	1150			Rear	2000×1910	2000×1950		
					Side	2400×1730	2400×2150		
P20	20	1350		Rear	2000×2060	2000×2100			
				Side	2400×1880	2400×2200			
P24	24	1600		Rear	2200×1860	2200×1900			
				Side	2600×1680	2600×2100			
2S				900	1100×2100	Side	1850×2530	1850×2530	
						Rear	2200×2110	2200×2150	
					1000	1800×1500	Side	2600×1880	2600×2200
							Rear	2400×1960	2400×2000
					1100	2000×1350	Side	2800×1730	2800×2150
							Rear	2200×2310	2200×2350
1800×1700	Side	2600×2080	2600×2300						
	Rear	2400×2160	2400×2200						
2000×1550	Side	2800×1930	2800×2300						
	Rear	2500×2250	2500×2250						
2100×1600	Side	2880×1980	2880×2200						
	Rear	2180×2830	2180×2830						

[Terms of the table]

- This table shows standard specifications without the fireproof landing door and counterweight safety. Please consult our local agents for other specifications.
- CO: 2-panel center opening doors, 2S: 2-panel side sliding doors.
- Minimum hoistway dimensions (AH and BH) shown in the table are after waterproofing of the pit and do not include plumb tolerance.

Note:

- \* The minimum hoistway dimensions (AH and BH) shown in the table above is a space for a car when two or more cars are located in the same hoistway. If only one car is located in the hoistway and the rated speed is 2.5 m/sec, the hoistway dimensions are different from those shown. Please consult our local agents for details.

## Hoistway Plan

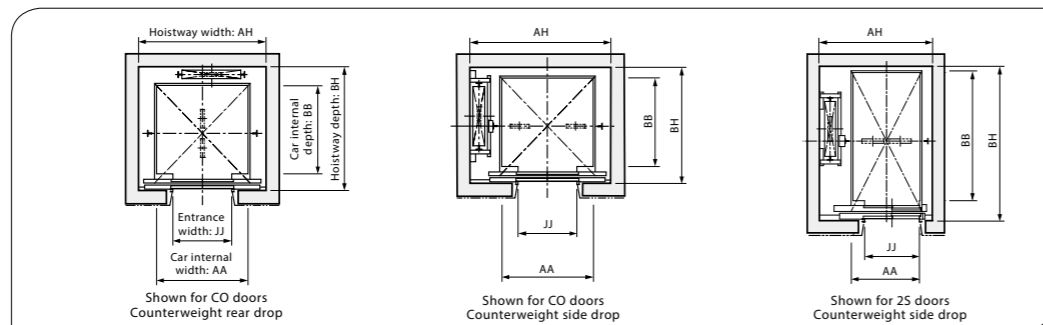

## Machine Room Plan Example

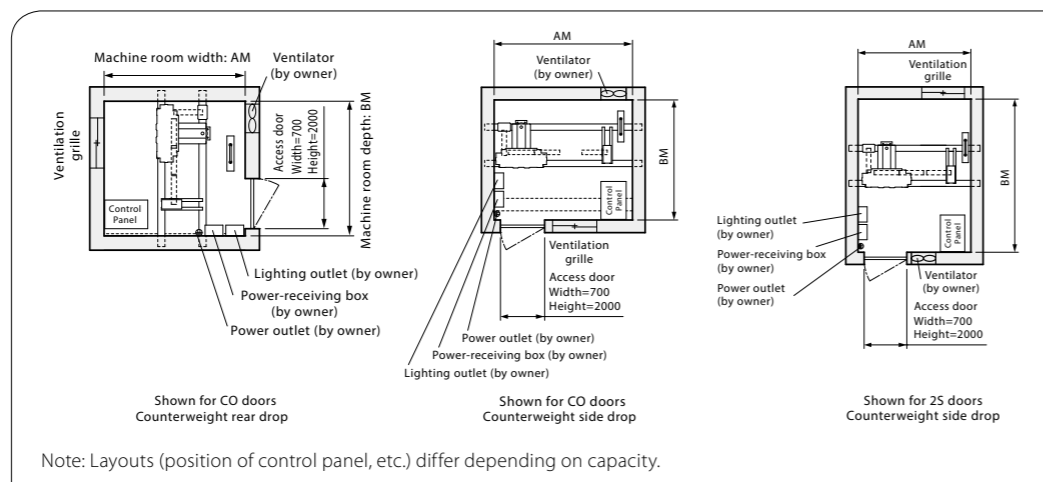

Note: Layouts (position of control panel, etc.) differ depending on capacity.

## Vertical Dimensions

Mitsubishi Electric Standard									
Rated speed (m/sec)	Rated capacity (kg)	Maximum travel (m) TR	Maximum number of stops	Minimum overhead (mm) OH		Minimum pit depth (mm) PD		Minimum machine room clear height (mm) HM	Minimum floor to floor height (mm)
				TR≤80	80<TR≤120	TR≤90	90<TR		
1.0	450≤Capacity≤1600	60	30	4400		1360		2200	2500 <sup>*2</sup>
1.5	550≤Capacity≤1600	90		4560		1410			
1.75				4630		1410			
2.0	750≤Capacity≤1350	120 <sup>*1</sup>	36	4720	4820	1550	1650		
	1350<Capacity≤1600	90	30						
2.5	750≤Capacity≤1350	120 <sup>*1</sup>	36	4950	5050	1900	2000		
	1350<Capacity≤1600	90	30						

[Terms of the table]

- This table shows standard specifications without counterweight safety. Please consult our local agents for other specifications.

[Notes]

\*1 Maximum travel is 90m when the counterweight is installed in a side drop position.

\*2 Some specifications require more than 2500mm as a minimum floor height. Please consult our local agents if the floor height is less than entrance height HH + 700mm.

## Elevation

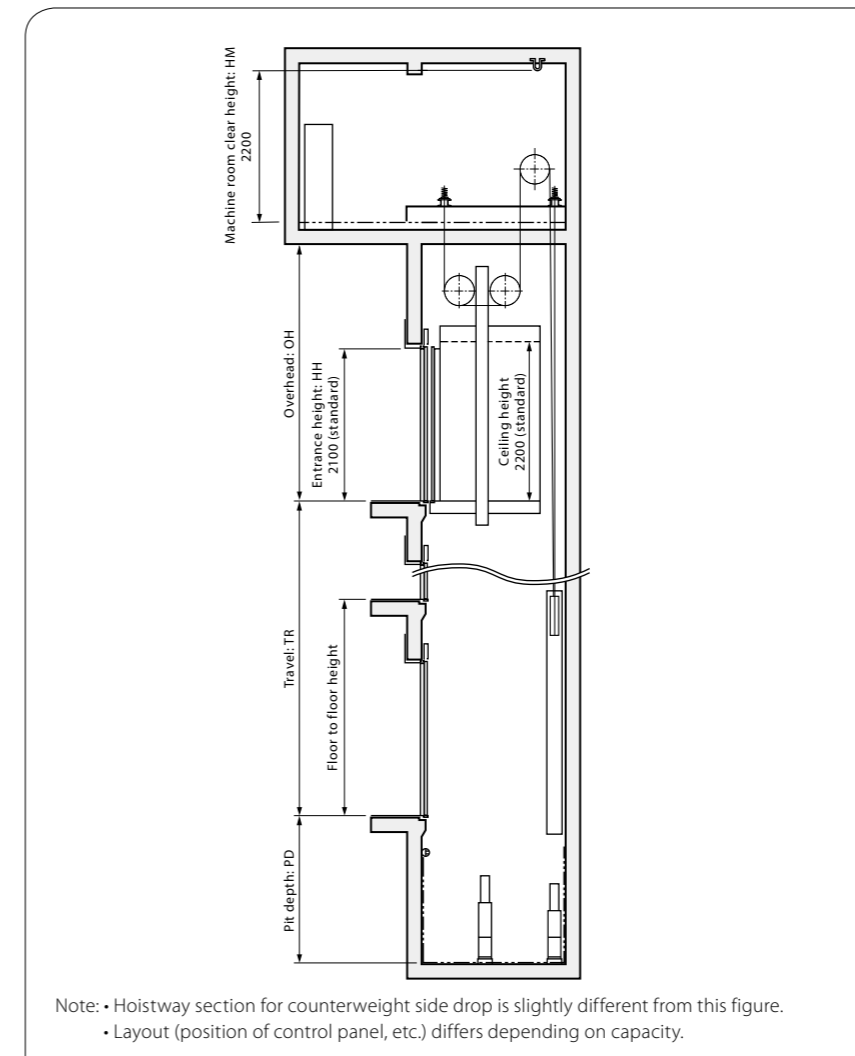

Note: • Hoistway section for counterweight side drop is slightly different from this figure.  
• Layout (position of control panel, etc.) differs depending on capacity.

## Basic code compliance

The dimensional information shown here in this page is based on Mitsubishi Electric standard car size. For safety features, please consult our local agent.

## Horizontal Dimensions

EN81-1									
Code number	Number of persons	Rated capacity (kg)	Rated speed (m/sec)	Door type	Entrance width (mm) JJ	Car internal dimensions (mm) AA×BB	Counterweight position	Minimum hoistway dimensions (mm) AH×BH/car*	Minimum machine room dimensions (mm) AM×BM/car
P11	11	825	1.0 1.6 1.75 2.0 2.5	CO	900	1400×1350	Rear	1950×1930	1970×1930
P14	14	1050					Side	2210×1700	2210×1900
				2S		Rear	2000×1980	2000×1980	
P17	17	1275				Side	2410×1740	2410×1910	
				CO		Side	1910×2510	1910×2510	
P18	18	1350				Rear	2400×2030	2400×2030	
			2S	Side	2820×1740	2820×1940			
CO	Side	2020×2680		2020×2680					
	2S	Rear	2400×2130	2400×2130					
CO		Side	2820×1840	2820×1990					

[Terms of the table]

• This table shows standard specifications without the fireproof landing door and counterweight safety.

Please consult our local agents for other specifications.

• CO: 2-panel center opening doors, 2S: 2-panel side sliding doors.

• Minimum hoistway dimensions (AH and BH) shown in the table are after waterproofing of the pit and do not include plumb tolerance.

Note:

\* The minimum hoistway dimensions (AH and BH) shown in the table above is a space for a car when two or more cars are located in the same hoistway.

If only one car is located in the hoistway and the rated speed is 2.5 m/sec, the hoistway dimensions are different from those shown.

Please consult our local agents for details.

## Hoistway Plan

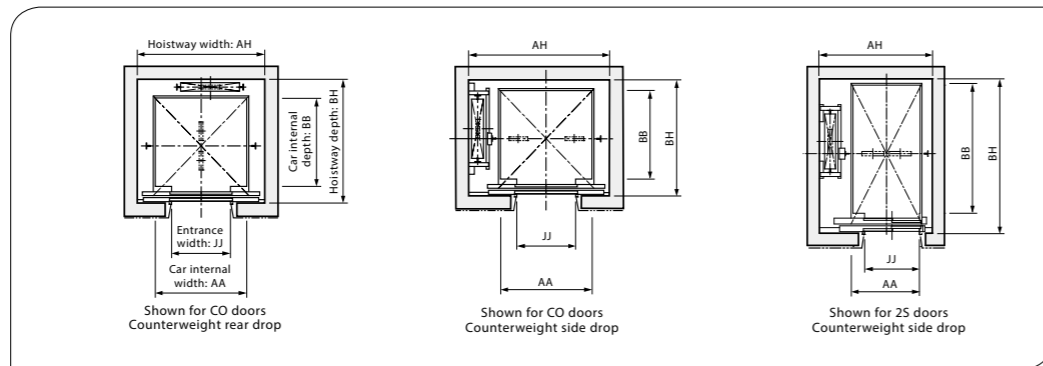

## Machine Room Plan Example

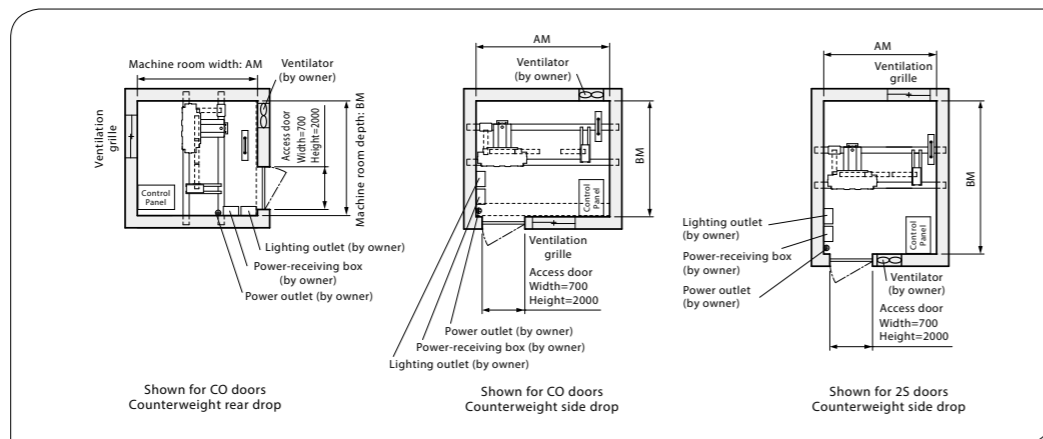

## Vertical Dimensions

EN81-1								
Rated speed (m/sec)	Rated capacity (kg)	Maximum travel (m) TR	Maximum number of stops	Minimum overhead (mm) OH		Minimum pit depth (mm) PD		Minimum machine room clear height (mm) HM
				TR≤90	90<TR≤120	Code number P11 and P14	Code number P17 and P18	
1.0	825≤Capacity≤1350	60	30	4400		1360	1520	2200 <sup>*2</sup>
1.6		90		4560		1410	1560	
1.75		4630		1430	1590			
2.0	825≤Capacity≤1050	90	30	4720	4820	1550	1650	
	1050<Capacity≤1350	120 <sup>*1</sup>	36					
2.5	825≤Capacity≤1050	90	30	4950	5050	1900	1900	
	1050<Capacity≤1350	120 <sup>*1</sup>	36					

[Terms of the table]

• This table shows standard specifications without counterweight safety.

Please consult our local agents for other specifications.

[Notes]

\*1 Maximum travel is 90m when the counterweight is installed in a side drop position.

\*2 This dimension does not include the height of hoisting beam. The height of hoisting beam must be 100mm or more.

\*3 Some specifications require more than 2500mm as a minimum floor height. Please consult our local agents if the floor height is less than entrance height HH + 700mm.

## Elevation

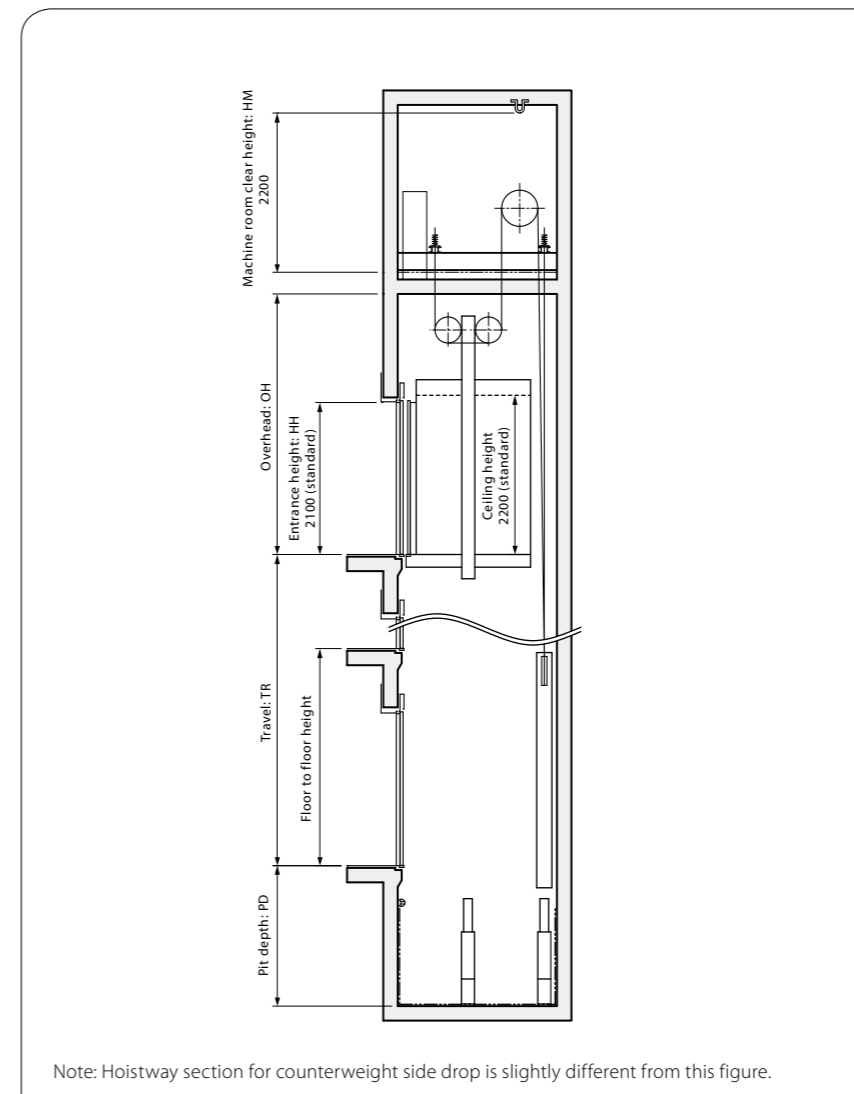

Note: Hoistway section for counterweight side drop is slightly different from this figure.

### Basic code compliance

The dimensional information shown here in this page is based on the requirements of EN81-1.

For other components, please consult our local agent.

## Horizontal Dimensions

GB7588									
Code number	Number of persons	Rated capacity (kg)	Rated speed (m/sec)	Door type	Entrance width (mm) JJ	Car internal dimensions (mm) AA×BB	Counterweight position	Minimum hoistway dimensions (mm) AH×BH/car*	Minimum machine room dimensions (mm) AM×BM/car
P10	10	750	1.0 1.6 1.75 2.0 2.5	CO	900	1400×1300	Rear	1950×1880	1970×1880
P11	11	825					Side	2190×1680	2190×1900
P12	12	900				Rear	1950×1930	1970×1930	
						Side	2210×1700	2210×1900	
P14	14	1050				Rear	2000×1910	2000×1910	
						Side	2410×1690	2410×1900	
P16	16	1200		Rear	2000×1980	2000×1980			
				Side	2410×1740	2410×1910			
P17	17	1275		Rear	2200×1930	2200×1930			
				Side	2610×1700	2610×1900			
P18	18	1350		Rear	2000×2080	2000×2080			
				Side	2410×1840	2410×1960			
CO	1000	1800×1500		Rear	2000×2130	2200×2130			
				Side	1910×2510	1910×2510			
		2000×1350		Rear	2620×1840	2620×1990			
				Side	2400×1980	2400×1980			
		2000×1400		Rear	2820×1700	2820×1930			
				Side	2400×2030	2400×2030			
2S	1100	1200×2300	Rear	2820×1740	2820×1940				
			Side	2020×2680	2020×2680				
CO	1000	1800×1680	Rear	2400×2130	2400×2130				
			Side	2820×1840	2820×1990				
CO	1000	1800×1680	Rear	2200×2310	2200×2310				
			Side	2620×2020	2620×2080				

[Terms of the table]

• This table shows standard specifications without the fireproof landing door and counterweight safety.

Please consult our local agents for other specifications.

• CO: 2-panel center opening doors, 2S: 2-panel side sliding doors.

• Minimum hoistway dimensions (AH and BH) shown in the table are after waterproofing of the pit and do not include plumb tolerance.

Note:

\* The minimum hoistway dimensions (AH and BH) shown in the table above is a space for a car when two or more cars are located in the same hoistway.

If only one car is located in the hoistway and the rated speed is 2.5 m/sec, the hoistway dimensions are different from those shown.

Please consult our local agents for details.

## Hoistway Plan

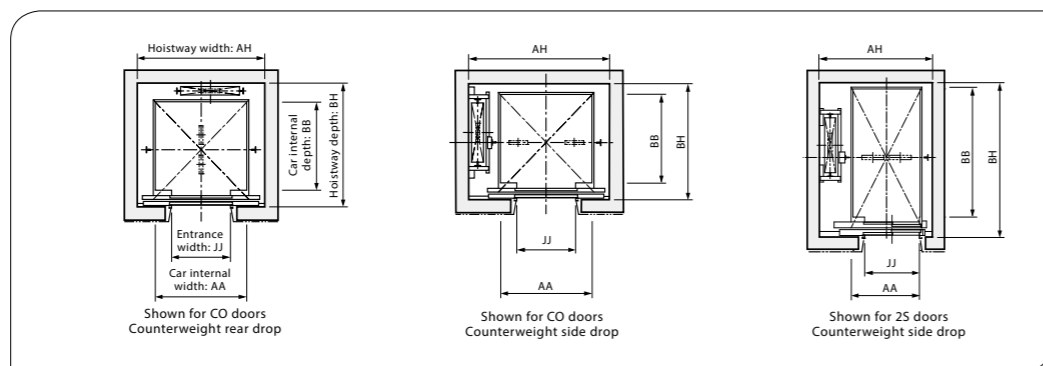

## Machine Room Plan Example

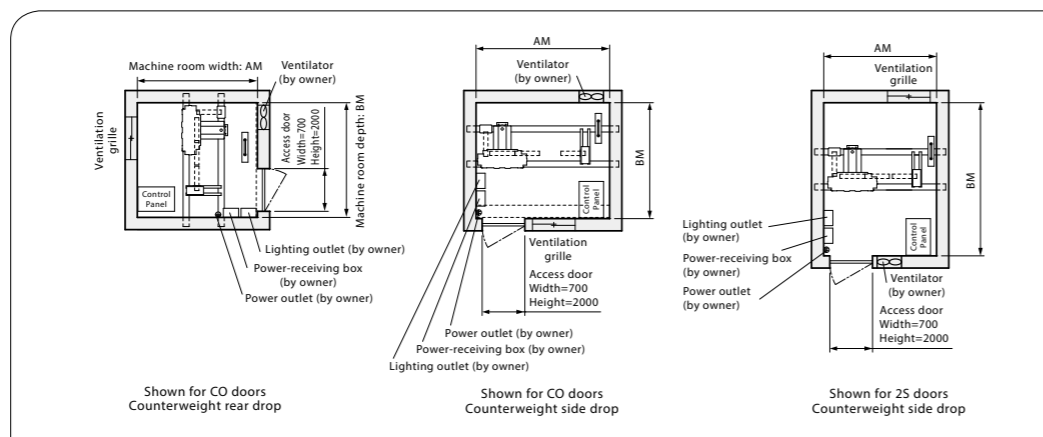

## Vertical Dimensions

GB7588									
Rated speed (m/sec)	Rated capacity (kg)	Maximum travel (m) TR	Maximum number of stops	Minimum overhead (mm) OH		Minimum pit depth (mm) PD		Minimum machine room clear height (mm) HM	Minimum floor to floor height (mm)
				TR≤90	90<TR≤120	Code number P10-P12 and P14	Code number P16-P18		
1.0	750≤Capacity≤1350	60	30	4400		1360	1520	2200 <sup>*2</sup>	2500 <sup>*3</sup>
1.6		90		4560		1410	1560		
1.75				4630		1430	1590		
2.0	750≤Capacity≤1050	90	30	4720	4820	1550	1650		
	1050<Capacity≤1350	120 <sup>*1</sup>	36						
2.5	750≤Capacity≤1050	90	30	4950	5050	1900	1900		
	1050<Capacity≤1350	120 <sup>*1</sup>	36						

[Terms of the table]

• This table shows standard specifications without counterweight safety.

Please consult our local agents for other specifications.

[Notes]

\*1 Maximum travel is 90m when the counterweight is installed in a side drop position.

\*2 This dimension does not include the height of hoisting beam. The height of hoisting beam must be 100mm or more.

\*3 Some specifications require more than 2500mm as a minimum floor height. Please consult our local agents if the floor height is less than entrance height HH + 700mm.

## Elevation

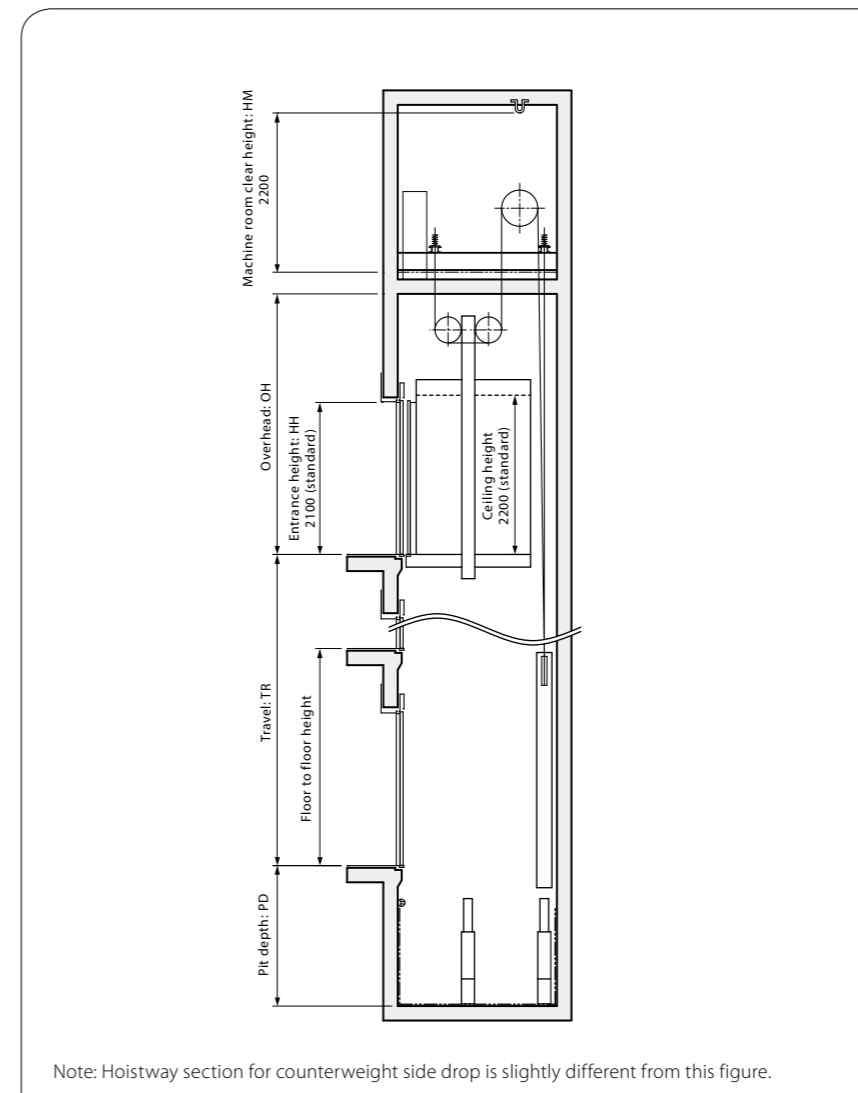

Note: Hoistway section for counterweight side drop is slightly different from this figure.

## Basic code compliance

The dimensional information shown here in this page is based on the requirements of GB7588.

For other components, please consult our local agent.

# Important Information on Elevator Planning

## Work Not Included in Elevator Contract

The following items are excluded from Mitsubishi Electric's elevator installation work. Their conditions and other details are to be conformed to the statement of local laws or Mitsubishi Electric elevator's requirements on the responsibility of the building owner or general contractor.

- Construction of the elevator machine room with proper beams and slabs, equipped with a lock, complete with illumination, ventilation and waterproofing.
- Access to the elevator machine room sufficient to allow passage of the control panel and traction machine.
- Architectural finishing of the machine room floor, and the walls and floors in the vicinity of the entrance hall after installation has been completed.
- Construction of an illuminated, ventilated and waterproofed hoistway.
- The provision of a ladder to the elevator pit.
- The provision of openings and supporting members as required for equipment installation.
- The provision of separate beams when the hoistway dimensions markedly exceed the specifications, and intermediate beams and separator partitions when two or more elevators are installed.
- The provision of an emergency exit door, inspection door and pit access door, when required, and access to the doors.
- All other work related to building construction.
- The provision of the main power and power for illumination, and their electrical switch boxes in the machine room, and laying of the wiring from the electrical room.
- The provision of outlets and laying of the wiring in the machine room and the hoistway, plus the power from the electrical switch box.
- The laying of conduits and wiring between the elevator pit and the terminating point for the devices installed outside the hoistway, such as the emergency bell, intercom, monitoring and security devices.
- The power consumed in installation work and test operations.
- All the necessary building materials for grouting in of brackets, bolts, etc.
- The test provision and subsequent alteration as required, and eventual removal of the scaffolding as required by the elevator contractor, and any other protection of the work as may be required during the process.
- The provision of a suitable, locked space for the storage of elevator equipment and tools during elevator installation.
- The security system, such as a card reader, connected to Mitsubishi Electric's elevator controller, when supplied by the building owner or general contractor.

Note: Work responsibilities in installation and construction shall be determined according to local laws.

## Elevator Site Requirements

- The temperature of the machine room and elevator hoistway shall be below 40°C.
- The following conditions are required for maintaining elevator performance.
  - a. The relative humidity shall be below 90% on a monthly average and below 95% on a daily average.
  - b. Prevention against icing and condensation occurring due to a rapid drop in the temperature shall be provided in the machine room and elevator hoistway.
  - c. The machine room and the elevator hoistway shall be finished with mortar or other materials so as to prevent concrete dust.
- Voltage fluctuation shall be within a range of +5% to -10%.

## Ordering Information

Please include the following information when ordering or requesting estimates:

- The desired number of units, speed and loading capacity.
- The number of stops or number of floors to be served.
- The total elevator travel and each floor-to-floor height.
- Operation system.
- Selected design and size of car.
- Entrance design.
- Signal equipment.
- A sketch of the part of the building where the elevators are to be installed.
- The voltage, number of phases, and frequency of the power source for the motor and lighting.



## State-of-the-Art Factories... For the Environment. For Product Quality.

Mitsubishi Electric elevators and escalators are currently operating in approximately 90 countries around the globe. Built placing priority on safety, our elevators, escalators and building system products are renowned for their excellent efficiency, energy savings and comfort. The technologies and skills cultivated at the Inazawa Works in Japan and 12 global manufacturing factories are utilized in a worldwide network that provides sales, installation and maintenance in support of maintaining and improving product quality. As a means of contributing to the realization of a sustainable society, we consciously consider the environment in business operations, proactively work to realize a low-carbon, recycling-based society, and promote the preservation of biodiversity.

### ISO9001/14001 certification

Mitsubishi Elevator Asia Co., Ltd. has acquired ISO 9001 certification from the International Organization for Standardization based on a review of quality management. The plant has also acquired environmental management system standard ISO 14001 certification.



## MITSUBISHI ELECTRIC CORPORATION

HEAD OFFICE : TOKYO BLDG., 2-7-3, MARUNOUCHI, CHIYODA-KU, TOKYO 100-8310, JAPAN  
[www.MitsubishiElectric.com/elevator](http://www.MitsubishiElectric.com/elevator)

**⚠ Safety Tips:** Be sure to read the instruction manual fully before using this product.