



Programmable DC Power Supply
62000L Series
User's Manual



Programmable DC Power Supply 62000L Series User's Manual



Version 1.0
March 2017

Legal Notices

The information in this document is subject to change without notice.

Chroma ATE INC. makes no warranty of any kind with regard to this manual, including, but not limited to, the implied warranties of merchantability and fitness for a particular purpose. Chroma ATE INC. shall not be held liable for errors contained herein or direct, indirect, special, incidental or consequential damages in connection with the furnishing, performance, or use of this material.

CHROMA ATE INC.

66 Huaya 1st Road, Guishan, Taoyuan 33383, Taiwan

Copyright Notices. Copyright 2017 Chroma ATE INC., all rights reserved. Reproduction, adaptation, or translation of this document without prior written permission is prohibited, except as allowed under the copyright laws.

Warranty

All of Chroma's instruments are warranted against defects in material and workmanship for a period of one year from date of shipment. Chroma agrees to repair or replace any assembly or component found to be defective, under normal use during this period. Chroma's obligation under this warranty is limited solely to repairing any such instrument, which in Chroma's sole opinion proves to be defective within the scope of the warranty when returned to the factory or to an authorized service center. Purchaser is responsible for the shipping and cost of the service item to Chroma factory or service center. Shipment should not be made without prior authorization by Chroma.

This warranty does not apply to any products repaired or altered by persons not authorized by Chroma, or not in accordance with instructions furnished by Chroma. If the instrument is defective as a result of misuse, improper repair, or abnormal conditions or operations, repairs will be billed at cost.

Chroma assumes no responsibility for its product being used in a hazardous or dangerous manner either alone or in conjunction with other equipment. High voltage used in some instruments may be dangerous if misused. Special disclaimers apply to these instruments. Chroma assumes no liability for secondary charges or consequential damages and in any event, Chroma's liability for breach of warranty under any contract or otherwise, shall not exceed the purchase price of the specific instrument shipped and against which a claim is made.

Any recommendations made by Chroma regarding the use of its products are based upon tests believed to be reliable; Chroma makes no warranty of the results to be obtained. This warranty is in lieu of all other warranties, expressed or implied, and no representative or person is authorized to represent or assume for Chroma any liability in connection with the sale of our products other than set forth herein.

CHROMA ATE INC.

66 Huaya 1st Road, Guishan,
Taoyuan 33383, Taiwan
Tel: 886-3-327-9999
Fax: 886-3-327-2886
e-mail: info@chromaate.com
<http://www.chromaate.com>

Material Contents Declaration

The recycling label shown on the product indicates the Hazardous Substances contained in the product as the table listed below.

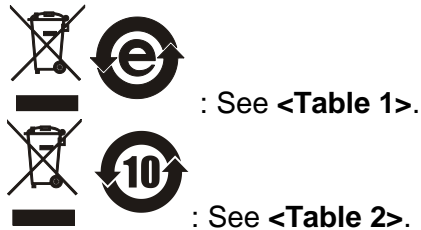

<Table 1>

Part Name	Hazardous Substances					
	Lead	Mercury	Cadmium	Hexavalent Chromium	Polybrominated Biphenyls/ Polybromodiphenyl Ethers	Selected Phthalates Group
	Pb	Hg	Cd	Cr ⁶⁺	PBB/PBDE	DEHP/BBP/DBP/DIBP
PCBA	O	O	O	O	O	O
CHASSIS	O	O	O	O	O	O
ACCESSORY	O	O	O	O	O	O
PACKAGE	O	O	O	O	O	O

“O” indicates that the level of the specified chemical substance is less than the threshold level specified in the standards of SJ/T-11363-2006 and EU Directive 2011/65/EU.

“X” indicates that the level of the specified chemical substance exceeds the threshold level specified in the standards of SJ/T-11363-2006 and EU Directive 2011/65/EU.

Remarks: The CE marking on product is a declaration of product compliance with EU Directive 2011/65/EU.

Disposal

Do not dispose of electrical appliances as unsorted municipal waste, use separate collection facilities. Contact your local government for information regarding the collection systems available. If electrical appliances are disposed of in landfills or dumps, hazardous substances can leak into the groundwater and get into the food chain, damaging your health and well-being. When replacing old appliances with new one, the retailer is legally obligated to take back your old appliances for disposal at least for free of charge.



<Table 2>

Part Name	Hazardous Substances					
	Lead	Mercury	Cadmium	Hexavalent Chromium	Polybrominated Biphenyls/ Polybromodiphenyl Ethers	Selected Phthalates Group
	Pb	Hg	Cd	Cr ⁶⁺	PBB/PBDE	DEHP/BBP/DBP/DIBP
PCBA	×	○	○	○	○	○
CHASSIS	×	○	○	○	○	○
ACCESSORY	×	○	○	○	○	○
PACKAGE	○	○	○	○	○	○

“○” indicates that the level of the specified chemical substance is less than the threshold level specified in the standards of SJ/T-11363-2006 and EU Directive 2011/65/EU.

“×” indicates that the level of the specified chemical substance exceeds the threshold level specified in the standards of SJ/T-11363-2006 and EU Directive 2011/65/EU.

1. Chroma is not fully transitioned to lead-free solder assembly at this moment; however, most of the components used are RoHS compliant.
2. The environment-friendly usage period of the product is assumed under the operating environment specified in each product's specification.

Disposal

Do not dispose of electrical appliances as unsorted municipal waste, use separate collection facilities. Contact your local government for information regarding the collection systems available. If electrical appliances are disposed of in landfills or dumps, hazardous substances can leak into the groundwater and get into the food chain, damaging your health and well-being. When replacing old appliances with new one, the retailer is legally obligated to take back your old appliances for disposal at least for free of charge.





Declaration of Conformity

For the following equipment :

Programmable DC Power Supply

(Product Name/ Trade Name)

62010L-36-7, 62015L-60-6

(Model Designation)

CHROMA ATE INC.

(Manufacturer Name)

66 Huaya 1st Road, Guishan, Taoyuan 33383, Taiwan

(Manufacturer Address)

Is herewith confirmed to comply with the requirements set out in the Council Directive on the Approximation of the Laws of the Member States relating to Electromagnetic Compatibility (2014/30/EU) and Low Voltage Directive (2014/35/EU). For the evaluation regarding the Directives, the following standards were applied :

EN 61326-1:2013

CISPR 11:2009+A1:2010 (Class A)

IEC 61000-4-2:2008, IEC 61000-4-3:2010, IEC 61000-4-4:2012,

IEC 61000-4-5:2005, IEC 61000-4-6:2013, IEC 61000-4-8:2009,

IEC 61000-4-11:2004

EN 61010-1:2010 and IEC 61010-1:2010

The equipment describe above is in conformity with Directive 2011/65/EU of the European Parliament and of the Council of 8 June 2011 on the restriction of the use of certain hazardous substances in electrical and electronic equipment.

The following importer/manufacturer or authorized representative established within the EUT is responsible for this declaration :

CHROMA ATE INC.

(Company Name)

66 Huaya 1st Road, Guishan, Taoyuan 33383, Taiwan

(Company Address)

Person responsible for this declaration:

Mr. Vincent Wu

(Name, Surname)

T&M BU Vice President

(Position/Title)

Taiwan

(Place)

2017.02.24

(Date)

(Legal Signature)

Safety Summary

The following general safety precautions must be observed during all phases of operation, service, and repair of this instrument. Failure to comply with these precautions or specific WARNINGS given elsewhere in this manual will violate safety standards of design, manufacture, and intended use of the instrument. *Chroma* assumes no liability for the customer's failure to comply with these requirements.



BEFORE APPLYING POWER

Verify that the power is set to match the rated input of this power supply.



PROTECTIVE GROUNDING

Make sure to connect the protective grounding to prevent an electric shock before turning on the power.



NECESSITY OF PROTECTIVE GROUNDING

Never cut off the internal or external protective grounding wire, or disconnect the wiring of protective grounding terminal. Doing so will cause a potential shock hazard that may bring injury to a person.



FUSES

Only fuses with the required rated current, voltage, and specified type (normal blow, time delay, etc.) should be used. Do not use repaired fuses or short-circuited fuse holders. To do so could cause a shock or fire hazard.



DO NOT OPERATE IN AN EXPLOSIVE ATMOSPHERE













Do not operate the instrument in the presence of flammable gases or fumes. The instrument should be used in an environment of good ventilation.



DO NOT REMOVE THE COVER OF THE INSTRUMENT

Operating personnel must not remove the cover of the instrument. Component replacement and internal adjustment can be done only by qualified service personnel.

Safety Symbols

	DANGER – High voltage.
	Explanation: To avoid injury, death of personnel, or damage to the instrument, the operator must refer to the explanation in the instruction manual.
	High temperature: This symbol indicates the temperature is hazardous to human beings. Do not touch it to avoid any personal injury.
	Protective grounding terminal: This symbol indicates that the terminal must be connected to ground before operation of the equipment to protect against electrical shock in case of a fault.
	Functional grounding: To identify an earth (ground) terminal in cases where the protective ground is not explicitly stated. This symbol indicates the power connector does not provide grounding.
	Frame or chassis: To identify a frame or chassis terminal.
	Alternating Current (AC)
	Direct Current (DC) / Alternating Current (AC)
	Direct Current (DC)
	Push-on/Push-off power switch
	The WARNING sign highlights an essential operating or maintenance procedure, practice, condition, statement, etc., which if not strictly observed, could result in injury to, or death of, personnel or long term health hazards.
	The CAUTION sign highlights an essential operating or maintenance procedure, practice, condition, statement, etc., which if not strictly observed, could result in damage to, or destruction of, equipment.
	The Notice sign highlights an essential operating or maintenance procedure, condition, or statement.

Revision History

The following lists the additions, deletions and modifications in this manual at each revision.

Date	Version	Revised Sections
Mar. 2017	1.0	Complete this manual.

Table of Contents

1. General Information.....	1-1
1.1 Features & Operations.....	1-1
1.2 Precautions.....	1-5
1.3 Maintaining the 62000L Series	1-5
1.4 Product Users.....	1-5
1.5 Safety Information.....	1-6
1.6 Symbols and Terms.....	1-7
1.7 Electrical Specifications	1-8
1.8 Contents	1-9
1.9 Dimension	1-9
2. Preliminary Check	2-1
2.1 Power-On Check	2-1
2.2 Output Check.....	2-1
2.2.1 Voltage Output Check	2-1
2.2.2 Current Output Check	2-2
2.3 Input Power Check	2-2
2.3.1 Power-Line Cord Check	2-2
2.3.2 Power-Line Voltage Selection	2-2
2.4 Panel Check & Setting.....	2-3
2.4.1 Front Panel Overview.....	2-3
2.4.2 Rear Panel Overview	2-4
2.4.3 Voltage & Current Limit Settings.....	2-5
2.4.4 Display Check.....	2-6
3. Power Supply Operation	3-1
3.1 Constant Voltage Operation.....	3-2
3.2 Constant Current Operation.....	3-3
3.3 Storing and Recalling Operation States	3-4
3.4 Setting the Overvoltage Protection	3-5
3.5 Setting the Overcurrent Protection.....	3-6
3.6 Remote Sensing (for 62010L-36-7 only)	3-7
3.6.1 Constant Voltage Regulation.....	3-8
3.6.2 Output Rating.....	3-9
3.6.3 Output Interference	3-9
3.6.4 Stability	3-9
3.6.5 Remote Sensing Connections	3-9
3.7 Master & Slave Application (62010L-36-7 Only)	3-10
3.7.1 Connections in Series	3-11
3.7.2 Connections in Parallel.....	3-13
3.7.3 Other Settings for Multiple Connections	3-15
3.8 Turning Off the Output	3-17
3.9 SEQ (Sequencing Mode)	3-17
3.10 System Operations	3-22
3.10.1 Error States.....	3-22
3.10.2 Beep/Alarm Settings.....	3-22
3.10.3 Display Control.....	3-23
3.10.4 OCP Delay (OCPDEL) Settings.....	3-24
3.10.5 Vrange	3-24
3.10.6 Style.....	3-24
3.10.7 Identification.....	3-25
3.10.8 SCPI Command Version	3-25

3.11	Calibration.....	3-25
3.11.1	Un-secure Calibration.....	3-26
3.11.2	Securing Calibration.....	3-26
3.11.3	Changing the Security Code.....	3-27
3.11.4	Calibration Procedures.....	3-27
3.11.5	Calibration String.....	3-29
3.12	Remote Control Settings.....	3-30
3.12.1	Remote Interface Selection.....	3-30
3.12.1.1	USB Interface.....	3-30
3.12.1.2	GPIB Interface.....	3-30
4.	Remote Control Reference.....	4-1
4.1	SCPI Language Summary.....	4-1
4.1.1	SCPI Language Introduction.....	4-1
4.1.2	Symbols Used in SCPI Commands.....	4-1
4.1.3	Command Format in This Manual.....	4-2
4.1.4	MIN and MAX Parameters.....	4-2
4.1.5	Setting and Querying Commands.....	4-2
4.1.6	SCPI Command Terminators.....	4-3
4.1.7	Common SCPI Commands.....	4-3
4.1.8	SCPI Parameter Types.....	4-3
4.2	SCPI Commands.....	4-4
4.2.1	Output Settings and Operation Commands.....	4-4
4.2.2	Triggering Commands.....	4-8
4.2.2.1	Trigger Source Options.....	4-8
4.2.2.2	Triggering Command Description.....	4-9
4.2.3	Output Control Commands.....	4-9
4.2.3.1	Commands for Master & Slave Application.....	4-10
4.2.3.2	Commands for Output Sequence.....	4-10
4.2.4	System-Related Commands.....	4-12
4.2.5	Calibration Commands.....	4-14
4.2.6	Status Reporting Commands.....	4-15
4.2.7	IEEE-488 Conformance Information.....	4-17
4.3	Programming Overview.....	4-17
4.3.1	Regarding Programming Ranges.....	4-17
4.3.2	Regarding SCPI Status Registers.....	4-18
4.3.2.1	The Questionable Status Register.....	4-20
4.3.2.2	The Standard Event Register.....	4-20
4.3.2.3	The Status Byte Register.....	4-21
5.	Error Messages.....	5-1
5.1	Execution Errors.....	5-1
5.2	Self-Test Errors.....	5-4
5.3	Calibration Errors.....	5-4

1. General Information

This section contains general information about 62000L series Programmable DC Power Supply. The information is shown below:

1. Features & Operations Overview
2. Warranty Information
3. Safety Information
4. Symbols and Terms
5. Specifications
6. Inspection
7. Options and Accessories

If you have any questions after reading this information, please contact your local service representative.

1.1 Features & Operations

The 62000L series is a high performance auto-ranging portable DC power supply (Max.: 108W, 36V, 7A / 150W, 60V, 6A) with a single channel output, and standard GPIB and USB interfaces. The outstanding features and easy operation provide a great solution for your R&D, manufacturing test, and QC inspection requirements.

Key Features:

- Auto-ranging allows you to freely adjust voltage and current

This feature eliminates the need to manually select the optimum range allowing all of the power to be available across all of the voltage and current settings as shown below.

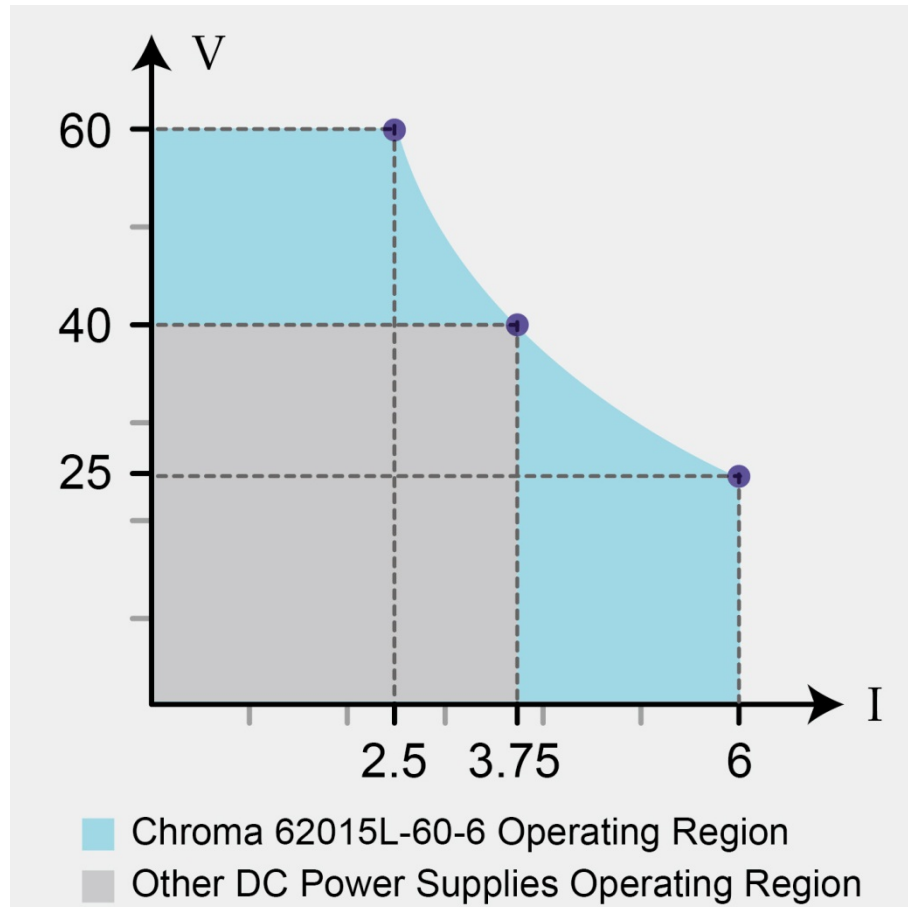

- Easy-To-Use Control Knob
The knob on the 62000L series utilizes photo-interrupted technology. It's durable and reliable. The enhanced sensitivity completely replaces the need for numerical input keys.



- Highly Readable Display
- High Accuracy and Resolution
- Fast Response Time (TR: 62010L-36-7<30us / 62015L-60-6<50us)
The oscilloscope test below measures the time for the output voltage to recover to within 15 mV of nominal output voltage. The overshoot change is a result of a 7 A to 3.5 A load step, with the recovery taking only 13.6 us.

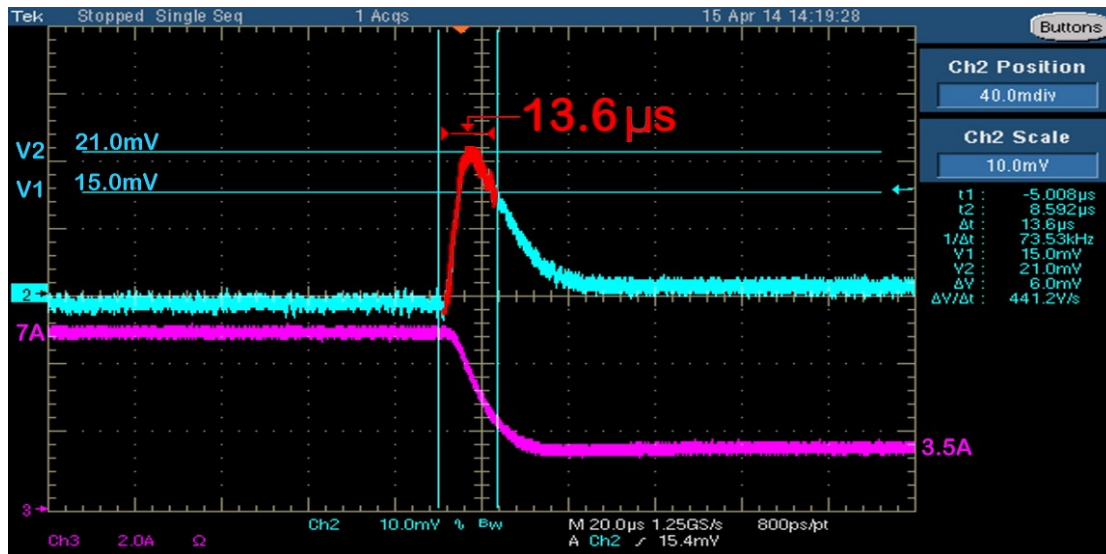

Wave in Blue: Voltage / Wave in Purple: Current
Fast Response Time – 1

This oscilloscope test measures the time for the output voltage to recover to within 15 mV of nominal output voltage. The undershoot change is a result of a 3.5 A to 7 A load step, with the recovery taking only 14.0 μ s.

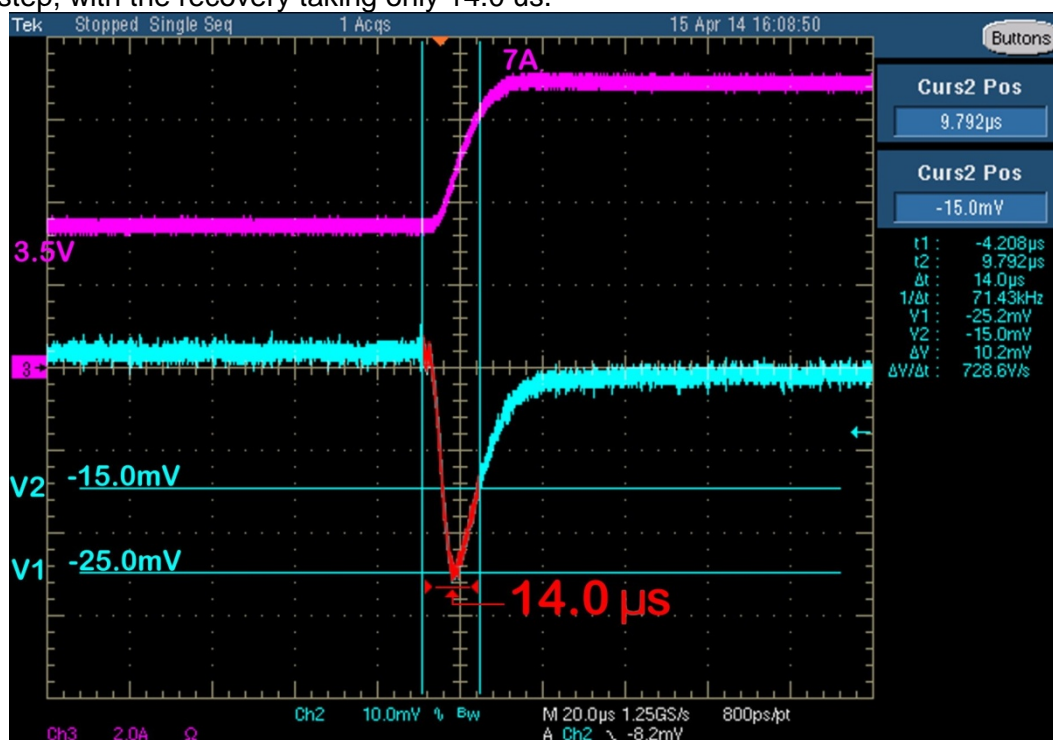

Wave in Blue: Voltage / Wave in Purple: Current
Fast Response Time – 2

- Remote Voltage Sense without Shorting Bars (for 62010L-36-7 only)
- Overvoltage Protection (OVP), Overcurrent Protection (OCP), and Over-Temperature Protection (OTP)
- Excellent Load and Line Regulation
- Low Ripple and Noise (<2 mVpp/350 μ Vrms, 2 mArms [20Hz~20MHz])
- Sixteen Storage Locations (0 ~ 15) for User-Defined Operating States
- Easy-To-Stack-Up Body

The 62000L series includes front and rear non-slip bumpers whose indentation allows the same models to be stacked.



The Front Bumper



The Rear Bumper



Units Stacked

- Hidden Carrying Handle



Hidden State



Holding State

- Portable Size (H: 2U, W: 1/2U) and Light Weight (<2.5Kgs or 5.5Lbs)
The 62000L series weight is less than 2.5Kgs. The carton size for one P961XA is 26(W)*14(H)*34(D) cm. The shipping weight for marine shipment is about 2.5 Kgs. For air shipment the weight is about 3Kgs.

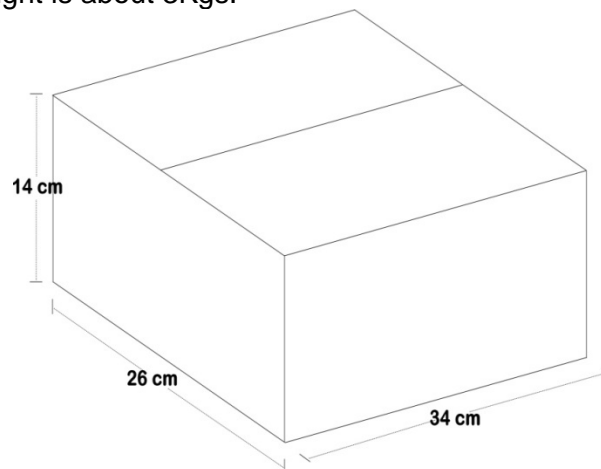

- Fast Voltage Programming Speed

Flexible Features:

- Standard USB / GPIB (IEEE-488) Interfaces
- SCPI Commands Compatible with the Keysight E3632A
- Easy I/O Setup through the Front Panel
- Easy Way to Complete Calibration
- Powerful Voltage Integration Solution via Master-Slave Connection Up to 7 Devices (Max. 252V for 62010L-36-7 only)
- Powerful Current Integration Solution via Master-Slave Connection Up to 7 Devices (Max. 49A for 62010L-36-7 only)
- Compensative External Sense when Conducting Master-Slave Connection (for 62010L-36-7 only)

Operational Features:

- Autoranging from 1mV to 36V / 1mV to 60V and from 1mA to 7A / 1mA to 6A
- Constant Voltage (CV) or Constant Current (CC) Operation
- Selective OVP and OCP Settings
- Short Circuit Protection
- Sixteen Storage Locations
- External Sense for Load Voltage (for 62010L-36-7 only)
- Error Message Tips
- Calibration via the Front Panel or Remote Interfaces
- High Efficiency with A Durable Control Knob



! The performance accuracy is subject to calibration accuracy.

1.2 Precautions

- Please carefully read the manual before operating this device.
- This manual is for reference only. Please consult your distributor for further assistance.
- The contents of this manual may be amended by the manufacturer without notice.
- Never dismantle the equipment or the equipment may be damaged.
- This equipment must not be used in dangerous situations where damage may result.
- This product should be placed in a safe area while not in use. The maximum weight loading on the 62000L series case is 20Kgs. Exceeding this might cause the equipment to malfunction.

1.3 Maintaining the 62000L Series

To clean the instrument, use a damp cloth or mild, water-based cleaner. Only clean the exterior of the instrument. Do not apply cleaner directly to the instrument or allow liquids to enter or spill on the instrument.

1.4 Product Users

This product is intended for use by qualified personnel who are cognizant of shock hazards and familiar with the safety precautions required to avoid possible injury. Read and follow all

installation, operation, and maintenance information carefully before using the product. Refer to the documentation contained in this guide for complete product specifications. If the product is used in a manner not specified, the protection provided by the product warranty may be voided.

The types of product users are:

Responsible person is the individual or group responsible for the use and maintenance of equipment, for ensuring that the equipment is operated within its specifications and operating limits, and for ensuring that operators are adequately trained.

Operators use the product for its intended function. They must be trained in electrical safety procedures and proper use of the instrument. They must be protected from electric shock and contact with hazardous live circuits.

Maintenance personnel perform routine procedures on the product to keep it operating properly, for example, setting the line voltage or replacing consumable materials. Maintenance procedures are described in the user documentation. The procedures explicitly state if the operator may perform them. Otherwise, they should be performed only by service personnel.

Service personnel are trained to work on live circuits, perform safe installations, and repair products. Only properly trained service personnel may perform installation and service procedures.

1.5 Safety Information



CAUTION Please read through the following safety information before using the product.

- **Measurement Category II** is for measurements performed on circuits which are directly connected to the low voltage installation.

To avoid possible electric shock or personal injury, please read and follow these guidelines carefully:

- Follow the guidelines in this manual and **DO NOT** use the power supply if the case is damaged. Check the case and terminals. Then contact your distributor for the case replacement.
- When using the probes, always keep your fingers behind the finger guards.
- Always connect the common test leads (black) before connecting the live test leads (red), and disconnect the live test leads (red) before disconnecting the common test leads (black). This will reduce the chance of an electric shock.
- If you need to open the power supply's case or replace any parts, read the instructions in this manual first. You must be qualified to perform this action.
- When replacing fuses, use only the same type and same rating as specified.
- Do not try to operate the power supply if it is damaged. Disconnect the power from the equipment and consult the local service representative. Return the product to Chroma service department if necessary.
- Make sure your power cord corresponds to requirements of local regulations. When replacing it, the specification must be the same as the previous one. An incorrect power cord may cause unpredictable harm or damage. Some rules to follow are shown below.

- A. Use the power cord that is shipped with your product.
- B. Ground the product. The 62000L series is grounded through the grounding conductor of the power cord. To avoid electric shock, only use an approved power cord with the product, and verify that it's connected to earth ground.
- C. Position the unit on a firm, stable surface.
- D. Shown below are the cord's connections.
 - Green: Earth (E)
 - Blue: Neutral (N)
 - Brown: Live (L) - Phase



Note | This appliance must be connected to earth ground.

1.6 Symbols and Terms



This symbol indicates hazards that may cause damage to the instrument or even result in personal injury.



This symbol indicates high voltage may be present. Use extra caution before taking any action.



This symbol indicates the frame or chassis terminal needs to be connected to actual earth ground.



This symbol indicates a "Protective Conductor Terminal."



This symbol indicates an earth (ground) terminal.



This symbol indicates this product complies with the essential requirements or the applicable European laws or directives with respect to safety, health, environment, and consumer protections.

Note | The complete set of 62000L series specifications is included in specification table.

1.7 Electrical Specifications

ELECTRICAL SPECIFICATIONS		
Model	62010L-36-7	62015L-60-6
Output Ratings (@ 0°C ~ 40°C)		
Output Voltage	0~36V	0~60V
Output Current	0~7A	0~6A
Output Power	108W	150W
Line Regulation ¹		
Voltage	0.01%+2mV	0.01%+2mV
Current	0.01%+250uA	0.01%+250uA
Load Regulation ²		
Voltage	< 0.01%+2mV	< 0.01%+2mV
Current	< 0.01%+250uA	< 0.01%+250uA
Measurement Accuracy		
Voltage	0.05%+5mV	0.05%+5mV
Current	0.15%+5mA	0.15%+5mA
Output Noise & Ripple ³		
Voltage Noise (p-p)	< 2mVp-p	< 3mVp-p
Voltage Ripple (rms)	< 0.35mVrms	< 0.5mVrms
Current Ripple (rms)	< 2mArms	< 2mArms
Transient Response Time		
100% to 50% load change	< 30usec	< 50usec
Temperature Coefficient ⁴		
Voltage	0.01%+3mV	0.01%+10mV
Current	0.02%+3mA	0.02%+3mA
Drift ⁴		
Voltage	0.02%+1mV	0.05%+10mV
Current	0.1%+1mA	0.15%+2mA
Programming & Measurement Resolution		
Voltage (Front Panel)	1mV	10mV
Current (Front Panel)	0.1mA	1mA
Voltage (Remote Interface)	1mV	1mV
Current (Remote Interface)	0.1mA	0.21mA
Voltage (Analog Programming Interface)	1mV	1mV
Current (Analog Programming Interface)	0.21mA	1mA
Programming Accuracy ⁵		
Voltage	0.05%+10mV	0.05%+10mV
Current	0.2%+10mA	0.2%+10mA
Programming Response Time ⁶		
Rise Time (Full Load)	< 40ms	< 100ms
Rise Time (No Load)	< 20ms	< 35ms
Fall Time (Full Load)	< 40ms	< 50ms
Fall Time (No Load)	< 400ms	< 500ms
Measure Voltage, Current (under GPIB command using Measure)	< 20ms	< 20ms
OVP/OCP		
OVP Accuracy	0.1%+0.2V	0.1%+0.3V
OCP Accuracy	0.2%+0.2A	0.2%+0.3A

OVP Activation Time	<1.5ms (when the trip voltage is equal or greater than 2V) <10ms (when the trip voltage is less than 2V)
OCP Activation Time	<10ms
AC Input Operating Voltage Range	1 ϕ 100~120Vac \pm 10% V_{LN} or 1 ϕ 220~240Vac \pm 10% V_{LN} , 47~63 Hz
Operating Temperature	0°C to 40°C
Operating Humidity	Maximum relative humidity 80% for temperature up to 35°C
Storage Temperature	- 40°C to 70°C
Operating Altitude	Up to 2000 M
Interfaces	USB & GPIB standard
Dimension (H x W x D)	88.6 x 214.6 x 280.7 mm / 3.49 x 8.45 x 11.05 inch
Weight	< 2.5 kg / 5.5 lbs

- Note**
1. Change in output voltage or current for any load change within ratings.
 2. For 0-100% load step with nominal line voltage.
 3. with outputs ungrounded, or either output terminal grounded, 20 Hz to 20 MHz.
 4. Maximum change in output/read-back per °C after a 30-minute warm-up.
 5. The accuracy specifications are gained under 1-hour warm-up condition and the calibration at 25°C.
 6. Maximum time required for output voltage to settle within 1% of its total excursion (for resistive load). Excludes command processing time.

1.8 Contents

Make sure that you have received the following items in the shipment of your power supply. If anything is missing, damaged, or malfunctioning, contact your distributor.

- One 62010L-36-7 or 62015L-60-6 (88.6[H] x 214.6 [W] x 280.7 [D] mm, < 2.5 Kgs)
- USB & GPIB interface card (USB cord included)
- Front/rear bumper
- NEMA 5–15 one power line cord
- One CD (including this electronic User's Manual)

1.9 Dimension

1. The dimension without the front & rear bumpers, and the terminals is (LxWxD - 214.6 x 88.6 x 280.7 mm).
2. The dimension with the front & rear bumpers, but without the terminals is (LxWxD – 226.8 x 107 x 305 mm).

2. Preliminary Check

Before using this power supply for the first time, please complete the following actions.

1. Make sure that the power line voltage setting on the rear panel is correct:
The power line voltage must be set to the proper value for your country once you receive this unit. There are 115 Vac and 230 Vac selections available.
2. Make sure that the correct power line fuse is installed: For 115 Vac, a 4 AT fuse is used.
For 230 Vac, a 2.5 AT fuse is used.
3. Make sure that the power cord is connected.

2.1 Power-On Check

When the power supply is powered on, it will execute an automatic self-test that checks the internal microprocessor and allows the user to check the display visually.

- All of the segment of the display will light up during the power-on self-test is executing.
- If the power-on test failed, an error is generated and the **ERR** annunciator is lit.

2.2 Output Check

An output check is performed in order to verify that the power supply outputs are valid and properly responding to commands from the front panel.

2.2.1 Voltage Output Check

Through the following steps, you may check the basic voltage functions under no load conditions.

1. Turn on the power supply: The power-on/reset state is running, the output is disabled (the OFF light is on), and the knob is selected for voltage control.
2. Enable the outputs: After pressing the Output On/Off button once, some symbols, such as OVP, OCP are lit, as well as the CV or CC according to the resistance of the test load. The blinking cursor can be changed by turning the knob. Please note that the display is in the meter mode which means that the display shows the actual output voltage and current.
3. Verify that the front panel voltmeter responds to knob control within the 0~36V(62010L-36-7)/0~60V(62015L-60-6) ranges: Rotate the knob clockwise or counter-clockwise to check whether the voltmeter tracks the knob control, and the ammeter shows nearly zero amps.
4. Make sure that the voltage can be adjusted within the 0~36V (62010L-36-7)/0~60V (62015L-60-6) range: Rotate the knob until the voltmeter shows 36V/60V.

2.2.2 Current Output Check

Through the following steps, you may check the basic current functions with a short on the power supply's output.

1. Turn on the power supply: The power-on/reset state is running, the output is disabled (the OFF light is on), and the knob is selected for voltage control.
2. Connect a short across the (+) and (–) output terminals with an insulated test lead.
3. Enable the output: Some symbols, such as OVP, OCP are lit, as well as the CV or CC according to the resistance of the test lead. The blinking cursor can be changed by turning the knob. Please note that the display is in the meter mode which means that the display shows the actual output voltage and current.
4. Verify that the front panel ammeter responds to knob control within the 0~7A(62010L-36-7)/0~6A(62015L-60-6) range: Rotate the knob clockwise or counter-clockwise to check whether the ammeter tracks the knob control and shows nearly zero.
5. Make sure that the current can be adjusted within the 0~7A/0~6A range: Rotate the knob until the ammeter shows 7A/6A.

2.3 Input Power Check

This power supply can operate properly using a 115V or 230V single phase AC power source at 50Hz to 60Hz. The rear panel shows the nominal input voltage set for the power supply at the factory. If need be, the power-line voltage setting can be changed according to the instructions as shown in “Power-Line Voltage Selection” below.

2.3.1 Power-Line Cord Check

A power-line cord, which has an appropriate plug for your location, is shipped with the power supply. If a wrong power-line cord is included with your power supply, contact your local distributor.

This power-line cord consists of a 3-wire grounding type power lead where the third conductor is the ground. You should ground the power supply by plugging the power-line cord into a proper outlet. Please do not operate this equipment without effective grounding facilities.

2.3.2 Power-Line Voltage Selection

To select the power-line voltage, you have to adjust two components, including the power-line voltage selector and the power-line fuse. They are located on the power-line module on the rear panel.

When you want to change the power-line voltage, please proceed as follows.

1. Remove the power cord: Use a flat-blade screwdriver to remove the fuse-holder assembly from the rear panel.
2. Install the correct line fuse: Take out the power-line voltage selector from the power-line module and install the correct fuse
 - 115Vac, 4AT Fuse

- 230Vac, 2.5AT Fuse
- 3. Change position of the power-line voltage selector until the correct voltage appears.
- 4. Put back the power-line voltage selector and the fuse-holder assembly.



Note The default setting is 230V, make sure that the correct voltage is applied and the fuse works properly.

2.4 Panel Check & Setting

The front panel overview discusses the function key description, various settings, and the description of the display. The rear panel overview discusses the optional interfaces.

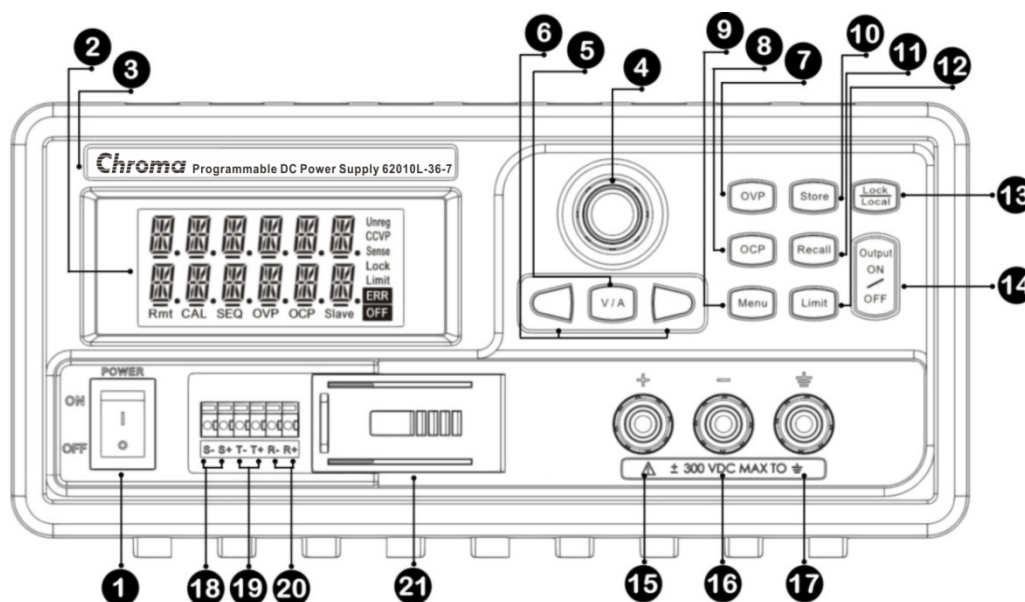
2.4.1 Front Panel Overview



1. **Power Switch:** Press the (I) side to turn the power on and the (O) side to turn the power off.
2. **Display:** During operation, the display shows information about the output (top row) for voltage, and (bottom row) for current. During configuration, the display shows a control interface.
3. **Brand & Model Sticker Area:** This area shows the product manufacturer and model name.
4. **Navigation Wheel:** Rotate this knob to increase or decrease the flashing digit by turning the knob clockwise or counter-clockwise. It is also used to select menu items.
5. **V/A Button:** Press this button to change the output from Volts to Current or Current to Volts. Pressing this button long under the SEQ mode in output condition, the display will show the information of V & A, V & W, or SEQCNT.
6. **Arrow Buttons:** Press  once. The display cursor moves right one digit. Press  once. The display cursor moves left one digit. Pressing these buttons under the Store and the Recall, you can see the set parameters.
7. **OVP Button:** Enable or disable the overvoltage protection function, set the trip voltage level, and clear overvoltage condition.

8. **OCP Button:** Enable or disable the overcurrent protection function, set the trip current level, and clear overcurrent condition.
9. **Menu:** This button accesses the function settings. When the Menu button is pressed, and the knob is rotated, the display will show SENSE, MA/SL, SEQ, SYSTEM, CAL, and GPIB one by one. This button is also used to answer "Yes", i.e. "Confirmed" or "Applied."
10. **Store Button:** Store an operating state at the location 0, 1, 2... or 15.
11. **Recall Button:** Recall a previously stored operating state from the location 0, 1, 2... or 15.
12. **Limit Button:** Press it to show the voltage and current limit values on the display and allow the knob adjustment to set the limit values.
13. **Lock/Local Button:** When pressing the **LOCK** button, the Lock annunciator on the display is lit, and the Lock function is enabled until the same button is pressed once again. This button can be used as the Local Key when the power supply is operating under the remote interface mode.
14. **Output On/Off Button:** Enable or disable the power supply output. This key toggles between on and off.
15. **Positive Terminal:** Red terminal outputs positive voltage.
16. **Negative Terminal:** Black terminal outputs negative voltage.
17. **GND Terminal:** Terminal is at earth potential. Used for measurement of control circuits designed to be operated with one terminal at earth potential.
18. **Sensing Terminal (S+/S-):** The Remote Sensing Terminal is used to compensate for load current dependent voltage drops.
19. **Transfer Terminal (T+/T-):** Under the Master-Slave Mode, the master unit's T+ connects to the first slave unit's R+. Then its R- connects to the other unit's R+, and so on. The last slave unit's R- connects to the master unit's T-.
20. **Recipient Terminal (R+/R-):** Under the Master-Slave Mode, the master unit's T+ connects to the first slave unit's R+. Then its R- connects to the other unit's R+ and so on. The last slave unit's R- connects to the master unit's T-.
21. **Remote Sensing Cover:** This cover is used to protect against moisture and dust.

2.4.2 Rear Panel Overview

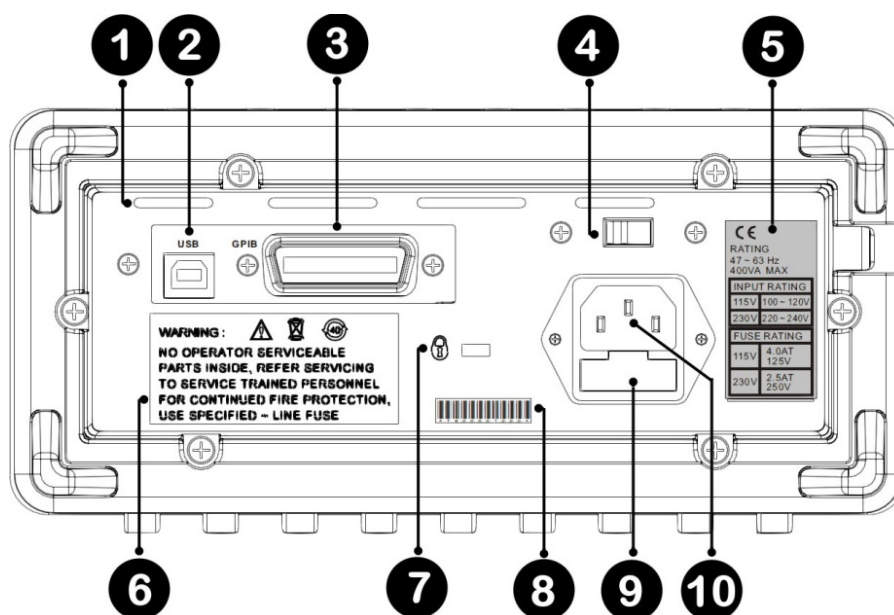

1. **Air Outlet:** There are four air vents for cooling purposes.
2. **USB Interface:** USB interface

3. **GPIO Interface:** Through the IEEE-488 interface, you can communicate with any PC which has an IEEE-488 port.
4. **Power-Line Voltage Setting:** There are 115V & 230V options.
5. **Information:** This power supply conforms to CE requirements, with a maximum of 400VA consumption. As the note indicates the power supply requires the correct rated power line voltage and specified power line fuse.
6. **Warning Indication:** If there is something wrong with the unit, please ask trained personnel for assistance. To maintain fire protection, use the correct specified line fuse.
7. **Security Lock Port:** This port is used to insert a security lock that prevents the unit from being stolen or moved.
8. **Serial Number:** The number is the identification of the unit. If repairs are needed please supply this number and the condition of the units to your local distributor or the factory via the email address info@chromaate.com.
9. **Fuse Holder:** If the fuse is broken, please use the correctly rated one to replace it.
10. **Power Line Inlet:** This input is for power line voltages only. Before powering the unit on, please check the voltage setting 115V/230V in order to make sure it meets your local requirements.

2.4.3 Voltage & Current Limit Settings

The CV Limit refers to a required setting condition when outputting a constant voltage in need. The CC Limit refers to a required setting condition when outputting a constant current in need.

The concept of the CV/CC limit setting is not the same as the Vrange's at the section 3.10.5 since the limit depends on the relationships between the interactive factors of voltage setting, resistance (R_{Load}), and rated/non-rated current. For example:

1. When $\frac{CV_Limit}{R_{Load}} < CC_Limit$, the power supply will be in the CV mode, and its voltage will output constantly. The output current is in an inversed ratio with the R_{Load}.
2. When $\frac{CV_Limit}{R_{Load}} \geq CC_Limit$, the power supply will be in the CC mode, and its current will output constantly. The output voltage is in a direct ratio with the R_{Load}, and it will stop rising when the output voltage is equal to the setting value of the CV Limit, however, if the R_{Load} increases, the power supply will turn to the CV mode to output.

Besides this, there is something you should know below.

If adjusting a CV limit under the Output ON, please make sure whether this supply is in the CV mode since the knob rotation in the CV meter mode will trig the CV limit setting mode simultaneously, and the values on the both displays are the same. In this case, if the same condition exists in the CC mode, once the R_{Load} changes, it might burn out your DUT. So in the CC mode, before the R_{Load} changes, you have to press the limit button once, and adjust the CV limit value to protect your DUT.

If adjusting a CC limit under the Output ON, please make sure whether this supply is in the CC mode since the knob rotation in the CC meter mode will trig the CC limit setting mode simultaneously, and the values on the both displays are the same. In this case, if the same condition exists in the CV mode, once the R_{Load} changes, it might burn out your DUT. So in the CV mode, before the R_{Load} changes, you have to press the limit button once, and adjust the CC limit value to protect your DUT.

To set the voltage and current limit values through the front panel, please follow the procedures below.

1. Press the **Limit** button to display the default values.
2. Move the blinking cursor to the proper position by using the **▶** or **◀** buttons, and change the blinking cursor value to the required voltage limit by rotating the control knob. If the limit change times out, press the **Limit** button again.
3. Set the knob to current control mode using the **V/A** button.
4. Move the blinking cursor to the proper position by using the **▶** or **◀** buttons, and change the value to the required current limit by rotating the control knob.
5. Press the **Output On/Off** button to enable the output and set the limit. In a few seconds, the display will go into the output meter mode automatically and display the voltage and current of the output. You can force the display to go into output meter mode right away by pressing **Limit** button again.

2.4.4 Display Check

To get familiar with your power supply, you need to familiarize yourself with the display. The whole display will light up for 3 seconds when the unit is powered on. After two short beeps, the supply will initialize in the OUTPUT OFF condition.

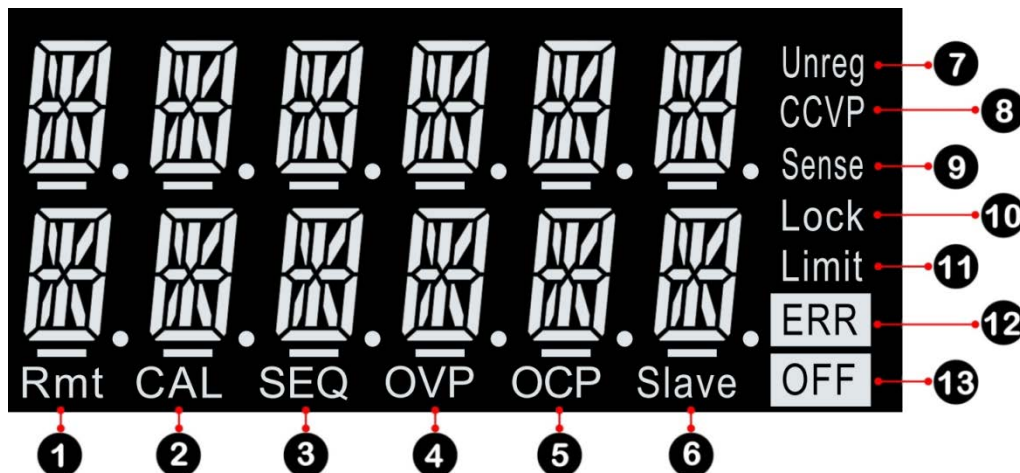

1. **Rmt**: The power supply is in the remote interface mode.
2. **CAL**: The power supply is in the calibration mode.
3. **SEQ**: The power supply is in the sequencing mode. You can set the voltage and current output value and the timing. There are 8 steps to set sequencing values.
4. **OVP**: When this symbol is lit solidly, the overvoltage protection function is enabled. If the OVP item blinks then the overvoltage protection circuit has caused the power supply to shut down.
5. **OCP**: When this symbol is lit solidly, the overcurrent protection function is enabled. If the OCP item blinks then the overcurrent protection circuit has caused the power supply to shut down.
6. **Slave**: When this symbol is lit, the power supply's status has been set to SLAVE in parallel or in series (for P9610A only).
7. **Unreg**: The power supply's output is unregulated. It's neither CV nor CC.
8. **CV/CC/CP**: CV or CC means the power supply is under the constant voltage mode or the constant current mode, respectively. When CP is lit and exceeding the rated VA under either the CV or the CC mode, the rated power (For 62010L-36-7: **108W** / For 62015L-60-6: **150W**) can not be raised any further.
9. **Sense**: When this symbol is lit, the Remote Sense function is enabled (for 62010L-36-7 only).

10. **Lock:** Press the **Lock** button. The front panel can not be operated until you release the condition by pressing the **LOCK** button again.
11. **Limit:** The display shows the values for the voltage and current limits.
12. **ERR:** Some hardware or remote interface command errors are detected and the error has not been cleared.
13. **OFF:** The power supply's output is disabled.

Note | You can display the following condition after rebooting your power supply. To show "OUTPUT OFF" on the display, you have to select 0 through the menu operation of the path, Menu > SYSTEM >STYLE. To show "CV & CC Limit Setting with lit annunciators, Limit and OFF" you have to select 1 through the menu operation of the path, Menu > SYSTEM >STYLE. This setting doesn't support Master/Slave mode, and SEQ mode.

3. Power Supply Operation

Please read the following overview of the front panel keys before operating the power supply.

- The power supply is configured to front panel operation mode by default before shipment. While powering on, the power supply automatically enters into the front panel operation mode. When the power supply is under the remote operation mode, you can return to the front panel operation mode by pressing the **Local** button if you didn't lock the key by command.
- This power supply is autoranging. You can set a desired voltage and current within 0V ~ 36V, 0A ~ 7A (on the 62010L-36-7) or 0V ~ 60V, 0A ~ 6A (on the 62015L-60-6). The product of the voltage and current must be less than 108W (62010L-36-7) or 150W (62015L-60-6). For example, on the P9611A, when the voltage is set to the maximum of 60V, the maximum output current is $150\text{W}/60\text{V} = 2.5\text{A}$. For a 40V setting, the maximum output current is 3.75A. The maximum output power of 150W is available for all Volt/Amp combinations that lie on the hyperbolic curve in blue as pictured below.

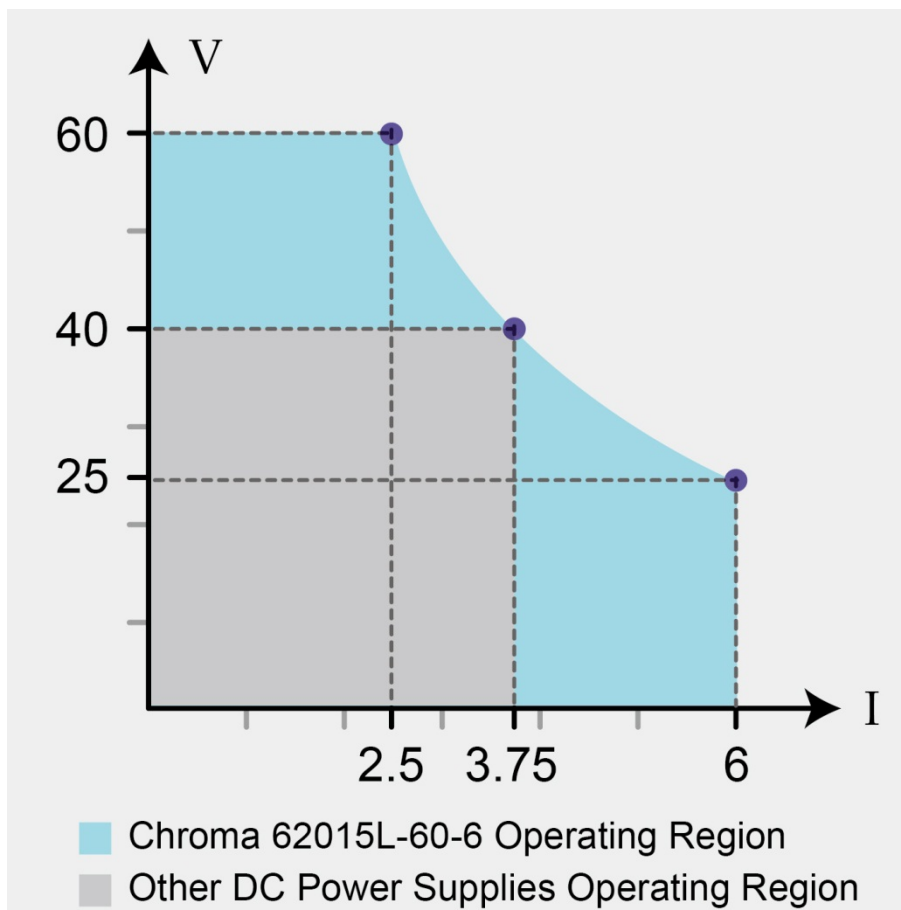

- Pressing the **Limit** button causes the display of the power supply to change to the limit mode. The present limit values are displayed. Under this mode, you can observe the change of the limit values by adjusting the control knob. If the **Limit** button is pressed again, or if the function times-out in several seconds, the display turns back to the meter mode. The actual output voltage and current will be shown.
- The power supply's output can be enabled or disabled from the front panel by pressing the **Output ON/OFF** button. When you turn off the output, the **OUTPUT OFF** symbols and **OFF** are lit on the display.

- The display presents operating status and error codes for the power supply. For example, when an error occurs, the **ERR** symbol will light up on the display. For more information, please refer to “2.4.4 Display Check.”

3.1 Constant Voltage Operation

Constant voltage (CV) operation, using the front panel or through remote control, is reviewed below.

Front Panel Operation:

1. **Connect a load to the output terminals:** Before turning the power on, connect a load to the + and – output terminals.
2. **Initial turn on of the power supply:** When the power supply is first turned on, it disables the output.
3. **Set the limit mode:** When the **Limit** lights up on the display by pressing the **Limit** button, the limit mode is entered. You can see the voltage and current limit values on the display.

Note Under the constant voltage mode, the voltage values between the meter and the limit mode are identical. In addition, if the display is under the meter mode, you are not able to see the change in the current limit value when adjusting the knob. Therefore, to see the change in the current limit value in the constant voltage mode, enter the limit mode.

4. **Use the knob to set the desired current limit:** Press the **Limit** button on the front panel and set the knob to current control by pressing the **V/A** button. The cursor under the first digit of the ammeter flashes. You can change the flashing cursor using the **▶** or **◀** buttons, and adjust the value to the desired current limit by turning the knob. The limit setting is disabled and the Limit on the display extinguishes in 5 seconds without any operations.
5. **Use the knob to set the desired voltage limit:** Press the **Limit** button on the front panel and set the knob to voltage control by pressing the **V/A** button. The cursor under the second digit of the voltmeter flashes. You can change the flashing digit using the **▶** or **◀** buttons, and adjust the value to the desired output voltage. The limit setting is disabled and the Limit on the display extinguishes in 5 seconds without any operations.
6. **Get back to the meter mode:** Press the **Limit** button or let the display time-out after several seconds to get back to meter mode.
7. **Enable the output:** The **OFF** symbol on the display is turned off by pressing Output button. Then, OVP, OCP, and CV light up. The display goes into the meter mode. Under this mode, the display shows the actual output voltage and current.
8. **To make sure that the power supply is under the constant voltage mode:** If you operate the power supply under the constant voltage (CV) mode, make sure that the CV on the display is lit. If the CC on the display is lit, please select a higher current limit.

Note

1. To use the control knob to set a desired voltage and current limit, you can use the **▶** or **◀** buttons to move the flashing cursor to a desired location.
2. If a load change during actual CV operation causes the current limit to be exceeded, the power supply will automatically adjust the constant current, and the output voltage will drop in proportion.
3. When the VA value from setting the meter mode or the limit mode exceeds the rated power like 108W on the 62010L-36-7, or 150W on the 62015L-60-6, the limit signal on the display will flash until you decrease the voltage or the current in order to set the power lower than the rated value.

Remote Operation:**CURRent** {<current> /MIN/MAX}

This command sets the current.

VOLTage {<voltage> /MIN/MAX}

This command sets the voltage.

OUTPut ON

This command enables the output.

3.2 Constant Current Operation

Constant current (CC) operation, using the front panel or through remote control, is reviewed below. The relative operation buttons are the same as the ones at *section 3.1*.

Front Panel Operation:

- 1. Connect a load to the output terminals:** Before turning on the power, connect a load to the + and – output terminals.
- 2. Initial turn on of the power supply:** When the power supply is first turned on, it disables the output.
- 3. Set the limit mode:** When the **Limit** flashes on the display, the limit mode is entered. You can see the voltage and current limit values on the display.

Note Under the constant current mode, the current values between the meter and the limit mode are identical. In addition, if the display is under the meter mode, are not able to see the change in the voltage limit value when adjusting the knob. Therefore, to see the change in the voltage limit value in the constant current mode, enter the limit mode.

- 4. Use the knob to set the desired current limit:** Press the **Limit** button on the front panel and set the knob to current control by pressing the **V/A** button. The cursor under the first digit of the ammeter flashes. You can change the flashing cursor using the **▶** or **◀** buttons, and adjust the value to the desired current limit by turning the knob. The limit setting is disabled and the Limit on the display extinguishes in 5 seconds without any operations.
- 5. Use the knob to set the desired voltage limit:** Press the **Limit** button on the front panel and set the knob to current control by pressing the **V/A** button. The cursor under the second digit of the voltmeter flashes. You can change the flashing digit using the **▶** or **◀** buttons, and adjust the value to a desired output voltage. The limit setting is disabled, and the Limit on the display extinguishes in 5 seconds without any operations.
- 6. Get back to the meter mode:** Press the **Limit** button or let the display time-out after several seconds to get back to meter mode. Then the Limit on the display turns off, and the display shows “OUTPUT OFF.”
- 7. Enable the output:** The **OFF** on the display is turned off. Then OVP, OCP, and CC are lit. The display goes into the meter mode. Under this mode, the display shows the actual output voltage and current.
- 8. To make sure that the power supply is under the constant current mode:** If you operate the power supply under the constant current (CC) mode, make sure that the CC on the display is lit. If the CV on the display is lit, choose a higher voltage limit.

Note

- To use the knob to set a desired voltage and current limit, you can use the **▶** or **◀** buttons to move the flashing cursor to the right or left.
- If a load change during actual CC operation causes the voltage limit to be

- exceeded, the power supply will automatically adjust the constant voltage, and the output current will drop in proportion.
3. When the VA value from setting the meter mode or the limit mode exceeds the rated power like 108W on the 62010L-36-7, or 150W on the 62015L-60-6, the limit signal on the display will flash until you decrease the voltage or the current in order to set the power lower than the rated value.

Remote Operation:

VOLTage {<voltage> |MIN|MAX}

This command sets the voltage.

CURRent {<current> |MIN|MAX}

This command sets the current.

OUTPut ON

This command is applied to enable the output.

3.3 Storing and Recalling Operation States

The power supply can remember 16 different operating states in non-volatile memory. An operating state contains CV limit, CC limit, OVP trip level, OVP ON/OFF state, OCP trip level and OCP ON/OFF state. Location 0 is the power-on state. You can recall one of the saved states through the front panel or remote control. The reset state (62010L-36-7's factory default - OVP Level: 39.6V/OVP ON/OCP Level: 7.7A/OCP ON/Voltage Limit: 0V/Current Limit: 3A) is initially saved in the locations from 0 to 15. You might use the following procedures to store and recall an operating state.

Note | The 62015L-60-6 has the factory default, OVP Level: 66V/OVP ON/OCP Level: 6.6A/OCP ON/Voltage Limit: 0V/Current Limit: 6A.

Storing an Operating State via the Front Panel

1. Press the **Store** button.
2. Rotate the knob and select a location from 0 to 15, where you want to save your settings. You can use **▶** or **◀** buttons to review the settings stored in the selected location.
3. Press the **Store** button to store active operating state. If you want the settings you define as the power-on state, save your settings in Location 0.
4. To abort the storing operation, press any other button except the Store button.

Recalling a Stored State via the Front Panel

1. Press the **Recall** button.
2. Rotate the knob and select the stored location you want. You can use **▶** or **◀** buttons to review the settings stored in the selected location.
3. Press the **Recall** button once again to recall the stored settings.
4. To abort the recall operation, press any other button except the Recall.

Remote Operation:

***SAVE** {0|1|...|15}

Save an operating state to a specified location.

***RCL** {0|1|...|15}

Recall a stored state from a specified location.

3.4 Setting the Overvoltage Protection

The overvoltage protection is designed to prevent the load from output voltages that reach a specified value greater than the defined protection value. To accomplish the OVP, the output is shorted via an internal SCR when the trip level is set greater than 3V or by programming the output to 1V when the trip level is set to less than 3V.

The following procedures show how to set the OVP trip level, how to check OVP operation, and how to clear overvoltage condition.

To set the OVP level and enable the OVP circuit via the Front Panel

1. **Turn on the power supply:** When the power supply turns on, it goes into a disabled output state.
2. **Get into the OVP menu and set a desired trip level:** Press the **OVP** key. You will see **LEVEL 39.60V/66V** on the 62010L-36-7/62015L-60-6 display. Press the **▶** or **◀** buttons to move the cursor and adjust the control knob for a desired OVP trip level. The trip levels can be set within 0V to 39.6V/66V.
3. **Enable the OVP circuit:** Press **OVP** key again. The OVP with the blinking **ON** symbols shows on the display. Press the same button once again to finish. The power supply will exit the OVP menu and the display will return to the meter mode. Then you will see the OVP lit at the bottom of the display.
4. **Exit the OVP menu without saving:** Before applying the above procedure, you can press any other key to exit from the present OVP settings, which will not be saved in the non-volatile memory.

Inspecting the OVP settings via the Front Panel

To inspect OVP operation, increase the output voltage to near the trip point. Then raise the output by rotating the knob until the OVP circuit trips. This operation will cause the power supply output to drop to zero, the **OVP** on the display will blink, and the **CV** symbol will light. The **OVP TRIP** message is displayed immediately.

Clearing the overvoltage condition via the Front Panel

If the OVP Trip symbol appears, and this condition is caused by an external voltage source like a battery, disconnect the source first. The following procedures show you how to clear the overvoltage condition and revert to the normal mode operation.

1. **Set the OVP trip level:** Press the **OVP** button and raise the OVP trip level with the knob so that the trip level's value is higher than the output level. To review the output voltage value, you can press the **Limit** button.
2. **Move to the clear mode:** Press the **OVP** button. The OVP symbol will blink **ON**.
3. **Clear OVP and exit the settings:** Rotate the knob clockwise in order to see the blinking **CLEAR** symbol. Press the **OVP** button again to clear the previous memorized OVP value. The output will return to the meter mode.

Remote Operation:

VOLT:PROT {<voltage>|MIN|MAX}

Set the OVP level.

VOLT:PROT:STAT {OFF|ON}

Disable or enable the OVP circuit.

VOLT:PROT:CLE

Clear the tripped OVP circuit.

Note ⓘ The OVP circuit contains a crowbar SCR, which efficiently shorts the output of

the power supply once the overvoltage condition occurs. If the output of your power supply connects an external voltage source such as a battery, the SCR will continuously sink a large amount of current from the source and possibly damage the power supply. To avoid the damage, a diode must be connected in series with the output as shown below.

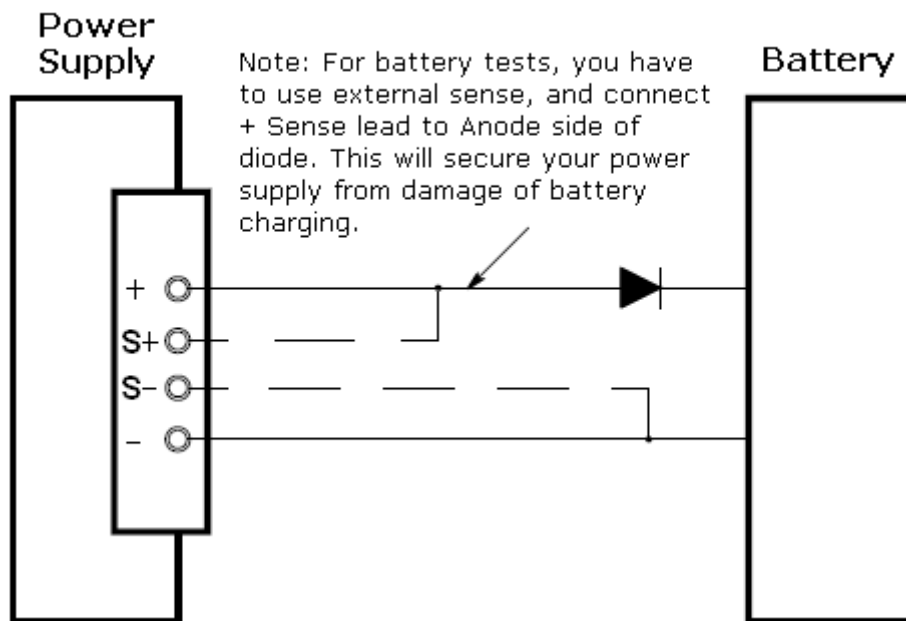

3.5 Setting the Overcurrent Protection

The overcurrent protection is designed to prevent the load from output currents that reach a specified value greater than the defined protection value.

The following procedures show how to set the OCP trip level, how to check OCP operation, and how to clear the overcurrent condition.

Setting the OCP level and enabling the OCP circuit via the front panel

1. **Turn on the power supply:** When the power supply first turns on, the output is disabled.
2. **To get into the OCP menu and set a desired trip level:** Press the **OCP** button once, you will see the **LEVEL 7.70A/6.6A** on the P9610A/11A display. Press the **▶** or **◀** buttons to move the cursor and adjust the control knob for a desired OCP trip level.
3. **Enable the OCP circuit:** Press the **OCP** button once again. The OCP symbol will blink **ON**. Press the same key to finish. The power supply will exit the OCP menu and the display will return to the meter mode. Then you can see the OCP lit at the bottom of the display.
4. **Exit the OCP menu without saving:** Before applying the above procedure, you can press any other key to exit from the OCP changing operation. The conditions will not be saved.

Inspecting the OCP settings via the front panel

To inspect OCP setting, increase the output current to near the trip point. Then raise the output by rotating the knob until the OCP circuit trips. This operation will cause the power

supply output to drop to zero and the **OC** symbol will start to blink. The **OC TRIP** message will be displayed immediately.

Clearing the overcurrent condition via the front panel

When the OCP Trip appears, and if it was caused by an external voltage source like a battery, disconnect the source first. The following procedures show you how to clear the overcurrent condition and revert to the normal mode operation.

1. **Set the OCP trip level or the output current level:** Press the **OC** button once and raise the OCP trip level with the knob. The trip level's value has to be higher than the output level.
2. **Move to the clear mode:** Press the **OC** button once. The OCP symbol will blink **ON**.
3. **Clear OCP and exit the settings:** Rotate the knob clockwise to see the blinking **CLEAR** symbol. Press the **OC** button once again to clear the previously memorized OCP value. The output will return to the meter mode.

Remote Operation:

CURR:PROT {<current>|MIN|MAX}

Set the OCP level.

CURR:PROT:STAT {OFF|ON}

Disable or enable the OCP circuit.

CURR:PROT:CLE

Clear the tripped OCP circuit.

3.6 Remote Sensing (for 62010L-36-7 only)

Remote Sensing is applied to keep regulation from degrading which might occur due to the voltage drop between the output connection of the power supply and the load.

After connecting the power supply to the load, voltage is sensed at the load rather than at the power supply's output terminals. This connection allows the power supply to generate sufficient voltage to the load automatically due to the voltage drop in applications with long lead lengths, and read back an accurate voltage directly over the load.

When the Remote Voltage Sense is applied, the OVP circuit senses the voltage at the load terminals, not the power supply output terminals.

How to use Remote Voltage Sense

There are three steps to using the Remote Voltage Sense. First of all, the output + and – of the P9610A have to be wired to your DUT's + and - terminals. Second, the sense + and – of the P9610A have to be wired to your DUT's + and - terminals. Third, you need to enable the sense option via the front panel.

1. Wire the 62010L-36-7's output to your DUT:

You can connect the output + & – of the power supply, and DUT's + & - through either banana leads, or bare leads.

Note When you use bare leads to connect the power supply, please rotate the + & - terminals of the power supply counter-clockwise to release some spaces for bare leads' insertion. Then rotate the terminals clockwise to fasten the connection.



2. Wire the 62010L-36-7's sense to your DUT:

The terminals of the positive sense (S+) and the negative sense (S-) are located with the terminals of the positive transfer (T+), the negative transfer (T-), the positive recipient (R+), and the negative recipient (R-). The terminals (T+/T-/R+/R-) are used for Master-Slave control.



To wire the sense terminal of your power supply, you need to use a screwdriver with a flat head whose diameter is equivalent to or less than 3 millimeters. With the screwdriver pressing on the red area, you can insert a lead into the terminal as shown below.



Negative Sense Connection



Positive Sense connection

3. Enable the sense via the front panel operation:

To enable the remote sense, you have to turn off the output first and press the Menu button once. The SENSE symbol will blink. Press the Menu button once again. The display will show a blinking INT. Rotate the knob to display the blinking EXT symbol. Press the Menu button to finish the setting. The output will return to the meter mode. The sense signal will light at the right side of the display as shown below. To exit the configuration session, press any other key to exit.

3.6.1 Constant Voltage Regulation

The constant voltage (CV) regulation specification for load applications applies at the output terminals of the power supply. Under the Remote Voltage Sense, you have to add 5mV to this specification for each drop of 1V between the positive load point and + output terminal of the power supply since the load current is changed. For this potential issue, the lead length has to

be taken into account. It is important to keep the resistance of the sense leads at or below 0.50Ω for each lead in order to meet the above-specified performance.

3.6.2 Output Rating

The rated output voltage and current specifications apply at the output terminals. When using Remote Voltage Sense, any voltage dropped along the load leads has to be taken into account and added to the load voltage in order to achieve the correct output voltage. However, the performance specifications cannot be assured when the maximum output voltage at the output terminals is exceeded. In the event this occurs, **UNREG** will be shown on the display.

3.6.3 Output Interference

Any interference (noise) occurring on the sense leads also appears at the output of the power supply. This may affect the voltage load regulation as well. To minimize external noise, it is better to twist the sense leads, and run them in parallel and close to the load leads. The sense leads must be shielded in any case, and the shield must be grounded at the power supply end only.

Note ⓘ Don't use the shield as one of the sense conductors.

3.6.4 Stability

When you use the external sense under certain combinations of load lead lengths, and large load capacitances, a filter may be created as part of the voltage feedback loop. In addition, the extra phase shift generated by this filter can decrease the power supply's stability, slowing down the transient response. In extreme cases, it may cause power supply oscillations. To minimize this potential issue, keep the load leads as short as possible and twist them together. When the remote sense leads are used, various adverse effects can occur as a result of accidental open-connections of the sense or load leads during external sense operation. To avoid these effects, please provide secure permanent connections.

3.6.5 Remote Sensing Connections

Remote Sensing needs to connect the load leads from the output terminals to the load and the sense leads from the sense terminals to the load as shown below.

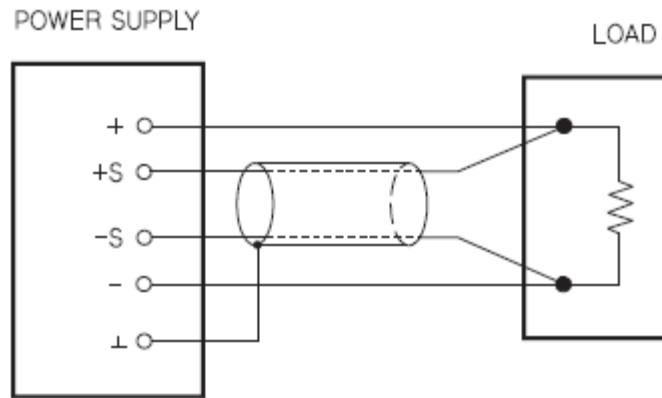

- Note**
1. For voltage sense connections, the sense leads have to be connected to the output terminals.
 2. Before the connecting the external sense connections, we strongly recommended you to turn off the power supply.

Wire Shielding & Load Line Impedance

When wiring any loads with the 62010L-36-7, some rules have to be kept in mind.

1. If the wiring to a load is long, the phase shift caused by the inductance and capacitance of the wiring becomes non-negligible, and then causing oscillation. In that case, the capacitor prevents oscillation.
2. If the load current changes to pulse form in a sudden, the output voltage may increase due to the effects from the inductance component of the wiring. In that case, the capacitor also prevents variations via output.
3. Twisting the load wires is able to reduce the inductance component, and stabilize the output.
4. Use a capacitor whose withstand voltage is greater than or equal to 120% of the units rated voltage.
5. When you finish using the remote sensing function, please remove the sensing wires, and make sure to turn off the remote sensing by setting the sense state to INT (internal).

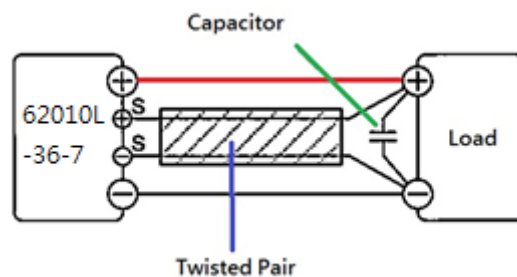

3.7 Master & Slave Application (62010L-36-7 Only)

If you have applications that need voltages and currents greater than the rated maximum outputs, you can achieve this using multiple power supplies. The power supply can output an extended range of voltages or currents by connecting more units. Up to 7 units, limited to the same model, in series or in parallel may be connected if your application requires higher output voltage or current, such as greater than 36V (up to 252V) or greater than 7A (up to 49A).

3.7.1 Connections in Series

To output voltage in the 36V to 252V range, connect two or more power supplies in series. Series connections can be utilized up to the output isolation rating of any power supply in order to obtain a higher voltage than that available from a single power supply. These series connected power supplies can be operated with one load across both power supplies or with a separate load for each power supply. The power supply has a reverse polarity diode connected across the output terminals. That means if operated in series with other power supplies, damage will not occur if the load is short-circuited or if one of the power supplies is turned on separately from its series partner.

⚡ CAUTION : When power supplies operate in series, it can not enable remote sensing function.

The connection diagram for series connections is illustrated below.

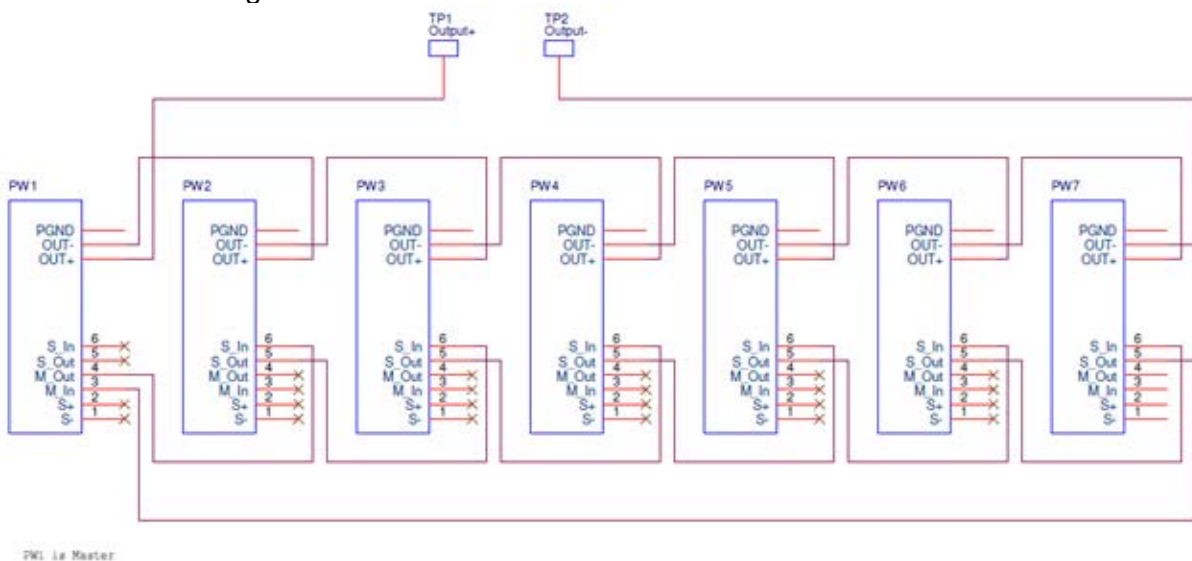

How to accomplish series connections:

For example, in order to connect 3 units (62010L-36-7) in series to output 108V, follow the procedures below. There are three steps.

1. Control signal connection

Connect T+ (Master) to R+ (Slave1), R- (Slave1) to R+ (Slave2), and R- (Slave2) to T- (Master). This setup concept is always used if you want to make up other output systems with two or more P9610As.

⚡ CAUTION : 1. When making the series connection, please do not wire the sense to your DUT (Device under Test) in order to prevent any internal circuit damage from high voltage coming from the DUT.
2. The maximum number of series or parallel units is seven (7).

Master Unit



Slave Unit



2. Output terminal connection

Connect the Master output + to the DUT +, the Master output - to the Slave1 output +, the Slave1 output - to the Slave2 output +, and the Slave2 output - to the DUT - to form the connection in series. The connection with reversed polarities, such as the Master output connected

to the DUT - and so on, is also available.

3. Master/Slave mode Setup

When the connection in series is used, the output voltage is the sum of the voltages from the connected power supplies. Each of the individual power supplies must be properly set in order to obtain the total output voltage.

Output Connection



Notice

The sum won't be shown on the display. You have to calculate this for yourself or prepare a load (or a meter) to inspect and confirm the total output value.

● Master Unit (Quantity X 1):

This setup requires only 1 unit. Before setting this unit to the Master, disable the output.

1. Press the **Menu** button.
2. Rotate the Knob to show MA/SL on the display.
3. Press the **Menu** button to confirm.
4. Rotate the Knob to show SETUP on the display.
5. Press the **Menu** button to confirm.
6. Rotate the Knob to show MODE on the display.
7. Press the **Menu** button to confirm.
8. Rotate the Knob to show S-MA on the display.
9. Press the **Menu** button to finish the settings.
10. To quit the configuration, press any other key to exit.

● Slave Unit (Quantity X 1 to 6):

The buttons used are the same as the ones used for setting the master unit. This connection requires at least 1 unit, and at most 6 units. For example: If two slave units are required, each unit has to be set to the slave state. Before setting this unit to Slave, disable the output.

1. Press the **Menu** button.
2. Rotate the Knob to show MA/SL on the display.
3. Press the **Menu** button to confirm.
4. Rotate the Knob to show SETUP on the display.
5. Press the **Menu** button to confirm.
6. Rotate the Knob to show MODE on the display.
7. Press the **Menu** button to confirm.
8. Rotate the Knob to show S-SL on the display.
9. Press the **Menu** button to finish the settings.
10. To quit the configuration, press any other key to exit.

● STATE ON:

To activate the Master-Slave function using a series connection, you have to enable the state from OFF to ON through the following procedures. When the slave state is enabled, the Slave signal will show at the bottom right like the picture "Slave State." However, when the master state is enabled, there is no signal shown at the bottom right.

1. Press the **Menu** button.
2. Rotate the Knob to show MA/SL on the display.
3. Press the **Menu** button to confirm.
4. Rotate the Knob to show STATE on the display.
5. Press the **Menu** button to confirm.
6. Rotate the Knob to show ON on the display.

7. Press the **Menu** button to finish the settings.

To quit the configuration, press any other key to exit.

When the above settings are done, but before enabling the output on the master unit, the display on the master unit should display S-MA OFF and slave unit should show S-SL OFF as in the picture to the right side.

- Unit 1, set the slave condition to the output off state.
- Unit 2, set the slave condition to the output off state.
- Unit 3, set the slave condition to the output off state.

After enabling the output on the master unit, the display on the master unit shows a voltage value and a current value. On the display of the slave units, only a voltage value will be shown.

- Unit 1, set the master condition to the output on state.
- Unit 2, set the slave condition to the output on state.
- Unit 3, set the slave condition to the output on state.

3.7.2 Connections in Parallel

To output current within the 7A to 49A range, parallel operation of two or more power supplies is necessary. Using parallel connections, CV/CC capability, and the automatic crossover operation, you can obtain a total output current greater than that available from single power supply. The total output current is the sum of the currents from the connected power supplies. The output of each power supply can be set separately. The output voltage controls of the Master power supply should be set to the desired output voltage. The Slaves will work in CC mode with the CC Limit the same as the master output current.

⚡ CAUTION : When power supplies operate in parallel, there must less than three of power supplies can enable remote sensing function.

The connection diagram in parallel is illustrated below.

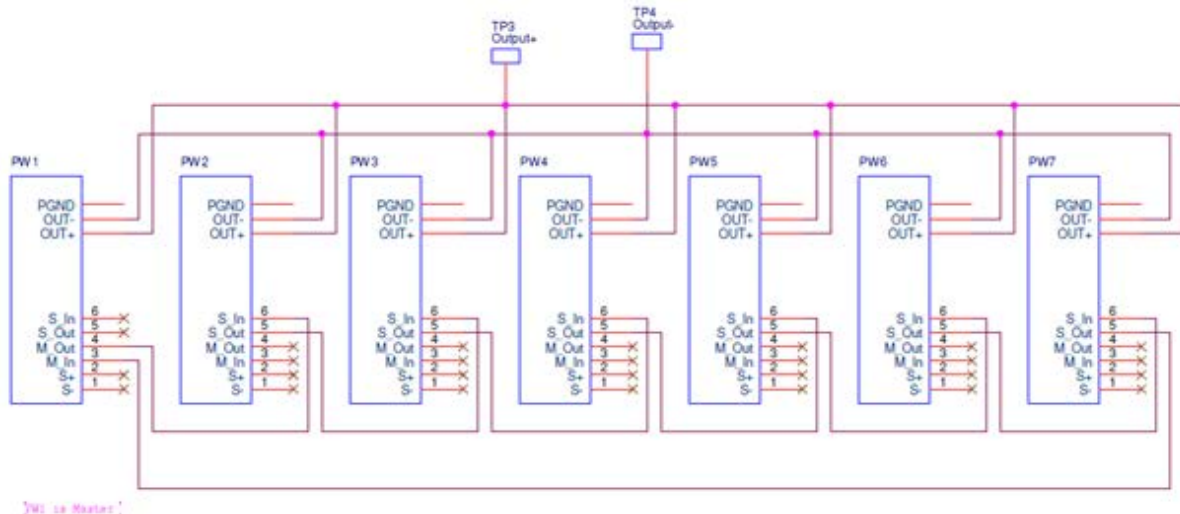

How to connection power supplies in parallel:

For example, to connect 3 units in parallel for to output 21A, please follow the procedures below. There are three parts to the setup.

1. Control signal connection

Connect T+ (Master) to R+ (Slave1), R- (Slave1) to R+ (Slave2), and R- (Slave2) to T- (Master). Then connect S+ (Master) to the positive side of the DUT (Device under Test), and S- (Master) to the negative side of the DUT. This setup concept is always used if you want to make up other output systems with two or more 62010L-36-7s in parallel.



CAUTION

1. When making the series connection, please wire the sense to your DUT to do the necessary current compensation.
2. Each control system can use seven (7) units at most.

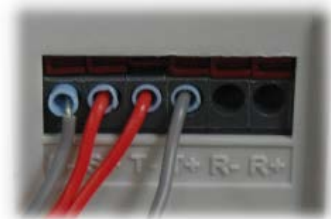

Master Unit

2. Output terminal connection

Connect the Slave2 output - to the Slave1 output -, the Slave2 output + to the Slave output +, the Slave1 output - to the Master output -, the Slave1 output + to the Master output +, the Master output - to the DUT -, and the Master output + to the DUT + to form the connection in parallel.

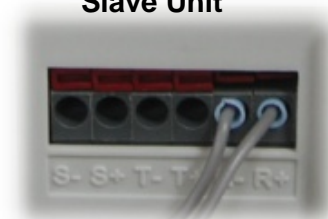

Slave Unit

3. Master/Slave mode Setup

When the connection in parallel is used, the output current is the sum of the currents from the connected power supplies. Each of the individual power supplies must be properly set in order to obtain the total output current.



Notice

- The sum will not be shown on the display. You have to calculate that yourself or include a load (or a meter) to inspect the total output current.

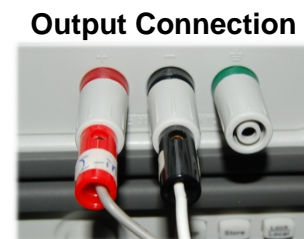

Output Connection

● Master Unit (Quantity X 1):

The buttons used are the same as the ones for setting the units in series. This setup requires only 1 unit. Before setting this unit to Master, disable the output.

1. Press the **Menu** button.
2. Rotate the Knob to show MA/SL on the display.
3. Press the **Menu** button to confirm.
4. Rotate the Knob to show SETUP on the display.
5. Press the **Menu** button to confirm.
6. Rotate the Knob to show MODE on the display.
7. Press the **Menu** button to confirm.
8. Rotate the Knob to show P-MA on the display.
9. Press the **Menu** button to finish the settings.

To quit the configuration, press any other key to exit.

● Slave Unit (Quantity X 1 to 6):

The buttons used are the same as the ones used for setting the units in series. This connection requires at least 1 unit and at most 6 units. For example: If two slave units are

required, each unit has to be set to the slave state. Before setting this unit to Slave, you have to disable the output.

1. Press the **Menu** button.
2. Rotate the Knob to show MA/SL on the display.
3. Press the **Menu** button to confirm.
4. Rotate the Knob to show SETUP on the display.
5. Press the **Menu** button to confirm.
6. Rotate the Knob to show MODE on the display.
7. Press the **Menu** button to confirm.
8. Rotate the Knob to show P-SL on the display.
9. Press the **Menu** button to finish the settings.

To quit the configuration, press any other key to exit.

● **STATE ON:**

Before enabling the state, you have to disable the output. To activate the Master-Slave function using parallel connections, you have to enable the state from OFF to ON through the following procedures. When the slave state is enabled, the Slave signal will be shown at the bottom right like the picture "Slave State." However, when the master state is enabled, there is no signal shown at the bottom right.

1. Press the **Menu** button.
2. Rotate the Knob to show MA/SL on the display.
3. Press the **Menu** button to confirm.
4. Rotate the Knob to show STATE on the display.
5. Press the **Menu** button to confirm.
6. Rotate the Knob to show ON on the display.
7. Press the **Menu** button to finish the settings.

To quit the configuration, press any other key to exit.

When the above settings are completed, but before enabling the output on the master unit, the display on the master unit will show P-MA OFF, with P-SL OFF on the slave unit, as shown in the picture to the right.

- Unit 1, set the master condition to the output off state.
- Unit 2, set the slave condition to the output off state.
- Unit 3, set the slave condition to the output off state.

After enabling the output on the master unit, the display on the master unit shows a voltage value and a current value. On the display of the slave units, only a voltage value is shown.

- Unit 1, set the master condition to the output on state.
- Unit 2, set the slave condition to the output on state.
- Unit 3, set the slave condition to the output on state.

3.7.3 Other Settings for Multiple Connections

● **DELAY:** Before setting the DELAY, you have to disable the output. This Delay allows you to set a delay time for the output/control timing when the P9610A(s) is/are set to the master or normal mode in a sub-system. When the 62010L-36-7(s) is/are set to the master or normal

mode in a sub-system. When the main system's output is enabled, the 62010L-36-7 sub-system's set to the master or normal mode, will be also activated according to the delay time (at most 60 seconds). In the meantime, the **OFF** annunciator at the bottom right will blink until the delay time is up and the display returns to the meter mode. Then the slave unit(s) in the sub-system can be controlled by the sub-system's master unit(s), and output the similar power as the master. This sub-system application can be branched again and again to meet large system requirements. The procedures for setting the delay time are as follows:

1. Press the **Menu** button.
2. Rotate the Knob to show MA/SL on the display.
3. Press the **Menu** button to confirm.
4. Rotate the Knob to show SETUP on the display.
5. Press the **Menu** button to confirm.
6. Rotate the Knob to show DELAY on the display.
7. Press the **Menu** button to confirm.
8. Rotate the Knob to show T_ON on the display.
9. Press the **Menu** button to set a desired delay time.
10. Press the **Menu** button to finish the settings.

To quit the configuration, press any other key to exit.

● **P-MA (Master Settings in Parallel)**: For parallel systems, the master settings can also be set the same on the other 62010L-36-7s for sub-system applications. When the main system's output is enabled, the P9610A sub-system, set to master mode, will be also activated in a few seconds according to the delay time setting. The procedures for setting the P-MA mode are described in the *section 3.7.2*.

● **NORMAL**: Before enabling the NORMAL mode, you have to disable the output. Then select the normal mode through the following procedures. Enabling this mode requires that you remove the output connections to the other 62010L-36-7(s). The unit(s) under the normal mode will only have a single output. The control connection from the master unit can exist and wait for the order to output. When enabling the master's output, the unit(s) under the normal mode, after the defined delay time, will go into the meter mode, and limit their output to the defined voltages and currents according to the limit settings. To check the limited value, press the **Limit** button once. When the slave function is activated under the NORMAL mode, the maximum output value on each slave unit follows the present adjustment. The buttons used are the same as the ones when setting the DELAY time.

1. Press the **Menu** button.
2. Rotate the Knob to show MA/SL on the display.
3. Press the **Menu** button to confirm.
4. Rotate the Knob to show SETUP on the display.
5. Press the **Menu** button to confirm.
6. Rotate the Knob to show MODE on the display.
7. Press the **Menu** button to confirm.
8. Rotate the Knob to show NORMAL on the display.
9. Press the **Menu** button to finish the settings.

To quit the configuration, press any other key to exit.

● **TRACK**: Before enabling the track mode, you have to disable the output. When enabling the track mode, the unit under the track mode will track the master's voltage. This mode only works in series connections. The procedures for setting the track mode are as follows:

The buttons used are the same as the ones when setting the DELAY time.

1. Press the **Menu** button.
2. Rotate the Knob to show MA/SL on the display.
3. Press the **Menu** button to confirm.
4. Rotate the Knob to show SETUP on the display.
5. Press the **Menu** button to confirm.
6. Rotate the Knob to show MODE on the display.
7. Press the **Menu** button to confirm.
8. Rotate the Knob to show TRACK on the display.
9. Press the **Menu** button to finish the settings.

To quit the configuration, press any other key to exit.

3.8 Turning Off the Output

The output of the power supply can be disabled or enabled through the front panel operation or the remote operation. In addition, you can use the Lock/Local key to limit the output and prevent inappropriate levels.

Front Panel Operation:

- To turn on and off the output, press the **Output ON/OFF** button. When the output of the power supply is disabled, the **OFF** symbol shows on the display. The voltage value is 0V and the current value is 0.02A. When the output of the power supply is enabled, the **OFF** symbol disappears.
- The output state is not able to be saved in the non-volatile memory. The default of the output state is off when you turn on the power supply from the front panel or reset it through the remote operation.

Remote Operation:

OUTP {OFF/ON}

Disable or enable the output.

Lock/Local Button

To prevent incorrect actions (Lock) or to return to local operation from the remote control (Local), the Lock/Local button is used.

The **Lock/Local** button can be used to disable the knob and other buttons so that you can prevent any unwanted changes. Press this button again to enable the front panel operation. If active, remote mode usage is also inhibited.

3.9 SEQ (Sequencing Mode)

The 62000L series supports a sequencing mode. This mode allows you to output different voltages and currents over time. There are 8 steps to the setup. When the SEQ is activated, the sequence is run from start to finish step-by-step. Before adjusting the sequencing settings, disable the output.

- Note** 1. Pressing the V/A button long on the front panel under the SEQ mode in output condition, the display will show the information of V & A, V & W, or

SEQCNT.

- V & A: The display shows the output voltage and current.
 - V & W: The display shows the output voltage and power.
 - SEQCNT: The display shows the rest of the SEQ cycle numbers.
2. If you set the start step at step 1 and the stop step at step 4, the power supply will run in order (i.e. step 1, step 2, step 3, and step 4). If you set the start step at step 4, and the stop step at step 1, the power supply will still run in order (i.e. step 4, step 5, step 6, step 7, step 0 and then step 1).

Front Panel Operation:

The next figure of the SEQ family tree of operations on the front panel provides you with an easy map for setting with the required buttons.

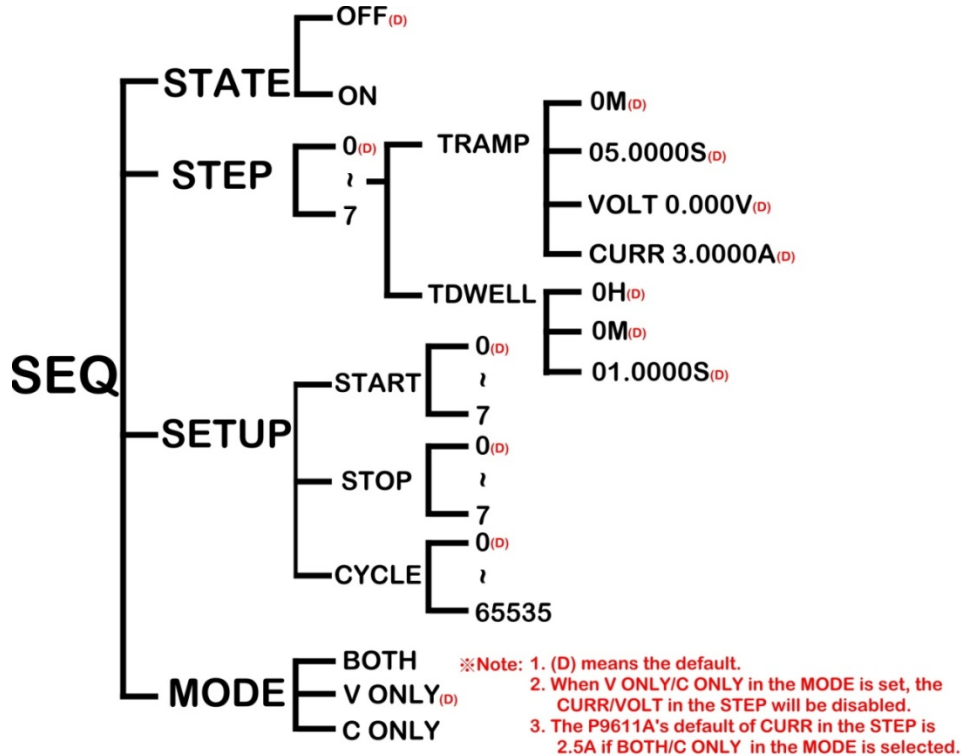

- **SEQ:** Configuration Sequencing Mode parameter menu. You need to disable the output before using this menu.
- **STEP:** The SEQ's settings can be saved from step 0 to step 7. In the step settings, you need to set TRAMP (ramp time) including M (minute), S (second), VOLT (voltage), or CURR (current), and TDWELL (dwelling time) including H (hour), M (minute), and S (second)
- **SETUP:** This setting includes START, STOP, and CYCLE.
 1. **START:** Setting the start step of the output sequence. There are 0 ~7 for you to choose from.
 2. **STOP:** Setting the stop step of the output sequence. There are 0 ~7 for you to choose from.
 3. **CYCLE:** You can set the cycle times between the start and the stop steps. If 0 is used, the cycling will keep running.
- **MODE:** Setting this MODE affects the voltage and current settings in the sequencing mode. In the Ramp process, linear interpolation is used.
 - *. **Both:** Auto modifies the CV limit and CC limit settings on sequencing step.
 - *. **V ONLY:** Auto modifies CV limit level value on sequencing step. The CC limit value is the same as CC limit setting.
 - *. **C ONLY:** Auto modifies CC limit level value on sequencing step. The CV limit value is

the same as CV limit setting.

- **STATE:** To enable or disable the SEQ mode.

In the following example: There are 3 steps used and shown on the oscilloscope. The dotted lines in green divide the following waveform into 3 segments. Each segment has its own setting value.

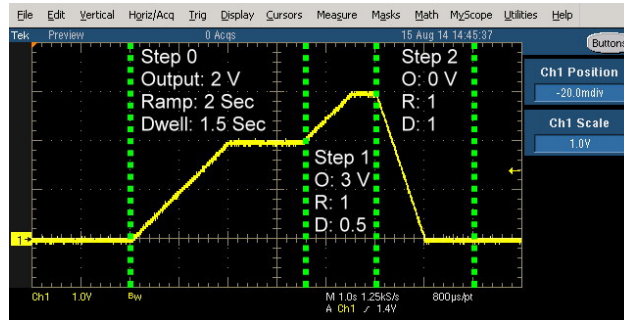

No Load State

- **Step 0:** 2V, 2 seconds for the ramp time and 1.5 seconds for the dwelling time are set. The procedures are as follows:
 1. Make sure the output is disabled. If the display doesn't show **OFF**, please press the **Output ON/OFF** button once on the front panel.
 2. Press the **Menu** button.
 3. Rotate the Knob to show SEQ on the display.
 4. Press the **Menu** button to confirm.
 5. Rotate the Knob to show STEP on the display.
 6. Press the **Menu** button to confirm. STEP 0 (default) will show on the display.
 7. Press the **Menu** button once to confirm the selection. TRAMP 0M will show on the display. Then leave 0M in this setting.
 8. Press the **Menu** button once to confirm. TRAMP 00.500S (default) will show on the display. Then press the **▶** or **◀** buttons to move the cursor, and rotate the knob to set 02.000S.
 9. Press the **Menu** button once to confirm. VOLT 00.000V (default) will show on the display. Then press the right & left direction button to move the cursor, and rotate the knob to set 02.000V.
 10. Press the **Menu** button once to confirm. TDWELL 0H (default) will show on the display. Then leave 0H in this setting.
 11. Press the **Menu** button once to confirm. TDWELL 0M (default) will show on the display. Then leave 0M in this setting.
 12. Press the **Menu** button once to confirm. TDWELL 01.000S (default) will show on the display. Then press the **▶** or **◀** buttons to move the cursor and rotate the knob to set 01.500S.
 13. Press the **Menu** button once to confirm. The Menu will return to SEQ menu.
- **Step 1:** 3V, 1 second for the ramp time, and 0.5 seconds for the dwelling time are set. The setting procedures are similar to those listed in step 0. If you're familiar with the setup procedure, please skip the following and set the values directly on the front panel.
 1. Rotate the Knob to show STEP on the display.
 2. Press the **Menu** button once to confirm. STEP 0 (default) will show on the display.
 3. Rotate the knob to STEP 1.
 4. Press the **Menu** button once to confirm the selection. TRAMP 0M (default) will show on the display. Then leave 0M in this setting.

5. Press the **Menu** button once to confirm. TRAMP 00.500S (default) will show on the display. Then press the **▶** or **◀** buttons to move the cursor, and rotate the knob to set 02.000S.
 6. Press the **Menu** button once to confirm. VOLT 00.000V (default) will show on the display. Then press **▶** or **◀** button to move the cursor, and rotate the knob to set 02.000V.
 7. Press the **Menu** button once to confirm. TDWELL 0H (default) will show on the display. Then set 0H in this setting.
 8. Press the **Menu** button once to confirm. TDWELL 0M (default) will show on the display. Then set 0M in this setting.
 9. Press the **Menu** button once to confirm. TDWELL 01.000S (default) will show on the display. Then press the **▶** or **◀** buttons to move the cursor and rotate the knob to leave 01.500S.
 10. Press the **Menu** button once to confirm. The Menu will return to SEQ menu.
- **Step 2:** 0V, 1 second for the ramp time, and 1 second for the dwelling time are set. The setting procedures are similar those listed in step 1. If you are familiar with the procedure, please skip the procedures from 1 to 10 and set the values directly on the front panel. For procedures 11 to 21, some settings have to be enabled so that the SEQ will run correctly according to your settings.
 1. Rotate the Knob to show STEP on the display.
 2. Press the **Menu** button to confirm. STEP 0 (default) will show on the display.
 3. Rotate the knob to STEP 2.
 4. Press the **Menu** button once to confirm the selection. TRAMP 0M (default) will show on the display. Then set 0M in this setting.
 5. Press the **Menu** button once to confirm. TRAMP 00.500S (default) will show on the display. Then press the **▶** or **◀** buttons to move the cursor, and rotate the knob to set 01.000S.
 6. Press the **Menu** button once to confirm. VOLT 00.000V (default) will show on the display.
 7. Press the **Menu** button once to confirm. TDWELL 0H (default) will show on the display. Then set 0H in this setting.
 8. Press the **Menu** button once to confirm. TDWELL 0M (default) will show on the display. Then set 0M in this setting.
 9. Press the **Menu** button once to confirm. TDWELL 01.000S (default) will show on the display.
 10. Press the **Menu** button once to confirm. The Menu will return to SEQ menu.
 11. Rotate the Knob to show SETUP on the display.
 12. Press the **Menu** button once to confirm. START will show on the display.
 13. Press the **Menu** button once to confirm. START 0 (default) will show on the display. Then set 0 in this setting.
 14. Press the **Menu** button once to confirm. STOP 7(default) will show on the display. Then rotate the knob to leave 2.
 15. Press the **Menu** button once to confirm. CYCLE 0(default) will show on the display. Then rotate the knob to set 1.
 16. Press the **Menu** button once to confirm. The Menu will return to SEQ menu.
 17. Press the **Menu** button once to confirm. A blinking OFF under STATE shows on the display.
 18. Rotate the knob to ON.
 19. Press the **Menu** button to confirm. The Menu will return to SEQ menu.
 20. To quit the configuration, press any other key to exit SEQ menu.
 21. Press the **Output ON/OFF** button once on the front panel and the source will be output sequentially.

Remote Operation:**OUTPut:SEQuence[:STATe] {0|1|OFF|ON}**

Enable/Disable output sequence function.

OUTPut:SEQuence[:STATe]?

Return 0 if output sequence is disabled, and return 1 if output sequence is enabled.

OUTPut:SEQuence:MODE {0|1|2}

Set mode of output sequence. 0 is voltage only. 1 is current only. 2 is for both voltage and current.

OUTPut:SEQuence:MODE?

Query sequence mode. Return 0, 1 or 2.

OUTPut:SEQuence:CYCLe {<cycle>}

Set output sequence repeat cycle. The value of cycle is 0~65535. 0 means always repeat.

OUTPut:SEQuence:CYCLe?

Query output sequence repeat cycle.

OUTPut:SEQuence:SETUp {<start step>},{<stop step>}

Set start step and stop step of output sequence. Step is S0~S7.

OUTPut:SEQuence:SETUp?

Query start step and stop step.

OUTPut:SEQuence:STEP:VOLTage {<step>},{<voltage>|DEF|MIN|MAX}

Set voltage of a step. Step is S0~S7.

OUTPut:SEQuence:STEP:VOLTage? {<step>}

Query voltage setup of a step. Step is S0~S7. Return voltage in Volts.

OUTPut:SEQuence:STEP:CURREnt {<step>},{<current>|DEF|MIN|MAX}

Set current of a step. Step is S0~S7.

OUTPut:SEQuence:STEP:CURREnt? {<step>}

Query current setup of a step. Step is S0~S7. Return current in amps.

OUTPut:SEQuence:STEP:RAMP {<step>},{<time in ms>|MIN|MAX}

Set ramp time of a step. Step is S0~S7. The ramp time allows you to set from 0 to 3599999ms.

OUTPut:SEQuence:STEP:RAMP? {<step>}

Query ramp time of a step. Step is S0~S7. Return ramp time in ms.

OUTPut:SEQuence:STEP:DWELI {<step>},{<time in ms>|MIN|MAX}

Set width of a step. Step is S0~S7. Maximum dwell is 86399999ms.

OUTPut:SEQuence:STEP:DWELI? {<step>}

Query width of a step. Step is S0~S7. Return dwell in ms.

OUTPut:SEQuence:STEP? {<step>}

Query a step setting. Step is S0~S7.

3.10 System Operations

This section provides information about system such as error message querying, beep settings, display control, OCP delay setting, Style and power supply identity querying. Most of the items in System Operation provide information for servicing procedures.

3.10.1 Error States

Once an error occurs, the **ERR** indicator is lit. Errors can be generated by invalid operation or hardware failure. A record with up to 32 errors is saved in the power supply's error queue. For more information, please refer to the following instructions and the chapter "[Error Messages](#)."

- Errors are retrieved in a first-in-first-out (FIFO) sequence. The first returned error is the first saved error. When all of errors are read from the queue, there will be no ERROR symbol shown on the display.
- When more than 32 errors have occurred when operating the power supply over the remote control, the last error saved in the queue (the most recent error) will be replaced with -350, Too many errors. After removing the errors from the queue, you can save the next error. If there is no error when you read the error queue, the power supply shows "**NO ERROR**" on the display, or responds with +0, No errors over the remote control.
- You can clear the error queue when turning off the power supply or after commanding a *CLS (Clear Status). Please note that the *RST (Reset) doesn't clear the error queue.

Front Panel Operation:

To check and remove error message(s), please follow the procedures below.

1. Press the **Menu** button once. Rotate the knob to the SYSTEM.
2. Press the **Menu** button once to confirm. A blinking ERROR will show on the display.
3. Press the **Menu** button once to check the error message, such as -221 at the upper line, and SETTINGS CONFLICT at the bottom line in scrolling text. If there are still other error message(s), repeatedly pressing the **Menu** button will read and clear the errors stored in the queue. After the last press, NO ERROR will appear on the display.

Remote Operation:

SYST:ERR?

Read an error from the error queue.

3.10.2 Beep/Alarm Settings

Beeps are used to indicate a front panel operation (button pressing or knob rotating) is detected or to alarm an unexpected condition (OVP/OCP tripped) occurs. You can change the beep behaviors.

- The **NORMAL** beep is used to indicate a front panel operation (button pressing or knob rotating) is detected. By default the NORMAL beep is ON.
- The **ALARM** is used to alarm an OVP/OCP is tripped. By default the ALARM is OFF. If the OVP/OCP alarm is enabled, a continuous buzzer sound is generated if the OVP/OCP is tripped until the OVP/OCP trip condition is clear.

Front Panel Operation:

1. Press the **Menu** button once. Rotate the knob to the SYSTEM.
2. Press the **Menu** button once to confirm. Rotate the knob to the beep.
3. Press the **Menu** button once to confirm. A blinking NORMAL/ALARM will show on the display.
4. Press the **Menu** button once to confirm. A blinking ON will show on the display.
5. Rotate the knob to the OFF selection.
6. Press the **Menu** button once to finish the settings.
7. To quit the configuration, press any other key to exit.

Remote Operation:

SYST:BEEPer:NORMAl[:STATe] {0|1|OFF|ON}

Commanding 0 or OFF, will disable the beep. Commanding 1 or ON will enable the beep.

SYST:BEEPer:NORMAl[:STATe]?

Query the present state of the beeper.

SYST:BEEPer:ALARm:OVP[:STATe] {0|1|OFF|ON}

Commanding 0 or OFF will disable the OVP alarm. Commanding 1 or ON enables the alarm.

SYST:BEEPer:ALARm:OVP[:STATe]?

Query the present state of the alarm for the OVP.

SYST:BEEPer:ALARm:OCP[:STATe] {0|1|OFF|ON}

Commanding 0 or OFF disables the OCP alarm. Commanding 1 or ON enables the alarm.

SYST:BEEPer:ALARm:OCP[:STATe]?

Query the present state of the alarm for the OCP.

3.10.3 Display Control

The display control allows you to turn ON/OFF the display or display a message on the screen via remote operation. This feature only affects when the power supply is under remote control.

- After the display is turned off, there are no message shown on the display and all indicators should be lit on local operation will not lit anymore. Only the **ERR** indicator will be lit once an error occurs.
- You can set a string (up to 49 characters) to show on the display. Limited by the display digits, the string is scrolling if it is longer than 6 characters. Only alphanumeric characters and '-' can be displayed and all letters will be change to uppercase letters. Characters that can not be shown will be replaced with a space.
- The display is enabled again and the displaying string is cleared while the power supply is back to local operation.

Remote Operation:

DISPlay {OFF|ON}

Disable/enable the display.

DISPlay:TEXT <quoted string>

Display a string in the screen. The string must be enclosed in quoted. For example, DISPlay:TEXT "HELLO WORLD" will show "HELLO WORLD" on the screen

DISPlay:TEXT:CLEAr

Clear the displayed message.

3.10.4 OCP Delay (OCPDEL) Settings

If the OCP level is set to a value less than the CC limit, the inrush current upon output turning on can easily cause an OCP trip. To avoid the current output being blocked by frequent OCP trips an OCP delay is necessary. The OCP delay is a time interval that OCP function is paused upon the output is turn on. The default for the OCP delay is 0.15s. This can be adjusted according to your application. To change the delay time, please follow the procedures below.

Front Panel Operation:

1. Press the **Menu** button once. Rotate the knob to the SYSTEM.
2. Press the **Menu** button once to confirm. Rotate the knob to the OCPDEL.
3. Press the **Menu** button once to confirm.
4. Rotate the knob and **▶** or **◀** to leave a value, such as 0.2s.
5. Press the **Menu** button once to finish the settings.
6. To quit the configuration, press any other key to exit.

Remote Operation:

SOURCE:CURRENT:PROTECTION:DELAY {<ms>|MIN|MAX}

The OCP delay time can be set to a value from 0 to 9.999s.

SOURCE:CURRENT:PROTECTION:DELAY?

Query the present delay time of the OCP.

3.10.5 Vrange

Through the front panel, the Vrange is allowed users to set a maximum and a minimum values for voltage. When the values are set, the available working voltage within the set range just can be adjusted.

Front Panel Operation:

1. Press the **Menu** button once. Rotate the knob to the SYSTEM.
2. Press the **Menu** button once to confirm. Rotate the knob to the VRANGE.
3. Press the **Menu** button once to confirm. A blinking VMAX will show on the display.
4. Press the **Menu** button once to confirm. You are allowed to set a maximum voltage value.
5. Press the **Menu** button once to confirm, and then set a minimum voltage value.
6. Press the **Menu** button once to confirm. The display will show the display status with the minimum voltage you set.

3.10.6 Style

You can display the following condition after rebooting your power supply.

To show "OUTPUT OFF" on the display, you have to select 0 through the menu operation of the path, Menu > SYSTEM >STYLE. To show "CV & CC Limit Setting with lit annunciators, Limit and OFF" you have to select 1 through the menu operation of the path, Menu > SYSTEM >STYLE. This setting doesn't support Master/Slave mode, and SEQ mode.

Front Panel Operation:

1. Press the **Menu** button once. Rotate the knob to the SYSTEM.

2. Press the **Menu** button once to confirm. Rotate the knob to the STYLE.
3. Press the **Menu** button once to confirm. Rotate the knob to 0 for showing “OUTPUT OFF” on the display after rebooting your power supply. Rotate the knob to 1 for showing “CV & CC Limit Setting with lit annunciators, Limit and OFF” on the display after rebooting your power supply.
4. Press the **Menu** button once to confirm.

3.10.7 Identification

You can read the identification string about the power supply via this menu. An identification string about the power supply contains brand name, model name, serial number, main MCU firmware version, and USB/GPIB card firmware version if the power supply has USB/GPIB card built in.

- The identification string can also query by the command *IDN?.

Front Panel Operation:

1. Press the **Menu** button once. Rotate the knob to the SYSTEM.
2. Press the **Menu** button once to confirm. Rotate the knob to the ABOUT.
3. Press the **Menu** button once to confirm.
4. The following message is an example. The identification string with a brand name, a model name, a serial number, and a firmware version is scrolling on the display.

CHROMA ATE,62010L-36-7,L01000000066,1.00-1.00

Remote Operation:

***IDN?**

Query the identification string of the power supply. The returned identification string is like CHROMA ATE,62010L-36-7,L01000000066,1.00-1.00.

3.10.8 SCPI Command Version

The power supply is compliant with the rules and regulations of the present version of SCPI. The SCPI version is the same as what you command from the remote interface.

Remote Operation:

SYST:VERS?

Query the SCPI version. A string will be returned in the form of YYYY.V where the Y stands for the year of the version, and the V stands for the version number for the year (for example, 1996.0).

3.11 Calibration

This section provides the information about how to calibrate the power supply.

 **CAUTION** : The power supply can not reach its specified accuracy without properly calibration. Before calibrating the power supply, make sure you are qualified to do that and read this section carefully.

3.11.1 Un-secure Calibration

By default, the calibration is secured to prevent un-qualified calibration. Before starting calibrating the power supply the security must be disabled. To disable the calibration security, follow the procedure below.

Note It is recommended to enable the calibration security to prevent the power supply from being calibrated by un-qualified user. If you forget the security code you set before, use the master code to disable the security and set your security code again. The master code is the last six characters of the serial number of your power supply.

Front Panel Operation:

1. Press the **Menu** button once. Rotate the knob to the CAL.
2. Press the **Menu** button once to confirm. A blinking SECURE will show on the display.
3. Press the **Menu** button once to confirm. A blinking ON (default) will show on the display.
4. Rotate the knob to OFF.
5. Press the **Menu** button once to confirm. The default number, six zeroes (**000000**), will show on the display.
6. Use knob and **▶** or **◀** button to leave the security code. After the security code is set, press the **Menu** button to disable the security.
7. Press any other key to exit the configuration menu.

Remote Operation:

CAL:SEC:STAT {OFF|ON},<code>

Enable/Disable the calibration security. The code is an un-quoted string with six alphanumeric characters.

3.11.2 Securing Calibration

After the calibration is completed, it's recommended to enable the security again to prevent un-qualified calibration. To enable the calibration security, follow the procedures below.

Front Panel Operation:

1. Press the **Menu** button once. Rotate the knob to the CAL.
2. Press the **Menu** button once to confirm. A blinking SECURE will show on the display.
3. Press the **Menu** button once to confirm. A blinking OFF will show on the display.
4. Rotate the knob to ON.
5. Press the **Menu** button once to confirm. The default number, six zeroes (**000000**), will show on the display.
6. Use the knob and the **▶** or **◀** buttons to enter the new security code.
7. Press any other key to exit the configuration.

Remote Operation:

CAL:SEC:STAT {OFF|ON},<code>

Enable/Disable the calibration security. The code is an un-quoted string with 6 alphanumeric characters.

3.11.3 Changing the Security Code

To change to a new code, you have to unsecure the power supply first. Please perform the procedures in the previous section.

Front Panel Operation:

Please follow [section 3.11.1](#) to unsecure, and [section 3.11.2](#) to re-secure your power supply with a new code.

Remote Operation:

CAL:SEC:STAT OFF,<code>

Disable the security using security code.

CAL:SEC:CODE <new code>

Set a new security code. The code is an un-quoted string with 6 alphanumeric characters.

CAL:SEC:STAT ON,<new code>.

Secure with the new code.

3.11.4 Calibration Procedures

This section describes the procedure to calibrate the power supply from the front panel. *Table 3-1* shows the calibration points that should be used to calibrate the output voltage and current for the power supply.

Table 3-1 Calibration Points

Voltage / Current	Calibration Point
CAL V	V_LO
	V_HI
CAL C	C_LO
	C_HI

Please follow the procedures below to calibrate the output voltage and current of the power supply.

1. Disconnect all loads from the power supply.
2. To calibrate the output voltage, connect a DVM (e.g. Model 12061) across the output terminals. To calibrate output current, connect an appropriate current monitoring resistor across the output terminals and connect a DVM across the terminals of the monitoring resistor.
3. Unsecure the power supply according to the procedure given in the [section 3.12.1](#). If the procedures are performed, the mode will exit when complete.

Note

1. An accurate digital multimeter is required. The model must be able to withstand the input current, 7A, or the high current will burn out the DVM's current fuse and possibly damage the DVM's circuitry.
2. The power supply needs to be in calibration mode. Use the procedures in [section 3.12.1](#) to check the condition and to set the display as shown below.

**SECURE
OFF**

4. Press the **Menu** button once. Rotate the knob to the CAL.
5. Press the **Menu** button once to confirm.

6. Rotate the knob to CAL V to calibrate output voltage, and to CAL C to calibrate output current. Select CAL V to calibrate the output voltage.
7. Press the **Menu** button once to confirm. A blinking V_LO will show on the display.
8. Press the **Menu** button once to confirm. the supply starts running the LO voltage adjustment. The display will look like the state below.

V_LO
01.800V

9. Read the DVM and adjust the voltage value on the display of the 62000L series to match the measured value. For example, if the DVM's reading is 2.029V, use the knob and the **▶** or **◀** buttons to adjust the display value to 2.029V. The display will look like the state below. For accurate calibration, you should wait for the DVM reading to stabilize for several seconds.

V_LO
1.429V

10. Press the **Menu** button once to confirm. Then the supply starts running the HI voltage adjustment. The display will look like the state below.

V_HI
34.200V

11. Read the DVM and adjust the voltage value on the display of the 62000L series to match the measured value. For example, if the DVM's reading is 32.063V, use the knob and the **▶** or **◀** buttons to adjust the display value to 32.063V. The display will look like the state below. For accurate calibration, you should wait for the DVM reading to stabilize for several seconds.

V_HI
33.063

12. Press the **Menu** button once to finish the settings.
13. Disconnect the banana jack from the INPUT HI of the DVM as the pictures shown below.



14. Plug the banana jack into the CURRENT terminal of the DVM as the pictures shown below.

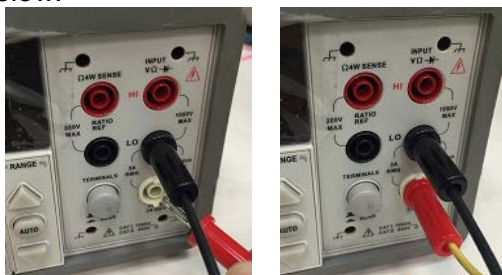

15. Rotate the knob to CAL C to calibrate output current.
16. Press the **Menu** button once to confirm. A blinking C_LO will show on the display.
17. Press the **Menu** button once to confirm. It starts running the LO current adjustment. The display will look like the state below.

C_LO
0.3200A

18. Read the DVM and adjust the current value on the display of the 62000L series to match the measured value. For example, if the DVM's reading is 0.3500A, use the knob and the

▶ or ◀ buttons to adjust the display value to 0.3500A. The display will look like the state below. For accurate calibration, you should wait for the DVM reading to stabilize for several seconds.

```
C_LO
0.3500A
```

19. Press the **Menu** button once to confirm. The supply will start running the HI current adjustment. The display will look like the state below.

```
C_HI
6.4000A
```

20. Read the DVM and adjust the current value on the display of the 62000L series to match the measured value. For example, if the DVM's reading is 6.6500A, use the knob and the ▶ or ◀ buttons to adjust the display value to 6.6500A. The display will look like the state below. For accurate calibration, you should wait for the DVM reading to stabilize for several seconds.

```
C_HI
6.6500A
```

21. Press the **Menu** button once to finish the calibration adjustment. To quit the calibration, press any other key to exit.



If you calibrate the power supply using the remote interface, you can also abort a calibration by placing a command via the remote interface or pressing the Local button on the front panel.

3.11.5 Calibration String

You can leave a string before/after the calibration is completed. Usually used this string to record the last calibration date or the next calibration due date. The calibration string contains max 35 characters.

To read the calibration message, you can go through it via the front panel operation and the remote control. To save the calibration message, you have to operate via the remote control only.

Front Panel Operation:

To get the calibration information on the 62000L series, please follow the procedures below.

1. Press the **Menu** button once. Rotate the knob to the CAL.
2. Press the **Menu** button once to confirm. Rotate the knob to STRING.
3. Press the **Menu** button once to confirm. The calibration information in a scrolling text will show on the display.
4. Use the ▶ or ◀ buttons to move forwards/backwards, or stop the running information
5. Press any other button to exit.

Remote Operation:

- The power supply has to be unsecured before setting the calibration string.
- The calibration string is limited up to 35 characters.

CAL:STR <quoted string>

Save the calibration message. For example, use the command **CAL:STR "CAL 14-09-13"** to store the last calibration date or the next calibration due date.

3.12 Remote Control Settings

To operate the power supply through remote interface you must install communication card is necessary. For more information about programming the power supply through the remote control, refer to the Chapter "[Remote Control Reference](#)".

3.12.1 Remote Interface Selection

The USB (Model: PWR-opt01) and GPIB + USB (Model: PWR-opt02) interfaces are optional accessories for the power supply. When using these interfaces, you are allowed to leave both cords on the USB's and GPIB's interfaces between your power supply and the computer at the same time. You don't need to disconnect either connection.

3.12.1.1 USB Interface

When the USB interface is used, make sure both ends of your USB cord at your power supply and computer are well connected.

- When the USB interface is connected, your computer will detect this device and require that a VISA driver be installed. If you had the driver installed previously, there will be no issue with the remote communication. If not, please go to the National Instruments website to download the NI-VISA Run-Time Engine, version 4.2 or greater. After installing the driver, the power supply will be found via the USB interface.

3.12.1.2 GPIB Interface

Each device on the GPIB interface has its own unique address. A repeated address will cause problems for GPIB communication. The power supplier provides 31 addresses (0 – 30) for you to choose from. The current address will show up on the display when you go into the Menu via the front panel. The factory default is 10.

Note ⓘ You can select the GPIB address only from the front panel.

- The GPIB address is saved in non-volatile memory, and isn't changed when the power supply is turned off or after resetting a remote interface.
- The default of the GPIB address is 10. Avoid using the address for any instrument on the interface bus.

Front Panel Operation:

To check /set the GPIB address, please follow the procedures below. Please note that this setting is available for the 62000L series unit whose GPIB card is installed.

1. Press the **Menu** button once. Rotate the knob to the GPIB.
2. Press the **Menu** button once to confirm. A blinking ADDR will show on the display.
3. Press the **Menu** button once to confirm. ADDR 10 (default) will show on the display.
4. Rotate the knob to the desired address (if the address 10 doesn't meet your needs).
5. Press the **Menu** button once to apply the address you set. To quit the configuration, press any other key to exit. When a new GPIB address is chosen, it will be saved in non-volatile memory, and will not be changed when the power supply is turned off or after resetting a

remote interface.

GPIB Cable Limitations:

Using the GPIB cable to connect the power supply and computer, you have the following limitations.

- The total number of connections, including the computer, can not exceed 15.
- The total length of all the GPIB cables used can not be more than 2 meters times the number of connections, up to a maximum of 20 meters.
- The individual GPIB cable lengths can not exceed 4 meters. Otherwise, the data transmission might be intermittent.
- GPIB connectors can not be stacked over three connector blocks. Make sure that all connectors are completely in position and firmly secured by the screws.

4. Remote Control Reference

If you are a new user of the SCPI language, please read this chapter very carefully before attempting to program the power supply. Incorrectly commanding the power supply could cause unpredictable operation of the power supply output that may damage connected devices.

4.1 SCPI Language Summary

4.1.1 SCPI Language Introduction

SCPI is an ASCII-based instrument command language designed for test and measurement instruments. Its commands are based on a hierarchical structure, also known as a tree system. In this system, related commands are grouped together under a common node or root, or formed as subsystems. There is a tree example about a portion of the SOURce subsystem down here

```
[SOURce:]
  CURRent {<current>|MIN|MAX|UP|DOWN}
  CURRent? [MIN|MAX]
  CURRent:
    TRIGgered {<current>|MIN|MAX}
    TRIGgered? {MIN|MAX}
  VOLTage {<voltage>|MIN|MAX|UP|DOWN}
  VOLTage? [MIN|MAX]
  VOLTage:
    TRIGgered {<voltage>|MIN|MAX}
    TRIGgered? {MIN|MAX}
```

4.1.2 Symbols Used in SCPI Commands

Before continue introduce the SCPI commands for 62000L series, you need to know the following notations used for the SCPI command syntax.

- **Square Brackets ([])** : Indicate optional keywords or parameters, and can be omitted. The brackets are not sent with the command string. **Braces ({})** : Enclose parameters within a command string. The braces are not sent with the command string.
- **Triangle Brackets (<>)** : Indicate that you have to substitute a value or a code for the enclosed parameter. For example, the SCPI command **CURRent {<current>}** whose parameter is the current enclosed in triangle brackets means you have to specify a value for the parameter such as 0.1A. The brackets are not sent with the command string.
- **A Vertical Bar (|)** : separates one of two or more alternative parameters.
- **Colon (:)** : Separates a command keyword from a lower-level keyword. For example, **SOURce:CURRent:TRIGgered**.
- **Blank Space ()** : A blank space is used to separate a parameter from a command keyword.
- **Comma (,)** : A comma (,) is used to separate parameters. For example, **APPLY 36,3**.
- **Semicolon (;)** : A semicolon (;) is used to separate two command string and let you can combine two commands in a command string. For example, commanding with the

following string **VOLT MAX;CURR MAX** is the same as commanding with **VOLT MAX** and then **CURR MAX**.

 **CAUTION** It's vital to use a colon and a semicolon to combine commands from different subsystems. For example, in the following command string, an error appears if they are not used.

DISP:TEXT:CLE;:SOUR:CURR MIN

4.1.3 Command Format in This Manual

The format used on SCPI commands in this manual is like below.

CURRent {<current>|MINimum|MAXimum|UP|DOWN}

The above command consisting of upper-case and lower-case letters is the basic SCPI syntax. The upper-case letters indicate the abbreviated spelling for the command. To shorten program lines, you may use an abbreviated form. Generally, in order to create more readable programs, it is best to use the complete form.

For example, via the above syntax statement, *CURRENT* and *CURR* are both available forms. But when using unqualified and fragment forms, such as *CUR* and *CURREN*, an error will be generated.

4.1.4 MIN and MAX Parameters

For many commands, the minimum/maximum values can be substituted by a parameter MINimum/MAXimum. For example, in the following command:

CURRent {<current>|MIN|MAX}

To set the current limit to minimum value (0A), you can use the command *CURR 0* or use *CURR MIN*.

4.1.5 Setting and Querying Commands

Commands can group as setting commands and querying commands. Setting commands are used to set value or state of the device. For example, **VOLT 5** will set the CV limit to 5V. Commands that ends with character '?' are querying commands and you can use these commands to query active setting values and states of the device. For example, **VOLT?** is used to query the active CV limit value. In some querying commands, you can add MIN/MAX/DEF parameters to query the minimum/maximum/default value of the setting. For example, **VOLT? MAX** will return the maximum CV limit value of the power supply.

 **CAUTION** If you send two query commands without reading the response from the first, and want to read the second response, you may receive some data from the first response followed by the complete second response. To prevent this, do not send a query command without reading the response. If the situation can't be prevented, send a device clear before sending the second query command.

4.1.6 SCPI Command Terminators

A command string sent to the power supply has to end with a <new line> character. The message from the IEEE-488 EOI (end-or-identify) is analyzed as a <new line> character and used to terminate a command string substituting a <new line> character. It's also accepted that a <carriage return> is followed by a <new line>. Command string termination always reset the current SCPI command path to the root level. Generally, the <new line> character has the ASCII decimal code of 10.

4.1.7 Common SCPI Commands

The GPIB (IEEE-488.2 standard) defines a set of common commands performing functions like reset, self-test, and status operations. GPIB commands always start with an asterisk "*", consisting of four to five characters in length, and may include one or more parameters. The command keyword is separated from the first parameter by a blank space. You can use a semicolon ";" to separate multiple commands as shown below:

****RST; *CLS; *ESE 32; *OPC?***

4.1.8 SCPI Parameter Types

The SCPI language defines several different data formats in order to be used in program messages and response messages. Generally, these parameters are in numeric, discrete, Boolean, and string.

Numeric Parameters:

Number-required commands accept commonly used decimal representations of numbers such as decimal points and scientific notation. Some special numeric parameters like MINimum, MAXimum, and DEFault are also accepted, as well as sending engineering unit suffixes (V, A, or S) with numeric parameters. If you leave acceptable numeric values, the power supply will round the input numeric parameters automatically. For example:

VOLT {<voltage>|MIN|MAX|UP|DOWN}

Discrete Parameters:

You can use discrete parameters to program settings that have a limited number of values like *BUS* and *IMM*. When querying, responses will return the short form in all upper-case letters invariably. For example:

TRIG:SOUR {BUS|IMM}

Boolean Parameters:

You can use Boolean parameters to represent a single binary condition that is either true or false. If it's a false condition, the power supply will accept OFF or 0. If it's a true condition, the power supply will accept ON or 1. When querying a Boolean setting, the power supply will return 0 or 1 invariably. For example:

DISP {OFF|ON}

String Parameters:

String parameters contain virtually any set of ASCII characters. A string has to start and end with matching quotes; either with a single quote or with a double quote. You can type it twice without any characters in between to include the quote delimiter as part of the string. For example:

DISP:TEXT <quoted string>

4.2 SCPI Commands

This section collects the commands and provides the descriptions about output setting & operation, triggering, system, calibration, status, and IEEE-488 conformance.

4.2.1 Output Settings and Operation Commands

This section provides commands to program the power supply output operation. Although the **APPLY** command leaves the most straightforward way to program the CV/CC limit settings, the **VOLT** and **CURR** commands give more flexibility to change the individual settings.

APPLY {<voltage>|DEF|MIN|MAX},{<current>|DEF|MIN|MAX}
APPLY?

[**SOURCE**:]

CURRENT[:**LEVEL**][:**IMMEDIATE**][:**AMPLITUDE**] {<current>|MIN|MAX}
CURRENT[:**LEVEL**][:**IMMEDIATE**][:**AMPLITUDE**?] {MIN|MAX}
CURRENT[:**LEVEL**][:**IMMEDIATE**]:**STEP**[:**INCREMENT**] {<current>|DEF}
CURRENT[:**LEVEL**][:**IMMEDIATE**]:**STEP**[:**INCREMENT**?] {DEF}
CURRENT[:**LEVEL**]:**TRIGGERED**[:**AMPLITUDE**] {<current>|MIN|MAX}
CURRENT[:**LEVEL**]:**TRIGGERED**[:**AMPLITUDE**?] {MIN|MAX}
CURRENT:**PROTECTION**[:**LEVEL**] {<current>|MIN|MAX}
CURRENT:**PROTECTION**[:**LEVEL**?] {MIN|MAX}
CURRENT:**PROTECTION**:**STATE** {0|1|OFF|ON}
CURRENT:**PROTECTION**:**STATE**?
CURRENT:**PROTECTION**:**TRIPPED**?
CURRENT:**PROTECTION**:**CLEAR**
VOLTAGE[:**LEVEL**][:**IMMEDIATE**][:**AMPLITUDE**] {<voltage>|MIN|MAX}
VOLTAGE[:**LEVEL**][:**IMMEDIATE**][:**AMPLITUDE**?] {MIN|MAX}
VOLTAGE[:**LEVEL**]:**TRIGGERED**[:**AMPLITUDE**] {<voltage>|MIN|MAX}
VOLTAGE[:**LEVEL**]:**TRIGGERED**[:**AMPLITUDE**?] {MIN|MAX}
VOLTAGE:**PROTECTION**[:**LEVEL**] {<voltage>|MIN|MAX}
VOLTAGE:**PROTECTION**[:**LEVEL**?] {MIN|MAX}
VOLTAGE:**PROTECTION**:**STATE** {0|1|OFF|ON}
VOLTAGE:**PROTECTION**:**STATE**?
VOLTAGE:**PROTECTION**:**TRIPPED**?
VOLTAGE:**PROTECTION**:**CLEAR**

MEASURE

:**CURRENT**[:**DC**?]
[:**VOLTAGE**][:**DC**?]
:**SENSE**:**EXTERNAL** {OFF|ON}
:**SENSE**:**EXTERNAL**?

OUTPUT

[:**STATE**] {0|1|OFF|ON}
[:**STATE**?]

For a clearer command description, please read the following examples carefully.

***APPLy* {<voltage>|DEF|MIN|MAX},{<current>|DEF|MIN|MAX}**

This command is used to set the CV/CC limit values. It is combination of the commands VOLT and CURR. If one of the voltage and current value are not in the valid data range, an error occurs. The CV/CC limit values changes as soon as the command is executed.

Instead of entering voltage/current value, the parameters DEF/MIM/MAX are also acceptable. MINimum and MAXimum set the voltage or current to the minimum and maximum available value of the CC/CV limit levels. If a DEFault parameter is used, the CV/CC limit level stored in the location 0 will be set.

If there is only one parameter following the APPLy command, the power supply will use it to set the CV limit.

APPLy?

This command is used to query the active applied CV/CC limit value. The CV/CC limit values will return in the scientific format and separated by a comma.

***OUTPut* {OFF|ON}**

This command is used to enable or disable the output of the power supply. After reset, the output is always turned OFF.

OUTPut?

This query command is used to query the output state. If the output is turned ON, 1 is returned. If the output is turned OFF, 0 is returned.

***CURRent* {<current>|MINimum|MAXimum|UP|DOWN}**

This command is used to set the CC limit level of the power supply. If the output is turn ON, this commands change the output of the power supply to the newly programmed CC limit level.

The ***MINimum*** or ***MAXimum*** can be substituted for a specific value used on current. The predetermined ***UP*** or ***DOWN*** parameter can be used to increase or decrease one step of the CC limit level. The command ***CURRent:STEP*** describe below is used to set the amount of increment and decrement step.

***CURRent?* {MINimum|MAXimum}**

This query command is used to return the presently programmed current level of the power supply. The presently programmed current level will return in scientific format. When commanding ***CURR? MAX*** and ***CURR? MIN***, the highest and lowest programmable current levels return.

***CURRent:STEP* {<numeric value>|DEFault}**

This command is used to set the step size that used to increase or decrease the CC limit value with CURR command describe above. The default step is 5mA.

***CURRent:STEP?* {DEFault}**

This query command is used to query the active current step. The active current step value will return in scientific format.

***CURRent:TRIGgered* {<current>|MINimum|MAXimum}**

This command is used to program the pending triggered current level, which is a stored value that is transferred to the output terminals when a trigger occurs. Subsequent **CURRENT** commands won't affect any pending triggered levels.

CURRENT:TRIGgered? [MINimum|MAXimum]

This query command is used to query the triggered current level presently programmed. When commanding **CURR:TRIG? MAX** and **CURR:TRIG? MIN**, the power supply returns the highest and lowest programmable triggered current levels.

CURRENT:PROTection {<current>|MINimum|MAXimum}

This command is used to set the current level where the overcurrent protection (OCP) circuit will trip. If the output current is greater than the OCP level, the output current will be programmed to zero. Then the Questionable Status register "OCP" bit will be set as well. This condition can be cleared by commanding **CURR:PROT:CLE** after the condition caused the OCP trip is removed.

CURRENT:PROTection? {MINimum|MAXimum}

This query command is used to query the overcurrent protection trip level presently programmed. When commanding **CURR:PROT? MAX** and **CURR:PROT? MIN**, the power supply returns the maximum and minimum programmable overcurrent trip levels.

CURRENT:PROTection:STATe {0|1|OFF|ON}

This command is used to enable or disable the overcurrent protection function.

CURRENT:PROTection:STATe?

This query command is used to return the state of the overcurrent protection function. If the OCP is enabled, 1 is returned. Otherwise 0 is returned.

CURRENT:PROTection:TRIPped?

This query command is used to query if a OCP tripped event occurred. If there is no OCP tripped event occurred, 0 is returned. Otherwise 1 is returned. To clear OCP tripped event, use the **CURRENT:PROTection:CLEar** command.

CURRENT:PROTection:CLEar

This command is used to clear the overcurrent protection tripped event. After commanding, the output current is restored to the state in which it was before the current protection tripped and the OCP trip level keeps unchanged to the value presently programmed. Before clearing the tripped event, keep the output current lower than the trip OCP point, or adjust the OCP trip level to be greater than the output setting.

MEASure:CURRENT?

This command is used to query the current output value measured by the power supply. The reading value is returned in the scientific format.

VOLTage {<voltage>|MINimum|MAXimum|UP|DOWN}

This command is used to set the CV limit level of the power supply. If the output is turn ON, this commands change the output of the power supply to the newly programmed CV limit level.

The **MINimum** or **MAXimum** can be substituted for a specific value used on current. The predetermined **UP** or **DOWN** parameter can be used to increase or decrease one step of the CV limit level. The command **VOLTage:STEP** describe below is used to set the amount of increment and decrement step.

VOLTage? [MINimum|MAXimum]

This query command is used to query the presently programmed voltage level of the power supply. The presently programmed voltage level will return in scientific format. When commanding **VOLTage? MAX** and **VOLTage? MIN**, the highest and lowest programmable voltage levels return.

VOLTage:STEP {<numeric value>|DEFault}

This command is used to set the step size that used to increase or decrease the CV limit value with VOLT command describe above. The default step is 5mV.

VOLTage:STEP? {DEFault}

This query command is used to query the active voltage step. The active voltage step value will return in scientific format.

CURRent:TRIGgered {<current>|MINimum|MAXimum}

This command is used to program the pending triggered current level, which is a stored value that is transferred to the output terminals when a trigger occurs. Subsequent **CURRent** commands won't affect any pending triggered

VOLTage:TRIGgered {<voltage>|MINimum|MAXimum}

This command is used to program the pending triggered voltage level, which is a stored value that is transferred to the output terminals when a trigger occurs. Subsequent **VOLTage** commands won't affect any pending triggered levels.

VOLTage:TRIGgered? [MINimum|MAXimum]

This query command is used to query the triggered voltage level presently programmed. When commanding **VOLT:TRIG? MAX** and **VOLT:TRIG? MIN**, the power supply returns the highest and lowest programmable triggered voltage levels.

VOLTage:PROTection {<voltage>|MINimum|MAXimum}

This command is used to set the voltage level where the overvoltage protection (OVP) circuit will trip. If the output voltage is greater than the OVP level, an internal SCR will shorten the output. Then the Questionable Status register "OVP" bit will be set as well. This condition can be cleared by commanding **VOLT:PROT:CLE** after the condition caused the OVP trip is removed.

VOLTage:PROTection? {MINimum|MAXimum}

This query command is used to return the overvoltage protection trip level presently programmed. When commanding **VOLT:PROT? MAX** and **VOLT:PROT? MIN**, the power supply returns the maximum and minimum programmable overvoltage trip levels.

VOLTage:PROTection:STATe {0|1|OFF|ON}

This command is used to enable or disable the overvoltage protection function.

VOLTage:PROTection:STATe?

This query command is used to return the state of the overvoltage protection function. If the OVP is enabled, 1 is returned. Otherwise 0 is returned.

VOLTage:PROTection:TRIPped?

This query command is used to query if a OVP tripped event occurred. If there is no OVP tripped event occurred, 0 is returned. Otherwise 1 is returned. To clear OVP tripped event, use the **VOLTage:PROTection:CLEar** command.

VOLTage:PROTection:CLEar

This command is used to clear the overvoltage protection tripped event. After commanding, the output voltage is restored to the state in which it was before the protection feature occurred and the OVP trip level keeps unchanged to the value presently programmed. Before clearing the tripped event, keep the output voltage lower than the trip OVP point, or adjust the OVP trip level more greatly than the output setting.

MEASure[:VOLTage]?

This command is used to query the voltage output value measured by the power supply. The reading value is returned in the scientific format.

4.2.2 Triggering Commands

The power supply under the triggering system allows a change in voltage and current when receiving a trigger. In addition, it also allows you to select a trigger source, and to insert a trigger. To trigger the power supply, you need to finish the following multi-step process.

- First of all, you have to specify the source from which the power supply will accept the trigger. A bus (software) trigger or an immediate trigger from the remote interface is acceptable.
- After that, the time delay between the detection of the trigger on the specified trigger source and the start of any corresponding output change is available to be set.

Note | The time delay is feasible for the bus trigger source only.

- At last, you have to provide an **INITiate** command. If selecting the **IMMediate** source, the selected output will be set to the triggered level right away. However, if the trigger source is the bus, your power supply will be set to the triggered level after receiving GET (the Group Execute Trigger) or ***TRG** command.

The following commands are collected and used to deal with triggering. For more detailed description, please check from the [section 4.2.2.1](#) and [4.2.2.2](#).

INITiate[:IMMediate]

TRIGger[:SEquence]

:DELay {<seconds>|MIN|MAX}

:DELay?

:SOURce {BUS|IMM}

:SOURce?

***TRG**

4.2.2.1 Trigger Source Options

You have to specify the source from which the power supply will accept the trigger. In addition, the trigger is stored in volatile memory. And the source is set to bus after powering on the power supply or resetting a remote interface.

Bus Triggering:

- Send **TRIG:SOUR BUS** to select the bus trigger source.
- Send ***TRG** to trigger the power supply via the remote interface, such as USB or GPIB after selecting the bus source. When sending this command, the trigger acts after the specified time delay if any delay is given.

- Send a wait command ***WAI** to ensure synchronization once the bus source is selected. When commanding ***WAI**, the power supply will wait for all pending operations to finish before executing other additional commands. For example, the command, **TRIG:SOUR BUS; *TRG; *WAI; *TRG; *WAI** guarantees that the first trigger is accepted and will be executed before the second trigger is recognized.
- Use the operation complete query (***OPC?**) or the operation complete (***OPC**) command to generate signal when the last operation is finished. Commanding ***OPC?** will return 1 to the output buffer when the last operation is finished. Commanding ***OPC** will set the OPC bit 0 in the Standard Event register when the operation is finished.

Immediate Triggering:

- Send **TRIG:SOUR IMM** to select the immediate trigger source.
- After selecting **IMMEDIATE** as a trigger source, **INITiate** immediately transfers the **VOLT:TRIG** or **CURR:TRIG** value to the VOLT or CURR value. All delay will be ignored.

4.2.2.2 Triggering Command Description

For new users, please read the command description carefully before commanding. Incorrectly commanding the supply will result in no reaction.

INITiate

If the trigger source is IMMEDIATE, this command complete one full trigger cycle. If the trigger source is BUS, this command initiates the trigger system.

TRIGger:DElay {<seconds>|MINimum|MAXimum}

This command is used to set the time delay between the detection of an event on the specified trigger source and the start of any corresponding trigger action on the output. Select from 0 to 3600 seconds, i.e. MIN = 0 seconds, and MAX = 3600 seconds. At ***RST**, the value is set to 0 seconds.

TRIGger:DElay? [MINimum|MAXimum]

This query command is used to query the trigger delay.

TRIGger:SOURce {BUS|IMMEDIATE}

This command is used to select the trigger source of the power supply. Either a bus trigger or an internal immediate trigger will be accepted. At ***RST**, the bus trigger source is selected.

TRIGger:SOURce?

This query command is used to query the present trigger source, such as **BUS** or **IMM**.

***TRG**

This command is used to generate a trigger to the trigger subsystem that has selected a bus trigger as its source.

4.2.3 Output Control Commands

This section provides information about commands for multiple output control and output sequence.

4.2.3.1 Commands for Master & Slave Application

The commands in this section are used to control the Master & Slave application. For more details about Master & Slave application, please refer to the [section 3.7](#).

OUTPut:

:CONTRol:DELay {<on delay>|MIN|MAX},{<off delay>|MIN|MAX}
:CONTRol:DELay?
:CONTRol:MODE {0|1|2|3|4|5}
:CONTRol:MODE?
:CONTRol[:STATe] {0|1|OFF|ON}
:CONTRol[:STATe]?

OUTPut:CONTRol:DELay {<on delay>|MIN|MAX},{<off delay>|MIN|MAX}

This command is used to set the turn-on delay and turn-off delay of the master-slave control. The available value is 0~60s.

OUTPut:CONTRol:DELay?

This command is used to query the turn-on and turn-off delay of the master-slave control. The turn-on delay and the turn-off delay returns and separated by a comma. For example, the returned "+3,+5" is indicate the turn-on delay is 3 seconds and the turn-off delay is 5 seconds.

OUTPut:CONTRol:MODE {0|1|2|3|4|5}

This command is used to set the operation mode of the master-slave control. 0 is the P-MA (parallel master) mode. 1 is the P-SL (parallel slave) mode. 2 is the S-MA (serial master) mode. 3 is the S-SL (serial slave) mode. 4 is the NORMAL mode. And 5 is the TRACK mode.

OUTPut:CONTRol:MODE?

This command is used to query the operation mode of the master-slave control.

OUTPut:CONTRol[:STATe] {0|1|OFF|ON}

This command is used to enable/disable the master-slave control function.

OUTPut:CONTRol[:STATe]?

This command is used to query the ON/OFF state of the master-slave control function. If the master-slave control is enabled, 1 is returned. Otherwise, 0 is returned.

4.2.3.2 Commands for Output Sequence

The commands in this section are used to control output sequence. For more details about output sequence control, please refer to [section 3.9](#).

OUTPut:

:SEQuence[:STATe] {0|1|OFF|ON}
:SEQuence[:STATe]?
:SEQuence:MODE {0|1|2}
:SEQuence:MODE?
:SEQuence:CYCLe {<cycle>}
:SEQuence:CYCLe?
:SEQuence:SETup {<start step>},{<stop step>}
:SEQuence:SETup?
:SEQuence:STEP:CURRent {<step>},{<current>|DEF|MIN|MAX}

:SEquence:STEP:CURRent? {<step>}
:SEquence:STEP:DWELI {<step>},{<time in ms>|MIN|MAX}
:SEquence:STEP:DWELI? {<step>}
:SEquence:STEP:RAMP {<step>},{<time in ms>|MIN|MAX}
:SEquence:STEP:RAMP? {<step>}
:SEquence:STEP:VOLTAge {<step>},{<voltage>|DEF|MIN|MAX}
:SEquence:STEP:VOLTAge? {<step>}
:SEquence:STEP? {<step>}

OUTPut:SEquence[:STATe] {0|1|OFF|ON}
 Enable/Disable output sequence function.

OUTPut:SEquence[:STATe]?
 Return 0 if output sequence is disabled, and return 1 if output sequence is enabled.

OUTPut:SEquence:MODE {0|1|2}
 Set mode of output sequence. 0 is voltage only. 1 is current only. 2 is both voltage and current are controlled by the output sequence.

OUTPut:SEquence:MODE?
 Query sequence mode. Return 0, 1 or 2.

OUTPut:SEquence:CYCLe {<cycle>}
 Set output sequence repeat cycle. The value of cycle is 0~65535. 0 means always repeat.

OUTPut:SEquence:CYCLe?
 Query output sequence repeat cycle.

OUTPut:SEquence:SETup {<start step>},{<stop step>}
 Set start step and stop step of output sequence. Step is S0~S7.

OUTPut:SEquence:SETup?
 Query start step and stop step.

OUTPut:SEquence:STEP:VOLTAge {<step>},{<voltage>|DEF|MIN|MAX}
 Set voltage of a step. Step is S0~S7.

OUTPut:SEquence:STEP:VOLTAge? {<step>}
 Query voltage setup of a step. Step is S0~S7. Return voltage in Volts.

OUTPut:SEquence:STEP:CURRent {<step>},{<current>|DEF|MIN|MAX}
 Set current of a step. Step is S0~S7.

OUTPut:SEquence:STEP:CURRent? {<step>}
 Query current setup of a step. Step is S0~S7. Return current in amps.

OUTPut:SEquence:STEP:RAMP {<step>},{<time in ms>|MIN|MAX}
 Set ramp time of a step. Step is S0~S7. The ramp time allows you to set from 0 to 3599999ms.

OUTPut:SEquence:STEP:RAMP? {<step>}
 Query ramp time of a step. Step is S0~S7. Return ramp time in ms.

OUTPut:SEquence:STEP:DWELI {<step>},{<time in ms>|MIN|MAX}

Set dwelling of a step. The step index is from S0 to S7. Maximum dwelling is 86399999ms.

OUTPut:SEquence:STEP:DWELI? {<step>}

Query dwelling of a step. The step index is from is S0 to S7. Return dwelling in ms.

OUTPut:SEquence:STEP? {<step>}

Query a step setting. Step is S0~S7.

4.2.4 System-Related Commands

The following system-related commands are used to display the power supply's status. For detailed command information, please read the command descriptions coming next to the commands.

DISPlay[:WINDow]

[:STATe] {OFF|ON}

[:STATe]?

:TEXT[:DATA] <quoted string>

:TEXT[:DATA]?

:TEXT:CLear

SYSTem

:BEEPer[:IMMEDIATE]

:BEEPer:ALARm:OVP[:STATe] {0|1|OFF|ON}

:BEEPer:ALARm:OVP[:STATe]?

:BEEPer:ALARm:OCP[:STATe] {0|1|OFF|ON}

:BEEPer:ALARm:OCP[:STATe]?

:BEEPer:NORMal[:STATe] {0|1|OFF|ON}

:BEEPer:NORMal[:STATe]?

:ERRor?

:VERSion?

***IDN?**

***RST**

***TST?**

***SAV {0|1|2|3}**

***RCL {0|1|2|3}**

DISPLay {OFF|ON}

This command is used to turn the front-panel display off or on. When turning off the display, the display will show nothing, but ERR annunciator. After returning to the local mode by pressing LOCAL key on the front panel, the display will be turned on automatically.

DISPlay?

This query command is used to query the display ON/OFF status. If 0 is returned, it means the display is under OFF status. If 1 is returned, it means the display is under ON status.

DISPlay:TEXT <quoted string>

This command is used to set a string to display on the front panel. Once the command is executed, the front panel display will be turned OFF, and the string will be shown on the display. The string to set can only contain up to 49 alphanumeric characters and must in enclosed quotes. The string will scroll on the display if it is longer than 6 characters. ALL letters displaying on the display will replace with uppercase ones and characters that can not

display will replace with blank spaces. After turning the display ON, the string will not show anymore.

DISPlay:TEXT?

This query command is used to query the string set to display on the front panel screen.

DISPlay:TEXT:CLEAr

This command is used to clear the message shown on the front panel.

SYSTem:BEEPer

This command is used to issue a single beep instantly.

SYSTem:ERRor?

This command is used to get an error that queued in the power supply's error queue. If there's no errors in the error queue, a message "+0,No errors" will return. For more detail please refer to "[Error States](#)"

SYSTem:VERSion?

This query command is used to query the SCPI version used in the power supply. The retrieved value is a string in the form of YYYY.V where Y stands for the year of the version, and V stands for a version number for that year (for example, 1996.0).

***IDN?**

This query command is used to query the identification string of the power supply. The identification string contains 4 fields like that are shown below.

CHROMA ATE,62010L-36-7,L01000000066,1.00-1.00

The first field is the manufacturer name. The second field is the model name. The third field is the serial number of the device. And the last field is the firmware versions of the main MCU and communication card.

***RST**

This command is used to set the power supply to its power on state.

- The CV/CC limits are reset to the values that stored in the location 0.
- The OVP/OCP trip levels and ON/OFF states are reset to the values that stored in the location 0.
- BUS is selected as the trigger source.
- The voltage/current trigger level are set to 0V and 1A.
- Trigger delay of the voltage/current is set to 0s.
- The voltage and current step are reset to default values, 5mV and 5mA.
- The display is turned ON.

***TST?**

This command is used to request a self-test and will return the result of the test. If the self-test is passed, 0 is returned. If the test if failed, 1 is returned. One or more errors will also be generated if the self-test is failed.

***SAV {0|1|...|15}**

This command is used to save the present operation states to the non-volatile memory. Select the location 0~15 to store the operation states to. The operation states that stored in the location 0 will set as power-on settings. For more details, please refer to the "Storing and Recalling Operation States".

***RCL {0|1|...|15}**

This command is used to recall the stored operation states. For more details, please refer to the "Storing and Recalling Operation States".

4.2.5 Calibration Commands

The following calibration commands are used to calibrate your power supply. For detailed command information, please read the command descriptions coming next to the commands.

CALibration

:COUNT?
:CURRENT[:DATA] <numeric value>
:CURRENT:LEVel {MIN|MAX}
:SECure:STATe {OFF|ON},<code>
:STRing <string>
:STRing?
:VOLTage[:DATA] <numeric value>
:VOLTage:LEVel {MIN|MAX}

CALibration:COUNT?

This query command is used to return the number of time that it has been calibrated.

CALibration:CURRENT[:DATA] <numeric value>

This command is used to enter the CC calibration data. Before using this command, a calibration level should set first or an calibration sequence interrupt error will be generated.

CALibration:CURRENT:LEVel [MINimum|MAXimum]

This command is used to set the CC calibration level of the power supply. There are two calibration points for the power supply to calibrate CC. The MIN level must be calibrated first or a calibration sequence interrupt error will be generated.

CALibration:SECure:CODE < code>

This command is used to change the security code. To change the security code, you must un-secure the calibration first and secure the calibration again with the new code after entering the new security code with this command. The code is an un-quoted string with 6 alphanumeric characters. No matter the uppercase or lowercase letters.

CALibration:SECure:STATe {OFF|ON},<code>

This command is used to enable/disable the calibration security of the power supply. The code is an un-quoted string with 6 alphanumeric characters. No matter the uppercase or lowercase letters.

CALibration:SECure:STATe?

This command is used to query the calibration security state of the power supply. If the security is enabled, 1 is return. If the security is disabled, 0 is return.

CALibration:STRing <quoted string>

This command is used to write a message about the calibration. For example, you can use this command to save the calibration date. The string can contains up to 35 alphanumeric characters and must in an enclosed quote.

CALibration:STRing?

This command is used to query the calibration string.

CALibration:VOLTage[:DATA] <numeric value>

This command is used to enter the CV calibration data. Before using this command, a calibration level should set first or an calibration sequence interrupt error will be generated.

CALibration:VOLTage:LEVel {MINimum|MIDDLE|MAXimum}

This command is used to set the CV calibration level of the power supply. There are two calibration points for the power supply to calibrate CV. The MIN level must be calibrate first or an calibration sequence interrupt error will be generated.

4.2.6 Status Reporting Commands

The following commands are used to report event statuses, cleaning statuses, and set/enable bits in specific events. For detailed command information, please read the command descriptions coming next to the commands.

STATus

:QUESTionable:CONDition?
:QUESTionable:ENABle <enable value>
:QUESTionable:ENABle?
:QUESTionable[:EVENT?]

CLS**ESE <enable value>*****ESE?*****ESR?*****OPC*****OPC?*****PSC {0/1}*****PSC?*****SRE <enable value>*****SRE?*****STB?*****WAI****STATus:QUESTionable:CONDition?**

This command is used to query the operation mode of the power supply. If 0 is returned, the power supply is output off or the output is un-regulation. If 1 is returned, the power supply in under CC mode. If 2 is returned, the power supply is under CV mode. If 3 is returned, the power supply is under CP mode.

STATus:QUESTionable?

This command is used to query Questionable Status Event register. A decimal value is returned, and conforms to the binary-weighted sum of all bits in the register. These bits are locked. Reading the event register can clear it.

STATus:QUESTionable:ENABle <enable value>

This command is used to set the Questionable Status Enable register. Then the corresponding bits in the Questionable Status Event register are enabled to report to the Status Byte.

STATus:QUESTionable:ENABle?

This command is used to query the Questionable Status Enable register. Then the power supply will return a binary-weighted decimal representing the bits set in the enable register.

***CLS**

This command is used to clear all event registers and Status Byte register.

***ESE <enable value>**

This command is used to enable bits in the Standard Event Enable register. Then the selected bits will be reported to the Status Byte.

***ESE?**

This command is used to query the Standard Event Enable register. Then the power supply will return a decimal value which conforms to the binary-weighted sum of all bits in the register.

***ESR?**

This command is used to query the Standard Event register. Then the power supply will return a decimal value which conforms to the binary-weighted sum of all bits in the register.

***OPC**

After this command is executed, the "OPC" bit, bit 0 of the Standard Event register, is set to 1..

***OPC?**

After the command is executed, 1 is returned.

***PSC {0|1}**

Enable/Disable power-on status clear function. By default, the PSC is enabled and the Status Byte enable register and the Standard Event enable register are cleared while the power supply is power on. Use command *PSC 0 to prevent the registers from been cleared while power on.

***PSC?**

This query command is used to query the power-on status clear setting. If PSC is enabled, return 1. Otherwise return 0..

***SRE <enable value>**

This command is used to set the Status Byte Enable register.

***SRE?**

This command is used to query the Status Byte Enable register. Then the power supply will return a binary-weighted decimal representing the bits set in the enable register.

***STB?**

This command is used to query the Status Byte summary register. *STB? Is similar to a serial poll, but its process is like any instrument command. Using this command will return the same result as a serial poll, but the Request Service bit (bit 6) won't be cleared if a serial poll has occurred.

***WAI**

This command is used to instruct the power supply to wait for all pending operations done before executing additional commands over the remote interface. It's used only in the triggered mode.

4.2.7 IEEE-488 Conformance Information

The following commands are used to command IEEE-488. Since most of them are described above, limited information about the definitions of the dedicated hardware lines and addressed commands are listed here.

***CLS**
***ESE <enable value>**
***ESE?**
***ESR?**
***IDN?**
***OPC**
***OPC?**
***PSC {0/1}**
***PSC?**
***RST**
***RCL <recall index>**
***SAV <store index>**
***SRE <enable value>**
***SRE?**
***STB?**
***TRG**
***TST**

Dedicated Hardware Lines:

ATN – Attention
 IFC – Interface Clear
 REN – Remote Enable
 SRQ – Service Request Enable

Addressed Commands:

DCL – Device Clear
 EOI – End or Identify
 GET – Group Execute Trigger
 GTL – Go to Local
 LLO – Local Lockout
 SDC – Selected Device Clear
 SPD – Serial Poll Disable
 SPE – Serial Poll Enable

4.3 Programming Overview

This section provides an overview of the basic techniques used to program the power supply over the remote interface.

4.3.1 Regarding Programming Ranges

62000L series is a power supply with the auto range feature. You don't have to set values depending on the range. The available programming value for a parameter varies according to the desired output range of the power supply. Please refer to the following table to identify the programming values.

Source	Item	Value Info. (62010L-36-7/62015L-60-6)	
Voltage	Programming Range	0V to 37.8V	0V to 60V
	MAX Value	37.8V	60V
	MIN Value	0V	0V
	DEFAult Value	Value stored in location 0	Value stored in location 0
	*RST Value	Value stored in location 0	Value stored in location 0
Current	Programming Range	0A to 7.35A	0A to 6A
	MAX Value	7.35A	6A
	MIN Value	0A	0A
	DEFAult Value	Value stored in location 0	Value stored in location 0
	*RST Value	Value stored in location 0	Value stored in location 0

4.3.2 Regarding SCPI Status Registers

All SCPI devices utilize status registers in the same way. The status system can record different kinds of condition groups, such as the Status Byte register, the Standard Event register, and the Questionable Status register. For example, the Status Byte register records high-level summary information which is reported in the other register groups. The following diagram illustrates the SCPI status system used by the power supply.

SCPI status system

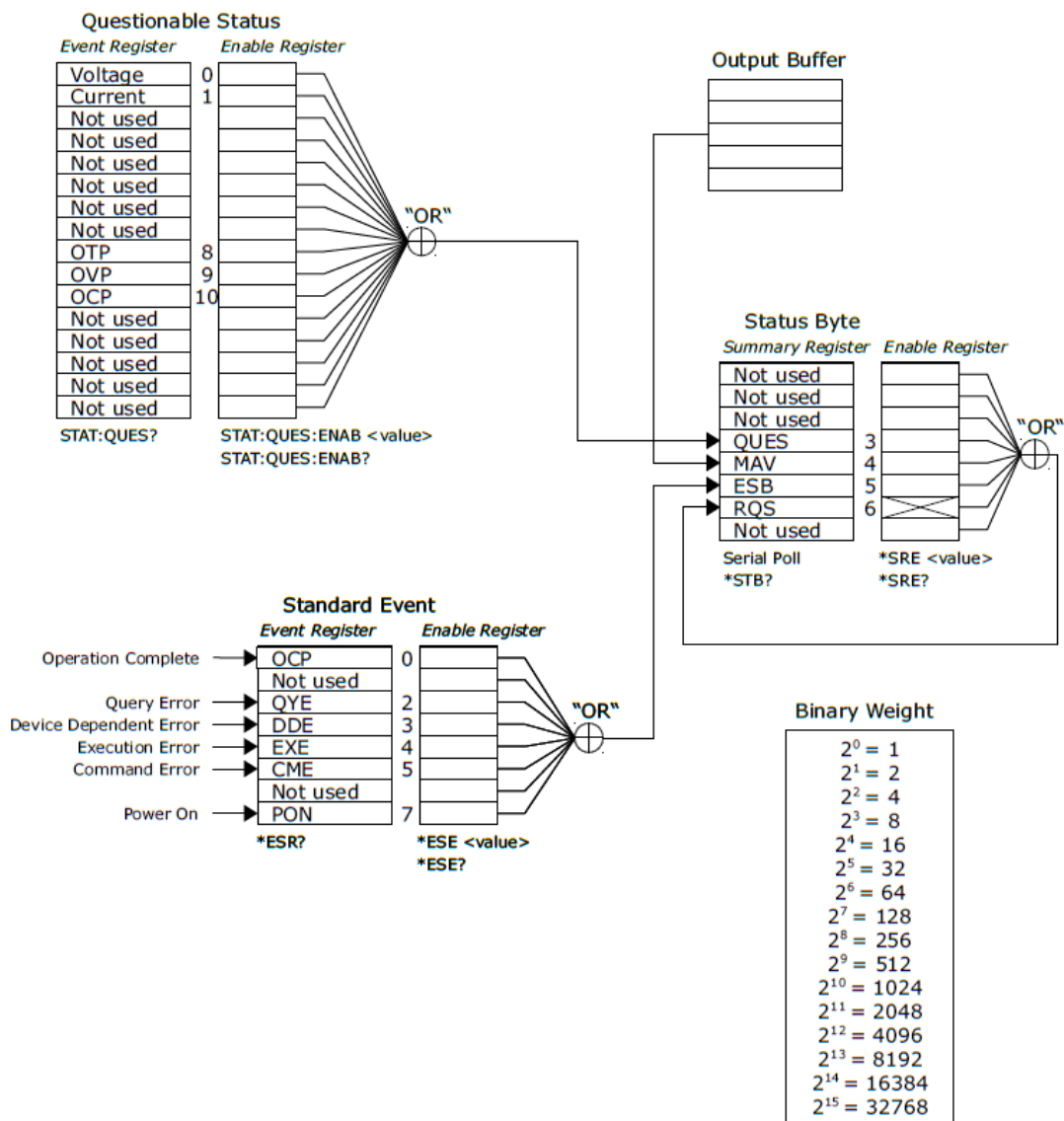

In addition, an event register is a read-only register that can generate defined conditions from the power supply. Bits in an event register are under a locked status. Once an even bit is set, the following status changes will be ignored. Bits in an event register are automatically cleared by a query, such as ***ESR?**, **STAT:QUES:EVENT?** or ***CLS**. But sending ***RST** or device clear won't clear bits in event registers. Querying an event register will return a decimal value which conforms to the binary-weighted sum of all bits set in the register.

On the other hand, an enable register can define which bits in the corresponding even register are ORed logically to form a single summary bit. Enable registers is able to read and write. When querying an enable register, it won't be cleared. Using ***CLS** can't clear enable registers, but it will clear the bits in the event registers. To enable bits in an enable register, you have to write a decimal value which conforms to the binary-weighted sum of the bits that you prefer enable in the register.

4.3.2.1 The Questionable Status Register

The Questionable Status register reports information about the power supply.

The bit 0 and bit 1 provides the information about the output CV/CC regulation. If the power supply is/was in CC (constant current) mode, the bit 0 sets to 1. If the power supply is/was in CV (constant voltage) mode, the bit 1 sets to 1.

The bit 8 ~ bit 10 provides information that one of the protection event is tripped. If the over temperature protection (OTP) tripped event is detected, bit 8 sets to 1. If the over voltage protection (OVP) tripped event is detected, bit 9 sets to 1. If the over current protection (OCP) tripped event is detected, bit 10 sets to 1.

To read the Questionable Status register, use the command below.

STATus:QUEStionable?

Any or all of the Questionable Status Events can be reported in the Questionable Status Summary bit (QUES, bit 3) of Status Byte register through the enable register. To set the enable register mask, write a decimal value to the register using the following command.

STATus:QUEStionable:ENABle <value>.

The bits of Questionable Status register are latched can only cleared by the command **STAT:QUES?** or ***CLS**.

Bit definition – Questionable status register

Bit	Decimal value	Definition
0 Voltage	1	The power supply is/was in constant current mode.
1 Current	2	The power supply is/was in constant voltage mode.
2-7 Not used	0	Always set to 0.
8 OTP	256	The over temperature protection circuit has tripped.
9 OVP	512	The over voltage protection circuit has tripped.
10 OCP	1024	The over current protection circuit has tripped.
11-15 Not used	0	Always set to 0.

4.3.2.2 The Standard Event Register

The Standard Event register reports the types of instrument events, such as power-on detected, command syntax errors, command execution errors, self-test or calibration errors, query errors, or when executing ***OPC**. All of these statuses can be reported in the Standard Event summary bit 5 of the Status Byte register via the enable register. To set the enable register mask, you have to use ***ESE** to write a decimal value to the register.

Note : An error status like Standard Event register bit 2, 3, 4, or 5 will record one or more errors in the error queue. Use **SYST:ERR?** to read the error queue.

Bit	Decimal Value	Definition
0 OPC	1	Operation accomplished. All commands prior to and including *OPC have been executed.
1 Not Used	0	Always set to 0.
2 QYE	4	Query Error. The power supply tried to read the output buffer, which is empty. Or, a new command line was received before a preceding query had been read. Or, the I/O buffers are full.
3 DDE	8	Device Error. A self-test or calibration error occurred.
4 EXE	16	Execution Error. An execution error occurred. The Error codes are within -211 to -221.
5 CME	32	Command Error. A command syntax error occurred. The Error codes are within -101 to -178.
6 Not used	0	Always set to 0.
7 PON	128	Power On. Power has been turned off and on since the last time the event register was read or cleared.

In addition, the Standard Event register will be cleared under the following conditions.

- Execute ***CLS**.
- Use ***ESR?** to query the event register. For example, 28 (4 + 8 + 16) is returned when the status of the Standard Event register has been queried, and QYE, DDE, and EXE condition have occurred.

In addition, the Standard Event Enable register will be cleared under the following conditions.

- Execute ***ESE 0**.
- Turn on the power supply, use ***PSC 1** to configure the power supply.

Note : You can't clear the enable register at power-on if you have previously configured the power supply with ***PSC 0**.

4.3.2.3 The Status Byte Register

The Status Byte summary register can generate conditions from the other status registers. Querying data that is waiting in the output buffer of the power supply is going to be immediately generated through the "Message Available" bit (bit4) of the Status Byte register. In addition, bits in the summary register are not locked. Clearing an event register will also clear the corresponding bits in the Status Byte summary register. Reading all messages in the output buffer and any pending queries will clear the message available bit.

Bit	Decimal Value	Definition
0-2 Not Used	0	Always set to 0.
3 QUES	8	One or more bits are set in the Questionable Status register (bits must be enabled in the enable register.)
4 MAV	16	Data is available in the output buffer.
5 ESB	32	One or more bits are set in the Standard Event register (bits must be enabled in the enable register.)
6 RQS	64	The power supply is requiring service (Serial Poll).
7 Not Used	0	Always set to 0.

When executing ***CLS**, the Status Byte summary register will be cleared. Using ***ESR?** to query the Standard Event register will clear only bit 5 in the Status Byte summary register. For

example, 24 (8+16) will be returned when querying the status of the Status Byte register, QUES and MAV conditions have occurred.

In addition, the Status Byte Enable register will be cleared under the following conditions.

- Execute ***SRE 0**.
- Turn on the power and previously configured the power supply with ***PSC 1**.

Note : If previously configuring the power supply with ***PSC 0**, the enable register won't be cleared at power-on.

4.3.2.3.1 Read Status Byte Request

The power supply implements a 488.2 USB488 interface and the host may read the Status Byte summary register at any time with the READ_STATUS_BYTE request. If the power supply receives a READ_STATUS_BYTE request from the host, an USB488 Interrupt-IN packet as shown as the following table.

Offset	Field	Size	Value	Definition	
0	bNotify	1	Bitmap	D7	Must be 1. See the USBTMC specs.
				D0~D6	The bTag value must be the same as the bTag value in the READ_STATUS_BYTE request.
1	bNotify	1	Status Byte	The IEEE-488.2 defined Status Byte returned during a serial poll.	

4.3.2.3.2 Service Request (SRQ)

When the request service bit (RQS, bit 6) in the Status Byte is set, an USB488 Interrupt-IN packet due to a SRQ condition is queued to send to the host. Select which summary bits will generate the service request by setting the Status Byte enable register with ***SRE** command.

If the response is queued, the Status Byte is modified in the same way an IEEE-488.2 device modifies the Status Byte after a SRQ/serial poll sequence. This means the power supply will clear the RQS bit of the Status Byte register after a Status Byte (with RQS set) is queued to be sent on the Interrupt-IN pipe.

The request service (RQS) bit is cleared only by queuing a response Interrupt-IN packet due to the SRQ condition or by reading the event register whose summary bit is causing the service request.

Offset	Field	Size	Value	Definition	
0	bNotify1	1	Bitmap	D7	Must be 1. See the USBTMC specs.
				D0~D6	bTag. The bTag field must be 0x01.
1	bNotify2	1	Status Byte	The IEEE-488.2 defined Status Byte returned during a serial poll.	

In addition, the following procedures present how to generate an SRQ interrupt.

- Clear the output queue of the power supply.
- Use ***CLS** to clear the event registers.
- Use ***ESE** to set up the enable masks of Standard Event register. Use the command ***SRE**

to set up the enable masks of the Status Byte summary register.

- Send ***OPC?** and enter the result to verify synchronization.
- Now, if any of the conditions corresponding to the enabled summary bits in the Status Byte register occurs, the power supply send a USB488 Interrupt-IN packet as shown as the above table to the host.

4.3.2.3.3 Use ***STB?** to Read the Status Byte

***STB?** is used to query the Status Byte register. The return value while querying the Status Byte register is a decimal value that corresponds to the binary-weighted sum of the bits set in the register. Since the request service bit (RQS, bit 6) of the Status Byte register is reported and cleared by a SRQ process, you don't have to read the state of the RQS bit with ***STB**. Executing ***STB?** can't clear the Status Byte summary register.

4.3.2.3.4 The Message Available Bit (MAV)

The Message Available bit (MAV, bit 4) of the Status Byte summary register indicates that data in the power supply's output queue is available to read into USB bus. The MAV bit is cleared only after all messages have been read from the output queue.

4.3.2.3.5 Use ***OPC**

The Operation Complete bit (OPC, bit 0) of the Standard Event register indicates if a command sequence is completed. After a ***OPC** command is executed, the OPC bit of the Standard Event register is set. Send ***OPC** after a query command that loads message into output queue, and you can use the OPC bit to determine if the message is available. However, the output queue will fill and the power supply will stop processing commands if there are too many messages generated by the commands before the ***OPC** executes sequentially.

In addition, the following procedures present how to determine if a command sequence is completed.

- Clear the power supply's output queue.
- Use ***CLS** to clear the event registers.
- Execute ***ESE 1** to enable the operation complete bit (OPC, bit 0) in the Standard Event register.
- Send ***OPC?** and enter the result to ensue synchronization.
- Execute ***OPC** as the last command sequentially after the command string you use to program the configuration of the power supply. The operation complete bit (OPC, bit 0) is set in the Standard Event register when the command sequence is completed.
- Check the standard event bit (ESB, bit 5) in the Status Byte summary register to determine if the command sequence is completed. The power supply will also generate a SRQ interrupt if you configure it.

5. Error Messages

When a syntax or hardware error has been detected, the front-panel Err annunciator turns on and the power supply beeps once each time an error is generated. A record of up to 32 errors is stored in the power supply's error queue.

Errors are retrieved in first-in-first-out (FIFO) order. The first error that was stored first is returned first. The Err annunciator turns off when all errors stored in the error queue have been read.

If more than 32 errors have been detected, the most recent error (the last error stored in the queue) is replaced with **-350, "Too many errors."** No additional errors are stored until you remove errors from the queue. Reading the error message stored in the queue will remove it at the same time. If no errors are stored when you read the error queue, the power supply responds with **+0, "No Errors"** over the remote interface or **NO ERROR** from the front panel operation.

When the power supply has been powered off or after a ***CLS** (clear status) command has been executed, the error queue is cleared. The ***RST** (reset) command does not clear the error queue.

On the other hand, if all of the error messages are from execution, Self-Test, and calibration, then the following sections will describe which error code represents the status.

Front-panel operation:

Press the ERROR key repeatedly to read the errors stored in the queue if the Err annunciator is on. The error is removed from the queue after being read by user.

Remote interface operation:

Use **SYSTem:ERRor?** to read the latest error message from the error queue. The returned error messages have the 73 following format.

-113,"Undefined header"

5.1 Execution Errors

-101 Invalid Character

There is one or more invalid character in the command string. Characters such as #, \$, or % are not available in a command and may have been inserted in the command keyword or within a parameter.

Example: `#VOLT 10`

-102 Syntax Error

There is one or more syntax error in the command string. You may have inserted a blank space before or after a colon in the command header, or before a comma.

Example: `VOLT:LEV ,10`

-103 Invalid Separator

There is one or more invalid separator in the command string. You may have used a comma instead of a colon, semicolon, or blank space; or you may have used a blank space instead of a comma.

Example: VOLT,10

-108 Parameter not Allowed

More parameters than expected for the command were received. You may have added a parameter to a command that does not accept a parameter or you entered extra parameters for the command.

Example: *OPC 1

-109 Missing parameter

Fewer parameters than expected for the command were received. One or more parameters that are required for the command were omitted.

Example: VOLT:LEV

-113 Undefined Header

A command that is not valid for this power supply was received. The command may not be a valid one or you have misspelled it. If you are using the short form of the command, remember that its maximum length is four letters.

Example: TRIGG:DEL 3

-121 Invalid Character in Number

An invalid character was found in the number specified for a parameter value.

Example: *ESE B01010102

-124 Too Many Digits

The received numeric parameter was found that contained more than 21 digits.

-131 Invalid Suffix

A suffix was incorrectly specified for a numeric parameter. You may have misspelled the suffix or the suffix is not available for the parameter.

-138 Suffix not Allowed

The received parameter contains suffix that not accept by the command.

Example : CURR 1V

-141 Invalid Character Data

Invalid character data was found. The character data element may contain an invalid character or the particular element received was not valid for the header.

-144 Invalid character data length

There are too many characters in the character data.

Example : CAL:SEC:CODE 01234567

-151 Invalid String Data

An invalid character string was received. Check to see if you have enclosed the character string in single or double quotes.

Example : DISP:TEXT "HELLO"

-211 Trigger Ignored

A Group Execute Trigger (GET) or *TRG was received but the trigger was ignored. Make sure that the trigger source should be selected to the bus and the trigger subsystem should be initiated by INIT[:IMM] command.

-213 Init ignored

An INITiate command has received but could not to execute because of current device settings.

-221 Settings Conflict

Indicate that the operation can not complete under present states of the power supply. For example, try to change the output sequence step settings without turning off the output first will generate this error.

-222 Data out of Range

The value of the numeric parameter for the command is outside the valid range.

Example: VOLT:LEV -3

-224 Illegal Parameter Value

A discrete parameter was received but did not accept by the command. You may have used an invalid parameter choice. Check the parameter list and choose a correct one.

Example: DISP MAX (MAX is not a valid choice).

-330 Self-test Failed

The complete self-test of the power supply from the remote interface (*TST? Command) failed. In addition to this error, more specific self-test errors are also reported.

-350 Too many errors

Too many errors occurred (more than 32 errors) and the error queue is overflow. No additional errors are stored until you remove errors from the queue. Reading the error message stored in the queue will remove it at the same time. The error queue is cleared when the power supply has been powered off, or after a *CLS (clear status) command has been executed.

-410 Query INTERRUPTED

A command which sends data to the output buffer was received, but there were data from a previous command still in the output buffer (the previous data is not overwritten). The output buffer is cleared when the power supply has been powered off, or after a *RST (reset) command has been executed.

-420 Query UNTERMINATED

The power supply was requested to talk (i.e., to send data over the interface) but a command which sends data to the output buffer has not been received. For example, you may have executed an APPLy command (which does not generate data) and then attempted an ENTER statement to read data from the remote interface.

-430 Query DEADLOCKED

A command which generates too much data to fit in the output buffer was received and the input buffer is also full. Command execution continues but all data are lost.

-440 Query UNTERMINATED after Indefinite Response

The *IDN? Command must be the last query command within a command string. Any query command after *IDN? generates this error.

Example: *IDN?;;SYST:VERS?

501 Isolator UART framing error

Internal UART communication failed.

5.2 Self-Test Errors

The following errors indicate failures that may occur during a self-test.

602 DATA read/write failed

Failed to read data stored from non-volatile memory or write data to it.

632 Hardware test failed

634 Connection test failed

5.3 Calibration Errors

The following errors indicate failures that may occur during a calibration. Refer to the Service Guide for more information.

701 Cal security disabled by master code

Calibration security has disabled by master code.

702 Cal Secured

The power supply is secured and calibration is not allowed.

703 Invalid Secure Code

The security code attempt to unsecure or secure the power supply was wrong. Use the security code that the same as what you used to secure the power supply to unsecure it, and vice versa. The security codes should be a 6 alphanumeric characters string without quotes.

705 Cal aborted

A calibration progress is aborted.

706 Cal invalid data value

Received calibration data is out of range.

708 Cal Invalid Command

A command which is not available in calibration mode, for example OUTP OFF, was received.

709 Cal initialize failed

Failed to initialize calibration progress.

711 Cal Sequence Interrupted

Calibration sequence was interrupted. You may lose some steps in calibration procedure.

712 Bad DAC Cal Data

Failed to calibrate internal DAC.

714 Bad OVP cal data

715 Bad OCP cal data

Chroma's Continuous Quality Process User Manual Customer Feedback

Chroma welcomes all comments and recommendations to improve this publication in the future editions. Please scan the QR code below or click the URL <http://www.chromaate.com/survey?n=793ce6db-17ef-4cd3-b0de-8bbd09aa38e0> to fill in the customer feedback form. Thank you!





CHROMA ATE INC.

致茂電子股份有限公司

66 Huaya 1st Road, Guishan,

Taoyuan 33383, Taiwan

台灣桃園市 33383 龜山區

華亞一路 66 號

T +886-3-327-9999

F +886-3-327-8898

Mail: info@chromaate.com

<http://www.chromaate.com>