



Wireless Streaming Speaker

WX-021

Owner's Manual

Before using this unit, be sure to read the "Safety Brochure."

MusicCast

EN

# Table of contents

<b>Introduction .....</b>	<b>3</b>	<b>Useful features .....</b>	<b>16</b>
About this document .....	3	Favorites .....	16
Accessories .....	3	Alarm .....	17
<b>Using the unit .....</b>	<b>4</b>	Child lock function .....	19
<b>Parts of the unit .....</b>	<b>5</b>	Option settings .....	20
Top panel .....	5	Firmware updates .....	22
Rear panel .....	6	Using iPhone settings to connect to a network .....	23
<b>Use MusicCast CONTROLLER to connect to a network .....</b>	<b>7</b>	Mounting the speaker on a wall .....	24
<b>Play from an input source .....</b>	<b>8</b>	<b>Troubleshooting .....</b>	<b>26</b>
Listening to music stored on the mobile device .....	8	General .....	26
Listening to Internet radio .....	9	Network .....	27
Listening to streaming services .....	9	Bluetooth .....	29
Listening to music stored on a media server .....	10	<b>File formats, and devices/media supported by the unit .....</b>	<b>30</b>
Listening to music via AirPlay .....	11	<b>Specifications .....</b>	<b>31</b>
Listening to music via Bluetooth .....	12	<b>Trademarks .....</b>	<b>32</b>
<b>Pair the unit with MusicCast-enabled devices .....</b>	<b>13</b>		
Configuring a MusicCast network .....	13		
Using two units as stereo speakers (MusicCast Stereo function) .....	14		
Using two units as surround speakers (MusicCast Surround function) .....	15		

# Introduction

## About this document

This document explains all unit functions and operation in detail. The supplied Quick Manual provides brief instructions on connecting the unit to a network through the playing of music files stored on a mobile device. Keep the Quick Manual at hand for future reference.

- In this document, smartphones and other mobile devices running the iOS or Android operating systems are collectively referred to as “mobile devices”.
- The term “iPhone” as used in this document also refers to “iPod touch” and “iPad” devices.
- Illustrations in this manual may differ slightly from the actual objects depicted.
- MusicCast CONTROLLER app screenshots in this document were captured on a device running the English version of iOS. Actual screen displays may differ depending upon the version of the app or iOS used.
- Symbols and conventions

**Caution** Indicates information that should be read before use to prevent failure or physical damage.

**Note** Indicates precautions and supplementary information that should be read before using the unit.

↔ References another page or pages that provide additional information.

## Accessories

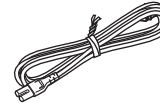

Power cord

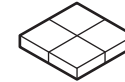

Anti-vibration pads

Use when mounting the unit on the wall (↔ p. 24)



Quick Manual



Safety Brochure

# Using the unit

- This unit is a wireless streaming speaker that can be used with a home network or audio system to play audio from Internet radio, media server (computer or NAS), AirPlay or Bluetooth devices on the same network.
- The unit itself is small, yet it delivers the rich sound made possible with Yamaha's exclusive digital signal processor (DSP).
- The unit can be operated and a home audio network configured using the dedicated MusicCast CONTROLLER app. (⇨ p. 7 "Use MusicCast CONTROLLER to connect to a network")

## ♪ Use MusicCast CONTROLLER to configure a home audio network ♪

### Play audio from an incredibly wide range of input sources with superior sound quality

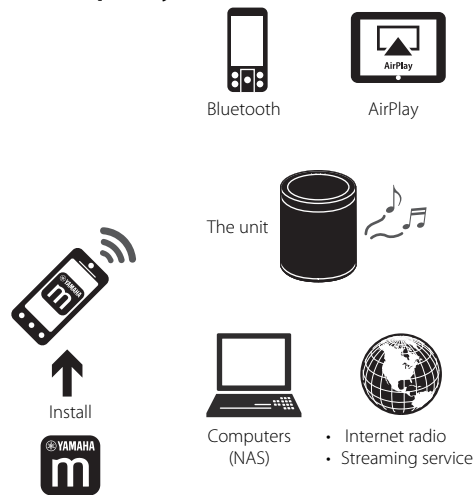

A wireless LAN router (access point) is required.

### Using two units

The two units can act as stereo speakers, or they can be combined with a Yamaha amplifier and act as wireless surround sound speakers.

(⇨ p. 14 "Using two units as stereo speakers (MusicCast Stereo function)")  
(⇨ p. 15 "Using two units as surround speakers (MusicCast Surround function)")

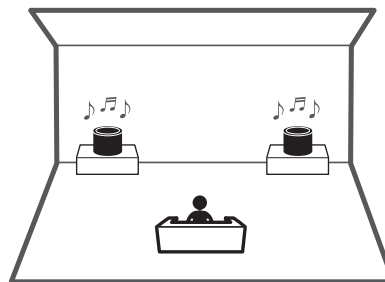

### Combining with MusicCast-enabled devices

Listen to Internet radio stations in multiple rooms or play music files. Use MusicCast to enjoy music throughout the house.

(⇨ p. 13 "Configuring a MusicCast network")

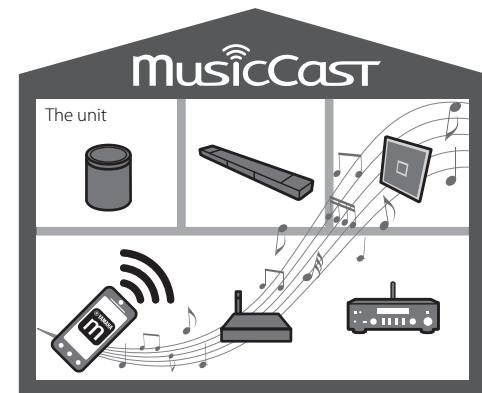

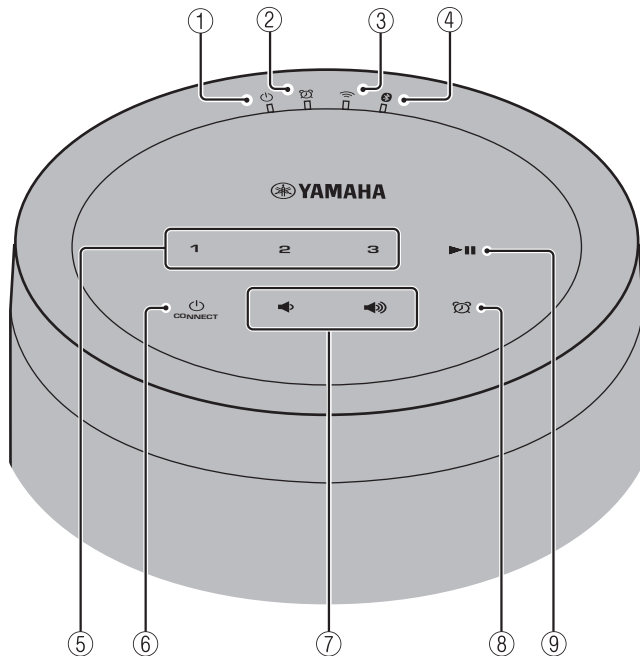

# Parts of the unit

## Top panel



### Indicators

- ①  Power indicator (☞ p. 7)  
Glow steadily when the unit is on.
- ②  Alarm indicator (☞ p. 17)

- ③  Wireless LAN indicator (☞ p. 21)  
Glow steadily when the unit is connected to a wireless LAN router. If the MusicCast Stereo or MusicCast Surround function is used, this indicator will glow steadily even when the unit is connected to a network using the network cable.

- ④  Bluetooth indicator (☞ p. 12, 21)

### Control panel

The control panel is touch sensitive. Tap icons with your finger to control functions.

- ⑤ **1, 2, 3** (☞ p. 16)

- ⑥  (Power)/CONNECT (☞ p. 7)

#### Auto standby

The unit will automatically enter standby mode if no audio is played, and no operations are performed, for more than 20 minutes (auto standby function). See "Option settings" (☞ p. 20) to disable the auto standby function.

- ⑦  Adjust sound volume.

- ⑧  (☞ p. 17)  
Set the alarm.

- ⑨  Play or pause a song.

# Rear panel

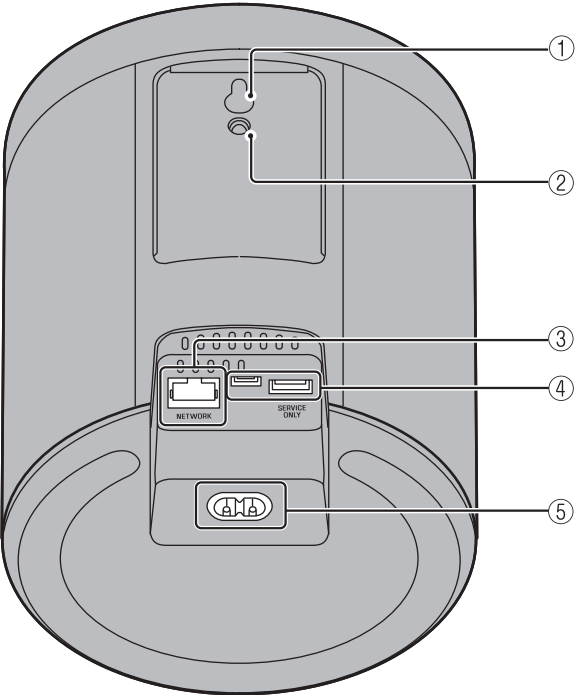

- ① Hole for wall-mount hanger (except for the U.S.A. and Canada models; ☞ p. 24)
- ② Hole for wall-mount screw (☞ p. 25)
- ③ NETWORK jack (☞ p. 7)
- ④ SERVICE ONLY jack  
Use when the unit requires maintenances.
- ⑤ Power connector (☞ p. 7)

# Use MusicCast CONTROLLER to connect to a network

## 1 Connect the unit to an electrical outlet.

Connect the power cord (supplied) to the power connector on the unit, and then plug the power cord into an electrical outlet.

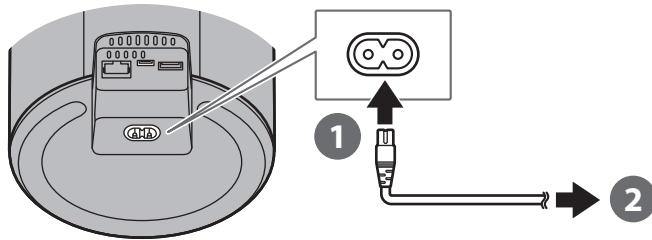

### Note

When the power cord is plugged into an electrical outlet, touch-sensitive components on the unit will be adjusted. This adjustment takes approximately five seconds. Do not operate the unit while this adjustment is in progress to prevent the unit from malfunctioning.

## 2 Connect to a network.

Follow steps 1–3 at right to connect to a network.

The unit can be connected to a network using either a wired or a wireless connection. A network cable (available separately) is required for a wired network connection.

### Note

- For a wired network connection, connect a standard shielded twisted pair (STP) network cable (straight, category 5 or higher; sold separately) to the NETWORK jack on the rear panel.
- For more information on Internet connections, refer to the documentation provided with your network devices.

- Security software installed on your computer or network device settings (firewall, etc.) may prevent the unit from accessing your computer or Internet radio stations. If this occurs, modify security software or network device settings to permit access by the unit.

- 1 Download the MusicCast CONTROLLER app to your mobile device from the App Store or Google Play.
- 2 Use the app to configure network settings.

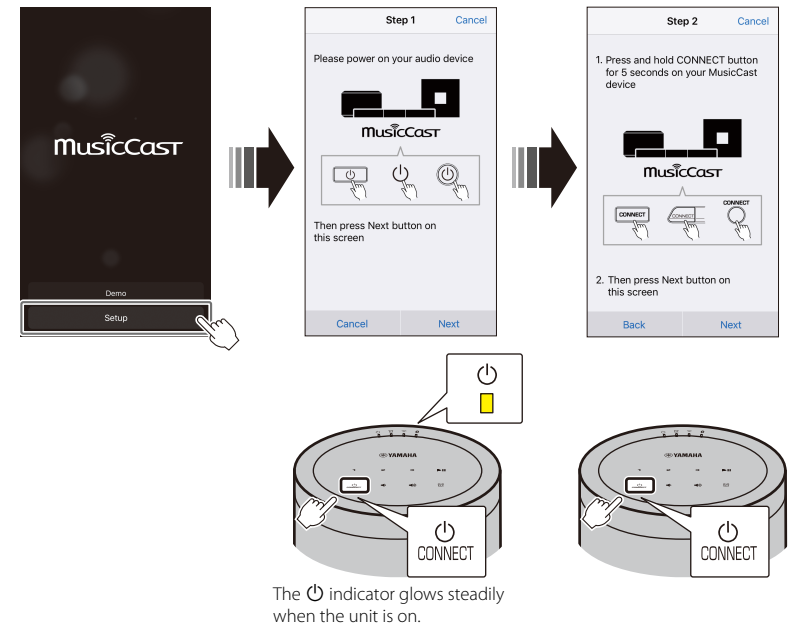

The  indicator glows steadily when the unit is on.

- 3 Follow the app's on-screen instructions to complete network settings.

# Play from an input source

Use the MusicCast CONTROLLER app to play music. Select a room registered with the unit to open the input source selection screen. This screen provides access to various input sources.

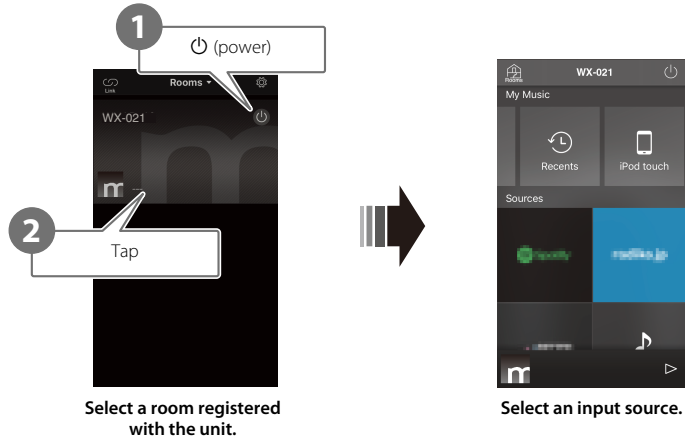

## Listening to music stored on the mobile device

Play music files stored on the mobile device to which the MusicCast CONTROLLER app has been installed.

### Note

The types (formats) of audio files that can be played vary by mobile device. See documentation provided with your mobile device for information on the supported file formats.

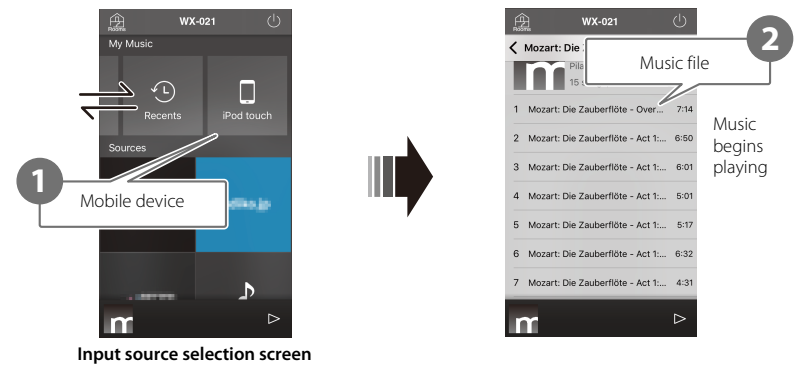



## Listening to Internet radio

Listen to radio broadcasts from around the world that are distributed via the Internet.

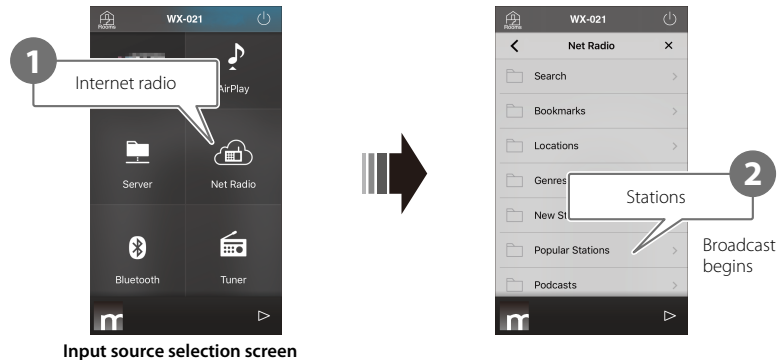

Input source selection screen

### Note

- Some Internet radio stations may not be available, or may be available only during certain hours.
- This service may be terminated without prior notice.
- This function uses airable.Radio's extensive catalog. "airable" is a service of Tune In GmbH.

## Listening to streaming services

A streaming service can be heard using the MusicCast CONTROLLER app. On the MusicCast CONTROLLER screen, select the room registered with the unit, and select the streaming service to be tuned into by its station name. For details, see the MusicCast CONTROLLER app.

### Note

- Service is limited to certain areas.
- Services supported with the unit may not be available depending upon some regions where the unit is purchased.
- Service may change or be discontinued without notice.
- After registering the unit in the MusicCast CONTROLLER app, the streaming service can be used. For details, see "Use MusicCast CONTROLLER to connect to a network" (☞ p. 7).
- For details on music streaming services, see the supplements for streaming services. Access the Yamaha Downloads site to download the supplement. <https://download.yamaha.com/>

# Listening to music stored on a media server

Music files stored on a computer or network attached storage (NAS) device on the same network as the unit can be played. In such instances, the computer (or NAS) serves as a media server.

**Note**

- Connect the unit and computer (or NAS) to the same wireless LAN router (access point).
- For information on music files that can be played using the unit, see "File formats, and devices/media supported by the unit" (↔ p. 30).

## 1 Configure media sharing.

Media sharing must be enabled to play music stored on the media server (computer or NAS). The following instructions use Windows Media Player 12 as an example. Follow the on-screen instructions, as shown below, to configure media sharing.

**Windows Media Player 12**

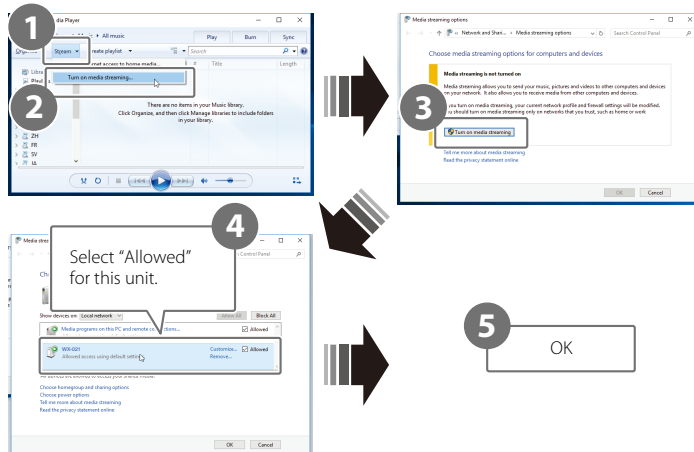

**Note**

- Windows Media Player 12 screenshots were captured using a computer with an English interface.
- If the media server (computer or NAS) uses an application other than Windows Media Player to play audio, see documentation supplied with the computer (or NAS) or the software application for instructions on enabling media sharing.
- For details on media sharing, see Windows Media Player's help.

## 2 Play a music file.

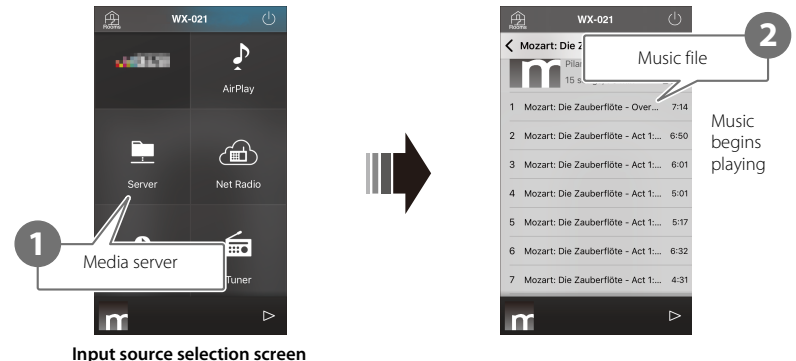

# Listening to music via AirPlay

Music files in iTunes, or stored on an iPhone, can be played using the AirPlay function.

## Note

- Connect the unit, computer (or NAS), and iPhone to the same wireless LAN router (access point).
- For information on iPhone compatibility, see “File formats, and devices/media supported by the unit” (⇨ p. 30).

## 1 Start iTunes, or display the iPhone’s music playback screen.

When iTunes, or the iPhone, recognizes the unit, the AirPlay icon will be displayed on the screen.

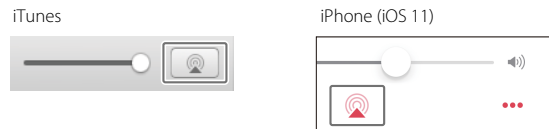

## Note

If the icon is not displayed, check to see that the unit and the computer (or iPhone) are correctly connected to the wireless LAN router.

## 2 Click or tap the AirPlay icon in iTunes or on the iPhone, and select the unit (a room registered with the unit) as the audio output destination.

## 3 Play a music file.

The unit’s input source changes to AirPlay, and music will begin playing.



# Listening to music via Bluetooth

The unit can be used to play music from a Bluetooth device, such as a mobile device or digital music player.

For more information regarding Bluetooth, see documentation provided with Bluetooth devices.

## Note

- If one or more Bluetooth devices has been connected to the unit before, the unit will automatically connect to the last connected device when Bluetooth is enabled. Terminate this connection to connect a new device.
- Tap and hold **▶||** on the unit for at least three seconds to terminate the Bluetooth connection.

## Listening to music on a Bluetooth device

Audio from a Bluetooth device can be played over a wireless connection.

## Note

When connecting a Bluetooth device to the unit for the first time, complete step **1** (shown at right) within five minutes of having turned on the unit.

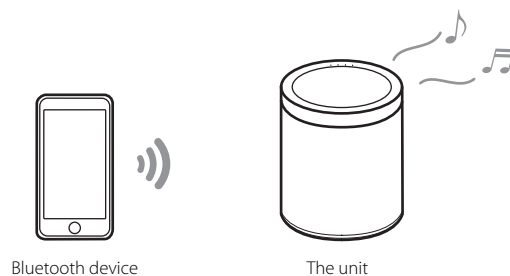

## 1 Connect a Bluetooth device to the unit.

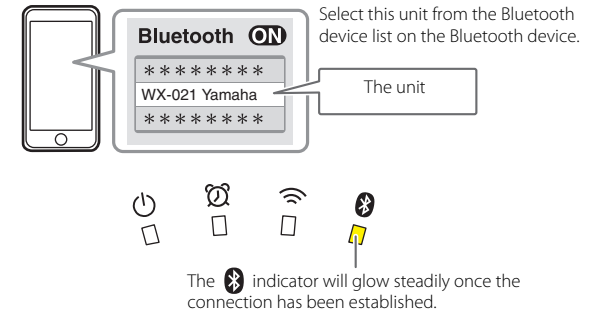

## 2 Play a music file.

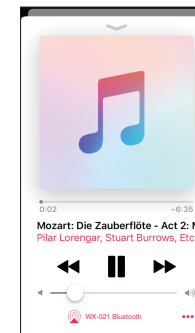

## Note

If a Bluetooth connection could not be established, delete the unit from the list of devices registered with the Bluetooth device, and repeat steps **1** and **2**.

# Pair the unit with MusicCast-enabled devices

Multiple units can be used, or the unit can be paired with other MusicCast-enabled devices, to enjoy higher quality audio. A home audio network can be configured using MusicCast CONTROLLER.

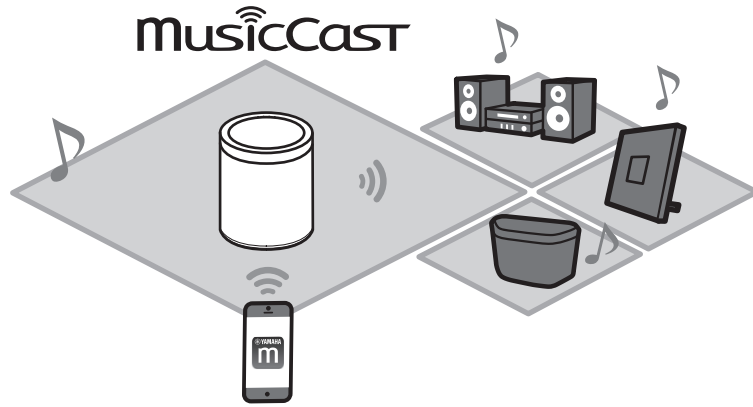

## Configuring a MusicCast network

Register the unit with the MusicCast CONTROLLER app, and then register other MusicCast-enabled devices with the app.

### Note

To register the unit with the app, see "Use MusicCast CONTROLLER to connect to a network" (p. 7).

- 1 Tap  (Settings).
- 2 Follow the on-screen instructions to register MusicCast-enabled devices.

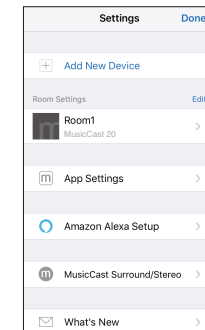

# Using two units as stereo speakers (MusicCast Stereo function)

Two units can be used together as stereo speakers by assigning and positioning one unit as the left speaker and the other as the right speaker.

When using this function, update the firmware for the units to the latest versions (☞ p. 22 “Firmware updates”).

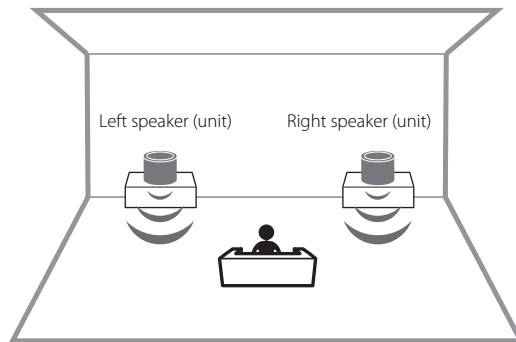

## Note

- When the MusicCast Stereo function is used, one unit is set as the “Pairing Master” and the other as the “Pairing Device”. The “Pairing Device” only supports the following operations.
  - Turning the units on and off
  - Adjusting the volume
- When the MusicCast Stereo function is used, the option settings available are “Initialize the unit” (☞ p. 20) and “Enable/disable the child lock function” (☞ p. 21).
- If the alarm has been set, turn it off before configuring MusicCast Stereo.

- 1 Register the first and second units with the same location on the MusicCast CONTROLLER app (☞ p. 13 “Configuring a MusicCast network”).**
- 2 Follow the app’s on-screen instructions to complete the settings.**



## Connecting the unit to a subwoofer on the same network

The unit can be connected to a MusicCast-enabled network subwoofer for more dynamic bass.

Follow the MusicCast CONTROLLER app’s on-screen instructions to register the unit and a MusicCast-enabled network subwoofer with the same location. (☞ p. 7 “Use MusicCast CONTROLLER to connect to a network”)

- Refer to documentation provided with the network subwoofer for more information.
- If the alarm has been set, turn it off before connecting the network subwoofer.

# Using two units as surround speakers (MusicCast Surround function)

MusicCast Surround-enabled devices such as AV receivers or sound bars can be paired with the units to enjoy multi-channel audio.

When using this function, update the firmware for the units and MusicCast Surround-enabled devices to the latest versions (☞ p. 22 “Firmware updates”). See documentation provided with external devices for information on firmware updates.

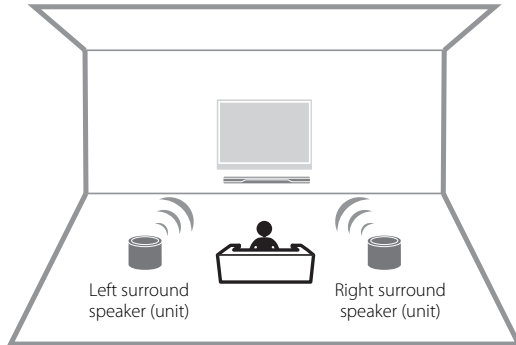

**1** Register the units and a MusicCast Surround-enabled AV receiver or sound bar with the same location on the MusicCast CONTROLLER app (☞ p. 13 “Configuring a MusicCast network”).

**2** Follow the app’s on-screen instructions to complete the settings.



Configure MusicCast Surround on the AV receiver or sound bar that will be paired with the unit.

## Note

- The following functions and operations are not available when the units are used as a surround sound speakers.
  - Favorites function
  - Alarm function
  - Volume adjustment  
The volume is adjusted to match the volume level specified with the AV receiver or sound bar.
  - Option settings other than “Initialize the unit” (☞ p. 20) and “Enable/disable the child lock function” (☞ p. 21).
- If the alarm has been set, turn it off before configuring MusicCast Surround.

# Useful features

## Favorites

Favorite songs, Internet radio stations, and such can be registered as favorites with the unit and with the MusicCast app. Once registered, favorites can easily be selected for listening. Up to three favorites can be registered with the unit. Up to 40 favorites can be registered with the MusicCast CONTROLLER app. The following input sources can be registered.

- Media servers (computers or NAS) containing music files, Internet radio stations, and streaming services
- Bluetooth

### Register favorites with the unit

**1** Use the MusicCast CONTROLLER app to play the input source to be registered.

**2** Press and hold **1**, **2**, or **3** on the unit for at least three seconds during playback.

The  indicator flashes three times, and the input source is assigned to that favorites number.

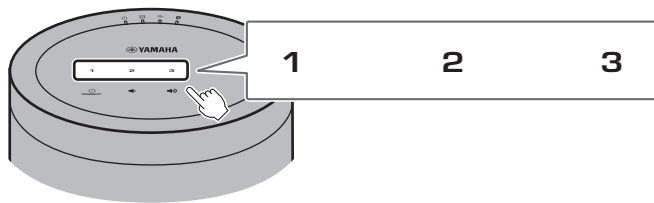

### Note

Favorites assigned to **1**, **2** and **3** on the unit will also be assigned to MusicCast CONTROLLER app "Favorites" 1, 2, and 3. If favorite 1, 2, or 3 is changed with either the unit or the MusicCast CONTROLLER app, the corresponding favorite will also be automatically changed with the other.

### Play favorite input sources

Tap **1**, **2** or **3** on the unit.

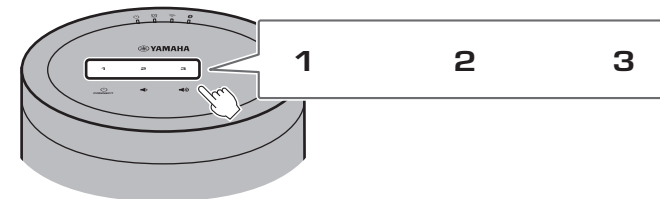



# Alarm

The MusicCast CONTROLLER app can be used to set the alarm. The alarm can sound as beeps, or as network content played from a media server (computer or NAS) or Internet radio station, for example.

Alarm type	
Three alarm types—music, beeps, combination of music and beeps—are available.	
<b>Music only</b>	Music begins playing at the specified time. The volume starts low and gradually increases.
<b>Music + beeps</b>	Music begins playing at low volume three minutes prior to the specified time, increasing gradually. Beeps begin sounding over the music at the specified time.
<b>Beeps only</b>	Beeps begin sounding at the specified time.

## Set the alarm

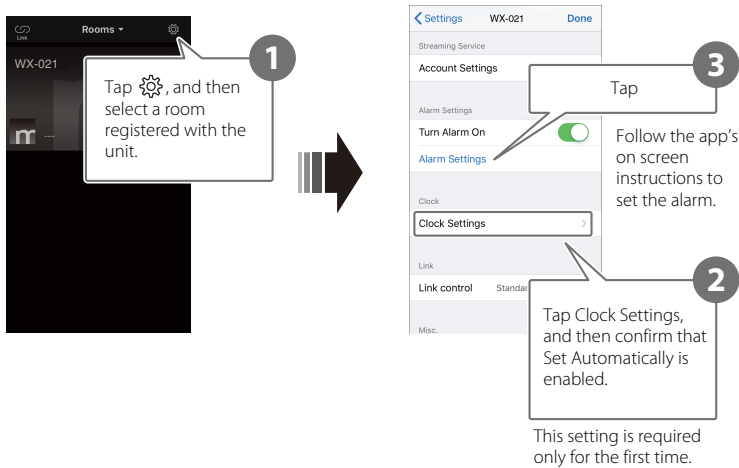

### 1 Use the MusicCast CONTROLLER app to set the alarm.



**Note**

No alarm will sound if "Music only" is selected for the alarm type and the specified network content is unavailable for some reason. Therefore, selecting "Music + beeps" or "Beeps" only is recommended for important alarms.

## 2 Tap on the unit.

The  indicator glows steadily and the alarm is turned on.  
Alarm status alternates between on and off each time  is tapped.

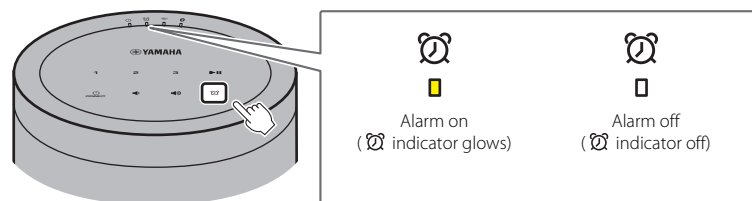

### Note

Alarm settings are retained when the alarm is turned off. When  is tapped to turn on the alarm, the last alarm setting specified is applied.

## Stop the alarm

Tap any of the icons on the unit's control panel while the alarm is sounding to stop the alarm.

### Note

If the alarm is not stopped manually, it will stop automatically after one hour has passed.

## Snooze function

The MusicCast CONTROLLER app can be used to set the snooze function, which stops the alarm and sets it to sound again five minutes later.

When this function is enabled, the alarm will stop and then go off again five minutes later when any of the icons on the control panel is tapped. To stop the alarm completely, press and hold any of the icons on the control panel for at least five seconds.

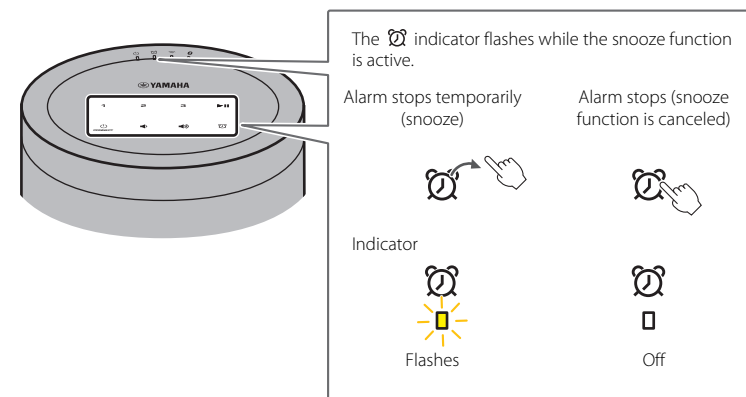

### Note

When "Music + beeps" is selected as the alarm type, tapping any of the icons on the control panel while the alarm is sounding will stop only the beeps. Tap any of the icons again to stop the music as well. Note that the alarm will sound again five minutes later. To stop both the music and beeps completely, press and hold any of the icons on the control panel for at least five seconds.

# Child lock function

This unit is equipped with a child lock function. When the child lock function is enabled, some control panel operations are disabled to prevent unintended or accidental operation.

This function is disabled by default. When the child lock function is enabled, only the following functions can be operated via the control panel. Use the MusicCast CONTROLLER app to operate other functions.



## When the unit is in standby mode

- turn on the unit
- configure options (☞ p. 20)

## When the unit is on

- set the unit to standby mode
- stop the alarm

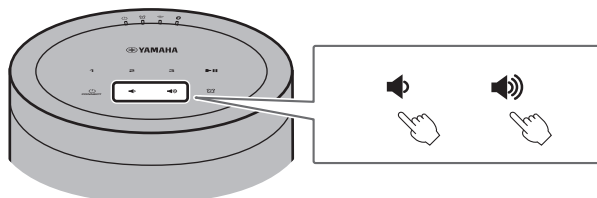

## Enabling/disabling the child lock function

- 1 Tap and hold  and  on the control panel simultaneously for at least five seconds when the unit is in standby mode.**



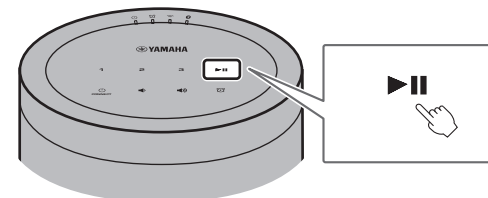

- 2 Tap and hold  at least three seconds.**



The  and  indicators will flash three times, and the child lock function will be enabled.



To disable the child lock function, repeat steps **1** and **2**.

The  and  indicators will flash twice, and the child lock function will be disabled.

### Note









If no operations are performed for ten seconds or more after performing step **1**, the unit will revert to standby mode without enabling/disabling the child lock function. Proceed from step **1** again to enable/disable the child lock function.

# Option settings

The following options can be changed when the unit is in option setting mode. To set the unit to option setting mode, tap and hold  and  on the control panel simultaneously for at least five seconds when the unit is in standby mode.

## Note

- If no operations are performed for ten seconds or more, option setting mode will be cancelled.
- The option settings available when the MusicCast Stereo function or MusicCast Surround function is used, or when a MusicCast-enabled network subwoofer is connected to the unit are "Initialize the unit" and "Enable/disable the child lock function".











Setting menu	Default	Instructions
Initialize the unit	—	Tap and hold  /CONNECT on the control panel for at least three seconds. The  indicator will flash twice, and the unit will be initialized.
Enable/disable Network standby*	Enabled	Tap and hold <b>1</b> on the control panel for at least three seconds. The  and  indicators will flash twice, and this function will be disabled. Repeating this operation alternately enables and disables this function. When this function is enabled, the  and  indicators will flash three times.
Enable/disable Auto standby	Enabled	Tap and hold <b>2</b> on the control panel for at least three seconds. The  indicator will flash twice, and this function will be disabled. Repeating this operation alternately enables and disables this function. When this function is enabled, the  indicator will flash three times.

\* This option enables or disables network operations when the unit is in standby mode. When network standby mode is disabled, network operations are terminated while the unit is in standby mode. Further, a special "eco standby" mode that minimizes power consumption is enabled. The following operation and functions are not available in eco standby mode. To perform or use them, tap /CONNECT on the unit to turn on the unit.

- Using the MusicCast CONTROLLER app to turn on the unit
- AirPlay
- Bluetooth
- MusicCast Stereo/MusicCast Surround function



With an advanced energy saving design, this product achieves a low power consumption of not more than two watts when in Network Standby mode





Setting menu	Default	Instructions
Enable/disable Wireless LAN	Enabled	<p>Tap and hold <b>3</b> on the control panel for at least three seconds.</p> <p>The  indicator will flash twice, and wireless LAN function will be disabled. Repeating this operation alternately enables and disables this function.</p> <p>When this function is enabled, the  indicator will flash three times. Be sure to configure network settings using the MusicCast CONTROLLER app to connect the unit to a network (☞ p. 7).</p>
Enable/disable Bluetooth	Enabled	<p>Tap and hold  on the control panel for at least three seconds.</p> <p>The  indicator will flash twice, and Bluetooth will be disabled. Repeating this operation alternately enables and disables this function.</p> <p>When this function is enabled, the  indicator will flash three times.</p>
Enable/disable the child lock function	Disabled	<p>Tap and hold  for at least three seconds.</p> <p>The  and  indicators will flash three times, and this function will be enabled. Repeating this operation alternately enables and disables this function.</p> <p>When this function is disabled, the  and  indicators will flash twice.</p>

# Firmware updates

The unit's firmware can be updated if it is connected to the Internet. When new firmware is released, a notice is displayed by the MusicCast CONTROLLER app. Follow the app's on-screen instructions to update the unit's firmware.

## Update progress indicators

Update progress can be confirmed using the indicators on the unit.

Status	Indicators
Update in progress	 <p>Indicators other than the  indicator will flash or glow as the update progresses.</p>
Update completed successfully	 <p>Glow steadily</p> <p>When the update has been successfully completed, the unit will automatically turn off and then on again.</p>
Update failed	 <p>Indicators will flash or glow depending upon the cause of the failure.</p> <p>Unplug the power cord from the electrical outlet, plug it in again, and try to update the unit's firmware again.</p>

### Note

- Do not attempt to operate the unit, or disconnect the power cord or network cable while firmware is being updated.
- Insufficient Internet speed or other wireless network issues may cause a firmware update to fail.

# Using iPhone settings to connect to a network

When the unit is turned on for the first time after purchase or after initializing the unit, the  indicator on the unit flashes, and the unit will automatically begin searching for an iOS device such as an iPhone. Network settings from your iOS device can be applied to the unit for easy connection to an existing wireless network.

- Download and install the MusicCast CONTROLLER app to your iOS device to take full advantage of all the features this unit offers (☞ p. 7).
- iOS device network settings cannot be automatically applied to the unit (this feature) when a network cable is connected to the unit.

## Note

- Be sure that the iOS device is connected to the wireless LAN router (access point).
- An iOS device running iOS 7.1 or later is required.
- iOS device network settings cannot be applied to the unit to establish a wireless connection if the wireless LAN router uses WEP encryption.

## 1 While the indicator is flashing, open the iOS device's Wi-Fi settings, and then specify this unit as the AirPlay speaker.

iOS 11 (English interface)

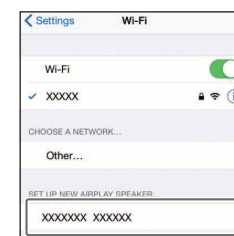

— Name of the unit

## 2 Choose the wireless network (access point) to which the unit will be connected.

Once network settings have been successfully shared, the unit will automatically connect to the selected wireless network.

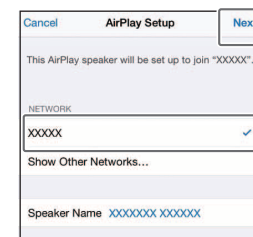

— Tap here to start setup

— Selected network

# Mounting the speaker on a wall

The unit can be mounted on a wall. Be sure to attach the supplied anti-vibration pads to the four corners of the rear panel to prevent the transmission of sound vibrations to the wall.

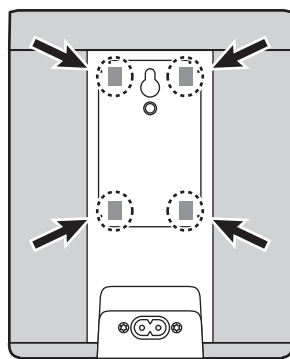

## Caution

Be sure to check the stability of the unit after mounting it on the wall. Yamaha is not responsible for any accidents resulting from improper mounting or installation. Have a professional mount the unit if you have any safety concerns.

## Using the wall mount hanger hole (does not apply to the U.S.A. and Canada models)

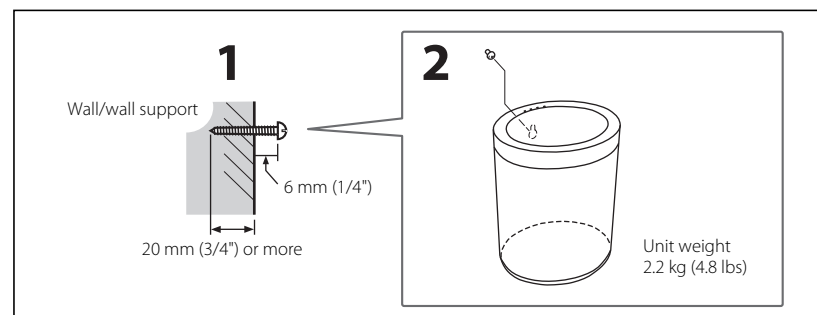

- 1** Screw a self-tapping screw (3.5–4 mm (1/8") in diameter; not supplied) into a wall or other vertical support of sufficient strength.
- 2** Position the wall mount hanger hole on the rear panel over the head of the screw.

Push the unit toward the wall until the head of the screw is fully inserted in the wall mount hanger hole.



**Caution**

If the unit falls, it may be damaged or cause injury. Observe the following precautions when mounting the unit on a wall.

- Do not mount the unit on a wall covered with a material such as mortar or veneer that peels easily.
- Do not use a nail or double-sided tape to mount the unit on a wall.
- Take all necessary precautions to prevent the unit from falling. Such measures may include the use of a cable or wire anchor.

**Using the wall mount screw hole**

Use the wall mount screw hole on the rear panel to mount the unit on a common wall mount hanger bracket (sold separately).

**Caution**

- Be sure to use a wall mount hanger bracket that is compatible with this unit to prevent the unit from falling or overturning.
- Use a wall mount hanger bracket with a load capacity of 4.5 kg (10 lbs) or more.
- Follow mounting instructions provided with the wall mount hanger bracket and mount the unit correctly.
- When a common mount bracket (sold separately) is used, be sure to attach a cable or wire anchor to the unit and the mount bracket.

**Note**

Use a wall mount hanger bracket that supports a unified-thread screw like those used on camera tripod heads. Refer to the chart below and prepare a screw that conforms to the specifications indicated.

Mounting screw specifications  
1/4-20 UNC

Diameter	6.35 mm (1/4")
Threads/inch	20

Wall mount screw hole specifications

Diameter	6.35 mm (1/4")
Depth	8 mm (3/8")

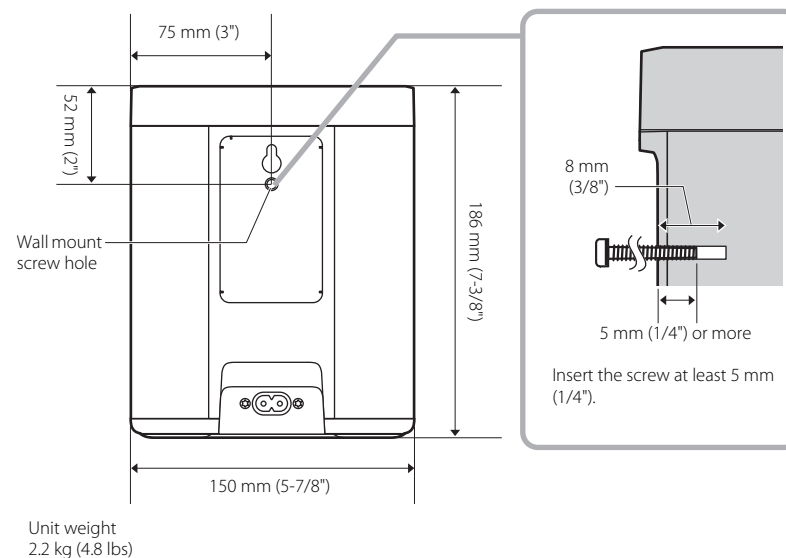

# Troubleshooting

Refer to the table below if the unit fails to function properly. If the problem is not listed, or if the symptoms persist after following the instructions provided, turn off the unit, disconnect the unit from the electrical outlet, and contact your nearest authorized Yamaha dealer or service center.

## General

Problem	Cause	Solution
<b>The unit is not on. The touch sensors do not respond.</b>	A touch sensor was tapped or touched inadvertently while the unit was starting up (a period of approx. five seconds after the power cable is plugged into an electrical outlet).	Avoid tapping or inadvertently touching the touch sensors while the unit is starting up. Do not attempt to turn on the unit until start-up is complete (☞ p. 5).
<b>The unit turns off as soon as it is powered on. The unit does not operate properly.</b>	The power cord is not properly connected.	Be sure that the power cord is firmly inserted into the power connector jack on the unit and the electrical outlet.
<b>The unit cannot be operated.</b>	The internal microcomputer has frozen due to an external electrical shock (lightning, excessive static electricity, etc.) or a drop in power supply voltage.	Unplug the unit from the electrical outlet, wait for at least 30 seconds, and then plug the unit into the electrical outlet again.
<b>No sound comes from the unit.</b>	An input source has not been properly selected.	Use the MusicCast CONTROLLER app to select an input source (☞ p. 8).
	The volume level is set to the minimum level or volume is muted.	Increase the volume.
<b>Interference from nearby electronic equipment is producing noise.</b>	The unit is too close to other electronic equipment.	Position the unit farther away from other electronic equipment.

# Network

Problem	Cause	Solution
<b>Cannot configure connection using the MusicCast CONTROLLER app.</b>	The mobile device is not connected to the wireless LAN router (access point).	Connect the mobile device to the wireless LAN router, and then use MusicCast CONTROLLER to configure connection settings.
	The unit is turned off.	Turn on the unit.
<b>The MusicCast CONTROLLER app does not recognize the unit.</b>	The unit and the mobile device are not on the same network.	Confirm network connections and wireless LAN router settings, and then connect the unit and mobile device to the same network.
	A wireless LAN router that supports multiple SSIDs is used.	The router's network splitter may be blocking access to the unit. When connecting a mobile device, use an SSID that is able to access to the unit. Try connecting to the primary SSID.
<b>The network feature does not function.</b>	Network information (IP address) has not been properly obtained.	Enable the DHCP server function on the router.
	The unit is starting up (a period of approx. 20 seconds after the power cable is plugged into an electrical outlet).	Do not attempt to operate the unit until start-up is complete.
	An IPv6-only router is being used.	Use an IPv4-compatible router.
<b>Files on the media server (computer or NAS) are not displayed (do not play).</b>	The file format is not supported by the unit or the media server (computer or NAS).	Be sure to use a file format that is supported by both the unit and the media server. For information on music files supported by this unit, see "File formats, and devices/media supported by the unit" (☞ p. 30).
<b>The MusicCast CONTROLLER app does not recognize the media server (computer or NAS).</b>	Media server sharing settings are not correct.	Configure sharing settings to allow the unit access to folders on the media server (☞ p. 10).
	Security software installed on your media server is blocking access by the unit.	Confirm settings for security software installed on the media server.
	The unit and the media server are not connected to the same network.	Confirm network connections and wireless LAN router settings, and then connect the unit and media server to the same network.

Problem	Cause	Solution
<b>Unable to play Internet radio.</b>	The selected Internet radio station is currently offline.	The radio station may be experiencing problems with their network, may not be broadcasting, or their services may have been terminated. Try to play the station later or select another station.
	The selected Internet radio station is currently broadcasting silence.	Some Internet radio stations broadcast silence at certain times of the day. When this occurs, there are no problems with reception, but no sound plays. Try the station later or select another station.
	Access to the network is restricted by network device (wireless LAN router, etc.) firewall settings.	Check device firewall settings. Internet radio can be played only through the port specified by each radio station. The port number varies depending on the radio station.
<b>Firmware update failed.</b>	The network connection is unstable.	Try again later.
<b>The unit is unable to connect to the Internet via a wireless LAN router (access point).</b>	The wireless LAN router is turned off.	Turn on the wireless LAN router.
	The unit and the wireless LAN router are too far apart.	Place the unit and the wireless LAN router closer to each other.
	There is an obstacle between the unit and the wireless LAN router.	Move the unit and the wireless LAN router to a location with a direct line of sight (no obstacles) between the two.
	The unit's wireless LAN function is disabled.	Enable the unit's wireless LAN function (☞ p. 21).
<b>The MusicCast CONTROLLER app does not detect a wireless network.</b>	A device that operates in the 2.4 GHz band (microwave oven, wireless network device, etc.) is interfering with wireless communication.	Turn off the offending device, or move it farther away from the unit and the wireless LAN router.
	Access to the network is restricted by the wireless LAN router's (access point's) firewall settings.	Confirm wireless LAN router firewall settings.
<b>My iPhone does not recognize the unit when using AirPlay.</b>	A wireless LAN router that supports multiple SSIDs is used.	The router's network splitter may be blocking access to the unit. When connecting a mobile device, use an SSID that is able to access to the unit. Try connecting to the primary SSID.

# Bluetooth

Problem	Cause	Solution
<b>Unable to connect the unit to a Bluetooth device.</b>	The Bluetooth device does not support the Advanced Audio Distribution Profile (A2DP).	Use a Bluetooth device that supports A2DP.
	The passkey for devices such as a Bluetooth adapter is not "0000".	Use a Bluetooth device with a passkey of "0000."
	The unit and the Bluetooth device are too far apart.	Move the Bluetooth device closer to the unit.
	A device that operates in the 2.4 GHz band (microwave oven, wireless network device, etc.) is interfering with wireless communication.	Move the unit and Bluetooth device farther away from the device. If the wireless LAN router supports the 5 GHz band, connect network devices to the network using the 5 GHz band.
	The unit is already connected to another Bluetooth device.	Terminate the current Bluetooth connection, and then connect to the new device.
	The unit's Bluetooth function is disabled.	Enable the unit's Bluetooth function (⇨ p. 21).
<b>No sound is played, or sound is interrupted during playback.</b>	The Bluetooth connection has been terminated.	Establish the Bluetooth connection again (⇨ p. 12).
	The unit and the Bluetooth device are too far apart.	Move the Bluetooth device closer to the unit.
	A device that operates in the 2.4 GHz band (microwave oven, wireless network device, etc.) is interfering with wireless communication.	Move the unit and Bluetooth device farther away from the device. If the wireless LAN router supports the 5 GHz band, connect network devices to the network using the 5 GHz band.
	The Bluetooth device is not configured to transmit audio signal to this unit.	On the Bluetooth device, select this unit as the audio output destination.
	The volume level on the Bluetooth device is set too low.	Increase the volume on the Bluetooth device.

# File formats, and devices/media supported by the unit

This unit supports the following file formats, devices, and media.

## File formats

File	Sampling frequency	Quantization bitrate (bits)	Bitrate	No. channels	Gapless playback
<b>WAV</b>	32/44.1/48/				
<b>(Linear PCM format only)</b>	88.2/96/176.4/192 kHz	16/24	—	2	✓
<b>MP3</b>	32/44.1/48 kHz	—	up to 320 kbps	2	—
<b>WMA</b>	32/44.1/48 kHz	—	up to 320 kbps	2	—
<b>MPEG-4 AAC</b>	32/44.1/48 kHz	—	up to 320 kbps	2	—
<b>FLAC</b>	32/44.1/48/88.2/96/176.4/192 kHz	16/24	—	2	✓
<b>ALAC</b>	32/44.1/48/88.2/96 kHz	16/24	—	2	✓
<b>AIFF</b>	32/44.1/48/88.2/96/176.4/192 kHz	16/24	—	2	✓

- The file formats that can be played may vary depending upon the software installed on media servers (computer or NAS). For details, refer to the documentation provided with media server software.
- Digital Rights Management (DRM) content cannot be played.

## AirPlay devices

Supports iOS 7 or later for setup using Wireless Accessory Configuration.

AirPlay works with iPhone, iPad, and iPod touch with iOS 4.3.3 or later, Mac with OS X Mountain Lion or later, and PC with iTunes 10.2.2 or later.

Made for:

iPhone X, iPhone 8 Plus, iPhone 8, iPhone 7 Plus, iPhone 7, iPhone SE, iPhone 6s Plus, iPhone 6s, iPhone 6 Plus, iPhone 6, iPhone 5s, iPhone 5c, iPhone 5, iPhone 4s  
iPad Pro (10.5"), iPad Pro (12.9") 2nd Generation, iPad Pro (12.9") 1st Generation, iPad Pro (9.7"), iPad mini 4, iPad Air 2, iPad mini 3, iPad Air, iPad mini 2, iPad mini, iPad (5th generation), iPad (4th generation), iPad (3rd generation), iPad 2  
iPod touch (6th generation), iPod touch (5th generation)  
(as of May 2018)

## Bluetooth devices

This unit supports Bluetooth devices that use the Advanced Audio Distribution Profile (A2DP). Yamaha does not guarantee that the unit can be connected to all Bluetooth devices.

# Specifications

## Player

Network	
Ethernet interface	100 Base-TX/10 Base-T
Internet radio	airable.radio service supported
Supported file format	WAV, MP3, WMA, MPEG-4 AAC, FLAC, ALAC, AIFF
AirPlay	AirPlay supported

Wi-Fi	
Wireless LAN standards	IEEE 802.11 a/b/g/n/ac* * 20 MHz channel bandwidth only
Radio frequency	2.4 GHz, 5 GHz
Available security method	WEP, WPA2-PSK (AES), Mixed Mode

## Bluetooth

Bluetooth version	Bluetooth Ver. 4.2
Supported profile	A2DP (Advanced Audio Distribution Profile) AVRCP (Audio/Video Remote Control Profile)
Compatible codec	SBC, AAC
RF output power	Bluetooth Class 2
Maximum communication range	10 m (33 ft) (without interference)

## General

Power voltage/frequency	U.S.A. and Canada models	AC 120 V, 60 Hz	
	Taiwan model	AC 110 to 120 V, 50/60 Hz	
	Other models	AC 100 to 240 V, 50/60 Hz	
Power consumption	10 W		
Standby power consumption	Network standby off/ Bluetooth standby off	0.2 W	
	Network standby on	Wired	1.5 W
		Wireless (Wi-Fi)	1.7 W
		Bluetooth	1.5 W
Wireless (Wi-Fi/ Bluetooth)	1.9 W		
Maximum Output power	40 W (tweeter 6 Ω 15 W, woofer 4 Ω 25 W) (1 kHz, 10 % THD)		
Driver unit	3 cm soft dome tweeter x1, 9 cm woofer x1, Passive radiator x2		
Weight	2.2 kg (4.8 lbs)		
Dimensions (W x H x D)	150 x 186 x 130 mm (5-7/8 x 7-3/8 x 5-1/8 inch)		

The contents of this manual apply to the latest specifications as of the publishing date. To obtain the latest manual, access the Yamaha website then download the manual file.

# Trademarks



MusicCast is a trademark or registered trademark of Yamaha Corporation.



The Bluetooth® word mark and logos are registered trademarks owned by Bluetooth SIG, Inc. and any use of such marks by Yamaha Corporation is under license.

## Windows™

Windows is a registered trademark of Microsoft Corporation in the United States and other countries.

Internet Explorer, Windows Media Audio and Windows Media Player are either registered trademarks or trademarks of Microsoft Corporation in the United States and/or other countries.

## Android™ Google Play™

Android and Google Play are trademarks of Google LLC.



The Wi-Fi CERTIFIED™ Logo is a certification mark of Wi-Fi Alliance®.

## Explanations regarding GPL

This product utilizes GPL/LGPL open-source software in some sections. You have the right to obtain, duplicate, modify, and redistribute this open-source code only. For information on GPL/LGPL open source software, how to obtain it, and the GPL/LGPL license, refer to the Yamaha Corporation website (<https://download.yamaha.com/sourcecodes/musiccast/>).

## Licenses

For information on the licenses of the third-party software in this product, refer to the following.

[http://\(IP address of this product\\*\)/licenses.html](http://(IP address of this product*)/licenses.html)

\* IP address of this product is checked with MusicCast CONTROLLER.



Yamaha Eco-Label is a mark that certifies products of high environmental performance.



App Store is a service mark of Apple Inc.

Use of the Works with Apple badge means that an accessory has been designed to work specifically with the technology identified in the badge and has been certified by the developer to meet Apple performance standards.

Apple, iPad, iPad Air, iPad Pro and iPhone are trademarks of Apple Inc., registered in the U.S. and other countries.



YAMAHA CORPORATION

10-1 Nakazawa-cho, Naka-ku, Hamamatsu, 430-8650 Japan

Yamaha Global Site  
<https://www.yamaha.com/>

Yamaha Downloads  
<https://download.yamaha.com/>

Manual Development Group  
© 2018 Yamaha Corporation

Published 05/2018 KSOE-C0

WX-021OM/EN







# Say hello to Spotify Premium

Spotify Premium lets you listen to millions of songs ad-free – the artists you love, the latest hits and discoveries just for you. Simply hit play to hear any song you like, at the highest sound quality.

Check out our current Premium offers at [spotify.com/premium](https://spotify.com/premium)

## Your new device has Spotify Connect built in.

Spotify Connect lets you control the music playing on your device, using the Spotify app on your mobile, tablet or PC.

Listening is seamless. You can take calls, play games, even switch your phone off – all without interrupting the music.

Learn more at [spotify.com/connect](https://spotify.com/connect)

## How to use Connect

You'll need Spotify Premium to use Connect, see details above.

- 1 Add your new device to the same wifi network as your phone, tablet or PC (see product user instructions for details).
- 2 Open the Spotify app on your phone, tablet or PC, and play any song.
- 3 If you're using the app on a phone - tap the song image in the bottom left of the screen. For tablet and PC move to step 4.
- 4 Tap the Connect icon 
- 5 Pick your device from the list. If you can't see it, just check it's connected to the same wifi network as your phone, tablet or PC.

**All done! Happy listening.**

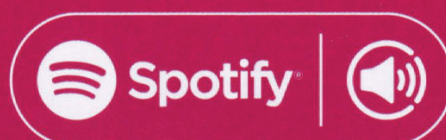



**Wireless Streaming Speaker**  
**Enceinte Réseau Sans Fil**  
**Беспроводная акустическая система**  
**WX-021**

**Safety Brochure**  
**Brochure sur la Sécurité**  
**Sicherheitsbroschüre**  
**Säkerhetsanvisningar**  
**Volantino sulla sicurezza**

**Folleto de seguridad**  
**Veiligheidsbrochure**  
**Брошюра по безопасности**  
**Brochura de Segurança**

**EN FR DE SV IT ES NL RU PT**

**musicCast**

UCRABG  
LEVFPS

English

Français

Deutsch

Svenska

Italiano

Español

Nederlands

Русский

Português



# IMPORTANT SAFETY INSTRUCTIONS

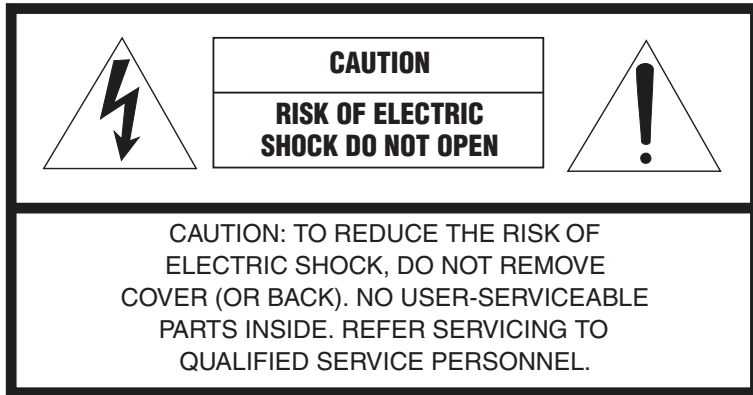

The above warning is located on the bottom of the unit.

- **Explanation of Graphical Symbols**

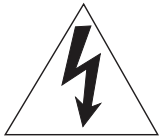

The lightning flash with arrowhead symbol, within an equilateral triangle, is intended to alert you to the presence of uninsulated “dangerous voltage” within the product’s enclosure that may be of sufficient magnitude to constitute a risk of electric shock to persons.



The exclamation point within an equilateral triangle is intended to alert you to the presence of important operating and maintenance (servicing) instructions in the literature accompanying the appliance.

- 1 Read these instructions.
- 2 Keep these instructions.
- 3 Heed all warnings.
- 4 Follow all instructions.
- 5 Do not use this apparatus near water.
- 6 Clean only with dry cloth.

- 7 Do not block any ventilation openings. Install in accordance with the manufacturer’s instructions.
- 8 Do not install near any heat sources such as radiators, heat registers, stoves, or other apparatus (including amplifiers) that produce heat.
- 9 Do not defeat the safety purpose of the polarized or grounding-type plug. A polarized plug has two blades with one wider than the other. A grounding type plug has two blades and a third grounding prong. The wide blade or the third prong are provided for your safety. If the provided plug does not fit into your outlet, consult an electrician for replacement of the obsolete outlet.
- 10 Protect the power cord from being walked on or pinched particularly at plugs, convenience receptacles, and the point where they exit from the apparatus.
- 11 Only use attachments/accessories specified by the manufacturer.
- 12 Use only with the cart, stand, tripod, bracket, or table specified by the manufacturer, or sold with the apparatus. When a cart is used, use caution when moving the cart/ apparatus combination to avoid injury from tip-over.
- 13 Unplug this apparatus during lightning storms or when unused for long periods of time.
- 14 Refer all servicing to qualified service personnel. Servicing is required when the apparatus has been damaged in any way, such as power-supply cord or plug is damaged, liquid has been spilled or objects have fallen into the apparatus, the apparatus has been exposed to rain or moisture, does not operate normally, or has been dropped.



## IMPORTANT

Please record the serial number of this unit in the space below.

MODEL: \_\_\_\_\_

Serial No.: \_\_\_\_\_

The serial number is located on the bottom of the unit. Retain this booklet in a safe place for future reference.

## FCC INFORMATION (USA)

### 1 **IMPORTANT NOTICE: DO NOT MODIFY THIS UNIT!**

This product, when installed as indicated in the instructions contained in this manual, meets FCC requirements. Modifications not expressly approved by Yamaha may void your authority, granted by the FCC, to use the product.

### 2 **IMPORTANT:** When connecting this product to accessories and/or another product use only high quality shielded cables. Cable/s supplied with this product **MUST** be used. Follow all installation instructions. Failure to follow instructions could void your FCC authorization to use this product in the USA.

### 3 **NOTE:** This product has been tested and found to comply with the requirements listed in FCC Regulations, Part 15 for Class “B” digital devices. Compliance with these requirements provides a reasonable level of assurance that your use of this product in a residential environment will not result in harmful interference with other electronic devices. This equipment generates/uses radio frequencies and, if not installed and used according to the instructions found in the users manual, may cause interference harmful to the operation of other electronic devices.

Compliance with FCC regulations does not guarantee that interference will not occur in all installations. If this product is found to be the source of interference, which can be determined by turning the unit “OFF” and “ON”, please try to eliminate the problem by using one of the following measures: Relocate either this product or the device that is being affected by the interference.

Utilize power outlets that are on different branch (circuit breaker or fuse) circuits or install AC line filter/s.

In the case of radio or TV interference, relocate/reorient the antenna. If the antenna lead-in is 300 ohm ribbon lead, change the lead-in to coaxial type cable.

If these corrective measures do not produce satisfactory results, please contact the local retailer authorized to distribute this type of product. If you can not locate the appropriate retailer, please contact Yamaha Corporation of America A/V Division, 6600 Orangethorpe Avenue, Buena Park, CA 90620, USA. The above statements apply **ONLY** to those products distributed by Yamaha Corporation of America or its subsidiaries.

## COMPLIANCE INFORMATION STATEMENT (DECLARATION OF CONFORMITY PROCEDURE)

Responsible Party:	Yamaha Corporation of America A/V Division
Address:	6600 Orangethorpe Avenue, Buena Park, CA 90620
Telephone:	714-522-9011
Type of Equipment:	Wireless Streaming Speaker
Model Name:	WX-021

\* This applies only to products distributed by YAMAHA CORPORATION OF AMERICA.

## FCC/IC NOTICE (U.S.A. and Canada)

This equipment complies with FCC/IC radiation exposure limits set forth for an uncontrolled environment and meets the FCC radio frequency (RF) Exposure Guidelines and RSS-102 of the IC radio frequency (RF) Exposure rules. This equipment has very low levels of RF energy that is deemed to comply without maximum permissive exposure evaluation (MPE).

This device complies with Part 15 of FCC Rules and Industry Canada licence-exempt RSS standard(s).

Operation is subject to the following two conditions:

- (1) this device may not cause interference, and
- (2) this device must accept any interference, including interference that may cause undesired operation of this device.

This transmitter must not be co-located or operated in conjunction with any other antenna or transmitter.

(for Canada)

5150-5350 MHz band is restricted to indoor operation only.

High-power radars are allocated as primary users (i.e. priority users) of the bands 5250-5350 MHz and 5650-5850 MHz and that these radars could cause interference and/or damage to LE-LAN devices.

**CAN ICES-3(B)/NMB-3(B)**

# PRECAUTIONS

**PLEASE READ CAREFULLY BEFORE USE. BE SURE TO FOLLOW THESE INSTRUCTIONS.**

**The precautions listed below are to prevent risk of harm to the user and others, as well as to prevent property damage, and to help the user use this unit properly and safely. Be sure to follow these instructions.**

After reading this manual, be sure to keep it in a safe place where it can be referenced at any time.

- Be sure to request inspections or repairs from the dealer where you purchased the unit or from qualified Yamaha service personnel.
- Yamaha cannot be held responsible for injury to you or damage of the products caused by improper use or modifications to the unit.
- This product is for ordinary homes. Do not use for applications requiring high reliability, such as managing lives, health care or high-value assets.



## **WARNING**

**This content indicates “risk of serious injury or death.”**

### **Power supply/power cord**

- Do not do anything that could damage the power cord.
  - Do not place it near a heater.
  - Do not bend it excessively or alter it.
  - Do not scratch it.
  - Do not place it under a heavy object.Using the power cord with the core of the cord exposed could cause electric shocks or a fire.
- Do not touch the power plug or cord if there is a chance of lightning. Failure to observe this may cause electric shocks.
- Use this unit with the power supply voltage printed on it. Failure to connect to an appropriate AC outlet may cause a fire, electric shocks, or malfunctions.
- Be sure to use the supplied power cord. Also, do not use the supplied power cord for other units. Failure to observe the above may cause a fire, burns, or malfunctions.
- Check the electric plug periodically and remove any dirt or dust which may have accumulated on it. Failure to observe this may cause a fire or electric shocks.
- When setting up the unit, make sure that the AC outlet you are using is easily accessible. If some trouble or malfunction occurs, immediately turn off the power switch and disconnect the plug from the AC outlet. Even when the power switch is turned off, as long as the power cord is not unplugged from the wall AC outlet, the unit will not be disconnected from the power source.
- If you hear thunder or suspect approaching lightning, quickly turn off the power switch and pull the power plug from the AC outlet. Failure to observe this may cause a fire or malfunctions.
- If not using the unit for long periods of time, be sure to pull the power plug from the AC outlet. Failure to observe this may cause a fire or malfunctions.



## Do not disassemble

---

- Do not disassemble or modify this unit. Failure to observe this may cause a fire, electric shocks, injury, or malfunctions. If you notice any irregularities, be sure to request an inspection or repair from the dealer where you purchased the unit or from qualified Yamaha service personnel.

## Water warning

---

- Do not expose the unit to rain, use it near water or in damp or wet conditions, or place on it any containers (such as vases, bottles or glasses) containing liquids which might spill into any openings or places where water may drop. A liquid such as water getting into the unit may cause a fire, electric shocks, or malfunctions. If any liquid such as water seeps into the device, turn off the power immediately and unplug the power cord from the AC outlet. Then, request an inspection from the dealer where you purchased the unit or from qualified Yamaha service personnel.
- Never insert or remove an electric plug with wet hands. Do not handle this unit with wet hands. Failure to observe this may cause electric shocks or malfunctions.

## Fire warning

---

- Do not place any burning items or open flames near the unit, since they may cause a fire.

## Installation

---

- Install in the manner instructed in the manual. Falling or toppling may result in injury or damage.
- Confirm that the finished installation is safe and secure. Also, carry out safety inspections periodically. Failure to observe this may cause devices to fall and result in injury.

## Maintenance and care

---

- Do not use aerosols or spray-type chemicals that contain combustible gas for cleaning or lubrication. The combustible gas will remain inside the unit, which may cause explosion or fire.

## Wireless unit

---

- Do not use this unit near medical devices or inside medical facilities. Radio waves from this unit may affect electro-medical devices.
- Do not use this unit within 15 cm (6 in) of persons with a heart pacemaker implant or a defibrillator implant. Radio waves from this unit may affect electro-medical devices, such as a heart pacemaker implant or defibrillator implant.

## If you notice any abnormality

---

- If any of the following abnormalities occur, immediately turn off the power and disconnect the power plug.
  - The power cord/plug is damaged.
  - An unusual smell or smoke is emitted from the unit.
  - Foreign material gets into the interior of the unit.
  - There is a loss of sound during use.
  - There is a crack or damage in the unit.Continued use could cause electric shocks, a fire, or malfunctions. Immediately request an inspection or repair from the dealer where you purchased the unit or from qualified Yamaha service personnel.
- Be careful not to drop or apply strong impact to this unit. If you suspect the unit may have been damaged due to dropping or impact, immediately turn off the power and pull the power plug from the AC outlet. Failure to observe this may cause electric shocks, a fire, or malfunctions. Immediately request an inspection from the dealer where you purchased the unit or from qualified Yamaha service personnel.



## **CAUTION**

---

**This content indicates “risk of injury.”**

### **Power supply/power cord**

---

- Do not use an AC outlet where the power plug fits loosely when inserted. Failure to observe this may cause a fire, electric shocks, or burns.
- When removing the electric plug from an AC outlet, always hold the plug itself and not the cord. Pulling by the cord can damage it and cause electric shocks or a fire.
- Insert the power plug firmly all the way into the AC outlet. Using the unit when it is not plugged in sufficiently can cause dust to accumulate on the plug, causing a fire or burns.

### **Installation**

---

- Do not place the unit in an unstable position where it might accidentally drop or fall over and cause injuries.
- When installing this unit:
  - Do not cover it with any cloth.
  - Do not install it on a carpet or rug.
  - Make sure the top surface faces up; do not install on its sides or upside down.
  - Do not use the device in a confined, poorly-ventilated location. Failure to observe the above may trap heat inside the unit, causing a fire or malfunctions. Ensure that there is adequate space around the unit: at least 5 cm (2 in) on top, 5 cm (2 in) on the sides, and 5 cm (2 in) on the rear.
- Do not install the unit in places where it may come into contact with corrosive gases or salt air or places that have excessive smoke or steam. Doing so may result in malfunction.
- Avoid being near the unit during a disaster, such as an earthquake. Since the unit may turn over or fall and cause injury, quickly move away from the unit and go to a safe place.

- Before moving this unit, be sure to turn off the power switch and disconnect all connection cables. Failure to observe this may damage the cables or cause you to trip and fall.

### **Hearing loss**

---

- Do not use the unit for a long period of time at a high or uncomfortable volume level, since this can cause permanent hearing loss. If you experience any hearing loss or ringing in the ears, consult a physician.
- Before connecting the unit to other devices, turn off the power for all devices. Also, before turning the power of all devices on or off, make sure that all volume levels are set to the minimum. Failing to do so may result in hearing loss, electric shock, or device damage.

### **Maintenance**

---

- Remove the power plug from the AC outlet before cleaning the unit. Failure to observe this may cause electric shocks.

### **Handling caution**

---

- Do not do the following:
  - stand on or sit on the equipment.
  - put heavy items on top of the equipment.
  - place the equipment in a stack.
  - apply unreasonable force to buttons, switches, input/output terminals, etc.
- Avoid pulling the connected cables to prevent injuries or damage to the unit by causing it to fall.
- Do not operate the unit if the sound is distorting. Prolonged use in this condition could cause overheating and result in fire.

# Notice

---

**Indicates points that you must observe in order to prevent product failure, damage or malfunction and data loss.**

## Power supply/power cord

---

- If not using the unit for a long period of time, be sure to pull the power plug from the outlet. Even if the ⏻ (Standby/On) switch has been turned off (the power light is off), a minute current is still flowing.

## Installation

---

- Do not use this unit in the vicinity of other electronic equipment, such as a radio, or mobile phone. Failure to observe this may cause this unit or the radio to produce noise.
- Do not use this unit in a location that is exposed to direct sunlight that becomes extremely hot, such as near a heater, or extremely cold, or that is subject to excessive dust or vibration. Failure to observe this may cause the unit's panel to become deformed, the internal components to malfunction, or for operation to become unstable.
- Install this unit as far away from other electronic equipment as possible to prevent digital signals from this unit interfering with other electronic equipment.
- If the wireless function will be used, avoid installing this unit near metal walls or desks, microwave ovens, or other wireless network device. Obstructions could reduce transmission distance.
- Do not place magnetically sensitive items (watches, credit or ATM cards, etc.) near the unit.

## Handling

---

- Do not place vinyl, plastic, or rubber products on this unit. Failure to observe this may cause discoloration or deformation in the panel of this unit.
- If the ambient temperature changes drastically (such as during unit transportation or under rapid heating or cooling) and there is a chance condensation may have formed in the unit, leave the unit for several hours without turning on the power until it is completely dry before use. Using the unit while there is condensation can cause malfunctions.

## Maintenance

---

- When cleaning the unit, use a dry, soft cloth. Using chemicals such as benzine or thinner, cleaning agents, or chemical scrubbing cloths can cause discoloration or deformation.

# Information

## About content in this manual

- The illustrations and screens in this manual are for instructional purposes only.
- The company names and product names in this manual are the trademarks or registered trademarks of their respective companies.
- Software may be revised and updated without prior notice.

## Wireless communication functions [U.K. and Europe models]

### Bluetooth

Radio Frequency (Operational Frequency): 2402 MHz to 2480 MHz

Maximum Output Power (EIRP): 7.26 dBm

### Wi-Fi (2.4 GHz)

Radio Frequency: 2402 MHz to 2482 MHz

Maximum Output Power (EIRP): 19.97 dBm

### Wi-Fi (5 GHz)

Radio Frequency, Maximum Output Power (EIRP):

5170 to 5250 MHz, 22.20 dBm

5250 to 5330 MHz, 22.17 dBm

5490 to 5710 MHz, 24.46 dBm

5735 to 5835 MHz, 13.86 dBm

- Wireless devices transmitting over a 5 GHz frequency band can only be used indoors. Use of such devices outdoors is prohibited by law.

<b>Power voltage/ frequency</b>	U.S.A. and Canada models	AC 120 V, 60 Hz	
	Taiwan model	AC 110 to 120 V, 50/60 Hz	
	Other models	AC 100 to 240 V, 50/60 Hz	
<b>Power consumption</b>	10 W		
<b>Standby power consumption</b>	Network standby off/ Bluetooth standby off	0.2 W	
	Network standby on	Wired	1.5 W
		Wireless (Wi-Fi)	1.7 W
		Bluetooth	1.5 W
Wireless (Wi-Fi/ Bluetooth)	1.9 W		
<b>Weight</b>	2.2 kg (4.8 lbs)		
<b>Dimensions (W x H x D)</b>	150 x 186 x 130 mm (5-7/8 x 7-3/8 x 5-1/8 inch)		
<b>Ethernet interface</b>	100 Base-TX/10 Base-T		
<b>Wireless LAN standards</b>	IEEE 802. 11 a/b/g/n/ac* * 20 MHz channel bandwidth only		
<b>Bluetooth version</b>	Bluetooth Ver. 4.2		

The model number, serial number, power requirements, etc., may be found on or near the name plate, which is at the bottom of the unit. You should note this serial number in the space provided below and retain this manual as a permanent record of your purchase to aid identification in the event of theft.

**Model No.**

---

**Serial No.**

---

(bottom\_en\_01)

Este produto contém a placa WN9711BTAAC-YA, código de homologação ANATEL 01708-18-02386.

Para consultas, visite: [www.anatel.gov.br](http://www.anatel.gov.br)

A informação abaixo refere-se à certificação do módulo sem fio usado com este produto.



**MODELO: WN9711BTAAC-YA 01708-18-02386**

Este equipamento não tem direito à proteção contra interferência prejudicial e não pode causar interferência em sistemas devidamente autorizados.

#### Information for users on collection and disposal of old equipment:



This symbol on the products, packaging, and/or accompanying documents means that used electrical and electronic products should not be mixed with general household waste. For proper treatment, recovery and recycling of old products, please take them to applicable collection points, in accordance with your national legislation.

By disposing of these products correctly, you will help to save valuable resources and prevent any potential negative effects on human health and the environment which could otherwise arise from inappropriate waste handling.

For more information about collection and recycling of old products, please contact your local municipality, your waste disposal service or the point of sale where you purchased the items.

#### For business users in the European Union:

If you wish to discard electrical and electronic equipment, please contact your dealer or supplier for further information.

#### Information on Disposal in other Countries outside the European Union:

This symbol is only valid in the European Union. If you wish to discard these items, please contact your local authorities or dealer and ask for the correct method of disposal.

(weee\_eu\_en\_02)

#### Informations concernant la collecte et le traitement des déchets d'équipements électriques et électroniques



Le symbole sur les produits, l'emballage et/ou les documents joints signifie que les produits électriques ou électroniques usagés ne doivent pas être mélangés avec les déchets domestiques habituels. Pour un traitement, une récupération et un recyclage appropriés des déchets d'équipements électriques et électroniques, veuillez les déposer aux points de collecte prévus à cet effet, conformément à la réglementation nationale.

En vous débarrassant correctement des déchets d'équipements électriques et électroniques, vous contribuerez à la sauvegarde de précieuses ressources et à la prévention de potentiels effets négatifs sur la santé humaine qui pourraient advenir lors d'un traitement inapproprié des déchets.

Pour plus d'informations à propos de la collecte et du recyclage des déchets d'équipements électriques et électroniques, veuillez contacter votre municipalité, votre service de traitement des déchets ou le point de vente où vous avez acheté les produits.

#### Pour les professionnels dans l'Union européenne :

Si vous souhaitez vous débarrasser des déchets d'équipements électriques et électroniques, veuillez contacter votre vendeur ou fournisseur pour plus d'informations.

#### Informations sur la mise au rebut dans d'autres pays en dehors de l'Union européenne :

Ce symbole est seulement valable dans l'Union européenne. Si vous souhaitez vous débarrasser de déchets d'équipements électriques et électroniques, veuillez contacter les autorités locales ou votre fournisseur et demander la méthode de traitement appropriée.

(weee\_eu\_fr\_02)

#### Verbraucherinformation zur Sammlung und Entsorgung alter Elektrogeräte



Befindet sich dieses Symbol auf den Produkten, der Verpackung und/oder beiliegenden Unterlagen, so sollten benutzte elektrische Geräte nicht mit dem normalen Haushaltsabfall entsorgt werden. In Übereinstimmung mit Ihren nationalen Bestimmungen bringen Sie alte Geräte bitte zur fachgerechten Entsorgung, Wiederaufbereitung und Wiederverwendung zu den entsprechenden Sammelstellen.

Durch die fachgerechte Entsorgung der Elektrogeräte helfen Sie, wertvolle Ressourcen zu schützen, und verhindern mögliche negative Auswirkungen auf die menschliche Gesundheit und die Umwelt, die andernfalls durch unsachgerechte Müllentsorgung auftreten könnten.

Für weitere Informationen zum Sammeln und Wiederaufbereiten alter Elektrogeräte kontaktieren Sie bitte Ihre örtliche Stadt- oder Gemeindeverwaltung, Ihren Abfallentsorgungsdienst oder die Verkaufsstelle der Artikel.

#### Information für geschäftliche Anwender in der Europäischen Union:

Wenn Sie Elektrogeräte ausrangieren möchten, kontaktieren Sie bitte Ihren Händler oder Zulieferer für weitere Informationen.

#### Entsorgungsinformation für Länder außerhalb der Europäischen Union:

Dieses Symbol gilt nur innerhalb der Europäischen Union. Wenn Sie solche Artikel ausrangieren möchten, kontaktieren Sie bitte Ihre örtlichen Behörden oder Ihren Händler und fragen Sie nach der sachgerechten Entsorgungsmethode.

(weee\_eu\_de\_02)

#### Användarinformation, beträffande insamling och dumpning av gammal utrustning



Denna symbol på produkter, förpackningar och dokument innebär att använda elektriska och elektroniska produkter inte får blandas med vanligt hushållsavfall.

För rätt handhavande, återställande och återvinning av gamla produkter, vänligen medtag dessa till lämpliga samlingsplatser, i enlighet med din nationella lagstiftning.

Om du gör dig av med produkterna på rätt sätt hjälper du till att spara värdefulla naturresurser och förhindrar eventuella skadliga effekter på människors hälsa och miljö, som annars kan uppkomma vid felaktig hantering av avfall.

Mer information om uppsamling och återvinning av uttjänta produkter får du hos lokala myndigheter, avfallshanteringstjänsten där du bor eller där du inhandlade varorna.

#### För företagare inom EU:

Om du vill göra dig av med elektrisk och elektronisk utrustning, vänligen kontakta din försäljare eller leverantör för mer information.

#### Information om sophantering i andra länder utanför EU:

Denna symbol gäller endast inom EU. Om du vill slänga dessa föremål, vänligen kontakta dina lokala myndigheter eller försäljare och fråga efter det korrekta sättet att slänga dem.

(weee\_eu\_sv\_02)

### Informazioni per gli utenti sulla raccolta e lo smaltimento di vecchia attrezzatura



Questi simboli sui prodotti, sull'imballaggio e/o sui documenti che li accompagnano, indicano che i prodotti elettrici ed elettronici non devono essere mischiati con i rifiuti generici.

Per il trattamento, il recupero e il riciclaggio appropriato di vecchi prodotti, si prega di portarli ai punti di raccolta designati, in accordo con la legislazione locale.

Smaltendo correttamente questi prodotti si potranno recuperare risorse preziose, oltre a prevenire potenziali effetti negativi sulla salute e l'ambiente che potrebbero sorgere a causa del trattamento improprio dei rifiuti.

Per ulteriori informazioni sulla raccolta e il riciclaggio di vecchi prodotti, si prega di contattare l'amministrazione comunale locale, il servizio di smaltimento dei rifiuti o il punto vendita dove sono stati acquistati gli articoli.

#### **Per utenti imprenditori dell'Unione europea:**

Se si desidera scartare attrezzatura elettrica ed elettronica, si prega di contattare il proprio rivenditore o il proprio fornitore per ulteriori informazioni.

#### **Informazioni sullo smaltimento negli altri Paesi al di fuori dell'Unione europea:**

Questi simboli sono validi solamente nell'Unione Europea; se si desidera scartare questi articoli, si prega di contattare le autorità locali o il rivenditore e richiedere informazioni sulla corretta modalità di smaltimento.

(weee\_eu\_it\_02)

### Información para usuarios sobre la recogida y eliminación de los equipos antiguos



Este símbolo en los productos, embalajes y documentos anexos significa que los productos eléctricos y electrónicos no deben mezclarse con los desperdicios domésticos normales.

Para el tratamiento, recuperación y reciclaje apropiados de los productos antiguos, llévelos a puntos de reciclaje correspondientes, de acuerdo con la legislación nacional.

Al deshacerse de estos productos de forma correcta, ayudará a ahorrar recursos valiosos y a impedir los posibles efectos desfavorables en la salud humana y en el entorno que de otro modo se producirían si se trataran los desperdicios de modo inapropiado.

Para obtener más información acerca de la recogida y el reciclaje de los productos antiguos, póngase en contacto con las autoridades locales, con el servicio de eliminación de basuras o con el punto de venta donde adquirió los artículos.

#### **Para los usuarios empresariales de la Unión Europea:**

Si desea desechar equipos eléctricos y electrónicos, póngase en contacto con su vendedor o proveedor para obtener más información.

#### **Información sobre la eliminación en otros países fuera de la Unión Europea:**

Este símbolo solo es válido en la Unión Europea. Si desea desechar estos artículos, póngase en contacto con las autoridades locales o con el vendedor y pregúnteles el método correcto.

(weee\_eu\_es\_02)



### Informatie over ophalen en weggooien van oude apparatuur



Dit symbool op de apparaten, verpakking en/of meegeleverde documenten betekent dat gebruikte elektrische en elektronische apparaten niet met het gewone huishoudelijke afval mogen worden gemengd.

Voor juist behandelen, hergebruik of recyclen van oude apparatuur brengt u deze naar de desbetreffende ophaalpunten in overeenstemming met de nationale wetgeving.

Door deze apparatuur op de juiste manier weg te gooien, helpt u waardevolle bronnen te sparen en mogelijk negatieve effecten op de gezondheid van de mens en op het milieu te voorkomen, die het gevolg kunnen zijn van niet-aangepaste afvalverwerking.

Voor meer informatie over ophalen en recyclen van oude apparatuur neemt u contact op met de lokale overheid, uw afvalophaalmaatschappij of het verkooppunt waar u de items hebt gekocht.

#### **Voor zakelijke gebruikers in de Europese Unie:**

Als u elektrische en elektronische apparatuur wilt weggooien, neemt u voor meer informatie contact op met uw dealer of leverancier.

#### **Informatie over weggooien in landen buiten de Europese Unie:**

Dit symbool is alleen geldig in de Europese Unie. Als u deze items wilt weggooien, neemt u contact op met de lokale overheid of een lokale dealer en vraagt u om instructies voor het correct weggooien.

(weee\_eu\_nl\_02)

### Informações para os utilizadores relativas à recolha e eliminação de equipamentos usados



Este símbolo, presente em produtos, embalagens e/ou incluído na documentação associada, indica que os produtos elétricos e eletrónicos usados não devem ser eliminados juntamente com os resíduos domésticos em geral.

O procedimento correto consiste no tratamento, recuperação e reciclagem de produtos usados, pelo que deve proceder à respetiva entrega nos pontos de recolha adequados, em conformidade com a legislação nacional em vigor.

A eliminação destes produtos de forma adequada permite poupar recursos valiosos e evitar potenciais efeitos prejudiciais para a saúde pública e para o ambiente, associados ao processamento incorreto dos resíduos.

Para mais informações relativas à recolha e reciclagem de produtos usados, contacte as autoridades locais, o serviço de eliminação de resíduos ou o ponto de venda onde foram adquiridos os itens relevantes.

#### **Informações para utilizadores empresariais na União Europeia:**

Para proceder à eliminação de equipamento elétrico e eletrónico, contacte o seu revendedor ou fornecedor para obter informações adicionais.

#### **Informações relativas à eliminação em países não pertencentes à União Europeia:**

Este símbolo é válido exclusivamente na União Europeia. Caso pretenda eliminar este tipo de itens, contacte as autoridades locais ou o seu revendedor e informe-se acerca do procedimento correto para proceder à respetiva eliminação.

(weee\_eu\_pt\_02a)

<b>EN</b>	<b>SIMPLIFIED EU DECLARATION OF CONFORMITY</b>
<p>Hereby, Yamaha Music Europe GmbH declares that the radio equipment type [WX-021] is in compliance with Directive 2014/53/EU. The full text of the EU declaration of conformity is available at the following internet address:  <a href="https://europe.yamaha.com/en/support/compliance/doc.html">https://europe.yamaha.com/en/support/compliance/doc.html</a></p>	
<b>FR</b>	<b>DECLARATION UE DE CONFORMITE SIMPLIFIEE</b>
<p>Le soussigné, Yamaha Music Europe GmbH, déclare que l'équipement radioélectrique du type [WX-021] est conforme à la directive 2014/53/UE. Le texte complet de la déclaration UE de conformité est disponible à l'adresse internet suivante:  <a href="https://europe.yamaha.com/en/support/compliance/doc.html">https://europe.yamaha.com/en/support/compliance/doc.html</a></p>	
<b>DE</b>	<b>VEREINFACHTE EU-KONFORMITÄTSEKTLÄRUNG</b>
<p>Hiermit erklärt Yamaha Music Europe GmbH, dass der Funkanlagentyp [WX-021] der Richtlinie 2014/53/EU entspricht. Der vollständige Text der EU-Konformitätserklärung ist unter der folgenden Internetadresse verfügbar:  <a href="https://europe.yamaha.com/en/support/compliance/doc.html">https://europe.yamaha.com/en/support/compliance/doc.html</a></p>	
<b>SV</b>	<b>FÖRENKLAD EU-FÖRSÄKRAN OM ÖVERENSSTÄMMELSE</b>
<p>Härmed försäkrar Yamaha Music Europe GmbH att denna typ av radioutrustning [WX-021] överensstämmer med direktiv 2014/53/EU. Den fullständiga texten till EU-försäkringen om överensstämmelse finns på följande webbadress:  <a href="https://europe.yamaha.com/en/support/compliance/doc.html">https://europe.yamaha.com/en/support/compliance/doc.html</a></p>	
<b>IT</b>	<b>DICHIARAZIONE DI CONFORMITÀ UE SEMPLIFICATA</b>
<p>Il fabbricante, Yamaha Music Europe GmbH, dichiara che il tipo di apparecchiatura radio [WX-021] è conforme alla direttiva 2014/53/UE. Il testo completo della dichiarazione di conformità UE è isponibile al seguente indirizzo Internet:  <a href="https://europe.yamaha.com/en/support/compliance/doc.html">https://europe.yamaha.com/en/support/compliance/doc.html</a></p>	
<b>ES</b>	<b>DECLARACIÓN UE DE CONFORMIDAD SIMPLIFICADA</b>
<p>Por la presente, Yamaha Music Europe GmbH declara que el tipo de equipo radioeléctrico [WX-021] es conforme con la Directiva 2014/53/UE. El texto completo de la declaración UE de conformidad está isponible en la dirección Internet siguiente:  <a href="https://europe.yamaha.com/en/support/compliance/doc.html">https://europe.yamaha.com/en/support/compliance/doc.html</a></p>	
<b>PT</b>	<b>DECLARAÇÃO UE DE CONFORMIDADE SIMPLIFICADA</b>
<p>O(a) abaixo assinado(a) Yamaha Music Europe GmbH declara que o presente tipo de equipamento de rádio [WX-021] está em conformidade com a Diretiva 2014/53/UE. O texto integral da declaração de conformidade está disponível no seguinte endereço de Internet:  <a href="https://europe.yamaha.com/en/support/compliance/doc.html">https://europe.yamaha.com/en/support/compliance/doc.html</a></p>	
<b>NL</b>	<b>VEREENVOUDIGDE EU-CONFORMITEITSVERKLARING</b>
<p>Hierbij verklaar ik, Yamaha Music Europe GmbH, dat het type radioapparatuur [WX-021] conform is met Richtlijn 2014/53/EU. De volledige tekst van de EU-conformiteitsverklaring kan worden geraadpleegd op het volgende internetadres:  <a href="https://europe.yamaha.com/en/support/compliance/doc.html">https://europe.yamaha.com/en/support/compliance/doc.html</a></p>	

<b>BG</b>	<b>ОПРОСТЕНА ЕС ДЕКЛАРАЦИЯ ЗА СЪОТВЕТСТВИЕ</b>
<p>С настоящото Yamaha Music Europe GmbH декларира, че този тип радиосъоръжение [WX-021] е в съответствие с Директива 2014/53/ЕС. Цялостният текст на ЕС декларацията за съответствие може да се намери на следния интернет адрес:  <a href="https://europe.yamaha.com/en/support/compliance/doc.html">https://europe.yamaha.com/en/support/compliance/doc.html</a></p>	
<b>CS</b>	<b>ZJEDNODUŠENÉ EU PROHLÁŠENÍ O SHODĚ</b>
<p>Tímto Yamaha Music Europe GmbH prohlašuje, že typ rádiového zařízení [WX-021] je v souladu se směrnicí 2014/53/EU. Úplné znění EU prohlášení o shodě je k dispozici na této internetové adrese: <a href="https://europe.yamaha.com/en/support/compliance/doc.html">https://europe.yamaha.com/en/support/compliance/doc.html</a></p>	
<b>DA</b>	<b>FORENKLET EU-OVERENSSTEMMELSESESKLÆRING</b>
<p>Hermed erklærer Yamaha Music Europe GmbH, at radioudstyrstypen [WX-021] er i overensstemmelse med direktiv 2014/53/EU. EU-overensstemmelseserklæringens fulde tekst kan findes på følgende internetadresse:  <a href="https://europe.yamaha.com/en/support/compliance/doc.html">https://europe.yamaha.com/en/support/compliance/doc.html</a></p>	
<b>ET</b>	<b>LIHTSUSTATUD ELI VASTAVUSDEKLARATSIOON</b>
<p>Käesolevaga deklareerib Yamaha Music Europe GmbH, et käesolev raadioseadme tüüp [WX-021] vastab direktiivi 2014/53/EL nõuetele. ELi vastavusdeklaratsiooni täielik tekst on kättesaadav järgmisel internetiaadressil:  <a href="https://europe.yamaha.com/en/support/compliance/doc.html">https://europe.yamaha.com/en/support/compliance/doc.html</a></p>	
<b>EL</b>	<b>ΑΠΛΟΥΣΤΕΥΜΕΝΗ ΔΗΛΩΣΗ ΣΥΜΜΟΡΦΩΣΗΣ ΕΕ</b>
<p>Με την παρούσα ο/η Yamaha Music Europe GmbH, δηλώνει ότι ο ραδιοεξοπλισμός [WX-021] πληροί την οδηγία 2014/53/ΕΕ. Το πλήρες κείμενο της δήλωσης συμμόρφωσης ΕΕ διατίθεται στην ακόλουθη ιστοσελίδα στο διαδίκτυο:  <a href="https://europe.yamaha.com/en/support/compliance/doc.html">https://europe.yamaha.com/en/support/compliance/doc.html</a></p>	
<b>HR</b>	<b>POJEDNOSTAVLJENA EU IZJAVA O SUKLADNOSTI</b>
<p>Yamaha Music Europe GmbH ovime izjavljuje da je radijska oprema tipa [WX-021] u skladu s Direktivom 2014/53/EU. Cjeloviti tekst EU izjave o sukladnosti dostupan je na sljedećoj internetskoj adresi: <a href="https://europe.yamaha.com/en/support/compliance/doc.html">https://europe.yamaha.com/en/support/compliance/doc.html</a></p>	
<b>LV</b>	<b>VIENKĀRŠOTA ES ATBILSTĪBAS DEKLARĀCIJA</b>
<p>Ar šo Yamaha Music Europe GmbH deklarē, ka radioiekārta [WX-021] atbilst Direktīvai 2014/53/ES. Pilns ES atbilstības deklarācijas teksts ir pieejams šādā interneta vietnē:  <a href="https://europe.yamaha.com/en/support/compliance/doc.html">https://europe.yamaha.com/en/support/compliance/doc.html</a></p>	
<b>LT</b>	<b>SUPAPRASTINTA ES ATITIKTIES DEKLARACIJA</b>
<p>Aš, Yamaha Music Europe GmbH, patvirtinu, kad radijo įrenginių tipas [WX-021] atitinka Direktyvą 2014/53/ES. Visas ES atitikties deklaracijos tekstas prieinamas šiuo interneto adresu: <a href="https://europe.yamaha.com/en/support/compliance/doc.html">https://europe.yamaha.com/en/support/compliance/doc.html</a></p>	
<b>HU</b>	<b>EGYSZERŰSÍTETT EU-MEGFELELŐSÉGI NYILATKOZAT</b>
<p>Yamaha Music Europe GmbH igazolja, hogy a [WX-021] típusú rádióberendezés megfelel a 2014/53/EU irányelvnek. Az EU-megfelelőségi nyilatkozat teljes szövege elérhető a következő internetes címen: <a href="https://europe.yamaha.com/en/support/compliance/doc.html">https://europe.yamaha.com/en/support/compliance/doc.html</a></p>	

<b>PL</b>	<b>UPROSZCZONA DEKLARACJA ZGODNOŚCI UE</b>
Yamaha Music Europe GmbH niniejszym oświadcza, że typ urządzenia radiowego [WX-021] jest zgodny z dyrektywą 2014/53/UE. Pełny tekst deklaracji zgodności UE jest dostępny pod następującym adresem internetowym: <a href="https://europe.yamaha.com/en/support/compliance/doc.html">https://europe.yamaha.com/en/support/compliance/doc.html</a>	
<b>RO</b>	<b>DECLARAȚIA UE DE CONFORMITATE SIMPLIFICATĂ</b>
Prin prezenta, Yamaha Music Europe GmbH declară că tipul de echipamente radio [WX-021] este în conformitate cu Directiva 2014/53/UE. Textul integral al declarației UE de conformitate este disponibil la următoarea adresă internet: <a href="https://europe.yamaha.com/en/support/compliance/doc.html">https://europe.yamaha.com/en/support/compliance/doc.html</a>	
<b>SK</b>	<b>ZJEDNODUŠENÉ EÚ VYHLÁSENIE O ZHODE</b>
Yamaha Music Europe GmbH týmto vyhlasuje, že rádiové zariadenie typu [WX-021] je v súlade so smernicou 2014/53/EÚ. Úplné EÚ vyhlásenie o zhode je k dispozícii na tejto internetovej adrese: <a href="https://europe.yamaha.com/en/support/compliance/doc.html">https://europe.yamaha.com/en/support/compliance/doc.html</a>	
<b>SL</b>	<b>POENOSTAVLJENA IZJAVA EU O SKLADNOSTI</b>
Yamaha Music Europe GmbH potrjuje, da je tip radijske opreme [WX-021] skladen z Direktivo 2014/53/EU. Celotno besedilo izjave EU o skladnosti je na voljo na naslednjem spletnem naslovu: <a href="https://europe.yamaha.com/en/support/compliance/doc.html">https://europe.yamaha.com/en/support/compliance/doc.html</a>	
<b>FI</b>	<b>YKSINKERTAISTETTU EU-VAATIMUSTENMUKAISUUSVAKUUTUS</b>
Yamaha Music Europe GmbH vakuuttaa, että radiolaitetyyppi [WX-021] on direktiivin 2014/53/EU mukainen. EU-vaatimustenmukaisuusvakuutuksen täysimittainen teksti on saatavilla seuraavassa internetosoitteessa: <a href="https://europe.yamaha.com/en/support/compliance/doc.html">https://europe.yamaha.com/en/support/compliance/doc.html</a>	
<b>TR</b>	<b>BASİTLEŞTİRİLMİŞ AVRUPA BİRLİĞİ UYGUNLUK BİLDİRİMİ</b>
İşbu belge ile, Yamaha Music Europe GmbH, radyo cihaz tipinin [WX-021], Direktif 2014/53/AB'ye uygunluğunu beyan eder. AB uyumu beyanının tam metni aşağıdaki internet adresinden edinilebilir: <a href="https://europe.yamaha.com/en/support/compliance/doc.html">https://europe.yamaha.com/en/support/compliance/doc.html</a>	



AT	CZ	FR	IE	LU	PT	ES	LI	MK
BE	DK	DE	IT	MT	RO	SE	NO	TR
BG	EE	EL	LV	NL	SK	UK	CH	ME
CY	FI	HU	LT	PL	SI	IS	HR	RS

**Important Notice: Guarantee Information for customers in EEA\* and Switzerland****English**

For detailed guarantee information about this Yamaha product, and Pan-EEA\* and Switzerland warranty service, please either visit the website address below (Printable file is available at our website) or contact the Yamaha representative office for your country.

\* EEA: European Economic Area

**Remarque importante: informations de garantie pour les clients de l'EEE et la Suisse****Français**

Pour des informations plus détaillées sur la garantie de ce produit Yamaha et sur le service de garantie applicable dans l'ensemble de l'EEE ainsi qu'en Suisse, consultez notre site Web à l'adresse ci-dessous (le fichier imprimable est disponible sur notre site Web) ou contactez directement Yamaha dans votre pays de résidence. \* EEE : Espace Economique Européen

**Wichtiger Hinweis: Garantie-Information für Kunden in der EWR\* und der Schweiz****Deutsch**

Für nähere Garantie-Information über dieses Produkt von Yamaha, sowie über den Pan-EWR\*- und Schweizer Garantieservice, besuchen Sie bitte entweder die folgend angegebene Internetadresse (eine druckfähige Version befindet sich auch auf unserer Webseite), oder wenden Sie sich an den für Ihr Land zuständigen Yamaha-Vertrieb. \*EWR: Europäischer Wirtschaftsraum

**Viktigt: Garantiinformation för kunder i EES-området\* och Schweiz****Svenska**

För detaljerad information om denna Yamahaprodukt samt garantiservice i hela EES-området\* och Schweiz kan du antingen besöka nedanstående webbadress (en utskriftsvänlig fil finns på webbplatsen) eller kontakta Yamahas officiella representant i ditt land. \* EES: Europeiska Ekonomiska Samarbetsområdet

**Avviso importante: informazioni sulla garanzia per i clienti residenti nell'EEA\* e in Svizzera****Italiano**

Per informazioni dettagliate sulla garanzia relativa a questo prodotto Yamaha e l'assistenza in garanzia nei paesi EEA\* e in Svizzera, potete consultare il sito Web all'indirizzo riportato di seguito (è disponibile il file in formato stampabile) oppure contattare l'ufficio di rappresentanza locale della Yamaha. \* EEA: Area Economica Europea

**Aviso importante: información sobre la garantía para los clientes del EEE\* y Suiza****Español**

Para una información detallada sobre este producto Yamaha y sobre el soporte de garantía en la zona EEE\* y Suiza, visite la dirección web que se incluye más abajo (la versión del archivo para imprimir esta disponible en nuestro sitio web) o póngase en contacto con el representante de Yamaha en su país. \* EEE: Espacio Económico Europeo

**Belangrijke mededeling: Garantie-informatie voor klanten in de EER\* en Zwitserland****Nederlands**

Voor gedetailleerde garantie-informatie over dit Yamaha-product en de garantieservice in heel de EER\* en Zwitserland, gaat u naar de onderstaande website (u vind een afdrukbaar bestand op onze website) of neemt u contact op met de vertegenwoordiging van Yamaha in uw land. \* EER: Europese Economische Ruimte

<http://europe.yamaha.com/warranty/>

Yamaha Global Site  
<http://www.yamaha.com/>

Yamaha Downloads  
<http://download.yamaha.com/>

Manual Development Group  
© 2018 Yamaha Corporation

Published 05/2018 KSOE-A0

YAMAHA CORPORATION

10-1 Nakazawa-cho, Naka-ku, Hamamatsu, 430-8650 Japan

WX-021SB/9M

### Product Registration

Thank you for purchasing a Yamaha product.  
To help us provide better services to our customers via the Internet, we encourage you to complete product registration.

<http://4wrd.it/MEMBER>



### Produktregistrierung

Vielen Dank, dass Sie sich für ein Yamaha Produkt entschieden haben.  
Damit wir unseren Kunden den bestmöglichen Service auch über das Internet anbieten können, empfehlen wir Ihnen, eine Produktregistrierung abzuschließen.

<http://4wrd.it/MEMBER>



### Enregistrement du Produit

Merci d'avoir acheté un produit Yamaha.  
Pour nous aider à fournir un meilleur service à nos clients via Internet, nous vous encourageons à compléter l'enregistrement du produit

<http://4wrd.it/MEMBER>



### 产品注册

谢谢您购买雅马哈产品。  
您完成产品注册后，能够得到我们提供的更完备的在线服务。

<http://4wrd.it/MEMBER>



### Registrazione Prodotto

Grazie per avere comprato un prodotto Yamaha.  
Al fine di migliorare i nostri servizi online, vi preghiamo completare la registrazione del Suo prodotto.

<http://4wrd.it/MEMBER>



### 제품 등록

야마하 제품을 구매해 주셔서 감사합니다.  
인터넷을 통해 고객에게 더 나은 서비스를 제공할 수 있도록 제품 등록을 완료하시기 바랍니다.

<http://4wrd.it/MEMBER>



### Регистрация продукта

Благодарим вас за покупку продукта Yamaha.  
Чтобы помочь нам предоставлять лучшие услуги нашим клиентам через Интернет, мы рекомендуем вам пройти регистрацию продукта.

<http://4wrd.it/MEMBER>

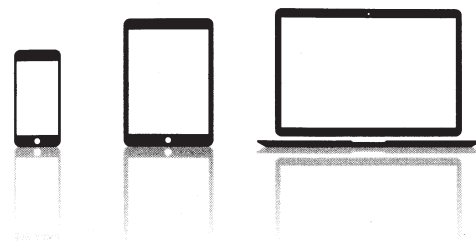



# Worldwide Representative Offices

ZY73900

For details of products, please contact your nearest Yamaha representative or the authorized distributor listed below.  
Pour plus de détails sur les produits, contactez votre représentant Yamaha le plus proche de chez vous ou le distributeur agréé indiqué ci-dessous.

## NORTH AMERICA

### CANADA

**Yamaha Canada Music Ltd.**  
135 Milner Avenue, Tronto, Ontario M1S 3R1,  
Canada

### U.S.A.

**Yamaha Corporation of America**  
6600 Orangethorpe Avenue, Buena Park,  
CA 90620, USA

## CENTRAL & SOUTH AMERICA

### MEXICO

**Yamaha de México S.A. de C.V.**  
Av. Insurgentes Sur 1647 Piso 9, Col. San José  
Insurgentes, Delegación Benito Juárez, México, D.F.,  
C.P. 03900, México

### BRAZIL

**Yamaha Musical do Brasil Ltda.**  
Rua Fidêncio Ramos, 302 - Cj 52 e 54 - Torre B -  
Vila Olímpia - CEP 04551-010 - São Paulo/SP  
Brazil

### ARGENTINA

**Yamaha Music Latin America, S.A.  
Sucursal Argentina**  
Olga Cossetini 1553, Piso 4 Norte  
Madero Este-C1107CEK  
Buenos Aires, Argentina

### PANAMA AND OTHER LATIN AMERICAN COUNTRIES / CARIBBEAN COUNTRIES

**Yamaha Music Latin America, S.A.**  
Edif. Torre Banco General, Piso 7, Urbanización  
Marbella,  
Calle 47 y Aquilino de la Guardia,  
Ciudad de Panamá, Panamá

## EUROPE

### EUROPEAN COUNTRIES

**Yamaha Music Europe GmbH**  
Siemensstrasse 22-34, 25462 Rellingen, Germany

### RUSSIA

**Yamaha Music (Russia) LLC.**  
Room37, entrance 7, bld. 7, Kievskaya street,  
Moscow, 121059, Russia

## AFRICA

### Yamaha Music Gulf FZE

JAFZA-16, Office 512, P.O.Box 17328, Jabel Ali FZE,  
Dubai, U.A.E





## MIDDLE EAST

### TURKEY

**Yamaha Music Europe GmbH**  
Siemensstrasse 22-34, 25462 Rellingen, Germany

### OTHER COUNTRIES

**Yamaha Music Gulf FZE**  
JAFZA-16, Office 512, P.O.Box 17328, Jabel Ali FZE,  
Dubai, U.A.E

## ASIA

### THE PEOPLE'S REPUBLIC OF CHINA

**Yamaha Music & Electronics (China) Co.,Ltd.**  
2F, Yunhedasha, 1818 Xinzha-lu, Jingan-qu,  
Shanghai, China

### INDIA

**Yamaha Music India Private Limited**  
P-401, JMD Megapolis, Sector-48, Sohna Road,  
Gurgaon-122018, Haryana, India

### INDONESIA

**PT. Yamaha Musik Indonesia (Distributor)**  
**PT. Nusantik**  
Yamaha Music Center Bldg., Jalan Jend. Gatot  
Subroto Kav. 4, Jakarta 12930, Indonesia

### REPUBLIC OF KOREA

**Yamaha Music Korea Ltd.**  
11F, Prudential Tower, 298, Gangnam-daero,  
Gangnam-gu, Seoul, 06253, Korea

### MALAYSIA

**Yamaha Music (Malaysia) Sdn., Bhd.**  
No.8, Jalan Perbandaran, 47301 Kelana Jaya,  
Petaling Jaya, Selangor, Malaysia

## SINGAPORE

**Yamaha Music (Asia) PRIVATE LIMITED**  
Block 202 Hougang Street 21, #02-00,  
Singapore 530202, Singapore

## TAIWAN

**Yamaha Music & Electronics Taiwan Co., Ltd.**  
2F., No.1, Yuandong Rd. Banqiao Dist.  
New Taipei City 22063 Taiwan (R.O.C.)

## THAILAND

**Siam Music Yamaha Co., Ltd.**  
3, 4, 15, 16th Fl., Siam Motors Bldg.,  
891/1 Rama 1 Road, Wangmai, Pathumwan,  
Bangkok 10330, Thailand

## VIETNAM

**Yamaha Music Vietnam Company Limited**  
15th Floor, Nam A Bank Tower  
201-203 Cach Mang Thang Tam St., Ward 4, Dist.3,  
Ho Chi Minh City, Vietnam

## OTHER COUNTRIES

**Yamaha Corporation**  
Nakazawa-cho 10-1, Naka-ku, Hamamatsu,  
Japan 430-8650

## OCEANIA

### AUSTRALIA / NEW ZEALAND

**Yamaha Music Australia Pty. Ltd.**  
Level 1, 80 Market Street, South Melbourne,  
VIC 3205 Australia



# LIMITED WARRANTY ON HOME AUDIO PRODUCTS

Thank you for selecting a YAMAHA product. YAMAHA products are designed and manufactured to provide a high level of defect-free performance. Yamaha Corporation of America ("YAMAHA") is proud of the experience and craftsmanship that goes into each and every YAMAHA product. YAMAHA sells its products through a network of reputable, specially authorized dealers and is pleased to offer you, the Original Owner, the following Limited Warranty, which applies only to products that have been (1) directly purchased from YAMAHA's authorized dealers in the USA, including Puerto Rico (the "Warranted Area") and (2) used exclusively in the Warranted Area. YAMAHA suggests that you read the Limited Warranty thoroughly, and invites you to contact your authorized YAMAHA dealer or YAMAHA Customer Service if you have any questions.

## THIS WARRANTY COVERS THE LISTED PRODUCTS AGAINST DEFECTS IN MATERIALS OR WORKMANSHIP FOR THE NUMBER OF YEARS IDENTIFIED BELOW.

<u>Warranty Term</u>	<u>Duration of Warranty from Date of Purchase by or for the Original Owner</u>
<p><b>Type of Product</b></p> <p><i>A/V and Stereo Receivers, Processor and Integrated Amplifiers, Separate Amplifiers and Preamplifiers, Tuners, CD Players and Changers, HDD Players and Recorders, Network Players, Powered Loudspeakers, Media Controllers and Speaker Systems purchased individually, as a pair, or as part of an Integrated or Packaged System.</i></p>	<p>..... 2 years</p>
<p><i>Cassette Decks, Blu-ray Disc Players, DVD Players and Changers, Integrated Systems (Receiver or Amplifier combined or on same chassis with CD, DVD or Blu-ray Disc Player), Desktop Audio Systems (i.e. TSX and PDX Series), Multimedia Speakers, Headphones, Earphones and Accessories.</i></p>	<p>..... 1 year</p>

**Coverage:** YAMAHA will, at its option, repair or replace the product covered by this warranty if it becomes defective, malfunctions or otherwise fails to conform with this warranty under normal use and service during the term of this warranty, without charge for labor or materials. Repairs may be performed using new or refurbished parts that meet or exceed YAMAHA specifications for new parts. If YAMAHA elects to replace the product, the replacement may be a reconditioned unit. You will be responsible for any installation or removal charges and for any initial shipping charges if the product(s) must be shipped for warranty service. However, YAMAHA will pay the return shipping charges to any destination within the USA if the repairs are covered by the warranty. This warranty does not cover (a) damage, deterioration or malfunction resulting from accident, negligence, misuse, abuse, improper installation or operation or failure to follow instructions according to the Owner's Manual for this product; any shipment of the product (claims must be presented to the carrier); repair or attempted repair by anyone other than YAMAHA or an authorized YAMAHA Service Center; (b) any unit which has been altered or on which the serial number has been defaced, modified or removed; (c) normal wear, battery or battery replacement and any periodic maintenance; (d) deterioration due to perspiration, corrosive atmosphere or other external causes such as extremes in temperature or humidity; (e) damages attributable to power line surge or related electrical abnormalities, lightning damage or acts of God; (f) RFI/EMI (Interference/noise) caused by improper grounding or the improper use of either certified or uncertified equipment, if applicable; or (g) interference arising from the use of wireless communication devices (e.g. 2.4 GHz cordless telephones), or other radio frequency emitting products such as microwave ovens, whether such interference impairs the operation of the product or vice-versa. Consult the Owner's Manual for guidance on set-up procedures for minimizing the risks of interference. Any evidence of alteration, erasing or forgery of proof-of-purchase documents will cause this warranty to be void. This warranty covers only the Original Owner and is not transferable.

**In Order to Obtain Warranty Service:** Warranty service will only be provided for defective products within the Warranted Area. Contact your local authorized YAMAHA dealer who will advise you of the procedures to be followed. If this is not successful, contact YAMAHA at the address, telephone number or website shown below. YAMAHA may request that you send the defective product to a local authorized YAMAHA Servicer or authorize return of the defective product to YAMAHA for repair. For products requiring in-home service, contact your local authorized Yamaha dealer to arrange for service. If you are uncertain as to whether a dealer has been authorized by YAMAHA, please contact YAMAHA's Service Department at the number shown below, or check Yamaha's website at <http://usa.yamaha.com>. Product(s) shipped for service should be packed securely and must be accompanied by a detailed explanation of the problem(s) requiring service, together with the original or a machine reproduction of the bill of sale or other dated, proof-of-purchase document describing the product, as evidence of warranty coverage. Should any product submitted for warranty service be found ineligible therefore, an estimate of repair cost will be furnished and the repair will be accomplished only if requested by you and upon receipt of payment or acceptable arrangement for payment.

**Limitation of Implied Warranties and Exclusion of Damages:** ANY IMPLIED WARRANTIES, INCLUDING WARRANTIES OF MERCHANTABILITY AND FITNESS FOR A PARTICULAR PURPOSE SHALL BE LIMITED IN DURATION TO THE APPLICABLE PERIOD OF TIME SET FORTH ABOVE. YAMAHA SHALL NOT BE RESPONSIBLE FOR INCIDENTAL OR CONSEQUENTIAL DAMAGES OR FOR DAMAGES BASED UPON INCONVENIENCE, LOSS OF USE, DAMAGE TO ANY OTHER EQUIPMENT OR OTHER ITEMS AT THE SITE OF USE OR INTERRUPTION OF PERFORMANCES OR ANY CONSEQUENCES. YAMAHA'S LIABILITY FOR ANY DEFECTIVE PRODUCT IS LIMITED TO REPAIR OR REPLACEMENT OF THE PRODUCT, AT YAMAHA'S OPTION. SOME STATES DO NOT ALLOW LIMITATIONS ON HOW LONG AN IMPLIED WARRANTY LASTS OR THE EXCLUSION OR LIMITATION OF INCIDENTAL OR CONSEQUENTIAL DAMAGES, SO THE ABOVE LIMITATION OR EXCLUSION MAY NOT APPLY TO YOU. This Warranty gives you specific legal rights, and you may also have other rights which vary from state to state. This is the only express warranty applicable to the product specified herein; Yamaha neither assumes nor authorizes anyone to assume for it any other express warranty.

If you have any questions about service received or if you need assistance in locating an authorized YAMAHA Servicer, please contact:



CUSTOMER SERVICE  
Yamaha Corporation of America  
6600 Orangethorpe Avenue, Buena Park, California 90620-1373  
Telephone: 800-292-2982  
<http://usa.yamaha.com>

**Do not return any product to the above address without a written Return Authorization issued by YAMAHA.**