

**IMPORTANT**  
Read and understand this entire manual carefully before assembling or using this stove. Keep this manual for future reference. If you do not understand this manual or have any questions, please call Cascade Designs at 1-800-531-9531.

**• Never use this stove in an enclosed space such as a camper, tent, vestibule, car, or home.**

**• Using it in an enclosed space can kill you.**

**• This stove can produce carbon monoxide, which has no odor.**

**CARBON MONOXIDE HAZARD**



**! DANGER**

**FOR YOUR SAFETY**

**Do not store or use gasoline or other liquids with flammable vapors in the vicinity of this or any other stove.**

**FOR YOUR SAFETY**

**If you smell gas**

- 1. Do not attempt to light stove.**
- 2. Extinguish any open flame.**
- 3. Disconnect from fuel canister.**

**LIMITED WARRANTY/LIMITATIONS OF REMEDIES AND LIABILITY**  
USA and Canada

**Limited Warranty.** Cascade Designs, Inc. ("Cascade"), to the original owner ("Owner"), under intended use and maintenance, warrants the enclosed product ("Product") to be free from defects in materials and workmanship for the life of the Product. No warranty against defects in materials and workmanship will apply if Product is (i) altered in any way, (ii) used for purposes inconsistent with Product's intended purpose or design, or (iii) improperly maintained. Warranty will furthermore be voided where Owner/user (i) failed to follow Product instructions or warnings or (ii) subjected Product to misuse, abuse, or neglect.

Cascade reserves the right to replace any discontinued product with a new product of comparable value and function. A returned product deemed irreparable becomes the property of Cascade and will not be returned.

EXCLUDING THE LIMITED WARRANTY PROVIDED ABOVE, CASCADE, ITS AFFILIATES AND THEIR SUPPLIERS, TO THE MAXIMUM EXTENT PERMITTED BY LAW, MAKE NO WARRANTIES, EXPRESSED OR IMPLIED, AND DISCLAIM ALL WARRANTIES, DUTIES AND CONDITIONS, WHETHER EXPRESSED, IMPLIED OR STATUTORY, WITH RESPECT TO THE PRODUCT, INCLUDING WITHOUT LIMITATION ANY IMPLIED WARRANTIES OF MERCHANTABILITY, AGAINST LATENT DEFECTS, FITNESS FOR A PARTICULAR PURPOSE, OR CORRESPONDENCE TO DESCRIPTION.

**Warranty Service.** To obtain service under this warranty, the warranty-eligible Product must be presented to a Cascade authorized dealer. In the United States and Canada, warranty service may also be obtained by calling 1-800-531-9531 (M-F, 8:00-4:30, PDT).

Owner is responsible for all costs associated with returning Product to Cascade for service. Where at its sole discretion Cascade deems Product eligible for warranty repair or replacement, Cascade will pay the shipping and handling associated with returning reported or replaced Product to Owner. In instances where Cascade deems a returned product ineligible for warranty service, Cascade will, if possible, repair product for a reasonable charge that includes return shipping and handling. For warranty return service details, please go to [www.msrgear.com](http://www.msrgear.com).

**Limitation of Remedies.** Should a court of competent jurisdiction find the limited warranty set forth above breached, Cascade's only obligation will be to, at its option, either repair or replace Product. Should the aforementioned remedy fail of its essential purpose, Cascade will, in exchange for return of Product, refund to Owner Product's original purchase price. THE FOREGOING REMEDY IS THE SOLE AND EXCLUSIVE REMEDY OF THE PURCHASER AGAINST CASCADE, ITS AFFILIATES AND THEIR SUPPLIERS, REGARDLESS OF LEGAL THEORY.

**Limitation of Liability.** Cascade's, its affiliates' and their suppliers' maximum liability is limited to incidental damages not to exceed the original purchase price of the Product. CASCADE, ITS AFFILIATES AND THEIR SUPPLIERS HEREBY DISCLAIM AND EXCLUDE ANY LIABILITY FOR ANY CONSEQUENTIAL OR OTHER DAMAGES RESULTING FROM ANY REASON WHATSOEVER. THIS EXCLUSION AND LIMITATION APPLIES TO ALL LEGAL THEORIES UNDER WHICH DAMAGES MAY BE SOUGHT, AND WILL APPLY EVEN IF ANY REMEDY FAILS OF ITS ESSENTIAL PURPOSE.

This limited warranty gives Owner specific legal rights; Owner may have additional rights, which may vary state to state.

Always completely follow safety, use, operation, and maintenance instructions for this or any other Cascade product.

European Union customer statutory rights are not affected.

**! DANGER**



**CARBON MONOXIDE, FIRE & EXPLOSION HAZARD**

There are serious hazards associated with using this stove and fuel. Accidental fire, explosion, and misuse can cause death, serious burns, and property damage. You are responsible for your own safety and the safety of those in your group. Please use good judgment.

This stove is for **OUTDOOR USE ONLY**. Never use this stove in a tent, vestibule, car, house, or inside any enclosed area. This stove consumes oxygen and produces carbon monoxide gas, which is poisonous and has no odor. This stove can easily ignite nearby combustible materials and flammable liquids or vapors. If you use this stove in an enclosed area you can be killed or seriously burned.

Keep stove and canister away from other heat sources. Never use any kind of windscreen. Never use cookware or an Outback Oven™ with a diameter larger than 8 inches (20.3 cm). If you expose the canister to high heat, it will explode and you can be killed or seriously burned.

Never let children use this stove. Keep children at least 10 feet (3 m) away from the stove and cooking area, and supervise them at all times.

READ, UNDERSTAND, AND FOLLOW ALL instructions and warnings in this manual before using this stove. Failure to follow warnings and instructions can result in death, serious burns or other injury, and property damage.

**! WARNING**

Do not attempt to use this stove: (1) before reading and fully understanding this Instruction Manual; (2) if you are not prepared or comfortable attending to a burning and/or hot stove at all times; (3) if you observe leaking fuel; or (4) if you observe any condition with the stove system or in the surrounding environment that would make operation of an open flamed device dangerous. Failure to follow these directions can cause an unsafe situation leading to fire, burns, severe injury or death.

This stove is designed for the outside (i.e., not within enclosed spaces of any kind; e.g., tents) boiling of water or cooking of food only—never use it for any other purpose. Use of stove within any enclosed space, or for a purpose other than boiling water or cooking food can cause fire, burns, severe injury or death.

Do not disassemble stove beyond what is described in these instructions. Do not modify stove. Disassembly or modification of stove in any manner not consistent with these instructions voids warranty and can result in an unsafe situation where fire, burns, severe injury or death can occur.

Do not use stove if parts are missing or broken, or with replacement parts not specific to your stove model. Use of stove with missing or broken parts, or with replacement parts not specific to your stove model, can result in an unsafe situation where fire, burns, severe injury or death can occur.

Cascade Designs, Inc. warrants the use of appropriately sized MSR® brand cookware only—use of cookware other than MSR® brand cookware will be at user's own risk and discretion.

**MSR®**  
MOUNTAIN SAFETY RESEARCH®

For product service and information contact  
**Cascade Designs, Inc.**  
4000 First Avenue South, Seattle, WA 98134 USA  
1-800-531-9531 or 206-505-9500  
[www.msrgear.com](http://www.msrgear.com)



Printed on recycled paper containing 30% post-consumer waste.

**INSTRUCTION MANUAL**



**MSR®**  
MOUNTAIN SAFETY RESEARCH®

**SUPERFLY™ STOVE/ SUPERFLY STOVE WITH AUTOSTART**

**FOR OUTDOOR USE ONLY**



**AGA 6089**

Nominal rate:  
10,000 BTU/h.  
3.5 kW h.  
269 g/h.

# GENERAL SAFETY INFORMATION

To avoid being killed or seriously injured, READ, UNDERSTAND, AND FOLLOW ALL warnings and instructions in this manual before you use this stove.

This stove is a lightweight, compact device made for cooking outdoors. Please consult with your local outdoor retailer to learn more about cooking outdoors. Seek qualified instruction before you venture outdoors.

You are responsible for your own safety and the safety of those in your group. This manual is not intended to replace your good judgment.

## Fuel Canister Safety

This stove uses a liquid pressurized gas (LPG) canister that is highly flammable and explosive. Use only MSR® premium blend canister fuel, 70 Butane/30 Propane or 80 IsoButane/20 Propane mix, certified to EN 417 (4 ounces/113 g or 8 ounces/227 g). For any fuel canister, follow this safety information:

- Listen and smell for leaking gas. Leaking gas is a serious hazard. LPG is invisible and odorless, and strong odorant additives can fade over time. Leaks are not always detectable by smell. Do not use this stove if it is leaking, damaged, or does not operate properly.
- Check that the stove and fuel canister connection is secure and tight. If the connection does not look or feel secure, or if you hear or smell leaking gas, do not use stove or canister. Move stove to a well-ventilated area away from any ignition source to locate and stop the leak. Only check for leaks outdoors using soapy water. Do not try to detect leaks using a flame.
- Only change the canister outside and away from people.
- Never use fuel canisters larger than 8 ounces (227 g) or more than 4 inches (10 cm) in height, because oversized canisters increase stove instability.
- Check the seals before connecting a new fuel canister to the stove. Do not use stove if seals are damaged or worn.
- Keep stove and fuel canister away from other heat sources. If you expose the fuel canister to high heat, the canister will explode or leak and you can be killed or seriously burned.
- Follow all warnings on fuel canister regarding use and storage.

# KNOW YOUR MSR® SUPERFLY™ STOVE

Please familiarize yourself with the parts of your SuperFly stove and the following instructions before connecting the stove to its fuel canister. Never use this stove in any other way than is described in the following instructions.

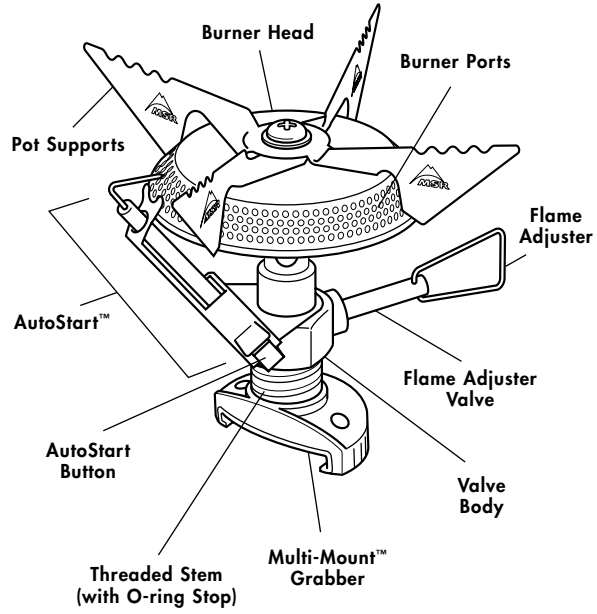

# SUPERFLY™ STOVE OPERATING INSTRUCTIONS

## 1 CONNECT STOVE AND CANISTER

The SuperFly stove attaches to fuel canisters differently than other stoves because of its Multi-Mount™ technology.

1. Unfold Flame Adjuster.
2. Close Flame Adjuster Valve.
3. Screw Multi-Mount Grabber to the bottom of Threaded Stem.
4. Slide Multi-Mount Grabber under canister lip.
5. Hold Multi-Mount Grabber in place and finger-tighten stove until connection is secure.

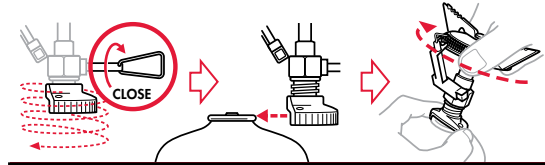

**WARNING**

Never over tighten fuel canister to stove. Over tightening can damage stove or canister causing fuel to leak. Leaking fuel can cause fire, burns, severe injury or death.

Use extreme caution when using stove in temperatures below freezing. In freezing temperatures O-rings can stiffen and leak fuel. Always check for fuel leaks before and after lighting stove. Use of a leaking stove can cause fire, burns, severe injury or death.

Keep children far away from stove and fuel—Cascade Designs, Inc. recommends no less than 10 feet (3+ meters). Never leave a burning or hot stove unattended. An unattended stove can lead to fire and/or a situation where children, pets, or the unwary can be burned, injured, or killed.

## 2 SET UP STOVE

1. Clear cooking area of combustible materials and flammable liquids or vapors.
  2. Place stove assembly on a solid, stable, even surface to ensure stability.
  3. Rotate Pot Supports fully open.
- Pot Supports should not touch AutoStart.

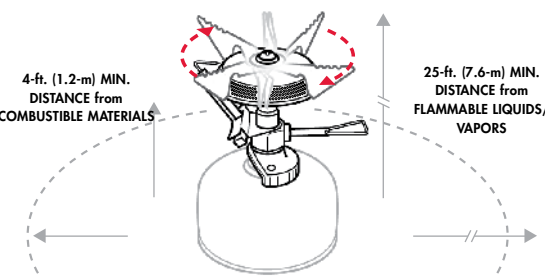

**WARNING**

Keep combustibles at least 4 feet (1.2 meters) away from the top and sides of a burning stove, or a stove that you are in the process of lighting. Keep flammable liquids and vapors at least 25 feet (7.6 meters) away from the top and sides of a burning stove, or a stove that you are in the process of lighting. This stove can ignite combustible materials, flammable liquids and vapors creating a situation where fire, burns, severe injury or death can result.

Never attempt lighting stove if flame adjuster valve is left open. If flame adjuster valve is left open, close it immediately and thoroughly ventilate area before lighting stove. Failure to ventilate area can result in an explosion that can cause fire, burns, severe injury or death.

## 3 TURN STOVE ON

1. Open Flame Adjuster Valve (about 1/4 turn) to release fuel. Listen for hiss as fuel flows into Burner Head.
  2. Click AutoStart Button quickly to ignite fuel. Fuel ignition may take several clicks.
  3. Turn Flame Adjuster Valve to desired flame setting. Proper flame will appear blue.
- NOTE: To light fuel without AutoStart, hold lit match/lighter near Burner Ports and slowly open Flame Adjuster Valve.

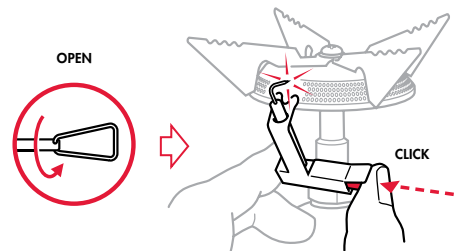

**WARNING**

Never place your head or body above the stove while lighting, or cooking. Because stove maintains an open flame, placement of head or body above stove is an unsafe practice that can cause fire, burns, severe injury or death.

## 4 USE STOVE TO COOK

1. Add food or liquid to cookware.
2. Place cookware onto the center of the stove.
3. Turn Flame Adjuster Valve to adjust heat.

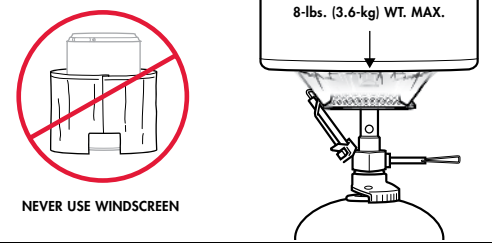

**WARNING**

Never move a burning or hot stove. Always extinguish stove and cool for at least 5 minutes before moving. Moving a burning or hot stove can cause fire, burns, severe injury or death. Never use cookware or an Outback Oven™ with a diameter greater than 8 inches (20.3 centimeters). Never place and operate two or more stoves together. Never operate stove with empty or dry cookware. Never use non-MSR® reflectors or diffusers. Use of stove in any of the preceding manners can result in the fuel canister exploding and causing fire, burns, severe injury or death. Never use cookware of any size that is ill-suited and/or inappropriate for use with stove, particularly its pot supports (e.g., cookware with a convex or concave bottom, some enameled cookware, etc.). Use of stove with ill-suited and/or inappropriate cookware can result in cookware and/or stove instability and a situation where hot cookware and/or cookware contents can spill and cause fire, burns, severe injury or death.

## 5 TURN STOVE OFF

1. Close Flame Adjuster Valve when cooking is done.
  2. After flames are out, wait 5 minutes for stove to cool.
  3. Fold Flame Adjuster.
  4. Close Pot Supports.
  5. Move stove assembly away from any ignition sources.
- Hold Multi-Mount Grabber in place and unscrew stove from canister. A small amount of gas may escape when unscrewing stove.

If canister is completely empty of fuel, follow proper disposal requirements in your local area.

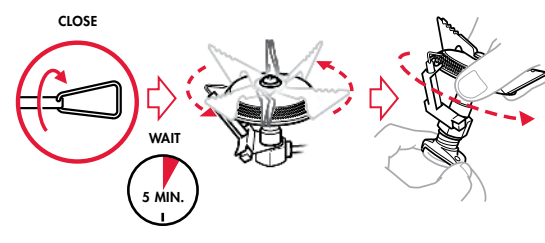

**WARNING**

Always disconnect stove from canister before storing it. Failure to disconnect stove from canister before storing may cause fuel to leak and cause fire, burns, severe injury or death. Always store fuel canisters in a well-ventilated location away from any possible heat or ignition source such as: water heaters, stoves, pilot lights, or furnaces; or where temperatures exceed 120 F (49 C). Storing fuel canisters near any heat or ignition source or where temperatures exceed 120 F (49 C), can result in the canister exploding and causing fire, burns, severe injury or death.

## TROUBLESHOOTING

Problem	Cause	Solution
Diminished flames	Low fuel	Replace canister
Stove does not light	Cold canister	Swap canisters
	Windy conditions	Shelter stove behind a rock/natural barrier
	Empty canister	Replace canister
	Damaged AutoStart	Bend electrode closer to Burner Ports (<3/16 in./4.8 mm)  Hold lit match/lighter near Burner Ports and slowly open Flame Adjuster Valve  Replace AutoStart

Stove service must only be done by an individual authorized by Cascade Designs, Inc. If you have any questions about these instructions, your stove, replacement parts, or repairs, please contact:

Cascade Designs, Inc., USA - 1-800-531-9531 or 206-505-9500  
 Cascade Designs, Ltd., Ireland - (+353) 21-4621400  
[www.msrgear.com](http://www.msrgear.com) [info@cascaadedesigns.com](mailto:info@cascaadedesigns.com)