

Canon

EOS
REBEL T5i
EOS 700D



Canon

EOS
REBEL T5i

EOS 700D

INSTRUCTION MANUAL



E

INSTRUCTION
MANUAL

The "Quick Reference Guide" is included at the end of this manual.

Introduction

The EOS REBEL T5i/EOS 700D is a digital single-lens reflex camera featuring a fine-detail CMOS sensor with approx. 18.00 effective megapixels, DIGIC 5, high-precision and high-speed 9-point AF, approx. 5 fps continuous shooting, Live View shooting, and Full High-Definition (Full HD) movie shooting.

Before Starting to Shoot, Be Sure to Read the Following

To avoid botched pictures and accidents, first read the “Safety Precautions” (p.349-351) and “Handling Precautions” (p.16-17).

Refer to This Manual while Using the Camera to Further Familiarize Yourself with the Camera

While reading this manual, take a few test shots and see how they come out. You can then better understand the camera.

Testing the Camera Before Use and Liability

After shooting, play images back and check whether they have been properly recorded. If the camera or memory card is faulty and the images cannot be recorded or downloaded to a computer, Canon cannot be held liable for any loss or inconvenience caused.

Copyrights

Copyright laws in your country may prohibit the use of your recorded images or copyrighted music and images with music in the memory card for anything other than private enjoyment. Also be aware that certain public performances, exhibitions, etc., may prohibit photography even for private enjoyment.



This camera is compatible with SD memory cards, SDHC memory cards, and SDXC memory cards. In this manual, “card” refers to all these cards.

*** The camera does not come with a card for recording images/movies.** Please purchase it separately.

Item Check List

Before starting, check that all the following items have been included with your camera. If anything is missing, contact your dealer.



Camera
(with eyecup and body cap)



**Battery Pack
LP-E8**
(with protective cover)



**Battery Charger
LC-E8/LC-E8E***



Wide Strap



Interface Cable



EOS DIGITAL Solution Disk
(Software/Software Instruction Manuals)



**Camera
Instruction Manual**
(this booklet)

* Battery Charger LC-E8 or LC-E8E is provided. (The LC-E8E comes with a power cord.)

- If you purchased a Lens Kit, check that the lens is included.
- Depending on the Lens Kit type, a lens instruction manual may also be included.
- Be careful not to lose any of the above items.

Software Instruction Manuals

The Software Instruction Manuals are included on the EOS DIGITAL Solution Disk as PDF files. See page 367 for instructions to look up information in the Software Instruction Manuals.



Conventions Used in this Manual

Icons in this Manual



: Indicates the Main Dial.

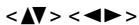

: Indicates the <◆> Cross keys.



: Indicates the Setting button.

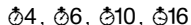

: Indicates that the corresponding function remains active for 4 sec., 6 sec., 10 sec., or 16 sec. respectively after you let go of the button.

* In this manual, the icons and markings indicating the camera's buttons, dials, and settings correspond to the icons and markings on the camera and on the LCD monitor.

MENU : Indicates a function that can be changed by pressing the <MENU> button and changing the setting.

☆ : When shown on the upper right of a page, it indicates that the function is available only in the Creative Zone modes (p.24).

(p.**): Reference page number for more information.



: Warning to prevent shooting problems.



: Supplemental information.



: Tips or advice for better shooting.



: Problem-solving advice.

Basic Assumptions

- All operations explained in this manual assume that the power switch is already set to <ON> (p.34).
- It is assumed that all the menu settings and Custom Functions are set to their defaults.
- The illustrations in this manual show the camera attached with the EF-S18-55mm f/3.5-5.6 IS STM lens as an example.

Chapters

For first-time DSLR users, Chapters 1 and 2 explain the camera's basic operations and shooting procedures.

	Introduction	2
1	Getting Started	27
2	Basic Shooting and Image Playback	57
3	Creative Shooting	85
4	Advanced Shooting	109
5	Shooting with the LCD Monitor (Live View Shooting)	145
6	Shooting Movies	173
7	Handy Features	203
8	Wireless Flash Photography	229
9	Image Playback	241
10	Post-Processing Images	273
11	Printing Images	279
12	Customizing the Camera	295
13	Reference	305
14	Downloading Images to a Personal Computer	361
15	Quick Reference Guide and Index	369



Contents at a Glance

Shooting

- **Shoot automatically** → **p.57 - 75** (Basic Zone modes)

- **Shoot continuously** → **p.104** (Continuous shooting)

- **Take a picture of yourself in a group** → **p.106** (Self-timer)

- **Freeze the action** → **p.110** (Tv Shutter-priority AE)
- **Blur the action**

- **Blur the background** → **p.64** (Creative Auto)
- **Keep the background in sharp focus** → **p.112** (Av Aperture-priority AE)

- **Adjust the image brightness (exposure)** → **p.119** (Exposure compensation)

- **Shoot in low light** → **p.58, 107** (Flash photography)
p.92 (ISO speed setting)

- **Shoot without flash** → **p.63** (Flash Off)
p.76 (Flash Off)

- **Photograph fireworks at night** → **p.116** (Bulb exposure)

- **Shoot while viewing the LCD monitor** → **p.145** (Live View shooting)

- **Using Creative Filters** → **p.152** (Creative filters)

- **Shoot movies** → **p.173** (Movie shooting)

Image Quality

- **Shoot with image effects matching the subject** → **p.95** (Picture Style)





-
- **Make a large-size print of the picture** → p.88 (L, L, RAW)
 - **Take many pictures** → p.88 (S1, S1, S2, S3)
-

Focusing

-
- **Change the point of focus** → p.100 (AF point selection)
 - **Shoot a moving subject** → p.70, 98 (AI Servo AF)
-

Playback

-
- **View the images on the camera** → p.84 (Playback)
 - **Search for pictures quickly** → p.242 (Index display)
p.243 (Image browsing)
 - **Rate images** → p.248 (Ratings)
 - **Prevent important images from accidental deletion** → p.266 (Image protect)
 - **Delete unnecessary images** → p.268 (Delete)
 - **Auto play images and movies** → p.258 (Slide show)
 - **View the images or movies on a TV set** → p.262 (Video OUT)
 - **Adjust the LCD monitor brightness** → p.205 (LCD monitor brightness)
-

Printing

-
- **Print pictures easily** → p.279 (Direct printing)
-



Index to Features

Power

- **Battery**
 - Charging → p.28
 - Installing/Removing → p.30
 - Battery check → p.35
- **Power outlet** → p.306
- **Auto power off** → p.34

Card

- **Installing/Removing** → p.31
- **Format** → p.48
- **Release shutter without card** → p.204

Lens

- **Attaching/Detaching** → p.39
- **Zoom** → p.40
- **Image Stabilizer** → p.41

Basic Settings

- **Dioptric adjustment** → p.42
- **Language** → p.38
- **Zone/Date/Time** → p.36
- **Beeper** → p.204

LCD Monitor

- **Using the LCD Monitor** → p.33
- **LCD auto off/on** → p.217
- **Brightness adjustment** → p.205
- **Touch screen** → p.53

Recording Images

- **Creating/Selecting a folder** → p.206
- **File numbering** → p.208

Image Quality

- **Image-recording quality** → p.88
- **Picture Style** → p.95
- **White balance** → p.137
- **Color space** → p.141
- **Image enhancement features**
 - Auto Lighting Optimizer → p.125
 - Lens peripheral illumination correction → p.129
 - Chromatic aberration correction → p.130
 - Noise reduction for long exposures → p.127
 - Noise reduction for high ISO speeds → p.126
 - Highlight tone priority → p.299

AF

- **AF operation** → p.97
- **AF point selection** → p.100
- **Manual focusing** → p.103

Drive

- **Drive mode** → p.22
- **Continuous shooting** → p.104
- **Self-timer** → p.106
- **Maximum burst** → p.90

Shooting

- **Shooting mode** → p.24
- **ISO speed** → p.92
- **Feature guide** → p.52
- **Bulb** → p.116
- **Mirror lockup** → p.142
- **Metering mode** → p.117
- **Remote control** → p.307
- **Quick Control** → p.44

Exposure Adjustment

- Exposure compensation → p.119
- AEB → p.121
- AE lock → p.123

Flash

- Built-in flash → p.107
 - Flash exposure compensation → p.120
 - FE lock → p.124
- External flash → p.309
- Flash control → p.218
 - Wireless flash → p.229

Live View Shooting

- Live View shooting → p.145
- Autofocusing (AF) methods → p.159
- Continuous AF → p.156
- Touch Shutter → p.168
- Aspect ratio → p.157
- Grid display → p.156
- Quick Control → p.151
- Creative filters → p.152

Movie Shooting

- Movie shooting → p.173
- Movie Servo AF → p.196
- Sound recording → p.198
- Grid display → p.198
- Manual exposure → p.177
- Still photo shooting → p.182
- Quick Control → p.184
- Video snapshot → p.187

Playback

- Image review time → p.204
- Single-image display → p.84
- Shooting information display → p.270
- Index display → p.242
- Image browsing (Jump display) → p.243
- Magnified view → p.244
- Image rotate → p.247
- Rating → p.248
- Movie playback → p.254
- Editing out movie's first/last scene → p.256
- Slide show → p.258
- Viewing images on TV → p.262
- Protect → p.266
- Erase → p.268
- Quick Control → p.250

Image Editing

- Creative filters → p.274
- Resize → p.277

Printing

- PictBridge → p.282
- Print Order (DPOF) → p.289
- Photobook Set-up → p.293

Customization

- Custom Functions (C.Fn) → p.296
- My Menu → p.303

Software



- Downloading images to a personal computer → p.361
- Software instruction manual → p.367

Contents













Introduction 2

Item Check List.....	3
Conventions Used in this Manual.....	4
Chapters.....	5
Contents at a Glance.....	6
Index to Features.....	8
Handling Precautions.....	16
Quick Start Guide.....	18
Nomenclature.....	20





1 Getting Started 27

Charging the Battery.....	28
Installing and Removing the Battery.....	30
Installing and Removing the Card.....	31
Using the LCD Monitor.....	33
Turning on the Power.....	34
Setting the Time Zone, Date and Time.....	36
Selecting the Interface Language.....	38
Attaching and Detaching a Lens.....	39
About the Lens Image Stabilizer.....	41
Basic Operation.....	42
 Quick Control for Shooting Functions.....	44
 Menu Operations.....	46
Formatting the Card.....	48
Switching the LCD Monitor Display.....	50
Feature Guide.....	52
 Touch Screen Operations.....	53







2 Basic Shooting and Image Playback 57

 Fully Automatic Shooting (Scene Intelligent Auto)	58
 Full Auto Techniques (Scene Intelligent Auto)	61
 Disabling Flash	63
 Creative Auto Shooting	64
 Shooting Portraits	67
 Shooting Landscapes	68
 Shooting Close-ups	69
 Shooting Moving Subjects	70
SCN : Special Scene Mode	71
 Shooting Night Portraits (With a Tripod)	72
 Shooting Night Scenes Handheld	73
 Shooting Backlit Scenes	74
 Quick Control	76
Shoot by Ambience Selection	77
Shoot by Lighting or Scene Type	81
 Image Playback	84





3 Creative Shooting 85

P : Program AE	86
Setting the Image-Recording Quality	88
ISO: Changing the ISO Speed	92
 Optimal Image Characteristics for the Subject (Picture Style) ...	95
AF: Changing the Autofocus Operation (AF Operation)	97
 Selecting the AF Point	100
Subjects Difficult to Focus	103
MF : Manual Focusing	103
 Continuous Shooting	104
 Using the Self-timer	106
 Using the Built-in Flash	107

4 Advanced Shooting 109

Tv : Conveying the Subject's Movement	110
Av : Changing the Depth of Field	112
Depth of Field Preview	114
M : Manual Exposure	115
 Changing the Metering Mode	117
Setting Exposure Compensation	119
Auto Exposure Bracketing (AEB)	121
 Locking the Exposure (AE Lock)	123
 Locking the Flash Exposure (FE Lock)	124
Auto Correction of Brightness and Contrast (Auto Lighting Optimizer) ...	125
Noise Reduction Settings	126
Lens Peripheral Illumination / Chromatic Aberration Correction....	129
 Customizing Image Characteristics (Picture Style)	132
 Registering Preferred Image Characteristics (Picture Style).....	135
WB : Matching the Light Source (White Balance).....	137
 Adjusting the Color Tone for the Light Source	139
Setting the Color Reproduction Range (Color Space).....	141
Mirror Lockup to Reduce Camera Shake	142

5 Shooting with the LCD Monitor (Live View Shooting) 145



















 Shooting with the LCD Monitor	146
Shooting Function Settings	151
 Using Creative Filters	152
 Menu Function Settings	156
Changing the Autofocus Method (AF Method)	159
 Shooting with the Touch Shutter	168
MF : Focus Manually	170

6 Shooting Movies 173

🎥 Shooting Movies	174
Autoexposure Shooting	174
Manual Exposure Shooting	177
Shooting Still Photos	182
Shooting Function Settings	184
Setting the Movie-recording Size	185
Shooting Video Snapshots	187
Movie Menu Function Settings	196

7 Handy Features 203

Handy Features	204
Disabling the Beeper	204
Card Reminder	204
Setting the Image Review Time	204
Setting the Auto Power-off Time	205
Adjusting the LCD Monitor Brightness	205
Creating and Selecting a Folder	206
File Numbering Methods	208
Setting Copyright Information	210
Auto Rotation of Vertical Images	212
Checking Camera Settings	213
Reverting the Camera to the Default Settings	214
Preventing the LCD Monitor from Turning Off Automatically	217
Changing the Shooting Settings Screen Color	217
Setting the Flash	218
🧹 Automatic Sensor Cleaning	223
Appending Dust Delete Data	224
Manual Sensor Cleaning	226

8	Wireless Flash Photography	229
	Using Wireless Flash.....	230
	Easy Wireless Flash Shooting.....	231
	Custom Wireless Flash Shooting	234
	Other Settings	238
9	Image Playback	241
	  Searching for Images Quickly.....	242
	 /  Magnified View.....	244
	 Playing Back with the Touch Screen.....	245
	 Rotating the Image.....	247
	Setting Ratings.....	248
	 Quick Control During Playback.....	250
	 Enjoying Movies	252
	 Playing Movies	254
	 Editing a Movie's First and Last Scenes	256
	Slide Show (Auto Playback).....	258
	Viewing the Images on TV	262
	 Protecting Images.....	266
	 Erasing Images.....	268
	INFO.: Shooting Information Display	270
10	Post-Processing Images	273
	 Applying Creative Filters to the Image.....	274
	 Resizing a JPEG Image	277
11	Printing Images	279
	Preparing to Print	280
	 Printing.....	282
	Cropping the Image	287
	 Digital Print Order Format (DPOF)	289
	 Direct Printing with DPOF.....	292
	 Specifying Images for a Photobook.....	293

12 Customizing the Camera 295

Setting Custom Functions	296
Custom Function Settings	298
C.Fn I: Exposure	298
C.Fn II: Image	299
C.Fn III: Autofocus/Drive	300
C.Fn IV: Operation/Others	301
Registering My Menu	303

13 Reference 305

Using a Household Power Outlet	306
Remote Control Shooting	307
External Speedlites	309
Using Eye-Fi Cards	311
Function Availability Table According to Shooting Mode	314
System Map	316
Menu Settings	318
Troubleshooting Guide	324
Error Codes	337
Specifications	338
Handling Precautions: EF-S18-55mm f/3.5-5.6 IS STM, EF-S18-135mm f/3.5-5.6 IS STM	347
Safety Precautions	349

14 Downloading Images to a Personal Computer 361

Downloading Images to a Personal Computer	362
About the Software	364
Installing the Software	366
Software Instruction Manual	367

15 Quick Reference Guide and Index 369

Quick Reference Guide	370
Index	382

Handling Precautions

Camera Care

- This camera is a precision instrument. Do not drop it or subject it to physical shock.
- The camera is not waterproof and cannot be used underwater. If you accidentally drop the camera into water, promptly consult the nearest Canon Service Center. Wipe off any water droplets with a dry cloth. If the camera has been exposed to salty air, wipe it with a well-wrung wet cloth.
- Never leave the camera near anything having a strong magnetic field such as a magnet or electric motor. Also avoid using or leaving the camera near anything emitting strong radio waves such as a large antenna. Strong magnetic fields can cause camera misoperation or destroy image data.
- Do not leave the camera in excessive heat such as in a car in direct sunlight. High temperatures can cause the camera to malfunction.
- The camera contains precision electronic circuitry. Never attempt to disassemble the camera yourself.
- Do not block the mirror operation with your finger, etc. Doing so may cause a malfunction.
- Use a blower to blow away dust on the lens, viewfinder, reflex mirror, and focusing screen. Do not use cleaners that contain organic solvents to clean the camera body or lens. For stubborn dirt, take the camera to the nearest Canon Service Center.
- Do not touch the camera's electrical contacts with your fingers. This is to prevent the contacts from corroding. Corroded contacts can cause camera misoperation.
- If the camera is suddenly brought in from the cold into a warm room, condensation may form on the camera and internal parts. To prevent condensation, first put the camera in a sealed plastic bag and let it adjust to the warmer temperature before taking it out of the bag.
- If condensation forms on the camera, do not use the camera. This is to avoid damaging the camera. If there is condensation, remove the lens, card and battery from the camera, and wait until condensation has evaporated before using the camera.
- If the camera will not be used for an extended period, remove the battery and store the camera in a cool, dry, well-ventilated location. Even while the camera is in storage, press the shutter button a few times once in a while to check that the camera is still working.
- Avoid storing the camera where there are chemicals that result in rust and corrosion such as in a chemical lab.
- If the camera has not been used for an extended period, test all its functions before using it. If you have not used the camera for some time or if there is an important shoot such as a foreign trip coming up, have the camera checked by your Canon dealer or check the camera yourself and make sure it is working properly.

LCD Monitor

- Although the LCD monitor is manufactured with very high precision technology with over 99.99% effective pixels, there may be a few dead pixels displaying only black or red, etc., among the remaining 0.01% or less pixels. Dead pixels are not a malfunction. They do not affect the images recorded.
- If the LCD monitor is left on for a prolonged period, screen burn-in may occur where you see remnants of what was displayed. However, this is only temporary and will disappear when the camera is left unused for a few days.
- The LCD monitor display may seem slow in low temperatures, or look black in high temperatures. It will return to normal at room temperature.

Cards

To protect the card and its recorded data, note the following:

- Do not drop, bend, or wet the card. Do not subject it to excessive force, physical shock, or vibration.
- Do not touch the card's electronic contacts with your fingers or anything metallic.
- Do not affix any stickers, etc., on the card.
- Do not store or use the card near anything having a strong magnetic field such as a TV set, speakers, or magnet. Also avoid places prone to having static electricity.
- Do not leave the card in direct sunlight or near a heat source.
- Store the card in a case.
- Do not store the card in hot, dusty, or humid locations.

Lens

After detaching the lens from the camera, put down the lens with the rear end up and attach the lens caps to avoid scratching the lens surface and electrical contacts.

Contacts



Cautions Regarding Prolonged Use

If you use continuous shooting, Live View shooting, or movie shooting for a prolonged period, the camera may become hot. Although this is not a malfunction, holding the hot camera for a long period can cause slight skin burns.

About Smudges Adhering to the Front of the Sensor

Besides dust entering the camera from outside, in rare cases lubricant from the camera's internal parts may adhere to the front of the sensor. If visible spots still remain after the automatic sensor cleaning, having the sensor cleaned by a Canon Service Center is recommended.

Quick Start Guide

1

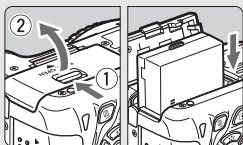

Insert the battery (p.30).

- To charge the battery, see page 28.

2

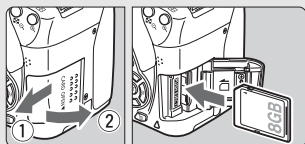

Insert a card (p.31).

- With the card's label facing toward the back of the camera, insert it into the card slot.

3

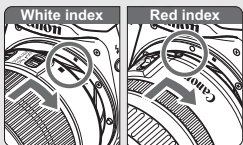

Attach the lens (p.39).

- Align the lens' white or red index with the camera's index in the matching color.

4

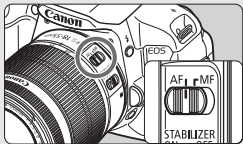

Set the lens focus mode switch to <AF> (p.39).

5

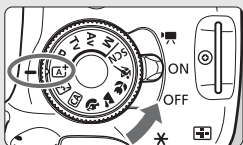

Set the power switch to <ON>, and set the Mode Dial to <AI+> (Scene Intelligent Auto) (p.58).

- All the necessary camera settings will be set automatically.

6

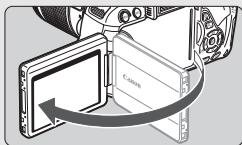
**Flip out the LCD monitor** (p.33).

- When the LCD monitor displays the time zone and date/time setting screens, see page 36.

7

**Focus the subject** (p.43).

- Look through the viewfinder and aim the viewfinder center over the subject.
- Press the shutter button halfway, and the camera will focus the subject.
- If necessary, the built-in flash will be raised automatically.

8

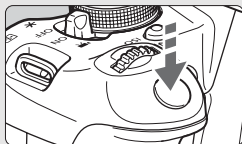
**Take the picture** (p.43).

- Press the shutter button completely to take the picture.

9

**Review the picture** (p.204).

- The captured image will be displayed for 2 sec. on the LCD monitor.
- To display the image again, press the <▶> button (p.84).

- To shoot while looking at the LCD monitor, see “Live View Shooting” (p.145).
- To view the images captured so far, see “Image Playback” (p.84).
- To delete an image, see “Erasing Images” (p.268).

Nomenclature

The names in bold indicate the parts mentioned up until the “Basic Shooting and Image Playback” section.

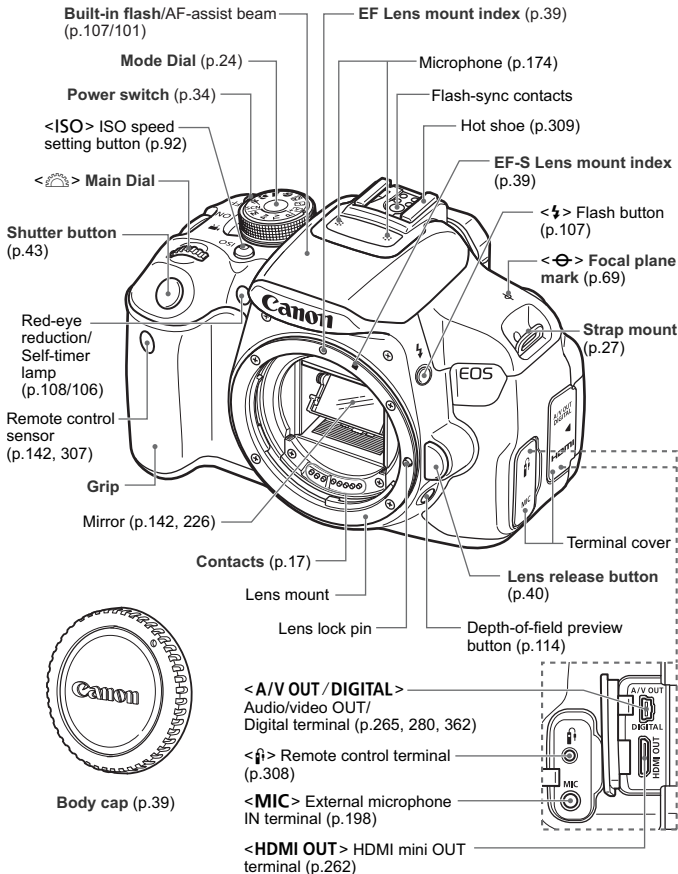

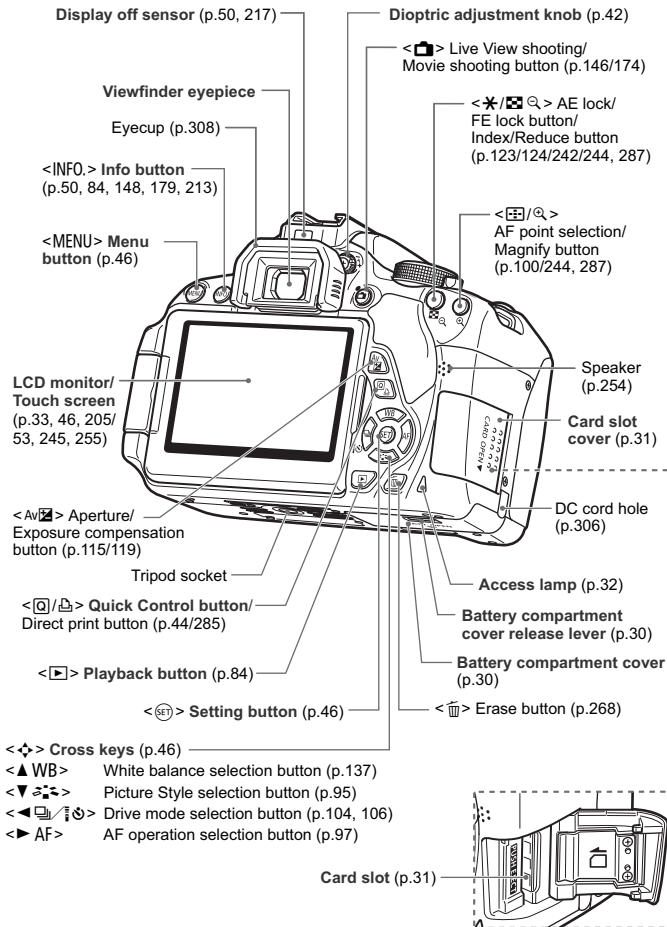

Shooting Settings (in Creative Zone modes, p.24)

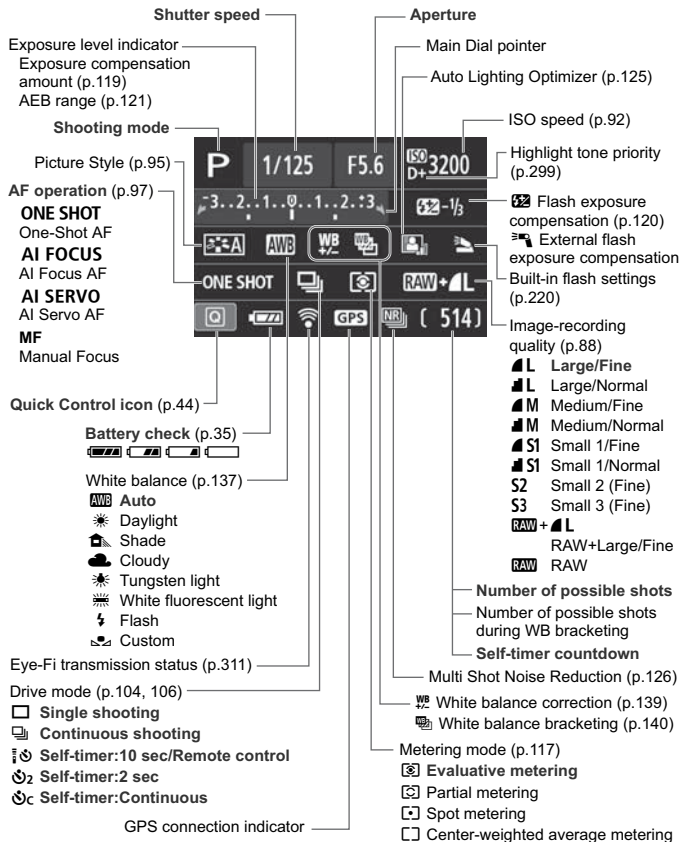

The display will show only the settings currently applied.

Viewfinder Information

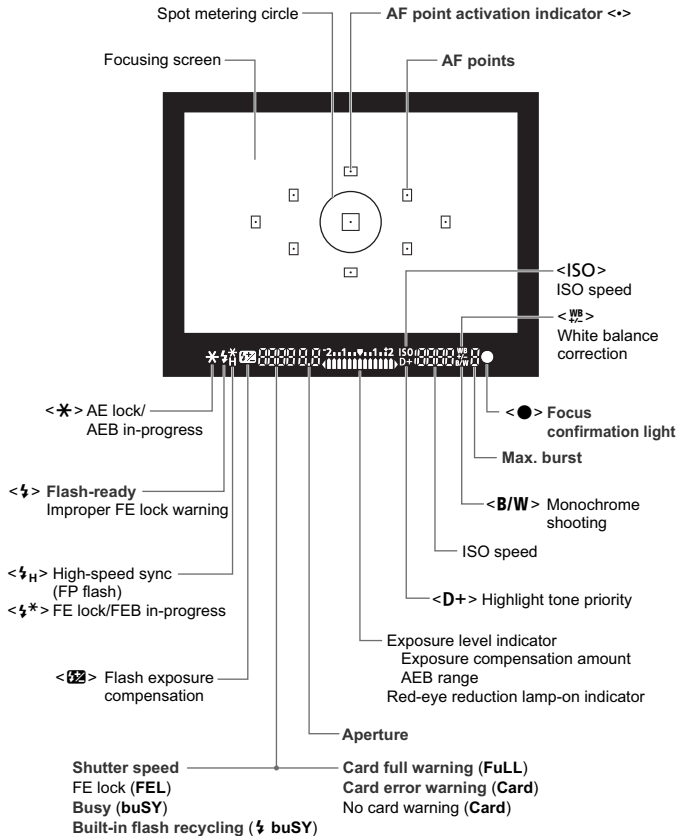

The display will show only the settings currently applied.

Mode Dial

The Mode Dial includes the Basic Zone modes and Creative Zone modes.

Creative Zone

These modes give you more control for shooting various subjects.

- P** : Program AE (p.86)
- Tv** : Shutter-priority AE (p.110)
- Av** : Aperture-priority AE (p.112)
- M** : Manual exposure (p.115)

Basic Zone

All you do is press the shutter button. The camera sets everything to suit the subject or scene.

- A+** : **Scene Intelligent Auto** (p.58)
- [Flash Off]** : **Flash Off** (p.63)
- CA** : **Creative Auto** (p.64)

Image Zone

- [Portrait]** : Portrait (p.67)
- [Landscape]** : Landscape (p.68)
- [Close-up]** : Close-up (p.69)
- [Sports]** : Sports (p.70)
- SCN** : Special Scene Mode (p.71)
 - [Night Portrait]** : Night Portrait (p.72)
 - [Handheld Night Scene]** : Handheld Night Scene (p.73)
 - [HDR Backlight Control]** : HDR Backlight Control (p.74)

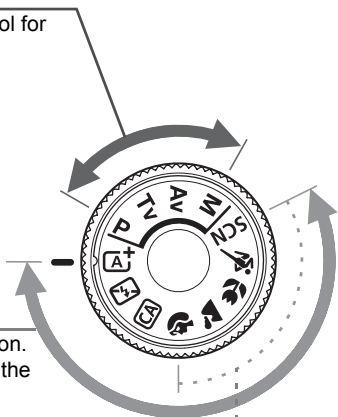

Lens

Lens without a distance scale

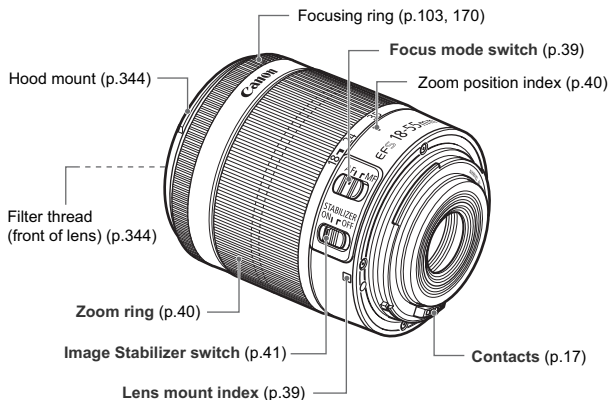

Lens with a distance scale

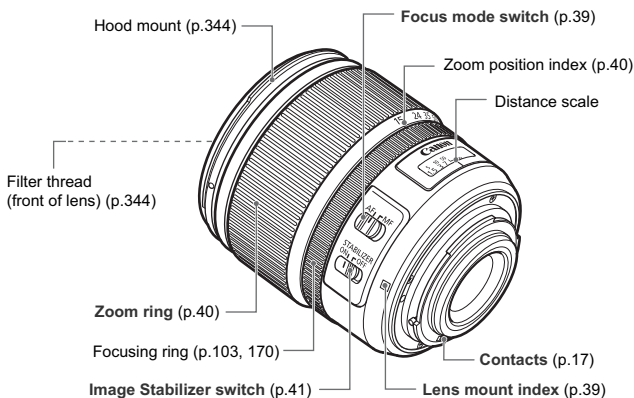

Battery Charger LC-E8

Charger for Battery Pack LP-E8 (p.28).

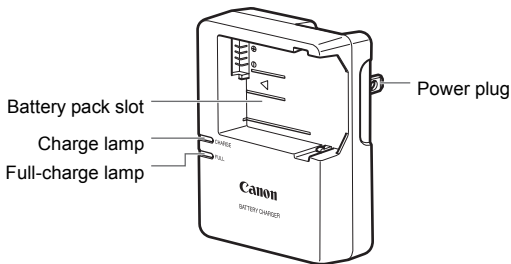

**IMPORTANT SAFETY INSTRUCTIONS-SAVE THESE INSTRUCTIONS.
DANGER-TO REDUCE THE RISK OF FIRE OR ELECTRIC SHOCK,
CAREFULLY FOLLOW THESE INSTRUCTIONS.**

For connection to a supply not in the U.S.A., use an attachment plug adapter of the proper configuration for the power outlet, if needed.

Battery Charger LC-E8E

Charger for Battery Pack LP-E8 (p.28).

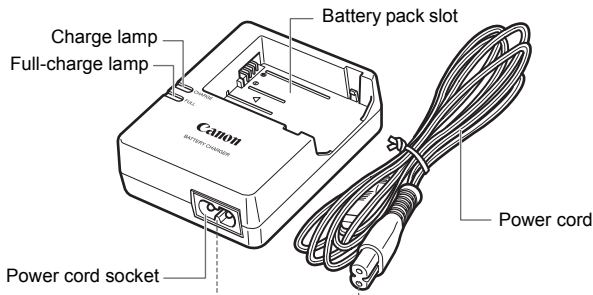

1

Getting Started

This chapter explains preparatory steps before you start shooting and basic camera operations.

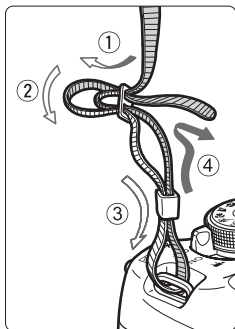

Attaching the Strap

Pass the end of the strap through the camera's strap mount eyelet from the bottom. Then pass it through the strap's buckle as shown in the illustration. Pull the strap to take up any slack and make sure the strap will not loosen from the buckle.

- The eyepiece cover is also attached to the strap (p.308).

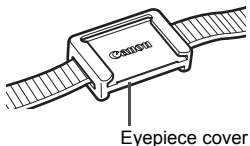

Charging the Battery

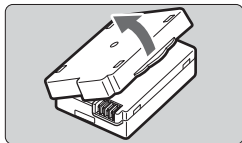

1 Remove the protective cover.

- Detach the protective cover provided with the battery.

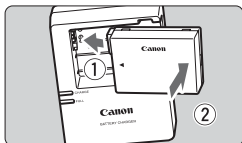

2 Attach the battery.

- As shown in the illustration, attach the battery securely to the charger.
- To detach the battery, follow the above procedure in reverse.

LC-E8

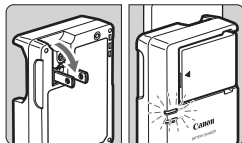

3 Recharge the battery.

For LC-E8

- As shown by the arrow, flip out the battery charger's prongs and insert the prongs into a power outlet.

LC-E8E

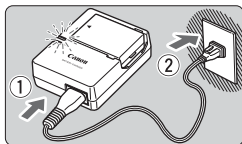

For LC-E8E

- Connect the power cord to the charger and insert the plug into a power outlet.
- ▶ Recharging starts automatically and the charge lamp lights up in orange.
- ▶ When the battery is fully recharged, the full-charge lamp will light up in green.

- **It takes approx. 2 hours to fully recharge a completely exhausted battery at 23°C / 73°F. The time required to recharge the battery will vary greatly depending on the ambient temperature and the battery's remaining capacity.**
- For safety reasons, recharging in low temperatures (6°C - 10°C / 43°F - 50°F) will take longer (up to approx. 4 hours).



Tips for Using the Battery and Charger

- **Upon purchase, the battery is not fully charged.**
Recharge the battery before using.
 - **Recharge the battery on the day before or on the day it is to be used.**
Even during storage, a charged battery will gradually drain and lose its capacity.
 - **After recharging the battery, detach it and disconnect the charger from the power outlet.**
 - **When not using the camera, remove the battery.**
If the battery is left in the camera for a prolonged period, a small amount of power current is released, resulting in excess discharge and shorter battery life. Store the battery with the protective cover (provided) attached. Storing the battery when it is fully charged may lower the battery's performance.
 - **The battery charger can also be used in foreign countries.**
The battery charger is compatible with a 100 V AC to 240 V AC 50/60 Hz power source. If necessary, attach a commercially-available plug adapter for the respective country or region. Do not attach any portable voltage transformer to the battery charger. Doing so can damage the battery charger.
 - **If the battery becomes exhausted quickly even after being fully charged, the battery has reached the end of its service life.**
Purchase a new battery.
-
- After disconnecting the charger's power plug, do not touch the prongs for at least 3 sec.
 - Do not charge any battery other than a Battery Pack LP-E8.
 - Battery Pack LP-E8 is dedicated to Canon products only. Using it with an incompatible battery charger or product may result in malfunction or accidents for which Canon cannot be held liable.

Installing and Removing the Battery

Load a fully charged Battery Pack LP-E8 into the camera.

Installing the Battery

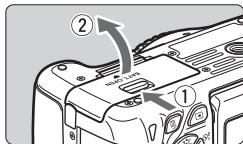

1 Open the cover.

- Slide the lever as shown by the arrows and open the cover.

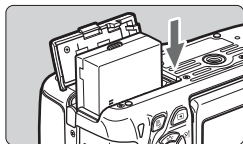

2 Insert the battery.

- Insert the end with the battery contacts.
- Insert the battery until it locks in place.

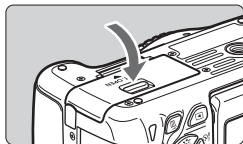

3 Close the cover.

- Press the cover until it snaps shut.

Removing the Battery

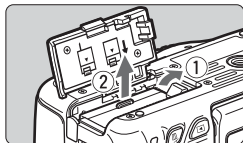

Open the cover and remove the battery.

- Press the battery release lever as shown by the arrow and remove the battery.
- To prevent short circuiting of the battery contacts, be sure to attach the protective cover (provided, p.28) to the battery.

 After opening the battery compartment cover, be careful not to swing it back further. Otherwise, the hinge may break.

Installing and Removing the Card

The card (sold separately) can be an SD, SDHC, or SDXC memory card. SDHC and SDXC memory cards with UHS-I can also be used. The captured images are recorded onto the card.

- **Make sure the card's write-protect switch is set upward to enable writing/erasing.**

Installing the Card

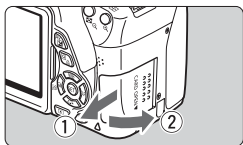

1 Open the cover.

- Slide the cover as shown by the arrows to open it.

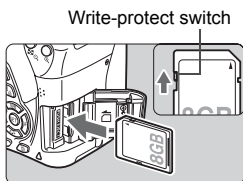

2 Insert the card.

- As shown by the illustration, face the card's label side toward you and insert it until it clicks in place.

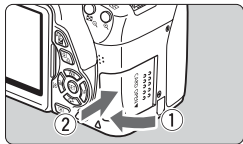

3 Close the cover.

- Close the cover and slide it in the direction shown by the arrows until it snaps shut.
- When you set the power switch to <ON>, the number of possible shots (p.35) will be displayed on the LCD monitor.



Possible shots



- The number of possible shots depends on the remaining capacity of the card, image-recording quality, ISO speed, etc.
- Setting [CAMERA 1: Release shutter without card] to [Disable] will prevent you from forgetting to insert a card (p.204).

Removing the Card

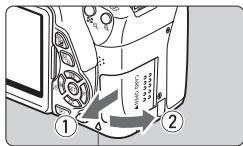

Access lamp

1 Open the cover.

- Set the power switch to <OFF>.
- **Make sure the access lamp is off, then open the cover.**
- If [Recording...] is displayed, close the cover.

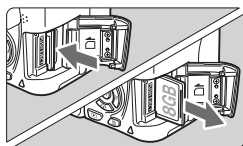

2 Remove the card.

- Gently push in the card, then let go to eject it.
- Pull the card straight out, then close the cover.

- **When the access lamp is lit or blinking, it indicates that images are being written to or read by the card, being erased, or data is being transferred. Do not open the card slot cover during this time. Also, never do any of the following while the access lamp is lit or blinking. Otherwise, it can damage the image data, card, or camera.**
 - Removing the card.
 - Removing the battery.
 - Shaking or banging the camera around.
- If the card already contains recorded images, the image number may not start from 0001 (p.208).
- If a card-related error message is displayed on the LCD monitor, remove and reinsert the card. If the error persists, use a different card. If you can transfer all the images on the card to a computer, transfer all the images and then format the card with the camera (p.48). The card may then return to normal.
- Do not touch the card's contacts with your fingers or metal objects.

Using the LCD Monitor

After you flip out the LCD monitor, you can set menu functions, use Live View shooting, shoot movies, and play back images and movies. You can change the direction and angle of the LCD monitor.

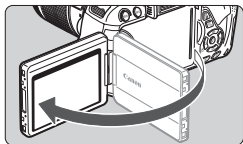

1 Flip out the LCD monitor.

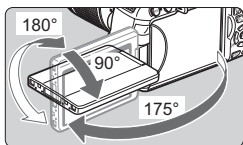

2 Rotate the LCD monitor.

- When the LCD monitor is swung out, you can rotate it up or down, or face it forward toward the subject.
- The indicated angle is only approximate.



3 Face it toward you.

- Normally, face the LCD monitor toward you.



Be careful not to force and break the hinge when rotating the LCD monitor.



- When not using the camera, close the LCD monitor with the screen facing inward. This will protect the screen.
- During Live View shooting or movie shooting, facing the LCD monitor toward the subject will display a mirror image on the screen.
- Depending on the angle of the LCD monitor, the display may turn off right before the LCD monitor is closed.

Turning on the Power

If you turn on the power switch and the time zone and date/time setting screens appear, see page 36 to set the time zone and date/time.

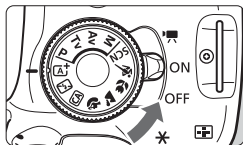

- < > : The camera turns on. You can shoot movies (p.173).
- < ON > : The camera turns on. You can shoot still photos.
- < OFF > : The camera is turned off and does not operate. Set to this position when not using the camera.

About the Automatic Self-Cleaning Sensor

- Whenever you set the power switch to < ON > or < OFF >, sensor cleaning will be executed automatically. (A small sound may be heard.) During the sensor cleaning, the LCD monitor will display < >.
- You can still shoot during sensor cleaning. Press the shutter button halfway (p.43) to stop the sensor cleaning and take a picture.
- If you repeatedly turn the power switch < ON >/< OFF > at a short interval, the < > icon may not be displayed. This is normal and not a problem.

MENU About Auto Power Off

- To save battery power, the camera turns off automatically after approx. 30 seconds of non-operation. To turn on the camera again, just press the shutter button halfway (p.43).
- You can set the auto power off time with [**F2: Auto power off**] (p.205).

If you set the power switch to < OFF > while an image is being recorded to the card, [**Recording...**] will be displayed and the power will turn off after the card finishes recording the image.

Checking the Battery Level

When the power is turned on, the battery level will be indicated in one of four levels.



 : Battery level is sufficient.

 : Battery level is low, but the camera can still be used.

 : Battery will be exhausted soon. (Blinks)

 : Recharge the battery.

Battery Life

[Approx. number of shots]

Temperature	At 23°C / 73°F	At 0°C / 32°F
No Flash	550	470
50% Flash Use	440	400

- The figures above are based on a fully-charged Battery Pack LP-E8, no Live View shooting, and CIPA (Camera & Imaging Products Association) testing standards.
- Possible shots with Battery Grip BG-E8
 - With two LP-E8 batteries: approx. twice as many shots as with the camera alone.
 - With size-AA/LR6 alkaline batteries (at 23°C / 73°F): approx. 470 shots with no flash, approx. 270 shots with 50% flash use.



- The number of possible shots will decrease with any of the following operations:
 - Pressing the shutter button halfway for a prolonged period.
 - Activating the AF frequently without taking a picture.
 - Using the lens Image Stabilizer.
 - Using the LCD monitor often.
- The number of possible shots may decrease depending on the actual shooting conditions.
- The lens operation is powered by the camera's battery. Depending on the lens used, the number of possible shots may be lower.
- For the number of possible shots with Live View shooting, see page 147.

MENU Setting the Time Zone, Date and Time

When you turn on the power for the first time or if the time zone and date/time have been reset, the Time zone and Date/Time setting screens will appear. Follow the steps below to set the time zone first. You can also set the time zone of your current address. Then if you travel to another time zone, you can simply set your destination's time zone so that the correct date/time is recorded.

Note that the date/time appended to recorded images will be based on this date/time setting. Be sure to set the correct date/time.

Set the Time Zone

[London] is set by default.

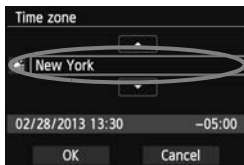

- Press the <MENU> button.
- Under the [F2] tab, select [Time zone], then press <SET>.
- Press the <◀▶> key to select a time zone.
- Press <SET> so <☑> is displayed.
- Press the <▲▼> key to select the time zone, then press <SET>.

- The menu setting procedure is explained on pages 46-47.
- The time displayed on the lower right is the time difference compared with Coordinated Universal Time (UTC). If you do not see your time zone, set the time zone while referring to the difference with UTC.

Set the Date and Time

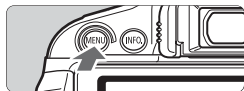

1 Display the menu screen.

- Press the <MENU> button.



2 Under the [F2] tab, select [Date/Time].

- Press the <◀▶> key to select the [F2] tab.
- Press the <▲▼> key to select [Date/Time], then press <SET>.

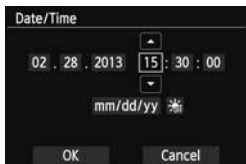

3 Set the date and time.

- Press the <◀▶> key to select the date or time number.
- Press <SET> so <☐> is displayed.
- Press the <▲▼> key to set the number, then press <SET>. (Returns to <☐>.)

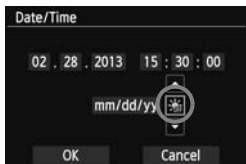

4 Set the daylight saving time.

- Set it if necessary.
- Press the <◀▶> key to select [☀/☒].
- Press <SET> so <☐> is displayed.
- Press the <▲▼> key to select [☀], then press <SET>.
- When the daylight saving time is set to [☀], the time set in step 3 will advance by 1 hour. If [☒] is set, the daylight saving time will be canceled and the time will go back by 1 hour.

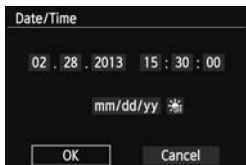

5 Exit the setting.

- Press the <◀▶> key to select [OK], then press <SET>.
- ▶ The date/time and daylight saving time will be set and the menu will reappear.



If you store the camera without the battery or if the camera's battery becomes exhausted, the time zone and date/time may be reset. If this happens, set the time zone and date/time again.



- The date/time that was set will start from when you press <SET> in step 5.
- After changing the time zone, check that the correct date/time has been set.
- You can also set the daylight saving time with [F2: Time zone].
- The [F2: Time zone] and [F2: Date/Time] daylight saving time settings are linked.

MENU Selecting the Interface Language

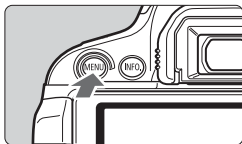

1 Display the menu screen.

- Press the <MENU> button to display the menu screen.

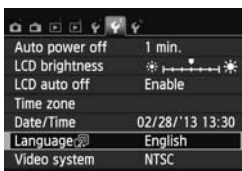

2 Under the [F2] tab, select [Language].

- Press the <◀▶> key to select the [F2] tab.
- Press the <▲▼> key to select [Language] (the sixth item from the top), then press <SET>.



3 Set the desired language.

- Press the <◆> key to select the language, then press <SET>.
- ▶ The interface language will change.



Attaching and Detaching a Lens

The camera is compatible with all Canon EF lenses and EF-S lenses.
The camera cannot be used with EF-M lenses.

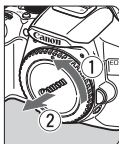
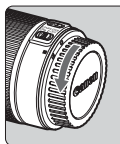

1 Remove the caps.

- Remove the rear lens cap and the body cap by turning them as shown by the arrows.

White index



Red index

2 Attach the lens.

- Align the lens' red or white index with the camera's index matching the same color. Turn the lens as shown by the arrow until it clicks in place.

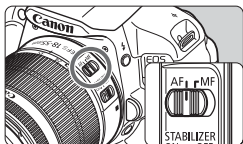

3 Set the lens focus mode switch to <AF>.

- <AF> stands for Autofocus.
- If it is set to <MF> (manual focus), autofocus will not operate.

4 Remove the front lens cap.

Minimizing Dust

- When changing lenses, do it quickly in a place with minimal dust.
- When storing the camera without a lens attached, be sure to attach the body cap to the camera.
- Remove dust on the body cap before attaching it.

About Zooming

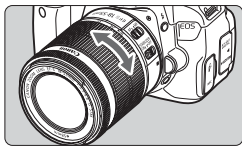

To zoom, turn the zoom ring on the lens with your fingers.

If you want to zoom, do it before focusing. Turning the zoom ring after achieving focus may throw off the focus.

Detaching the Lens

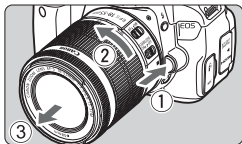

While pressing the lens release button, turn the lens as shown by the arrows.

- Turn the lens until it stops, then detach it.
- Attach the rear lens cap to the detached lens.

- ⚠ Do not look at the sun directly through any lens. Doing so may cause loss of vision.
- When attaching or detaching a lens, set the camera's power switch to <OFF>.
- If the front part (focusing ring) of the lens rotates during autofocus, do not touch the rotating part.
- **If you purchased a lens kit with the EF-S18-55mm f/3.5-5.6 IS STM or EF-S18-135mm f/3.5-5.6 IS STM lens, see "Handling Precautions" on page 347.**



Image Conversion Factor

Since the image sensor size is smaller than the 35mm film format, it will look like the lens focal length is increased by approx. 1.6x.

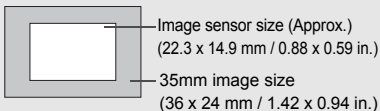

About the Lens Image Stabilizer

When you use the IS lens' built-in Image Stabilizer, camera shake is corrected to obtain a sharper shot. The procedure explained here is based on the EF-S18-55mm f/3.5-5.6 IS STM lens as an example.

* IS stands for Image Stabilizer.

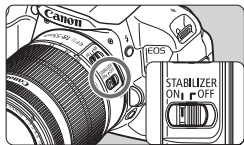

- 1 Set the IS switch to <ON>.**
 - Also set the camera's power switch to <ON>.
- 2 Press the shutter button halfway.**
 - ▶ The Image Stabilizer will operate.
- 3 Take the picture.**
 - When the picture looks steady in the viewfinder, press the shutter button completely to take the picture.

- The Image Stabilizer cannot correct "subject blur", when the subject moves at the time of exposure.
- For bulb exposures, set the IS switch to <OFF>. If <ON> is set, Image Stabilizer misoperation may occur.
- The Image Stabilizer may not be effective for excessive shaking such as on a rocking boat.

- The Image Stabilizer can operate with the lens focus mode switch set to either <AF> or <MF>.
- When using a tripod, you can still shoot with the IS switch set to <ON> with no problem. However, to save battery power, setting the IS switch to <OFF> is recommended.
- The Image Stabilizer is effective even when the camera is mounted on a monopod.
- Some IS lenses enable you to switch the IS mode manually to suit the shooting conditions. However, the following lenses switch the IS mode automatically:
 - EF-S18-55mm f/3.5-5.6 IS STM
 - EF-S18-135mm f/3.5-5.6 IS STM
 - EF-S18-55mm f/3.5-5.6 IS II
 - EF-S18-200mm f/3.5-5.6 IS
 - EF-S15-85mm f/3.5-5.6 IS USM
 - EF-S55-250mm f/4-5.6 IS II

Basic Operation

Adjusting the Viewfinder Clarity

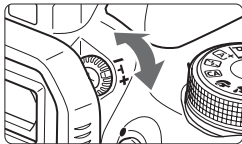

Turn the dioptic adjustment knob.

- Turn the knob left or right until the nine AF points in the viewfinder look sharp.

If the camera's dioptic adjustment still cannot provide a sharp viewfinder image, using E-series Dioptic Adjustment Lenses (10 types, sold separately) is recommended.

Holding the Camera

To obtain sharp images, hold the camera still to minimize camera shake.

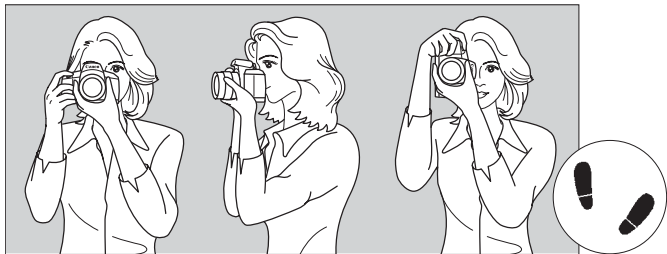

Horizontal shooting

Vertical shooting

1. Wrap your right hand around the camera grip firmly.
2. Hold the lens bottom with your left hand.
3. Rest your hand's right index finger lightly on the shutter button.
4. Press your arms and elbows lightly against the front of your body.
5. To maintain a stable stance, place one foot slightly ahead of the other.
6. Press the camera against your face and look through the viewfinder.

To shoot while looking at the LCD monitor, see page 145.

Shutter Button

The shutter button has two steps. You can press the shutter button halfway. Then you can further press the shutter button completely.

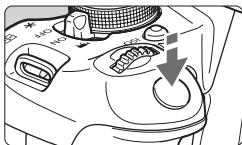

Pressing halfway

This activates autofocus and the automatic exposure system that sets the shutter speed and aperture.

The exposure setting (shutter speed and aperture) is displayed in the viewfinder (ⓘ4).

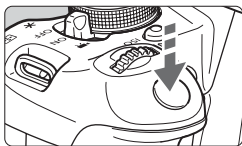

Pressing completely

This releases the shutter and takes the picture.

Preventing Camera Shake

Hand-held camera movement during the moment of exposure is called camera shake. It can cause blurred pictures. To prevent camera shake, note the following:

- Hold and steady the camera as shown on the preceding page.
- Press the shutter button halfway to autofocus, then slowly press the shutter button completely.



- If you press the shutter button completely without pressing it halfway first or if you press the shutter button halfway and then press it completely immediately, the camera will take a moment before it takes the picture.
- Even during menu display, image playback, or image recording, you can instantly go back to shooting-ready by pressing the shutter button halfway.

Q Quick Control for Shooting Functions

You can directly select and set the shooting functions displayed on the LCD monitor. This is called the Quick Control screen.



1 Press the **<Q>** button.

- ▶ The Quick Control screen will appear (10).

2 Set the desired function.

- Press the **<◇>** key to select a function.
- ▶ The selected function and Feature guide (p.52) will appear.
- Turn the **<DIAL>** dial to change the setting.

Basic Zone modes



Creative Zone modes



3 Take the picture.

- Press the shutter button completely to take the picture.
- ▶ The captured image will be displayed.

- For the functions settable in Basic Zone modes and the setting procedure, see page 76.
- In steps 1 and 2, you can also use the LCD monitor's touch screen (p.53).

Sample Quick Control Screen

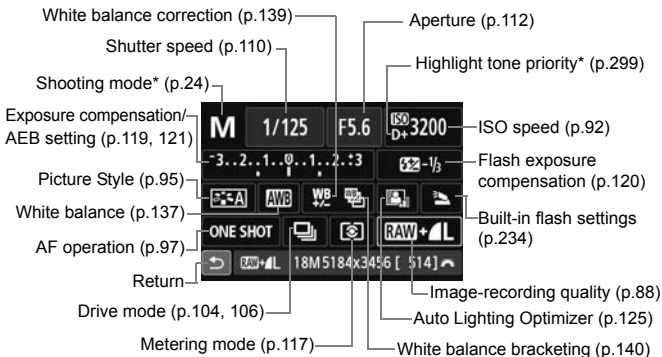

* Asterisked functions cannot be set with the Quick Control screen.

Function Setting Screen

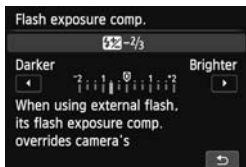

- Select the desired function and press <SET>. The function's setting screen will appear.
- Press the <◀▶> key or turn the <WHEEL> dial to change the setting. There are also functions that are set by pressing the <INFO.> button.
- Press <SET> to finalize the setting and return to the Quick Control screen.

MENU Menu Operations

You can set various settings with the menus such as the image-recording quality, date/time, etc. While looking at the LCD monitor, use the <MENU> button, <⬆> cross keys, and <SET> button on the back of the camera to operate the menus.

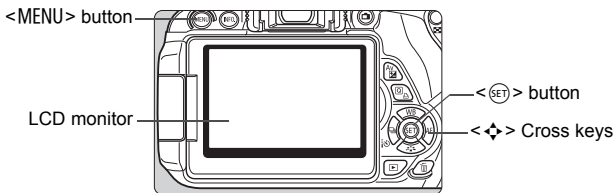

Menu Screen

The menu tabs and items displayed will differ depending on the shooting mode.

Basic Zone modes



Movie shooting



Creative Zone modes

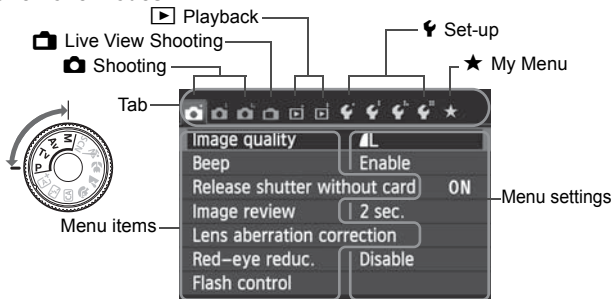

Menu Setting Procedure

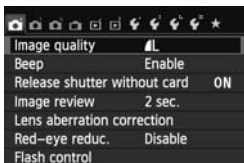

1 Display the menu screen.

- Press the <MENU> button to display the menu screen.

2 Select a tab.

- Press the <◀▶> key to select a menu tab.
- For example, the [📷3] tab refers to the screen displayed when the 📷 (Shooting) tab's third dot [📷•] from the left is selected.

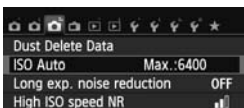

3 Select the desired item.

- Press the <▲▼> key to select the item, then press <ⓈET>.

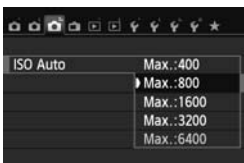

4 Select the setting.

- Press the <▲▼> or <◀▶> key to select the desired setting. (Some settings require you to press either the <▲▼> or <◀▶> key to select it.)
- The current setting is indicated in blue.

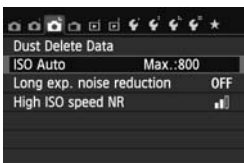

5 Set the desired setting.

- Press <ⓈET> to set it.

6 Exit the setting.

- Press the <MENU> button to return to the shooting settings display.



- In step 2, you can also turn the <📷> dial to select a menu tab.
- In steps 2 to 5, you can also use the LCD monitor's touch screen (p.53).
- The explanation of menu functions hereinafter assumes that you have pressed the <MENU> button to display the menu screen.
- To cancel, press the <MENU> button.
- For details about each menu item, see page 318.

MENU Formatting the Card

If the card is new or was previously formatted by another camera or computer, format the card with the camera.

- !** When the card is formatted, all images and data in the card will be erased. Even protected images will be erased, so make sure there is nothing you need to keep. If necessary, transfer the images to a computer, etc., before formatting the card.

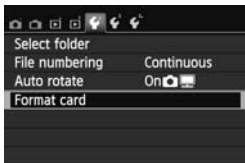

1 Select [Format card].

- Under the [**1**] tab, select [**Format card**], then press <SET>.



2 Format the card.

- Select [**OK**], then press <SET>.
- ▶ The card will be formatted.
- ▶ When the formatting is completed, the menu will reappear.

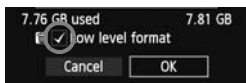

- For low-level formatting, press the <✔> button to append [**Low level format**] with a checkmark <✔>, then select [**OK**].

**Execute [Format card] in the following cases:**

- The card is new.
- The card was formatted by a different camera or a computer.
- The card is full with images or data.
- A card-related error is displayed (p.337).

About Low-level Formatting

- Perform low-level formatting if the card's recording or reading speed seems slow or if you want to totally erase all data in the card.
- Since low-level formatting will format all recordable sectors in the card, the formatting will take slightly longer than normal formatting.
- You can stop the low-level formatting by selecting [**Cancel**]. Even in this case, normal formatting will be completed and you can use the card as usual.



- When the card is formatted or data is erased, only the file management information is changed. The actual data is not completely erased. Be aware of this when selling or discarding the card. When discarding the card, execute low-level formatting or destroy the card physically to prevent the personal data from being leaked.
- **Before using a new Eye-Fi card, the software in the card must be installed in your computer. Then format the card with the camera.**



- The card capacity displayed on the card format screen may be smaller than the capacity indicated on the card.
- This device incorporates exFAT technology licensed from Microsoft.

Switching the LCD Monitor Display

The LCD monitor can display the shooting settings screen, menu screen, captured images, etc.

Shooting Settings



- When you turn on the power, the shooting settings will be displayed.
- When your eye is near the viewfinder eyepiece, the display off sensor (p.21, 217) will turn off the LCD monitor to prevent glare. When your eye leaves the viewfinder eyepiece, the LCD monitor will turn on again.
- By pressing the <INFO.> button, you can switch the LCD monitor screen as follows: Display the shooting settings screen (p.22), turn off the LCD monitor screen, or display the camera settings screen (p.213).

Menu Functions

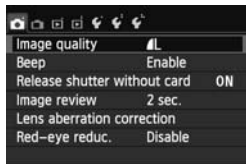

- Appears when you press the <MENU> button. Press the button again to return to the shooting settings screen.

Captured Image



- Appears when you press the <▶> button. Press the button again to return to the shooting settings screen.



- With [**2: LCD auto off**], you can prevent the LCD monitor from turning off automatically (p.217).
- Even when the menu screen or captured image is displayed, pressing the shutter button will enable you to shoot immediately.



- If you wear sunglasses and look through the viewfinder eyepiece, the LCD monitor may not turn off automatically. If this occurs, press the <INFO.> button to turn off the LCD monitor.
- Nearby fluorescent lighting may cause the LCD monitor to turn off. If this occurs, take the camera away from the fluorescent lighting.

Feature Guide

The Feature guide is a simple description of the respective function or option. It is displayed when you change the shooting mode or use the Quick Control screen to set a shooting function, in Live View shooting, movie shooting, or during playback. When you select a function or option on the Quick Control screen, the Feature guide description is displayed. The Feature guide turns off when you tap the description or proceed with the operation.

● Shooting mode (Sample)

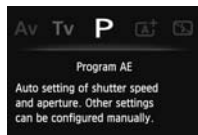

● Quick Control (Sample)



Shooting functions



Live View shooting



Playback

MENU Disabling the Feature Guide

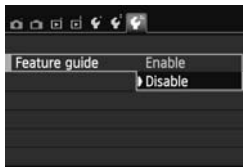

Select [Feature guide].

- Under the [**3**] tab, select [**Feature guide**], then press <SET>. Select [**Disable**], then press <SET>.

Touch Screen Operations

The LCD monitor is a touch-sensitive panel that you can operate with your fingers.

Tap

Quick Control (Sample display)



- Use your finger to tap (touch and let go) the LCD monitor.
- By tapping, you can select menus, icons, etc., displayed on the LCD monitor.
- Icons that you can tap are displayed in a frame (excluding the menu screen).

For example, when you tap [Q], the Quick Control screen appears. By tapping [↶], you can return to the preceding screen.

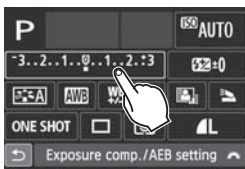

Operations possible by tapping the screen

- Setting menu functions after pressing the <MENU> button
- Quick Control
- Setting functions after pressing the <ISO>, <WB>, <▲ WB>, <▼ WB>, <◀ WB/AF>, or <▶ AF> button
- Setting functions during Live View shooting
- Setting functions during movie shooting
- Playback operations

Drag

Menu screen (Sample display)

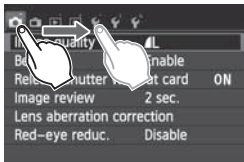

- Slide your finger while touching the LCD monitor.

Scale display (Sample display)

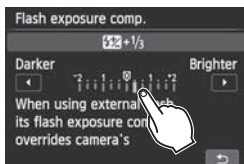

Operations possible by dragging your finger on the screen

- Selecting a menu tab or item after pressing the <MENU> button
- Setting a scale control
- Setting functions during Live View shooting
- Setting functions during movie shooting
- Playback operations (swipe)

MENU Silencing the Beep during Touch Operations

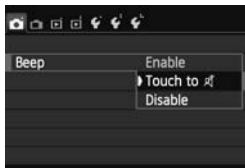

If [**1: Beep**] is set to [**Touch to [silence icon]**], the beep will not sound during touch operations.

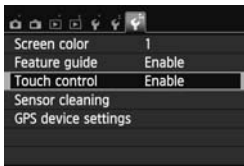
MENU Touch Control Settings**1 Select [Touch control].**

- Under the [**43**] tab, select [**Touch control**], then press <SET>.

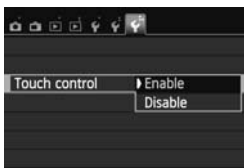
**2 Set the Touch control.**

- Select [**Enable**].
- Setting it to [**Disable**] will disable touch operations.

⚠ Cautions for Touch Screen Operations

- Since the LCD monitor is not pressure sensitive, do not use any sharp objects such as your fingernail, ballpoint pens, etc., for touch operations.
- Do not use wet fingers for touch screen operations.
- If the LCD monitor has any moisture or if your fingers are wet, the touch screen may not respond or misoperation may occur. In such a case, turn off the power and wipe the LCD monitor with a cloth.
- Do not attach any protective sheet (commercially available) or sticker on the LCD monitor. It may make the touch operation response slow.





2

Basic Shooting and Image Playback

This chapter explains how to use the Basic Zone modes on the Mode Dial for best results and how to play back images.

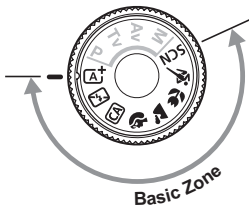
With Basic Zone modes, all you do is point and shoot while the camera sets everything automatically (p.76, 314). Also, to prevent botched pictures due to mistaken operations, the main shooting settings cannot be changed.



 If you set the Mode Dial to <SCN> while the LCD monitor is off, press the <Q> button to check the shooting mode before shooting (p.71).

[A⁺] Fully Automatic Shooting (Scene Intelligent Auto) ■

<[A⁺]> is a fully automatic mode. The camera analyzes the scene and sets the optimum settings automatically. It also adjusts focus automatically by detecting whether the subject is still or moving (p.61).

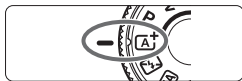

1 Set the Mode Dial to **<[A⁺]>**.

AF point



2 Aim any AF point over the subject.

- All the AF points will be used to focus, and generally the closest object will be focused.
- Aiming the center AF point over the subject will make focusing easier.

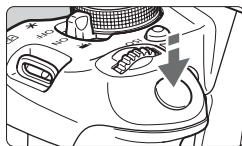

3 Focus the subject.

- Press the shutter button halfway, and the lens focusing ring will rotate to focus.
- ▶ The dot inside the AF point achieving focus flashes briefly in red. At the same time, the beeper will sound and the focus confirmation light **<●>** in the viewfinder will light up.
- ▶ If necessary, the built-in flash will be raised automatically.



Focus confirmation light



4 Take the picture.

- Press the shutter button completely to take the picture.
- ▶ The captured image will be displayed for 2 sec. on the LCD monitor.
- After taking the picture, retract the built-in flash by pushing it down with your fingers.



The **<A⁺>** mode makes the colors look more impressive in nature, outdoor, and sunset scenes. If the desired color tone is not obtained, use a Creative Zone mode and select a Picture Style other than **<A>** and shoot (p.95).



FAQ

- **The focus confirmation light **<●>** blinks and focus is not achieved.**
Aim the AF point over an area having good contrast, then press the shutter button halfway (p.43). If you are too close to the subject, move away and try again.
- **Multiple AF points flash simultaneously.**
This indicates that focus is achieved at all those AF points. When the AF point covering the desired subject flashes, take the picture.
- **The beeper continues to beep softly. (The focus confirmation light **<●>** does not light up.)**
It indicates that the camera is focusing continuously on a moving subject. (The focus confirmation light **<●>** does not light up.) You can take sharp pictures of a moving subject.
Note that focus lock (p.61) will not work in this case.
- **Pressing the shutter button halfway does not focus the subject.**
If the focus mode switch on the lens is set to **<MF>** (manual focus), set it to **<AF>** (autofocus).

- **The flash was raised even though it was daylight.**

For a backlit subject, the flash may pop up to help lighten the subject's dark areas. If you do not want the flash to fire, set it to Flash Off (p.63). Except for the flash setting, the settings will be the same as in <**A⁺**>.

- **The flash fired and the picture came out extremely bright.**

Move farther from the subject and shoot. When shooting flash photography, if the subject is too close to the camera, the picture may come out extremely bright (overexposure).

- **In low light, the built-in flash fired a series of flashes.**

Pressing the shutter button halfway may trigger the built-in flash to fire a series of flashes to assist autofocusing. This is called AF-assist beam. Its effective range is approx. 4 meters/13.1 feet.

- **When flash was used, the bottom part of the picture came out unnaturally dark.**

You were too close to the subject and the lens barrel created a shadow. Move further away from the subject. If a hood is attached to the lens, remove it before taking the flash picture.

[A⁺] Full Auto Techniques (Scene Intelligent Auto) ■

Recomposing the Shot



Depending on the scene, position the subject toward the left or right to create a balanced background and good perspective.

In the <[A⁺]> mode, while you press the shutter button halfway to focus a still subject, the focus will be locked. You can then recompose the shot and press the shutter button completely to take the picture. This is called “focus lock”. Focus lock is also possible in other Basic Zone modes (except <[A]>).

Shooting a Moving Subject



In the <[A⁺]> mode, if the subject moves (distance to camera changes) while or after you focus, AI Servo AF will take effect to focus the subject continuously. (The beeper will continue beeping softly.) As long as you keep aiming the AF point on the subject while pressing the shutter button halfway, the focusing will be continuous. When you want to take the picture, press the shutter button completely.

Live View Shooting

You can shoot while viewing the image on the LCD monitor. This is called "Live View shooting". For details, see page 145.



1 Display the Live View image on the LCD monitor.

- Press the button.
- ▶ The Live View image will appear on the LCD monitor.



2 Focus the subject.

- Press the shutter button halfway to focus.
- ▶ When focus is achieved, the AF point will turn green and the beeper will sound.

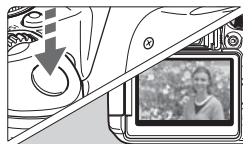

3 Take the picture.

- Press the shutter button completely.
- ▶ The picture will be taken and the captured image is displayed on the LCD monitor.
- ▶ After the image review ends, the camera will return to Live View shooting automatically.
- Press the button to end the Live View shooting.

You can also rotate the LCD monitor in different directions (p.33).



Normal angle



Low angle



High angle

Disabling Flash

The camera analyzes the scene and sets the optimum settings automatically. In places where flash photography is prohibited, use the <  > (Flash Off) mode. This mode is also effective for capturing the particular ambience of a scene, such as candlelight scenes.

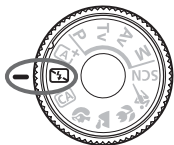

Shooting Tips

- **Prevent camera shake if the numeric display in the viewfinder blinks.**

Under low light when camera shake is prone to occur, the viewfinder's shutter speed display will blink. Hold the camera steady or use a tripod. When using a zoom lens, use the wide-angle end to reduce blur caused by camera shake.

- **Take portraits without flash.**

In low-light conditions, tell the subject to keep still until the picture is taken. If the person moves during the exposure, he or she may look blurred in the picture.

CA Creative Auto Shooting

In the <CA> mode, you can easily change the depth of field, drive mode, and flash firing. You can also choose the ambience you want to convey in your images. The default settings are the same as the <A+> mode.

* CA stands for Creative Auto.



1 Set the Mode Dial to <CA>.

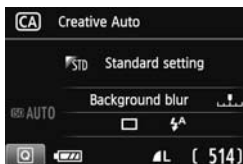

2 Press the <Q> button. (10)

▶ The Quick Control screen will appear.

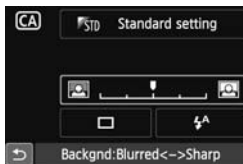

3 Set the desired function.

- Press the <◀▶> key to select the function to be set.
- ▶ The selected function and Feature guide (p.52) will appear.
- For setting procedure and details on each function, see pages 65-66.

4 Take the picture.

- Press the shutter button completely to take the picture.

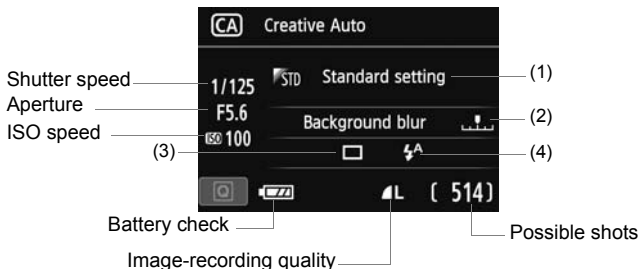

Pressing the **<Q>** button enables you to set the following:

(1) Ambience-based shots



You can choose the ambience you want to convey in your images. Turn the **<☀>** dial to select the desired ambience. You can also select it from a list by pressing **<SET>**. For details, see page 77.

(2) Blurring/sharpening the background



If you move the index mark toward the left, the background will look more blurred. If you move it toward the right, the background will look more in focus. If you want to blur the background, see “Shooting Portraits” on page 67. Press the **<◀▶>** key or turn the **<☀>** dial to select the desired ambience.

Depending on the lens and shooting conditions, the background may not look so blurred. This function cannot be set (grayed out) while the built-in flash is raised in the **<⚡^>** or **<⚡>** mode. If flash is used, this setting will not be applied.

(3) Drive mode: Turn the  dial to set it as desired. You can also select it from a list by pressing .

 **Single shooting:**

Shoot one image at a time.

 **Continuous shooting:**

While you hold down the shutter button completely, shots will be taken continuously. You can shoot up to approx. 5 shots per sec.

 **Self-timer: 10sec./remote:**



The picture is taken 10 seconds after you press the shutter button. A remote controller can also be used.

 **Self-timer: 2sec.:**

The picture is taken 2 seconds after you press the shutter button.

 **Self-timer: Continuous:**

Press the  key to set the number of multiple shots (2 to 10) to be taken with the self-timer. 10 seconds after you press the shutter button, the set number of multiple shots will be taken.

(4) Flash firing: Turn the  dial to set it as desired. You can also select it from a list by pressing .

 **Auto flash** : The flash fires automatically when necessary.



 **Flash on** : The flash fires at all times.

 **Flash off** : The flash is disabled.



If you use an external Speedlite, **[Flash firing]** cannot be set.



- When using the self-timer, see the  notes on page 106.
- When using , see "Disabling Flash" on page 63.

Shooting Portraits

The  (Portrait) mode blurs the background to make the human subject stand out. It also makes skin tones and the hair look softer.



Shooting Tips

- **The further the distance between the subject and background, the better.**

The further the distance between the subject and background, the more blurred the background will look. The subject will also stand out better in front of a plain, dark background.

- **Use a telephoto lens.**
If you have a zoom lens, use the telephoto end to fill the frame with the subject from the waist up. Move in closer if necessary.
- **Focus the face.**
Check that the AF point covering the face flashes in red. For close-ups of the face, focus the eyes.



- The default setting is  (Continuous shooting). If you hold down the shutter button, you can shoot continuously to obtain different poses and facial expressions (max. approx. 5 shots/sec.).
- If necessary, the built-in flash will fire automatically.

Shooting Landscapes

Use the <  > (Landscape) mode for wide scenery or to have everything in focus from near to far. For vivid blues and greens, and very sharp and crisp images.

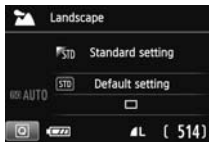

Shooting Tips

- **With a zoom lens, use the wide-angle end.**

When using the wide-angle end of a zoom lens, objects near and far will be in focus better than at the telephoto end. It also adds breadth to landscapes.

- **Shooting night scenes.**

Since the built-in flash will be disabled, this mode <  > is also good for night scenes.

When shooting night scenes, use a tripod to prevent camera shake.





The built-in flash will not fire even in backlit or low-light conditions.

Shooting Close-ups

When you want to photograph flowers or small things up close, use the  (Close-up) mode. To make small things appear much larger, use a macro lens (sold separately).



Shooting Tips

- **Use a simple background.**
A simple background makes the flower, etc., stand out better.
- **Move as close as possible to the subject.**
Check the lens for its minimum focusing distance. Some lenses have indications such as  **0.25m/0.8ft**>. The lens minimum focusing distance is measured from the  (focal plane) mark on the top of the camera to the subject. If you are too close to the subject, the focus confirmation light  will blink.
Under low light, the built-in flash will fire. If you are too close to the subject and the bottom of the picture looks dark, move away from the subject.
- **With a zoom lens, use the telephoto end.**
If you have a zoom lens, using the telephoto end will make the subject look larger.

Shooting Moving Subjects

To photograph a moving subject, whether it is a child running or a moving vehicle, use the < > (Sports) mode.

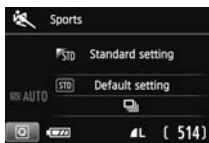

Shooting Tips

- **Use a telephoto lens.**

Using a telephoto lens is recommended so you can shoot from afar.

- **Use the center AF point to focus.**

Aim the center AF point over the subject, then press the shutter button halfway to autofocus. During autofocusing, the beeper will continue beeping softly. If focus cannot be achieved, the focus confirmation light <●> will blink.

The default setting is < > (Continuous shooting). When you want to take the picture, press the shutter button completely. If you hold down the shutter button, continuous shooting (max. approx. 5 shots per sec.) and autofocusing will take effect to capture the movement of the subject.

 Under low light when camera shake is prone to occur, the viewfinder's shutter speed display on the bottom left will blink. Hold the camera steady and shoot.

SCN: Special Scene Mode

Select “Night Portrait”, “Handheld Night Scene”, or “HDR Backlight Control” shooting mode. The camera sets everything to suit the selected shooting mode.



1 Set the Mode Dial to <SCN>.



2 Press the <Q> button. (10)
▶ The Quick Control screen will appear.

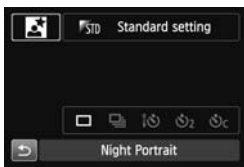

3 Select the shooting mode.

- Press the <▲▼> or <◀▶> key to select the shooting mode icon.
- Turn the <☀> dial to select a shooting mode.
- You can also select the shooting mode icon and press <SET> to display a selection of shooting modes from which you can select one.

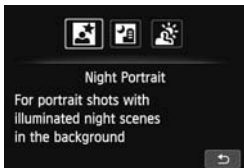

Available Shooting Modes in the <SCN> Mode

	Shooting Mode	Page
	Night Portrait	p.72
	Handheld Night Scene	p.73
	HDR Backlight Control	p.74

Shooting Night Portraits (With a Tripod)

To shoot people at night and obtain a natural-looking night scene in the background, use the  (Night Portrait) mode.

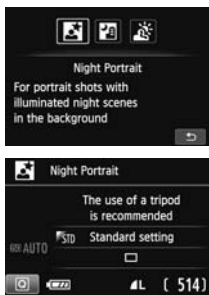

Shooting Tips



- **Use a wide-angle lens and a tripod.**

When using a zoom lens, use the wide-angle end to obtain a wide night view. Also, use a tripod to prevent camera shake.

- **Check the subject's brightness.**

Under low light, the built-in flash will fire automatically to obtain a good exposure of the subject. You should then play back the image to check the image brightness. If the subject looks dark, move nearer and shoot again.

- **Also shoot in another shooting mode.**

Since camera shake is prone to occur with night shots, shooting also with  and  is recommended.



- Tell the subject to keep still even after the flash fires.
- If you use the self-timer together with flash, the self-timer lamp will light up briefly after the picture is taken.
- See the caution on page 75.

Shooting Night Scenes Handheld

Normally, a tripod is necessary to steady your camera when shooting a night scene. However, with the  (Handheld Night Scene) mode, you can shoot night scenes while handholding the camera. Four shots are taken continuously for each picture, and the resulting image with reduced camera shake is recorded.

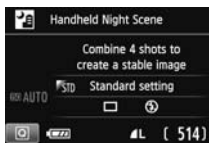
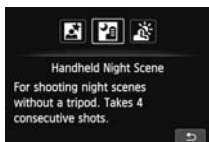



Shooting Tips

- **Hold the camera firmly.**

While shooting, hold the camera firmly and steadily. In this mode, four shots are aligned and merged into a single image. However, if there is significant misalignment in any of the four shots due to camera shake, they may not align properly in the final image.

- **For shots of people, turn on the flash.**

If you want to include people in a night scene shot, press the  button to set  (Flash on).

To take a nice portrait, the first shot will use flash. Tell the person not to move until all four continuous shots are taken.



See the cautions on page 75.

Shooting Backlit Scenes

When shooting a scene having both bright and dark areas, use the <  > (HDR Backlight Control) mode. When you take one picture in this mode, three continuous shots are taken at different exposures. This results in one image, with a wide tonal range, that has minimized the blocked-up shadows caused by backlighting.

* HDR stands for High Dynamic Range.

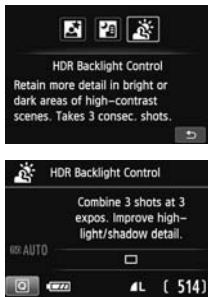

Shooting Tips

● Hold the camera firmly.

While shooting, hold the camera firmly and steadily. In this mode, three shots are aligned and merged into a single image. However, if there is significant misalignment in any of the three shots due to camera shake, they may not align properly in the final image.

- Flash cannot be used. In low light, the AF-assist beam will be emitted (p.101).
- See the cautions on page 75.



Caution for <[Night Portrait icon]> (Night Portrait) and <[Handheld Night Scene icon]> (Handheld Night Scene)

- During Live View shooting, it may be difficult to focus dots of light such as in a night scene. In such a case, you should set the AF method to [Quick mode] and shoot. If it is still difficult to focus, set the lens' focus mode switch to [MF] and focus manually.

Cautions for <[Handheld Night Scene icon]> (Handheld Night Scene)

- When shooting flash photography, if the subject is too close to the camera, the picture may come out extremely bright (overexposure).
- If you use flash to shoot a night scene with few lights, the shots may not align correctly. This can result in a blurry photo.
- If you use flash and the human subject is close to the background which is also illuminated by the flash, the shots may not align correctly. This can result in a blurry photo. Unnatural shadows and unsuitable colors may also appear.
- Shooting with an external Speedlite
 - When using a Speedlite with automatic flash coverage setting, the zoom position will be fixed to the wide end, regardless of the lens' zoom position.
 - When using a Speedlite with manual flash coverage switch, shoot with the flash head retracted to the wide (normal) position.

Cautions for <[HDR Backlight Control icon]> (HDR Backlight Control)

- Note that the image may not be rendered with a smooth gradation and may look irregular or have significant noise.
- HDR Backlight Control may not be effective for excessively backlit scenes or extremely high-contrast scenes.

Cautions for <[Handheld Night Scene icon]> (Handheld Night Scene) and <[HDR Backlight Control icon]> (HDR Backlight Control)

- Compared with other shooting modes, the shooting area will be smaller.
- [RAW] + [L] or [RAW] cannot be selected. Even if [RAW] + [L] or [RAW] has been set for another shooting mode, the picture will be recorded in [L].
- If you shoot a moving subject, the subject's movement may leave afterimages or the surrounding area of the subject may become dark.
- The image alignment may not function properly with repetitive patterns (lattice, stripes, etc.), flat or single-tone images, or greatly misaligned shots caused by camera shake.
- Compared to normal shooting, recording the image to the card will take longer. During the processing of the images, "BUSY" will be displayed and you cannot take another picture until the processing is completed.
- If the shooting mode is set to <[Handheld Night Scene icon]> or <[HDR Backlight Control icon]>, direct printing (p.280) is not possible.

Q Quick Control

Example: Portrait mode

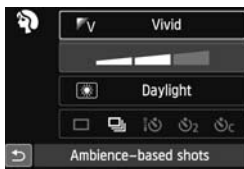

In Basic Zone modes when the shooting settings screen is displayed, you can press the <Q> button to display the Quick Control screen. The table below indicates the functions that can be set with the Quick Control screen in each Basic Zone mode.

1 Set the Mode Dial to a Basic Zone mode.

2 Press the <Q> button. (⊙10)

▶ The Quick Control screen will appear.

3 Set the function.

- Press the <⬆> key to select a function. (This step is not necessary in the <A+> and <L> modes.)
- ▶ The selected function and Feature guide (p.52) will appear.
- Press the <▶> key or turn the <☀> dial to change the setting.

Settable Functions in Basic Zone Modes

●: Default setting ○: User selectable □: Not selectable

Function		A+	L	CA	Portrait	Landscape	Flower	Leaf	SCN			
									SCN1	SCN2	SCN3	
Drive mode	□: Single shooting	●	●	●	○	●	●	○	●	●	●	
	□: Continuous shooting	○	○	○	●	○	○	●	○	○	○	
	Self-timer (p.106)	⊙	○	○	○	○	○	○	○	○	○	○
		⊙2	○	○	○	○	○	○	○	○	○	○
⊙c		○	○	○	○	○	○	○	○	○	○	
Flash firing	⚡: Automatic firing	●	□	●	●	□	●	□	●	□	□	
	⚡: Flash on (Fires at all times)	□	□	○	□	□	□	□	○	□	□	
	⊙: Flash off	□	●	○	□	●	□	●	□	●	●	
Ambience-based shots (p.77)		□	□	○	○	○	○	○	○	○	□	
Light/scene-based shots (p.81)		□	□	□	○	○	○	○	□	□	□	
Blurring/sharpening the background (p.65)		□	□	○	□	□	□	□	□	□	□	

* If you change the shooting mode or set the power switch to <OFF>, it will revert to the default settings (except the self-timer).

Shoot by Ambience Selection

Except in the <A+>, <A>, and <A-> Basic Zone modes, you can select the ambience for shooting.

Ambience	CA	A+	A	A-	A	SCN		Ambience Effect
						A	A	
STD Standard setting	<input type="radio"/>	<input type="radio"/>	<input type="radio"/>	<input type="radio"/>	<input type="radio"/>	<input type="radio"/>	<input type="radio"/>	No setting
V Vivid	<input type="radio"/>	<input type="radio"/>	<input type="radio"/>	<input type="radio"/>	<input type="radio"/>	<input type="radio"/>	<input type="radio"/>	Low / Standard / Strong
S Soft	<input type="radio"/>	<input type="radio"/>	<input type="radio"/>	<input type="radio"/>	<input type="radio"/>	<input type="radio"/>	<input type="radio"/>	Low / Standard / Strong
W Warm	<input type="radio"/>	<input type="radio"/>	<input type="radio"/>	<input type="radio"/>	<input type="radio"/>	<input type="radio"/>	<input type="radio"/>	Low / Standard / Strong
I Intense	<input type="radio"/>	<input type="radio"/>	<input type="radio"/>	<input type="radio"/>	<input type="radio"/>	<input type="radio"/>	<input type="radio"/>	Low / Standard / Strong
C Cool	<input type="radio"/>	<input type="radio"/>	<input type="radio"/>	<input type="radio"/>	<input type="radio"/>	<input type="radio"/>	<input type="radio"/>	Low / Standard / Strong
B Brighter	<input type="radio"/>	<input type="radio"/>	<input type="radio"/>	<input type="radio"/>	<input type="radio"/>	<input type="radio"/>	<input type="radio"/>	Low / Medium / High
D Darker	<input type="radio"/>	<input type="radio"/>	<input type="radio"/>	<input type="radio"/>	<input type="radio"/>	<input type="radio"/>	<input type="radio"/>	Low / Medium / High
M Monochrome	<input type="radio"/>	<input type="radio"/>	<input type="radio"/>	<input type="radio"/>	<input type="radio"/>	<input type="radio"/>	<input type="radio"/>	Blue / B/W / Sepia

1 Set the Mode Dial to any of the following modes: <CA>, <A+>, <A>, <A->, <A>, <A->, or <SCN>.

- If the shooting mode is <SCN>, set one of the following: <A> or <A->.



2 Display the Live View image.

- Press the <A> button to display the Live View image.
- ▶ You can check the ambience effect on the screen.



3 On the Quick Control screen, select the desired ambience.

- Press the <Q> button (10).
- Press the <A> key to select [STD Standard setting]. [Ambience-based shots] will appear on the screen.

- Press the <◀▶> key or turn the <☀> dial to select the desired ambience.
- ▶ The LCD monitor will display how the image will look with the selected ambience.



4 Set the ambience effect.

- Press the <▲▼> key to select the effect bar so that [Effect] appears at the bottom.
- Press the <◀▶> key or turn the <☀> dial to select the desired effect.

5 Take the picture.

- Press the shutter button completely to take the picture.
- To shoot through the viewfinder, first press the <📷> button to exit Live View shooting. Then press the shutter button completely to take the picture.
- If you change the shooting mode or set the power switch to <OFF>, the setting will revert back to [STD Standard setting].

- ⚠ The Live View image shown with the ambience setting applied will not look exactly the same as the actual photo taken.
- Using flash may minimize the ambience effect.
- In bright outdoors, the Live View image you see on the screen may not have exactly the same brightness or ambience as the actual photo. Set [🔧2: LCD brightness] to 4 and look at the image while the screen is unaffected by stray light.

📷 If you do not want the Live View image to be displayed when setting functions, press the <📷> button after step 1. Then you can set [Ambience-based shots] and [Effect] on the Quick Control screen.

Ambience Settings

Standard setting

Standard image characteristics for the respective shooting mode. Note that <👤> has image characteristics geared for portraits and <🏞️> is geared for landscapes. Each ambience is a modification of the respective shooting mode's image characteristics.

Vivid

The subject will look sharp and vivid. It makes the photo look more impressive than with [ **Standard setting**].

Soft

The subject will look softer and more dainty. Good for portraits, pets, flowers, etc.

Warm

The subject will look softer with warmer colors. Good for portraits, pets, and other subjects to which you want to give a warm look.

Intense

While the overall brightness is slightly lowered, the subject is emphasized for a more intense feeling. Makes the human or living subject stand out more.

Cool

The overall brightness is slightly lowered with a cooler color cast. A subject in the shade will look more calm and impressive.

 **B Brighter**

The picture will look brighter.

 **D Darker**

The picture will look darker.

 **M Monochrome**

The picture will be monochrome. You can select the monochrome color to be black and white, sepia, or blue. When **[Monochrome]** is selected, **<B/W>** will appear in the viewfinder.

Shoot by Lighting or Scene Type

In the <📷>, <🏠>, <🌸>, and <🌧️> Basic Zone modes, you can shoot while the settings match the lighting or scene type. Normally, [STD Default setting] is adequate, but if the settings match the lighting condition or scene, the picture will look more accurate to your eye. For Live View shooting, if you set both [Light/scene-based shots] and [Ambience-based shots] (p.77), you should first set [Light/scene-based shots]. This will make it easier to see the resulting effect on the LCD monitor.

Lighting or Scene	📷	🏠	🌸	🌧️
[STD] Default setting	○	○	○	○
☀️ Daylight	○	○	○	○
🏠 Shade	○	○	○	○
☁️ Cloudy	○	○	○	○
💡 Tungsten light	○	■	○	○
💡 Fluorescent light	○	■	○	○
🌅 Sunset	○	○	○	○

- 1 Set the Mode Dial to any of the following modes: <📷>, <🏠>, <🌸> or <🌧️>.



- 2 Display the Live View image.
 - Press the <📷> button to display the Live View image.
 - ▶ You can check the resulting effect on the screen.

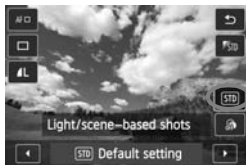

3 On the Quick Control screen, select the lighting or scene type.

- Press the <Q> button (☼10).
- Press the <▲▼> key to select [**STD** Default setting]. [**Light/scene-based shots**] will appear on the screen.
- Press the <◀▶> key or turn the <☼> dial to select the desired lighting or scene type.
 - ▶ The resulting image with the selected lighting or scene type will be displayed.

4 Take the picture.

- Press the shutter button completely to take the picture.
- To shoot through the viewfinder, first press the <📷> button to exit Live View shooting. Then press the shutter button completely to take the picture.
- If you change the shooting mode or set the power switch to <OFF>, the setting will revert back to [**STD** Default setting].

- If you use flash, the setting will switch to [**STD** Default setting]. (However, the shooting information will display the lighting or scene type that was set.)
- If you want to set this together with [**Ambience-based shots**], set the [**Light/scene-based shots**] that best matches the ambience you have set. In the case of [**Sunset**] for example, warm colors will become prominent so the ambience you set may not work well.

- If you do not want the Live View image to be displayed when setting functions, press the <Q> button after step 1. Then you can set [**Light/scene-based shots**] on the Quick Control screen.

Lighting or Scene Type Settings

 **Default setting**

Default setting suited for most subjects.

 **Daylight**

For subjects under sunlight. Gives more natural-looking blue skies and greenery, and reproduces light-colored flowers better.

 **Shade**

For subjects in the shade. Suitable for skin tones, which may look too bluish, and for light-colored flowers.

 **Cloudy**

For subjects under overcast skies. Makes skin tones and landscapes, which may otherwise look dull on a cloudy day, look warmer. Also effective for light-colored flowers.

 **Tungsten light**

For subjects lit under tungsten lighting. Reduces the reddish-orange color cast caused by tungsten lighting.

 **Fluorescent light**

For subjects under fluorescent lighting. Suited for all types of fluorescent lighting.

 **Sunset**

Suitable when you want to capture the sunset's impressive colors.

▶ Image Playback

The easiest way to play back images is explained below. For more details on the playback procedure, see page 241.



1 Play back the image.

- Press the <▶> button.
- ▶ The last captured image or last image viewed will appear.



2 Select an image.

- To view images starting with the last image, press the <◀> key. To view images starting with the first (oldest) image, press the <▶> key.
- Each time you press the <INFO.> button, the display format will change.



No information



With basic information

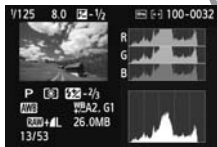

Histogram



Shooting information display

3 Exit the image playback.

- Press the <▶> button to exit the image playback and return to the shooting settings display.

3

Creative Shooting

In Basic Zone modes, to prevent spoiled shots, advanced function settings cannot be changed. However, in the <P> (Program AE) mode, you can set various functions and be more creative.

- In the <P> mode, the camera sets the shutter speed and aperture automatically to obtain a standard exposure.
- The difference between the Basic Zone modes and <P> is explained on page 314.
- The functions explained in this chapter can also be used in the <Tv>, <Av>, and <M> modes explained in Chapter 4.
- The ☆ mark shown on the right of the page title indicates that the function is available only in Creative Zone modes (p.24).

* <P> stands for Program.

* AE stands for Auto Exposure.

P: Program AE

The camera automatically sets the shutter speed and aperture to suit the subject's brightness. This is called Program AE.



1 Set the Mode Dial to <P>.



2 Focus the subject.

- Look through the viewfinder and aim the selected AF point over the subject. Then press the shutter button halfway.
- ▶ The dot inside the AF point achieving focus lights up briefly in red, and the focus confirmation light <●> on the viewfinder's bottom right lights up (in One-Shot AF mode).
- ▶ The shutter speed and aperture will be set automatically and displayed in the viewfinder.



3 Check the display.

- A standard exposure will be obtained as long as the shutter speed and aperture display do not blink.

4 Take the picture.

- Compose the shot and press the shutter button completely.



Shooting Tips

- **Change the ISO speed or use the built-in flash.**

To match the subject and ambient lighting level, you can change the ISO speed (p.92) or use the built-in flash (p.107). In the <P> mode, the built-in flash will not fire automatically. So under low light, press the <⚡> (flash) button to raise the built-in flash.

- **The program can be shifted. (Program shift)**

After pressing the shutter button halfway, turn the <☀> dial to change the shutter speed and aperture setting combination (program). Program shift is canceled automatically after the picture is taken. Program shift is not possible with flash.



- If the "30" shutter speed and the maximum aperture blink, it indicates underexposure. Increase the ISO speed or use flash.
- If the "4000" shutter speed and the minimum aperture blink, it indicates overexposure. Decrease the ISO speed.



Differences Between <P> and <A+> (Scene Intelligent Auto)

In the <A+> mode, many functions such as the AF operation and metering mode are set automatically to prevent spoiled shots. The functions you can change are limited. Whereas in the <P> mode, only the shutter speed and aperture are set automatically. You can freely set the AF operation, metering mode, and other functions (p.314).

MENU Setting the Image-Recording Quality ■

You can select the pixel count and the image quality. Ten image-recording quality settings are provided: **L**, **L**, **M**, **M**, **S1**, **S1**, **S2**, **S3**, **RAW** + **L**, **RAW**.

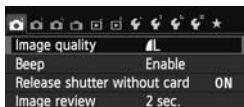

1 Select [Image quality].

- Under the [**1**] tab, select [Image quality], then press <SET>.
- ▶ [Image quality] will appear.

Pixels recorded (pixel count)

Possible shots

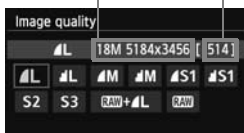

2 Select the image-recording quality.

- The respective quality's pixel count and number of possible shots will be displayed to help you select the desired quality. Then press <SET>.

Guide to Image-recording Quality Settings (Approx.)

Image Quality			Pixels Recorded (megapixels)	File Size (MB)	Possible Shots	Maximum Burst
L	High quality	JPEG	Approx. 17.9 (18M)	6.4	1140	22 (30)
L				3.2	2240	2240 (2240)
M	Medium quality		Approx. 8.0 (8M)	3.4	2150	410 (2150)
M				1.7	4200	4200 (4200)
S1	Low quality		Approx. 4.5 (4.5M)	2.2	3350	3350 (3350)
S1				1.1	6360	6360 (6360)
S2			Approx. 2.5 (2.5M)	1.3	5570	5570 (5570)
S3			Approx. 0.35 (0.35M)	0.3	21560	21560 (21560)
RAW + L	High quality		Approx. 17.9 (18M)	23.5+6.4	230	3 (3)
RAW		23.5		290	6 (6)	

* Figures for the file size, number of possible shots, and maximum burst are based on Canon's 8 GB test card and testing standards (3:2 aspect ratio, ISO 100, and Standard Picture Style). **These figures will vary depending on the subject, card brand, aspect ratio, ISO speed, Picture Style, Custom Functions, and other settings.**

* Figures in parentheses apply to an UHS-I compatible 8 GB card based on Canon's testing standards.

FAQ

- **I want to select the image-recording quality matching the paper size for printing.**

Paper size

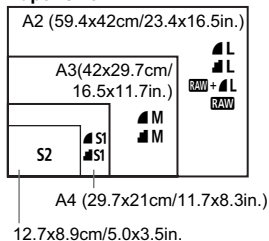

Refer to the diagram on the left when choosing the image-recording quality. If you want to crop the image, selecting a higher quality (more pixels) such as **L**, **L**, **RAW + L**, or **RAW** is recommended. **S2** is suitable for playing the images on a digital photo frame. **S3** is suitable for emailing the image or using it on a Web site.

- **What's the difference between **L** (Fine) and **L** (Normal)?**

It indicates a different image quality due to a different compression rate. Even with the same number of pixels, the **L** image has higher image quality. If **L** is selected, the image quality will be slightly lower, but more images can be saved to the card. Both **S2** and **S3** have **L** quality.

- **I was able to take more shots than the number of possible shots indicated.**

Depending on the shooting conditions, you may be able to take more shots than was indicated. It may also be fewer than indicated. The number of possible shots displayed is only approximate.

- **Does the camera display the maximum burst?**

The maximum burst is displayed in the viewfinder's right side. Since it is only a single-digit indicator **0 - 9**, any number higher than 9 will be displayed only as "9". Note that this number will also be displayed even when no card is installed in the camera. Be careful not to shoot without a card in the camera.

- **When should I use **RAW** ?**

RAW images require processing with your computer. For details, see "About **RAW**" and "About **RAW + L**" on the next page.

About RAW

RAW is the raw image data before it is made into **L** or other images. Although **RAW** images require software such as Digital Photo Professional (provided, p.364) so that they can be displayed on the computer, they also offer flexibility for image adjustments possible only with **RAW**. **RAW** is effective when you want to precisely adjust the image yourself or shoot an important subject.

About RAW + L

RAW + **L** records both a **RAW** and **L** image with a single shot. The two images are saved to the card simultaneously. The two images will be saved in the same folder with the same file numbers (file extension .JPG for JPEG and .CR2 for RAW). **L** images can be viewed or printed even with a computer that does not have the software provided with the camera installed.

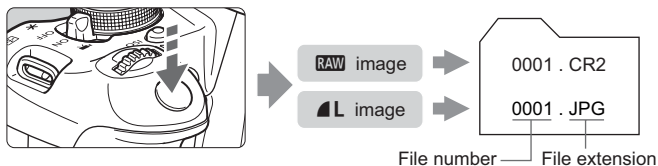

- To display **RAW** images on a computer, using the provided software is recommended (p.364).
- Commercially-available software may not be able to display **RAW** images taken with this camera. To see if the **RAW** images are compatible with other software, check with the respective software manufacturer.

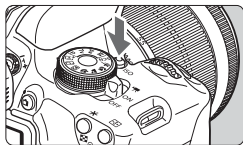

ISO: Changing the ISO Speed [☆]

Set the ISO speed (image sensor's sensitivity to light) to suit the ambient light level. In Basic Zone modes, the ISO speed is set automatically (p.93).



- 1 Press the <ISO> button. ()**
▶ [ISO speed] will appear.



- 2 Set the ISO speed.**
 - Press the <◀▶> key or turn the < > dial to select the desired ISO speed, then press < >.
 - You can also set the ISO speed in the viewfinder while turning the < > dial.
 - With [AUTO] selected, the ISO speed will be set automatically (p.93).

ISO Speed Guide

ISO Speed	Shooting Situation (No flash)	Flash Range
100 - 400	Sunny outdoors	The higher the ISO speed, the farther the flash range will extend (p.107).
400 - 1600	Overcast skies or evening time	
1600 - 12800, H	Dark indoors or night	

* High ISO speeds will result in grainier images.

 Under [**4: Custom Functions (C.Fn)**], if [**2: ISO expansion**] is set to [**1: On**], "H" (equivalent to ISO 25600) can also be set (p.298).

- Under [**4: Custom Functions (C.Fn)**], if [**3: Highlight tone priority**] is set to [**1: Enable**], ISO 100 and "H" (equivalent to ISO 25600) cannot be selected (p.299).
- Shooting in high temperatures may result in images that look grainier. Long exposures can also cause irregular colors in the image.



- When you shoot at high ISO speeds, noise (such as dots of light and banding) may become noticeable.
- If you use a high ISO speed and flash to shoot a close subject, overexposure may result.
- With ISO 12800 or “H” (equivalent to ISO 25600), the maximum burst for continuous shooting will greatly decrease.
- As “H” (equivalent to ISO 25600) is an expanded ISO speed setting, noise (such as dots of light and banding) and irregular colors will be more noticeable, and the resolution will be lower than usual.
- As the maximum ISO speed that can be set differs between still photo shooting and movie shooting (manual exposure), the ISO speed you set may change when you switch from still photo shooting to movie shooting. Even if you switch back to still photo shooting, the ISO speed will not revert to the original setting.

The maximum ISO speed settable varies depending on the setting for [2: ISO expansion] under [4: Custom Functions (C.Fn)].

- When [0: Off] is set: If you set ISO 12800 during still photo shooting and then switch to movie shooting, ISO speed will be changed to ISO 6400.
- When [1: On] is set: If you set ISO 12800 or “H” (equivalent to ISO 25600) during still photo shooting and then switch to movie shooting, the ISO speed will change to “H” (equivalent to ISO 12800).

ISO [AUTO]

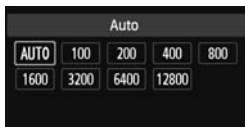

If the ISO speed is set to [AUTO], the actual ISO speed to be set will be displayed when you press the shutter button halfway. As indicated on the next page, the ISO speed will be set automatically to suit the shooting mode.

Shooting Mode	ISO Speed Setting
/ / / / / / /	Automatically set within ISO 100 - ISO 6400
	ISO 100
	Automatically set within ISO 100 - ISO 12800
P / Tv / Av / M *1	Automatically set within ISO 100 - ISO 6400*2
With flash	ISO 400*3*4*5

*1: Fixed at ISO 400 for bulb exposures.

*2: Depends on the maximum ISO speed limit set.

*3: If fill flash results in overexposure, ISO 100 or a higher ISO speed will be set.

*4: Except in the , , and modes.

*5: Automatically set within ISO 400 - ISO 1600 (or up to the maximum limit) in the , , , , and **<P>** modes if you use bounce flash with an external Speedlite.

- When **[AUTO]** is set, the ISO speed is indicated in whole-stop increments. However, the ISO speed is actually set in finer increments. Therefore, in the image's shooting information (p.270), you may find an ISO speed such as 125 or 640 displayed as the ISO speed.
- In the **** mode, the ISO speed shown in the table is actually used even if ISO 100 is not displayed.

MENU Setting the Maximum ISO Speed for **[ISO Auto]** ☆

For ISO Auto, you can set the maximum ISO speed limit within ISO 400 - ISO 6400.



Under the **[3]** tab, select **[ISO Auto]**, then press **<SET>**. Select the ISO speed, then press **<SET>**.

Optimal Image Characteristics for the Subject [☆]

By selecting a Picture Style, you can obtain image characteristics matching your photographic expression or the subject.

In Basic Zone modes, you cannot select the Picture Style.

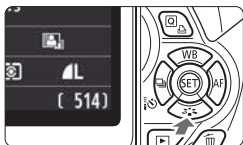

1 Press the <▼ > button.

▶ [Picture Style] will appear.



2 Select a Picture Style.

- Press the <◀▶> key or turn the < > dial to select the desired Picture Style, then press <SET>.

Picture Style Characteristics

Auto

The color tone will be adjusted to suit the scene. The colors will look vivid, especially for blue skies, greenery, and sunsets in nature, outdoor, and sunset scenes.



If the desired color tone is not obtained with [Auto], use another Picture Style.

Standard

The image looks vivid, sharp, and crisp. This is a general-purpose Picture Style suitable for most scenes.



Portrait

For nice skin tones. The image looks softer. Suited for close-up portraits.

By changing the [Color tone] (p.133), you can adjust the skin tone.

Landscape

For vivid blues and greens, and very sharp and crisp images. Effective for impressive landscapes.

Neutral

This Picture Style is for users who prefer to process images with their computer. For natural colors and subdued images.

Faithful

This Picture Style is for users who prefer to process images with their computer. When the subject is captured under a color temperature of 5200K, the color is adjusted colorimetrically to match the subject's color. Images will appear dull and subdued.

Monochrome

Creates black-and-white images.



Black-and-white images shot in formats other than **RAW** cannot be reverted to color. If you want to later shoot pictures in color, make sure the **[Monochrome]** setting has been canceled. When **[Monochrome]** is selected, **<B/W>** will appear in the viewfinder.

User Def. 1-3

You can register a basic style such as **[Portrait]**, **[Landscape]**, a Picture Style file, etc., and adjust it as desired (p.135). Any User Defined Picture Style that has not been set will have the same default settings as the **[Auto]** Picture Style.

AF: Changing the Autofocus Operation ☆

You can select the AF (autofocus) operation characteristics suiting the shooting conditions or subject. In Basic Zone modes, the optimum AF operation is set automatically for the respective shooting mode.

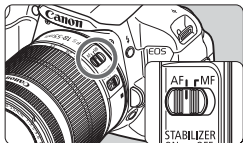

1 On the lens, set the focus mode switch to <AF>.

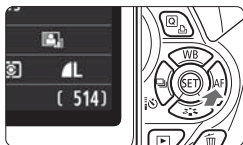

2 Press the <▶ AF> button.
▶ [AF operation] will appear.



3 Select the AF operation.

- Press the <◀▶> key or turn the <DIAL> dial to select the desired AF operation, then press <SET>.

4 Focus the subject.

- Aim the AF point over the subject and press the shutter button halfway. The camera will then autofocus in the selected AF operation.

One-Shot AF for Still Subjects

Suited for still subjects. When you press the shutter button halfway, the camera will focus only once.

- When focus is achieved, the dot inside the AF point achieving focus lights up briefly in red, and the focus confirmation light <●> in the viewfinder will also light up.
- With evaluative metering (p.117), the exposure setting will be set at the same time focus is achieved.
- While you hold down the shutter button halfway, the focus will be locked. You can then recompose the shot if desired.



- If focus cannot be achieved, the focus confirmation light <●> in the viewfinder will blink. If this occurs, the picture cannot be taken even if the shutter button is pressed completely. Recompose the picture and try to focus again. Or see “Subjects Difficult to Focus” (p.103).
- If [1: Beep] is set to [Disable], the beeper will not sound when focus is achieved.

AI Servo AF for Moving Subjects

This AF operation is suited for moving subjects when the focusing distance keeps changing. While you hold down the shutter button halfway, the subject will be focused continuously.

- The exposure is set at the moment the picture is taken.
- When the AF point selection (p.100) is automatic, the camera first uses the center AF point to focus. During autofocusing, if the subject moves away from the center AF point, focus tracking continues as long as the subject is covered by another AF point.



With AI Servo AF, the beeper will not sound even when focus is achieved. Also, the focus confirmation light <●> in the viewfinder will not light up.

AI Focus AF for Automatic Switching of AF Operation

AI Focus AF switches the AF operation from One-Shot AF to AI Servo AF automatically if a still subject starts moving.

- After the subject is focused in One-Shot AF operation, if the subject starts moving, the camera will detect the movement, change the AF operation automatically to AI Servo AF, and keep tracking the moving subject.



When focus is achieved with AI Focus AF with the Servo operation active, the beeper will continue beeping softly. However, the focus confirmation light <●> in the viewfinder will not light up. Note that focus will not be locked in this case.

Selecting the AF Point [☆]

In Basic Zone modes, the camera will normally focus the closest subject automatically. Therefore, it may not always focus your target subject. In the <P>, <Tv>, <Av>, and <M> modes, you can select the AF point and use it to focus the target subject.

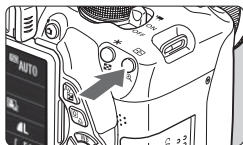

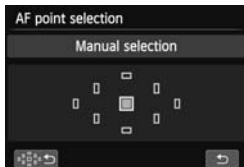

1 Press the button. (ⓘ6)

- ▶ The selected AF point will be displayed on the LCD monitor and in the viewfinder.



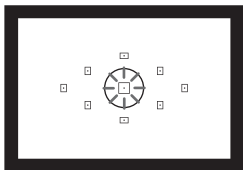

2 Select the AF point.

- Use the  key to select the AF point.
- While looking at the viewfinder, you can select the AF point by turning the  dial until the desired AF point lights up in red.
- When all the AF points light up, automatic AF point selection will be set. The AF point will be selected automatically to focus the subject.
- Pressing  toggles the AF point selection between the center AF point and automatic AF point selection.



3 Focus the subject.

- Aim the selected AF point over the subject and press the shutter button halfway to focus.

 You can also tap the screen to select AF points. During manual AF point selection, tapping the  icon at the bottom left of the screen will switch to automatic AF point selection.







Shooting Tips

- **When shooting a portrait up close, use One-Shot AF and focus the eyes.**
If you focus the eyes first, you can then recompose and the face will remain sharp.
- **If it is difficult to focus, select and use the center AF point.**
The center AF point is the most sensitive among the nine AF points.
- **To make it easier to focus a moving subject, set the camera to automatic AF point selection and AI Servo AF (p.98).**
The center AF point will first be used to focus the subject. During autofocusing, if the subject moves away from the center AF point, focus tracking continues as long as the subject is covered by another AF point.

AF-Assist Beam with the Built-in Flash

Under low-light conditions, when you press the shutter button halfway, the built-in flash fires a brief burst of flashes. It illuminates the subject to enable easier autofocusing.



- The AF-assist beam will not be fired in the following shooting modes: , , and .
- The AF-assist beam cannot be emitted with AI Servo AF operation.
- The effective range of the AF-assist beam emitted by the built-in flash is approx. 4 meters/13.1 feet.
- In Creative Zone modes, when you raise the built-in flash with the  button (p.107), the AF-assist beam will be emitted when necessary. Note that depending on the setting for [4: AF-assist beam firing] under [4: Custom Functions (C.Fn)], AF beam will not be emitted (p.300).

AF Operation and Maximum Lens Apertures

With maximum apertures up to f/5.6:

Cross-type focusing (vertical and horizontal lines detected simultaneously) is possible with all AF points. With certain lenses (see below), the off-center AF points will detect only vertical or horizontal lines (no cross-type focusing).

With maximum apertures up to f/2.8:

High-precision AF* with vertical and horizontal lines detection is possible with the center AF point, in addition to the cross-type focusing (vertical and horizontal lines detected simultaneously).

The remaining eight AF points enable cross-type focusing in the same way as when using lenses with maximum apertures up to f/5.6.

* Except with the EF28-80mm f/2.8-4L USM and EF50mm f/2.5 Compact Macro.

 If you use an Extender (sold separately) and the maximum aperture becomes smaller than f/5.6, AF shooting will not be possible (except in [L+Tracking], [FlexiZone - Multi], and [FlexiZone - Single] during Live View shooting). For details, refer to the Extender's instruction manual.

Lenses not Enabling Cross-Type Focusing with all AF Points

The following lenses enable only horizontal-line sensitive focusing with the three AF points on the left and the three AF points on the right and only vertical-line sensitive focusing with the top and bottom AF points. Cross-type focusing is possible only with the center AF point.

EF35-80mm f/4-5.6

EF35-80mm f/4-5.6 II

EF35-80mm f/4-5.6 III

EF35-80mm f/4-5.6 USM

EF35-105mm f/4.5-5.6

EF35-105mm f/4.5-5.6 USM

EF80-200mm f/4.5-5.6 II

EF80-200mm f/4.5-5.6 USM

Subjects Difficult to Focus

Autofocus can fail to achieve focus (viewfinder's focus confirmation light <●> blinks) with certain subjects such as the following:

- Very low-contrast subjects
(Example: Blue sky, solid-color walls, etc.)
- Subjects in very low light
- Extremely backlit or reflective subjects
(Example: Car with a highly reflective body, etc.)
- Near and far subjects covered by an AF point
(Example: Animal in a cage, etc.)
- Repetitive patterns
(Example: Skyscraper windows, computer keyboards, etc.)

In such cases, do either of the following:

- (1) With One-Shot AF, focus an object at the same distance as the subject and lock the focus before recomposing (p.61).
- (2) Set the lens focus mode switch to <MF> and focus manually.

 For subjects difficult to focus during Live View shooting with [**Tracking**], [**FlexiZone - Multi**], or [**FlexiZone - Single**], see page 165.

MF: Manual Focusing

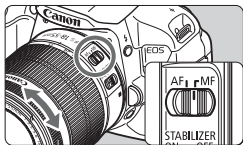

Focusing ring

- 1 Set the lens focus mode switch to <MF>.
- 2 Focus the subject.
 - Focus by turning the lens focusing ring until the subject looks sharp in the viewfinder.

 If you hold down the shutter button halfway during manual focusing, the AF point achieving focus will light up briefly in red, the beeper will sound, and the focus confirmation light <●> in the viewfinder will light up.



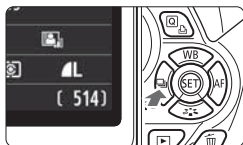

Continuous Shooting

You can shoot up to approx. 5 shots per second. This is effective for shooting a child running toward you or capturing different facial expressions.



1 Press the <<    >> button.

2 Select < >.

- Press the <<   >> key or turn the < > dial to select < > continuous shooting, then press < >.

3 Take the picture.

- The camera shoots continuously while you hold down the shutter button completely.

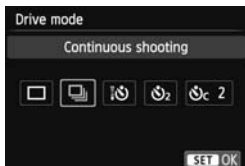

Shooting Tips

- **Also set the AF operation (p.97) matching the subject.**
 - **For a moving subject**

When AI Servo AF is set, focusing will be continuous during continuous shooting.
 - **For still subjects**

When One-Shot AF is set, the camera will focus only once during continuous shooting.
- **Flash can also be used.**

Since the flash will require recycling time, the continuous shooting speed will be slower.



- The maximum continuous shooting speed of approx. 5 shots per second is achieved* with a shutter speed of 1/500 sec. or faster and at the maximum aperture (differs depending on the lens). The continuous shooting speed may decrease due to shutter speed, aperture, subject conditions, brightness, lens, flash use, etc.

* With the following lenses, 5 shots per second is achieved with One-Shot AF and the Image Stabilizer turned off: EF300mm f/4L IS USM, EF28-135mm f/3.5-5.6 IS USM, EF75-300mm f/4-5.6 IS USM, and EF100-400mm f/4.5-5.6L IS USM.

- In AI Servo AF operation, the continuous shooting speed may become slightly slower depending on the subject and the lens used.
- When the battery level is low, the continuous shooting speed will become slightly slower.

Using the Self-timer

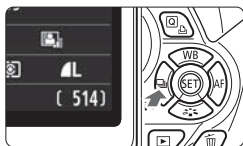

1 Press the **<< [] [] [] >>** button.

2 Select the self-timer.

- Press the **< [] >** key or turn the **< [] >** dial to select the self-timer, then press **< [] >**.

[] [] : **10-sec. self-timer**

The remote controller can also be used (p.307).

[] [] : **2-sec. self-timer** (p.142)

[] [] : **10-sec. self-timer plus continuous shots**

Press the **< [] >** key to set the number of multiple shots (2 to 10) to be taken with the self-timer.

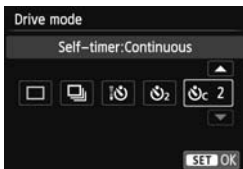

3 Take the picture.

- Look through the viewfinder, focus the subject, then press the shutter button completely.
- ▶ You can check the self-timer operation with the self-timer lamp, beeper, and countdown display (in seconds) on the LCD monitor.
- ▶ Two seconds before the picture is taken, the self-timer lamp will light up and the beeper will sound faster.

- With **< [] [] >**, the interval between the multiple shots may be prolonged depending on the shooting functions settings such as the image-recording quality or flash.
- If you do not look through the viewfinder when you press the shutter button, attach the eyepiece cover (p.308). If stray light enters the viewfinder when the picture is taken, it may throw off the exposure.

- The **< [] [] >** enables you to shoot while not touching the camera mounted on a tripod. This prevents camera shake while you shoot still lifes or long exposures.
- After taking self-timer shots, playing back the image (p.84) to check focus and exposure is recommended.
- When using the self-timer to shoot only yourself, use focus lock (p.61) on an object at about the same distance as where you will stand.
- To cancel the self-timer after it starts, press the **< [] [] [] [] >** button.

⚡ Using the Built-in Flash

In indoors, low light, or backlit conditions in daylight, just raise the built-in flash and press the shutter button to take flash pictures. In the <P> mode, the shutter speed (1/60 sec. - 1/200 sec.) will be set automatically to prevent camera shake.

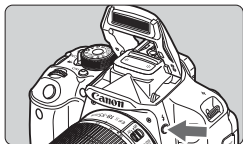

1 Press the <⚡> button.

- In Creative Zone modes, you can press the <⚡> button anytime to take flash pictures.
- While the flash is recycling, “⚡buSY” is displayed in the viewfinder, and [BUSY⚡] is displayed on the LCD monitor.



2 Press the shutter button halfway.

- In the bottom left of the viewfinder, check that the <⚡> icon is lit.

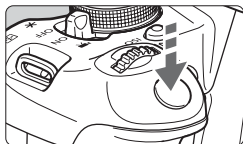

3 Take the picture.

- When focus is achieved and you press the shutter button completely, the flash will fire for the picture.

Effective Flash Range

[Approx. in meters/feet]

ISO Speed (p.92)	EF-S18-55mm f/3.5-5.6 IS STM, EF-S18-55mm f/3.5-5.6 IS II EF-S18-135mm f/3.5-5.6 IS STM, EF-S55-250mm f/4-5.6 IS II		
	Wide Angle		Telephoto
	f/3.5	f/4	f/5.6
100	1 - 3.7 / 3.3 - 12.1	1 - 3.3 / 3.3 - 10.8	1 - 2.3 / 3.3 - 7.5
200	1 - 5.3 / 3.3 - 17.4	1 - 4.6 / 3.3 - 15.1	1 - 3.3 / 3.3 - 10.8
400	1 - 7.4 / 3.3 - 24.3	1 - 6.5 / 3.3 - 21.3	1 - 4.6 / 3.3 - 15.1
800	1 - 10.5 / 3.3 - 34.4	1 - 9.2 / 3.3 - 30.2	1 - 6.6 / 3.3 - 21.7
1600	1 - 14.9 / 3.3 - 48.9	1 - 13 / 3.3 - 42.7	1 - 9.3 / 3.3 - 30.5
3200	1 - 21.0 / 3.3 - 68.9	1 - 18.4 / 3.3 - 60.3	1 - 13.1 / 3.3 - 43.0
6400	1 - 29.7 / 3.3 - 97.4	1 - 26 / 3.3 - 85.3	1 - 18.6 / 3.3 - 61.0
12800	1 - 42.0 / 3.3 - 137.8	1 - 36.8 / 3.3 - 120.6	1 - 26.3 / 3.3 - 86.3
H: 25600	1 - 59.4 / 3.3 - 194.9	1 - 52 / 3.3 - 170.6	1 - 37.1 / 3.3 - 121.7

💡 Shooting Tips

- **If the subject is far away, increase the ISO speed** (p.92).
By increasing the ISO speed, you can extend the flash range.
- **In bright light, decrease the ISO speed.**
If the exposure setting in the viewfinder blinks, decrease the ISO speed.
- **Detach the lens hood and do not get too close to the subject.**
If the lens has a hood attached or you are too close to the subject, the bottom of the picture may look dark due to the obstructed flash. For important shots, check the image on the LCD monitor to make sure the flash exposure looks natural (not dark at the bottom).

MENU Red-eye Reduction

Using the red-eye reduction lamp before taking a flash picture can reduce red eye.

Red-eye reduction will function in any shooting mode except <M>, <A>, <S>, or <P>.

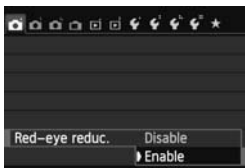

- Under the [CAMERA 1] tab, select [Red-eye reduc.], then press <SET>. Select [Enable], then press <SET>.
- For flash photography, when you press the shutter button halfway, the red-eye reduction lamp will light up. Then when you press the shutter button completely, the picture will be taken.

- The red-eye reduction feature is most effective when the subject looks at the red-eye reduction lamp, when the room is well lit, or when you are close to the subject.
- When you press the shutter button halfway, the scale display on the bottom of the viewfinder will shrink and turn off. For best results, take the picture after this scale display turns off.
- The effectiveness of red-eye reduction varies depending on the subject.



4

Advanced Shooting

This chapter builds on Chapter 3 and introduces more ways to shoot creatively.



- The first half of this chapter explains how to use the <Tv>, <Av>, and <M> modes on the Mode Dial.
- All the functions explained in Chapter 3 can also be used in the <Tv>, <Av>, and <M> modes.
- To see which functions can be used in each shooting mode, see page 314.
- The ☆ mark shown on the right of the page title indicates that the function is available only in Creative Zone modes (p.24).

About the Main Dial Pointer

 1/125

 F5.6

 3..2..1..0..1..2..3

The pointer icon < > displayed together with the shutter speed, aperture setting, or exposure compensation amount indicates that you can turn the < > dial to adjust the respective setting.

Tv: Conveying the Subject's Movement

You can either freeze the action or create motion blur with the <Tv> (Shutter-priority AE) mode on the Mode Dial.

* <Tv> stands for Time value.



Blurred motion
(Slow shutter speed: 1/30 sec.)



Frozen action
(Fast shutter speed: 1/2000 sec.)



1 Set the Mode Dial to <Tv>.

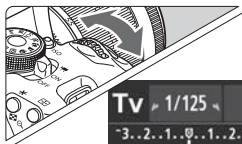

2 Set the desired shutter speed.

- See “Shooting Tips” for advice on setting the shutter speed.
- Turning the <shutter speed> dial to the right sets a faster shutter speed, and turning it to the left sets a slower one.



3 Take the picture.

- When you focus and press the shutter button completely, the picture will be taken at the selected shutter speed.



Shutter Speed Display

The LCD monitor displays the shutter speed as a fraction. However, the viewfinder displays only the denominator. Also, “0”5” indicates 0.5 sec. and “15” is 15 sec.





Shooting Tips

- **To freeze the motion of a fast-moving subject**
Use a fast shutter speed such as 1/4000 sec. to 1/500 sec.
- **To blur a running child or animal and convey an impression of motion**
Use a medium shutter speed such as 1/250 sec. to 1/30 sec. Follow the moving subject through the viewfinder and press the shutter button to take the picture. If you use a telephoto lens, hold it steady to prevent camera shake.
- **To blur a flowing river or fountain**
Use a slow shutter speed of 1/30 sec. or slower. Use a tripod to prevent hand-held camera shake.
- **Set the shutter speed so that the aperture display does not blink.**

If you press the shutter button halfway and change the shutter speed while the aperture is displayed, the aperture display will also change to maintain the same exposure (amount of light reaching the image sensor). If you exceed the adjustable aperture range, the aperture display will blink to indicate that the standard exposure cannot be obtained.



If the exposure will be too dark, the maximum aperture (smallest number) will blink. If this happens, turn the  dial to the left to set a slower shutter speed or increase the ISO speed.

If the exposure will be too bright, the minimum aperture (highest number) will blink. If this happens, turn the  dial to the right to set a faster shutter speed or decrease the ISO speed.

⚡ Using the Built-in Flash

To obtain a correct flash exposure, the flash output will be set automatically (autoflash exposure) to match the automatically-set aperture. The shutter speed can be set from 1/200 sec. to 30 sec.

Av: Changing the Depth of Field

To blur the background or to make everything near and far look sharp, set the Mode Dial to <Av> (Aperture-priority AE) to adjust the depth of field (range of acceptable focus).

* <Av> stands for Aperture value, which is the size of the diaphragm hole inside the lens.



Blurred background
(With a low aperture f/number: f/5.6)



Sharp foreground and background
(With a high aperture f/number: f/32)



1 Set the Mode Dial to <Av>.

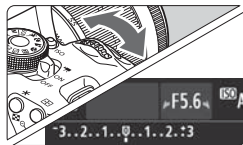

2 Set the desired aperture.

- The higher the f/number, the wider the depth of field where sharper focus is obtained in both the foreground and background.
- Turning the <aperture dial> to the right will set a higher f/number (smaller aperture opening), and turning it to the left will set a lower f/number (larger aperture opening).



3 Take the picture.

- Focus and press the shutter button completely. The picture will be taken with the selected aperture.



Aperture Display

The higher the f/number, the smaller the aperture opening will be. The apertures displayed will differ depending on the lens. If no lens is attached to the camera, "00" will be displayed for the aperture.



Shooting Tips

- **When using an aperture with a high f/number or shooting in low light scenes, note that camera shake can occur.**

A higher aperture f/number will make the shutter speed slower. Under low light, the shutter speed can be as long as 30 sec. In such cases, increase the ISO speed and hold the camera steady or use a tripod.

- **The depth of field depends not only on the aperture, but also on the lens and on the subject distance.**

Since wide-angle lenses have a wide depth of field (range of acceptable focus in front of and behind the point of focus), you need not set a high aperture f/number to obtain a sharp picture from the foreground to the background. On the other hand, a telephoto lens has a narrow depth of field.

The closer the subject, the narrower the depth of field. A farther subject will have a wider depth of field.

- **Set the aperture so that the shutter speed display does not blink.**

If you press the shutter button halfway and change the aperture while the shutter speed is displayed, the shutter speed display will also change to maintain the same exposure (amount of light reaching the image sensor). If you exceed the adjustable shutter speed range, the shutter speed display will blink to indicate that the standard exposure cannot be obtained.

If the picture will be too dark, the “30” (30 sec.) shutter speed display will blink. If this happens, turn the <  > dial to the left to set a lower aperture f/number or increase the ISO speed.

If the picture will be too bright, the “4000” (1/4000 sec.) shutter speed display will blink. If this happens, turn the <  > dial to the right to set a higher aperture f/number or decrease the ISO speed.

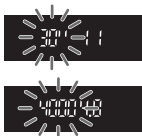

⚡ Using the Built-in Flash

To obtain a correct flash exposure, the flash output will be set automatically to match the set aperture (autoflash exposure). The shutter speed will be set automatically between 1/200 sec. - 30 sec. to suit the scene's brightness.

In low light, the main subject is exposed with the automatic flash, and the background is exposed with a slow shutter speed set automatically. Both the subject and background look properly exposed (automatic slow-speed flash sync). If you are handholding the camera, keep it steady to prevent camera shake. Using a tripod is recommended.

To prevent a slow shutter speed, under [📷 1: Flash control], set [Flash sync. speed in Av mode] to [1/200-1/60 sec. auto] or [1/200 sec. (fixed)] (p.219).

Depth of Field Preview ☆

The aperture opening (diaphragm) changes only at the moment when the picture is taken. Otherwise, the aperture remains fully open. Therefore, when you look at the scene through the viewfinder or on the LCD monitor, the depth of field will look narrow.

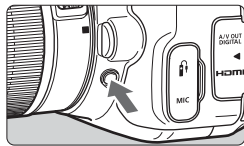

Press the depth-of-field preview button to stop down the lens to the current aperture setting and check the depth of field (range of acceptable focus).

 While looking at the Live View image (p.146) and holding down the depth-of-field preview button, you can change the aperture and see how the depth of field changes.

M: Manual Exposure

You can set both the shutter speed and aperture manually as desired. While referring to the exposure level indicator in the viewfinder, you can set the exposure as desired. This method is called manual exposure.

* <M> stands for Manual.



1 Set the Mode Dial to <M>.

2 Set the ISO speed (p.92).

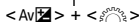

3 Set the shutter speed and aperture.

- To set the shutter speed, turn the <Shutter Speed> dial.
- To set the aperture, hold down the <Av/□> button and turn the <Aperture> dial.

Standard exposure index



Exposure level mark

4 Focus the subject.

- Press the shutter button halfway.
- ▶ The exposure setting will be displayed in the viewfinder.
- The exposure level mark <|> indicates how far the current exposure level is from the standard exposure level.

5 Set the exposure and take the picture.

- Check the exposure level and set the desired shutter speed and aperture.
- If the exposure compensation amount exceeds ± 2 stops from the standard exposure, the end of the exposure level indicator will display <◀> or <▶> in the viewfinder. (On the LCD monitor, if the exposure level exceeds ± 3 stops, <◀> or <▶> will be displayed.)



If ISO Auto is set, the ISO speed setting will change to suit the shutter speed and aperture to obtain a standard exposure. Therefore, you may not obtain the desired exposure effect.

- In [**2: Auto Lighting Optimizer**], if the checkmark <√> for [**Disable during man expo**] is removed, it can be set in the <M> mode (p.125).
- When ISO Auto is set, you can press the <★> button to lock the ISO speed.
- After recomposing the picture, you can see the exposure level difference on the exposure level indicator (p.22, 23) compared to when you pressed the <★> button.

⚡ Using the Built-in Flash

To obtain a correct flash exposure, the flash output will be set automatically (autoflash exposure) to match the manually-set aperture. The shutter speed can be set from 1/200 sec. to 30 sec. or <BULB>.

BULB: Bulb Exposures

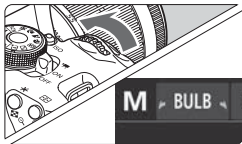

A bulb exposure keeps the shutter open for as long as you hold down the shutter button. It can be used to photograph fireworks and other subjects requiring long exposures. In step 3 on the preceding page, turn the <☀️> dial to the left to set <BULB>. The elapsed exposure time will be displayed on the LCD monitor.

- ⚠️ ● Do not point the camera toward an intense light source, such as the sun on a sunny day or an intense artificial light source. Doing so may damage the image sensor or the camera's internal components.
- Since bulb exposures produce more noise than usual, the image may look a little grainy.
- When [**3: Long exp. noise reduction**] is set to [**Auto**] or [**Enable**], noise generated by the long exposure can be reduced (p.127).
- If ISO Auto is set, the ISO speed will be ISO 400 (p.94).

- For bulb exposures, using a tripod and Remote Switch (sold separately, p.308) is recommended.
- You can also use a remote controller (sold separately, p.307) for bulb exposures. When you press the remote controller's transmit button, the bulb exposure will start immediately or 2 sec. later. Press the button again to stop the bulb exposure.

Changing the Metering Mode ☆

Four methods (metering modes) to measure the subject's brightness are provided. Normally, evaluative metering is recommended.

In Basic Zone modes, evaluative metering is set automatically.

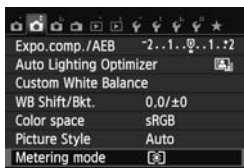

1 Select [Metering mode].

- Under the [2] tab, select [Metering mode], then press <SET>.

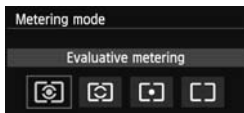

2 Set the metering mode.

- Select the metering mode, then press <SET>.

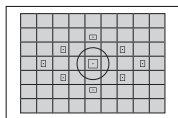

Evaluative metering

This is a general-purpose metering mode suited even for backlit subjects. The camera sets the exposure automatically to suit the scene.

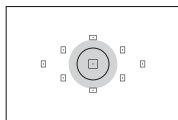

Partial metering

Effective when the background is much brighter than the subject due to backlighting, etc. The gray area in the left figure is where the brightness is metered to obtain the standard exposure.

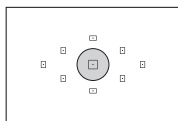

Spot metering



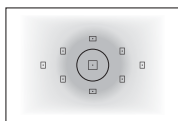

This is for metering a specific part of the subject or scene. The gray area in the left figure is where the brightness is metered to obtain the standard exposure. This metering mode is for advanced users.



☐ Center-weighted average metering

The brightness is metered at the image center and then averaged for the entire scene. This metering mode is for advanced users.

Metering Range During Live View Shooting

- With  (evaluative metering) and  (center-weighted average metering), the metering range is almost the same as with viewfinder shooting.
- With  (partial metering) and  (spot metering), the metering range slightly differs from viewfinder shooting. The approximate metering ranges are as shown below:



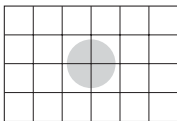

Partial metering

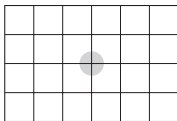

Spot metering



* The figures show when [Grid 2 ] is set. The metering ranges are not displayed on the LCD monitor.

 With  (evaluative metering) during viewfinder shooting, the exposure setting will be locked when you press the shutter button halfway and focus is achieved. With  (partial metering),  (spot metering), and  (center-weighted average metering), exposure setting is set at the moment of exposure. (The exposure setting is not locked when you press the shutter button halfway.) During Live View shooting, the exposure setting is set at the moment of exposure, regardless of the metering mode setting.

Setting Exposure Compensation ☆

Av Setting Exposure Compensation

Set exposure compensation if the exposure (without flash) does not come out as desired. This feature can be used in Creative Zone modes (except <M>). You can set the exposure compensation up to ± 5 stops in 1/3-stop increments.

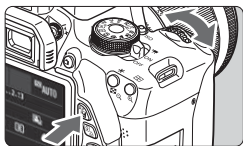

Increased exposure for a brighter image



Decreased exposure for a darker image





Dark exposure





Increased exposure for a brighter image

Making it brighter:

Hold down the <Av > button and turn the <> dial to the right. (Increased exposure)

Making it darker:

Hold down the <Av > button and turn the <> dial to the left. (Decreased exposure)

- ▶ As shown in the figure, the exposure level is displayed on the LCD monitor and in the viewfinder.
- **After taking the picture, cancel the exposure compensation by setting it back to 0.**



- The exposure compensation amount displayed in the viewfinder goes up to only ± 2 stops. If the exposure compensation amount exceeds ± 2 stops, the end of the exposure level indicator will display <◀> or <▶>.
- If you want to set exposure compensation exceeding ± 2 stops, setting it with [ 2: Expo.comp./AEB] (p.121) or with the Quick Control screen (p.44) is recommended.

Flash Exposure Compensation

Set flash exposure compensation if the flash exposure of the subject does not come out as desired. You can set the exposure compensation up to ± 2 stops in 1/3-stop increments.

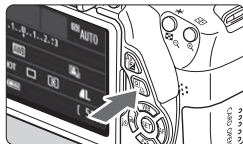

1 Press the $\langle \text{Q} \rangle$ button. (10)

- ▶ The Quick Control screen will appear (p.44).



2 Select $\langle \text{FEC} \rangle$.

- Press the $\langle \blacktriangleleft \blacktriangleright \rangle$ key to select $\langle \text{FEC} \rangle$.
- ▶ **[Flash exposure comp.]** will be displayed at the bottom.



3 Set the exposure compensation amount.

- To make the flash exposure brighter, turn the $\langle \text{dial} \rangle$ dial to the right (increased exposure). To make it darker, turn the $\langle \text{dial} \rangle$ dial to the left (decreased exposure).
- ▶ When you press the shutter button halfway, the $\langle \text{FEC} \rangle$ icon will appear in the viewfinder.
- **After taking the picture, cancel the flash exposure compensation by setting it back to 0.**

 If **[2: Auto Lighting Optimizer]** (p.125) is set to any setting other than **[Disable]**, the image may look bright even if a decreased exposure compensation or decreased flash exposure compensation is set.

 You can also set flash exposure compensation with **[Built-in flash settings]** in **[1: Flash control]** (p.220).

MENU Auto Exposure Bracketing ☆

This feature takes exposure compensation a step further by varying the exposure automatically (up to ± 2 stops in 1/3-stop increments) with three shots as shown below. You can then choose the best exposure. This is called AEB (Auto Exposure Bracketing).



Standard exposure



Darker exposure
(Decreased exposure)



Brighter exposure
(Increased exposure)



1 Select [Expo.comp./AEB].

- Under the [CAMERA] tab, select [Expo.comp./AEB], then press <SET>.



AEB range

2 Set the AEB range.

- Turn the <WHEEL> dial to set the AEB range.
- Press the <LEFT/RIGHT> key to set the exposure compensation amount. If AEB is combined with exposure compensation, AEB will be applied centering on the exposure compensation amount.
- Press <SET> to set it.
- When you press the <MENU> button to exit the menu, the AEB range will be displayed on the LCD monitor.



3 Take the picture.

- Focus and press the shutter button completely. The three bracketed shots will be taken in this sequence: standard exposure, decreased exposure, and increased exposure.

Canceling AEB

- Follow steps 1 and 2 to turn off the AEB level display.
- The AEB setting will also be canceled automatically if the power switch is set to <OFF>, flash recycling is completed, etc.



Shooting Tips

● Using AEB with continuous shooting

If <[]> continuous shooting (p.104) is set and you press the shutter button completely, the three bracketed shots will be taken continuously in this sequence: standard exposure, decreased exposure, and increased exposure.

● Using AEB with <[]> single shooting

Press the shutter button three times to take the three bracketed shots. The three bracketed shots will be exposed in the following sequence: standard exposure, decreased exposure, and increased exposure.

● Using AEB with the self-timer or a remote controller (sold separately)

With the self-timer or a remote control shooting (<[]> or <[]>), you can take three continuous shots after a 10-sec. or 2-sec. delay. With <[]> (p.106) set, the number of continuous shots will be three times the number set.

- AEB cannot be used with flash, Multi Shot Noise Reduction, Creative filters, or bulb exposures.
- If [2: Auto Lighting Optimizer] (p.125) is set to any setting other than [Disable], the AEB's effect may be minimal.

✳ Locking the Exposure ☆

You can lock the exposure when the area of focus is to be different from the exposure metering area or when you want to take multiple shots at the same exposure setting. Press the <✳> button to lock the exposure, then recompose and take the shot. This is called AE lock. It is effective for backlit subjects.

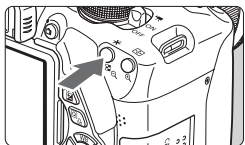

1 Focus the subject.

- Press the shutter button halfway.
- ▶ The exposure setting will be displayed.



2 Press the <✳> button. (☉4)



- ▶ The <✳> icon lights up in the viewfinder to indicate that the exposure setting is locked (AE lock).
- Each time you press the <✳> button, the current autoexposure setting is locked.



3 Recompose and take the picture.

- If you want to maintain the AE lock while taking more shots, hold down the <✳> button and press the shutter button to take another shot.

AE Lock Effects

Metering Mode (p.117)	AF Point Selection Method (p.100)	
	Automatic Selection	Manual Selection
 *	AE lock is applied at the AF point that achieved focus.	AE lock is applied at the selected AF point.
	AE lock is applied at the center AF point.	

* When the lens' focus mode switch is set to <MF>, AE lock is applied at the center AF point.

✳ Locking the Flash Exposure ☆

If the subject is on the side of the frame and you use flash, the subject may turn out to be too bright or dark depending on the background, etc. This is when you should use FE lock. After setting the proper flash exposure for the subject, you can recompose (put the subject toward the side) and shoot. This feature can also be used with a Canon EX-series Speedlite.

* FE stands for Flash Exposure.

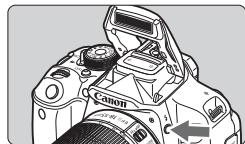

1 Press the <⚡> button.

- ▶ The built-in flash will rise.
- Press the shutter button halfway and look in the viewfinder to check that the <⚡> icon is lit.



2 Focus the subject.

Spot metering circle

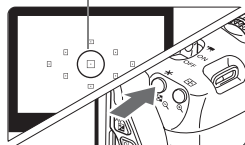

3 Press the <✳> button. (Ⓜ16)

- Aim the spot metering circle over the subject, then press the <✳> button.
- ▶ The flash will fire a preflash and the required flash output is calculated and retained in memory.
- ▶ In the viewfinder, “FEL” is displayed for a moment and <⚡✳> will light up.
- Each time you press the <✳> button, a preflash is fired and the required flash output is calculated and retained in memory.



4 Take the picture.

- Compose the shot and press the shutter button completely.
- ▶ The flash is fired when the picture is taken.

- If the subject is too far away and beyond the effective range of the flash, the <⚡> icon will blink. Get closer to the subject and repeat steps 2 to 4.
- FE lock cannot be used during Live View shooting.

MENU Auto Correction of Brightness and Contrast ☆

If the image comes out dark or the contrast is low, the brightness and contrast can be corrected automatically. This function is called Auto Lighting Optimizer. The default setting is [Standard]. With JPEG images, the correction is done when the image is captured.

In Basic Zone modes, [Standard] is set automatically.

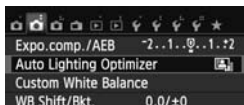

1 Select [Auto Lighting Optimizer].

- Under the [M2] tab, select [Auto Lighting Optimizer], then press <SET>.

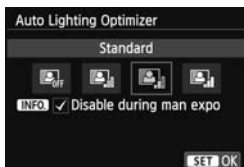

2 Select the setting.

- Select the desired setting, then press <SET>.

3 Take the picture.

- The image will be recorded with the brightness and contrast corrected if necessary.

- Under [F4: Custom Functions (C.Fn)], if [3: Highlight tone priority] is set to [1: Enable], the Auto Lighting Optimizer will be set automatically to [Disable] and the setting cannot be changed.
- If a setting other than [Disable] is set and you use exposure compensation or flash exposure compensation to darken the exposure, the image may still come out bright. If you want a darker exposure, set this function to [Disable].
- Depending on the shooting conditions, noise may increase.

📄 In step 2, if you press the <INFO.> button and uncheck <✓> the [Disable during man expo] setting, the Auto Lighting Optimizer can be set in the <M> mode.

MENU Noise Reduction Settings ☆

High ISO Speed Noise Reduction

This function reduces the noise generated in the image. Although noise reduction is applied at all ISO speeds, it is particularly effective at high ISO speeds. At low ISO speeds, the noise in the darker parts of the image (shadow areas) is further reduced. Change the setting to suit the noise level.

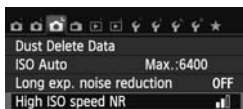

1 Select [High ISO speed NR].

- Under the [CAMERA 3] tab, select [High ISO speed NR], then press <SET>.

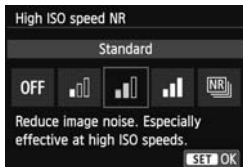

2 Set the setting.

- Select the desired setting, then press <SET>.
- ▶ The setting screen closes and the menu will reappear.

● [NR]: Multi Shot Noise Reduction

Noise reduction with higher image quality than when [High] is applied. For a single photo, four shots are taken continuously and aligned and merged automatically into a single JPEG image.







3 Take the picture.

- The image will be recorded with noise reduction applied.

⚠ With [High] or [Multi Shot Noise Reduction], the maximum burst for continuous shooting will greatly decrease.

📄 If you play back a RAW+L or RAW image with the camera or print an image directly, the effect of the high ISO speed noise reduction may look minimal. Check the noise reduction effect or print noise-reduced images with Digital Photo Professional (provided software, p.364).

About [Multi Shot Noise Reduction]



- The following functions cannot be set: AEB, WB bracketing, [ 3: Long exp. noise reduction],  +  / . If any of these has already been set, [Multi Shot Noise Reduction] cannot be set.
- Flash shooting is not possible. The AF-assist beam will be emitted according to the [ 4: Custom Functions (C.Fn)]'s [ 4: AF-assist beam firing] setting.
- You cannot set [Multi Shot Noise Reduction] for bulb exposures.
- If you turn off the power or change the shooting mode to a Basic Zone mode, movie shooting, or bulb, the setting will change to [Standard].
- If there is significant misalignment in the image due to camera shake, the noise reduction effect may be minimal.
- If you are handholding the camera, keep it steady to prevent camera shake. Using a tripod is recommended.
- If you shoot a moving subject, the subject's movement may leave afterimages or the surrounding area of the subject may become dark.
- The image alignment may not function properly with repetitive patterns (lattice, stripes, etc.) or flat, single-tone images.
- Recording the image to the card will take longer than with normal shooting. During the processing of the images, "BUSY" will be displayed and you cannot take another picture until the processing is completed.
- [ 3: Dust Delete Data] cannot be set.
- If [Multi Shot Noise Reduction] is set, direct printing (p.280) is not possible.

Long Exposure Noise Reduction

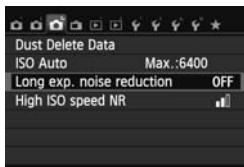
You can reduce noise in long exposures.



1 Select [Long exp. noise reduction].

- Under the [ 3] tab, select [Long exp. noise reduction], then press .

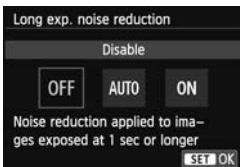

2 Set the setting.

- Select the desired setting, then press <SET>.
- ▶ The setting screen closes and the menu will reappear.

● [Auto]

For 1 sec. or longer exposures, noise reduction is performed automatically if noise typical of long exposures is detected. This [Auto] setting is effective in most cases.

● [Enable]

Noise reduction is performed for all exposures of 1 sec. or longer. The [Enable] setting may be able to reduce noise that otherwise cannot be detected with the [Auto] setting.

3 Take the picture.

- The image will be recorded with noise reduction applied.

- With [Auto] and [Enable], the noise reduction process after the picture is taken may take the same amount of time as the exposure. You cannot take another picture until the noise reduction process is completed.
- Images taken at ISO 1600 or higher may look grainier with the [Enable] setting than with the [Disable] or [Auto] setting.
- With [Auto] and [Enable], if a long exposure is shot with the Live View image displayed, "BUSY" will be displayed during the noise reduction process. The Live View display will not reappear until the noise reduction is completed. (You cannot take another picture.)

MENU Lens Peripheral Illumination / Chromatic Aberration Correction

Peripheral light fall-off is a phenomenon that makes the image corners look darker due to the lens characteristics. Color fringing along subject outlines is another chromatic aberration. Both lens aberrations can be corrected. **RAW** images can be corrected with Digital Photo Professional (provided software, p.364).

Peripheral Illumination Correction

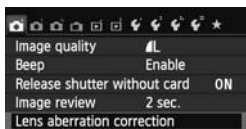

1 Select [Lens aberration correction].

- Under the [**1**] tab, select [**Lens aberration correction**], then press < **SET** >.

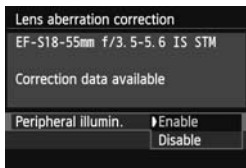

2 Select the setting.

- Check that [**Correction data available**] is displayed for the attached lens.
- Select [**Peripheral illum.**], then press < **SET** >.
- Select [**Enable**], then press < **SET** >.
- If [**Correction data not available**] is displayed, see “About the Lens Correction Data” on page 131.

3 Take the picture.

- The image will be recorded with the peripheral illumination corrected.



Depending on shooting conditions, noise may appear on the image periphery.



- The correction amount applied will be slightly lower than the maximum correction amount settable with Digital Photo Professional (provided software).
- The higher the ISO speed, the lower the correction amount will be.

Chromatic Aberration Correction

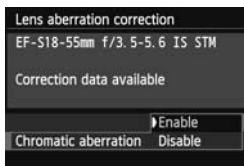

1 Select the setting.

- Check that [**Correction data available**] is displayed for the attached lens.
- Select [**Chromatic aberration**], then press <SET>.
- Select [**Enable**], then press <SET>.
- If [**Correction data not available**] is displayed, see “About the Lens Correction Data” on the next page.

2 Take the picture.

- The image will be recorded with the chromatic aberration corrected.



- With [**Enable**], the maximum burst for continuous shooting will greatly decrease.
- If you play back a **RAW** image shot with the chromatic aberration corrected, the image will be displayed on the camera without the chromatic aberration correction applied. Check the chromatic aberration correction with Digital Photo Professional (provided software, p.364).

About the Lens Correction Data

The camera already contains lens peripheral illumination correction data and chromatic aberration correction data for approx. 25 lenses. If you select **[Enable]**, the peripheral illumination correction and chromatic aberration correction will be applied automatically for any lens whose correction data is registered in the camera.

With EOS Utility (provided software), you can check which lenses have their correction data registered in the camera. You can also register the correction data for unregistered lenses. For details, refer to the EOS Utility Instruction Manual (p.367).

Notes for Peripheral Illumination Correction and Chromatic Aberration Correction

-  ● Peripheral illumination correction and chromatic aberration correction cannot be applied to JPEG images already taken.
 - When using a non-Canon lens, setting the corrections to **[Disable]** is recommended, even if **[Correction data available]** is displayed.
 - If you use the magnified view during Live View shooting, the peripheral illumination correction and chromatic aberration correction will not be reflected in the image shown on the screen.
-
-  ● If the effect of the correction is not visible, magnify the image and check it.
 - Corrections can be applied even when an Extender or Life-size Converter is attached.
 - If the correction data for the attached lens is not registered to the camera, the result will be the same as when the correction is set to **[Disable]**.
 - If the lens does not have distance information, the correction amount will be lower.

Customizing Image Characteristics ☆

You can customize a Picture Style by adjusting individual parameters such as **[Sharpness]** and **[Contrast]**. To see the resulting effects, take test shots. To customize **[Monochrome]**, see page 134.

1 Press the **<V [INFO] >** button.



2 Select a Picture Style.

- Select a Picture Style, then press the **<INFO.>** button.
- ▶ The Detail setting screen will appear.

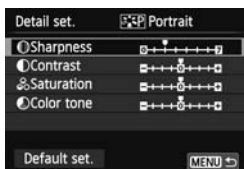

3 Select a parameter.

- Select a parameter such as **[Sharpness]**, then press **<SET>**.



4 Set the parameter.

- Press the **<◀▶>** key to adjust the parameter as desired, then press **<SET>**.
- Press the **<MENU>** button to save the adjusted parameters. The Picture Style selection screen will reappear.
- ▶ Any parameter settings different from the default will be displayed in blue.

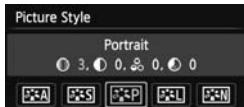

- By selecting **[Default set.]** in step 3, you can revert the respective Picture Style to its default parameter settings.
- To shoot with the Picture Style you modified, follow step 2 on page 95 to select the modified Picture Style and then shoot.

Parameter Settings and Effects

Sharpness

Adjusts the sharpness of the image.

To make it less sharp, set it toward the **0** end. The closer it is to **0**, the softer the image will look.

To make it sharper, set it toward the **7** end. The closer it is to **7**, the sharper the image will look.

Contrast

Adjusts the image contrast and the vividness of colors.

To decrease the contrast, set it toward the minus end. The closer it is to **-**, the more muted the image will look.

To increase the contrast, set it toward the plus end. The closer it is to **+**, the crisper the image will look.

Saturation

The image's color saturation can be adjusted.

To decrease the color saturation, set it toward the minus end. The closer it is to **-**, the more diluted the colors will look.

To increase the color saturation, set it toward the plus end. The closer it is to **+**, the bolder the colors will look.

Color tone

The skin tones can be adjusted.

To make the skin tone redder, set it toward the minus end. The closer it is to **-**, the redder the skin tone will look.

To make the skin tone less red, set it toward the plus end. The closer it is to **+**, the more yellow the skin tone will look.

Monochrome Adjustment

For Monochrome, you can also set **[Filter effect]** and **[Toning effect]** in addition to **[Sharpness]** and **[Contrast]** explained on the preceding page.

Filter Effect

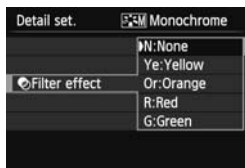

With a filter effect applied to a monochrome image, you can make white clouds or green trees stand out more.

Filter	Sample Effects
N : None	Normal black-and-white image with no filter effects.
Ye: Yellow	The blue sky will look more natural, and the white clouds will look crisper.
Or: Orange	The blue sky will look slightly darker. The sunset will look more brilliant.
R : Red	The blue sky will look quite dark. Fall leaves will look crisper and brighter.
G : Green	Skin tones and lips will appear muted. Tree leaves will look crisper and brighter.

Increasing the **[Contrast]** will make the filter effect more pronounced.

Toning Effect

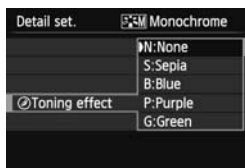

By applying a toning effect, you can create a monochrome image in that color. It can make the image look more impressive.

The following can be selected: **[N:None]**, **[S:Sepia]**, **[B:Blue]**, **[P:Purple]** or **[G:Green]**.

🔍 Registering Preferred Image Characteristics ☆

You can select a base Picture Style such as [Portrait] or [Landscape], adjust its parameters as desired and register it under [User Def. 1], [User Def. 2], or [User Def. 3].

You can create multiple Picture Styles whose parameter settings such as sharpness and contrast are different.

You can also adjust the parameters of a Picture Style that has been registered to the camera with EOS Utility (provided software, p.364).

1 Press the <▼🔍> button.



2 Select [User Def.*].

- Select a [User Def.*] style, then press <INFO.>.
- ▶ The Detail setting screen will appear.



3 Press <SET>.

- With [Picture Style] selected, press <SET>.



4 Select the base Picture Style.

- Press the <🔍> key or turn the <🔍> dial to select the base Picture Style, then press <SET>.
- To adjust the parameters of a Picture Style that has been registered to the camera with EOS Utility (provided software), select the Picture Style here.



5 Select a parameter.

- Select a parameter such as **[Sharpness]**, then press <SET>.



6 Set the parameter.

- Press the <◀▶> key to adjust the parameter as desired, then press <SET>. For details, see “Customizing Image Characteristics” on pages 132-134.
- Press the <MENU> button to register the modified Picture Style. The Picture Style selection screen will then reappear.
- ▶ The base Picture Style will be indicated on the right of **[User Def.*]**.



- If a Picture Style has already been registered under **[User Def.*]**, changing the base Picture Style in step 4 will nullify the parameter settings of the registered Picture Style.
- If you execute **[Clear all camera settings]** (p.214), all the **[User Def.*]** settings will revert to their defaults. Picture Styles registered via EOS Utility (provided software) will have only their modified parameters reverted to their default settings.

- To shoot with a registered Picture Style, follow step 2 on page 95 to select **[User Def.*]**, then shoot.
- For the procedure to register a Picture Style file to the camera, refer to the EOS Utility Instructions (p.367).

WB: Matching the Light Source ☆

The function adjusting the color tone so that white objects look white in the picture is called white balance (WB). Normally, the <AWB> (Auto) setting will obtain the correct white balance. If natural-looking colors cannot be obtained with <AWB>, you can select the white balance that matches the light source or set it manually by shooting a white object.

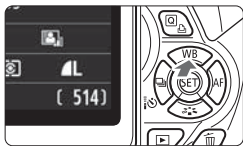

1 Press the <▲ WB> button.

- ▶ [White balance] will appear.

2 Select the white balance.

- Press the <◀▶> key or turn the <☀️> dial to select the desired white balance, then press <SET>.
- The “Approx. ****K” (K: Kelvin) displayed for the white balance settings <☀️>, <🏠>, <☁️>, <🌞> or <🌧️> is the respective color temperature.

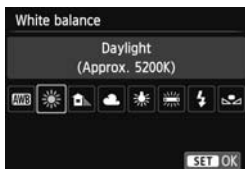

📷 Custom White Balance

Custom white balance enables you to manually set the white balance for a specific light source for better accuracy. Perform this procedure under the actual light source to be used.

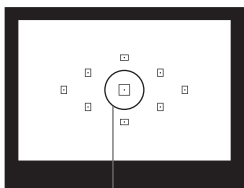

1 Photograph a white object.

- The plain, white object should fill the spot metering circle.
- Focus manually and set the standard exposure for the white object.
- You can set any white balance.

Spot metering circle

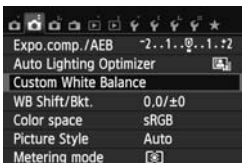

2 Select [Custom White Balance].

- Under the [CAMERA] tab, select [**Custom White Balance**], then press <SET>.
- ▶ The custom white balance selection screen will appear.



3 Import the white balance data.

- Select the image that was captured in step 1, then press <SET>.
- ▶ On the dialog screen that appears, select [**OK**] and the data will be imported.
- When the menu reappears, press the <MENU> button to exit the menu.

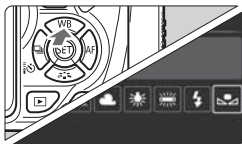

4 Select the custom white balance.

- Press the <▲ WB> button.
- Select <[WB]>, then press <SET>.

- If the exposure obtained in step 1 differs greatly from the standard exposure, a correct white balance may not be obtained.
- An image captured while the Picture Style was set to [**Monochrome**] (p.96) or an image processed with a Creative filter cannot be selected in step 3.

- Instead of a white object, an 18% gray card (commercially available) can produce a more accurate white balance.
- The personal white balance registered with EOS Utility (provided software, p.364) will be registered under <[WB]>. If you perform step 3, the data for the registered personal white balance will be erased.

WB \pm Adjusting the Color Tone for the Light Source ☆

You can correct the white balance that has been set. This adjustment will have the same effect as using a commercially-available color temperature conversion filter or color compensating filter. Each color can be corrected to one of nine levels.

This function is for advanced users who are familiar with using color temperature conversion or color compensating filters.

White Balance Correction

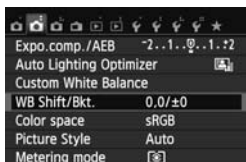

1 Select [WB Shift/Bkt.].

- Under the [**2**] tab, select [**WB Shift/Bkt.**], then press <SET>.
- ▶ The WB correction/WB bracketing screen will appear.

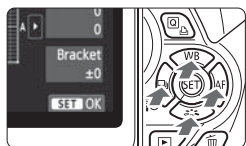

2 Set the white balance correction.

- Press the <◊> key to move the “■” mark to the desired position.
- B is for blue, A for amber, M for magenta, and G for green. The color in the respective direction will be corrected.
- On the upper right, “SHIFT” indicates the direction and correction amount.
- Pressing the <⏏> button will cancel all the [WB Shift/Bkt.] settings.
- Press <SET> to exit the setting and return to the menu.

Sample setting: A2, G1

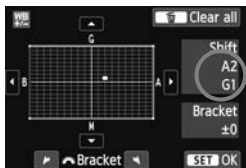

- When the white balance is corrected, <WB> will be displayed in the viewfinder and on the LCD monitor.
- One level of the blue/amber correction is equivalent to approx. 5 mireds of a color temperature conversion filter. (Mired: Measuring unit indicating the density of a color temperature conversion filter.)

White Balance Auto Bracketing

With just one shot, three images having a different color balance can be recorded simultaneously. Based on the color temperature of the current white balance setting, the image will be bracketed with a blue/amber bias or magenta/green bias. This is called white balance bracketing (WB-BKT). White balance bracketing is possible up to ± 3 levels in single-level increments.

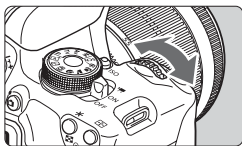

B/A bias ± 3 levels

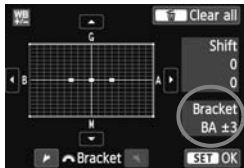

Set the white balance bracketing amount.

- In step 2 for white balance correction, when you turn the dial, the “■” mark on the screen will change to “■ ■ ■” (3 points). Turning the dial to the right sets the B/A bracketing, and turning it to the left sets the M/G bracketing.
- ▶ On the right, “**Bracket**” indicates the bracketing direction and correction amount.
- Pressing the button will cancel all the [WB Shift/Bkt.] settings.
- Press to exit the setting and return to the menu.

Bracketing Sequence

The images will be bracketed in the following sequence: 1. Standard white balance, 2. Blue (B) bias, and 3. Amber (A) bias, or 1. Standard white balance, 2. Magenta (M) bias, and 3. Green (G) bias.

- During WB bracketing, the maximum burst for continuous shooting will be lower and the number of possible shots will also decrease to approx. one-third the normal number.
- You can also set white balance correction and AEB together with white balance bracketing. If you set AEB in combination with white balance bracketing, a total of nine images will be recorded for a single shot.
- Since three images are recorded for one shot, it takes longer to record the shot to the card.
- “**Bkt.**” stands for bracketing.

MENU Setting the Color Reproduction Range ☆

The range of reproducible colors is called the color space. With this camera, the color space for captured images can be set to sRGB or Adobe RGB. For normal shooting, sRGB is recommended. In Basic Zone modes, sRGB is set automatically.

1 Select [Color space].

- Under the [**2**] tab, select [Color space], then press <SET>.

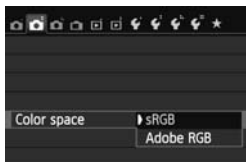

2 Set the desired color space.

- Select [sRGB] or [Adobe RGB], then press <SET>.

About Adobe RGB

This color space is mainly used for commercial printing and other industrial uses. This setting is not recommended if you do not know about image processing, Adobe RGB, and Design rule for Camera File System 2.0 (Exif 2.21 or higher). The image will look very subdued in a sRGB personal computer environment and with printers not compatible with Design rule for Camera File System 2.0 (Exif 2.21 or higher). Post-processing of the image with software will therefore be required.



- If the captured still photo was shot in the Adobe RGB color space, the first character in the file name will be an underscore “_”.
- The ICC profile is not appended. Refer to explanations about the ICC profile in the Digital Photo Professional Instruction Manual (p.367).

Mirror Lockup to Reduce Camera Shake [☆]

The camera's mechanical shake caused by the reflex mirror action can blur images taken with a super telephoto lens or close-up (macro) lens. In such cases, mirror lockup is effective.

Mirror lockup is enabled by setting [5: Mirror lockup] to [1: Enable] in the [4: Custom Functions (C.Fn)] (p.300).

1 Focus the subject, then press the shutter button completely.

- ▶ The mirror will swing up.

2 Press the shutter button completely again.

- ▶ The picture is taken and the mirror goes back down.
- After taking the picture, set [5: Mirror lockup] to [0: Disable].



Shooting Tips

● Using the self-timer <1/2>, <2/2> with mirror lockup

When you press the shutter button completely, the mirror locks up, then the picture is taken 10 sec. or 2 sec. later.

● Remote control shooting

Since you do not touch the camera when the picture is taken, remote control shooting together with mirror lockup can further prevent camera shake (p.307). With Remote Controller RC-6 (sold separately) set to a 2-sec. delay, press the transmit button and the mirror will lockup before the picture is taken 2 sec. later.



- In very bright light such as at the beach or a ski slope on a sunny day, take the picture promptly after mirror lockup.
- Do not point the camera toward an intense light source, such as the sun on a sunny day or an intense artificial light source. Doing so may damage the image sensor or the camera's internal components.
- If you use the self-timer and bulb exposure in combination with a mirror lockup, keep pressing the shutter button completely (self-timer delay time + bulb exposure time). If you let go of the shutter button during the self-timer countdown, there will be a shutter-release sound, but no picture will be taken.



- Even if or is set for drive mode, single shooting will take effect.
- When [ **3: High ISO speed NR**] is set to [**Multi Shot Noise Reduction**], four continuous shots will be taken for the single picture regardless of the [**5: Mirror lockup**] setting.
- If 30 seconds elapse after the mirror has locked up, it will go back down automatically. Pressing the shutter button completely again locks up the mirror again.



5

Shooting with the LCD Monitor (Live View Shooting)

You can shoot while viewing the image on the camera's LCD monitor. This is called "Live View shooting".

If you handhold the camera and shoot while viewing the LCD monitor, camera shake can cause blurred images. Using a tripod is recommended.





About Remote Live View Shooting

With EOS Utility (provided software, p.364) installed in your computer, you can connect the camera to the computer and shoot remotely while viewing the computer screen. For details, refer to the EOS Utility Instruction Manual (p.367).

Shooting with the LCD Monitor



1 Display the Live View image.

- Press the  button.
- ▶ The Live View image will appear on the LCD monitor. In the  mode, the scene icon for the scene detected by the camera is displayed on the upper left (p.149).
- By default, Continuous AF (p.156) will take effect.
- The Live View image will closely reflect the brightness level of the actual image you capture.



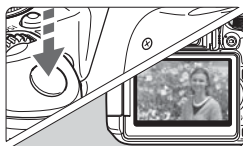

2 Focus the subject.

- When you press the shutter button halfway, the camera will focus with the current AF method (p.159).



3 Take the picture.

- Press the shutter button completely.
- ▶ The picture will be taken and the captured image is displayed on the LCD monitor.
- ▶ After the image review ends, the camera will return to Live View shooting automatically.
- Press the  button to exit Live View shooting.

- The image's field of view is approx. 99% (when the image-recording quality is set to JPEG  L).
- In Creative Zone modes, you can check the depth of field by pressing the depth-of-field preview button.
- During continuous shooting, the exposure set for the first shot will also be applied to subsequent shots.
- You can also tap the subject on the LCD monitor to focus (p.159-167) and shoot (p.168).
- You can also use a remote controller (sold separately, p.307) for Live View shooting.

Enabling Live View Shooting

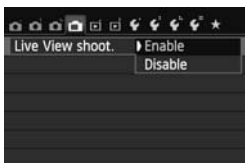

Set [: Live View shoot.] to [Enable].

Battery Life with Live View Shooting [Approx. number of shots]

Temperature	Shooting Conditions	
	No Flash	50% Flash Use
At 23°C / 73°F	200	180
At 0°C / 32°F	170	150

- The figures above are based on a fully-charged Battery Pack LP-E8 and CIPA (Camera & Imaging Products Association) testing standards.
- With a fully-charged Battery Pack LP-E8, continuous Live View shooting is possible as for approx. 1 hr. 30 min. at 23°C / 73°F.



- In the < > and < > shooting modes, the picture area will be smaller than with other shooting modes.
- Do not point the camera toward an intense light source, such as the sun on a sunny day or an intense artificial light source. Doing so may damage the image sensor or the camera's internal components.
- **Cautions for using Live View shooting are on pages 171-172.**



- When flash is used, there will be two shutter sounds, but only one shot will be taken. Also, the time it takes to take the picture after you press the shutter button completely will be slightly longer than with viewfinder shooting.
- If the camera is not operated for a prolonged period, the power will turn off automatically as set with [2: Auto power off] (p.205). If [2: Auto power off] is set to [Disable], Live View shooting will end automatically after approx. 30 min. (camera power remains on).
- With the stereo AV cable AVC-DC400ST (sold separately) or HDMI cable HTC-100 (sold separately), you can display the Live View image on a TV (p.262, 265).

Information Display

- Each time you press the <INFO.> button, the information display will change.

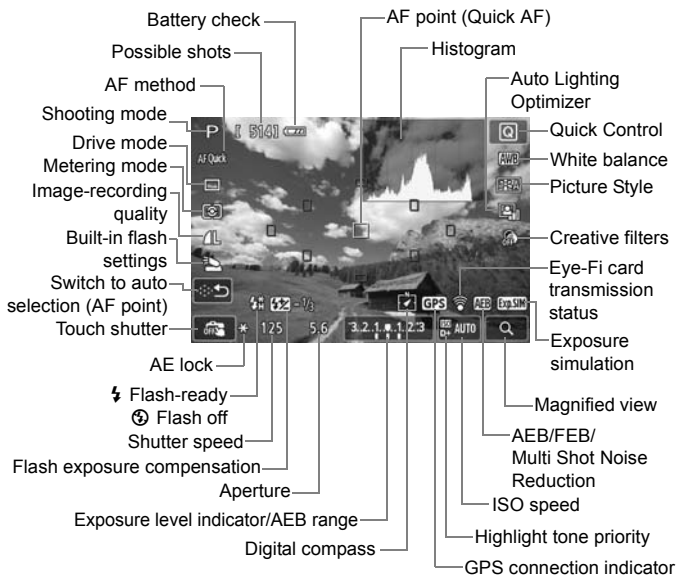

- When <Exp.SIM> is displayed in white, it indicates that the Live View image brightness is close to what the captured image will look like.
- If <Exp.SIM> is blinking, it indicates that the Live View image is displayed at a brightness that differs from the actual shooting result because of low- or bright-light conditions. However, the actual image recorded will reflect the exposure setting. Note that noise may be more noticeable than the actual image recorded.
- If you use the <Bulb> or <Flash> shooting mode, bulb exposure, or flash, the <Exp.SIM> icon and histogram will be grayed out (for your reference). The histogram may not be properly displayed in low- or bright-light conditions.

Scene Icons

During Live View shooting in the $\langle \text{A}^+ \rangle$ mode, an icon representing the scene detected by the camera will be displayed and the shooting will be adapted to that scene. For certain scenes or shooting conditions, the icon displayed may not match the actual scene.

Background \ Subject	Portrait ^{*1}		Non-Portrait			Background Color
		Movement	Nature and Outdoor Scene	Movement	Close ^{*2}	
Bright						Gray
Backlit						
Blue sky included						Light blue
Backlit						
Sunset	*3			*3		Orange
Spotlight						Dark blue
Dark						
With tripod	*4*5	*3	*4*5	*3		

*1: Displayed only when the AF method is set to [A^+ +Tracking]. If another AF method is set, the “Non-Portrait” icon will be displayed even if a person is detected.

*2: Displayed when the attached lens has distance information. With an Extension Tube or Closeup Lens, the icon displayed may not match the actual scene.

*3: The icon suiting the scene detected will be displayed.

*4: Displayed when all the following conditions apply: The shooting scene is dark, it is a night scene, and the camera is mounted on a tripod.

<→ Continued on next page>

*5: Displayed with any of the lenses below:

- EF-S18-55mm f/3.5-5.6 IS II
- EF-S55-250mm f/4-5.6 IS II
- EF300mm f/2.8L IS II USM
- EF400mm f/2.8L IS II USM
- Image Stabilizer lenses marketed in 2012 or later.

*4*5: If the conditions in both *4 and *5 apply, the shutter speed will become slow.

Final Image Simulation

The final image simulation reflects the effects of the Picture Style, white balance, etc., in the Live View image so you can see how the captured image will look like.

During shooting, the Live View image will automatically reflect the function settings listed below.

Final Image Simulation During Live View Shooting

- Picture Style
 - * All settings such as sharpness, contrast, color saturation, and color tone will be reflected.
- White balance
- White balance correction
- Ambience-based shots
- Light/scene-based shots
- Creative filters
- Metering mode
- Exposure
- Depth of field (with depth-of-field preview button ON)
- Auto Lighting Optimizer
- Peripheral illumination correction
- Highlight tone priority
- Aspect ratio (image area confirmation)

Shooting Function Settings

Function settings particular to Live View shooting are explained here.

Quick Control

If you press the **<Q>** button while the image is displayed on the LCD monitor in a Creative Zone mode, you can set any of the following: **AF method**, **drive mode**, metering mode, **image-recording quality**, built-in flash settings, white balance, Picture Style, Auto Lighting Optimizer, and **Creative filters**.

In Basic Zone modes, you can set the functions in bold and the settings shown in the table on page 76.



1 Press the **<Q>** button.

- ▶ The settable functions will be displayed.

2 Select a function and set it.

- Press the **<▲▼>** key to select a function.
- ▶ The selected function and Feature guide (p.52) will appear.
- Press the **<◀▶>** key or turn the **<DISP>** dial to change the setting.
- To set the drive mode's **<C>** setting or Picture Style parameters, press the **<INFO.>** button.

3 Exit the setting.

- Press **<SET>** to finalize the setting and return to Live View shooting.
- You can also select **<↶>** to return to Live View shooting.



- In Creative Zone modes, you can set the ISO speed by pressing the **<ISO>** button.
- For details on metering modes, see page 117.

Using Creative Filters

While looking at the Live View screen, you can shoot while applying a filter effect (Grainy B/W, Soft focus, Fish-eye effect, Art bold effect, Water painting effect, Toy camera effect, and Miniature effect). These are called Creative filters.

When you shoot with a Creative filter applied, only images applied with a Creative filter will be saved. If you also want to save the image without a Creative filter, shoot the image without the Creative filter and apply the Creative filter afterward, then save it as a separate image (p.274).

1 Set any shooting mode except <P> or <S>.

2 Press the <Q> button.

▶ The Quick Control screen will appear.

3 Select [OFF].

- Press the <▲▼> key to select [OFF] (Creative filter) on the screen's right side.



4 Select the Creative filter effect.

- Press the <◀▶> key to select a Creative filter (p.154).

▶ The Creative filter's effect will appear on the screen.





5 Adjust the Creative filter's effect.

- Press the <INFO.> button (except for the Miniature effect).
- Press the <◀▶> key to adjust the Creative filter's effect, then press <SET>.
- For the Miniature effect, press <SET>, then press the <▲▼> key to move the white frame to where you want it to look sharp.

6 Take the picture.

- ▶ The picture will be applied with the Creative filter.

Even if you set the drive mode to <□> or the self-timer to <Ⓢc>, single shooting will take effect.

- Creative filters cannot be used if any of the following is set: **RAW**+JPEG or **RAW** image quality, AEB, white balance bracketing, or multi shot noise reduction.
- When you shoot with a Creative filter, the histogram will not be displayed.

Creative Filter Characteristics

-  **Grainy B/W**

Makes the image grainy and black and white. By adjusting the contrast, you can change the black-and-white effect.

-  **Soft focus**

Gives the image a soft look. By adjusting the blur, you can change the degree of softness.

-  **Fish-eye effect**

Gives the effect of a fish-eye lens. The image will have a barrel-type distortion.

Depending on the level of this filter effect, the amount trimmed along the image periphery will change. Also, since this filter effect magnifies the image center, the apparent resolution at the center may degrade depending on the number of recorded pixels. Set the filter effect while checking the resulting image. The AF method will either be FlexiZone - Single (fixed at center) or Quick mode.

-  **Art bold effect**

Makes the photo look like an oil painting and the subject look three-dimensional. You can adjust the contrast and saturation. Note that the sky, white walls, and similar subjects may not be rendered with a smooth gradation and may look irregular or have significant noise.

-  **Water painting effect**

Makes the photo look like a watercolor painting with soft colors. You can adjust the color density. Note that night scenes or dark scenes may not be rendered with a smooth gradation and may look irregular or have significant noise.

-  **Toy camera effect**

Gives a color cast typical of toy cameras and darkens the image's four corners. By adjusting the color tone, you can change the color cast.

-  **Miniature effect**

Creates a diorama effect. You can change where the image is to look sharp. In step 5, you can press the <@> button (or tap [Ⓜ] on the screen) to change the white frame's orientation (horizontal/vertical) where you want the image to look sharp. The AF method will be FlexiZone - Single with the camera focusing the center of the white frame.



- With Grainy B/W, the grainy effect displayed on the LCD monitor will not look the same as the actual photo.
- With the Soft focus or Miniature effect, the blur effect displayed on the LCD monitor may not look the same as the actual photo. You can check the blur effect for the actual photo by pressing the depth-of-field preview button (only in Creative Zone modes).

Menu Function Settings

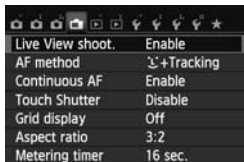

Live View shoot.	Enable
AF method	AF+Tracking
Continuous AF	Enable
Touch Shutter	Disable
Grid display	Off
Aspect ratio	3:2
Metering timer	16 sec.

The menu options below are displayed.

The functions settable on this menu screen only apply during Live View shooting. These functions do not take effect during viewfinder shooting.

- **Live View shooting**

You can set Live View shooting to **[Enable]** or **[Disable]**.

- **AF method**

You can select **[AF+Tracking]** (p.159), **[FlexiZone - Multi]** (p.161), **[FlexiZone - Single]** (p.162), or **[Quick mode]** (p.166).

- **Continuous AF**

The default setting is **[Enable]**.

Since the focus is constantly close to the subject, when you press the shutter button, the camera quickly focuses the subject. If **[Enable]** is set, the lens will operate frequently and consume more battery power. This will reduce the number of possible shots (battery life). Also, if the AF method is set to **[Quick mode]**, Continuous AF will be automatically set to **[Disable]**. If you select another AF method, Continuous AF will revert to the original setting.

During Continuous AF, turn off the power before you set the lens's focus mode switch to **<MF>**.

- **Touch Shutter**

Just by tapping the LCD monitor screen, you can focus and take the picture automatically. For details, see page 168.

- **Grid display**

With **[Grid 1 2x2]** or **[Grid 2 3x3]**, you can display grid lines to help you level the camera vertically or horizontally.

● Aspect ratio *

The image's aspect ratio can be set to **[3:2]**, **[4:3]**, **[16:9]**, or **[1:1]**. The area surrounding the Live View image is masked in black when the following aspect ratios are set: **[4:3]** **[16:9]** **[1:1]**.

JPEG images will be saved with the set aspect ratio. **RAW** images will always be saved with the **[3:2]** aspect ratio. Since the aspect ratio information is appended to the **RAW** image, the image will be generated in the respective aspect ratio when you process the **RAW** image with the provided software. In the case of the **[4:3]**, **[16:9]**, and **[1:1]** aspect ratios, the aspect-ratio lines will appear during image playback, but the lines are not actually drawn on the image.





Image Quality	Aspect Ratio and Pixel Count (approx.)			
	3:2	4:3	16:9	1:1
L	5184x3456 (17.9 megapixels)	4608x3456 (16.0 megapixels)	5184x2912* (15.1 megapixels)	3456x3456 (11.9 megapixels)
RAW				
M	3456x2304 (8.0 megapixels)	3072x2304 (7.0 megapixels)	3456x1944 (6.7 megapixels)	2304x2304 (5.3 megapixels)
S1	2592x1728 (4.5 megapixels)	2304x1728 (4.0 megapixels)	2592x1456* (3.8 megapixels)	1728x1728 (3.0 megapixels)
S2	1920x1280 (2.5 megapixels)	1696x1280* (2.2 megapixels)	1920x1080 (2.1 megapixels)	1280x1280 (1.6 megapixels)
S3	720x480 (350,000 pixels)	640x480 (310,000 pixels)	720x400* (290,000 pixels)	480x480 (230,000 pixels)



- Asterisked image-recording qualities do not exactly match the set aspect ratio.
- The image area displayed for the asterisked aspect ratio is slightly larger than the recorded area. Check the captured images on the LCD monitor when shooting.
- If you use a different camera to directly print images shot with this camera in the 1:1 aspect ratio, the images may not be correctly printed.

● **Metering timer**[☆]

You can change how long the exposure setting is displayed (AE lock time). In Basic Zone modes, metering timer is fixed at 16 sec.

-  ● The Live View shooting will stop with any of the following operations. To resume Live View shooting, press the button again.
- When selecting [3: **Dust Delete Data**], [3: **Sensor cleaning**], [4: **Clear settings**], or [4: **Camera firmware ver.**]
- Even if a low ISO speed is set, noise may be noticeable in the displayed Live View image under low light. However, when you shoot, the image recorded will have minimal noise. (The image quality of the Live View image is different from that of the recorded image.)

Changing the Autofocus Method (AF Method) ■

Selecting the AF Method

You can select the AF method suiting the shooting conditions or subject. The following AF methods are provided: [**☺ (face)+Tracking**], [**FlexiZone - Multi**] (p.161), [**FlexiZone - Single**] (p.162), and [**Quick mode**] (p.166). AF methods other than the [**Quick mode**] use the image sensor to autofocus while displaying the Live View image.

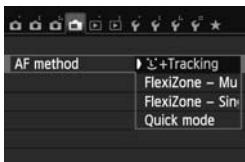

Select the AF method.

- Under the [**📷**] tab, select [**AF method**].
- Select the desired AF method, then press <[**SET**]>.
- While the Live View image is displayed, you can also press the <[**Q**]> button to select the AF method on the Quick Control screen (p.151).

☺ (face)+Tracking: AF ☺

Human faces are detected and focused. If a face moves, the AF point <[**☺**]> also moves to track the face.



1 Display the Live View image.

- Press the <[**📷**]> button.
- ▶ The Live View image will appear on the LCD monitor.

2 Select an AF point.

- When a face is detected, the <[**☺**]> AF point will appear over the face to be focused.
- If multiple faces are detected, <[**☺**]> will be displayed. Press the <[**◀▶**]> key to move the <[**☺**]> frame over the desired target face.
- You can also tap the LCD monitor screen to select the face or subject. If the subject is not a face, <[**📷**]> will be displayed.

- If no faces are detected or if you tap the LCD monitor but do not select any face or subject, the camera will switch to **[FlexiZone - Multi]** with automatic selection (p.161).

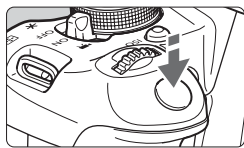

3 Focus the subject.

- Press the shutter button halfway to focus.
- ▶ When focus is achieved, the AF point will turn green and the beeper will sound.
- ▶ If focus is not achieved, the AF point will turn orange.



4 Take the picture.

- Check the focus and exposure, then press the shutter button completely to take the picture (p.146).

- ❗ If the focus is far off, face detection will not be possible. If you set **[Continuous AF]** to **[Enable]**, you can prevent the image from becoming greatly out of focus.
- An object other than a human face may be detected as a face.
- Face detection will not work if the face is very small or large in the picture, too bright or too dark, or partially hidden.
- The **< [] >** may cover only part of the face.

- 📄 If you press **< [SET] >** or the **< [] >** button, the AF point **< [] >** will appear at the center and you can use the **< [] >** keys to move the AF point.
- Since AF is not possible with a face detected near the edge of the picture, the **< [] >** will be grayed out. If you press the shutter button halfway, the subject will be focused in FlexiZone - Multi method with automatic selection.

When [Continuous AF] (p.156) or [Movie servo AF] (p.196) is set to [Enable]

- When [**L**+Tracking] or [FlexiZone - Multi] with automatic selection is set, the AF point will be momentarily displayed in the image center if the subject is not detected. If you press the shutter button halfway, the camera will focus in FlexiZone - Multi method with automatic selection. If you press the shutter button halfway during movie shooting, the center AF point will be used to focus.

FlexiZone - Multi: AF ()

Up to 31 AF points (automatically selected) covering a wide area can be used to focus. This wide area can also be divided into 9 zones for focusing (zone selection).









Area frame

1 Display the Live View image.

- Press the <  > button.
- ▶ The Live View image will appear on the LCD monitor.



2 Select the AF zone. ☆

- Pressing <  > or the <  > button will toggle between automatic selection and zone selection. In Basic Zone modes, automatic selection is set automatically.
- Use the <  > keys to select a zone. To return to the center zone, press <  > or the <  > button again.
- You can also tap the LCD monitor screen to select a zone. When a zone is selected, tap [] on the screen to switch to automatic selection.

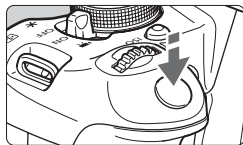

3 Focus the subject.

- Aim the AF point over the subject and press the shutter button halfway.
- ▶ When focus is achieved, the AF point will turn green and the beeper will sound.
- ▶ If focus is not achieved, the area frame will turn orange.



4 Take the picture.

- Check the focus and exposure, then press the shutter button completely to take the picture (p.146).

- When the camera does not focus the desired target subject with automatic AF point selection, switch the AF method to zone selection or **[FlexiZone - Single]**, and refocus.
- Depending on the aspect ratio setting, the number of AF points will differ. At **[3:2]**, there will be 31 AF points. At **[1:1]** and **[4:3]**, there will be 25 AF points. At **[16:9]**, 21 AF points. Also, at **[16:9]**, there will be only three zones.
- For movie shooting, there will be 21 AF points (or 25 AF points if **[640x480]** is set) and three zones (or 9 zones if **[640x480]** is set).

FlexiZone - Single: AF □

Since only one AF point is used to focus, you can focus the target subject.



AF point

1 Display the Live View image.

- Press the **<Live View>** button.
- ▶ The Live View image will appear on the LCD monitor.
- ▶ The AF point **<□>** will appear. During movie shooting, if **[Movie servo AF]** is set to **[Enable]**, the AF point will be displayed in a larger size.



2 Move the AF point.

- Press the <⬅➡> key to move the AF point to where you want to focus. (It cannot be moved to the edges of the picture.) To return the AF point to the center, press <SET> or the <🗑️> button.
- You can also tap the LCD monitor screen to move the AF point.

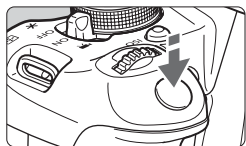

3 Focus the subject.

- Aim the AF point over the subject and press the shutter button halfway.
- ▶ When focus is achieved, the AF point will turn green and the beeper will sound.
- ▶ If focus is not achieved, the AF point will turn orange.



4 Take the picture.

- Check the focus and exposure, then press the shutter button completely to take the picture (p.146).

Notes About [**L**+Tracking], [FlexiZone - Multi], and [FlexiZone - Single]

AF Operation

- Focusing will take longer than with [Quick mode].
- Even when focus has been achieved, pressing the shutter button halfway will focus again.
- The image brightness may change during and after the AF operation.
- If the light source changes while the Live View image is displayed, the screen may flicker and focusing may be difficult. If this happens, exit Live View shooting and autofocus under the actual light source.
- When [FlexiZone - Multi] is set and you press the <Q> button (or tap <Q> on the screen), the center of the selected zone (or image center with automatic selection) will be magnified. If you press the shutter button halfway, the display will return to normal and the camera will focus.
- When [FlexiZone - Single] is set and you press the <Q> button (or tap <Q> on the screen), the area covered by the AF point will be magnified. Press the shutter button halfway to focus while in the magnified view. This is effective when the camera is attached to a tripod and you need to attain very precise focus. If focusing is difficult in the magnified view, return to the normal display and use AF. Note that the AF speed may differ between the normal and magnified views.
- If you magnify the view after focusing with [FlexiZone - Multi] or [FlexiZone - Single] in the normal view, it may not look focused.
- If [**L**+Tracking] is set, magnified view is not possible.



- If you shoot a peripheral subject and it is slightly out of focus, aim the center AF point or zone over the subject to focus, focus again and then take the picture.
- The AF-assist beam will not be emitted. However, if an EX-series Speedlite (sold separately) equipped with an LED light is used, the LED light will turn on for AF-assist when necessary.
- In magnified view, the higher the magnification, the more difficult focusing will be because of camera shake when shooting hand-held (as well as when the lens focus mode switch is set to <MF>). Using a tripod is recommended.

Shooting conditions that make focusing difficult

- Low-contrast subjects such as the blue sky, solid-color flat surfaces or when highlights or shadow details are lost.
- Subjects in low light.
- Stripes and other patterns where there is contrast only in the horizontal direction.
- Subjects with repetitive patterns (skyscraper windows, computer keyboards, etc.).
- Fine lines and subject outlines.
- Under a light source whose brightness, color, or pattern keeps changing.
- Night scenes or points of light.
- When the image flickers under fluorescent or LED light sources.
- Extremely small subjects.
- Subjects at the edge of the picture.
- Subjects strongly reflecting light.
- The AF point covers both a near and faraway subject (such as an animal in a cage).
- Subjects that keep moving within the AF point and cannot keep still due to camera shake or subject blur.
- A subject approaching or moving away from the camera.
- Autofocusing while the subject is very far out of focus.
- Soft focus effect is applied with a soft focus lens.
- A special effect filter is used.
- Noise (spots, banding, etc.) appears on the screen during AF.



- If focus is not achieved with the above shooting conditions, set the lens focus mode switch to **<MF>** and focus manually.
- If you use AF with any of the following lenses, using **[Quick mode]** is recommended. If you use the **[+Tracking]**, **[FlexiZone - Multi]** or **[FlexiZone - Single]** for AF, it may take a longer time to achieve focus or the camera may not be able to achieve correct focus.
 EF50mm f/1.4 USM, EF50mm f/1.8 II, EF50mm f/2.5 Compact Macro,
 EF75-300mm f/4-5.6 III, EF75-300mm f/4-5.6 III USM
 For information on discontinued lenses, refer to your local Canon Web site.

Quick Mode: AFQuick

The dedicated AF sensor is used to focus in One-Shot AF operation (p.98), using the same AF method as with viewfinder shooting. Although you can focus the target subject quickly, **the Live View image will be interrupted momentarily during the AF operation.**

You can use nine AF points to focus (automatically selected). You can also select one AF point to focus and focus only the area covered by that AF point (manually selected). In Basic Zone modes, the AF point will be selected automatically. You cannot select the AF point.

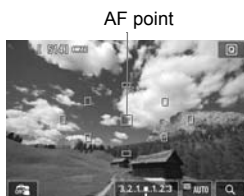









1 Display the Live View image.

- Press the <  > button.
- ▶ The Live View image will appear on the LCD monitor.
- The small boxes are the AF points.



2 Select the AF point. ☆

- Pressing <  > or the <  > button will toggle between automatic selection and manual selection.
- Use the <   > keys to select an AF point. To return the AF point to the center, press <  > or the <  > button.
- You can also tap the LCD monitor screen to select the AF point. During manual selection, tap [ ] on the screen to switch to automatic selection.



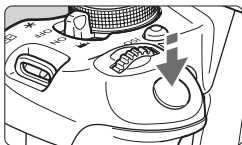

3 Focus the subject.

- Aim the AF point over the subject and press the shutter button halfway.
- ▶ The Live View image will turn off, the reflex mirror will go back down, and AF will be executed. (No picture is taken.)
- ▶ When focus is achieved, the AF point that achieved focus will turn green and the Live View image will reappear.
- ▶ If focus is not achieved, the AF point will turn orange and blink.



4 Take the picture.

- Check the focus and exposure, then press the shutter button completely to take the picture (p.146).



- When [Quick mode] is set, [Continuous AF] cannot be set (p.156).
- The [Quick mode] cannot be set for movie shooting.



You cannot take a picture during autofocusing. Take the picture while the Live View image is displayed.

Shooting with the Touch Shutter

Just by tapping the LCD monitor screen, you can focus and take the picture automatically. This works in all shooting modes.







1 Display the Live View image.

- Press the  button.
- ▶ The Live View image will appear on the LCD monitor.



2 Enable the touch shutter.

- Tap [] on the screen's bottom left. Each time you tap the icon, it will toggle between [] and [].
- [] (Touch Shutter: Enable)
Enables you to focus and shoot by tapping the screen.
- [] (Touch Shutter: Disable)
You can tap where you want to focus on the screen. Then press the shutter button completely to shoot.



3 Tap the screen to shoot.

- Tap the face or subject on the screen.
- ▶ At the point you tap, the camera will focus in the AF method that was set (p.159-167). When [**FlexiZone - Multi**] is set, it will switch to [**FlexiZone - Single**].
- ▶ When focus is achieved, the AF point turns green and the picture is taken automatically.
- If focus is not achieved, the AF point turns orange. Tap the face or subject on the screen again.



- Even if (continuous shooting) is set, single shooting will take effect.
- The touch shutter does not work with the magnified view.
- When [6: Shutter/AE lock button] is set to [1: AE lock/AF] or [3: AE/AF, no AE lock] under [4: Custom Functions (C.Fn)], autofocus does not take effect.



- You can also enable the touch shutter by setting [Touch Shutter: Enable] in the [img alt="camera icon" data-bbox="325 285 365 305"/> tab.
- To take a bulb exposure, tap the screen twice. The first tap on the screen will start the bulb exposure. Tapping it again will stop the exposure. Be careful not to shake the camera when tapping the screen.

MF: Focus Manually

You can magnify the image and focus precisely with manual focus.

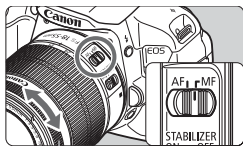

1 Set the lens focus mode switch to <MF>.

- Turn the lens focusing ring to focus roughly.

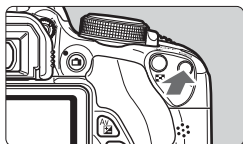

2 Display the magnifying frame.

- Press the <Q> button.
 - ▶ The magnifying frame will appear.
- You can also tap [Q] on the screen to magnify the image.



Magnifying frame

3 Move the magnifying frame.

- Press the <D> key to move the magnifying frame to the position where you want to focus.
- To return the magnifying frame to the center, press <SET> or the <W> button.

4 Magnify the image.

- Each time you press the <Q> button, the magnification within the frame will change as follows:

→ 1x → 5x → 10x → Magnification canceled

5 Focus manually.

- While looking at the magnified image, turn the lens focusing ring to focus.
- After achieving focus, press the <Q> button to return to the normal view.



AE lock
Magnified area position
Magnification

6 Take the picture.

- Check the focus and exposure, then press the shutter button to take the picture (p.146).









Live View Shooting Cautions

Image Quality

- When you shoot at high ISO speeds, noise (such as dots of light and banding) may become noticeable.
- Shooting in high temperatures may cause noise and irregular colors in the image.
- If Live View shooting is used continuously for a long period, the camera's internal temperature may rise, and image quality may deteriorate. Stop Live View shooting when not shooting images.
- If you shoot a long exposure while the camera's internal temperature is high, image quality may deteriorate. Stop Live View shooting and wait a few minutes before shooting again.

White and Red Internal Temperature Warning

- If the camera's internal temperature increases due to prolonged Live View shooting or under a high ambient temperature, a white icon  will appear. If you continue shooting while this icon is displayed, the image quality of still photos may deteriorate. It is recommended to temporarily exit Live View shooting and allow the camera to cool down before shooting again.
- If the camera's internal temperature further increases while the white icon  is displayed, a red icon  will start blinking. This blinking icon indicates that the Live View shooting will soon stop automatically. If this happens, you will not be able to shoot again until the camera's internal temperature decreases. Turn off the power and let the camera rest for a while.
- Using Live View shooting at a high temperature for a prolonged period will cause the  and  icons to appear earlier. When you are not shooting, turn off the camera.
- If the camera's internal temperature is high, the image quality of high ISO speed images or long exposures may be degraded even before the white icon  is displayed.

Live View Shooting Cautions

Shooting Result

- If you take the picture in magnified view, the exposure may not come out as desired. Return to the normal view before taking the picture. In magnified view, the shutter speed and aperture will be displayed in orange. Even if you take the picture in magnified view, the image will be captured in the normal view.
- If [2: Auto Lighting Optimizer] (p.125) is not set to [Disable], the image may look bright even if a decreased exposure compensation or decreased flash exposure compensation is set.
- If you use a TS-E lens (other than the TS-E17mm f/4L or TS-E24mm f/3.5L II) and shift or tilt the lens or use an Extension Tube, the standard exposure may not be obtained or an irregular exposure may result.

Live View Image

- Under low- or bright-light conditions, the Live View image may not reflect the brightness of the captured image.
- If the light source within the image changes, the screen may flicker. If this happens, exit Live View shooting and resume shooting under the actual light source.
- If you point the camera to a different direction, it may throw off the Live View image's correct brightness momentarily. Wait until the brightness level stabilizes before shooting.
- If there is a very bright light source in the picture, the bright area might appear black on the LCD monitor. However, the actual captured image will correctly show the bright area.
- In low light, if you set the [2: LCD brightness] to a bright setting, chrominance noise may appear in the Live View image. However, the chrominance noise will not be recorded in the captured image.
- When you magnify the image, the image sharpness may look more pronounced than in the actual image.

Custom Functions

- During Live View shooting, certain Custom Function settings will not take effect (p.297).

Lens and Flash

- The focus preset function is possible for Live View shooting only when using a (super) telephoto lens equipped with the focus preset mode marketed since the second half of 2011.
- FE lock is not possible when the built-in flash or an external Speedlite is used. Modeling flash will not work with an external Speedlite.

6

Shooting Movies



You can shoot movies by setting the power switch to . The movie recording format will be MOV.

Cards that can record movies

When shooting movies, use a large-capacity SD card rated **SD Speed Class 6** “CLASS 6” or higher.

If you use a slow-writing card when shooting movies, the movie may not be recorded properly. Also, if you play back a movie on a card with a slow reading speed, the movie may not play back properly.

To check the card's read/write speed, refer to the card manufacturer's Web site.

About Full HD 1080

Full HD 1080 indicates compatibility with High-Definition featuring 1080 vertical pixels (scanning lines).



Shooting Movies

Connecting the camera to a TV set is recommended to play back the movies shot (p.262, 265).

Autoexposure Shooting

When the shooting mode is not set to <M>, autoexposure control will take effect to suit the scene's current brightness.

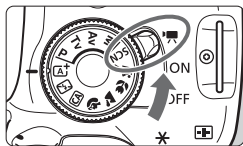

1 Set the power switch to <Movie camera icon>.

- ▶ The reflex mirror will make a sound, then the image will appear on the LCD monitor.

2 Set the shooting mode.

- Set the Mode Dial to any shooting mode except <M>.

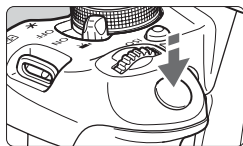

3 Focus the subject.

- Before shooting a movie, focus with AF or manual focus (p.159-167, 170).
- By default, [Movie Servo AF: Enable] is set so that the camera will always focus. To stop Movie Servo AF, see page 196.



4 Shoot the movie.

- Press the <Start/Stop Movie Shooting button> to start shooting a movie. To stop movie shooting, press <Start/Stop Movie Shooting button> again.
- ▶ While the movie is being shot, the "●" mark will be displayed on the upper right of the screen.

Recording movie

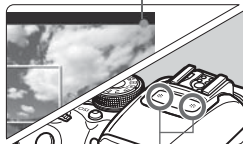

Microphone



- Cautions for movie shooting are on pages 200 and 201.
- If necessary, also read the Live View shooting cautions on pages 171 and 172.





















- In Basic Zone modes, the shooting result will be the same as in the $\langle \text{A}^+ \rangle$ mode. Also, the scene icon for the scene detected by the camera is displayed on the upper left (p.176).
- In the $\langle \text{Av} \rangle$ and $\langle \text{Tv} \rangle$ shooting modes, the settings will be the same as in the $\langle \text{P} \rangle$ mode.
- Settable menu functions will differ between Basic Zone modes and Creative Zone modes (p.322).
- The ISO speed (ISO 100 - ISO 6400), shutter speed, and aperture are set automatically.
- In Creative Zone modes, you can press the $\langle * \rangle$ button to lock the exposure (AE lock, p.123,198). After applying AE lock during movie shooting, you can cancel it by pressing the $\langle \text{AE-L} \rangle$ button. (AE lock setting is retained until you press the $\langle \text{AE-L} \rangle$ button.)
- In Creative Zone modes, you can hold down the $\langle \text{Av} \text{ []} \rangle$ button and turn the $\langle \text{EV} \text{ []} \rangle$ dial to set the exposure compensation.
- Pressing the shutter button halfway displays the shutter speed and ISO speed at the bottom of the screen. This is the exposure setting for taking a still photo (p.179). The exposure setting for movie shooting is not displayed. Note that the exposure setting for movie shooting may differ from that for still photo shooting.
- If you shoot a movie with autoexposure, the shutter speed and aperture will not be recorded in the image information (Exif).

Using an EX-series Speedlite (Sold Separately) Equipped with an LED Light

This camera is compatible with the function turning on the LED light automatically in low-light conditions during autoexposure shooting. **For details, refer to the Speedlite's instruction manual.**

Scene Icons

During movie shooting in a Basic Zone mode, an icon representing the scene detected by the camera will be displayed and the shooting will be adapted to that scene. For certain scenes or shooting conditions, the icon displayed may not match the actual scene.

Background \ Subject	Portrait ^{*1}	Non-Portrait		Background Color
		Nature and Outdoor Scene	Close ^{*2}	
Bright				Gray
Backlit				
Blue sky included				Light blue
Backlit				
Sunset	*3		*3	Orange
Spotlight				Dark blue
Dark				

*1: Displayed only when the AF method is set to [**☺+Tracking**]. If another AF method is set, the “Non-Portrait” icon will be displayed even if a person is detected.

*2: Displayed when the attached lens has distance information. With an Extension Tube or Closeup Lens, the icon displayed may not match the actual scene.

*3: The icon suiting the scene detected will be displayed.

Manual Exposure Shooting

In the <M> mode, you can freely set the shutter speed, aperture, and ISO speed for the movie shooting. Using manual exposure to shoot movies is for advanced users.

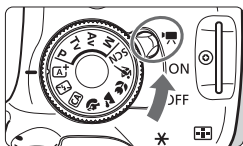

1 Set the power switch to <ON>.

- ▶ The reflex mirror will make a sound, then the image will appear on the LCD monitor.



2 Set the Mode Dial to <M>.



3 Set the shutter speed and aperture.

- To set the shutter speed, turn the <Shutter Speed> dial. The settable shutter speeds depend on the frame rate <FR>.
 - 60 / 50 : 1/4000 sec. - 1/60 sec.
 - 30 / 25 / 24 : 1/4000 sec. - 1/30 sec.
- To set the aperture, hold down the <Av> button and turn the <Aperture> dial.

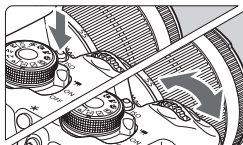

4 Set the ISO speed.

- Press the <ISO> button and press the <Left/Right Arrow> key or turn the <Shutter Speed> dial to select the ISO speed.
- For details on the ISO speed, see the next page.

5 Focus and shoot the movie.

- The procedure is the same as steps 3 and 4 for “Autoexposure Shooting” (p.174).

ISO speed during manual-exposure shooting

- With [**Auto**], the ISO speed will be set automatically within ISO 100 - ISO 6400.
- You can set the ISO speed manually within ISO 100 - ISO 6400 in whole-stop increments. Under [**4: Custom Functions (C.Fn)**], if [**2: ISO expansion**] is set to [**1: On**], the manual setting range will expand so you can also select H (equivalent to ISO 12800).
- Under [**4: Custom Functions (C.Fn)**], if [**3: Highlight tone priority**] is set to [**1: Enable**], the ISO speed will be ISO 200 - ISO 6400.

- Since shooting a movie at ISO 12800 may result in much noise, it is designated as an expanded ISO speed (displayed as “H”).
- Under [**4: Custom Functions (C.Fn)**], if [**2: ISO expansion**] is set to [**1: On**] and you switch from still photo shooting to movie shooting, the manual setting range’s maximum will be H (equivalent to ISO 12800). Even if you switch back to still photo shooting, the ISO speed will not revert to the original setting.
- Exposure compensation cannot be set.
- Changing the shutter speed or aperture during movie shooting is not recommended since the changes in the exposure will be recorded.
- If you change the shutter speed while shooting under fluorescent or LED lighting, image flicker may be recorded.

- When ISO Auto is set, you can press the <★> button to lock the ISO speed.
- After recomposing the picture, you can see the exposure level difference on the exposure level indicator (p.179) compared to when you pressed the <★> button.
- By pressing the <INFO.> button, you can display the histogram.
- When shooting a movie of a moving subject, a shutter speed of 1/30 sec. to 1/125 sec. is recommended. The faster the shutter speed, the less smooth the subject’s movement will look.

Information Display



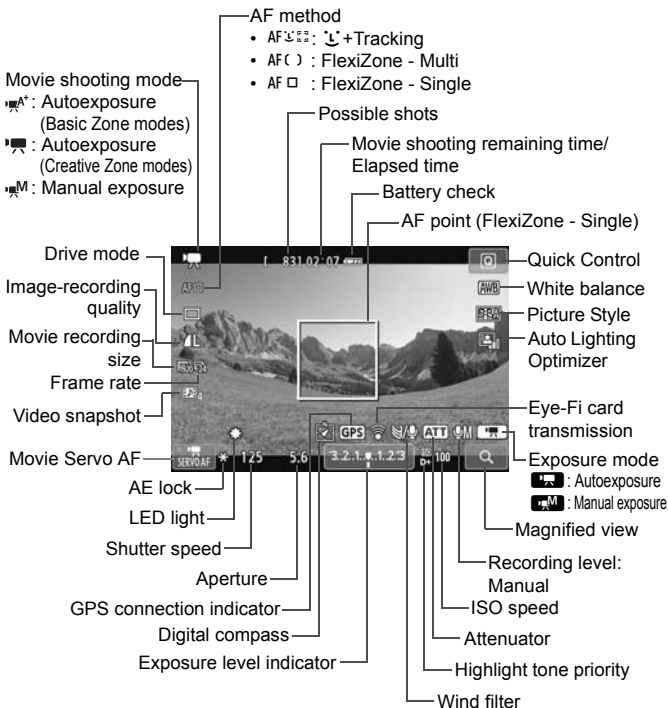

- Each time you press the <INFO.> button, the information display will change.



When movie shooting starts, the movie shooting remaining time will change to the elapsed time.

Notes on Movie Shooting

- Do not point the camera toward an intense light source, such as the sun on a sunny day or an intense artificial light source. Doing so may damage the image sensor or the camera's internal components.
- If <AWB> is set, you should not change the ISO speed or aperture during movie shooting because it may also change the white balance.
- If you shoot a movie under fluorescent or LED lighting, the movie may flicker.
- Zooming the lens during movie shooting is not recommended. Zooming the lens can cause changes in the exposure regardless of whether the lens' maximum aperture changes or not. Exposure changes may be recorded as a result.
- You cannot magnify the image during movie shooting.
- Be careful not to cover the microphone (p.174) with your finger, etc.
- **Cautions for movie shooting are on pages 200 and 201.**
- **If necessary, also read the Live View shooting cautions on pages 171 and 172.**

- Movie-related settings are under the [ 1] and [ 2] tabs (p.196).
- A movie file is recorded each time you shoot a movie. If the file size exceeds 4 GB, a new file will be automatically created.
- The movie image's field of view is approx. 100% (with movie recording size set to [ 1920]).
- The sound will be recorded in stereo by the camera's built-in microphone (p.174).
- Most commercially-available external stereo microphones with a 3.5 mm diameter miniplug can be connected to the camera. If an external microphone has been connected to the camera's external microphone IN terminal (p.20), it will be given priority over the built-in microphone.
- You can use Remote Controller RC-6 (sold separately, p.307) to start and stop the movie shooting if the drive mode is < >. Set the shooting timing switch to <2> (2-sec. delay), then press the transmit button. If the switch is set to < > (immediate shooting), still photo shooting will take effect.
- With a fully-charged Battery Pack LP-E8, the total movie shooting time will be as follows: approx. 1 hr. 40 min. at room temperature (23°C/73°F), and approx. 1 hr. 20 min. at low temperature (0°C/32°F).
- The focus preset function is possible for movie shooting only when using a (super) telephoto lens equipped with the focus preset mode marketed since the second half of 2011.

Final Image Simulation

The final image simulation is a function that allows you to see the effects of the Picture Style, white balance, etc., on the image. During movie shooting, the image displayed will automatically reflect the effects of the settings listed below.

Final image simulation for movie shooting

- Picture Style
 - * All settings such as sharpness, contrast, color saturation, and color tone will be reflected.
- White balance
- White balance correction
- Exposure
- Depth of field
- Auto Lighting Optimizer
- Peripheral illumination correction
- Highlight tone priority

Shooting Still Photos

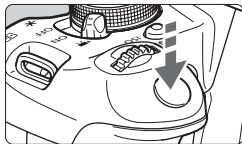

While shooting a movie, you can also take a still photo by pressing the shutter button completely.

Taking still photos during movie shooting

- If you take a still photo during movie shooting, the movie will record a still moment lasting approx. 1 sec.
- The captured still photo will be recorded to the card, and the movie shooting will resume automatically when the Live View image is displayed.
- The movie and still photo will be recorded as separate files on the card.
- Functions particular to still photo shooting are shown below. Other functions will be the same as for movie shooting.

Function	Settings
Image-Recording Quality	As set in [1: Image quality]. When the movie recording size is [1920x1080] or [1280x720], the aspect ratio will be 16:9. When the size is [640x480], the aspect ratio will be 4:3.
ISO Speed*	<ul style="list-style-type: none"> • With autoexposure shooting: Automatically set within ISO 100 - ISO 6400. • With manual exposure shooting: See "ISO speed during manual-exposure shooting" on page 178.
Exposure Setting	<ul style="list-style-type: none"> • Autoexposure shooting: Automatically-set shutter speed and aperture (displayed when pressing the shutter button halfway). • Manual exposure shooting: Manually-set shutter speed and aperture.
AEB	Canceled
Flash	Flash off

* If highlight tone priority is set, the ISO speed range will start from ISO 200.

Regardless of the drive mode setting, single shooting will take effect for still photo shooting during movie shooting.



When you press the shutter button halfway to autofocus during movie shooting, the following phenomena may occur.

- Focus may become far off momentarily.
- The brightness of the recorded movie may be different from that of the actual scene.
- The recorded movie may be momentarily still.
- Lens operation noise may be recorded.
- You may not take a still photo when focus is not achieved in cases such as the subject is moving.

Shooting Function Settings

Function settings particular to movie shooting are explained here.

Quick Control

If you press the  while the image is displayed on the LCD monitor, you can set any of the following: **AF method**, **drive mode**, **image-recording quality (still photos)**, **movie-recording size**, **video snapshots**, white balance, Picture Style, and Auto Lighting Optimizer.



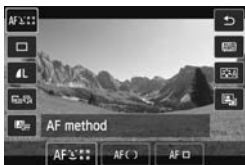

In Basic Zone modes, only the functions in bold can be set.





1 Press the button. (10)

- ▶ The settable functions will be displayed.

2 Select a function and set it.

- Press the  key to select a function.
- ▶ The function and Feature guide (p.52) will appear.
- Press the  key or turn the  dial to change the setting.
- To set the drive mode's  setting or Picture Style parameters, press the .

3 Exit the setting.

- Press  to finalize the setting and return to movie shooting.
- You can also select  to return to movie shooting.

MENU Setting the Movie-recording Size



The menu option [**2: Movie rec. size**] enables you to select the movie's image size [****x****] and frame rate [/**] (frames recorded per second). The /** (frame rate) switches automatically depending on the [**2: Video system**] setting.







● Image size

- 1920 [1920x1080]** : Full High-Definition (Full HD) recording quality.
The aspect ratio will be 16:9.
- 1280 [1280x720]** : High-Definition (HD) recording quality.
The aspect ratio will be 16:9.
- 640 [640x480]** : Standard-definition recording quality.
The aspect ratio will be 4:3.

● Frame rate (fps: frames per second)

- 30/60** : For areas where the TV format is NTSC (North America, Japan, Korea, Mexico, etc.).
- 25/50** : For areas where the TV format is PAL (Europe, Russia, China, Australia, etc.).
- 24** : Mainly for motion pictures.

Total Movie Recording Time and File Size Per Minute

Movie-Recording Size	Total Recording Time (approx.)			File Size (approx.)	
	4 GB Card	8 GB Card	16 GB Card		
[1920x1080]		11 min.	22 min.	44 min.	330 MB/min.
					
					
[1280x720]		11 min.	22 min.	44 min.	330 MB/min.
					
[640x480]		46 min.	1 hr. 32 min.	3 hr. 4 min.	82.5 MB/min.
					

● **About Movie Files Exceeding 4 GB**

Even if you shoot a movie exceeding 4 GB, you can keep shooting without interruption.

During movie shooting, approx. 30 sec. before the movie reaches the 4 GB file size, the elapsed shooting time displayed in the movie shooting screen will start blinking. If you keep shooting the movie and the file size exceeds 4 GB, a new movie file will be created automatically and the elapsed shooting time or time code will stop blinking.

When you play back the movie, you will have to play each movie file individually. Movie files cannot play back consecutively automatically. After the movie playback ends, select the next movie to be played.

● **Movie Shooting Time Limit**

The maximum recording time of one movie clip is 29 min. 59 sec. If the movie shooting time reaches 29 min. 59 sec., the movie shooting will stop automatically. You can resume movie shooting by pressing the  button. (A new movie file is recorded.)

 An increase of the camera's internal temperature may cause movie shooting to stop before the maximum recording time shown in the table above (p.200).

MENU Shooting Video Snapshots

You can easily create a short movie with the video snapshot function. A video snapshot is a short movie clip lasting approx. 2 sec., 4 sec., or 8 sec. A collection of video snapshots is called a video snapshot album and can be saved to the card as a single movie file. By changing the scene or angle in each video snapshot, you can create dynamic short movies.

A video snapshot album can also be played together with background music (p.193, 255).

Video Snapshot Album Concept

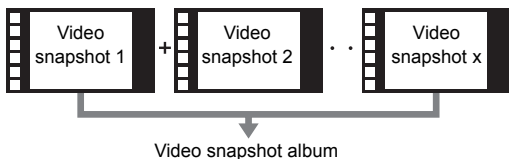

Setting the Video Snapshot Shooting Duration

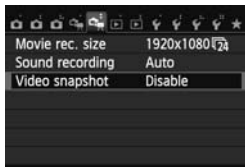

1 Select [Video snapshot].

- Under the [MENU] tab, select [Video snapshot], then press <SET>.

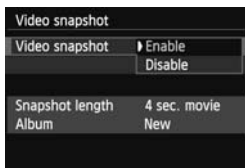

2 Select [Enable].

- Select [Enable], then press <SET>.

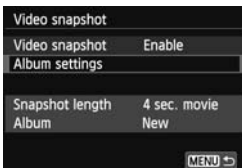

3 Select [Album settings].

- Select [**Album settings**], then press <SET>.
- If you want to continue shooting for an existing album, go to “Adding to an Existing Album” (p.192).

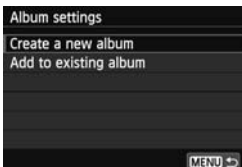

4 Select [Create a new album].

- Select [**Create a new album**], then press <SET>.

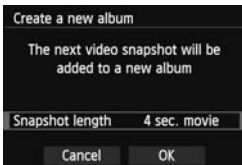

5 Select the Snapshot length.

- Press <SET> and use <▲▼> to select the snapshot's length, then press <SET>.



Shooting duration

6 Select [OK].

- Select [**OK**], then press <SET>.
- Press the <MENU> button to exit the menu and return to the movie shooting screen. A blue bar will appear to indicate the snapshot length.
- Go to “Creating a Video Snapshot Album” (p.189).

Creating a Video Snapshot Album



7 Shoot the first video snapshot.

- Press the < > button and shoot.
- ▶ The blue bar indicating the shooting duration will gradually decrease. After the set shooting duration elapses, the shooting stops automatically.
- ▶ After the LCD monitor turns off and the access lamp stops blinking, the confirmation screen will appear (p.190).



8 Save as a video snapshot album.

- Press the < > key to select [**Save as album**], then press < >.
- ▶ The movie clip will be saved as the video snapshot album's first video snapshot.



9 Continue to shoot more video snapshots.

- Repeat step 7 to shoot the next video snapshot.
- Press the < > key to select [**Add to album**], then press < >.
- To create another video snapshot album, select [**Save as a new album**], then select [].

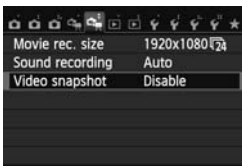











10 Quit the video snapshot shooting.

- Set [Video snapshot] to [Disable].
To return to normal movie shooting, be sure to set [Disable].
- Press the <MENU> button to exit the menu and return to the normal movie shooting screen.

On-screen Options in Steps 8 and 9

Function	Description
Save as album (Step 8)	The movie clip will be saved as the video snapshot album's first video snapshot.
Add to album (Step 9)	The video snapshot just recorded will be added to the album recorded immediately before.
Save as a new album (Step 9)	A new video snapshot album is created and the movie clip is saved as the first video snapshot. The new album will be a different file from the previously recorded album.
Playback video snapshot (Steps 8 and 9)	The video snapshot just recorded will be played. For playback operations, see the table on the next page.
Do not save to album (Step 8) Delete without saving to album (Step 9)	If you want to delete the video snapshot you just recorded and not save it to the album, select [OK].

[Playback video snapshot] Operations

Function	Playback Description
 Play	By pressing <SET>, you can play or pause the just-recorded video snapshot.
 First frame	Displays the first scene of the album's first video snapshot.
 Skip backward*	Each time you press <SET>, the video snapshot skips back by a few seconds.
 Previous frame	Each time you press <SET>, the previous frame is displayed. If you hold down <SET>, it will rewind the movie.
 Next frame	Each time you press <SET>, the movie will play frame-by-frame. If you hold down <SET>, it will fast forward the movie.
 Skip forward*	Each time you press <SET>, the video snapshot skips forward by a few seconds.
 Last frame	Displays the last scene of the album's last video snapshot.
	Playback position
mm' ss"	Playback time (minutes:seconds)
 Volume	You can adjust the built-in speaker's (p.254) volume by turning the <VOLUME> dial.
 MENU 	Pressing the <MENU> button returns to the previous screen.

* With [Skip backward/Skip forward], the skipping duration will correspond to the number of seconds set under [Video snapshot] (approx. 2 sec., 4 sec., or 8 sec.).

Adding to Existing Album

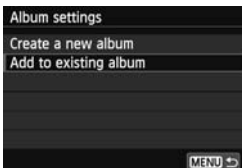

1 Select [Add to existing album].

- Follow step 4 on page 188 to select [Add to existing album], then press <SET>.



2 Select an existing album.

- Press the <◀▶> key to select an album, then press <SET>.
- Check the text, select [OK], then press <SET>.
- ▶ Certain video snapshot settings will change to match the existing album's settings.
- Press the <MENU> button to exit the menu and return to the movie shooting screen.

3 Shoot the video snapshot.

- Go to "Creating a Video Snapshot Album" (p.189).

! You cannot select an album shot with another camera.

Cautions for Shooting Video Snapshots

- You can add to an album only video snapshots with the same duration (approx. 2 sec., 4 sec., or 8 sec. each).
- Note that if you do any of the following while shooting video snapshots, a new album will be created for subsequent video snapshots.
 - Changing the [Movie rec. size] (p.185).
 - Changing the [Sound rec.] setting from [Auto/Manual] to [Disable] or from [Disable] to [Auto/Manual] (p.198).
 - Updating the firmware.
- You cannot take still photos while shooting a video snapshot.
- The shooting duration of a video snapshot is only approximate. Depending on the frame rate, the shooting duration displayed during playback may not be exact.

Playing an Album

You can play back a completed album in the same way as a normal movie (p.254).



1 Play back the movie.

- Press the <▶> button to display images.



2 Select the album.

- Press the <◀▶> key to select an album.
- On the single-image display, the [SET] icon displayed on the upper left indicates that the image is a video snapshot.

3 Play back the album.

- Press <SET>.
- On the movie playback panel displayed, select [▶] (Play), then press <SET>.



Background Music

- Music recorded on the memory card must be used only for private enjoyment. Do not violate the rights of the copyright holder.
- You can play background music when you play back albums, normal movies, and slide shows on the camera (p.255, 258). To play background music, you must first copy the background music to the card using EOS Utility (provided software). For information on how to copy the background music, refer to the EOS Utility Instruction Manual (p.367).

Editing an Album

After shooting, you can rearrange, delete, or play back the video snapshots in the album.



1 On the playback panel, select [X] (Edit).

- ▶ The editing screen will be displayed.



2 Select an editing operation.

- Use the <◀▶> keys to select an editing operation, then press <SET>.

Function	Description
↔ Move snapshot	Press the <◀▶> key to select the video snapshot you want to move, then press <SET>. Press the <◀▶> key to move the snapshot, then press <SET>.
🗑 Delete snapshot	Press the <◀▶> key to select the video snapshot you want to delete, then press <SET>. The [🗑] icon will be displayed on the selected video snapshot. Pressing <SET> again will cancel the selection and [🗑] will disappear.
▶ Play snapshot	Press the <◀▶> key to select the video snapshot you want to play, then press <SET>.



3 Save the edited album.

- Press the <MENU> button to return to the Editing panel at the screen's bottom.
- Press the <◀▶> key to select [] (Save), then press <Ⓢ>.
- ▶ The save screen will appear.
- To save it as a new movie, select [**New file**]. To save it and overwrite the original movie file, select [**Overwrite**], then press <Ⓢ>.



- If the card does not have enough free space, [**New file**] will not be available.
- When the battery level is low, editing albums is not possible. Use a fully-charged battery.



Provided Software Usable with Albums

- **EOS Video Snapshot Task:** Editing albums is possible. This is an add-on function for ImageBrowser EX.

MENU Movie Menu Function Settings

When you set the power switch to <M>, the [CAM 1/CAM 2] tab will show functions dedicated to movie shooting. The menu options are as follows.

[CAM 1] menu

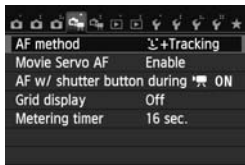

[CAM 2] menu

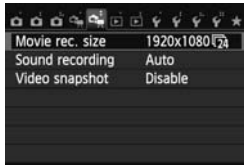

- **AF method**







The AF methods are the same as described on pages 159-165. You can select [**+Tracking**], [**FlexiZone - Multi**], or [**FlexiZone - Single**].

- **Movie Servo AF**

The default setting is [**Enable**]. You can focus by pressing the shutter button halfway regardless of the setting.

- **When [Enable] is set:**

- You can shoot a movie while focusing a moving subject continuously. Note that the camera may record the lens operation noise. To reduce the recording of the lens operation noise, use a commercially-available external microphone. Using EF-S18-55mm f/3.5-5.6 IS STM or EF-S18-135mm f/3.5-5.6 IS STM lens can minimize the focusing noise recorded during movie shooting.
- During Movie Servo AF, turn off the power before you set the lens's focus mode switch to <MF>.

- If you want to hold the focus at a certain point or avoid recording the lens operation noise before or during movie shooting, you can temporarily stop Movie Servo AF by performing one of the operations below. When you stop Movie Servo AF, the AF point will turn gray. When you perform the same operation below again, Movie Servo AF will resume.
 - Tap the  icon on the lower left of the screen.
 - Press the  button.
 - If **[6: Shutter/AE lock button]** is set to **[2: AF/AF lock, no AE lock]** in the **[4: Custom Functions (C.Fn)]**, Movie Servo AF will stop while you hold down the  button. When you let go of the  button, Movie Servo AF will resume.
 - While Movie Servo AF is stopped, if you press the **<MENU>** button,  button etc. and then return to movie shooting, Movie Servo AF will resume.
 - **For cautions when [Movie servo AF] is set to [Enable], see page 202.**
- **When [Disable] is set:**
 - You can focus only when the shutter button is pressed halfway.
- **AF with shutter button during  (movie recording)**
When you press the shutter button while shooting a movie, you can shoot a still photo. The default setting is **[ONE SHOT]**.
 - **When [ONE SHOT] is set:**
 - You can refocus and shoot a still photo by pressing the shutter button halfway while shooting a movie.
 - When shooting a static subject (not moving), you can perform shooting in precise focus.
 - **When [Disable] is set:**
 - You can immediately start shooting a still photo by pressing the shutter button, even though focus is not achieved. It is effective when you want give priority to the shutter chance rather than to focus.

● **Grid display**

With [Grid 1 \equiv] or [Grid 2 \equiv], you can display grid lines to help you level the camera vertically or horizontally.

● **Metering timer**★

You can change how long the exposure setting is displayed (AE lock time).

● **Movie recording size**

You can set the movie recording size (image size and frame rate). For details, see pages 185-186.

● **Sound recording**★

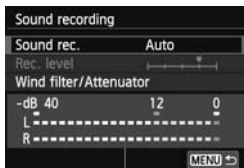

Level meter

Normally, the built-in microphone will record stereo sound. If a commercially-available microphone equipped with a mini plug (3.5 mm diameter) is connected to the camera's external microphone IN terminal (p.20), it will be given priority.

[Sound rec./Rec. level] options

[Auto] : The sound-recording level is adjusted automatically. Auto level control will operate automatically in response to the sound level.

[Manual] : For advanced users. You can adjust the sound recording level to one of 64 levels. Select [Rec. level] and look at the level meter while pressing the <◀▶> key to adjust the sound recording level.

While looking at the peak hold indicator (approx. 3 sec.), adjust so that the level meter sometimes lights up the "12" (-12 dB) mark on the right for the loudest sounds. If it exceeds "0", the sound will be distorted.

[Disable] : Sound will not be recorded.

[Wind filter]

When set to **[Enable]**, it reduces wind noise when there is wind outdoors. This feature takes effect only with the built-in microphone.

Note that **[Enable]** will also reduce low bass sounds, so set this function to **[Disable]** when there is no wind. It will record a more natural sound than with **[Enable]**.

[Attenuator]

Even if you set **[Sound recording]** to **[Auto]** or **[Manual]** and shoot, sound distortion may still result if there is a very loud sound. In such a case, setting it to **[Enable]** is recommended.







- In Basic Zone modes, the settings available for **[Sound recording]** will be **[On/Off]**. If **[On]** is set, the sound-recording level will be adjusted automatically (same as with **[Auto]**). However, the wind filter function will not take effect.
- The sound volume balance between L (left) and R (right) cannot be adjusted.
- Both L and R record audio at a 48 kHz/16-bit sampling rate.

● Video snapshot

You can shoot video snapshots. For details, see page 187.

Movie Shooting Cautions

White and Red Internal Temperature Warning Icons

- If the camera's internal temperature increases due to prolonged movie shooting or under a high ambient temperature, a white icon  will appear. Even if you shoot a movie while this icon is displayed, the movie's image quality will hardly be affected. However, if you shoot still photos, the image quality of the still photos may deteriorate. It is recommended to stop still photo shooting for a while and allow the camera to cool down.
- If the camera's internal temperature further increases while the white icon  is displayed, a red icon  will start blinking. This blinking icon indicates that movie shooting will soon stop automatically. If this happens, you will not be able to shoot again until the camera's internal temperature decreases. Turn off the power and let the camera rest for a while.
- Shooting a movie at a high temperature for a prolonged period will cause the  and  icons to appear earlier. When you are not shooting, turn off the camera.

Recording

- If the attached lens has an Image Stabilizer and you set the Image Stabilizer (IS) switch to **<ON>**, the Image Stabilizer will operate at all times even if you do not press the shutter button halfway. The Image Stabilizer consumes battery power and may shorten the total movie shooting time or decrease the number of possible shots. If you use a tripod or if the Image Stabilizer is not necessary, it is recommended to set the IS switch to **<OFF>**.
- The camera's built-in microphone will also pick up camera operation noise. Using a commercially-available external microphone can prevent (or reduce) these noises from being recorded.
- Do not connect anything other than an external microphone to the camera's external microphone IN terminal.
- If the brightness changes during autoexposure movie shooting, that part may look momentarily still when you play back the movie. In such cases, shoot movies with manual exposure.

Movie Shooting Cautions

Recording

- If you use a card with a slow writing speed, a five-level indicator may appear on the right of the screen during movie shooting. It indicates how much data has not yet been written to the card (remaining capacity of the internal buffer memory). The slower the card, the faster the indicator will climb upward. If the indicator becomes full, movie shooting will stop automatically.



Indicator

If the card has a fast writing speed, the indicator will either not appear or the level (if displayed) will hardly go upward.

First, shoot a few test movies to see if the card can write fast enough.

- If there is a very bright light source in the picture, the bright area may appear black on the LCD monitor. In movies, the bright areas will be recorded in almost the same way you see it on the LCD monitor.

Still Photo Shooting During Movie Shooting

- Regarding the image quality of still photos, see “Image Quality” on page 171.

TV Connection

- If you connect the camera to a TV set (p.262, 265) and shoot a movie, the TV will not output any sound during the shooting. However, the sound will be properly recorded.



Cautions when [Movie servo AF] is set to [Enable]

Shooting Conditions that Make Focusing Difficult

- A fast-moving subject approaching or moving away from the camera.
- A subject moving at a close distance in front of the camera.
- Also refer to “Shooting conditions that make focusing difficult” on page 165.
- Since using Movie Servo AF will consume battery power, the number of possible shots and the possible movie shooting time will be reduced.
- During zooming or image magnification, Movie Servo AF operation will be stopped momentarily.
- **During movie shooting, if a subject approaches / moves away, or if the camera is moved vertically or horizontally (panning), the recorded movie image may momentarily expand or contract (change in image magnification).**

7

Handy Features

- Disabling the Beeper (p.204)
- Card Reminder (p.204)
- Setting the Image Review Time (p.204)
- Setting the Auto Power-off Time (p.205)
- Adjusting the LCD Monitor Brightness (p.205)
- Creating and Selecting a Folder (p.206)
- File Numbering Methods (p.208)
- Setting Copyright Information (p.210)
- Auto Rotation of Vertical Images (p.212)
- Checking Camera Settings (p.213)
- Reverting the Camera to the Default Settings (p.214)
- Preventing the LCD Monitor from Turning Off Automatically (p.217)
- Changing the Shooting Settings Screen Color (p.217)
- Setting the Flash (p.218)
- Automatic Sensor Cleaning (p.223)
- Appending Dust Delete Data (p.224)
- Manual Sensor Cleaning (p.226)

Handy Features

MENU Disabling the Beeper

You can prevent the beeper from sounding when focus is achieved, during self-timer operation, and during touch screen operations.



Under the [**1**] tab, select [**Beep**], then press <SET>. Select [**Disable**], then press <SET>.

To silence the beeper only during touch screen operations, select [**Touch to** ].

MENU Card Reminder

This setting prevents shooting if there is no card in the camera.

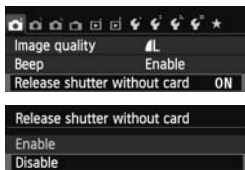

Under the [**1**] tab, select [**Release shutter without card**], then press <SET>. Select [**Disable**], then press <SET>.

If there is no card inserted in the camera and you press the shutter button, "**Card**" will be displayed in the viewfinder, and you cannot release the shutter.

MENU Setting the Image Review Time

You can set how long the image is displayed on the LCD monitor immediately after capture. If [**Off**] is set, the image will not be displayed immediately after image capture. If [**Hold**] is set, the image review will be displayed up until the [**Auto power off**] time.

During image review, if you operate any camera controls such as pressing the shutter button halfway, the image review will end.

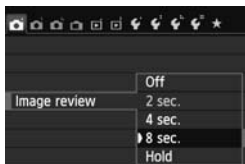

Under the [**1**] tab, select [**Image review**], then press <SET>. Select the desired setting, then press <SET>.

MENU Setting the Auto Power-off Time

To save battery power, the camera turns off automatically after the set time of idle operation elapses. You can set this auto power-off time. When the camera has turned off due to auto power off, you can turn it on again by pressing the shutter button halfway or pressing any of the following buttons: <MENU>, <INFO.>, <▶>, <📷>, etc.

If [Disable] is set, either turn off the camera or press the <INFO.> button to turn off the LCD monitor to save battery power.

Even when [Disable] is set, if the camera is not used for 30 min., the LCD monitor will turn off automatically. To turn on the LCD monitor again, press the <INFO.> button.

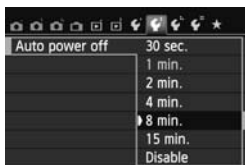

Under the [**2**] tab, select [**Auto power off**], then press <SET>. Select the desired setting, then press <SET>.

MENU Adjusting the LCD Monitor Brightness

You can adjust the brightness of the LCD monitor to make it easier to read.

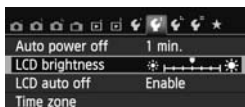

Under the [**2**] tab, select [**LCD brightness**], then press <SET>. With the adjustment screen displayed, press the <◀▶> key to adjust the brightness, then press <SET>.



When checking the exposure of an image, set the LCD monitor brightness to 4 and prevent the ambient light from affecting the reviewed image.

MENU Creating and Selecting a Folder

You can freely create and select the folder where the captured images are to be saved.

This operation is optional since a folder will be created automatically for saving captured images.

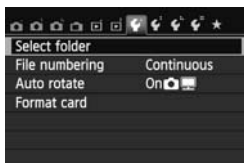
Creating a Folder**1 Select [Select folder].**

- Under the [**1**] tab, select [**Select folder**], then press <SET>.

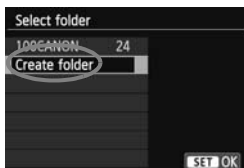
**2 Select [Create folder].**

- Select [**Create folder**], then press <SET>.

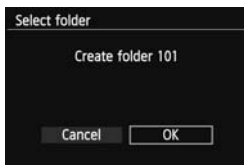
**3 Create a new folder.**

- Select [**OK**], then press <SET>.
- ▶ A new folder with the folder number increased by one is created.

Selecting a Folder

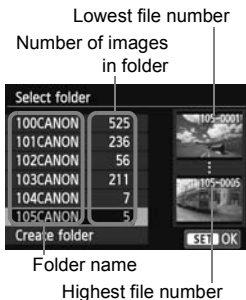

- With the folder selection screen displayed, select a folder and press **<SET>**.
- ▶ The folder where the captured images will be saved is selected.
- Subsequent captured images will be recorded into the selected folder.



About Folders

As with “100CANON” for example, the folder name starts with three digits (folder number) followed by five alphanumeric characters. A folder can contain up to 9999 images (file number 0001 - 9999). When a folder becomes full, a new folder with the folder number increased by one is created automatically. Also, if manual reset (p.209) is executed, a new folder will be created automatically. Folders numbered from 100 to 999 can be created.

Creating Folders with a Personal Computer

Open the card on the screen, and create a new folder named “DCIM”. Open the DCIM folder and create as many folders as necessary to save and organize your images. The folder name must follow the format “100ABC_D”. The first three digits are the folder number, from 100 to 999. The next five characters can be any combination of upper- and lower-case letters from A to Z, numerals, and the underscore “_”. The space cannot be used. Also note that two folder names cannot share the same three-digit folder number (for example, “100ABC_D” and “100W_XYZ”), even if the other five characters in each name are different, since the camera cannot recognize the folders.

MENU File Numbering Methods

The image files will be numbered from 0001 to 9999 in the order the images are taken, then saved in a folder. You can change how the file number is assigned.

The file number will appear on your computer in this format:

IMG_0001.JPG.

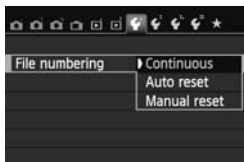

Under the [**F1**] tab, select [**File numbering**], then press <SET>. The available settings are described below. Select the option, then press <SET>.

- **[Continuous]: The file numbering continues in sequence even after you replace the card or create a folder.**

Even after you replace the card or create a new folder, the file numbering continues in sequence up to 9999. This is convenient when you want to save images numbered anywhere between 0001 to 9999 in multiple cards or folders into one folder in your personal computer.

However, if the replacement card or existing folder already contains images recorded previously, the file numbering of the new images may continue from the file numbering of the existing images in the card or folder. If you want to use continuous file numbering, use a newly formatted card each time.

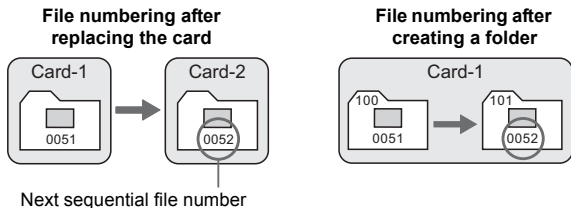

- **[Auto reset]: The file numbering restarts from 0001 each time the card is replaced or a new folder is created.**

When you replace the card or create a folder, the file numbering restarts from 0001 for the new images saved. This is convenient if you want to organize images according to cards or folders.

However, if the replacement card or existing folder already contains images recorded previously, the file numbering of the new images may continue from the file numbering of the existing images in the card or folder. If you want to save images with the file numbering starting from 0001, use a newly formatted card each time.

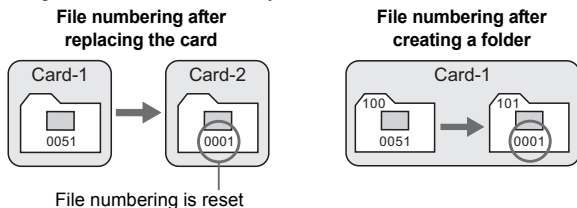

- **[Manual reset]: To reset the file numbering to 0001 manually or to start from file number 0001 in a new folder.**

When you reset the file numbering manually, a new folder is created automatically and the file numbering of images saved to that folder starts from 0001.

This is convenient if you want to use different folders for the images taken yesterday and the ones taken today, for example. After the manual reset, the file numbering returns to continuous or auto reset. (There will be no Manual reset confirmation screen.)

- If the file number in folder 999 reaches 9999, shooting will not be possible even if the card still has storage capacity. The LCD monitor will display a message telling you to replace the card. Replace it with a new card.

- For both JPEG and RAW images, the file name will start with "IMG_". Movie file names will start with "MVI_". The extension will be ".JPG" for JPEG images, ".CR2" for RAW images, and ".MOV" for movies.

MENU Setting Copyright Information ☆

When you set the copyright information, it will be appended to the image as Exif information.

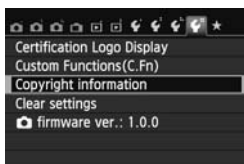
**1 Select [Copyright information].**

- Under the [**4**] tab, select [**Copyright information**], then press <SET>.

**2 Select the option to be set.**

- Select [**Enter author's name**] or [**Enter copyright details**], then press <SET>.
- ▶ The text entry screen will appear.
- Select [**Display copyright info.**] to check the copyright information currently set.
- Select [**Delete copyright information**] to delete the copyright information currently set.

**3 Enter text.**

- Refer to "Text Entry Procedure" on the next page and enter the copyright information.
- Enter up to 63 alphanumeric characters and symbols.

4 Exit the setting.

- After entering the text, press the <MENU> button to exit.
- On the confirmation dialog, select [**OK**] and press <SET>.

Text Entry Procedure



- **Changing the entry area:**
Press the <Q> button to toggle between the top and bottom entry areas.
- **Moving the cursor:**
Press the <◀▶> key to move the cursor.
- **Entering text:**
In the bottom area, press the <◆> key or turn the <⚙> dial to select a character, then press <SET> to enter it.
- **Changing the entry mode:***
Select [Aa=1@] at the bottom right of the bottom entry area. Each time you press <SET>, the entry mode will change as follows: Lower case → Numerals / Symbols 1 → Numerals / Symbols 2 → Upper case.
* When [Touch control: Disable] is set, you can display all the available characters on one screen.
- **Deleting a character:**
Press the <⏪> button to delete one character.
- **Exiting:**
Press the <MENU> button, check the text, select [OK], then press <SET>. The screen in step 2 will reappear.
- **Canceling the text entry:**
Press the <INFO.> button, check the text, select [OK], then press <SET>. The screen in step 2 will reappear.



You can also set or check the copyright information with EOS Utility (provided software, p.364).

MENU Auto Rotation of Vertical Images

Vertical images are rotated automatically so they are displayed vertically on the camera's LCD monitor and on the personal computer instead of horizontally. You can change the setting for this feature.

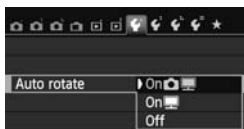

Under the [**F1**] tab, select [**Auto rotate**], then press <[**SET**]>. The available settings are described below. Select the option, then press <[**SET**]>.

- [**On**] : The vertical image is automatically rotated during playback on both the camera's LCD monitor and on the computer.
- [**On**] : The vertical image is automatically rotated only on the computer.
- [**Off**] : The vertical image is not automatically rotated.

? FAQ

- **The vertical image is not rotated during the image review immediately after it is captured.**
Press the <[**▶**]> button and the image playback will display the rotated image.
- **[On] is set, but the image does not rotate during playback.**
Auto rotate will not work with vertical images captured while [**Auto rotate**] was set to [**Off**]. If the vertical image is taken while the camera is pointed up or down, the image may not be rotated automatically for playback. In such a case, see "Rotating the Image" on page 247.
- **On the camera's LCD monitor, I want to rotate an image captured when [On] had been set.**
Set [**On**], then play back the image. It will be rotated.
- **The vertical image does not rotate on the computer screen.**
The software used is not compatible with image rotation. Use the software provided with the camera instead.

INFO. Checking Camera Settings

While the shooting settings (p.50) are displayed, press the <INFO.> button to display the camera's major function settings.

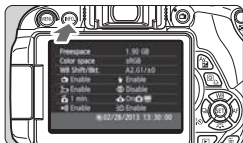

Settings display

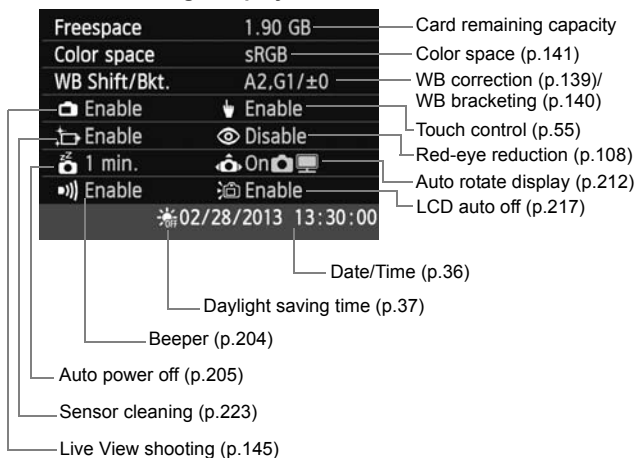

MENU Reverting the Camera to the Default Settings [☆]

The camera's shooting settings and menu settings can be reverted to their defaults. This option is available in Creative Zone modes.

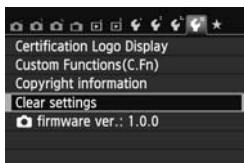
**1** Select **[Clear settings]**.

- Under the [**4**] tab, select [**Clear settings**], then press <SET>.

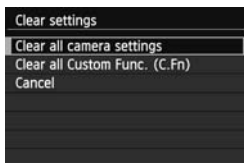
**2** Select **[Clear all camera settings]**.

- Select [**Clear all camera settings**], then press <SET>.

**3** Select **[OK]**.

- Select [**OK**], then press <SET>.
- ▶ Setting [**Clear all camera settings**] will reset the camera to the default settings as shown on the next page.

? FAQ● **Clearing all camera settings:**

After the procedure above, select [**Clear all Custom Func. (C.Fn)**] in [**4: Clear settings**] to clear all the Custom Function settings (p.296).

Shooting Settings









AF operation	One-Shot AF
AF point selection	Automatic selection
Drive mode	 (Single shooting)
Metering mode	 (Evaluative metering)
ISO speed	AUTO (Auto)
ISO Auto	Maximum 6400
Exposure compensation/AEB	Canceled
Built-in flash settings	Normal firing
Flash exposure compensation	0 (Zero)
Custom Functions	Unchanged
External flash function setting	Unchanged

Image-recording Settings

Image quality	 L
Picture Style	Auto
Auto Lighting Optimizer	Standard
Peripheral illumination correction	Enable/Correction data retained
Chromatic aberration correction	Disable/Correction data retained
Color space	sRGB
White balance	 (Auto)
Custom White Balance	Canceled
White balance correction	Canceled
White balance bracketing	Canceled
Long exposure noise reduction	Disable
High ISO speed noise reduction	Standard
File number	Continuous
Auto cleaning	Enable
Dust Delete Data	Erased

Camera Settings

Auto power off	30 sec.
Beep	Enable
Release shutter without card	Enable
Image review	2 sec.
Histogram display	Brightness
Image jump with 	 10 (10 images)
Auto rotate	On 
LCD brightness	
LCD auto off	Enable
Time zone	Unchanged
Date/Time	Unchanged
Language	Unchanged
Video system	Unchanged
Screen color	1
Feature guide	Enable
Touch control	Enable
Copyright information	Unchanged
Control over HDMI	Disable
Eye-Fi transmission	Disable
My Menu settings	Unchanged
Display from My Menu	Disable

Live View Shooting

Live View shooting	Enable
AF method	☺+Tracking
Continuous AF	Enable
Touch Shutter	Disable
Grid display	Off
Aspect ratio	3:2
Metering timer	16 sec.

Movie Shooting

AF method	☺+Tracking
Movie Servo AF	Enable
AF with shutter button during 	ONE SHOT
Grid display	Off
Metering timer	16 sec.
Movie recording size	1920x1080
Sound recording	Auto
Video snapshot	Disable

MENU Preventing the LCD Monitor from Turning Off Automatically

You can prevent the display-off sensor from turning off the shooting setting display on the LCD monitor when your eye approaches the viewfinder.

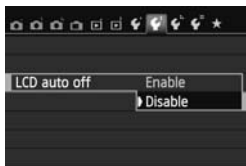

Under the [**2**] tab, select [**LCD auto off**], then press <SET>. Select [**Disable**], then press <SET>.

MENU Changing the Shooting Settings Screen Color

You can change the background color of the shooting settings screen.

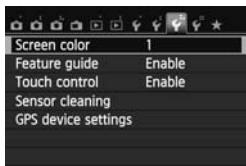

Under the [**3**] tab, select [**Screen color**], then press <SET>. Select the desired color, then press <SET>.

When you exit the menu, the selected color will be displayed for the shooting settings screen.



MENU Setting the Flash ☆

The built-in flash and external Speedlite settings can be set with the camera's menu. You can use the camera's menu to set the external Speedlite function settings only if **an EX-series Speedlite compatible with this function is attached**.

The setting procedure is the same as when setting a camera menu function.

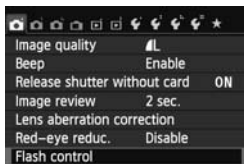

Select [Flash control].

- Under the [📷 1] tab, select [Flash control], then press <SET>.
- ▶ The flash control screen will appear.

[Flash firing]

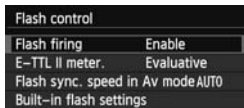

- Normally, set this to [Enable].
- If [Disable] is set, neither the built-in flash nor the external Speedlite will fire. This is useful when you only want to use the flash's AF-assist beam.

[E-TTL II meter.]

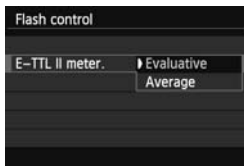

- For normal flash exposures, set this to [Evaluative].
- [Average] is for advanced users. As with an external Speedlite, the metering area is averaged. Flash exposure compensation may be necessary.

Even if [Flash firing] is set to [Disable], if focus is difficult to achieve in low light, the flash may still fire a series of flashes (AF-assist beam, p.101).

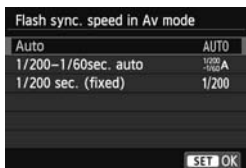
[Flash sync. speed in Av mode]

You can set the flash-sync speed for flash photography in the aperture-priority AE (**Av**) mode.

- **AUTO: Auto**

The flash sync speed is set automatically within a range of 1/200 sec. to 30 sec. to suit the scene's brightness. High-speed sync is also possible.

- $\frac{1}{200}$ - $\frac{1}{60}$ A: **1/200-1/60 sec. auto**

Prevents a slow shutter speed from being set in low-light conditions. It is effective for preventing subject blur and camera shake.

However, while the subject will be properly exposed with the flash, the background may come out dark.

- 1/200: **1/200 sec. (fixed)**

The flash-sync speed is fixed at 1/200 sec. This more effectively prevents subject blur and camera shake than with **[1/200-1/60 sec. auto]**. However, in low light, the subject's background will come out darker than with **[1/200-1/60 sec. auto]**.



If **[1/200-1/60 sec. auto]** or **[1/200 sec. (fixed)]** is set, high-speed sync is not possible in the **<Av>** mode.

[Built-in flash settings] and [External flash func. setting]

You can set the functions in the table below. The functions displayed under [External flash func. setting] will vary depending on the Speedlite model.

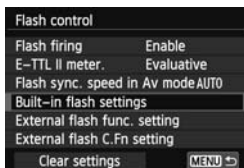

- Select [Built-in flash settings] or [External flash func. setting].
- ▶ The flash functions will be displayed. With [Built-in flash settings], the highlighted functions can be selected and set.

Sample screen

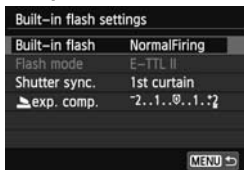

[Built-in flash settings]

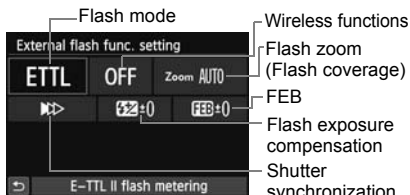

[External flash func. setting]

[Built-in flash settings] and [External flash func. settings] Functions

Function	[Built-in flash settings]			[External flash func. setting]	Page
	Normal Firing	Easy Wireless (p.231)	Custom Wireless (p.234)		
Flash mode			○	○	221
Shutter synchronization	○			○	221
FEB*				○	
Wireless functions			○	○	229
Channel		○	○	○	232
Flash group			○	○	235
Flash exposure compensation	○	○	○	○	120
Zoom*				○	

* For [FEB] (Flash exposure bracketing) and [Zoom], refer to the instruction manual of a Speedlite compatible with the functions.

- **Shutter synchronization**

Normally, set this to **[1st curtain]** so that the flash fires immediately after the exposure starts.

If **[2nd curtain]** is set, the flash will fire right before the shutter closes. When this is combined with a slow shutter speed, you can create a trail of light such as from car headlights at night. With E-TTL II (auto flash exposure), two flashes will be fired: once when you press the shutter button completely, and once immediately before the exposure ends. Also, with shutter speeds faster than 1/30 sec., 1st curtain synchronization will automatically take effect.

If an external Speedlite is attached, you can also select **[Hi-speed]** (⚡_H). For details, refer to the Speedlite's instruction manual.

- **Wireless functions**

When performing optical transmission wireless flash shooting using the master function of the built-in flash, see “Wireless Flash Photography” on page 229. When performing wireless flash shooting with radio or optical transmission using the master function of the external Speedlite, refer to the Speedlite's instruction manual.

- **Flash exposure compensation**

See “Flash Exposure Compensation” on page 120.

- **Flash mode**

You can select the flash mode to suit your desired flash shooting.

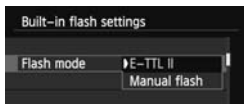

- **[E-TTL II]** is the standard mode of EX-series Speedlites for automatic flash shooting.
- **[Manual flash]** is for advanced users who want to set the **[Flash output]** (1/1 to 1/128) themselves.
- Regarding other flash modes, refer to the instruction manual of a Speedlite compatible with the functions.

Setting the External Speedlite Custom Functions

The Custom Functions displayed under **[External flash C.Fn setting]** will vary depending on the Speedlite model.

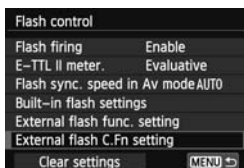

1 Display the Custom Function.

- With the camera ready to shoot with an external Speedlite, select **[External flash C.Fn setting]**, then press **< (SET) >**.

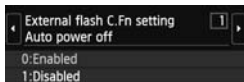

2 Set the Custom Function.

- Press the **< ◀ ▶ >** key to select the function number, then set the function. The procedure is the same as setting the camera's Custom Functions (p.296).

Clear the Settings

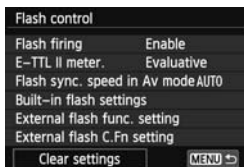

1 Select [Clear settings].

- Under the **[📷 1: Flash control]** tab, select **[Clear settings]**, then press **< (SET) >**.

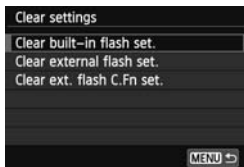

2 Select the settings to be cleared.

- Select **[Clear built-in flash set.]**, **[Clear external flash set.]**, or **[Clear ext. flash C.Fn set.]**, then press **< (SET) >**.
- When you select **[OK]**, the respective flash settings will be cleared.

Automatic Sensor Cleaning

Whenever you set the power switch to <ON> or <OFF>, the Self Cleaning Sensor Unit operates to automatically shake off the dust on the front of the sensor. Normally, you need not pay attention to this operation. However, you can choose to perform sensor cleaning at any time, or disable it.

Cleaning the Sensor Now

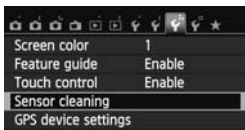

1 Select [Sensor cleaning].

- Under the [**3**] tab, select [**Sensor cleaning**], then press <SET>.

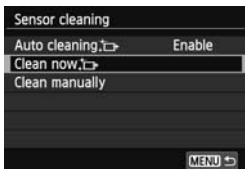

2 Select [Clean now].

- Select [**Clean now**], then press <SET>.
- Select [**OK**] on the dialog screen, then press <SET>.
- ▶ The screen will indicate that the sensor is being cleaned. (A small sound may be heard.) Although there will be a shutter sound during the cleaning, a picture is not taken.



- For best results, perform the sensor cleaning with the camera placed upright and stable on a table or other flat surface.
- Even if you repeat the sensor cleaning, the result will not improve much. Immediately after the sensor cleaning is finished, the [**Clean now**] option will remain disabled temporarily.

Disabling Automatic Sensor Cleaning

- In step 2, select [**Auto cleaning**] and set it to [**Disable**].
- ▶ The sensor cleaning will no longer be executed when you set the power switch to <ON> or <OFF>.

MENU Appending Dust Delete Data ☆

Normally, the Self Cleaning Sensor Unit will eliminate most of the dust that may be visible on captured images. However, in case visible dust still remains, you can append the Dust Delete Data to the image for erasing the dust spots later. The Dust Delete Data is used by Digital Photo Professional (provided software, p.364) to erase the dust spots automatically.

Preparation

- Prepare a solid white object such as a sheet of paper.
- Set the lens focal length to 50 mm or longer.
- Set the lens focus mode switch to <MF> and set the focus to infinity (∞). If the lens has no distance scale, look at the front of the lens and turn the focusing ring clockwise all the way.

Obtain the Dust Delete Data

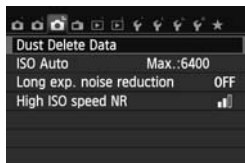

1 Select [Dust Delete Data].

- Under the [CAMERA 3] tab, select [Dust Delete Data], then press <SET>.



2 Select [OK].

- Select [OK] and press <SET>. After the automatic self-cleaning of the sensor is performed, a message will appear. Although there will be a shutter sound during the cleaning, a picture is not taken.

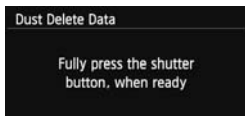
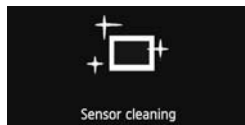

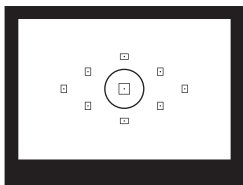

3 Photograph a solid-white object.

- At a distance of 20 cm - 30 cm (0.7 ft. - 1.0 ft.), fill the viewfinder with a patternless, solid-white object and take a picture.
- ▶ The picture will be taken in aperture-priority AE mode at an aperture of f/22.
- Since the image will not be saved, the data can still be obtained even if there is no card in the camera.
- ▶ When the picture is taken, the camera will start collecting the Dust Delete Data. When the Dust Delete Data is obtained, a message will appear. Select [OK], and the menu will reappear.
- If the data was not obtained successfully, an error message will appear. Follow the “Preparation” procedure on the preceding page, then select [OK]. Take the picture again.

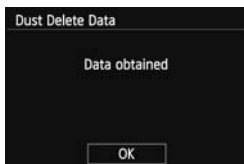

About the Dust Delete Data

After the Dust Delete Data is obtained, it is appended to all the JPEG and **RAW** images captured thereafter. Before an important shoot, it is recommended to update the Dust Delete Data by obtaining it again. For details about using Digital Photo Professional (provided software, p.364) to erase dust spots, refer to the Digital Photo Professional Instruction Manual (p.367).

The Dust Delete Data appended to the image is so small that it hardly affects the image file size.

 Be sure to use a solid-white object such as a new sheet of white paper. If the paper has any pattern or design, it may be recognized as dust data and affect the accuracy of the dust deletion with the software.

MENU Manual Sensor Cleaning ☆

Dust that could not be removed by the automatic sensor cleaning can be removed manually with a blower, etc. Before cleaning the sensor, detach the lens from the camera.

The surface of the image sensor is extremely delicate. If the sensor needs to be cleaned directly, having it done by a Canon Service Center is recommended.

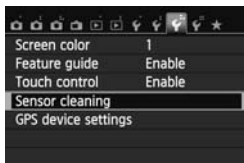

1 Select [Sensor cleaning].

- Under the [**3**] tab, select [**Sensor cleaning**], then press <SET>.

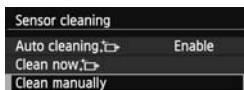

2 Select [Clean manually].

- Select [**Clean manually**], then press <SET>.



3 Select [OK].

- Select [**OK**], then press <SET>.
- ▶ In a moment, the reflex mirror will lockup and the shutter will open.

4 Clean the sensor.

5 End the cleaning.

- Set the power switch to <OFF>.

 If you use a battery, make sure it is fully charged. If the battery grip with size-AA/LR6 batteries is attached, manual sensor cleaning will not be possible.

 For the power source, using AC Adapter Kit ACK-E8 (sold separately) is recommended.



- **While cleaning the sensor, never do any of the following. If the power is cut off, the shutter will close and the shutter curtains and image sensor may get damaged.**
 - **Setting the power switch to <OFF>.**
 - **Opening the battery compartment cover.**
 - **Opening the card slot cover.**
- The surface of the image sensor is extremely delicate. Clean the sensor with care.
- Use a plain blower without any brush attached. A brush can scratch the sensor.
- Do not insert the blower tip inside the camera beyond the lens mount. If the power is turned off, the shutter will close and the shutter curtains or reflex mirror may get damaged.
- Never use canned air or gas to clean the sensor. The blowing force can damage the sensor or the spray gas can freeze on the sensor.
- If the battery level becomes low while you clean the sensor, the beeper will sound as a warning. Stop cleaning the sensor.
- If a smudge that cannot be removed with a blower remains, having the sensor cleaned by a Canon Service Center is recommended.



8

Wireless Flash Photography

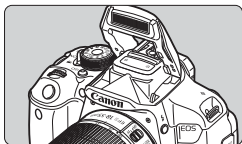

You can use the built-in flash for wireless flash shooting.

The camera's built-in flash can work as a master unit with Canon Speedlites with a wireless slave feature and wirelessly trigger the Speedlite(s) to fire.

Canceling the slave unit's auto power off

To cancel the slave unit's auto power off, press the camera's **< * >** button. If you are using manual flash firing, press the slave unit's test firing (PILOT) button to cancel the auto power off.



Be sure to also read the information about wireless flash photography in the Speedlite's instruction manual.

Using Wireless Flash ☆

Slave Unit Settings and Position

Regarding your Speedlite (slave unit), refer to its instruction manual and set it as follows. The settings other than the ones below for the slave unit's control are all set with the camera. Different types of Canon Speedlite slave units can be used and controlled together.

- (1) Set the Speedlite as a slave unit.
- (2) Set the Speedlite's transmission channel to the same channel as set on the camera.*¹
- (3) If you want to set the flash ratio (p.236), set the slave unit ID.
- (4) Position the camera and slave unit(s) within the range shown below.
- (5) Face the slave unit's wireless sensor toward the camera.*²

Example of Wireless Flash Set-up

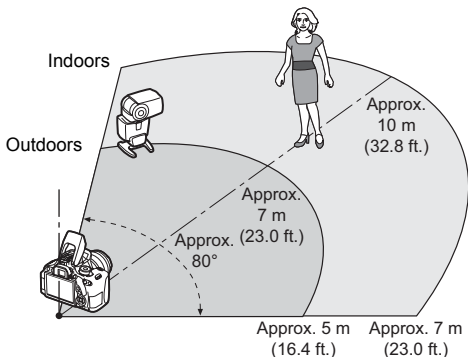

*1: If the Speedlite does not have a transmission channel setting function, the camera can work with any channel.

*2: In small rooms, the slave unit may work even if its wireless sensor does not face the camera. The camera's wireless signals can bounce off the walls and be received by the slave unit. When using an EX-series Speedlite with fixed flash head and wireless sensor, take pictures to make sure it can fire.

ⓘ The camera's master unit function cannot be used for wireless flash shooting with radio transmission.

Easy Wireless Flash Shooting

The basics of easy, fully automatic wireless flash shooting are explained below.

Fully Automatic Shooting with One External Speedlite

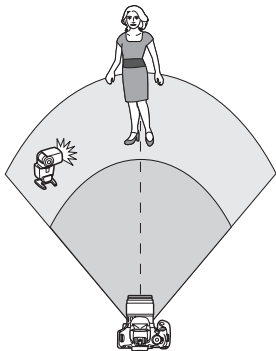

Steps 1 to 4 and 6 apply to all wireless flash shooting. Therefore, these steps are omitted in the other wireless flash setups explained on the pages hereafter.

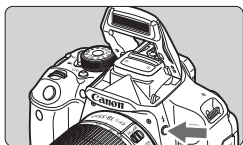

1 Press the <⚡> button to raise the built-in flash.

- For wireless flash shooting, be sure to raise the built-in flash.

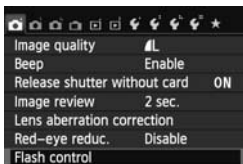

2 Select [Flash control].

- Under the [📷1] tab, select [Flash control], then press <SET>.

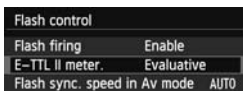

3 Select [Evaluative].

- For [E-TTL II meter.], select [Evaluative], then press <SET>.

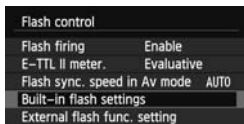

4 Select [Built-in flash settings].

- Select [**Built-in flash settings**], then press <SET>.

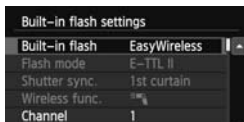

5 Select [EasyWireless].

- Under [**Built-in flash**], select [**EasyWireless**], then press <SET>.

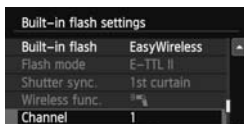

6 Set [Channel].

- Set the transmission channel (1-4) to the same one as the slave unit.

7 Take the picture.

- Set the camera and take picture in the same way as with normal shooting.

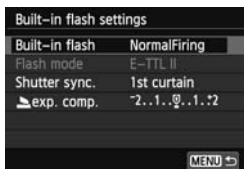

8 Exit the wireless flash shooting.

- For [**Built-in flash**], select [**NormalFiring**].



- Setting [**E-TTL II meter.**] to [**Evaluative**] is recommended.
- Even though the firing of the built-in flash is disabled when [**EasyWireless**] is set, it will still fire a small flash to control the slave unit. Depending on shooting conditions, the flash fired to control the slave unit may appear in the picture.
- Firing a test flash is not possible with the slave unit.

Fully Automatic Shooting with Multiple External Speedlites

You can have multiple slave units fire as if they were a single Speedlite. This is convenient when you need a large flash output.

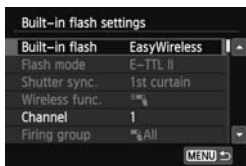

Basic settings:

Flash mode : E-TTL II

E-TTL II meter. : Evaluative

Built-in flash : EasyWireless

Channel : (Same as slave units)

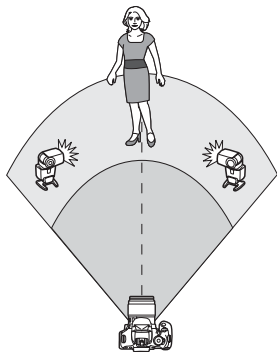

All the slave units will fire at the same output and be controlled to obtain a standard exposure.

No matter what the slave ID is (A, B, or C), all the slave units will fire as one group.

Flash Exposure Compensation

If the flash exposure looks too dark or too bright, you can set flash exposure compensation to adjust the slave units' flash output.

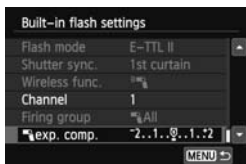

- Select [**exp. comp.**], then press **<SET>**.
- If the flash exposure is too dark, press the **<▶>** key to increase the flash exposure and make it brighter. If the flash exposure is too bright, press the **<◀>** key to decrease the flash exposure and make it darker.



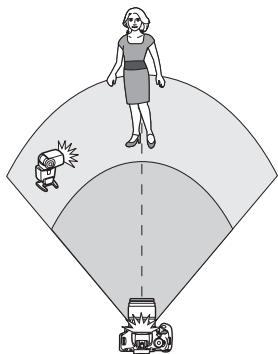

Custom Wireless Flash Shooting

Fully Automatic Shooting with One External Speedlite and Built-in Flash



This section describes fully automatic wireless flash shooting with one external Speedlite and the built-in flash.

You can change the flash ratio between the external Speedlite and built-in flash to adjust how the shadows look on the subject.

On the menu screens, the  and  icons refer to the external Speedlite, and the  and  icons refer to the built-in flash.

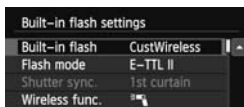

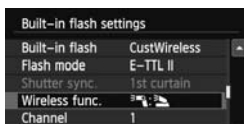

1 Select [CustWireless].

- Follow step 5 on page 232 to select [CustWireless], then press .





2 Select [Wireless func.].

- Under [Wireless func.], select  : , then press .



3 Set the desired flash ratio and take the picture.

- Select  :  and set the flash ratio within 8:1 to 1:1. Setting a flash ratio to the right of 1:1 is not possible.
- If the built-in flash output is not enough, set a higher ISO speed (p.92).

 The 8:1 to 1:1 flash ratio is equivalent to 3:1 to 1:1 stops (1/2-stop increments).

Fully Automatic Shooting with Multiple External Speedlites

Multiple Speedlite slave units can be treated as one flash unit or separated into slave groups whose flash ratio can be set.

The basic settings are shown below. By changing the **[Firing group]** setting, you can shoot with various wireless flash setups with multiple Speedlites.

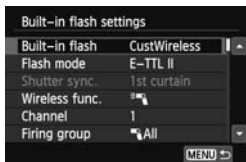

Basic settings:

Flash mode : E-TTL II

E-TTL II meter. : Evaluative

Wireless func. : [Wireless icon]

Channel : (Same as slave units)

[All] Using multiple slave Speedlites as one flash unit

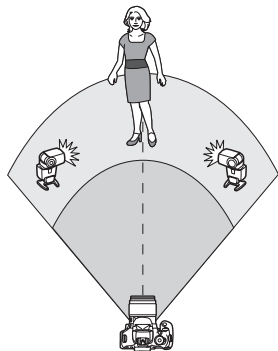

This is convenient when you need a large flash output. All the slave units will fire at the same output and be controlled to obtain a standard exposure.

No matter what the slave ID is (A, B, or C), all the slave units will fire as one group.



Set **[Firing group]** to **[All]**, then take the picture.

[(A:B)] Multiple slave units in multiple groups

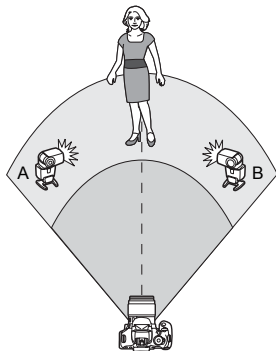

Divide the slave units into groups A and B and change the flash ratio to obtain the desired lighting effect.

Refer to your Speedlite's instruction manual to set one slave unit's slave ID to A (Group A) and the other slave unit's ID to B (Group B), and position them as shown in the illustration.

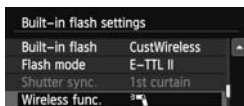

1 Select [Wireless func.].

- Follow step 2 on page 234 to select [, then press <SET>.

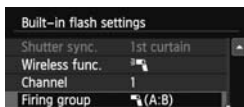

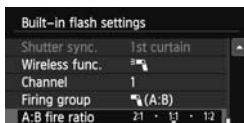

2 Set [Firing group] to [(A:B)].



3 Set the desired flash ratio and take the picture.

- Select [A:B fire ratio] and set the flash ratio.

 If [Firing group] is set to [ (A:B)], group C will not fire.

 The 8:1 to 1:1 to 1:8 flash ratio is equivalent to 3:1 to 1:1 to 1:3 stops (1/2-stop increments).

Fully Automatic Shooting with the Built-in Flash and Multiple External Speedlites

The built-in flash can also be added to wireless flash shooting explained on pages 235-236.

The basic settings are shown below. By changing the **[Firing group]** setting, you can shoot with various wireless flash setups of multiple Speedlites complemented with the built-in flash.

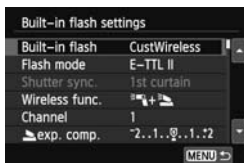

1 Basic settings:

- Flash mode** : E-TTL II
- E-TTL II meter.** : Evaluative
- Wireless func.** : [Icon]
- Channel** : (Same as slave units)



2 Select [Firing group].

- Select the firing group, then set the flash ratio, flash exposure compensation, and other necessary settings before shooting.

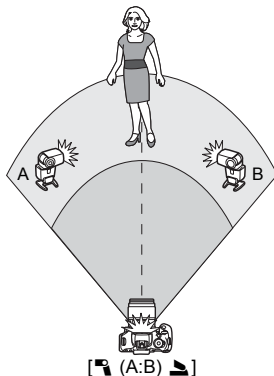
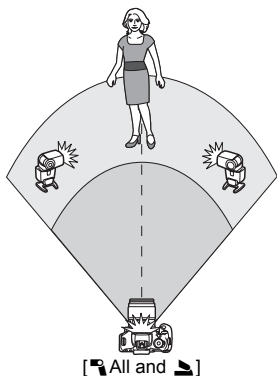

Other Settings

Flash Exposure Compensation

When **[Flash mode]** is set to **[E-TTL II]**, flash exposure compensation can be set. The flash exposure compensation settings (see below) which can be set will differ depending on the **[Wireless func.]** and **[Firing group]** settings.

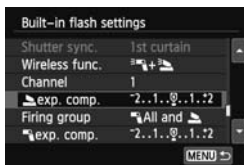

[Flash exp. comp.]

- The flash exposure compensation is applied to the built-in flash and all external Speedlites.

[exp. comp.]

- The flash exposure compensation is applied to the built-in flash.

[exp. comp.]

- The flash exposure compensation is applied to all external Speedlites.

FE Lock

If **[Flash mode]** is set to **[E-TTL II]**, you can press the **< * >** button to perform FE lock.

Setting the Flash Output Manually for Wireless Flash Shooting

When **[Flash mode]** is set to **[Manual flash]**, flash exposure can be set manually. The flash output settings (**[Flash output]**, **[Group A output]**, etc.) that can be set will differ depending on the **[Wireless func.]** setting (see below).

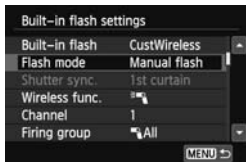

[Wireless func.]

- **[Firing group: All]**: The manual flash output setting will be applied to all the external Speedlites.
- **[Firing group: (A:B)]**: You can set the flash output separately for slave groups A and B.

[Wireless func.]

- **[Firing group: All and]**: The flash output can be set separately for the external Speedlite(s) and built-in flash.
- **[Firing group: (A:B)]**: You can set the flash output separately for slave groups A and B. You can also set the flash output for the built-in flash.



9

Image Playback

This chapter explains functions related to viewing photos and movies, with more detail than in Chapter 2 “Basic Shooting and Image Playback”. Here you will find explanations of how to play back and erase photos and movies with the camera and view them on a TV set.

About images shot and saved with another device

The camera may not be able to properly display images captured with a different camera, edited with a computer, or had their file names changed.

▶ Searching for Images Quickly

▣ Display Multiple Images on One Screen (Index Display)

Search for images quickly with the index display showing four or nine images on one screen.



1 Play back the image.

- When you press the <▶> button, the last image captured will be displayed.

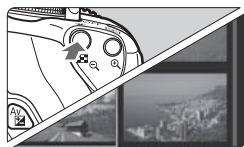

2 Switch to the index display.

- Press the <▣ Q> button.
- ▶ The 4-image index display will appear. The currently-selected image will be highlighted in a blue frame.
- Press the <▣ Q> button again to switch to the 9-image index display.
- Pressing the <Q> button will switch the display from 9 images to 4 images and then to 1 image.



3 Select an image.

- Press the <◀▶> key to move the blue frame to select an image.
- Turning the <⚙> dial will display the next screen or previous image.
- Press <SET> and the selected image will be displayed as a single image.

Jump through Images (Jump Display)

With the single-image display, you can turn the <  > dial to jump through the images forward or backward according to the jump method set.

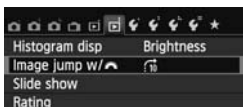

1 Select [Image jump w/].

- Under the [▶2] tab, select [Image jump w/ ], then press < (SET) >.



2 Select the jump method.

- Press the <  > key to select the jump method, then press < (SET) >.

 : Display images one by one

 : Jump 10 images

 : Jump 100 images

 : Display by date

 : Display by folder

 : Display movies only

 : Display stills only

 : Display by image rating (p.248)

Turn the <  > dial to select.



Jump method

Playback position

3 Browse by jumping.

- Press the < ▶ > button to play back images.
- On the single-image display, turn the <  > dial.





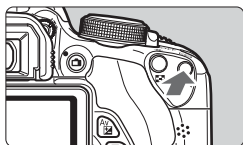

- To search images according to the shooting date, select [Date].
- To search images according to folder, select [Folder].
- If the card contains both movies and still photos, select [Movies] or [Stills] to display only either ones.
- If no images match the selected [Rating], you cannot browse through the images with the <  > dial.

Magnified View

You can magnify a captured image by approx. 1.5x to 10x on the LCD monitor.



1 Magnify the image.



- Press the  button during image playback.
- ▶ The image will be magnified.
- If you hold down the  button, the image will be magnified until it reaches the maximum magnification.
- Press the   button to reduce the magnification. If you hold down the button, the magnification will be reduced to the single-image display.





Magnified area position



2 Scroll around the image.

- Use the  key to scroll around the magnified image.
- To exit the magnified display, press the  button and the single-image display will return.



-  ● In magnified view, you can turn the  dial to view another image at the same magnification.
- The image cannot be magnified during the image review immediately after shooting.
- A movie cannot be magnified.

Playing Back with the Touch Screen

The LCD monitor is a touch-sensitive panel that you can touch with your fingers for playback operations. **Press the <▶> button to play back images.**

Browsing Images



Swipe with one finger.

- With the single-image display, use **one finger** to swipe the image to the left or right to see another image. Swipe to the left to see the next (newer) image or swipe to the right to see the previous (older) image.
- With the index display, use **one finger** to scroll up or down the screen to display another screen of index images. Swipe your finger up to see newer images or swipe your finger down to see the older images. When you select an image and tap it, it will be displayed as a single image.

Jump through Images (Jump Display)

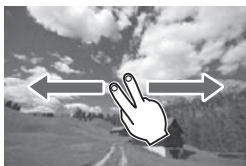

Swipe with two fingers.

When you use **two fingers** to swipe left or right on the screen, you can jump through images with the method set in [Image jump w/ 

Reduce Image (Index Display)



Pinch two fingers.

Touch the screen with two fingers spread apart, and pinch your fingers together on the screen.

- Each time you pinch your fingers, the screen changes from a single-image display to a 4-image index display and 9-image index display. Spreading two fingers on the screen will reverse this operation.
- The selected image is highlighted in a blue frame. When you tap the selected image, it will be displayed as a single image.

Magnify Image



Spread two fingers apart.

Touch the screen with two fingers together, then spread your fingers apart on the screen.

- As you spread your fingers, the image will be magnified.
- The image can be magnified up to 10x.
- You can scroll around the image by swiping your finger.
- To reduce the image, pinch your fingers together on the screen.
- Tapping the [↶] icon will return to the single-image display.

 Touch screen operations explained on pages 245 - 246 are also possible while viewing images on a TV set connected to your camera (p.262, 265).

Rotating the Image

You can rotate the displayed image to the desired orientation.

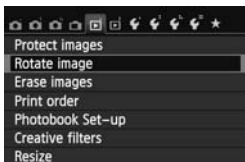

1 Select [Rotate image].

- Under the [] tab, select [Rotate image], then press <SET>.



2 Select an image.



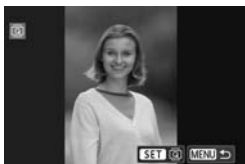

- Press the <◀▶> key to select the image to be rotated.
- You can also select an image on the index display (p.242).



3 Rotate the image.

- Each time you press <SET>, the image will rotate clockwise as follows: 90° → 270° → 0°.
- To rotate another image, repeat steps 2 and 3.
- To exit and return to the menu, press the <MENU> button.



- If you have set [**1: Auto rotate**] to [**On**  ] (p.212) before taking vertical shots, you need not rotate the image as described above.
- If the rotated image is not displayed in the rotated orientation during image playback, set [**1: Auto rotate**] to [**On**  ].
- A movie cannot be rotated.

MENU Setting Ratings

You can rate images and movies with one of five rating marks: [★]/[★•]/[★••]/[★•••]/[★••••]. This function is called rating.



1 Select [Rating].

- Under the [▶] 2 tab, select [Rating], then press <SET>.



2 Select an image or movie.

- Press the <◀▶> key to select an image or movie to be rated.
- You can display three images by pressing the <[grid] Q> button. To return to the single-image display, press the <Q> button.



3 Rate the image or movie.

- Press the <▲▼> key to select a rating.
- ▶ The total number of images and movies rated will be counted for each rating.
- To rate another image or movie, repeat steps 2 and 3.
- Press the <MENU> button to return to the menu.









The total number of images with a given rating that can be displayed is 999. If there are more than 999 images with a given rating, [###] will be displayed for that rating.

Taking Advantage of Ratings

- With [▶2: **Image jump w/** , you can display only images and movies with a specific rating.
- With [▶2: **Slide show**], you can play back only images and movies with a specific rating.
- With Digital Photo Professional (provided software, p.364), you can select only images and movies with a specific rating (still photos only).
- With Windows 8.1, Windows 8, or Windows 7, etc., you can see each file's rating as part of the file information display or in the provided image viewer (still photos only).

Quick Control During Playback

During playback, you can press the <Q> button to set any of the following: [: **Protect images**], [: Rotate image], [: **Rating**], [: Creative filters], [: Resize (JPEG images only)], and [: **Image jump w/ **].

For movies, only the functions in bold above can be set.



1 Press the <Q> button.

- During image playback, press the <Q> button.
- ▶ The Quick Control screen will appear.









2 Select a function and set it.

- Press the <▲▼> key to select a function.
- ▶ The name and current setting of the selected function are displayed at the bottom of the screen.
- Set it by pressing the <◀▶> key.
- For Creative filters and Resize, press <SET> and set the function. For details, see page 274 for Creative filters and page 277 for Resize. To cancel, press the <MENU> button.

3 Exit the setting.

- Press the <Q> button to exit the Quick Control screen.

 To rotate an image, set [**1: Auto rotate**] to [**On**  ]. If [**1: Auto rotate**] is set to [**On** ] or [**Off**], the [**Rotate image**] setting will be recorded to the image, but the camera will not rotate the image for display.

-  ● Pressing the <> button during the index display will switch to the single-image display and the Quick Control screen will appear. Pressing the <> button again will return to the index display.
- For images taken with another camera, the functions you can select may be limited.

Enjoying Movies

You can play back movies in the following three ways:

Playback on a TV set (p.262, 265)



Use the stereo AV cable AVC-DC400ST (sold separately) or HDMI cable HTC-100 (sold separately) to connect the camera to a TV set. Then you can play back captured movies and still photos on the TV.

If you have a High-Definition TV set and connect your camera with an HDMI cable, you can watch Full High-Definition (Full HD: 1920x1080) and High-Definition (HD: 1280x720) movies with higher image quality.

- Since hard disk recorders do not have an HDMI IN terminal, the camera cannot be connected to a hard disk recorder with an HDMI cable.
- Even if you connect the camera to a hard disk recorder with a cable, you cannot play or save movies and images.
- If the playback device is not compatible with MOV files, the movie cannot be played.

Playback on the Camera's LCD Monitor (p.254-261)

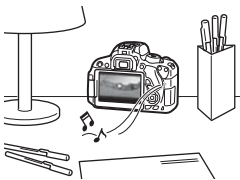

You can play back movies on the camera's LCD monitor. You can also edit out the movie's first and last scenes, and play back the still photos and movies on the card in an automatic slide show.

- A movie edited with a personal computer cannot be rewritten to the card and played back with the camera. However, video snapshot albums edited with EOS Video Snapshot Task (p.195) can be played on the camera.

Playback and Editing with a Personal Computer (p.365)



The movie files recorded on the card can be transferred to a personal computer and played with ImageBrowser EX (provided software).

- To have the movie play back smoothly on a personal computer, use a high-performance personal computer. Regarding the computer hardware requirements for ImageBrowser EX, refer to the PDF file ImageBrowser EX User Guide.
- If you want to use commercially-available software to play back or edit the movies, make sure it is compatible with MOV files. For details on commercially-available software, contact the software manufacturer.

▶ Playing Movies



1 Play back the image.

- Press the <▶> button to display images.



2 Select a movie.

- Press the <◀▶> key to select a movie.
- On the single-image display, the <SET [MOV]> icon displayed on the upper left indicates a movie. If the movie is a video snapshot, <SET [STILL]> will be displayed.
- You can press the <INFO.> button to switch to the shooting information display (p.271).
- In the index display, perforations at the left edge of a thumbnail indicate a movie. **As movies cannot be played on the index display, press <SET> to switch to the single-image display.**



3 In the single-image display, press <SET>.

- ▶ The movie playback panel will appear at the bottom of the screen.



4 Play back the movie.

- Select [▶] (Play), then press <SET>.
- ▶ The movie will start playing.
- You can pause the movie playback by pressing <SET>.
- During movie playback, you can turn the <☀> dial to adjust the built-in speaker's sound volume.
- For more details on the playback procedure, see the next page.

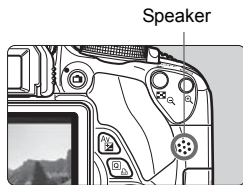

ⓘ The camera might not be able to play movies shot by another camera.

Movie Playback Panel

Operation	Playback Description
Play	Pressing <SET> toggles between play and stop.
Slow motion	Adjust the slow motion speed by pressing the <◀▶> key. The slow-motion speed is indicated at the upper right of the screen.
First frame	Displays the movie's first frame.
Previous frame	Each time you press <◀SET>, the previous frame is displayed. If you hold down <◀SET>, it will rewind the movie.
Next frame	Each time you press <▶SET>, the movie will play frame-by-frame. If you hold down <▶SET>, it will fast forward the movie.
Last frame	Displays the movie's last frame.
Background music*	Play back a movie with the selected background music (p.261).
Edit	Displays the editing screen (p.256).
	Play back position
mm' ss"	Playback time (minutes:seconds)
Volume	You can adjust the built-in speaker's (p.254) volume by turning the <◀🔊> dial.
MENU	Pressing the <MENU> button returns to the single-image display.

* When background music is set, the movie's sound will not be played.

Playback with the Touch Screen

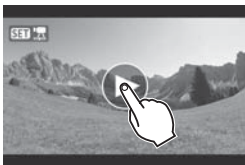

Tap [▶] at the center of the screen.

- ▶ The movie will start playing.
- To display the movie playback panel, tap <SET> on the upper left of the screen.
- To pause the movie while it is playing, tap the screen. The movie playback panel will also appear.



- With a fully-charged Battery Pack LP-E8, the continuous playback time at 23°C/73°F will be as follows: approx. 2 hr. 30 min.
- If you took a still photo while you shot the movie, the still photo will be displayed for approx. 1 sec. during the movie playback.

✂ Editing a Movie's First and Last Scenes

You can edit out the first and last scenes of a movie (except video snapshots) in 1-sec. increments.



1 On the movie playback screen, select [✂].

- ▶ The editing screen will be displayed.



2 Specify the part to be edited out.

- Select either [✂] (Cut beginning) or [✂] (Cut end), then press <SET>.
- Press the <◀▶> key to see the previous or next frames. Holding it down will fast forward the frames.
- After deciding which part to edit out, press <SET>. The portion highlighted in blue on the top of the screen is what will remain.



3 Check the edited movie.

- Select [▶] and press <SET> to play back the portion highlighted in blue.
- To change the editing, go back to step 2.
- To cancel the editing, press the <MENU> button, select [OK] on the confirmation screen, then press <SET>.



4 Save the edited movie.

- Select [**□**], then press <SET>.
- ▶ The save screen will appear.
- To save it as a new movie, select [**New file**]. To save it and overwrite the original movie file, select [**Overwrite**]. Then press <SET>.
- On the confirmation screen, select [**OK**], then press <SET> to save the edited movie and return to the movie playback screen.

- ⓘ ● Since the editing is performed in approx. 1-sec. increments (position indicated by [**✂**]), the exact position where the movie is edited may differ slightly from the position you specified.
- If the card does not have enough free space, [**New file**] will not be available.
- When the battery level is low, editing the movie is not possible. Use a fully-charged battery.

MENU Slide Show (Auto Playback)

You can play back the images on the card as an automatic slide show.

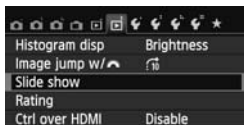

1 Select [Slide show].

- Under the [▶] 2 tab, select [Slide show], then press <SET>.

Number of images to be played



2 Select the images to be played.

- Press the <▲▼> key to select the desired option, then press <SET>.

[All images/Movies/Stills]

- Press the <▲▼> key to select one of the following: [📁] **All images** / [🎞️] **Movies** / [📷] **Stills**. Then press <SET>.

[Date/Folder/Rating]

- Press the <▲▼> key to select one of the following: [📅] **Date** / [📁] **Folder** / [★] **Rating**.
- When <INFO [INFO] [↵]> is highlighted, press the <INFO.> button.
- Press the <▲▼> key to select the desired option, then press <SET>.

[Date]









[Folder]



[Rating]



Item	Playback Description
 All images	All the still photos and movies on the card will be played back.
 Date	Still photos and movies taken on the selected shooting date will be played back.
 Folder	Still photos and movies in the selected folder will be played back.
 Movies	Only the movies on the card will be played back.
 Stills	Only the still photos on the card will be played back.
 Rating	Only the still photos and movies with the selected rating will be played back.



3 Set [Set up] as desired.

- Press the <▲▼> key to select [Set up], then press <SET>.
- Set the [Display time], [Repeat], [Transition effect], and [Background music] for the still photos.
- The background music selection procedure is explained on page 261.
- After selecting the settings, press the <MENU> button.

[Display time]



[Repeat]



[Transition effect]

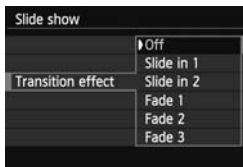

[Background music]

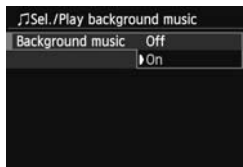

4 Start the slide show.

- Press the <▲▼> key to select [Start], then press <SET>.
- ▶ After [Loading image...] is displayed, the slide show will start.

5 Quit the slide show.

- To quit the slide show and return to the setting screen, press the <MENU> button.

- To pause the slide show, press <SET>. During pause, [||] will be displayed on the upper left of the image. Press <SET> again to resume the slide show. You can also pause the slide show by tapping the screen.
- During auto playback, you can press the <INFO.> button to change the still photo display format (p.84).
- During movie playback, you can adjust the sound volume by turning the <🔊> dial.
- During auto playback or pause, you can press the <◀▶> key to view another image.
- During auto playback, auto power off will not work.
- The display time may vary depending on the image.
- To view the slide show on a TV set, see page 262.

Selecting the Background Music



1 Select [Background music].

- Set [Background music] to [On], then press <SET>.

2 Select the background music.

- Press the <▲▼> key to select the desired background music, then press <SET>. You can also select multiple background music tracks.

3 Play the background music.

- To listen to a sample of the background music, press the <INFO.> button.
- Press the <▲▼> key to play another background music track. To stop listening to the background music, press the <INFO.> button again.
- Adjust the sound volume by turning the <VOLUME> dial.
- To delete a background music track, press the <▲▼> key and select the track, then press the <DELETE> button.



At the time of purchase, you cannot select background music with the camera. You must first use EOS Utility (provided software) to copy the background music to the card. For details, refer to the EOS Utility Instruction Manual (p.367).

Viewing the Images on TV

You can view the still photos and movies on a TV set.

Viewing on High-Definition (HD) TV Sets (Connected with HDMI)

HDMI Cable HTC-100 (sold separately) is required.

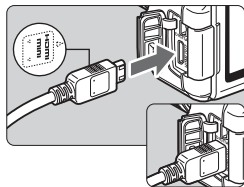

1 Connect the HDMI cable to the camera.

- With the plug's <▲ HDMI MINI> logo facing the front of the camera, insert it into the <HDMI OUT> terminal.

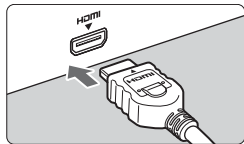

2 Connect the HDMI cable to the TV set.

- Connect the HDMI cable to the TV's HDMI IN port.

3 Turn on the TV and switch the TV's video input to select the connected port.

4 Set the camera's power switch to <ON>.

- Adjust the movie's sound volume with the TV set. The sound volume cannot be adjusted with the camera.
- Before connecting or disconnecting the cable between the camera and television, turn off the camera and TV set.
- Depending on the TV set, part of the image displayed may be cut off.

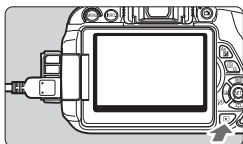

5 Press the <▶> button.

- ▶ The image will appear on the TV screen. (Nothing will be displayed on the camera's LCD monitor.)
- The images will automatically be displayed at the TV's optimum resolution.
- By pressing the <INFO.> button, you can change the display format.
- To play back movies, see page 254.



The images cannot be output at the same time from both the <HDMI OUT> and <A/V OUT> terminals.



- Do not connect any other device's output to the camera's <HDMI OUT> terminal. Doing so may cause a malfunction.
- Certain TVs may not be able to play back the captured images. In such a case, use the stereo AV cable AVC-DC400ST (sold separately) to connect to the TV.

Using HDMI CEC TV Sets

If the TV set connected to the camera with an HDMI cable is compatible with HDMI CEC*, you can use the TV set's remote control for playback operations.

* An HDMI-standard function enabling HDMI devices to control each other so that you can control them with one remote control unit.

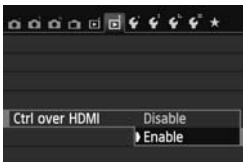

1 Set [Ctrl over HDMI] to [Enable].

- Under the [▶2] tab, select [Ctrl over HDMI], then press <SET>.
- Select [Enable], then press <⊙>.

2 Connect the camera to a TV set.

- Use an HDMI cable to connect the camera to the TV.
- ▶ The TV's input will switch automatically to the HDMI port connected to the camera.

3 Press the camera's <▶> button.

- ▶ An image will appear on the TV screen and you can use the TV's remote control to play back images.

4 Select an image.

- Point the remote control toward the TV set and press the ←/→ button to select an image.

Still photo playback menu



Movie playback menu



↶ : Return

☐☐☐☐ : 9-image index

🎬 : Play movie

👉 : Slide show

INFO. : Disp. shooting info

🔄 : Rotate

5 Press the remote control's Enter button.

- ▶ The menu appears and you can perform the playback operations shown on the left.
- Press the ←/→ button to select the desired option, then press the Enter button. For a slide show, press the remote control's 1/4 button to select an option, then press the Enter button.
- If you select **[Return]** and press the Enter button, the menu will disappear and you can use the ←/→ button to select an image.

- Some TV sets require you to first enable the HDMI CEC connection. For details, refer to the TV set's instruction manual.
- Certain TV sets, even those compatible with HDMI CEC, may not operate properly. In such a case, disconnect the HDMI cable, set [**▶**2: **Ctrl over HDMI**] to [**Disable**], and use the camera to control the playback operation.

Viewing on Non-HD TV Sets (Connected with AV Cable)

Stereo AV Cable AVC-DC400ST (sold separately) is required.

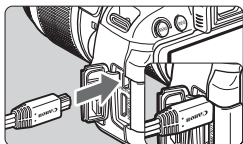

1 Connect the AV cable to the camera.

- With the plug's <Canon> logo facing the back of the camera, insert it into the <A/V OUT> terminal.

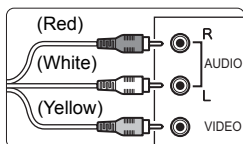

2 Connect the AV cable to the TV set.

- Connect the AV cable to the TV's video IN terminal and audio IN terminal.

3 Turn on the TV and switch the TV's video input to select the connected port.

4 Set the camera's power switch to <ON>.

5 Press the <▶> button.

- ▶ The image will appear on the TV screen. (Nothing will be displayed on the camera's LCD monitor.)
- To play back movies, see page 254.

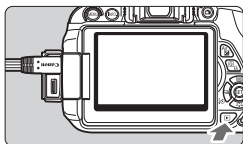



- Do not use any AV cable other than the Stereo AV cable AVC-DC400ST (sold separately). Images may not be displayed if you use a different cable.
- If the video system format does not match the TV's, the images will not be displayed properly. If this happens, switch to the proper video system format with [**2: Video system**].

Protecting Images

Protecting an image prevents it from being erased accidentally.

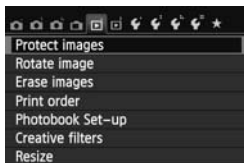
MENU Protecting a Single Image



- 1 Select [Protect images].**
 - Under the [] **1** tab, select [**Protect images**], then press < >.
 - ▶ The protect setting screen will appear.









- 2 Select [Select images].**
 - Select [**Select images**], then press < >.
 - ▶ The images will be displayed.

Image protect icon



- 3 Protect the image.**
 - Press the < < > key to select the image to be protected, then press < >.
 - ▶ When an image is protected, the < > icon will appear on the top of the screen.
 - To cancel the image protection, press < > again. The < > icon will disappear.
 - To protect another image, repeat step 3.
 - Press the <MENU> button to return to the menu.

MENU Protecting All Images in a Folder or on a Card

You can protect all the images in a folder or on a card at one time.



When you select **[All images in folder]** or **[All images on card]** in [▶ 1: Protect images], all the images in the folder or on the card will be protected.

To cancel the image protection, select **[Unprotect all images in folder]** or **[Unprotect all images on card]**.

 **If you format the card (p.48), the protected images will also be erased.**



- Movies can also be protected.
- Once an image is protected, it cannot be erased by the camera's erase function. To erase a protected image, you must first cancel the protection.
- If you erase all the images (p.269), only the protected images will remain. This is convenient when you want to erase unnecessary images all at once.

Erasing Images

You can either select and erase images one by one or erase them in one batch. Protected images (p.266) will not be erased.

- 1 **Once an image is erased, it cannot be recovered. Make sure you no longer need the image before erasing it. To prevent important images from being erased accidentally, protect them. Erasing a **RAW** + **L** image will erase both the RAW and JPEG images.**

Erasing a Single Image



- 1 **Play back the image to be erased.**

- 2 **Press the  button.**

▶ The Erase menu will appear at the bottom of the screen.



- 3 **Erase the image.**

- Select [**Erase**], then press **<SET>**. The image displayed will be erased.

MENU Checkmarking **<✓>** Images to be Erased in a Batch

By appending checkmarks **<✓>** to the images to be erased, you can erase multiple images at one time.

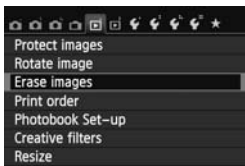

- 1 **Select [**Erase images**].**

- Under the [**1**] tab, select [**Erase images**], then press **<SET>**.

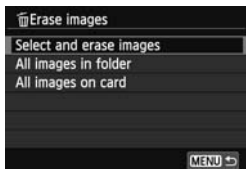

2 Select [Select and erase images].

- Select [**Select and erase images**], then press <SET>.
- ▶ The images will be displayed.
- To display the three-image display, press the <☑ Q> button. To return to the single-image display, press the <Q> button.



3 Select the images to be erased.

- Press the <◀▶> key to select the image to be erased, then press <SET>.
- ▶ A checkmark <✓> will be displayed on the upper left of the screen.
- To select other images to be erased, repeat step 3.

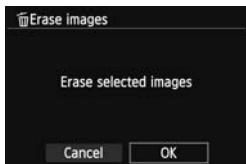

4 Erase the image.

- Press the <☑> button.
- Select [**OK**], then press <SET>.
- ▶ The selected images will be erased.

MENU Erasing All Images in a Folder or on a Card

You can erase all the images in a folder or on a card at one time. When [**1: Erase images**] is set to [**All images in folder**] or [**All images on card**], all the images in the folder or on the card will be erased.

 To also erase protected images, format the card (p.48).

INFO.: Shooting Information Display

Sample Image Taken in a Creative Zone Mode

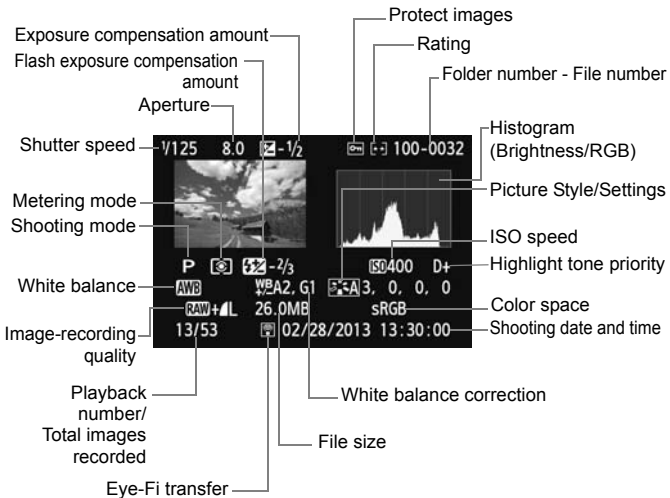

* With **RAW** + **L** images, the **RAW** file size is displayed.

* For still photos taken during movie shooting, **<M>** will be displayed.

* If a Creative filter or Resize has been applied to the image, the **<C>** icon will be displayed.

* Photos taken with flash without any flash exposure compensation are marked with the **<F>** icon. Photos taken with flash exposure compensation are marked with the **<F>** icon.

Sample Image Taken in a Basic Zone Mode

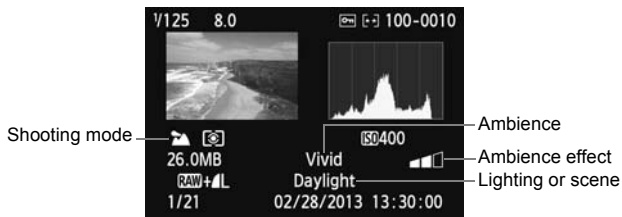

* With images taken in a Basic Zone mode, the information displayed will differ depending on the shooting mode.

* Photos taken in the <CA> mode will show [Background blur].

Sample Movie

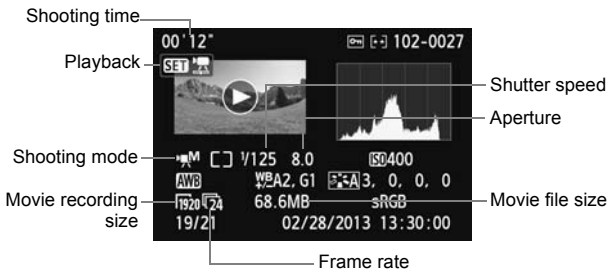

* If manual exposure was used, the shutter speed, aperture, and ISO speed (when set manually) will be displayed.

* The <M> icon will be displayed for video snapshots.

● About the Highlight Alert

When the shooting information is displayed, any overexposed areas of the image will blink. To obtain more image detail in the overexposed areas, set the exposure compensation to a negative amount and shoot again.

● About the Histogram

The brightness histogram shows the exposure level distribution and overall brightness. The RGB histogram is for checking the color saturation and gradation. The display can be switched with [**2: Histogram disp**].

[Brightness] Display

This histogram is a graph showing the distribution of the image's brightness level. The horizontal axis indicates the brightness level (darker on the left and brighter on the right), while the vertical axis indicates how many pixels exist for each brightness level. The more pixels there are toward the left, the darker the image. The more pixels there are toward the right, the brighter the image. If there are too many pixels on the left, the shadow detail will be lost. If there are too many pixels on the right, the highlight detail will be lost. The gradation in-between will be reproduced. By checking the image and its brightness histogram, you can see the exposure level inclination and the overall gradation.

Sample Histograms



Dark image



Normal brightness



Bright image

[RGB] Display

This histogram is a graph showing the distribution of each primary color's brightness level in the image (RGB or red, green, and blue). The horizontal axis indicates the color's brightness level (darker on the left and brighter on the right), while the vertical axis indicates how many pixels exist for each color brightness level. The more pixels there are toward the left, the darker and less prominent the color. The more pixels there are toward the right, the brighter and denser the color. If there are too many pixels on the left, the respective color information will be lacking. If there are too many pixels on the right, the color will be too saturated with no gradation. By checking the image's RGB histogram, you can see the color's saturation and gradation condition, as well as white balance inclination.

10

Post-Processing Images

After shooting, you can apply Creative filters or resize the images (downsize the pixel count).



- The camera may not be able to process images taken with another camera.
- Post-processing images as described in this chapter cannot be performed while the camera is connected to a personal computer via the <DIGITAL> terminal.

Applying Creative Filters to the Image

You can apply the following Creative filters to an image and save it as a new image: Grainy B/W, Soft focus, Fish-eye effect, Art bold effect, Water painting effect, Toy camera effect, and Miniature effect.

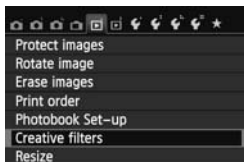

1 Select [Creative filters].

- Under the [▶1] tab, select [Creative filters], then press <SET>.
- ▶ The images will be displayed.



2 Select an image.

- Select the image you want to apply a filter to.
- By pressing the <☒ Q> button, you can switch to the index display and select an image.

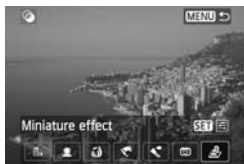

3 Select a filter.

- When you press <SET>, the types of Creative filters will be displayed.
- For details on Creative filter characteristics, see pages 275, 276.
- Press the <◀▶> key to select a filter, then press <SET>.
- ▶ The image will be displayed with the corresponding filter applied.



4 Adjust the filter effect.

- Press the <◀▶> key to adjust the filter effect, then press <SET>.
- For the Miniature effect, press the <▲▼> key and select the image area (within the white frame) where you want the image to look sharp. Then press <SET>.

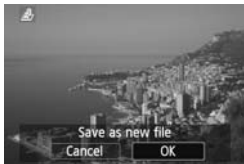



5 Save the image.

- Select **[OK]** to save the image.
- Check the destination folder and image file number, then select **[OK]**.
- To apply a filter to another image, repeat steps 2 to 5.
- Press the **<MENU>** button to return to the menu.



When shooting **RAW** + **L** or **RAW** images, the Creative filter will be applied to the **RAW** image and the image will be saved as a JPEG image. If an aspect ratio is set for Live View shooting and a Creative filter is applied to the **RAW** image, the image will be saved in the aspect ratio that was set.

Creative Filter Characteristics

-  **Grainy B/W**
Makes the image grainy and black and white. By adjusting the contrast, you can change the black-and-white effect.
-  **Soft focus**
Gives the image a soft look. By adjusting the blur, you can change the degree of softness.

-  **Fish-eye effect**

Gives the effect of a fish-eye lens. The image will have a barrel-type distortion.

Depending on the level of this filter effect, the area trimmed along the periphery of the image changes. Also, since this filter effect will magnify the image center, the apparent resolution at the center may degrade depending on the number of recorded pixels. Set the filter effect in step 4 while checking the resulting image.

-  **Art bold effect**

Makes the photo look like an oil painting and the subject look three-dimensional. You can adjust the contrast and saturation. Note that the sky, white walls, and similar subjects may not be rendered with a smooth gradation and may look irregular or have significant noise.

-  **Water painting effect**

Makes the photo look like a watercolor painting with soft colors. You can adjust the color density. Note that night scenes or dark scenes may not be rendered with a smooth gradation and may look irregular or have significant noise.

-  **Toy camera effect**

Gives a color cast typical of toy cameras and darkens the image's four corners. By adjusting the color tone, you can change the color cast.

-  **Miniature effect**

Creates a diorama effect. You can change where the image looks sharp. In step 4, you can press the <INFO.> button (or tap [F3] on the screen) to change the white frame's orientation (horizontal/vertical) where you want the image to look sharp.

Resizing a JPEG Image

You can resize an image to make the pixel count lower and save it as a new image. Resizing an image is possible only with JPEG L/M/S1/S2 images. **JPEG S3 and RAW images cannot be resized.**

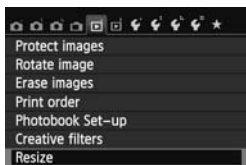

1 Select [Resize].

- Under the [1] tab, select [Resize], then press <SET>.
- ▶ The images will be displayed.



2 Select an image.

- Select the image you want to resize.
- By pressing the <Q> button, you can switch to the index display and select an image.



Target sizes

3 Select the desired image size.

- Press <SET> to display the image sizes.
- Press the <◀▶> key to select the desired image size, then press <SET>.



4 Save the image.

- Select [OK] to save the resized image.
- Check the destination folder and image file number, then select [OK].
- To resize another image, repeat steps 2 to 4.
- Press the <MENU> button to return to the menu.

Resize Options According to Original Image Size

Original Image Size	Available Resize Settings			
	M	S1	S2	S3
L	<input type="radio"/>	<input type="radio"/>	<input type="radio"/>	<input type="radio"/>
M		<input type="radio"/>	<input type="radio"/>	<input type="radio"/>
S1			<input type="radio"/>	<input type="radio"/>
S2				<input type="radio"/>
S3				

About Image Sizes

The image size displayed in step 3 on the preceding page, such as [***M ***x***], has a 3:2 aspect ratio. The image size according to aspect ratios is shown in the table below.

The asterisked image-recording quality figures do not exactly match the aspect ratio. The image will be cropped slightly.

Image Quality	Aspect Ratio and Pixel Count (Approx.)			
	3:2	4:3	16:9	1:1
M	3456x2304 (8.0 megapixels)	3072x2304 (7.0 megapixels)	3456x1944 (6.7 megapixels)	2304x2304 (5.3 megapixels)
S1	2592x1728 (4.5 megapixels)	2304x1728 (4.0 megapixels)	2592x1456* (3.8 megapixels)	1728x1728 (3.0 megapixels)
S2	1920x1280 (2.5 megapixels)	1696x1280* (2.2 megapixels)	1920x1080 (2.1 megapixels)	1280x1280 (1.6 megapixels)
S3	720x480 (350,000 pixels)	640x480 (310,000 pixels)	720x400* (290,000 pixels)	480x480 (230,000 pixels)

11

Printing Images

- **Printing** (p.280)
You can connect the camera directly to a printer and print out the images on the card. The camera is compatible with “ PictBridge” which is the standard for direct printing.
- **Digital Print Order Format (DPOF)** (p.289)
DPOF (Digital Print Order Format) enables you to print images recorded on the card according to your printing instructions such as the image selection, quantity to print, etc. You can print multiple images in one batch or give the print order to a photofinisher.
- **Specifying Images for a Photobook** (p.293)
You can specify images in the card for printing in a photobook.

Preparing to Print

The direct printing procedure can be performed entirely with the camera while you look at the LCD monitor.

Connecting the Camera to a Printer

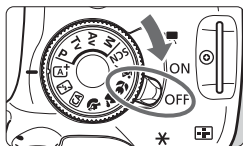

1 Set the camera's power switch to <OFF>.

2 Set up the printer.

- For details, see the printer's instruction manual.

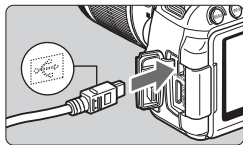

3 Connect the camera to the printer.

- Use the interface cable provided with the camera.
- Connect the cable to the camera's <DIGITAL> terminal with the cable plug's <↔> icon facing the front of the camera.
- To connect to the printer, refer to the printer's instruction manual.

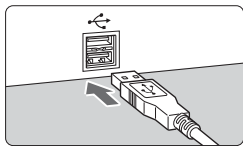

4 Turn on the printer.

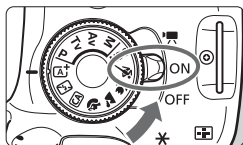

5 Set the camera's power switch to <ON>.

- ▶ Some printers may make a beeping sound.

PictBridge



6 Play back the image.

- Press the <▶> button.
- ▶ The image will appear, and the <📷> icon will appear on the upper left to indicate that the camera is connected to a printer.



- Before using the printer, make sure it has a PictBridge connection port.
- Movies cannot be printed.
- The camera cannot be used with printers compatible only with CP Direct or Bubble Jet Direct.
- Do not use any interface cable other than the one provided.
- If there is a long beeping sound in step 5, it indicates a problem with the printer. Resolve the problem displayed in the error message (p.288).
- Printing is not possible if the <📷> or <📷> shooting mode or Multi Shot Noise Reduction has been set.



- You can also print **RAW** images taken with this camera.
- If you use a battery pack to power the camera, make sure it is fully charged. With a fully-charged battery, printing up to approx. 3 hr. 30 min is possible.
- Before disconnecting the cable, first turn off the camera and printer. Hold the plug (not the cord) to pull out the cable.
- For direct printing, using AC Adapter Kit ACK-E8 (sold separately) to power the camera is recommended.

Printing

The screen display and setting options will differ depending on the printer. Some settings may not be available. For details, refer to the printer's instruction manual.

Printer-connected icon



1 Select the image to be printed.

- Check that the icon is displayed on the upper left of the LCD monitor.
- Press the key to select the image to be printed.

2 Press .

- ▶ The print setting screen will appear.

Print setting screen



Sets the printing effects (p.284).

Sets the date or file number imprinting to on or off.

Sets the quantity to be printed.

Sets the cropping (trimming) (p.287).

Sets the paper size, type, and layout.

Returns to the screen in step 1.

Starts the printing.

The paper size, type, and layout you have set are displayed.

* Depending on the printer, certain settings such as the date and file number imprinting and cropping may not be selectable.

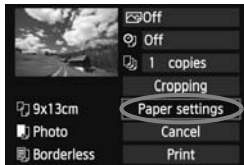

3 Select [Paper settings].

- Select [Paper settings], then press .
- ▶ The paper settings screen will appear.

Setting the Paper Size



- Select the size of the paper loaded in the printer, then press **<SET>**.
- ▶ The paper type screen will appear.

Setting the Paper Type



- Select the type of the paper loaded in the printer, then press **<SET>**.
- ▶ The page layout screen will appear.

Setting the Page Layout

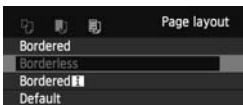

- Select the page layout, then press **<SET>**.
- ▶ The print settings screen will reappear.

Bordered	The print will have white borders along the edges.
Borderless	The print will have no borders. If your printer cannot print borderless prints, the print will have borders.
Bordered [i]	The shooting information*1 will be imprinted on the border on 9x13 cm and larger prints.
xx-up	Option to print 2, 4, 8, 9, 16, or 20 images on one sheet.
20-up [i] 35-up [i]	20 or 35 images will be printed as thumbnails on A4 or Letter size paper*2. • [20-up [i]] will have the shooting information*1 imprinted.
Default	The page layout will vary depending on the printer model or its settings.

*1: From the Exif data, the camera name, lens name, shooting mode, shutter speed, aperture, exposure compensation amount, ISO speed, white balance, etc., will be imprinted.

*2: After ordering the prints with "Digital Print Order Format (DPOF)" (p.289), it is recommended that you print by following "Direct Printing with DPOF" (p.292).



If the image's aspect ratio is different from the printing paper's aspect ratio, the image may be cropped significantly if you print it as a borderless print. If the image is cropped, it may look more grainy on the paper due to the fewer number of pixels.



4 Set the printing effects (image optimization).

- Set them if necessary. If you do not need to set any printing effects, go to step 5.
- **What is displayed on the screen differs depending on the printer.**
- Select the option, then press <SET>.
- Select the desired printing effect, then press <SET>.
- If the <INFO> icon is displayed brightly next to <INFO>, you can also adjust the printing effect (p.286).

Printing Effect	Description
On	The image will be printed using the printer's standard colors. The image's Exif data is used to make automatic corrections.
Off	No automatic correction will be applied.
Vivid	The image will be printed with higher saturation to produce more vivid blues and greens.
NR	Image noise is reduced before printing.
B/W B/W	Prints in black-and-white with true blacks.
B/W Cool tone	Prints in black-and-white with cool, bluish blacks.
B/W Warm tone	Prints in black-and-white with warm, yellowish blacks.
Natural	Prints the image in the actual colors and contrast. No automatic color adjustments are applied.
Natural M	The printing characteristics are the same as the "Natural" setting. However, this setting enables finer printing adjustments than with "Natural."
Default	The printing will differ depending on the printer. For details, refer to the printer's instruction manual.

* When you change the printing effects, changes are reflected in the image displayed on the upper left. Note that the printed image may look slightly different from the displayed image, which is only an approximation. This also applies to [Brightness] and [Adjust levels] on page 286.

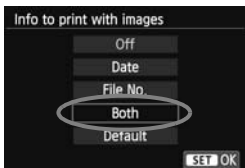

5 Set the date and file number imprinting.

- Set them if necessary.
- Select <[Info]>, then press <[SET]>.
- Set as desired, then press <[SET]>.



6 Set the number of copies.

- Set it if necessary.
- Select <[Info]>, then press <[SET]>.
- Set the number of copies, then press <[SET]>.

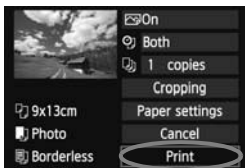

7 Start printing.

- Select [Print], then press <[SET]>.



- With Easy printing, you can print another image using the same settings. Just select the image and press the <[Print]> button. With Easy printing, the number of copies will always be 1. (You cannot set the number of copies.) Also, any cropping (p.287) will not be applied.
- The [Default] setting for printing effects and other options are the printer's own default settings as set by the printer's manufacturer. Refer to the printer's instruction manual to find out what the [Default] settings are.
- Depending on the image's file size and image-recording quality, it may take some time for the printing to start after you select [Print].
- If image tilt correction (p.287) is applied, it may take longer to print the image.
- To stop the printing, press <[SET]> while [Stop] is displayed, then select [OK].
- If you execute [Clear all camera settings] (p.214), all the settings will revert to their defaults.

Adjustment of Printing Effects

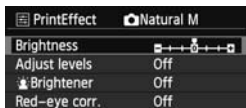
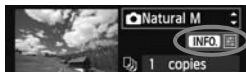

In step 4 on page 284, select the printing effect. When the  icon is displayed brightly next to **<INFO.>**, you can press the **<INFO.>** button. You can then adjust the printing effect. What can be adjusted or what is displayed will depend on the selection made in step 4.

● Brightness

The image brightness can be adjusted.

● Adjust levels

When you select [**Manual**], you can change the histogram's distribution and adjust the image's brightness and contrast.

With the Adjust levels screen displayed, press the **<INFO.>** button to change the position of the . Press the **<◀▶>** key to freely adjust the shadow level (0-127) or highlight level (128-255).

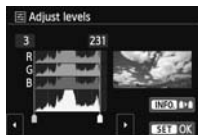

● Brightener

Effective in backlit conditions that can make the subject's face look dark. When [**On**] is set, the face will be brightened for printing.

● Red-eye corr.

Effective in flash images where the subject has red eye. When [**On**] is set, the red eye will be corrected for printing.

- The [ **Brightener**] and [**Red-eye corr.**] effects will not be reflected on the screen.
- When you select [**Detail set.**], you can adjust the [**Contrast**], [**Saturation**], [**Color tone**], and [**Color balance**]. To adjust the [**Color balance**], use the **<◀▶>** keys. B is for blue, A for amber, M for magenta, and G for green. The image's color balance will be corrected towards the selected color.
- If you select [**Clear all**], all the printing effect settings will be reverted to their defaults.

Cropping the Image

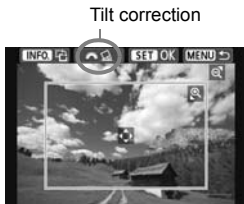



You can crop the image and print only the cropped portion as if the image was recomposed.

Set the cropping right before printing. If you set the cropping and then set the print settings, you may have to set the cropping again before printing.

- 1 On the print settings screen, select [Cropping].
- 2 Set the cropping frame size, position, and aspect ratio.
 - The image area within the cropping frame will be printed. The cropping frame's aspect ratio can be changed with [Paper settings].

Changing the cropping frame size

When you press the  or  button, the size of the cropping frame will change. The smaller the cropping frame, the larger the image magnification will be for printing.



Moving the cropping frame

Press the  key to move the frame over the image vertically or horizontally. Move the cropping frame until it covers the desired image area.

Rotating the frame

Pressing the <INFO.> button will toggle the cropping frame between the vertical and horizontal orientations. This enables you to create a vertically oriented print from a horizontal image.

Image tilt correction

By turning the  dial, you can adjust the image tilt angle up to ± 10 degrees in 0.5-degree increments. When you adjust the image tilt, the  icon on the screen will turn blue.

- 3 Press <SET> to exit the cropping.

- ▶ The print settings screen will reappear.
- You can check the cropped image area on the upper left of the print settings screen.

- Depending on the printer, the cropped image area may not be printed as you specified.
- The smaller you make the cropping frame, the grainier the picture will look in the print.
- While cropping the image, look at the camera's LCD monitor. If you look at the image on a TV screen, the cropping frame may not be displayed accurately.



Handling Printer Errors

If you resolve a printer error (no ink, no paper, etc.) and select [**Continue**] to resume printing but it does not resume, operate the buttons on the printer to resume printing. For details on resuming the printing, refer to the printer's instruction manual.

Error Messages

If a problem occurs during printing, an error message will appear on the camera's LCD monitor. Press <  > to stop printing. After fixing the problem, resume printing. For details on how to fix a printing problem, refer to the printer's instruction manual.

Paper Error

Check whether the paper is properly loaded in the printer.

Ink Error

Check the printer's ink level, and check the waste ink tank.

Hardware Error

Check for any printer problems other than paper and ink problems.

File Error

The selected image cannot be printed via PictBridge. Images taken with a different camera or images edited with a computer may not be printable.

Digital Print Order Format (DPOF)

You can set the print type, date imprinting, and file number imprinting. The print settings will be applied to all print-ordered images. (They cannot be set individually for each image.)

Setting the Printing Options

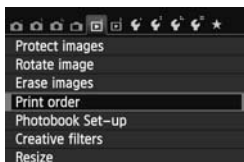

1 Select [Print order].

- Under the [▶1] tab, select [Print order], then press <SET>.

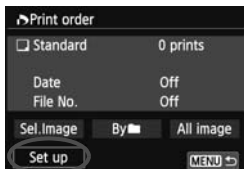

2 Select [Set up].

- Select [Set up], then press <SET>.

3 Set the options as desired.

- Set the [Print type], [Date], and [File No.].
- Select the option to be set, then press <SET>. Select the desired setting, then press <SET>.

[Print type]

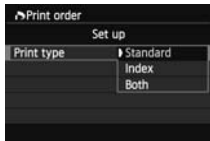

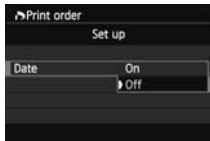

[Date]



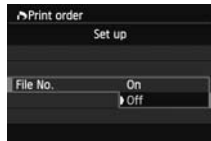

[File No.]



Print type		Standard	Prints one image on one sheet.
		Index	Multiple thumbnail images are printed on one sheet.
		Both	Prints both the standard and index prints.
Date	On	[On] imprints the recorded date on the print.	
	Off		
File number	On	[On] imprints the file number on the print.	
	Off		

4 Exit the setting.

- Press the <MENU> button.
- ▶ The print order screen will reappear.
- Next, select [**Sel.Image**], [**By** ], or [**All image**] to order the images to be printed.

- 
- Even if [**Date**] and [**File No.**] are set to [**On**], the date or file number may not be imprinted depending on the print type setting and printer model.
 - With [**Index**] prints, the [**Date**] and [**File No.**] cannot both be set to [**On**] at the same time.
 - When printing with DPOF, you must use the card whose print order specifications have been set. It will not work if you just extract images from the card and try to print them.
 - Certain DPOF-compatible printers and photofinishers may not be able to print the images as you specified. Refer to the printer's instruction manual before printing. Or check with your photofinisher about compatibility when ordering prints.
 - Do not insert into the camera a card whose print order was set by a different camera and then try to specify a print order. The print order may be overwritten. Also, depending on the image type, the print order may not be possible.

 **RAW** images and movies cannot be print ordered. You can print **RAW** images through direct printing (p.292).

Print Ordering

● Sel.Image

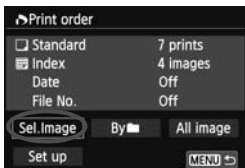

Select and order images one by one. To display the three-image display, press the <[Checkmark] [Magnifying Glass]> button. To return to the single-image display, press the <[Magnifying Glass]> button.

Press the <MENU> button to save the print order to the card.



Quantity

Total images selected

[Standard] [Both]

Press the <[Up Arrow]> key to set the number of copies to be printed for the displayed image.



Checkmark

Index icon

[Index]

Press <[SET]> to add a checkmark to the box <[Checkmark]>. The image will be included in the index print.

● By [Folder Icon]

Select [**Mark all in folder**] and select the folder. A print order for one copy of all the images in the folder will be placed. If you select [**Clear all in folder**] and select the folder, the print order for that folder will all be canceled.

● All image

If you select [**Mark all on card**], one copy of all the images on the card will be set for printing. If you select [**Clear all on card**], the print order will be cleared for all the images on the card.



- Note that **RAW** images and movies will not be included in the print order even if you set "By [Folder Icon]" or "All image".
- When using a PictBridge printer, print no more than 400 images for one print order. If you specify more than this, all the images may not be printed.

Direct Printing with DPOF



With a PictBridge printer, you can easily print images with DPOF.

1 Prepare to print.

- See page 280. Follow the “Connecting the Camera to a Printer” procedure up to step 5.

2 Under the [▶ 1] tab, select [Print order].

3 Select [Print].

- [Print] will be displayed only if the camera is connected to a printer and printing is possible.

4 Set the [Paper settings] (p.282).

- Set the printing effects (p.284) if necessary.

5 Select [OK].

- Before printing, be sure to set the paper size.
- Certain printers cannot imprint the file number.
- If [Bordered] is set, certain printers may imprint the date on the border.
- Depending on the printer, the date may appear faint if it is imprinted on a bright background or on the border.

- Under [Adjust levels], [Manual] cannot be selected.
- If you stopped the printing and want to resume printing the remaining images, select [Resume]. Note that printing will not resume if you stop the printing and any of the following occurs:
 - Before resuming the printing, you changed the print order or deleted print-ordered images.
 - When you set the index, you changed the paper setting before resuming the printing.
 - When you paused the printing, the card's remaining capacity was low.
- If a problem occurs during printing, see page 288.

Specifying Images for a Photobook

When you select images (up to 998 images) to be used for a photobook and transfer them from the camera to a computer using EOS Utility (provided software), the images will be copied to a dedicated folder. This function is convenient when you order a photobook from the Internet.

Specify One Image at a Time

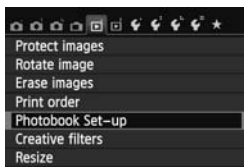



1 Select [Photobook Set-up].

- Under the [] 1 tab, select [**Photobook Set-up**], then press <SET>.



2 Select [Select images].

- Select [**Select images**], then press <SET>.
- ▶ The images will be displayed.
- To display the three-image display, press the <  > button. To return to the single-image display, press the < > button.



3 Select the image to be specified.

- Press the <◀▶> key to select the image to be specified, then press <SET>.
- Repeat this step to select another image. The number of images which have been specified will be displayed on the screen's upper left.
- To cancel the specified image, press <SET> again.
- To return to the menu, press the <MENU> button.

Specifying All Images in a Folder or on a Card

You can specify all the images in a folder or card at one time.



When [**▶ 1: Photobook Set-up**] is set to [**All images in folder**] or [**All images on card**], all the images in the folder or on the card will be specified.

To cancel the image specification, select [**Clear all in folder**] or [**Clear all on card**].

⚠ Do not specify images already specified for a photobook in another camera for another photobook with this camera. The photobook settings may be overwritten.

📷 RAW images and movies cannot be specified.

12

Customizing the Camera

You can customize various camera functions to suit your picture-taking preferences with Custom Functions. Custom Functions can be set and used only in Creative Zone modes.

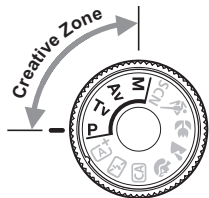

MENU Setting Custom Functions ☆

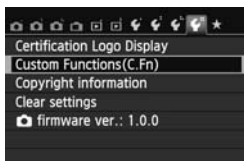

1 Select [Custom Functions (C.Fn)].

- Under the [F4] tab, select [Custom Functions (C.Fn)], then press <SET>.

Custom Function number

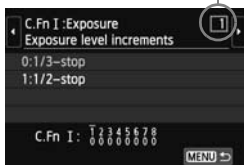

2 Select the Custom Function number.

- Press the <◀▶> key to select the Custom Function number, then press <SET>.

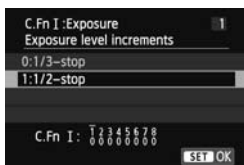

3 Change the setting as desired.

- Press the <▲▼> key to select the setting (number), then press <SET>.
- Repeat steps 2 and 3 if you want to set another Custom Functions.
- At the bottom of the screen, the current Custom Function settings are indicated below the respective function numbers.

4 Exit the setting.



- Press the <MENU> button.
- ▶ The screen for step 1 will reappear.

Clearing All Custom Functions

Under [F4: Clear settings], select [Clear all Custom Func. (C.Fn)] to clear all the Custom Function settings currently set (p.214).

Custom Functions

C.Fn I: Exposure

			 LV Shooting	 Movie Shooting
1	Exposure level increments	p.298	<input type="radio"/>	<input type="radio"/>
2	ISO expansion		<input type="radio"/>	In M

C.Fn II: Image

3	Highlight tone priority	p.299	<input type="radio"/>	<input type="radio"/>
---	-------------------------	-------	-----------------------	-----------------------

C.Fn III: Autofocus/Drive

4	AF-assist beam firing	p.300	<input type="radio"/> (With AFQuick*)	
5	Mirror lockup			

* If you use an EX-series Speedlite (sold separately) equipped with an LED light, the LED light will turn on for AF-assist even in the AF $\frac{1}{2}$, AF(), and AF□ modes.

C.Fn IV: Operation/Others

6	Shutter/AE lock button	p.301	<input type="radio"/>	<input type="radio"/>
7	Assign SET button	p.302	<input type="radio"/> (Except 3)	<input type="radio"/> (Except 2, 3)*
8	LCD display when power ON	p.302		

* [5: ISO speed] is settable only for manual exposure shooting.



The shaded Custom Functions do not function during Live View (LV shooting) or movie shooting. (Settings are disabled.)

MENU Custom Function Settings [☆]

Custom Functions are organized into four groups based on the function type: C.Fn I: Exposure, C.Fn II: Image, C.Fn III: Autofocus/Drive, C.Fn IV: Operation/Others.

C.Fn I: Exposure

C.Fn-1 Exposure level increments

0: 1/3-stop

1: 1/2-stop

Sets 1/2-stop increments for the shutter speed, aperture, exposure compensation, AEB, flash exposure compensation, etc. This is effective when you prefer to control the exposure in less fine increments than 1/3-stop increments.

 With setting 1, the exposure level will be displayed in the viewfinder and on the LCD monitor as shown below.



C.Fn-2 ISO expansion

0: Off

1: On

When you set the ISO speed, you will be able to set “H” (equivalent to ISO 25600) for still photos and “H” (equivalent to ISO 12800) for movies. Note that if [C.Fn-3: Highlight tone priority] is set to [1: Enable], “H” cannot be set.

C.Fn II: Image

C.Fn-3 Highlight tone priority

0: Disable

1: Enable

Improves the highlight detail. The dynamic range is expanded from the standard 18% gray to bright highlights. The gradation between the grays and highlights becomes smoother.



- With setting 1, the Auto Lighting Optimizer (p.125) is automatically set to **[Disable]** and the setting cannot be changed.
- With setting 1, noise (grainy image, banding, etc.) may become slightly more pronounced than with setting 0.



With setting 1, the settable range will be ISO 200 - ISO 12800 (up to ISO 6400 for movies).

Also, the <D+> icon will be displayed on the LCD monitor and in the viewfinder when highlight tone priority is enabled.

C.Fn III: Autofocus/Drive

C.Fn-4 AF-assist beam firing

The settings to specify whether or not the AF-assist beam is emitted by the camera's built-in flash or by an external, EOS-dedicated Speedlite can be set.

0: Enable

If necessary, the AF-assist beam will be emitted by the built-in flash or external Speedlite.

1: Disable

The AF-assist beam is not emitted.

2: Enable external flash only

If an external Speedlite is attached, it will emit the AF-assist beam when necessary. The camera's built-in flash will not fire the AF-assist beam.

3: IR AF assist beam only

Among external Speedlites, only those which have an infrared AF-assist beam will be able to emit the beam. This prevents any Speedlite which uses a series of intermittent flashes (like the built-in flash) from firing the AF-assist beam.

With an EX-series Speedlite equipped with an LED light, the LED light will not automatically turn on for AF-assist.

 If the external Speedlite's [AF-assist beam firing] Custom Function is set to [Disabled], the Speedlite will not emit the AF-assist beam even if the camera's C.Fn-4 is set to 0, 2, or 3.

C.Fn-5 Mirror lockup

0: Disable

1: Enable

Prevents mechanical vibrations in the camera caused by the reflex mirror action (mirror shock), which can disturb shooting with super telephoto lenses or close-up (macro) shooting. See page 142 for the mirror lockup procedure.

C.Fn IV: Operation/Others

C.Fn-6 Shutter/AE lock button

0: AF/AE lock

1: AE lock/AF

This is convenient when you want to focus and meter separately. Press the <★> button to autofocus, and press the shutter button halfway to apply AE lock.

2: AF/AF lock, no AE lock

In the AI Servo AF operation, you can press the <★> button to stop the AF operation momentarily. This prevents the AF from being thrown off by any obstacle passing between the camera and subject. The exposure is set at the moment the picture is taken.

3: AE/AF, no AE lock

This is useful for subjects which keep moving and stopping repeatedly. During AI Servo AF, you can press the <★> button to start or stop the AI Servo AF operation. The exposure is set at the moment the picture is taken. Thus, the optimum focusing and exposure will always be achieved as you wait for the decisive moment.



During Live View shooting or movie shooting

- With setting 1 or 3, press the <★> button for One-Shot AF. Also, using the touch shutter will take a picture without autofocusing.
- With setting 2, press the shutter button halfway for One-Shot AF.

C.Fn-7 Assign SET button

You can assign a frequently-used function to <SET>. Press <SET> when the camera is ready to shoot.

0: Normal (disabled)

1: Image quality

Press <SET> to display the image-recording quality setting screen on the LCD monitor. Select the desired image-recording quality, then press <SET>.

2: Flash exposure compensation

When you press <SET>, the flash exposure compensation setting screen will appear. Set the flash exposure compensation, then press <SET>.

3: LCD monitor On/Off

Press <SET> to turn on or off the LCD monitor.

4: Menu display

Press <SET> to display the menu screen.

5: ISO speed

The ISO speed setting screen will appear. Press the <◀▶> key or turn the <ISO> dial to change the ISO speed. You can also refer to the viewfinder to set the ISO speed.

C.Fn-8 LCD display when power ON

0: Display on

When the power switch is turned on, the shooting settings will be displayed (p.50).

1: Previous display status

If you pressed the <INFO.> button and turned off the camera while the LCD monitor was off, the shooting settings will not be displayed when you turn on the camera again. This helps to save battery power. The menu screens and image playback will still be displayed when used. If you pressed the <INFO.> button to display the shooting settings and then turn off the camera, the shooting settings will be displayed when you turn on the camera again.

MENU Registering My Menu ☆

Under the My Menu tab, you can register up to six menu options and Custom Functions whose settings you change frequently.

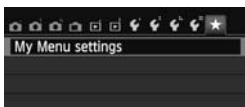

1 Select [My Menu settings].

- Under the [★] tab, select [My Menu settings], then press <SET>.

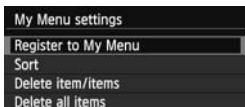

2 Select [Register to My Menu].

- Select [Register to My Menu], then press <SET>.

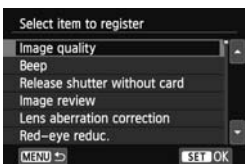

3 Register the desired items.

- Select an item to register, then press <SET>.
- On the confirmation dialog, select [OK] and press <SET> to register the item.
- You can register up to six items.
- To return to the screen in step 2, press the <MENU> button.

About My Menu Settings

● Sort

You can change the order of the registered items in My Menu. Select [Sort] and select the item whose order you want to change. Then press <SET>. With [◆] displayed, press the <▲▼> key to change the order, then press <SET>.

● Delete item/items and Delete all items

You can delete any of the registered items. [Delete item/items] deletes one item at a time, and [Delete all items] deletes all registered items.

● Display from My Menu

When [Enable] is set, the [★] tab will be displayed first when you display the menu screen.



13

Reference

This chapter provides reference information for camera features, system accessories, etc.



Certification Logo

If you select [**4: Certification Logo Display**] and press <SET>, some of the logos of the camera's certifications will appear. Other certification logos can be found in this Instruction Manual, on the camera body, or on the camera's package.

Using a Household Power Outlet

With AC Adapter Kit ACK-E8 (sold separately), you can connect the camera to a household power outlet and not worry about the remaining battery level.

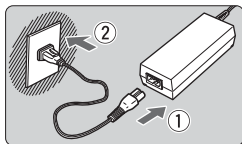

1 Connect the power cord.

- Connect the power cord as shown in the illustration.
- After using the camera, unplug the power plug from the power outlet.

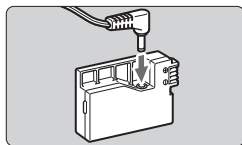

2 Connect the DC Coupler.

- Connect the DC cord's plug to the DC Coupler.

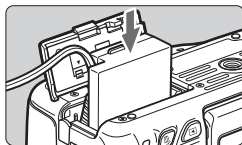

3 Insert the DC Coupler.

- Open the cover and insert the DC Coupler until it locks in place.

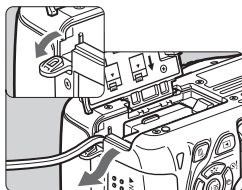

4 Push in the DC cord.

- Open the DC cord hole cover and install the cord as shown.
- Close the cover.

 Do not connect or disconnect the power cord while the camera's power switch is set to <ON>.

Remote Control Shooting

Remote Controller RC-6 (Sold Separately)

This remote controller enables you to take pictures wirelessly up to approx. 5 meters/16.4 feet from the camera. You can either shoot immediately or use a 2-sec. delay.

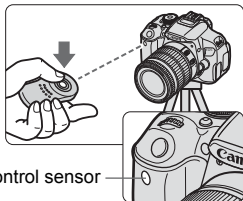

Remote control sensor

- Set the self-timer to $\langle \text{self-timer icon} \rangle$ (p.106).
- Point the remote controller toward the camera's remote control sensor and press the transmit button.
- ▶ The camera will autofocus.
- ▶ When focus is achieved, the self-timer lamp will light up and the picture will be taken.

- Fluorescent or LED lighting may cause camera misoperation by triggering the shutter inadvertently. Try to keep the camera away from such light sources.
- If you point a remote controller for a TV set toward the camera and operate it, it may cause camera misoperation by triggering the shutter inadvertently.

- Remote Controller RC-1/RC-5 (sold separately) can also be used.
- Remote control shooting is also possible with an EX-series Speedlite equipped with a remote-release function.
- The Remote Controller can also be used during movie shooting (p.173). Note that still photo shooting in the movie shooting mode is not possible with the Remote Controller RC-5.

Remote Switch RS-60E3 (Sold Separately)

Remote Switch RS-60E3 (sold separately) comes with an approx. 60 cm/2.0 ft cord. When connected to the camera's remote control terminal, it can be pressed halfway and completely, just like the shutter button.

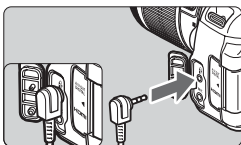

Using the Eyepiece Cover

When you use the self-timer, bulb, or Remote Switch and do not look through the viewfinder, stray light entering the viewfinder can cause the image to look dark. To prevent this, use the eyepiece cover (p.27) attached to the camera strap.

During Live View shooting and movie shooting, attaching the eyepiece cover is unnecessary.

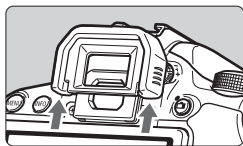

1 Remove the eyecup.

- Push the bottom of the eyecup to remove.

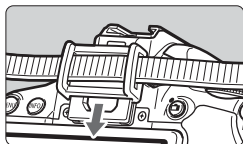

2 Attach the eyepiece cover.

- Slide the eyepiece cover down into the eyepiece groove to attach it.
- After taking the picture, detach the eyepiece cover and attach the eyecup by sliding it down the eyepiece groove.

External Speedlites

EOS-dedicated, EX-series Speedlites

Basically operates like a built-in flash for easy operation.

When an EX-series Speedlite (sold separately) is attached to the camera, almost all the autoflash control is done by the camera. In other words, it is like a high-output flash attached externally in place of the built-in flash.

For detailed instructions, refer to the EX-series Speedlite's instruction manual. This camera is a Type-A camera that can use all the features of EX-series Speedlites.





Shoe-mount Speedlites



Macro Lites



- With an EX-series Speedlite not compatible with flash function settings (p.220), only **[Flash exposure compensation]** can be set for **[External flash func. setting]**. (With certain EX-series Speedlites, **[Shutter synchronization]** is also settable.)
- If flash exposure compensation is set with the external Speedlite, the flash exposure compensation icon displayed on the camera's LCD monitor will change from  to .
- If the Speedlite's Custom Function has the flash metering mode set to TTL autoflash, the flash will fire at full output only.

Canon Speedlites Other Than the EX-series

- **With an EZ/E/EG/ML/TL-series Speedlite set in TTL or A-TTL autoflash mode, the flash can be fired at full output only.** Set the camera's shooting mode to <M> (manual exposure) or <Av> (aperture-priority AE) and adjust the aperture setting before shooting.
- When using a Speedlite that has manual flash mode, shoot in the manual flash mode.

Using Non-Canon Flash Units

Sync Speed

The camera can synchronize with compact, non-Canon flash units at 1/200 sec. or slower shutter speeds. Use a sync speed slower than 1/200 sec.

Be sure to test the flash unit beforehand to make sure it synchronizes properly with the camera.

Cautions for Live View shooting

A non-Canon flash will not fire during Live View shooting.



- If the camera is used with a flash unit or flash accessory dedicated to another camera brand, the camera may not operate properly and malfunction may result.
- Do not attach a high-voltage flash unit on the camera's hot shoe. It may not fire.

Using Eye-Fi Cards

With a commercially-available Eye-Fi card already set up, you can automatically transfer captured images to a personal computer or upload them to an online service via a wireless LAN.

The image transfer is a function of the Eye-Fi card. For instructions on how to set up and use the Eye-Fi card or to troubleshoot any image transfer problems, refer to the Eye-Fi card's instruction manual or contact the card's manufacturer.

⚠ The camera is not guaranteed to support Eye-Fi card functions (including wireless transfer). In case of an issue with an Eye-Fi card, please check with the card manufacturer. Also note that approval is required to use Eye-Fi cards in many countries or regions. Without approval, use of the card is not permitted. If it is unclear whether the card has been approved for use in your area, please check with the card manufacturer.

1 Insert an Eye-Fi card (p.31).

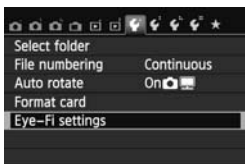

2 Select [Eye-Fi settings].

- Under the [**1**] tab, select [**Eye-Fi settings**], then press <SET>.
- This menu is displayed only when an Eye-Fi card is inserted into the camera.



3 Enable Eye-Fi transmission.

- Press <SET>, set [**Eye-Fi trans.**] to [**Enable**], then press <SET>.
- If you set [**Disable**], automatic transmission will not occur even with the Eye-Fi card inserted (transmission status icon ).

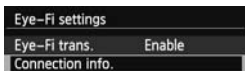

4 Display the connection information.

- Select [**Connection info.**], then press <SET>.



5 Check the [Access point SSID:].

- Check that an access point is displayed for [Access point SSID:].
- You can also check the Eye-Fi card's MAC address and firmware version.
- Press the <MENU> button three times to exit the menu.

6 Take the picture.

- ▶ The picture is transferred and the <Wi-Fi icon> switches from gray (not connected) to one of the icons below.
- For transferred images, [Image icon] is displayed in the shooting information display (p.270).



Transmission status icon

- 📶 (Gray) **Not connected** : No connection with access point.
- 📶 (Blinking) **Connecting** : Connection with access point.
- 📶 (Displayed) **Connected** : Connection to access point established.
- 📶 (↑) **Transferring** : Image transfer to access point in progress.





Cautions for Using Eye-Fi Cards

- If “” is displayed, an error occurred while retrieving the card information. Turn the camera's power switch off and on again.
- Even if [**Eye-Fi trans.**] is set to [**Disable**], it may still transmit a signal. In hospitals, airports, and other places where wireless transmissions are prohibited, remove the Eye-Fi card from the camera.
- If the image transfer does not function, check the Eye-Fi card and personal computer settings. For details, refer to the card's instruction manual.
- Depending on the wireless LAN's connection conditions, the image transfer may take longer or it may be interrupted.
- Because of the transmission function, the Eye-Fi card may become hot.
- The battery power will be consumed faster.
- During the image transfer, auto power off will not take effect.

Function Availability Table According to Shooting Mode

●: Set automatically ○: User selectable □: Not selectable/Disabled

Function	Basic Zone										Creative Zone				Movie	
	A+	TV	CA	SR	SL	SR	SR	SCN	SCN	SCN	P	Tv	Av	M	AF	AF ⁺¹
All image quality settings selectable	○	○	○	○	○	○	○	○	○ ⁺²	○ ⁺²	○	○	○	○	○	○
ISO speed	Automatically set/Auto ISO	●	●	●	●	●	●	●	●	●	○	○	○	○	○	○
	Manual										○	○	○	○	○	○ ⁺³
	Maximum for Auto										○	○	○	○		
Picture Style	Automatic Selection/Auto	●	●	●	●	●	●	●	●	●	○	○	○	○	○	○ ⁺⁴
	Manual selection										○	○	○	○	○	○ ⁺⁵
Ambience-based shots			○	○	○	○	○	○	○							
Light/scene-based shots				○	○	○	○									
White balance	Auto	●	●	●	●	●	●	●	●	●	○	○	○	○	○	○ ⁺⁴
	Preset										○	○	○	○	○	○ ⁺⁵
	Custom										○	○	○	○	○	○ ⁺⁵
	Correction/Bracketing										○	○	○	○	○ ⁺⁶	○ ⁺⁵
Auto Lighting Optimizer	●	●	●	●	●	●	●	●	●	●	○	○	○	○	○	○ ⁺⁵
Lens aberration correction	Peripheral illumination correction	○	○	○	○	○	○	○	○	○	○	○	○	○	○	○
	Chromatic aberration correction	○	○	○	○	○	○	○	○	○	○	○	○	○	○	○
Long exposure noise reduction											○	○	○	○		
High ISO speed noise reduction	●	●	●	●	●	●	●	●	●	●	○	○	○	○		
Highlight tone priority											○	○	○	○	○	○ ⁺⁵
Color space	sRGB	●	●	●	●	●	●	●	●	●	○	○	○	○	○	○ ⁺⁵
	Adobe RGB										○	○	○	○	○	○ ⁺⁵
Focusing	One-Shot AF				●	●	●		●	●	●	○	○	○	○	AF 
	AI Servo AF								●			○	○	○	○	AF ()
	AI Focus AF	●	●	●								○	○	○	○	AF 
	AF point selection	●	●	●	●	●	●	●	●	●	○	○	○	○	○	AFQuick ⁺⁷
	AF-assist beam	●		●	●	⁺⁸	●	⁺⁸	●	●	●	○	○	○	○	○

*1: The  icon indicates still photo shooting in the movie shooting mode.

*2: RAW +  or RAW cannot be selected.

*3: Settable only for manual exposures.

*4: Set automatically in Basic Zone modes.

*5: Settable only in Creative Zone modes.

Function		Basic Zone									Creative Zone				Movie	
		A+	S	CA	AF	AF	AF	AF	SCN	SCN	SCN	P	Tv	Av	M	Movie
Metering mode	Evaluative metering	●	●	●	●	●	●	●	●	●	○	○	○	○		
	Metering mode selection										○	○	○	○		
Exposure	Program shift										○					
	Exposure compensation										○	○	○		○*5 Other than M	
	AEB										○	○	○	○		
	AE lock										○	○	○	*9	○*5	
	Depth-of-field preview										○	○	○	○		
Drive	Single shooting	○	○	○	○	○	○	○	○	○	○	○	○	○		○
	Continuous shooting	○	○	○	○	○	○	○	○	○	○	○	○	○		○*10
	⏏ (10 sec.)	○	○	○	○	○	○	○	○	○	○	○	○	○		○*10
	⏏ ₂ (2 sec.)	○	○	○	○	○	○	○	○	○	○	○	○	○		○*10
	⏏ _c (Continuous)	○	○	○	○	○	○	○	○	○	○	○	○	○		○*10
Built-in flash	Automatic firing	●		○	●		●	●								
	Manual firing			○					○		○	○	○	○		
	Flash off		●	○		●		●		○	●	○	○	○		●
	Red-eye reduction	○		○	○		○		○	○		○	○	○		
	FE lock										○	○	○	○		
	Flash exposure compensation										○	○	○	○		
	Wireless control										○	○	○	○		
External flash	Function settings										○	○	○	○		
	Custom Function settings										○	○	○	○		
Live View shooting		○	○	○	○	○	○	○	○	○	○	○	○	○		
Aspect ratio*7											○	○	○	○		
Quick Control		○	○	○	○	○	○	○	○	○	○	○	○	○		○
Feature guide		○	○	○	○	○	○	○	○	○	○	○	○	○		○

*6: White balance correction can be set.

*7: Settable only for Live View shooting.

*8: If the AF method is <AFQuick> during Live View shooting, the external Speedlite will emit the AF-assist beam when necessary.

*9: With Auto ISO, you can set a fixed ISO speed.

*10: Works only before the start of movie shooting.

System Map

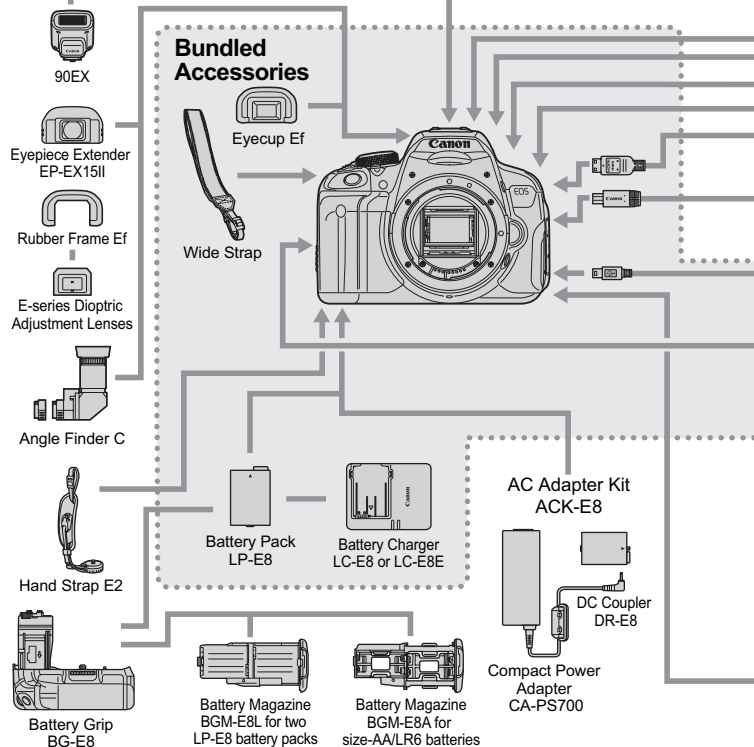
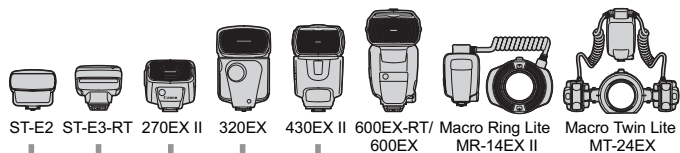

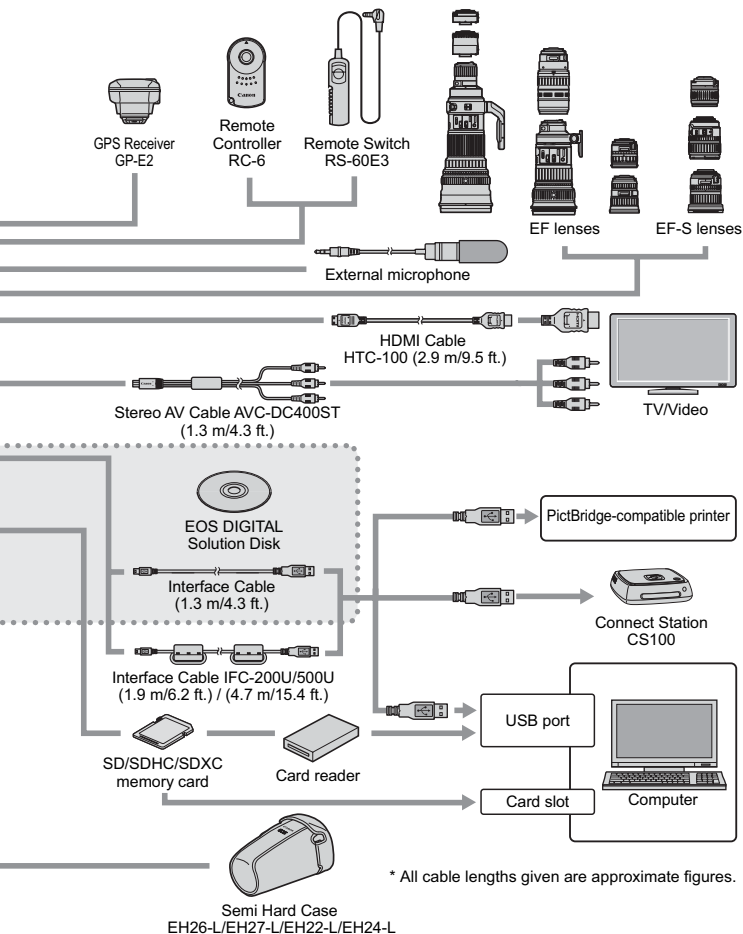

MENU Menu Settings

For Viewfinder Shooting and Live View Shooting

📷 Shooting 1 (Red)

Page

Image quality	L / L / M / M / S1 / S1 / S2 / S3 / RAW + L* / RAW*	88
Beep	Enable / Touch to / Disable	204
Release shutter without card	Enable / Disable	204
Image review	Off / 2 sec. / 4 sec. / 8 sec. / Hold	204
Lens aberration correction	Peripheral illumination: Enable / Disable Chromatic aberration: Enable / Disable	129
Red-eye reduction	Disable / Enable	108
Flash control	Flash firing / E-TTL II metering / Flash sync. speed in Av mode / Built-in flash settings / External flash function settings / External flash C.Fn settings / Clear settings	218

* Not selectable if the > or > shooting mode, Multi Shot Noise Reduction, or a Creative filter is set.

📷 Shooting 2 (Red)

Exposure compensation/AEB	1/3-stop or 1/2-stop increments, ±5 stops (AEB: ±2 stops)	121
Auto Lighting Optimizer	Disable / Low / Standard / High Disable during manual exposure	125
Custom White Balance	Manual setting of white balance	137
White balance shift/bracketing	WB correction: White balance correction BKT setting: White balance bracketing	139 140
Color space	sRGB / Adobe RGB	141
Picture Style	Auto / Standard / Portrait / Landscape / Neutral / Faithful / Monochrome / User Def. 1-3	95 132 135
Metering mode	Evaluative metering / Partial metering / Spot metering / Center-weighted average metering	117



Shaded menu options are not displayed in Basic Zone modes.

Shooting 3 (Red)

Page

Dust Delete Data	Obtains data to be used to erase dust spots	224
ISO Auto	Max.: 400 / Max.: 800 / Max.: 1600 / Max.: 3200 / Max.: 6400	94
Long exposure noise reduction	Disable / Auto / Enable	127
High ISO speed noise reduction	Disable / Low / Standard / High / Multi Shot Noise Reduction	126

Live View Shooting (Red)

Live View shooting	Enable / Disable	147
AF method	+Tracking / FlexiZone - Multi / FlexiZone - Single / Quick mode	159
Continuous AF	Enable / Disable	156
Touch Shutter	Disable / Enable	168
Grid display	Off / Grid 1  / Grid 2 	156
Aspect ratio	3:2 / 4:3 / 16:9 / 1:1	157
Metering timer	4 sec. / 16 sec. / 30 sec. / 1 min. / 10 min. / 30 min.	158

Playback 1 (Blue)



Protect images	Select images / All images in folder / Unprotect all images in folder / All images on card / Unprotect all images on card	266
Rotate image	Rotate vertical images	247
Erase images	Select and erase images / All images in folder / All images on card	268
Print order	Specify images to be printed (DPOF)	289
Photobook Set-up	Select images / All images in folder / Clear all in folder / All images on card / Clear all on card	293
Creative filters	Grainy B/W / Soft focus / Fish-eye effect / Art bold effect / Water painting effect / Toy camera effect / Miniature effect	274
Resize	Downsize the image's pixel count	277

▶ Playback 2 (Blue)

Page

Histogram display	Brightness / RGB	272
Image jump w/ 	1 image / 10 images / 100 images / Date / Folder / Movies / Stills / Rating	243
Slide show	Playback description / Display time / Repeat / Transition effect / Background music	258
Rating	[OFF] / [•] / [••] / [•••] / [••••] / [•••••]	248
Control over HDMI	Disable / Enable	263

🔧 Set-up 1 (Yellow)

Select folder	Create and select a folder	206
File numbering	Continuous / Auto reset / Manual reset	208
Auto rotate	On   / On  / Off	212
Format card	Initialize and erase data on the card	48
Eye-Fi settings*	Eye-Fi transmission: Disable / Enable Connection information	311

* Displayed only when an Eye-Fi card is used.

🔧 Set-up 2 (Yellow)

Auto power off	30 sec. / 1 min. / 2 min. / 4 min. / 8 min. / 15 min. / Disable	205
LCD brightness	Seven brightness levels provided	205
LCD auto off	Enable / Disable	217
Time zone	Daylight saving time* / Time zone	36
Date/Time	Date (year, month, day) / Time (hour, min., sec.) / Daylight saving time*	36
Language 	Select the interface language	38
Video system	NTSC / PAL	265

* The daylight saving time setting is linked to [Time zone] and [Date/time].

☛ Set-up 3 (Yellow)

Page

Screen color	Select the shooting settings screen color	217
Feature guide	Enable / Disable	52
Touch control	Enable / Disable	55
Sensor cleaning	Auto cleaning: Enable / Disable	223
	Clean now	
	Clean manually	226
GPS device settings	Settings available when the GPS Receiver GP-E2 (sold separately) is attached	–

☛ Set-up 4 (Yellow)

Certification Logo Display	Displays some of the logos of the camera's certifications	305
Custom Functions (C.Fn)	Customize camera functions as desired	296
Copyright information	Display copyright information / Enter author's name / Enter copyright details / Delete copyright information	210
Clear settings	Clear all camera settings / Clear all Custom Func. (C.Fn)	214
📷 Firmware Ver.*	For updating the firmware	–

* During firmware updates, the touch screen will be disabled to prevent accidental operations.

★ My Menu (Green)

My Menu settings	Register frequently-used menu options and Custom Functions	303
-------------------------	--	-----

📍 When using a GPS device, be sure to check the countries and areas of use, and use the device in accordance with the laws and regulations of the country or region.

For Movie Shooting

Shooting 1 (Red)

Page

Image quality	L / L / M / M / S1 / S1 / S2 / S3 / RAW + L / RAW	88
Beep	Enable / Touch to / Disable	204
Release shutter without card	Enable / Disable	204
Image review	Off / 2 sec. / 4 sec. / 8 sec. / Hold	204
Lens aberration correction	Peripheral illumination: Enable / Disable	129

Shooting 2 (Red)

Exposure compensation	1/3-stop or 1/2-stop increments, ±5 stops	121
Auto Lighting Optimizer	Disable / Low / Standard / High Disable during manual exposure	125
Custom White Balance	Manual setting of white balance	137
White balance shift/bracketing	WB correction: White balance correction BKT setting: White balance bracketing	139 140
Color space	sRGB / Adobe RGB	141
Picture Style	Auto / Standard / Portrait /	95
	Landscape / Neutral 1 / Faithful /	132
	Monochrome / User Def. 1-3	135

Shooting 3 (Red)



Dust Delete Data	Obtains data to be used to erase dust spots	224
------------------	---	-----









- Shaded menu options are not displayed in Basic Zone modes.
- The menu tabs and options displayed will differ between viewfinder shooting/Live View shooting and movie shooting. Note that the menu tabs and options displayed in [▶1] Playback 1, [▶2] Playback 2, [⚙1] Set-up 1 to [⚙4] Set-up 4 and [★] My Menu are the same as those displayed in viewfinder shooting/Live View shooting (p.319 - 321).
- The [🎥1] and [🎥2] Menu tabs will appear only for movie shooting.

 **Movie 1 (Red)**

Page

AF method	+Tracking / FlexiZone - Multi / FlexiZone - Single	196
Movie Servo AF	Enable / Disable	196
AF with shutter button during 	ONE SHOT / Disable	197
Grid display	Off / Grid 1  / Grid 2 	198
Metering timer	4 sec. / 16 sec. / 30 sec. / 1 min. / 10 min. / 30 min.	198

 **Movie 2 (Red)**

Movie recording size	1920x1080 ( /  / ) / 1280x720 ( / ) / 640x480 ( / )	185
Sound recording*	Sound recording: Auto / Manual / Disable	198
	Recording level	
	Wind filter/Attenuator: Disable / Enable	
Video snapshot	Video snapshot: Enable / Disable	187
	Album settings: Create a new album / Add to existing album	

* In Basic Zone modes, [Sound recording] will be set to [On/Off].

Troubleshooting Guide

If a problem occurs with the camera, first refer to this Troubleshooting Guide. If this Troubleshooting Guide does not resolve the problem, contact your dealer or nearest Canon Service Center.

Power-Related Problems

The battery pack does not recharge.

- Do not recharge any battery pack other than a genuine Canon Battery Pack LP-E8.

The battery charger's lamp blinks.

- If there is a problem with the battery charger, the protective circuit will stop the charging operation and the charge lamp will blink in orange. If this happens, disconnect the charger's power plug from the power outlet and remove the battery pack. Attach the battery pack to the charger again and wait a while before connecting the charger to a power outlet again.

The camera does not operate even when the power switch is set to <ON>.

- Make sure the battery is properly installed in the camera (p.30).
- Make sure the battery compartment cover is closed (p.30).
- Make sure the card slot cover is closed (p.31).
- Recharge the battery (p.28).
- Press the <INFO.> button (p.50).

The access lamp still blinks even when the power switch is set to <OFF>.

- If the power is turned off while an image is being recorded to the card, the access lamp will remain on/continue to blink for a few seconds. When the image recording is completed, the power will turn off automatically.

The battery becomes exhausted quickly.

- Use a fully-charged battery pack (p.28).
- The rechargeable battery pack performance will degrade over repeated use. Purchase a new one.
- The number of possible shots will decrease with any of the following operations:
 - Pressing the shutter button halfway for a prolonged period.
 - Often activating only the AF without taking a picture.
 - Using the lens Image Stabilizer.
 - Using the LCD monitor often.
 - Continuing Live View shooting or movie shooting for a prolonged period.

The camera turns off by itself.

- Auto power off is in effect. If you do not want auto power off to take effect, set [**F2: Auto power off**] to [**Disable**] (p.205).
- Even if [**F2: Auto power off**] is set to [**Disable**], the LCD monitor will still turn off after the camera is left idle for 30 min. (The camera's power does not turn off.) Press the <INFO.> button to turn on the LCD monitor.

Shooting-Related Problems

No images can be shot or recorded.

- Make sure the card is properly inserted (p.31).
- Slide the card's write-protect switch to the Write/Erase position (p.31).
- If the card is full, replace the card or delete unnecessary images to make room (p.31, 268).
- If you try to focus in the One-Shot AF operation while the focus confirmation light <●> in the viewfinder blinks, a picture cannot be taken. Press the shutter button halfway again to refocus automatically, or focus manually (p.43, 103).

The card cannot be used.

- If a card error message is displayed, see page 32 or 337.

The image is out of focus.

- Set the lens focus mode switch to <AF> (p.39).
- To prevent camera shake, press the shutter button gently (p.42, 43).
- If the lens has an Image Stabilizer, set the IS switch to <ON>.
- In low light, the shutter speed may become slow. Use a faster shutter speed (p.110), set a higher ISO speed (p.92), use flash (p.107), or use a tripod.

I cannot lock the focus and recompose the shot.

- Set the AF operation to One-Shot AF. Focus lock is not possible in the AI Servo AF and AI Focus AF operations (p.98).

With FlexiZone - Multi, it takes longer to autofocus.

- Depending on the shooting conditions, it may take longer to focus the subject. Use FlexiZone - Single instead or focus manually.

The continuous shooting speed is slow.

- Depending on the lens type, shutter speed, aperture, subject conditions, brightness, etc., the continuous shooting speed may become slower.

The maximum burst during continuous shooting is lower.

- With ISO 12800 or "H" (equivalent to ISO 25600), the maximum burst for continuous shooting will greatly decrease (p.93).
- Set [ 3: High ISO speed NR] to [Standard/Low/Disable]. If it is set to [High] or [Multi Shot Noise Reduction], the maximum burst during continuous shooting will greatly decrease (p.126).
- With [Chromatic aberration: Enable], the maximum burst for continuous shooting will greatly decrease (p.130).
- During WB bracketing, the maximum burst for continuous shooting will decrease (p.140).
- If you shoot something that has fine detail (such as a field of grass), the file size will be larger and the actual maximum burst may be lower than the number mentioned on page 89.

ISO 100 cannot be set.

- Under [**F4: Custom Functions (C.Fn)**], if [**3: Highlight tone priority**] is set to [**1: Enable**], ISO 100 cannot be set. If [**0: Disable**] is set, ISO 100 can be set (p.299). This also applies to movie shooting (p.178).

ISO speed [H] (ISO 25600) cannot be set.

- Under [**F4: Custom Functions (C.Fn)**], if [**3: Highlight tone priority**] is set to [**1: Enable**], the [H] ISO speed (25600) cannot be selected even when [**2: ISO expansion**] is set to [**1: On**]. If [**0: Disable**] is set for [**3: Highlight tone priority**], [H] can be set (p.298).

The Auto Lighting Optimizer cannot be set.

- Under [**F4: Custom Functions (C.Fn)**], if [**3: Highlight tone priority**] is set to [**1: Enable**], the Auto Lighting Optimizer cannot be set. If [**0: Disable**] is set, the Auto Lighting Optimizer can be set (p.299).

Even though I set a decreased exposure compensation, the image comes out bright.

- Set [**2: Auto Lighting Optimizer**] to [**Disable**]. When [**Standard/Low/High**] is set, even if you set a decreased exposure compensation or flash exposure compensation, the image may come out bright (p.125).

When I use the <Av> mode with flash, the shutter speed becomes slow.

- If you shoot at night when the background is dark, the shutter speed becomes slow automatically (slow-sync shooting) so that both the subject and background are properly exposed. To prevent a slow shutter speed, under [**1: Flash control**], set [**Flash sync. speed in Av mode**] to [**1/200-1/60 sec. auto**] or [**1/200 sec. (fixed)**] (p.219).

The built-in flash is raised by itself.

- In the **A⁺**, **CA**, **☺**, **☹**, **☹**, and **☹** modes, the built-in flash will be raised automatically when flash is necessary.

The built-in flash does not fire.

- If you shoot continuously with the built-in flash at short intervals, the flash may stop operating to protect the flash unit.

The flash always fires at full output.

- If you use a flash unit other than an EX-series Speedlite, the flash will always be fired at full output (p.310).
- Under [**☺1: Flash control**] and [**External flash C.Fn setting**], if [**Flash metering mode**] is set to [**TTL**], the flash will always fire at full output (p.220).

I cannot set flash exposure compensation with external flash function setting.

- If flash exposure compensation has been set on an external Speedlite, [**Flash exposure compensation**] (p.221) cannot be set in the [**External flash func. setting**] screen. Also, if you set flash exposure compensation with the camera and then set flash exposure compensation with the external Speedlite, the Speedlite's flash exposure compensation setting will be given priority. When the Speedlite's flash exposure compensation is canceled (set to 0), [**Flash exposure compensation**] can be set with the camera.

High-speed sync cannot be set in the <Av> mode.

- Under [ 1: Flash control], set [Flash sync. speed in Av mode] to [Auto] (p.219).



The camera makes a noise when it is shaken.

- The built-in flash's pop-up mechanism moves slightly. This is normal.

The shutter makes two shooting sounds during Live View shooting.

- If you use flash, the shutter will make two sounds each time you shoot (p.147).

During Live View and movie shooting, a white < > or red < > icon is displayed.

- It indicates that the camera's internal temperature is high. If the white < > icon is displayed, the still photo's image quality may deteriorate. If the red < > icon is displayed, it indicates that the Live View or movie shooting will soon stop automatically (p.171, 200).

Movie shooting stops by itself.

- If the card's writing speed is slow, movie shooting may stop automatically. Use an SD Speed Class 6 "CLASS 6" or faster card. To find out the card's read/write speed, refer to the card manufacturer's Web site, etc.
- If the movie shooting time reaches 29 min. 59 sec., the movie shooting will stop automatically.

The ISO speed cannot be set for movie shooting.

- In shooting modes other than <M>, the ISO speed is set automatically. In the <M> mode, you can freely set the ISO speed (p.178).

The exposure changes during movie shooting.

- If you change the shutter speed or aperture during movie shooting, the changes in the exposure may be recorded.
- Zooming the lens during movie shooting can cause changes in the exposure regardless of whether the lens' maximum aperture changes or not. Changes in the exposure may be recorded as a result.

The subject looks distorted during movie shooting.

- If you move the camera to the left or right quickly (high-speed panning) or shoot a moving subject, the image may look distorted.

The image flickers or horizontal stripes appear during movie shooting.

- Flickering, horizontal stripes (noise), or irregular exposures can be caused by fluorescent light, LED bulbs, or other light sources during movie shooting. Also, changes in the exposure (brightness) or color tone may also be recorded. In the <M> mode, a slow shutter speed may solve the problem.

Operation Problems

During touch screen operations, the beeper suddenly sounds softer.

- Check if your finger is covering the speaker (p.21).

Touch screen operation is not possible.

- Check if [Enable] is set with [👉3: Touch control] (p.55).

Display Problems

The menu screen shows few tabs and options.

- In Basic Zone modes and in movie shooting mode, certain tabs and menu options are not displayed. Set the shooting mode to a Creative Zone mode (p.46).

The file name's first character is an underscore (“_”).

- Set the color space to sRGB. If Adobe RGB is set, the first character will be an underscore (p.141).

The file name starts with “MVI_”.

- It is a movie file (p.209).

The file numbering does not start from 0001.

- If the card already contains recorded images, the image number may not start from 0001 (p.208).

The shooting date and time displayed is incorrect.

- Make sure the correct date and time has been set (p.36).
- Check the time zone and daylight savings time (p.36).

The date and time is not in the picture.

- The shooting date and time does not appear in the picture. The date and time is instead recorded in the image data as shooting information. When printing, you can imprint the date and time in the picture by using the date and time recorded in the shooting information (p.285).

[###] is displayed.

- If the card has recorded a number of images greater than the camera can display, [###] will be displayed (p.249).

The LCD monitor does not display a clear image.

- If the LCD monitor is dirty, use a soft cloth to clean it.
- In low or high temperatures, the LCD monitor display may seem slow or may look black. It will return to normal at room temperature.

[Eye-Fi settings] does not appear.

- **[Eye-Fi settings]** will appear only when an Eye-Fi card is inserted in the camera. If the Eye-Fi card has a write-protect switch set to the LOCK position, you will not be able to check the card's connection status or disable Eye-Fi card transmission (p.311).

Playback Problems

Part of the image blinks in black.

- It is the highlight alert (p.272). Overexposed highlight areas with a loss of highlight detail will blink.

The image cannot be erased.

- If the image is protected, it cannot be erased (p.266).

The movie cannot be played back.

- Movies edited with a personal computer using the provided ImageBrowser EX (p.365) or other software cannot be played back with the camera. However, video snapshot albums edited with EOS Video Snapshot Task (p.195) can be played back on the camera.

When the movie is played back, camera operation noise can be heard.

- If you operate the camera's dials or lens during movie shooting, the operation noise will also be recorded. Using an external microphone (commercially available) is recommended (p.198).

The movie has still moments.

- During autoexposure movie shooting, if there is a drastic change in the exposure level, the recording will stop momentarily until the brightness stabilizes. If this happens, shoot with <M> shooting mode (p.177).

No image appears on the TV screen.

- Make sure the stereo AV cable or HDMI cable's plug is inserted all the way in (p.262, 265).
- Set the video OUT system (NTSC/PAL) to the same video system as the TV set (p.265).

There are multiple movie files for a single movie shoot.

- If the movie file size reaches 4 GB, another movie file will be created automatically (p.186).

My card reader does not recognize the card.

- Depending on the card reader and computer OS used, SDXC cards may not be correctly recognized. If this occurs, connect your camera to the computer with the provided interface cable, then transfer the images to your computer using EOS Utility (provided software, p.364).

I cannot resize the image.

- JPEG S3 and RAW images cannot be resized (p.277).

Sensor Cleaning Problems

The shutter makes a noise during sensor cleaning.

- If you selected [**Clean now** ], the shutter will make a noise, but no picture is taken (p.223).

Automatic sensor cleaning does not work.

- If you repeatedly turn the power switch <ON>/<OFF> at a short interval, the < > icon may not be displayed (p.34).

Printing-Related Problems

There are fewer printing effects than listed in this instruction manual.

- What is displayed on the screen differs depending on the printer. This instruction manual lists all the printing effects available (p.284).

Computer Connection Problems

I cannot download images to a computer.

- Install the provided software (EOS DIGITAL Solution Disk CD-ROM) on the computer (p.366).

Error Codes

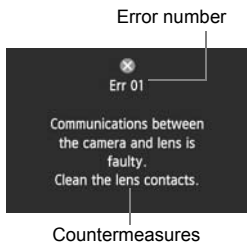

If there is a problem with the camera, an error message will appear. Follow the on-screen instructions.

Number	Error Message and Solution
01	Communications between the camera and lens is faulty. Clean the lens contacts.
	→ Clean the electrical contacts on the camera and lens or use a Canon lens (p.17, 20).
02	Card cannot be accessed. Reinsert/change card or format card with camera.
	→ Remove and insert the card again, replace the card, or format the card (p.31, 48).
04	Cannot save images because card is full. Replace card.
	→ Replace the card, erase unnecessary images, or format the card (p.31, 268, 48).
05	The built-in flash could not be raised. Turn the camera off and on again.
	→ Operate the power switch (p.34).
06	Sensor cleaning is not possible. Turn the camera off and on again.
	→ Operate the power switch (p.34).
10, 20, 30, 40, 50, 60, 70, 80, 99	Shooting is not possible due to an error. Turn the camera off and on again or re-install the battery.
	→ Operate the power switch, remove and install the battery pack again, or use a Canon lens (p.34, 30).

* If the error still persists, write down the error number and contact your nearest Canon Service Center.

Specifications

• Type

Type:	Digital, single-lens reflex, AF/AE camera with built-in flash
Recording media:	SD memory card, SDHC memory card, SDXC memory card * Compatible with UHS-I
Image sensor size:	Approx. 22.3 x 14.9 mm
Compatible lenses:	Canon EF lenses (including EF-S lenses) * Excluding EF-M lenses (35 mm-equivalent focal length is approx. 1.6 times the lens focal length)
Lens mount:	Canon EF mount

• Image Sensor

Type:	CMOS sensor
Effective pixels:	Approx. 18.00 megapixels
Aspect ratio:	3:2
Dust delete feature:	Auto, Manual, Dust Delete Data appending

• Recording System

Recording format:	Design rule for Camera File System (DCF) 2.0
Image type:	JPEG, RAW (14-bit Canon original) RAW+JPEG Large simultaneous recording possible
Recorded pixels:	L (Large) : Approx. 17.90 megapixels (5184 x 3456) M (Medium) : Approx. 8.00 megapixels (3456 x 2304) S1 (Small 1) : Approx. 4.50 megapixels (2592 x 1728) S2 (Small 2) : Approx. 2.50 megapixels (1920 x 1280) S3 (Small 3) : Approx. 350,000 pixels (720 x 480) RAW : Approx. 17.90 megapixels (5184 x 3456)

• Image Processing During Shooting

Picture Style:	Auto, Standard, Portrait, Landscape, Neutral, Faithful, Monochrome, User Def. 1 - 3
Basic+:	Ambience-based shots, Light/scene-based shots
White balance:	Auto, Preset (Daylight, Shade, Cloudy, Tungsten light, White fluorescent light, Flash), Custom White balance correction and white balance bracketing features provided * Flash color temperature information transmission enabled
Noise reduction:	Applicable to long exposures and high ISO speed shots
Automatic image brightness correction:	Auto Lighting Optimizer
Highlight tone priority:	Provided
Lens aberration correction:	Peripheral illumination correction, Chromatic aberration correction

• Viewfinder

Type:	Eye-level pentamirror
Coverage:	Vertical/Horizontal approx. 95% (with Eye point approx. 19 mm)
Magnification:	Approx. 0.85x (-1 m ⁻¹ with 50mm lens at infinity)
Eye point:	Approx. 19 mm (from eyepiece lens center at -1 m ⁻¹)
Built-in dioptic adjustment:	Approx. -3.0 - +1.0 m ⁻¹ (dpt)
Focusing screen:	Fixed, Precision Matte
Mirror:	Quick-return type
Depth-of-field preview:	Provided

• Autofocus

Type:	TTL secondary image-registration, phase detection
AF points:	Nine cross-type AF points (Cross-type AF sensitive to f/2.8 with center AF point)
Focusing brightness range:	EV -0.5 - 18 (center AF point, at 23°C/73°F, ISO 100)
AF operation:	One-Shot AF, AI Servo AF, AI Focus AF
AF-assist beam:	Small series of flashes fired by built-in flash

• Exposure Control

Metering modes:	63-zone TTL full-aperture metering <ul style="list-style-type: none"> • Evaluative metering (linked to all AF points) • Partial metering (approx. 9% of viewfinder at center) • Spot metering (approx. 4% of viewfinder at center) • Center-weighted average metering
Metering brightness range:	EV 1 - 20 (at 23°C/73°F, ISO 100)
Exposure control:	Program AE (Scene Intelligent Auto, Flash Off, Creative Auto, Portrait, Landscape, Close-up, Sports, Special scene (Night Portrait, Handheld Night Scene, HDR Backlight Control), Program), Shutter-priority AE, Aperture-priority AE, Manual exposure
ISO speed: (Recommended exposure index)	Basic Zone modes*: ISO 100 - ISO 6400 set automatically * Portrait: ISO 100, Handheld Night Scene: ISO 100 - ISO 12800 set automatically Creative Zone modes: ISO 100 - ISO 12800 set manually (whole-stop increments), ISO 100 - ISO 6400 set automatically, maximum ISO speed settable for ISO Auto, or ISO expansion to "H" (equivalent to ISO 25600)
Exposure compensation:	Manual: ±5 stops in 1/3- or 1/2-stop increments AEB: ±2 stops in 1/3- or 1/2-stop increments (Can be combined with manual exposure compensation)

AE lock: Auto: Applied in One-Shot AF with evaluative metering when focus is achieved
Manual: With AE lock button

• Shutter

Type: Electronically-controlled, focal-plane shutter
Shutter speeds: 1/4000 sec. to 30 sec. (Total shutter speed range. Available range varies by shooting mode.), Bulb, X-sync at 1/200 sec.

• Flash

Built-in flash: Retractable, auto pop-up flash
Guide No.: Approx. 13/43 (ISO 100, in meters/feet)
Flash coverage: Approx. 17mm lens angle of view
Recycling time approx. 3 sec.
Wireless master function provided

External flash: EX-series Speedlite (Flash functions settable with the camera)
Flash metering: E-TTL II autofocus
Flash exposure compensation: ± 2 stops in 1/3- or 1/2-stop increments
FE lock: Provided
PC terminal: None

• Drive System

Drive mode: Single shooting, continuous shooting, self-timer with 10-sec. or 2-sec. delay and 10-sec. delay with continuous shooting

Continuous shooting speed: Max. approx. 5 shots/sec.

Max. burst (Approx.): JPEG Large/Fine: 22 (30) shots
RAW: 6 (6) shots
RAW+JPEG Large/Fine: 3 (3) shots

* Figures in parentheses apply to an UHS-I compatible 8 GB card based on Canon's testing standards.
* Figures are based on Canon's testing standards (ISO 100 and "Standard" Picture Style) using an 8 GB card.

• Live View Shooting

Aspect ratio settings: 3:2, 4:3, 16:9, 1:1
Focusing: Hybrid CMOS AF System* (Face+Tracking, FlexiZone-Multi, FlexiZone-Single), Phase-difference detection (Quick mode)
Manual focusing (approx. 5x / 10x magnification possible)
* Focusing brightness range: EV 1 - 18 (at 23°C/73°F, ISO 100)

Continuous AF:	Provided
Touch shutter:	Provided
Metering modes:	Real-time metering with image sensor Evaluative metering (315 zones), Partial metering (approx. 8.8% of Live View screen), Spot metering (approx. 2.8% of Live View screen), Center-weighted average metering
Metering brightness range:	EV 0 - 20 (at 23°C/73°F, ISO 100)
Creative filters:	Grainy B/W, Soft focus, Fish-eye effect, Art bold effect, Water painting effect, Toy camera effect, Miniature effect
Grid display:	Two types
• Movie Shooting	
Recording format:	MOV
Movie:	MPEG-4 AVC / H.264 Variable (average) bit rate
Audio:	Linear PCM
Recording size and frame rate:	1920x1080 (Full HD): 30p/25p/24p 1280x720 (HD) : 60p/50p 640x480 (SD) : 30p/25p * 30p: 29.97 fps, 25p: 25.00 fps, 24p: 23.98 fps, 60p: 59.94 fps, 50p: 50.00 fps
File size:	1920x1080 (30p/25p/24p): Approx. 330 MB/min. 1280x720 (60p/50p) : Approx. 330 MB/min. 640x480 (30p/25p) : Approx. 82.5 MB/min.
Focusing:	Hybrid CMOS AF System* (Face+Tracking, FlexiZone-Multi, FlexiZone-Single) Manual focusing (approx. 5x / 10x magnification possible) * Focusing brightness range: EV 1 - 18 (at 23°C/73°F, ISO 100)
Metering modes:	Center-weighted average and evaluative metering with the image sensor * Automatically set by the focusing mode
Servo AF:	Provided
Metering brightness range:	EV 0 - 20 (at 23°C/73°F, ISO 100)
Exposure control:	Program AE for movies and manual exposure
Exposure compensation:	±3 stops in 1/3-stop increments (Still photos: ±5 stops)

ISO speed: (Recommended exposure index)	With autoexposure shooting: ISO 100 - ISO 6400 set automatically With manual exposure: ISO 100 - ISO 6400 set automatically/ manually, expandable to H (equivalent to ISO 12800)
Video snapshots:	Settable to 2 sec./4 sec./8 sec.
Sound recording:	Built-in stereo microphone External stereo microphone terminal provided Sound recording level adjustable, wind filter provided, attenuator provided
Grid display:	Two types

• LCD Monitor

Type:	TFT color liquid-crystal monitor
Monitor size and dots:	Wide, 7.7 cm (3.0-in.) (3:2) with approx. 1.04 million dots
Angle adjustment:	Possible
Brightness adjustment:	Manual (7 levels)
Interface languages:	25
Touch screen technology:	Capacitive sensing
Feature guide:	Displayable

• Playback

Image display formats:	Single-image display, Single-image + Info display (Basic info, shooting info, histogram), 4-image index, 9-image index
Zoom magnification:	Approx. 1.5x - 10x
Highlight alert:	Overexposed highlights blink
Image browsing methods:	Single image, jump by 10 or 100 images, by shooting date, by folder, by movies, by stills, by rating
Image rotate:	Possible
Ratings:	Provided
Movie playback:	Enabled (LCD monitor, video/audio OUT, HDMI OUT) Built-in speaker
Image protect:	Possible
Slide show:	All images, by date, by folder, by movies, by stills, by rating Five transition effects selectable
Background music:	Selectable for slide shows and movie playback

• Post-Processing of Images

Creative filters:	Grainy B/W, Soft focus, Fish-eye effect, Art bold effect, Water painting effect, Toy camera effect, Miniature effect
Resize:	Possible

• Direct Printing

Compatible printers:	PictBridge-compatible printers
Printable images:	JPEG and RAW images
Print ordering:	DPOF Version 1.1 compatible

• Custom Functions

Custom Functions:	8
My Menu registration:	Possible
Copyright information:	Entry and inclusion possible

• Interface

Audio/video OUT/

Digital terminal:	Analog video (compatible with NTSC/PAL)/stereo audio output Personal computer communication and direct printing (Hi-Speed USB equivalent), GPS Receiver GP-E2 connection
-------------------	---

HDMI mini OUT terminal: Type C (auto switching of resolution), CEC-compatible

External microphone

IN terminal: 3.5 mm diameter stereo mini-jack

Remote control terminal: For Remote Switch RS-60E3

Wireless remote control: Remote Controller RC-6

Eye-Fi card: Compatible

• Power

Battery:	Battery Pack LP-E8 (Quantity 1) * AC power can be supplied via AC Adapter Kit ACK-E8 * With Battery Grip BG-E8 attached, size-AA/LR6 batteries can be used
----------	---

Possible shots: With viewfinder shooting:
(Based on CIPA Approx. 440 shots at 23°C/73°F, approx. 400 shots at 0°C/32°F
testing standards) With Live View shooting:
Approx. 180 shots at 23°C/73°F, approx. 150 shots at 0°C/32°F

Movie shooting time: Approx. 1 hr. 40 min. at 23°C/73°F
Approx. 1 hr. 20 min. at 0°C/32°F
(with a fully-charged Battery Pack LP-E8)

• Dimensions and Weight

Dimensions (W x H x D): Approx. 133.1 x 99.8 x 78.8 mm / 5.2 x 3.9 x 3.1 in.

Weight: Approx. 580 g / 20.5 oz. (CIPA Guidelines),
Approx. 525 g / 18.5 oz. (Body only)

• Operation Environment

Working temperature range: 0°C - 40°C / 32°F - 104°F

Working humidity: 85% or less

• Battery Pack LP-E8

Type: Rechargeable lithium-ion battery

Rated voltage: 7.2 V DC

Battery capacity: 1120 mAh

Working temperature range: During charging: 6°C - 40°C / 43°F - 104°F

During shooting: 0°C - 40°C / 32°F - 104°F

Working humidity: 85% or less

Dimensions (W x H x D): Approx. 37.1 x 15.4 x 55.2 mm / 1.5 x 0.6 x 2.2 in.

Weight: Approx. 52 g / 1.8 oz.

• Battery Charger LC-E8

Compatible battery: Battery Pack LP-E8

Recharging time: Approx. 2 hours (at 23°C/73°F)

Rated input: 100 - 240 V AC (50/60 Hz)

Rated output: 8.4 V DC / 720 mA

Working temperature range: 6°C - 40°C / 43°F - 104°F

Working humidity: 85% or less

Dimensions (W x H x D): Approx. 69 x 28 x 87.5 mm / 2.7 x 1.1 x 3.4 in.

Weight: Approx. 82 g / 2.9 oz.

• Battery Charger LC-E8E

Compatible battery: Battery Pack LP-E8

Recharging time: Approx. 2 hours (at 23°C/73°F)

Rated input: 100 - 240 V AC (50/60 Hz)

Rated output: 8.4 V DC / 720 mA

Working temperature range: 6°C - 40°C / 43°F - 104°F

Working humidity: 85% or less

Dimensions (W x H x D): Approx. 69 x 28 x 87.5 mm / 2.7 x 1.1 x 3.4 in.

Weight: Approx. 82 g / 2.9 oz. (excluding power cord)

• EF-S18-55mm f/3.5-5.6 IS STM

Angle of view: Diagonal extent: 74°20' - 27°50'

Horizontal extent: 64°30' - 23°20'

Vertical extent: 45°30' - 15°40'

Lens construction: 13 elements in 11 groups

Minimum aperture: f/22 - 36

Closest focusing distance: 0.25 m / 0.82 ft. (from image sensor plane)

Max. magnification:	0.36x (at 55 mm)
Field of view:	199 x 129 - 63 x 42 mm / 7.83 x 5.08 - 2.48 x 1.65 in. (at 0.25 m / 0.82 ft.)
Filter size:	58 mm
Lens cap:	E-58 II
Max. diameter x length:	Approx. 69.0 x 75.2 mm / 2.72 x 2.96 in.
Weight:	Approx. 205 g / 7.2 oz.
Hood:	EW-63C (sold separately)
Case:	LP1016 (sold separately)

• EF-S18-135mm f/3.5-5.6 IS STM

Angle of view:	Diagonal extent: 74°20' - 11°30' Horizontal extent: 64°30' - 9°30' Vertical extent: 45°30' - 6°20'
Lens construction:	16 elements in 12 groups
Minimum aperture:	f/22 - 36
Closest focusing distance*:	At 18 mm focal length: 0.39 m / 1.28 ft. (Approx. 372 x 248 mm / 14.6 x 9.8 in. field of view) At 135 mm focal length: 0.39 m / 1.28 ft. (Approx. 80 x 53 mm / 3.1 x 2.1 in. field of view) * Distance from image sensor plane

Max. magnification:	0.28x (at 135 mm)
Filter size:	67 mm
Lens cap:	E-67 II
Max. diameter x length:	Approx. 76.6 x 96.0 mm / 3.0 x 3.8 in.
Weight:	Approx. 480 g / 16.9 oz.
Hood:	EW-73B (sold separately)
Case:	LP1116 (sold separately)

• EF-S18-55mm f/3.5-5.6 IS II

Angle of view:	Diagonal extent: 74°20' - 27°50' Horizontal extent: 64°30' - 23°20' Vertical extent: 45°30' - 15°40'
Lens construction:	11 elements in 9 groups
Minimum aperture:	f/22 - 36
Closest focusing distance:	0.25 m / 0.82 ft. (From image sensor plane)
Max. magnification:	0.34x (at 55mm)
Field of view:	207 x 134 - 67 x 45 mm / 8.1 x 5.3 - 2.6 x 1.8 in. (at 0.25 m / 0.82 ft.)
Filter size:	58 mm

Lens cap:	E-58 II
Max. diameter x length:	Approx. 68.5 x 70.0 mm / 2.7 x 2.8 in.
Weight:	Approx. 200 g / 7.1 oz.
Hood:	EW-60C (sold separately)
Case:	LP814 (sold separately)

• **EF-S55-250mm f/4-5.6 IS II**

Angle of view:	Diagonal extent: 27°50' - 6°15' Horizontal extent: 23°20' - 5°20' Vertical extent: 15°40' - 3°30'
Lens construction:	12 elements in 10 groups
Minimum aperture:	f/22 - 32
Closest focusing distance:	1.1 m / 3.6 ft. (From image sensor plane)
Max. magnification:	0.31x (at 250mm)
Field of view:	328 x 218 - 73 x 49 mm / 12.9 x 8.6 - 2.9 x 1.9 in. (at 1.1m / 3.6 ft.)
Filter size:	58 mm
Lens cap:	E-58 II
Max. diameter x length:	Approx. 70.0 x 108.0 mm / 2.8 x 4.3 in.
Weight:	Approx. 390 g / 13.8 oz.
Hood:	ET-60 (sold separately)
Case:	LP1019 (sold separately)

- All the data above is based on Canon's testing standards and CIPA (Camera & Imaging Products Association) testing standards and guidelines.
- Dimensions, maximum diameter, length and weight listed above are based on CIPA Guidelines (except weight for camera body only).
- Product specifications and the exterior are subject to change without notice.
- If a problem occurs with a non-Canon lens attached to the camera, consult the respective lens maker.

Handling Precautions: EF-S18-55mm f/3.5-5.6 IS STM, EF-S18-135mm f/3.5-5.6 IS STM

The kit lenses use a stepping motor that drives the focus lens. The motor controls the focus lens even during zooming.

1. When the camera is OFF

The motor does not operate while the camera is OFF or when the camera is OFF due to the auto power off function. Therefore, users must be aware of the following points.

- Manual focusing is not possible.
- During zooming, inaccurate focusing may occur.

2. When the lens is in sleep mode

If not operated for a certain period of time, this lens will enter sleep mode in order to save power, apart from the camera's auto power off. To exit sleep mode, press the shutter button halfway.

In sleep mode, the motor will not operate even if the camera is ON. Therefore, users must be aware of the following points.

- Manual focusing is not possible.
- During zooming, inaccurate focusing may occur.

3. During initial reset

When the camera is turned ON or when the camera is turned ON by pressing the shutter button halfway when the camera is OFF due to the auto power off function*¹, the lens performs an initial reset of the focus lens.

- Although the image in the viewfinder will appear out of focus during the initial reset, this is not a malfunction.
- Although the shutter can be released during the initial reset, users must wait approx. 1 second*² after the initial reset has completed before shooting.

*1: Applicable to the following EF-S lens compatible digital SLR cameras:
EOS 7D Mark II, EOS 7D, EOS 70D, EOS 60D, EOS 60Da, EOS 50D, EOS 40D, EOS 30D, EOS 20D, EOS 20Da, EOS REBEL T3i/600D, EOS REBEL T2i/550D, EOS REBEL T1i/500D, EOS REBEL XSi/450D, EOS REBEL T5/1200D, EOS REBEL T3/1100D, EOS REBEL XS/1000D, EOS DIGITAL REBEL XTi/400D DIGITAL, EOS DIGITAL REBEL XT/350D DIGITAL, EOS DIGITAL REBEL/300D DIGITAL

*2: The initial reset time varies depending on the camera used.

Trademarks

- Adobe is a trademark of Adobe Systems Incorporated.
- Microsoft and Windows are trademarks or registered trademarks of Microsoft Corporation in the United States and/or other countries.
- Macintosh and Mac OS are trademarks of Apple Inc., registered in the U.S. and other countries.
- SDXC logo is a trademark of SD-3C, LLC.
- HDMI, HDMI logo, and High-Definition Multimedia Interface are trademarks or registered trademarks of HDMI Licensing LLC.
- All other trademarks are the property of their respective owners.

About MPEG-4 Licensing

"This product is licensed under AT&T patents for the MPEG-4 standard and may be used for encoding MPEG-4 compliant video and/or decoding MPEG-4 compliant video that was encoded only (1) for a personal and non-commercial purpose or (2) by a video provider licensed under the AT&T patents to provide MPEG-4 compliant video. No license is granted or implied for any other use for MPEG-4 standard."

* Notice displayed in English as required.

Use of genuine Canon accessories is recommended

This product is designed to achieve excellent performance when used with genuine Canon accessories. Canon shall not be liable for any damage to this product and/or accidents such as fire, etc., caused by the malfunction of non-genuine Canon accessories (e.g., a leakage and/or explosion of a battery pack). Please note that this warranty does not apply to repairs arising out of the malfunction of non-genuine Canon accessories, although you may request such repairs on a chargeable basis.

Safety Precautions

The following precautions are provided to prevent harm or injury to yourself and others. Make sure to thoroughly understand and follow these precautions before using the product.

If you experience any malfunctions, problems, or damage to the product, contact the nearest Canon Service Center or the dealer from whom you purchased the product.



Warnings: Follow the warnings below. Otherwise, death or serious injuries may result.

- To prevent fire, excessive heat, chemical leakage, explosions, and electrical shock, follow the safeguards below:
 - Do not use any batteries, power sources, or accessories not specified in the Instruction Manual. Do not use any home-made or modified batteries.
 - Do not short-circuit, disassemble, or modify the battery. Do not apply heat or solder to the battery. Do not expose the battery to fire or water. Do not subject the battery to strong physical shock.
 - Do not insert the battery's plus and minus ends incorrectly.
 - Do not recharge the battery in temperatures outside the allowable ambient temperature range. Also, do not exceed the recharging time indicated in the Instruction Manual.
 - Do not insert any foreign metallic objects into the electrical contacts of the camera, accessories, connecting cables, etc.
- When disposing of a battery, insulate the electrical contacts with tape to prevent contact with other metallic objects or batteries. This is to prevent a fire or an explosion.
- If excessive heat, smoke, or fumes are emitted when recharging the battery, immediately unplug the battery charger from the power outlet to stop recharging. Otherwise, it may cause a fire, heat damage or electrical shock.
- If the battery leaks, changes color, deforms, or emits smoke or fumes, remove it immediately. Be careful not to get burned in the process. It may cause a fire, electrical shock or skin burn if you keep using it.
- Prevent any battery leakage from contacting your eyes, skin, and clothing. It can cause blindness or skin problems. If the battery leakage contacts your eyes, skin, or clothing, flush the affected area with lots of clean water without rubbing it. See a physician immediately.
- Do not leave any cords near a heat source. It can deform the cord or melt the insulation and cause a fire or electrical shock.
- Do not hold the camera in the same position for long periods of time. Even if the camera does not feel too hot, prolonged contact with the same body part may cause skin redness, blistering or low-temperature contact burns. Using a tripod is recommended for people with circulation problems or very sensitive skin, or when using the camera in very hot places.
- Do not fire the flash at anyone driving a car or other vehicle. It may cause an accident.
- Do not fire the flash near a person's eyes. It may impair the person's vision. When using flash to photograph an infant, keep at least 1 meter/3.3 feet away.

- When the camera or accessories are not in use, make sure to remove the battery and disconnect the power plug from the equipment before storing. This is to prevent electrical shock, excessive heat, fire, or corrosion.
- Do not use the equipment where there is flammable gas. This is to prevent an explosion or a fire.
- If you drop the equipment and the casing breaks open to expose the internal parts, do not touch the internal parts. There is a possibility of an electrical shock.
- Do not disassemble or modify the equipment. High-voltage internal parts can cause electrical shock.
- Do not look at the sun or an extremely bright light source through the camera or lens. Doing so may damage your vision.
- Keep equipment out of the reach of children and infants, including when in use. Straps or cords may accidentally cause choking, electrical shock, or injury. Choking or injury may also occur if a child or infant accidentally swallows a camera part or accessory. If a child or infant swallows a part or accessory, consult a physician immediately.
- Do not store the equipment in dusty or humid places. Likewise, store the battery with its protective cover attached to prevent short-circuit. This is to prevent a fire, excessive heat, electrical shock, or burn.
- Before using the camera inside an airplane or hospital, check if it is allowed. Electromagnetic waves emitted by the camera may interfere with the plane's instruments or the hospital's medical equipment.
- To prevent a fire and electrical shock, follow the safeguards below:
 - Always insert the power plug all the way in.
 - Do not handle a power plug with wet hands.
 - When unplugging a power plug, grasp and pull the plug instead of the cord.
 - Do not scratch, cut, or excessively bend the cord or put a heavy object on the cord. Also do not twist or tie the cords.
 - Do not connect too many power plugs to the same power outlet.
- Do not use a cord whose wire is broken or insulation is damaged.
- Unplug the power plug periodically and clean off the dust around the power outlet with a dry cloth. If the surrounding is dusty, humid, or oily, the dust on the power outlet may become moist and short-circuit the outlet, causing a fire.
- Do not connect the battery directly to an electrical outlet or a car's cigarette lighter outlet. The battery may leak, generate excessive heat or explode, causing a fire, burns or injuries.
- A thorough explanation of how to use the product by an adult is required when the product is used by children. Supervise children while they are using the product. Incorrect usage may result in electrical shock or injury.
- Do not leave a lens or lens-attached camera in the sun without the lens cap attached. Otherwise, the lens may concentrate the sun's rays and cause a fire.
- Do not cover or wrap the product with a cloth. Doing so may trap heat within and cause the casing to deform or catch fire.
- Be careful not to get the camera wet. If you drop the product in the water or if water or metal get inside the product, promptly remove the battery. This is to prevent a fire and an electrical shock.
- Do not use paint thinner, benzene, or other organic solvents to clean the product. Doing so may cause fire or a health hazard.

**Cautions:** Follow the cautions below. Otherwise physical injury or property damage may result.

- Do not use or store the product inside a car under the hot sun or near a heat source. The product may become hot and cause skin burns. Doing so may also cause battery leakage or explosion, which will degrade the performance or shorten the life of the product.
- Do not carry the camera around when it is attached to a tripod. Doing so may cause injury. Also make sure the tripod is sturdy enough to support the camera and lens.
- Do not leave the product in a low-temperature environment for an extended period of time. The product will become cold and may cause injury when touched.
- Never play the provided CD-ROM in a drive that is not compatible with the CD-ROM. If you use it in a music CD player, you may damage the speakers and other components. When using headphones, there is also a risk of injury to your ears from excessively loud volume.

Digital Camera Model DS126431 Systems

This device complies with Part 15 of the FCC Rules. Operation is subject to the following two conditions: (1) This device may not cause harmful interference, and (2) this device must accept any interference received, including interference that may cause undesired operation.

Note: This equipment has been tested and found to comply with the limits for class B digital devices, pursuant to Part 15 of the FCC Rules. These limits are designed to provide reasonable protection against harmful interference in a residential installation. This equipment generates, uses and can radiate radio frequency energy and, if not installed and used in accordance with the instructions, may cause harmful interference to radio communications. However, there is no guarantee that interference will not occur in a particular installation. If this equipment does cause harmful interference to radio or television reception, which can be determined by turning the equipment off and on, the user is encouraged to try to correct the interference by one or more of the following measures:

- Reorient or relocate the receiving antenna.
- Increase the separation between the equipment and receiver.
- Connect the equipment into an outlet on a circuit different from that to which the receiver is connected.
- Consult the dealer or an experienced radio/TV technician for help.

The cable with the ferrite core provided with the digital camera must be used with this equipment in order to comply with Class B limits in Subpart B of Part 15 of the FCC rules.

Do not make any changes or modifications to the equipment unless otherwise specified in the manual. If such changes or modifications should be made, you could be required to stop operation of the equipment.

Canon U.S.A. Inc.
One Canon Park, Melville, NY 11747, U.S.A.
Tel No. 1-800-OK-CANON (1-800-652-2666)

CAN ICES-3 (B) / NMB-3 (B)



When connecting to and using a household power outlet, use only AC Adapter Kit ACK-E8 (rated input: 100-240 V AC 50/60 Hz, rated output: 7.4 V DC). Using anything else can cause fire, overheating, or electrical shock.



USA and Canada only:

The Lithium ion/polymer battery that powers the product is recyclable. Please call 1-800-8-BATTERY for information on how to recycle this battery.

For CA, USA only

Included lithium battery contains Perchlorate Material – special handling may apply. See www.dtsc.ca.gov/hazardouswaste/perchlorate/ for details.

CAUTION

RISK OF EXPLOSION IF BATTERY IS REPLACED BY AN INCORRECT TYPE.
DISPOSE OF USED BATTERIES ACCORDING TO LOCAL REGULATION.

14

Downloading Images to a Personal Computer

This chapter explains how to download images from the camera to your personal computer, gives an overview of the software in the EOS DIGITAL Solution Disk (CD-ROM) provided with the camera, and explains how to install the software on your personal computer. It also explains how to view the Software Instruction Manuals.



EOS DIGITAL Solution Disk
(Software/Software Instruction Manuals)

Downloading Images to a Personal Computer

You can use the provided software to download the images in the camera to your personal computer. There are two ways to do this.

Download by Connecting the Camera to the Personal Computer

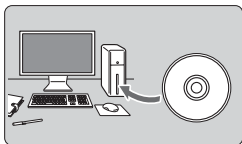

1 Install the software (p.366).

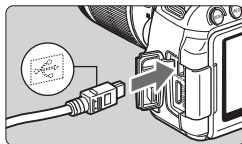

2 Use the provided interface cable to connect the camera to your personal computer.

- Use the interface cable provided with the camera.
- Connect the cable to the camera's <DIGITAL> terminal with the cable plug's <↔> icon facing the front of the camera.
- Connect the cord's plug to the personal computer's USB terminal.

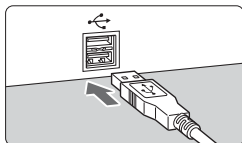

3 Use EOS Utility to download the images/movies.

- For details, refer to the EOS Utility Instruction Manual (p.367).

Downloading Images with a Card Reader

If you have a commercially-available card reader, you can use it to download images to your personal computer.

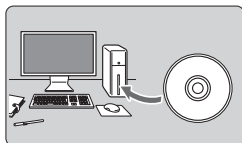

1 Install the software (p.366).

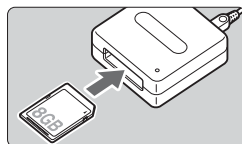

2 Insert the card into the card reader.

3 Use Canon software to download the images/movies.

- ▶ Use Digital Photo Professional.
- ▶ Use ImageBrowser EX.
- For details, refer to the Software Instruction Manuals (p.367).



When downloading images from the camera to your personal computer, if you do not use Canon software and instead use a card reader, copy the DCIM folder on the card to your personal computer.

About the Software



EOS DIGITAL Solution Disk

Various software for EOS DIGITAL cameras are contained on the EOS DIGITAL Solution Disk.

EOS Utility

With the camera connected to a personal computer, EOS Utility enables you to transfer still photos and movies shot with the camera to the computer. You can also use this software to set various camera settings and shoot remotely with the computer connected to the camera. Also, you can copy background music tracks, such as EOS Sample Music*, to the card.

* Can be used as background music during playback of video snapshot albums, movies, or slide shows on the camera.

Digital Photo Professional

This software is recommended for users who mainly shoot **RAW** images. You can view, edit, process, and print **RAW** images at high speed. You can also edit JPEG images while retaining the original images.

Picture Style Editor

You can edit Picture Styles and create and save original Picture Style files. This software is aimed at advanced users who are experienced in processing images.

ImageBrowser EX

Connect to the Internet to download and install the software*. This software is recommended for users who mainly shoot JPEG images. You can easily view and play back still photos, MOV movies, and video snapshot albums and also print JPEG images.

* EOS DIGITAL Solution Disk is necessary for downloading and installing ImageBrowser EX.

 Note that the software ZoomBrowser EX/ImageBrowser provided with previous cameras does not support still photos and MOV movie files shot with this camera (it is not compatible). Use ImageBrowser EX.

Installing the Software

- **Do not connect the camera to your computer before you install the software. The software will not be installed correctly.**
- When downloading and installing ImageBrowser EX, follow the steps below as with other EOS software included on the EOS DIGITAL Solution Disk. Note that Internet connection is necessary. Downloading or installing software is not possible in environments with no Internet connection.
- Even if your computer already has ImageBrowser EX installed, follow the steps below to reinstall ImageBrowser EX. It will be updated to the latest version with features optimized for your camera. Also, the latest functions may be added with the auto update feature.
- For software other than ImageBrowser EX, if a previous version is installed, follow the steps below to reinstall the software. (The newer version will overwrite the previous version.)

1 Insert the EOS DIGITAL Solution Disk into your computer.

- For Macintosh, double-click to open the CD-ROM icon displayed on the desktop, then double-click on **[setup]**.

2 Click [Easy Installation] and follow the on-screen instructions to install.

- If the install screen for “Microsoft Silverlight” is displayed during installation, install “Microsoft Silverlight”.

3 Click [Restart] and remove the CD-ROM after the computer restarts.

- When the computer has restarted, the installation is complete.

Software Instruction Manual



Software Instruction Manuals are contained on the EOS DIGITAL Solution Disk. Instructions for copying and viewing the Software Instruction Manual PDFs are as follows.

1 Insert the EOS DIGITAL Solution Disk into your computer.

2 Close the install screen.

- When the EOS DIGITAL Solution Disk install screen appears, close the install screen.

3 Open the CD-ROM.

4 Open the [Manual] folder.

5 Copy the [English] folder to your computer.

- Instruction Manual PDFs with the names below are copied.

	Windows	Macintosh
EOS Utility	EUx.xW_E_xx	EUx.xM_E_xx
Digital Photo Professional	DPPx.xW_E_xx	DPPx.xM_E_xx
Picture Style Editor	PSEx.xW_E_xx	PSEx.xM_E_xx

- Instruction manual for ImageBrowser EX (ImageBrowser EX User Guide) is included in the software.







6 Double-click the copied PDF file.

- Adobe Reader (most recent version recommended) must be installed on your computer.
- Adobe Reader can be downloaded free from the Internet.

MEMO

15

Quick Reference Guide and Index

Menu Operations - - - - -	p.370
Image-recording Quality - - - - -	p.371
 Picture Style- - - - -	p.371
 Quick Control - - - - -	p.372
Nomenclature - - - - -	p.373
Basic Zone Modes - - - - -	p.375
 Using the Built-in Flash- - - - -	p.375
Creative Zone Modes - - - - -	p.376
P : Program AE - - - - -	p.376
Tv : Shutter-priority AE - - - - -	p.376
Av : Aperture-priority AE- - - - -	p.376
AF: AF Operation - - - - -	p.377
 AF Point - - - - -	p.377
ISO: ISO Speed - - - - -	p.378
 Drive Mode - - - - -	p.378
 Live View Shooting- - - - -	p.379
 Shooting Movies - - - - -	p.380
Image Playback- - - - -	p.381

Quick Reference Guide

Menu Operations

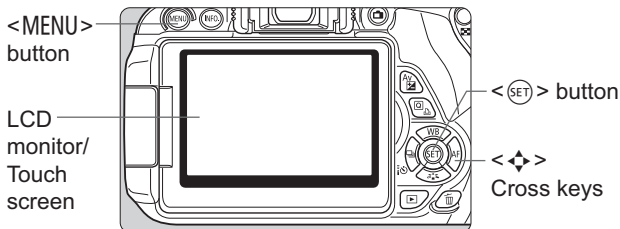

1. Press the <MENU> button to display the menu.
2. Press the <◀▶> key to select a tab, then press the <▲▼> key to select the desired item.
3. Press <SET> to display the setting.
4. After setting the item, press <SET>.

Basic Zone Modes



Movie Shooting

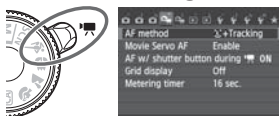

Creative Zone Modes

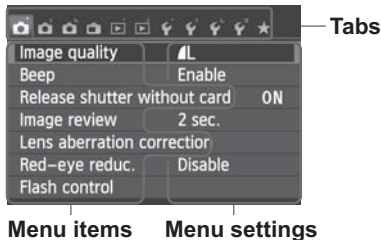
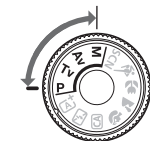
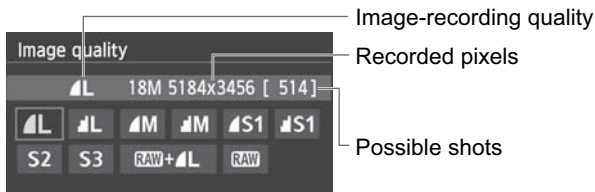

Image-Recording Quality

- Select [**1: Image quality**], then press <SET>.
- Press the <◀▶> key to select the quality, then press <SET>.



Picture Style ☆



- Press the <▼> button.
- Press the <◀▶> key to select the Picture Style, then press <SET>.

Style	Description
Auto	Color tones optimized for the particular scene.
Standard	Vivid colors and sharp images.
Portrait	Nice skin tones and slightly sharp images.
Landscape	Vivid blue skies and greenery and very sharp images.
Monochrome	Black-and-white images.

- For <Neutral> (Neutral) and <Faithful> (Faithful), see page 96.

Q Quick Control

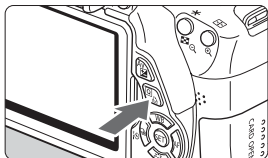

- Press the <Q> button.
- ▶ The Quick Control screen will appear.

Basic Zone Modes

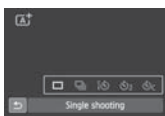
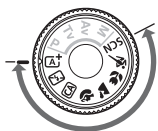

Creative Zone Modes



Labels for the Quick Control screen:

- Shooting mode
- Exposure compensation/AEB setting
- Picture Style
- AF operation
- White balance
- Return
- Drive mode
- White balance correction
- Shutter speed
- Aperture
- Highlight tone priority
- ISO speed
- Flash exposure compensation
- Auto Lighting Optimizer
- Built-in flash settings
- Image-recording quality
- White balance bracketing
- Metering mode

- In Basic Zone modes, the settable functions differ depending on the shooting mode.
- Press the <⬠> key to select a function, then turn the <⚙> dial to set it.

Nomenclature

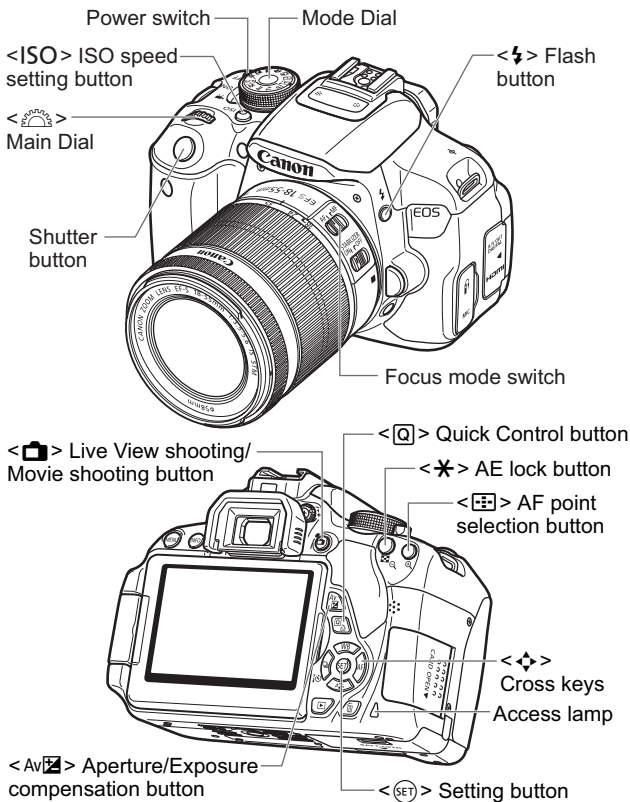

Shooting Settings

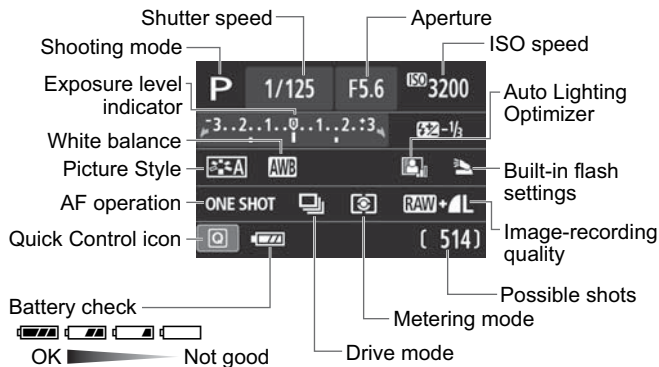

Viewfinder Information

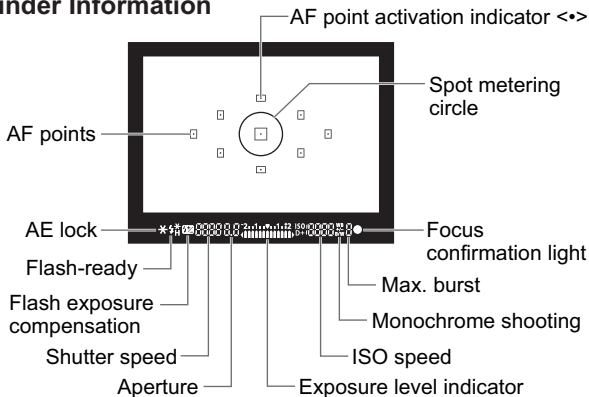

Basic Zone Modes

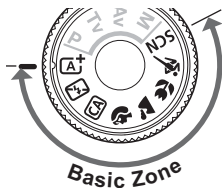

All the settings necessary for shooting are set automatically. You just press the shutter button, and the camera does the rest.

- Scene Intelligent Auto
- Flash Off
- Creative Auto
- Portrait
- Landscape
- Close-up
- Sports
- SCN** Special scene
 - Night Portrait
 - Handheld Night Scene
 - HDR Backlight Control

- At the **SCN** position, press the button, select the shooting mode icon with key, and turn the dial to set the shooting mode.

⚡ Using the Built-in Flash

Basic Zone Modes

If necessary, the built-in flash will be raised and fire automatically in low-light or backlit conditions (except in the > > > > modes).

Creative Zone Modes

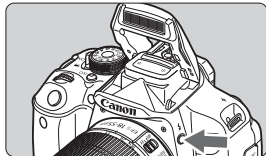

- Press the button to raise the built-in flash, then shoot.

Creative Zone Modes

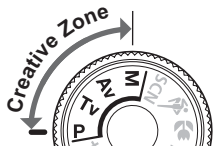

You can change the camera settings as desired to shoot in various ways.

P: Program AE

The camera automatically sets the shutter speed and aperture in the same way as the $\langle \text{A}^+ \rangle$ mode.

- Set the Mode Dial to $\langle \text{P} \rangle$.

Tv: Shutter-priority AE



- Set the Mode Dial to $\langle \text{Tv} \rangle$.
- Turn the $\langle \text{A}^+ \rangle$ dial to set the desired shutter speed, then focus the subject.
- ▶ The aperture will be set automatically.
- If the aperture display blinks, turn the $\langle \text{A}^+ \rangle$ dial until it stops blinking.

Av: Aperture-priority AE



- Set the Mode Dial to $\langle \text{Av} \rangle$.
- Turn the $\langle \text{A}^+ \rangle$ dial to set the desired aperture, then focus the subject.
- ▶ The shutter speed will be set automatically.
- If the shutter speed display blinks, turn the $\langle \text{A}^+ \rangle$ dial until it stops blinking.

AF: AF Operation ☆

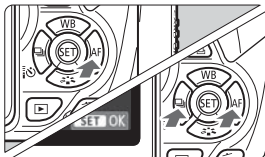

- Set the lens focus mode switch to <AF>.
- Press the <▶ AF> button.
- Press the <◀▶> key or turn the <☀> dial to select the AF operation, then press <SET>.

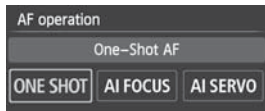

ONE SHOT (One-Shot AF):

For still subjects

AI FOCUS (AI Focus AF):

Switches the AF operation automatically

AI SERVO (AI Servo AF):

For moving subjects

AF Point ☆

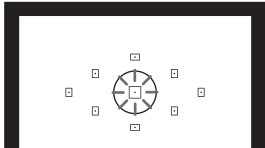
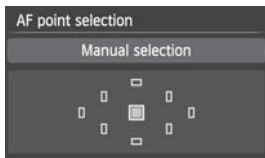

- Press the <☒> button.
- Press the <◆> key to select the AF point.
- While looking through the viewfinder, you can select the AF point by turning the <☀> dial until the desired AF point flashes in red.
- Pressing <SET> toggles the AF point selection between the center AF point and automatic AF point selection.

ISO: ISO Speed ☆

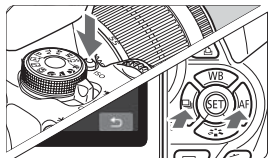

- Press the <ISO> button.
- Press the <◀▶> key or turn the <DIAL> dial to select the ISO speed, then press <SET>.
- When [AUTO] is selected, the ISO speed is set automatically. When you press the shutter button halfway, the ISO speed setting is displayed.

Drive Mode

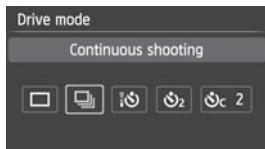
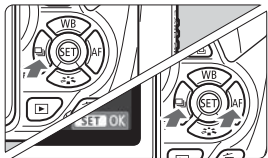

- Press the <◀▶> button.
 - Press the <◀▶> key or turn the <DIAL> dial to select the drive mode, then press <SET>.
- : **Single shooting**
 □ : **Continuous shooting**
 ⏱ : **Self-timer:10 sec./Remote control**
 ⏱₂ : **Self-timer:2 sec.**
 ⏱_C : **Self-timer:Continuous**

Live View Shooting



- Press the  button to display the Live View image.



- Press the shutter button halfway to focus.

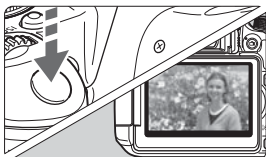



- Press the shutter button completely to take the picture.

● Battery Life with Live View Shooting

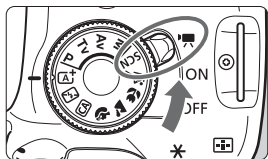

Temperature	No Flash	50% Flash Use
At 23°C / 73°F	Approx. 200 shots	Approx. 180 shots

Shooting Movies



- Set the power switch to .
- Set the Mode Dial to any shooting mode except **M**.



- Press the  button to start shooting a movie.
- To stop movie shooting, press the  button again.

Recording movie

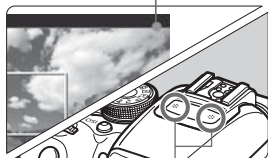

Microphone

Image Playback

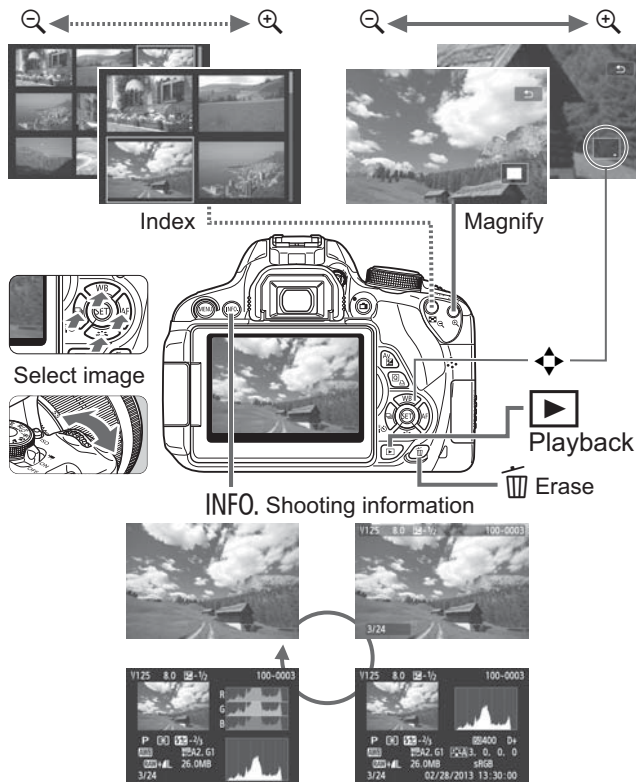

Index

Numerics

10-sec. or 2-sec. delay	106
1280x720	185
1920x1080	185
4- or 9-image index display.....	242
640x480	185
9-point AF auto selection	100

A

A ⁺ (Scene Intelligent Auto).....	58
AC Adapter Kit	306
Access lamp	32
Accessories	3
Adobe RGB.....	141
AE lock	123
AEB.....	121, 298
AF → Focusing	
AF point	100
AI FOCUS (AI Focus AF).....	99
AI SERVO (AI Servo AF)	98
AI Servo AF	61, 98
Ambience-based shots	77
Aperture-priority AE	112
Art bold effect.....	154, 276
Aspect ratio	157
Audio/video OUT	252, 265
Auto Lighting Optimizer	125
Auto playback	258
Auto power off.....	34, 205
Auto reset	209
Auto rotate of vertical images	212
Autofocus.....	97, 100
Automatic selection of AF point	100
Av (Aperture-priority AE).....	112
A/V OUT	252, 265

B

B/W (Monochrome).....	96, 134
Background music.....	261
Basic Zone modes	24
Battery	28, 30, 35
Battery check	35
Battery Grip	35, 316
Beeper.....	204
Black-and-white image....	77, 96, 134
Bracketing	121, 140
Brightness (exposure)	119
Auto exposure bracketing (AEB)	121, 298
Autoexposure lock (AE lock)...	123
Exposure compensation	119
Measurement method (Metering mode)	117
Built-in flash.....	107
BULB (Bulb exposure)	116
Bulb exposures	116

C

CA (Creative Auto).....	64
Cable.....	3, 262, 265, 280, 316, 362
Camera	
Camera shake	142
Clear camera settings.....	214
Holding the camera.....	42
Settings display.....	213
Camera shake.....	41, 42
Card	17, 31, 48
Card reminder	204
Format	48
Low-level format	49
Problem	32, 49
SD speed class.....	173
Write-protect	31
Center-weighted average metering	118
Charger	26, 28
Chromatic aberration correction..	130

Cleaning (Image sensor)223, 226
 Clear camera settings 214
 Close-ups 69
 Color space (color reproduction range)..... 141
 Color temperature 137
 Color tone 133
 Continuous 208
 Continuous shooting 104
 Contrast 133
 Copyright information210
 Creative Auto 64
 Creative filters 152, 274
 ☆ icon4
 Creative Zone modes 24
 Cropping (printing)287
 Custom Functions 296
 Custom WB 137

D

Date/Time 36
 Daylight saving time 37
 DC coupler 306
 Depth-of-field preview 114
 Dial20, 109
 Digital terminal 280, 362
 Dioptic adjustment 42
 Direct printing 292
 DPOF 289
 Dragging 54
 Drive mode 22, 66, 104, 106
 Dust Delete Data 224

E

Erase (image) 268
 Error codes 337
 Evaluative metering 117
 Exposure compensation 119
 Exposure level increments 298
 Extension209

External Speedlite 309
 Eyecup 308
 Eye-Fi card 311
 Eyepiece cover 27, 308

F

Faithful 96
 FE lock 124
 Feature guide 52
 FEB 220
 File name 208
 File size 89, 186, 270
 Filter effect 134, 274
 Final image simulation 150, 181
 Fine (Image-recording quality) 22
 Firmware Ver. 321
 First-curtain synchronization 221
 Fish-eye effect 154, 276
 Flash
 Built-in flash 107
 Custom Functions 222
 Effective range 107
 External Speedlite 309
 FE lock 124
 Flash control 218
 Flash exposure compensation 120
 Flash off 63, 66, 76
 Flash-sync speed 310
 Manual flash 221, 239
 Red-eye reduction 108
 Shutter synchronization (1st/2nd curtain) 221
 Wireless 229
 Flash exposure compensation 120
 Flash mode 220, 221
 Flash-sync contacts 20
 Focus confirmation light 58
 Focus lock 61
 Focus mode switch 39, 103, 170

Focusing	
AF method	159, 196
AF operation	97
AF point selection	100
AF-assist beam	101, 300
Beeper	204
Difficult-to-focus subjects	103, 165, 202
Manual focusing	103, 170
Out of focus	41, 42, 103, 165
Recompose	61
Folder Create/Select	206
Format (card initialization)	48
Frame rate	185
Full Auto (Scene Intelligent Auto)	58
Full High-Definition (Full HD)	185, 252

G

Grainy B/W	154, 275
Grid display	156, 198

H

Handheld Night Scene	73
HDMI	252, 262
HDMI CEC	263
HDR Backlight Control	74
High ISO speed noise reduction ..	126
High-Definition (HD)	185, 252
Highlight alert	272
Highlight detail loss	272
Highlight tone priority	299
Histogram (Brightness/RGB)	272
Hot shoe	309
Household power	306

I

ICC profile	141
-------------------	-----

Image

Auto playback	258
Auto rotate	212
Erase	268
Highlight alert	272
Histogram	272
Image characteristics (Picture Style)	95, 132, 135
Index	242
Jump display (Image browsing)	243
Magnified view	244
Manual rotate	247
No.	208
Playback	84, 241
Protect	266
Rating	248
Review time	204
Shooting information	270
Slide show	258
Transfer	311
View on TV	252, 262
Image conversion factor	40
Image dust prevention.	223, 224, 226
Image review	204
Image Stabilizer (lens)	41
Image Zone	24
Image-recording quality	88
Index display	242
ISO speed	92
Automatic setting (Auto)	93
ISO expansion	298
Maximum ISO speed with ISO Auto	94

J

JPEG	89
Jump display	243

L

Landscape	68, 96
Language selection	38
Large (Image-recording quality)	22

- LCD monitor..... 17
 Brightness adjustment..... 205
 Image playback 84, 241
 Menu screen..... 46, 318
 Screen color 217
 Shooting settings display..... 22, 50
 Vari-Angle..... 33, 62
- Lens..... 25, 39
 Chromatic aberration
 correction..... 130
 Image stabilizer 41
 Lock release 40
 Peripheral illumination
 correction..... 129
- Light/scene-based shots81
- Live View shooting62, 145
 Aspect ratio157
 Continuous AF156
 Creative filters152
 Face+Tracking..... 159
 FlexiZone - Multi 161
 FlexiZone - Single..... 162
 Grid display156
 Information display 148
 Manual focusing 103, 170
 Metering timer..... 158
 Possible shots 147
 Quick Control151
 Quick mode 166
- Long exposure noise reduction.... 127
- Long exposures 116
- M**
- M (Manual exposure) 115
- Macro photography..... 69
- Magnified view 170, 244
- Malfunction324
- Manual exposure 115, 177
- Manual focus (MF)..... 103, 170
- Manual reset..... 209
- Manual selection (AF)..... 100
- Maximum burst..... 89, 90
- Medium (Image-recording
 quality)..... 22, 278
- Memory card → Card
- Menu 46
 My Menu 303
 Setting procedure..... 47
 Settings 318
- MENU** icon..... 4
- Metering mode 117
- Metering timer 158, 198
- MF (Manual focusing)..... 103, 170
- Microphone..... 174
- Miniature effect..... 155, 276
- Mirror lockup..... 142, 300
- Mode Dial 24
- Monochrome 77, 96, 134
- Movie 173
 AF method 184, 196
 Attenuator 199
 Autoexposure..... 174
 Edit..... 256
 Editing out first and
 last scenes 256
 Enjoying 252
 File size 186
 Frame rate 185
 Grid display 198
 Information display..... 179
 Manual exposure 177
 Manual focusing..... 174
 Metering timer 198
 Movie recording size 185
 Movie Servo AF 196
 Playback 254
 Quick Control 184
 Recording time..... 186
 Sound recording..... 187, 198
 Still photo shooting..... 182
 Video snapshot 187
 Video snapshot album 187
 View on TV..... 252, 262
 Wind filter 199

Multi Shot Noise Reduction 126
 My Menu 303

N

Neutral 96
 Night Portrait 72
 Night scene 72, 73
 Noise reduction
 High ISO speed 126
 Long exposures 127
 Nomenclature 20
 Non-Canon flash units 310
 Normal (Image-recording quality) ... 22
 NTSC 185, 320

O

ONE SHOT (One-Shot AF) 98
 One-Shot AF 98

P

P (Program AE) 86
 PAL 185, 320
 Paper settings (printing) 282
 Partial metering 117
 Peripheral illumination
 correction 129
 Personal white balance 138
 Photobook Set-up 293
 PictBridge 279
 Picture Style 95, 132, 135
 Pixels 88
 Playback 84, 241
 Portrait 67, 95
 Possible shots 35, 88, 147
 Power
 Auto power off 205
 Battery check 35
 Household power 306
 Possible shots 35, 88, 147
 Recharge 28
 Predictive (AI Servo) 98

Pressing completely 43
 Pressing halfway 43
 Printing 279
 Cropping 287
 Layout 283
 Paper settings 282
 Photobook Set-up 293
 Print Order (DPOF) 289
 Printing effects 284
 Tilt correction 287
 Program AE 86
 Program shift 87
 Protect
 (image erase-protection) 266

Q











Q (Quick
 Control) 44, 76, 151, 184, 250
 Quick Control 76
 Quick mode 166

R

Rating mark 248
 RAW 22, 91
 RAW+JPEG 22, 91
 Recharge 28
 Red-eye reduction 108
 Release shutter without card 204
 Remote control shooting 307
 Remote switch 308
 Resize 277
 Revert to default settings 214
 Rotate (image) 212, 247, 287

S

Safety precautions 349
 Saturation 133
 Scene icon 149, 176
 SD, SDHC, SDXC card → Card
 Second-curtain synchronization .. 221
 Self-timer 106
 Sensor cleaning 223, 226

Sepia (Monochrome) 77, 134
 Sharpness 133
 Shooting information display 270
 Shooting mode 24
 Av (Aperture-priority AE) 112
 M (Manual exposure) 115
 P (Program AE) 86
 Tv (Shutter-priority AE) 110
  (Scene Intelligent Auto) 58
  (Flash Off) 63
  (Creative Auto) 64
  (Portrait) 67
  (Landscape) 68
  (Close-up) 69
  (Sports) 70
 SCN (Special scene) 71
  (Night Portrait) 72
  (Handheld Night Scene) ...73
  (HDR Backlight Control) .. 74
 Shooting mode's settable functions 314
 Shooting settings display 22, 50
 Shutter button 43
 Shutter synchronization 221
 Shutter-priority AE 110
 Single shooting 66, 315
 Single-image display 84
 Single-point AF 100
 Slide show 258
 Small (Image-recording quality) 22, 278
 Soft focus 154, 275
 Software 3, 364
 Speaker 254
 Special scene mode 71
 Sports 70
 Spot metering 117
 sRGB 141
 Stopped-down aperture 114
 Strap 27
 System map 316

T

Tap (Touch) 53
 Temperature warning 171, 200
 Time zone 36
 Tone priority 299
 Toning effect (Monochrome) 134
 Touch beeping 54
 Touch screen 21, 53, 245, 255
 Touch shutter 168
 Toy camera effect 155, 276
 Tripod socket 21
 Tv (Shutter-priority AE) 110

U

USB (Digital) terminal 280, 362

V

Vari-Angle LCD monitor 33, 62
 Video snapshot 187
 Video snapshot album 187
 Video system 185, 265, 320
 View on TV 252, 262
 Viewfinder 23
 Dioptic adjustment 42
 Volume (Movie playback) 255

W

Water painting effect 154, 276
 WB (White balance) 137
 White balance 137
 Bracketing 140
 Correction 139
 Custom 137
 Personal 138
 Wind filter 199
 Wireless flash shooting 229
 Custom wireless shooting 234
 Easy wireless shooting 231

Canon

The descriptions in this Instruction Manual are current as of April 2015. For information on the compatibility with any products introduced after this date, contact any Canon Service Center. For the latest version Instruction Manual, refer to the Canon Web site.