



E104-BT51 User Manual

CC2640R2F BLE5.0 Low power consumption

Bluetooth to serial port module



CONTENT

1. OVERVIEW.....	4
1.1 BRIEF INTRODUCTION.....	4
1.2 FEATURES.....	4
1.3 APPLICATION.....	5
2. SPECIFICATION AND PARAMETER.....	5
2.1 LIMIT PARAMETER.....	5
2.2 OPERATING PARAMETER.....	5
3. SIZE AND PIN DEFINITION.....	7
4. RECOMMENDED CONNECTION DIAGRAM.....	9
5. FUNCTION DESCRIPTION.....	9
5.1 POWER MODE.....	9
5.1.1 <i>Low power consumption mode</i>	9
5.1.2 <i>Wake-up mode</i>	10
5.2 DATA VALID INDICATION.....	10
5.3 GPIO LEVEL READING.....	11
5.4 GPIO LEVEL OUTPUT.....	11
5.5 PWM OUTPUT.....	11
5.6 ADC ACQUISITION.....	12
5.7 BATTERY VOLTAGE SERVICE.....	12
5.8 MAC ADDRESS BINDING.....	13
5.9 BLUETOOTH MAXIMUM PACKET LENGTH MTU CONFIGURATION.....	14
5.10 UUID CONFIGURATION.....	14
5.11 BROADCAST DATA CAN BE SWITCHED.....	14
5.12 CONFIGURATION OVER AIR.....	15
5.13 STATUS OR EVENT PRINTING.....	16
6. OPERATION COMMAND.....	16
6.1 AT COMMAND TEST.....	18
6.2 READ AND CONFIGURE BAUD RATE.....	18
6.3 READ AND CONFIGURE STOP BIT.....	18
6.4 READ AND SET SERIAL PARITY.....	19
6.5 SET AND READ SERIAL DATA LENGTH.....	19
6.6 CHECK THE CURRENT BROADCAST STATUS, TURN ON GENERAL BROADCAST, IBEACON BROADCAST, TURN BROADCAST.....	19
6.7 QUERY AND SET GENERAL BROADCAST DATA (SAVE WHEN POWER OFF).....	19
6.8 QUERY AND SET GENERAL BROADCAST DATA (DO NOT SAVE WHEN POWER OFF).....	20
6.9 QUERY AND SET IBEACON MAJOR BROADCAST DATA.....	20
6.10 QUERY AND SET IBEACON MINOR BROADCAST DATA.....	20
6.11 QUERY AND SET IBEACON UUID.....	20
6.12 QUERY AND SET IBCTXPWR.....	21
6.13 READ AND SET THE DEVICE NAME (SAVE WHEN POWER DOWN).....	21
6.14 READ AND SET THE DEVICE NAME (DO NOT SAVE WHEN POWER OFF).....	21
6.15 READ SOFTWARE VERSION NUMBER.....	22
6.16 READ AND SET BROADCAST INTERVAL.....	22

6.17 READ AND SET THE MINIMUM CONNECTION INTERVAL.....	22
6.18 READ AND SET THE MAXIMUM CONNECTION INTERVAL.....	22
6.19 READ AND SET TIMEOUT.....	23
6.20 SET AND QUERY DELAY TIMES.....	23
6.21 DISCONNECT THE CURRENT CONNECTION.....	23
6.22 QUERY THE CURRENT CONNECTION STATUS.....	23
6.23 QUERYING THE LOCAL MAC ADDRESS.....	23
6.24 QUERY THE MAC ADDRESS OF THE CONNECTED DEVICE.....	24
6.25 READ MAC BINDING STATUS, ENABLE OR DISABLE MAC BINDING.....	24
6.26 READ AND SET BINDING MAC.....	24
6.27 QUERY AND SET THE MTU LENGTH.....	24
6.28 QUERY AND SET THE UUID LENGTH OF THE TRANSPARENT TRANSMISSION SERVICE.....	25
6.29 QUERY AND SET THE BLUETOOTH SERVICE UUID.....	25
6.30 QUERY AND SET THE BLUETOOTH READ SERVICE UUID.....	25
6.31 QUERY AND SET THE BLUETOOTH WRITE SERVICE UUID.....	25
6.32 QUERY, ENABLE, DISABLE SERIAL PORT DELAY.....	26
6.33 RESTART COMMAND.....	26
6.34 RESTORE FACTORY.....	26
6.35 AUTHENTICATE CONFIGURATION OVER AIR PASSWORD.....	26
6.36 UPDATE AND QUERY CONFIGURATION OVER AIR PASSWORD.....	27
6.37 QUERY AND SET TRANSMIT POWER.....	27
6.38 ENTER SLEEP IMMEDIATELY.....	27
6.39 QUERY AND SET PRINTING STATUS.....	27
6.40 READ IO INPUT.....	28
6.41 SET AND READ IO OUTPUT.....	28
6.42 SET AND READ PWM ENABLE.....	28
6.43 SET AND QUERY PWM OUTPUT PERIOD.....	28
6.44 SET AND QUERY PWM DUTY CYCLE.....	29
6.45 QUERY ADC SAMPLING VALUE.....	29
6.46 SET AND READ THE MAXIMUM BATTERY VOLTAGE.....	29
6.47 SET AND QUERY THE MINIMUM BATTERY VOLTAGE.....	29
6.48 QUERY RSSI.....	30
7. UUID DESCRIPTION.....	30
7.1 EBYTE DATA TRANSMISSION UUID.....	30
7.2 STANDARD BATTERY VOLTAGE SERVICE UUID.....	30
8. QUICK START.....	31
8.1 QUICK GUIDE TO CONFIGURATION MODE.....	31
8.2 QUICK GUIDE TO TRANSPARENT TRANSMISSION AND CONFIGURATION OVER AIR MODE.....	32
8.3 GUIDE TO BLUETOOTH BATTERY SERVICE.....	40
9. HARDWARE DESIGN.....	41
10. FAQ.....	42
10.1 COMMUNICATION RANGE IS TOO SHORT.....	42
10.2 MODULE IS EASY TO DAMAGE.....	43
10.3 BIT ERROR RATE IS TOO HIGH.....	43

11. WELDING OPERATION GUIDANCE.....	43
11.1 REFLOW SOLDERING TEMPERATURE.....	43
11.2 REFLOW SOLDERING CURVE.....	44
12. RELATED MODELS.....	44
13. BATCH PACKAGING.....	46
14. REVISION HISTORY.....	46
15. ABOUT US.....	47

1. Overview

1.1 Brief introduction

E104-BT51 is a serial to BLE Bluetooth slave module based on Bluetooth protocol version 5.0, which is small-sized, low power consumption, and works in the 2.4GHz frequency band.

E104-BT51 module is a serial to BLE Bluetooth module developed by Chengdu Ebyte Electronic Technology Co., Ltd. based on TI CC2640R2F chip. This module uses AT commands to set parameters, and is easy to operate and configure. The module only supports the Bluetooth slave mode. The module functionally supports low-power broadcasting with changeable content, transparent transmission of data and continuous transmission of files with variable baud rate. It supports air command configuration and IO port level reading , IO port switch level setting, PWM output with variable frequency and period, AD analog acquisition, Bluetooth battery voltage service. The module can be widely used in smart wear, home automation, home security, personal health care, smart appliances, accessories and remote control, automotive electronics, lighting industry, industrial internet, smart data collection, smart control, etc. The module supports a maximum baud rate of 921600bps and a 2M PHY air rate of Bluetooth 5.0.

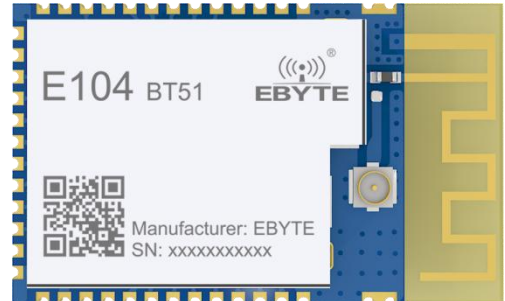

1.2 Features

- Support Bluetooth BLE 5.0 protocol;
- Support adjustable Bluetooth packet length;
- Support two operating modes of configuration and transparent transmission;
- Support auto-broadcast and auto-connection upon power on;
- Support iBeacon and general broadcast switching;
- Support broadcast data can be set;
- Support MAC address binding;
- Support multiple serial port modes and baud rates;
- Support customized 16-bit UUID and 128-bit UUID;
- Support Bluetooth parameter configuration over air;
- Maximum communication distance up to 75m (0dBm);
- Support ultra-low power consumption sleep mode, and broadcasts data synchronously and connection is maintained
- Support IO port level reading;
- Support IO port level output;
- Support PWM output with variable frequency period;
- Support ADC analog acquisition;
- Support battery voltage detection service;
- Support 2M, 1M airspeed;
- MTU data transmission unit maximum 230 bytes;
- Built-in PCB antenna, no external antenna required;

1.3 Application

- Wireless meter reading and sensing
- Smart home
- Industrial remote control and telemetry
- Smart buildings, smart construction
- Automatic data collection
- Health sensor
- Smart wearable device
- Smart robot
- Wireless sensing
- Electronic label
- Intelligent control

2. Specification and parameter

2.1 Limit parameter

Main Parameter	Performance		Note
	Min	Max	
Voltage supply [V]	0	3.6	Voltage over 3.8V will cause permanent damage to module
Blocking power [dBm]	-	10	Chances of burn is slim when modules are used in short distance
Operating temperature [°C]	-40	+85	Industrial grade

2.2 Operating parameter

Main parameter		Performance			Note
		Min	Typ	Max	
Operating voltage[V]		1.8	3.3	3.6	≥3.3 V ensures output power
Communication level [V]			3.0		For 5V TTL, it may be at risk of burning down
Operating temperature [°C]		-40	-	+85	Industrial design
Frequency [MHz]		2402	-	2480	Support ISM band
Power consumption	Transmitting current (mA)	-	9.1		
	Receiving current (mA)	-	6.1		
	Sleep current (μA)	-	1.2		Software shutdown
Maximum Transmitting power [dBm]		4.6	5	5.5	
Receiving sensitivity [dBm]		-98.5	-99	-100.5	Air rate is 250k bps

Sleep broadcast current(Default)	-	29.93	-	Unit: uA. Broadcast interval is 1s
Wake up broadcast current (Default)	-	1581	-	Unit: uA. Broadcast interval is 1s
Wake up no broadcast current(Default)	-	1570	-	Unit: uA.
Wake up connection current(Default)	-	2301	-	Unit: uA. Connection interval is 1s
Sleep connection current (Default)	-	259.1	-	Unit: uA. Connection interval is 1s

Main parameter	Description	Note
Reference distance	75m (0dBm)	Clear and open environment, height 1.5m (only 75m can be tested by the host)
Transmission length	128Byte	
Bluetooth protocol	BLE5.0	
Communication interface	UART	
Package	SMD	
Interface	1.27 mm	
Size	17.5*28.7mm	
Antenna	PCB	50Ω Impedance

3. Size and pin definition

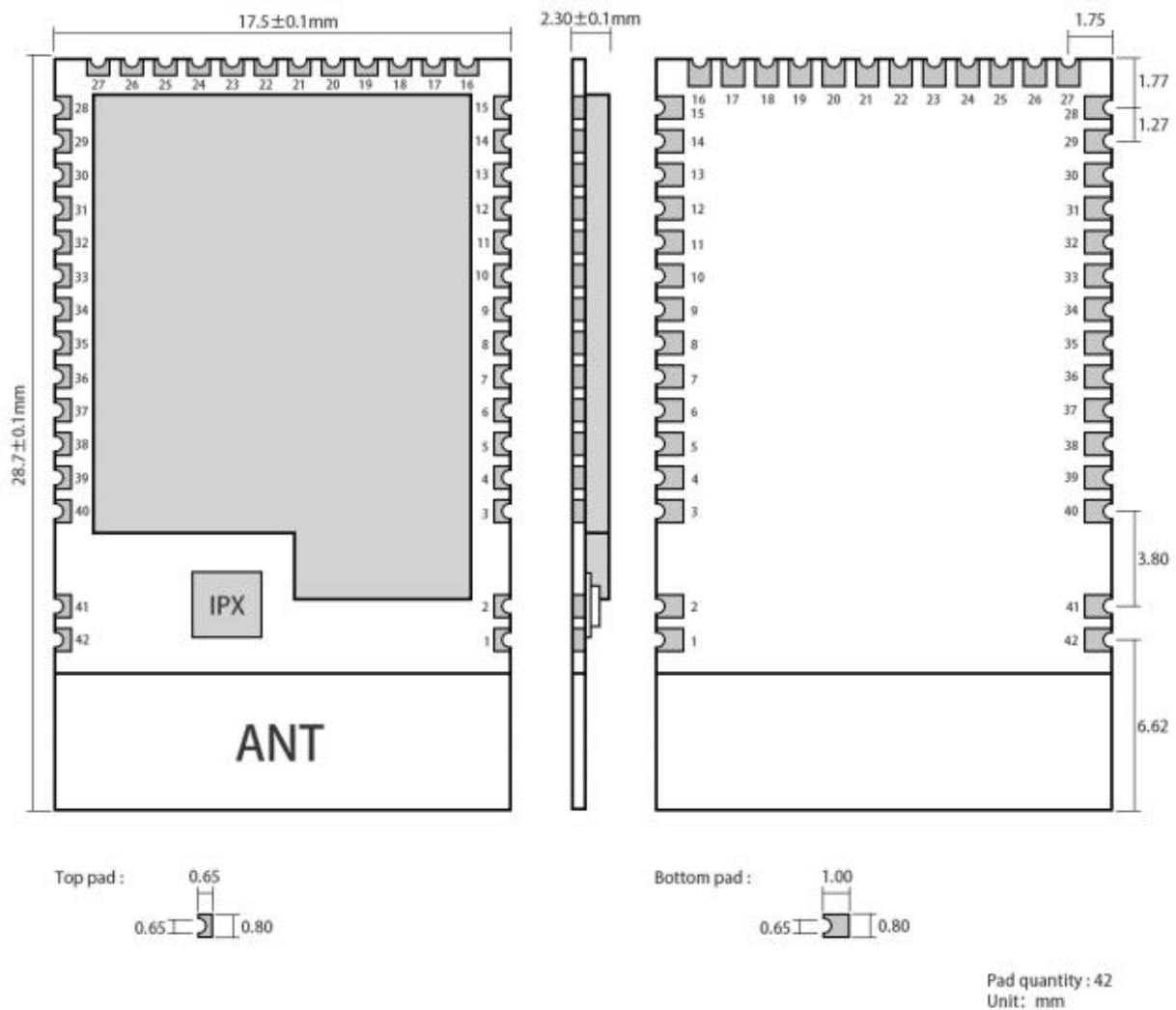

Pin No.	Name	Direction	Function
1	GND		Ground, connected to power supply reference ground
2	GND		Ground, connected to power supply reference ground
3	GND		Ground, connected to power supply reference ground
4	DIO_0	Input/Output	General IO port, sensor controller (see CC26xx manual for details) reserved
5	DIO_1	Input/Output	General IO port, sensor controller (see CC26xx manual for details) reserved
6	DIO_2	Input/Output	RX
7	DIO_3	Input/Output	TX
8	DIO_4	Input/Output	OUT GPIO0
9	DIO_5	Input/Output	OUT GPIO1
10	DIO_6	Input/Output	OUT GPIO2

11	DIO_7	Input/Output	OUT GPIO3
12	DIO_8	Input/Output	PWM0
13	DIO_9	Input/Output	PWM1
14	DIO_10	Input/Output	PWM2
15	DIO_11	Input/Output	PWM3
16	DIO_12	Input/Output	WAKEUP/SLEEP (Wake up sleep)
17	DIO_13	Input/Output	MODE (Mode selection)
18	DIO_14	Input/Output	DATA ((Data indication)
19	DIO_15	Input/Output	LINK (Connection indication)
20	JTAG_TMS20	Input/Output	JTAG_TMSC, High drive capability (see CC26xx manual for details)
21	JTAG_TCK	Input/Output	JTAG_TCKC, High drive capability (see CC26xx manual for details)
22	DIO_16	Input/Output	High drive general IO port, JTAG_TDO (see CC26xx manual for details)
23	DIO_17	Input/Output	High drive general IO port, JTAG_TDI (see CC26xx manual for details)
24	DIO_18	Input/Output	General IO port, (see CC26xx manual for details) reserved (Baseboard button)
25	DIO_19	Input/Output	INGPIO0
26	DIO_20	Input/Output	INGPIO1
27	GND		Ground, connected to power supply reference ground
28	DIO_21	Input/Output	INGPIO2
29	VCC		Power supply, 1.8~3.8V
30	DIO_22	Input/Output	INGPIO3
31	DIO_23	Input/Output	ADC0
32	nRESET	Input/Output	Reset, low (see CC26xx manual for details)
33	DIO_24	Input/Output	ADC1
34	DIO_25	Input/Output	Battery voltage acquisition
35	DIO_26	Input/Output	General IO port, sensor controller, digital (see CC26xx manual for details) reserved
36	DIO_27	Input/Output	General IO port, sensor controller, digital (see CC26xx manual for details) reserved
37	DIO_28	Input/Output	General IO port, sensor controller, digital (see CC26xx manual for details) reserved
38	DIO_29	Input/Output	General IO port, sensor controller, digital (see CC26xx manual for details) reserved
39	DIO_30	Input/Output	General IO port, sensor controller, digital (see CC26xx manual for details) reserved
40	GND		Ground, connected to power supply reference ground
41	GND		Ground, connected to power supply reference ground
42	GND		Ground, connected to power supply reference ground

4. Recommended connection diagram

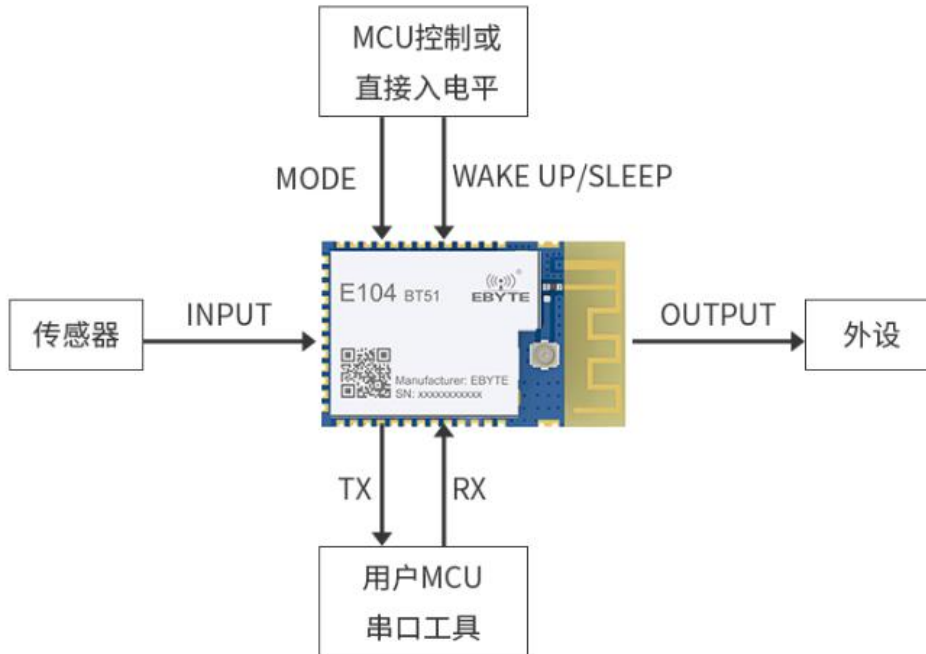

Note: The sensor refers to connecting an external device to a pin with an input function, the peripheral device refers to connecting an external device to a pin with an output function, and the MODE and WAKEUP / SLEEP pins refer to The two control pins are connected to the corresponding level state. If the module needs to be woken up, the WAKEUP / SLEEP (DIO_12) pin should be connected to a low level, or a falling edge signal should be given to the pin in time. If you need to switch between AT configuration mode and transparent transmission mode, you need to give the corresponding edge of the MODE (DIO_13) pin.

5. Function description

5.1 Power mode

5.1.0 Low power consumption mode

Power mode refers to the different operations of WAKEUP / SLEEP (DIO_12). The working state (power consumption) of the module will change differently. The rising edge enters low power consumption mode, and the falling edge enters wake mode.

About the WAKEUP / SLEEP (DIO_12) pin operation description here: 1), the pin detects the edge signal; 2), the pin has

an edge latch function, that is, the level of the pin will change with the external edge. For example, the pin initialization defaults to high level (low power consumption mode). In the future, the pin can only detect the falling edge signal. If the module wakes up after detecting the falling edge signal, the pin becomes low at this time, and only the rising edge can be detected. Edge signal; 3). The above-mentioned high-level and low-level during power-on means that the pin needs to be kept in the high-level or low-level state from the moment of power-on to the normal initialization of the module.

5.1.1 Low power consumption mode

The low power consumption mode means that the BLE function continues to run after the module enters this mode, and the peripherals of the module except the wake-up pin and the indication function pin are turned off, such as PWM and IO output. If a lower power consumption setting is required, the AT command can be used to close the broadcast, disconnect, set a longer broadcast interval and connection interval to achieve the purpose.

There are two ways to enter low power consumption mode: command entry and pin entry.

1. The AT command sends "AT + SLEEP" to immediately enter the low power consumption mode;

2. Enter low power consumption by keeping the rising edge of the WAKEUP pin at over 100ms

The module will actively detect the WAKEUP / SLEEP (DIO_12) pin when it is powered on. If it is high, it will directly enter the low power consumption (SLEEP) mode after power on, if it is low, it will enter the wakeup (WAKEUP) mode. The WAKEUP / SLEEP (DIO_12) pin is initialized to a high level by default. If no operation is performed on this pin, the module powers on and enters the low power consumption (SLEEP) mode.

After the module enters the low power consumption mode, if LOGMSG is turned on, it will output: sleep. During the low power consumption mode, if the broadcast is turned on, the broadcast will continue, and if the device is connected, the connection will not be disconnected. After receiving BLE Bluetooth data during the connection, it will actively wake up the device and print the received data, after printing, continue to enter the low power consumption mode. If data needs to be sent during low power consumption, you need to give the WAKEUP pin a falling edge level that lasts for more than 100ms, and wake up the device before sending data.

5.1.2 Wake-up mode

Wake-up mode refers to the normal operation of the module's peripherals, which remain active and do not close the serial port. At this time, the module continuously receives serial port data, and the power consumption is high. If the device needs to wake up in low power consumption mode, giving the WAKEUP pin a falling edge that lasts longer than 100ms, and the module is woken up. After waking up, if LOGMSG is turned on, it will output: wakeup.

Note: When using AT configuration and data transparent transmission, the module must be in wake-up mode. Otherwise, the module cannot receive the data from the serial port (TX) pin.

5.2 Data valid indication

In the transparent transmission mode, after Bluetooth receives the data, it is transmitted transparently through the serial port. In order to ensure that the external MCU can receive the data correctly, users can set the delayed output data through the "AT + DELAYDATA = 1" command. After setting, the module's DATA pin will output a low level 10ms

before sending data to wake up the external MCU. After 10ms, the data starts to be sent, and the DATA pin is pulled high. as shown in the picture below:



5.3 GPIO Level reading

The E104-BT51 module has four IO read pins. For some places where switch value need to be collected, the level value of the pin can be queried through the AT command "AT + READGPIO?", this function extends the acquisition mode of the module. Users do not need to add an additional MCU when collecting signals. They can directly collect signals through the module, which saves users more resources and reduces the amount of user code development. It is convenient and quick to use. To read GPIO level, refer to AT command 6.40 Read IO input.

5.4 GPIO Level output

The E104-BT51 module has four IO output pins. For some places where level signal control is needed, the GPIO level status can be set by the AT command "AT + OUTGPIO = [para]". Users can use the E104-BT51 module as the controller to control some devices, and the device can be controlled directly through the module without adding an additional MCU, which saves users more resources and reduces the amount of user code development. It is convenient and quick to use. To set the GPIO output, refer to command 6.41 setting and read IO output.

5.5 PWM Output

The E104-BT51 module considers the comprehensiveness of the user's use, and the level control mode may not meet the requirements and can not realize precise control in some occasions. Therefore, the E104-BT51 module has 4 PWM output pins. Users can set the PWM cycle and duty cycle to achieve the control purpose according their needs. Set the PWMx enable via AT command "AT + PWMx = 1", set the period (frequency) of PWMx via AT command "AT + PERIODx = [para]", and set the duty cycle of PWMx via AT command "AT + DUTYx = [para]". The unit of duty cycle and period (frequency) is us, so you need to pay attention that the duty cycle should not be greater than the period when using it. After changing the PWM frequency, the duty cycle needs to be set again according to the specific value. When users use the E104-BT51 module for PWM control, they can directly control the PWM waveform through the module output without adding an additional MCU, which saves users more resources and reduces the amount of user code development. It is convenient and quick to use. For details on setting the PWM enable, refer to 6.42 Setting and reading the PWM Enable. For details on setting the PWM output period, refer to 6.43 Setting and querying the PWM output period. For details on setting the PWM output duty cycle, refer to 6.44 Setting and querying the PWM duty.

Send AT command: AT + PWM0 = 1, open PWM0 baud rate, output PWM square wave with default period of 100us and duty cycle of 50us.

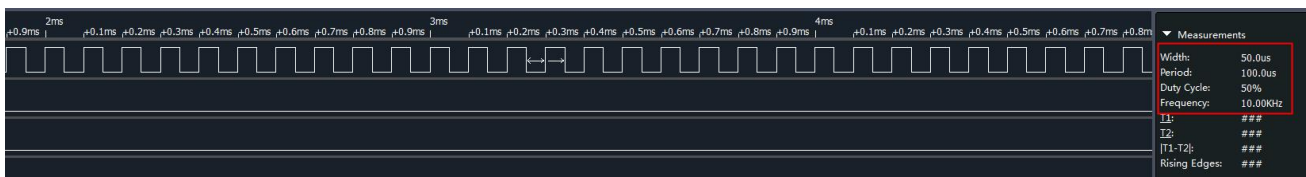
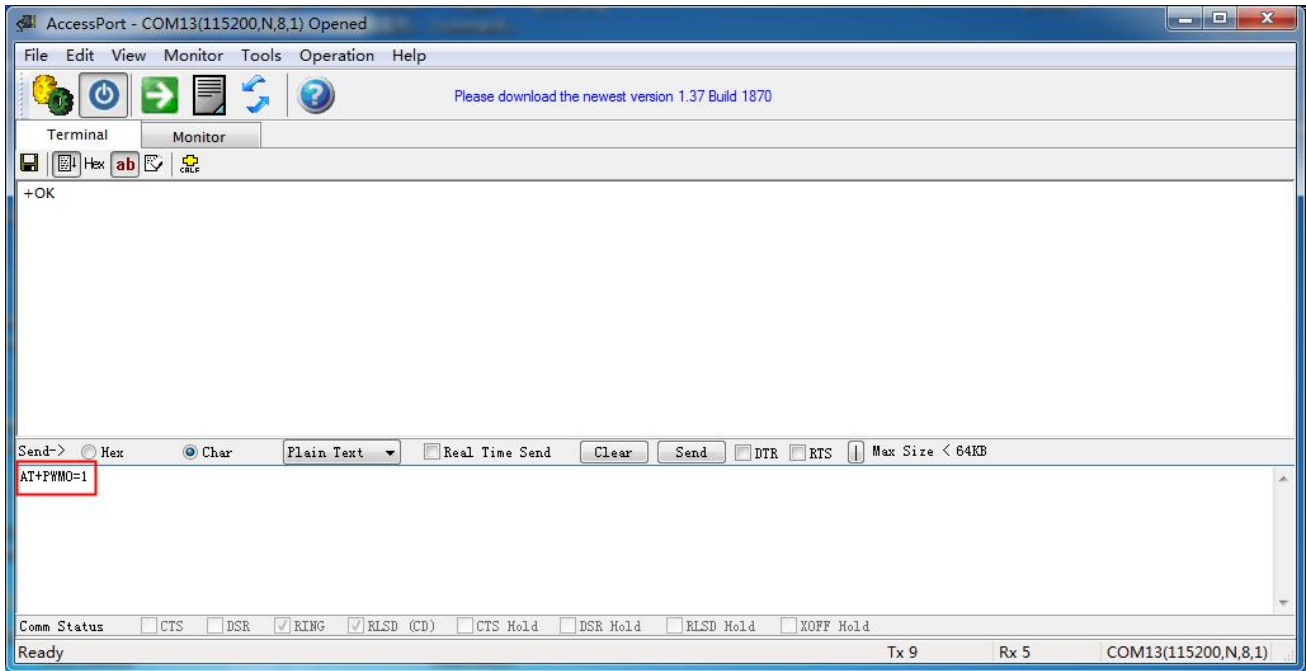

5.6 ADC Acquisition

The E104-BT51 module, in order to adapt to a wider range of data acquisition, adds two 12-bit precision ADC acquisition channels, the reference voltage is fixed ref is 4.3V, uses the command "AT + ADCx?" to read the ADC value of the ADCx pin and display it in decimal. User can calculate the voltage Vx to be measured according to the formula. Formula: $ref / 4096 = Vx / ADC$. For details on reading the ADC acquisition volume, refer to [Command 6.45 Querying the ADC Sample Value](#).

Notice: This module does not need to do voltage division or other operations, just connect the target to be tested to the detection pins (DIO_23, DIO_24), and then ground the module.

5.7 Battery voltage service

The E104-BT51 module in order to enable the battery voltage to be obtained in a timely manner, and can be displayed intuitively in mobile phones or other devices, this module adds a battery voltage service. You only need to connect a specific ADC acquisition pin to the corresponding battery pin, the device will automatically collect battery voltage data periodically, calculate the corresponding percentage according to the user's preset voltage upper and lower limits, and update to the Bluetooth service in real time to wait for other host devices to obtain data. Users can calculate the corresponding voltage value based on the ratio updated by the Bluetooth service. We use p to represent the percentage of battery service, Btmax to represent the set full battery voltage, and Btmin to represent the minimum battery

voltage, in order to make the calculation more accurate, mV is used as the unit, that is, 3.2v voltage value is converted to 3200 to participate in the calculation. The voltage / ratio characteristic curve is shown below. Calculation formula: $p = (v - B_{tmin}) / (B_{tmax} - B_{tmin})$. The actual voltage value can be calculated according to the p-in formula of the battery. (Note: B_{tmax} and B_{tmin} are the values set by AT. Here 3200 and 2000 are just examples.) For details on setting B_{tmax} and B_{tmin} , refer to the command 6.46 Setting, reading the maximum battery voltage, 6.47 Setting, and querying the minimum battery voltage.

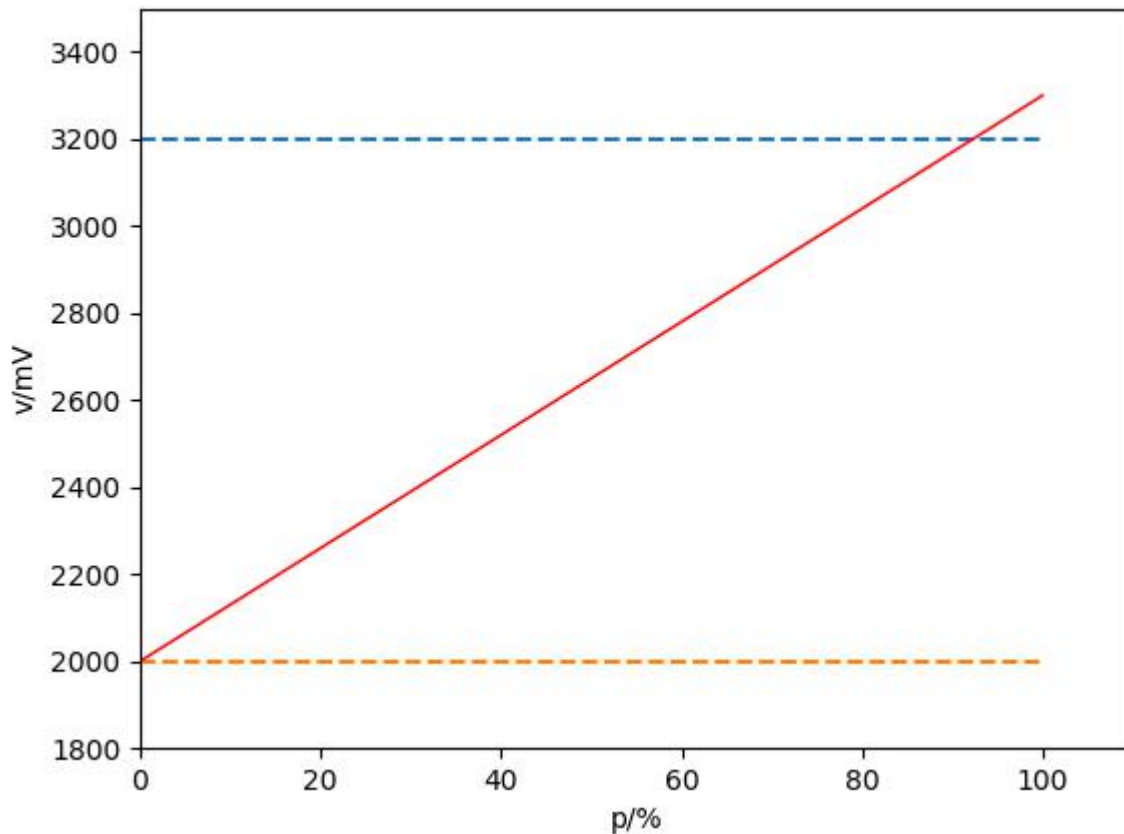

Note: This module does not need to do voltage division or other operations, just connect the positive electrode of the battery to the detection pin (DIO_25), and then ground the module.

5.8 MAC Address binding

The E104-BT51 module supports MAC binding function. When the slave module sets the binding connection address and enables binding, it retrieves whether the host MAC address is a binding address before accepting the host connection request. When the address matches successfully, the connection can be established, otherwise the slave will continue to broadcast. For details on setting command, refer to 6.25 Reading MAC Binding Status, and enabling and disabling MAC binding. For details on setting the binding address, refer to 6.26 Reading and Setting MAC Binding.

5.9 Bluetooth maximum packet length MTU configuration

MTU is an abbreviation of the communication term Maximum Transmission Unit (MTU), which refers to the maximum packet size (in bytes) that can be passed on a layer of a communication protocol. This parameter is usually related to the communication interface (network interface card, serial port, etc.).

The E104-BT51 module supports the long packet standard of Bluetooth 5.0. You can configure the maximum single packet data length of Bluetooth through the AT command "AT + MTU = xx". 251 bytes by default, 27 to 251 bytes available. Increasing the packet length can realize the large packet data transmission of Bluetooth. For details on setting command, refer to 6.27 Querying and Setting the MTU Length.

Note: After the packet length is configured, it will take effect on the next Bluetooth connection. Due to some hosts do not support parameter change requests initiated by slaves, there may be a set MTU length that does not take effect after connection, which is normal.

5.10 UUID Configuration

The module supports flexible UUID configuration. You can command "AT + UUIDTYPE = 1" to enable the 128-bit UUID function. You can customize the transparent transmission service UUID, receiving characteristic field UUID, and sending characteristic field UUID via commands "AT + + SVRUUID = xx", "AT + READUUID = xx", and "AT + WRITEUUID = xx". UUID, of which xx represents a hexadecimal number. For details on setting method, refer to 6.28 Querying and Setting the UUID Length of the Transparent Transmission Service. This function can solve the problem of mismatch with UUID of APP communication, meet more custom requirements, and have wider practicability.

5.11 Broadcast data can be switched

The broadcast of the E104-BT51 is divided into general broadcast and iBeacon broadcast. It supports that command can configure and select the broadcast mode.

General broadcast packet format:

The broadcast information includes advertising and scan response, advertising is the broadcast message sent actively, and scan response is the broadcast message returned after receiving the host scan request.

Advertising:

Fixed field	Len	Vendor field	Manufa data
020106	N	0xFF	Configurable, Max 26 bytes

Example: 0201061AFF4C0002155241444955004E4554574F524B53434F00010002D2

For the content of the set broadcast data, please refer to 6.7 Querying and Setting the General Broadcast Data (save after power off).

Scan response:

Len	16digit UUID	UUID	Len	Broadcast name	Device name
0x03	0x03	Configurable	N	0x09	Configurable, Max 22 bytes
Example: 0303F0FF1009453130342D4254303034					

iBeacon Broadcast packet format:

1. The command configures UUID, Major, Minor, and TXPWR respectively
2. The command AT + ADV = 2 is configured to work in iBeacon broadcast mode, and broadcast immediately
3. Bluetooth connection is not supported in iBeacon broadcast mode

Advertising:

iBeacon Prefix	UUID	Major	Minor	TXPWR
9B	16B	2B	2B	1B
Example: 0201061AFF4C000215FDA50693A4E24FB1AFCFC6EB076478252775848F00				

Because the format of iBeacon broadcast data is fixed, only Major, Minor, and TXPWR can be modified. For details on setting iBeacon data, refer to 6.9 Querying and Setting iBeacon Major Broadcast Data.

5.12 Configuration over air

Configuration over air refers to the use of the mobile phone APP program BLE test tool to implement wireless configuration of the module without using the serial debugging assistant. The E104-BT51 module supports configuration over air. Our open configuration over air channel is FFF3 under the main service FFF0. The features under this channel support read, write, and notification. E104-BT51 open some IO port reading, PWM setting and other operations, that is, users can use configuration over air mode to read the IO status to collect information and cooperate with the PWM setting to perform some control operations.

Methods for configuration over air:

1. After the slave connection is established, the host (mobile phone app) sends AT commands through the Bluetooth service feature "CONFIG CHANNEL" to configure module parameters over the air. (The configuration channel of E104-BT51 is FFF3 under the main service FFF0).
2. "Configuration over air" requires password authentication. The command "AT + AUTH = xxx" sends authentication information, and the Bluetooth service feature "CONFIG CHANNEL" sends authentication command AT + AUTH. After successful authentication, it can enter the configuration status.
3. Authentication succeeds and remains valid until the connection is disconnected.
4. The MOD pin has no effect on the process of configuration over air .
5. Configuration over air is used for all AT commands.

5.13 Status or event printing

1. The command AT + LOGMSG configures the serial port printing function of status information.
2. Status information includes: connection, disconnection, wake up, and sleep.

The format is as follows:

Status	Printing information
Connection	STA:connection \r\n
Disconnection	STA:disconnection \r\n
Wake up,	wakeup\r\n
Sleep	sleep\r\n

3. Connection command, after the Bluetooth connection is established, the LINK pin outputs a low level, and after the Bluetooth connection is disconnected, the LINK pin outputs a high level.

5.14 AT configuration

The MODE pin controls the AT configuration mode or transparent transmission mode of the module. During the connection, the rising edge enters the transparent transmission mode, and the falling edge enters the AT mode.

The module defaults to the AT command mode in the unconnected state. At this time, the serial data will be treated as AT commands (the module is in the wake-up mode); when the module is connected, if you want to configure AT, you need to give MODE (DIO_13) The pin has a falling edge signal greater than 100ms. After detecting the falling edge, the module enters AT configuration mode. Serial port data will not be transparently transmitted. It will be treated as an AT command. After the configuration is completed, the MODE pin will be given a rise greater than 100ms Along the signal, the module enters the transparent transmission mode.

6. Operation command

Note: Before sending operation commands, first ensure that the module is in wake-up mode, otherwise it will not be able to receive configuration commands.

1. Instructions:

1. All AT commands do not need to return (\ r), line feed (\ n)
2. The return result of AT instruction ends with \ r \ n
3. The AT command format is "AT + xxx" For example:
Send the command of querying the device name "AT + NAME?"

2. Command return

Return value	Description
1	Command does not exist
2	Incorrect command length (such as querying the device name: AT + NAME ?, if sent as:

	AT + NAME? 123, the length is incorrect)
3	Invalid parameter (parameter range error)
4	PWM duty cycle is greater than the period
5	PWM cycle range error
6	Configuration over air password authentication failed
7	Change configuration over air Password length error
8	UUID configuration error
9	Unknown mistake
11	AT operation failed
12	Binding MAC address length error
13	Device is disconnected and operation is invalid
14	MAC address is invalid

3、Factory parameter

	Device name	E104-BT51_V1.0
E104-BT51 Default parameter	Broadcast data	CDEBYTE
	Configuration over air password	123456
	version No.	V1.0
	IBC_Major	1027
	IBC_Minor	507
	2-byte service UUID	0xF0, 0xFF
	16-byte service UUID	0x00,0x01,0x02,0x03,0x04,0x05,0x06,0x07, 0x08,0x09,0x0a,0x0b,0x0c,0x0d,0x0e,0x0f
	2-byte client UUID1	0xF1, 0xFF
	16-byte UUID1	0x01,0x01,0x02,0x03,0x04,0x05,0x06,0x07, 0x08,0x09,0x0a,0x0b,0x0c,0x0d,0x0e,0x0f
	2-byte client UUID2	0xF2, 0xFF
	16-byte UUID2	0x02,0x01,0x02,0x03,0x04,0x05,0x06,0x07, 0x08,0x09,0x0a,0x0b,0x0c,0x0d,0x0e,0x0f
	Parity bit	0
	Stop bit	1
	Baud rate	115200
	Broadcast type	General broadcast
	TXPWR (RSSI)	0
	Broadcast interval	250ms
	Maximum connection interval	40ms
	Minimum connection interval	40ms
	Connection timeout	5s
Default UUID type	2 bytes	
Transmit power	0dBm	

Status printing	On
MTU length	200
MAC binding enable	Off
MAC binding address	0x01, 0x01, 0x01, 0x01, 0x01, 0xc0
Delay output enable	Off
PWM period	100us
PWM duty cycle	50us
GPIO output	Low level (0)

6.1 AT Command test

Command	Response	Parameter
AT	+OK	No
Description: No		

6.2 Read and configure baud rate

Command	Response	Parameter
Query: AT+BAUD?	+OK=[para]	para:0~D
Setting: AT+BAUD=[para]	+OK: Success +ERR=[NUM]: Error	0=1200 1=2400 2=4800 3=9600 4=14400 5=19200 6=28800 7=38400 8=57600 9=76800 A=115200 B=230400 C=460800 D=921600
Description: Restart to take effect, save when power off		

6.3 Read and configure stop bit

Command	Response	Parameter
---------	----------	-----------

Query: AT+STOPB?	+OK=[para]	para:0,1 ASCII
Setting: AT+STOPB=[para]	+OK: Success +ERR=[NUM]: Error	0: 1 stop bit 1: 2 stop bits
Description: Restart to take effect, save when power off		

6.4 Read and set serial parity

Command	Response	Parameter
Query: AT+?	+OK=[para]	para:0,1,2
Setting: AT+PARI=[para]	+OK: Success +ERR=[NUM]: Error	0: No parity 1: Even parity 2: Odd parity
Description: Restart to take effect, save when power off		

6.5 Set and read serial data length

Command	Response	Parameter
Query: AT+DATALEN?	+OK=[para]	para:2,3
Setting: AT+DATALEN=[para]	+OK: Success +ERR=[NUM]: Error	2: Data length 7 3: Data length 8
Description: Restart to take effect, save when power off		

6.6 Check the current broadcast status, turn on general broadcast, iBeacon broadcast, turn broadcast

Command	Response	Parameter
Query: AT+ADVEN?	+OK=[para]	para:0、1、2
Setting: AT+ADVEN=[para]	+OK: Success +ERR=[NUM]: Error	0: Turn off broadcast 1: General broadcast 2: iBeacon broadcast
Description: It takes effect on next broadcast, save when power off		

6.7 Query and set general broadcast data (save when power off)

Command	Response	Parameter
---------	----------	-----------

Query: AT+ADVDATA?	+OK=[para]	para: 1. Support ASCII、HEX 2. Length is no longer than 26bytes
Setting: AT+ADVDATA=[para]	+OK: Success +ERR=[NUM]: Error	
Description: It takes effect on next broadcast, save when power off, can be sent as a string or hexadecimal For example, change to the string "CDEBYT": AT + ADVDATA = CDEBYT For example, change to hexadecimal "313233A4B5": 41542B4144564441543D 313233A4B5		

6.8 Query and set general broadcast data (do not save when power off)

Command	Response	Parameter
Query: AT+ADVDATA1?	+OK=[para]	para: 1. Support ASCII、HEX 2. Length is no longer than 26bytes
Setting: AT+ADVDATA1=[para]	+OK: Success +ERR=[NUM]: Error	
Description: It takes effect on next broadcast, do not save when power off, can be sent as a string or hexadecimal. For example, change to the string"CDEBYT": AT+ADVDATA=CDEBYT For example, change to hexadecimal"313233A4B5": 41542B4144564441543D 313233A4B5		

6.9 Query and set IBeacon Major broadcast data

Command	Response	Parameter
Query: AT+IBCMAJOR?	+OK=[para]	para: 0~65535
Setting: AT+IBCMAJOR=[para]	+OK: Success +ERR=[NUM]: Error	
Description: It takes effect on next broadcast, save when power off.		

6.10 Query and set IBeacon Minor broadcast data

Command	Response	Parameter
Query: AT+IBCMINOR?	+OK=[para]	para: 0~65535
Setting: AT+ IBCMINOR =[para]	+OK: Success +ERR=[NUM]: Error	
Description: It takes effect on next broadcast, save when power off.		

6.11 Query and set iBeacon UUID

Command	Response	Parameter
---------	----------	-----------

Query: AT+IBCUUID?	+OK=[para]	para: 16-bit UUID
Setting: AT+IBCUUID=[para]	+OK: Success +ERR=[NUM]: Error	
Description: It takes effect on next broadcast, save when power off. For example: Set iBeacon UUID to“FDA50693A4E24FB1AFCFC6EB07647825” 41 54 2B 49 42 43 4E 55 55 49 44 3D FDA50693A4E24FB1AFCFC6EB07647825		

6.12 Query and set IBCTXPWR

Command	Response	Parameter
Query: AT+ IBCTXPWR?	+OK=[para]	para: -128~127
Setting: AT+ IBCTXPWR =[para]	+OK: Success +ERR=[NUM]: Error	
Description: It takes effect on next broadcast, save when power off.		

6.13 Read and set the device name (save when power down)

Command	Response	Parameter
Query: AT+NAME?	+OK=[para]	para:Broadcast device name, Broadcast name is not larger than 25 bytes
Setting: AT+NAME=[para]	+OK: Success +ERR=[NUM]: Error	
Description: It takes effect on next broadcast, save when power off, can be sent as a string or hexadecimal. For example, set to the string“E104-BT51”: AT+NAME=E104-BT51 For example, set to hexadecimal“31323334”: 41 54 2B 4E 41 4D 45 3D 31323334		

6.14 Read and set the device name (do not save when power off)

Command	Response	Parameter
Query: AT+NAME1?	+OK=[para]	para:Broadcast device name, Broadcast name is not larger than 25 bytes
Setting: AT+NAME1=[para]	+OK: Success +ERR=[NUM]: Error	
Description: It takes effect on next broadcast, do not save when power off, can be sent as a string or hexadecimal. For example, set to the string“E104-BT51”: AT+NAME=E104-BT51 For example, set to hexadecimal“31323334”: 41 54 2B 4E 41 4D 45 3D 31323334		

6.15 Read software version number

Command	Response	Parameter
Query: AT+VERSION?	+OK=[para]	para: Version No.
Description: It takes effect immediately		

6.16 Read and set broadcast interval

Command	Response	Parameter
Query: AT+ADVINTV?	+OK=[para]	para:32~16000 Example:
Setting: AT+ADVINTV=[para]	+OK: Success +ERR=[NUM]: Error	para=1600 actual interval: 1600*0.625ms=1s
Description: It takes effect on next broadcast, save when power off		

6.17 Read and set the minimum connection interval

Command	Response	Parameter
Query: AT+CONMININTV?	+OK=[para]	para: 6~3200
Setting: AT+CONMININTV=[para]	+OK: Success +ERR=[NUM]: Error	Example: 8 8*1.25ms=10ms
Description: It takes effect on next connection, save when power off		
Note: The minimum connection interval must be less than or equal to the maximum connection interval, and less than the timeout time * 8		

6.18 Read and set the maximum connection interval

Command	Response	Parameter
Query: AT+CONMAXINTV?	+OK=[para]	para: 6~3200
Setting: AT+CONMAXINTV=[para]	+OK: Success +ERR=[NUM]: Error	Example: 8 8*1.25ms=10ms
Description: It takes effect on next connection, save when power off		
Note: The maximum connection interval must be greater than or equal to the minimum connection interval, and less than the timeout * 8		

6.19 Read and set timeout

Command	Response	Parameter
Query: AT+ CONTIMEOUT?	+OK=[para]	para: 10~3200
Setting: AT+CONTIMEOUT=[para]	+OK: Success +ERR=[NUM]: Error	Example: 500 500*10ms=5s
Description: It takes effect on next connection, save when power off		
Note: Connection timeout must be greater than (maximum and minimum connection interval) / 8		

6.20 Set and query delay times

Command	Response	Parameter
Query: AT+CONLATENCY?	+OK=[para]	para: 0~500
Setting: AT+CONLATENCY=[para]	+OK: Success +ERR=[NUM]: Error	
Description: It takes effect on next connection, save when power off		
Note: Delay times * connection interval < connection timeout		

Namely: $CONMAXINTV * 1.25ms * CONLATENCY < CONTIMEOUT * 10$

6.21 Disconnect the current connection

Command	Response	Parameter
Query: AT+DISCON	+OK	NO
Description: It takes effect immediately, can only be used when connecting, otherwise it returns error		

6.22 Query the current connection status

Command	Response	Parameter
Query: AT+CONSTA?	+OK=[para]	para: Connected: connection established Disconnect: connection disconnected
Description: It takes effect immediately		

6.23 Querying the Local MAC Address

Command	Response	Parameter
Query: AT+MAC?	+OK=[para]	para:MAC address

		Example: F0E1D2C3B4A5
Description:MAC address displays as hexadecimal ASCII		

6.24 Query the MAC address of the connected device

Command	Response	Parameter
Query: AT+PEERMAC?	+OK=[para]	para:MAC address Example: F0E1D2C3B4A5
Description: ASCIIImmediately It takes effect immediately, can only be used when connecting, otherwise an error is returned and the MAC address displays as hexadecimal ASCII		

6.25 Read MAC binding status, enable or disable MAC binding

Command	Response	Parameter
Query: AT+BONDEN?	+OK=[para]	para:0,1
Setting: AT+ BONDEN =[para]	+OK: Success +ERR=[NUM]: Error	0: Binding disabled 1: Binding enabled
Description: Restart to take effect, save when power off		

6.26 Read and set binding MAC

Command	Response	Parameter
Query: AT+BONDMAC?	+OK=[para]	para:MAC address
Setting: AT+BONDMAC=[para]	+OK: Success +ERR=[NUM]: Error	Example: F0E1D2C3B4A5
Description: Restart to take effect, save when power off, follow the small segment mode, that is, the MAC address high level is followed, and the MAC address displays as hexadecimal ASCII For example, set the banding MAC to "F0E1D2C3B4A5": 41 54 2B 42 4F 4E 44 4D 41 43 3D F0E1D2C3B4A5		

6.27 Query and set the MTU length

Command	Response	Parameter
Query: AT+MTU?	+OK=[para]	para:27~230
Setting: AT+MTU=[para]	+OK: Success +ERR=[NUM]: Error	
Description: It takes effect on next connection, save when power off		

6.28 Query and set the UUID length of the transparent transmission service

Command	Response	Parameter
Query: AT+UUIDTYPE?	+OK=[para1]	Para1: 0、1
Setting: AT+UUIDTYPE=[para1]	+OK: Success +ERR=[NUM]: Error	0: 2-byte UUID 1: 16-byte UUID
Description: Restart to take effect, save when power off		

6.29 Query and set the Bluetooth service UUID

Command	Response	Parameter
Query: AT+SVRUUID?	+OK=[para2]	Para1: UUID value
Setting: AT+SVRUUID=[para2]	+OK: Success +ERR=[NUM]: Error	UUID is HEX
Description: Restart to take effect, save when power off, Set according to the UUID length, follow the little-endian pattern, the high level is followed For example, set the two-byte UUID to "FFFO": 41 54 2B 55 55 49 44 53 56 52 3D F0FF For example, the sixteen-byte UUID is "11223344556677889900AABBCCDDEEFF": 41 54 2B 55 55 49 44 53 56 52 3D FFEEDDCCBBAA00998877665544332211		

6.30 Query and set the Bluetooth read service UUID

Command	Response	Parameter
Query: AT+READUUID?	+OK=[para1]	Para1: UUID value
Setting: AT+READUUID=[para1]	+OK: Success +ERR=[NUM]: Error	
Description: Restart to take effect, save when power off, Set according to the UUID length, follow the little-endian pattern, the high level is followed For example, set the two-byte UUID to "FFF1": 41 54 2B 55 55 49 44 43 48 41 52 31 3D F1FF For example, the sixteen-byte UUID is "11223344556677889900AABBCCDDEEF1": 41 54 2B 55 55 49 44 53 56 52 3D F1EEDDCCBBAA00998877665544332211		

6.31 Query and set the Bluetooth write service UUID

Command	Response	Parameter
Query: AT+WRITEUUID?	+OK=[para1]	Para1: UUID value
Setting: AT+WRITEUUID=[para1]	+OK: Success +ERR=[NUM]: Error	

Description: Restart to take effect, save when power off, Set according to the UUID length, follow the little-endian pattern, the high level is followed

For example, set the two-byte UUID to“FFF2”: 41 54 2B 55 55 49 44 43 48 41 52 32 3D F2FF

For example, the sixteen-byte UUID is“11223344556677889900AABBCCDDEEF2”:

41 54 2B 55 55 49 44 53 56 52 3D F2EEDDCCBBAA00998877665544332211

6.32 Query, enable, disable serial port delay

Command	Response	Parameter
Query: AT+DELAYDATA?	+OK=[para]	para:0、 1
Setting: AT+DELAYDATA=[para]	+OK: Success +ERR=[NUM]: Error	0: Disabled 1: Enabled
Description: It takes effect immediately, save when power off		

6.33 Restart command

Command	Response	Parameter
AT+RESET	+OK	No
Description: It takes effect immediately, equivalent to power off and restart		

6.34 Restore Factory

Command	Response	Parameter
AT+RESTORE	+OK	No
Description: It takes effect immediately, the parameters set by users are always changed to the parameters at the factory and restarted		

6.35 Authenticate configuration over air password

Command	Response	Parameter
Authentication: AT+AUTH =[para]	+OK: Success +ERR=[NUM]: Error	para: 6-byte password
Description: 1. Password cannot be changed before successful authentication. 2. This command is only used in configuration over air, other methods have no practical meaning.		

6.36 Update and query configuration over air password

Command	Response	Parameter
Query: AT+UPAUTH?	+OK:Success	para:6-byte password
Update: AT+UPAUTH=[para]	+ERR=[NUM]: Error	
Description: It takes effect on next configuration over air, save when power off		

6.37 Query and set transmit power

Command	Response	Parameter
Query: AT+ TRANSPWR?	+OK=[para]	para: 0~9
Setting: AT+ TRANSPWR =[para]	+OK: Success +ERR=[NUM]: Error	0:-21dBm 1:-18dBm 2:-15dBm 3:-12dBm 4:-9dBm 5:-6dBm 6:-3dBm 7:0dBm 8:1dBm 9:2dBm A:3dBm B:4dBm C:5dBm
Description: It takes effect immediately, save when power off		

6.38 Enter sleep immediately

Command	Response	Parameter
Query: AT+SLEEP?	STA:sleep	No
Description: It takes effect immediately, If the broadcast is not turned off, the broadcast continue broadcasting with broadcast with broadcast interval as wake-up time, and the pin wakes up		

6.39 Query and set printing status

Command	Response	Parameter
Query: AT+LOGMSG?	+OK=[para]	para: 0、 1

Setting: AT+LOGMSG=[para]	+OK: Success +ERR=[NUM]: Error	0: Disabled 1: Enabled
Description: It takes effect immediately, save when power off		

6.40 Read IO input

Command	Response	Parameter
Query: AT+READGPIO?	+OK=[para]	para: 0~F
Description: It takes effect immediately		

INPUTGPIO3, 2, 1, 00:00, which means that all collected data is low level, hexadecimal: 0, INPUTGPIO3, 2, 1, 0: 1001, which means INPUTGPIO3, 0 is high level INPUTGPIO2, 1 bit Low level, hexadecimal: 9

6.41 Set and read IO output

Command	Response	Parameter
Query: AT+OUTGPIO?	+OK=[para]	para: 0~F (Hexadecimal code)
Setting: AT+OUTGPIO=[para]	+OK: Success +ERR=[NUM]: Error	
Description: It takes effect immediately, save when power off		

OUTGPIO3, 2, 1, 0: 0000, which means that they are all low level, and the hexadecimal number is 0; OUTGPIO3, 2, 1, 0: 1010, which means that OUTGPIO3, 1 outputs high, OUTGPIO2, 0 output low, and the hexadecimal number is A.

6.42 Set and read PWM enable

Command	Response	Parameter
Query: AT+PWMx?	+OK=[para]	x:No.
Setting: AT+PWMx=[para]	+OK: Success +ERR=[NUM]: Error	para: 0 Disable PWM 1 Enable PWM
Description: It takes effect immediately, save when power off. For example, setting PWM1 enabled: AT + PWM1 = 1		

6.43 Set and query PWM output period

Command	Response	Parameter
Query: AT+PERIODx?	+OK=[para]	para: 10~100000 Unit us
Setting: AT+PERIODx=[para]	+OK: Success +ERR=[NUM]: Error	x: No.
Description:		

- 1.It takes effect immediately, save when power off.
- 2.4-way PWM output frequencies can be different.

6.44 Set and query PWM duty cycle

Command	Response	Parameter
Query: AT+DUTYx?	+OK=[para]	para: 0~ PERIODx Unit us
Setting: AT+ DUTYx =[para]	+OK: Success +ERR=[NUM]: Error	x:No.
Description: 1.It takes effect immediately, save when power off. 2.4-way PWM output frequencies can be different, and the duty cycle can also be different.		

6.45 Query ADC sampling value

Command	Response	Parameter
Query: AT+ADCx?	+OK=[para]	para: 0~4096
Setting: AT+ ADCx =[para]	+OK: Success +ERR=[NUM]: Error	x:No.
Description: 12-bit ADC acquisition, output displays in decimal		

6.46 Set and read the maximum battery voltage

Command	Response	Parameter
Query: AT+ BATMAX?	+OK=[para]	para: BATMIN~3800
Setting: AT+BATMAX=[para]	+OK: Success +ERR=[NUM]: Error	(Unit: mV)
Description: Set according to the full voltage of the battery		

Because the working voltage of the chip is limited to 1.8V ~ 3.8V, the maximum BATMAX is 3800.

6.47 Set and query the minimum battery voltage

Command	Response	Parameter
Query: AT+ BATMIN?	+OK=[para]	para: 1800~BATMAX
Setting: AT+BATMIN=[para]	+OK: Success +ERR=[NUM]: Error	(Unit: mV)

Description: Set according to the minimum voltage of the battery

Because the working voltage of the chip is limited to 1.8V ~ 3.8V, the maximum BATMIN is 1800.

6.48 Query RSSI

Command	Response	Parameter
Query: AT+RSSI?	+OK=[para] +ERR=[NUM]	para: -128~127
Description: It takes effect immediately, can only be used when connecting, otherwise returns error		

7. UUID Description

7.1 Ebyte data transmission UUID

Channel	UUID	HANDLE	Attribute	Description
EBYTE DATA SERVICE	0xFFFF0 (Default)	31	-	This channel is a custom serial transceiver channel
BLE DATA BUFF	0xFFFF1 (Default)	33	Read only, notify	This channel is the module receiving the serial data channel and returns to the Bluetooth host in a notified manner. The maximum data length of a single packet is 251 bytes. Description: If the host is an Android or IPHONE cell phone, you need to enable the notification function in order to receive the module data.
CENTER DATA BUFF	0xFFFF2 (Default)	37	Read, write	This channel is the host-side transmission data channel. The single packet data length is limited to a maximum of 251 bytes. After the module receives the Bluetooth data, it will transmit transparently through the serial port directly.
BLE DATA CONFIG	0xFFFF3 (Default)	40	Read, write, notify	Configuration over air channel

7.2 Standard battery voltage service UUID

Channel	UUID	HANDLE	Attribute	Description
BATTERY SERVICE	0x180F	43	-	This channel is the standard battery voltage service UUID specified by the Bluetooth Alliance

Battery Level	0x2a19	45	Notify	This channel is the battery voltage level of Bluetooth standard
---------------	--------	----	--------	---

8. Quick start

8.1 Quick Guide to Configuration Mode

Use PC XCOM serial assistant soft armor to demonstrate the configuration mode, or use other software with serial port sending and receiving.

1. Open "XCOM V2.0.exe" software, find the corresponding serial port number, open it, and select the parameters according to the default values.
2. Configure related parameters according to the operation command in Chapter 6. Here demonstrates setting the device name.

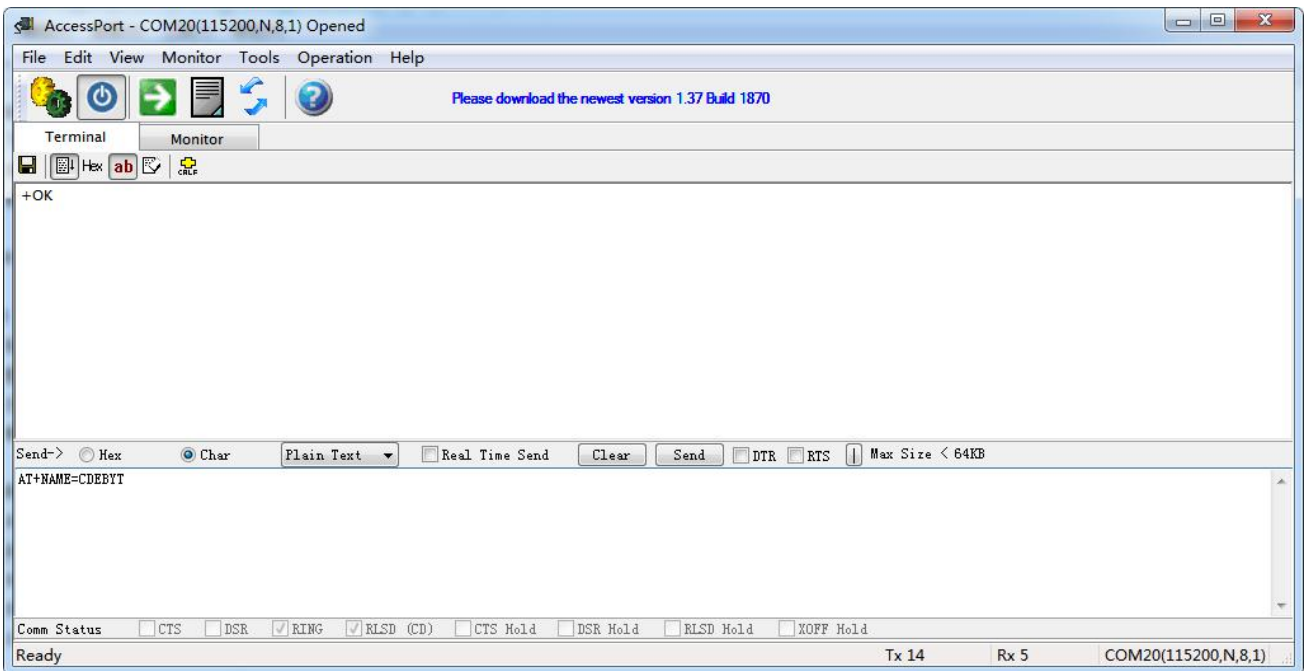

3. Since configuration over air mode involves the use of transparent transmission, refer to 8.2 Quick guide to transparent transmission and Configuration over air mode for the configuration over air mode.

8.2 Quick Guide to Transparent Transmission and Configuration over air Mode

Use Android phone (system version 4.3 or above) or Apple IPHONE 4s or above or BLE-capable Ipad to communicate with the module. The example here is demonstrated on an Android phone.

1. Search for "BLE Scanner" in app store, download and install. (Tips: Cannot found in some app stores, you can go to Baidu to download) After the installation is successful, perform step 2.
2. After successfully installing the APP in step 1, open "BLE Scanner", find the E104-BT51_V1.0 module, and click E104-BT51_V1.0 to connect the module. After the connection is established successfully, the 5 service lists on the right will appear (tips: if the connection establishment fails or the service list cannot be refreshed, it is usually the reason of the mobile APP, then exit and re-establish the connection), and then perform step 3 after successful , otherwise continue to step 2.
3. If the operation in step 2 is successful, click on the service in the red box on the left to enter Ebyte custom transparent transmission service. After success, the interface shown on the right will appear. Enter step 4, otherwise continue to step 3.

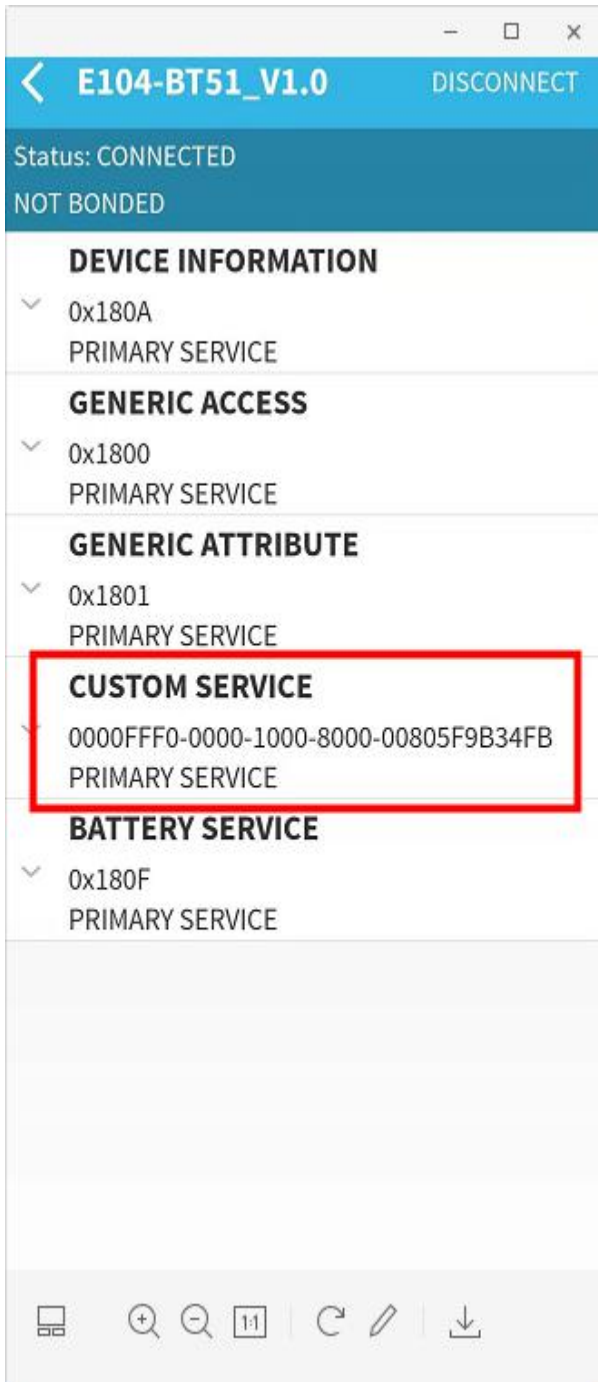

E104-BT51 Service list

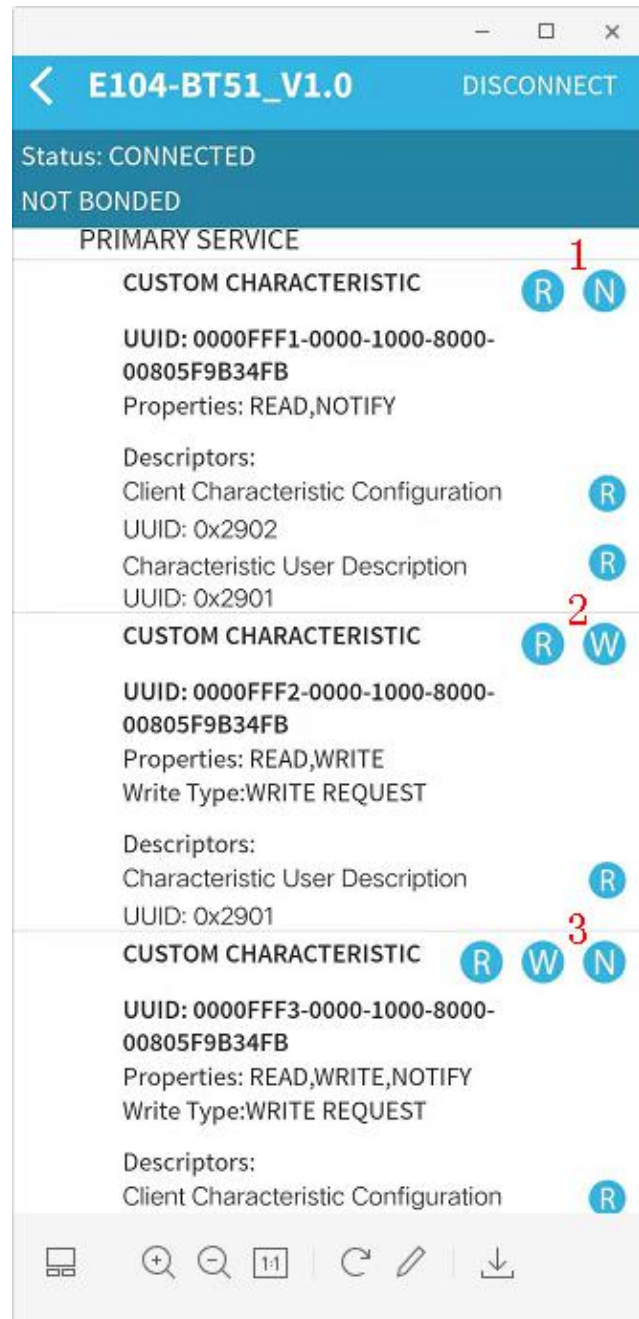

E104-BT51 Transparent transmission channel

In the picture, 1 is the notification channel, 2 is the write channel, and 3 is the configuration over air channel.

4. After step 3 is successful, click to enter service 1, and then click the On N button. Use the serial port assistant to send data. The red part is the data content received by the serial port, the module sends a notification to the mobile APP.

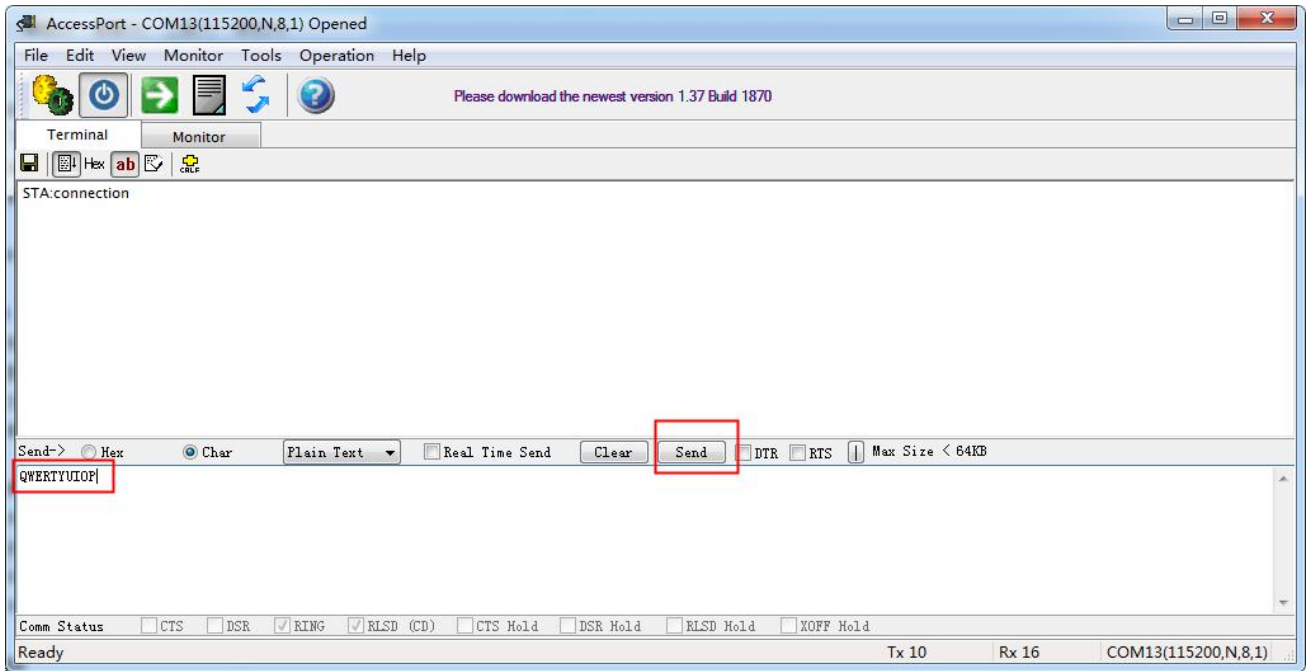

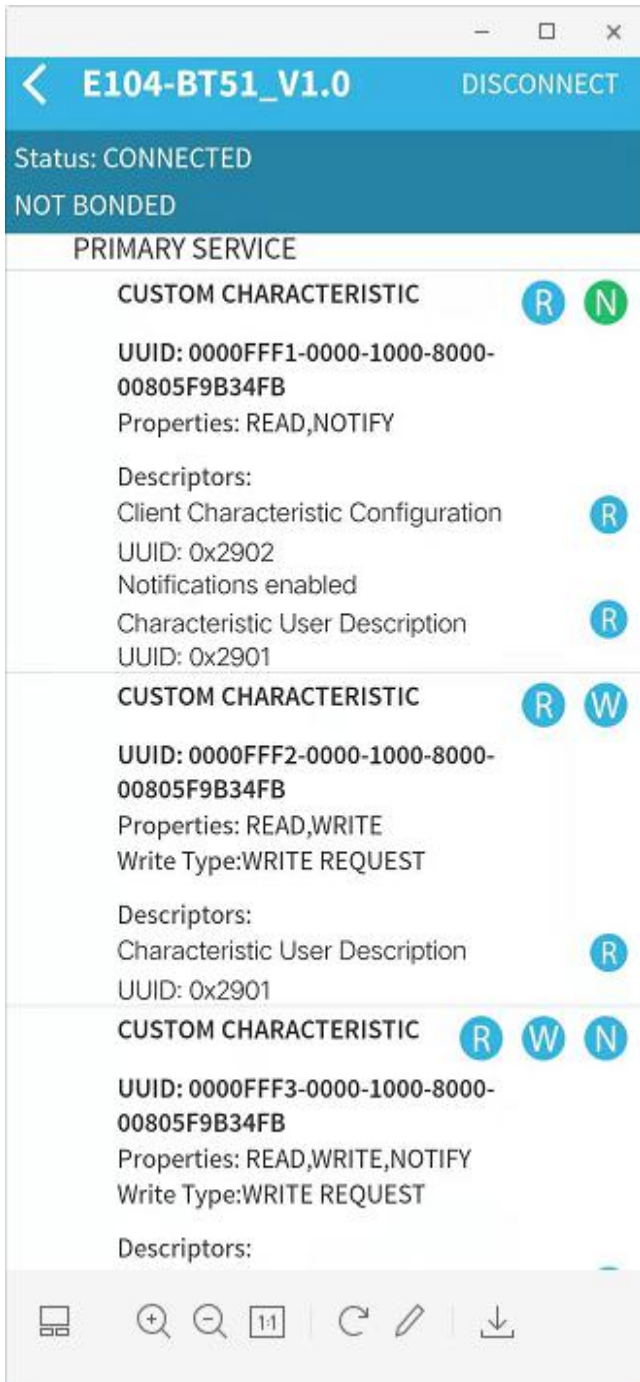

Open mobile APP notification

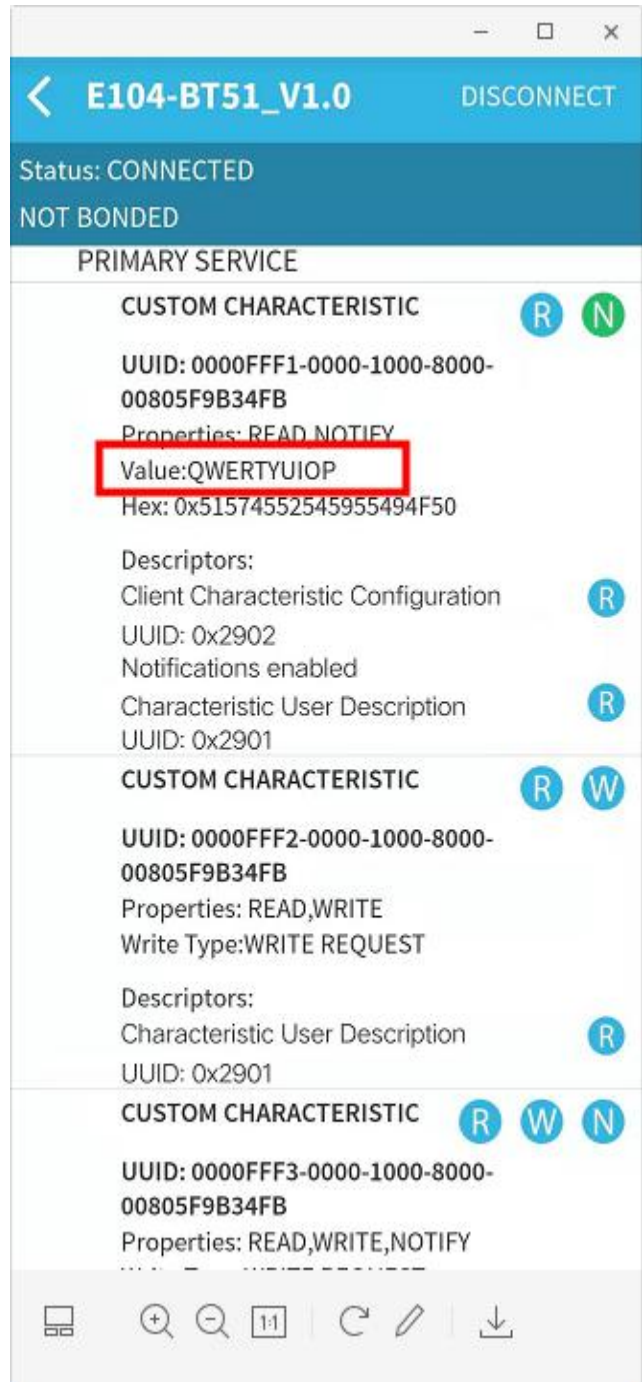

Mobile APP receiving data

5. Click W button of service 2 as shown in step 3 to enter the write operation. After editing the content, click OK to send the data. On the serial port assistant, check the data sent by the mobile APP to the module.

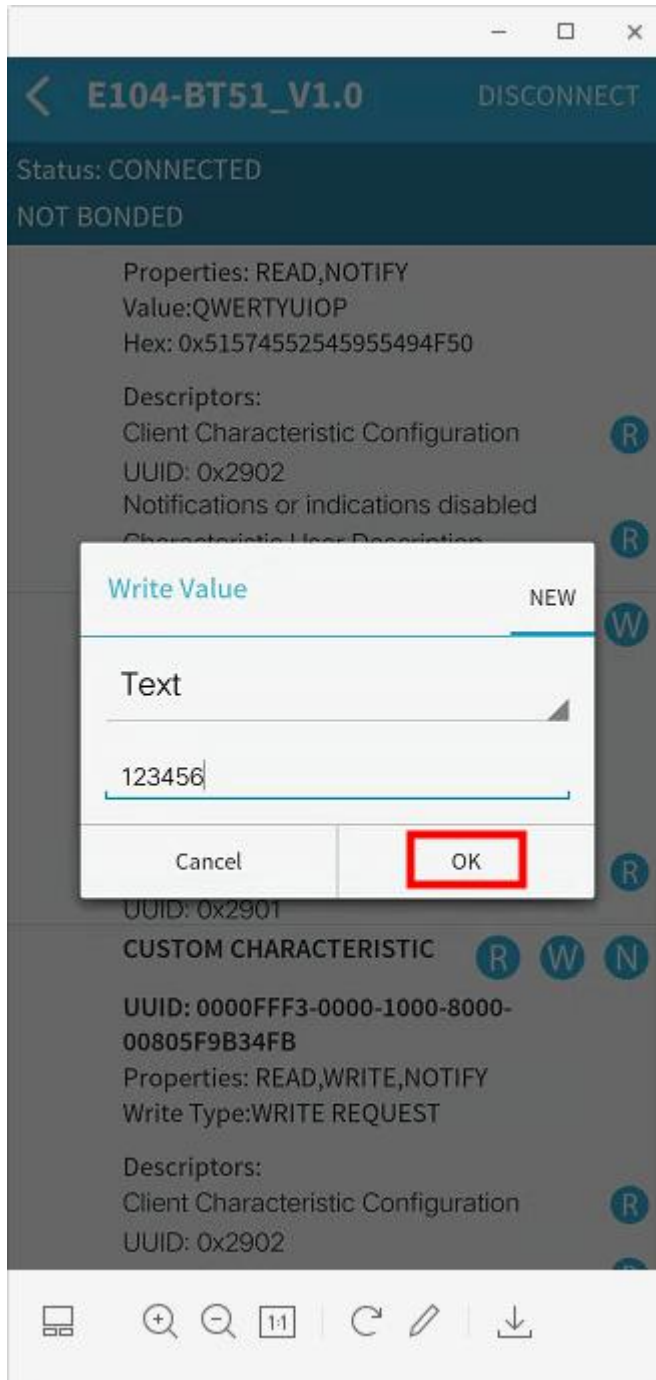

Mobile APP sending data

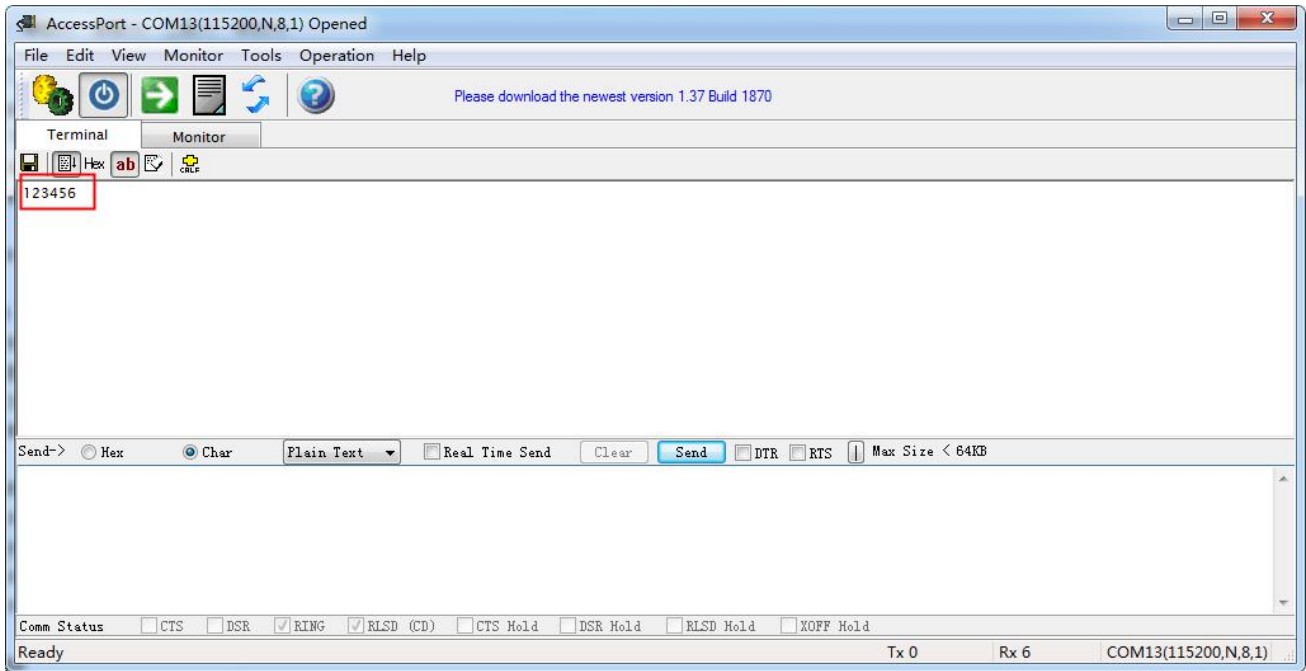

6. Configuration over air, click N button at service 3 to turn on the configuration over air notification function, and then click W button to enter the configuration over air mode. In the configuration over air, password needs to be verified first. (When editing the control configuration password, please note that all characters must be entered in English mode, otherwise an error will be reported) .

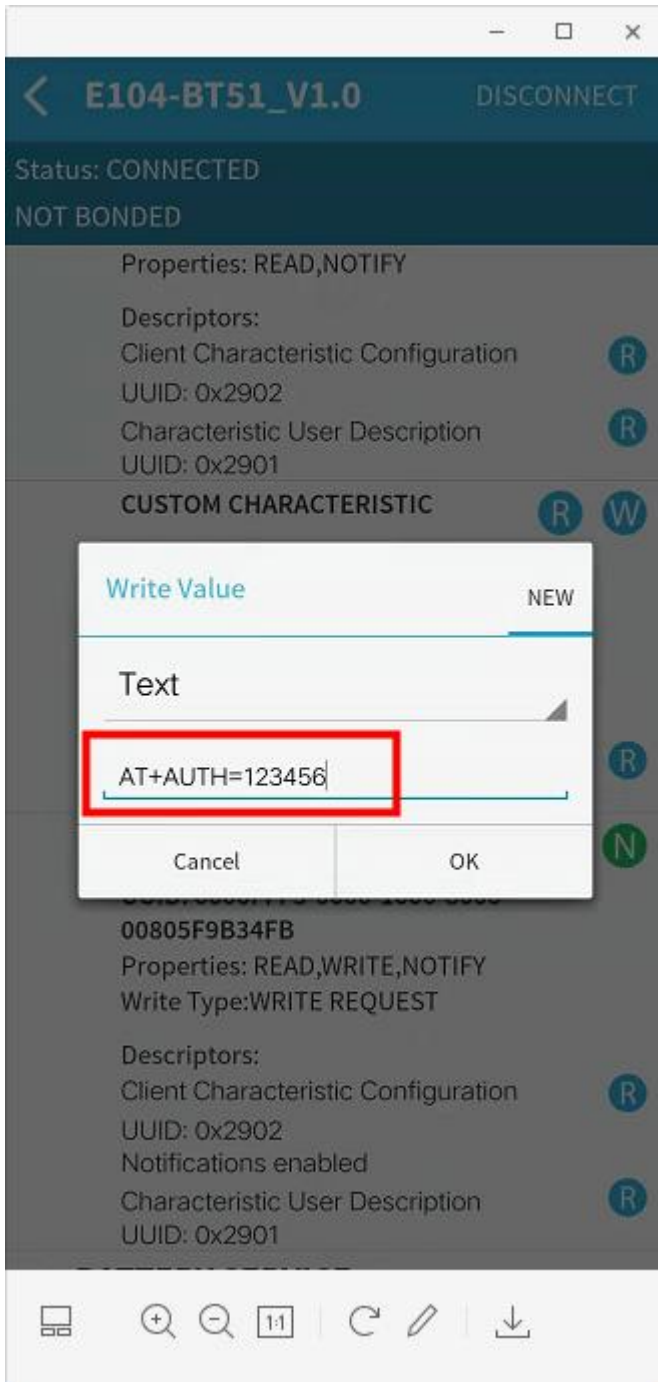

After passing the password authentication of configuration over air, Return + OK to start configuration.

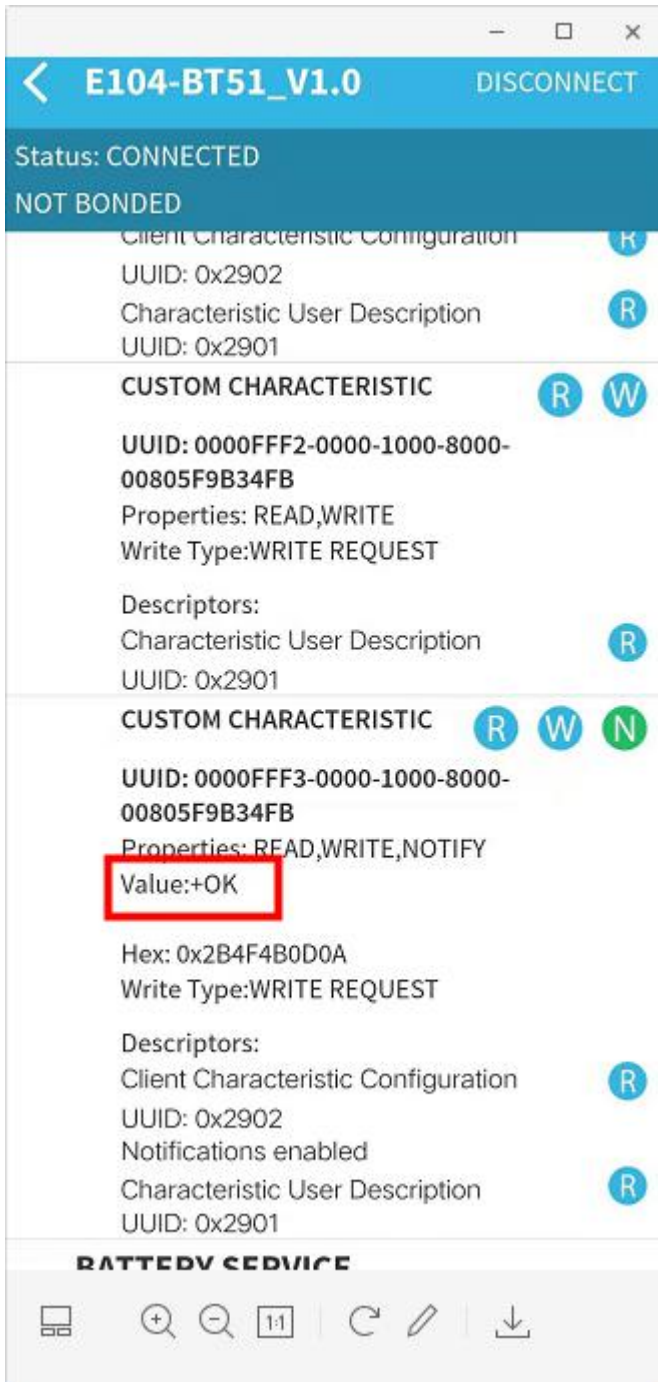

After successful password authentication, you will get the returning message “+ OK”. At this point, you can perform configuration over air. Here is a demonstration of reading the device name.

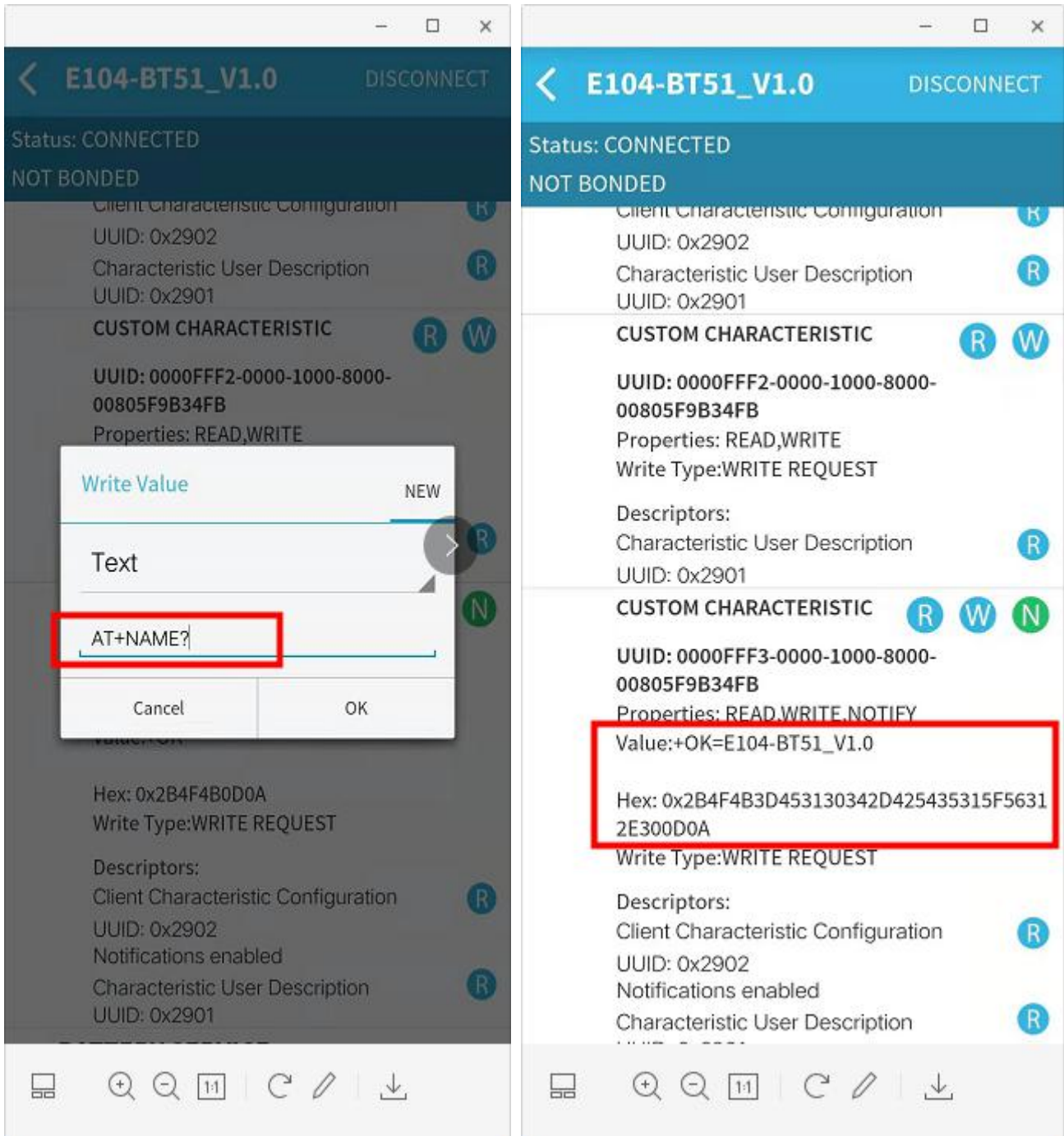

8.3 Guide to Bluetooth battery service

Connect the battery voltage collection pin (34) of the module to the battery to be tested. After connecting the device according to Section 8.2, click Battery Service, and then click N button under the service to enable the notification function. The module will continuously send the collected battery voltage percentage to the APP, and battery range can be set to the maximum and minimum values according to the full voltage of the battery.

For details, please refer to 6.46 Setting, and Reading the Maximum Battery Voltage and 6.47 Setting, and Querying the Minimum Battery Voltage.

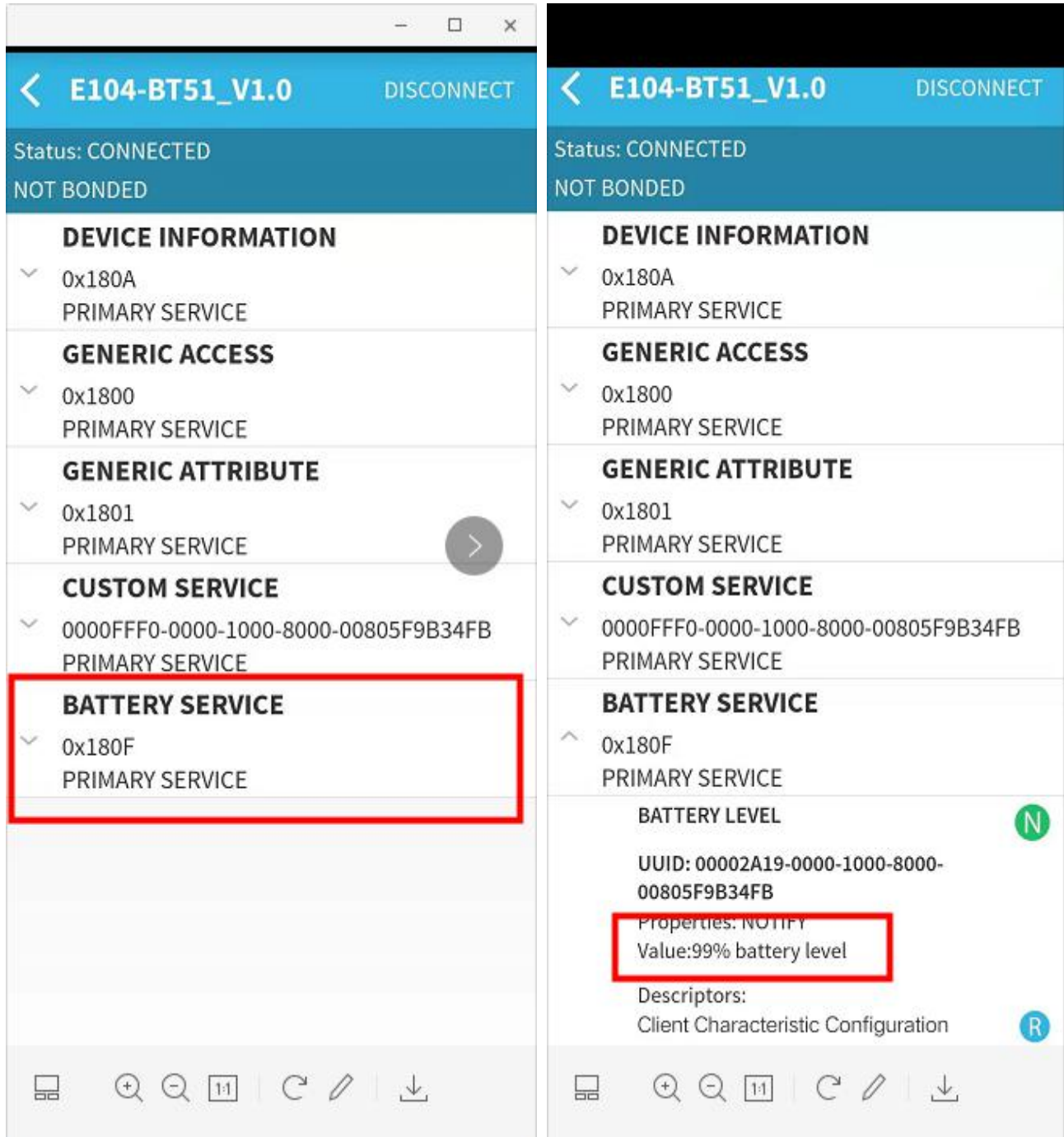

9. Hardware design

- It is recommended to use a DC stabilized power supply. The power supply ripple factor is as small as possible, and the module needs to be reliably grounded;

- Please pay attention to the correct connection of the positive and negative poles of the power supply. Reverse connection may cause permanent damage to the module;
- Please check the power supply to ensure it is within the recommended voltage otherwise when it exceeds the maximum value the module will be permanently damaged;
- Please check the stability of the power supply, the voltage can not be fluctuated frequently;
- When designing current supply circuit, 30% margin is recommended to be remained so as to ensure long-term stable operation of the whole module;
- The module should be as far away as possible from the power supply, transformers, high-frequency wiring and other parts with large electromagnetic interference;
- High-frequency digital routing, high-frequency analog routing, and power routing must be avoided under the module. If it is necessary to pass through the module, assume that the module is soldered to the Top Layer, and the copper is spread on the Top Layer of the module contact part(well grounded), it must be close to the digital part of the module and routed in the Bottom Layer;
- Assuming the module is soldered or placed over the Top Layer, it is wrong to randomly route over the Bottom Layer or other layers, which will affect the module's spurs and receiving sensitivity to varying degrees;
- It is assumed that there are devices with large electromagnetic interference around the module that will greatly affect the performance. It is recommended to keep them away from the module according to the strength of the interference. If necessary, appropriate isolation and shielding can be done;
- Assume that there are traces with large electromagnetic interference (high-frequency digital, high-frequency analog, power traces) around the module that will greatly affect the performance of the module. It is recommended to stay away from the module according to the strength of the interference. If necessary, appropriate isolation and shielding can be done;
- If the communication line uses level, 1k-5.1k resistor must be connected in series(not recommended, there is a risk of damage)
- Try to stay from some physical layers such as TTL protocol at 2.4GHz , for example: USB3.0;
- The antenna installation structure has a great impact on the performance of the module. Be sure to keep the antenna exposed, preferably vertically. When the module is installed inside the case, a high-quality antenna extension cable can be used to extend the antenna to the outside of the case;
- The module must not be installed inside metal shield, which will greatly reduce the transmission distance.

10. FAQ

10.1 Communication range is too short

- The communication distance will be affected when obstacle exists.
- Data lose rate will be affected by temperature, humidity and co-channel interference.
- The ground will absorb and reflect wireless radio wave, so the performance will be poor when testing near ground.
- Seawater has great ability in absorbing wireless radio wave, so performance will be poor when testing near the sea.
- The signal will be affected when the antenna is near metal object or put in a metal case.
- Power register was set incorrectly, air data rate is set as too high (the higher the air data rate, the shorter the distance).
- When the power supply at room temperature is lower than the recommended low voltage, the lower the voltage is,

the lower the transmitting power is.

- The use of the antenna and the module is poorly matched or the quality of the antenna itself is defective.

10.2 Module is easy to damage

- Please check the power supply and ensure it is within the recommended range. Voltage higher than the peak will lead to a permanent damage to the module.
- Please check the stability of power supply and ensure the voltage not to fluctuate too much.
- Please make sure anti-static measures are taken when installing and using, high frequency devices have electrostatic susceptibility.
- Please ensure the humidity is within limited range for some parts are sensitive to humidity.
- Please avoid using modules under too high or too low temperature.

10.3 Bit error rate is too high

- When there are co-channel signal interference nearby, be away from interference sources or modify frequency and channel to avoid interference;
- Unfavorable power supply may cause code error. Make sure that the power supply is reliable.
- The quality of extension cables and feeders is poor or too long can also cause high bit error rate.

11. Welding operation guidance

11.1 Reflow Soldering Temperature

Profile Feature	Curve feature	Sn-Pb Assembly	Pb-Free Assembly
Solder Paste	Solder paste	Sn63/Pb37	Sn96.5/Ag3/Cu0.5
Preheat Temperature min (T _{smin})	Minimum preheating temperature	100°C	150°C
Preheat temperature max (T _{smax})	Maximum preheating temperature	150°C	200°C
Preheat Time (T _{smin} to T _{smax})(ts)	Preheating time	60-120 sec	60-120 sec
Average ramp-up rate(T _{smax} to T _p)	Average rising rate	3°C/second max	3°C/second max

Liquidous Temperature (TL)	Liquid phase temperature	183°C	217°C
Time (tL) Maintained Above (TL)	Time above liquidus	60-90 sec	30-90 sec
Peak temperature (Tp)	Peak temperature	220-235°C	230-250°C
Average ramp-down rate (Tp to Tsmax)	Average descent rate	6°C/second max	6°C/second max
Time 25°C to peak temperature	Time of 25 ° C to peak temperature	6 minutes max	8 minutes max

11.2 Reflow Soldering Curve

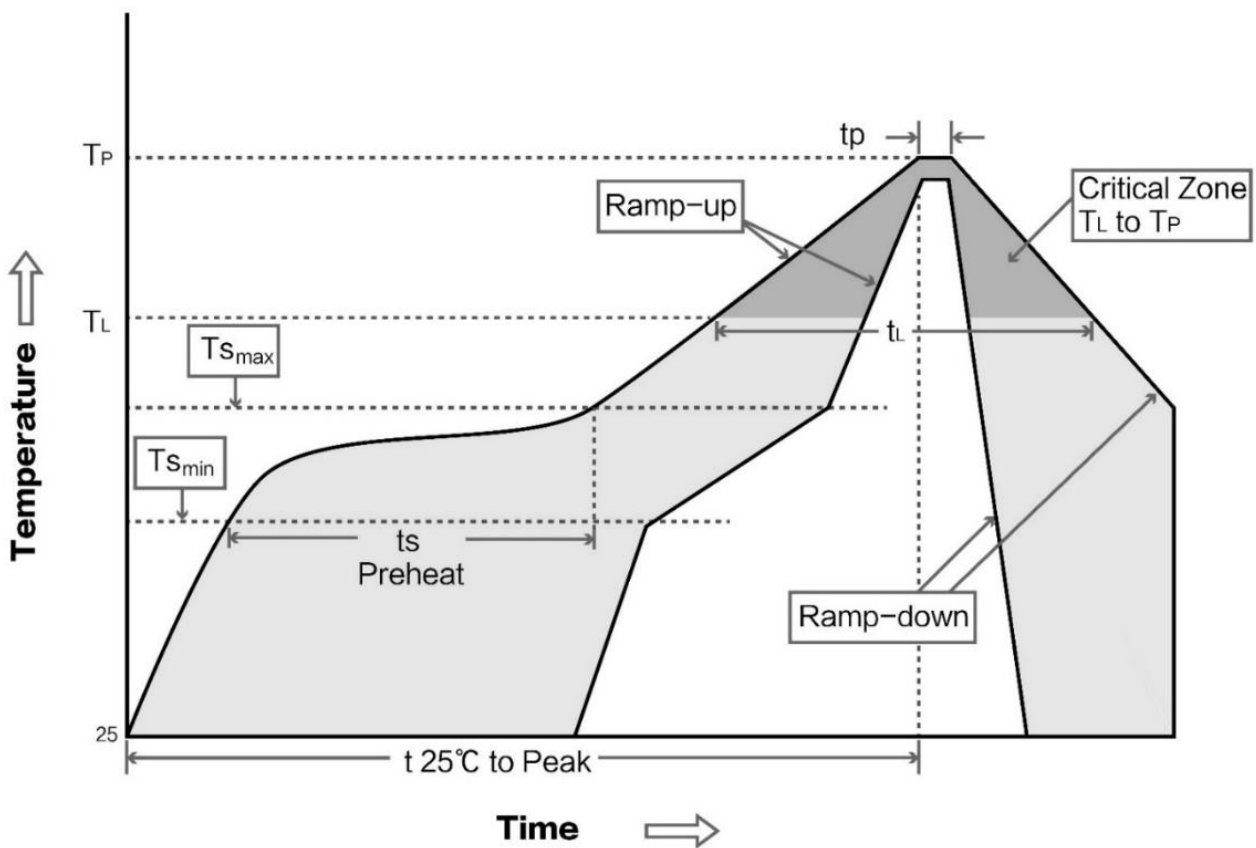

12. Related models

Model No.	Chip	Frequency Hz	Transmit power dBm	Communication interface	Support protocol BLE	Size mm	Antenna	Function
E72-2G4M05S1 B	CC2640	2.4G	5	I/O	4.2	17.5*28.7	PCB/IPX	Hardware resources secondary development
E73-2G4M04S1 A	nRF52810	2.4G	4	I/O	4.2/5.0	17.5*28.7	PCB/IPX	Hardware resources

								secondary development
E73-2G4M04S1 B	nRF52832	2.4G	4	I/O	4.2/5.0	17.5*28.7	PCB/IPX	Hardware resources secondary development
E73-2G4M08S1 C	nRF52840	2.4G	8	I/O	4.2/5.0	13*18	PCB/IPX	Hardware resources secondary development
E73-2G4M04S1 D	nRF51822	2.4G	4	I/O	4.2	17.5*28.7	PCB/IPX	Hardware resources secondary development
E104-BT01	CC2541	2.4G	0	I/O	4.0	14*22	PCB	Hardware resources secondary development
E104-BT02	DA14580	2.4G	0	TTL	4.2	14*22	PCB	Industry's lowest power consumption High-speed continuous transmission, sniff
E72-2G4M04S2 B	CC2640	2.4G	2	TTL	4.2	14*23	PCB/IPX	Built-in ARM dual-core Multi-role mode
E104-2G4U04A	CC2540	2.4G	0	USB	4.0	18*59	PCB	Dongle Protocol analyzer
E104-BT05	TSLR8266	2.4G	0	I/O	4.2	10*14.5	PCB	Low power consumption, transparent transmission, IO acquisition, IO output, PWM output
E104-BT51	CC2640R2F	2.4G	5	I/O	5.0	17.5*28.7mm	PCB	BLE5.0, 2MPHY, low power

								consumption, battery service, transparent transmission, PWM output, IO output, IO acquisition, ADC acquisition
--	--	--	--	--	--	--	--	---

13. Batch packaging

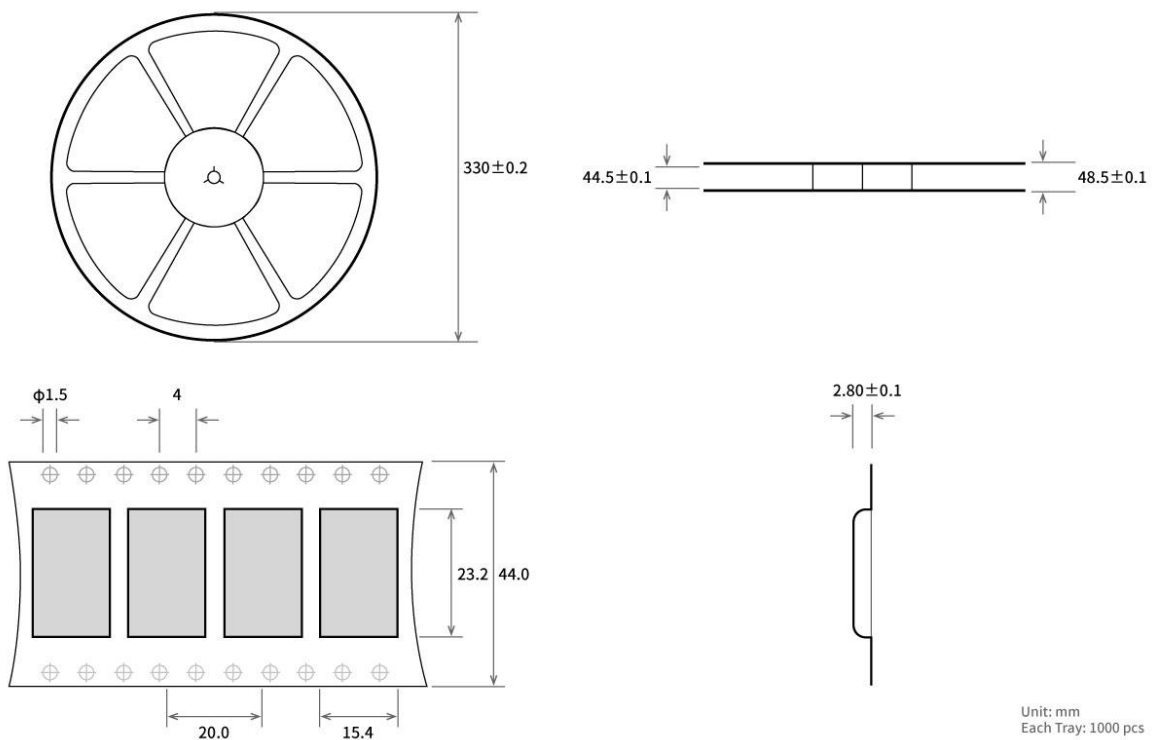

14. Revision history

Version	Date	Description	Issued by
1.0	2019-12-11	Initial version	Ren

15. About us

Sales hotline: 4000-330-990

Tel: 028-61399028

Support: support@cdebyte.com

Website: www.ebyte.com

Address: Innovation Center B333~D347, 4# XI-XIN road, High-tech district (west), Chengdu, Sichuan, China



Chengdu Ebyte Electronic Technology Co.,Ltd.