

# Installation & Instruction Manual

## Replacement of an Electronic Control Board

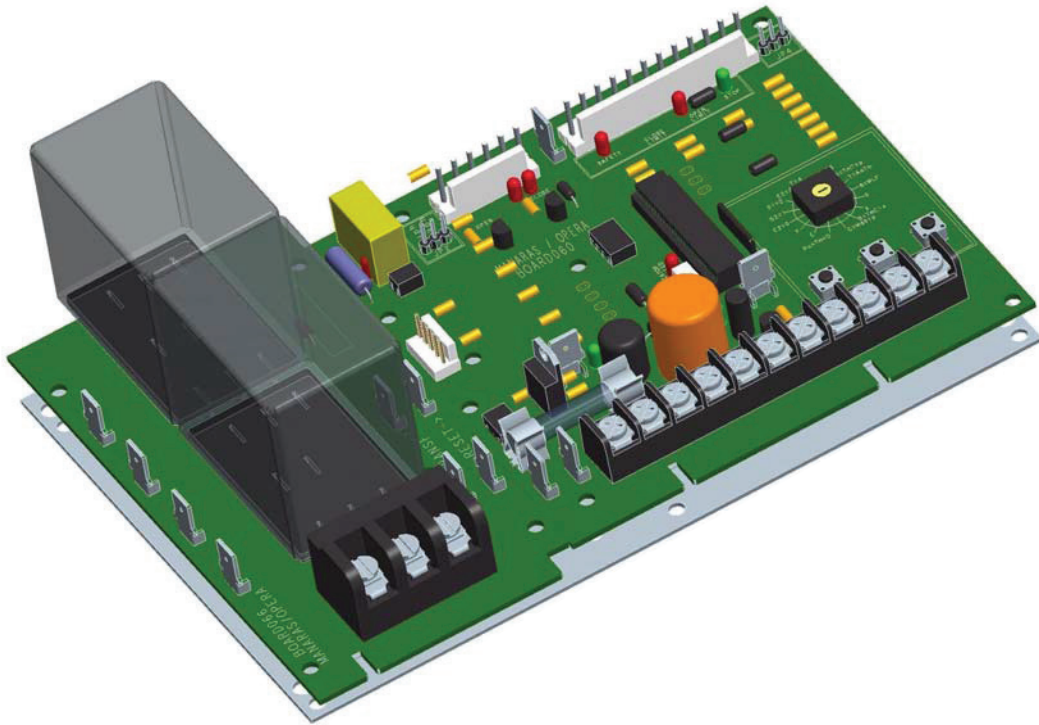

**Note:** Read this manual carefully before replacing the existing board and place this installation manual in an accessible place near the operator. For future reference record:

Model # \_\_\_\_\_

Date \_\_\_\_\_

Wiring Diagram # \_\_\_\_\_

Door No. # \_\_\_\_\_



For more information, please visit [www.devancocanada.com](http://www.devancocanada.com)  
or call toll free at 855-931-3334

BOOK075 REV 2 - 2009/11/18

**Table of contents**





**Page**

General information and instructions..... 4

**Section I:** Replacement of BORAD030/040/050/055 by BOARD065 ..... 4-11

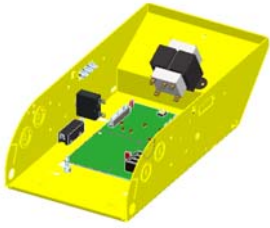
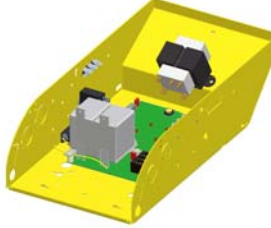

Step by step changeover instructions (refer to the table below to find the appropriate page)

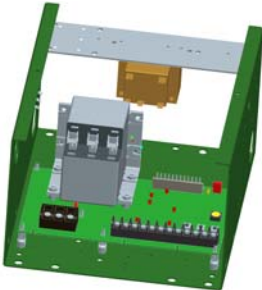
**Location of board in various control boxes**

<p><b>BOARD030</b></p> 	<p><b>BOARD050/55</b></p> 	<p><b>BOARD040</b></p> 	<p><b>BOARD050/55</b></p> 
<p>Opera series control box (CBOX025)</p>			
<p>Center mounted electronic board. Refer to <b>page 6</b></p>		<p>Bottom-end mounted electronic board. Refer to <b>page 7</b></p>	
<p><b>BOARD030/040/050/055</b></p> 	<p><b>BOARD030/040/050/055</b></p> 		
<p>CBOX001: (GH/MGH/MGT/MGSL &amp; N4/12 &amp; 4X)</p>		<p>CBOX009: (MTH/MTBH, MSJ, MLS &amp; N4/12 &amp; 4X)</p>	
<p>Center mounted electronic board. Refer to <b>page 9</b></p>		<p>Center mounted electronic board. Refer to <b>page 10</b></p>	

**Section II:** Replacement of Power or Control Board from 060 series by:

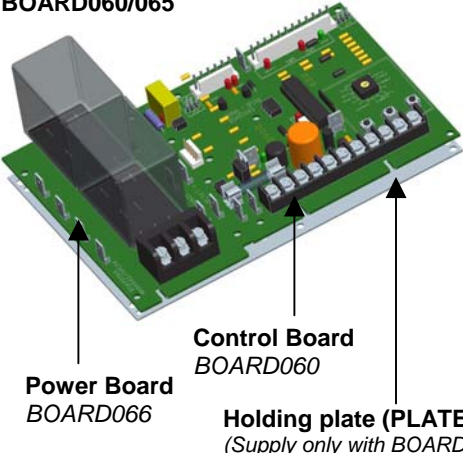
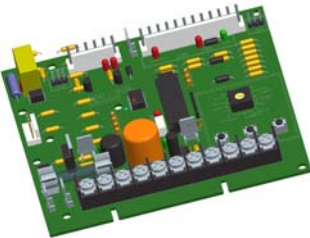
BOARD060R/066R (R - for replacement)..... 12

<p><b>BOARD060/065</b></p>  <p><b>Power Board</b> BOARD066</p> <p><b>Control Board</b> BOARD060</p> <p><b>Holding plate (PLATE089)</b> (Supply only with BOARD065)</p>	<p><b>BOARD060R – Control Board</b></p>  <p>Refer to <b>page 13</b></p>
<p><b>BOARD066R – Power Board</b></p>  <p>Refer to <b>page 14</b></p>	

Note: All drawings shown are only for reference.

<b><u>Section III</u></b> .....	<b>15</b>
Wiring of BOARD065 on 115-1PH (all models).....	16-17
Wiring of BOARD065 on 220-1PH / 4 motor wire leads (all models).....	18-19
Wiring of BOARD065 on 220-1PH / 3 motor wire leads (all models).....	20-21
Wiring of BOARD065 on 208/460/575-3PH (all models).....	22-23
<b><u>Section IV</u></b> ( <i>general information on BOARD060 series</i> ).....	<b>24</b>
External Wiring.....	24
LED monitoring status.....	25
Program Settings.....	26
Mode Settings.....	27



### **WARNING**

Switch-off the incoming power on the operator and if required, carefully disconnect all wires from the ECB terminal strips (TB1-Accessories) and (TB3-power supply)  
*(If needed, mark all the wires coming from accessories)*

Follow the instructions carefully before changing from one board to another

**Neglecting to follow these instructions will result in complete damage to the controller. If you are not confident, please consult Manaras for assistance.**

## INSTRUCTIONS FOR REPLACING THE EXISTING BOARD



### **IMPORTANT**

- Manaras-Opera has only one Electronic Control Board applicable for all voltages (115/230V – 1PH or 208/460/575V – 3PH) on all operator models.
- Jumpers JP2 & JP4 are used for the configuration of the ECB according to the line voltage and they are supplied separately in a plastic bag.
- Some holding studs and other fittings needed for fixing and connecting the new board are also supplied separately.

**NOTE:** Failure to set the jumpers correctly will lead to serious damage to the ECB.

**NOTE:** Before starting the changeover or removing any wiring from the currently installed board, please check if you received all the following parts.

WITH BOARD065	
Qty	Parts descriptions
1	Plate ( <i>PLATE089 including 10 standoffs</i> )
1	Control board ( <i>BOARD060</i> )
1	Power board ( <i>BOARD066</i> )
4	Self tapping screw
2	Header jumpers for JP2 & JP4 ( <i>in plastic bag</i> )
1	Single black jumper & a double spade terminal. ( <i>see NOTE 1 on page11</i> )
4	Extra standoffs with plastic rivets
1	Double black jumper ( <i>see NOTE 3 on page11</i> )
1	Small spade connector ( <i>CONNECTOR012</i> )
1	Instruction manual

WITH BOARD060R	
Qty	Parts descriptions
1	Control Board ( <i>BOARD060R</i> ) <i>NB: Check for a factory set purple jumper on #10 &amp; #11</i>
1	Instruction manual
WITH BOARD066R	
1	Power Board ( <i>BOARD066R</i> )
1	Instruction manual



### **IMPORTANT**

In some applications, before and after placing the new electronic board in the control box, some slight modifications should be done in the control box before proceeding to its final installation. Please follow the instructions carefully for a safe and rapid changeover from one board to another.



### **WARNING**

**Important:**  
Always disconnect the main power from the operator before starting any intervention on the Electronic Control Board



Philips head screwdriver



A pair of cutters



A pair of long nose pliers

**Suggested tools needed for the changeover.**

# Section I

Replacement of BOARD030, 040, 050 or 055  
by  
BOARD065

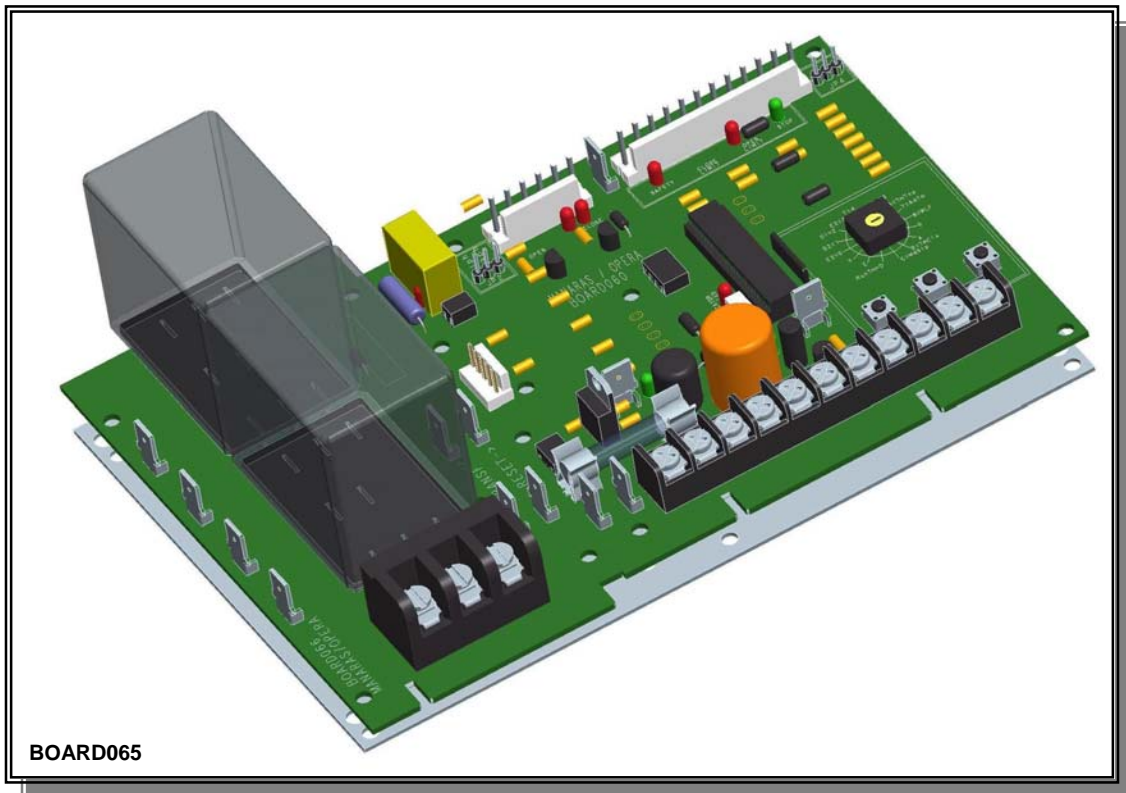

## **1 - CENTER MOUNT: REPLACEMENT OF BOARD030/040/050/055**

**BY BOARD0065 ON A 115/220/208/460/575V – CONTROL** (OPH/J, OSH, OHJ, OGH)

### **1<sup>st</sup> step:** Unplug all the existing wires from

- The transformer
- The reset (for single phase)
- The hoist switch
- The open and close limit switches  
(Advance Close Limit Switch if available. *Note: Adv. Close Limit Switch not required with BOARD065 may be removed from control box*)
- Radio control terminal strip.
- Electrical motor

**2nd step:** Remove the existing electronic board from the control box and all connected wires.

**3rd step:** Remove ALL the existing standoffs (plastic support) from the bottom of the control box.

**4th step:** Place the plate (PLATE089) on the bottom of the control box and use the 4 self-tapping screws to fasten.

Align the four holes on the plate to the corresponding holes of the control box and fasten it using the self-tapping screws.

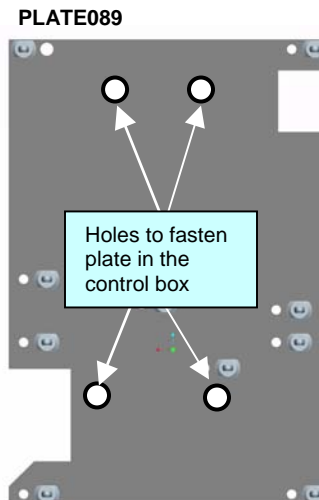

**5th step:** Once the plate is secured, mount the Power and Control Boards on the plate. Use the corresponding standoffs to secure the two boards.

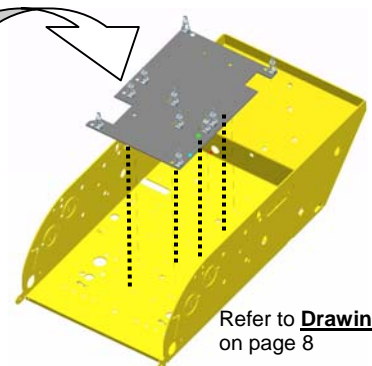
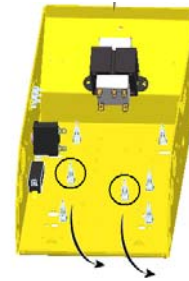
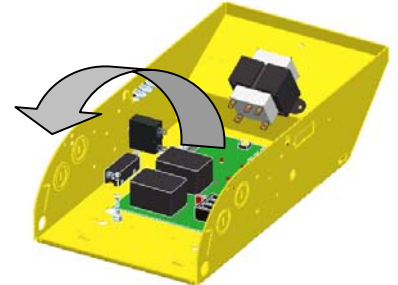

Refer to **Drawing 1** on page 8

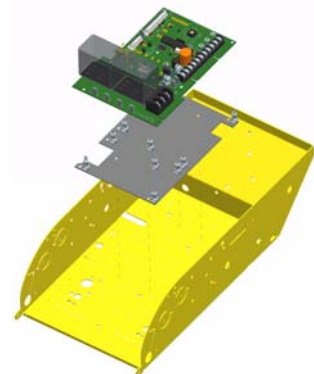

Once the installation of the Power and Control Boards is completed, please refer to page 16 to 23 for the electrical wiring instructions.  
(Also refer to notes on page 11 regarding connection of solenoid and 3 wires motor leads)

## **2 - BOTTOM END MOUNT: REPLACEMENT OF BOARD030/040/050/055**

**BY BOARD0065 ON A 115/220/208/460/575V – CONTROL** (OPH/J, OSH, OHJ, OGH)

### **1<sup>st</sup> step:** Unplug all the existing wires from

- The transformer
- The reset (for single phase)
- The hoist switch
- The open and close limit switches  
(Advance Close Limit Switch if available. *Note:* Adv. Close Limit Switch not required with BOARD065 may be removed from control box)
- Radio control terminal strip.
- Electrical motor

### **2nd step:** Remove the existing electronic board from the control box and all connected wires.

### **3rd step:** (A) Remove ALL the existing standoffs (plastic support) from the bottom end of the control box

### **(B)** Place the transformer on the bottom end of the control box.

Match the holes and use the existing self-tapping screws to fix the transformer on the bottom end of the control box  
(Refer to the drawing beside)

### **4th step:** Place the plate (PLATE089) on the bottom of the control box and use the 4 self tapping screws to fasten.

Align the four holes on the plate to the corresponding holes of the control box and fasten it using the self-tapping screws.

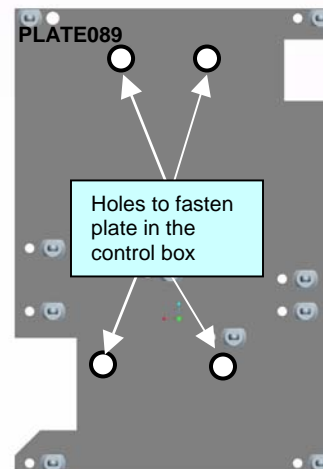

### **5th step:** Once the plate is secured, mount the Power and Control Boards on the plate. Use the corresponding standoffs to secure the two boards.

Once the installation of the Power and Control Boards is completed, please refer to page 16 to 23 for the electrical wiring instructions.  
(Also refer to notes on page 11 regarding connection of solenoid and 3 wires motor leads)

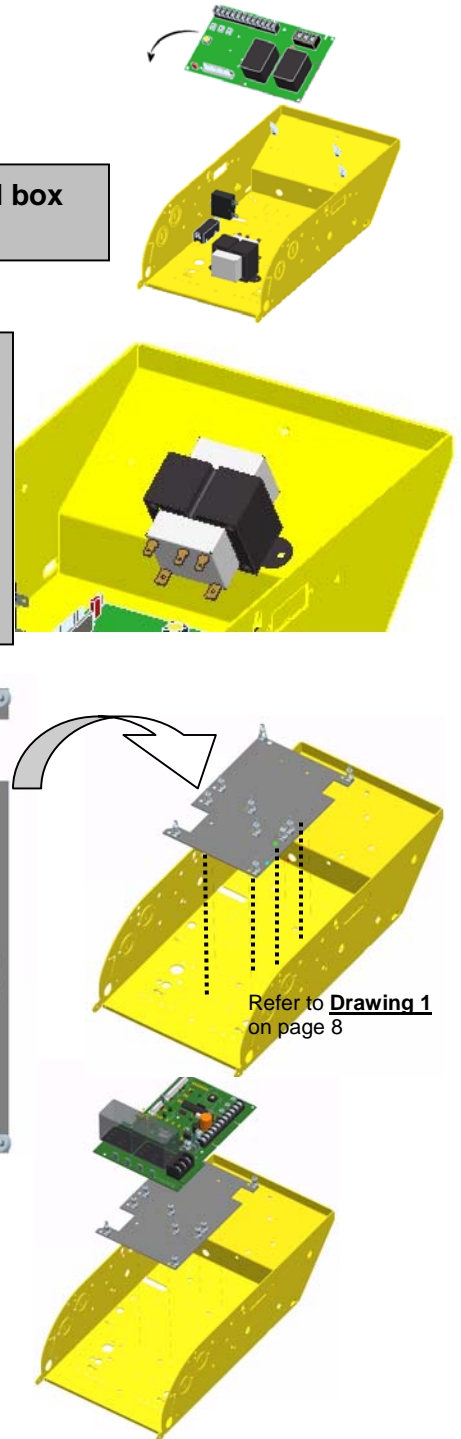

**Drawing 1: Fixing PLATE089 in an Opera control box.**

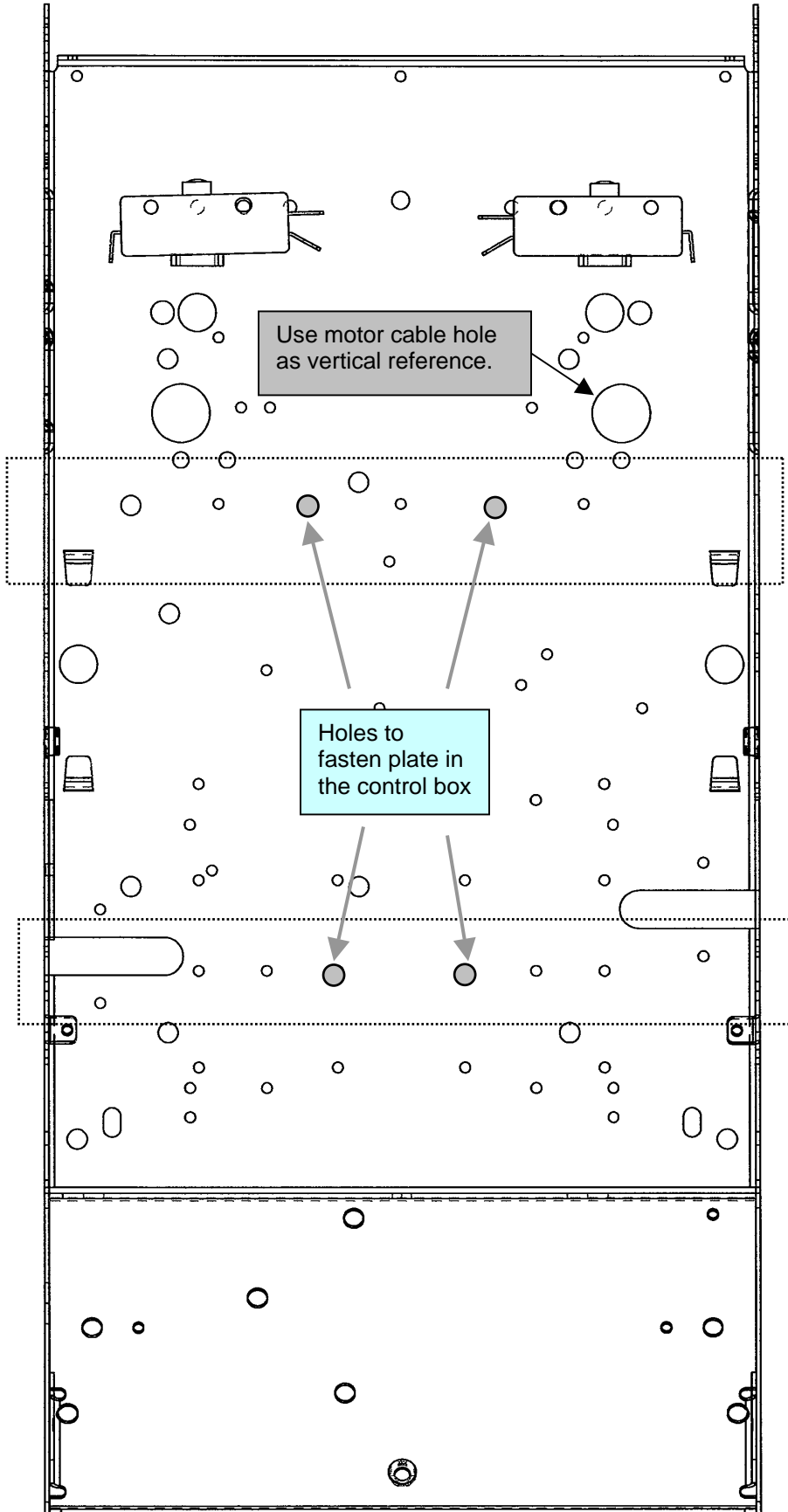

Opera control box with PLATE089 placed.

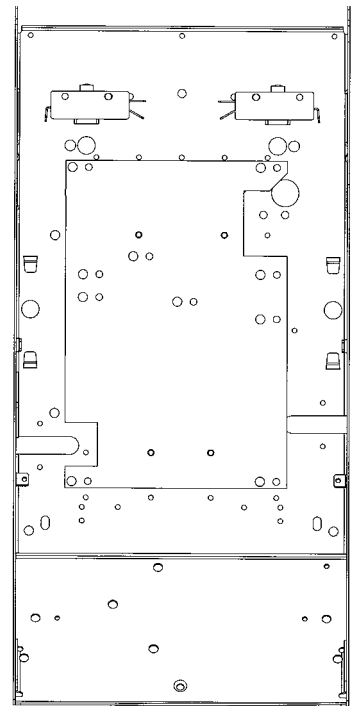



### **3 – CENTER MOUNT: REPLACEMENT OF BOARD030/040/050/055**

#### **BY BOARD0065 ON A 115/220/208/460/575V – CONTROL**

*(GH/MGH/MGSL/MGT)*

#### **1<sup>st</sup> step: Unplug all the existing wires from**

- The transformer
- The reset *(for single phase)*
- The hoist switch
- The open and close limit switches  
*(Advance Close Limit Switch if available. Note: Adv. Close Limit Switch not required with BOARD065 may be removed from control box)*
- Radio control terminal strip.
- Electrical motor

**2nd step:** Remove the existing electronic board from the control box and all connected wires.

#### **Important:**

Keep all the existing standoffs on the bottom of the control box.

**3rd step:** Align the holes on the plate with the existing standoffs and secure the plate.

**4th step:** Align the holes of each board (Power and Control) to the standoffs on the plate and secure the boards.

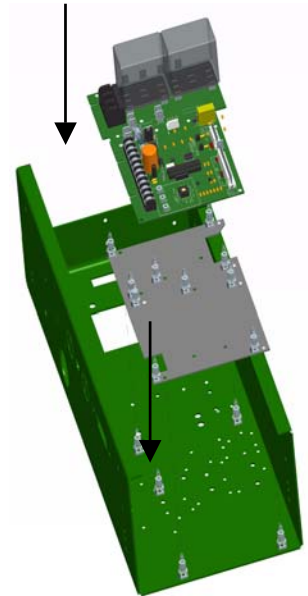
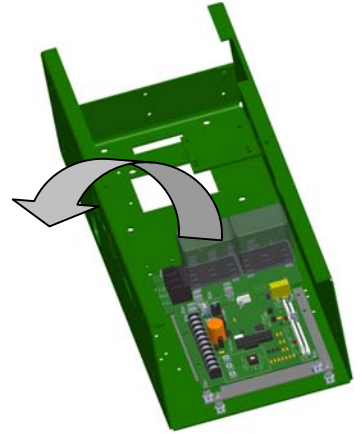

Once the installation of the Power and Control Boards is completed, please refer to page 16 to 23 for the electrical wiring instructions.  
*(Also refer to notes on page 11 regarding connection of solenoid and 3 wires motor leads)*

## **4 – CENTER MOUNT: REPLACEMENT OF BOARD030/040/050/055**

### **BY BOARD0065 ON A 115/220/208/460/575V – CONTROL**

*(MTH/MTBH/MSL/MSJ)*

#### **1<sup>st</sup> step: Unplug all the existing wires from**

- The transformer
- The reset *(for single phase)*
- The hoist switch
- The open and close limit switches  
*(Advance Close Limit Switch if available. Note: Adv. Close Limit Switch not required with BOARD065 may be removed from control box)*
- Radio control terminal strip.
- Electrical motor

**2nd step: Remove the existing electronic board from the control box and all connected wires.**

**Important:**  
Keep all the existing standoffs on the bottom of the control box.

**3rd step: Align the holes on the plate with the existing standoffs and secure the plate.**

**4th step: Align the holes of each board (Power and Control) to the standoffs on the plate and secure the boards.**

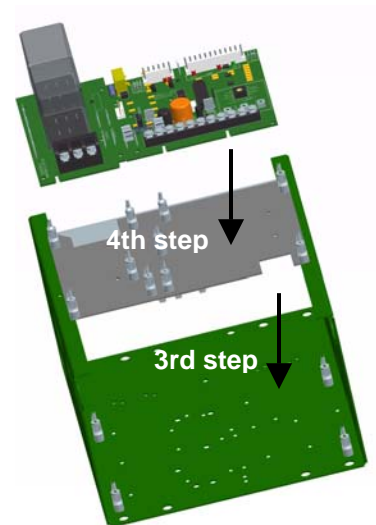
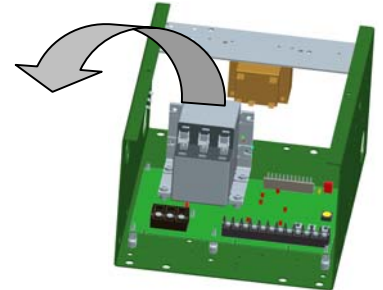

Once the installation of the Power and Control Boards is completed, please refer to page 16 to 23 for the electrical wiring instructions.  
*(Also refer to notes on page 11 regarding connection of solenoid and 3 wires motor leads)*

**NOTE 1:**

The single black jumper wire and the double spade terminal provided are used on operator built with BOARD040 in 220V/1PH application where the electric motor has **three (3) leads**.

- Please refer to the electrical wiring diagrams on page 16 to 23 for more details
- Also refer to the drawing below for more wiring instructions.

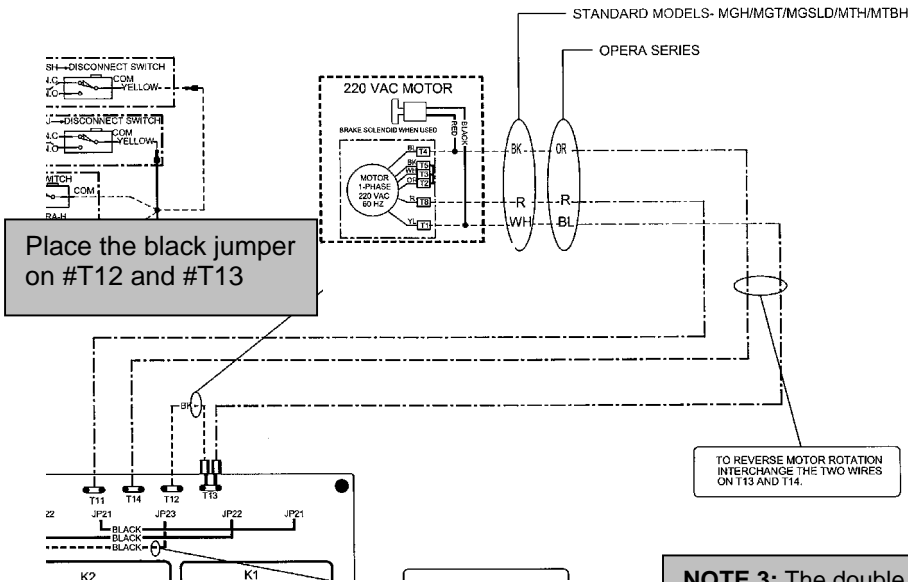

**Applicable on motor with 3 leads**

- Place the double spade terminal on #T13 of the power board.
- Connect one lead of the motor wire (blue for Opera series & white from std models) on one side of the double spade terminal.
- Put the black jumper on the other side of the double spade terminal and #T12 of the power board.

**Note:** Make sure that the connections are properly done and tight.

**IMPORTANT**

**Note 2:** Upon reception of a replacement Power Board, #T1 and #T2 are already wired

**For 115/220V-1PH applications connect:**  
#T1 to any terminal on the reset  
#T2 to any terminal on the reset

**For 208/460/575V-3PH applications:**  
Use only one single black wire and make a jumper from #T1 to #T2 (other black wire is not required, may be removed from the control box)

**NOTE 3:** The double black jumper wires provided are used only on operator built with a solenoid inside the control box (GH, MGH, MGT, MGSL and in N4/12 & N4X of these models)

To facilitate the connection of the electrical motor and the solenoid on the new Power Board, the double jumper wires are required.

**On a 115/220V-1PH operator:**

- Cut the black wire coming from electrical motor; use the red connector to join it to the jumper wire. Connect the second end of the jumper to #T14.
- Cut the white wire coming from electrical motor; use the red connector to join it to the jumper wire. Connect the second end of the jumper to #T13

**On a 208/460/575V-3PH operator:**

- Cut the black wire coming from electrical motor; use the red connector to join the motor wire to the jumper wire. Connect the second end of the jumper to #T14.
- Cut the red wire coming from electrical motor; use the red connector to join the motor wire to the jumper wire. Connect the second end of the jumper to #T13.

**Connect the two black wires with the isolated terminals to the solenoid.**

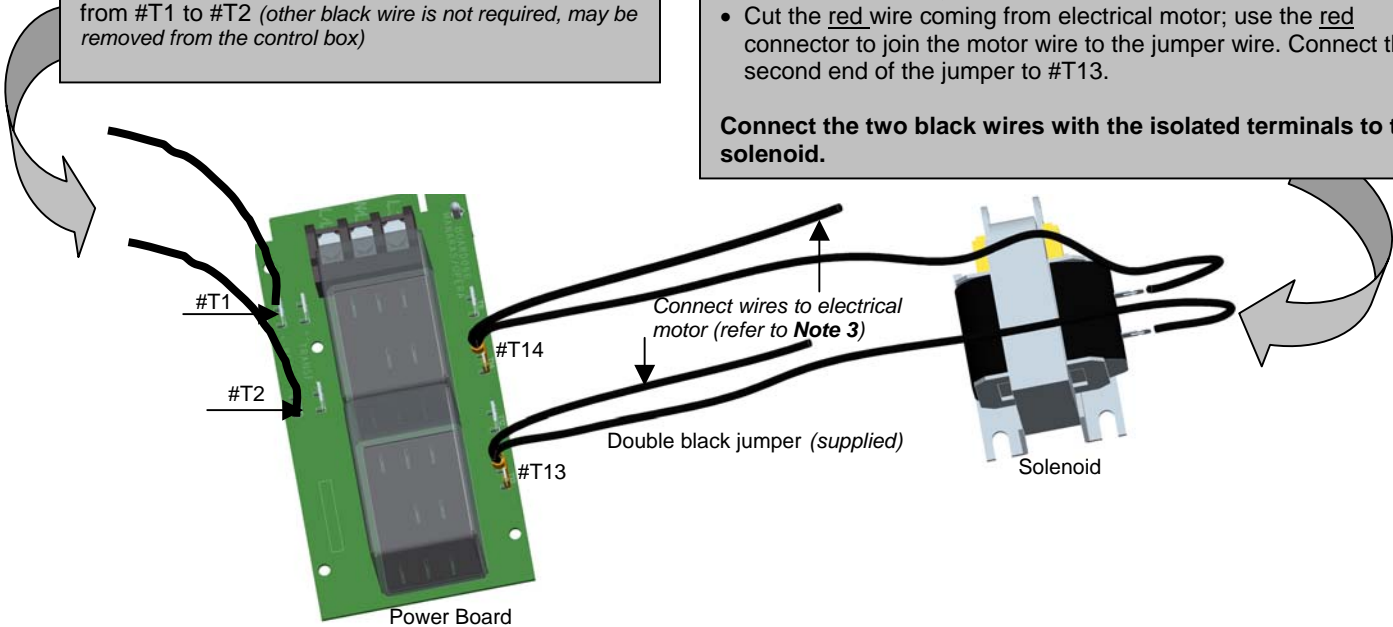

# Section II

Replacement of Power or Control Board

(From 060 series)

by

BOARD060R & 066R

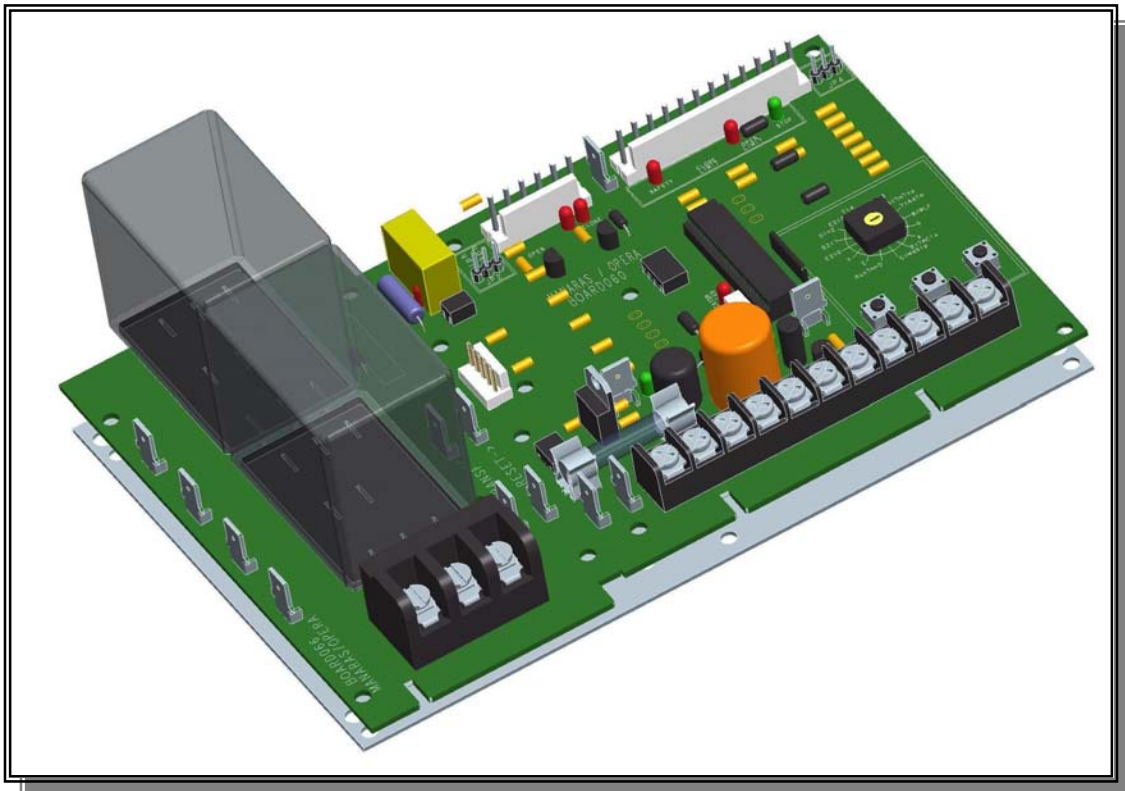

# Replacement of a Control Board (BOARD060) by a BOARD060R

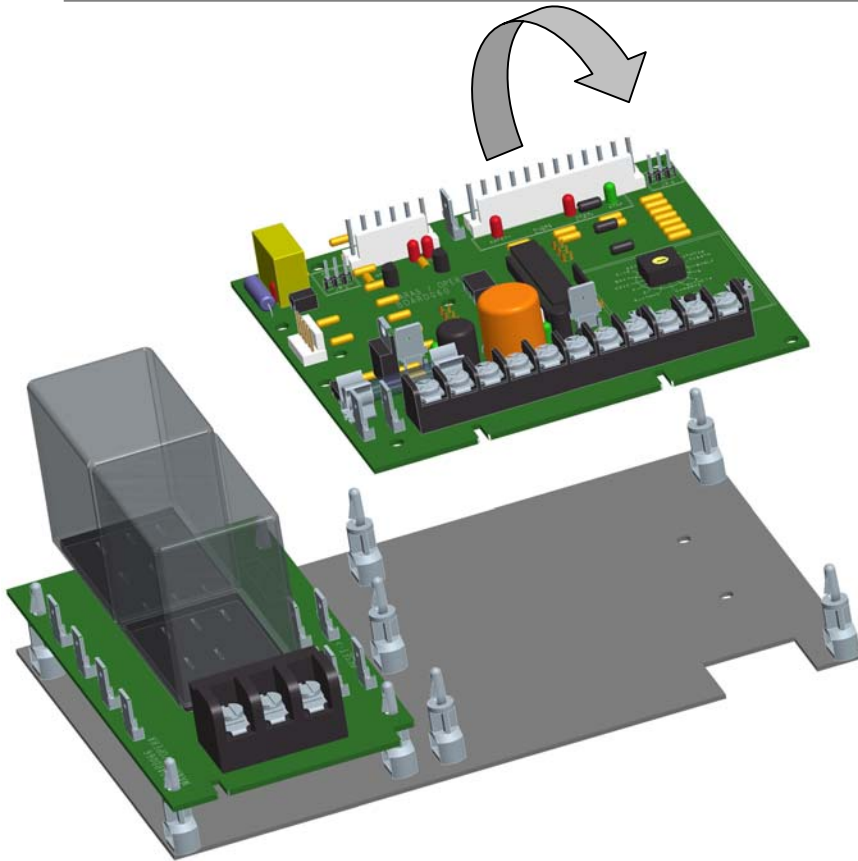

**WARNING**

**Important:**  
Always disconnect the main power from the operator before starting any intervention on the Electronic Control Board

## **Step by step changeover instructions:**

### Removal of existing Control Board:

- Disconnect all the wires from TB1 (*external accessories*).
- Unplug the rapid connectors from TB2 and TB4.
- Disconnect the purple wire from #T5 and the brown one from #T6.
- Disconnect the warning light module (*if any*) from TB5.
- Use a pair of long nose pliers to press the tips of the 5 standoffs and take the control board out.

### **Secure the new Control Board on the standoffs**

#### Once the new control board is placed:

- Re-plug the rapid connectors on TB2 and TB4.
- Plug back the purple and the brown wires on #T5 and #T6 for the 24V.
- Re-plug the warning light module (*if any*).
- Place the headers jumpers (*JP2 and JP4, refer to proper drawing on page 16 to 23*)
- Check for the factory set jumper (*purple*) on #10 and #11.

After making all these connections, put a jumper on #8 and #9 to test the new board by using the on board buttons.

- Program the features if required (*refer to page 26 for program settings*).
- Take out the jumper from #8 and #9
- Re-connect all the wires to their respective terminal on TB1 (*external accessories*)
- Make a complete functionality test of the operator with the new Control Board.

**For more details, refer to the appropriate electrical drawing from page 16 to 23.**

## Replacement of a Power Board (BOARD066) by a BOARD066R

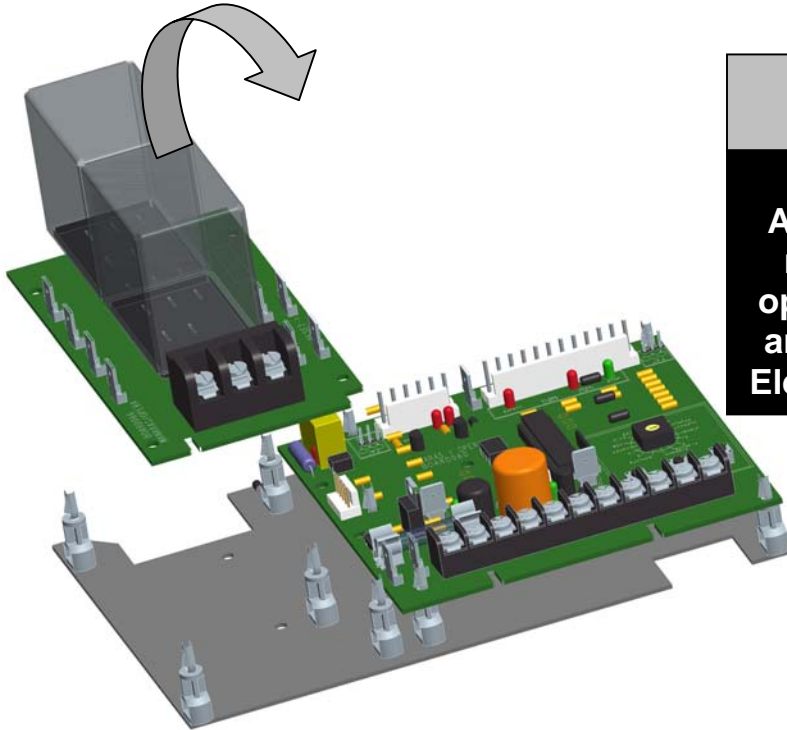

**WARNING**

**Important:**  
Always disconnect the main power from the operator before starting any intervention on the Electronic Control Board

### **Step by step changeover instructions:**

From existing Power Board disconnect the following:

- The main power line from TB3
- All motor wires from #T11, #T12, #T13 and #T14.
- Transformer leads from #T41 and #T42
- Overload protection or reset from #T1 and #T2
- Un-plug the rapid connector TB4 from Control Board.
- Use a pair of long nose pliers to press the tips of the 5 standoffs and take the Power Board out.

### **Secure the new Power Board on the standoffs**

Once the new power board is placed:

- Re-plug the rapid connectors on TB4 (control board)
- Connect back the transformer leads from #T41 and #T42
- Place back the wire for overload protection or reset from #T1 and #T2
- Re-connect all motor wires on #T11, #T12, #T13 and #T14.
- Connect main power line on TB3

Note:

- For 115V/1PH, cut and remove the black jumper JP23 of the power board.
- For 220V/1PH and 208/460/575V/3PH, cut and remove the yellow jumper JP13 on the power board.
- For 208/460/575V/3PH, cut the black and white wires coming from Power Board to TB4  
(these two wire are not required on 3 phase applications)

After making all these connections test the new board by using the on board buttons.

- Make a complete functionality test of the operator with the new Control Board.

**For more details, refer to the appropriate electrical drawing from page 16 to 23.**

# Section III

## Wiring instructions and electrical drawings

Wiring of BOARD065	Wiring instructions (page)	Wiring diagrams (page)
115V/1PH-60HZ (OPH/J, OSH, OHJ, GH/OGH, MGH, MSJ, MTH/MTBH, MGT, MSL, MGSL)	16	17
220V/1PH-60HZ (4 motor leads) (OPH/J, OSH, OHJ, GH/OGH, MGH, MSJ, MTH/MTBH, MGT, MSL, MGSL)	18	19
220V/1PH-60HZ (3 motor leads) (OPH/J, OSH, OHJ, GH/OGH, MGH, MSJ, MTH/MTBH, MGT, MSL, MGSL)	20	21
208/460/575V/3PH-60HZ (OPH/J, OSH, OHJ, GH/OGH, MGH, MSJ, MTH/MTBH, MGT, MSL, MGSL)	22	23
Power and control wiring diagrams	24	
LED monitoring status	25	
Programs	26	
Program settings	26	
Mode setting	27	

**WIRING OF BOARD065 (center & bottom end mount) ON A 115V – 1PH CONTROL**

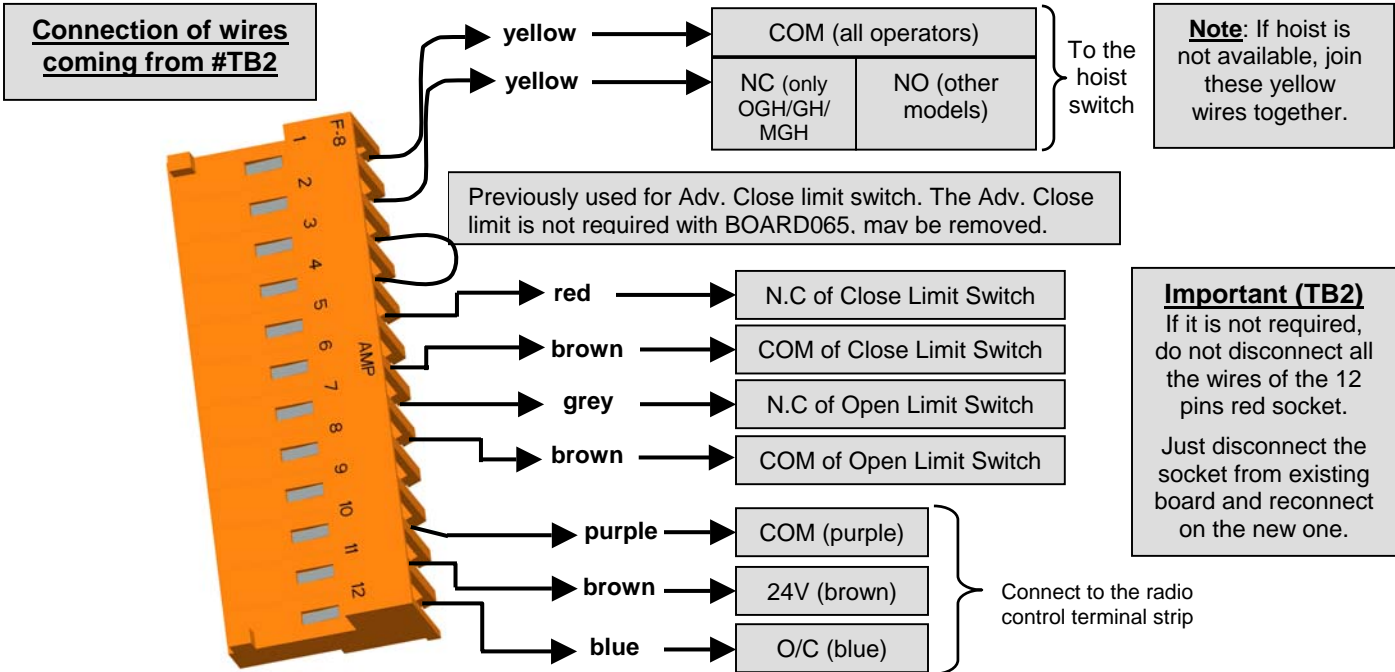

**Single-phase 115V motor connections**

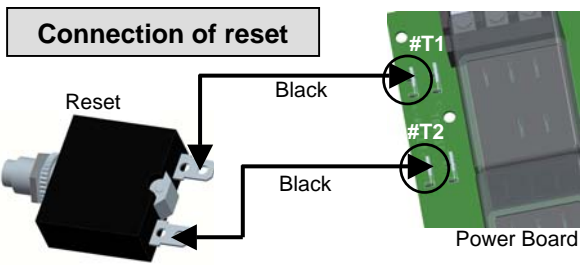
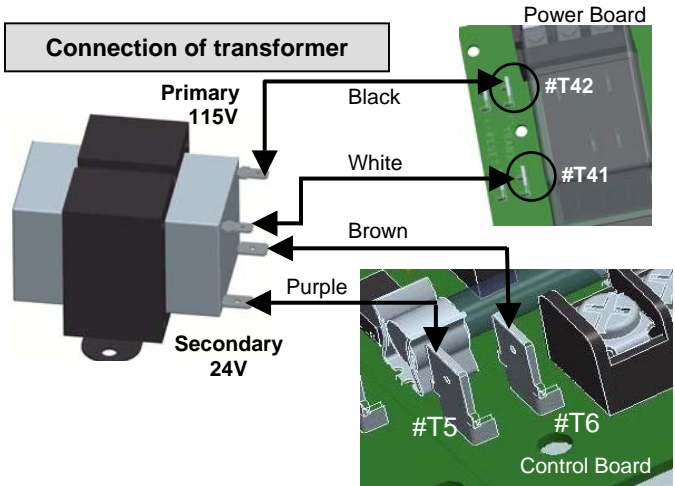
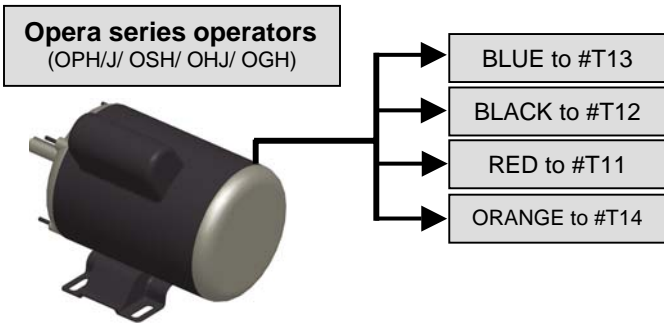
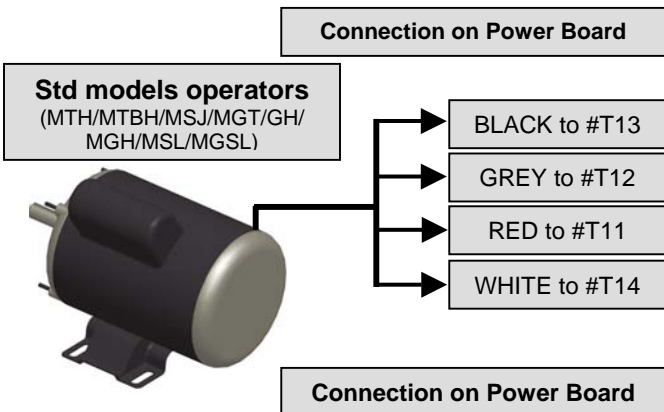

**Reverse rotation**  
 Interchange wires:  
 on #T13 & #T14

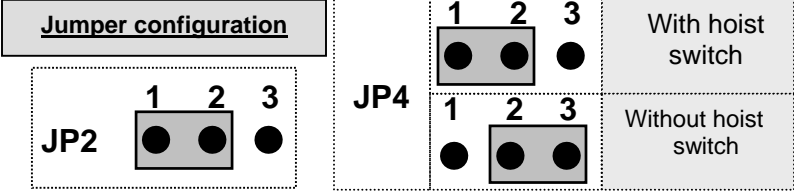

**Connection of the Power to Control Board**  
 Connect the 5 wires rapid connector from Power Board to #TB4 on the Control Board

**Important:** For 115V/1PH application, cut and remove the Black jumper (JP23) on the Power Board (BOARD066)



REPLACEMENT DRAWING - TO BE USED WITH OPERATORS BUILT WITH BOARD030/040/050/055 -115VAC -1PH.

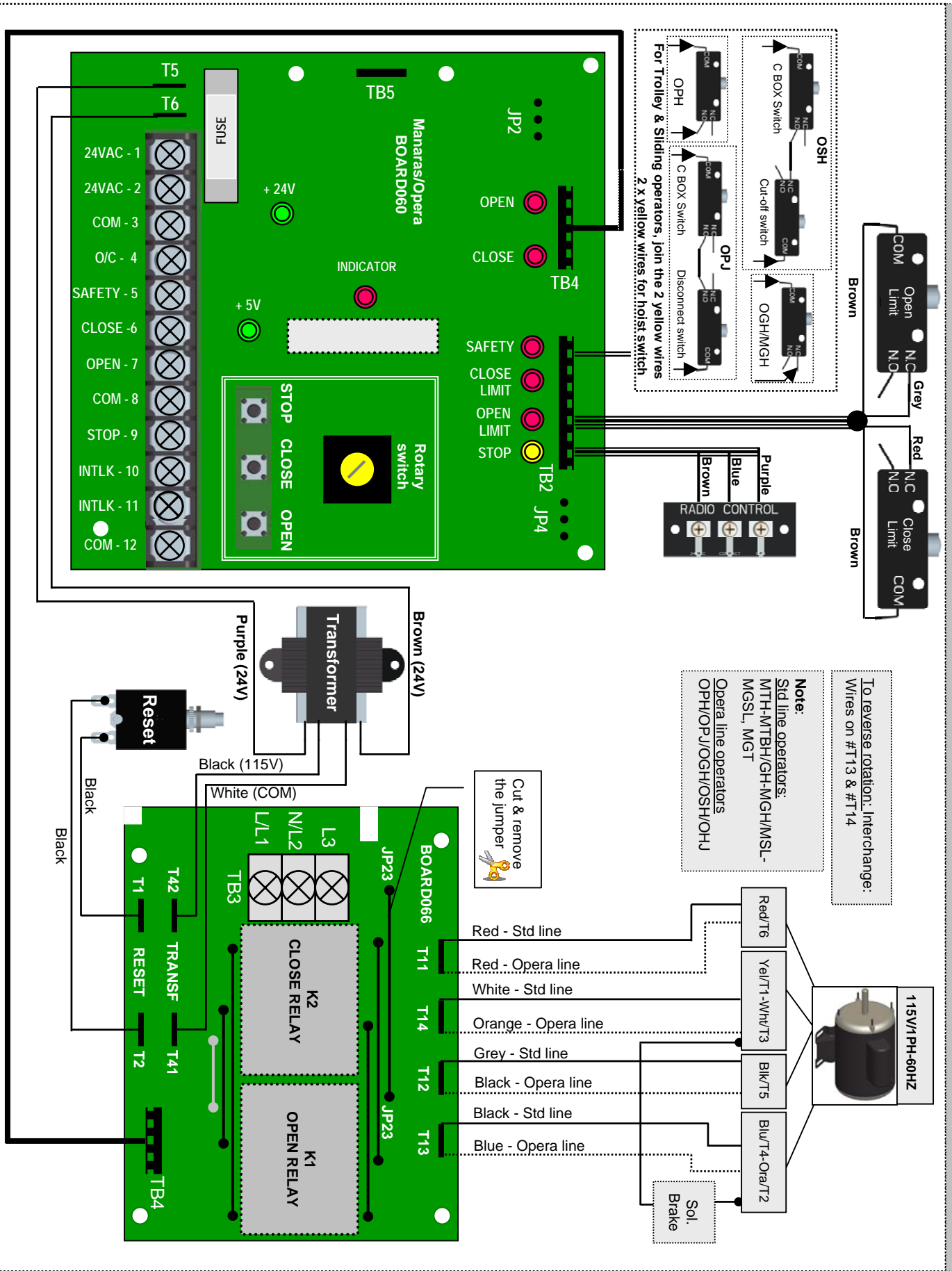

**WIRING OF BOARD065 (center & bottom end mount) ON A 220V- 1PH CONTROL (4 motor leads)**

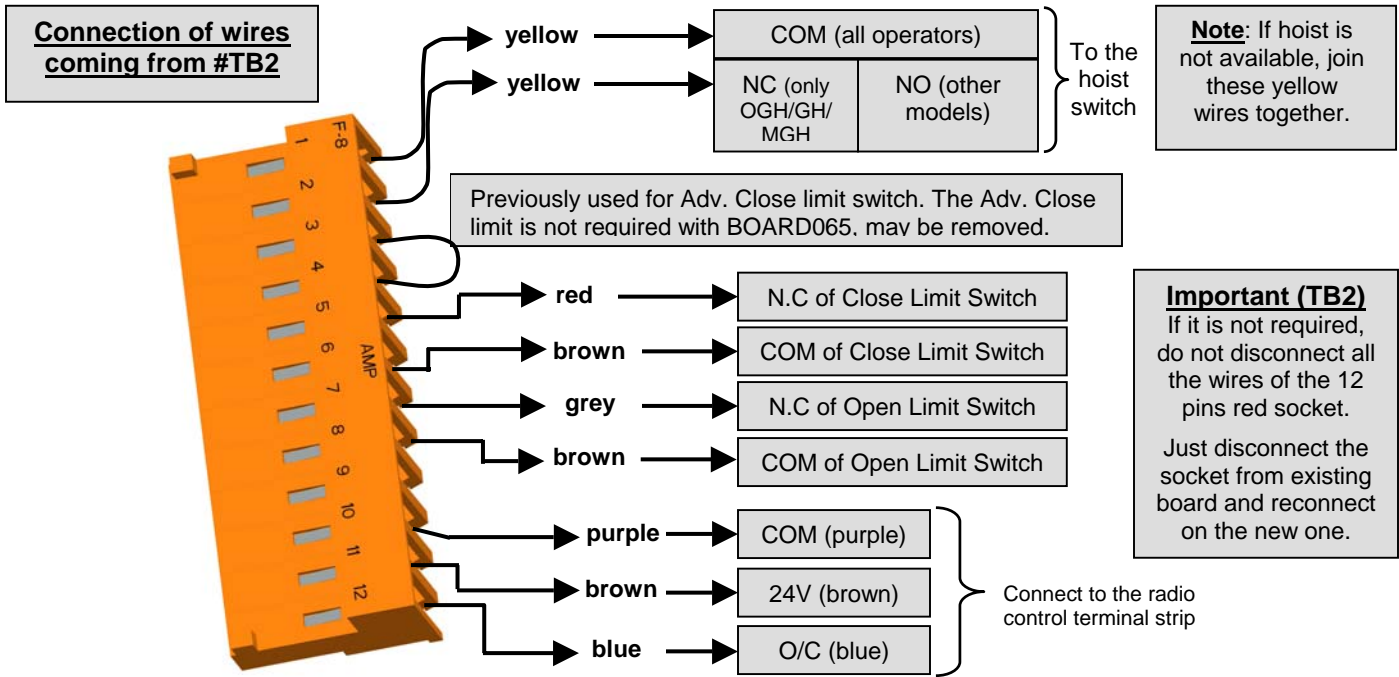

**Single-phase 220V motor connections**

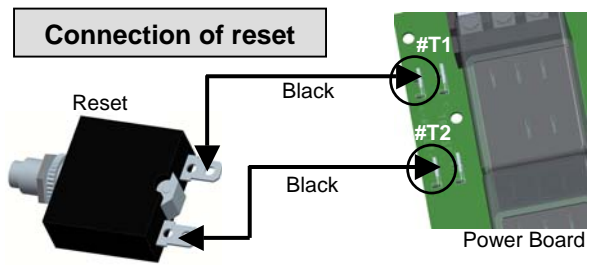
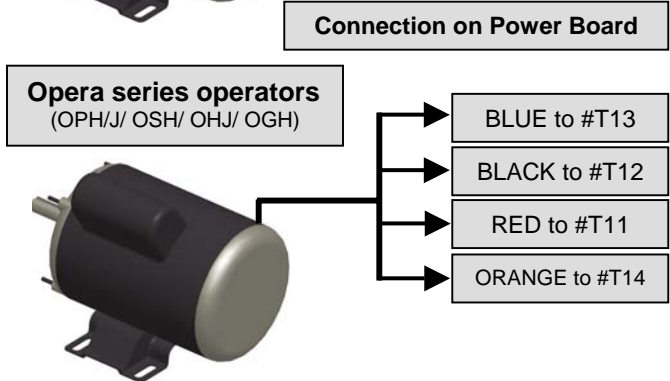
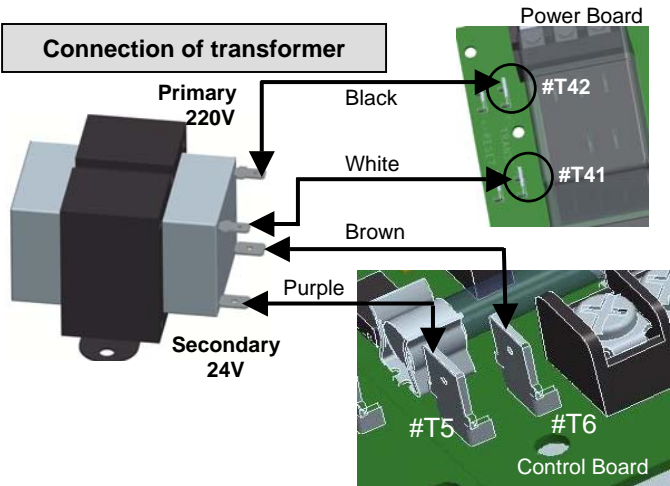
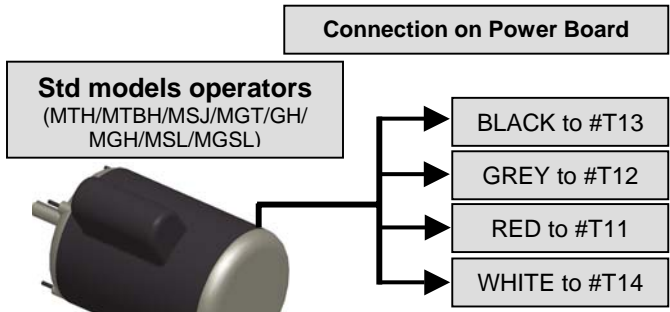

**Reverse rotation**  
 Interchange wires:  
 on #T13 & #T14

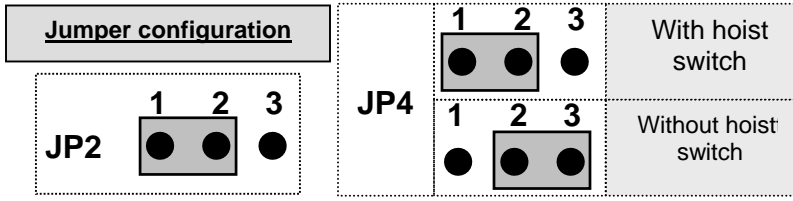

**Connection of the Power to Control Board**

Connect the 5 wires rapid connector from Power Board to #TB4 on the Control Board

**Important:** For 220V/1PH application, cut and remove the Yellow jumper (JP13) and Black jumper (JP23) from the Power Board (BOARD066)

REPLACEMENT DRAWING - TO BE USED WITH OPERATORS BUILT WITH BOARD030/050/055 -220VAC -1PH (4 leads)

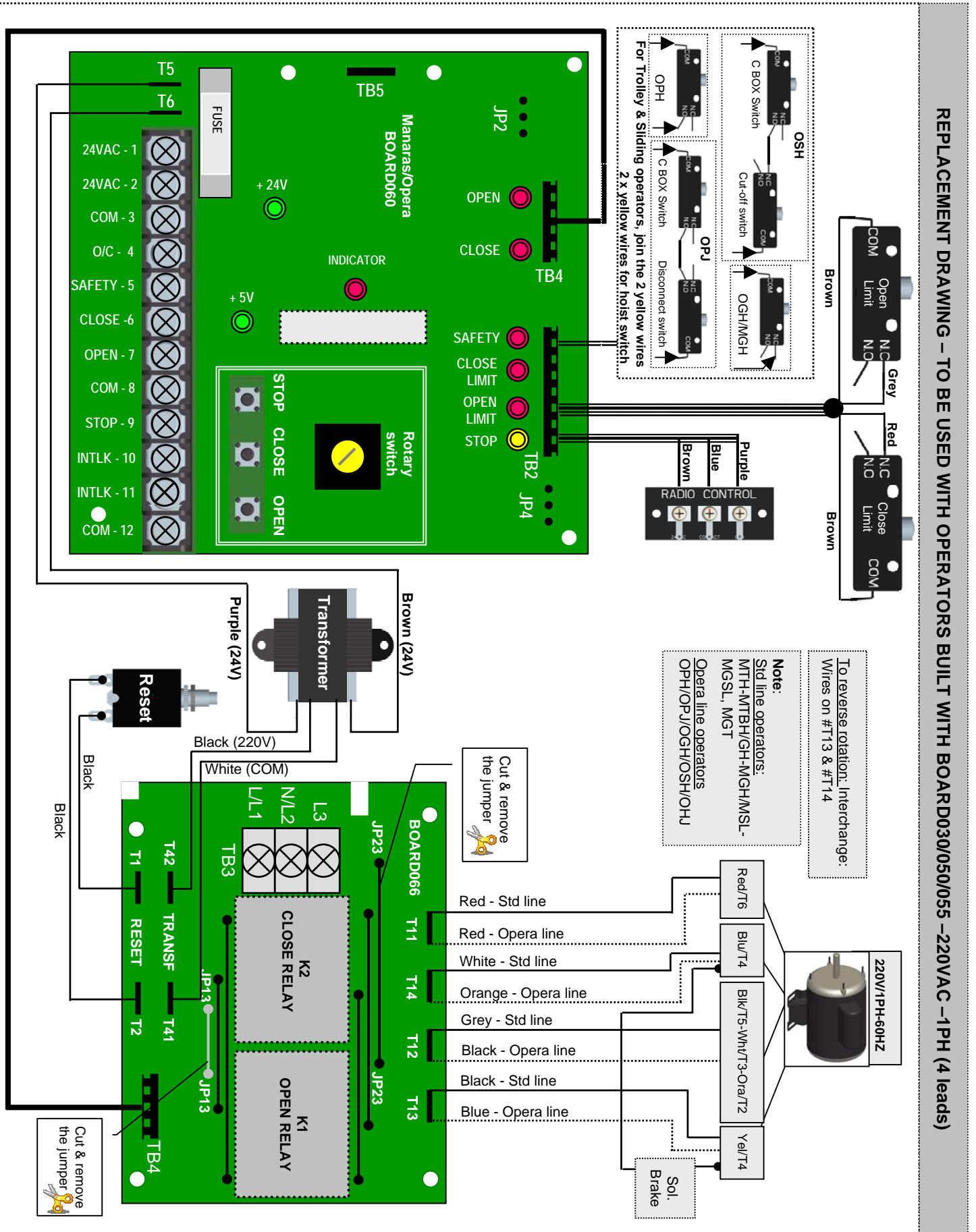

**WIRING OF BOARD065 (center & bottom end mount) ON A 220V- 1PH CONTROL (3 motor leads)**

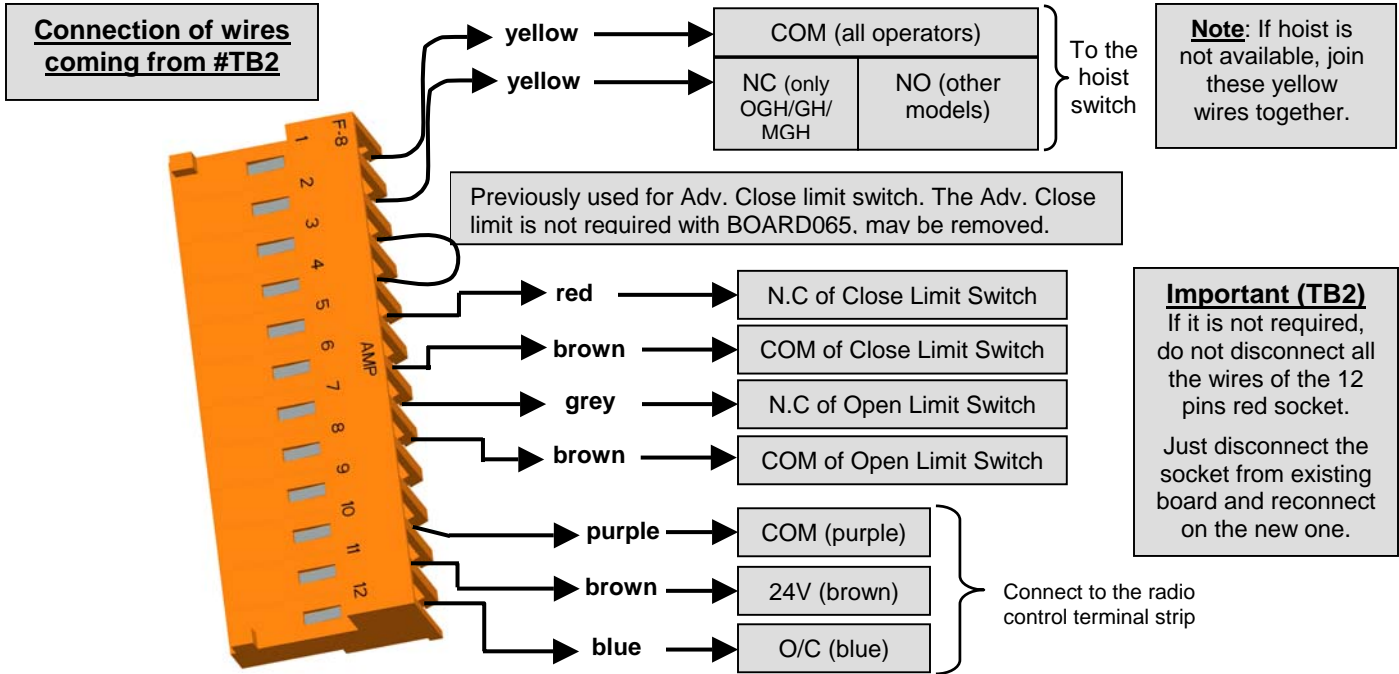

**Single-phase 220V motor connections**

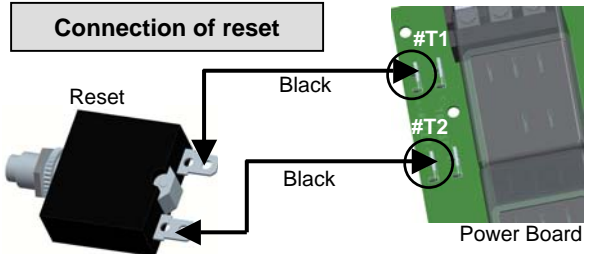
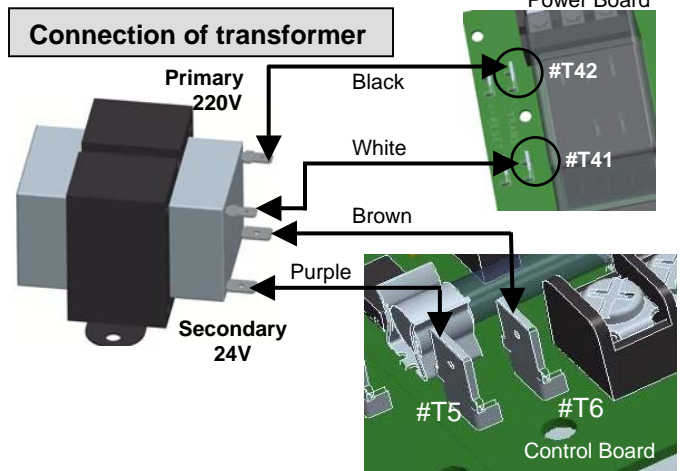
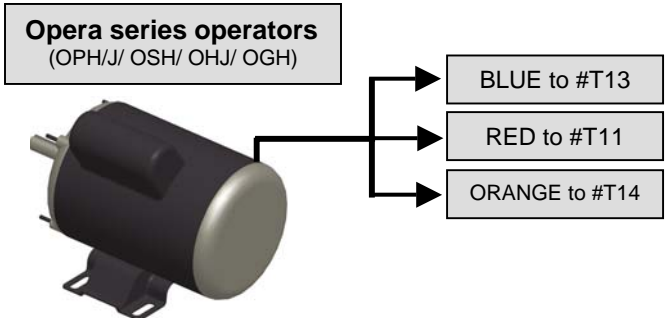
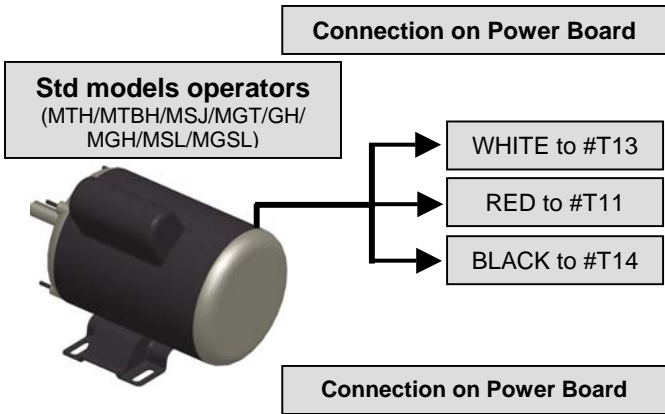

**Reverse rotation**  
 Interchange wires:  
 on #T13 & #T14

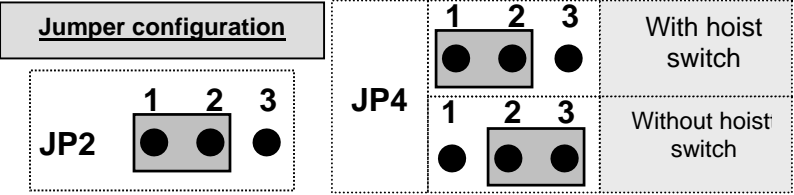

**Connection of the Power to Control Board**  
 Connect the 5 wires rapid connector from Power Board to #TB4 on the Control Board

**Important:** For 220V/1PH application, cut and remove the Yellow jumper (JP13) and Black jumper (JP23) from the Power Board (BOARD066)

REPLACEMENT DRAWING - TO BE USED WITH OPERATORS BUILT WITH BOARD040/050/055 -220VAC -1PH (3 wires)

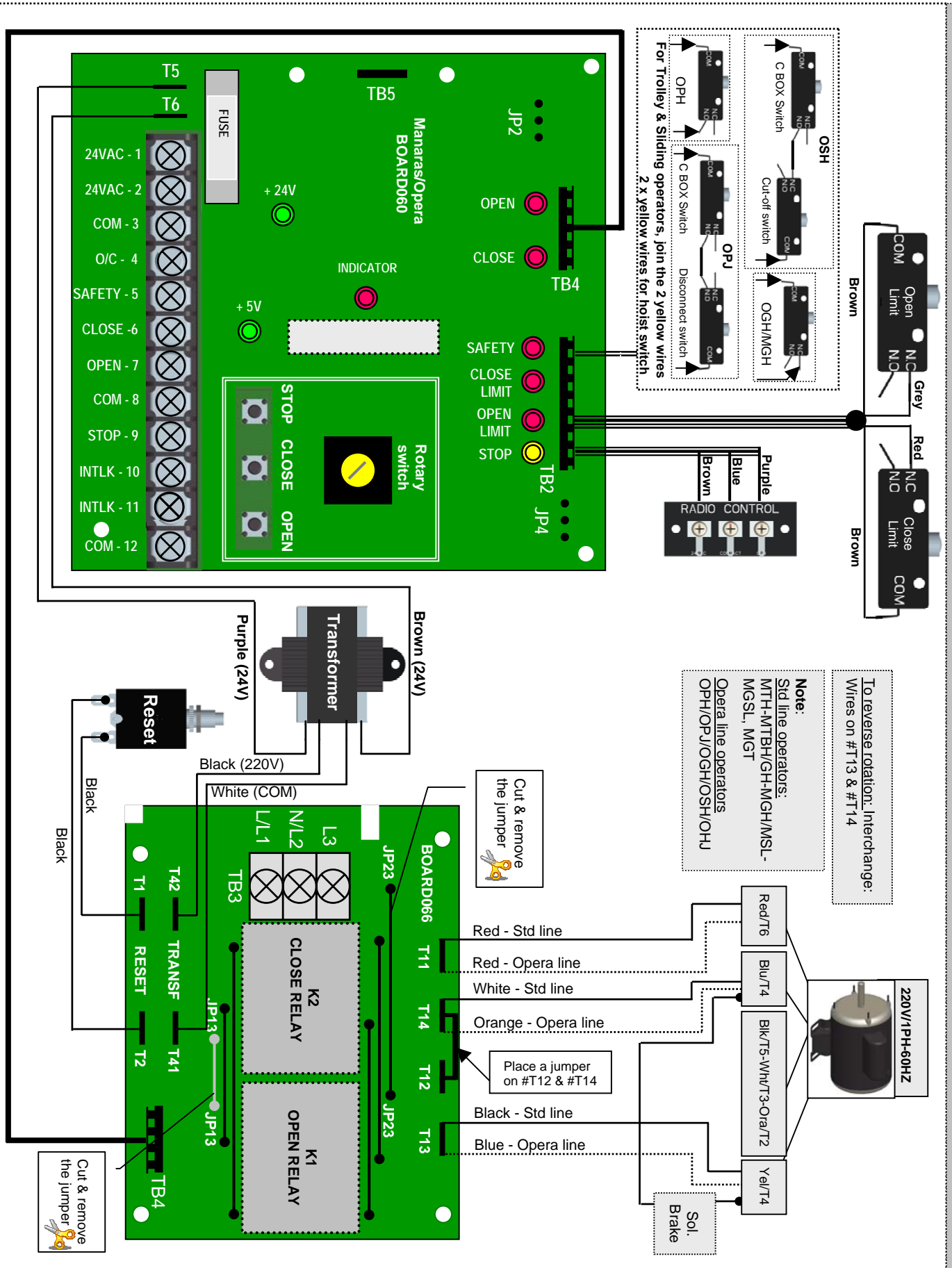

**WIRING OF BOARD065 (center & bottom end mount) ON A 208/460/575V- 3PH CONTROL**

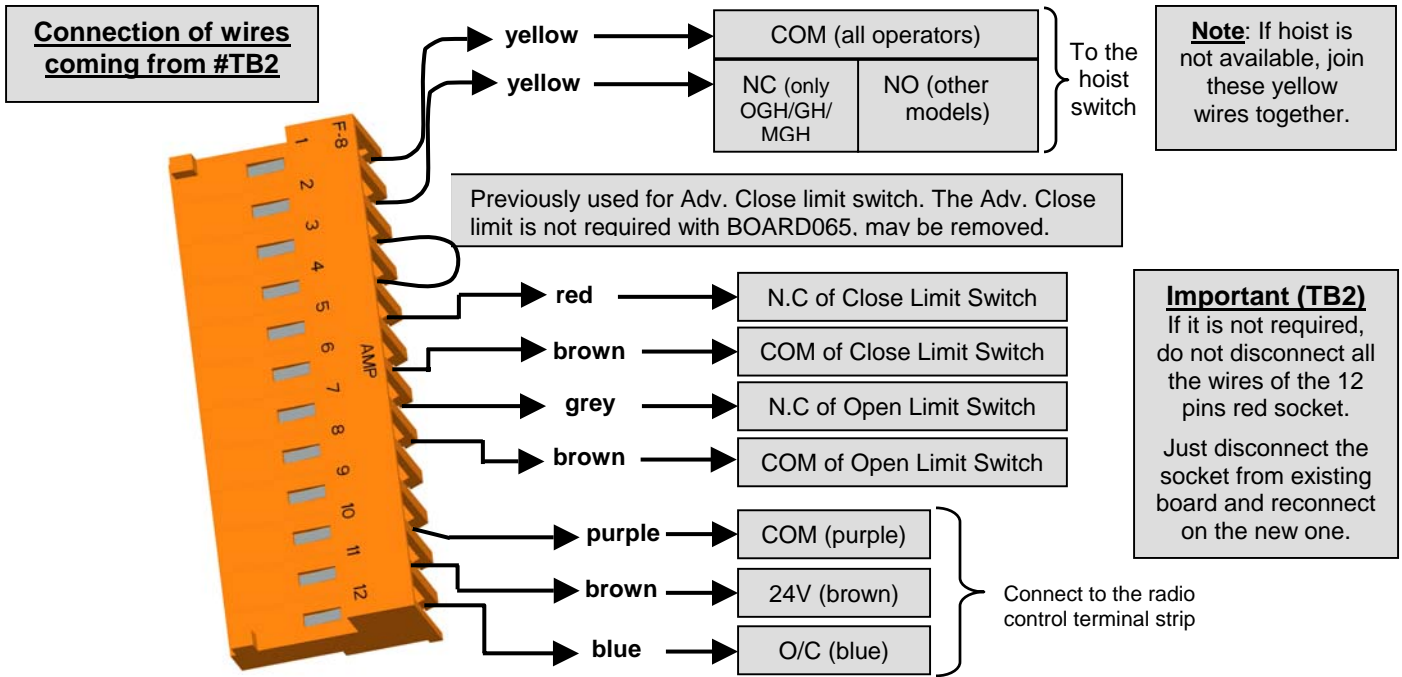

**208/460/575V-3ph motor connections**

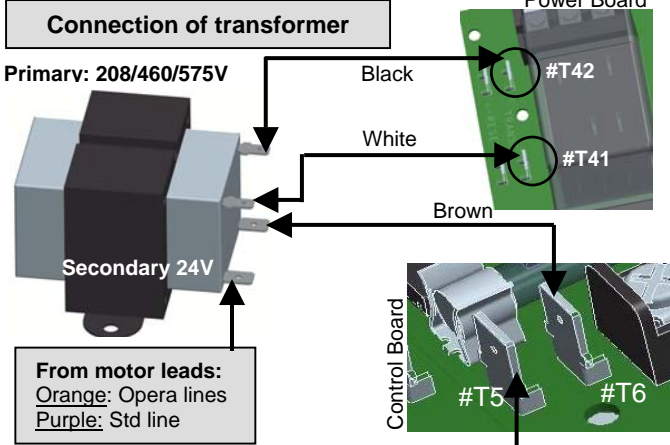
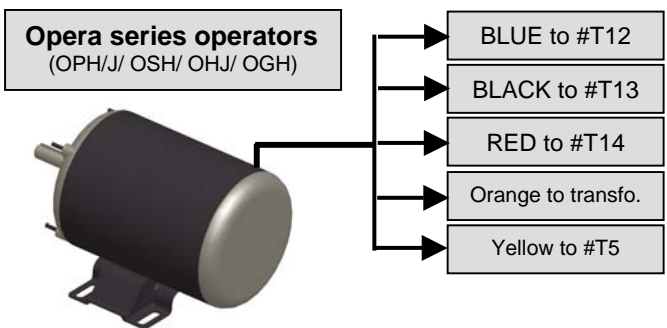
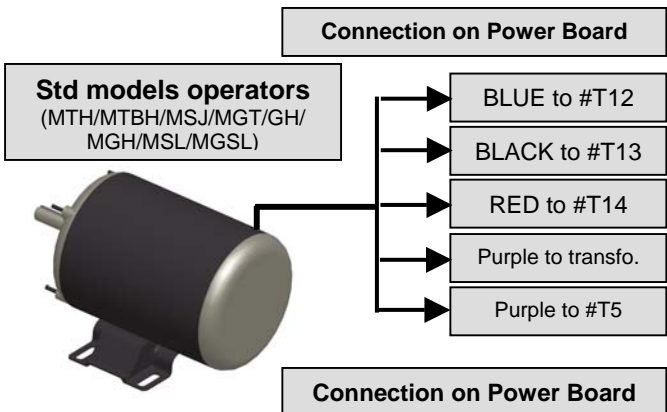

**Either:** use a wire nut to connect the Purple from #T5 to: Yellow wire from motor lead of Opera line / Purple wire from motor lead of standard line.  
**Or:** where it's possible, connect directly the Yellow or Purple wire from motor lead to #T5. Use the small spade connector (supplied) to connect the wire on #T5 (cut & remove the large one)

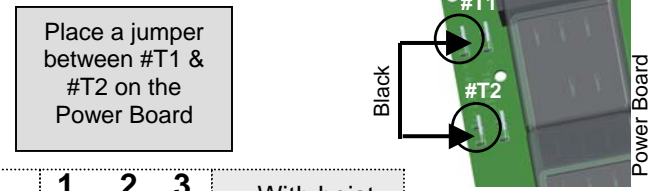

**Connection of the Power to Control Board**

Connect the 5 wires rapid connector from Power Board to #TB4 on the Control Board

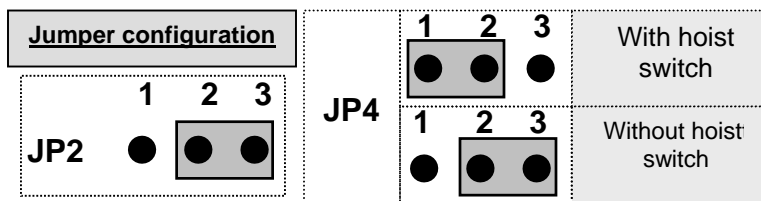

**Reverse rotation**  
 Interchange wires: on #T13 & #T14

**Important for 3-Ph applications**

1. Place a jumper wire between #T1 & #T2 on the Power Board
2. Cut and remove the Yellow jumper (JP13) on the Power Board (BOARD066)
3. Cut and remove the Black & White wires from the 5 wires rapid connector (TB4 on the Control Board – BOARD060)

REPLACEMENT DRAWING - TO BE USED WITH OPERATORS BUILT WITH BOARD030/40/050/055 - 208/460/575V - 3-PH

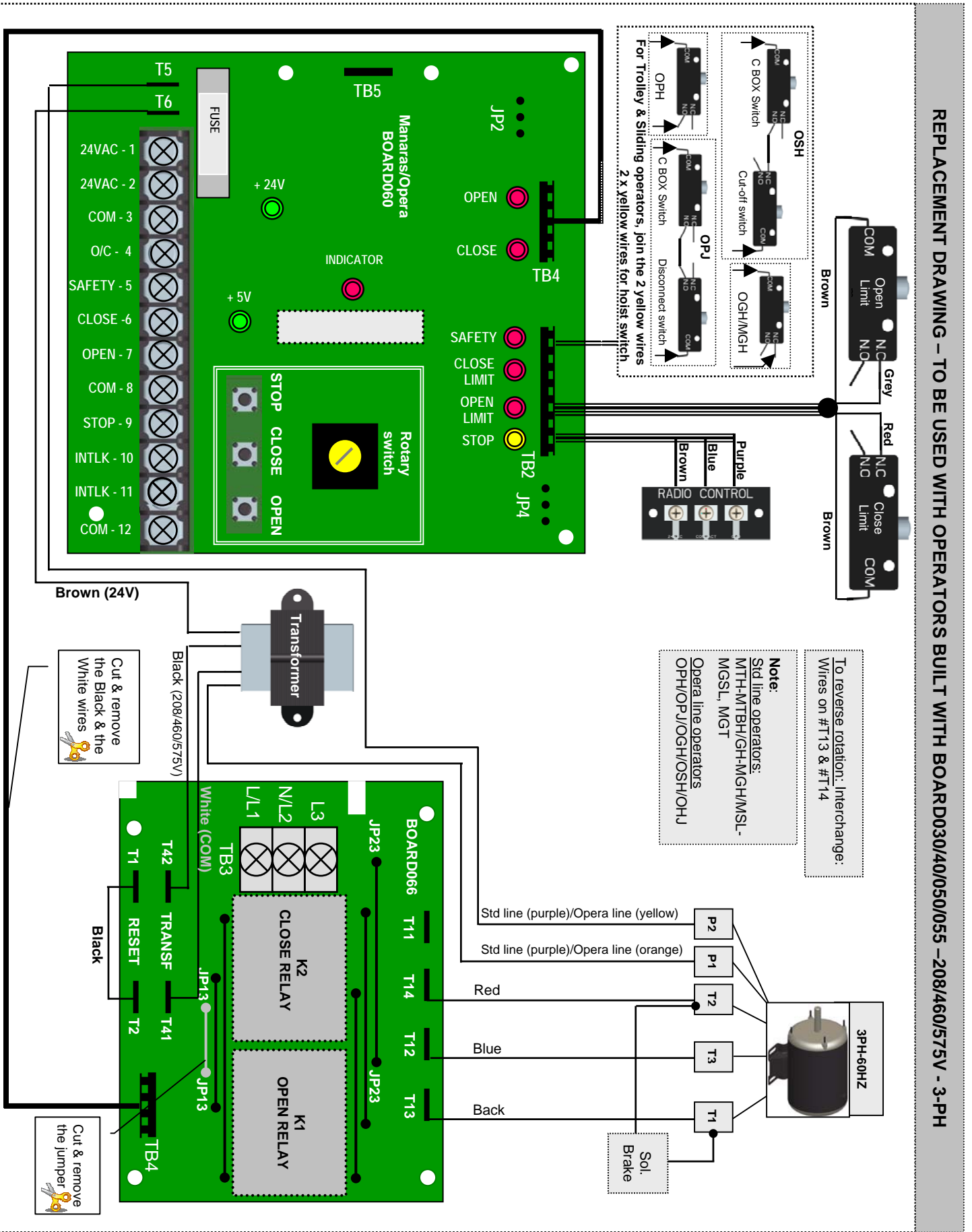

## Section IV: POWER AND CONTROL WIRING DIAGRAM

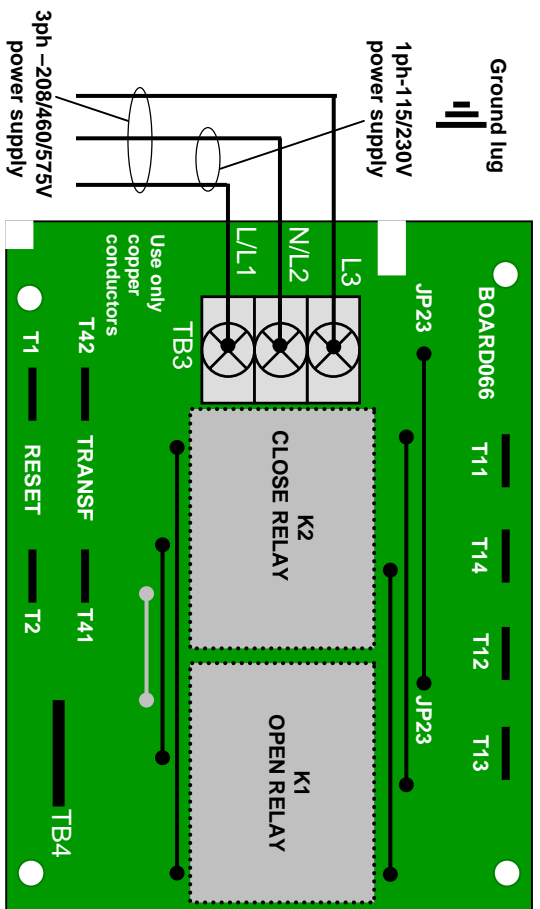

**VERY IMPORTANT NOTES**

- Before installing power and control wiring, be sure to follow all specifications described below. Failure to do so may damage the operator.**
- The operator must be properly grounded and connected in accordance to local electrical codes.
  - Use different knockouts available on EACH side of the control box to pass the power and control wiring through.
  - Ensure maximum separation between power wirings and low voltage control wirings in the control box.
  - If a push button is not used, a jumper must be placed between #8 & #9  
*\*\*\*Under this condition a stop command is not available to stop the door during its travel.*
  - 2 Amp fuse** is used to protect 24VDC on electronic board and also the 24VAC supply for auxiliary control devices

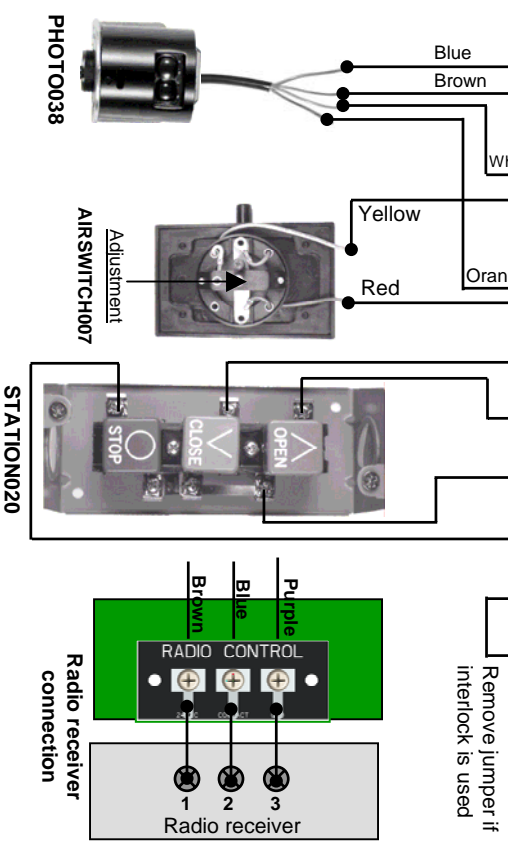
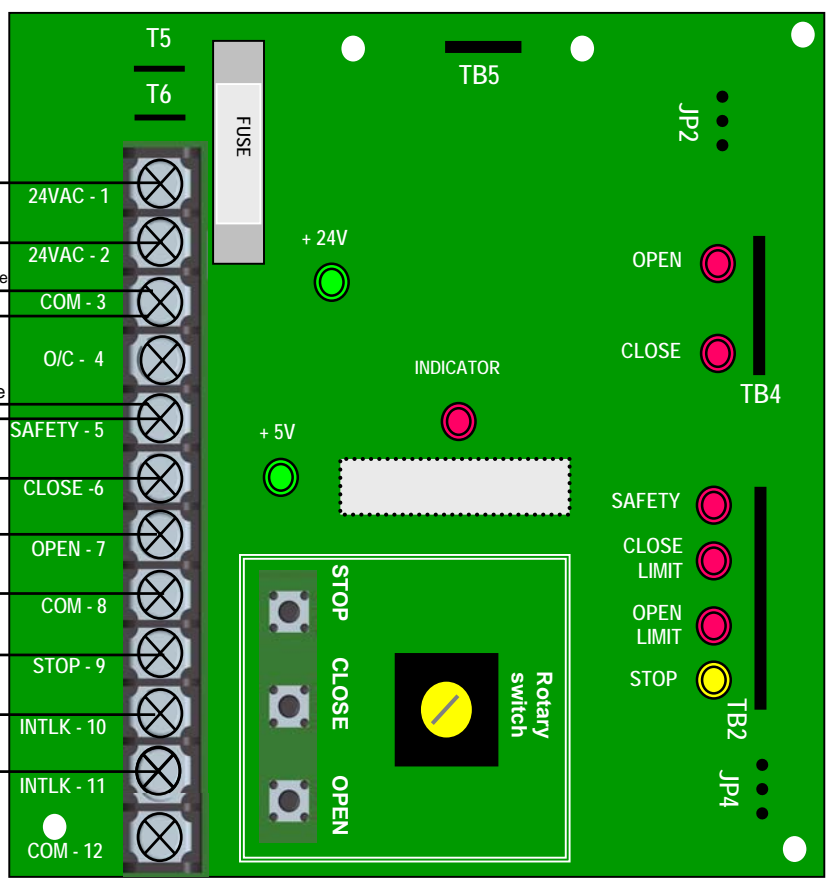



## **LED MONITORING STATUS**

LED's on the ECB help with wiring and making troubleshooting diagnoses. Every LED states the actual position of the door. The board has a non-volatile memory and all the LED's will return to their initial state after a power interruption.

L.E.D	Color	Status
<b>+24 V</b>	Green	When ON indicates the presence of 24VDC on the Logic Board
<b>+5 V</b>	Green	When ON indicates the presence of 5VDC power in the Control Circuit
<b>Open Limit</b>	Red	When ON indicates door position, completely open.
<b>Open</b>	Red	Only when the <b>open relay</b> is activated (open relay is energized)
<b>Close Limit</b>	Red	When ON indicates door position, completely close.
<b>Close</b>	Red	Only when the <b>close relay</b> is activated (close relay is energized)
<b>Safe</b>	Red	Light ON only when safety devices are activated.
<b>INDICATOR</b>	Red	Flashes only when motor runs in opposite direction and activates the wrong limit switch.
		Stay ON only when the "centrifugal switch" is opened ( <i>please contact technical support</i> )
<b>STOP</b>	Yellow	In normal conditions light; stay ON, goes OFF every time when press STOP button or hoist is engaged

### **Stop LED OFF:**

- Check if the Stop button is properly connected on #8 and #9 or if a Normally Closed contact is used.
- Verify if the Hoist is properly engaged and if the Hoist switch is closed (or if any external interlock device remains open)

## **EXTERNAL CONTROLS**

Refer to the wiring diagram on page 24 before connecting power or any external device to the ECB. Neglecting to use the proper terminals will result in complete damage to the ECB. If you are not certain about procedures, please consult Manaras for assistance.



### **WARNING**

**IF THE MOTOR ROTATION IS NOT CORRECT, DO NOT ATTEMPT CORRECTION BY REVERSING WIRES ON CONTROL STATION.**

**Program and Program settings**

Programming ability and door control at electrical box are provided by Open/Close/Stop buttons and Rotary Switch located on the ECB.

• **Programs**

PROGRAMS	FUNCTIONS AND DESCRIPTIONS
<b>RUN TIMER</b>	The Run Timer automatically stops the operator after an adjustable time delay either travelling upwards or downwards. The Run Timer is designed to protect the door and the operator by preventing the motor over running much longer than the normal time.
<b>MID-STOP</b>	Mid-Stop function will, when active, move the door from the down position to a predetermined Mid-stop position when the open button or Open/Close device is activated. Once at Mid-Stop, subsequent Open/close commands will close the door. To move the door to full open position, the open button must be pressed again.
<b>TIMER TO CLOSE</b>	Timer to Close is a function that, when active, will close the door after an adjustable time delay once the door has reached its fully open and mid-stop position. The timer to close function works only in T and TS modes.
<b>TIMER TO CLOSE (from fully open position only)</b>	Option used in conjunction with MID STOP function. When activated, Timer to Close is active from the fully open position only and not from the mid-stop position.
<b>ADVANCE CLOSED TIME</b>	“Advance close limit switch” is not needed with this feature. Advance close time will disable the reversing device once the close limit switch is activated and will stop the door after 200 milliseconds before it reaches the fully closed position. <i>Note: Door distance traveled within these 200 milliseconds may vary depending on the door speed.</i>

• **Program setting**

Door should be in fully closed position while setting any of the following programs.

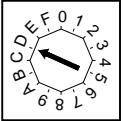
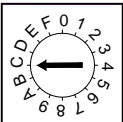
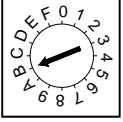
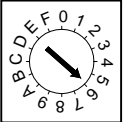
PROGRAM SETTING			
PROGRAMS	ACTIVATE	DEACTIVATE	SELECT SWITCH
<b>RUN TIMER</b>	<ul style="list-style-type: none"> <li>• Check if close limit switch is activated.</li> <li>• Set select switch on D.</li> <li>• Press “Open” button to add 10 sec to the total time needed to open the door.</li> <li>• Set the select switch on run mode (0, 1, 2, 3, 4 or 5).</li> </ul>	<ul style="list-style-type: none"> <li>• Set select switch on D.</li> <li>• Press “Stop” button.</li> <li>• Set the select switch on run mode (0, 1, 2, 3, 4 or 5).</li> </ul>	
<b>MID-STOP</b>	<ul style="list-style-type: none"> <li>• Check if the close limit is activated.</li> <li>• Set select switch on “C”.</li> <li>• Press “Open” button then press “Stop” button on desired Mid-Stop position.</li> <li>• Set the select switch back on run mode (0, 1, 4 or 5).</li> </ul>	<ul style="list-style-type: none"> <li>• Set select switch on “C”.</li> <li>• Press “Stop”, “Close” and “Open” buttons consecutively.</li> <li>• Set the select switch back on run mode (0, 1, 4 or 5).</li> </ul>	
<b>TIMER TO CLOSE</b>	<ul style="list-style-type: none"> <li>• Set select switch on “B”.</li> <li>• Press “Open” button to add 15 sec or “Close” button to add 1 sec each time (max. 4 minutes &amp; 15 seconds).</li> <li>• Set the select switch on T or TS mode.</li> </ul>	<ul style="list-style-type: none"> <li>• Set select switch on “B”.</li> <li>• Press “Stop” button the timer to close is reset to 0 sec but still activated.</li> <li>• To defeat the timer to close completely set the switch on desired position (0, 1, 2 or 3).</li> </ul>	
<b>TIMER TO CLOSE (from fully open position only)</b>	<ul style="list-style-type: none"> <li>• Set select switch on “6”.</li> <li>• First press the “Close” button and then the “Stop” button.</li> <li>• Set the select switch on T or TS mode.</li> </ul>	<ul style="list-style-type: none"> <li>• Set select switch on “6”.</li> <li>• Press “Close” button.</li> <li>• Set the select switch on T or TS mode.</li> </ul> <p>*Now the Timer to Close works from fully Open and Mid-Stop positions.</p>	
<b>Controlling Timer to Close from floor level (using wall buttons)</b>			
While door is in closed position, by pressing “Stop” 3 times and “Close” 3 times consecutively on the push button station, the timer to close is deactivated ( <i>timer to close is suspended</i> ).		Timer to close is re-activated ( <i>timer to close is back to normal function</i> ) simply when door is closed either from fully open or from mid-stop positions.	

**Mode setting**

For any mode setting the door should be in either on fully open or fully closed position.

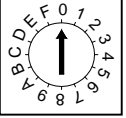
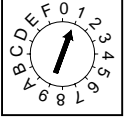
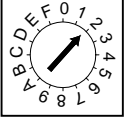
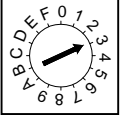
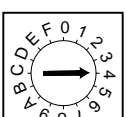
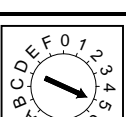
Wiring Type	Wiring Type & Functions	Select Switch
<b>C2</b> (factory preset)	<b>Set select switch on 0</b> Momentary contact to open and stop, constant pressure to close with 3 buttons station. Activation of safety devices will reverse the door during closing. Auxiliary devices function as an Open control and to reverse door during closing.	
<b>B2</b>	<b>Set the select switch on 1.</b> Momentary contact to Open/Close and Stop with 3 buttons station. Activation of safety devices will reverse the door during closing. Auxiliary devices function as Open/Close control and reverse the door during closing.	
<b>D1</b>	<b>Set the select switch on 2.</b> Constant pressure to Open and constant pressure to Close. Activation of safety devices will stop the door during closing.	
<b>E2</b>	<b>Set the select switch on 3</b> Momentary contact to open and constant pressure to Close. Release of Close button activates the door upwards. Activation of safety devices will reverse door motion to fully open position.	
<b>T</b>	<b>Set the select switch on 4.</b> Momentary contact to Open / Close and Stop. When Timer to Close is programmed, safety devices will reverse the door but will disable the Timer to Close. Timer to close will also be disabled if there is a power outage, a chain hoist is engaged or the stop is pressed before elapsed time. The timer resumes its normal operation, once the close cycle is completed.	
<b>TS</b>	<b>Set the select switch on 5.</b> Momentary contact to Open / Close and Stop. Timer to Close if programmed, safety devices reverse upon activation and will refresh Timer to Close. Timer to close also gets refreshed, if there is a power outage, a chain hoist is engaged or a stop button is pressed before elapsed time.	

**IMPORTANT NOTES:**

- STOP JUMPER**

- While testing the operator or adjusting the cams using the O/C/S buttons available on the Electronic Control Board, a jumper should be placed between #8 & #9. Once the tests or adjustments are completed the jumper should be removed before connecting the wall 3-push buttons station. Failure to remove the stop jumper, **the STOP BUTTON WILL NOT RESPOND.**
- A stop jumper should be installed between #8 & #9 when using a Key switch, a single button Radio control or a 2-buttons station (Open/Close). **IN THESE CONDITIONS NO STOP COMMAND IS AVAILABLE TO STOP THE DOOR DURING THE TRAVELING.**

**WARNING**

**MOTORIZED DOORS CAN CAUSE SEVERE INJURY OR DEATH. MANARAS STRONGLY RECOMMENDS THE USE OF ENTRAPMENT PROTECTION SYSTEMS, ESPECIALLY IN THE CASES OF MOMENTARY CONTACT TO CLOSE (B2 WIRING) AND TIMER TO CLOSE (T & TS).**

***HOW TO ORDER  
REPAIR PARTS***

**DEVANCO CANADA**

19192 HAY ROAD, UNIT Q  
SUMMERSTOWN, ON K0C 2E0

TOLL FREE: 855-931-3334

[www.devancocanada.com](http://www.devancocanada.com)

**WHEN ORDERING REPAIR PARTS  
PLEASE SUPPLY THE  
FOLLOWING INFORMATION:**

- ✓ PART NUMBER
- ✓ DESCRIPTION
- ✓ MODEL NUMBER