

MSP Low-Power Microcontrollers



MSP Microcontrollers

MSP microcontrollers (MCUs) from Texas Instruments (TI) are 16-bit and 32-bit mixed-signal processors designed for ultra-low power. Our MCUs offer the lowest power consumption and the perfect mix of integrated peripherals for thousands of applications. We also provide all of the hardware and software tools you need to get started today! Not only that, TI has a plethora of complementary components to meet your needs. The new MSP432™ microcontrollers are 32-bit microcontrollers offering higher performance with a standardized ARM® while still providing the low power benefits of MSP MCUs.

Learn more today at ti.com/msp.



Continuously innovating in ultra-low power

- Lowest power standby (350 nA with RTC)
- Lowest power ARM® Cortex®-M4F (167.4 ULPBench)
- Real-time power profiling to the peripheral level with Energy-Trace™ technology



Advancing peripherals to enable the industrial world

- The only MCU portfolio with non-volatile FRAM
- Touch the revolution with CapTivate™ technology
- Smart analog and digital peripherals including ADCs, USB and LCD operating independently of CPU



Connecting devices, making them simpler and more reliable

- Update your system wirelessly with zero buffering
- FRAM enables system state retention when power fails
- 20+ wired and wireless connectivity options supported by LaunchPad™ Development Kits, reference designs and software stacks

Multiple low-power modes

The MSP MCU clock system has the ability to enable and disable various clocks and oscillators which allow the microcontroller to enter various low-power modes (LPMs). The flexible clocking system optimizes overall current consumption by only enabling the required clocks when appropriate.

Instant wakeup

The ultra-fast 1- μ s digitally controlled oscillator (DCO) start-up allows MSP-based systems to remain in low-power modes for the longest possible interval – extending battery life. The DCO is fully user programmable in select microcontrollers.

Ultra-Low Power is in Our DNA

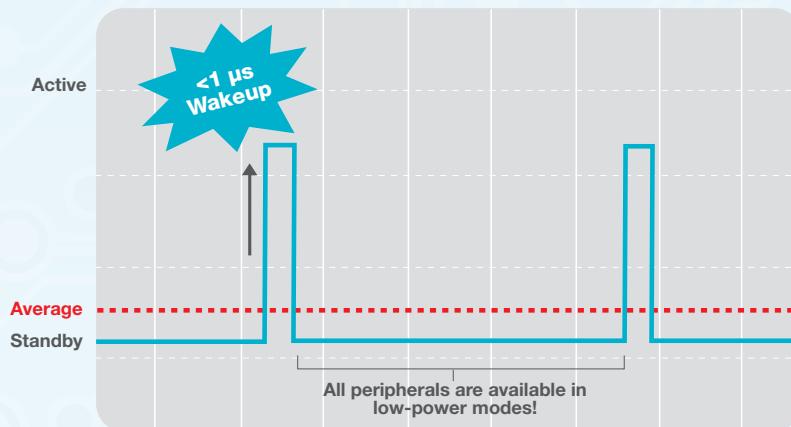

Real-time clock

The low-power real-time clock (RTC), available on all MSP MCUs, precisely keeps real time and enables wakeup at specified intervals. Some microcontrollers also include a switchable battery backup system that maintains operations when the primary power supply fails.

Direct memory access

The MSP MCUs also feature a direct memory access controller, enabling memory transfer with no CPU intervention. This means higher throughput of peripheral modules and lower system power.

Autonomous peripherals

Intelligent analog and digital peripherals can run autonomously in low-power modes. This allows our MCUs to operate as efficiently as possible.

Embedded FRAM enables lowest power

- Industry-leading active power consumption (<math><100 \mu A/MHz</math>)
- 250 \times less power than Flash writes
- Protected write completion

Learn more about the MSP MCU's nonvolatile embedded memory solution on page 15 or on the web at ti.com/fram

MSP = ultra-low power, but you can see for yourself!

Two options:

- Scores available online at: www.eembc.org/ulpbench/score.php
- Evaluate in your system with EEMBC EnergyMonitor

Focus on **application-level power**

- Accounts for system functions: **real-time clock**, **power modes** and **integrated hardware**
- Provides a true comparison of system current and energy efficiency across microcontrollers

ULPBENCH™

An EEMBC Benchmark

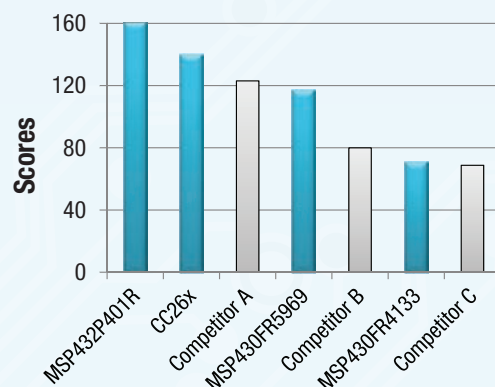

Ultra-Low-Power MCUs

MSP FRAM Microcontrollers – Reinventing the Low-Power MCU

Everyone says their MCUs are ultra-low power. So what makes us different? Ultra-low power is in our DNA! The MSP MCU is designed from the ground up specifically for ultra-low-power applications.



Ultra-Low Power

- Lowest power standby (350 nA with RTC)
- 100- μ A/MHz active and ultra-low-power nonvolatile writes
- System state retention when power fails



Reshaping the Connected World

- Dynamic allocation of application and data storage
- Capture more data and reduce manufacturing costs with 100 \times faster writes than Flash
- Update your system wirelessly with zero buffering



The Highest Reliability

- 10^{15} write cycle endurance and 10-year data retention at 85 $^{\circ}$ C
- Code and data protection with integrated security features
- Memory resistance to electromagnetic fields and radiation



MSP FRAM MCUs – Now featuring CapTIvate™ Touch technology

Enabling the industry's lowest power touch- and proximity-sensing solutions

ti.com/captivate

Performance

- Up to 60-mm glass / 25-mm plastic overlays
- Proximity sensing up to 30 cm with 3D gestures
- 0.025-cm slider resolution

Reliability

- Design systems to meet EMC standards
 - Up to 10V RMS conducted noise
 - Up to 4KV EFT and ESD
- Enhanced moisture-rejection capabilities

Flexibility

- Enables self and mutual capacitance in the same design
- Supports multi-touch capabilities
- Metal overlay for water/dirt proof, glove-friendly designs

Low power

- <4 μ A while sensing four buttons (CPU asleep)
- Hardware state machine to off-load CPU

Ease of use

- Configure and tune sensors in five minutes or less with CapTIvate Design Center GUI
- Quick time-to-market with design guides for:
 - Noise immunity
 - Moisture rejection
 - Proximity and gestures

Now available on
MSP430FR25xx/26xx





MSP432™ MCUs – MSP430™ power at ARM® Cortex®-M4 performance!

Introducing ARM-to-MSP low power.

MSP's expanded portfolio provides you the freedom to move between 16-bit and 32-bit, based on your application needs

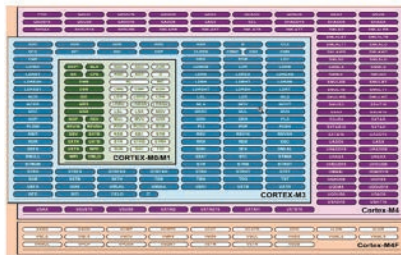

- ➔ Increase your product's performance and processing capability
- ➔ Standardize on an industry-standard core, ARM Cortex
- ➔ Take advantage of the benefits of MSP430 MCUs

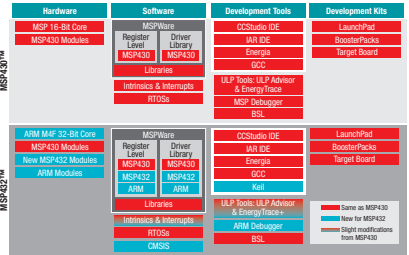
Increased performance and ARM core	MSP low-power benefits	Scalability between MSP430 16-bit and MSP432 32-bit families
<ul style="list-style-type: none"> ARM Cortex-M4 with DSP extensions and floating-point unit 48 MHz 1MSPS 14-bit ADC Simultaneous Flash read/write DriverLib in ROM 	<ul style="list-style-type: none"> <100µA/MHz active power <1µA deep sleep Selectable RAM retention EnergyTrace+™ technology ULP Advisor™ 	<ul style="list-style-type: none"> MSPWare APIs and code examples reuse existing code from MSP-compatible peripherals DriverLib APIs provided for new system modules 

What's new to the MSP family in MSP432?

- 48-MHz ARM Cortex-M4 with FPU
- DriverLib in ROM
- Wide voltage range
- Simultaneous Flash read/write
- 128-bit Flash buffer and pre-fetch
- Selectable RAM retention
- 64KB RAM
- 1MSPS ADC14
- 8-channel DMA
- Memory protection unit
- Integrated LDO and DC/DC
- NVIC with tail-chaining
- Tuneable DCO
- Peripheral and SRAM memory bit-band
- 20-mA high drive I/Os
- 32-bit timer
- JTAG security and advanced IP protection
- UART | I²C | SPI bootstrap loader
- EnergyTrace+

Did you know that our MCUs offer integration designed with your applications in mind? The 450+ MSP microcontrollers offer high-performance peripherals including USB, RF, LCD controllers and Sigma-Delta ADCs. This allows designers to find the appropriate MSP microcontroller for many low-power applications. This integration enables solutions with smaller physical footprints and reduced bill of materials costs.

Energy Harvesting Sensor Network

The MSP430FR59xx MCU with FRAM technology can control wireless sensor networks by harnessing the body heat of the user

- Differential ADC – connect directly to sensors and limit interference
- Industry-standard communication protocols
- AES module – protect your important data

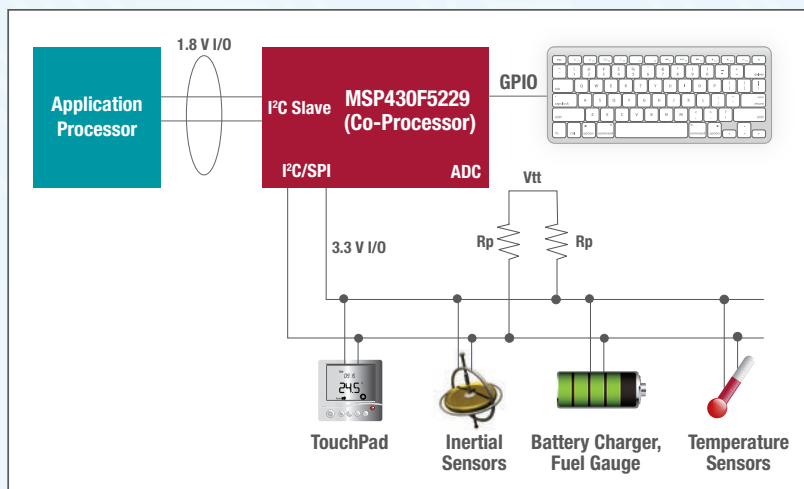
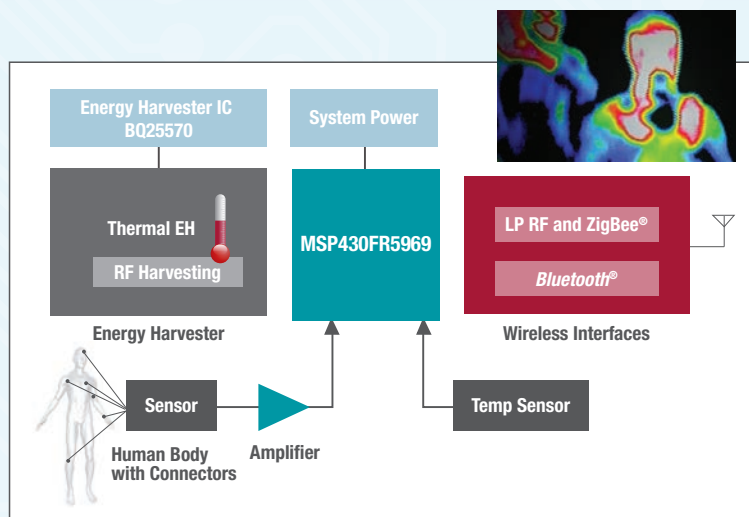

Co-Processor for Smart Devices

The MSP430F52xx MCU can operate as an always-on ultra-low power co-processor to an applications processor. The MSP can be used to offload functions such as sensor hub, keyboard control, battery and power management, capacitive touch, haptics, and proximity detection.

- Split rail 1.8 V/3.3 V – directly connect to applications processors and sensors alike

Energy Harvesting



Industrial



Consumer and Portable Electronics



The low-power, high-performance MSP432P401Rxx Cortex®-M4 microcontroller is ideal for industrial, building and home automation applications.

- For these applications, MSP432 has the following advantages:
 - Low power for long battery life
 - 32-bit, 48-MHz, floating-point performance for advanced algorithms
 - Real-time processing including remote firmware updates with dual-bank Flash
 - AES256 advanced security
 - Four secure zones for software security and flexibility for application developers
 - Higher Flash/RAM ratio (up to 64KB RAM) giving sufficient flexibility for software development
 - Multiple communication ports for advanced connectivity options
- Intelligent sensing
 - Parametrics: Thermal, current
 - Signature analysis (i.e., glass breakage detection)
 - Access control: Motion sensing, proximity, fingerprint scan

Key Benefits

- Advanced integration and sensing with MSP ULP and Cortex-M4F performance
- Low-power capabilities enable application customization and flexibility
- Extending ULP DNA into higher speed and performance allowing real-time processing of (multiple) sensor data, human interfaces and shorter active duty cycles
- High-performance analog integration enables higher speed and precision improving signature analysis for sensing applications such as motion and glass breakage detection

MSP432 Industrial Security Panel Solution

- Human interface
 - AUDIO: Voice detection and word recognition
 - DISPLAY: Enhanced UI with touch-enabled QVGA LCD

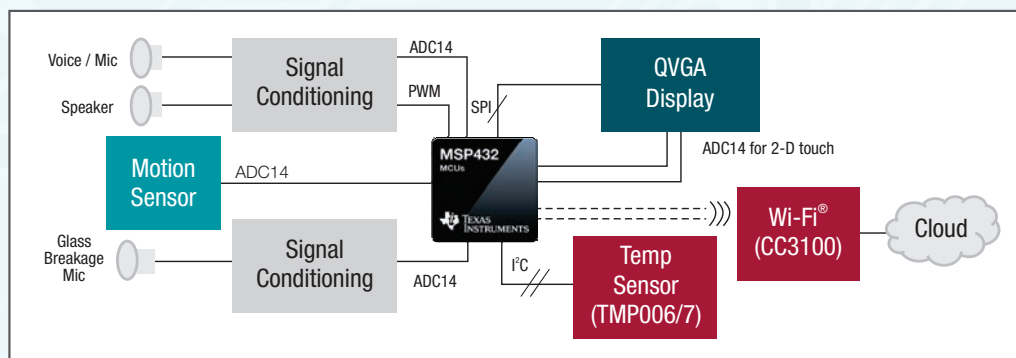

Medical



Security and Safety



Smart Grid



The MSP MCUs have some great analog integration which makes them extremely suitable for industrial applications that need increased precision and reduce system area and cost!

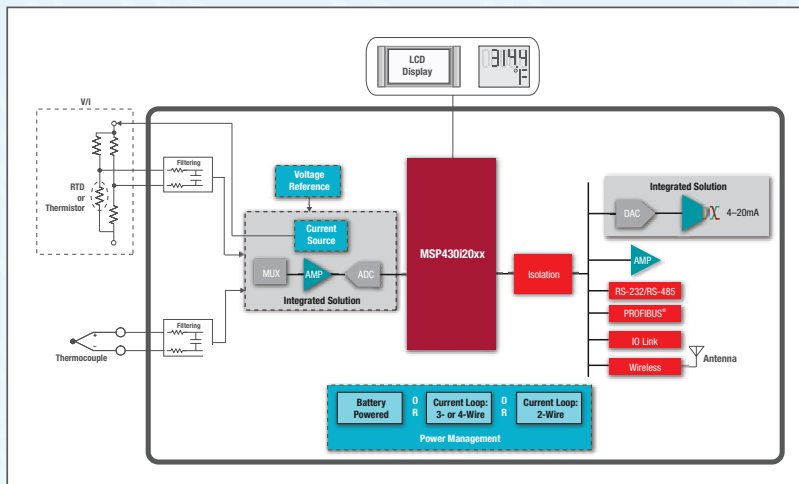

Factory Automation and Control

The MSP430i20xx MCU has integrated analog and features ideal for many industrial applications.

- 4 24-bit Sigma-Delta converters with differential PGA inputs for precise measurements
- Internal DCO that eliminates the need for external crystal
- Temperature range of -40°C to 105°C

Fire and Smoke Detection

Power consumption is critical in smoke detectors to extend the time they can run on a battery. The MSP-430FR2033 MCU is ideal for the application with integration that simplifies the design and reduces system cost.

An operational amplifier magnifies the IR receiver current as a trans-impedance amplifier, for sampling by the ADC in the MSP430™. Between sampling periods, the operational amplifier and IR circuitry are shut down, and the microcontroller is in a standby mode, consuming less current.

Advantages of using an MSP430FR2033 MCU in a smoke detector are:

- Ultra-low power consumption
 - Active mode: 126 $\mu\text{A}/\text{MHz}$
 - Standby
 - LPM3.5 With VLO: 0.4 μA
- Intelligent digital peripherals such as IR modulation logic

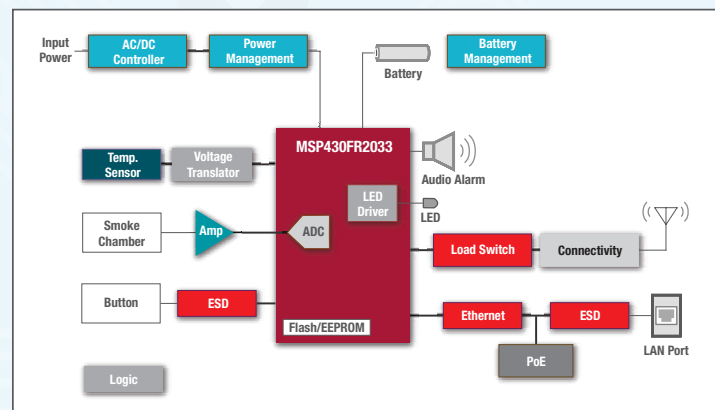

- High IO
 - Total 60 I/Os on 64-pin package
- Integrated FRAM
 - FRAM features extremely fast writes (100× the write speed of Flash) that help customer to reduce the programming time for mass production
- Shutdown (LPM4.5): 15 nA

Energy Harvesting



Industrial



Consumer and Portable Electronics

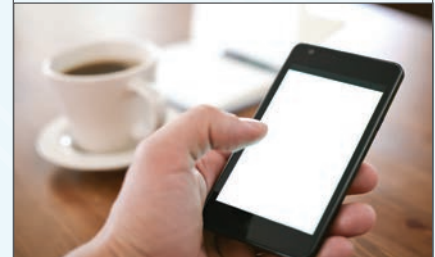

Our MSP peripherals have been designed to give you maximum functionality and provide system-level interrupts, resets and bus arbitration at the lowest power. Many peripherals function autonomously, thereby minimizing CPU time spent in active mode. This means that MSP MCUs offer more performance with less power. The potential applications are endless!

Smart Utility Meter

The MSP430F67xx MCU is perfect for precisely measuring electricity usage.

- Up to 7 24-bit Sigma-Delta ADCs – 2000:1 dynamic range
- Multiplier – accelerate calculations
- RTC module – reliable meter readings
- Auxiliary power supply – back up system support
- Meets or exceeds global regulatory requirements

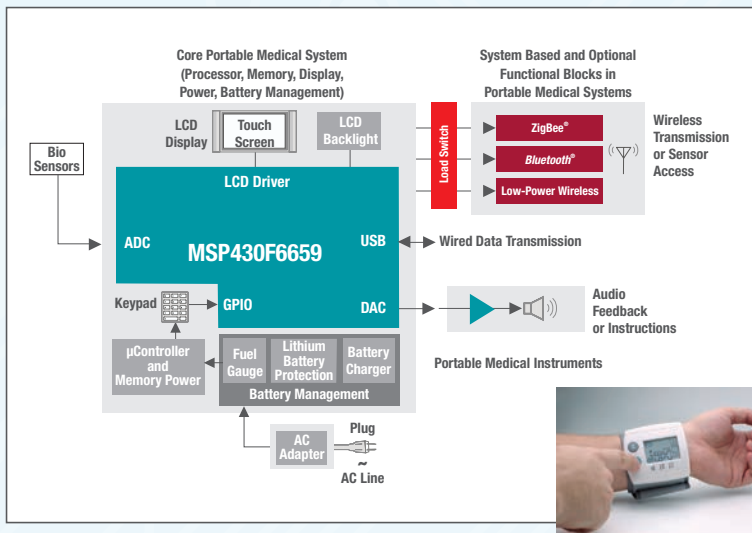
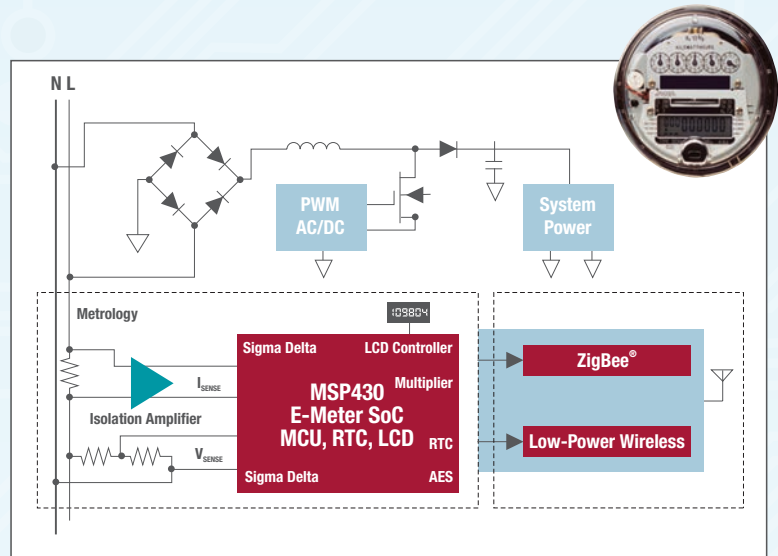

Portable Medical Devices

The MSP430F6659 MCU has integrated peripherals to meet the needs of many portable medical applications.

- 512 kB Flash – run virtually any wireless stack and allows for over-the-air updates
- USB and LCD controllers
- 6 serial ports
- 16-channel, 12-bit ADC – directly interface with analog sensors
- DAC – drive speakers; generate bias for sensors



Medical



Security and Safety



Smart Grid

The MSP software ecosystem can help you tap into the ultra-low power, performance and intelligent peripherals that are integrated in all MSP microcontrollers. Need help? Support is available for a variety of professional and open-sourced Integrated Development Environments and you can quicken time to market and maximize code efficiency using the complete suite of MSP tools.

Development environments



Code Composer Studio™ (CCStudio) IDE

Eclipse-based IDE for all TI embedded processors



IAR Embedded Workbench

Strong third-party IDE offering with project management tools and editor



MSP GCC

Free, open-source, GCC tool chain for MSP available standalone or integrated in CCStudio IDE



Energia

Open-source electronics prototyping platform for the TI LaunchPad. Learn more @ www.energia.nu

Design resources

MSP Peripheral Driver Library

Full API for configuring, enabling and using integrated MSP peripherals

USB Developers Package

Everything you need for adding USB to your application

CapTivate Design Center GUI

Configure touch sensors, tune in real time, auto generate software

Energy Library

- > Software suite for quick ramp-up in metering, smartgrid, energy monitoring applications and home/building automation
- > (IAR only today, CCStudio port coming soon!)

Software optimization

EnergyTrace™ technology

Optimize code for ultra-low-power (ULP):

- > Power profiling that goes beyond a multimeter, to display MCU state information
- > Dynamic range from nA to mA

ULP Advisor™ Software

- > Check entire project against a set of ULP rules
- > Highlights areas of improvement within code

Optimizer Assistant

- > Tool for optimizing code performance and size by leveraging compiler settings

Optimized IQmathLib library

- > Library to optimize your fixed-point math performance

EnergyTrace™ Technology

Features/ Nomenclature	EnergyTrace technology	EnergyTrace+™ technology	EnergyTrace++™ technology
Current monitoring	•	•	•
CPU state (PC)		•	•
Peripheral/ System state		•	•
Microcontrollers supported	All MSP430™ MCUs	MSP432P4x MCUs	MSP430FR59/69 MCUs
Development tool required	MSP-FET or eZ-FET (available on the MSP-EXP430FR4133)	XDS110-ET (available on the MSP-EXP432P401R)	MSP-FET or eZ-FET (available on the MSP-EXP430FR5969)

A complete ecosystem for real-time power debugging

- Graphical User Interface in **Code Composer Studio™ IDE** and **IAR** provides energy profiles of your application
- Measure current from nA to mA
- View low-power modes over time and
- Examine whether peripherals are on or off

It's all in MSPWare™ software

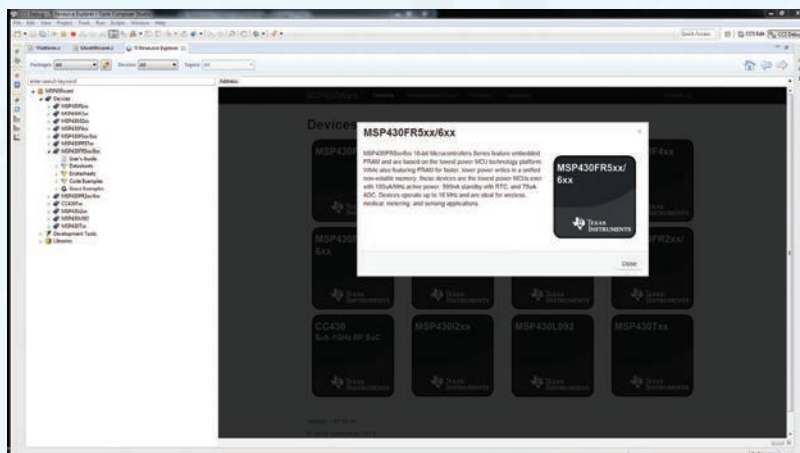



Supports all 16-bit MSP430 and 32-bit MSP432™ microcontrollers

MSPWare Features:

- Collection of MSP430 design resources
- Sleek and intuitive GUI for browsing content
- Automatic filtering of content using a unique 2-pane view
- Auto-updates through the web
- Features the MSP430 Driver Library
- Available as a Code Composer Studio™ IDE plugin or standalone executable

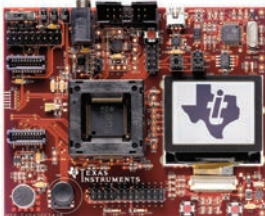
In addition to our software, we offer hardware development tools for beginners to experienced engineers. These tools range from low-cost development kits like the LaunchPad to highly-integrated, application-specific platforms and target boards for integrating MSP into your designs. So get started today!

Beginner Evaluation	Advanced Education	Development
<p>MSP LaunchPad</p> <ul style="list-style-type: none"> Rapid prototyping for just \$9.99: <ul style="list-style-type: none"> Modular hardware offers easy evaluation at a low cost <p>eZ430 tools</p> <ul style="list-style-type: none"> Complete development kits: <ul style="list-style-type: none"> Offering on-board emulation and small, unique form factors 	<p>Experimenter's boards</p> <ul style="list-style-type: none"> Designed for full system evaluation: <ul style="list-style-type: none"> Fully integrated: offers everything from push buttons to LCD 	<p>Target boards and emulation tools</p> <ul style="list-style-type: none"> Designed for integration into your system: Design Kits (MSP-FET430Uxyz) contain the following: <ul style="list-style-type: none"> Target board (MSP-TS430xyz) Breakout boards for all MSP microcontrollers Flash Emulation Tool (FET) (MSP-FET) to program and debug ANY MSP microcontroller Now with EnergyTrace™ Technology 

LaunchPads with EnergyTrace

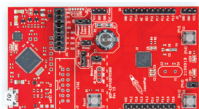

\$15.99
MSP-EXP430FR5969

Target MCU: MSP430FR5969

BoosterPack Pinout: 20-pin

Specs:

- 16 MHz 16-bit MSP CPUx core
- 64 KB FRAM / 2 KB SRAM
- 12-bit differential ADC, comparator, timers, I²C, UART, SPI, 40 capacitive touch I/Os
- 0.1 F super capacitor for board power



\$12.99
MSP-EXP432P401R

Target MCU: MSP432P401R

BoosterPack Pinout: 20- and 40-pin DIP socket / BoosterPack header

Specs:

- 48MHz 32-bit ARM® Cortex®-M4F core
- 256-KB Flash / 64-KB RAM
- 14-bit differential ADC, comparator, 16-bit and 32-bit timers, I²C, UART, SPI, 84 capacitive touch I/O, 1.62-V I/O

Lift-Off with TI LaunchPad: A Microcontroller Evaluation Kit

LaunchPad is a low-cost, easy-to-use microcontroller development board from Texas Instruments. Starting at \$9.99 USD, LaunchPad boards offer a snapshot into the world of TI's broad MCU portfolio. Blink LEDs, spin motors, make robots and much more with easy-to-use LaunchPad kits and a variety of software options to suit your maker or developer needs. See all LaunchPads at ti.com/launchpad

BoosterPacks = Plug-in modules for LaunchPad that feature unique TI products or enable entire applications. BoosterPacks are available from TI, third parties and online communities!

See all BoosterPacks at ti.com/boosterpacks

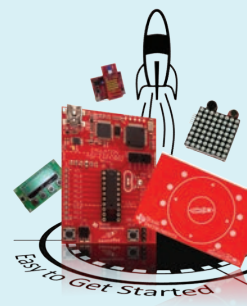

MSP MCUs and TI can scale with your applications. The MSP portfolio consists of over 400 microcontrollers ranging from the MSP Value Line to our revolutionary, highly integrated microcontrollers with embedded FRAM memory.

Series	Ultra-Low Power					Low Power + Performance		Wireless MCUs	
	L09x Low Voltage	G2x/ i2x	F1x	F2x/ F4x	FRxx FRAM	F5x/6x	MSP432P4x	RF430CL (RF430FRL)	CC430 (RF430F5)
Part Number									
Max speed (MHz)	4	16	16	16	24	25	48	4	20
NVM (max KB)	0	56	120	120	128	512	256	Fixed Function (2)	32
SRAM (max KB)	2	4	10	8	2	67	64	4	4
GPIO	11	4–32	10–48	14–80	17–40	29–90	84	Up to 8	30–44 (27)
Comparator	●	●	●	●	●	●	●		●
Timer	●	●	●	●	●	●	●	●	●
ADC	●	●	●	●	●	●	●	●	●
DAC	●		●	●		●			
UART		●	●	●	●	●	●		●
I ² C		●	●	●	●	●	●	●	●
SPI		●	●	●	●	●	●	●	●
Capacitive touch		●			†		●		
Multiplier		●	●	●	●	●	●		●
DMA			●	●	●	●	●		●
Op amps			●	●		●			
LCD				●	●	●			●
RTC				●	●	●	●		●
PMM					●	●	●	●	●
1.8-V I/O						●	●		
CRC					●	●	●	●	●
High-resolution timer						●			
USB						●			
Hardware encryption (AES)					●	●	●		●
FRAM					●			●	
RF								13.56 MHz: ISO 15693 / 14443B / 18000-3	Sub-1GHz (adds Lo Pwr / 134.2 kHz, 3D front end)

† Enabled with new CapTivate touch technology

Check out the other great products from TI and unlock the full potential of your applications:

Collect data

Sensors – The TMP006 sensor measures the temperature of an object without the need to make contact with the object.

ti.com/sensorproducts

Analog Front Ends – Devices like the LMP91000 bridge the gap between sensors and the MSP MCU which can significantly simplify a system.

ti.com/analog



Power the system

Power – TI offers regulators, fuel gauges, battery monitors, and load switches. The TPS709 linear drop out regulator can regulate voltage to the MCU, while devices such as the TPS3839 reset IC can accurately track battery activity to ensure the MSP MCU remains in a safe state.

ti.com/power

Grow with MSP

Transmit and receive data

Wireless – TI offers radios ranging from sub-1 GHz to Wi-Fi®. The CC1101 is a highly integrated RF transceiver for low-power wireless applications in the 315-/433-/868-/915-MHz ISM bands. Devices like the high-performance TRF7970 13.56-MHz transceiver enable low-power NFC solutions. The CC2564 paired with an MSP430 MCU offer a dual-mode solution for *Bluetooth*® connectivity. The CC3200 is a Wi-Fi solution that simplifies Internet connectivity. ti.com/wireless



Technology	Hardware	Software	Additional information
NFC	TRF7970A	NFCLink	ti.com/nfclink
NFC	RF430CL330H	Application code	ti.com/RF430CL330H-tools
NFC	RF430FRL15xH	Application code	ti.com/RF430FRL15xH-tools
Sub-1 GHz (w/ LF FE)	RF430F5978	Application code	ti.com/RF430F5978-tools
Sub-1 GHz	CC1101	SimpliciTI™	ti.com/simpliciti
<i>Bluetooth</i> ®/BLE	CC256x	TI <i>Bluetooth</i> Stack	ti.com/tool/tiblueetoothstack-sdk
Wi-Fi®	CC3000	SimpleLink	ti.com/simplelink
GPS	CC4000	SimpleLink	ti.com/simplelink

FRAM: The Future of Embedded Memory

FRAM, or Ferroelectric Random Access Memory, is a non-volatile memory that combines the speed, ultra-low-power, endurance and flexibility of SRAM with the reliability and stability of Flash to combine program and data into one unified memory space for the lowest power and easiest-to-use microcontroller architecture. ti.com/fram

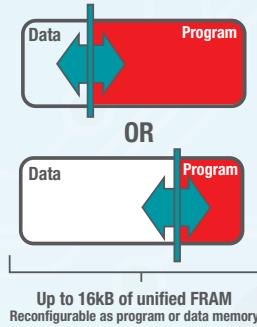

What does this mean for you?

- Lower power
- Faster data throughput
- Virtually unlimited write endurance
- Configurable as program or data memory

Specifications	FRAM	SRAM	EEPROM	Flash
Non-volatile – Retains data without power	●		●	●
High write speeds	●	●		
Ultra-low active power	●	●		
High write endurance	●	●		
Soft errors below measurable limits	●			
Dynamic – Bit-wise programmable	●	●		
Unified memory	●			
Flexible code and data partitioning	●			

MSP FRAM Series – Up to 24 MHz

Part Number	Frequency (MHz)	Non-volatile Memory (KB)	SRAM (KB)	GPIO	I ² C	SPI	UART	DMA	ADC	Comparator (Channels)	Timers 16-Bit	Timers 32-Bit	Multipliers	AES	Additional Features	Operating Temperature Range (°C)	Package Group	1 ku Price (U.S. \$) ¹
FR2x																		
MSP430FR2032	16	8.5	1	60	1	2	1	0	ADC10-10ch	0	2	0	N/A	N/A	RTC, BOR, Temp sensor	-40 to 85	TSSOP, LQFP	0.99
MSP430FR2033	16	15.5	2	60	1	2	1	0	ADC10-10ch	0	2	0	N/A	N/A	RTC, BOR, Temp sensor	-40 to 85	LQFP, TSSOP	1.15
MSP430FR2110*	16	2	1	12	0	1	1	0	ADC10-8ch	4	1	0	N/A	N/A	RTC, BOR, Temp sensor	-40 to 85	TSSOP, QFN	0.55
MSP430FR2111*	16	3.75	1	12	0	1	1	0	ADC10-8ch	4	1	0	N/A	N/A	RTC, BOR, Temp sensor	-40 to 85	TSSOP, QFN	0.60
MSP430FR2310	16	2	1	16	1	2	1	0	ADC10-8ch	2	2	0	N/A	N/A	OpAmp, TIA, RTC, BOR	-40 to 85	TSSOP, QFN	0.65
MSP430FR2311	16	3.75	1	16	1	2	1	0	ADC10-8ch	2	2	0	N/A	N/A	OpAmp, TIA, RTC, BOR	-40 to 85	TSSOP, QFN	0.70
MSP430FR2532	16	8.5	1	15	1	1	2	0	ADC10-10ch	0	4	0	1	0	CapTivate I/O	-40 to 85	RGE	0.90
MSP430FR2632	16	8.5	2	15	1	1	2	0	ADC10-10ch	0	4	0	1	0	CapTivate I/O	-40 to 85	RGE	1.50
MSP430FR2533	16	15.5	2	19	1	2	2	0	ADC10-10ch	0	4	0	1	0	CapTivate I/O	-40 to 85	RHB, DA	2.05
MSP430FR2633	16	15.5	4	19	1	2	2	0	ADC10-10ch	0	4	0	1	0	CapTivate I/O	-40 to 85	RHB, DA	2.35
MSP430FR2433	16	15.5	4	15	1	1	2	0	ADC10-10ch	0	4	0	1	0	N/A	-40 to 85	RGE	1.15
FR4x																		
MSP430FR4131	16	4.5	0.5	60	1	2	1	0	ADC10-10ch	0	2	0	N/A		LCD, RTC, BOR, Temp sensor	-40 to 85	LQFP, TSSOP	1.25
MSP430FR4132	16	8.5	1	60	1	2	1	0	ADC10-10ch	0	2	0	N/A		LCD, RTC, BOR, Temp sensor	-40 to 85	LQFP, TSSOP	1.40
MSP430FR4133	16	15.5	2	60	1	2	1	0	ADC10-10ch	0	2	0	N/A	N/A	LCD, RTC, BOR, Temp sensor	-40 to 85	LQFP, TSSOP	1.55
FR572x																		
MSP430FR5720	8	4	1	21	1	2	1	3	ADC10-8ch	12	3	0	32×32	N/A	RTC, BOR, IrDA, Temp sensor	-40 to 85	TSSOP, VQFN	1.22
MSP430FR5721	8	4	1	32	1	3	2	3	ADC10-12ch	16	5	0	32×32	N/A	RTC, BOR, IrDA, Temp sensor	-40 to 85	TSSOP, VQFN	1.25
MSP430FR5722	8	8	1	21	1	2	1	3	Slope	12	3	0	32×32	N/A	RTC, BOR, IrDA	-40 to 85	TSSOP, VQFN	1.24
MSP430FR5723	8	8	1	32	1	3	2	3	Slope	16	5	0	32×32	N/A	RTC, BOR, IrDA	-40 to 85	TSSOP, VQFN	1.27
MSP430FR5724	8	8	1	21	1	2	1	3	ADC10-8ch	12	3	0	32×32	N/A	RTC, BOR, IrDA, Temp sensor	-40 to 85	TSSOP, VQFN	1.27
MSP430FR5725	8	8	1	32	1	3	2	3	ADC10-12ch	16	5	0	32×32	N/A	RTC, BOR, IrDA, Temp sensor	-40 to 85	TSSOP, VQFN	1.30
MSP430FR5726	8	16	1	21	1	2	1	3	Slope	12	3	0	32×32	N/A	RTC, BOR, IrDA	-40 to 85	TSSOP, VQFN	1.29
MSP430FR5727	8	16	1	32	1	3	2	3	Slope	16	5	0	32×32	N/A	RTC, BOR, IrDA	-40 to 85	TSSOP, VQFN	1.32
MSP430FR5728	8	16	1	21	1	2	1	3	ADC10-8ch	12	3	0	32×32	N/A	RTC, BOR, IrDA, Temp sensor	-40 to 85	TSSOP, VQFN	1.32
MSP430FR5729	8	16	1	32	1	3	2	3	ADC10-12ch	16	5	0	32×32	N/A	RTC, BOR, IrDA, Temp sensor	-40 to 85	TSSOP, VQFN	1.35
FR573x																		
MSP430FR5730	24	4	1	21	1	2	1	3	ADC10-8ch	12	3	0	32×32	N/A	RTC, BOR, IrDA, Temp sensor	-40 to 85	TSSOP, VQFN	1.42
MSP430FR5731	24	4	1	32	1	3	2	3	ADC10-12ch	16	5	0	32×32	N/A	RTC, BOR, IrDA, Temp sensor	-40 to 85	TSSOP, VQFN	1.45

¹Prices are quoted in U.S. dollars and represent year 2016 suggested resale price.

²Available 3Q 2016.

MSP FRAM Series – Up to 24 MHz (continued)

Part Number	Frequency (MHz)	Non-volatile Memory (KB)	SRAM (kB)	GPIO	I ² C	SPI	UART	DMA	ADC	Comparator (Channels)	Timers 16-Bit	Timers 32-Bit	Multipliers	AES	Additional Features	Operating Temperature Range (°C)	Package Group	1 ku Price (U.S. \$) ¹
FR573x (continued)																		
MSP430FR5732	24	8	1	21	1	2	1	3	Slope	12	3	0	32×32	N/A	RTC, BOR, IrDA	-40 to 85	TSSOP, VQFN	1.44
MSP430FR5733	24	8	1	32	1	3	2	3	Slope	16	5	0	32×32	N/A	RTC, BOR, IrDA	-40 to 85	TSSOP, VQFN	1.47
MSP430FR5734	24	8	1	21	1	2	1	3	ADC10-8ch	12	3	0	32×32	N/A	RTC, BOR, IrDA, Temp sensor	-40 to 85	TSSOP, VQFN	1.47
MSP430FR5735	24	8	1	32	1	3	2	3	ADC10-12ch	16	5	0	32×32	N/A	RTC, BOR, IrDA, Temp sensor	-40 to 85	TSSOP, VQFN	1.50
MSP430FR5736	24	16	1	21	1	2	1	3	Slope	12	3	0	32×32	N/A	RTC, BOR, IrDA	-40 to 85	TSSOP, VQFN	1.49
MSP430FR5737	24	16	1	32	1	3	2	3	Slope	16	5	0	32×32	N/A	RTC, BOR, IrDA	-40 to 85	TSSOP, VQFN	1.52
MSP430FR5738	24	16	1	21	1	2	1	3	ADC10-8ch	12	3	0	32×32	N/A	RTC, BOR, IrDA, Temp sensor	-40 to 85	DSBGA, TSSOP, VQFN	1.52
MSP430FR5739	24	16	1	32	1	3	2	3	ADC10-12ch	16	5	0	32×32	N/A	RTC, BOR, IrDA, Temp sensor	-40 to 85	TSSOP, VQFN	1.55
FR58xx																		
MSP430FR5847	16	32	1	33	1	3	2	3	ADC12-14ch	16	5	0	32×32	N/A	RTC, BOR, IrDA, Temp sensor	-40 to 85	TSSOP, VQFN	2.05
MSP430FR58471	16	32	1	33	1	3	2	3	ADC12-14ch	16	5	0	32×32	N/A	RTC, BOR, IrDA, Temp sensor	-40 to 85	VQFN	2.05
MSP430FR5848	16	48	2	33	1	3	2	3	ADC12-14ch	16	5	0	32×32	N/A	RTC, BOR, IrDA, Temp sensor	-40 to 85	TSSOP, VQFN	2.15
MSP430FR5849	16	64	2	33	1	3	2	3	ADC12-14ch	16	5	0	32×32	N/A	RTC, BOR, IrDA, Temp sensor	-40 to 85	TSSOP, VQFN	2.20
MSP430FR5857	16	32	1	33	1	3	2	3	ADC12-14ch	16	5	0	32×32	N/A	RTC, BOR, IrDA, Temp sensor	-40 to 85	TSSOP, VQFN	2.05
MSP430FR5858	16	48	2	33	1	3	2	3	ADC12-14ch	16	5	0	32×32	N/A	RTC, BOR, IrDA, Temp sensor	-40 to 85	TSSOP, VQFN	2.15
MSP430FR5859	16	64	2	33	1	3	2	3	ADC12-14ch	16	5	0	32×32	N/A	RTC, BOR, IrDA, Temp sensor	-40 to 85	TSSOP, VQFN	2.20
MSP430FR5867	16	32	1	40	1	3	2	3	ADC12-16ch	16	5	0	32×32	N/A	RTC, BOR, IrDA, Temp sensor	-40 to 85	VQFN	2.20
MSP430FR58671	16	32	1	40	1	3	2	3	ADC12-16ch	16	5	0	32×32	N/A	RTC, BOR, IrDA, Temp sensor	-40 to 85	VQFN	2.15
MSP430FR5868	16	48	2	40	1	3	2	3	ADC12-16ch	16	5	0	32×32	N/A	RTC, BOR, IrDA, Temp sensor	-40 to 85	VQFN	2.30
MSP430FR5869	16	64	2	40	1	3	2	3	ADC12-16ch	16	5	0	32×32	N/A	RTC, BOR, IrDA, Temp sensor	-40 to 85	VQFN	2.30
MSP430FR5870	16	32	2	51	2	4	2	3	ADC12-8ch	8	5	0	32×32	N/A	Real-time clock, Watchdog, Temp sensor, Brown out reset, IrDA	-40 to 85	64QFN, 64LQFP	2.15
MSP430FR5872	16	64	2	51	2	4	2	3	ADC12-8ch	8	5	0	32×32	N/A	Real-time clock, Watchdog, Temp sensor, Brown out reset, IrDA	-40 to 85	64QFN, 64LQFP	2.30
MSP430FR58721	16	64	2	51	2	4	2	3	ADC12-8ch	8	5	0	32×32	N/A	Real-time clock, Watchdog, Temp sensor, Brown out reset, IrDA	-40 to 85	64QFN, 64LQFP	2.30
MSP430FR5887	16	64	2	48	2	4	2	3	ADC12-12ch	12	5	0	32×32	N/A	RTC, Scan interface, BOR, IrDA, Temp sensor	-40 to 85	LQFP, VQFN	4.19
MSP430FR5888	16	96	2	48	2	4	2	3	ADC12-12ch	12	5	0	32×32	N/A	RTC, Scan interface, BOR, IrDA, Temp sensor	-40 to 85	LQFP, VQFN	4.27
MSP430FR5889	16	128	2	48	2	4	2	3	ADC12-12ch	12	5	0	32×32	N/A	RTC, Scan interface, BOR, IrDA, Temp sensor	-40 to 85	LQFP, VQFN	4.35
MSP430FR58891	16	128	2	48	2	4	2	3	ADC12-12ch	12	5	0	32×32	N/A	RTC, Scan interface, BOR, IrDA, Temp sensor	-40 to 85	LQFP, VQFN	4.35

¹ Prices are quoted in U.S. dollars and represent year 2016 suggested resale price.

MSP FRAM Series – Up to 24 MHz (continued)

Part Number	Frequency (MHz)	Non-volatile Memory (KB)	SRAM (KB)	GPIO	I ² C	SPI	UART	DMA	ADC	Comparator (Channels)	Timers 16-Bit	Timers 32-Bit	Multipliers	AES	Additional Features	Operating Temperature Range (°C)	Package Group	1 ku Price (U.S. \$) ¹
FR59xx																		
MSP430FR5922	16	64	2	51	2	4	2	3	ADC12-8ch	8	5	0	32×32	AES256	Real-time clock, Watchdog, Temp sensor, Brown out reset, IrDA	-40 to 85	56TSSOP, 64QFN, 64LQFP	
MSP430FR59221	16	64	2	51	2	4	2	3	ADC12-8ch	8	5	0	32×32	AES256	Real-time clock, Watchdog, Temp sensor, Brown out reset, IrDA	-40 to 85	56TSSOP, 64QFN, 64LQFP	
MSP430FR5947	16	32	1	33	1	3	2	3	ADC12-14ch	16	5	0	32×32	AES256	RTC, BOR, IrDA, Temp sensor	-40 to 85	TSSOP, VQFN	2.10
MSP430FR59471	16	32	1	33	1	3	2	3	ADC12-14ch	16	5	0	32×32	AES256	RTC, BOR, IrDA, Temp sensor	-40 to 85	VQFN	2.10
MSP430FR5948	16	48	2	33	1	3	2	3	ADC12-14ch	16	5	0	32×32	AES256	RTC, BOR, IrDA, Temp sensor	-40 to 85	TSSOP, VQFN	2.20
MSP430FR5949	16	64	2	33	1	3	2	3	ADC12-14ch	16	5	0	32×32	AES256	RTC, BOR, IrDA, Temp sensor	-40 to 85	TSSOP, VQFN	2.25
MSP430FR5957	16	32	1	33	1	3	2	3	ADC12-14ch	16	5	0	32×32	AES256	RTC, BOR, IrDA, Temp sensor	-40 to 85	TSSOP, VQFN	2.10
MSP430FR5958	16	48	2	33	1	3	2	3	ADC12-14ch	16	5	0	32×32	AES256	RTC, BOR, IrDA, Temp sensor	-40 to 85	TSSOP, VQFN	2.20
MSP430FR5959	16	64	2	33	1	3	2	3	ADC12-14ch	16	5	0	32×32	AES256	RTC, BOR, IrDA, Temp sensor	-40 to 85	TSSOP, VQFN	2.25
MSP430FR5967	16	32	1	40	1	3	2	3	ADC12-16ch	16	5	0	32×32	AES256	RTC, BOR, IrDA, Temp sensor	-40 to 85	VQFN	2.20
MSP430FR5968	16	48	2	40	1	3	2	3	ADC12-16ch	16	5	0	32×32	AES256	RTC, BOR, IrDA, Temp sensor	-40 to 85	VQFN	2.25
MSP430FR5969	16	64	2	40	1	3	2	3	ADC12-16ch	16	5	0	32×32	AES256	RTC, BOR, IrDA, Temp sensor	-40 to 85	VQFN	2.35
MSP430FR59691	16	64	2	40	1	3	2	3	ADC12-16ch	16	5	0	32×32	AES256	RTC, BOR, IrDA, Temp sensor	-40 to 85	VQFN	2.35
MSP430FR5970	16	32	2	51	2	4	2	3	ADC12-8ch	8	5	0	32×32	AES256	Real-time clock, Watchdog, Temp sensor, Brown out reset, IrDA	-40 to 85	64QFN, 64LQFP	2.20
MSP430FR5972	16	64	2	51	2	4	2	3	ADC12-8ch	8	5	0	32×32	AES256	Real-time clock, Watchdog, Temp sensor, Brown out reset, IrDA	-40 to 85	64QFN, 64LQFP	2.35
MSP430FR59721	16	64	2	51	2	4	2	3	ADC12-8ch	8	5	0	32×32	AES256	Real-time clock, Watchdog, Temp sensor, Brown out reset, IrDA	-40 to 85	64QFN, 64LQFP	2.35
MSP430FR5986	16	48	2	48	2	4	2	3	ADC12-12ch	12	5	0	32×32	AES256	RTC, Scan interface, BOR, IrDA, Temp sensor	-40 to 85	LQFP	4.16
MSP430FR5987	16	64	2	48	2	4	2	3	ADC12-12ch	12	5	0	32×32	AES256	RTC, Scan interface, BOR, IrDA, Temp sensor	-40 to 85	LQFP, VQFN	4.24
MSP430FR5988	16	96	2	48	2	4	2	3	ADC12-12ch	12	5	0	32×32	AES256	RTC, Scan interface, BOR, IrDA, Temp sensor	-40 to 85	LQFP, VQFN	4.32
MSP430FR5989	16	128	2	48	2	4	2	3	ADC12-12ch	12	5	0	32×32	AES256	RTC, Scan interface, BOR, IrDA, Temp sensor	-40 to 85	LQFP, VQFN	4.40
MSP430FR59891	16	128	2	48	2	4	2	3	ADC12-12ch	12	5	0	32×32	AES256	RTC, Scan interface, BOR, IrDA, Temp sensor	-40 to 85	LQFP, VQFN	4.40

¹Prices are quoted in U.S. dollars and represent year 2016 suggested resale price.

MSP FRAM Series – Up to 24 MHz (continued)

Part Number	Frequency (MHz)	Non-volatile Memory (KB)	SRAM (KB)	GPIO	I ² C	SPI	UART	DMA	ADC	Comparator (Channels)	Timers 16-Bit	Timers 32-Bit	Multipliers	AES	Additional Features	Operating Temperature Range (°C)	Package Group	1 ku Price (U.S. \$) ¹
FR68xx																		
MSP430FR6820	16	32	2	52	2	4	2	3	ADC12-8ch	8	5	0	32×32	N/A	LCD, Real-time clock, Watchdog, Temp sensor, Brown out reset, IrDA	-40 to 85	56TSSOP, 64QFN, 64LQFP	2.35
MSP430FR6822	16	64	2	52	2	4	2	3	ADC12-8ch	8	5	0	32×32	N/A	LCD, Real-time clock, Watchdog, Temp sensor, Brown out reset, IrDA	-40 to 85	56TSSOP, 64QFN, 64LQFP	2.50
MSP430FR68221	16	64	2	52	2	4	2	3	ADC12-8ch	8	5	0	32×32	N/A	LCD, Real-time clock, Watchdog, Temp sensor, Brown out reset, IrDA	-40 to 85	56TSSOP, 64QFN, 64LQFP	2.50
MSP430FR6870	16	32	2	51	2	4	2	3	ADC12-8ch	8	5	0	32×32	N/A	LCD, Real-time clock, Watchdog, Temp sensor, Brown out reset, IrDA	-40 to 85	64QFN, 64LQFP	2.35
MSP430FR6872	16	64	2	51	2	4	2	3	ADC12-8ch	8	5	0	32×32	N/A	LCD, Real-time clock, Watchdog, Temp sensor, Brown out reset, IrDA	-40 to 85	64QFN, 64LQFP	2.50
MSP430FR68721	16	64	2	51	2	4	2	3	ADC12-8ch	8	5	0	32×32	N/A	LCD, Real-time clock, Watchdog, Temp sensor, Brown out reset, IrDA	-40 to 85	64QFN, 64LQFP	2.50
MSP430FR6877	16	64	2	83	2	4	2	3	ADC12-16ch	16	5	0	32×32	N/A	LCD, RTC, BOR, IrDA, Temp sensor	-40 to 85	LQFP	3.79
MSP430FR6879	16	128	2	83	2	4	2	3	ADC12-16ch	16	5	0	32×32	N/A	LCD, RTC, BOR, IrDA, Temp sensor	-40 to 85	LQFP	3.95
MSP430FR68791	16	128	2	83	2	4	2	3	ADC12-16ch	16	5	0	32×32	N/A	LCD, RTC, BOR, IrDA, Temp sensor	-40 to 85	LQFP	3.95
MSP430FR6887	16	64	2	83	2	4	2	3	ADC12-16ch	16	5	0	32×32	N/A	LCD, RTC, Scan interface, BOR, IrDA, Temp sensor	-40 to 85	LQFP	4.29
MSP430FR6888	16	96	2	83	2	4	2	3	ADC12-16ch	16	5	0	32×32	N/A	LCD, RTC, Scan interface, BOR, IrDA, Temp sensor	-40 to 85	LQFP	4.37
MSP430FR6889	16	128	2	83	2	4	2	3	ADC12-16ch	16	5	0	32×32	N/A	LCD, RTC, Scan interface, BOR, IrDA, Temp sensor	-40 to 85	LQFP	4.45
FR69xx																		
MSP430FR6920	16	32	2	52	2	4	2	3	ADC12-8ch	8	5	0	32×32	AES256	LCD, Real-time clock, Watchdog, Temp sensor, Brown out reset, IrDA	-40 to 85	56TSSOP, 64QFN, 64LQFP	2.40
MSP430FR6922	16	64	2	52	2	4	2	3	ADC12-8ch	8	5	0	32×32	AES256	LCD, Real-time clock, Watchdog, Temp sensor, Brown out reset, IrDA	-40 to 85	56TSSOP, 64QFN, 64LQFP	2.55
MSP430FR69221	16	64	2	52	2	4	2	3	ADC12-8ch	8	5	0	32×32	AES256	LCD, Real-time clock, Watchdog, Temp sensor, Brown out reset, IrDA	-40 to 85	56TSSOP, 64QFN, 64LQFP	2.55
MSP430FR6927	16	64	2	52	2	4	2	3	ADC12-16ch	12	5	0	32×32	AES256	LCD, RTC, BOR, IrDA, Temp sensor	-40 to 85	LQFP, VQFN	3.79
MSP430FR69271	16	64	2	52	2	4	2	3	ADC12-16ch	12	5	0	32×32	AES256	LCD, RTC, BOR, IrDA, Temp sensor	-40 to 85	LQFP, VQFN	3.79
MSP430FR6928	16	96	2	52	2	4	2	3	ADC12-16ch	12	5	0	32×32	AES256	LCD, RTC, BOR, IrDA, Temp sensor	-40 to 85	LQFP	3.87

¹Prices are quoted in U.S. dollars and represent year 2016 suggested resale price.

MSP FRAM Series – Up to 24 MHz (continued)

Part Number	Frequency (MHz)	Non-volatile Memory (KB)	SRAM (KB)	GPIO	I ² C	SPI	UART	DMA	ADC	Comparator (Channels)	Timers 16-Bit	Timers 32-Bit	Multipliers	AES	Additional Features	Operating Temperature Range (°C)	Package Group	1 ku Price (U.S. \$) ¹
FR69xx (continued)																		
MSP430FR6970	16	32	2	51	2	4	2	3	ADC12-8ch	8	5	0	32×32	AES256	LCD, Real-time clock, Watchdog, Temp sensor, Brown out reset, IrDA	-40 to 85	64QFN, 64LQFP	2.40
MSP430FR6972	16	64	2	51	2	4	2	3	ADC12-8ch	8	5	0	32×32	AES256	LCD, Real-time clock, Watchdog, Temp sensor, Brown out reset, IrDA	-40 to 85	64QFN, 64LQFP	2.55
MSP430FR69721	16	64	2	51	2	4	2	3	ADC12-8ch	8	5	0	32×32	AES256	LCD, Real-time clock, Watchdog, Temp sensor, Brown out reset, IrDA	-40 to 85	64QFN, 64LQFP	2.55
MSP430FR6972	16	64	2	51	2	4	2	3	ADC12-8ch	8	5	0	32×32	AES256	LCD, RTC, BOR, IrDA, Temp sensor	-40 to 85	LQFP	2.55
MSP430FR6977	16	64	2	83	2	4	2	3	ADC12-16ch	16	5	0	32×32	AES256	LCD, RTC, BOR, IrDA, Temp sensor	-40 to 85	LQFP	3.84
MSP430FR6979	16	128	2	83	2	4	2	3	ADC12-16ch	16	5	0	32×32	AES256	LCD, RTC, BOR, IrDA, Temp sensor	-40 to 85	LQFP	4.00
MSP430FR69791	16	128	2	83	2	4	2	3	ADC12-16ch	16	5	0	32×32	AES256	LCD, RTC, BOR, IrDA, Temp sensor	-40 to 85	LQFP	4.00
MSP430FR6987	16	64	2	83	2	4	2	3	ADC12-16ch	16	5	0	32×32	AES256	LCD, RTC, Scan interface, BOR, IrDA, Temp sensor	-40 to 85	LQFP	4.34
MSP430FR6988	16	96	2	83	2	4	2	3	ADC12-16ch	16	5	0	32×32	AES256	LCD, RTC, Scan interface, BOR, IrDA, Temp sensor	-40 to 85	LQFP	4.42
MSP430FR6989	16	128	2	83	2	4	2	3	ADC12-16ch	16	5	0	32×32	AES256	LCD, RTC, Scan interface, BOR, IrDA, Temp sensor	-40 to 85	LQFP	4.50
MSP430FR69891	16	128	2	83	2	4	2	3	ADC12-16ch	16	5	0	32×32	AES256	LCD, RTC, Scan interface, BOR, IrDA, Temp sensor	-40 to 85	LQFP	4.50

¹ Prices are quoted in U.S. dollars and represent year 2016 suggested resale price.

G2x/i2x

High performance for cost-sensitive applications

The MSP430G2xx and MSP430i2x 16-bit microcontrollers feature Flash-based ultra-low-power MCUs up to 16 MIPS with 1.8V – 3.6V operation. Includes the very-low power oscillator (VLO), internal pull-up/pull-down resistors and low-pin-count options.

Microcontroller parameters

- Flash options: 0.5 KB – 56 KB
- RAM options: 128 B – 4 KB
- GPIO options: 10, 16, 24, 28, 32 pins
- ADC options: Slope, 10-bit SAR, 24-bit Sigma-Delta Converter
- Other integrated peripherals: Capacitive Touch I/O (CT), High Frequency Oscillator (HF)

MSP430G2xx Series – Up to 16 MHz

Part Number	Frequency (MHz)	Non-volatile Memory (KB)	SRAM (kB)	GPIO	FC	SPI	UART	DMA	ADC	Comparator (Channels)	Timers 16-Bit	Timers 32-Bit	Multiplier	AES	Additional Features	Operating Temperature Range (°C)	Package Group	1ku Price ¹ (U.S. \$)
G2xx0																		
MSP430G2210	16	2	0.125	4	1	1	0	0	Slope	4	1	0	N/A	N/A		–40 to 85	SOIC	0.35
MSP430G2230	16	2	0.125	4	1	1	0	1	ADC10-4ch	0	1	0	N/A	N/A	Temp sensor	–40 to 85	SOIC	0.40
G2xx1																		
MSP430G2001	16	0.5	0.125	10	0	0	0	0	N/A	0	1	0	N/A	N/A	BOR	–40 to 85	PDIP, QFN, TSSOP	0.34
MSP430G2101	16	1	0.125	10	0	0	0	0	N/A	0	1	0	N/A	N/A	BOR	–40 to 85	PDIP, QFN, TSSOP	0.44
MSP430G2121	16	1	0.125	10	1	1	0	0	N/A	0	1	0	N/A	N/A	BOR	–40 to 85	PDIP, QFN, TSSOP	0.46
MSP430G2201	16	2	0.125	10	0	0	0	0	N/A	0	1	0	N/A	N/A	BOR	–40 to 85	PDIP, QFN, TSSOP	0.47
MSP430G2221	16	2	0.125	10	1	1	0	0	N/A	0	1	0	N/A	N/A	BOR	–40 to 85	PDIP, QFN, TSSOP	0.49
MSP430G2111	16	1	0.125	10	0	0	0	0	Slope	8	1	0	N/A	N/A	BOR	–40 to 85	PDIP, QFN, TSSOP	0.46
MSP430G2211	16	2	0.125	10	0	0	0	0	Slope	8	1	0	N/A	N/A	BOR	–40 to 85	PDIP, QFN, TSSOP	0.49
MSP430G2131	16	1	0.125	10	1	1	0	0	ADC10-8ch	0	1	0	N/A	N/A	Temp sensor, BOR	–40 to 85	PDIP, QFN, TSSOP	0.49
MSP430G2231	16	2	0.125	10	1	1	0	0	ADC10-8ch	0	1	0	N/A	N/A	Temp sensor, BOR	–40 to 85	PDIP, QFN, TSSOP	0.55
G2xx2																		
MSP430G2102	16	1	0.125	16	1	1	0	0	N/A	0	1	0	N/A	N/A	BOR	–40 to 85	PDIP, TSSOP, QFN	0.48
MSP430G2202	16	2	0.25	16	1	1	0	0	N/A	0	1	0	N/A	N/A	BOR	–40 to 85	PDIP, QFN, TSSOP	0.50
MSP430G2302	16	4	0.25	16	1	1	0	0	N/A	0	1	0	N/A	N/A	BOR	–40 to 85	PDIP, QFN, TSSOP	0.55
MSP430G2402	16	8	0.25	16	1	1	0	0	N/A	0	1	0	N/A	N/A	BOR	–40 to 85	PDIP, QFN, TSSOP	0.65
MSP430G2112	16	1	0.125	16	1	1	0	0	Slope	8	1	0	N/A	N/A	BOR	–40 to 85	PDIP, QFN, TSSOP	0.49
MSP430G2212	16	2	0.25	16	1	1	0	0	Slope	8	1	0	N/A	N/A	BOR	–40 to 85	PDIP, QFN, TSSOP	0.55
MSP430G2312	16	4	0.25	16	1	1	0	0	Slope	8	1	0	N/A	N/A	BOR	–40 to 85	PDIP, QFN, TSSOP	0.60
MSP430G2412	16	8	0.25	16	1	1	0	0	Slope	8	1	0	N/A	N/A	BOR	–40 to 85	PDIP, QFN, TSSOP	0.65
MSP430G2132	16	1	0.125	16	1	1	0	0	ADC10-8ch	0	1	0	N/A	N/A	Temp sensor, BOR	–40 to 85	PDIP, QFN, TSSOP	0.55
MSP430G2232	16	2	0.25	16	1	1	0	0	ADC10-8ch	0	1	0	N/A	N/A	Temp sensor, BOR	–40 to 85	PDIP, QFN, TSSOP	0.55
MSP430G2332	16	4	0.25	16	1	1	0	0	ADC10-8ch	0	1	0	N/A	N/A	Temp sensor, BOR	–40 to 85	QFN, PDIP, TSSOP	0.60
MSP430G2432	16	8	0.25	16	1	1	0	0	ADC10-8ch	0	1	0	N/A	N/A	Temp sensor, BOR	–40 to 85	PDIP, QFN, TSSOP	0.70
MSP430G2152	16	1	0.125	16	1	1	0	0	ADC10-8ch	8	1	0	N/A	N/A	Temp sensor, BOR	–40 to 85	PDIP, QFN, TSSOP	0.55
MSP430G2252	16	2	0.25	16	1	1	0	0	ADC10-8ch	8	1	0	N/A	N/A	Temp sensor, BOR	–40 to 85	PDIP, QFN, TSSOP	0.60
MSP430G2352	16	4	0.25	16	1	1	0	0	ADC10-8ch	8	1	0	N/A	N/A	Temp sensor, BOR	–40 to 85	PDIP, QFN, TSSOP	0.65
MSP430G2452	16	8	0.25	16	1	1	0	0	ADC10-8ch	8	1	0	N/A	N/A	Temp sensor, BOR		PDIP, QFN, TSSOP	0.70

¹Prices are quoted in U.S. dollars and represent year 2016 suggested resale price for TSSOP package.

MSP430G2xx Series – Up to 16 MHz (continued)

Part Number	Frequency (MHz)	Non-volatile Memory (KB)	SRAM (KB)	GPIO	I ² C	SPI	UART	DMA	ADC	Comparator (Channels)	Timers 16-Bit	Timers 32-Bit	Multiplier	AES	Additional Features	Operating Temperature Range (°C)	Package Group	1ku Price ¹ (U.S. \$)
G2xx3																		
MSP430G2203	16	2	0.25	24	1	2	1	0	N/A	0	2	0	N/A	N/A	BOR, IrDA	-40 to 85	PDIP, TSSOP, VQFN	0.60
MSP430G2303	16	4	0.25	24	1	2	1	0	N/A	0	2	0	N/A	N/A	BOR, IrDA	-40 to 85	PDIP, TSSOP, VQFN	0.65
MSP430G2403	16	8	0.5	24	1	2	1	0	N/A	0	2	0	N/A	N/A	BOR, IrDA	-40 to 85	PDIP, TSSOP, VQFN	0.75
MSP430G2213	16	2	0.25	24	1	1	1	0	Slope	8	2	0	N/A	N/A	BOR, IrDA	-40 to 85	PDIP, TSSOP, VQFN	0.63
MSP430G2313	16	4	0.25	24	1	1	1	0	Slope	8	2	0	N/A	N/A	BOR, IrDA	-40 to 85	PDIP, TSSOP, VQFN	0.65
MSP430G2413	16	8	0.5	24	1	1	1	0	Slope	8	2	0	N/A	N/A	BOR, IrDA	-40 to 85	PDIP, TSSOP, VQFN	0.75
MSP430G2513	16	16	0.5	24	1	1	1	0	Slope	8	2	0	N/A	N/A	BOR, IrDA	-40 to 85	PDIP, TSSOP, VQFN	0.90
MSP430G2233	16	2	0.25	24	1	2	1	0	ADC10-8ch	0	2	0	N/A	N/A	Temp sensor, BOR, IrDA	-40 to 85	PDIP, TSSOP, VQFN	0.60
MSP430G2333	16	4	0.25	24	1	2	1	0	ADC10-8ch	0	2	0	N/A	N/A	Temp sensor, BOR, IrDA	-40 to 85	PDIP, TSSOP, VQFN	0.65
MSP430G2433	16	8	0.5	24	1	2	1	0	ADC10-8ch	0	2	0	N/A	N/A	Temp sensor, BOR, IrDA	-40 to 85	PDIP, TSSOP, VQFN	0.75
MSP430G2533	16	16	0.5	24	1	2	1	0	ADC10-8ch	0	2	0	N/A	N/A	Temp sensor, BOR, IrDA	-40 to 85	PDIP, TSSOP, VQFN	0.90
MSP430G2153	16	1	0.25	24	1	1	1	0	ADC10-8ch	8	2	0	N/A	N/A	Temp sensor, BOR, IrDA	-40 to 85	PDIP, TSSOP, VQFN	0.60
MSP430G2253	16	2	0.25	24	1	1	1	0	ADC10-8ch	8	2	0	N/A	N/A	Temp sensor, BOR, IrDA	-40 to 85	PDIP, TSSOP, VQFN	0.65
MSP430G2353	16	4	0.25	24	1	1	1	0	ADC10-8ch	8	2	0	N/A	N/A	Temp sensor, BOR, IrDA	-40 to 85	PDIP, TSSOP, VQFN	0.70
MSP430G2453	16	8	0.5	24	1	1	1	0	ADC10-8ch	8	2	0	N/A	N/A	Temp sensor, BOR, IrDA	-40 to 85	PDIP, TSSOP, VQFN	0.80
MSP430G2553	16	16	0.5	24	1	1	1	0	ADC10-8ch	8	2	0	N/A	N/A	Temp sensor, BOR, IrDA	-40 to 85	PDIP, TSSOP, VQFN	0.90
G2xx4																		
MSP430G2444	16	8	0.5	32	1	1	1	0	ADC10-12ch	0	2	0	N/A	N/A	Temp sensor, BOR, IrDA	-40 to 85	DSBGA, TSSOP, VQFN	1.05
MSP430G2544	16	16	0.5	32	1	1	1	0	ADC10-12ch	0	2	0	N/A	N/A	Temp sensor, BOR, IrDA		DSBGA, VQFN, TSSOP	1.10
MSP430G2744	16	32	1	32	1	1	1	0	ADC10-12ch	0	2	0	N/A	N/A	Temp sensor, BOR, IrDA	-40 to 85	TSSOP, VQFN, DSBGA	1.14
G2xx5																		
MSP430G2755	16	32	4	32	1	2	1	0	ADC10-12ch	8	3	0	N/A	N/A	Temp sensor, BOR, IrDA		TSSOP, VQFN	1.20
MSP430G2855	16	48	4	32	1	2	1	0	ADC10-12ch	8	3	0	N/A	N/A	Temp sensor, BOR, IrDA		TSSOP, VQFN	1.24
MSP430G2955	16	56	4	32	1	2	1	0	ADC10-12ch	8	3	0	N/A	N/A	Temp sensor, BOR, IrDA		TSSOP, VQFN	1.30

¹Prices are quoted in U.S. dollars and represent year 2016 suggested resale price for TSSOP package.

MSP430i20xx I-Series – Up to 16 MHz

Part Number	Frequency (MHz)	Non-volatile Memory (KB)	SRAM (KB)	GPIO	I ² C	SPI	UART	DMA	ADC	Comparator (Channels)	Timers 16-Bit	Timers 32-Bit	Multiplier	AES	Additional Features	Operating Temperature Range (°C)	Package Group	1ku Price ¹ (U.S. \$)
i20xx																		
MSP430i2020	16	16	1	16	1	2	1	0	SigmaDelta24-2ch	0	2	0	16×16	N/A	Temp sensor, BOR, IrDA	-40 to 105	TSSOP, VQFN	1.50
MSP430i2021	16	32	2	16	1	2	1	0	SigmaDelta24-2ch	0	2	0	16×16	N/A	Temp sensor, BOR, IrDA	-40 to 105	TSSOP, VQFN	1.58
MSP430i2030	16	16	1	16	1	2	1	0	SigmaDelta24-2ch	0	2	0	16×16	N/A	Temp sensor, BOR, IrDA	-40 to 105	TSSOP, VQFN	1.60
MSP430i2031	16	32	2	16	1	2	1	0	SigmaDelta24-3ch	0	2	0	16×16	N/A	Temp sensor, BOR, IrDA	-40 to 105	TSSOP, VQFN	1.70
MSP430i2040	16	16	1	16	1	2	1	0	SigmaDelta24-4ch	0	2	0	16×16	N/A	Temp sensor, BOR, IrDA	-40 to 105	TSSOP, VQFN	1.70
MSP430i2041	16	32	2	16	1	2	1	0	SigmaDelta24-4ch	0	2	0	16×16	N/A	Temp sensor, BOR, IrDA	-40 to 105	TSSOP, VQFN	1.75

¹Prices are quoted in U.S. dollars and represent year 2016 suggested resale price.

F – Family**Ultra-low power with increased integration and performance**

Our largest family of microcontrollers, offers ultra-low power with options featuring unmatched analog and digital integration.

Microcontroller parameters

- Up to 25 MHz
- Flash options: 0.5 KB – 512 KB
- RAM options: 128 B – 64 KB
- GPIO options: Up to 90 pins

MSP430F1xx Series – Up to 8 MHz

Part Number	Frequency (MHz)	Non-volatile Memory (KB)	SRAM (kB)	GPIO	I ² C	SPI	UART	DMA	ADC	Comparators	Timers 16-Bit	Timers 32-Bit	Multiplier	AES	Additional Features	Operating Temperature Range (°C)	Package Group	1 ku Price ¹ (U.S. \$)
F11x1																		
MSP430F1101A	8	1	0.125	14	0	0	0	0	Slope	Yes	1	0	N/A	N/A	Watchdog	-40 to 85	SOIC, TSSOP, TVSOP, VQFN	1.06
MSP430F1111A	8	2	0.125	14	0	0	0	0	Slope	Yes	1	0	N/A	N/A	Watchdog	-40 to 85	SOIC, TSSOP, TVSOP, VQFN	1.22
MSP430F1121A	8	4	0.25	14	0	0	0	0	Slope	Yes	1	0	N/A	N/A	Watchdog	-40 to 85	SOIC, TSSOP, TVSOP, VQFN	1.56
F11x2																		
MSP430F1122	8	4	0.25	14	0	0	0	0	ADC10-5ch	0	1	0	N/A	N/A	Temp sensor, BOR	-40 to 85	SOIC, TSSOP, VQFN	1.67
MSP430F1132	8	8	0.25	14	0	0	0	0	ADC10-5ch	0	1	0	N/A	N/A	Temp sensor, BOR	-40 to 85	SOIC, TSSOP, VQFN	1.78
F12x																		
MSP430F122	8	4	0.25	22	0	1	1	0	Slope	Yes	1	0	N/A	N/A	Watchdog	-40 to 85	SOIC, TSSOP, VQFN	1.67
MSP430F123	8	8	0.25	22	0	1	1	0	Slope	Yes	1	0	N/A	N/A	Watchdog	-40 to 85	SOIC, TSSOP, VQFN	1.72
F12x2																		
MSP430F1222	8	4	0.25	22	0	1	1	0	ADC10-8ch	0	1	0	N/A	N/A	Temp sensor, BOR	-40 to 85	SOIC, TSSOP, VQFN	1.72
MSP430F1232	8	8	0.25	22	0	1	1	0	ADC10-8ch	0	1	0	N/A	N/A	BOR	-40 to 85	DIESALE, SOIC, TSSOP, VQFN	1.83
F13x																		
MSP430F133	8	8	0.25	48	0	1	1	0	ADC12-8ch	Yes	2	0	N/A	N/A	Temp sensor	-40 to 85	LQFP, TQFP, VQFN	2.94
MSP430F135	8	16	0.5	48	0	1	1	0	ADC12-8ch	Yes	2	0	N/A	N/A	Temp sensor	-40 to 85	LQFP, TQFP, VQFN	3.28
F14x																		
MSP430F147	8	32	1	48	0	2	2	0	ADC12-8ch	Yes	2	0	16×16	N/A	Temp sensor	-40 to 85	LQFP, TQFP, VQFN	4.00
MSP430F1471	8	32	1	48	0	2	2	0	Slope	Yes	2	0	16×16	N/A	Temp sensor	-40 to 85	LQFP, VQFN	4.55
MSP430F148	8	48	2	48	0	2	2	0	ADC12-8ch	Yes	2	0	16×16	N/A	Temp sensor	-40 to 85	LQFP, TQFP, VQFN	4.33
MSP430F1481	8	48	2	48	0	2	2	0	Slope	Yes	2	0	16×16	N/A	Temp sensor	-40 to 85	LQFP, VQFN	5.11
MSP430F149	8	60	2	48	0	2	2	0	ADC12-8ch	Yes	2	0	16×16	N/A	Temp sensor	-40 to 85	LQFP, TQFP, VQFN	4.66
MSP430F1491	8	60	2	48	0	2	2	0	Slope	Yes	2	0	16×16	N/A	Temp sensor	-40 to 85	LQFP, VQFN	5.11
F15x																		
MSP430F155	8	16	0.5	48	1	1	1	3	ADC12-8ch	Yes	2	0	N/A	N/A	Temp sensor, BOR	-40 to 85	LQFP, VQFN	5.38
MSP430F156	8	24	1	48	1	1	1	3	ADC12-8ch	Yes	2	0	N/A	N/A	Temp sensor, BOR	-40 to 85	LQFP, VQFN	5.61
MSP430F157	8	32	1	48	1	1	1	3	ADC12-8ch	Yes	2	0	N/A	N/A	Temp sensor, BOR	-40 to 85	LQFP, VQFN	5.95
F16x																		
MSP430F1610	8	32	5	48	1	2	2	3	ADC12-8ch	Yes	2	0	16×16	N/A	Temp sensor, BOR	-40 to 85	LQFP, VQFN	8.72
MSP430F1611	8	48	10	48	1	2	2	3	ADC12-8ch	Yes	2	0	16×16	N/A	Temp sensor, BOR	-40 to 85	LQFP, VQFN	9.16
MSP430F1612	8	55	5	48	1	2	2	3	ADC12-8ch	Yes	2	0	16×16	N/A	Temp sensor, BOR	-40 to 85	LQFP, VQFN	9.50
MSP430F167	8	32	1	48	1	2	2	3	ADC12-8ch	Yes	2	0	16×16	N/A	Temp sensor, BOR	-40 to 85	LQFP, VQFN	6.88
MSP430F168	8	48	2	48	1	2	2	3	ADC12-8ch	Yes	2	0	16×16	N/A	Temp sensor, BOR	-40 to 85	LQFP, VQFN	7.61
MSP430F169	8	60	2	48	1	2	2	3	ADC12-8ch	Yes	2	0	16×16	N/A	Temp sensor, BOR	-40 to 85	LQFP, VQFN	8.16

¹Prices are quoted in U.S. dollars and represent year 2016 suggested resale price.

MSP430F2xx Series – Up to 16 MHz

Part Number	Frequency (MHz)	Non-volatile Memory (KB)	SRAM (KB)	GPIO	PC	SPI	UART	DMA	ADC	Comparators	Timers 16-Bit	Timers 32-Bit	Multiplier	AES	Additional Features	Operating Temperature Range (°C)	Package Group	1 ku Price ¹ (U.S. \$)
F20xx																		
MSP430F2001	16	1	0.125	10	0	0	0	0	Slope	Yes	1	0	N/A	N/A	BOR	-40 to 105, -40 to 85	PDIP, QFN, TSSOP	0.46
MSP430F2002	16	1	0.125	10	1	1	0	0	ADC10-8ch	0	1	0	N/A	N/A	Temp sensor, BOR	-40 to 105, -40 to 85	PDIP, QFN, TSSOP	0.65
MSP430F2003	16	1	0.125	10	1	1	0	0	SigmaDelta16-4ch	0	1	0	N/A	N/A	Temp sensor, BOR	-40 to 105, -40 to 85	PDIP, TSSOP, QFN	0.99
MSP430F2011	16	2	0.125	10	0	0	0	0	Slope	Yes	1	0	N/A	N/A	BOR	-40 to 105, -40 to 85	PDIP, QFN, TSSOP	0.55
MSP430F2012	16	2	0.125	10	1	1	0	0	ADC10-8ch	0	1	0	N/A	N/A	Temp sensor, BOR	-40 to 105, -40 to 85	PDIP, QFN, TSSOP	0.85
MSP430F2013	16	2	0.125	10	1	1	0	0	SigmaDelta16-4ch	0	1	0	N/A	N/A	Temp sensor, BOR	-40 to 105, -40 to 85	PDIP, QFN, TSSOP	1.10
F21xx																		
MSP430F2101	16	1	0.125	16	0	0	0	0	Slope	Yes	1	0	N/A	N/A	BOR	-40 to 105, -40 to 85	SOIC, TSSOP, TVSOP, VQFN	0.60
MSP430F2111	16	2	0.125	16	0	0	0	0	Slope	Yes	1	0	N/A	N/A	BOR	-40 to 105, -40 to 85	SOIC, TSSOP, TVSOP, VQFN	0.70
MSP430F2112	16	2	0.25	24	1	2	1	0	ADC10-8ch	Yes	2	0	N/A	N/A	Temp sensor, BOR	-40 to 105, -40 to 85	TSSOP, VQFN, WQFN	1.10
MSP430F2121	16	4	0.25	16	0	0	0	0	Slope	Yes	1	0	N/A	N/A	BOR	-40 to 105, -40 to 85	SOIC, TVSOP, TSSOP, VQFN	0.90
MSP430F2122	16	4	0.5	24	1	2	1	0	ADC10-8ch	Yes	2	0	N/A	N/A	Temp sensor, BOR	-40 to 105, -40 to 85	TSSOP, VQFN, WQFN	1.40
MSP430F2131	16	8	0.25	16	0	0	0	0	Slope	Yes	1	0	N/A	N/A	BOR	-40 to 105, -40 to 85	SOIC, TSSOP, VQFN, TVSOP	1.20
MSP430F2132	16	8	0.5	24	1	2	1	0	ADC10-8ch	Yes	2	0	N/A	N/A	Temp sensor, BOR	-40 to 105, -40 to 85	TSSOP, VQFN, WQFN	1.50
F22x2																		
MSP430F2232	16	8	0.5	32	1	1	1	0	ADC10-12ch	0	2	0	N/A	N/A	Temp sensor, BOR	-40 to 105, -40 to 85	DSBGA, TSSOP, VQFN	1.65
MSP430F2252	16	16	0.5	32	1	1	1	0	ADC10-12ch	0	2	0	N/A	N/A	Temp sensor, BOR	-40 to 105, -40 to 85	DSBGA, TSSOP, VQFN	1.95
MSP430F2272	16	32	1	32	1	1	1	0	ADC10-12ch	0	2	0	N/A	N/A	Temp sensor, BOR	-40 to 105, -40 to 85	DSBGA, TSSOP, VQFN	2.00
F22x4																		
MSP430F2234	16	8	0.5	32	1	1	1	0	ADC10-12ch	0	2	0	N/A	N/A	BOR, OpAmp, Temp sensor	-40 to 105, -40 to 85	DSBGA, TSSOP, VQFN	1.85
MSP430F2254	16	16	0.5	32	1	1	1	0	ADC10-12ch	0	2	0	N/A	N/A	BOR, OpAmp, Temp sensor	-40 to 105, -40 to 85	DSBGA, TSSOP, VQFN	2.15
MSP430F2274	16	32	1	32	1	1	1	0	ADC10-12ch	0	2	0	N/A	N/A	BOR, OpAmp, Temp sensor	-40 to 105, -40 to 85	DSBGA, TSSOP, VQFN	2.25
F23x0																		
MSP430F2330	16	8	1	32	1	1	1	0	Slope	Yes	2	0	16x16	N/A	BOR	-40 to 105, -40 to 85	DSBGA, VQFN	1.60
MSP430F2350	16	16	2	32	1	1	1	0	Slope	Yes	2	0	16x16	N/A	BOR	-40 to 105, -40 to 85	DSBGA, VQFN	1.80
MSP430F2370	16	32	2	32	1	1	1	0	Slope	Yes	2	0	16x16	N/A	BOR	-40 to 105, -40 to 85	DSBGA, VQFN	1.95
F23x																		
MSP430F233	16	8	1	48	1	1	1	0	ADC12-8ch	Yes	2	0	16x16	N/A	Temp sensor, BOR	-40 to 105	LQFP, VQFN	2.15
MSP430F235	16	16	2	48	1	1	1	0	ADC12-8ch	Yes	2	0	16x16	N/A	Temp sensor, BOR	-40 to 105	LQFP, VQFN	2.60
F24x/10																		
MSP430F247	16	32	4	48	2	2	2	0	ADC12-8ch	Yes	2	0	16x16	N/A	Temp sensor, BOR	-40 to 105	LQFP, VQFN	2.75
MSP430F248	16	48	4	48	2	2	2	0	ADC12-8ch	Yes	2	0	16x16	N/A	Temp sensor, BOR	-40 to 105	LQFP, VQFN	3.40
MSP430F249	16	60	2	48	2	2	2	0	ADC12-8ch	Yes	2	0	16x16	N/A	Temp sensor, BOR	-40 to 105	LQFP, VQFN	3.70
MSP430F2410	16	56	4	48	2	2	2	0	ADC12-8ch	Yes	2	0	16x16	N/A	Temp sensor, BOR	-40 to 105	LQFP, VQFN	4.60

¹ Prices are quoted in U.S. dollars and represent year 2016 suggested resale price.

MSP430F2xx Series – Up to 16 MHz (continued)

Part Number	Frequency (MHz)	Non-volatile Memory (KB)	SRAM (kB)	GPIO	PC	SPI	UART	DMA	ADC	Comparators	Timers 16-Bit	Timers 32-Bit	Multiplier	AES	Additional Features	Operating Temperature Range (°C)	Package Group	1 ku Price ¹ (U.S. \$)
F24x1																		
MSP430F2471	16	32	4	48	2	2	2	0	Slope	Yes	2	0	16x16	N/A	Temp sensor, BOR	-40 to 105	LQFP, VQFN	3.15
MSP430F2481	16	48	4	48	2	2	2	0	Slope	Yes	2	0	16x16	N/A	Temp sensor, BOR	-40 to 105	LQFP, VQFN	3.00
MSP430F2491	16	60	2	48	2	2	2	0	Slope	Yes	2	0	16x16	N/A	Temp sensor, BOR	-40 to 105	LQFP, VQFN	3.80
F241x																		
MSP430F2416	16	92	4	48	2	2	2	0	ADC12-8ch	Yes	2	0	16x16	N/A	Temp sensor, BOR	-40 to 105	BGA MicroStar Junior™, LQFP	4.70
MSP430F2417	16	92	8	48	2	2	2	0	ADC12-8ch	Yes	2	0	16x16	N/A	Temp sensor, BOR	-40 to 105	BGA MicroStar Junior, LQFP	4.80
MSP430F2418	16	116	8	48	2	2	2	0	ADC12-8ch	Yes	2	0	16x16	N/A	Temp sensor, BOR	-40 to 105	BGA MicroStar Junior, LQFP	5.00
MSP430F2419	16	120	4	48	2	2	2	0	ADC12-8ch	Yes	2	0	16x16	N/A	Temp sensor, BOR	-40 to 105	BGA MicroStar Junior, LQFP	5.30
F261x																		
MSP430F2616	16	92	4	48	2	2	2	3	ADC12-8ch	Yes	2	0	16x16	N/A	Temp sensor, BOR	-40 to 105	BGA MicroStar Junior, LQFP	5.85
MSP430F2617	16	92	8	48	2	2	2	3	ADC12-8ch	Yes	2	0	16x16	N/A	Temp sensor, BOR	-40 to 105	BGA MicroStar Junior, LQFP	6.05
MSP430F2618	16	116	8	48	2	2	2	3	ADC12-8ch	Yes	2	0	16x16	N/A	Temp sensor, BOR	-40 to 105	BGA MicroStar Junior, LQFP	6.35
MSP430F2619	16	120	4	48	2	2	2	3	ADC12-8ch	Yes	2	0	16x16	N/A	Temp sensor, BOR	-40 to 105	BGA MicroStar Junior, LQFP	6.65

¹Prices are quoted in U.S. dollars and represent year 2016 suggested resale price.

Analog Front End (MSP430AFE2xx) Series – Up to 12 MHz

Part Number	Frequency (MHz)	Non-volatile Memory (KB)	SRAM (kB)	GPIO	PC	SPI	UART	DMA	ADC	Comparators	Timers 16-Bit	Timers 32-Bit	Multiplier	AES	Additional Features	Operating Temperature Range (°C)	Package Group	1 ku Price ¹ (U.S. \$)
AFE2xx																		
MSP430AFE221	12	4	0.25	11	0	1	1	0	SigmaDelta24-1ch	0	1	0	16x16	N/A	Temp sensor, BOR		TSSOP	1.80
MSP430AFE222	12	4	0.25	11	0	1	1	0	SigmaDelta24-2ch	0	1	0	16x16	N/A	Temp sensor, BOR	-40 to 85	TSSOP	1.95
MSP430AFE223	12	4	0.25	11	0	1	1	0	SigmaDelta24-3ch	0	1	0	16x16	N/A	Temp sensor, BOR	-40 to 85, -55 to 125	TSSOP	2.10
MSP430AFE231	12	8	0.5	11	0	1	1	0	SigmaDelta24-1ch	0	1	0	16x16	N/A	Temp sensor, BOR	-40 to 85	TSSOP	1.85
MSP430AFE232	12	8	0.5	11	0	1	1	0	SigmaDelta24-2ch	0	1	0	16x16	N/A	Temp sensor, BOR	-40 to 85	TSSOP	2.00
MSP430AFE233	12	8	0.5	11	0	1	1	0	SigmaDelta24-3ch	0	1	0	16x16	N/A	Temp sensor, BOR	-40 to 85	TSSOP	2.10
MSP430AFE251	12	16	0.5	11	0	1	1	0	SigmaDelta24-1ch	0	1	0	16x16	N/A	Temp sensor, BOR	-40 to 85	TSSOP	1.90
MSP430AFE252	12	16	0.5	11	0	1	1	0	SigmaDelta24-2ch	0	1	0	16x16	N/A	Temp sensor, BOR	-40 to 85	TSSOP	2.05
MSP430AFE253	12	16	0.5	11	0	1	1	0	SigmaDelta24-3ch	0	1	0	16x16	N/A	Temp sensor, BOR	-40 to 85	TSSOP	2.20

¹Prices are quoted in U.S. dollars and represent year 2016 suggested resale price.

MSP430F4xx Series – Up to 16 MHz with LCD

Part Number	Frequency (MHz)	Non-volatile Memory (KB)	SRAM (kB)	GPIO	FC	SPI	UART	DMA	ADC	Comparators	Timers 16-Bit	Timers 32-Bit	Multiplier	AES	Additional Features	Operating Temperature Range (°C)	Package Group	1 ku Price ¹ (U.S. \$)
F41x																		
MSP430F412	8	4	0.25	48	0	0	0	0	Slope	Yes	1	0	N/A	N/A	LCD, BOR	-40 to 85	LQFP, VQFN	1.30
MSP430F413	8	8	0.25	48	0	0	0	0	Slope	Yes	1	0	N/A	N/A	LCD, BOR	-40 to 85	LQFP, VQFN	1.35
MSP430F415	8	16	0.5	48	0	0	0	0	Slope	Yes	2	0	N/A	N/A	LCD, BOR	-40 to 85	LQFP, VQFN	1.50
MSP430F417	8	32	1	48	0	0	0	0	Slope	Yes	2	0	N/A	N/A	LCD, BOR	-40 to 85	LQFP, VQFN	1.75
F41x2																		
MSP430F4132	8	8	0.5	56	1	1	1	0	ADC10-8ch	Yes	2	0	N/A	N/A	LCD, RTC, Temp sensor, BOR	-40 to 85	LQFP, VQFN	1.50
MSP430F4152	8	16	0.5	56	1	1	1	0	ADC10-8ch	Yes	2	0	N/A	N/A	LCD, RTC, Temp sensor, BOR	-40 to 85	LQFP, VQFN	1.70
F42x																		
MSP430F423A	8	8	0.25	14	0	1	1	0	SigmaDelta16-3ch	0	1	0	16x16	N/A	LCD, Temp sensor, BOR	-40 to 85	LQFP	2.05
MSP430F425A	8	16	0.5	14	0	1	1	0	SigmaDelta16-3ch	0	1	0	16x16	N/A	LCD, Temp sensor, BOR	-40 to 85	LQFP	2.30
MSP430F427A	8	32	1	14	0	1	1	0	SigmaDelta16-3ch	0	1	0	16x16	N/A	LCD, Temp sensor, BOR	-40 to 85	LQFP	2.50
FW42x																		
MSP430FW423	8	8	0.25	48	0	0	0	0	Slope	Yes	2	0	N/A	N/A	Scan interface	-40 to 85	LQFP	2.50
MSP430FW425	8	16	0.5	48	0	0	0	0	Slope	Yes	2	0	N/A	N/A	Scan interface	-40 to 85	LQFP	2.80
MSP430FW427	8	32	1	48	0	0	0	0	Slope	Yes	2	0	N/A	N/A	Scan interface	-40 to 85	LQFP	3.10
MSP430FW428	8	48	2	48	0	0	0	0	Slope	Yes	2	0	N/A	N/A	Scan interface	-40 to 85	LQFP	3.30
MSP430FW429	8	60	2	48	0	0	0	0	Slope	Yes	2	0	N/A	N/A	Scan interface	-40 to 85	LQFP	3.55
FE42x																		
MSP430FE423A	8	8	0.25	14	0	1	1	0	SigmaDelta16-3ch	0	1	0	16x16	N/A	ESP430	-40 to 85	LQFP	3.78
MSP430FE425A	8	16	0.5	14	0	1	1	0	SigmaDelta16-3ch	0	1	0	16x16	N/A	ESP430	-40 to 85	LQFP	5.12
MSP430FE427A	8	32	1	14	0	1	1	0	SigmaDelta16-3ch	0	1	0	16x16	N/A	ESP430	-40 to 85	LQFP	4.39
MSP430FE4232	8	8	0.25	14	0	1	1	0	SigmaDelta16-3ch	0	1	0	16x16	N/A	ESP430	-40 to 85	LQFP	2.15
MSP430FE4242	8	12	0.5	14	0	1	1	0	SigmaDelta16-3ch	0	1	0	16x16	N/A	ESP430	-40 to 85	LQFP	2.25
MSP430FE4252	8	16	0.5	14	0	1	1	0	SigmaDelta16-3ch	0	1	0	16x16	N/A	ESP430	-40 to 85	LQFP	2.35
MSP430FE4272	8	32	1	14	0	1	1	0	SigmaDelta16-3ch	0	1	0	16x16	N/A	ESP430	-40 to 85	LQFP	2.45
F42x0																		
MSP430F4250	8	16	0.25	32	0	0	0	0	SigmaDelta16-5ch	0	1	0	N/A	N/A	LCD, DAC, Temp sensor, BOR	-40 to 85	SSOP, VQFN	3.05
MSP430F4260	8	24	0.25	32	0	0	0	0	SigmaDelta16-5ch	0	1	0	N/A	N/A	LCD, DAC, Temp sensor, BOR	-40 to 85	SSOP, VQFN	3.40
MSP430F4270	8	32	0.25	32	0	0	0	0	SigmaDelta16-5ch	0	1	0	N/A	N/A	LCD, DAC, Temp sensor, BOR	-40 to 85	SSOP, VQFN	3.65
FG42x0																		
MSP430FG4250	8	16	0.25	32	0	0	0	0	SigmaDelta16-5ch	0	1	0	N/A	N/A	DAC12, (2) OpAmp	-40 to 85	SSOP, QFN	3.30
MSP430FG4260	8	24	0.25	32	0	0	0	0	SigmaDelta16-5ch	0	1	0	N/A	N/A	DAC12, (2) OpAmp	-40 to 85	SSOP, QFN	3.60
MSP430FG4270	8	32	0.25	32	0	0	0	0	SigmaDelta16-5ch	0	1	0	N/A	N/A	DAC12, (2) OpAmp	-40 to 85	SSOP, QFN	4.00
F43x																		
MSP430F435	8	16	0.5	48	1	1	1	0	ADC12-8ch	Yes	2	0	N/A	N/A	LCD, Temp sensor, BOR	-40 to 85	LQFP	3.40
MSP430F436	8	24	1	48	1	1	1	0	ADC12-8ch	Yes	2	0	N/A	N/A	LCD, Temp sensor, BOR	-40 to 85	LQFP	3.70

¹Prices are quoted in U.S. dollars and represent year 2016 suggested resale price.

MSP430F4xx Series – Up to 16 MHz with LCD (continued)

Part Number	Frequency (MHz)	Non-volatile Memory (KB)	SRAM (KB)	GPIO	FC	SPI	UART	DMA	ADC	Comparators	Timers 16-Bit	Timers 32-Bit	Multiplier	AES	Additional Features	Operating Temperature Range (°C)	Package Group	1 ku Price ¹ (U.S. \$)
F43x (continued)																		
MSP430F437	8	32	1	48	1	1	1	0	ADC12-8ch	Yes	2	0	N/A	N/A	LCD, Temp sensor, BOR	-40 to 85	LQFP	3.90
MSP430F438	8	48	2	48	0	1	1	1	ADC12-12ch	Yes	2	0	N/A	N/A	LCD, Temp sensor, BOR	-40 to 85	LQFP	5.40
MSP430F439	8	60	2	48	0	1	1	1	ADC12-12ch	Yes	2	0	N/A	N/A	LCD, Temp sensor, BOR	-40 to 85	LQFP	5.95
F43x1																		
MSP430F4351	8	16	0.5	48	1	1	1	0	Slope	Yes	2	0	N/A	N/A	LCD, BOR	-40 to 85	LQFP	2.65
MSP430F4361	8	24	1	48	1	1	1	0	Slope	Yes	2	0	N/A	N/A	LCD, BOR	-40 to 85	LQFP	3.50
MSP430F4371	8	32	1	48	1	1	1	0	Slope	Yes	2	0	N/A	N/A	LCD, BOR	-40 to 85	LQFP	3.60
FG43x																		
MSP430FG437	8	32	1	48	0	1	1	0	12 ch ADC12	Yes	2	0	N/A	N/A	(2) DAC12, (3) OpAmp	-40 to 85	LQFP	3.85
MSP430FG438	8	48	2	48	0	1	1	0	12 ch ADC12	Yes	2	0	N/A	N/A	(2) DAC12, (3) OpAmp	-40 to 85	LQFP	4.50
MSP430FG439	8	60	2	48	0	1	1	0	12 ch ADC12	Yes	2	0	N/A	N/A	(2) DAC12, (3) OpAmp	-40 to 85	LQFP	5.25
F44x																		
MSP430F447	8	32	1	48	2	2	2	0	ADC12-8ch	Yes	2	0	16×16	N/A	LCD, Temp sensor, BOR	-40 to 85	LQFP	4.05
MSP430F448	8	48	2	48	2	2	2	0	ADC12-8ch	Yes	2	0	16×16	N/A	LCD, Temp sensor, BOR	-40 to 85	LQFP	4.35
MSP430F4481	8	48	2	48	2	2	2	0	Slope	Yes	2	0	16×16	N/A	LCD, Temp sensor, BOR	-40 to 85	LQFP	4.05
MSP430F449	8	60	2	48	2	2	2	0	ADC12-8ch	Yes	2	0	16×16	N/A	LCD, Temp sensor, BOR	-40 to 85	LQFP	4.65
MSP430F4491	8	60	2	48	2	2	2	0	Slope	Yes	2	0	16×16	N/A	LCD, Temp sensor, BOR	-40 to 85	LQFP	4.40
F461x																		
MSP430F4616	8	92	4	80	1	1	1	3	ADC12-12ch	Yes	2	0	16×16	N/A	LCD, RTC, Temp sensor, BOR	-40 to 85	LQFP	6.30
MSP430F46161	8	92	4	80	1	1	1	3	Slope	Yes	2	0	16×16	N/A	LCD, RTC, Temp sensor, BOR	-40 to 85	LQFP	5.40
MSP430F4617	8	92	8	80	1	1	1	3	ADC12-12ch	Yes	2	0	16×16	N/A	LCD, RTC, Temp sensor, BOR	-40 to 85	LQFP	6.70
MSP430F46171	8	92	8	80	1	1	1	3	Slope	Yes	2	0	16×16	N/A	LCD, RTC, Temp sensor, BOR	-40 to 85	LQFP	5.80
MSP430F4618	8	116	8	80	1	1	1	3	ADC12-12ch	Yes	2	0	16×16	N/A	LCD, RTC, Temp sensor, BOR	-40 to 85	LQFP	7.10
MSP430F46181	8	116	8	80	1	1	1	3	Slope	Yes	2	0	16×16	N/A	LCD, RTC, Temp sensor, BOR	-40 to 85	LQFP	6.20
MSP430F4619	8	120	4	80	1	1	1	3	ADC12-12ch	Yes	2	0	16×16	N/A	LCD, RTC, Temp sensor, BOR	-40 to 85	LQFP	6.70
MSP430F46191	8	120	4	80	1	1	1	3	Slope	Yes	2	0	16×16	N/A	LCD, RTC, Temp sensor, BOR	-40 to 85	LQFP	5.80
FG46xx																		
MSP430FG4616	8	92	4	80	1	1	1	3	ADC12-12ch	Yes	2	0	16×16	N/A	LCD, RTC, Temp sensor, Watchdog, OpAmp, BOR	-40 to 85	BGA, LQFP	7.45
MSP430FG4617	8	92	8	80	1	1	1	3	ADC12-12ch	Yes	2	0	16×16	N/A	LCD, RTC, Temp sensor, Watchdog, OpAmp, BOR	-40 to 85	BGA, LQFP	7.95
MSP430FG4618	8	116	8	80	1	1	1	3	ADC12-12ch	Yes	2	0	16×16	N/A	LCD, RTC, Temp sensor, Watchdog, OpAmp, BOR	-40 to 85	BGA, LQFP	8.35
MSP430FG4619	8	120	4	80	1	1	1	3	ADC12-12ch	Yes	2	0	16×16	N/A	LCD, RTC, Temp sensor, Watchdog, OpAmp, BOR	-40 to 85	BGA, LQFP	7.95

¹Prices are quoted in U.S. dollars and represent year 2016 suggested resale price.

MSP430F4xx Series – Up to 16 MHz with LCD (continued)

Part Number	Frequency (MHz)	Non-volatile Memory (KB)	SRAM (kB)	GPIO	FC	SPI	UART	DMA	ADC	Comparators	Timers 16-Bit	Timers 32-Bit	Multiplier	AES	Additional Features	Operating Temperature Range (°C)	Package Group	1 ku Price ¹ (U.S. \$)
F471xx																		
MSP430F47126	16	56	4	72	2	2	2	3	SigmaDelta16-6ch	Yes	2	0	32×32	N/A	LCD, RTC, Temp sensor, BOR	-40 to 85	LQFP	5.10
MSP430F47127	16	56	4	72	2	2	2	3	SigmaDelta16-7ch	Yes	2	0	32×32	N/A	LCD, RTC, Temp sensor, BOR	-40 to 85	LQFP	5.20
MSP430F47163	16	92	4	72	2	4	2	3	SigmaDelta16-3ch	Yes	2	0	32×32	N/A	LCD, RTC, Temp sensor, BOR	-40 to 85	LQFP	5.00
MSP430F47166	16	92	4	68	2	4	2	3	SigmaDelta16-6ch	Yes	2	0	32×32	N/A	LCD, RTC, Temp sensor, BOR	-40 to 85	LQFP	5.70
MSP430F47167	16	92	4	68	2	4	2	3	SigmaDelta16-7ch	Yes	2	0	32×32	N/A	LCD, RTC, Temp sensor, BOR	-40 to 85	LQFP	4.75
MSP430F47173	16	92	8	72	2	4	2	3	SigmaDelta16-3ch	Yes	2	0	32×32	N/A	LCD, RTC, Temp sensor, BOR	-40 to 85	LQFP	5.10
MSP430F47176	16	92	8	68	2	4	2	3	SigmaDelta16-6ch	Yes	2	0	32×32	N/A	LCD, RTC, Temp sensor, BOR	-40 to 85	LQFP	5.90
MSP430F47177	16	92	8	68	2	4	2	3	SigmaDelta16-7ch	Yes	2	0	32×32	N/A	LCD, RTC, Temp sensor, BOR	-40 to 85	LQFP	4.85
MSP430F47183	16	116	8	72	2	4	2	3	SigmaDelta16-3ch	Yes	2	0	32×32	N/A	LCD, RTC, Temp sensor, BOR	-40 to 85	LQFP	5.30
MSP430F47186	16	116	8	68	2	4	2	3	SigmaDelta16-6ch	Yes	2	0	32×32	N/A	LCD, RTC, Temp sensor, BOR	-40 to 85	LQFP	7.40
MSP430F47187	16	116	8	68	2	4	2	3	SigmaDelta16-7ch	Yes	2	0	32×32	N/A	LCD, RTC, Temp sensor, BOR	-40 to 85	LQFP	6.10
MSP430F47193	16	120	4	72	2	4	2	3	SigmaDelta16-3ch	Yes	2	0	32×32	N/A	LCD, RTC, Temp sensor, BOR	-40 to 85	LQFP	5.50
MSP430F47196	16	120	4	68	2	4	2	3	SigmaDelta16-6ch	Yes	2	0	32×32	N/A	LCD, RTC, Temp sensor, BOR	-40 to 85	LQFP	7.70
MSP430F47197	16	120	4	68	2	4	2	3	SigmaDelta16-7ch	Yes	2	0	32×32	N/A	LCD, RTC, Temp sensor, BOR	-40 to 85	LQFP	6.35
MSP430F4783	16	48	2	72	2	2	2	0	SigmaDelta16-3ch	Yes	2	0	32×32	N/A	LCD, RTC, Temp sensor, BOR	-40 to 85	LQFP	4.00
MSP430F4784	16	48	2	72	2	2	2	0	SigmaDelta16-4ch	Yes	2	0	32×32	N/A	LCD, RTC, Temp sensor, BOR	-40 to 85	LQFP	4.00
MSP430F4793	16	60	2.5	72	2	2	2	0	SigmaDelta16-3ch	Yes	2	0	32×32	N/A	LCD, Temp sensor, BOR	-40 to 85	LQFP	4.30
MSP430F4794	16	60	2.5	72	2	2	2	0	SigmaDelta16-4ch	Yes	2	0	32×32	N/A	LCD, Temp sensor, BOR	-40 to 85	LQFP	4.30
FG47x																		
MSP430FG477	8	32	2	48	1	1	1	0	SigmaDelta16-5ch	Yes	2	0	N/A	N/A	DAC12, (2) OpAmp	-40 to 85	LQFP, BGA	4.75
MSP430FG478	8	48	2	48	1	1	1	0	SigmaDelta16-5ch	Yes	2	0	N/A	N/A	DAC12, (2) OpAmp	-40 to 85	LQFP, BGA	5.55
MSP430FG479	8	60	2	48	1	1	1	0	SigmaDelta16-5ch	Yes	2	0	N/A	N/A	DAC12, (2) OpAmp	-40 to 85	LQFP, BGA	6.20
F47x																		
MSP430F477	8	32	2	48	1	2	1	0	SigmaDelta16-5ch	Yes	2	0	N/A	N/A	LCD, RTC, DAC, Temp sensor, BOR	-40 to 85	BGA MicroStar Junior™, LQFP	4.60
MSP430F478	8	48	2	48	1	2	1	0	SigmaDelta16-5ch	Yes	2	0	N/A	N/A	LCD, RTC, DAC, Temp sensor, BOR	-40 to 85	BGA MicroStar Junior, LQFP	5.00
MSP430F479	8	60	2	48	1	2	1	0	SigmaDelta16-5ch	Yes	2	0	N/A	N/A	LCD, RTC, DAC, Temp sensor, BOR	-40 to 85	BGA MicroStar Junior, LQFP	5.35

¹Prices are quoted in U.S. dollars and represent year 2016 suggested resale price.

32-bit low power MCUs

MSP432P4x microcontrollers are the ideal combination of TI's MSP430 low-power DNA, advanced mixed-signal features, and the high-performance processing capabilities of ARM®'s

32-bit Cortex®-M4F RISC engine. MSP432P4x MCUs cater to a large number of applications where both efficient data processing and enhanced low-power operation are paramount.

MSP432™ MCU

Selecting the high-performance ARM Cortex-M4F core

Highest CoreMark score: 3.41/MHz

- 48-MHz ARM® Cortex®-M4F
 - Full ARM instruction set
 - DSP extensions
 - FPU engine
- Wide voltage range 1.62 – 3.7 V
- Integrated LDO & DC/DC
- Selectable RAM retention
- Independent Flash banks
- DriverLib in-ROM
- 128-bit Flash buffer & pre-fetch
- 14-bit ADC
- 8-channel DMA
- NVIC with tail-chaining
- Peripheral & SRAM memory bit-band

Industry-leading ultra-low power

- Active power: 95 µA per MHz
- Sleep mode: 850 nA (with RTC)
- ULPBench score: 167.4

MSP432™ MCU

Optimizing the architecture for ultra-low power

Industry's lowest-power ARM Cortex-M CPU

- 48-MHz ARM® Cortex®-M4F
 - Full ARM instruction set
 - DSP extensions
 - FPU engine
- Wide voltage range 1.62 – 3.7 V
- Integrated LDO & DC/DC
- Selectable RAM retention
- Independent Flash banks
- DriverLib in-ROM
- 128-bit Flash buffer & pre-fetch
- 14-bit ADC
- 8-channel DMA
- NVIC with tail-chaining
- Peripheral & SRAM memory bit-band

Industry-leading ULP

- Active power: 85 µA per MHz
- Sleep mode: 850 nA (with RTC)
- ULPBench score: 167.4

Incorporating high-performance peripherals and features

- Simultaneously read and erase from Flash
- Execute up to 200% faster with DriverLib in ROM vs. Flash
- 14-bit 1MSPS ADC with 13.2ENOB, differential mode and 2 window comparators

Optimizing peripherals for ultra-low power

- Save 40% more power with the integrated DC/DC vs. LDO
- Save 30 nA per RAM bank with selectable RAM retention
- Consume minimal power (375 µA) when sampling sensors at 1MSPS with 14-bit ADC
- DriverLib in ROM consumes up to 35% less power than Flash

MSP432P401xx Series																		
Part Number	Frequency (MHz)	Non-volatile Memory (KB)	SRAM (kB)	GPIO	PC	SPI	UART	DMA	ADC	Comparator (Channels)	Timers 16-Bit	Timers 32-Bit	Multiplier	AES	Additional Features	Operating Temperature Range (°C)	Package Group	1 ku Price (U.S. \$)
MSP432P401R	48	256	64	84	4	8	4	8	ADC14-24ch	8	4	2	32x32	256	IP protection, RTC, Temp sensor, BOR, IrDA	-40 to 85	LQFP, ZXH80, RGC64	Check online
MSP432P401M	48	128	32	84	4	8	4	8	ADC14-24ch	8	4	2	32x32	256	IP protection, RTC, Temp sensor, BOR, IrDA	-40 to 85	PZ100, ZXH80, RGC64	Check online

MSP430F5xx Series – Up to 25 MHz

Part Number	Frequency (MHz)	Non-volatile Memory (KB)	SRAM (kB)	GPIO	PC	SPI	UART	DMA	ADC	Comparator (Channels)	Timers 16-Bit	Timers 32-Bit	Multiplier	AES	Additional Features	Operating Temperature Range (°C)	Package Group	1 ku Price ¹ (U.S. \$)
F51xx																		
MSP430F5131	25	8	1	31	1	2	1	3	Slope	16	3	0	32×32	N/A	BOR, IrDA	-40 to 85	DSBGA, TSSOP, WQFN	1.20
MSP430F5132	25	8	1	31	1	2	1	3	ADC10-9ch	16	3	0	32×32	N/A	Temp sensor, BOR, IrDA	-40 to 85	DSBGA, TSSOP, WQFN	1.25
MSP430F5151	25	16	2	31	1	2	1	3	Slope	16	3	0	32×32	N/A	BOR, IrDA	-40 to 85	DSBGA, TSSOP, WQFN	1.35
MSP430F5152	25	16	2	31	1	2	1	3	ADC10-9ch	16	3	0	32×32	N/A	Temp sensor, BOR, IrDA	-40 to 85	DSBGA, TSSOP, WQFN	1.50
MSP430F5171	25	32	2	31	1	2	1	3	Slope	16	3	0	32×32	N/A	BOR, IrDA	-40 to 85	DSBGA, TSSOP, WQFN	1.60
MSP430F5172	25	32	2	31	1	2	1	3	ADC10-9ch	16	3	0	32×32	N/A	Temp sensor, BOR, IrDA	-40 to 85	DSBGA, TSSOP, WQFN	1.70
F52xx																		
MSP430F5212	25	64	8	37	2	4	2	3	Slope	6	4	0	32×32	N/A	RTC, BOR, IrDA	-40 to 85	VQFN	2.05
MSP430F5214	25	128	8	37	2	4	2	3	Slope	6	4	0	32×32	N/A	RTC, BOR, IrDA	-40 to 85	VQFN	2.45
MSP430F5217	25	64	8	53	2	4	2	3	Slope	8	4	0	32×32	N/A	RTC, BOR, IrDA	-40 to 85	BGA MicroStar Junior™, DSBGA, VQFN	2.10
MSP430F5219	25	128	8	53	2	4	2	3	Slope	8	4	0	32×32	N/A	RTC, BOR, IrDA	-40 to 85	BGA MicroStar Junior, DSBGA, VQFN	2.50
MSP430F5222	25	64	8	37	2	4	2	3	ADC10-8ch	6	4	0	32×32	N/A	RTC, Temp sensor, BOR, IrDA	-40 to 85	VQFN	2.20
MSP430F5224	25	128	8	37	2	4	2	3	ADC10-8ch	6	4	0	32×32	N/A	RTC, Temp sensor, BOR, IrDA	-40 to 85	VQFN	2.60
MSP430F5227	25	64	8	53	2	4	2	3	ADC10-10ch	8	4	0	32×32	N/A	RTC, Temp sensor, BOR, IrDA	-40 to 85	BGA MicroStar Junior, DSBGA, VQFN	2.25
MSP430F5229	25	128	8	53	2	4	2	3	ADC10-10ch	8	4	0	32×32	N/A	RTC, Temp sensor, BOR, IrDA	-40 to 85	BGA MicroStar Junior, DSBGA, VQFN	2.65
MSP430F5232	25	64	8	37	2	4	2	3	Slope	6	4	0	32×32	N/A	RTC, BOR, IrDA	-40 to 85	VQFN	1.65
MSP430F5234	25	128	8	37	2	4	2	3	Slope	6	4	0	32×32	N/A	RTC, BOR, IrDA	-40 to 85	VQFN	2.05
MSP430F5237	25	64	8	53	2	4	2	3	Slope	8	4	0	32×32	N/A	RTC, BOR, IrDA	-40 to 85	BGA MicroStar Junior, VQFN	1.70
MSP430F5239	25	128	8	53	2	4	2	3	Slope	8	4	0	32×32	N/A	RTC, BOR, IrDA	-40 to 85	BGA MicroStar Junior, VQFN	2.10
MSP430F5242	25	64	8	37	2	4	2	3	ADC10-8ch	6	4	0	32×32	N/A	RTC, Temp sensor, BOR, IrDA	-40 to 85	VQFN	1.80
MSP430F5244	25	128	8	37	2	4	2	3	ADC10-8ch	6	4	0	32×32	N/A	RTC, Temp sensor, BOR, IrDA	-40 to 85	VQFN	2.20
MSP430F5247	25	64	8	53	2	4	2	3	ADC10-10ch	8	4	0	32×32	N/A	RTC, Temp sensor, BOR, IrDA	-40 to 85	BGA MicroStar Junior, VQFN	1.85
MSP430F5249	25	128	8	53	2	4	2	3	ADC10-10ch	8	4	0	32×32	N/A	RTC, Temp sensor, BOR, IrDA	-40 to 85	BGA MicroStar Junior, VQFN	2.25
MSP430F5252	25	128	16	53	4	8	4	3	Slope	8	4	0	32×32	N/A	RTC, BOR, IrDA	-40 to 85	BGA MicroStar Junior, VQFN	2.05
MSP430F5253	25	128	16	53	4	8	4	3	ADC10-10ch	8	4	0	32×32	N/A	RTC, Temp sensor, BOR, IrDA	-40 to 85	BGA MicroStar Junior, VQFN	2.05
MSP430F5254	25	128	32	53	4	8	4	3	Slope	8	4	0	32×32	N/A	RTC, BOR, IrDA	-40 to 85	BGA MicroStar Junior, VQFN	2.20
MSP430F5255	25	128	32	53	4	8	4	3	ADC10-10ch	8	4	0	32×32	N/A	RTC, Temp sensor, BOR, IrDA	-40 to 85	BGA MicroStar Junior, VQFN	2.55
MSP430F5256	25	128	16	53	4	8	4	3	Slope	8	4	0	32×32	N/A	RTC, BOR, IrDA	-40 to 85	BGA MicroStar Junior, VQFN	2.05
MSP430F5257	25	128	16	53	4	8	4	3	ADC10-10ch	8	4	0	32×32	N/A	RTC, Temp sensor, BOR, IrDA	-40 to 85	BGA MicroStar Junior, VQFN	2.05
MSP430F5258	25	128	32	53	4	8	4	3	Slope	8	4	0	32×32	N/A	RTC, BOR, IrDA	-40 to 85	BGA MicroStar Junior, VQFN	2.20
MSP430F5259	25	128	32	53	4	8	4	3	ADC10-10ch	8	4	0	32×32	N/A	RTC, Temp sensor, BOR, IrDA	-40 to 85	BGA MicroStar Junior, VQFN	2.55

¹Prices are quoted in U.S. dollars and represent year 2016 suggested resale price.

MSP430F5xx Series – Up to 25 MHz

Part Number	Frequency (MHz)	Non-volatile Memory (KB)	SRAM (kB)	GPIO	PC	SPI	UART	DMA	ADC	Comparator (Channels)	Timers 16-Bit	Timers 32-Bit	Multiplier	AES	Additional Features	Operating Temperature Range (°C)	Package Group	1 ku Price ¹ (U.S. \$)
F53x																		
MSP430F5304	25	8	6	31	1	2	1	3	ADC10-6ch	0	4	0	32×32	N/A	RTC, Temp sensor, BOR, IrDA	-40 to 85	LQFP, VQFN	1.55
MSP430F5308	25	16	6	47	2	4	2	3	ADC10-10ch	8	4	0	32×32	N/A	RTC, Temp sensor, BOR, IrDA	-40 to 85	BGA MicroStar Junior™, LQFP, VQFN	1.65
MSP430F5309	25	24	6	47	2	4	2	3	ADC10-10ch	8	4	0	32×32	N/A	RTC, Temp sensor, BOR, IrDA	-40 to 85	BGA MicroStar Junior, LQFP, VQFN	1.75
MSP430F5310	25	32	6	47	2	4	2	3	ADC10-10ch	8	4	0	32×32	N/A	RTC, Temp sensor, BOR, IrDA	-40 to 85	BGA MicroStar Junior, LQFP, VQFN	1.85
MSP430F5324	25	64	6	47	2	4	2	3	ADC12-10ch	8	4	0	32×32	N/A	RTC, Temp sensor, BOR, IrDA	-40 to 85	VQFN, BGA MicroStar Junior	2.10
MSP430F5325	25	64	6	63	2	4	2	3	ADC12-14ch	12	4	0	32×32	N/A	RTC, Temp sensor, BOR, IrDA	-40 to 85	LQFP	2.20
MSP430F5326	25	96	8	47	2	4	2	3	ADC12-10ch	8	4	0	32×32	N/A	RTC, Temp sensor, BOR, IrDA	-40 to 85	VQFN, BGA MicroStar Junior	2.45
MSP430F5327	25	96	8	63	2	4	2	3	ADC12-14ch	12	4	0	32×32	N/A	RTC, Temp sensor, BOR, IrDA	-40 to 85	LQFP	2.46
MSP430F5328	25	128	10	47	2	4	2	3	ADC12-10ch	8	4	0	32×32	N/A	RTC, Temp sensor, BOR, IrDA	-40 to 85	BGA MicroStar Junior, VQFN	2.55
MSP430F5329	25	128	10	63	2	4	2	3	ADC12-14ch	12	4	0	32×32	N/A	RTC, Temp sensor, BOR, IrDA	-40 to 85	LQFP	2.60
MSP430F5333	20	128	10	74	2	4	2	6	ADC12-12ch	12	4	0	32×32	N/A	RTC, Temp sensor, BOR, IrDA	-40 to 85	BGA MicroStar Junior, LQFP	3.00
MSP430F5335	20	256	18	74	2	4	2	6	ADC12-12ch	12	4	0	32×32	N/A	RTC, Temp sensor, BOR, IrDA	-40 to 85	BGA MicroStar Junior, LQFP	3.35
MSP430F5336	20	128	18	74	2	4	2	6	ADC12-12ch	12	4	0	32×32	N/A	RTC, DAC, Temp sensor, BOR, IrDA	-40 to 85	LQFP, BGA MicroStar Junior	3.45
MSP430F5338	20	256	18	74	2	4	2	6	ADC12-12ch	12	4	0	32×32	N/A	RTC, DAC, Temp sensor, BOR, IrDA	-40 to 85	BGA MicroStar Junior, LQFP	3.85
MSP430F5340	25	64	6	38	2	4	2	3	ADC12-7ch	5	4	0	32×32	N/A	RTC, Temp sensor, BOR, IrDA	-40 to 85	VQFN	2.15
MSP430F5341	25	96	8	38	2	4	2	3	ADC12-7ch	5	4	0	32×32	N/A	RTC, Temp sensor, BOR, IrDA	-40 to 85	VQFN	2.45
MSP430F5342	25	128	10	38	2	4	2	3	ADC12-7ch	5	4	0	32×32	N/A	RTC, Temp sensor, BOR, IrDA	-40 to 85	VQFN	2.60
MSP430F5358	20	384	34	74	3	6	3	6	ADC12-12ch	12	4	0	32×32	N/A	RTC, DAC, Temp sensor, BOR, IrDA	-40 to 85	BGA MicroStar Junior, LQFP	5.25
MSP430F5359	20	512	66	74	3	6	3	6	ADC12-12ch	12	4	0	32×32	N/A	RTC, DAC, Temp sensor, BOR, IrDA	-40 to 85	LQFP, BGA MicroStar Junior	5.35
F54xx																		
MSP430F5418A	25	128	16	67	2	4	2	3	ADC12-14ch	0	3	0	32×32	N/A	RTC, Temp sensor, BOR, IrDA	-40 to 85	LQFP	2.65
MSP430F5419A	25	128	16	87	4	8	4	3	ADC12-14ch	0	3	0	32×32	N/A	RTC, Temp sensor, BOR, IrDA	-40 to 85	BGA MicroStar Junior, LQFP	2.50
MSP430F5435A	25	192	16	67	2	4	2	3	ADC12-14ch	0	3	0	32×32	N/A	RTC, Temp sensor, BOR, IrDA	-40 to 85	LQFP	3.80
MSP430F5436A	25	192	16	87	4	8	4	3	ADC12-14ch	0	3	0	32×32	N/A	RTC, Temp sensor, BOR, IrDA	-40 to 85	BGA MicroStar Junior, LQFP	4.10
MSP430F5437A	25	256	16	67	2	4	2	3	ADC12-14ch	0	3	0	32×32	N/A	RTC, Temp sensor, BOR, IrDA	-40 to 85	LQFP	4.30
MSP430F5438A	25	256	16	87	4	8	4	3	ADC12-14ch	0	3	0	32×32	N/A	RTC, Temp sensor, BOR, IrDA	-40 to 85	BGA MicroStar Junior, LQFP	4.55
F55xx																		
MSP430F5500	25	8	6	31	1	2	1	3	Slope	4	4	0	32×32	N/A	USB, RTC, BOR, IrDA	-40 to 85	VQFN	1.45
MSP430F5501	25	16	6	31	1	2	1	3	Slope	4	4	0	32×32	N/A	USB, RTC, BOR, IrDA	-40 to 85	VQFN	1.60
MSP430F5502	25	24	6	31	1	2	1	3	Slope	4	4	0	32×32	N/A	USB, RTC, BOR, IrDA	-40 to 85	VQFN	1.65
MSP430F5503	25	32	6	31	1	2	1	3	Slope	4	4	0	32×32	N/A	USB, RTC, BOR, IrDA	-40 to 85	VQFN	1.75
MSP430F5504	25	8	6	31	1	2	1	3	ADC10-6ch	0	4	0	32×32	N/A	USB, RTC, Temp sensor, BOR, IrDA	-40 to 85	LQFP, VQFN	1.70

¹Prices are quoted in U.S. dollars and represent year 2016 suggested resale price.

MSP430F5xx Series – Up to 25 MHz (continued)

Part Number	Frequency (MHz)	Non-volatile Memory (KB)	SRAM (kB)	GPIO	I ² C	SPI	UART	DMA	ADC	Comparator (Channels)	Timers 16-Bit	Timers 32-Bit	Multiplier	AES	Additional Features	Operating Temperature Range (°C)	Package Group	1 ku Price ¹ (U.S. \$)
F55xx (continued)																		
MSP430F5505	25	16	6	31	1	2	1	3	ADC10-6ch	0	4	0	32×32	N/A	USB, RTC, Temp sensor, BOR, IrDA	-40 to 85	VQFN	1.75
MSP430F5506	25	24	6	31	1	2	1	3	ADC10-6ch	0	4	0	32×32	N/A	USB, RTC, Temp sensor, BOR, IrDA	-40 to 85	VQFN	1.80
MSP430F5507	25	32	6	31	1	2	1	3	ADC10-6ch	0	4	0	32×32	N/A	USB, RTC, Temp sensor, BOR, IrDA	-40 to 85	VQFN	1.90
MSP430F5508	25	16	6	47	2	4	2	3	ADC10-10ch	8	4	0	32×32	N/A	USB, RTC, Temp sensor, BOR, IrDA	-40 to 85	BGA MicroStar Junior, LQFP, VQFN	1.80
MSP430F5509	25	24	6	47	2	4	2	3	ADC10-10ch	8	4	0	32×32	N/A	USB, RTC, Temp sensor, BOR, IrDA	-40 to 85	BGA MicroStar Junior, LQFP, VQFN	1.85
MSP430F5510	25	32	6	47	2	4	2	3	ADC10-10ch	8	4	0	32×32	N/A	USB, RTC, Temp sensor, BOR, IrDA	-40 to 85	BGA MicroStar Junior, LQFP, VQFN	1.90
MSP430F5513	25	32	6	47	2	4	2	3	Slope	8	4	0	32×32	N/A	USB, RTC, BOR, IrDA	-40 to 85	BGA MicroStar Junior, VQFN	2.89
MSP430F5514	25	64	6	47	2	4	2	3	Slope	8	4	0	32×32	N/A	USB, RTC, BOR, IrDA	-40 to 85	BGA MicroStar Junior, VQFN	3.16
MSP430F5515	25	64	6	63	2	4	2	3	Slope	12	4	0	32×32	N/A	USB, RTC, BOR, IrDA	-40 to 85	LQFP	3.01
MSP430F5517	25	96	8	63	2	4	2	3	Slope	12	4	0	32×32	N/A	USB, RTC, BOR, IrDA	-40 to 85	LQFP	3.38
MSP430F5519	25	128	10	63	2	4	2	3	Slope	12	4	0	32×32	N/A	USB, RTC, BOR, IrDA	-40 to 85	LQFP	3.48
MSP430F5521	25	32	8	63	2	4	2	3	ADC12-14ch	12	4	0	32×32	N/A	USB, RTC, Temp sensor, BOR, IrDA	-40 to 85	LQFP	2.98
MSP430F5522	25	32	10	47	2	4	2	3	ADC12-10ch	8	4	0	32×32	N/A	USB, RTC, Temp sensor, BOR, IrDA	-40 to 85	BGA MicroStar Junior, VQFN	3.03
MSP430F5524	25	64	6	47	2	4	2	3	ADC12-10ch	8	4	0	32×32	N/A	USB, RTC, Temp sensor, BOR, IrDA	-40 to 85	BGA MicroStar Junior, DSBGA, VQFN	3.20
MSP430F5525	25	64	6	63	2	4	2	3	ADC12-14ch	12	4	0	32×32	N/A	USB, RTC, Temp sensor, BOR, IrDA	-40 to 85	LQFP	3.29
MSP430F5526	25	96	8	47	2	4	2	3	ADC12-10ch	8	4	0	32×32	N/A	USB, RTC, Temp sensor, BOR, IrDA	-40 to 85	BGA MicroStar Junior, DSBGA, VQFN	3.39
MSP430F5527	25	96	8	63	2	4	2	3	ADC12-14ch	12	4	0	32×32	N/A	USB, RTC, Temp sensor, BOR, IrDA	-40 to 85	LQFP	3.47
MSP430F5528	25	128	10	47	2	4	2	3	ADC12-10ch	8	4	0	32×32	N/A	USB, RTC, Temp sensor, BOR, IrDA	-40 to 85	BGA MicroStar Junior, DSBGA, VQFN	3.55
MSP430F5529	25	128	10	63	2	4	2	3	ADC12-14ch	12	4	0	32×32	N/A	USB, RTC, Temp sensor, BOR, IrDA	-40 to 85	LQFP	3.58
F563x																		
MSP430F5630	20	128	18	74	2	4	2	6	Slope	12	4	0	32×32	N/A	USB, RTC, BOR, IrDA	-40 to 85	BGA MicroStar Junior, LQFP	3.38
MSP430F5631	20	192	18	74	2	4	2	6	Slope	12	4	0	32×32	N/A	USB, RTC, BOR, IrDA	-40 to 85	BGA MicroStar Junior, LQFP	3.78
MSP430F5632	20	256	18	74	2	4	2	6	Slope	12	4	0	32×32	N/A	USB, RTC, BOR, IrDA	-40 to 85	BGA MicroStar Junior, LQFP	4.18
MSP430F5633	20	128	18	74	2	4	2	6	ADC12-12ch	12	4	0	32×32	N/A	USB, RTC, Temp sensor, BOR, IrDA	-40 to 85	BGA MicroStar Junior, LQFP	3.88
MSP430F5634	20	192	18	74	2	4	2	6	ADC12-12ch	12	4	0	32×32	N/A	USB, RTC, Temp sensor, BOR, IrDA	-40 to 85	BGA MicroStar Junior, LQFP	4.14
MSP430F5635	20	256	18	74	2	4	2	6	ADC12-12ch	12	4	0	32×32	N/A	USB, RTC, Temp sensor, BOR, IrDA	-40 to 85	BGA MicroStar Junior, LQFP	4.39
MSP430F5636	20	128	18	74	2	4	2	6	ADC12-12ch	12	4	0	32×32	N/A	USB, RTC, DAC, Temp sensor, BOR, IrDA	-40 to 85	BGA MicroStar Junior, LQFP	4.50
MSP430F5637	20	192	18	74	2	4	2	6	ADC12-12ch	12	4	0	32×32	N/A	USB, RTC, DAC, Temp sensor, BOR, IrDA	-40 to 85	BGA MicroStar Junior, LQFP	4.72
MSP430F5638	20	256	18	74	2	4	2	6	ADC12-12ch	12	4	0	32×32	N/A	USB, RTC, DAC, Temp sensor, BOR, IrDA	-40 to 85	BGA MicroStar Junior, LQFP	4.97
F565x																		
MSP430F5658	20	384	34	74	3	6	3	6	ADC12-12ch	12	4	0	32×32	N/A	USB, RTC, DAC, Temp sensor, BOR, IrDA	-40 to 85	BGA MicroStar Junior, LQFP	5.40
MSP430F5659	20	512	66	74	3	6	3	6	ADC12-12ch	12	4	0	32×32	N/A	USB, RTC, DAC, Temp sensor, BOR, IrDA	-40 to 85	BGA MicroStar Junior, LQFP	5.50

¹Prices are quoted in U.S. dollars and represent year 2016 suggested resale price.

MSP430F6xx Series – Up to 25 MHz with LCD

Part Number	Frequency (MHz)	Non-volatile Memory (KB)	SRAM (KB)	GPIO	I ² C	SPI	UART	DMA	ADC	Comparator (Channels)	Timers 16-Bit	Timers 32-Bit	Multiplier	AES	Additional Features	Operating Temperature Range (°C)	Package Group	1 ku Price ¹ (U.S. \$)
F643x																		
MSP430F6433	20	128	18	74	2	2	2	6	ADC12-16ch	12	4	0	32×32	N/A	LCD	-40 to 85	LQFP, BGA	3.65
MSP430F6435	20	256	18	74	2	2	2	6	ADC12-16ch	12	4	0	32×32	N/A	LCD	-40 to 85	LQFP, BGA	4.05
MSP430F6436	20	128	18	74	2	2	2	6	ADC12-16ch	12	4	0	32×32	N/A	LCD	-40 to 85	LQFP, BGA	4.20
MSP430F6438	20	256	18	74	2	2	2	6	ADC12-16ch	12	4	0	32×32	N/A	LCD	-40 to 85	LQFP, BGA	4.70
F645x																		
MSP430F6458	20	384	34	74	3	3	3	6	ADC12-16ch	12	4	0	32×32	N/A	LCD	-40 to 85	LQFP, BGA	7.20
MSP430F6459	20	512	66	74	3	3	3	6	ADC12-16ch	12	4	0	32×32	N/A	LCD	-40 to 85	LQFP, BGA	7.20
F663x																		
MSP430F6630	20	128	18	74	2	4	2	6	Slope	12	4	0	32×32	N/A	USB, LCD, RTC, BOR, IrDA	-40 to 85	BGA MicroStar Junior™, LQFP	4.24
MSP430F6631	20	192	18	74	2	4	2	6	Slope	12	4	0	32×32	N/A	USB, LCD, RTC, BOR, IrDA	-40 to 85	BGA MicroStar Junior, LQFP	4.46
MSP430F6632	20	256	18	74	2	4	2	6	Slope	12	4	0	32×32	N/A	USB, LCD, RTC, BOR, IrDA	-40 to 85	BGA MicroStar Junior, LQFP	4.72
MSP430F6633	20	128	18	74	2	4	2	6	ADC12-12ch	12	4	0	32×32	N/A	USB, LCD, RTC, Temp sensor, BOR, IrDA	-40 to 85	BGA MicroStar Junior, LQFP	4.32
MSP430F6634	20	192	18	74	2	4	2	6	ADC12-12ch	12	4	0	32×32	N/A	USB, LCD, RTC, Temp sensor, BOR, IrDA	-40 to 85	BGA MicroStar Junior, LQFP	4.57
MSP430F6635	20	256	18	74	2	4	2	6	ADC12-12ch	12	4	0	32×32	N/A	USB, LCD, RTC, Temp sensor, BOR, IrDA	-40 to 85	BGA MicroStar Junior, LQFP	4.79
MSP430F6636	20	128	18	74	2	4	2	6	ADC12-12ch	12	4	0	32×32	N/A	USB, LCD, RTC, DAC, Temp sensor, BOR, IrDA	-40 to 85	BGA MicroStar Junior, LQFP	4.54
MSP430F6637	20	192	18	74	2	4	2	6	ADC12-12ch	12	4	0	32×32	N/A	USB, LCD, RTC, DAC, Temp sensor, BOR, IrDA	-40 to 85	BGA MicroStar Junior, LQFP	4.79
MSP430F6638	20	256	18	74	2	4	2	6	ADC12-12ch	12	4	0	32×32	N/A	USB, LCD, RTC, DAC, Temp sensor, BOR, IrDA	-40 to 85	BGA MicroStar Junior, LQFP	5.04
F665x																		
MSP430F6658	20	384	34	74	3	6	3	6	ADC12-12ch	12	4	0	32×32	N/A	USB, LCD, RTC, DAC, Temp sensor, BOR, IrDA	-40 to 85	BGA MicroStar Junior, LQFP	6.48
MSP430F6659	20	512	66	74	3	6	3	6	ADC12-12ch	12	4	0	32×32	N/A	USB, LCD, RTC, DAC, Temp sensor, BOR, IrDA	-40 to 85	BGA MicroStar Junior, LQFP	6.48
FG642x																		
MSP430FG6425	20	64	10	73	2	4	2	6	SigmaDelta 16-10ch	12	4	0	32×32	N/A	OpAmp, DAC, LCD, RTC, Temp sensor, BOR	-40 to 85	BGA MicroStar Junior, LQFP	4.45
MSP430FG6426	20	128	10	73	2	4	2	6	SigmaDelta 16-10ch	12	4	0	32×32	N/A	OpAmp, DAC, LCD, RTC, Temp sensor, BOR	-40 to 85	BGA MicroStar Junior, LQFP	4.70
FG662x																		
MSP430FG6625	20	64	10	73	2	4	2	6	SigmaDelta 16-10ch	12	4	0	32×32	N/A	OpAmp, DAC, USB, LCD, RTC, Temp sensor, BOR	-40 to 85	BGA MicroStar Junior, LQFP	4.75
MSP430FG6626	20	128	10	73	2	4	2	6	SigmaDelta 16-10ch	12	4	0	32×32	N/A	OpAmp, DAC, USB, LCD, RTC, Temp sensor, BOR	-40 to 85	BGA MicroStar Junior, LQFP	5.00
F67xx																		
MSP430F6720	25	16	1	72	1	4	3	3	ADC10-6ch, SigmaDelta24-2ch	0	4	0	32×32	N/A	LCD, RTC, Temp sensor, BOR, IrDA	-40 to 85	LQFP	2.00
MSP430F6720A	25	16	1	72	1	4	3	3	ADC10-6ch, SigmaDelta24-2ch	0	4	0	32×32	N/A	LCD, RTC, Temp sensor, BOR, IrDA	-40 to 85	LQFP	2.00
MSP430F6721	25	32	2	72	1	4	3	3	ADC10-6ch, SigmaDelta24-2ch	0	4	0	32×32	N/A	LCD, RTC, Temp sensor, BOR, IrDA	-40 to 85	LQFP	2.10
MSP430F6721A	25	32	2	72	1	4	3	3	ADC10-6ch, SigmaDelta24-2ch	0	4	0	32×32	N/A	LCD, RTC, Temp sensor, BOR, IrDA	-40 to 85	LQFP	2.10

¹Prices are quoted in U.S. dollars and represent year 2016 suggested resale price.

MSP430F6xx Series – Up to 25 MHz with LCD

Part Number	Frequency (MHz)	Non-volatile Memory (KB)	SRAM (KB)	GPIO	I ² C	SPI	UART	DMA	ADC	Comparator (Channels)	Timers 16-Bit	Timers 32-Bit	Multiplier	AES	Additional Features	Operating Temperature Range (°C)	Package Group	1 ku Price ¹ (U.S. \$)
F67xx (continued)																		
MSP430F6723	25	64	4	72	1	4	3	3	ADC10-6ch, SigmaDelta24-2ch	0	4	0	32x32	N/A	LCD, RTC, Temp sensor, BOR, IrDA	-40 to 85	LQFP	2.30
MSP430F6723A	25	64	4	72	1	4	3	3	ADC10-6ch, SigmaDelta24-2ch	0	4	0	32x32	N/A	LCD, RTC, Temp sensor, BOR, IrDA	-40 to 85	LQFP	2.30
MSP430F6724	25	96	4	72	1	4	3	3	ADC10-6ch, SigmaDelta24-2ch	0	4	0	32x32	N/A	LCD, RTC, Temp sensor, BOR, IrDA	-40 to 85	LQFP	2.45
MSP430F6724A	25	96	4	72	1	4	3	3	ADC10-6ch, SigmaDelta24-2ch	0	4	0	32x32	N/A	LCD, RTC, Temp sensor, BOR, IrDA	-40 to 85	LQFP	2.45
MSP430F6725	25	128	4	72	1	4	3	3	ADC10-6ch, SigmaDelta24-2ch	0	4	0	32x32	N/A	LCD, RTC, Temp sensor, BOR, IrDA	-40 to 85	LQFP	2.60
MSP430F6725A	25	128	4	72	1	4	3	3	ADC10-6ch, SigmaDelta24-2ch	0	4	0	32x32	N/A	LCD, RTC, Temp sensor, BOR, IrDA	-40 to 85	LQFP	2.60
MSP430F6726	25	128	8	72	1	4	3	3	ADC10-6ch, SigmaDelta24-2ch	0	4	0	32x32	N/A	LCD, RTC, Temp sensor, BOR, IrDA	-40 to 85	LQFP	2.70
MSP430F6726A	25	128	8	72	1	4	3	3	ADC10-6ch, SigmaDelta24-3ch	0	4	0	32x32	N/A	LCD, RTC, Temp sensor, BOR, IrDA	-40 to 85	LQFP	2.70
MSP430F6730	25	16	1	72	1	4	3	3	ADC10-6ch, SigmaDelta24-3ch	0	4	0	32x32	N/A	LCD, RTC, Temp sensor, BOR, IrDA	-40 to 85	LQFP	2.45
MSP430F6730A	25	16	1	72	1	4	3	3	ADC10-6ch, SigmaDelta24-3ch	0	4	0	32x32	N/A	LCD, RTC, Temp sensor, BOR, IrDA	-40 to 85	LQFP	2.45
MSP430F6731	25	32	2	72	1	4	3	3	ADC10-6ch, SigmaDelta24-3ch	0	4	0	32x32	N/A	LCD, RTC, Temp sensor, BOR, IrDA	-40 to 85	LQFP	2.55
MSP430F6731A	25	32	2	72	1	4	3	3	ADC10-6ch, SigmaDelta24-3ch	0	4	0	32x32	N/A	LCD, RTC, Temp sensor, BOR, IrDA	-40 to 85	LQFP	2.55
MSP430F6733	25	64	4	72	1	4	3	3	ADC10-6ch, SigmaDelta24-3ch	0	4	0	32x32	N/A	LCD, RTC, Temp sensor, BOR, IrDA	-40 to 85	LQFP	2.75
MSP430F6733A	25	64	4	72	1	4	3	3	ADC10-6ch, SigmaDelta24-3ch	0	4	0	32x32	N/A	LCD, RTC, Temp sensor, BOR, IrDA	-40 to 85	LQFP	2.75
MSP430F6734	25	96	4	72	1	4	3	3	ADC10-6ch, SigmaDelta24-3ch	0	4	0	32x32	N/A	LCD, RTC, Temp sensor, BOR, IrDA	-40 to 85	LQFP	3.00
MSP430F6734A	25	96	4	72	1	4	3	3	ADC10-6ch, SigmaDelta24-3ch	0	4	0	32x32	N/A	LCD, RTC, Temp sensor, BOR, IrDA	-40 to 85	LQFP	3.00
MSP430F6735	25	128	4	72	1	4	3	3	ADC10-6ch, SigmaDelta24-3ch	0	4	0	32x32	N/A	LCD, RTC, Temp sensor, BOR, IrDA	-40 to 85	LQFP	3.15
MSP430F6735A	25	128	4	72	1	4	3	3	ADC10-6ch, SigmaDelta24-3ch	0	4	0	32x32	N/A	LCD, RTC, Temp sensor, BOR, IrDA	-40 to 85	LQFP	3.15
MSP430F6736	25	128	8	72	1	4	3	3	ADC10-6ch, SigmaDelta24-3ch	0	4	0	32x32	N/A	LCD, RTC, Temp sensor, BOR, IrDA	-40 to 85	LQFP	3.25
MSP430F6736A	25	128	8	72	1	4	3	3	ADC10-6ch, SigmaDelta24-3ch	0	4	0	32x32	N/A	LCD, RTC, Temp sensor, BOR, IrDA	-40 to 85	LQFP	3.30
MSP430F6745	25	128	16	90	2	6	4	3	ADC10-6ch, SigmaDelta24-4ch	0	4	0	32x32	AES128	LCD, RTC, Temp sensor, BOR, IrDA	-40 to 85	LQFP	4.13
MSP430F67451	25	128	16	90	2	6	4	3	ADC10-6ch, SigmaDelta24-4ch	0	4	0	32x32	N/A	LCD, RTC, Temp sensor, BOR, IrDA	-40 to 85	LQFP	3.86
MSP430F67451A	25	128	16	90	2	6	4	3	ADC10-6ch, SigmaDelta24-4ch	0	4	0	32x32	N/A	LCD, RTC, Temp sensor, BOR, IrDA	-40 to 85	LQFP	3.86
MSP430F6745A	25	128	16	90	2	6	4	3	ADC10-6ch, SigmaDelta24-4ch	0	4	0	32x32	AES128	LCD, RTC, Temp sensor, BOR, IrDA	-40 to 85	LQFP	4.13
MSP430F6746	25	256	16	90	2	6	4	3	ADC10-6ch, SigmaDelta24-4ch	0	4	0	32x32	AES128	LCD, RTC, Temp sensor, BOR, IrDA	-40 to 85	LQFP	4.94
MSP430F67461	25	256	16	90	2	6	4	3	ADC10-6ch, SigmaDelta24-4ch	0	4	0	32x32	N/A	LCD, RTC, Temp sensor, BOR, IrDA	-40 to 85	LQFP	4.67
MSP430F67461A	25	256	16	90	2	6	4	3	ADC10-6ch, SigmaDelta24-4ch	0	4	0	32x32	N/A	LCD, RTC, Temp sensor, BOR, IrDA	-40 to 85	LQFP	4.67
MSP430F6746A	25	256	16	90	2	6	4	3	ADC10-6ch, SigmaDelta24-4ch	0	4	0	32x32	AES128	LCD, RTC, Temp sensor, BOR, IrDA	-40 to 85	LQFP	4.94
MSP430F6747	25	256	32	90	2	6	4	3	ADC10-6ch, SigmaDelta24-4ch	0	4	0	32x32	AES128	LCD, RTC, Temp sensor, BOR, IrDA	-40 to 85	LQFP	4.79
MSP430F67471	25	256	32	90	2	6	4	3	ADC10-6ch, SigmaDelta24-4ch	0	4	0	32x32	N/A	LCD, RTC, Temp sensor, BOR, IrDA	-40 to 85	LQFP	4.79

¹Prices are quoted in U.S. dollars and represent year 2016 suggested resale price.

MSP430F6xx Series – Up to 25 MHz with LCD (continued)

Part Number	Frequency (MHz)	Non-volatile Memory (KB)	SRAM (KB)	GPIO	I ² C	SPI	UART	DMA	ADC	Comparator (Channels)	Timers 16-Bit	Timers 32-Bit	Multiplier	AES	Additional Features	Operating Temperature Range (°C)	Package Group	1 ku Price ¹ (U.S. \$)	
F67xx (continued)																			
MSP430F67471A	25	25	32	90	2	6	4	3	ADC10-6ch, SigmaDelta24-4ch	0	4	0	32x32	N/A	LCD, RTC, Temp sensor, BOR, IrDA	-40 to 85	LQFP	4.79	
MSP430F6747A	25	256	32	90	2	6	4	3	ADC10-6ch, SigmaDelta24-4ch	0	4	0	32x32	AES128	LCD, RTC, Temp sensor, BOR, IrDA	-40 to 85	LQFP	4.79	
MSP430F6748	25	512	16	90	2	6	4	3	ADC10-6ch, SigmaDelta24-4ch	0	4	0	32x32	AES128	LCD, RTC, Temp sensor, BOR, IrDA	-40 to 85	LQFP	6.11	
MSP430F67481	25	512	16	90	2	6	4	3	ADC10-6ch, SigmaDelta24-4ch	0	4	0	32x32	N/A	LCD, RTC, Temp sensor, BOR, IrDA	-40 to 85	LQFP	5.91	
MSP430F67481A	25	512	16	90	2	6	4	3	ADC10-6ch, SigmaDelta24-4ch	0	4	0	32x32	N/A	LCD, RTC, Temp sensor, BOR, IrDA	-40 to 85	LQFP	5.91	
MSP430F6748A	25	512	16	90	2	6	4	3	ADC10-6ch, SigmaDelta24-4ch	0	4	0	32x32	AES128	LCD, RTC, Temp sensor, BOR, IrDA	-40 to 85	LQFP	6.11	
MSP430F6749	25	512	32	90	2	6	4	3	ADC10-6ch, SigmaDelta24-4ch	0	4	0	32x32	AES128	LCD, RTC, Temp sensor, BOR, IrDA	-40 to 85	LQFP	6.49	
MSP430F67491	25	512	32	90	2	6	4	3	ADC10-6ch, SigmaDelta24-4ch	0	4	0	32x32	N/A	LCD, RTC, Temp sensor, BOR, IrDA	-40 to 85	LQFP	5.91	
MSP430F67491A	25	512	32	90	2	6	4	3	ADC10-6ch, SigmaDelta24-4ch	0	4	0	32x32	N/A	LCD, RTC, Temp sensor, BOR, IrDA	-40 to 85	LQFP	5.91	
MSP430F6749A	25	512	32	90	2	6	4	3	ADC10-6ch, SigmaDelta24-4ch	0	4	0	32x32	AES128	LCD, RTC, Temp sensor, BOR, IrDA	-40 to 85	LQFP	6.02	
MSP430F67621	25	64	4	72	1	4		3	ADC10-6ch, SigmaDelta24-3ch	0	4	0	32x32	N/A	LCD, RTC, Temp sensor, BOR, IrDA	-40 to 85	LQFP	2.60	
MSP430F67621A	25	64	4	72	1	4		3	ADC10-6ch, SigmaDelta24-3ch	0	4	0	32x32	N/A	LCD, RTC, Temp sensor, BOR, IrDA	-40 to 85	LQFP	2.60	
MSP430F67641	25	128	8	72	1	4	3	3	ADC10-6ch, SigmaDelta24-3ch	0	4	0	32x32	N/A	LCD, RTC, Temp sensor, BOR, IrDA	-40 to 85	LQFP	2.76	
MSP430F67641A	25	128	8	72	1	4	3	3	ADC10-6ch, SigmaDelta24-3ch	0	4	0	32x32	N/A	LCD, RTC, Temp sensor, BOR, IrDA	-40 to 85	LQFP	2.76	
MSP430F6765	25	128	16	90	2	6	4	3	ADC10-6ch, SigmaDelta24-6ch	0	4	0	32x32	AES128	LCD, RTC, Temp sensor, BOR, IrDA	-40 to 85	LQFP	4.36	
MSP430F67651	25	128	16	90	2	6	4	3	ADC10-6ch, SigmaDelta24-6ch	0	4	0	32x32	N/A	LCD, RTC, Temp sensor, BOR, IrDA	-40 to 85	LQFP	4.09	
MSP430F67651A	25	128	16	90	2	6	4	3	ADC10-6ch, SigmaDelta24-6ch	0	4	0	32x32	N/A	LCD, RTC, Temp sensor, BOR, IrDA	-40 to 85	LQFP	4.09	
MSP430F6765A	25	128	16	90	2	6	4	3	ADC10-6ch, SigmaDelta24-6ch	0	4	0	32x32	AES128	LCD, RTC, Temp sensor, BOR, IrDA	-40 to 85	LQFP	4.36	
MSP430F6766	25	256	16	90	2	6	4	3	ADC10-6ch, SigmaDelta24-6ch	0	4	0	32x32	AES128	LCD, RTC, Temp sensor, BOR, IrDA	-40 to 85	LQFP	4.06	
MSP430F67661	25	256	16	90	2	6	4	3	ADC10-6ch, SigmaDelta24-6ch	0	4	0	32x32	N/A	LCD, RTC, Temp sensor, BOR, IrDA	-40 to 85	LQFP	4.06	
MSP430F67661A	25	256	16	90	2	6	4	3	ADC10-6ch, SigmaDelta24-6ch	0	4	0	32x32	N/A	LCD, RTC, Temp sensor, BOR, IrDA	-40 to 85	LQFP	4.06	
MSP430F6766A	25	256	16	90	2	6	4	3	ADC10-6ch, SigmaDelta24-6ch	0	4	0	32x32	AES128	LCD, RTC, Temp sensor, BOR, IrDA	-40 to 85	LQFP	4.06	
MSP430F6767	25	256	32	90	2	6	4	3	ADC10-6ch, SigmaDelta24-6ch	0	4	0	32x32	AES128	LCD, RTC, Temp sensor, BOR, IrDA	-40 to 85	LQFP	5.29	
MSP430F67671	25	256	32	90	2	6	4	3	ADC10-6ch, SigmaDelta24-6ch	0	4	0	32x32	N/A	LCD, RTC, Temp sensor, BOR, IrDA	-40 to 85	LQFP	5.02	
MSP430F67671A	25	256	32	90	2	6	4	3	ADC10-6ch, SigmaDelta24-6ch	0	4	0	32x32	N/A	LCD, RTC, Temp sensor, BOR, IrDA	-40 to 85	LQFP	5.02	
MSP430F6767A	25	256	32	90	2	6	4	3	ADC10-6ch, SigmaDelta24-6ch	0	4	0	32x32	AES128	LCD, RTC, Temp sensor, BOR, IrDA	-40 to 85	LQFP	5.29	
MSP430F6768	25	512	16	90	2	6	4	3	ADC10-6ch, SigmaDelta24-6ch	0	4	0	32x32	AES128	LCD, RTC, Temp sensor, BOR, IrDA	-40 to 85	LQFP	6.41	
MSP430F67681	25	512	16	90	2	6	4	3	ADC10-6ch, SigmaDelta24-6ch	0	4	0	32x32	N/A	LCD, RTC, Temp sensor, BOR, IrDA	-40 to 85	LQFP	6.14	
MSP430F67681A	25	512	16	90	2	6	4	3	ADC10-6ch, SigmaDelta24-6ch	0	4	0	32x32	N/A	LCD, RTC, Temp sensor, BOR, IrDA	-40 to 85	LQFP	6.14	
MSP430F6768A	25	512	16	90	2	6	4	3	ADC10-6ch, SigmaDelta24-6ch	0	4	0	32x32	AES128	LCD, RTC, Temp sensor, BOR, IrDA	-40 to 85	LQFP	6.41	

¹Prices are quoted in U.S. dollars and represent year 2016 suggested resale price.

MSP430F6xx Series – Up to 25 MHz with LCD (continued)

Part Number	Frequency (MHz)	Non-volatile Memory (KB)	SRAM (KB)	GPIO	I ² C	SPI	UART	DMA	ADC	Comparator (Channels)	Timers 16-Bit	Timers 32-Bit	Multiplier	AES	Additional Features	Operating Temperature Range (°C)	Package Group	1 ku Price ¹ (U.S. \$)
F67xx (continued)																		
MSP430F6769	25	512	32	90	2	6	4	3	ADC10-6ch, SigmaDelta24-6ch	0	4	0	32x32	AES128	LCD, RTC, Temp sensor, BOR, IrDA	-40 to 85	LQFP	6.52
MSP430F67691	25	512	32	90	2	6	4	3	ADC10-6ch, SigmaDelta24-6ch	0	4	0	32x32	N/A	LCD, RTC, Temp sensor, BOR, IrDA	-40 to 85	LQFP	6.25
MSP430F67691A	25	512	32	90	2	6	4	3	ADC10-6ch, SigmaDelta24-6ch	0	4	0	32x32	N/A	LCD, RTC, Temp sensor, BOR, IrDA	-40 to 85	LQFP	6.25
MSP430F6769A	25	512	32	90	2	6	4	3	ADC10-6ch, SigmaDelta24-6ch	0	4	0	32x32	AES128	LCD, RTC, Temp sensor, BOR, IrDA	-40 to 85	LQFP	6.52
MSP430F6775	25	128	16	90	2	6	4	3	ADC10-6ch, SigmaDelta24-7ch	0	4	0	32x32	AES128	LCD, RTC, Temp sensor, BOR, IrDA	-40 to 85	LQFP	4.59
MSP430F67751	25	128	16	90	2	6	4	3	ADC10-6ch, SigmaDelta24-7ch	0	4	0	32x32	N/A	LCD, RTC, Temp sensor, BOR, IrDA	-40 to 85	LQFP	4.32
MSP430F67751A	25	128	16	90	2	6	4	3	AADC10-6ch, SigmaDelta24-7ch	0	4	0	32x32	N/A	LCD, RTC, Temp sensor, BOR, IrDA	-40 to 85	LQFP	4.32
MSP430F6775A	25	128	16	90	2	6	4	3	ADC10-6ch, SigmaDelta24-7ch	0	4	0	32x32	AES128	LCD, RTC, Temp sensor, BOR, IrDA	-40 to 85	LQFP	4.59
MSP430F6776	25	256	16	90	2	6	4	3	ADC10-6ch, SigmaDelta24-7ch	0	4	0	32x32	AES128	LCD, RTC, Temp sensor, BOR, IrDA	-40 to 85	LQFP	5.40
MSP430F67761	25	256	16	90	2	6	4	3	ADC10-6ch, SigmaDelta24-7ch	0	4	0	32x32	N/A	LCD, RTC, Temp sensor, BOR, IrDA	-40 to 85	LQFP	5.13
MSP430F67761A	25	256	16	90	2	6	4	3	ADC10-6ch, SigmaDelta24-7ch	0	4	0	32x32	N/A	LCD, RTC, Temp sensor, BOR, IrDA	-40 to 85	LQFP	5.13
MSP430F6776A	25	256	16	90	2	6	4	3	ADC10-6ch, SigmaDelta24-7ch	0	4	0	32x32	AES128	LCD, RTC, Temp sensor, BOR, IrDA	-40 to 85	LQFP	5.40
MSP430F6777	25	256	32	90	2	6	4	3	ADC10-6ch, SigmaDelta24-7ch	0	4	0	32x32	AES128	LCD, RTC, Temp sensor, BOR, IrDA	-40 to 85	LQFP	5.52
MSP430F67771	25	256	32	90	2	6	4	3	ADC10-6ch, SigmaDelta24-7ch	0	4	0	32x32	N/A	LCD, RTC, Temp sensor, BOR, IrDA	-40 to 85	LQFP	5.25
MSP430F67771A	25	256	32	90	2	6	4	3	ADC10-6ch, SigmaDelta24-7ch	0	4	0	32x32	N/A	LCD, RTC, Temp sensor, BOR, IrDA	-40 to 85	LQFP	5.25
MSP430F6777A	25	256	32	90	2	6	4	3	ADC10-6ch, SigmaDelta24-7ch	0	4	0	32x32	AES128	LCD, RTC, Temp sensor, BOR, IrDA	-40 to 85	LQFP	5.52
MSP430F6778	25	512	16	90	2	6	4	3	ADC10-6ch, SigmaDelta24-7ch	0	4	0	32x32	AES128	LCD, RTC, Temp sensor, BOR, IrDA	-40 to 85	LQFP	6.64
MSP430F67781	25	512	16	90	2	6	4	3	ADC10-6ch, SigmaDelta24-7ch	0	4	0	32x32	N/A	LCD, RTC, Temp sensor, BOR, IrDA	-40 to 85	LQFP	6.37
MSP430F67781A	25	512	16	90	2	6	4	3	ADC10-6ch, SigmaDelta24-7ch	0	4	0	32x32	N/A	LCD, RTC, Temp sensor, BOR, IrDA	-40 to 85	LQFP	6.37
MSP430F6778A	25	512	16	90	2	6	4	3	ADC10-6ch, SigmaDelta24-7ch	0	4	0	32x32	AES128	LCD, RTC, Temp sensor, BOR, IrDA	-40 to 85	LQFP	6.64
MSP430F6779	25	512	32	90	2	6	4	3	ADC10-6ch, SigmaDelta24-7ch	0	4	0	32x32	AES128	LCD, RTC, Temp sensor, BOR, IrDA	-40 to 85	LQFP	6.76
MSP430F67791	25	512	32	90	2	6	4	3	ADC10-6ch, SigmaDelta24-7ch	0	4	0	32x32	N/A	LCD, RTC, Temp sensor, BOR, IrDA	-40 to 85	LQFP	6.48
MSP430F67791A	25	512	32	90	2	6	4	3	ADC10-6ch, SigmaDelta24-7ch	0	4	0	32x32	N/A	LCD, RTC, Temp sensor, BOR, IrDA	-40 to 85	LQFP	6.48
MSP430F6779A	25	512	32	90	2	6	4	3	ADC10-6ch, SigmaDelta24-7ch	0	4	0	32x32	AES128	LCD, RTC, Temp sensor, BOR, IrDA	-40 to 85	LQFP	6.76

¹Prices are quoted in U.S. dollars and represent year 2016 suggested resale price.

Wireless Microcontrollers

Sub-1GHz RF + MSP MCU

This 16-bit MSP430-based RF microcontroller lineup provides tight integration between the microcontroller core, peripherals,

software, and RF transceiver, creating true system-on-chip solutions that are easy to use. Features <1-GHz RF transceiver with 1.8V–3.6V operation.

Embedded RF (Sub-1 GHz RF + MSP Microcontroller) Series – Up to 20 MHz

Part Number	Flash (KB)	SRAM (KB)	I/O (max)	16-Bit Timers			Watchdog and RTC	PMM: BOR, SVS, SVM, LDO	USCI		DMA	MPY	Comp B	Temp Sensor	ADC Ch/Res	Additional Features	Package(s)	1ku Price ¹ (U.S. \$)	Common Features
				Total	A	B			Ch A: UART/LIN/IrDA/SPI	Ch B: I ² C/SPI									
CC430F51xx series																			
CC430F5123	8	2	30	2	5	3	●	●	1	1	3 ch	32×32 [†]	●	●	6 ch ADC12	—	48QFN	2.50	<ul style="list-style-type: none"> • AES HW encryption • Max RF data rate 500 kbps • Best sensitivity: 110 dBm¹ • Frequency ranges: 300–348 MHz, 389–464 MHz, 779–929 MHz
CC430F5125	16	2	30	2	5	3	●	●	1	1	3 ch	32×32 [†]	●	●	6 ch ADC12	—	48QFN	2.60	
CC430F5133	8	2	30	2	5	3	●	●	1	1	3 ch	32×32 [†]	●	●	6 ch ADC12	—	48QFN	2.50	
CC430F5135	16	2	30	2	5	3	●	●	1	1	3 ch	32×32 [†]	●	●	6 ch ADC12	—	48QFN	2.60	
CC430F5137	32	4	30	2	5	3	●	●	1	1	3 ch	32×32 [†]	●	●	6 ch ADC12	—	48QFN	2.70	
CC430F5143	8	2	30	2	5	3	●	●	1	1	3 ch	32×32 [†]	●	●	6 ch ADC12	—	48QFN	2.60	
CC430F5145	16	2	30	2	5	3	●	●	1	1	3 ch	32×32 [†]	●	●	6 ch ADC12	—	48QFN	2.70	
CC430F5147	32	4	30	2	5	3	●	●	1	1	3 ch	32×32 [†]	●	●	6 ch ADC12	—	48QFN	2.80	
CC430F61xx series																			
CC430F6125	16	2	44	2	5	3	●	●	1	1	3 ch	32×32 [†]	●	—	—	96 seg LCD	64QFN	2.80	
CC430F6126	32	2	44	2	5	3	●	●	1	1	3 ch	32×32 [†]	●	—	—	96 seg LCD	64QFN	2.90	
CC430F6127	32	4	44	2	5	3	●	●	1	1	3 ch	32×32 [†]	●	—	—	96 seg LCD	64QFN	3.00	
CC430F6135	16	2	44	2	5	3	●	●	1	1	3 ch	32×32 [†]	●	●	8 ch ADC12	96 seg LCD	64QFN	3.00	
CC430F6137	32	4	44	2	5	3	●	●	1	1	3 ch	32×32 [†]	●	●	8 ch ADC12	96 seg LCD	64QFN	3.10	
CC430F6143	8	2	44	2	5	3	●	●	1	1	3 ch	32×32 [†]	●	●	8 ch ADC10	96 seg LCD	64QFN	3.00	
CC430F6145	16	2	44	2	5	3	●	●	1	1	3 ch	32×32 [†]	●	●	8 ch ADC10	96 seg LCD	64QFN	3.10	
CC430F6147	32	4	44	2	5	3	●	●	1	1	3 ch	32×32 [†]	●	●	8 ch ADC10	96 seg LCD	64QFN	3.20	
RF430F5xxx series																			
RF430F5978	32	4	27	2	5	3	●	●	1	1	3 ch	32×32 [†]	●	●	8 ch	3D low P/f FE	64QFN	5.75	

¹Prices are quoted in U.S. dollars and represent year 2016 suggested resale price.

[†]At 1.2 kBaud, 868 MHz, 1% packet error rate.

^{*}Represents number of capture/compare register per timer.

[†]Supports 64-bit result length.

Differentiated Performance: If you need low-voltage operation, industrial temperature range, or embedded RF, then you have come to the right place!

Application-Specific MSP Devices

Application	Part Number	Flash (KB)	SRAM (KB)	16-Bit Timers			ADC	Additional Features	Related Devices	Package(s)	1 ku Price ¹ (U.S. \$)
				Total	A'	B'					
NFC	RF430CL330H	FF**	3	—	—	—	—	Dynamic NFC interface transponder, NFC tag type 4	—	14TSSOP	0.85
NFC	RF430FRL15xH	2	4	1	1	—	ΣΔ14	NFC ISO15693 sensor transponder w/ prog MSP4307™	—	24QFN	2.50
Low Voltage (0.9V)	MSP430L092	—	2	2	2	—	ADC8	DAC8, COMP, SVS, temp. sensor, 11 I/Os, ROM-version available	—	14TSSOP	1.00
Contactless Power	MSP430BQ1010	—	—	—	—	—	—	Fixed-function, Qi-certified software for contactless power applications (receiver). Compliant with the Wireless Power Consortium. Comes pre-loaded by default.	BQ25046, BQ500110	32QFN	1.80
Haptics	MSP430TCH5E	—	—	—	—	—	—	Haptics-enabled device authenticated to run Immersion Touchsense technology	—	28TSSOP, 32QFN	1.80

¹Prices are quoted in U.S. dollars and represent year 2016 suggested resale price.

*Represents number of capture/compare registers per timer.

**Represents Fixed Function ROM.

Enhanced Performance

Part Number	Frequency (MHz)	Non-volatile Memory (KB)	SRAM (kB)	GPIO	I ² C	SPI	UART	DMA	ADC	Comparators	Timers 16-Bit	Timers 32-Bit	Multiplier	AES	Additional Features	Operating Temperature Range (°C)	Package Group	1 ku Price ¹ (U.S. \$)
Auto and EP																		
MSP430F2619S-HT	16	120	4	48	2	4	2	3	ADC12-8ch	Yes	2	0	16×16	N/A	DAC, Temp sensor, BOR	-55 to 150	LQFP, XCEPT	See Web
MSP430F2013-EP	16	2	0.125	10	1	1	0	0	SigmaDelta16-4ch	0	1	0	N/A	N/A	Temp sensor, BOR	-40 to 125	QFN	See Web
MSP430F2274-EP	16	32	1	32	1	1	1	0	ADC10-12ch	0	2	0	N/A	N/A	OpAmp, Temp sensor, BOR	-55 to 125	TSSOP, VQFN	See Web
MSP430F249-EP	16	60	2	48	4	2	2	0	ADC12-8ch	Yes	2	0	16×16	N/A	Temp sensor, BOR	-55 to 125	LQFP	See Web
MSP430F2618-EP	16	116	8	48	2	2	2	3	ADC12-8ch	Yes	2	0	16×16	N/A	DAC, Temp sensor, BOR	-40 to 105	BGA MicroStar Junior™	See Web
MSP430G2230-EP	16	2	0.125	4	1	1	0	1	ADC10-4ch	0	1	0	N/A	N/A	Temp sensor, BOR	-40 to 125	SOIC	See Web
MSP430G2231-EP	16	2	0.125	10	1	1	0	1	ADC10-8ch	0	1	0	N/A	N/A	Temp sensor, BOR	-40 to 125	TSSOP	See Web
MSP430G2302-EP	16	4	0.25	16	1	1	0	0	N/A	0	1	0	N/A	N/A	BOR	-40 to 85	TSSOP	See Web

¹Prices are quoted in U.S. dollars and represent year 2016 suggested resale price.

Note: Additional 105°C microcontrollers available on page 21.

Package Options

Ultra-Low-Power MSP MCU Selected Package Options

8-pin D (SOIC)

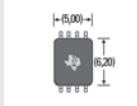

14-pin PW (TSSOP)

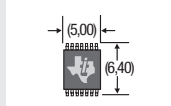

14-pin N (DIP)

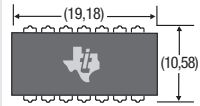

16-pin RSA (QFN)

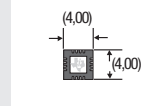

20-pin DVG (TVSOP)

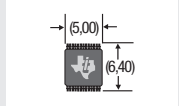

20-pin PW (TSSOP)

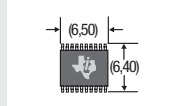

20-pin DW (SOIC)

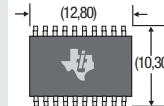

20-pin N (PDIP)

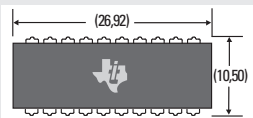

24-pin RGE (QFN)

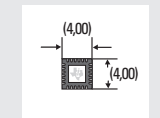

28-pin DW (SOIC)

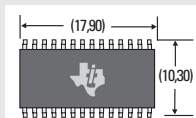

28-pin PW (TSSOP)

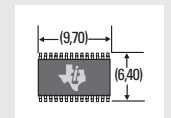

32-pin RTV (QFN)

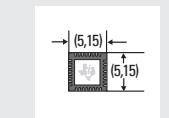

32-pin RHB (QFN)

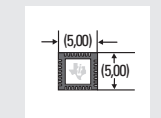

38-pin DA (TSSOP)

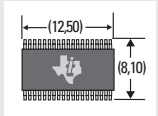

40-pin RHA (QFN)

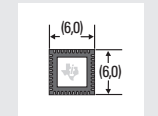

40-pin RSB (QFN)

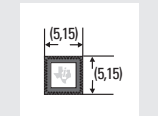

48-pin RGZ (QFN)

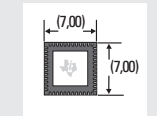

48-pin DL (SSOP)

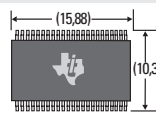

48-pin PT (LQFP)

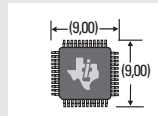

64-pin RGC, RTD (QFN)

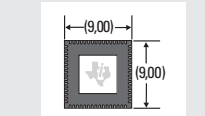

64-pin PM, PAG (LQFP/TQFP)

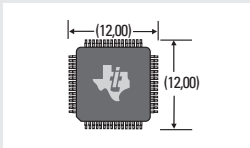

80-pin ZQE (BGA)

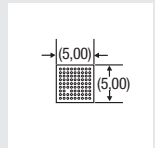

80-pin PN (LQFP)

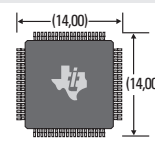

100-pin PZ (LQFP)

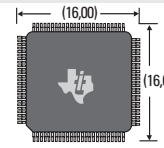

113-pin ZQW (BGA)

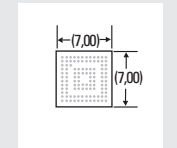

128-pin PEU (LQFP)

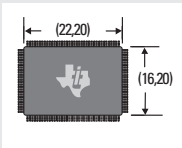

Die-Size BGA Packages

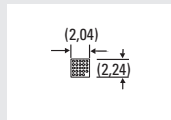
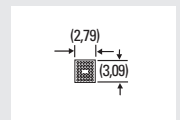
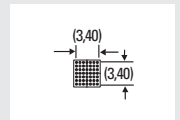
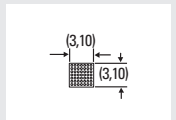
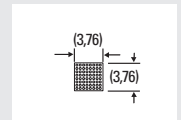
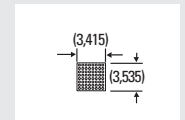
24-pin YQD (DSBGA)
MSP430FR573940-pin YFF (DSBGA)
MSP430F51xx49-pin YFF (DSBGA)
MSP430F22xx49-pin YFF (DSBGA)
MSP430F23xx64-pin YFF (DSBGA)
MSP430F55xx64-pin YFF (DSBGA)
MSP430F5229

More information on package dimensions available in the datasheets or at ti.com/packaging.

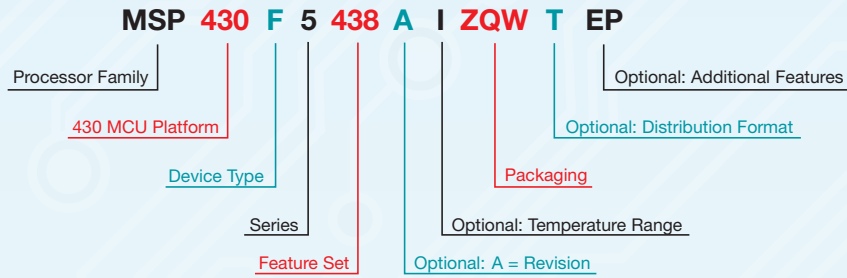

Processor Family	CC = Embedded RF Radio MSP = Mixed Signal Processor XMS = Experimental Silicon		
430 MCU Platform	TI's Low Power Microcontroller Platform		
Device Type	Memory Type C = ROM F = FLASH FR = FRAM G = FLASH L = No nonvolatile memory	Specialized Application AFE = Analog front end BT = <i>Bluetooth</i> [®] BQ = Contactless power CG = ROM medical FE = Flash energy meter FG = Flash medical FW = Flash electronic flow meter	
Series	1 Series = Up to 8 MHz 2 Series = Up to 16 MHz 3 Series = Legacy OTP 4 Series = Up to 16 MHz w/ LCD	5 Series = Up to 25 MHz 6 Series = Up to 25 MHz w/ LCD 0 = Low-voltage series	
Feature Set	Various levels of integration within a series		
Optional: A = Revision	N/A		
Optional: Temperature Range	S = 0°C to 50°C C = 0°C to 70°C I = -40°C to 85°C T = -40°C to 105°C		
Packaging	www.ti.com/packaging		
Optional: Distribution Format	T = Small reel (7 in) R = Large reel (11 in) No markings = Tube or tray		
Optional: Additional Features	Q1 = Automotive qualified EP = Enhanced product (-40°C to 105°C) HT = Extreme temperature parts (-55°C to 150°C)		

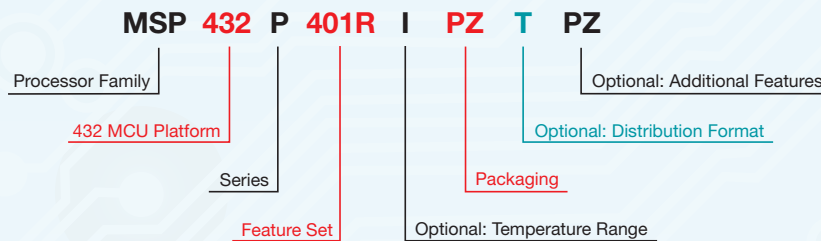

Processor Family	MSP = Mixed Signal Processor XMS = Experimental Silicon			
432 MCU Platform	TI's 32-bit Low-Pwer Microcontroller Platform			
Series	P = Performance and Low-Power Series			
Feature Set	First Digit 4 = Flash-based devices up to 48 MHz	Second Digit 0 = General Purpose	Third Digit 1 = ADC14	Fourth Digit R = 256-kB Flash 64-kB SRAM M = 128-kB Flash 32-kB SRAM
Optional: Temperature Range	S = 0°C to 50°C I = -40°C to 85°C T = -40°C to 105°C			
Packaging	www.ti.com/packaging			
Optional: Distribution Format	T = Small Reel (7 inch) R = Large Reel (11 inch) No Markings = Tube or Tray			
Optional: Additional Features	-EP = Enhanced Product (-40°C to 105°C) -HT = Extreme Temperature Parts (-55°C to 150°C) -Q1 = Automotive Q100 Qualified			

TI MCU Portfolio Overview

	Microcontrollers									
	Low Power		Performance			Wireless				
Key features	Combines smart analog with low system energy to fit any power budget <ul style="list-style-type: none"> World's only embedded FRAM MCU family Broad range of applications such as smart grid, wearables, sensors and energy harvesting 		Specializes in control loop and functional safety applications <ul style="list-style-type: none"> Experts in applications for motor control, industrial drives, digital power and transportation Support for functional safety standards like IEC 61508 and ISO 26262 			Connecting the world one product at a time with low-power wireless MCU solutions <ul style="list-style-type: none"> Utilize multiple protocols such as Sub-1 GHz, NFC, Wi-Fi®, Bluetooth®, Bluetooth Smart (Bluetooth low energy), 2.4 GHz and ZigBee® 				
Product family	MSP Ultra-Low-Power MCUs	MSP Low-Power + Performance MCUs	C2000™ Real-time Control MCUs	Control + Automation	Safety MCUs	RF430 MCUs	CC430 MCUs	SimpleLink™ CC1x	SimpleLink CC2x	SimpleLink CC3x
	Applications where the majority of devices live is in standby	Mostly "On" battery-powered applications needing significant compute requirements	Applications needing low latency closed-loop control	Expanding real-time control platforms with Host Control and Industrial Communications technology	Applications that require functional safety	Industry leading NFC and 13.56-MHz RF solutions	MSP with integrated sub-1 GHz RF transceiver for ultra-low power applications	Integrated sub-1 GHz RF transceiver with an 8051 MCU	Multi-protocol platform offering solutions for 2.4 GHz, Bluetooth, BLE and ZigBee technologies	Internet of Things solution with integrated Wi-Fi

TI Worldwide Technical Support

Internet

TI Semiconductor Product Information Center Home Page
support.ti.com

TI E2E™ Community Home Page
e2e.ti.com

Product Information Centers

Americas	Phone	+1(512) 434-1560
Brazil	Phone	0800-891-2616
Mexico	Phone	0800-670-7544
	Fax	+1(972) 927-6377
	Internet/Email	support.ti.com/sc/pic/americas.htm

Europe, Middle East, and Africa

Phone		
European Free Call		00800-ASK-TEXAS (00800 275 83927)
International		+49 (0) 8161 80 2121
Russian Support		+7 (4) 95 98 10 701
Note: The European Free Call (Toll Free) number is not active in all countries. If you have technical difficulty calling the free call number, please use the international number above.		
Fax		+(49) (0) 8161 80 2045
Internet		www.ti.com/asktexas
Direct Email		asktexas@ti.com

Japan

Fax	International	+81-3-3344-5317
	Domestic	0120-81-0036
Internet/Email	International	support.ti.com/sc/pic/japan.htm
	Domestic	www.tij.co.jp/pic

Asia

Phone	<u>Toll-Free Number</u>
Note: Toll-free numbers may not support mobile and IP phones.	
Australia	1-800-999-084
China	800-820-8682
Hong Kong	800-96-5941
India	000-800-100-8888
Indonesia	001-803-8861-1006
Korea	080-551-2804
Malaysia	1-800-80-3973
New Zealand	0800-446-934
Philippines	1-800-765-7404
Singapore	800-886-1028
Taiwan	0800-006800
Thailand	001-800-886-0010
International	+86-21-23073444
Fax	+86-21-23073686
Email	tiasia@ti.com or ti-china@ti.com
Internet	support.ti.com/sc/pic/asia.htm

Important Notice: The products and services of Texas Instruments Incorporated and its subsidiaries described herein are sold subject to TI's standard terms and conditions of sale. Customers are advised to obtain the most current and complete information about TI products and services before placing orders. TI assumes no liability for applications assistance, customer's applications or product designs, software performance, or infringement of patents. The publication of information regarding any other company's products or services does not constitute TI's approval, warranty or endorsement thereof.

B021014

The platform bar, C2000, Code Composer Studio, E2E, EnergyTrace, Grace, MSP430, MSP432, MicroStar Junior, SimpleLink, Sitara, ULP Advisor and WiLink are trademarks of Texas Instruments. All other trademarks are the property of their respective owners.

IMPORTANT NOTICE

Texas Instruments Incorporated and its subsidiaries (TI) reserve the right to make corrections, enhancements, improvements and other changes to its semiconductor products and services per JESD46, latest issue, and to discontinue any product or service per JESD48, latest issue. Buyers should obtain the latest relevant information before placing orders and should verify that such information is current and complete. All semiconductor products (also referred to herein as "components") are sold subject to TI's terms and conditions of sale supplied at the time of order acknowledgment.

TI warrants performance of its components to the specifications applicable at the time of sale, in accordance with the warranty in TI's terms and conditions of sale of semiconductor products. Testing and other quality control techniques are used to the extent TI deems necessary to support this warranty. Except where mandated by applicable law, testing of all parameters of each component is not necessarily performed.

TI assumes no liability for applications assistance or the design of Buyers' products. Buyers are responsible for their products and applications using TI components. To minimize the risks associated with Buyers' products and applications, Buyers should provide adequate design and operating safeguards.

TI does not warrant or represent that any license, either express or implied, is granted under any patent right, copyright, mask work right, or other intellectual property right relating to any combination, machine, or process in which TI components or services are used. Information published by TI regarding third-party products or services does not constitute a license to use such products or services or a warranty or endorsement thereof. Use of such information may require a license from a third party under the patents or other intellectual property of the third party, or a license from TI under the patents or other intellectual property of TI.

Reproduction of significant portions of TI information in TI data books or data sheets is permissible only if reproduction is without alteration and is accompanied by all associated warranties, conditions, limitations, and notices. TI is not responsible or liable for such altered documentation. Information of third parties may be subject to additional restrictions.

Resale of TI components or services with statements different from or beyond the parameters stated by TI for that component or service voids all express and any implied warranties for the associated TI component or service and is an unfair and deceptive business practice. TI is not responsible or liable for any such statements.

Buyer acknowledges and agrees that it is solely responsible for compliance with all legal, regulatory and safety-related requirements concerning its products, and any use of TI components in its applications, notwithstanding any applications-related information or support that may be provided by TI. Buyer represents and agrees that it has all the necessary expertise to create and implement safeguards which anticipate dangerous consequences of failures, monitor failures and their consequences, lessen the likelihood of failures that might cause harm and take appropriate remedial actions. Buyer will fully indemnify TI and its representatives against any damages arising out of the use of any TI components in safety-critical applications.

In some cases, TI components may be promoted specifically to facilitate safety-related applications. With such components, TI's goal is to help enable customers to design and create their own end-product solutions that meet applicable functional safety standards and requirements. Nonetheless, such components are subject to these terms.

No TI components are authorized for use in FDA Class III (or similar life-critical medical equipment) unless authorized officers of the parties have executed a special agreement specifically governing such use.

Only those TI components which TI has specifically designated as military grade or "enhanced plastic" are designed and intended for use in military/aerospace applications or environments. Buyer acknowledges and agrees that any military or aerospace use of TI components which have **not** been so designated is solely at the Buyer's risk, and that Buyer is solely responsible for compliance with all legal and regulatory requirements in connection with such use.

TI has specifically designated certain components as meeting ISO/TS16949 requirements, mainly for automotive use. In any case of use of non-designated products, TI will not be responsible for any failure to meet ISO/TS16949.

Products

Audio	www.ti.com/audio
Amplifiers	amplifier.ti.com
Data Converters	dataconverter.ti.com
DLP® Products	www.dlp.com
DSP	dsp.ti.com
Clocks and Timers	www.ti.com/clocks
Interface	interface.ti.com
Logic	logic.ti.com
Power Mgmt	power.ti.com
Microcontrollers	microcontroller.ti.com
RFID	www.ti-rfid.com
OMAP Applications Processors	www.ti.com/omap
Wireless Connectivity	www.ti.com/wirelessconnectivity

Applications

Automotive and Transportation	www.ti.com/automotive
Communications and Telecom	www.ti.com/communications
Computers and Peripherals	www.ti.com/computers
Consumer Electronics	www.ti.com/consumer-apps
Energy and Lighting	www.ti.com/energy
Industrial	www.ti.com/industrial
Medical	www.ti.com/medical
Security	www.ti.com/security
Space, Avionics and Defense	www.ti.com/space-avionics-defense
Video and Imaging	www.ti.com/video

TI E2E Community

e2e.ti.com