



CFX Opus 96 and CFX Opus 384
Real-Time PCR Systems

Instrument Guide



CFX Opus 96 and CFX Opus 384 Real-Time PCR Systems

Instrument Guide

BIO-RAD

Bio-Rad Technical Support

The Bio-Rad Technical Support department in the U.S. is open Monday through Friday, 5:00 AM to 5:00 PM, Pacific Time.

Phone: 1-800-424-6723, option 2

Email: Support@bio-rad.com (U.S./Canada Only)

For technical assistance outside the U.S. and Canada, contact your local technical support office or click the Contact us link at www.bio-rad.com.

Notice

No part of this publication may be reproduced or transmitted in any form or by any means, electronic or mechanical, including photocopy, recording, or any information storage or retrieval system, without permission in writing from Bio-Rad.

Bio-Rad reserves the right to modify its products and services at any time. This guide is subject to change without notice. Although prepared to ensure accuracy, Bio-Rad assumes no liability for errors or omissions, or for any damage resulting from the application or use of this information.

BIO-RAD, HARD-SHELL, and MICROSEAL are trademarks of Bio-Rad Laboratories, Inc. in certain jurisdictions.

SYBR is a trademark of Thermo Fisher Scientific Inc. Bio-Rad Laboratories, Inc. is licensed to sell reagents containing SYBR Green I for use in real-time PCR, for research purposes only.

All trademarks used herein are the property of their respective owner.

Copyright © 2020 by Bio-Rad Laboratories, Inc. All rights reserved.

Table of Contents

Safety and Regulatory Compliance	7
Safety Warning Labels	7
Safety and Regulatory Compliance	9
Safety Compliance	9
Electromagnetic Compatibility (EMC)	11
EMC Warnings and Notes	11
Hazards	12
Biohazards	12
Chemical Hazards	13
Explosive or Flammability Hazards	13
Electrical Hazards	14
Transport	14
Battery	14
Disposal	14
Chapter 1 Introduction	15
Main Features	15
Performance Specifications	16
Reaction Module Performance Specifications	16
Optical Detection Performance Specifications	17
Finding Out More	17
Chapter 2 Setting Up the CFX Opus System	19
Site Requirements	19
Bench Space Requirements	19
Environment Requirements	20
Power Requirements	20
Network Requirements	21
System Overview	22
Front View	22

Table of Contents

Back View	25
Unpacking the System	26
Packaged Instrument Specifications	26
Unpacking the System	28
Connecting the Power and Communication Cables	32
Removing the Shipping Screw	33
Logging In to CFX Opus	36
Starting the CFX Opus System	37
Creating CFX Opus User Accounts	38
Logging In to CFX Opus	40
Loading Sample Plates	42
Shutting Down the CFX Opus System	44
Chapter 3 Configuring the CFX Opus System	45
Touch Screen Overview	46
Software Files	48
Tools Screen	49
User Tools Screen Options	49
Admin Tools Screen Options	51
Renaming the CFX Opus System	53
Setting the Time Zone on CFX Opus Systems	54
Setting Up a Network Connection	56
Setting Up the CFX Opus Wi-Fi Adaptor	60
Setting Up Email Service	63
Changing Email Servers	64
Connecting to a Computer Running CFX Maestro Software	65
Managing Personal User Accounts	67
Setting User Passwords	67
Setting Up Your Email Address	69
Setting Up a Connection to a Shared Network Drive	70
Connecting to Your Bio-Rad BR.io Account	72
Managing User Accounts	75
Setting the Admin Password	75
Resetting User Passwords	76
Deleting CFX Opus User Accounts	77

Chapter 4 Creating Protocols	79
Parameters and Ranges for Protocol Steps	80
Creating a Protocol	82
Modifying the Settings in a Protocol Step	87
Changing Target Temperature and Hold Time	87
Adding or Removing a Temperature Gradient	89
Adding or Removing the Ramp Rate	90
Adding or Removing a Temperature Increment	91
Adding or Removing an Extend Time Option	92
Adding or Removing a Beep Alert	92
Changing Parameters in a Goto Step	94
Setting Sample Volume and Lid Temperature	95
Sample Volume and Temperature Control Modes	95
Lid Temperature	96
Editing a Protocol	97
Editing a Protocol	97
Adding a Protocol Step	101
Deleting a Protocol Step	102
Renaming a Protocol	102
Saving an Edited Protocol	102
Chapter 5 Running Protocols	105
Running a Protocol	106
Running a Saved Protocol	106
Running a Pending Run from Your BR.io Cloud Account	110
Running a Completed CFX Opus Run	113
Monitoring a Run	115
Pausing a Run	116
Skipping Steps in a Protocol	116
Stopping a Run	117
Extracting and Editing a Protocol from a Run	118
Chapter 6 Managing Files and Folders	121
The File Browser Screen	122
Managing Files and Folders	124

Table of Contents

Managing Files on the CFX Opus System	125
Managing Folders on the CFX Opus System	128
Backing Up and Restoring Files and Folders	130
Transferring Data Files	130
Appendix A CFX Opus System and CFX Maestro Software Catalog Numbers ...	131
Warranty	132
Appendix B Recommended Plastic Consumables	133
Plastic Consumables for the CFX Opus 384 System	133
Plastic Consumables for the CFX Opus 96 System	133
Plate Seals and Plate Sealer	133
Appendix C Maintenance and Troubleshooting	135
Cleaning and Maintaining the CFX Opus System	135
Maintaining Sufficient Airflow	140
Testing for Sufficient Airflow	140
Fixing Insufficient Airflow	140
Replacing Fuses	141
Upgrading System Software and Firmware	145
Verifying the Currently Installed Version	145
Upgrading the System Software and Firmware	145
Shutting Down the CFX Opus System	147
Returning the CFX Opus System to Bio-Rad	148
Installing the Shipping Plate and Screw	148
Troubleshooting CFX Opus Systems	151
Viewing and Exporting Log Files	151
Toubleshooting Issues	153
Appendix D Bio-Rad Free and Open-Source Notices for PCR Products	155
Software Notices	156
M2Mqtt (paho.mqtt.m2mqtt)	156
Standard Open License Text	160
EPL 1.0	160
Appendix E References	167

Safety and Regulatory Compliance

The CFX Opus real-time PCR system heats and cools very quickly during operation. Bio-Rad strongly recommends that you follow the safety specifications listed in this chapter and throughout this guide.

Note: Use only Bio-Rad-supplied USB cables (catalog #12012942) when using the CFX Opus real-time PCR system.

Safety Warning Labels

Warning labels posted on the CFX Opus real-time PCR system and in this manual warn you about sources of injury or harm. [Table 1](#) defines each safety warning label.

Table 1. General safety warnings







Icon	Meaning
	Operating the CFX instrument before reading this manual can constitute a personal injury hazard. The use of this instrument in a manner not specified in this manual or by Bio-Rad may result in the protection features of the instrument becoming impaired or disabled.
 	There are no biohazards or radioactive hazards associated with the CFX instrument itself. These hazards only become a concern when they are introduced into the system via the samples being tested. When handling biohazardous or radioactive samples, adhere to the recommended precautions and guidelines specific to your laboratory and location. These guidelines should include cleaning, monitoring, and disposal methods for the hazardous material(s) you are using.
	In addition, as identified above, there is a small risk of explosion, or of expulsion of liquids or vapors from the sample container(s). When working with hazardous materials the risk of injury from expelled material is compounded with the risk that the hazardous material themselves could be dispersed in and around the instrument. Users should take appropriate precautions for such a situation.

Table 1. General safety warnings, continued

Icon	Meaning
	<p>The CFX operates at temperatures high enough to cause serious burns. Always allow the reaction block to return to room temperature before opening the lid and removing samples. Even after the reaction block has cooled, the surrounding areas as well as the heater plate can remain hot for quite some time. In situations where there is not sufficient time to allow the instrument to cool, the use of protective equipment such as thermal gloves or “oven mitts” is recommended.</p>
	<p>The safety and performance of any system incorporating a CFX instrument is solely the responsibility of the assembler of the system.</p>
	<p>The CFX instrument can become hot enough during the course of normal operation to cause liquids in the samples to boil or vaporize, pressurizing the sample containers. There is the possibility that the sample container(s) could fail; leading to leaks, fluid spray, or explosive rupture and expelling vapors or liquids in and around the instrument.</p> <p>Users should always operate the instrument with the lid closed or wear safety goggles, thermal gloves, and other personal protection equipment during operation to avoid injury. Opening the instrument while samples are still hot, such as after aborting a run, can allow pressurized containers to leak, spray, or spurt liquid. Always allow the samples to cool before opening the lid.</p> <p>Users should never run a reaction with a lid or seal that is open, loose, punctured, or otherwise damaged because it will increase the likelihood of a dangerous rupture or explosion.</p> <p>Users should never run a reaction with volatile reagents that could increase the likelihood of a dangerous rupture or explosion.</p>

Safety and Regulatory Compliance

The CFX Opus real-time PCR system has been designed to be safely operated under the environmental conditions listed in [Table 2](#).

Table 2. Conditions for safe use

Usage Aspect	Conditions for Safe Use
Rated input power	100–240 VAC \pm 10%, 50–60 Hz, 850 W Max
Overvoltage category	II
Fuses	10 A, 250 V, 5 x 20 mm, fast blow (qty. 2)
Environment	Indoor use only
Operating temperature	15–31°C (operation over the range of 5°C–40°C is safe, but the instrument may not meet performance specifications)
Relative humidity	Up to 80% (noncondensing)
Altitude	Up to 2,000 meters above sea level
Pollution degree	2

Safety Compliance

The CFX Opus real-time PCR system has been tested and found to be in compliance with all applicable requirements of the following safety and electromagnetic standards:

- IEC 61010-1:2010 Safety requirements for electrical equipment for measurement, control, and laboratory use, Part 1: general requirements
- IEC 61010-2-010:2014 Safety requirements for electrical equipment for measurement, control and laboratory use — Part 2-010: Particular requirements for laboratory equipment for the heating of materials
- IEC 61010-2-081:2015 Safety requirements for electrical equipment for measurement, control and laboratory use — Part 2-081: Particular requirements for automatic and semi-automatic laboratory equipment for analysis and other purposes

- CAN/CSA-C22.2 NO. 61010-1-12:2018 Safety requirements for electrical equipment for measurement, control, and laboratory use, Part 1: General Requirements
- CAN/CSA-C22.2 NO. 61010-2-010:15 Safety requirements for electrical equipment for measurement, control, and laboratory use, Part 2-010: Particular requirements for laboratory equipment for the heating of materials
- CAN/CSA-C22.2 NO. 61010-2-081:15 Safety requirements for electrical equipment for measurement, control, and laboratory use, Part 2-081: Particular requirements for automatic and semi-automatic laboratory equipment for analysis and other purposes

- EN 61010-1:2010 Safety requirements for electrical equipment for measurement, control, and laboratory use, Part 1: General requirements
- EN 61010-2-010:2014 Safety requirements for electrical equipment for measurement, control and laboratory use — Part 2-010: Particular requirements for laboratory equipment for the heating of materials
- EN 61010-2-081:2015 Safety requirements for electrical equipment for measurement, control and laboratory use — Part 2-081: Particular requirements for automatic and semi-automatic laboratory equipment for analysis and other purposes

- UL 61010-1:2012 Safety requirements for electrical equipment for measurement, control and laboratory use — Part 1: General Requirements
- UL 61010-2-010:2019 Safety requirements for electrical equipment for measurement, control and laboratory use — Part 2-010: Particular requirements for laboratory equipment for the heating of materials
- UL 61010-2-081:2015 Safety requirements for electrical equipment for measurement, control and laboratory use — Part 2-081: Particular requirements for automatic and semi-automatic laboratory equipment for analysis and other purposes

Electromagnetic Compatibility (EMC)

The CFX Opus real-time PCR system has been tested and found to be in compliance with all applicable requirements of the following electromagnetic compatibility standards:

- IEC 61326-1:2012 Electrical equipment for measurement, control and laboratory use
- EN 61326-1:2013 Electrical equipment for measurement, control and laboratory use — EMC requirements — Part 1: General requirements. Tested as a Class A device
- FCC Part 15, Subpart B, Sections 15.107 and 15.109. Tested as a Class A digital device
- CAN ICES-003v6:2019 Interference-causing equipment standard, information technology equipment (including digital apparatus) — Limits and methods of measurement. Tested to Class A limits

EMC Warnings and Notes

- **Warning:** Changes or modifications to this unit, not expressly approved by Bio-Rad, could void the user's authority to operate the equipment.
- **Note:** This equipment has been tested and found to comply with the limits for a Class A digital device, pursuant to part 15 of the FCC Rules. These limits are designed to provide reasonable protection against harmful interference when the equipment is operated in a commercial environment. This equipment generates, uses, and can radiate radio frequency energy and, if not installed and used in accordance with the instruction manual, may cause harmful interference to radio communications. Operation of this equipment in a residential area is likely to cause harmful interference, in which case the user will be required to correct the interference at their own expense.
- **Note regarding FCC compliance:** Although this instrument has been tested and found to comply with Part 15, Subpart B of the FCC Rules for a Class A digital device, please note that this compliance is voluntary, for the instrument qualifies as an "exempted device" under 47 CFR 15.103(c), in regard to the cited FCC regulations in effect at the time of manufacture.
- **Note regarding cables:** This instrument was tested for EMC compliance using specially designed USB cables, which are supplied with the instrument. These cables, or Bio-Rad authorized replacements, must be used with this instrument to ensure continued compliance with the EMC emissions limits.

Hazards

The CFX Opus real-time PCR system is designed to operate safely when used in the manner prescribed by the manufacturer. If the CFX Opus real-time PCR system or any of its associated components is used in a manner not specified by the manufacturer, the inherent protection provided by the instrument may be impaired. Bio-Rad is not liable for any injury or damage caused by the use of this equipment in any unspecified manner, or by modifications to the instrument not performed by Bio-Rad or an authorized agent. Service of the CFX Opus real-time PCR system should be performed only by trained Bio-Rad personnel.

Biohazards

The CFX Opus real-time PCR system is a laboratory product. However, if biohazardous samples are present, adhere to the following guidelines and comply with any local guidelines specific to your laboratory and location.

Note: No biohazardous substances are exhausted during normal operations of this instrument.

General Precautions

- Always wear laboratory coat, laboratory gloves, and safety glasses with side shields or goggles.
- Keep your hands away from your mouth, nose, and eyes.
- Completely protect any cut or abrasion before working with potentially infectious materials.
- Wash your hands thoroughly with soap and water after working with any potentially infectious material before leaving the laboratory.
- Remove wristwatches and jewelry before working at the bench.
- Store all infectious or potentially infectious material in unbreakable leak-proof containers.
- Before leaving the laboratory, remove protective clothing.
- Do not use a gloved hand to write, answer the telephone, turn on a light switch, or touch anything that other people may touch without gloves.
- Change gloves frequently. Remove gloves immediately when they are visibly contaminated.
- Do not expose materials that cannot be properly decontaminated to potentially infectious material.
- Upon completion of an operation involving biohazardous material, decontaminate the work area with an appropriate disinfectant (for example, a 1:10 dilution of household bleach).

Surface Decontamination



WARNING! To prevent electrical shock, always turn off and unplug the instrument prior to performing decontamination procedures.

The following areas can be cleaned with any hospital-grade bactericide, virucide, or fungicide disinfectant:

- Outer lid and chassis
- Inner reaction block surface and reaction block wells
- Control panel and display

To prepare and apply the disinfectant, refer to the instructions provided by the product manufacturer. Always rinse the reaction block and reaction block wells several times with water after applying a disinfectant. Thoroughly dry the reaction block and reaction block wells after rinsing with water.

Important: Do not use abrasive or corrosive detergents or strong alkaline solutions. These agents can scratch surfaces and damage the reaction block, resulting in loss of precise thermal control.

Disposal of Biohazardous Material

Dispose of the following potentially contaminated materials in accordance with laboratory local, regional, and national regulations:

- Clinical samples
- Reagents
- Used reaction vessels or other consumables that may be contaminated

Chemical Hazards

The CFX Opus real-time PCR system contains no potentially hazardous chemical materials.

Explosive or Flammability Hazards

The CFX Opus real-time PCR system poses no uncommon hazard related to flammability or explosion when used in a proper manner as specified by Bio-Rad Laboratories.

Electrical Hazards

The CFX Opus real-time PCR system poses no uncommon electrical hazard to operators if installed and operated properly without physical modification and connected to a power source of proper specification.

Transport

Before moving or shipping the CFX Opus real-time PCR system decontamination procedures must be performed. Always move or ship the system in a separate container(s) in the Bio-Rad-supplied packaging material, which will protect the system from damage.

For information about transporting the system and to request the appropriate packaging material, contact your local Bio-Rad office.

Battery

This CFX Opus real-time PCR system uses two 3 V lithium-metal coin cell batteries to maintain time settings in the event of AC power loss. If the time does not remain set after the unit is turned off, it may be an indication that the batteries are getting weak.



WARNING! Do not attempt to change the batteries, they are not user serviceable. Instead, contact Bio-Rad Technical Support for assistance.

For the State of California, USA only

- Perchlorate material — Lithium batteries contain perchlorate material, special handling may apply. See www.dtsc.ca.gov/hazardouswaste/perchlorate

Disposal

The CFX Opus real-time PCR system contains electrical materials; they should not be disposed of as unsorted waste and must be collected separately, according to European Union Directive 2012/19/EU on waste electrical and electronic equipment — WEEE Directive. Before disposal, contact your local Bio-Rad representative for country-specific instructions.

Chapter 1 Introduction

The CFX Opus instrument is a real-time PCR system with an integrated 96-well or 384-well optical reaction module, depending on the model.

This guide explains how to set up and use the CFX Opus system to perform sensitive quantitative PCR.

Main Features

The main features of the CFX Opus system include:

- Connectivity to Bio-Rad's BR.io app in order to manage PCR file management and data analysis

Using the BR.io app, you can create real-time PCR experiments in the app, download and run them on your registered CFX Opus system, and then analyze the results in the BR.io app.

For more information about Bio-Rad's BR.io app, go to [BR.io](#). From the BR.io Home page, you can

- Explore the BR.io app via video
- Access helpful BR.io guides

To register for a BR.io account, see your company's IT administrator.

- Wireless and WLAN Ethernet network compatibility enables connectivity to your internal network for unlimited data access and storage on shared network drives as well connectivity to your BR.io cloud account
- USB drive compatibility provides an optional medium for protocol transfer and data storage
- USB ports enable direct connectivity to a computer running CFX Maestro software
- Programmable temperature gradient to quickly and easily identify optimal annealing temperatures

Performance Specifications

CFX Opus system components provide sensitive detection for precise quantification and target discrimination. The tables in this section list the reaction module and optical detection performance specifications for both the CFX Opus 96 and CFX Opus 384 real-time PCR systems.

Reaction Module Performance Specifications

Table 3. CFX Opus system reaction module specifications

Item	Specification	
	CFX Opus 96 systems	CFX Opus 384 systems
Volume	1–50 μ l (10–50 μ l Recommended)	1–30 μ l (5–30 μ l Recommended)
Maximum ramp rate	5°C/sec	2.5°C/sec
Average ramp rate	3.3°C/sec	2.0°C/sec
Lid temperature	30–110°C	
Heating and cooling method	Peltier	
Temperature range	4–100°C	
Increment	-10°C to 10°C/cycle	
Gradient		
Operational range	30–100°C	
Programmable span	1–24°C	
Temperature accuracy	\pm 0.2°C of programmed target at 90°C	
Temperature uniformity	\pm 0.3°C well-to-well within 10 sec of arrival at 90°C	

Optical Detection Performance Specifications

Table 4. CFX Opus optical detection specifications

Item	Specification	
	CFX Opus 96 systems	CFX Opus 384 systems
Excitation	6 filtered LEDs	5 filtered LEDs
Detection	6 filtered photodiodes	5 filtered photodiodes
Range of excitation/emission wavelengths	450–730 nm	450–690 nm
Multiplex analysis	5 targets per well	4 targets per well
Scan time		
All channels	12 sec	<20 sec
Single-channel fast scan	3 sec	8 sec
FRET	Yes	Yes
Sensitivity	Detects 1 copy of target sequence in human genomic DNA	
Dynamic range	10 orders of magnitude	

Finding Out More

The CFX Maestro system web site (bio-rad.com/CFXOpus) provides access to technical notes, manuals, product information, and technical support. This site also provides many technical resources on a wide variety of methods and applications related to real-time PCR.

Chapter 2 Setting Up the CFX Opus System

This chapter explains how to set up the CFX Opus system at your site.

Tip: Before setting up the CFX Opus system, familiarize yourself with the system and its reaction module, ports, and accessories.

Site Requirements

The tables in this section list the room, environment, power, and networking requirements necessary to successfully install and use the CFX Opus system. For weight and dimensions of the packaged instrument, see [Unpacking the System on page 26](#).

Note: Install your CFX Opus system on a flat, dry surface with sufficient cool airflow for it to run properly.

Bench Space Requirements



Caution: The CFX Opus system requires at least 10 cm behind and at least 5 cm along one side or the top to allow exhaust air to flow properly.

Additionally, ensure you provide sufficient space around the system to disconnect the power cord or to access the power switch in case of an emergency.

Note: If you plan to connect the CFX Opus system to the computer running CFX Maestro, ensure during setup that you have sufficient space near the system for the computer.

Table 5. CFX Opus system bench space requirements

Item	Specification
Dimensions	W: 13 in; 33 cm
	D: 22 in; 56 cm
	H: 14 in; 36 cm
Weight	48 lb; 22 kg

Environment Requirements

Table 6. CFX Opus system environment requirements

Parameter	Range	Humidity Range
Operating conditions	15 to 31°C 59 to 87.8°F	0–80% RH, non-condensing
Storage conditions	–20 to 60°C –4 to 140°F	0–80% RH, non-condensing

Power Requirements

Power to the CFX Opus system must be stable and within specifications to ensure proper operation. The power cord connected to the power inlet port must be rated for 10 amps or more.

Table 7. CFX Opus power requirements

Item	Specification
Input voltage	100–240 VAC ±10%; 50–60 Hz, single phase
Maximum power usage	<850 watts
Number of power sockets	<ul style="list-style-type: none"> ■ 1 socket for the CFX Opus system ■ (Optional) 1 socket for the computer running CFX Maestro software

Network Requirements

The CFX Opus system supports connectivity through Ethernet, USB, and wireless networking.

Table 8. CFX Opus system networking requirements

Item	Specification
Ethernet port	10/100 BASE-T (RJ45)*
USB ports	USB 2.0 type A (two on rear panel, one on front panel) USB 2.0 type B (one on rear panel)
Wireless connectivity	Requires the CFX Opus Wi-Fi adaptor appropriate for your locale (See your Bio-Rad Sales representative for more information.) Supports IEEE 802.11b/g/n 2.4 GHz, and IEEE 802.11 a/n/ac 5 GHz standards.*
USB barcode scanner (optional)	Scanner must be compatible with Microsoft Windows 10

* Default network support is DHCP. For information about configuring a static IP connection, see [Setting Up a Network Connection on page 56](#)

System Overview

The illustrations in this section display the main components of the system.

Front View

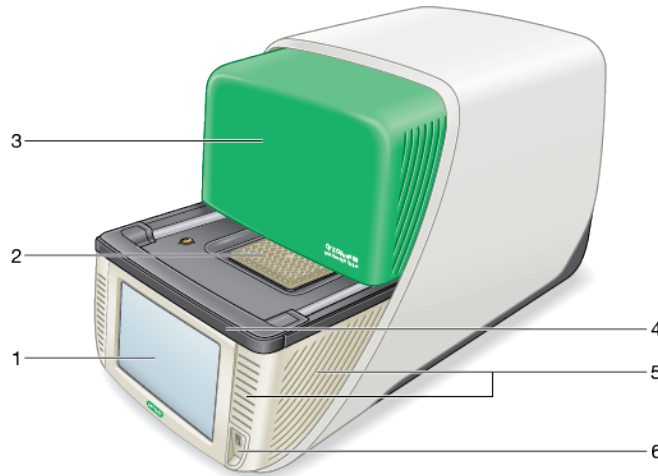

LEGEND

1. Touch screen display	2. Reaction block
3. Retractable lid (partially retracted)	4. LED system status bar
5. Air intake vents	6. USB A port

Details

- **Touch screen display** — provides access to all functions necessary to create and run protocols.
- **Reaction block** — holds the 96- or 384-well plate, depending on the instrument.
- **Retractable lid** — provides access to the reaction block.

Note: The CFX Opus instrument does not have a manual open/close button on the lid. To open or close the lid, use the button on the Home screen, Run Setup screen, or Run Status screen, or use the lid control in the CFX Maestro software.

- **LED system status bar** — indicates system status:
 - Green (constant) — run is in progress.
 - Green (flashing) — run is paused.
 - Blue (flashing) — lid is opening (flashes until lid is fully open); run has completed (flashes until lid is opened).
 - Red (flashing) — system error.
 - OFF — system is idle (not executing a run, lid not moving) or system is shut down.
- **Air intake vents** — allow the system to heat and cool quickly.



Important: Keep all air vents clean and clear of obstruction. Do not insert any object in the air vents while the system is operating. Fans or other internal moving parts may collide with the object and cause personal injury or damage the system. Conductive objects could contact internal circuitry and cause damage to the system.

- **USB A port** — connects the CFX Opus system to a USB drive, mouse, keyboard, CFX Opus Wi-Fi adaptor, or barcode scanner.

Special Considerations Regarding the CFX Opus Touch Screen

The following are special consideration regarding the CFX Opus instrument's touch screen. If you have any questions regarding the touch screen, contact Bio-Rad Technical Support.



WARNING! If any liquid leaks out of a damaged glass cell and comes in contact with your skin, wash thoroughly with soap and water.

Notes:

- A strong incident light shining on the touch screen for extended periods of time may degrade the quality and performance of the display.
- Do not expose the touch screen to strong ultraviolet rays or direct sunlight for long periods of time.
- Do not touch or scratch the surface of the touch screen with any hard object.

- The touch screen self-calibrates the first few seconds after turning on the instrument. During this process, do not
 - Touch the surface of the touch screen
 - Place your hands near the surface of the touch screen

If it cannot successfully calibrate during system initialization, the touch screen might not work properly for some time. If the problem persists, turn off and on the system or contact Bio-Rad Technical Support for assistance.

Back View

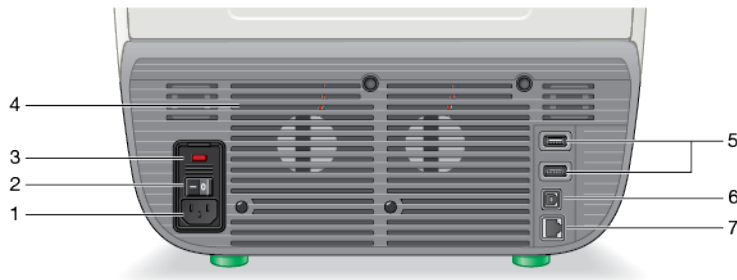

LEGEND

1. Power input	2. Power switch
3. Fuses	4. Cooling vents
5. USB Type A ports	6. USB Type B port
7. Ethernet port	

Details

- **Power input** — connects to AC power.
- **Power switch** — turns on or off power to the CFX Opus system.
- **Fuses** — provides access to the fuses.
- **Cooling vents** — cools the CFX Opus system.

Important: Do not block the cooling vents. For optimal operation, ensure that air can circulate behind the CFX Opus system.
- **USB type A ports** — transfer data to and from a USB flash drive or connect a USB mouse, keyboard, CFX Opus Wi-Fi adaptor, or barcode scanner.
- **USB type B port** — connects the CFX Opus system to a computer running CFX Maestro software.
- **Ethernet port** — connects the CFX Opus system to your network.

Unpacking the System

This section explains how to properly unpack the CFX Opus instrument. Read this section before you unpack the system.

Caution: The packaged CFX Opus instrument weighs approximately 57 lb (26 kg). Bio-Rad strongly recommends that you use a pallet jack to move the instrument from the shipping dock to the laboratory.



Important: Use proper lifting techniques when moving and lifting the instrument to prevent damage to the instrument and personal injury. Bio-Rad recommends that two or more people lift the instrument.

Packaged Instrument Specifications

[Table 9](#) lists the specifications of the packaged CFX Opus instrument. For information about bench space specifications, see [Site Requirements on page 19](#).

Table 9. Specifications for the packaged CFX Opus instrument

Parameter	Specification
Weight	57 lb; 26 kg
Dimensions	Depth: 28 in; 71 cm Width: 19 in; 48 cm Height: 19 in; 48 cm

The image [on page 27](#) depicts the CFX Opus instrument inside its packaging.

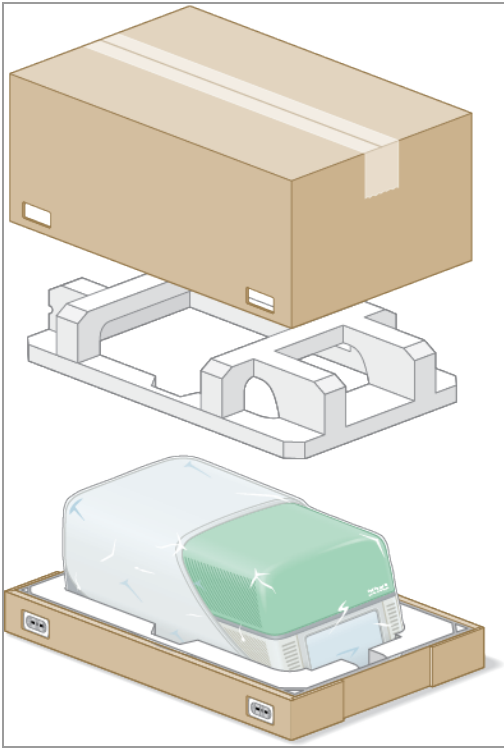

Unpacking the System

Install the CFX Opus system on a flat, dry surface with sufficient cool airflow to run properly. The AC power cord is approximately 5' in length. Ensure you have sufficient access to the power outlet before you unpack the system.

Note: Ensure that there is enough clear space on the lab bench for your instrument plus additional space to maneuver it while installing cables and accessories. If you plan to operate the system via CFX Maestro, ensure you have space on the lab bench for the computer running CFX Maestro software.

Caution: When handling the instrument, do not grip the LCD screen or retractable lid. To lift the instrument, position your hands underneath the right and left sides of the instrument.

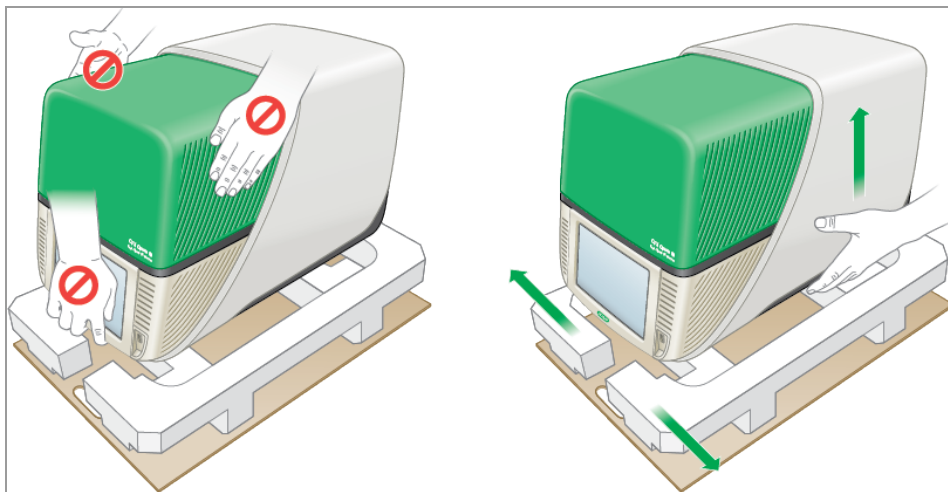

To unpack the system

1. Ensure that the path from the shipping dock to the laboratory is clear of obstacles and can accommodate the packaged CFX Opus instrument and a pallet jack.
2. Using a pallet jack, move the instrument container from the shipping dock to the laboratory.
Important: Bio-Rad strongly recommends that you do NOT use a hand truck to move the packaged instrument.
3. Release the instrument container next to the lab bench.
4. Using two people, lift and place container onto the lab bench.

5. With scissors or a box cutter, cut and remove the exterior straps that secure the container top to the base.

Tip: The exterior straps are very tight. Hold the straps securely while cutting to prevent injury.

6. Remove the plastic clips on the bottom corners by firmly pinching the tabs together and pulling the clips straight out.

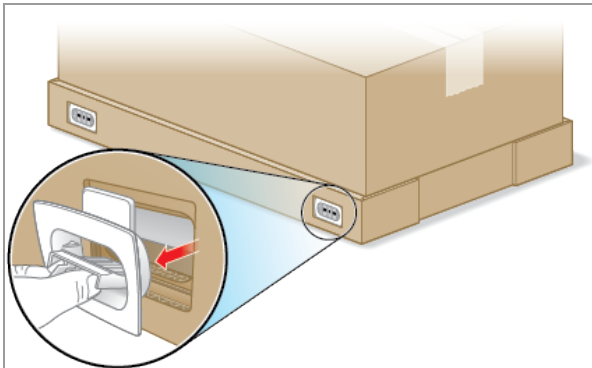

7. Lift the large container top up and out of the base and place it to the side.

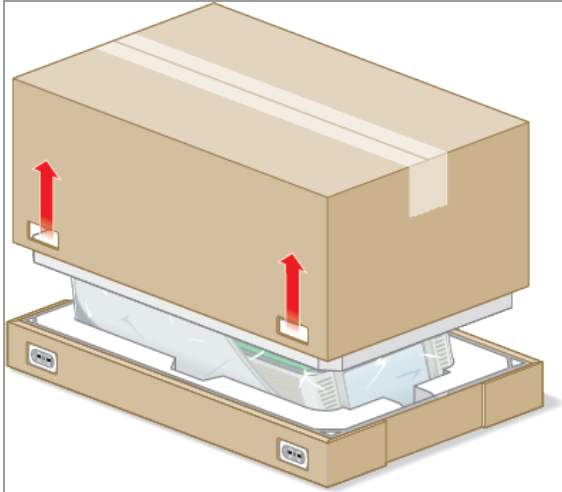

You see the CFX Opus instrument wrapped in plastic sheeting and inserted into the foam packing structure.

8. Remove the top foam insert and place it to the side.

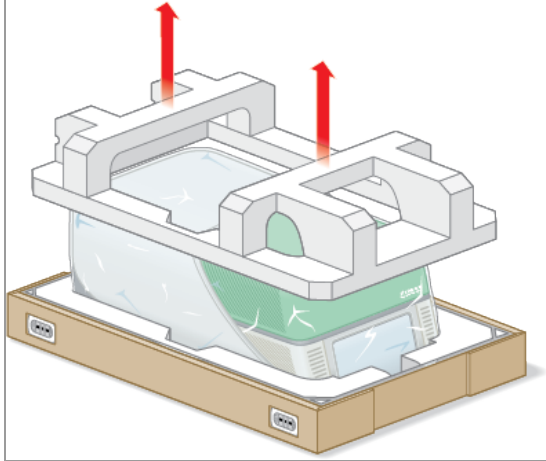

9. Standing in front of the instrument, fold down the front of the cardboard base.

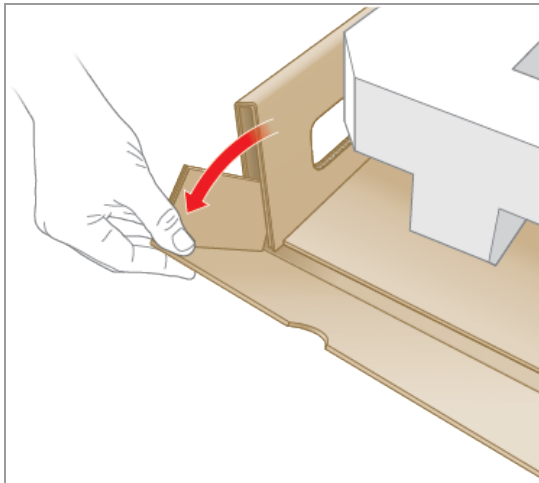

10. While another person holds the base, grasp the cardboard tray and slide the instrument completely out of the base.

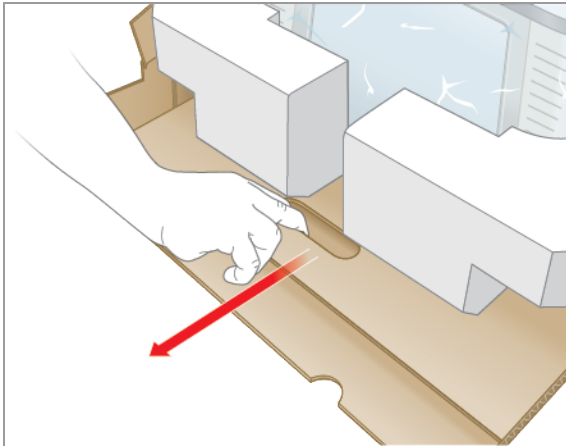

11. Using the lift points first on one side of the instrument and then the other, gently lift the instrument, remove the foam inserts, and place them to the side.
12. Using two people, carefully lift the instrument and remove the cardboard tray.
13. Slide the plastic cover toward the back of the instrument to remove.
14. Inspect the instrument for any damage.

Connecting the Power and Communication Cables

After you unpack the CFX Opus and install it on the lab bench, you will need to connect the power cord and (optionally) the communication cables. This section explains how to connect the cables.

Tip: Before connecting the cables, familiarize yourself with the CFX Opus system, its accessory kit, and power switches.

Important: Ensure you have enough room on the lab bench to reach the power switch on the back of the system after connecting the power cord and USB Type B and Ethernet cables. Use only the Bio-Rad-supplied power cord and USB Type B and Ethernet cables.

To connect the CFX Opus power and communication cables

1. Locate the accessory kit that shipped inside the CFX Opus container.
2. Remove the AC power cord and the USB and Ethernet cables from the accessory kit.
Tip: Store the packing material for future use. If any item is missing or damaged, contact your local Bio-Rad office.
3. Insert one end of the AC power cord into the power inlet port on back of the system.
4. Insert the other end of the AC power cord into an available grounded, surge-protected AC outlet.
5. (Optional) If you plan to connect the CFX Opus system to a computer running CFX Maestro software, insert the male end of the supplied USB Type B cable into the USB Type B port on the back of the system.
6. (Optional) If you plan to connect CFX Opus to your internal network, insert the Ethernet cable into the Ethernet port on the back of the system.

Removing the Shipping Screw

Important: The CFX Opus system ships with a red shipping screw inserted in the side of the lid to stabilize it during transport. You must remove the shipping screw before you can operate the system.

To remove the shipping screw

1. Locate the shipping screw plug that ships with the CFX Opus instrument.
Tip: This might be located in a plastic sheath taped to the front or side of the instrument.
2. Ensure the power cord is properly inserted into the power input on the back of the instrument.
3. If you have not yet done so, insert the other end of the power cord into an available grounded, surge-protected AC outlet.
4. Press the power switch on the back of the instrument to start the CFX Opus system.
5. The system recognizes that the shipping screw is inserted and displays a message on the touch screen instructing you to remove the screw. Tap OK.

The Remove Shipping Screw instructions appear.

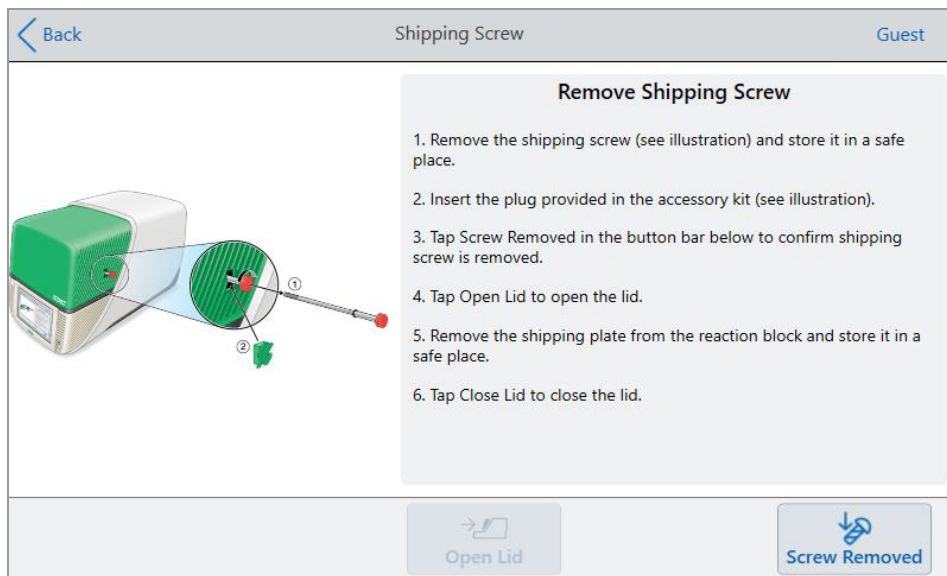

- To remove the shipping screw, turn it counter-clockwise and then pull it straight out of the access hole. Set the screw in a safe place.



Caution: Do not insert the shipping screw or any other object in the shipping screw hole while instrument is operating. Internal moving parts might collide with the object, which can cause personal injury or damage the system.

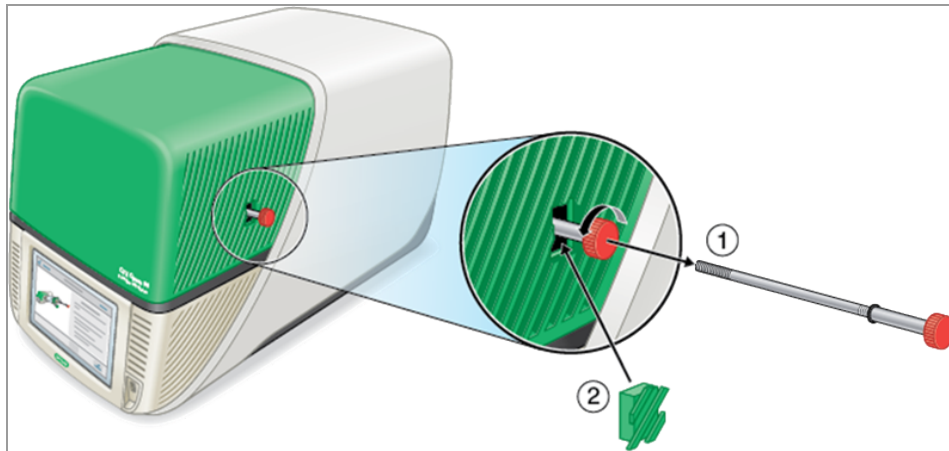

- Insert the shipping screw plug into the hole for the shipping screw.
Tip: The plug helps to prevent contamination of internal components.
- On the Shipping Screw screen, tap Screw Removed to confirm the screw is removed.
- Tap Open Lid to open the lid.
- Remove the shipping plate from the reaction block, and set it in a safe place.
Note: Save the screw and plate in a safe and accessible place. You must reinsert the shipping screw and shipping plate should you need to return the system for any reason.

11. On the Shipping Screw screen, tap Close Lid to close the lid.

The CFX Opus system is ready to use and displays the Login screen.

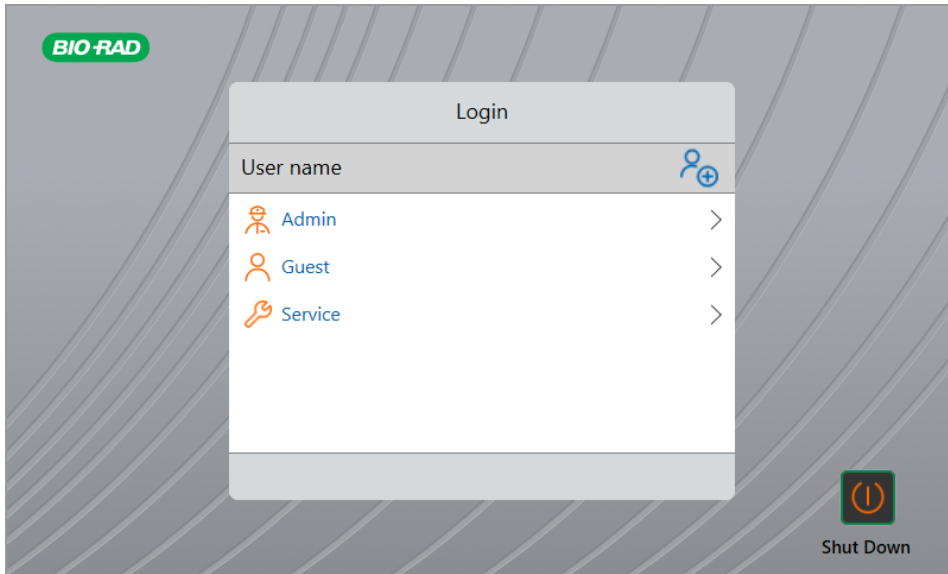

Logging In to CFX Opus

CFX Opus ships with three default users: Admin, System, and Guest. Users also have the option to create their own account when first logging in to the system.

Tip: Creating user accounts on the CFX Opus system is optional.

Any user can log in as Guest and access all protocols and runs in the Public folder including the qPCR files within the default Bio-Rad qPCR folder.

Any user, including the Guest account, can create folders and protocols, edit protocol templates, and run protocols. When logged in as Guest, users can create subfolders in the Public folder and save their protocols and run files into the selected folder.

Tip: All folders and files saved into the Public folder are available to all users of the CFX Opus system.

CFX Opus automatically creates a personal folder for each user who creates their own user account. When logged in, users can create subfolders within their personal folder and save their protocols and run files into the selected folder.

Note: For the Admin or Service user, all such files are saved into the respective folders. These folders are not accessible to any other user.

Starting the CFX Opus System

To start the CFX Opus system

- ▶ If you have not already done so, press the power switch on the back of the instrument to start the CFX Opus system.

You see the CFX Opus startup screen.

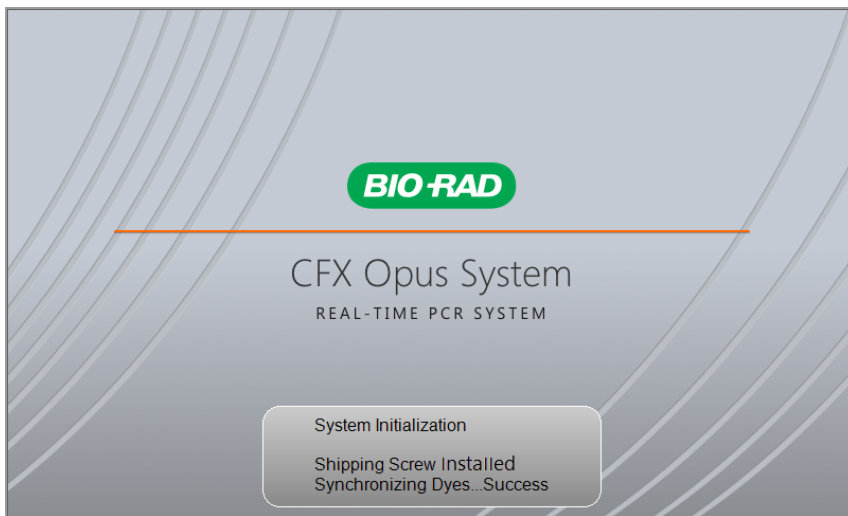

The system performs a series of initialization tests and then displays the Login screen.

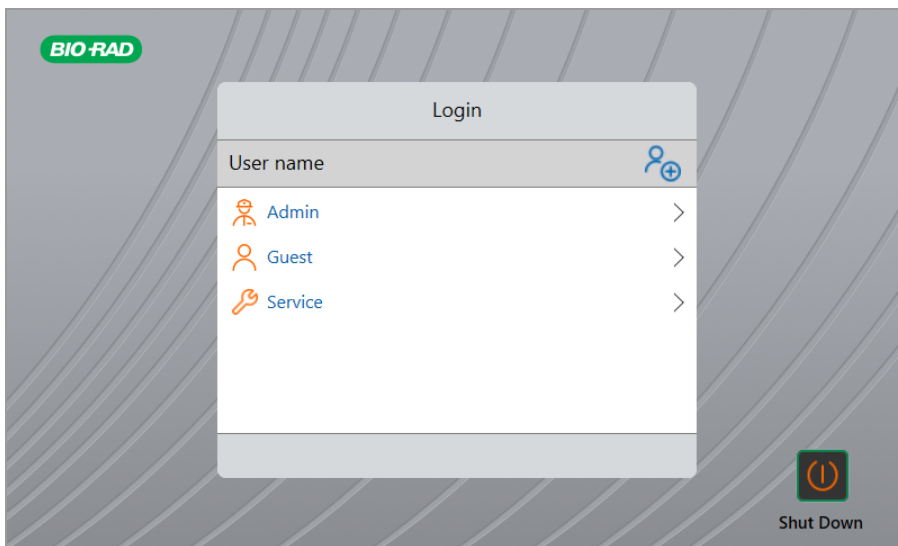

Creating CFX Opus User Accounts

Tip: Creating user accounts on the CFX Opus system is optional.

When logged in to the CFX Opus system, you can

- Create and manage a folder structure within a browser environment.
- Create and edit protocols and then save them to their personal folders.
- Run a protocol and save it to your personal folders.
- Delete protocols and runs in your personal folders.
- Copy a protocol or run file to a public folder or USB drive.
- Connect to a shared folder on the network to store or access protocol and run files.
- Connect to your BR.io account.
- Execute pending runs and upload results to your BR.io account.
- Create and change your password.

This section explains how to create user accounts on the CFX Opus system.

To create a new user

1. Do one of the following:
 - Turn on the CFX Opus system.
 - On the Home screen, tap Logout to log out a currently logged in user.

The Login list appears.

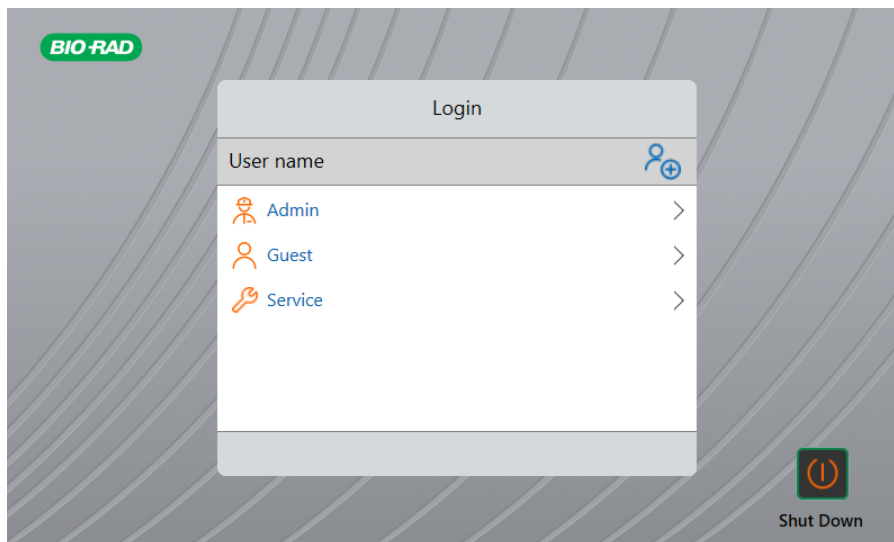

2. Tap the Create User icon:



3. Using the alphanumeric keypad that appears, type a user name and then tap OK.

The Password dialog appears.

4. Do one of the following:

- Enter and confirm a password using the alphanumeric keypad that appears, and then tap Save Password.

CFX Opus passwords can be any combination of alphanumeric characters. Passwords must be between 4–50 characters.

Note: If you plan to connect to a shared network folder or Bio-Rad's BR.io app, you must have a password.

- Tap Skip Password.

Tip: You can create a password some other time by accessing Tools > User Profile. See [Setting User Passwords on page 67](#) for more information.

The Home screen appears and displays your user name next to the Logout button.

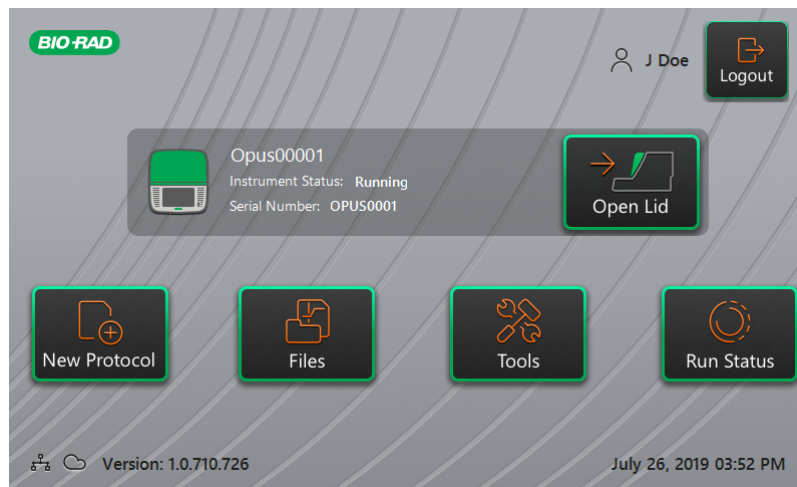

Logging In to CFX Opus

When the CFX Opus starts, the Login list appears and displays the existing users with the most recent user at the top.

Important: By default, the Admin account does not have a password. When accessed for the first time, Bio-Rad strongly recommends that you create a password for the Admin account and record the password in a password safe. Resetting a forgotten Admin password requires a phone call to Bio-Rad Technical Support. See [Setting User Passwords on page 67](#) for more information.

To log in to the Admin account when CFX Opus starts

1. In the Login list, locate and tap Admin.
2. When prompted, enter the Admin password using the alphanumeric keypad that appears and then tap OK.

To log in to a User account when CFX Opus starts

1. In the Login list, locate and tap your user name.
2. If prompted, enter your password using the alphanumeric keypad that appears and then tap OK.

Tip: After you create your user account, the keypad does not appear if you did not create a password.

To log in to the Guest account when CFX Opus starts

- ▶ In the Login list, locate and tap Guest.

Tip: The keypad does not appear because the Guest account does not have a password.

To change users

1. On the Home screen, tap Logout to log out the currently logged in user.

The Login list appears.

2. In the Login list, tap your user name.
3. If prompted, enter your password using the alphanumeric keypad that appears and then tap OK.

Tip: The keypad does not appear if the user account does not have a password.

To log out

- ▶ On the Home screen, tap Logout.

Loading Sample Plates

Important: Bio-Rad strongly recommends that you use only low-profile plates and flat-cap tubes with the CFX Opus real-time PCR systems. Using high-profile plates can crush tubes. Using domed-cap tubes can negatively affect plate reads.

For a list of plates and tubes compatible with the CFX Opus real-time PCR systems, visit us at www.bio-rad.com/cfxopus or contact your local Bio-Rad Sales representative.

To ensure uniform heating and cooling of samples, plates must be in complete contact with the reaction block. To ensure adequate contact, do the following:

- Confirm that the reaction block is clean before loading samples.
- Firmly press the individual tubes, tube strips, or microplates into the block wells.
- When using one or a few tubes, use the tube frame or load at least one empty tube in each corner of the block to ensure the lid exerts even pressure on individual tubes.

Loading Plates into the Optical Reaction Module



Caution: Never run a reaction with a lid or seal that is open, loose, punctured, or otherwise damaged. Doing so will increase the likelihood of a rupture, which could cause injury or contaminate the system.

Important: When running the CFX Opus, always balance the tube strips or add capped tubes to the corner wells to ensure the heated lid applies even pressure across the block.

To load plates into the optical reaction module

1. To open the motorized lid, do one of the following:
 - On the Home screen, tap Open Lid.
 - On the Run Setup screen, tap Open Lid.
 - In the Detected Instruments pane in CFX Maestro software, click Open Lid.
 - On the Start Run tab in the software, click Open Lid.
2. Place the microplate, individual tubes, or tube strips with sealed lids in the block.

Important: Ensure that the tubes are completely sealed to prevent leakage.

Tip: For optimal results, load sample volumes of 10–30 μ l for the CFX Opus 96 system and 5–30 μ l for the CFX Opus 384 system.

3. For accurate data analysis, verify that the orientation of reactions in the block is exactly the same as the orientation of the well contents in the plate layout in the BR.io app or in the CFX Maestro software.

Tip: You can edit the well contents from your BR.io account or from CFX Maestro software before, during, or after the run.

4. To close the motorized lid, do one of the following:
 - On the Home screen, tap Close Lid.
 - On the Run Setup screen, tap Close Lid.
 - In the Detected Instruments pane in CFX Maestro software, click Close Lid.
 - On the Start Run tab in the software, click Close Lid.

Important: Ensure that nothing blocks the lid when it closes. Although there is a safety mechanism to prevent the lid from closing if it senses an obstruction, do not place anything in the way of the lid before closing.

Shutting Down the CFX Opus System

Important: Follow these instructions to safely and completely shut down the CFX Opus system.

To shut down the CFX Opus system

1. Ensure that no protocol is running and the system is no longer in use.
2. If you have not already done so, remove the samples from the block.
 - a. On the Home screen, tap Open Lid to access the samples.
 - b. Remove the samples from the block and then tap Close Lid.
3. On the Home screen, tap Logout to log out of the system.
4. On the Login screen, tap Shut Down () to perform a soft shutdown of the system.
5. When the CFX Opus system has completed the soft shutdown process, press the power switch on the back of the instrument to shut down the system.

Chapter 3 Configuring the CFX Opus System

After successfully installing the CFX Opus system, you can configure the system according to the requirements at your site. Using the system's touch screen, the Admin user can perform the following tasks.

- Set the CFX Opus system's time zone and local time
- Enable or disable the system's screen saver
- Rename the system
- Set up network and wireless communication
- Set up the email service
- Connect the system to a computer running CFX Maestro

As a CFX Opus user, you can

- Create your own CFX Opus log-in account
- Set or change your password
- Set or change your email address
- Connect to your Bio-Rad BR.io account
- Set or change connection to a shared network folder

As a CFX Opus Guest user, you can

- Set or change your email account

This chapter explains how to configure the CFX Opus system.

Touch Screen Overview

This section provides an overview of the CFX Opus system touch screen features.

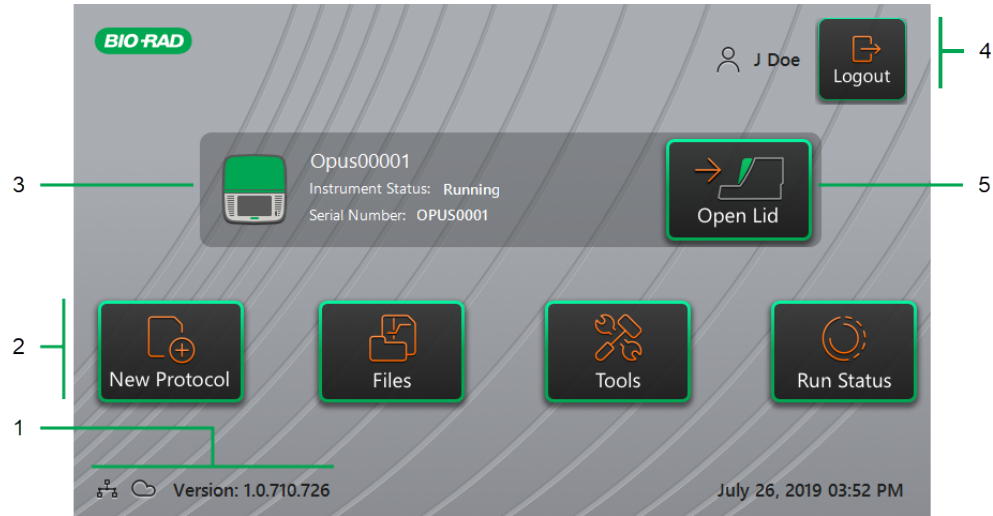

LEGEND

- | | |
|--------------------------------------|---------------------------|
| 1. Connectivity and software version | 2. Primary activity menu |
| 3. Instrument details | 4. Current logged in user |
| 5. Open/close lid | |

Details

- **Connectivity and software version** — displays the current software version and the type of operational connection:

- **Network connection** — indicates operational connection to either an Ethernet or wireless network:

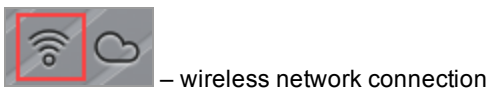

- **BR.io connection** — the  icon appears when the logged-in user is connected to the BR.io account. To manage the connection, see [Connecting to Your Bio-Rad BR.io Account on page 72](#).
- **Software version** — displays the touch screen software version. To manually install updates, see [Upgrading System Software and Firmware on page 145](#).
- **Primary activity menu** — provides quick access to the primary activities required to create and run protocols and manage the operation of the CFX Opus system.
 - **New Protocol** — opens the New Protocol screen in which you can create a new protocol. For details, see [Creating Protocols on page 79](#).
 - **Files** — opens the File Browser, where you can manage your files and execute runs. For details on managing files, see [Managing Files and Folders on page 121](#).
 - **Tools** — accesses menus from which users and administrators can perform system management operations.
 - **Run Status** — opens the Run Status screen to view the status of the current run.
- **Instrument status** — identifies the system, its serial number, and current status.
- **Logout action/status** — identifies the currently logged in user and enables the user to log out of the system
 - **Logout** — tap this button to log out of the system. The system then displays the Login list.





Tip: To create a new user account, see [Creating CFX Opus User Accounts on page 38](#).
 - **Logged in user** — identifies the user currently logged in to the system.
- **Open/Close Lid** — opens or closes the instrument lid.

If the lid is closed, the label is Open Lid. If the lid is open, the label is Close Lid. For details on loading plates, see [Loading Sample Plates on page 42](#).

Software Files

Table 10 lists the CFX Opus file types.

Table 10. CFX Opus file types

File Type	Icon	Details
Protocol		Contains protocol setup details to perform a PCR run.
Data		Contains the results of an experiment run and PCR analysis.
Pending run		Contains setup details of a protocol that was created in the BR.io app. This file appears in the File Browser when you successfully connect to your BR.io account.
JSON		A read-only file, which contains the run file data that appear in the details pane in the File Browser when a run file is selected. This file is generated after a run completes. It is exported with the .zpcr file and saved with the data files when the Save Location is either a USB drive or a shared network folder.

Tools Screen

From the Tools screen, users and administrators can access a variety of options. These options control the system. All options available to users are also available to administrators. Only those who log in with an administrator account have access to the Admin options.

User Tools Screen Options

Tip: You do not need to log in with a user account to access the User options. The Guest account can also access options on the Tools screen.

To access the User Tools screen

1. On the Home screen, tap Logout, and then log in with your user credentials.
2. On the Home screen, tap Tools.

The User Tools screen appears.

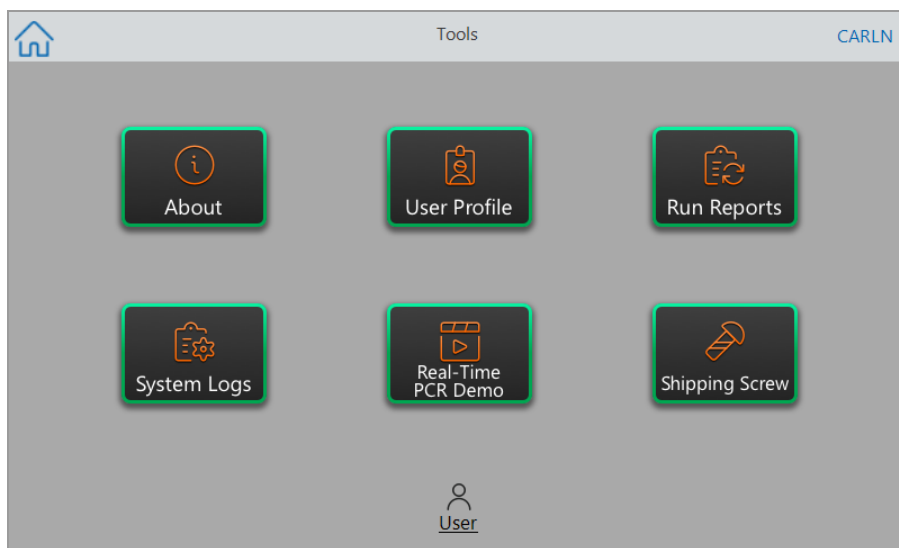

- **About** — view the current software version, serial number, disk space capacity and availability, as well as total number of run hours and cycles the system has accumulated.
- **User Profile** — view user profile options for password, email address, shared network drive, and (when registered) the BR.io account information.

Note: The Guest user can set only their email address.

- **Run Reports** — view the run report for each protocol run on the system. Users can export a specific run report or all run reports to an attached USB drive.

Tip: In addition to exporting run reports, Admin users can trim the list of run reports to remove older or invalid reports as well as recover the .zpcr file of selected runs.

- **System Logs** — view two types of logs:
 - Messages Log** — messages that occur during each run.
 - Usage Log** — all events that occur during each run.

Note: From this screen, logged in users can export all message and usage logs to an attached USB drive. Admin users can export all logs as well as clear all logs from the system.

- **Real-Time PCR Demo** — view a demonstration of a real-time 96-well or 384-well SYBR® or multiplex PCR run on the touch screen.
- **Shipping Screw** — view instructions for removing or installing the shipping screw.

Admin Tools Screen Options

All options available to users are also available to administrators. Only those who log in as Admin have access to the Admin options.

To access the Admin Tools screen

1. If necessary, on the Home screen tap Logout, and log in as Admin.
2. Tap Tools on the Home screen.

The Tools screen appears and displays the Admin options.

Tip: To view the standard User options, tap User on the bottom of the screen.

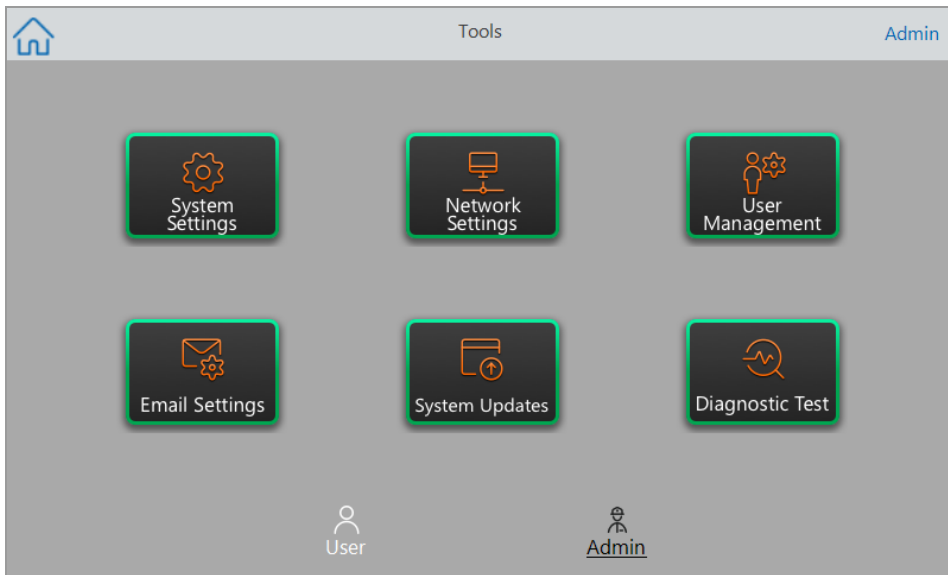

- **System Settings** — from this screen, Admin users can

- Set the time zone, date, and time on the system.
- Enable or disable password requirement.

Note: If a user creates a local user account without a password before you enable this requirement, that user will be prompted to create a password at the next log-in attempt.

- Enable or disable the screen saver and set its idle time.

Note: The screen saver appears after the system has been idle for a specified amount of time. The screen saver does not appear while a run is in progress.

- Rename the system.
- **Network Settings** — view details about the current network connection; use this screen to connect the system to the internal network via wireless or Ethernet connection.
- **User Management** — remove users and reset passwords.
- **Email Settings** — set email server information.
- **System Updates** — update the system software and firmware from an attached USB drive.

Note: The CFX Opus installer can include both software and firmware updates. CFX Opus firmware updates are not distributed in a separate package.

- **Diagnostic Test** — perform a series of diagnostic self tests on the system (for use when servicing the system).

Renaming the CFX Opus System

Initially, each CFX Opus system is given the name of the serial number. You can rename a system for easy identification.

To rename a CFX Opus system

1. On the Home screen, tap Logout, then log in as the Admin user.
2. On the Home screen, tap Tools to open the Tools menu.
3. In the Admin tools screen, tap System Settings to open the System Settings screen.

The screenshot shows the 'System Settings' screen with the following fields and options:

- Time zone: (UTC-11:00) Coordinated Universal Time-11
- Date: MM/dd/yyyy: 2/2/2020
- Time: HH:mm:ss: 11 : 58 : 18
- Password required:
- Screen saver: Time out (min): 15
- Instrument name: 0000

An 'Apply' button is located at the bottom right of the screen.

4. Tap the Instrument name field and type a new name using the alphanumeric keypad that appears.
5. Tap Apply to confirm the change in settings.
6. Tap Back to return to the Tools menu.

Setting the Time Zone on CFX Opus Systems

Initially, the time zone for each CFX Opus system is set to (UTC-11:00) Coordinated Universal Time-11. If your instrument is connected to the Internet, you can set the time zone according to your lab's best practices. You can then set the actual time on the system according to the time in which the system resides.

The time zone changes are applied immediately to the System Settings Date and Time fields and saved when you tap Apply. Any changes you made to the date and time prior to setting the time zone are lost. Changes to Date and Time made after the time zone change are saved and applied in addition to the time zone change when you tap Apply.

Run reports will display local time (that is, the time zone in which the instrument on which experiment is run is located).

Important: Even if you set the time zone, you must set the correct time. The system does not automatically detect the local time.

Tip: Time changes due to switching between daylight saving and standard time are performed automatically when you set the Time zone.

To set the time zone on the CFX Opus system

1. On the Home screen, tap Logout, then log in as the Admin user.
2. On the Home screen, tap Tools to open the Tools menu.
3. In the Admin tools screen, tap System Settings to open the System Settings screen.

System Settings

Time zone: (UTC-11:00) Coordinated Universal Time-11

Date: MM/dd/yyyy 2/2/2020

Time: HH:mm:ss 11 : 58 : 18

Password required:

Screen saver: Time out (min): 15

Instrument name: 0000

Apply

4. Tap the Time zone field and select the target time zone from the dropdown list that appears.
5. Tap the Date field and set the date using the calendar that appears.
6. Tap the Time fields and set the hour, minute, and second fields using the keypads that appear.

Note: The Hour field is a 24-hour field.

7. Tap Apply to confirm the change in settings.
8. Tap Back to return to the Tools menu.

Setting Up a Network Connection

When establishing a connection between the CFX Opus system and your internal network, a DHCP server is required so that the system receives an IP address. The DHCP server should be configured to always assign the same IP address to the system. See your network administrator for more information.

By default, the CFX Opus system's IP address is dynamic. That is, the IP address can change each time the system restarts. In these cases, the system must reestablish a connection to your internal network each time it starts. A static IP address never changes; thus the system always reconnects to the network each time it restarts.

This section explains how to set up a dynamic IP or static IP network connection on the CFX Opus system.

Setting Up a Dynamic IP Network Connection

Note: Before starting this procedure, ensure your CFX Opus system is turned off.

To set up an a dynamic IP network connection

1. If you have not already done so, insert the provided Ethernet cable into the Ethernet port on the back of the CFX Opus system.
2. Insert the loose end of the Ethernet cable into the network connection router or hub.
3. Turn on the system.

The CFX Opus system automatically detects an available IP address and connects to your network. The system displays the Ethernet icon in the lower left corner of the Home screen to indicate successful Ethernet network communication.



4. To test the dynamic IP configuration, log into CFX Opus as Admin and tap Tools on the Home screen.
5. In the Admin Tools list, tap Network Settings.

6. On the Network Settings screen, tap IP Config.

The IP Config dialog box appears and displays the current dynamic IP configuration details, for example:

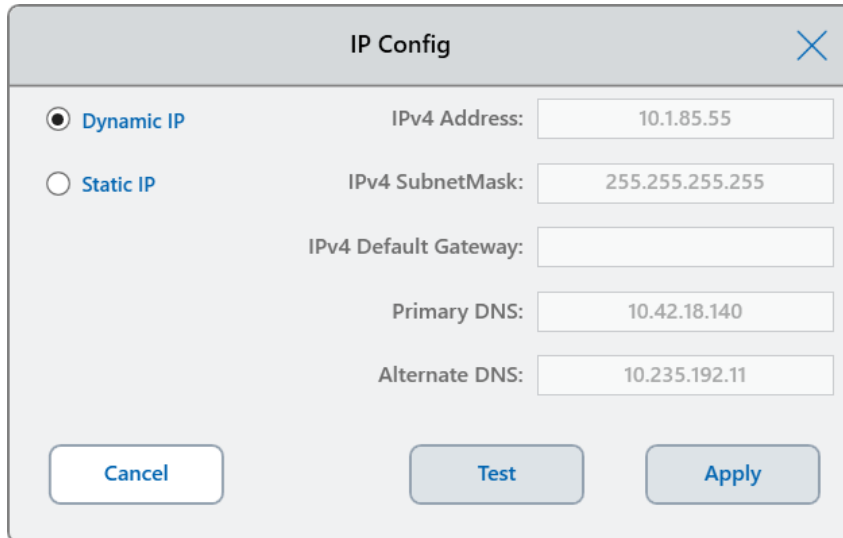

The screenshot shows a dialog box titled "IP Config" with a close button (X) in the top right corner. On the left, there are two radio buttons: "Dynamic IP" (selected) and "Static IP". To the right of these are several input fields: "IPv4 Address" (10.1.85.55), "IPv4 SubnetMask" (255.255.255.255), "IPv4 Default Gateway" (empty), "Primary DNS" (10.42.18.140), and "Alternate DNS" (10.235.192.11). At the bottom, there are three buttons: "Cancel", "Test", and "Apply".

7. Tap Test to test the connection.

A message appears indicating an Internet connection has been found.

8. Tap OK to close the message and then tap Cancel to close the IP Config dialog box and return to the Network Settings screen.
9. On the Network Settings screen, tap Back to return to the Tools screen.
10. If necessary, implement network security measures per your organization's security and privacy policies.

Setting Up a Static IP Network Connection

Note: Before starting this procedure, ensure your CFX Opus system is turned off.

When setting up a static IP network connection, you must provide the IPv4 address, subnet mask, default gateway, and primary and alternate DNS server details for your system. See your system administrator for the appropriate settings.

Note: CFX Opus supports only IPv4 connectivity. Ensure the settings are appropriate for your site.

To set up an a static IP network connection

1. If you have not already done so, insert the provided Ethernet cable into the Ethernet port on the back of the CFX Opus system.
2. Insert the loose end of the Ethernet cable into the network connection router or hub.
3. Turn on the system.

The CFX Opus system automatically detects an available IP address and connects to your network.

4. To set up a static IP configuration, log into CFX Opus as Admin and tap Tools on the Home screen.
5. In the Admin Tools list, tap Network Settings.
6. On the Network Settings screen, tap IP Config.

The IP Config dialog box appears.

7. Tap Static IP and provide the IP address, subnet mask, default gateway, and primary and alternate DNS server details for your site.
 - IP address — the specific numeric address for the CFX Opus system
 - IP subnet mask — the numeric filter used to define the subnet to which the IP address belongs
 - IP default gateway — (optional, required if you plan to access the CFX Opus system from CFX Maestro computers that are on another subnet) the IP address of the node that allows communication between subnets
 - Primary and alternate DNS servers — the IP address of the nodes that translate a server name to its IP address

The image shows a dialog box titled "IP Config" with a close button (X) in the top right corner. It contains two radio button options: "Dynamic IP" (unselected) and "Static IP" (selected). Below the "Static IP" option, there are five input fields for network configuration:

- IPv4 Address: 10.2.61.89
- IPv4 SubnetMask: 255.255.254.0
- IPv4 Default Gateway: 10.2.60.1
- Primary DNS: 10.42.18.140
- Alternate DNS: 10.42.18.139

 At the bottom of the dialog, there are three buttons: "Cancel", "Test" (which is highlighted with a dashed border), and "Apply".

8. Tap Test to test the connection.

A message appears indicating that an Internet connection has been found.

9. Tap OK to close the message and then tap Cancel to close the IP Config dialog box and return to the Network Settings screen.
10. On the Network Settings screen, tap Back to return to the Tools screen.
11. The system displays the Ethernet icon in the lower left corner of the Home screen to indicate successful Ethernet network communication.



12. If necessary, implement network security measures per your organization's security and privacy policies.

Setting Up the CFX Opus Wi-Fi Adaptor

Note: The CFX Opus Wi-Fi adaptor is specific to the country in which it is to be used. Contact your Bio-Rad Sales representative for the correct adaptor to purchase or visit bio-rad.com/cfxopus.

You can connect the CFX Opus system to internal wireless access points within your organization. When successfully connected, you can send email notifications directly to a specified user account and access your shared network folder. The CFX Opus system recognizes all wireless access points within your company and displays the strength of each connection for best connection. The system maintains the most recent connection until you change it.

This section explains how to connect the CFX Opus system to a wireless access point within your organization and how to change wireless connections.

Tip: To set up the email server and verify the email settings, see [Setting Up Email Service on page 63](#). To set up a shared network folder, see [Setting Up a Connection to a Shared Network Drive on page 70](#).

Important: Consult your system administrator for site-specific wireless IP connections and their secure passwords before continuing. Wireless networks that require additional authentication are not supported.

To connect the CFX Opus system to a wireless access point

1. Locate your locale-specific CFX Opus Wi-Fi adaptor and insert it into the USB A port on the system.
2. On the CFX Opus Home screen, tap Logout, then log in to the system as the Admin user.
3. Tap Tools to open the Tools screen and then tap Wireless Settings in the Admin tools list.

The Networks Settings dialog box appears. The following image appears if you have not established an Ethernet connection and this is the first time you are setting up a wireless connection.

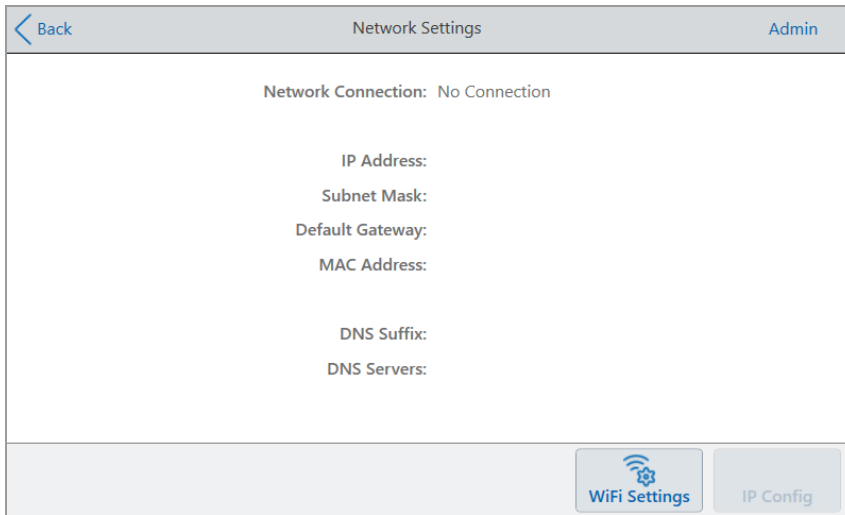

If you have previously connected CFX Opus to a wireless access point, its network connection information appears on the screen:

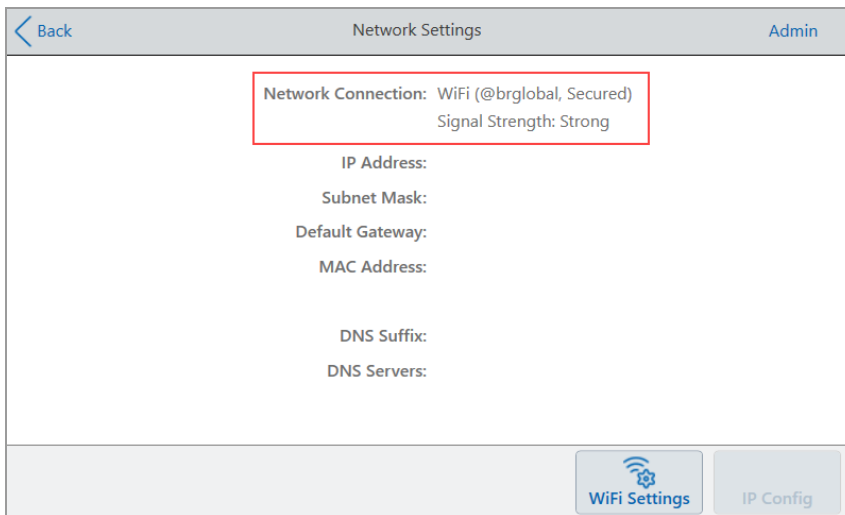

4. Tap WiFi Settings to display a list of available wireless connections.

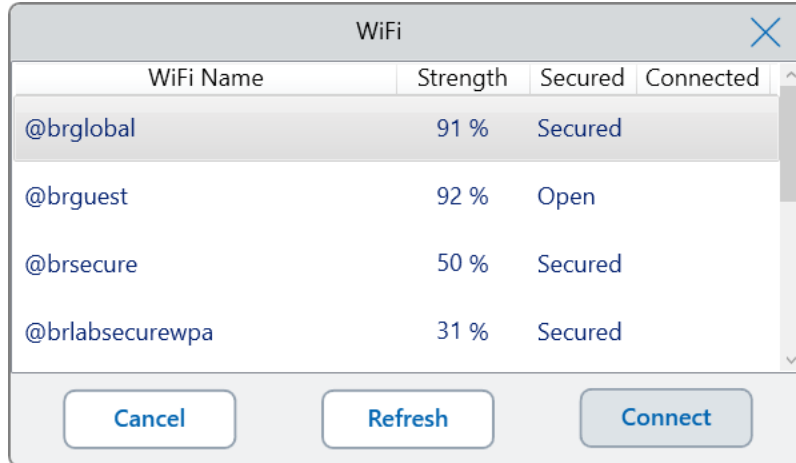

The system displays the name of each wireless access point, its privacy setting (Secured or Open), and its signal strength:

- Above 75% is considered Strong
- 50–75% is considered Good
- Less than 50% is considered Weak

Tip: If your preferred access point does not appear in the list, click Refresh to refresh the list.

5. Tap the preferred access point and then tap Connect.
6. If the preferred access point is secured, you must provide the Wi-Fi password in order to connect.

Note: If you do not know the password, contact your system administrator.

Type the Wi-Fi password in the alphanumeric keyboard that appears and then tap OK.

A message appears indicating that the Wi-Fi connection is successful.

7. Tap OK to close the message and return to the Network Settings screen.
8. On the Network Settings screen, tap Back to return to the Tools screen.
9. The system displays the Wi-Fi icon in the lower left corner of the Home screen to indicate successful wireless access point connection.



Setting Up Email Service

You can connect the CFX Opus system to your outgoing email server and have run notifications and reports emailed directly to a specified user account. CFX Opus saves the email server connection parameters until you change them.

By default, the system ships with Gmail server settings saved. You can create a Gmail account and have email sent to that account, or you can program the system to send email to a specific account on your site's email server.

This section explains how to connect the system to a custom email server.

Note: Before connecting the system to a custom email server, consult your system administrator for site-specific email server requirements.

To connect the CFX Opus system to a custom email server

1. On the Home screen, tap Logout and then log in as Admin.
2. On the Home screen, tap Tools to open the Tools screen.
3. In the Admin Tools screen, tap Email Settings to open the Email Setup dialog box.

The Email Setup dialog box displays the default Gmail server settings.

4. Provide the information for your company:
 - **Authentication** — by default Authentication is selected (required for Gmail email servers) and the Authenticated Account and Account Password fields are active. If your site does not require account authentication, clear this checkbox.

Tip: See your system administrator for the name of the authenticated account and its password.

- Authenticated Account** — the name of the authenticated account.
- Account Password** — the password for the authenticated account.

5. Tap Save to save the changes.
6. (Optional) To verify that the SMTP server settings are correct:

- a. Tap Test Email to open the Email Server dialog box.
- b. Provide a valid email address and enter a sample attachment size.

The size limit for attachments is determined by your company's server. Bio-Rad recommends testing an attachment size between 0.5 and 5 MB.

Tip: Enter 0 to send a test email with no attachment.

- c. Tap Send Email.

The system sends a test email to the email account.

- d. Tap Cancel to return to the Email Setup dialog box.

7. Tap Back to return to the Tools screen.

Changing Email Servers

CFX Opus saves the connection parameters for one email server at a time. It retains the most recent server connection until you change it.

To change to another email server

1. In the Email Setup dialog box, make the appropriate changes.
2. Tap Save and then tap Yes to save the changes.
3. Tap Back to return to the Tools screen.

Connecting to a Computer Running CFX Maestro Software

During installation, the CFX Maestro software installer automatically installs the instrument drivers onto the computer running the CFX Maestro software. CFX Maestro detects connected instruments when you start the software.

Important: You must disconnect the CFX Opus system from the CFX Maestro computer before you install the software. You do not need to turn off the system during the software installation.

To detect connected instruments

1. If you have not yet done so, insert the square (male) end of the supplied USB Type B cable into the USB Type B port located on the back of the instrument.
2. Insert the other (port) end into a USB port on the CFX Maestro computer.
3. If the system is not already running, press the power switch on the back of the instrument to turn it on.
4. Start CFX Maestro software.

The software automatically detects the connected instrument and displays its name in the Detected Instruments pane in the Home window.

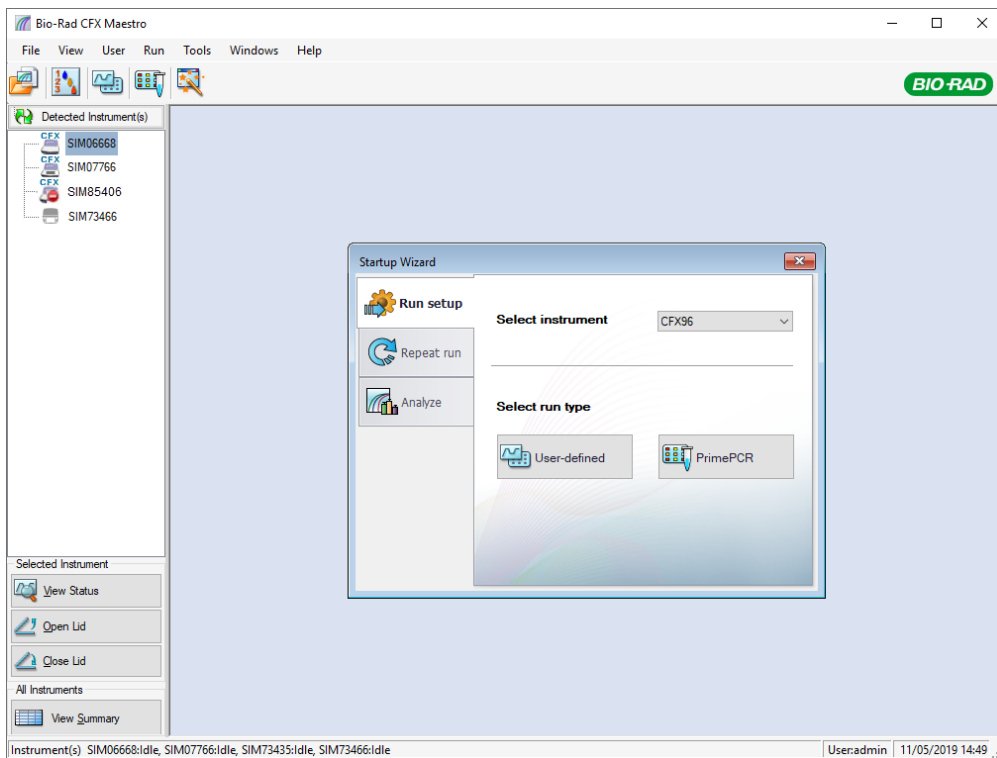

Note: If the instrument does not appear in the Detected Instruments pane, verify that the USB cable is properly installed. To reinstall drivers, select Tools > Reinstall Instrument Drivers in the CFX Maestro software Home window.

Managing Personal User Accounts

As a logged in CFX Opus user, you can

- Set or change your password
- Set or change your email address
- Set or change your shared network drive
- Connect to your BR.io account from CFX Opus

This section explains how to manage your personal account.

Important: Guest users can only set or change their email account.

Setting User Passwords

Bio-Rad recommends that you create a password at the time you create your user profile. You can change your password at any time. The section explains how to set a password if you did not create one at the time you created your user profile.

Note: If you plan to connect to Bio-Rad's BR.io app or a shared network drive, you must have a password.

Tip: CFX Opus passwords can be any combination of alphanumeric characters. Passwords must be between 4–50 characters.

To create a user password

1. From the Home screen, tap Tools, then in the Tools screen tap User Profile.

The User Profile screen appears.

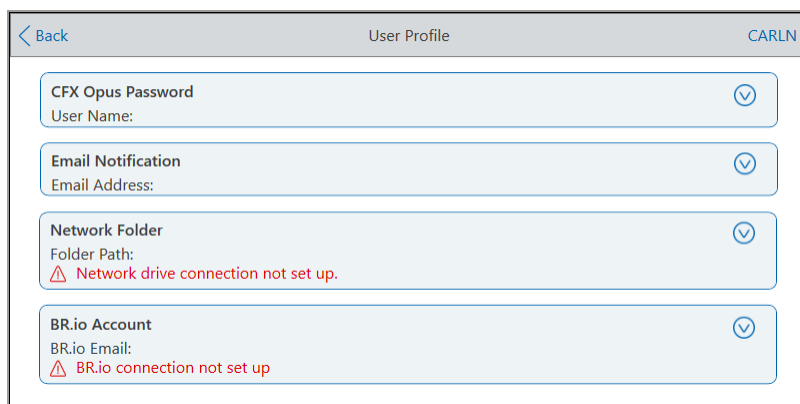

The screenshot shows the 'User Profile' screen with the following sections:

- CFX Opus Password**: User Name: [dropdown]
- Email Notification**: Email Address: [dropdown]
- Network Folder**: Folder Path: [dropdown] ⚠ Network drive connection not set up.
- BR.io Account**: BR.io Email: [dropdown] ⚠ BR.io connection not set up

2. In the CFX Opus Password section, tap  to expand the dialog box and then tap Change Password.

The Change Password dialog box appears.

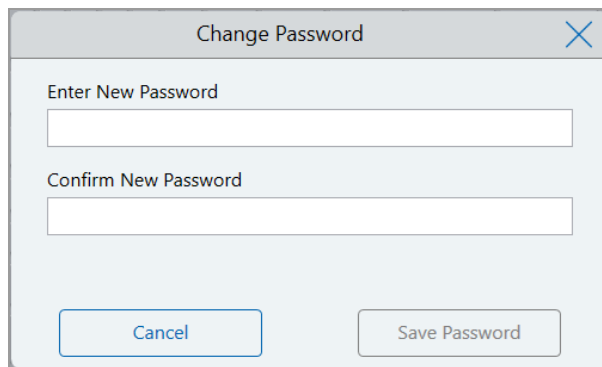

The image shows a 'Change Password' dialog box. It has a title bar with the text 'Change Password' and a close button (an 'X' icon) on the right. Below the title bar, there are two text input fields. The first field is labeled 'Enter New Password' and the second is labeled 'Confirm New Password'. At the bottom of the dialog box, there are two buttons: 'Cancel' on the left and 'Save Password' on the right.

3. Type and confirm your password using the alphanumeric keyboard and then tap Save Password.
4. Tap Back to return to the Tools screen, and then tap Home to return to the Home screen.

To change your password

1. In the CFX Opus Password section on the User Profile screen, tap Change Password.
2. Type your current password using the alphanumeric keyboard that appears, and then tap OK.

The Change Password dialog box appears.

3. In the Change Password dialog box, type and confirm your password using the alphanumeric keyboard that appears and then tap Save Password.
4. Tap Back to return to the Tools screen, and then tap Home to return to the Home screen.

Setting Up Your Email Address

Adding an email address to your CFX Opus user account allows you to be notified by email after a run is completed. This is an option in the Run Setup screen for executing runs. For details, see [Running Protocols on page 105](#).

Note: To receive email notifications from the CFX Opus system, your site administrator must configure the email service. For details, see [Setting Up Email Service on page 63](#).

To add an email address to your user account

1. From the Home screen, tap Tools, then in the User screen tap User Profile.

The User Profile screen appears.

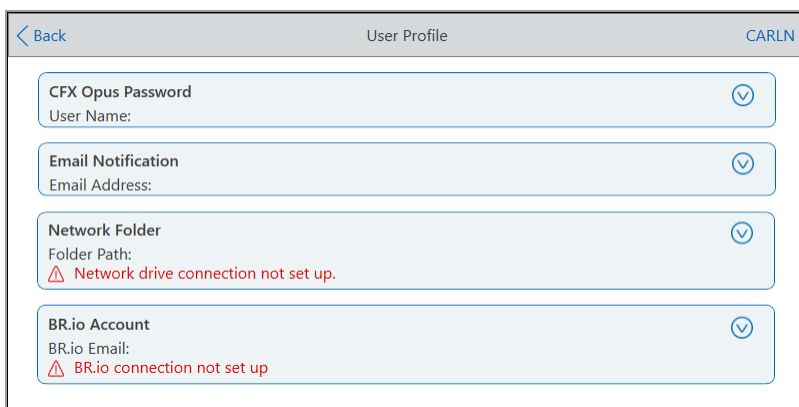

The screenshot shows the 'User Profile' screen with a header bar containing a back arrow, the text 'User Profile', and the name 'CARLN'. Below the header are four expandable sections, each with a dropdown arrow on the right:

- CFX Opus Password**: Shows 'User Name:'.
- Email Notification**: Shows 'Email Address:'.
- Network Folder**: Shows 'Folder Path:' and a red warning icon with the text 'Network drive connection not set up.'
- BR.io Account**: Shows 'BR.io Email:' and a red warning icon with the text 'BR.io connection not set up.'

2. In the Email Notification section, tap  to expand the dialog box.
3. Tap the Email Address field and type your email address using the alphanumeric keypad that appears, and then tap OK.
4. Tap Back to return to the Tools screen, and then tap Home to return to the Home screen.

Setting Up a Connection to a Shared Network Drive

Note: You must have a password on the CFX Opus system in order to connect to a shared network drive. See [Setting User Passwords on page 67](#) for more information.

You can connect your CFX Opus system user account to a shared drive on your internal network. When connected, you can create protocols on your CFX Opus system and save protocols and run files to your network drive. You can also copy CFX protocol files from your network drive to a folder on the CFX Opus system.

Important: Before you can connect the CFX Opus instrument to your BR.io account, your CFX Opus Admin must establish a connection to the Internet through either Ethernet or a wireless network connection. For more information, see [Setting Up a Network Connection on page 56](#) or [Setting Up the CFX Opus Wi-Fi Adaptor on page 60](#).

To connect to a shared network drive

1. From the Home screen, tap Tools, then in the User screen tap User Profile.

The User Profile screen appears.

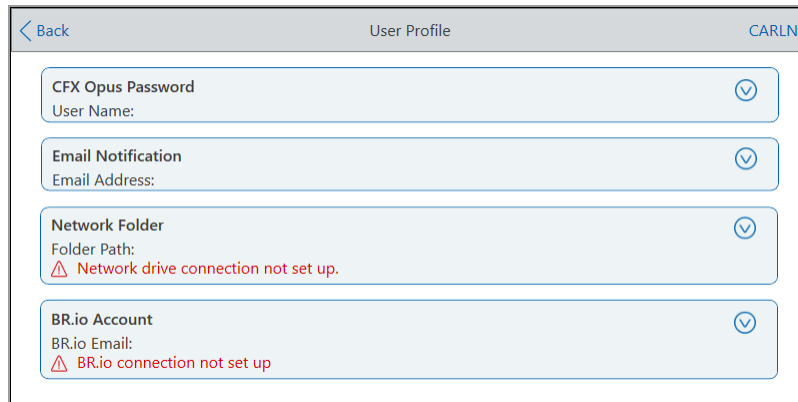

The screenshot shows the 'User Profile' screen with a 'Back' button on the left and 'CARLN' on the right. There are four main sections, each with a dropdown arrow on the right:

- CFX Opus Password:** Includes a 'User Name:' field.
- Email Notification:** Includes an 'Email Address:' field.
- Network Folder:** Includes a 'Folder Path:' field with a red warning triangle and the text 'Network drive connection not set up.'
- BR.io Account:** Includes a 'BR.io Email:' field with a red warning triangle and the text 'BR.io connection not set up.'

2. In the Network Folder section, tap  to expand the dialog box.
3. In the Folder Path section, type the path to the shared network folder using the following format:

`\\server_name\folder_name\...\target_folder`

Note: You must type the two backslashes (\\) at the beginning of the path, and separate each folder with a single backslash.

- In the Connection section, type the **global domain name** and user name you use to connect to that server in this format:

global_domain_name\user_name

You must include the backslash in the path, for example:

Global\CarlN

Tip: This user name might be different than your CFX Opus user name.

- (Optional) Tap Save User Password to save your network password on the CFX Opus system. You will not be prompted for a password the next time you log in to your CFX Opus account.
- Tap Connect.
- Type the password you use to connect to that server using the alphanumeric keyboard that appears and then tap OK.

When the connection is successful, the Network Folder status changes to Connected:

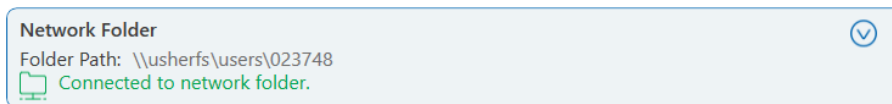

- Tap Back to return to the Tools screen, and then tap Home to return to the Home screen.
Tip: The system informs you when the folder to which you are connected is read-only.

To disconnect the CFX Opus instrument from your network drive

- From the Home screen, tap Tools, then in the User screen tap User Profile.
The User Profile screen appears.
- In the Network Folder section, tap the  icon to expand the dialog box.
- Tap Disconnect.
- Tap Back to return to the Tools screen, and then tap Home to return to the Home screen.

Connecting to Your Bio-Rad BR.io Account

Note: You must have a password on the CFX Opus system in order to connect to your BR.io account. See [Setting User Passwords on page 67](#) for more information. You must also set up a BR.io account. For information about registering a BR.io account, see the help information in the BR.io app.

You can connect multiple CFX Opus systems to your Bio-Rad BR.io account. When connected, you can create PCR experiments in the BR.io app, download them to and run them on one or more CFX Opus systems, and then analyze the uploaded results in the BR.io app. You can also run different PCR experiments from the BR.io on each CFX Opus system.

Important: Before you can connect the CFX Opus instrument to your BR.io account, your CFX Opus Admin must establish a connection to the Internet either through Ethernet or a wireless network communication. For more information, see [Setting Up a Network Connection on page 56](#) or [Setting Up the CFX Opus Wi-Fi Adaptor on page 60](#).

Tip: For more information about Bio-Rad's BR.io app, go to www.BR.io. To register for a BR.io account, see your company's IT administrator.

Connecting the CFX Opus System to Your BR.io Account

To connect the CFX Opus system to your BR.io account

1. From the Home screen, tap Tools, then in the User screen tap User Profile.

The User Profile screen appears.

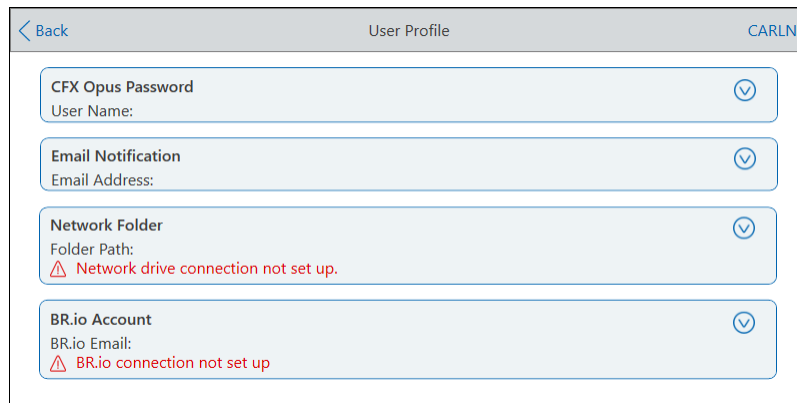

2. In the BR.io Account section, tap  to expand the dialog box.
3. Type the email address for your Bio-Rad cloud account and then tap Connect.
4. Type the password for your Bio-Rad cloud account and then tap OK.

A status dialog appears while your BR.io connection is authenticating. When the connection is successful, the BR.io Account status changes to Connected:

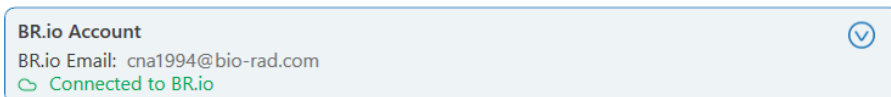

5. Tap Back to return to the Tools screen, and then tap Home to return to the Home screen.

When the CFX Opus system successfully connects to the BR.io

- The cloud icon appears in the bottom left corner of the Home screen:



- In the BR.io app, the Instrument Manager displays the connected instrument:

My Instruments			
TYPE	MODEL	NAME	STATUS
	CFX Opus 96	Instrument42	<input checked="" type="checkbox"/> Idle

Note: When you log into the CFX Opus system after establishing the BR.io account connection, you are automatically connected to your BR.io account. When you log in to your BR.io account, your instrument appears in the instrument list. When you log out of the CFX Opus system, your instrument is removed from the BR.io instrument list.

Disconnecting the CFX Opus System from Your BR.io Account

If you need to remove a CFX Opus system from your BR.io account, you must first disconnect the system from your CFX Opus user account.

To disconnect the CFX Opus system from your BR.io account

1. From the Home screen, tap Tools, then in the User screen tap User Profile.

The User Profile screen appears.

2. In the BR.io Account section, tap to expand the dialog box.

3. Tap Disconnect.

A status dialog appears to confirm your CFX Opus user account is disconnected from BR.io.

4. Tap Back to return to the Tools screen, and then tap Home to return to the Home screen.

Managing User Accounts

The CFX Opus Admin user can perform limited user management tasks. From the User Profile screen, the Admin user can create his own password. From the User Management screen, the Admin user can

- Change a user's password
- Delete a user account

This section explains how to set the Admin password and manage user accounts.

Setting the Admin Password

Important: The default Admin user does not have a password. Bio-Rad strongly recommends that the user who assumes the Admin role immediately set a password and store that password in a password safe. Resetting the Admin password requires a call to Bio-Rad Technical Support.

CFX Opus passwords can be any combination of alphanumeric characters. Passwords must be between 4–50 characters.

Note: If you plan to connect to Bio-Rad's BR.io app or a shared network drive, you must have a password.

To add the Admin password

1. On the Home screen, tap Logout to log out any logged-in user then log in as the Admin user.
2. On the Home screen, tap Tools to open the Admin Tools screen.
3. Tap the User icon on the bottom of the screen to display the User Tools screen then tap User Profile.

The User Profile screen appears.

4. In the CFX Opus Password section, tap the  icon and then tap Change Password.
5. In the Change Password dialog box, type and confirm your password using the alphanumeric keyboard that appears and then tap Save Password.
6. Tap Back to return to the Tools screen, and then tap Home to return to the Home screen.

To change the Admin password

1. In the CFX Opus Password section on the User Profile screen, tap Change Password.
2. Type your current password using the alphanumeric keyboard that appears, and then tap OK.

The Change Password dialog box appears.

3. In the Change Password dialog box, type and confirm your password using the alphanumeric keyboard that appears and then tap Save Password.
4. Tap Back to return to the Tools screen, and then tap Home to return to the Home screen.

Resetting User Passwords

In the event that a user forgets his password, the Admin user can reset the password for that user. Users can change their password at any time and as often as they choose.

To change or add a password for another user

1. On the Home screen, tap Logout then log in as the Admin user.
2. From the Home screen, tap Tools then in the Admin Tools screen tap User Management.

The User Management screen appears.

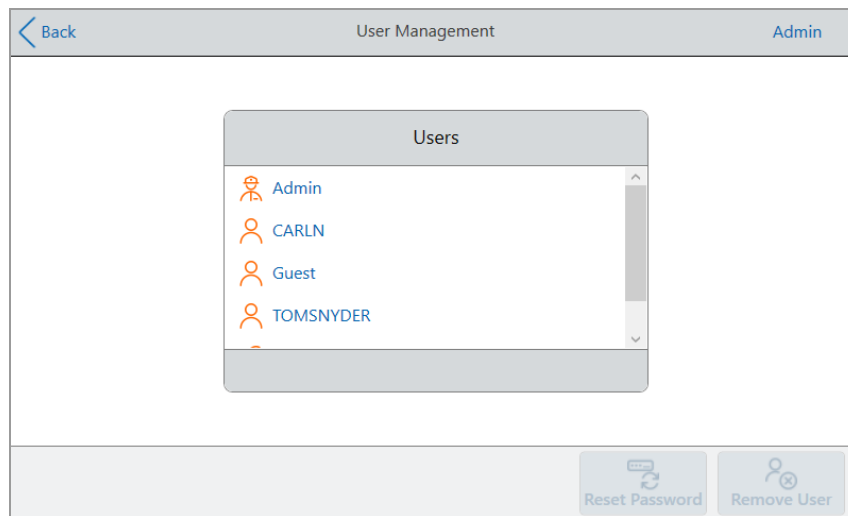

3. Tap the targeted user name on the Users list.
4. Tap Reset Password on the bottom toolbar.

The Reset Password dialog box appears.

5. Type and confirm the new password using the alphanumeric keyboard that appears, and then tap Save Password.
6. Tap Back to return to the Tools screen, and then tap Home to return to the Home screen.

Deleting CFX Opus User Accounts



WARNING! Deleting users accounts from the CFX Opus system also permanently deletes their protocols, run files, and user data. Take care when deleting users from the system.

Note: You cannot delete the Admin, Guest, or Service user accounts.

To delete a user account

1. On the Home screen, tap Logout then log in as the Admin user.
2. From the Home screen, tap Tools then in the Admin Tools screen tap User Management.

The User Management screen appears.

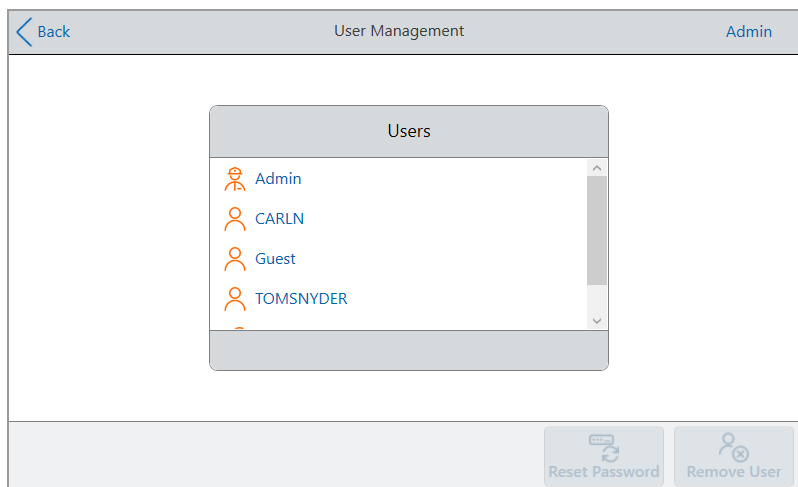

3. Tap the targeted user name on the Users list.
4. Tap Remove User on the bottom toolbar.

A warning appears informing that removing a user permanently deletes their user data.
5. Tap Cancel to cancel the screen or tap Remove to remove the user account and permanently delete their data.
6. Tap Back to return to the Tools screen and then tap Home to return to the Home screen.

Chapter 4 Creating Protocols

Using the touch screen on the CFX Opus system, you can create and edit protocols, change step parameters, and set the sample volume and lid temperature.

For each protocol, you can add, edit, or remove any of the following parameters:

- Plate “read”
- Temperature gradients
- Temperature increments
- Ramp rate
- Extend time
- Alert beeps
- Goto steps

A protocol can contain the following types of steps:

- Temperature — ramps to a target temperature at specified ramp rate and holds that temperature; can include a plate read at end of the step.
- Gradient — applies a temperature differential across the rows of the block; can include a plate read at end of the step.
- Goto — creates a cycle of a specific number of repetitions between certain steps in the protocol.
- Melt Curve — collects fluorescence data at specified temperature intervals between a starting temperature and an ending temperature; used to perform melt curve analysis. Includes a plate read after each interval.

The section [Parameters and Ranges for Protocol Steps on page 80](#) lists the options and ranges for protocol steps. Review the information in this section before creating your protocol.

Parameters and Ranges for Protocol Steps

Use the information in [Table 11 on page 80](#) to modify the default settings for the steps in your protocol.

Temperature Steps

The target temperature is a value between 4.0 and 100.0 °C, set in tenths of a degree. The system ramps up to this temperature and holds that value for a specified amount of time (the hold time).

Gradient Steps

The gradient range is the difference between the lower and upper temperatures in a gradient step. The maximum allowed range is 24°C. The lower temperature is a value between 30.0 and 99.0°C, set in tenths of a degree. The maximum upper temperature is 100°C. The thermal cycler ramps up to the target temperature gradient across the block and holds that temperature for a specified hold time.

Important: The instrument calculates the gradient value. When you enter a value in the gradient calculator's top and bottom fields, the software automatically calculates and assigns the temperatures for the remaining fields. When you enter a temperature in any field between the top and bottom field, the instrument automatically calculates the remaining fields. You cannot manually enter a temperature value in every field.

Table 11. Parameters and ranges for protocol steps

Parameter	Range	Description
Ramp rate	<ul style="list-style-type: none"> ■ For CFX Opus 96 systems: 0.1–5°C per sec ■ For CFX Opus 384 systems: 0.1–2.5°C per sec 	<p>Instructs the thermal cycler to ramp to the target temperature at the specified rate in that step.</p> <p>Available only to temperature steps.</p>
Increment	A number from –10.0 to 10.0°C per cycle in tenths of a degree	<p>Instructs the thermal cycler to change the target temperature of a step with each cycle, where a positive number increases the temperature and a negative number decreases the temperature.</p> <p>Available only to temperature steps.</p>

Table 11. Parameters and ranges for protocol steps, continued

Parameter	Range	Description
Extend	A time from –60 to 60 sec per cycle	Instructs the thermal cycler to extend the hold time with each cycle. A positive number increases the hold time and a negative number decreases the hold time. Available to both temperature and gradient steps.
Beep	(No parameters)	Instructs the thermal cycler to beep to signal that the thermal cycler has reached the target temperature for that step. Available only to temperature steps.
Plate read	(No parameters)	Instructs the thermal cycler to add a plate read to the selected step. Available to both temperature and gradient steps.

Creating a Protocol

Important: While creating your protocol, take care when setting the sample volume and lid temperature. If the lid temperature is too high, the sample temperature might rise above the target temperature. For more information about these settings, see [Setting Sample Volume and Lid Temperature on page 95](#).

To create a protocol

1. On the Home screen, tap New Protocol to open the New Protocol screen.

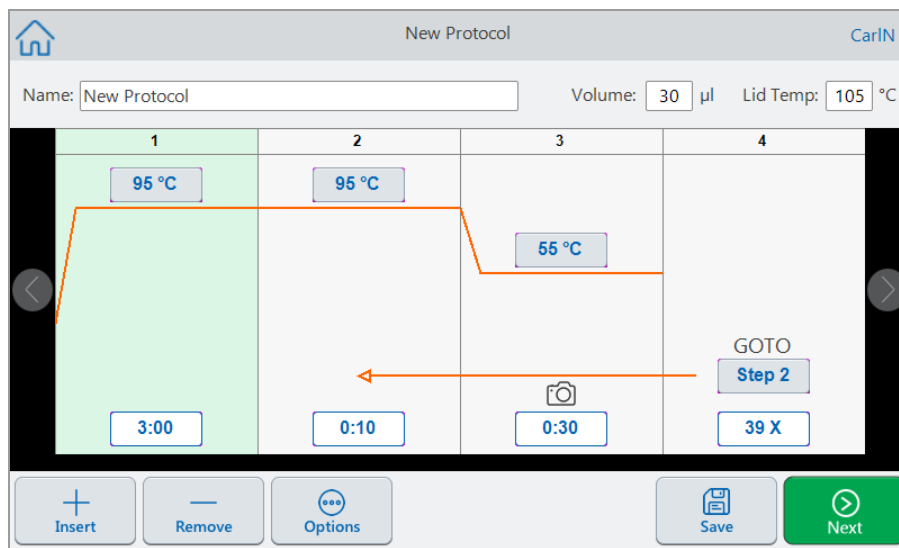

2. To set or change any of the following, tap its respective button or field and enter a value using the alphanumeric keypad that appears:
 - **Name** — the name of the protocol. The name can consist of up to 32 alphanumeric characters.
Tip: Spaces are considered as a character.
 - **Volume** — the reaction volume in µl.
Note: The volume setting affects the control mode used to determine when the sample reaches the target temperature. For details, see [Sample Volume and Temperature Control Modes on page 95](#).
 - **Lid temp** — the temperature of the lid in °C.

- **Temperature** — the target temperature of the step. For example:

95 °C (target temperature set to 95°C)

- **Time** — the hold time of the step (between 1 sec and 17:59:59) in the format of HH:MM:SS. For example:

0:10 (hold time set to 10 sec)

Tip: To set an infinite hold on a step, tap the  key.

- **Goto step number** — (for Goto steps only) the step number to which the Goto cycle returns. For example:

Step 2 (Goto cycle returns to step 2 and repeats the succeeding steps.)

- **Goto cycles** — (for Goto steps only) the number of times to repeat cycle. For example:

39 X (repeat the cycle 39 times)

3. (Optional) If your protocol requires a new temperature, gradient, melt curve, plate read, or Goto step:

- a. Select the step in the protocol that will precede the new step and tap Insert at the bottom of the screen.

The Insert Step dialog appears.

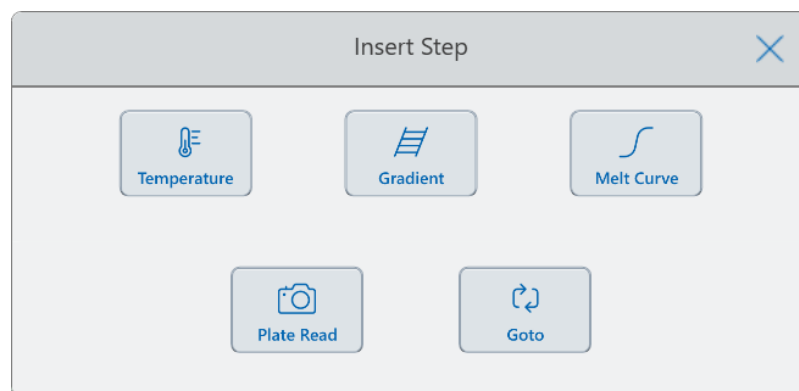

- b. Tap the type of step to insert.

The new step appears in the protocol, highlighted and to right of the selected step. The default temperature of the new step is 50°C and the default time is 30 sec (0:30). Tap time or temperature to edit the parameters in the new step.

4. (Optional) To delete a step, select the step and tap Remove at the bottom of the screen.
5. Tap Save to save the protocol.

The Save As dialog box appears:

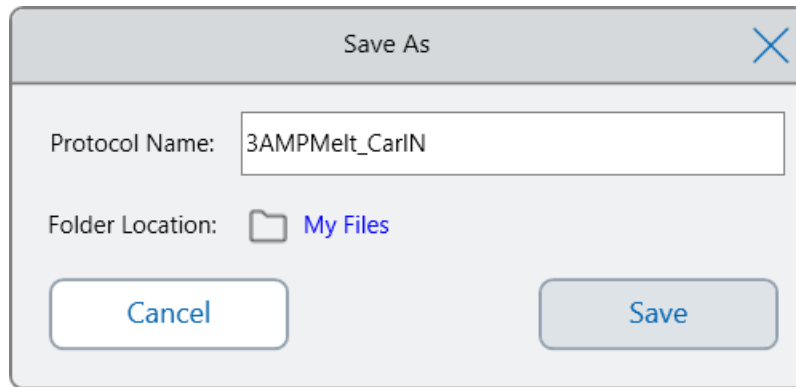

If you have a local user account, the default save location is your personal folder, which appears as My Files in the Save As dialog box. Protocols that are saved in that folder or any folder within the My Files folder structure are visible only to you. Files within your My Files structure are not available to or shareable with other users.

Alternatively, you can choose to save protocols to a shared network folder if you have enabled this setting. You can also choose to save to an attached USB drive.

Finally, you can save protocols to a location in the Public folder. Files that are saved in that folder or any folder within the Public folder structure are visible to and shareable with every CFX Opus user in your organization.

Important: Files saved to an alternate location are not concurrently saved on the CFX Opus system. Consider this before selecting the location.

For Guest users, the default save location is the Public folder. Guest users can save protocols only in the Public folder structure or to an attached USB drive.

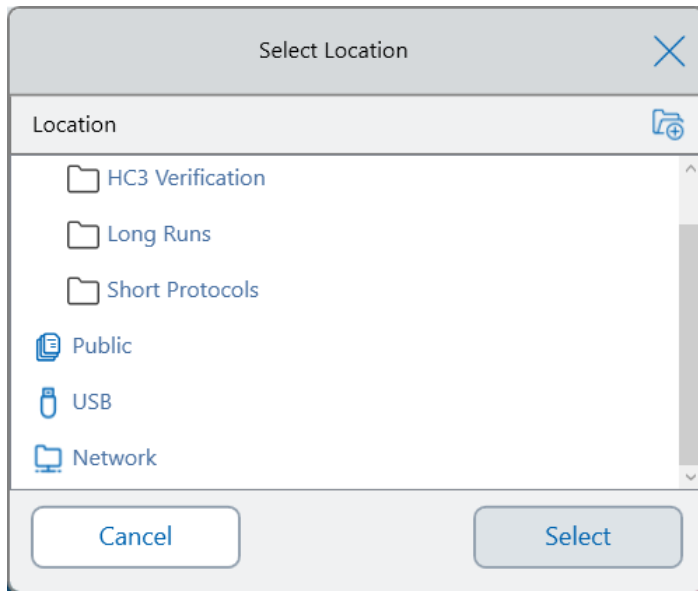

Tip: For more information about managing files and folders, see [Chapter 6, Managing Files and Folders](#).

6. In the Save As dialog box:
 - a. If you have not yet named the protocol, tap the Protocol Name field and type a name for the protocol in the alphanumeric keyboard that appears.
 - b. Do one of the following to determine the file destination:
 - Accept the default folder location.
 - Tap the Folder Location link to open the Select Location dialog box and select the new location. If necessary, tap Create Folder () to create a new folder in the currently-selected location. When you are finished, tap Select.
 - c. Tap Save to save the protocol or Cancel to return to the New Protocol screen.
7. In the New Protocol screen, tap Next to open the Run Setup dialog box.

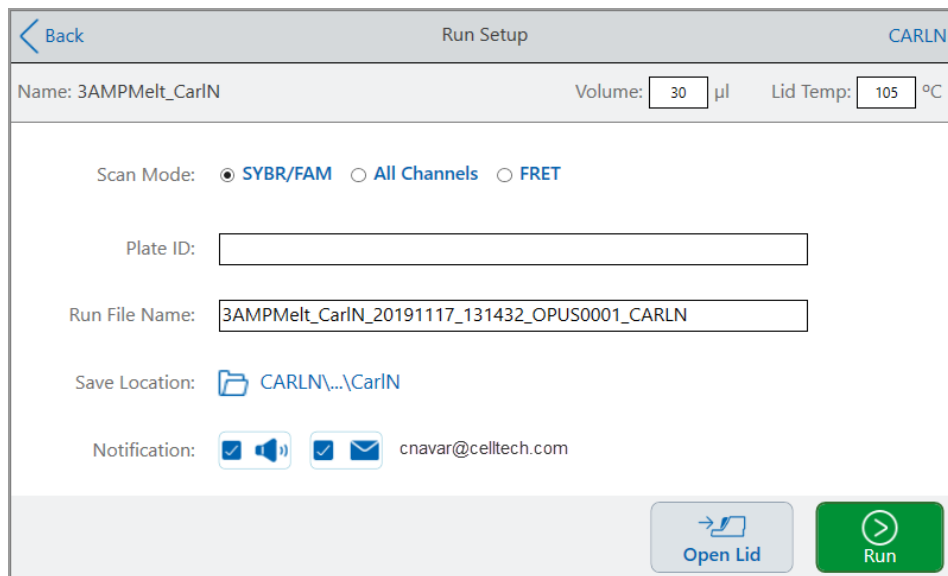

8. Adjust the run settings as needed for your protocol:

- Sample volume
- Lid temperature
- Scan mode

Important: If you plan to upload your completed run and analyze it using the BR.io app, you must choose either SYBR®/FAM or All Channels.

- (Optional) Plate ID
- Run file name

Tip: This is the name for the run file, separate from the protocol name.

- Save location

Tip: The default location is the user's personal folder (My Files), you can change this to save into the same folder as the folder containing the saved protocol, to a shared network drive, a USB, or to your BR.io account if you have enabled this setting.

- Notifications after the run is completed

You can have the system beep and/or send email to a specified email account when the run completes.

9. On the Run Setup screen, tap Run to start the run.

For more information, see [Chapter 5, Running Protocols](#).

Modifying the Settings in a Protocol Step

While you create your protocol, you can modify the default settings for each step. You can add or remove any of the following:

- Target temperature
- Hold time
- Temperature gradients
- Temperature increments
- Ramp rate
- Extend time
- Alert beeps

You can also modify the default settings of a Goto step. These tasks are explained in the sections that follow.

Changing Target Temperature and Hold Time

To change the target temperature and hold time

1. Select the target step and then tap Options on the bottom toolbar to open the Step Options dialog box:

The image shows a 'Step Options' dialog box with the following fields and controls:

- Temperature: 95 °C
- Gradient (°C): [empty]
- Time: 3:00 HH:MM:SS
- Ramp Rate: [empty] °C/s with up/down arrows
- Increment: [empty] °C/cycle with a plus sign and a small icon
- Extend: [empty] s/cycle with a plus sign and a small icon
- Beep: [empty] with a speaker icon
- Plate Read: [empty] with a camera icon
- OK button at the bottom center

2. Tap the appropriate option and enter a new value in the keypad that appears.
3. Tap OK to confirm and close the keypad.

4. Tap OK to close the Step Options dialog box.
5. Tap Save to save the changes.

Tip: Alternatively, tap the appropriate field in the target step and enter a new value in the keypad that appears. Tap OK to close the keypad and return to the protocol.

Adding or Removing a Temperature Gradient

To add a temperature gradient

1. On the protocol, select the target step and tap Options.

The Step Options dialog box appears.

The screenshot shows the 'Step Options' dialog box. The 'Gradient (°C)' checkbox is unchecked. The fields are: Temperature: 95 °C, Gradient (°C): , Time: 3:00 HH:MM:SS, Ramp Rate: °C/s ↕, Increment: °C/cycle ⬆️, Extend: s/cycle ⌚, Beep: 🔔, Plate Read: 📷, and an OK button.

2. In the Step Options dialog box, tap the Gradient checkbox. The gradient range appears to the right in the Step Options dialog box.

The screenshot shows the 'Step Options' dialog box with the 'Gradient (°C)' checkbox checked. A vertical gradient range is displayed on the right side, showing temperatures for wells A through H. The fields are: Temperature: °C, Gradient (°C): , Time: 3:00 HH:MM:SS, Ramp Rate: °C/s ↕, Increment: °C/cycle ⬆️, Extend: s/cycle ⌚, Beep: 🔔, Plate Read: 📷, and an OK button.

A	100
B	99.8
C	99.2
D	98.2
E	97.1
F	96.2
G	95.5
H	95

3. To change the gradient range, tap either the higher or lower value and enter a new value in the keypad that appears.

Important: The upper value of the gradient range must be within 24°C of the lower value.

4. Tap OK to confirm and close the keypad.
5. Tap OK to close the Step Options dialog box.
6. Tap Save to save the changes.

To remove the temperature gradient

1. On the protocol, select the gradient step and then tap Options.
The Step Options dialog box appears.
2. Clear the Gradient checkbox.
3. Tap OK to confirm and close the keypad.
4. Tap OK to close the Step Options dialog box.
5. Tap Save to save the changes.

Adding or Removing the Ramp Rate

The ramp rate option instructs the thermal cycler to ramp to the target temperature at a specified rate in that step.

To emulate a thermal cycler that runs at a slower ramp rate than the CFX Opus, change the ramp rate of the appropriate protocol step.

To add a ramp rate

1. On the protocol, select the target step and tap Options.
The Step Options dialog box appears.
2. Tap Ramp Rate and enter a value using the keypad that appears.
3. Tap OK to confirm and close the keypad.
4. Tap OK to close the Step Options dialog box.
5. Tap Save to save the changes.

To remove a ramp rate

1. On the protocol, select the ramp rate step and tap Options.
2. In the Step Options dialog box, tap Ramp Rate and then tap Off to clear the entry.
3. Tap OK to confirm and close the keypad.
4. Tap OK to close the Step Options dialog box.
5. Tap Save to save the changes.

Adding or Removing a Temperature Increment

An increment raises or lowers the target temperature of a step within each cycle.

To add a temperature increment

1. On the protocol, select the target step and tap Options.

The Step Options dialog box appears.

2. Tap Increment.
3. Enter an increment value using the keypad that appears.

Tip: A positive number increases the temperature, a negative number decreases the temperature.

4. Tap OK to confirm and close the keypad.
5. Tap OK to close the Step Options dialog box.
6. Tap Save to save the changes.

To remove a temperature increment

1. On the protocol, select the temperature increment step and tap Options.
2. In the Step Options dialog box, tap Increment and then tap 0 (zero) to clear the entry.
3. Tap OK to confirm and close the keypad.
4. Tap OK to close the Step Options dialog box.
5. Tap Save to save the changes.

Adding or Removing an Extend Time Option

The Extend option instructs the thermal cycler to extend the hold time with each cycle.

To add or modify an Extend option

1. On the protocol, select the target step and tap Options.
The Step Options dialog box appears.
2. Tap Extend and type a value using the keypad that appears.
3. Tap OK to confirm and close the keypad.
4. Tap OK to close the Step Options dialog box.
5. Tap Save to save the changes.

To remove an Extend option

1. On the protocol, select the extend step and tap Options.
2. In the Step Options dialog box, tap Extend and then tap 0 (zero) to clear the entry.
3. Tap OK to confirm and close the keypad.
4. Tap OK to close the Step Options dialog box.
5. Tap Save to save the changes.

Adding or Removing a Beep Alert

The thermal cycler can emit a beep sound when it reaches the target temperature of a protocol step.

To add a beep alert

1. On the protocol, select the target step and tap Options.
The Step Options dialog box appears.
2. Tap the Beep checkbox to select it.
3. Tap OK to confirm and close the keypad.
4. Tap OK to close the Step Options dialog box.
5. Tap Save to save the changes.

To remove a beep alert

1. On the protocol, select the beep step and tap Options.
2. In the Step Options dialog box, tap Beep to clear the checkbox.
3. Tap OK to confirm and close the keypad.
4. Tap OK to close the Step Options dialog box.
5. Tap Save to save the changes.

Changing Parameters in a Goto Step

The Goto step instructs the thermal cycler to return to a specific step in the protocol and repeat the series of steps a specified number of times. This creates a cycle in the PCR experiment. The Goto step in Step 4 in the following image instructs the thermal cycler to return to Step 2 and perform 34 additional repeats, for a total of 35 cycles.

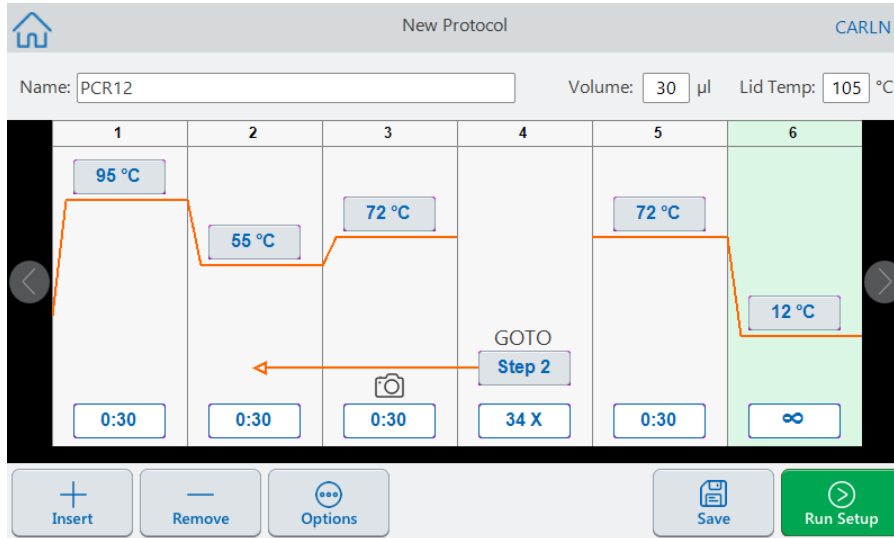

To change parameters in a Goto step

1. To change the return-to step, tap **Step** in the Goto step and type the new step number using the keypad that appears.
2. Tap OK to confirm and close the keypad.
3. To change the number of repeats, tap the repeat **X** on the Goto step and type a new value using the keypad that appears.
4. Tap OK to confirm and close the keypad.
5. Tap OK to close the Step Options dialog box.
6. Tap Save to save the changes.

Setting Sample Volume and Lid Temperature

Important: If the lid temperature is too high, the sample temperature might rise above the target temperature.

Sample Volume and Temperature Control Modes

The CFX Opus system uses one of two control modes to determine when the sample reaches the target temperature:

- **Calculated mode** — when a sample volume setting is greater than zero, the system calculates the sample temperature based on the sample volume. Bio-Rad recommends using the calculated mode because it most accurately represents the actual sample temperature.
- **Block mode** — when a sample volume setting is zero (0) μl , the system assumes that the sample temperature is the same as the measured block temperature.

To change the sample volume

1. On the New Protocol or Edit Protocol screen, tap Volume at the top of the screen and type a new value using keypad that appears.
2. Tap OK to confirm and close the keypad.

To view the control mode setting for a saved protocol or run file

1. From the Home screen, tap Files to open the File Browser screen.
2. Tap the location and folder in which the protocol or run file resides, and then tap the file's name to view its details.

For example, the image that follows shows that the PCR2 protocol uses the CALC (calculated) control mode:

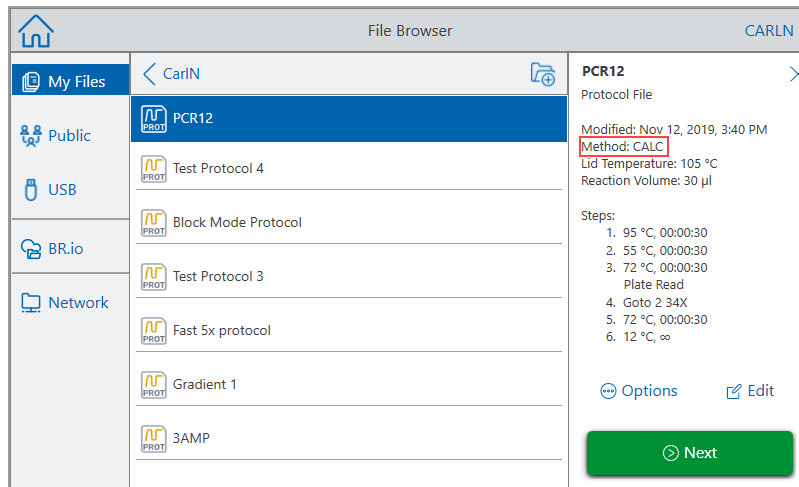

Lid Temperature

Note: For the CFX Opus 96-well system, Bio-Rad recommends a lid temperature of 105°C. For the CFX Opus 384-well system, Bio-Rad recommends a lid temperature of 95°C.

The CFX Opus's adjustable heated lid allows you to control the lid temperature. Heating the lid prevents condensation from forming inside the reaction wells. When the CFX Opus is running, the heated lid maintains the temperature specified for the protocol being run. Without a heated lid, water from the reagents can be lost to condensation, concentrating the reactants in the tube or plate.

The default lid temperature of the CFX Opus is 105°C for 96--well reaction blocks and 95°C for 384-well blocks.

Note: When the block is running an infinite hold at a temperature below 30.0°C, the lid heater maintains 31.0°C.

To change the lid temperature

1. On the New Protocol or Edit Protocol screen, tap Lid temp at the top of the screen and type a new value using keypad that appears.
2. Tap OK to confirm and close the keypad.

Editing a Protocol

You can edit any parameter within an existing protocol. You can then save it with the same name into the same or a different folder, or you can rename the protocol and save it into any folder. A renamed protocol does not overwrite the original protocol.

Tip: You can also open a completed run file, edit the original protocol, and save the protocol to another folder or with another name. For details, see [Extracting and Editing a Protocol from a Run on page 118](#).

Caution: Saving a protocol with the same name in the same folder overwrites the original protocol. You can have multiple protocols with the same name as long as they are saved in different folders.

CFX Opus provides two options with which to edit the protocol:

- Direct interaction with buttons that appear on the protocol:
 - On temperature, gradient, and melt curve steps, tap the temperature and step time buttons to set these parameters. More options are available in the Options dialog.
 - On Goto steps, tap the step number button to change the step at which the Goto cycle begins. Tap the cycles button to change the number of cycles to repeat.
- Tap Options on the bottom toolbar to open the Step Options dialog box, which provides access to all options available for the selected step.

Editing a Protocol

To edit a protocol

1. On the Home screen, tap **Files** to open the File Browser screen.

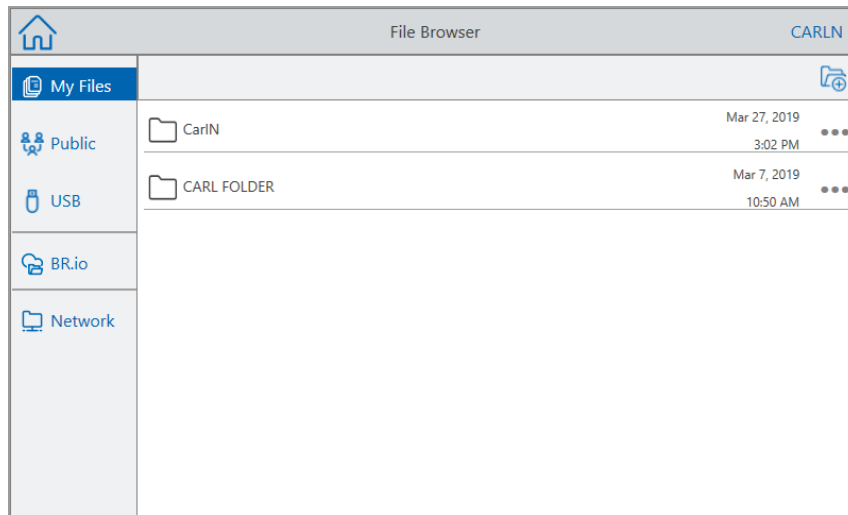

2. Tap the location and folder in which the protocol file resides, and then tap the file's name to select it.

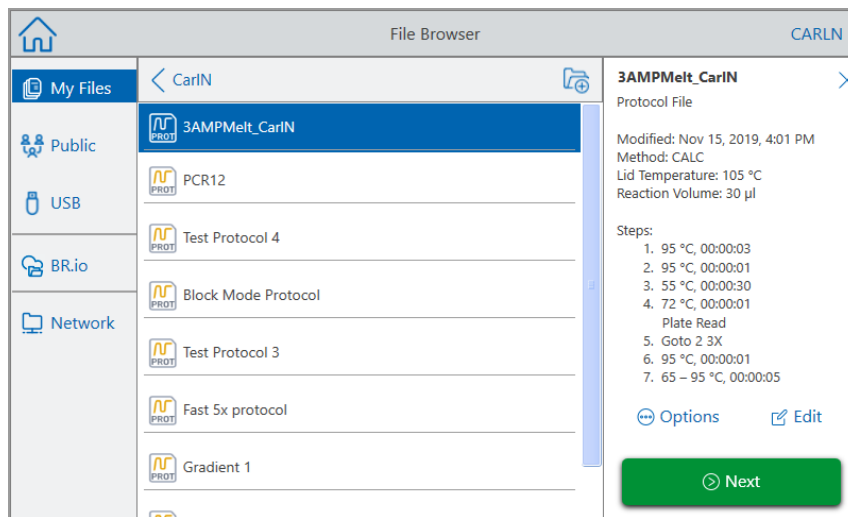

3. Tap Edit to open the Edit Protocol screen. The protocol appears in a graphical format.

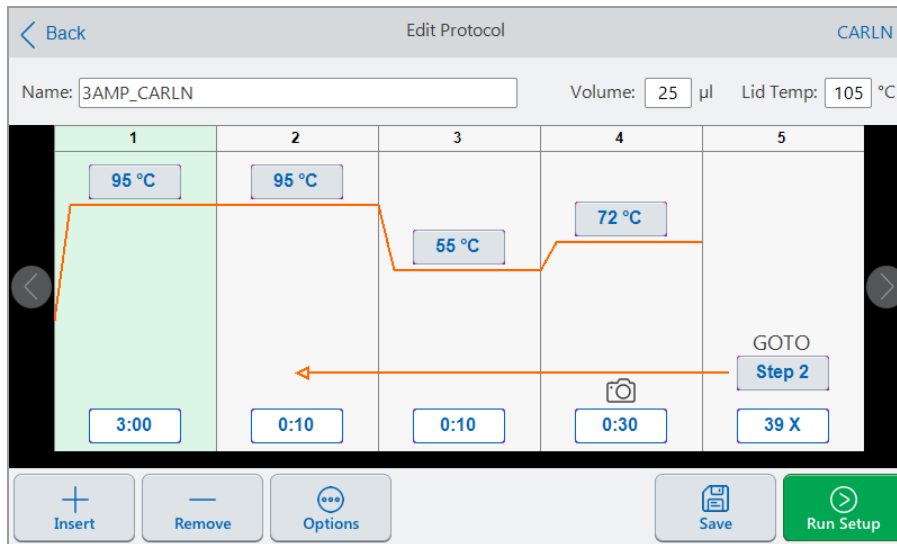

4. To set or change any of the following, tap its respective button or field and enter a value using the alphanumeric keypad that appears:
 - Name
 - Volume

Note: The volume setting affects the control mode used to determine when the sample reaches the target temperature. For details, see [Sample Volume and Temperature Control Modes on page 95](#).
 - Lid temp
 - Temperature
 - Step time
 - Goto step destination (start of cycle)
 - Goto number of cycles
5. (Optional) To add a new step, select a step in the protocol and tap Insert on the bottom toolbar. In the Insert Step dialog box, tap the type of step to insert. The new step appears to the right of the selected step. See [Editing a Protocol on page 97](#) for more information.
6. Tap Next to run the protocol to open the Run Setup dialog box and then tap Run to run the protocol.
7. Tap Save to enter a new file name, folder, and location in which to save the protocol.

Editing a qPCR Protocol

The CFX Opus system ships with a set of preconfigured sample qPCR protocols. These protocols are read-only. You can copy the sample qPCR protocols to any folder on the system, however copied sample protocols are also read-only. You cannot delete the copied protocol, even when saved to another folder.

The sample qPCR files are located in the Public > Bio-Rad qPCR folder, which is also read-only. Because the Bio-Rad qPCR folder is read-only, you cannot save files to or delete files from this folder.

However, any user, including the Guest user, can rename and save the protocol to another location before running it. Renamed protocols are open protocols and can be edited, copied, and deleted.

Note: You must save the renamed qPCR protocol to a location other than the Bio-Rad qPCR folder.

This section explains how to edit a sample qPCR protocol.

To edit a qPCR protocol

1. On the File Browser screen, tap Public in the left navigation pane and then tap the Bio-Rad qPCR folder to display the sample qPCR protocols.

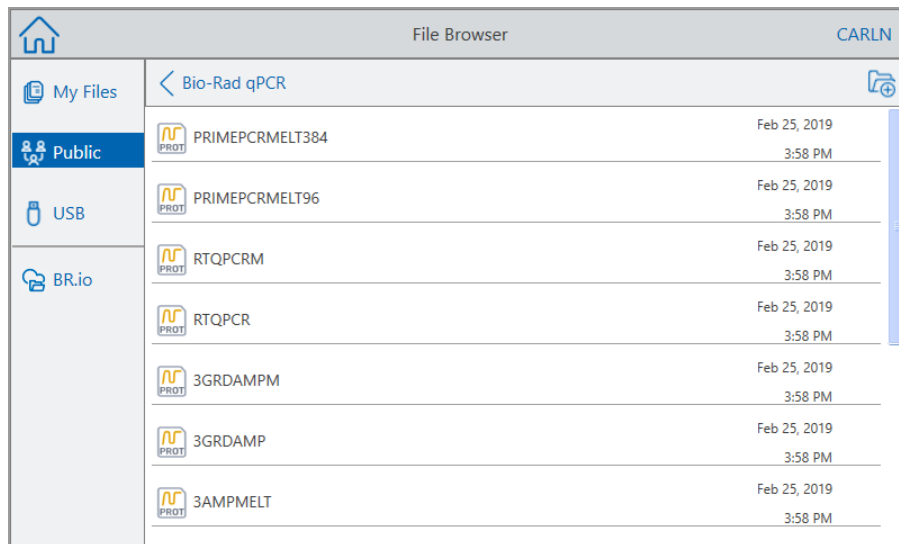

2. Select the target protocol and then tap Edit.

The Edit Protocol screen appears.

3. In Name field, type a new name for the protocol.

Tip: You must rename the protocol. Unless you rename it, the system will not save edits to a qPCR protocol regardless of the folder into which you choose to save it.

4. (Optional) In the Edit Protocol screen, make any necessary changes to the protocol and then tap Save.
5. In the Save As dialog box, tap the Folder Location link and select a location in which to save the protocol.
6. Verify that you changed the name of the file and then tap Save to save the renamed sample qPCR file.
7. On the Edit Protocol screen, do one of the following:
 - Tap Next to open the Run Setup to set up and run the protocol.
 - Tap Back to return to the File Browser screen.

Adding a Protocol Step

To add a protocol step

1. Tap the step in the protocol that will precede the new step and tap Insert on the bottom toolbar.

The Insert Step dialog box appears.

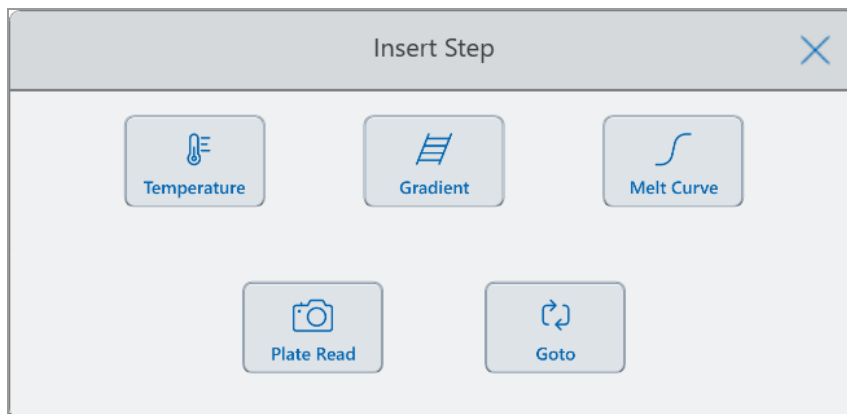

2. Tap the type of step to insert:
 - Temperature
 - Gradient
 - Melt curve

- Plate read

Note: The Plate Read option does not insert a step. Instead, it adds a plate read action to the selected step. If a step contains a plate read, it displays the following icon:



- Goto

The new step appears to the right of the selected step.

Tip: The default target temperature of a new step is 50°C and its default time is 30 sec (0:30). Tap the step's time or temperature or tap Options to edit the parameters in the new step.

Deleting a Protocol Step

To delete a protocol step

- ▶ On the protocol, select the target step and tap Remove on the bottom toolbar.

Renaming a Protocol

To rename a protocol

1. On the protocol, tap Name on the top of the screen.
2. Type a new name for the protocol using the alphanumeric keyboard that appears.
3. Tap OK to accept the name and close the keyboard.

Saving an Edited Protocol

To save an edited protocol

1. On the protocol, tap Save to open the Save As dialog box.

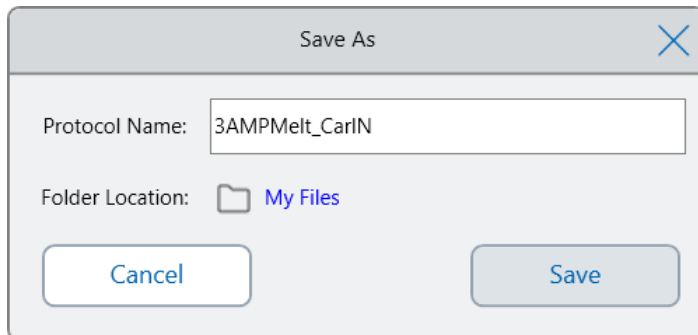

Important: Saving the protocol with the same name in the same location overwrites the original protocol. Saving the protocol with a new name or in another location creates a new protocol. The original file remains unchanged.

2. Tap the Protocol Name field and type a name for the protocol.
3. Do one of the following to determine the file destination:
 - Accept the existing folder location.
 - Tap the Folder Location link to open the Select Location dialog box and select the new location. If necessary, tap Create Folder (📁) to create a new folder in the selected location. When you are finished, tap Select.

Folder Location path displays the path to the selected destination:

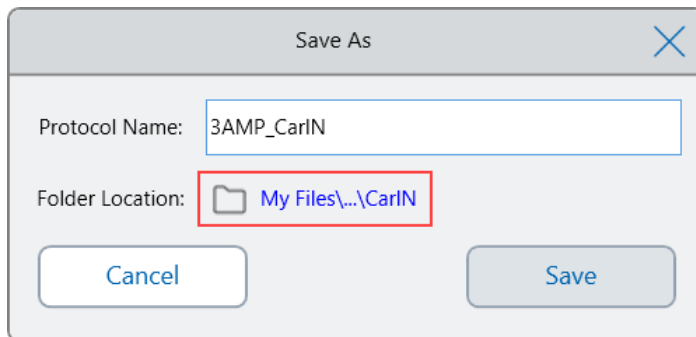

4. Click Save to save the protocol or Cancel to return to the Edit Protocol screen.

Chapter 5 Running Protocols

From the CFX Opus system you can

- Run a protocol
- Run a pending run created from a BR.io protocol
- Repeat a completed run
- View the status of a run
- Pause and resume a run
- Skip steps in a run
- Stop a run

This chapter explains how to perform these tasks using the system's touch screen.

Running a Protocol

CFX Opus offers several options for running a protocol:

- Run a new protocol.
- Run a saved protocol.
- Run a completed run again.
- Run a pending run from your BR.io account.
- Edit a protocol from a completed run, and then run the edited protocol.

This section explains these options in detail.

Running a Saved Protocol

Using the CFX Opus system's File Browser feature, logged-in users can select and run protocols that are saved locally in their My Files folder structure, an attached USB drive, or a shared network folder.



Guest users can run protocols saved in the Public folder structure or an attached USB drive.

Admin users can run saved protocols from any local folder, an attached USB drive, or a shared network folder.

To run a saved protocol

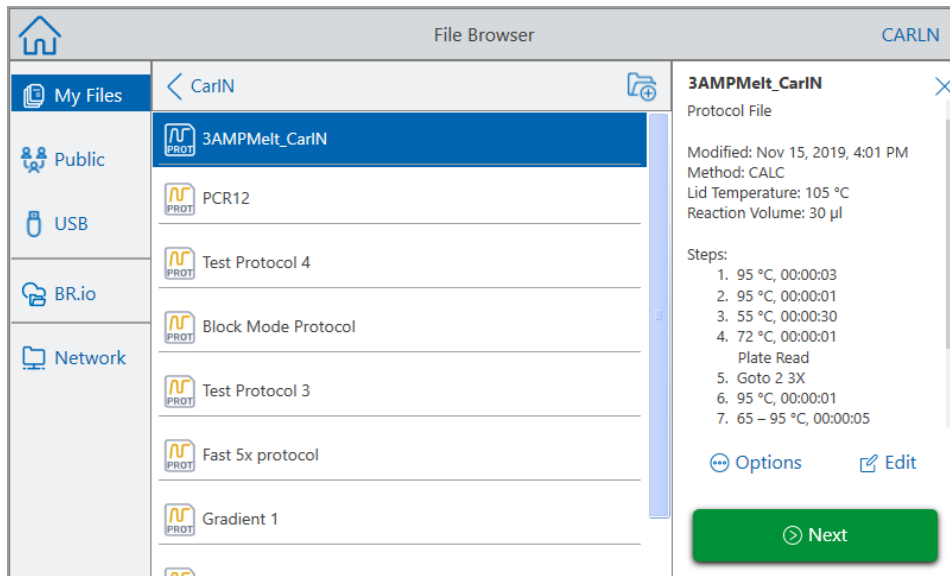
1. On the Home screen, tap Files to open the File Browser screen.
2. Tap the location and folder in which the protocol is saved and then tap the file's name to select it.



Tip: Protocol files are identified by a protocol icon () while run files are identified by a run icon (.

3. Tap Next.

The Run Setup dialog box appears.

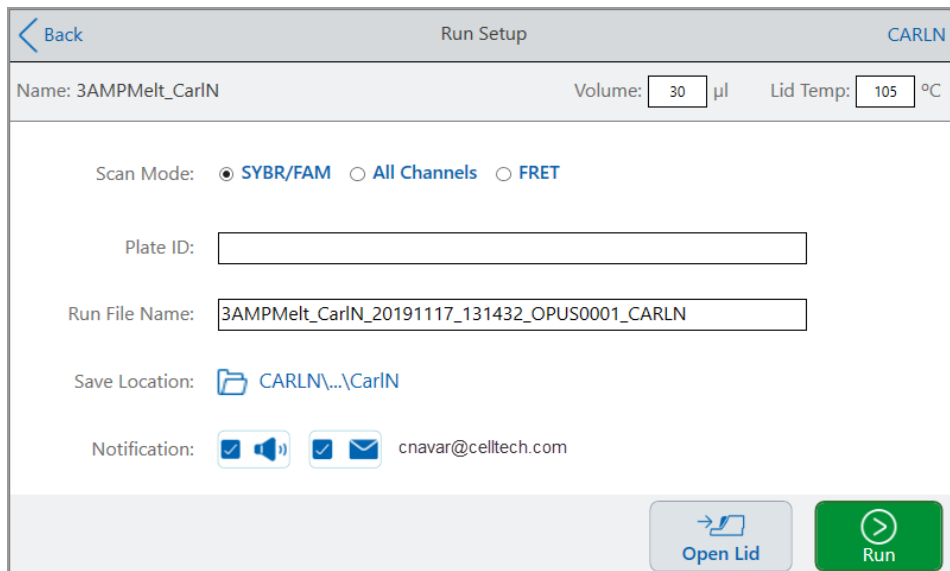

4. Adjust the run settings as needed for your experiment:

- Sample volume
- Lid temperature
- Scan mode

Note: If you plan to analyze your run data using the BR.io app, you must select either SYBR[®]/FAM or All Channels.

- (Optional) Plate ID

To add a plate ID, do one of the following:

- Tap the Plate ID field and manually enter the plate ID in the alphanumeric keyboard that appears and then tap OK to accept the plate ID and close the keyboard.

- Use a USB barcode scanner to scan the plate's barcode into this field:

- a. Connect a barcode scanner to one of the system's USB ports.

Note: The CFX Opus system only supports barcode scanners that are compatible with Windows 10 and are ready to use when connected.

- b. Tap the Plate ID field to view the Plate ID alphanumeric keyboard.

- c. Tap the text field in the keyboard and then scan the barcode to insert the barcode into the text field.

- d. Tap OK to accept the barcode and close the keyboard.

- Run file name — the default file name format is <ProtocolName>_<Date>_<Time>_<SerialNumber>_<UserName>. You can change it to a name of your choice.

Note: The run file name is limited to 64 characters.

- Save Location — the location in which to save the run file. The default location is the folder in which the saved protocol is located.

To save the run file in a different location, tap the location link to access the Select Location dialog and select the new location. If necessary, tap Create Folder () to create a new folder at the currently-selected location. When you are finished, tap Select.

■ Notifications after the run is completed:

□ Beep

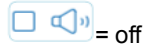

= off



= on

□ Email



= off



= on

Your email address appears next to the email icon.

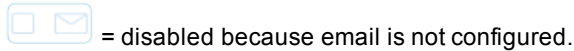

= disabled because email is not configured.

For information about setting up email, see [Setting Up Your Email Address on page 69](#).

5. As needed, tap Open Lid (and Close Lid) to insert the plate in the reaction block.
6. Tap Run to start the run.
7. When the run completes, the Status screen displays Protocol Complete. The system saves the run file into the location with the name indicated in [Step 4](#), for example:

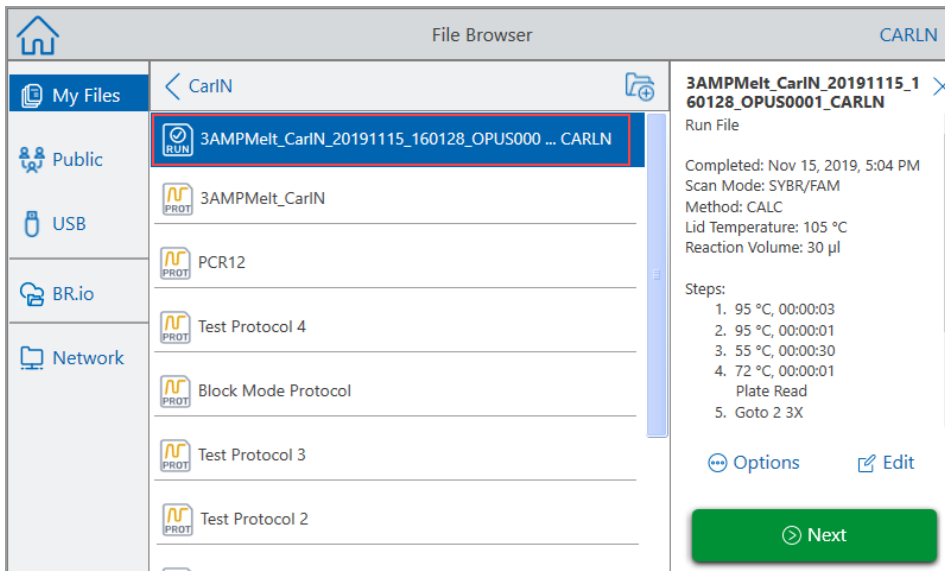

Running a Pending Run from Your BR.io Cloud Account

To run a pending run from your BR.io account

1. Make sure you have connected your CFX Opus instrument's user account to your BR.io account. For details, see [Connecting to Your Bio-Rad BR.io Account on page 72](#).
2. On the Home screen, tap Files to open the File Browser screen.
3. In the File Browser's left navigation pane, tap the BR.io icon to display the pending runs, and then tap the pending run you want to run.

Tip: BR.io pending runs are identified by a pending icon ().

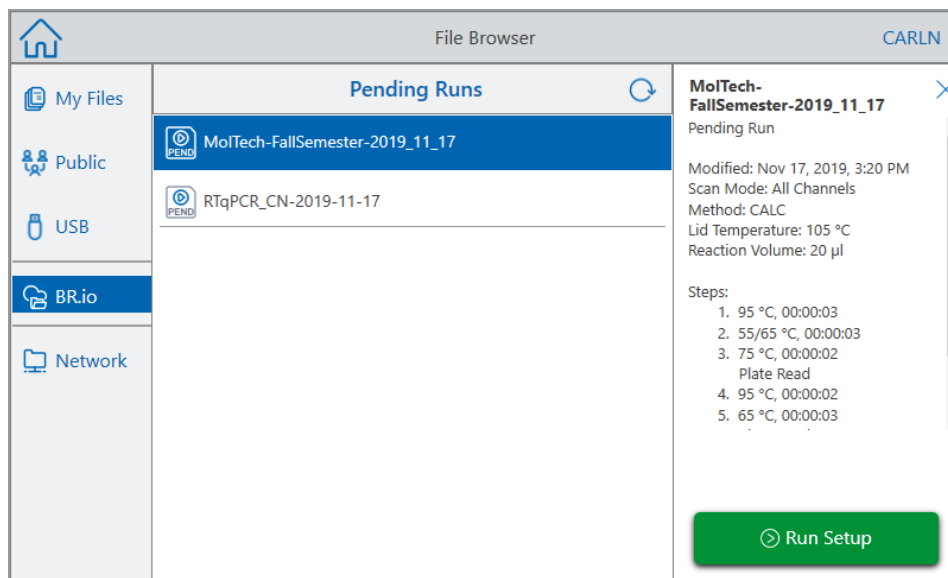

4. Tap Run Setup.

The Run Setup dialog box appears.

< Back CARLN
 Name: Volume: 20 µl Lid Temp: 105 °C
 Scan Mode: SYBR/FAM All Channels FRET
 Plate ID:
 Run File Name: MolTech-FallSemester-2019_11_17
 Save Location: BR.io (cnavar@celltech.com)
 Notification: cnavar@celltech.com

- Adjust the run settings as needed for your experiment.

See [Running a Saved Protocol on page 106](#) for more information.

Note: When the CFX Opus system connects to your BR.io account, your run file is automatically uploaded and is removed from the system.

In the event of an interruption to the CFX Opus/BR.io connection while your run is in progress and the connection is not restored before the end of the run, the run file is automatically saved to your My Files folder. In this case, you can copy the run file to an attached USB drive or to a shared network folder and analyze the data using CFX Maestro software.

- As needed, tap Open Lid (and Close Lid) to insert the plate in the reaction block.
- Tap Run to start the run.



While the run is in progress, the instrument status in your BR.io app is Running.

- When the run completes, the CFX Opus system displays a message indicating the run is uploaded to your BR.io account and the instrument status in your BR.io app is Idle.

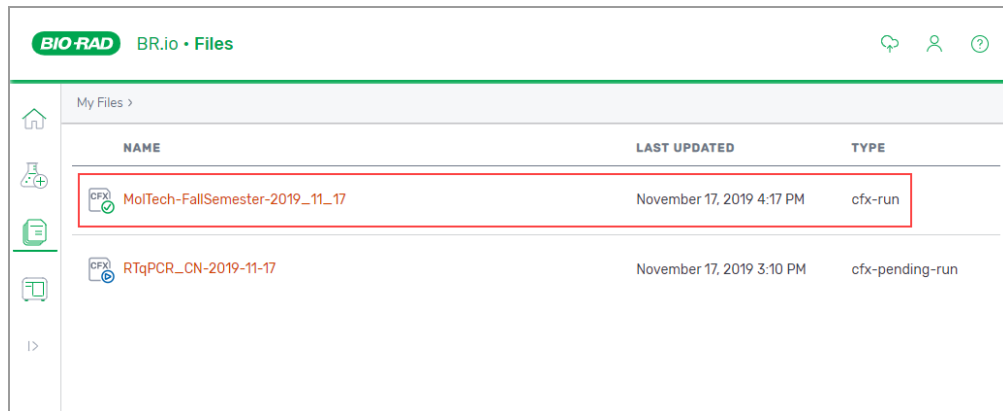
The CFX Opus system removes the pending run file from your BR.io location. The completed run file is available in your BR.io Files list. For example:



The screenshot shows the 'BR.io • Files' interface. It features a sidebar with navigation icons and a main content area with a table of files. The table has three columns: 'NAME', 'LAST UPDATED', and 'TYPE'. Two files are listed:

NAME	LAST UPDATED	TYPE
 MoiTech-FallSemester-2019_11_17	November 17, 2019 4:17 PM	cfx-run
 RTqPCR_CN-2019-11-17	November 17, 2019 3:10 PM	cfx-pending-run

Running a Completed CFX Opus Run

To run a completed run

1. On the Home screen, tap Files to open the File Browser screen.
2. Tap the location and folder in which the completed run file is located, and then tap the file's name to select it.

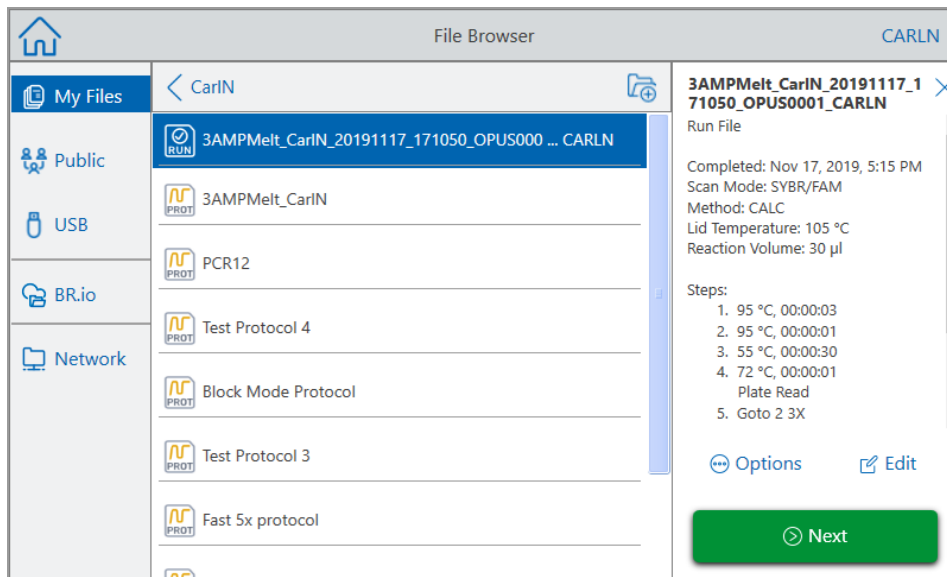

3. Tap Run Setup.

The Run Setup dialog box appears.

Back Run Setup CARLN

Name: 3AMPmelt_CarIN Volume: 30 µl Lid Temp: 105 °C

Scan Mode: SYBR/FAM All Channels FRET

Plate ID:

Run File Name: 3AMPmelt_CarIN_20191117_172455_OPUS0001_CARLN

Save Location: CARLN...\CarIN

Notification: cnavar@celtech.com

- Adjust the run settings as needed for your experiment.

See [Running a Saved Protocol on page 106](#) for more information.

- When the run completes, the system saves the run file into the location with the name indicated in [Step 4](#)

Tip: To differentiate the second run file from the original if you did not change the name, view the time stamp on the run file name, for example:

File Browser CARLN

My Files < CarIN

	3AMPmelt_CarIN_20191117_172455_OPUS000 ... CARLN	Nov 17, 2019 5:33 PM
	3AMPmelt_CarIN_20191117_171050_OPUS000 ... CARLN	Nov 17, 2019 5:15 PM
	3AMPmelt_CarIN	Nov 15, 2019 4:01 PM
	PCR12	Nov 12, 2019 3:40 PM
	Test Protocol 4	Nov 10, 2019 9:22 PM
	Block Mode Protocol	Nov 10, 2019 8:07 PM
	Test Protocol 3	Oct 30, 2019 3:08 PM

Monitoring a Run

During a run, you can use the status buttons on the Home screen to monitor the run.

To monitor a running protocol

1. To see the detailed status of a run in progress, tap the Run Status button on the Home screen.

The Run In-Progress screen appears.

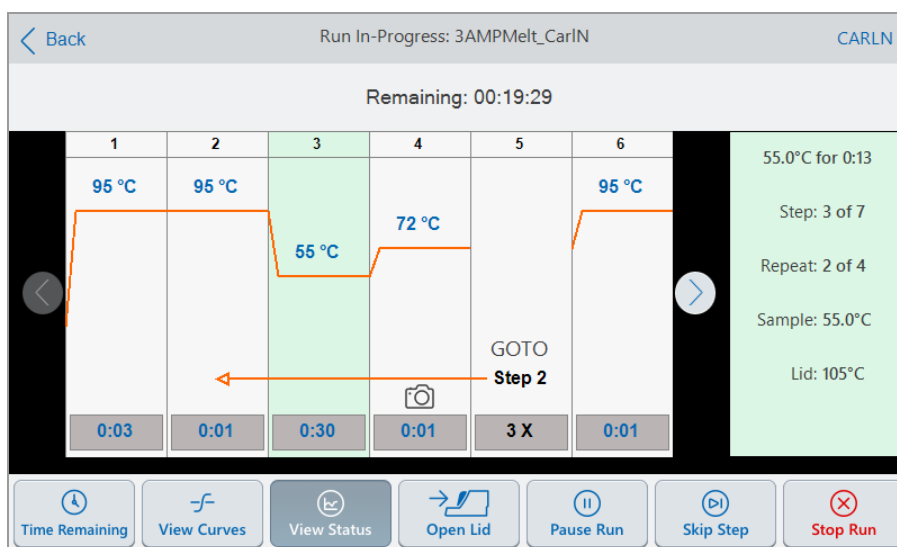

2. To view the remaining time for the run, tap Time Remaining.

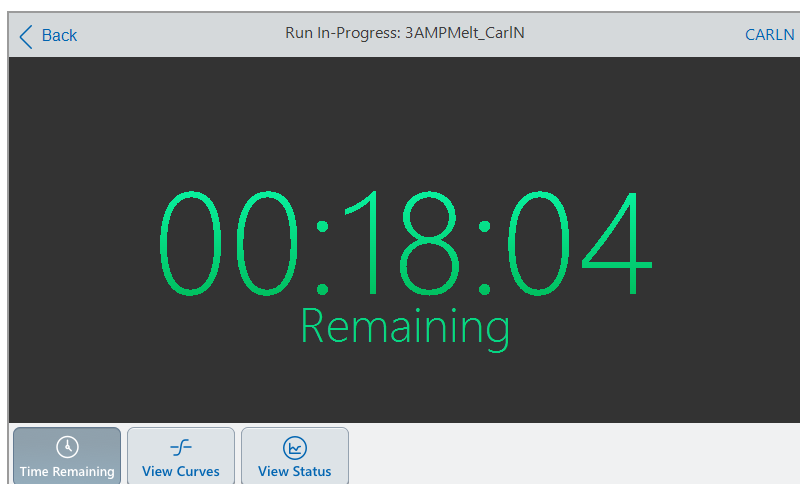

3. To return to the Run In-Progress screen, tap View Status.

Pausing a Run

From its status screen, you can temporarily pause a run in progress. While the run is paused, the system continues heating or cooling to the target temperature and maintains the lid temperature.

Tip: After a power failure, the CFX Opus system displays a warning message. When the power resumes the system automatically resumes the run in progress at the time of the power failure.

Important: Pausing a step can adversely change the outcome of the PCR reaction. If the protocol is paused during a temperature step, the PCR reaction stays at the target temperature for a longer hold time than the protocol step requires.

To pause or resume a running protocol

1. On the Home screen, tap the status button for the system.
The Run In-Progress screen appears.
2. On the Run In-Progress screen, do one of the following:
 - Tap Pause to pause the running protocol,
 - Tap Resume to resume the protocol.

Skipping Steps in a Protocol

From the status screen, you can skip steps in a protocol while it is running if it is necessary to shorten the protocol.

Notes:

- If the system is currently in an infinite hold, tap Skip Step to exit the hold.
- If you tap Skip Step while in a GOTO step, the software skips to the next cycle in the GOTO loop. If the GOTO step is in the last cycle when you tap Skip Step, the CFX Opus software exits the GOTO loop and continues to the next step in the protocol.
- By repeatedly skipping steps, it is possible to bypass several cycles of a GOTO loop and shorten the protocol.

To skip a step in a running protocol

1. If necessary, on the Home screen, tap Run Status to display the Run In-Progress screen.
2. Tap Skip Step to skip to the next step.

Tip: To skip more than one step, tap Skip Step multiple times.

Stopping a Run

You can stop a protocol while it is running. When the protocol is stopped, the block immediately stops changing temperature.



WARNING! Do not open the lid immediately after stopping a run. Opening the lid while samples are still hot can allow pressurized containers to leak, spray, or spurt liquid. Always allow the samples to cool before opening the lid.

To stop a run in progress

1. On the Home screen, tap the status button for the thermal cycler.
The Run In-Progress screen appears.
2. Tap Stop Run.

Extracting and Editing a Protocol from a Run

You can extract a protocol from a run, edit the protocol, and save it. This is helpful if, for example, you do not have access to the original protocol file.

This process creates a copy of the protocol file contained in the run file and does not impact the run file or the original protocol file. If you want to edit an existing protocol file on the CFX Opus system, see [Editing a Protocol on page 97](#).

Important: If you save the edited protocol with the same name and into the same location as the original file, the system prompts you whether you want to overwrite the original file. You cannot recover the original file if it is overwritten. Bio-Rad recommends that you save the file with another name or in a different location to avoid any loss of data.

To extract and edit a protocol from a run

1. On the Home screen, tap Files to open the File Browser screen.
2. Tap the location and folder in which the run file resides, and then tap the file's name to select it.

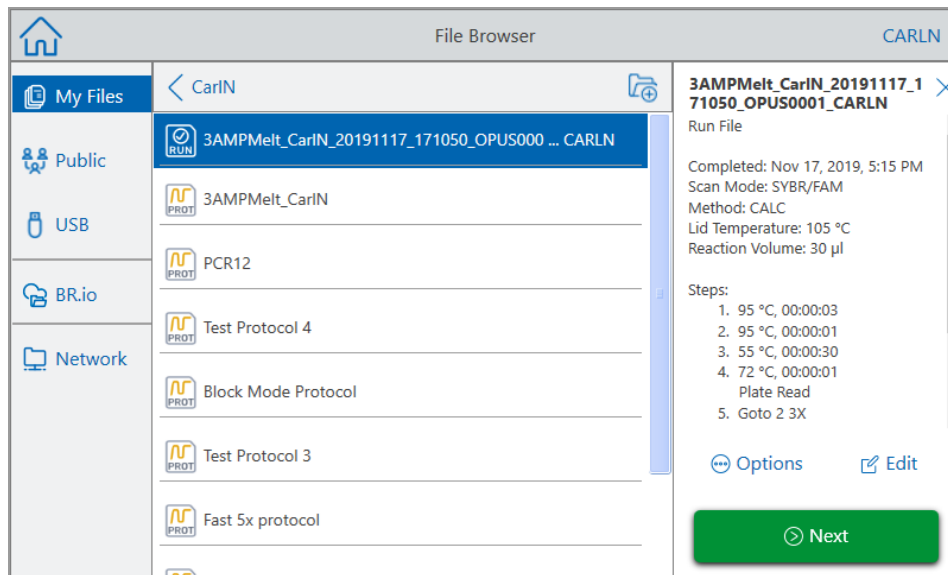

3. Tap Edit to open the Edit Protocol screen. The protocol appears in a graphical format.

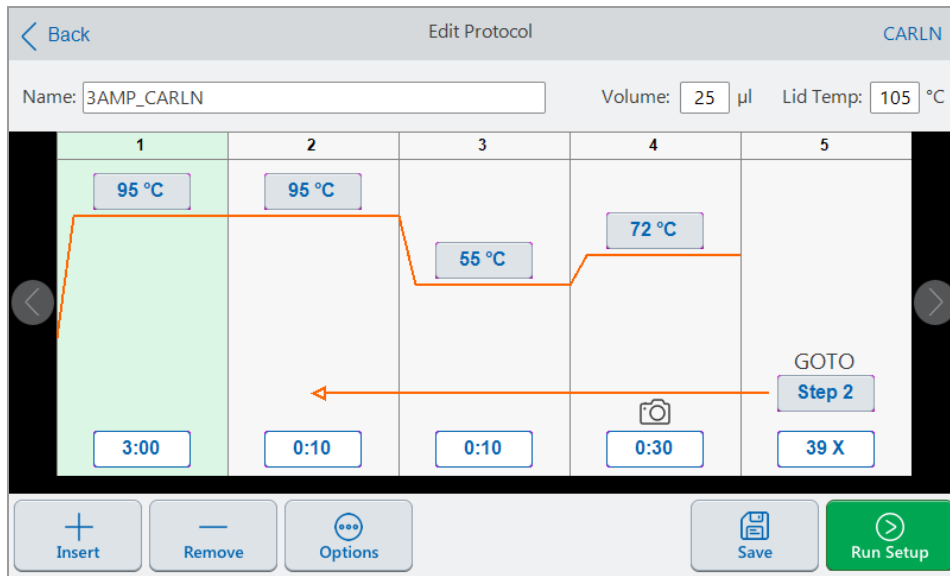

- To set or change any of the parameters, tap its respective button or field and enter a value using the alphanumeric keypad that appears.

For detailed information about the protocol parameters, see [Parameters and Ranges for Protocol Steps on page 80](#)

For detailed information about the settings in a protocol, see [Creating a Protocol on page 82](#).

- (Optional) To delete a step, select the step and tap Remove at the bottom of the screen.
- Tap Save to open the Save As dialog box.
- Type a new name for the protocol and (optionally) select a new location in which to save the protocol.
- Tap Save to save the protocol or Cancel to return to the Edit Protocol screen.
- (Optional) Tap Run Setup to set the run parameters and then run the protocol.

Chapter 6 Managing Files and Folders

Using the CFX Opus system's file browser feature, you can

- Create a sophisticated folder structure in which to manage your stored data files
- Save data files directly on the CFX Opus system or to a connected USB drive or shared network drive
- Copy files and folders to and from shared network drive
- Copy files and folders to and from a connected USB drive
- Rename files and folders on the system
- Delete unnecessary files and folders from the system

This chapter explains how to manage files and folders on the CFX Opus system.

The File Browser Screen

On the CFX Opus system, you manage folders and files using the File Browser screen.

To view the File Browser, tap Files on the Home screen.

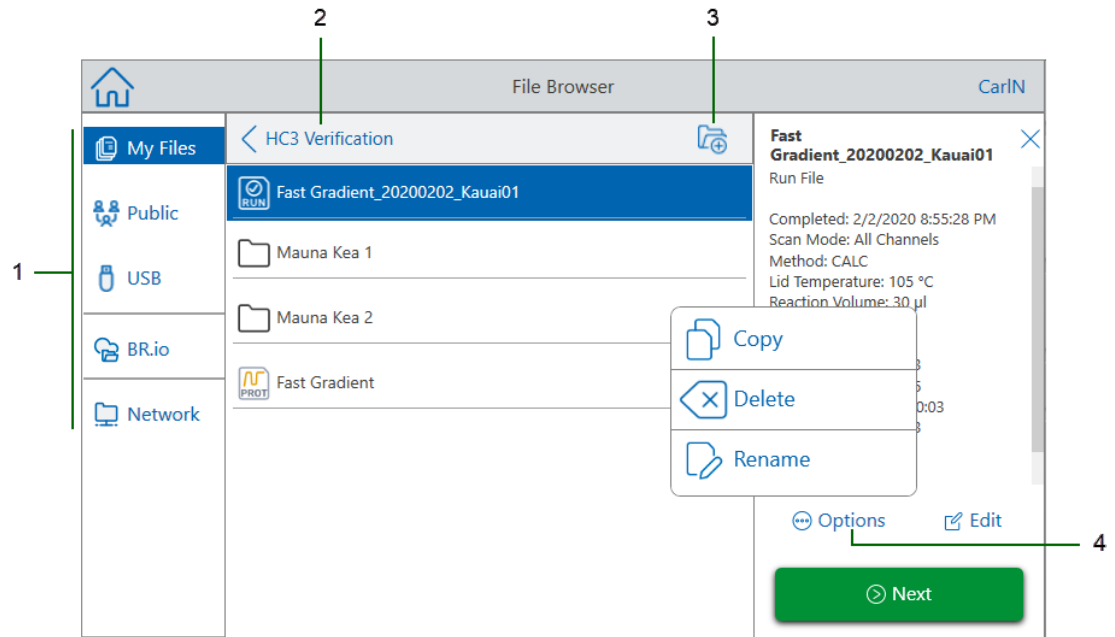

The Legend table on page 123 describes the File Browser screen in detail.

LEGEND

- 1 **Directories** — Potential directories:
 - **My Files** — file storage available only to the person logged in to the CFX Opus system.
Tip: This option is not available to users who do not have a local account (that is, users logged in as Guest).
 - **Public** — file storage available to all system users. Use this directory to share files across users.
Tip: This option is available to users who do not have a local account (that is, users logged in as Guest).
 - **USB** — file storage on a portable USB storage device connected to the CFX Opus system.
 - **BR.io** — contains pending run files available in the BR.io account for the logged in user only; requires a BR.io account and a connection to the account (for details, see [Connecting to Your Bio-Rad BR.io Account on page 72](#)).
 - **Network** — file storage on a network drive connected to the CFX Opus system via Ethernet or wireless communication (for details, see [Setting Up a Connection to a Shared Network Drive on page 70](#)).

- 2 **Sub-directory location** — identifies your current location within the selected directory.

- 3 **Create Folder** — enables you to create a folder within the current location.

- 4 **File management options** — after selecting a file, the file details pane appears. Management options include:
 - **Copy** — copies the existing file to a specified location
 - **Delete** — deletes the file from the system
 - **Rename** — renames the file at its current location

Managing Files and Folders

To manage files and folders, tap Files on the Home screen to open the File Browser screen. [Table 12](#) lists all the folder and file management functions available on the File Browser screen.

Notes:

- The folder and file management functionality is not available for files viewed in your BR.io folder.
- Folder and file names have a 32-character limit on the CFX Opus system.

Table 12. List of file and folder functions in the File Browser screen

Options	Function
File options	(all file actions occur locally on the instrument)
Copy	Copies the existing file to the specified location on the system, attached USB drive, or a connected shared network drive.
Delete	Deletes the file from the instrument.
Rename	Renames the file at its current location.
Folder options	
New Folder 	Creates a new folder in the current location.
Copy	Copies the existing folder to a specified location on the system, attached USB drive, or a connected shared network drive.
Delete	Deletes the folder and all of its contents.

Managing Files on the CFX Opus System

Using the CFX Opus system's File Browser, you can copy, rename, and delete protocol and run folders located

- Locally on the system
- On an attached USB
- On a connected shared network drive

Note: You cannot copy files to or from your BR.io account. When your CFX Opus connects to your BR.io account, CFX Opus automatically syncs with your BR.io account and displays a list of all current pending runs that are compatible with your system.

Tip: To resync the list after creating new pending runs in the BR.io app, tap Refresh on the File Browser.

This section explains how to manage files on the CFX Opus system.

Copying a File

To copy a file

1. On the Home screen, tap Files to view the File Browser screen.
2. On the File Browser screen, navigate to the file you want to copy, then tap the file to view the file details pane.
3. In the file details pane, tap Options and then tap Copy.

The Select Location dialog box appears.

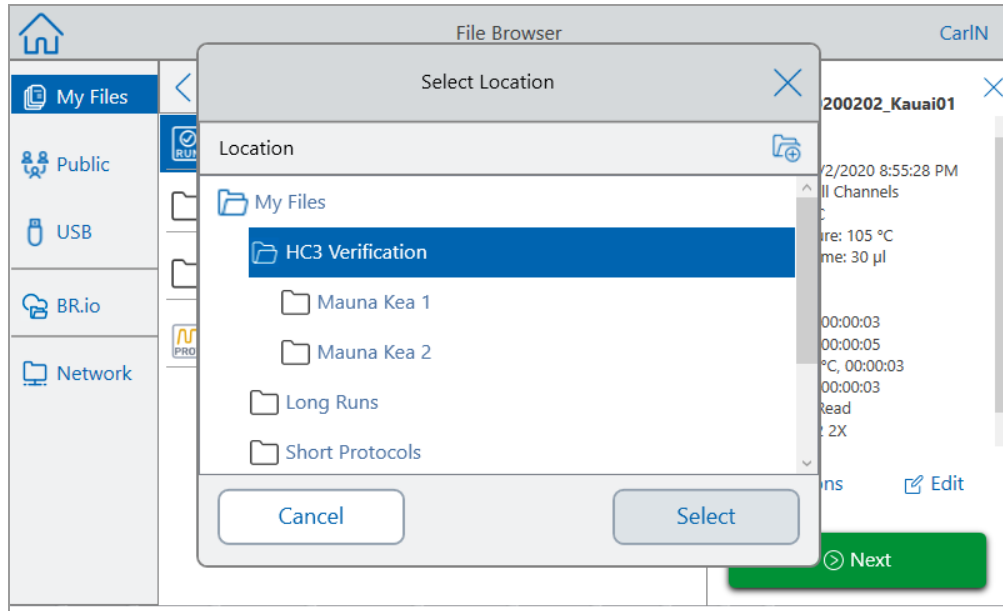

4. In the Select Location dialog box, do one of the following:
 - Navigate to an existing folder.
 - Navigate to the location to create a folder in which to save the file, then tap Create Folder (📁) to create a new folder in that location.
5. Tap Select to copy the file to the selected location or Cancel to return to the File Browser screen.

Note: If a file with the same name exists at the selected location, a dialog appears. Tap Yes to overwrite the existing file or No to return to the File Browser screen.

The CFX Opus system displays a confirmation message when the file is successfully copied.

Deleting a File

To delete a file

1. On the Home screen, tap Files to view the File Browser screen.
2. On the File Browser screen, navigate to the file you want to delete, then tap the file to view the file details pane.
3. In the file details pane, tap Options and then tap Delete.

The Delete confirmation message appears.

4. Tap Delete to confirm or Cancel to return to the File Browser screen.

The CFX Opus system displays a confirmation message when the file is successfully deleted.

Renaming a File

Notes:

- You can rename only protocol files. Run files cannot be renamed.
- The protocol files located in the Bio-Rad qPCR folder are read-only and cannot be renamed. However, you can copy a protocol file to another location, open the file and edit the parameters. You can then save the edited protocol with a new name.

To rename a file

1. On the Home screen, tap Files to view the File Browser screen.
2. On the File Browser screen, navigate to the file you want to rename, then tap the file to view the file details pane.
3. In the file details pane, tap Options, then tap Rename and type a new name for the file using the keypad that appears.
4. Tap OK to confirm.

Managing Folders on the CFX Opus System

Using the CFX Opus system's File Browser, you can copy, rename, and delete protocol and run folders located

- Locally on the system
- On an attached USB
- On a connected shared network drive

Note: You cannot copy folders to your BR.io account.

This section explains how to manage folders on the CFX Opus system.

Creating a New Folder

To create a new folder

1. On the Home screen, tap Files to view the File Browser screen.
2. On the File Browser screen, navigate to location in which you want to create the new folder.
3. Tap Create Folder (📁) and type a name using the alphanumeric keypad that appears and then tap OK to confirm.

The new folder appears in the File Browser.

Copying a Folder

You can copy a folder in one location on the system and save it and its contents into another location. For example, you can copy the folder to an attached USB drive, your shared network drive, or to the Public folder.

You can also copy a folder and save it into the same location. In this case, you must rename the copied folder. You cannot have more than one folder with the same name in the same location.

To copy a folder

1. On the Home screen, tap Files to view the File Browser screen.
2. On the File Browser screen, navigate to the folder you want to copy and then tap the ellipses for that folder to view the Options pane.

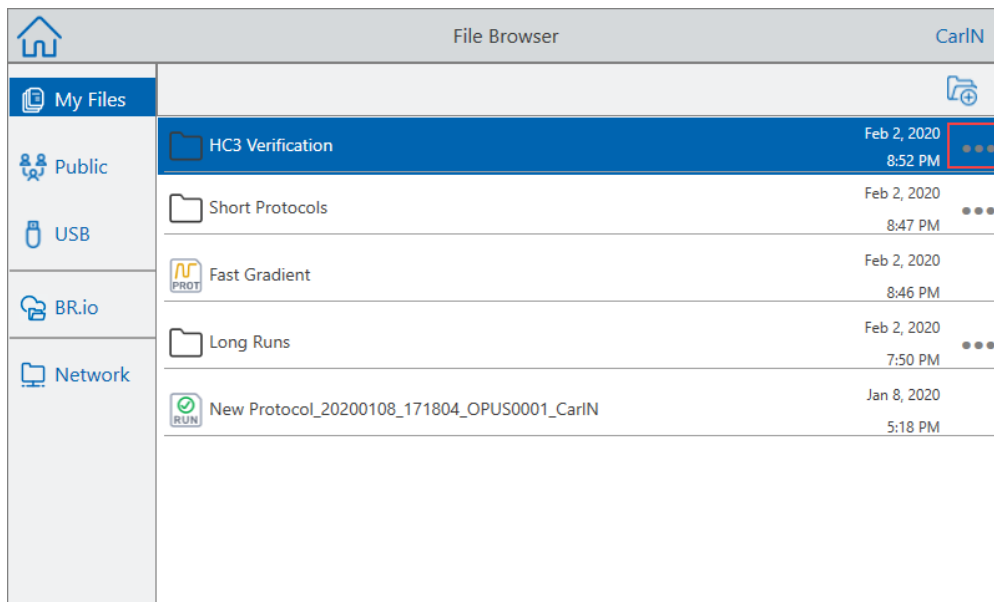

3. In the Options pane, tap Copy.

The Select Location dialog box appears.

4. In the Select Location dialog box, navigate to the target location.
5. Tap Select to copy the folder and its contents to the selected location or Cancel to return to the File Browser screen.

Note: If a folder with the same name exists at the selected location, a dialog appears. Tap OK to close the dialog and select another location.

The CFX Opus system displays a confirmation message when the folder and its contents are successfully copied.

Deleting a Folder

Important: When you delete a folder, its contents are also deleted. Take care when deleting folders from the CFX Opus system.

To delete a folder

1. On the Home screen, tap Files to view the File Browser screen.
2. On the File Browser screen, navigate to the folder you want to delete and tap its ellipses to view the Options pane.
3. In the Options pane, tap Delete. The Delete confirmation message appears.

4. Tap Delete to confirm or Cancel to return to the File Browser screen.

The CFX Opus system displays a confirmation message when the folder and its contents are successfully deleted.

Backing Up and Restoring Files and Folders

Using the CFX Opus system's file browser system you can quickly back up and restore your protocol and run files to an attached USB drive or to a shared network folder.

Tip: Bio-Rad recommends that you back up your data files often, and to a location other than another folder on the CFX Opus system. Follow the recommended SOPs in place at your site.

Notes: You can back up and restore only one file or folder at a time.

To back up or restore files

1. With the target file open in the File Browser screen, tap Options > Copy.
2. In the Select Location dialog box, tap the target destination and then tap Select.

To back up or restore folders

1. In the File Browser screen, tap the ellipses for the target folder and then tap Copy.
2. In the Select Location dialog box, tap the target destination and then tap Select.

Transferring Data Files

When the run is complete, CFX Maestro analyzes the fluorescence data. If the run is performed in stand-alone mode and saved on the instrument itself, the data need to be transferred to the CFX Maestro computer for analysis.

Before running the protocol, on the Run Setup screen you can elect to email the data file from the instrument to your email account after the run completes. If the computer running CFX Maestro provides you access to your email account, you can save the .zpcr file to a folder on the CFX Maestro computer and open it in CFX Maestro.

When the run completes, the run file is saved to the location you select on the Run Setup screen. The CFX Opus system can store up to 100 real-time PCR runs. Using the system's file browser feature, you can copy the run file to a shared network folder on the computer running CFX Maestro or to a connected USB drive, which you can then use to transfer the file to the computer running CFX Maestro.

Appendix A CFX Opus System and CFX Maestro Software Catalog Numbers

This appendix lists the catalog numbers for Bio-Rad's CFX Opus real-time PCR system, software services, CFX Maestro software, and accessories.

Table 13. Catalog numbers for Bio-Rad's CFX Opus system, software, and accessories

Catalog Number	Description
Instruments	
12011319	CFX Opus 96 Real-Time PCR System
12011452	CFX Opus 384 Real-Time PCR System
Software Services, CFX Maestro Software, and Accessories	
12013758	CFX Maestro 2.0 Software
12004128	CFX Maestro 1.1 Software for Mac
12012832	CFX Maestro 2.0 Software, Security Edition, 1 user license
12013028	CFX Maestro 2.0 Software, Security Edition, 5 user licenses
12012834	CFX Maestro Software 2.0, Chinese Edition
12012833	CFX Maestro Software 2.0, Russian Edition
1845025	Precision Melt Analysis Software, with calibration kit
12012942	USB cable*
12013205	Ethernet cable *
	CFX Opus Wi-Fi Adaptor Contact your Bio-Rad Sales representative for information about the adaptor specific to your locale or visit bio-rad.com/cfxopus .
* For continued compliance with EMC standards only use Bio-Rad-approved USB and Ethernet cables with this instrument.	

Warranty

The CFX Opus real-time PCR system and its associated accessories are covered by a standard Bio-Rad warranty. Contact your local Bio-Rad office for the details of the warranty.

Appendix B Recommended Plastic Consumables

Plastic Consumables for the CFX Opus 384 System

For optimal results, Bio-Rad recommends the following consumables for CFX Opus 384 systems:

- HSP3805 — Hard-Shell low-profile 384-well plates with clear shell and white wells
- HSP3865 — Hard-Shell low-profile 384-well plates with black shell and white wells

Plastic Consumables for the CFX Opus 96 System

The CFX Opus 96 System accepts low-profile 0.2 ml plates and tubes. Bio-Rad recommends the following consumables for optimal results:

- MLL9601 — Multiplate low-profile 96-well unskirted PCR plates with clear wells
- MLL9651 — Multiplate low-profile 96-well unskirted PCR plates with white wells
- HSP9601 — Hard-Shell low-profile 96-well skirted PCR plates with white shell and clear wells
- HSP9655 — Hard-Shell low-profile 96-well skirted PCR plates with white shell and white wells
- TLS0801 — Low-profile 0.2 ml 8-tube PCR strips without caps, clear
- TLS0851 — Low-profile 0.2 ml 8-tube PCR strips without caps, white
- TCS0803 — Optical flat 8-cap strip, for 0.2 ml PCR tubes and plates

Plate Seals and Plate Sealer

For optimal results, Bio-Rad recommends the following plate seals:

- MSB1001 — Microseal 'B' adhesive seals, optically clear (strong adhesive-based)
- MSC1001 — Microseal 'C' optical seals, optically clear (pressure-activated, adhesive-based)
- 1814030 — Optically clear heat seal plate sealer

Appendix B Recommended Plastic Consumables

Appendix C Maintenance and Troubleshooting

This appendix explains how to clean and maintain the CFX Opus system and how to troubleshoot problems that you might have.

Cleaning and Maintaining the CFX Opus System

The CFX Opus requires little maintenance for proper operation and precise thermal control. However, with long and constant use, the system will require some cleaning and other maintenance.

The CFX Opus system includes a sensitive optical shuttle system that moves quickly during data collection and a reaction block that must heat and cool quickly. Contamination of these components can interfere with thermal cycling and data collection.

Avoid contaminating your CFX Opus system by following these guidelines:

- Always clean the outside of any containers before placing them in the block.
- Never run a reaction with a seal that is open, loose, punctured, or otherwise damaged.
- Clean the reaction block and inner lid periodically to prevent the buildup of dirt, biohazardous material, or fluorescent solutions (see [Table 14 on page 137](#)).

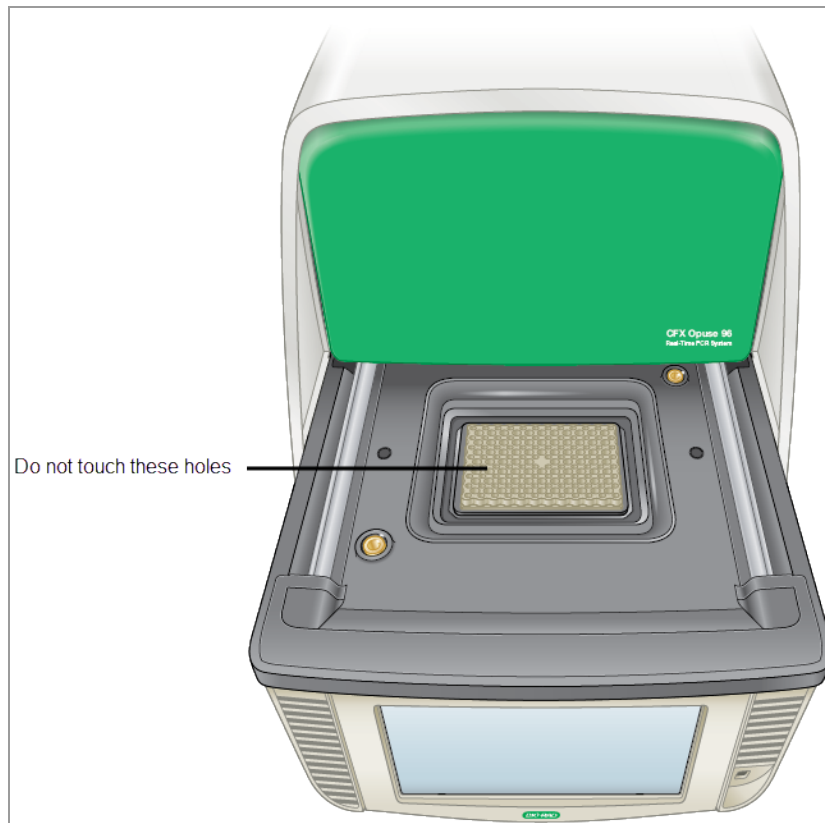





- Clean the outer surface of the CFX Opus system on a regular schedule to remove any debris or dirt that might interfere with proper function (see [Table 14 on page 137](#)). Clean the system to prevent damage to the air intake or reaction bay.

Important: For instructions on handling and cleaning radioactive or biohazardous materials, consult the guidelines for radiation safety and biosafety provided by your institution. These guidelines also include hazardous materials disposal methods.

CFX Opus Instrument Cleaning and Maintenance Safety Warnings

When cleaning and maintaining the CFX Opus instrument, always consider and follow the warnings listed in [Table 14](#) that follows.

Table 14. Cleaning and maintenance safety warnings

Warning	
	To prevent electrical shock, always turn off and unplug the instrument from the electrical outlet before cleaning it.
	A thermal cycler operates at temperatures high enough to cause serious burns. Always allow the entire instrument to return to room temperature before cleaning.
	When handling biohazardous or radioactive samples, adhere to the recommended precautions and guidelines specific to your laboratory and location. These guidelines should include cleaning, monitoring, and disposal methods for the hazardous material(s) you are using.
	In addition, as identified above, there is a small risk of explosion, or of expulsion of liquids or vapors from the sample container(s). When working with hazardous materials the risk of injury from expelled material is compounded with the risk that the hazardous material themselves could be dispersed in and around the instrument. Users should take appropriate precautions for such a situation.
	

CFX Opus Instrument Maintenance

Table 15 lists the components of the CFX Opus instrument that will require maintenance.

Table 15. CFX Opus system maintenance

Component	Action
Air vents	<p>Use a soft brush, damp cloth, or vacuum cleaner to remove light dust from the air vents. Remove any heavy dust that is deep in the vents with a vacuum cleaner.</p> <p>Tip: Cleaning the vents allows sufficient airflow for precise thermal control during a run.</p>
Touch screen	<p>Use any commercially available touch screen cleaning agent and a soft cloth to clean the touch screen.</p> <p>Note: Do not spray or pour cleaning agent directly onto the touch screen.</p> <p>Note: Do not use abrasive detergents or rough material because they can scratch the touch screen.</p>
Outside case of the system	<p>Use a damp cloth or tissue to clean spills off the outside case. If needed, use a mild soap solution and remove the residue completely.</p> <p>Tip: Cleaning the outside case prevents corrosion.</p>

Table 15. CFX Opus system maintenance, continued

Component	Action
Reaction block	<p>Important: Clean spills immediately to prevent them from drying inside wells.</p> <p>Use disposable plastic pipettes with water (recommended), 95% ethanol, or a 1:100 dilution of bleach in water. Always rinse the wells with water several times to remove all traces of ethanol, bleach, or soap.</p> <p>Note: Consider the following when cleaning the reaction block:</p> <ul style="list-style-type: none"> ■ If left in the block wells, bleach, ethanol, or soap could corrode the block and/or destroy tubes and microplates during a run. Always rinse the block thoroughly after cleaning it with any solution other than water. ■ Never clean the reaction block with strong alkaline solutions (strong soap, ammonia, or highly concentrated bleach). Never use corrosive or abrasive cleaning solutions. These cleaning agents can damage the block, preventing precise thermal control. ■ Never heat the block with cleaning solution on or in it. Heating the block with cleaning solution damages the block and lid, and can contaminate the optics. <p>If oil is used, the wells must be cleaned thoroughly and often. Use of oil in the wells is not recommended. Use a solution of 95% ethanol to clean oil on the reaction block. Do not allow oil to build up in the block.</p>

Maintaining Sufficient Airflow

The CFX Opus system requires sufficient airflow to heat and cool precisely to the correct target temperature. If the flow of air is blocked, the thermal cycler cannot ramp to the correct temperature in the specified time. This section explains how to test the airflow and how to fix low or warm airflow.

Testing for Sufficient Airflow

The airflow is sufficient when the system heats and cools to the correct target temperatures promptly. Bio-Rad suggests that you test the airflow when you set up the CFX Opus system in a new location. You can also measure the air temperature at any time to ensure sufficient airflow.

To determine the presence of sufficient airflow

1. Set up and start the system.
2. Adjust the local environment for typical conditions:
 - Turn on any nearby equipment, such as fans or other systems.
 - Open any window blinds to reproduce typical conditions during a run.
3. Run a typical PCR protocol for 30 min.

If more than one system is in the area, run a protocol on all the systems at the same time.

Note: Samples are not required for the test runs. However, you must include an empty microplate or capped strip tubes. The lid does not heat correctly if it touches the reaction block.

4. Measure the air temperature at the air intake vents of the system.

If the air intake temperature increases above 31°C, see [Fixing Insufficient Airflow](#) that follows.

Fixing Insufficient Airflow

If the air temperature near the system is above 31°C, make one or more of the following changes to increase the flow of cooler air around the system:

- Adjust air conditioning to lower the ambient air temperature.
- Move the system to another location.
- Provide more space around the system and between adjacent instruments. Arrange instruments so that the warm exhaust air from one instrument does not enter the air intake vents of another.

- Shield the system from heat sources such as radiators, heat-producing instruments, and bright sunlight.

Replacing Fuses

Fuses on the CFX Opus system are designed to blow in case of severe power surges or other causes of electrical short. This protects both the user and the system from excessive, potentially damaging electric currents. Fuses on the CFX Opus system rarely need to be replaced. However, some institutions prefer to replace fuses on a regular basis to maintain uninterrupted operation.

If the system does not turn on, first verify that the power cord is plugged in to a functioning power source. Also, verify that the power cord and power source are within the specifications for this system.

Finally, verify that the fuses are intact. If the fuses are broken or burned, replace the fuses. This section explains how to view and replace fuses on the CFX Opus system.

Tip: The system utilizes two 10 A, 250 V, 5 x 20 mm, fast blow fuses.



WARNING! To prevent electrical shock, always turn off and unplug the system from the electrical outlet before checking the fuses.

Important: You must unplug the power cord from the instrument to open the fuse door. Trying to open the fuse door while the cord is plugged in could damage the door.

To view and replace the fuses

1. Verify that you have powered off the instrument and unplugged the power cord from the back of the instrument.
2. Using your finger tip, gently pull the black fuse door on the back of the system out toward you.

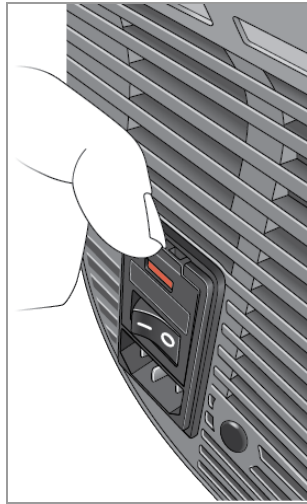

3. Using a small flathead screw driver, gently pry out the red fuse holder until you can grasp it with your fingers.

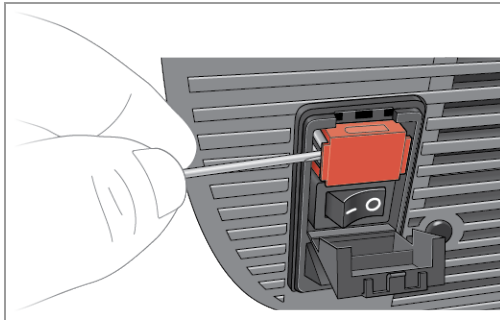

4. When you can firmly grasp the fuse holder, pull it straight out of the instrument.

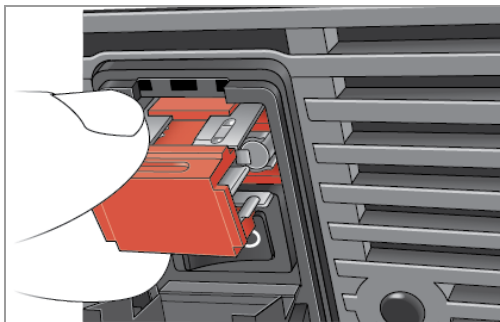

5. Using a finger tip, gently pry the fuse out of the fuse holder.
6. The fuse holder contains two fuses, one on each side. You must inspect both fuses.

A bad fuse displays a break or burned spot in the internal metal filament, or measures open with an Ohm meter. A good fuse has an internal metal filament or measures short (< 1 Ohm). If a fuse is bad or damaged, replace it with a new fuse of the same type and rating.

Note: Some fuses used in the CFX Opus instrument are made from ceramic and cannot be visually inspected. In this case, you must use an Ohm meter to determine whether the fuse is good. Alternatively, you can replace the fuse with a known good one without checking.

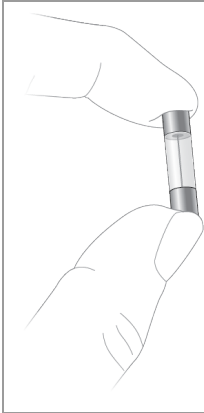

7. Assuming the prongs indicate the front of the fuse holder, insert the back end of a 10 A, 250 V, 5 x 20 mm, fast blow fuse into the middle bracket. Ensure the front end of the fuse faces the prongs. For example:

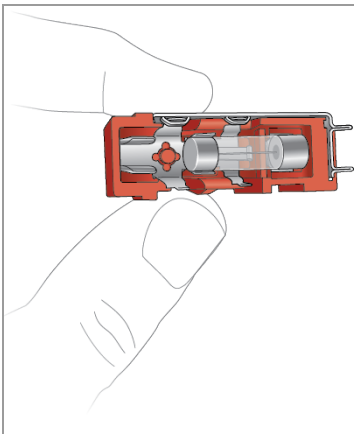

8. With the flat red square on the fuse holder facing upward, insert the fuse holder into the instrument and firmly press it into position.

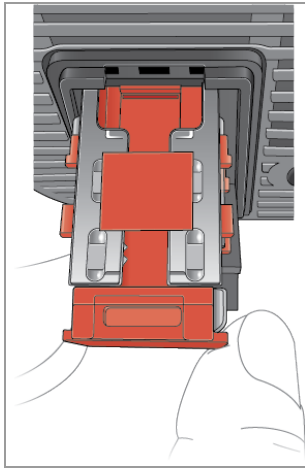

9. Close the fuse door, insert the power cord, and turn on the instrument.



Caution: If the CFX Opus instrument repeatedly blows one or more fuses, there could be an internal problem with the instrument. Contact Bio-Rad Technical Support for assistance in determining whether it is safe to replace the fuses again or if the instrument should be repaired.

Upgrading System Software and Firmware

Important: Only the Admin user can upgrade the CFX Opus system software and firmware.

When connected to the Internet, CFX Maestro software alerts you to software and firmware updates available for the CFX Opus systems. You access the updates from Bio-Rad's Firmware and Software Updates web site. The CFX Opus installer can include both software and firmware updates. CFX Opus firmware updates are not distributed in a separate package.

Before upgrading the system, Bio-Rad recommends that you verify the current version installed on the CFX Opus system. This section explains how to verify the installed version and how to upgrade the system.

Verifying the Currently Installed Version

To verify the current version of CFX Opus

1. On the CFX Opus Home screen, tap Tools to view the Tools screen
2. If you are logged in as Admin, tap the User icon at the bottom of the screen to view the tools available to all users.
3. Tap About and locate Opus Version on the About screen.
4. Note the currently installed version.

Ensure the version you are upgrading to is newer than the version currently installed.
5. Tap Back and then tap Home to return to the Home screen.

Upgrading the System Software and Firmware

Note: Depending on the type of upgrade, this process can take several minutes to complete.

To upgrade CFX Opus system software and firmware

1. From the CFX Maestro computer, log into bio-rad.com and go to the Firmware and Software Updates page to download the installer onto an attached USB drive.
2. Insert the USB drive into a USB port on the CFX Opus system.
3. On the Home screen, log in as the Admin user.
4. On the Home screen, tap Tools to open the Admin tools screen.
5. In the Admin tools screen, tap System Update to open the Software and Instrument Updates screen.

The Software and Instrument Updates screen appears.

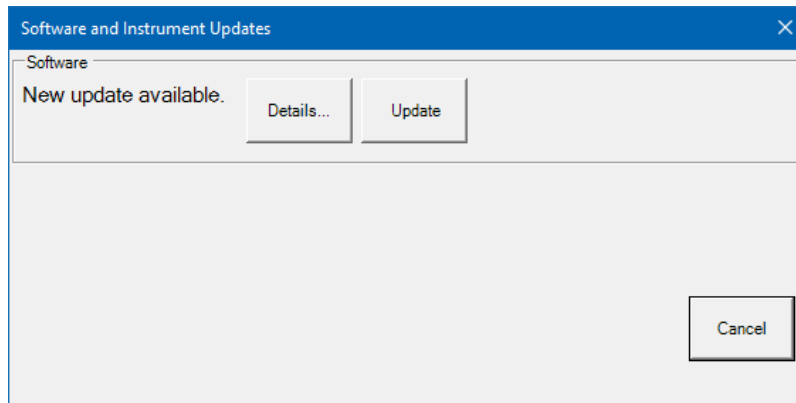

Important: While the upgrade is in progress, do not shut down the system and do not remove the USB drive.

6. (Optional) To get details about the update, tap Details.
7. Do one of the following:
 - To cancel the upgrade, tap Cancel.
 - To upgrade the system, tap Update and follow the prompts.

Note: When the upgrade complete, the system automatically restarts.

Shutting Down the CFX Opus System

Important: Follow these instructions to safely and completely shut down the CFX Opus system.

To shut down the CFX Opus system

1. Ensure that no protocol is running and the system is no longer in use.
2. If you have not already done so, remove the samples from the block.
 - a. On the Home screen, tap Open Lid to access the samples.
 - b. Remove the samples from the block and then tap Close Lid.
3. On the Home screen, tap Logout to log out of the system.
4. On the Login screen, tap Shut Down  to perform a soft shutdown of the system.
5. When the CFX Opus system has completed the soft shutdown process, press the power switch on the back of the instrument to shut down the system.

Returning the CFX Opus System to Bio-Rad

Important: Should you need to return your system to Bio-Rad, your Bio-Rad Technical Support specialist will provide instructions for decontaminating, packaging, and shipping the instrument. Before you return the instrument, you must install the shipping plate and shipping screw. This section explains these tasks.

Note: Locate the shipping screw and shipping plate that you saved when you installed the system. You will need these items to properly package the system. Bio-Rad will send you the packaging material required to safely return the system.

Important: Before you begin, ensure that you have completely backed up all data files to a shared network drive or a USB drive.

Installing the Shipping Plate and Screw

Tip: This information is also available on the CFX Opus touch screen to ensure you accurately install the screw.

To install the shipping plate and screw

1. If necessary, start the CFX Opus system and log in.
2. Copy all user data to a network drive or an attached USB drive.
3. On the Home screen, tap Tools to view the User Tools screen.

Note: The Shipping Screw button appears on the User > Tools screen. If you logged in as the Admin user, tap User at the bottom of the screen.

4. On the User Tools screen, tap Shipping Screw.

The Shipping Screw screen appears with instructions for installing the shipping screw.

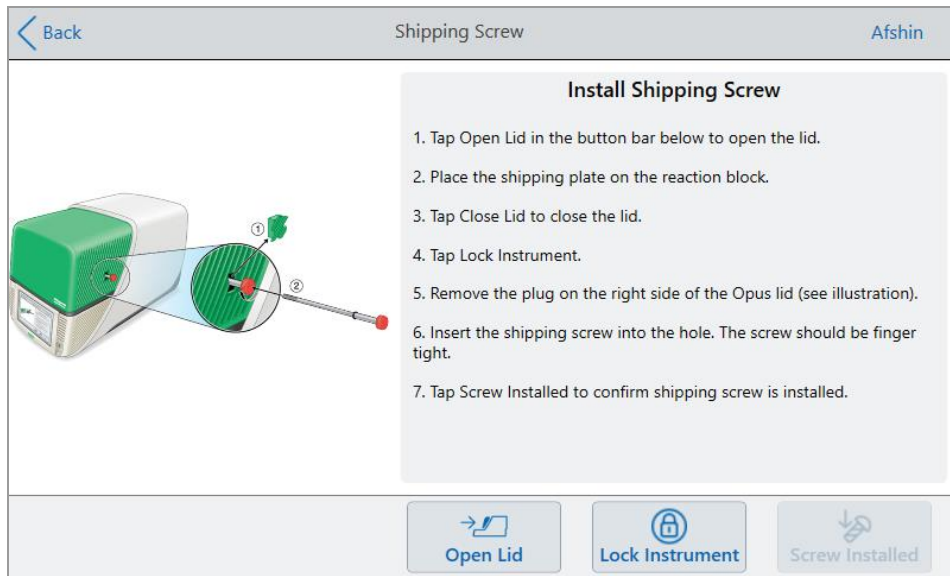

5. Follow the instructions to install the shipping screw.
 - a. Tap Open Lid on the bottom button bar.
 - b. Place the shipping plate on the reaction block.
 - c. On the Install Shipping Screw screen, tap Close Lid to close the lid.
 - d. Tap Lock Instrument to position the shuttle and lock the lid in place.

The system displays a message confirming that you have installed the shipping plate.



- If the shipping plate is installed, tap Yes. The system locks the instrument for shipping. When lock-down is complete, tap OK and continue with [Step e](#) that follows.
- If the shipping plate is not installed, tap No. The system stops the lock-down process and returns to the Install Shipping Screw screen.

Repeat the steps in this procedure and ensure to install the shipping plate.

- e. Remove the plug (store it in a safe place) and then install the shipping screw, turning it clockwise until it is securely in place.

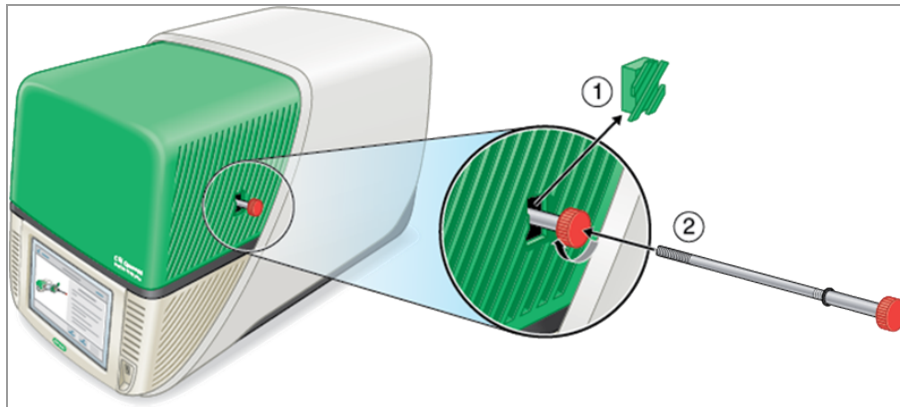

- f. On the Shipping Screw screen, tap Screw Installed to confirm the shipping screw is installed.
6. Tap Back to return to the Home screen.
 7. Log out of the system and then shut down the CFX Opus instrument.
 8. Package and ship the system to Bio-Rad according to the instructions provided by Bio-Rad.

Troubleshooting CFX Opus Systems

This section provides information on exporting system log information that can be used for troubleshooting purposes. It also lists potential problems and suggested solutions for the CFX Opus system.

Viewing and Exporting Log Files

CFX Opus system message and usage log files contain information that is helpful in troubleshooting problems with the system. Bio-Rad Technical Support might ask you to provide these files so that they can better assist you in resolving problems. You can export the log files to an attached USB drive.

The CFX Opus system retains all message and usage log data until it is cleared. Only the Admin user can clear the log file.

To view and export log files

1. If you have not yet done so, insert a USB drive into a USB port on the instrument.
2. On the Home screen, tap Tools and open the User Tools menu.
3. On the User Tools screen, tap System Logs.

The System Logs screen appears, displaying the message logs by default.

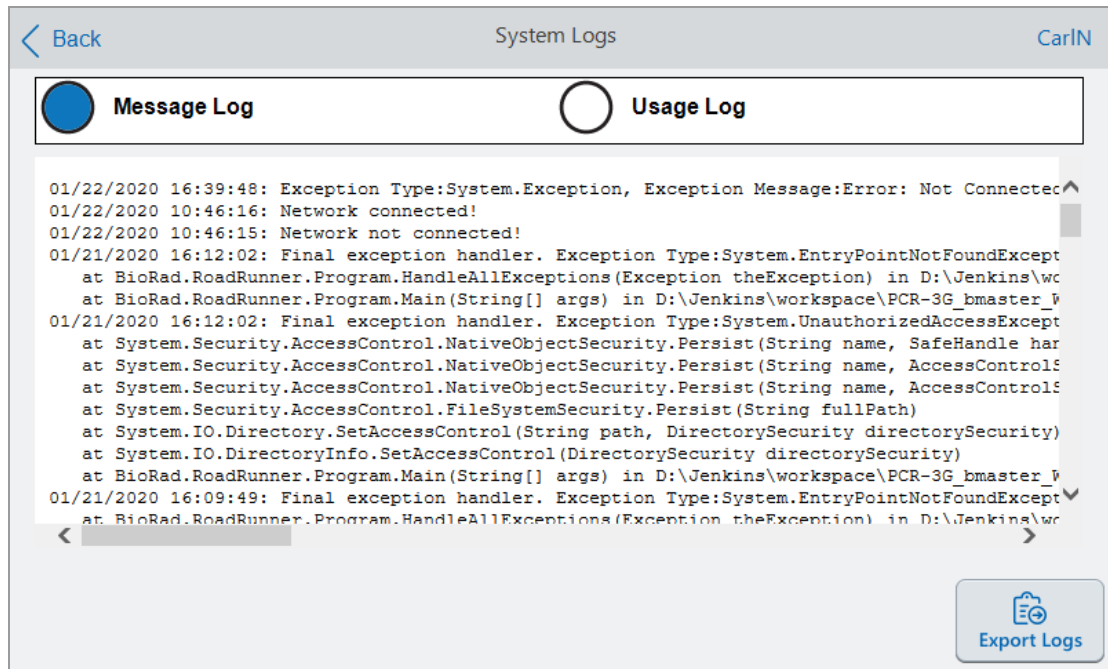

4. Tap Export Logs to export the system logs. CFX Opus creates a folder labeled Exports on the attached USB drive and exports the following .txt log files:

- SystemMessageLog
- SystemUsageLog
- DebugLog
- CloudLog (present only if the CFX Opus has a connection to Bio-Rad's BR.io app)
- OSLog
- FirmwareUpdateLog
- GUILog
- WCFLog

5. Click Back twice to return to the Home screen.

To view the log information, remove the USB drive from the CFX Opus system, insert it into a USB port on an available computer, and open the log files in a text editing or word processing program.

Troubleshooting Issues

Error	Possible causes	Troubleshooting steps
Unable to use USB drives	Power loss	Turn the CFX Opus system off and then on.
Unable to connect to BR.io after a run completes, before the run file is uploaded to your BR.io account	Communication loss	Copy the run file to an attached USB drive or to a shared network folder and analyze the data using CFX Maestro software.

Appendix D Bio-Rad Free and Open-Source Notices for PCR Products

This document includes licensing information relating to free, open-source, and public-source software and data (together, the “MATERIALS”) included with or used to develop Bio-Rad products and services. The terms of the applicable free, open-source, and public-source licenses (each an “OPEN LICENSE”) govern Bio-Rad’s distribution and your use of the MATERIALS. Bio-Rad and the third-party authors, licensors, and distributors of the MATERIALS disclaim all warranties and liability arising from all use and distribution of the MATERIALS. To the extent the OSS is provided under an agreement with Bio-Rad that differs from the applicable OSS LICENSE, those terms are offered by Bio-Rad alone.

Bio-Rad has reproduced below copyright and other licensing notices appearing within the MATERIALS. While Bio-Rad seeks to provide complete and accurate copyright and licensing information for all MATERIALS, Bio-Rad does not represent or warrant that the following information is complete, correct, or error-free. MATERIALS recipients are encouraged to (a) investigate the identified MATERIALS to confirm the accuracy of the licensing information provided and (b) notify Bio-Rad of any inaccuracies or errors found in this document so that Bio-Rad may update this document accordingly.

Certain OPEN LICENSES (such as the Affero General Public Licenses, Common Development and Distribution Licenses, Common Public License, Creative Commons Share-Alike License, Eclipse Public License, Mozilla Public Licenses, GNU General Public Licenses, GNU Library/Lesser General Public Licenses, and Open Data Commons Open Database License) require that the source materials be made available to recipients or other requestors under the terms of the same OPEN LICENSE.

The corresponding open source software is available for download from the links in the section that follows.

Software Notices

M2Mqtt (paho.mqtt.m2mqtt)

Project homepage/download sites:

<https://m2mqtt.wordpress.com/>

<https://www.nuget.org/packages/M2Mqtt/>

Bio-Rad source code site:

<https://github.com/bio-rad-lsg-open-source/Mqtt-4.3.0.0>

External source code site:

<https://github.com/eclipse/paho.mqtt.m2mqtt>

Project licensing notices:

Eclipse Foundation Software User Agreement

February 1, 2011

Usage Of Content

THE ECLIPSE FOUNDATION MAKES AVAILABLE SOFTWARE, DOCUMENTATION, INFORMATION AND/OR OTHER MATERIALS FOR OPEN SOURCE PROJECTS (COLLECTIVELY "CONTENT"). USE OF THE CONTENT IS GOVERNED BY THE TERMS AND CONDITIONS OF THIS AGREEMENT AND/OR THE TERMS AND CONDITIONS OF LICENSE AGREEMENTS OR NOTICES INDICATED OR REFERENCED BELOW. BY USING THE CONTENT, YOU AGREE THAT YOUR USE OF THE CONTENT IS GOVERNED BY THIS AGREEMENT AND/OR THE TERMS AND CONDITIONS OF ANY APPLICABLE LICENSE AGREEMENTS OR NOTICES INDICATED OR REFERENCED BELOW. IF YOU DO NOT AGREE TO THE TERMS AND CONDITIONS OF THIS AGREEMENT AND THE TERMS AND CONDITIONS OF ANY APPLICABLE LICENSE AGREEMENTS OR NOTICES INDICATED OR REFERENCED BELOW, THEN YOU MAY NOT USE THE CONTENT.

Applicable Licenses

Unless otherwise indicated, all Content made available by the Eclipse Foundation is provided to you under the terms and conditions of the Eclipse Public License Version 1.0 ("EPL"). A copy of the EPL is provided with this Content and is also available at <http://www.eclipse.org/legal/epl-v10.html>. For purposes of the EPL, "Program" will mean the Content.

Content includes, but is not limited to, source code, object code, documentation and other files maintained in the Eclipse Foundation source code repository ("Repository") in software modules ("Modules") and made available as downloadable archives ("Downloads").

- Content may be structured and packaged into modules to facilitate delivering, extending, and upgrading the Content. Typical modules may include plug-ins ("Plug-ins"), plug-in fragments ("Fragments"), and features ("Features").
- Each Plug-in or Fragment may be packaged as a sub-directory or JAR (Java™ ARchive) in a directory named "plugins".
- A Feature is a bundle of one or more Plug-ins and/or Fragments and associated material. Each Feature may be packaged as a sub-directory in a directory named "features". Within a Feature, files named "feature.xml" may contain a list of the names and version numbers of the Plug-ins and/or Fragments associated with that Feature.
- Features may also include other Features ("Included Features"). Within a Feature, files named "feature.xml" may contain a list of the names and version numbers of Included Features.

The terms and conditions governing Plug-ins and Fragments should be contained in files named "about.html" ("Abouts"). The terms and conditions governing Features and Included Features should be contained in files named "license.html" ("Feature Licenses"). Abouts and Feature Licenses may be located in any directory of a Download or Module including, but not limited to the following locations:

- The top-level (root) directory
- Plug-in and Fragment directories
- Inside Plug-ins and Fragments packaged as JARs
- Sub-directories of the directory named "src" of certain Plug-ins
- Feature directories

Note: if a Feature made available by the Eclipse Foundation is installed using the Provisioning Technology (as defined below), you must agree to a license ("Feature Update License") during the installation process. If the Feature contains Included Features, the Feature Update License should either provide you with the terms and conditions governing the Included Features or inform you

where you can locate them. Feature Update Licenses may be found in the "license" property of files named "feature.properties" found within a Feature. Such Abouts, Feature Licenses, and Feature Update Licenses contain the terms and conditions (or references to such terms and conditions) that govern your use of the associated Content in that directory.

THE ABOUTS, FEATURE LICENSES, AND FEATURE UPDATE LICENSES MAY REFER TO THE EPL OR OTHER LICENSE AGREEMENTS, NOTICES OR TERMS AND CONDITIONS. SOME OF THESE OTHER LICENSE AGREEMENTS MAY INCLUDE (BUT ARE NOT LIMITED TO):

- Eclipse Distribution License Version 1.0 (available at <http://www.eclipse.org/licenses/edl-v1.0.html>)
- Common Public License Version 1.0 (available at <http://www.eclipse.org/legal/cpl-v1.0.html>)
- Apache Software License 1.1 (available at <http://www.apache.org/licenses/LICENSE>)
- Apache Software License 2.0 (available at <http://www.apache.org/licenses/LICENSE-2.0>)
- Metro Link Public License 1.00 (available at <http://www.open-group.org/openmotif/supporters/metrolink/license.html>)
- Mozilla Public License Version 1.1 (available at <http://www.mozilla.org/MPL/MPL-1.1.html>)

IT IS YOUR OBLIGATION TO READ AND ACCEPT ALL SUCH TERMS AND CONDITIONS PRIOR TO USE OF THE CONTENT. If no About, Feature License, or Feature Update License is provided, please contact the Eclipse Foundation to determine what terms and conditions govern that particular Content.

Use of Provisioning Technology

The Eclipse Foundation makes available provisioning software, examples of which include, but are not limited to, p2 and the Eclipse Update Manager ("Provisioning Technology") for the purpose of allowing users to install software, documentation, information and/or other materials (collectively "Installable Software"). This capability is provided with the intent of allowing such users to install, extend and update Eclipse-based products. Information about packaging Installable Software is available at http://eclipse.org/equinox/p2/repository_packaging.html ("Specification").

You may use Provisioning Technology to allow other parties to install Installable Software. You shall be responsible for enabling the applicable license agreements relating to the Installable Software to be presented to, and accepted by, the users of the Provisioning Technology in accordance with the Specification. By using Provisioning Technology in such a manner and making it available in accordance with the Specification, you further acknowledge your agreement to, and the acquisition of all necessary rights to permit the following:

1. A series of actions may occur ("Provisioning Process") in which a user may execute the Provisioning Technology on a machine ("Target Machine") with the intent of installing, extending or updating the functionality of an Eclipse-based product.
2. During the Provisioning Process, the Provisioning Technology may cause third party Installable Software or a portion thereof to be accessed and copied to the Target Machine.
3. Pursuant to the Specification, you will provide to the user the terms and conditions that govern the use of the Installable Software ("Installable Software Agreement") and such Installable Software Agreement shall be accessed from the Target Machine in accordance with the Specification. Such Installable Software Agreement must inform the user of the terms and conditions that govern the Installable Software and must solicit acceptance by the end user in the manner prescribed in such Installable Software Agreement. Upon such indication of agreement by the user, the provisioning Technology will complete installation of the Installable Software.

Cryptography

Content may contain encryption software. The country in which you are currently may have restrictions on the import, possession, and use, and/or re-export to another country, of encryption software. BEFORE using any encryption software, please check the country's laws, regulations and policies concerning the import, possession, or use, and re-export of encryption software, to see if this is permitted.

Java and all Java-based trademarks are trademarks of Oracle Corporation in the United States, other countries, or both.

/LICENSE:

See **EPL-1.0** in the **Standard OSS License Text** appendix to this document.

Standard Open License Text

EPL 1.0

Eclipse Public License - v 1.0

THE ACCOMPANYING PROGRAM IS PROVIDED UNDER THE TERMS OF THIS ECLIPSE PUBLIC LICENSE ("AGREEMENT"). ANY USE, REPRODUCTION OR DISTRIBUTION OF THE PROGRAM CONSTITUTES RECIPIENT'S ACCEPTANCE OF THIS AGREEMENT.

1. DEFINITIONS

"Contribution" means:

- a) in the case of the initial Contributor, the initial code and documentation distributed under this Agreement, and
- b) in the case of each subsequent Contributor:
 - i) changes to the Program, and
 - ii) additions to the Program;

where such changes and/or additions to the Program originate from and are distributed by that particular Contributor. A Contribution 'originates' from a Contributor if it was added to the Program by such Contributor itself or anyone acting on such Contributor's behalf. Contributions do not include additions to the Program which: (i) are separate modules of software distributed in conjunction with the Program under their own license agreement, and (ii) are not derivative works of the Program.

"Contributor" means any person or entity that distributes the Program.

"Licensed Patents" mean patent claims licensable by a Contributor which are necessarily infringed by the use or sale of its Contribution alone or when combined with the Program.

"Program" means the Contributions distributed in accordance with this Agreement.

"Recipient" means anyone who receives the Program under this Agreement, including all Contributors.

2. GRANT OF RIGHTS

a) Subject to the terms of this Agreement, each Contributor hereby grants Recipient a non-exclusive, worldwide, royalty-free copyright license to reproduce, prepare derivative works of, publicly display, publicly perform, distribute and sublicense the Contribution of such Contributor, if any, and such derivative works, in source code and object code form.

b) Subject to the terms of this Agreement, each Contributor hereby grants Recipient a non-exclusive, worldwide, royalty-free patent license under Licensed Patents to make, use, sell, offer to sell, import and otherwise transfer the Contribution of such Contributor, if any, in source code and object code form. This patent license shall apply to the combination of the Contribution and the Program if, at the time the Contribution is added by the Contributor, such addition of the Contribution causes such combination to be covered by the Licensed Patents. The patent license shall not apply to any other combinations which include the Contribution. No hardware per se is licensed hereunder.

c) Recipient understands that although each Contributor grants the licenses to its Contributions set forth herein, no assurances are provided by any Contributor that the Program does not infringe the patent or other intellectual property rights of any other entity. Each Contributor disclaims any liability to Recipient for claims brought by any other entity based on infringement of intellectual property rights or otherwise. As a condition to exercising the rights and licenses granted hereunder, each Recipient hereby assumes sole responsibility to secure any other intellectual property rights needed, if any. For example, if a third party patent license is required to allow Recipient to distribute the Program, it is Recipient's responsibility to acquire that license before distributing the Program.

d) Each Contributor represents that to its knowledge it has sufficient copyright rights in its Contribution, if any, to grant the copyright license set forth in this Agreement.

3. REQUIREMENTS

A Contributor may choose to distribute the Program in object code form under its own license agreement, provided that:

a) it complies with the terms and conditions of this Agreement;
and

b) its license agreement:

i) effectively disclaims on behalf of all Contributors all warranties and conditions, express and implied, including warranties or conditions of title and non-infringement, and implied warranties or conditions of merchantability and fitness for a particular purpose;

ii) effectively excludes on behalf of all Contributors all liability for damages, including direct, indirect, special, incidental and consequential damages, such as lost profits;

iii) states that any provisions which differ from this Agreement are offered by that Contributor alone and not by any other party; and

iv) states that source code for the Program is available from such Contributor, and informs licensees how to obtain it in a reasonable manner on or through a medium customarily used for software exchange.

When the Program is made available in source code form:

a) it must be made available under this Agreement; and

b) a copy of this Agreement must be included with each copy of the Program.

Contributors may not remove or alter any copyright notices contained within the Program.

Each Contributor must identify itself as the originator of its Contribution, if any, in a manner that reasonably allows subsequent Recipients to identify the originator of the Contribution.

4. COMMERCIAL DISTRIBUTION

Commercial distributors of software may accept certain responsibilities with respect to end users, business partners and the like. While this license is intended to facilitate the commercial use of the Program, the Contributor who includes the Program in a commercial product offering should do so in a manner which does not create potential liability for other Contributors. Therefore, if a Contributor includes the Program in a commercial product offering, such Contributor ("Commercial Contributor") hereby agrees to defend and indemnify every other Contributor

("Indemnified Contributor") against any losses, damages and costs (collectively "Losses") arising from claims, lawsuits and other legal actions brought by a third party against the Indemnified Contributor to the extent caused by the acts or omissions of such Commercial Contributor in connection with its distribution of the Program in a commercial product offering. The obligations in this section do not apply to any claims or Losses relating to any actual or alleged intellectual property infringement. In order to qualify, an Indemnified Contributor must: a) promptly notify the Commercial Contributor in writing of such claim, and b) allow the Commercial Contributor to control, and cooperate with the Commercial Contributor in, the defense and any related settlement negotiations. The Indemnified Contributor may participate in any such claim at its own expense.

For example, a Contributor might include the Program in a commercial product offering, Product X. That Contributor is then a Commercial Contributor. If that Commercial Contributor then makes performance claims, or offers warranties related to Product X, those performance claims and warranties are such Commercial Contributor's responsibility alone. Under this section, the Commercial Contributor would have to defend claims against the other Contributors related to those performance claims and warranties, and if a court requires any other Contributor to pay any damages as a result, the Commercial Contributor must pay those damages.

5. NO WARRANTY

EXCEPT AS EXPRESSLY SET FORTH IN THIS AGREEMENT, THE PROGRAM IS PROVIDED ON AN "AS IS" BASIS, WITHOUT WARRANTIES OR CONDITIONS OF ANY KIND, EITHER EXPRESS OR IMPLIED INCLUDING, WITHOUT LIMITATION, ANY WARRANTIES OR CONDITIONS OF TITLE, NON- INFRINGEMENT, MERCHANTABILITY OR FITNESS FOR A PARTICULAR PURPOSE. Each Recipient is solely responsible for determining the appropriateness of using and distributing the Program and assumes all risks associated with its exercise of rights under this Agreement, including but not limited to the risks and costs of program errors, compliance with applicable laws, damage to or loss of data, programs or equipment, and unavailability or interruption of operations.

6. DISCLAIMER OF LIABILITY

EXCEPT AS EXPRESSLY SET FORTH IN THIS AGREEMENT, NEITHER RECIPIENT NOR ANY CONTRIBUTORS SHALL HAVE ANY LIABILITY FOR ANY DIRECT, INDIRECT, INCIDENTAL, SPECIAL, EXEMPLARY, OR CONSEQUENTIAL DAMAGES (INCLUDING WITHOUT LIMITATION LOST PROFITS), HOWEVER CAUSED AND ON ANY THEORY OF LIABILITY, WHETHER IN CONTRACT, STRICT LIABILITY, OR TORT (INCLUDING NEGLIGENCE OR OTHERWISE) ARISING IN ANY WAY OUT OF THE USE OR DISTRIBUTION OF THE PROGRAM OR THE EXERCISE OF ANY RIGHTS GRANTED HEREUNDER, EVEN IF ADVISED OF THE POSSIBILITY OF SUCH DAMAGES.

7. GENERAL

If any provision of this Agreement is invalid or unenforceable under applicable law, it shall not affect the validity or enforceability of the remainder of the terms of this Agreement, and without further action by the parties hereto, such provision shall be reformed to the minimum extent necessary to make such provision valid and enforceable.

If Recipient institutes patent litigation against any entity (including a cross-claim or counterclaim in a lawsuit) alleging that the Program itself (excluding combinations of the Program with other software or hardware) infringes such Recipient's patent (s), then such Recipient's rights granted under Section 2(b) shall terminate as of the date such litigation is filed.

All Recipient's rights under this Agreement shall terminate if it fails to comply with any of the material terms or conditions of this Agreement and does not cure such failure in a reasonable period of time after becoming aware of such noncompliance. If all Recipient's rights under this Agreement terminate, Recipient agrees to cease use and distribution of the Program as soon as reasonably practicable. However, Recipient's obligations under this Agreement and any licenses granted by Recipient relating to the Program shall continue and survive.

Everyone is permitted to copy and distribute copies of this Agreement, but in order to avoid inconsistency the Agreement is copyrighted and may only be modified in the following manner. The Agreement Steward reserves the right to publish new versions (including revisions) of this Agreement from time to time. No one other than the Agreement Steward has the right to modify this Agreement. The Eclipse Foundation is the initial Agreement

Steward. The Eclipse Foundation may assign the responsibility to serve as the Agreement Steward to a suitable separate entity. Each new version of the Agreement will be given a distinguishing version number. The Program (including Contributions) may always be distributed subject to the version of the Agreement under which it was received. In addition, after a new version of the Agreement is published, Contributor may elect to distribute the Program (including its Contributions) under the new version. Except as expressly stated in Sections 2 (a) and 2 (b) above, Recipient receives no rights or licenses to the intellectual property of any Contributor under this Agreement, whether expressly, by implication, estoppel or otherwise. All rights in the Program not expressly granted under this Agreement are reserved.

This Agreement is governed by the laws of the State of New York and the intellectual property laws of the United States of America. No party to this Agreement will bring a legal action under this Agreement more than one year after the cause of action arose. Each party waives its rights to a jury trial in any resulting litigation.

Appendix E References

1. Breslauer KJ et al. (1986). Predicting DNA duplex stability from the base sequence. *Proc Natl Acad Sci USA* 83, 3,746–3,750.
2. Sugimoto N et al. (1996). Improved thermodynamic parameters and helix initiation factor to predict stability of DNA duplexes. *Nucleic Acids Res* 24, 4,501–4,505.

Appendix E References



**Bio-Rad
Laboratories, Inc.**

Life Science
Group

Website bio-rad.com **USA** 1 800 424 6723 **Australia** 61 2 9914 2800 **Austria** 00 800 00 24 67 23 **Belgium** 00 800 00 24 67 23
Brazil 4003 0399 **Canada** 1 905 364 3435 **China** 86 21 6169 8500 **Czech Republic** 00 800 00 24 67 23 **Denmark** 00 800 00 24 67 23
Finland 00 800 00 24 67 23 **France** 00 800 00 24 67 23 **Germany** 00 800 00 24 67 23 **Hong Kong** 852 2789 3300
Hungary 00 800 00 24 67 23 **India** 91 124 4029300 **Israel** 0 3 9636050 **Italy** 00 800 00 24 67 23 **Japan** 81 3 6361 7000
Korea 82 2 3473 4460 **Luxembourg** 00 800 00 24 67 23 **Mexico** 52 555 488 7670 **The Netherlands** 00 800 00 24 67 23
New Zealand 64 9 415 2280 **Norway** 00 800 00 24 67 23 **Poland** 00 800 00 24 67 23 **Portugal** 00 800 00 24 67 23
Russian Federation 00 800 00 24 67 23 **Singapore** 65 6415 3188 **South Africa** 00 800 00 24 67 23 **Spain** 00 800 00 24 67 23
Sweden 00 800 00 24 67 23 **Switzerland** 00 800 00 24 67 23 **Taiwan** 886 2 2578 7189 **Thailand** 66 2 651 8311
United Arab Emirates 36 1 459 6150 **United Kingdom** 00 800 00 24 67 23

