

PRODUCT SELECTION GUIDE

# Electrification UK

## Contractor handbook

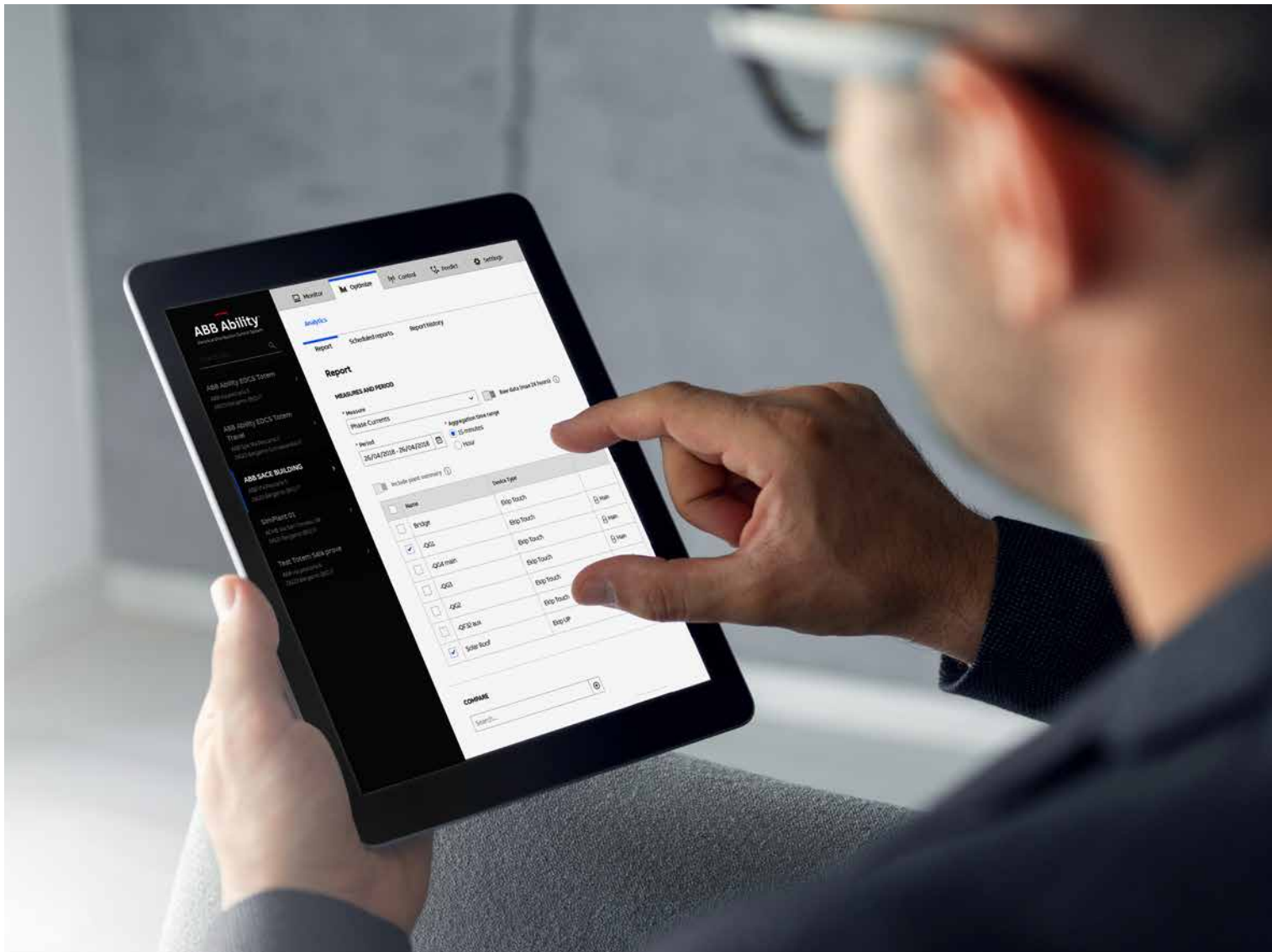

---

**ABB's Electrification Business Area is a global leader in electrical products and solutions, operating in more than 100 countries, with over 200 manufacturing sites. Our 50,000+ employees are dedicated to delivering safe, smart and sustainable electrification. With ABB Ability™ enabled digital solutions at its core, our portfolio protects, connects and optimises the flow of electrical energy for smarter electricity distribution for utilities, industry, buildings, infrastructure and mobility.**

---

# Table of contents

<b>004–015</b>	<b>1. Introduction</b>
<b>016–045</b>	<b>2. Residential / Commercial distribution</b>
<b>046–060</b>	<b>3. TPN Commercial / Industrial distribution</b>
<b>061–086</b>	<b>4. Enclosed switching products</b>
<b>087–091</b>	<b>5. Enclosed control products</b>
<b>092–113</b>	<b>6. Industrial plugs and sockets</b>
<b>114–128</b>	<b>7. Enclosures and switchboards</b>
<b>129–133</b>	<b>8. Enclosed control products</b>
<b>134–146</b>	<b>9. Electronic relays and controls</b>
<b>147–162</b>	<b>10. Motor control and protection</b>
<b>163–203</b>	<b>11. Cable management products</b>
<b>204–233</b>	<b>12. Emergi-Lite - Emergency lighting</b>
<b>234–253</b>	<b>13. Energy and lighting management</b>
<b>254–285</b>	<b>14. Smart home - Designed to make your life simpler</b>
<b>286–302</b>	<b>15. Furse - Earthing, lightning and surge protection</b>
<b>303–309</b>	<b>16. Jokab safety products</b>

# A safer, more reliable flow of electricity



"We make our customers more successful by identifying the challenges they face and creating opportunities through intelligent solutions to improve insight and efficiency into power distribution."

To meet the needs of this changing world, ABB's Electrification business is dedicated to developing pioneering technologies that, from the substation to the point of consumption, create a safer, smarter, more sustainable electrical flow – for everyone

With a broad range of market-leading products and solutions, a global sales network and customised support, ABB provides flexibility that improves energy performance, whatever the requirements. Our trusted, high-quality products are intelligent and cloud-based, enabling them to control and protect power more effectively.

Our portfolio spans a wide range of industries, from solar plants, where our inverters convert electricity to be used at low- and medium-voltage, to integrated systems for industrial sites and remote locations, to products that protect and connect electricity in the world around us.



Buildings



Data Centres



EV Charging



Marine



Oil &amp; Gas



Rail



Food &amp; Beverage



Manufacturing



Solar



Wind

# Digital services

## Simplified business solutions

By digitalising our services, we are easing the transformation for our customers from traditional office based operations, towards a digitalised future, enabling a more efficient pro-active work environment.

### E-Configure



With e-Configure, customers can completely integrate the ordering process, selecting, configuring and ordering their products more quickly and simply.

Learn more: <http://new.abb.com/low-voltage/software/e-configure>

### ABB Connect



ABB Connect helps you to find product information and stay connected to ABB's latest news and tools.

Learn more: <https://go.abb/connect>

### ABB Connect Partner Hub

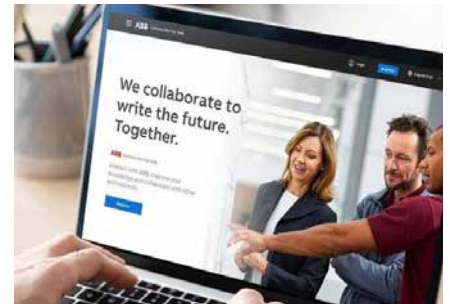

Join our dynamic, online platform that connects customers directly with key professionals, such as system integrators, and ABB Ability™ digital solutions and services.

Learn more: <https://partnerhub.connect.abb.com/> and <https://new.abb.com/about/our-businesses/electrification/abb-ability/partner-hub>

### Common Business OnLine (cBOL)



Business Online provides a common customer interface with electronic integration and order entry to ABB business lines - available to all business areas, and across all types of customers from channel partners to end-users.

Learn more: <https://bolservices.it.abb.com/CBOL/default>

### Building Information Modeling



ABB BIM objects are just one click away. Find them stored along with supporting documentation in our download centre or via selected third party repositories.

Learn more: <http://new.abb.com/low-voltage/building-information-modeling>

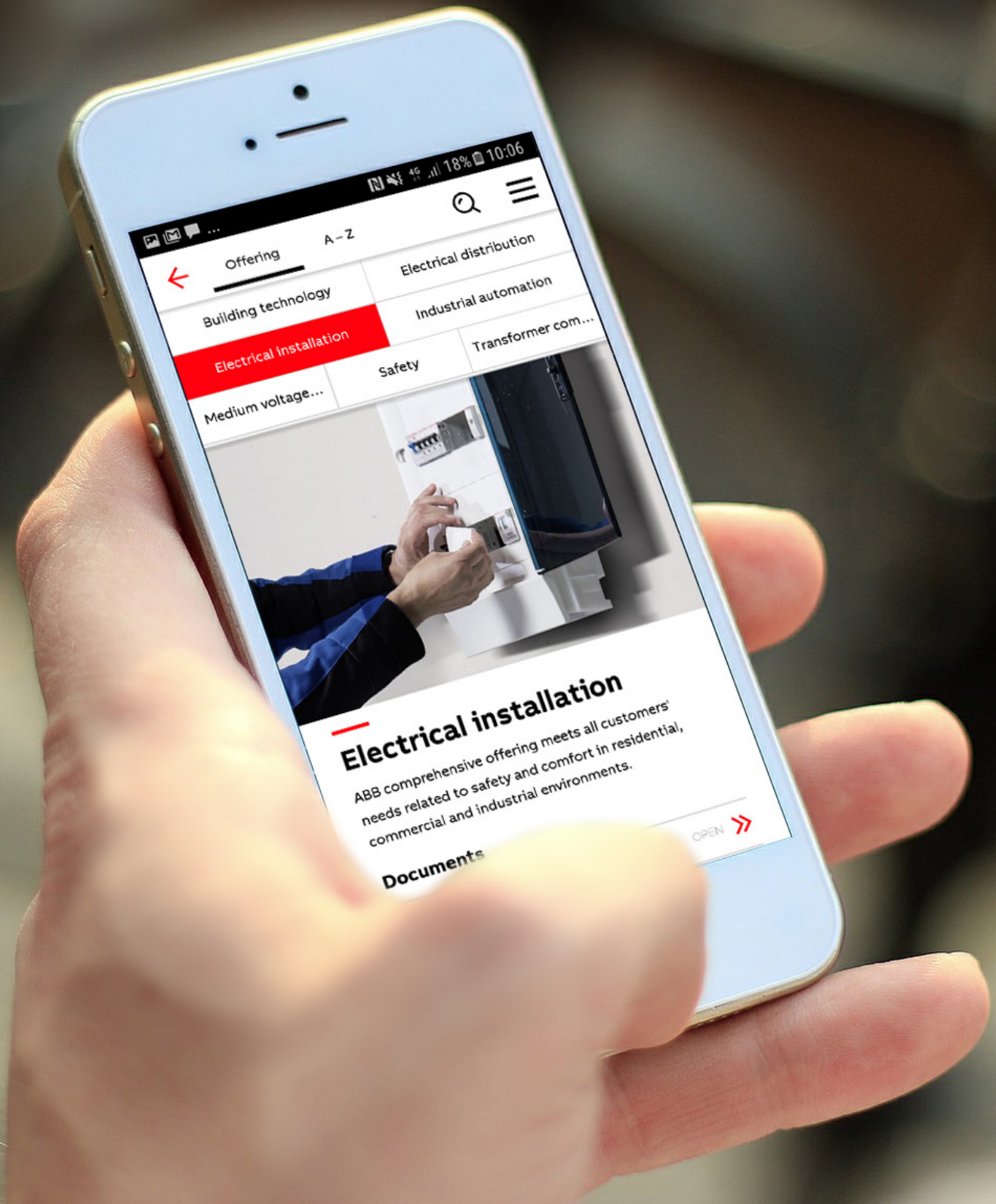

Offering A-Z

Building technology

Electrical distribution

**Electrical Installation**

Industrial automation

Medium voltage...

Safety

Transformer com...

**Electrical installation**

ABB comprehensive offering meets all customers' needs related to safety and comfort in residential, commercial and industrial environments.

Documents [OPEN >>](#)

# ABB Connect

## Electrification solutions at your fingertips

Whether you're exploring our product information, need technical data, installation videos or want to read the latest industry news, ABB Connect is the central resource for all your electrification needs.

With ABB Connect you can view



Product news



Literature



Training



Events



Installation videos

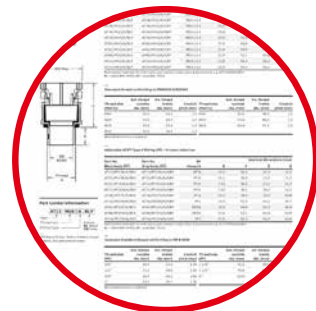

Technical information

Download ABB Connect for free:



iTunes  
(iOS)



Google Play  
(Android)



Microsoft Store  
(Windows 10)

# ABB Electrification business

## Service facilities

The ABB Electrification Service facility in Coleshill demonstrates our commitment to customer experience, enabling faster response for investigation, repair and refurbishment of ABB's Electrification portfolio.

Your business efficiency depends on your choices. ABB's service agreements let you focus on what you do best, while your power distribution system runs smoothly. With your equipment performance optimised, your cost control improved, it's your way towards less unplanned downtime and easier maintenance budgeting.

Here are some examples of the service choice you can make:



### Delivered maintenance services

This is the essential maintenance to prolong the lifetime of your assets. We take precise maintenance actions, including providing genuine ABB parts in preventive maintenance kits.



### Self maintenance services

We provide you with access to proprietary resources that allow you to manage your own maintenance. Resources include online troubleshooting tools, manuals and equipment histories.

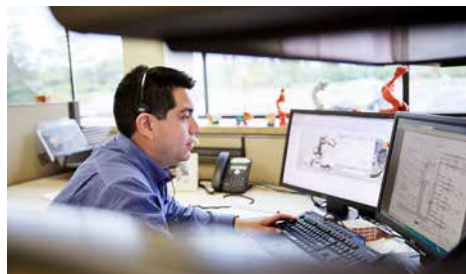

### Technical support

Expert help is only a phone call away. This solution is for all technical telephone assistance and rapid troubleshooting advice.



### On-site response time

For those times when you need help, and you need it now. One phone call and an expert will be on-site within the time agreed.



### Skills development services

Your investments improve performances when effectively used on a day-to-day basis. We share our expertise to elevate your operators' skills to maximise your investment.

Our centralised service facilities, located at Coleshill, Birmingham allow ABB to provide a faster and more efficient turnaround on maintenance, investigation and repair of electrical vehicle charging stations, solar inverters, low- and medium-voltage circuit breakers, low-voltage panels and other electrical apparatus including uninterruptible power supply (UPS) systems and emergency lighting.

Located directly opposite, our dedicated assembly site covers approximately 2,000 sq.m of warehouse space, and is used to pre-assemble and store our sub-distribution products, adding further added value from ABB services including all the testing facilities. Our centralised service facility produces both standard and custom variants of:



Assembled plastic and metal switches



Enclosed ATS panels



Assembled panel boards



Assembled distribution boards





**ABB**

—  
Let's write  
the future  
Together

# Product Training & CPD Seminars

## What courses and training are available?

We offer training in the following areas, among others:

- Products and systems
- Commissioning and user training
- Service and maintenance training
- Design and dimensioning
- Customer-specific tailored courses

ABB offer a wide range of free product training and support, providing informed decision making for your electrical installation needs.

With ABB Electrification Business you don't just have access to the most comprehensive range of Low and Medium Voltage products available - providing unlimited compatibility solutions - we also offer industry-leading support services.

These include structured training and seminars to help our customers develop a greater knowledge and understanding of their industry's legislation and standards - essential for making informed project specification decisions.

Our CPD seminars and training aim to:

- provide critical and relevant facts on changes in industry legislation
- address the impact of these changes on your business
- provide guidance on effective methodologies to simplify implementation
- address ways of reducing overall labour and maintenance costs



## CPD Seminars and training

Selectivity & Coordination with Power Circuit Breakers

Selecting Circuit Breakers Using Software Based Sources

Advanced Circuit Protection In Buildings and Infrastructure

Protection Against Electric Shock & Thermal Effects According to BS 7671 18th Edition

Life Safety Transfer Switching

LV Switchboard Design to BS EN 61439

Electronic Power Breaker Trip Units

Smart & Connected Communications (Bus Communications)

Energy Management and Asset Management

De-carbonising buildings (Low & Zero Carbon Buildings)

Modern Solutions for LV Breaker Distribution Applications

EV Charging

ABB Emergency Lighting Standards & Guidance - BS5266--2016, EN1838:2013 & EN50172:2004

Lightning Protection Standards; IEC / BS EN 62305

Surge Protection to BS EN 62305 / BS 7671 18th edition

## Product training

### Lighting

Emergency lighting, testing & monitoring

Central power supply systems

ICEL risk assessment

Introduction to metering

KNX Introduction

LV Protection & control

BS 5266 Emergency lighting - Part 1

Emergency lighting testing & monitoring

ICEL risk assessment

### Earthing & lightning protection overview

Earthing & lightning protection

Overvoltage protection to BS 7671

Central Power Supply System requirements

Lightning protection - Earthing

Lightning Protection - Surge Protection

New standards in lightning protection - Understanding BS EN 62305:2006

17th Edition first amendment - Surge protection

### Other

Understanding hazardous areas - LFH Conduit

Energy saving with variable speed drives

ABB i-bus KNX

Free@home

## Lunch & learn (technical seminars)

E-Max 2 MCCB

The new ATS

Discrimination study workshop

Fuse vs Fuseless

Introduction to circuit breakers

Zone selectivity

DOC software

Power quality

ABB breakers - A technical comparison

Directional, Differential and Zone Protection

Communications capabilities with ABB breakers

ABB Metering capability

MV Grid connection, MV switchgear and transformer offering

\* For a full list of all training courses we offer visit our website: [new.abb.com/low-voltage/service/training](http://new.abb.com/low-voltage/service/training)  
Where requested, we can tailor a course, provide an informal briefing or supply specific training on our product lines.

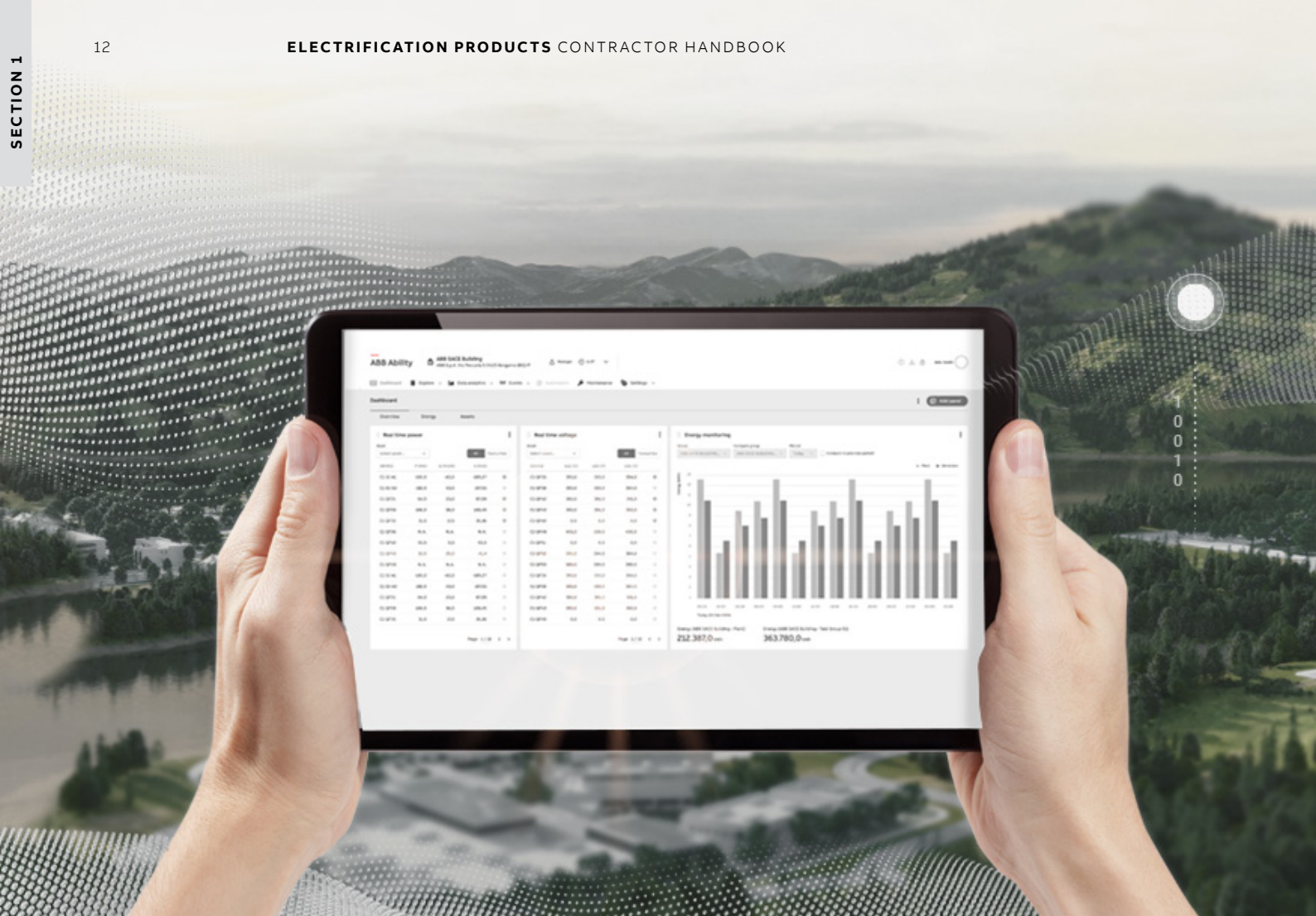

# ABB Ability™ Digital Solutions

for safer, smarter and  
more sustainable  
electrification

ABB Ability™ solutions deliver a safer, smarter, more sustainable electrical infrastructure by providing data-driven insights that enable you to reduce costs, increase comfort, and drive efficiency.

With our solutions, you can unlock the full potential of your equipment by quickly and easily adding innovative new features and functionality.

Our digital transformation solutions for Smart buildings, E-Mobility, Data Center, Food & beverage, Chemicals, oil and gas and many other transform the way you work by:

- Empowering better decisions with data and Improving reliability
- Increasing flexibility and Reducing cost
- Optimising comfort and Improving ROI (return of investment)

#### ABB Ability™ Energy and Asset Manager

ABB Ability™ Energy and Asset Manager provides application-specific asset and energy management. Users can view and analyze data on facility performance and manage assets to optimise energy consumption in real time and improve overall site efficiency. This SaaS assist conformity to assessments like ISO 50001, LEED, CIBSE TM39, BREEAM.

With instant access, anytime, anywhere the new solution is suitable for small and midsize factories, shopping malls or data centers, and could save customers up to 30% on their energy bills and up to 40% on maintenance costs.

Dashboard of ABB Ability™ Energy and Asset Manager



ABB is also delivering the future of electrification with **digital twin** solutions. In the near term, we'll be using digital twin solutions to integrate operations with the installation and commissioning of our products, ensuring our customers don't lose the connection between our pre- and post-sales support.



## Ordering products

— Helping you to find the correct product at a glance

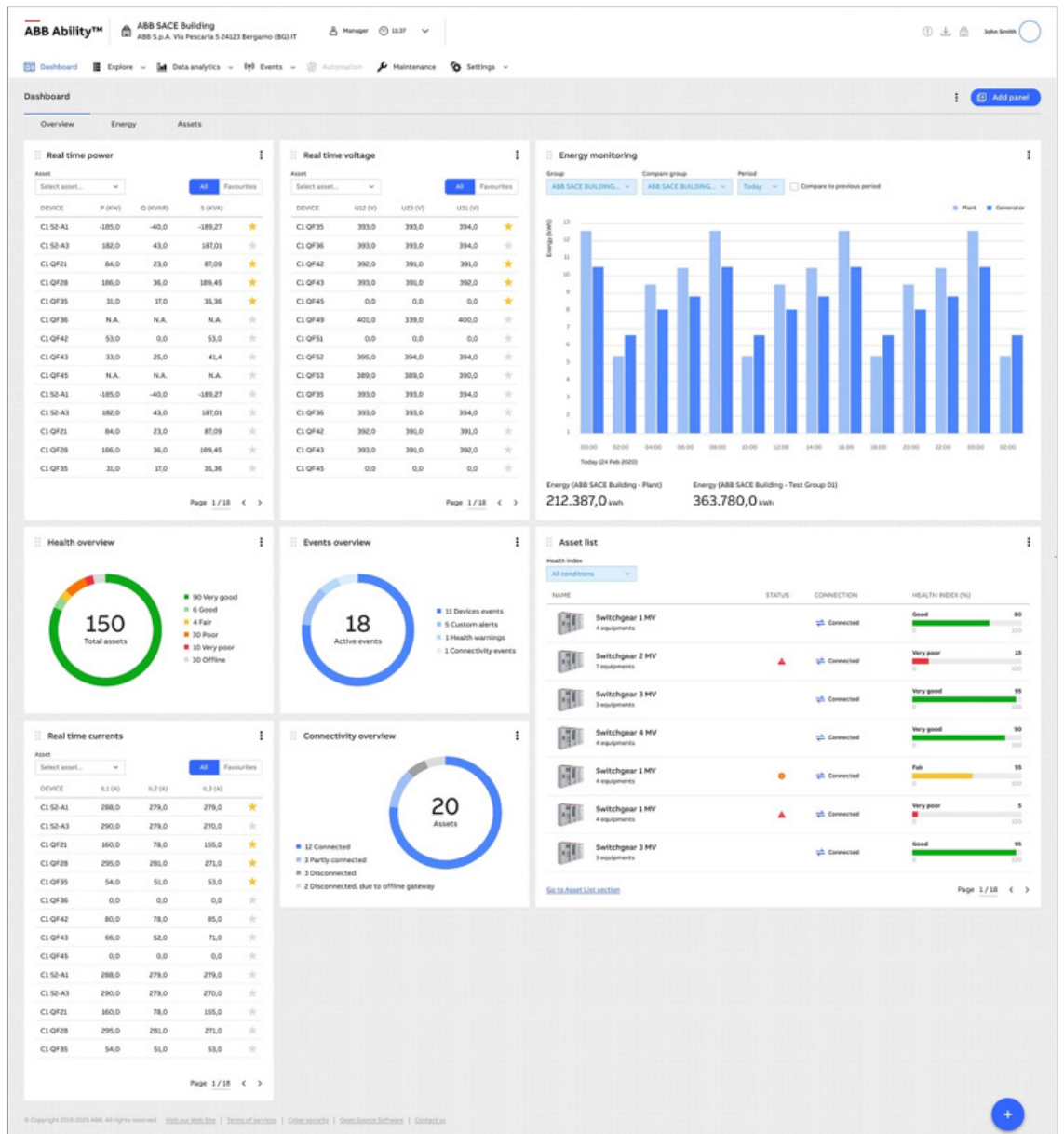
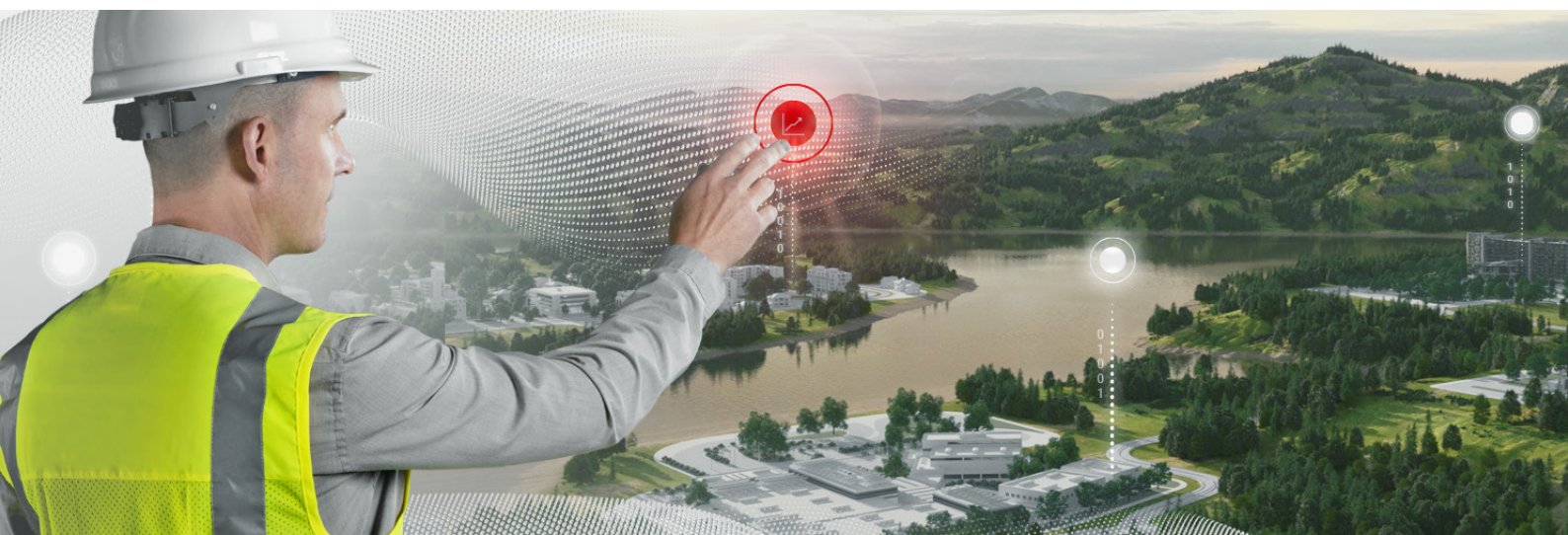

# How to use this book

## Quick guide to ordering products

**Section header**

This is the product group title

**Product image**

Helping you to find the correct product at a glance

46      ELECTRIFICATION PRODUCTS CONTRACTOR HANDBOOK

---

**ESB installation contactors**

Order codes



These devices are specifically made for commanding loads and signalling electrical conditions in any low-voltage distribution board. The functions of these devices are particularly switching, pushing and signalling electrical conditions in any installations (low-voltage area)

Main poles	Number of modules	Control coil voltage		Order Code
		40-50 Hz	DC	
2 N.O.	2	24 V	24 V	ESB 24-20*
		230...240 V	230...240 V	ESB 24-20*
4 N.O.	2	12 V	12 V	ESB 24-40*
		24 V	24 V	ESB 24-40*
		110...120 V	110...120 V	ESB 24-40*
4 N.C.	2	12 V	12 V	ESB 24-04*
		24 V	24 V	ESB 24-04*
		110...120 V	110...120 V	ESB 24-04*
2 N.O. 2 N.C.	2	12 V	12 V	ESB 24-22*
		24 V	24 V	ESB 24-22*
		110...120 V	110...120 V	ESB 24-22*
3 N.O. 1 N.C.	2	12 V	12 V	ESB 24-31*
		24 V	24 V	ESB 24-31*
		110...120 V	110...120 V	ESB 24-31*
4 N.O. 3 N.C.	2	12 V	12 V	ESB 24-13*
		24 V	24 V	ESB 24-13*
		110...120 V	110...120 V	ESB 24-13*
		230...240 V	230...240 V	ESB 24-13*

\* Ensure voltage is selected

**Description**

Item specific product description

2 x Distribution boards

**Order code**

When placing an order this is the number to quote

### Contact us - UK

<b>cBOL Online</b>	www.online.abb.com	24/7
<b>Phone</b>	0333 999 9900	Monday - Friday: (GMT) 9am - 5pm
<b>Email</b>	LV.Enquiries@gb.abb.com	
<b>Web</b>	new.abb.com/low-voltage	24/7

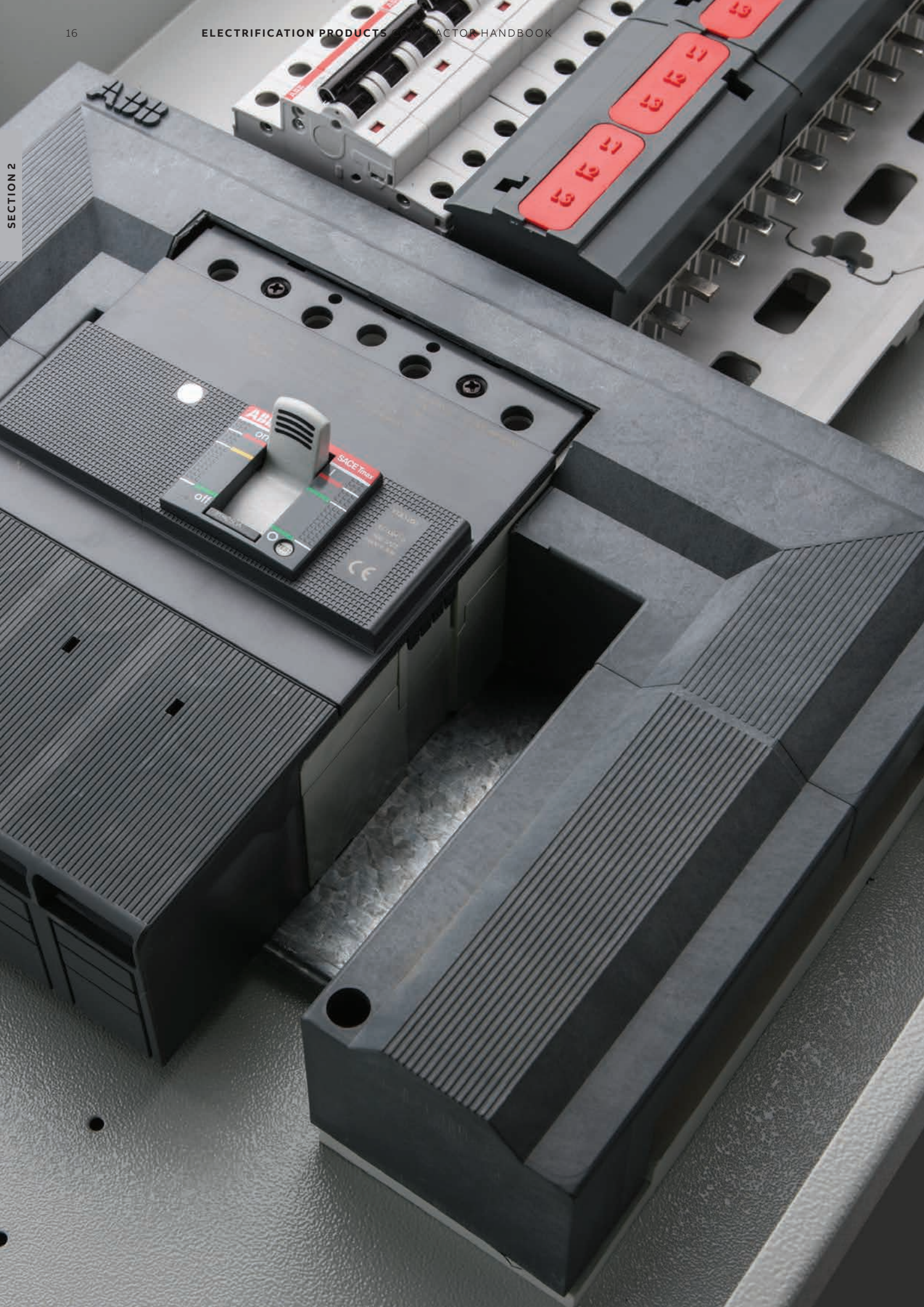

---

# Residential/Commercial distribution

<b>018</b>	<b>Introducing Arc Fault</b>
<b>022</b>	<b>Protecta Home consumer units</b>
<b>024</b>	<b>Protecta Plus distribution boards</b>
<b>035</b>	<b>Accessories &amp; DIN rail products for Protecta Plus</b>
<b>036</b>	<b>MCB - S 200 M series</b>
<b>037</b>	<b>RCBO DSE201 M series - Type A</b>
<b>038</b>	<b>RCCB F 200 series - Type A</b>
<b>039</b>	<b>Metering</b>
<b>041</b>	<b>ESB installation contactors</b>
<b>043</b>	<b>D Line digital time switches</b>
<b>044</b>	<b>T Line modular twilight switches</b>
<b>045</b>	<b>Modular sockets</b>



For more detailed product information, please refer to our online technical brochures available at: [new.abb.com/low-voltage/support/documentation](http://new.abb.com/low-voltage/support/documentation)

or contact our sales team via email [LV.enquiries@gb.abb.com](mailto:LV.enquiries@gb.abb.com)

or call 0333 999 9933



# Maximum safety and easy installation

Arc fault detection devices  
with integrated MCB and RCBO



- Complete protection against arc faults, overcurrent and earth faults
- Easy cross-wiring and installation
- Supply possible from both top and bottom side
- Family feeling in the System pro M compact® range
- LED for an easy troubleshooting of the network
- equipped also with memory recall function

# Maximum safety in buildings

## Extended fire protection in the electrical installation with AFDDs



Comprehensively protect people, irreplaceable goods and buildings – easier, better, safer. Extended fire protection in the electrical installation with ABB’s arc fault detection devices (AFDD) S-ARC1 and DS-ARC1

— 01 The S-ARC1 and DS-ARC1 reliably protect against arc faults.

Each year over two million fires erupt all over Europe. More than one third of these due to faults in the electrical installation which prevalingly occur as a result of dangerous arc faults.

### The best comprehensive protection

According to the product standard “IEC 62606 – General requirements for Arc Fault Detection Devices” an AFDD is a device intended to mitigate the effects of arcing faults by disconnecting the circuit when an arc fault is detected. This product standard is partially derived from the UL 1699 standard.

ABB's arc fault detection devices provide maximum safety in all buildings, thus protecting people and valuable assets. By early detecting arc faults and disconnecting the affected circuit they offer reliable and complete protection in any type of building.

- ABB offers two different versions:
- AFDD with integrated MCB: S-ARC1
  - AFDD with integrated RCBO: DS-ARC1

Both versions are integrated into ABB's proven System Pro M compact® range of modular DIN rail devices.



# Protection for people and irreplaceable goods

## Maximum safety in all kinds of applications

The majority of fires in buildings are caused by faults in the electrical installation. These fires are mainly caused by dangerous arc faults. The solution: S-ARC1 and DS-ARC1.

- 01 Areas of application for AFDDs Bedrooms and common rooms in nurseries
- 02 Areas of application for the AFDDs Paper manufacturing plants, printers
- 03 Causes of fire in Germany (2015)

S-ARC1 and DS-ARC1 provide maximum safety in all buildings, thus protecting people and valuable assets. By early detecting arc faults and disconnecting the affected circuit the AFDD's with integrated MCB or RCBO offers reliable and complete protection in any type of building.

**Safety in many building types**  
According to the wiring regulation IEC 60364-4-42, an arc fault detection device is strongly recommended in particular applications, as per example:

- **Sleeping and common rooms**
  - in nurseries
  - in senior and care homes
  - in equipment for disabled persons
- **Places and rooms with existing fire risks and flammable materials**, such as for example in production facilities, barns, carpenter workshops, paper manufacturing plants or printing shops where the fire risk is high
- **Places and rooms with prevalingly flammable building materials** like wood houses, flammable buildings or forced ventilation systems
- **Places and rooms with irreplaceable goods (cultural assets)**, such as those in museums, libraries, galleries, archives or architectural monuments

**Recommendation for any room**  
The use of the AFDD is additionally recommended in any rooms with sleeping facilities in private apartments, houses, hospitals (does not apply in medically used areas) and hotels. This also includes places with a fire-disseminating structure, such as the chimney effect in high-rise buildings or final circuits with high connected load, e.g. dishwashers, washing machines or dryers.

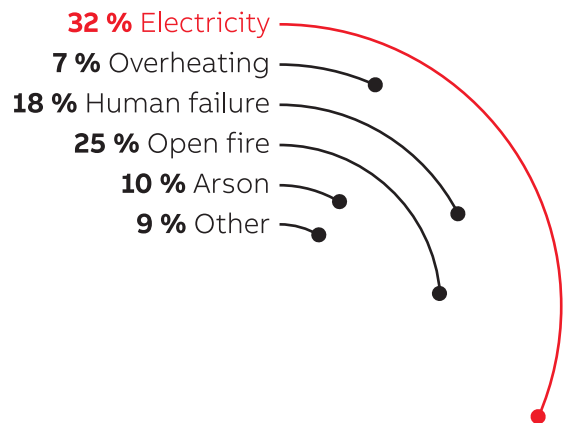

— 03



— 01  
— 02





01

—  
01 Security  
in buildings with  
flammable materials

With AFDDs many hazards triggered by disruptions in the electrical installation are detected in advance. Thus, the existing gap of protection against arc faults is closed, leading to complete safety in buildings for persons, investments and irreplaceable goods.

In case the overvoltage level exceeds 275 V, both S-ARC1 and DS-ARC1 are equipped with an overvoltage protection. In addition, DS-ARC1 also offers protection against earth fault currents.

**With S-ARC1 people and valuable assets are protected against:**

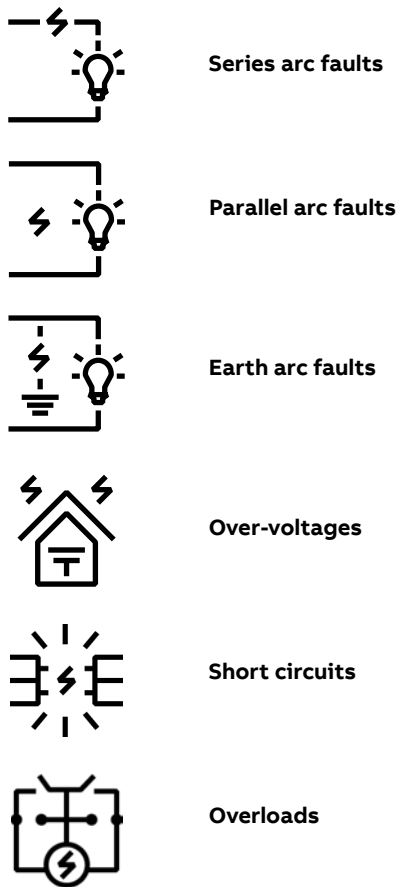

**With DS-ARC1 people and valuable assets are protected against:**

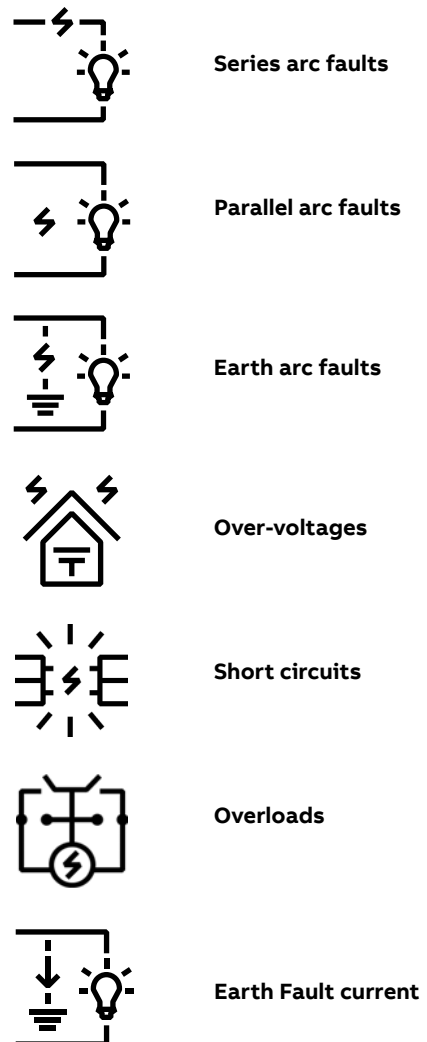

## Protecta Home - Consumer units

### Steel enclosures



#### Steel Enclosure to BS EN 61439-3

- Supplied factory fitted with switch disconnector and/or RCD, specification as table. Unit comes complete with shrouded busbar, earth and neutral bars and installation instructions
- Colour RAL7035 Steel
- Adaptable split load versions.

#### Steel enclosure to BS EN 61439-3

Way combinations	Incomer		Split load		Order code	
	Isolator	RCD	Isolator	RCD		
4	-	100A	-	-	HSMS4C	
7	-	100A	-	-	HSMS7C	
11	-	100A	-	-	HSMS11C	
16	-	100A	-	-	HSMS16C	
20	-	100A	-	-	HSMS20C	
4	-	-	80A/30mA	-	HSRC4C	
7	-	-	100A/30mA	-	HSRC7C	
11	-	-	100A/30mA	-	HSRC11C	
16	-	-	100A/30mA	-	HSRC16C	
20	-	-	100A/30mA	-	HSRC20C	
4+4	3+5, 2+6	-	-	100A	80A/30mA	HSSL4+4C
6+6	4+8, 5+7	-	-	100A	80A/30mA	HSSL6+6C
8+8	7+9, 9+7	-	-	100A	80A/30mA	HSSL8+8C
4+4	-	100A	80A/30mA	-	63A/30mA	HSSE4186C
6+6	-	100A	80A/30mA	-	63A/30mA	HSSE6186C
8+8	-	100A	80A/30mA	-	63A/30mA	HSSE8186C

#### Dimensions

Order code	Height	Width	Depth
HSMS4C - HSRC4C	256 mm	155 mm	110 mm
HSMS7C - HSRC7C	256 mm	210 mm	110 mm
HSMS11C - HSRC11C - HSSL4+4C - HSSE4186C	256 mm	282 mm	110 mm
HSMS16C - HSRC16C - HSSL6+6C - HSSE6186C	256 mm	368 mm	110 mm
HSMS20C - HSRC20C - HSSL8+8C - HSSE8186C	256 mm	440 mm	110 mm

## Protecta Home - Consumer units

### Outgoing MCBs and RCBOs

#### SH201 MCBs

	Breaking capacity kA	Rating Amps	Type B Order code	Type C Order code
	6kA	6	SH201-B6	SH201-C6
	6kA	10	SH201-B10	SH201-C10
	6kA	16	SH201-B16	SH201-C16
	6kA	20	SH201-B20	SH201-C20
	6kA	25	SH201-B25	SH201-C25
	6kA	32	SH201-B32	SH201-C32
	6kA	40	SH201-B40	SH201-C40
	6kA	50	SH201-B50	SH201-C50
	6kA	63	SH201-B63	SH201-C63

#### DSE201 - Type A RCBO

	Breaking capacity kA	Rating Amps	Sensitivity	Type B Order code	Type C Order code
	6kA	6	30mA	DSE201-B6 A30	DSE201-C6 A30
	6kA	10	30mA	DSE201-B10 A30	DSE201-C10 A30
	6kA	16	30mA	DSE201-B16 A30	DSE201-C16 A30
	6kA	20	30mA	DSE201-B20 A30	DSE201-C20 A30
	6kA	25	30mA	DSE201-B25 A30	DSE201-C25 A30
	6kA	32	30mA	DSE201-B32 A30	DSE201-C32 A30
	6kA	40	30mA	DSE201-B40 A30	DSE201-C40 A30
	6kA	50	30mA	DSE201-B50 A30	DSE201-C50 A30

## Accessories

#### Accessories

	Description	Order code
	MCB padlock adaptor 3mm hasp	SA1
	Padlock with 2 keys	SA2
	Spare 19 Module Busbar	PS 1/19/30
	MCB Blank module RAL7035	EPP-BP1
	Surge protector	EPH-SURGE

# Protecta Plus

## General features of the series

With the new Protecta Plus system, ABB has developed a new and personalised series of MCB distribution boards which can be expanded over time. The wide internal accessibility ensures a quick and easy approach to the electrical components assembly. The neutral and earth bars positioned on the inner sides of the distribution board are completely isolated to ensure better safety for users.

### Main construction features

- Structure in epoxy coated metal sheets, 1 mm, textured finish
- Wall installation for indoor environments
- Degree of protection - IP43 with door, IP30 without door
- Mechanical resistance: IK07
- Busbar rating: 250A
- Number of ways: 4, 8, 12, 16, 20, 24
- Maximum ambient temperature +35 °C
- Compliance with IEC BS EN 61439 1-2
- Simple wiring of all cabinets, both horizontally and vertically
- Easy internal accessibility that facilitates all the wiring operations and maintenance
- Prepackaged standardised kits for specific applications (e.g. surge protection, metering)

### A comprehensive range

The range consists of distribution boards for wall mounting in six heights from 590 mm to 1360 mm, 450 mm width and depth starting from 125 mm, ensuring the development of multiple solutions. Protecta Plus system is easy to design, quick to assemble and reliable to apply.

### Ease of wiring

With the new mounting concept, Protecta Plus offers great levels of flexibility and accessibility for installation and wiring. The internal module can be easily removed allowing the wiring of different equipment outside the distribution board. This solution allows for an easier installation with more rapid production times.

### Maximum accessibility

Thanks to the particularly large opening angle of the door, Protecta Plus offers the possibility to have optimal access to the distribution board, especially in case of maintenance. The perfectly reversible doors can be installed with right or left opening.

A series of rational solutions developed to achieve a complete range of capabilities and functions with a single type of distribution board to meet different installation requirements, whilst simplifying the work of the installer.

**Simplified series connection**  
The distribution boards can be combined side-by-side through pre-cut cable conduit holes large enough for the passage of wiring harnesses.

**Range**  
depth: 125 mm;  
width: 450 mm;  
6 heights: 590, 730, 870, 1050, 1220, 1360 mm.

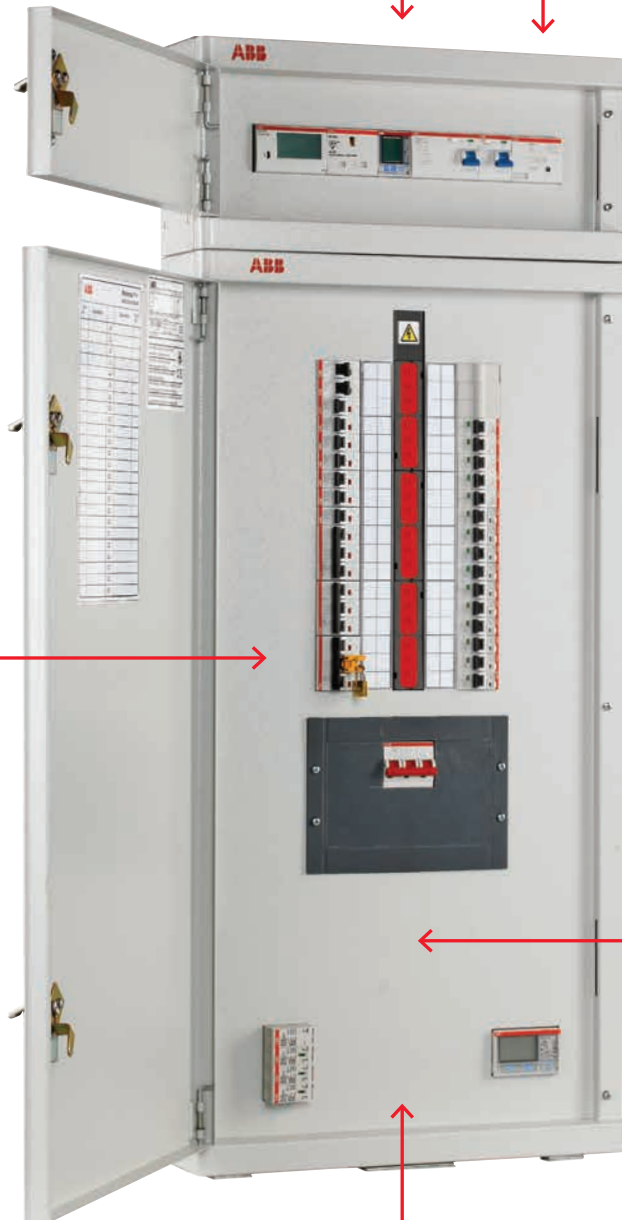

**Ergonomics and design**  
The design of this series is characterized by special features, such as rounded edges for a more efficient ergonomic look.

**High output capacity**  
Primary branch capacity up to 100A.

**Complete protection**  
Designed to ensure maximum protection and efficiency, through the prevision for the installation of surge protection devices and counters.

**Flexible mounting**  
The PAN assembly system can easily be removed from the bottom distribution board of the framework, ensuring quick and simple installation.

# Protecta Plus

## The details make the difference

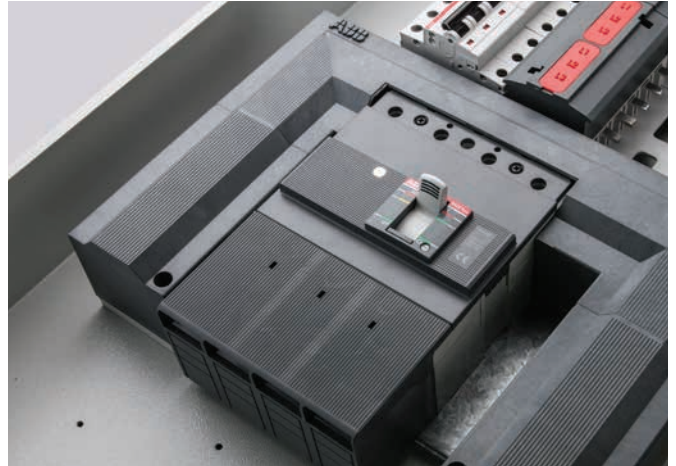

### Board width

Protecta Plus has been designed with a width of 450 mm, this combined with the reduced RCBO height of 115 mm gives the installer ample cable room either side of the board.

### One Solution

All Protecta Plus boards come as standard with 250A main bars. This gives the user a full range from 125A 3P through to 250A 4P incoming options.

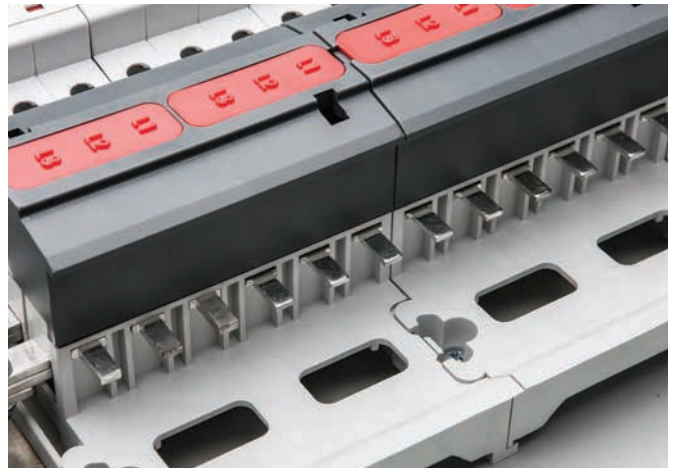
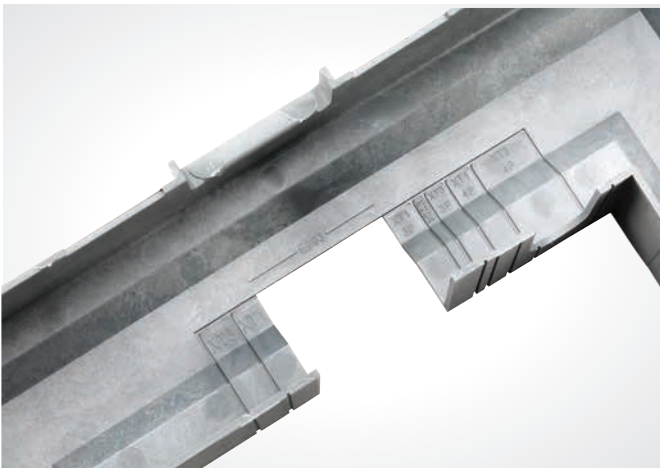

### Incoming shroud

The shroud comes ready to accept a 125A 3P incoming devices. The easy break technology and clear indication on the rear allows the user to modify the shroud dependant upon requirements up to 250A 4P.

### 100A Outgoing ways

The first two 3P outgoing ways are fitted with 3 mm branch copper to allow for 100A MCBs to be fitted. This allows for a maximum of **2 x 100A 3P** or **6 x 100A 1P** MCBs per board removing the need to move up to high performance boards or panel boards.



**Full MCB blank**

To aid installation and safety a custom MCB blank has been developed specifically for Protecta Plus.



**Clean earth**

Earth bars are fitted with removable links allowing the boards to be configured for 50/100% clean earth.

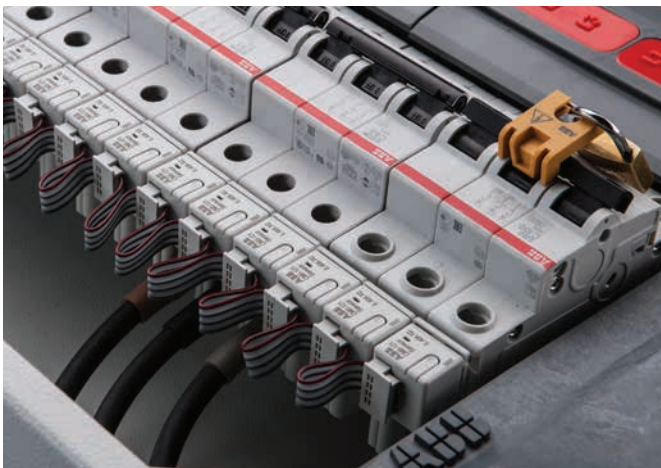

**Padlocking facilities**

All outgoing devices on Protecta Plus can be padlocked in on/off position for increased safety.

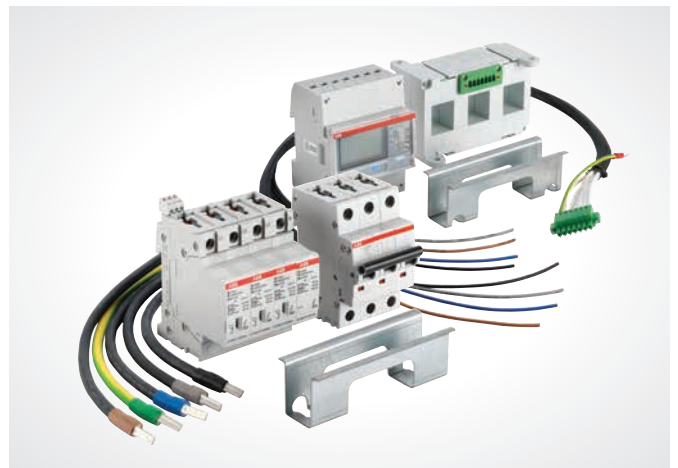

**Metering and surge protection**

Available in kit form to fit all Protecta Plus TPN boards. The boards have been designed to house these integrally.

# Protecta Plus

## Order process



Protecta Plus DB



Vertical split-load board



Horizontal split-load board



Incoming kit

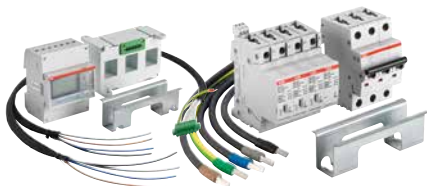

Meter/surge kits (optional)



Surge kits (optional)



Surge kits (optional)



MCB/RCBO/Blanks



Accessories

## Protecta Plus

### Order codes



**Pack contents: Standard distribution board**

- 250A distribution bar
- RAL7035 textured finish
- Door closing latch

**MCB distribution board - Type B**

Description	Order Code
Protecta Plus DB 4 Way 250A	EPP-W304
Protecta Plus DB 8 Way 250A	EPP-W308
Protecta Plus DB 12 Way 250A	EPP-W312
Protecta Plus DB 16 Way 250A	EPP-W316
Protecta Plus DB 20 Way 250A	EPP-W320
Protecta Plus DB 24 Way 250A	EPP-W324



**Pack contents: Horizontal split load kit**

- 2 x MID, Modbus ( RS485 ) & pulse meters
- Associated CTs
- Incoming isolators
- Internal cables
- **Requires 2 x MCB distribution board - Type B**

Please note as these kits allow for 4 to 24way boards cutting and crimping of cables is required.

**Horizontal split load kit**

Description	Order Code
125A 3P Horizontal split load kit - 2 x Meters	EPP-HSL-1253P
125A 4P Horizontal split load kit - 2 x Meters	EPP-HSL-1254P
160A 3P Horizontal split load kit - 2 x Meters	EPP-HSL-1603P
160A 4P Horizontal split load kit - 2 x Meters	EPP-HSL-1604P
250A 3P Horizontal split load kit - 2 x Meters	EPP-HSL-2503P
250A 4P Horizontal split load kit - 2 x Meters	EPP-HSL-2504P

\* M-Bus available on request

## Protecta Plus

### Order codes

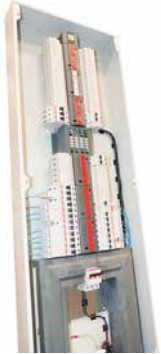

#### Pack contents: Vertical split load boards

- 2/3 MID, Modbus ( RS485 ) & pulse meters
- Associated CTs
- Incoming terminals
- Internal cables

Please note, no additional assembly is required.  
Units will be delivered with meters pre-configured to internal C.T sizing.

#### Vertical Split Load Boards - 42 variations are available

Order Code	No. of outgoing ways	Incomer rating (A)	No. of poles
EPP-VSL84	8+4 TPN	-125	3 P
EPP-VSL88	8+8 TPN	-160	4 P
EPP-VSL128	12+8 TPN	-250	
EPP-VSL1212	12+12 TPN		
EPP-VSL168	16+8 TPN		
EPP-VSL844	8+4+4 TPN		
EPP-VSL1284	12+8+4 TPN		

#### Example order codes

EPP-VSL1212-1253P 12+12 Way 125A 3P

EPP-VSL168-2503P 16+8 Way 250A 3P

\* M-Bus available on request



#### Pack contents

- 2 MID, Modbus ( RS485 ) & pulse meters
- Incoming terminals
- Internal cables

Please note, no additional assembly is required.

Order Code	Description	No. of outgoing ways	Incomer rating (A)	No. of poles
EPP-SSL1412-1002P	Single Phase Power & Lighting 14+12	14+12 TPN	-100A	2 P
EPP-SSL66-1002P	Single Phase Power & Lighting 6+6	6+6 TPN	-100A	2 P

\* M-Bus available on request

## Protecta Plus

### Order codes



**Pack contents: Incoming kit**

- Copper connection kit and fittings
- Incoming device
- Cover plate
- Instruction leaflet

#### Incoming connection kit

Description	Order Code
125A 3P Switch incoming connection kit	EPP-1253P
125A 4P Switch incoming connection kit	EPP-1254P
100A 4P RCD incoming connection kit 30mA Type AC - Left side neutral	EPP-1004R
160A 3P Switch incoming connection kit	EPP-1603P
160A 4P Switch incoming connection kit	EPP-1604P
250A 3P Switch incoming connection kit	EPP-2503P
250A 4P Switch incoming connection kit	EPP-2504P

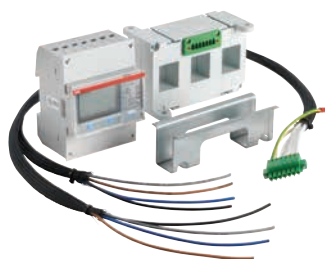

**Pack contents: Incoming metering**

- 1 x Meter
- 1 x C.T Block
- 1 x Wiring Loom & DIN support
- Instruction leaflet

Please note as these kits allow for 4 to 24way boards cutting and crimping of cables is required.

#### Incoming metering

Description	Order Code
125A MID Approved c/w pulse output	EPP-METMOD125A
125A MID Approved c/w pulse output & Modbus ( RS485 )	EPP-METMOD125B
125A MID Approved c/w pulse output, Modbus ( RS485 ) Imp / Exp	EPP-METMOD125C
160A MID Approved c/w pulse output	EPP-METMOD160A
160A MID Approved c/w pulse output & Modbus ( RS485 )	EPP-METMOD160B
160A MID Approved c/w pulse output, Modbus ( RS485 ) Imp / Exp	EPP-METMOD160C
250A MID Approved c/w pulse output	EPP-METMOD250A
250A MID Approved c/w pulse output & Modbus ( RS485 )	EPP-METMOD250B
250A MID Approved c/w pulse output, Modbus ( RS485 ) Imp / Exp	EPP-METMOD250C

\* M-Bus available on request

## Protecta Plus

### Order codes

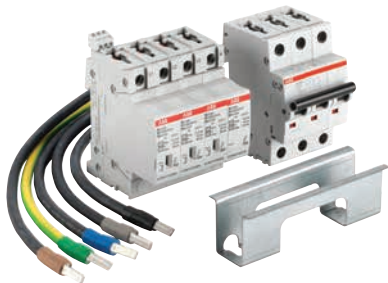

#### Pack contents: Surge protection

- 1 x Surge unit
- 1 x MCB 3P
- 1 x Wiring Loom & DIN support
- Instruction leaflet

Please note as these kits allow for 4 to 24way boards cutting and crimping of cables is required.

#### Surge protection

Description	Order Code
Type 1+2 surge protection - including 63A 3P MCB	EPP-SOULET1-2
Type 2 surge protection - including 63A 3P MCB	EPP-SOULE
Type 2/3 surge protection - including 63A 3P MCB	EPP-FURSE



#### Pack contents: Contactor control

- 3P contactor
- Control circuit & fuse protection
- Instruction leaflet

#### Contactor Control

Description	Order Code
125A AC1 rated 3P Contactor	EPP-CON125
160A AC1 rated 3P Contactor	EPP-CON160
250A AC1 rated 3P Contactor	EPP-CON250

## Protecta Plus

### Order codes



**Pack contents: Top extension boxes**

- Fixings
- DIN rail / mounting plate
- RAL7035 textured finish

**Extension boxes**

Type	No. of modules	Dimensions (mm)		Order Code
		Height	(W x D)	
Hinged door with 1 DIN rail	16	200	450 x 130	EPP-R1016
Hinged door with 2 DIN rail	32	400	450 x 130	EPP-R2032
Plain extension box 200mm		200	450 x 130	EPP-EB20
Plain extension box 400mm		400	450 x 130	EPP-EB40



**Pack contents: Type A distribution**

- Supplied factory fitted with 100A switch disconnecter
- RAL7035 textured finish

**MCB Distribution board - Type A**

Description	Order Code
Protecta Plus DB 2way 100A	EPP-W102
Protecta Plus DB 4way 100A	EPP-W104
Protecta Plus DB 8way 100A	EPP-W108
Protecta Plus DB 12way 100A	EPP-W112
Protecta Plus DB 16way 100A	EPP-W116
Protecta Plus DB 20way 100A	EPP-W120

## Protecta Plus

### Order codes



#### Pack contents: Row type boards

- Fixings
- DIN rail / mounting plate
- RAL7035 textured finish

#### Row type extension boxes

No. of modules	No. of rows	Sided width	Dimensions (mm)		Order Code
			Width	Height	
36	2	4way DB	590		EPP-R2036
54	3	8way DB	730		EPP-R3054
72	4	12way DB	870		EPP-R4072
90	5	16way DB	1050		EPP-R5090
108	6	20way DB	1220		EPP-R6108
126	7	24way DB	1360		EPP-R7126

#### Additional N/PE for side extension boxes

Description	Order Code
Protecta Plus - Row Type N-Bar 9	EPP-N-09
Protecta Plus - Row Type N-Bar 13	EPP-N-13
Protecta Plus - Row Type N-Bar 17	EPP-N-17
Protecta Plus - Row Type N-Bar 21	EPP-N-21
Protecta Plus - Row Type E-Bar 9	EPP-PE-09
Protecta Plus - Row Type E-Bar 13	EPP-PE-13
Protecta Plus - Row Type E-Bar 17	EPP-PE-17
Protecta Plus - Row Type E-Bar 21	EPP-PE-21

#### Terminal cover

Description	Order Code
Protecta Plus - Top Shroud	EPP-TC
Protecta Plus Mains TS - 4 way	EPP-MTCO4
Protecta Plus Mains TS - 8 way	EPP-MTCO8
Protecta Plus Mains TS - 12 way	EPP-MTC12
Protecta Plus Mains TS - 16 way	EPP-MTC16
Protecta Plus Mains TS - 20 way	EPP-MTC20
Protecta Plus Mains TS - 24 way	EPP-MTC24



## Protecta Plus

### Order codes

#### Labels for outgoing circuits

	No. of ways	Order Code
	4	EPP-LKIT-04
	8	EPP-LKIT-08
	12	EPP-LKIT-12
	16	EPP-LKIT-16
	24	EPP-LKIT-24

#### Replacement doors

Description	Order Code
Protecta Plus Trans Door - 4 ways / 2 rows	EPP-TD-04
Protecta Plus Trans Door - 8 ways / 3 rows	EPP-TD-08
Protecta Plus Trans Door - 12 ways / 4 rows	EPP-TD-12
Protecta Plus Trans Door - 16 ways / 4 rows	EPP-TD-16
Protecta Plus Trans Door - 20 ways / 5 rows	EPP-TD-20
Protecta Plus Trans Door - 24 ways / 6 rows	EPP-TD-24
Protecta Plus Solid Door - 4 ways / 2 rows	EPP-ST-04
Protecta Plus Solid Door - 8 ways / 3 rows	EPP-ST-08
Protecta Plus Solid Door - 12 ways / 4 rows	EPP-ST-12
Protecta Plus Solid Door - 16 ways / 4 rows	EPP-ST-16
Protecta Plus Solid Door - 20 ways / 5 rows	EPP-ST-20
Protecta Plus Solid Door - 24 ways / 6 rows	EPP-ST-24

## Accessories

	Description	Order Code
	MCB Blank RAL7035 Grey	EPP-BP1
	MCB Blank RAL9004 Black	EPP-BP1B
	Lock and Key	EPP-LK KEY
	Side by Side Connection Kit	EPP-KIT JOIN
	MCB Padlock Adaptor	SA 1
	MCB Padlock C/W 2 X Keys	SA 2
	125A Single Phase Kit	EPP-KIT-1251P*
	250A Single Phase Kit	EPP-KIT-2501P**
	Trunking adaptor plate	EPP-TRADT
	Protecta Plus - Glandplate Plain	EPP-GP-B
	Protecta Plus - Glandplate K Os	EPP-GP KO
	19 Modules 30 mm Busbar	PS1/19/30

\* Requires kit EPP-1254P

\*\* Required kit EPP-2504P

## MCB - S 200 M series

### Order codes

#### S 200 series M B

	Rated current in A	Rated current in kA		Order Code
		IEC/EN 60898-1		
		IEC/EN 60947-2	1 Pole	
	6	10kA/15kA	S201M-B6	S203M-B6
	10	10kA/15kA	S201M-B10	S203M-B10
	13	10kA/15kA	S201M-B13	S203M-B13
	16	10kA/15kA	S201M-B16	S203M-B16
	20	10kA/15kA	S201M-B20	S203M-B20
	25	10kA/15kA	S201M-B25	S203M-B25
	32	10kA/15kA	S201M-B32	S203M-B32
	40	10kA/15kA	S201M-B40	S203M-B40
	50	10kA/15kA	S201M-B50	S203M-B50
	63	10kA/15kA	S201M-B63	S203M-B63
	80	6kA	S201-B80	S203-B80
	100	6kA	S201-B100	S203-B100

#### S 200 series M C

	Rated current in A	Rated current in kA		Order Code
		IEC/EN 60898-1		
		IEC/EN 60947-2	1 Pole	
	6	10kA/15kA	S201M-C6	S203M-C6
	10	10kA/15kA	S201M-C10	S203M-C10
	13	10kA/15kA	S201M-C13	S203M-C13
	16	10kA/15kA	S201M-C16	S203M-C16
	20	10kA/15kA	S201M-C20	S203M-C20
	25	10kA/15kA	S201M-C25	S203M-C25
	32	10kA/15kA	S201M-C32	S203M-C32
	40	10kA/15kA	S201M-C40	S203M-C40
	50	10kA/15kA	S201M-C50	S203M-C50
	63	10kA/15kA	S201M-C63	S203M-C63
	80	6kA	S201-C80	S203-C80
	100	6kA	S201-C100	S203-C100

#### S 200 series M D

	Rated current in A	Rated current in kA		Order Code
		IEC/EN 60898-1		
		IEC/EN 60947-2	1 Pole	
	6	10kA/15kA	S201M-D6	S203M-D6
	10	10kA/15kA	S201M-D10	S203M-D10
	13	10kA/15kA	S201M-D13	S203M-D13
	16	10kA/15kA	S201M-D16	S203M-D16
	20	10kA/15kA	S201M-D20	S203M-D20
	25	10kA/15kA	S201M-D25	S203M-D25
	32	10kA/15kA	S201M-D32	S203M-D32
	40	10kA/15kA	S201M-D40	S203M-D40
	50	10kA/15kA	S201M-D50	S203M-D50
	63	10kA/15kA	S201M-D63	S203M-D63

## RCBO DSE201 M - Type A

### Order codes

#### DSE201 M - Type A



Rated residual current $I_{\Delta n}$ [mA]	Rated current in A	Rated current in kA		Order Code	
		B Characteristic	C Characteristic		
10	6	10kA/15kA	DSE201MB6A10	DSE201MC6A10	
	10	10kA/15kA	DSE201MB10A10	DSE201MC10A10	
	16	10kA/15kA	DSE201MB16A10	DSE201MC16A10	
	20	10kA/15kA	DSE201MB20A10	DSE201MC20A10	
	25	10kA/15kA	DSE201MB25A10	DSE201MC25A10	
	32	10kA/15kA	DSE201MB32A10	DSE201MC32A10	
	40	10kA/15kA	DSE201MB40A10	DSE201MC40A10	
	50	10kA	DSE201MB50A10	DSE201MC50A10	
30	6	10kA/15kA	DSE201MB6A30	DSE201MC6A30	
	10	10kA/15kA	DSE201MB10A30	DSE201MC10A30	
	16	10kA/15kA	DSE201MB16A30	DSE201MC16A30	
	20	10kA/15kA	DSE201MB20A30	DSE201MC20A30	
	25	10kA/15kA	DSE201MB25A30	DSE201MC25A30	
	32	10kA/15kA	DSE201MB32A30	DSE201MC32A30	
	40	10kA/15kA	DSE201MB40A30	DSE201MC40A30	
	50	10kA	DSE201MB50A30	DSE201MC50A30	
100	6	10kA/15kA		DSE201MC6A100	
	10	10kA/15kA		DSE201MC1 A100	
	16	10kA/15kA		DSE201MC16A100	
	20	10kA/15kA		DSE201MC20A100	
	25	10kA/15kA		DSE201MC25A100	
	32	10kA/15kA		DSE201MC32A100	
	40	10kA/15kA		DSE201MC40A100	
	50	10kA		DSE201MC50A100	
300	6	10kA/15kA		DSE201MC6A300	
	10	10kA/15kA		DSE201MC10A300	
	16	10kA/15kA		DSE201MC16A300	
	20	10kA/15kA		DSE201MC20A300	
	25	10kA/15kA		DSE201MC25A300	
	32	10kA/15kA		DSE201MC32A300	
	40	10kA/15kA		DSE201MC40A300	
	50	10kA		DSE201MC50A300	

## RCCB F 200 series A type

### Order codes

#### F 200 A type - F202



Number of poles	Rated residual current $I_{\Delta n}$ [mA]	Rated current in A	Order Code	
2	10	16	F202A-16/0.01	
		25	F202A-25/0.01	
		30	25	F202A-25/0.03
		40	F202A-40/0.03	
		63	F202A-63/0.03	
	100	80	F202A-80/0.03	
		100	F202A-100/0.03	
		25	F202A-25/0.1	
		40	F202A-40/0.1	
		63	F202A-63/0.1	
300	80	F202A-80/0.1		
	100	F202A-100/0.1		
	25	F202A-25/0.3		
	40	F202A-40/0.3		
	63	F202A-63/0.3		
500	80	F202A-80/0.3		
	100	F202A-100/0.3		
	25	F202A-25/0.5		
	40	F202A-40/0.5		
	63	F202A-63/0.5		
	80	F202A-80/0.5		

#### F 200 A type - F204



Number of poles	Rated residual current $I_{\Delta n}$ [mA]	Rated current in A	Order Code
4	30	25	F204A-25/0.03
		40	F204A-40/0.03
		63	F204A-63/0.03
		80	F204A-80/0.03
		100	F204A-100/0.03
	100	25	F204A-25/0.1
		40	F204A-40/0.1
		63	F204A-63/0.1
		80	F204A-80/0.1
		100	F204A-100/0.1
300	25	F204A-25/0.3	
	40	F204A-40/0.3	
	63	F204A-63/0.3	
	80	F204A-80/0.3	
	100	F204A-100/0.3	
500	25	F204A-25/0.5	
	40	F204A-40/0.5	
	63	F204A-63/0.5	
	80	F204A-80/0.5	
	100	F204A-100/0.5	

## Metering A & B series

### Order codes

#### A series - A41

80A SPN 4mod	Description	Order Code
	Pulse output	A41 111 - 100
	Pulse output, RS-485	A41 112 - 100
	Pulse output, M-Bus	A41 113 - 100
	2 output, 2 input, RS-485	A41 312 - 100
	2 output, 2 input, M-Bus	A41 313 - 100

#### A series - A43

80A TPN 7mod	Description	Order Code
	Pulse output	A43 111 - 100
	Pulse output, RS-485	A43 112 - 100
	Pulse output, M-Bus	A43 113 - 100
	2 output, 2 input, RS-485	A43 312 - 100
	2 output, 2 input, M-Bus	A43 313 - 100

#### B series - B21

65A SPN 2mod	Description	Order Code
	Pulse output	B21 111 - 100
	Pulse output, RS-485	B21 112 - 100
	Pulse output, M-Bus	B21 113 - 100
	2 output, 2 input, RS-485	B21 312 - 100
	2 output, 2 input, M-Bus	B21 313 - 100

#### B series - B23

65A TPN 4mod	Description	Order Code
	Pulse output	B23 111 - 100
	Pulse output, RS-485	B23 112 - 100
	Pulse output, M-Bus	B23 113 - 100
	2 output, 2 input, RS-485	B23 312 - 100
	2 output, 2 input, M-Bus	B23 313 - 100

## Metering C series

### Order codes

#### C series - C11

40A SPN 1Mod	Description	Order Code
	Pulse output	C11 110-101

#### C series - C13

40A TPN 3 Mod	Description	Order Code
	Pulse output	C13 110-101

## Metering EQmatic series

### Order codes

EQmatic Energy Analyzer the perfect solution for connecting all localized meters to a single connection point, with embedded data logging functions and TCIP internet gateway functionality. Designed for Modbus A & B EQ series meters with up to 16 or 64 devices connected to a single Eqmatic.

#### Eqmatic Gateway

40A TPN 3 Mod	Description	Order Code
	Energy Analyzer, 16 device, Modbus	QA/S 4.16.1
	Energy Analyzer, 64 device, Modbus	QA/S 4.64.1



## ESB installation contactors

### Order codes

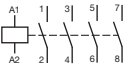
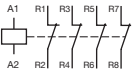
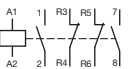

These devices are specifically made for commanding loads and signalling electrical conditions in any low-voltage distribution board. The functions of these devices are particularly switching, pushing and signalling electrical conditions in any installations (low-voltage area)

#### ESB 24

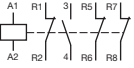



Main poles	Number of modules	Control coil voltage		Order Code
		40-50 Hz	DC	
2 N.O. 	2	24 V	24 V	ESB 24-20*
		230...240 V	230...240 V	ESB 24-20*
4 N.O. 	2	12 V	12 V	ESB 24-40*
		24 V	24 V	ESB 24-40*
		110...120 V	110...120 V	ESB 24-40*
		230...240 V	230...240 V	ESB 24-40*
4 N.C. 	2	12 V	12 V	ESB 24-04*
		24 V	24 V	ESB 24-04*
		110...120 V	110...120 V	ESB 24-04*
		230...240 V	230...240 V	ESB 24-04*
2 N.O. 2 N.C. 	2	12 V	12 V	ESB 24-22*
		24 V	24 V	ESB 24-22*
		110...120 V	110...120 V	ESB 24-22*
		230...240 V	230...240 V	ESB 24-22*
		12 V	12 V	ESB 24-31*
		24 V	24 V	ESB 24-31*
3 N.O. 1 N.C. 	2	110...120 V	110...120 V	ESB 24-31*
		230...240 V	230...240 V	ESB 24-31*
		12 V	12 V	ESB 24-13*
		24 V	24 V	ESB 24-13*
4 N.O. 3 N.C. 	2	24 V	24 V	ESB 24-13*
		110...120 V	110...120 V	ESB 24-13*
		230...240 V	230...240 V	ESB 24-13*

\* Ensure voltage is selected

## ESB installation contactors

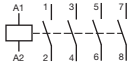
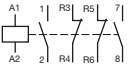

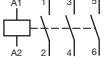

### Order codes

#### ESB 40

Main poles	Number of modules	Control coil voltage		Order Code
		40-50 Hz	DC	
4 N.O. 	3	12 V	12 V	ESB 40-40*
		24 V	24 V	ESB 40-40*
		110...120 V	110...120 V	ESB 40-40*
		230...240 V	230...240 V	ESB 40-40*
2 N.C. 	3	24 V	24 V	ESB 40-22*
		230 V	230 V	ESB 40-22*
1 N.C. 	3	24 V	24 V	ESB 40-31*
		230 V	230 V	ESB 40-31*
3 N.O. 	3	24 V	24 V	ESB 40-30*
		230 V	230 V	ESB 40-30*
2 N.O. 	3	24 V	24 V	ESB 40-20*
		230 V	230 V	ESB 40-20*

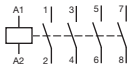
\* Ensure voltage is selected

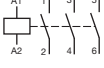
#### ESB 63

Main poles	Number of modules	Control coil voltage		Order Code
		40-50 Hz	DC	
4 N.O. 	3	12 V	12 V	ESB 63-40*
		24 V	24 V	ESB 63-40*
		110...120 V	110...120 V	ESB 63-40*
		230...240 V	230...240 V	ESB 63-40*
1 N.C. 	3	110 V	110 V	ESB 63-31*
		230 V	230 V	ESB 63-31*
3 N.O. 	3	230 V	230 V	ESB 63-30*
		400 V	400 V	ESB 63-30*
2 N.O. 	3	24 V	24 V	ESB 63-20*
		230 V	230 V	ESB 63-20*
1 N.O. 1 N.C. 	3	230 V	230 V	ESB 63-11*

\* Ensure voltage is selected

## D Line digital time switches

### Order codes

#### D Line weekly digital time switches

The unique design, with white backlit LCD display, and extreme ease of use with two lines of text menu and only four buttons, make D Line ideal to automate the installation functions.

Thanks to the innovative management of time vacation, the D Line digital time switches allow the exclusion of the normal weekly program in one or more periods of several years or between two different years.

The range includes 1 and 2 channel versions, equipped with large capacity internal battery to maintain operation without power supply and permanent memory EEPROM, to avoid the risk of program loss and to maintain the date and time settings in the event of power failure, irrespective of its duration.

The “Plus” version can transfer different types of program by using a D KEY to be quickly copied in using no digital time switches, avoiding the errors due to future modification. The “SYNCHRO” version can be coupled to the D DCF77 antenna, that allows an automatic synchronization of the digital time switch with the Frankfurt DCF77 time signal, or can be coupled to the D GPS antenna to allows synchronization received from the Global Positioning System.

The D Line is particularly useful in environments and situations where user management is required with a time schedule flexible enough to predict or exclude activities according to time and day of week or month.

#### D Line switches

		Channels no.	Type	Order Code
	D1 Plus	1	D1	2CSM258763R0621
		1	D1 PLUS	2CSM257583R0621
		1	D1 SYNCHRO	2CSM257493R0621
		2	D2	2CSM256313R0621
		2	D2 PLUS	2CSM277583R0621
		2	D2 SYNCHRO	2CSM277363R0621

#### Accessories

Versions	Type	Order Code
Programming key	D KEY	2CSM277143R0621
Programming software	D SW	2CSM299973R0621
DCF77 antenna	D DCF77	2CSM299983R0621
GPS antenna	D GPS	2CSM299993R0621

## T Line modular twilight switches

### Order codes

- 01 T1
- 02 T1 PLUS
- 03 LS-D

#### T Line modular twilight switches

These twilight switches allow to switch ON and switch OFF lighting devices according to a scheduled level of the ambient light. They are used in combination with an external sensor to detect if the ambient light is higher or lower than the set level.

A switching delay prevents them from operating unnecessarily when the light intensity suddenly changes (e.g. lightning, moving vehicles, etc.). The T1 twilight switch in 1 channel is preset at 10 lux

from factory and is equipped with 2 signalling LEDs that indicate the setpoint value and display the status of the contact. The operating instructions are printed on the side of the product. T1 PLUS switches feature a setpoint that can be adjusted for 4 different scale values (2:40, 20:200, 200:2000, 2000:15000). This makes them ideal for daytime applications where the lux values are very high. With a 10 lux preset factory setting, they are equipped with 2 signalling LEDs that indicate the setpoint value and display the status of the contact.

#### T Line modular twilight switches

Brightness range lux	Type	Order Code
2:200	T1	2CSM295563R1341
2:15000	T1 PLUS	2CSM295793R1341

#### Accessories for T Line modular twilight switches

The external sensor is supplied in the same package of the switch, but it's also available separately as spare part. The upper part of the external case (with screw locking), is made up of

thermoplastic materials and bears up against ultraviolet rays to guarantee a homogeneous diffusion of the daylight internally. LS-D is also equipped with a cable gland.

#### Accessories

Brightness range lux	Type	Order Code
External sensor	LS-D	2CSM295723R1341



01



02



03

## Modular sockets

### Order codes

#### British standard modular sockets

	Colour	Modules	Order Code
	Grey	3	M1363
	Grey with light	3	M1363-L



## E 90 fuse switch disconnectors

### Order codes

E 90 series fuse switch disconnectors are designed for switching circuits under load, providing protection against short circuits and overloads. The case is made of self-extinguishing thermoplastic material resistant to high temperatures (all materials are UL listed) while the contact clips are in silver plated copper. E 90 fuse switch disconnectors can be sealed or

padlocked to ensure operator safety during maintenance. Versions with blown fuse indicator allow to check whether the fuse is still working correctly or not. For easy and quick installation E 90 range is totally compatible with connecting bars, terminals and caps of S 200 MCBs. Thanks to cURus approval, they can be installed in UL certified machines.

#### E 90 fuse switch disconnectors for 10.3 x 38 mm fuses (AC-22B)

	Number of poles	Rated current In	Modules	Order Code
	1	32	1	E 91/32
	1	32	1	E 91/32s
	3	32	3	E 93/32
	3	32	3	E 93/32s
				

Fuses not included

---

# TPN Commercial / Industrial distribution

<b>047</b>	<b>ArTu PB Panel board</b>
<b>054</b>	<b>Plug in bases and outgoing MCCBs</b>
<b>057</b>	<b>Accessories</b>
<b>059</b>	<b>Incoming metering kits, surge protection and side chambers</b>
<b>060</b>	<b>Outgoing metering kits, surge protection and other accessories</b>



---

For more detailed product information, please refer to our online technical brochures available at: [new.abb.com/low-voltage/support/documentation](http://new.abb.com/low-voltage/support/documentation)

or contact our sales team via email [LV.enquiries@gb.abb.com](mailto:LV.enquiries@gb.abb.com)

or call 0333 999 9933

# ArTu PB panelboard

## Overview

The ArTu PB panelboard is available wall mounted as standard, and in three configurations of 6/8, 12/16 and 18/24 outgoing ways, giving you the ability to build your own custom panelboard.

The new system allows you to fit F1 single pole, together with XT1 and XT3 three pole MCCBs to the same busbar system using the new plug in bases designed by ABB. Side cable chambers are available which can be fitted on either side of the main structure. There is also an option of adding top, bottom and metering extension boxes. As standard the panelboard is fitted with a plain door but, an optional glazed version is available.

### Key features

- Robust metalwork system
- Incoming options up to 1250A
- Outgoing ways up to 400A
- Shrouding for spare ways and busbar covers for unused ways are both available for additional safety
- Comprehensive range of surge protection and metering solutions available

### General characteristics

- Compliance with IEC 61439-1 & 2
- ASTA Certified busbars
- Rated at 415V, 50-60Hz
- Rated current/I<sub>cn</sub>
- Up to 400A/35kA flat busbar
- Up to 800A/50kA profiled busbar
- Up to 1250A/65 kA profiled busbar
- Rated impulse withstand voltage U<sub>imp</sub> 8Kv
- Rated short-circuit short-time withstand current I<sub>cn</sub> up to 65kA
- Rated short-circuit peak current I<sub>cn</sub> up to 143kA
- IP43 ingress protection with door
- Colour light grey RAL 7035
- Supplied with plain door as standard
- Supplied without incomer, wide variety of options available
- Earth and neutral terminals are included
- 4 pole versions are available upon request



# ArTu PB panelboard

## General characteristics

### Surge Protection options

Complete portfolio of surge protection options available for Type 1-3 protection using either the Furse or Quicksafe ranges.

### Easy to access or expand

Removable side covers allow side access, future expansion of panelboard layout or additional accessory fitment.

### Adaptability

Layout and design can be altered using ABB's plug in bases to fit outgoing breakers to suit.

### Wide range of metering options

Metering chambers available with cutouts to house 96 x 96 meters. Blank cutout covers are also available for future addition.

### Flexibility

Incoming options from 250 - 1250A, 3 and 4 pole, which include shrouding for extra safety.

### Modular range of metalwork depth:

240mm; width: 690, 890mm; height: 1250, 1650, 2050mm

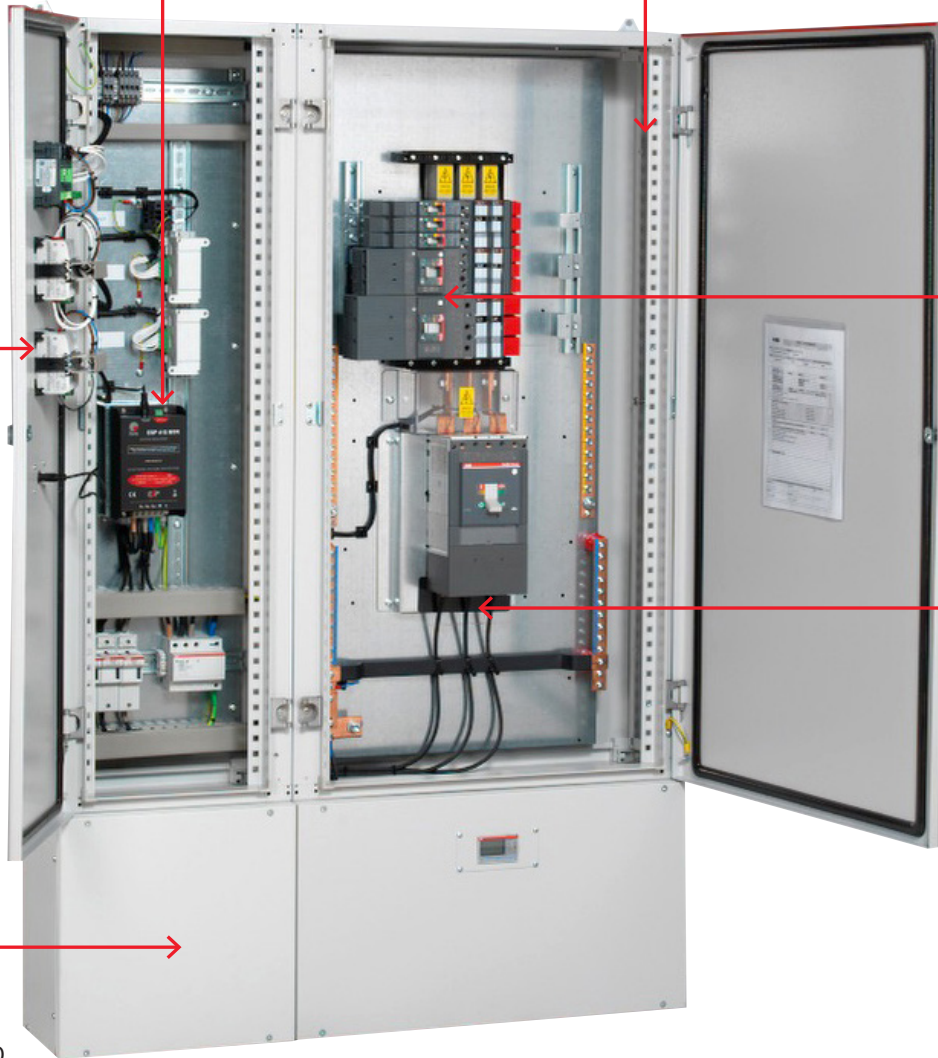

# ArTu PB panelboard

## The details which make the difference



### Flexibility

Flexible incoming options from 250A-1250A including shrouding for additional safety.



### Plug in technology

A spring loaded contact achieves a high contact force, again leading to a greater effective contact area.



### Easy Access

Removable side covers in addition to top and bottom gland plates ensure there are a variety of access points for efficient assembly, installation and maintenance.



### Modular design

Top / bottom extension boxes and side cable / metering chambers of one depth (240mm) allow for additional accessories or cabling to be added.

# ArTu PB Panelboard

## Order process

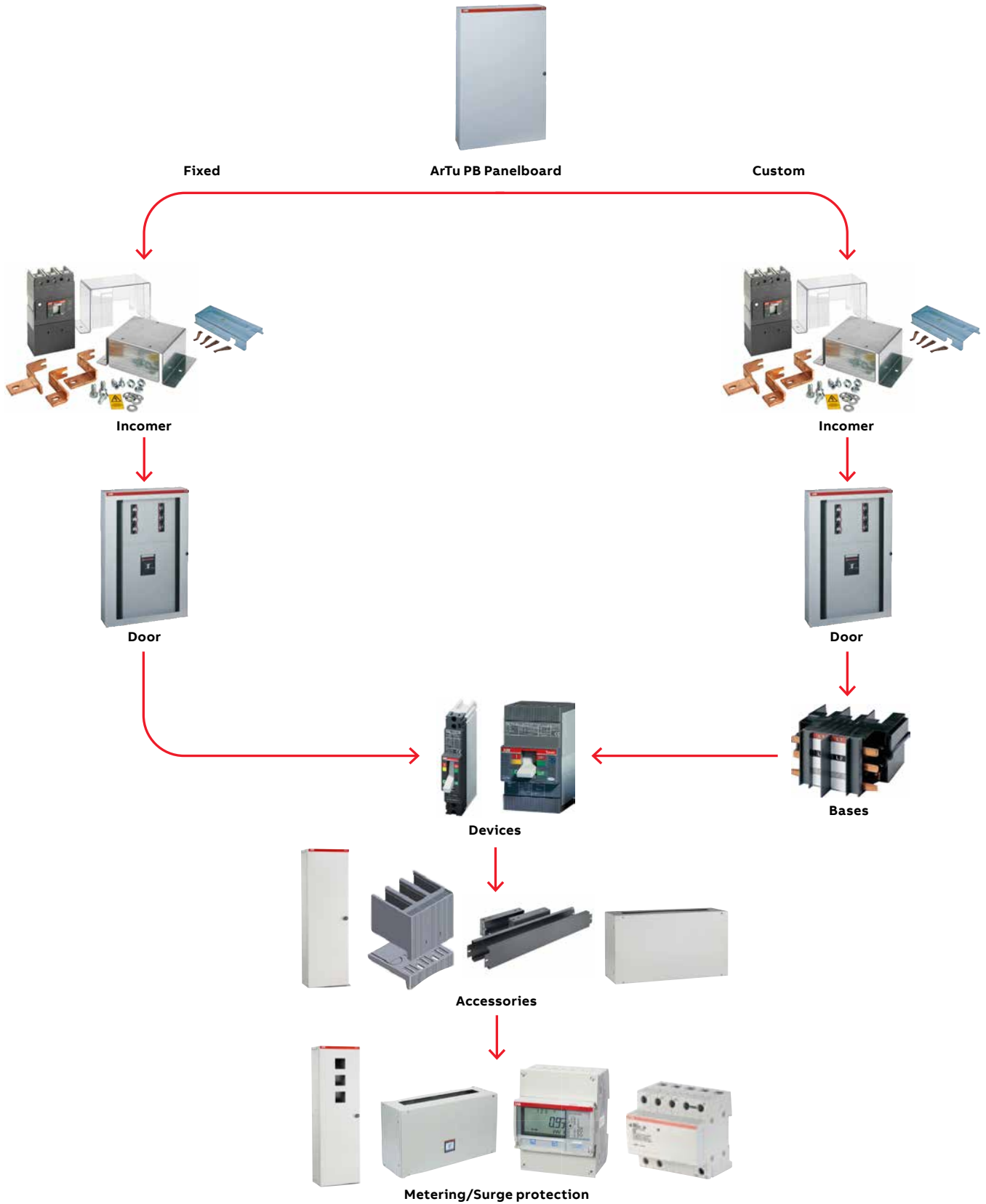

# ArTu PB Panelboard

## Order codes

### Fixed boards

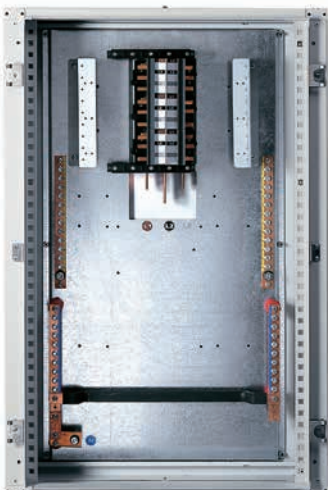

Ways	Outgoing MCCB Type	Copper Rating (A)	Dimensions (mm)			Order Code
			Height	Width	Depth	
6	XT1 160A	400A	1250	690	240	640T1PB3MD
	XT3 250A	400A	1250	690	240	640T3PB3MD
	XT3 250A	800A	1250	690	240	680T3PB3MD
12	XT1 160A	400A	1650	690	240	124T1PB3MD
	XT3 250A	400A	1650	690	240	124T3PB3MD
	XT1 160A	800A	1650	690	240	128T1PB3MD
	XT3 250A	800A	1650	690	240	128T3PB3MD
18	XT1 160A	400A	2050	690	240	184T1PB3MD
	XT1 160A	800A	2050	690	240	188T1PB3MD
	XT3 250A	800A	2050	690	240	188T3PB3MD

**Note:**  
Fixed boards are pre populated with plug in bases of set frame size.

### Custom boards

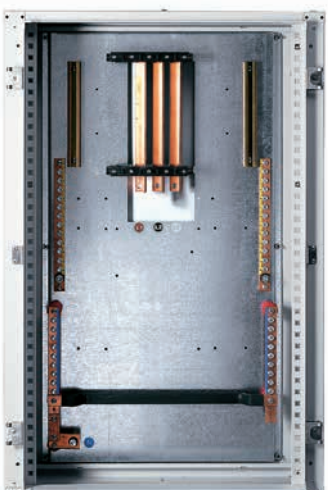

Ways	Outgoing MCCB Type	Copper Rating (A)	Dimensions (mm)			Order Code
			Height	Width	Depth	
6/8	F1 (SP) / XT1 / XT3	400A	1250	690	240	CU640PB3MD
	F1 (SP) / XT1 / XT3	800A	1250	690	240	CU680PB3MD
12/16	F1 (SP) / XT1 / XT3	400A	1650	690	240	CU124PB3MD
	F1 (SP) / XT1 / XT3	800A	1650	690	240	CU128PB3MD
18/24	F1 (SP) / XT1 / XT3	400A	2050	690	240	CU184PB3MD
	F1 (SP) / XT1 / XT3	800A	2050	690	240	CU188PB3MD
12/16	F1 (SP) XT1/ XT3	1250A	2050	690	240	CU12504T5PB3MD

**Note:**  
F1(SP) ratings: Up to 125A  
XT1 ratings: Up to 160A  
XT3 ratings: Up to 250A  
T5 ratings: Up to 400A

## Selection and ordering guide

### Incomer and inner cover options



#### Incomer options

Incomers below include the connection kit and terminal shrouds. Order inner cover to suit. Incoming devices are provided with front terminals as standard. If larger/different orientation of cables are required select alternative terminals accordingly.

#### 400/800A rated panelboards

Description	Inner Cover Type	Order Code
250A 3P Switch disconnecter	2	PB-2503SD
250A 4P Switch disconnecter	2	PB-2504SD
250A 3P 36kA Thermomagnetic (TMD) MCCB	2	PB-2503MCCB
250A 4P 36kA Thermomagnetic (TMD) MCCB	2	PB-2504MCCB
400A 3P Direct connection kit	1	400DC3/4P
400A 3P Switch disconnecter	3	PB-4003SD
400A 4P Switch disconnecter	3	PB-4004SD
400A 3P 36kA Electronic (LS/I) MCCB -LS/I	3	PB-4003MCCB
400A 4P 36kA Electronic (LS/I) MCCB-LS/I	3	PB-4004MCCB
630A 3P Switch disconnecter	3	PB-6303SD
630A 4P Switch disconnecter	3	PB-6304SD
630A 3P 50kA Electronic (LS/I) MCCB - PR221DS-LS/I	3	PB-6303MCCB
630A 4P 50kA Electronic (LS/I) MCCB - PR221DS-LS/I	3	PB-6304MCCB
800A 3P Direct connection kit	1	800DC3P
800A 3P Switch disconnecter – T6D800	4	PB-8003SD
800A 4P Switch disconnecter – T6D800	4	PB-8004SD
800A 3P 50kA Electronic (LS/I) MCCB - PR221DS-LS/I	4	PB-8003MCCB
800A 4P 50kA Electronic (LS/I) MCCB - PR221DS-LS/I	4	PB-8004MCCB

#### For 1250A rated panelboards

Description	Inner Cover Type	Order Code
1250A 3P Direct connection kit	5	1250DC3P
1000A 3P Switch disconnecter – T7D1000	6	PB-10003SD
1000A 3P 50kA Electronic (LS/I) MCCB – T7S1000-PR231/P LS/I	6	PB-10003MCCB
1250A 3P Switch disconnecter – T7D1250	6	PB-12503SD
1250A 3P 50kA Electronic (LS/I) MCCB – T7S1000-PR231/P LS/I	6	PB-12503MCCB

## Selection and ordering guide

Incomer and inner cover options



### For 400/800A rated panelboards

Description	Inner Cover Type	Order Code
Direct connection inner cover kit for 400/800A rated panelboard	1	P6X6DC
250A TP XT3/T3 Inner cover kit	2	P6X6T3
400/630A TP T5 Inner cover kit	3	P6X6T5
800A TP T6 Inner cover kit	4	P6X6T6

### For 1250A rated panelboards

Description	Inner Cover Type	Order Code
Direct connection inner cover kit for 1250A rated panelboard	5	P8XDC
800-1250A TP T7 inner cover kit	6	P8XT7

## Selection and ordering guide

### Plug in bases and outgoing MCCBs

#### Plug in bases - for custom panel boards only



Description	Order Code
F1 SP L1/L3	PLF11L1/L3P
F1 SP L2	PLF11L2P
XT1	PLT13P
XT3	PLT33P
T5 TP (Only available for fitment into 1250A)	PLT53PT

**Note:**

Both L1/L3 and L2 need to be ordered for SP device

#### Outgoing devices - A1C125 and A1N125 (Thermal Magnetic) MCCB - Single phase



Description	Order Code
16A SP 18kA	1SDA068745R1
20A SP 25kA	1SDA066686R1
25A SP 25kA	1SDA066687R1
32A SP 25kA	1SDA068755R1
40A SP 25kA	1SDA066689R1
50A SP 25kA	1SDA066690R1
63A SP 25kA	1SDA068766R1
80A SP 25kA	1SDA066693R1
100A SP 25kA	1SDA066695R1
125A SP 25kA	1SDA066696R1

\*Requires terminals for connecting to the base.

#### Outgoing devices - XT1B 3 pole (Thermal Magnetic) MCCB - Three phase



Description	Order Code
16A 3P 18kA	1SDX014883R1
20A 3P 18kA	1SDX014885R1
25A 3P 18kA	1SDX014886R1
32A 3P 18kA	1SDX014887R1
40A 3P 18kA	1SDX014888R1
50A 3P 18kA	1SDX014889R1
63A 3P 18kA	1SDX014891R1
80A 3P 18kA	1SDX002813R1
100A 3P 18kA	1SDX014310R1
125A 3P 18kA	1SDX014892R1
160A 3P 18kA	1SDX014894R1

## Selection and ordering guide

### Plug in bases and outgoing MCCBs

#### Outgoing devices - XT1C 3 pole (Thermal Magnetic) MCCB

	Description	Order Code
	16A 3P 25kA	1SDX014895R1
	20A 3P 25kA	1SDX018174R1
	25A 3P 25kA	1SDX014896R1
	32A 3P 25kA	1SDX014897R1
	40A 3P 25kA	1SDX014898R1
	50A 3P 25kA	1SDX014899R1
	63A 3P 25kA	1SDX014900R1
	80A 3P 25kA	1SDX014901R1
	100A 3P 25kA	1SDX014902R1
	125A 3P 25kA	1SDX014903R1
	160A 3P 25kA	1SDX014904R1

#### Outgoing devices - XT1N 3 pole (Thermal Magnetic) MCCB

	Description	Order Code
	16A 3P 36kA	1SDX018803R1
	20A 3P 36kA	1SDX018804R1
	25A 3P 36kA	1SDX018805R1
	32A 3P 36kA	1SDX014905R1
	40A 3P 36kA	1SDX014906R1
	50A 3P 36kA	1SDX014907R1
	63A 3P 36kA	1SDX014908R1
	80A 3P 36kA	1SDX014909R1
	100A 3P 36kA	1SDX014910R1
	125A 3P 36kA	1SDX014911R1
	160A 3P 36kA	1SDX014912R1

#### Outgoing devices - XT1S 3 pole (Thermal Magnetic) MCCB

	Description	Order Code
	16A TP 50kA	1SDA080830R1
	20A TP 50kA	1SDA080831R1
	25A TP 50kA	1SDA080832R1
	32A TP 50kA	1SDA080833R1
	40A TP 50kA	1SDA080834R1
	50A TP 50kA	1SDA067431R1
	63A TP 50kA	1SDA067432R1
	80A TP 50kA	1SDA067433R1
	100A TP 50kA	1SDA067434R1
	125A TP 50kA	1SDA067435R1
	160A TP 50kA	1SDA067436R1

## Selection and ordering guide

### Plug in bases and outgoing MCCBs

#### Outgoing devices - XT3N 3 pole (Thermal Magnetic) MCCB



Description	Order Code
63A TP 36kA MCCB - XT3N250 (Th /Mag) - TMD	1SDA068053R1
80A TP 36kA MCCB - XT3N250 (Th /Mag) - TMD	1SDA068054R1
100A TP 36kA MCCB - XT3N250 (Th /Mag) - TMD	1SDA068055R1
125A TP 36kA MCCB - XT3N250 (Th /Mag) - TMD	1SDA068056R1
160A TP 36kA MCCB - XT3N250 (Th /Mag) - TMD	1SDA068057R1
200A TP 36kA MCCB - XT3N250 (Th /Mag) - TMD	1SDA068058R1
250A TP 36kA MCCB - XT3N250 (Th /Mag) - TMD	1SDA068059R1

#### Outgoing devices - XT3S 3 pole (Thermal Magnetic) MCCB



Description	Order Code
63A 3P 50kA	1SDA068215R1
80A 3P 50kA	1SDA068216R1
100A 3P 50kA	1SDA068217R1
125A 3P 50kA	1SDA068218R1
160A 3P 50kA	1SDA068219R1
200A 3P 50kA	1SDA068220R1
250A 3P 50kA	1SDA068221R1

#### Outgoing devices - T5N 3 pole (Electronic) MCCB



Description	Order Code
320A 3P 36kA (Electronic PR221DS-LS/I)	1SDA054316R1
400A 3P 36kA (Electronic PR221DS-LS/I)	1SDA054317R1
320A 3P 36kA (Electronic PR222DS/P-LSI)	1SDA054320R1
400A 3P 36kA (Electronic PR222DS/P-LSI)	1SDA054321R1

#### Outgoing devices - T5S 3 pole (Electronic) MCCB



Description	Order Code
320A 3P 50kA (Electronic PR221DS-LS/I)	1SDA054332R1
400A 3P 50kA (Electronic PR221DS-LS/I)	1SDA054333R1
320A 3P 50kA (Electronic PR222DS/P-LSI)	1SDA054336R1
400A 3P 50kA (Electronic PR222DS/P-LSI)	1SDA054337R1

## Selection and ordering guide

### Accessories

#### Top/bottom extension modules

	Description	Dimensions (mm)	Order Code
	For 250 - 800A panelboard	365H x 690W x 240D	RC1000
	For side cable way	365H x 390W x 240D	RC2000
	For 1250A panelboard only	385H x 890W x 240D	RC0000

**Note:**

When fitting side extension/side metering modules together with a top or bottom extension box please order the required number of RC2000 extension modules to suit.

#### Side extension modules - 390mm width

	Height (mm)	Description	Order Code
	1250	Uprights	MI1200
		Cable container	VC1201
		Front door	PC1202
	1650	Uprights	MI1600
		Cable container	VC1600
		Front door	PC1602
	2050	Uprights	MI2000
		Cable container	VC2000
		Front door	PC2002

#### Plinths

	Description	Order Code
	Four corner feet 100mm high for main structure of 250 - 1250A panelboard	ZL1000
	Finishing profile plinth for 250 - 800A panelboard	ZL1001
	Finishing profile plinth for 1250A panelboard	ZL1101
	Two feet 100mm high for side extension or side metering module	ZL3000
	Finishing profile for side extension or side metering module	ZL2001

**Note:**

Plinths cannot be used when bottom extension boxes are fitted. This applies to the main panelboard structure as well as side extension and metering modules.

## Selection and ordering guide

### Accessories

Single pole breakers – front terminals for copper aluminium cables FC CuAl (single piece)  
3 pole breakers - front connection terminals for copper cables FC Cu (set of 3pcs)

Description	Order Code
F1 (Single pole) 2.5 - 25mm <sup>2</sup>	1SDA066234R1
F1 (Single pole) 25 - 50mm <sup>2</sup>	1SDA066240R1
XT1	1SDA066905R1
XT3	1SDA066913R1

Terminal shroud for MCCB



Description	Order Code
F1 Single pole terminal covers (Each)	ED0001
XT1 TP High terminal covers (Pair)	1SDA066664R1
XT3 TP High terminal covers (Pair)	1SDA066668R1
T5 TP High terminal covers (Pair)	1SDA054960R1

General accessories



Description	Order Code
Busbar shroud 630mm long (3 pcs)	SH630
MCCB blanking module for inner door (210mm)	SZ-BP1
F1/ XT1 Busbar shroud 10pcs	MODT1
XT3 Busbar shroud 10pcs	MODT3
T5 Busbar shroud 10pcs	MODT5
Wall fixing brackets (Pack of 2)	AL2000
Side by side kit to join side extension box to panelboard (1 pack)	AA1000
Neutral/ earth bar additional kit	AK1NEMD
Neutral/ earth bar extension kit for panelboards up to 800A	EX1NEMD
Neutral shroud 250 - 800A – pair	AD1082
Aluminium gland plate for 250 - 800A panelboards	ALF0600

## Selection and ordering guide

### Incoming metering kits and metering side chambers



Includes RC2000 enclosure, meter, fixing brackets, CT, terminals, wiring looms for breaker – terminals, terminals to CT & CT to meter.

#### Incoming metering modules using B24-112-100 MID approved class 1 meter with active energy, pulse output and RS-485 communication

Description	Order Code
250A Incoming metering module	PB-METMOD250-B
400A Incoming metering module	PB-METMOD400-B
630A Incoming metering module	PB-METMOD630-B
800A Incoming metering module	PB-METMOD800-B
1000A Incoming metering module	PB-METMOD1000-B
1250A Incoming metering module	PB-METMOD1250-B

#### Incoming metering modules using M2M MODBUS network analyser with active energy, pulse/alarm output and RS-485 communication

Description	Order Code
250A Incoming metering module	PB-METMOD250-M2M
400A Incoming metering module	PB-METMOD400-M2M
630A Incoming metering module	PB-METMOD630-M2M
800A Incoming metering module	PB-METMOD800-M2M
1000A Incoming metering module	PB-METMOD1000-M2M
1250A Incoming metering module	PB-METMOD1250-M2M



#### Metering Cable chamber for outgoing metering

Suitable size PB	Description	Order Code
6 W	PB Side metering chamber 1250 x 390 x 240mm (with 3 x 92 x 92 cutouts)	PB-SIDEMET-12
12W	PB Side metering chamber 1650 x 390 x 240mm (with 6 x 92 x 92 cutouts)	PB-SIDEMET-16
18W	PB Side metering chamber 2050 x 390 x 240mm (with 9 x 92 x 92 cutouts)	PB-SIDEMET-20
	92 x 92 Blank covers (un-used way)	EV1136



**Note:**  
Includes cable connection loom to power meters

## Selection and ordering guide

Outgoing meter kits, surge protection kits and other accessories



Includes meter, CT, terminals, wiring looms for breaker – terminals, terminals to CT & CT to meter.

**Outgoing metering modules for 3 pole breakers using M2M MODBUS network analyser with active energy, pulse/alarm output and RS-485 communication**

Description	Order Code
0 - 63A Outgoing metering kit	PBMET63-M2M
80 - 125A Outgoing metering kit	PBMET125-M2M
160 - 250A Outgoing metering kit	PBMET250-M2M
400A Outgoing metering kit	PBMET400-M2M

**Outgoing metering modules using B24-112-100 MID approved class 1 meter with active energy, pulse output and RS-485 communication**



Description	Order Code
<b>For 3 pole breakers</b>	
0 - 63A Outgoing metering kit	PBMET63-B
80 - 125A Outgoing metering kit	PBMET125-B
160 - 250A Outgoing metering kit	PBMET250-B
400A Outgoing metering kit	PBMET400-B
<b>For single pole breakers</b>	
0 - 63A Outgoing v with single core CT inc B24 - 112 - 100 meter	PBMET63-S-B
80 - 125A Outgoing metering kit with single core CT inc B24 - 112 - 100 meter	PBMET125-S-B

**Surge protection kits**



Description	Order Code
Surge Protection kit Type 1 & 2. Includes 63A breaker protection	PB-SOULE
Surge Protection kit Furse Type 1, 2 & 3. Includes 63A breaker protection and remote display	PB-FURSE

**Note:**  
A side extension box with hinged door must be used to house the surge protection kit. In addition the MCCB protection device for the surge protection device requires the use of a one three phase outgoing way. Fuse protection options may be available upon request. Please ask for details if required.  
Fuse protection options may be available upon request. Please ask for details if required

**Other accessories**

Description	Order Code
Neutral shroud 250 - 800A – pair	AD1082
Neutral shroud 1250A – pair	AD1084
Aluminium gland plate for 250 - 800A panelboards	ALF0600
Aluminium gland plate for 1250A panelboards	ALF0800

---

# Enclosed switching products

<b>062</b>	<b>Introducing enclosed automatic transfer switches</b>
<b>066</b>	<b>Plug &amp; play</b>
<b>068</b>	<b>Enclosed ATS</b>
<b>072</b>	<b>ATS accessories</b>
<b>076</b>	<b>TruONE</b>
<b>080</b>	<b>Technical data</b>
<b>085</b>	<b>TruONE accessories</b>



For more detailed product information, please refer to our online technical brochures available at: [new.abb.com/low-voltage/support/documentation](http://new.abb.com/low-voltage/support/documentation)

or contact our sales team via email [LV.enquiries@gb.abb.com](mailto:LV.enquiries@gb.abb.com)

or call 0333 999 9933

# Enclosed automatic transfer switches

## General specification

The handle is a direct mounted type, and it can be padlocked in the “0” position with three padlocks with a 5 ... 6 mm hasp. It is possible to operate switch with the manual handle in case of emergency, regardless of the position of switch and without any supply power.

### Technical specifications according to IEC 60947-3 and IEC 60947-6-1

• Type of equipment	ATSE
• Class of equipment	PC
• Rated operational voltage,	$U_e$ Max. 415 V
• Rated impulse withstand voltage,	$U_{imp}$ 6 kV
• Rated frequency	50 - 60 Hz
• EMC environment	A and B

### Bypass Requirement

In order to comply with BS8519 which states “Where the availability of the life safety and fire-fighting equipment is conditional to the occupation of the building, a bypass arrangement should be incorporated to enable the changeover device to be maintained without loss of service from the critical plant”.

The bypass switches consist of the following;

### Single or mains bypass

Operate isolators to give a seamless transfer to the primary supply bypassing the ATS. The front of the panel should indicate that the ATS has been bypassed and is safe to carry out maintenance.

### Dual Bypass

Operate isolators and change over switches to give a seamless transfer to bypass the ATS and to select either the primary supply or secondary supply.



# The one ATS with all these advantages



## Easy to Install

Reduces installation time by up to 80%.

Why waste time piecing together an ATS from multiple components and as many as 20 connection wires, not to mention the time spent testing? TruONE<sup>®</sup> is the first automatic transfer switch to put it all together, including the controller with detachable HMI. It can be installed with a single wire using standard enclosures.



## Safety and Protection

Reduces risk of operator injury.

TruONE<sup>®</sup> enables emergency manual operation — even under load — without opening the panel door when the HMI is mounted to the ATS frame. The HMI can be detached from the frame for door mounting, offering more flexibility for the panel designer. Best of all, regardless of the HMI installation method, there's no need for connecting dangerous line voltages to the door, so the risk of operator injury due to equipment malfunction is reduced.



## Optimum Interface

Simplifies connectivity.

TruONE<sup>®</sup> features cloud-based connectivity through the ABB Ability™ Electrical Distribution Control System (EDCS). ABB Ability simplifies implementation and use of TruONE<sup>®</sup> in coordination with other ABB devices, ensuring one common user interface and one common software environment. Market-leading modular connectivity with seven communication protocols ensures easy installation and connectivity now and far into the future.

# Even more advantages



## Speed Up Your Project

Now you can speed up your project even more, thanks to TruONE<sup>®</sup> automatic commissioning capabilities. Pre-made configuration files can be uploaded from your PC to TruONE<sup>®</sup>, minimising the risk of human error and reducing programming time by 80%.



## Continuous Operation

TruONE<sup>®</sup> features predictive maintenance, self-diagnostics and customer-replaceable critical modules to simplify service and significantly reduce downtime and service costs. Say goodbye to blinking lights and stopping motors. TruONE<sup>®</sup> provides a fast in-phase open transition of power, ensuring unnoticed generator use during business hours.



## Energy Efficiency

Full compatibility with ABB Ability<sup>™</sup> EDCS allows data processing from the site's electrical equipment to deliver analysis and make recommendations for optimising the electrical system's performance. This allows remote monitoring of plants, energy consumption and costs at a glance, making implementation of energy management strategies easier and faster.



## Optimized Logistics

TruONE<sup>®</sup> features a wide voltage range from 200 to 480 Vac (with +/-20% tolerance), reducing the need to stock multiple SKUs, reducing inventory and saving space in the warehouse.

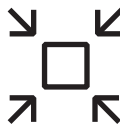

## Space Saving

TruONE<sup>®</sup> features plug-in factory and field-mount accessorising, so you don't need extra space inside the panel. Even in the case of specialised customer needs, you can use standard cabinets.



**ABB**

# Architecture

## Truly plug & play

**Embedded solution with Ekip Com Hub**  
 Emax 2 equipped with the new Ekip Com Hub establishes the cloud connection for the whole switchboard.

This dedicated cartridge-type communication module just needs to be inserted into the terminal box and connected to the internet.



ABB showcases a further evolution in the low-voltage distribution business, setting a new benchmark in terms of simplicity and performance.

ABB Ability™ Electrical Distribution Control System enables the collection of relevant information from the ABB devices installed in the low-voltage power distribution system.

These devices can be connected, plug & play, to the cloud-computing platform by sharing data either with Emax 2 (equipped with Ekip Com Hub) or with Ekip E-Hub via Modbus RS-485, Modbus TCP and Ekip Link.

Family	Device
ACB	Emax 2 (*)
ACB	New Emax (*)
MCCB	Tmax T (*)
MCCB	Tmax XT (*)
Metering device	M2M
Metering device	CMS 700
Fusegear	Slimline XR ITS 2
Signalling module for digital inputs (e.g. for MCCBs)	Ekip Signalling Modbus TCP
Digital Meters/Sensor	Pulse meter (**)
Analog Meters/Sensor	Analog meter (**)
Arc guard	TVOC-2
And many others to come...	

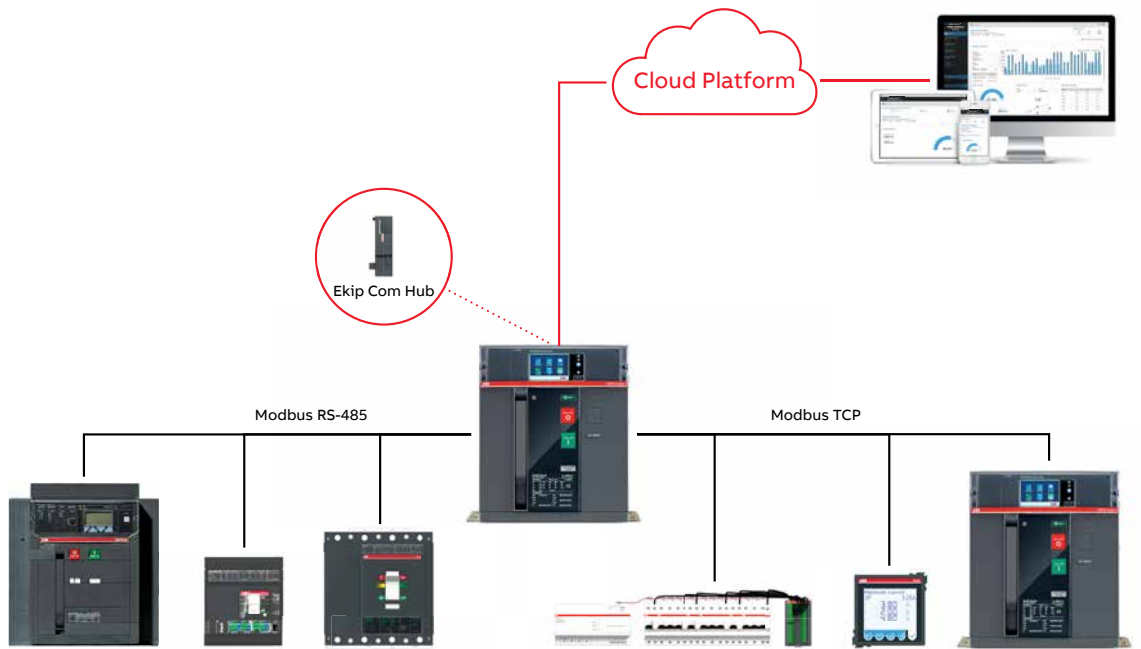
**External solution with Ekip E-Hub**

The Ekip E-Hub module can be mounted on DIN rail to collect data throughout the system. Moreover, it is possible to connect sensors for

environmental parameters (temperature, water, gas) via both analog and digital I/O. Modules for Wi-Fi or GPRS connection are provided as optional features.

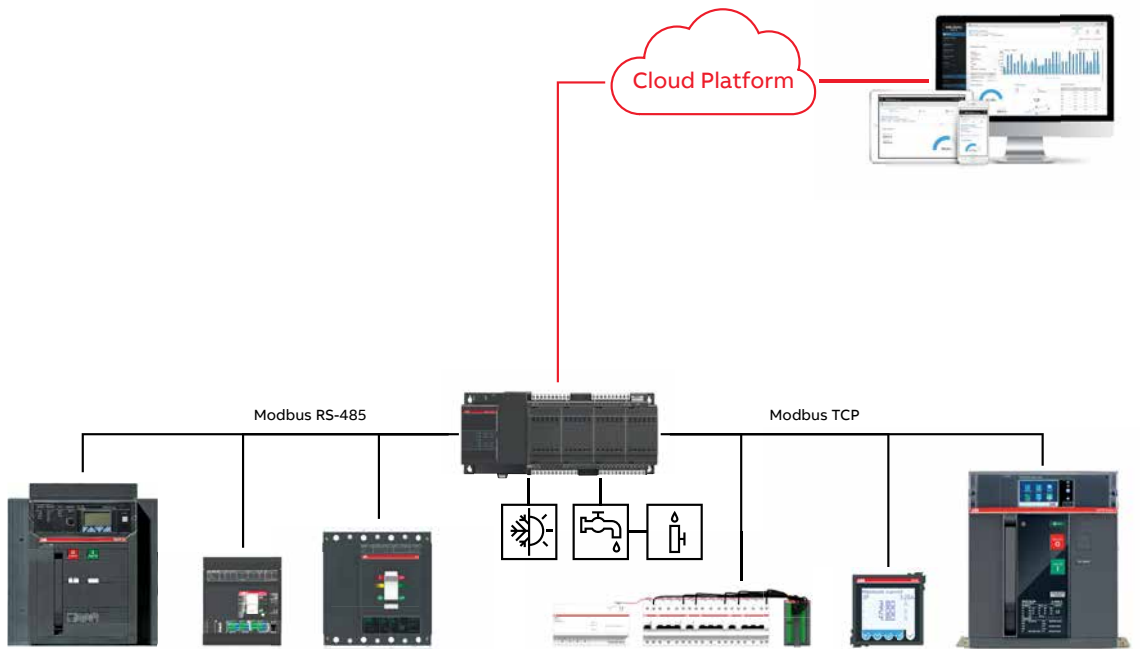

INFORMATION												COMMUNICATION
State	Current	Voltage	Power	Energy	Power Factor	Alarms	Maintenance & Diagnostics	Power Quality	Load management	Environmental parameters	General Info	Protocol
•	•	•	•	•	•	•	•	•	•		•	Modbus RS-485, Modbus TCP, Ekip Link
•	•	•	•	•	•	•	•				•	Modbus RS-485
•	•	•	•	•	•	•	•				•	Modbus RS-485
	•	•	•	•	•			•			•	Modbus RS-485, Modbus TCP
	•	•	•	•	•		•				•	Modbus RS-485
•											•	Modbus TCP
										•	•	Digital I/O
										•	•	Analog I/O
•						•					•	Modbus RS-485

\* Provided the product with dedicated accessories for communication and metering functions

\*\* only with Ekip E-Hub module

# Reliable in extreme conditions

You can be sure TruONE® exceeds standard requirements for performance and reliability to bring you dependable operation in even the most challenging electrical, mechanical and environmental conditions.



TruONE® is the only ATS to guarantee safe and reliable operation during dramatic variations in temperature (-25–+70°C) and voltage (200–480 Vac with +/-20% tolerance), and it's tolerant of vibrations (acc. IEC 60068-2-6) and shocks (acc. IEC 60068-2-27). TruONE® also has true short-circuit resilience, able to take the hit and remain fully operational after exposure to even the most dangerous phenomena.

Site conditions can change due to unexpected situations, but the performance of TruONE® does not.

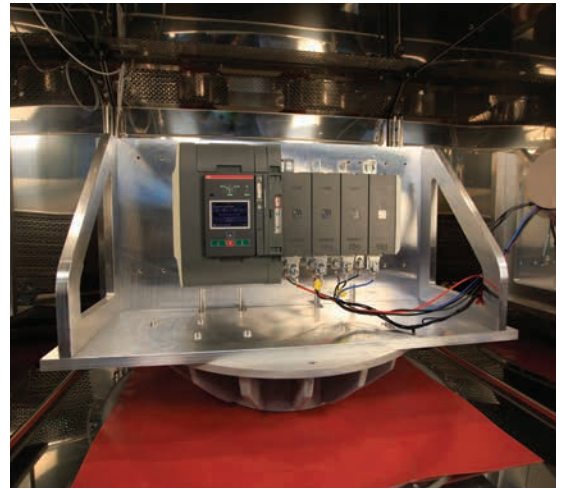

Testing for vibrations, shocks and a wide temperature range.

## Enclosure

### IP65 SR2 Sheet steel enclosures

The SR2 enclosures come from years in building the experience IP65 metal structures (in accordance with the IEC 60529 Standard), together with the innovative new production process used for construction patented by ABB.

Conforming to EN 62208 standard for low voltage switchgear and controlgear assemblies and allow realisation of electrical equipment conforming to

IEC 60204-1 standard "Safety of machinery", electrical equipment of machines and of the EN 60439-1 Standard and the new EN 61439-1-2 standard "Low voltage protection switchgear and controlgear for assemblies". The degree of protection, in accordance with the IEC 60529 standard "Degrees of protection of enclosures (IP Code)", is IP65.

## Ordering Information

### Enclosed ATS

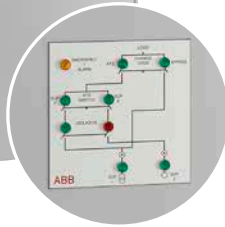

Mimic panel on front door for easy identification.



#### Features and benefits:

- I-O-II –operation with stable OFF position between positions I and II
- HMI can be mounted on the door upon request, please add -H to part number (e.g. OTOne40E4L3SBSR-H)

#### I-O-II Delayed transition - Open style operation

Enclosed ATS Part Number	Enclosed ATS with OMD300 or OMD800 Controller Description	Enclosure Size (mm)
OTA40E4C3SR	40A 4 pole ATS with OMD300 controller	600 x 600 x 250
OTA63E4C3SR	63A 4 pole ATS with OMD300 controller	600 x 600 x 250
OTA125E4C3SR	125A 4 pole ATS with OMD300 controller	600 x 600 x 250
OTA40E4C8SR	40A 4 pole ATS with OMD800 controller	600 x 600 x 250
OTA63E4C8SR	63A 4 pole ATS with OMD800 controller	600 x 600 x 250
OTA125E4C8SR	125A 4 pole ATS with OMD800 controller	600 x 600 x 250

#### Delayed transition – Open style, Level 2 DIP controls –

Bottom entry - Source 1 and Source 2 connections on bottom, load connections on top

Enclosed ATS with level 2 Controller Part Number	Enclosed ATS with OMD300 Controller Description	Enclosure Size (mm)
OTOne160E4L2SR	160A 4 pole ATS with level 2 controller	600 x 600 x 250
OTOne250E4L2SR	250A 4 pole ATS with level 2 controller	600 x 600 x 250
OTOne400E4L2SR	400A 4 pole ATS with level 2 controller	800 x 600 x 300
OTOne630E4L2SR	630A 4 pole ATS with level 2 controller	1000 x 800 x 400
OTOne800E4L2SR	800A 4 pole ATS with level 2 controller	1000 x 800 x 400
OTOne1000E4L2SR	1000A 4 pole ATS with level 2 controller	1400 x 800 x 500
OTOne1250E4L2SR	1250A 4 pole ATS with level 2 controller	1400 x 800 x 500
OTOne1600E4L2SR	1600A 4 pole ATS with level 2 controller	1400 x 800 x 500

Communication modules to be ordered separately.

#### Delayed transition – Open style, Level 3 LCD controls –

Bottom entry - Source 1 and Source 2 connections on bottom, load connections on top

ATS with level 3 Controller Part Number	Enclosed ATS with level 3 Controller Description	Enclosure Size (mm)
OTOne160E4L3SR	160A 4 pole ATS with level 3 controller	600 x 600 x 250
OTOne250E4L3SR	250A 4 pole ATS with level 3 controller	600 x 600 x 250
OTOne400E4L3AM	400A 4 pole ATS with level 3 controller	800 x 600 x 300
OTOne630E4L3AM	630A 4 pole ATS with level 3 controller	1000 x 800 x 400
OTOne800E4L3AM	800A 4 pole ATS with level 3 controller	1000 x 800 x 400
OTOne1000E4L3AM	1000A 4 pole ATS with level 3 controller	1400 x 800 x 500
OTOne1250E4L3AM	1250A 4 pole ATS with level 3 controller	1400 x 800 x 500
OTOne1600E4L3SAM	1600A 4 pole ATS with level 3 controller	1400 x 800 x 500

Communication modules to be ordered separately.

## Ordering Information

### Enclosed ATS single and dual bypass

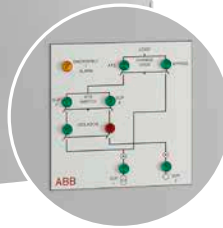

Mimic panel on front door for easy identification.

#### Features and benefits:

- I-O-II –operation with stable OFF position between positions I and II
- HMI can be mounted on the door upon request, please add -H to part number (e.g. OTOne40E4L3SBSR-H)

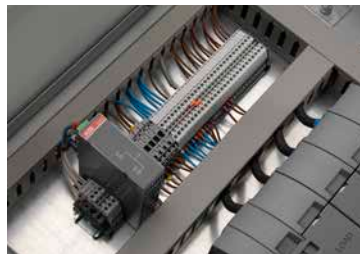

#### Delayed transition – I-O-II Level 3 LCD controller

Enclosed TruONE ATS Part Number	Enclosed ATS with single line bypass Description	Enclosure Size (mm)
OTOne40E4L3SBSR	40A 4 pole level 3 controller ATS, single bypass	1000 x 800 x 300
OTOne63E4L3SBSR	63A 4 pole level 3 controller ATS, single bypass	1000 x 800 x 300
OTOne100E4L3SBSR	100A 4 pole level 3 controller ATS, single bypass	1000 x 800 x 300
OTOne160E4L3SBSR	160A 4 pole level 3 controller ATS, single bypass	1200 x 1000 x 400
OTOne250E4L3SBSR	250A 4 pole level 3 controller ATS, single bypass	1200 x 1000 x 400
OTOne400E4L3SBAM	400A 4 pole level 3 controller ATS, single bypass	1200 x 1000 x 400
OTOne630E4L3SBAM	630A 4 pole level 3 controller ATS, single bypass	1600 x 1200 x 600
OTOne800E4L3DBAM	800A 4 pole level 3 controller ATS, single bypass	1600 x 1200 x 600

Enclosed TruONE ATS Part Number	Enclosed ATS with dual line bypass Description	Enclosure Size (mm)
OTOne40E4L3DBSR	40A 4 pole level 3 controller ATS, dual bypass	1000 x 800 x 300
OTOne63E4L3DBSR	63A 4 pole level 3 controller ATS, dual bypass	1000 x 800 x 300
OTOne100E4L3DBSR	100A 4 pole level 3 controller ATS, dual bypass	1000 x 800 x 300
OTOne160E4L3DBSR	160A 4 pole level 3 controller ATS, dual bypass	1200 x 1000 x 400
OTOne250E4L3SBSR	250A 4 pole level 3 controller ATS, dual bypass	1200 x 1000 x 400
OTOne400E4L3DBAM	400A 4 pole level 3 controller ATS, dual bypass	1200 x 1000 x 400
OTOne630E4L3DBAM	630A 4 pole level 3 controller ATS, dual bypass	1600 x 1200 x 600
OTOne800E4L3DBAM	800A 4 pole level 3 controller ATS, dual bypass	1600 x 1200 x 600

## Ordering Information

Enclosed ATS with overlapping neutral with no bypass, single bypass and dual bypass

### Features and benefits:

- I-II operation without stable OFF position
- Delivery includes handle for manual operation
- HMI can be mounted on the door upon request, please add -H to part number (e.g. OTOne40E4L3SBSR-H)

### Open transition – Open style, Level 3 LCD controller with overlapping neutral. I-II Operation

Bottom entry - Source 1 and Source 2 connections on bottom, load connections on top

Part Number	Enclosed ATS with level 3 controller Description	Enclosure Size (mm)
OTOne60E4L3OLNSR	60A 4 pole with TruOne level 3 controller & overlapping neutral	600 x 600 x 250
OTOne100E4L3OLNSR	100A 4 pole with TruOne level 3 controller & overlapping neutral	600 x 600 x 250
OTOne160E4L3OLNSR	160A 4 pole with TruOne level 3 controller & overlapping neutral	600 x 600 x 250
OTOne200E4L3OLNSR	200A 4 pole with TruOne level 3 controller & overlapping neutral	600 x 600 x 250
OTOne250E4L3OLNSR	250A 4 pole with TruOne level 3 controller & overlapping neutral	600 x 600 x 250
OTOne400E4L3OLNSR	400A 4 pole with TruOne level 3 controller & overlapping neutral	800 x 600 x 300
OTOne630E4L3OLNSR	630A 4 pole with TruOne level 3 controller & overlapping neutral	1000 x 800 x 400
OTOne800E4L3OLNSR	800A 4 pole with TruOne level 3 controller & overlapping neutral	1000 x 800 x 400

Part Number	Enclosed ATS with level 3 controller and single bypass Description	Enclosure Size (mm)
OTOne60E4L3OLNSBSR	60A 4 pole with TruOne level 3 controller & overlapping neutral	1000 x 800 x 300
OTOne100E4L3OLNSBSR	100A 4 pole with TruOne level 3 controller & overlapping neutral	1000 x 800 x 300
OTOne160E4L3OLNSBSR	160A 4 pole with TruOne level 3 controller & overlapping neutral	1000 x 800 x 300
OTOne200E4L3OLNSBSR	200A 4 pole with TruOne level 3 controller & overlapping neutral	1200 x 1000 x 400
OTOne250E4L3OLNSBSR	250A 4 pole with TruOne level 3 controller & overlapping neutral	1200 x 1000 x 400
OTOne400E4L3OLNSBAM	400A 4 pole with TruOne level 3 controller & overlapping neutral	1200 x 1000 x 400
OTOne630E4L3OLNSBAM	630A 4 pole with TruOne level 3 controller & overlapping neutral	1600 x 1200 x 600
OTOne800E4L3OLNSBAM	800A 4 pole with TruOne level 3 controller & overlapping neutral	1600 x 1200 x 600

Part Number	Enclosed ATS with level 3 controller and dual bypass Description	Enclosure Size (mm)
OTOne60E4L3OLNDBSR	60A 4 pole with TruOne level 3 controller & overlapping neutral	1000 x 800 x 300
OTOne100E4L3OLNDBSR	100A 4 pole with TruOne level 3 controller & overlapping neutral	1000 x 800 x 300
OTOne160E4L3OLNDBSR	160A 4 pole with TruOne level 3 controller & overlapping neutral	1000 x 800 x 300
OTOne200E4L3OLNDBSR	200A 4 pole with TruOne level 3 controller & overlapping neutral	1200 x 1000 x 400
OTOne250E4L3OLNDBSR	250A 4 pole with TruOne level 3 controller & overlapping neutral	1200 x 1000 x 400
OTOne400E4L3OLNDBAM	400A 4 pole with TruOne level 3 controller & overlapping neutral	1200 x 1000 x 400
OTOne630E4L3OLNDBAM	630A 4 pole with TruOne level 3 controller & overlapping neutral	1600 x 1200 x 600
OTOne800E4L3OLNDBAM	800A 4 pole with TruOne level 3 controller & overlapping neutral	1600 x 1200 x 600

## Accessories

### Automatic transfer switches



OXEA1

#### Auxiliary power supply module

Suitable for switches	Aux voltage	Type	Order number	Weight/unit kg
OX30...1600	12-24Vdc	OXEA1	1SCA148926R1001	0.04

The OXEA1 auxiliary power supply module is used for: a) connecting connectivity modules (signalling and communication) to the switch b) powering the ATS controller and connectivity modules from auxiliary 12-24 Vdc power supply, to keep them operational during power failures. A 12-24 Vdc power supply is not required when line power is available but it is necessary to keep the modules operational during power failures.

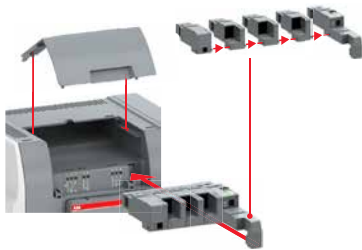

#### Connectivity modules

The connectivity modules are used in combination with OXEA1 auxiliary power supply module to enable communication capabilities (Ekip Com modules) and increase the number of digital inputs and outputs (Ekip Signalling modules). The maximum number of additional modules depends on the TruONE switch size: IEC 200-400 Amps and UL 30-260 Amps can fit three additional modules and IEC 500-1600 Amps and UL 400-1200 Amps can fit four additional modules. These modules are available with TruONE Level 3 and Level 4 controllers.



EKIP COM

The Ekip Com modules enable TruONE to be integrated in an industrial communication network for remote supervision and control of the switch. Several Ekip Com modules can be installed at the same time, thereby enabling connection to communication systems that use different protocols. The Ekip Com modules for Modbus RTU, Profibus-DP and DeviceNet contain a terminating resistor and DIP switch for optional activation to terminate the serial network or bus. The Profibus-DP module also contains a polarisation resistor and DIP switch for its activation.

#### Communication modules for Level 3 and Level 4 controllers

Suitable for switches	Protocol	Type	Order number	Weight/unit kg
OX30...1600	Modbus RTU	Ekip Com Modbus RTU-OX	1SDA104051R1	0.2
OX30...1600	Modbus TCP	Ekip Com Modbus TCP-OX	1SDA104052R1	0.2
OX30...1600	Profibus DP	Ekip Com Profibus	1SDA074152R1	0.2
OX30...1600	Profinet	Ekip Com Profinet	1SDA074153R1	0.2
OX30...1600	EtherNet/IP	Ekip Com EtherNet / IP	1SDA074155R1	0.2
OX30...1600	DeviceNet	Ekip Com DeviceNet	1SDA074154R1	0.2

## Accessories

### Automatic transfer switches



Ekip 2K SIGNALLING

The Ekip 2K Signalling modules add two input and two output contacts for controlling and remote signalling. They can be programmed with the HMI unit's display or with the Ekip Connect software. Three versions of the Ekip 2K Signalling modules are available: Ekip 2K-1, Ekip 2K-2, Ekip 2K-3. Simultaneous usage of same types is not possible.

#### Signalling modules for Level 3 and Level 4 controllers

Suitable for switches	No. of DI/DO	DI/DO numbering	Type	Order number	Weight/unit kg
OX30...1600	2/2	11,12/11,12	Ekip Signalling 2K-1-OX	1SDA104053R1	0.2
OX30...1600	2/2	21,22/21,22	Ekip Signalling 2K-2-OX	1SDA104054R1	0.2
OX30...1600	2/2	31,32/31,32	Ekip Signalling 2K-3-OX	1SDA104055R1	0.2



Ekip PROGRAMMING

The Ekip Programming module is used for programming TruONE via USB to a PC using the Ekip Connect software that can be downloaded online. It enables both online (line power available) and offline (no line power available) programming. Available for TruONE Level 3 and Level 4 controllers.

#### Ekip programming module

Suitable for switches	Type	Order number	Weight/unit kg
OX30...1600	Ekip Programming	1SDA076154R1	0.2



Ekip COM HUB

Ekip Com Hub is a communication module for cloud-based connectivity through the ABB Ability™ Electrical Distribution Control System (EDCS). TruONE equipped with Ekip Com Hub can establish the connection to ABB Ability for the whole low-voltage power distribution panel. This dedicated cartridge-type communication module just needs to be inserted into the TruONE and connected to the internet. For further information related to ABB Ability and Electrical Distribution Control System, please visit the dedicated website <https://new.abb.com/low-voltage/launches/abb-ability-edcs>. Available for TruONE Level 3 and Level 4 controllers.

#### Ekip com hub

Suitable for switches	Type	Order number	Weight/unit kg
OX30...1600	Ekip Programming	1SDA076154R1	0.2

## Accessories

### Automatic transfer switches



OXEB\_

#### Phase barriers

Grey plastic barriers for maintaining 1" clearance between the phases without terminal shrouds. Snap-on mounting. Included as standard for the LOAD side terminals with IEC 500-1600 Amps and UL 400-1200 Amps.

Suitable for switches	No. of poles	Units/type [pcs]	Type	Order number	Weight/unit kg
OX30...1600	3	4	OXEB1600/4	1SCA150201R1001	0.5
OX30...1600	4	6	OXEB1600/6	1SCA150202R1001	0.7

Note: Phase barriers cannot be used together with terminal shrouds.



OXEW1600\_

#### Wide blade kit

This is required for IEC 1000-1600 A and UL 800-1200 A switches on the LOAD side terminals, when wiring is done with four cables and using mechanical compression lugs.

Suitable for switches	No. of poles	Units/type [pcs]	Type	Order number	Weight/unit kg
IEC 1000-1600 Amps	3	6	OXEW1600/3	1SCA150204R1001	1.38
UL 800-1200 Amps	4	8	OXEW1600/4	1SCA150205R1001	1.83

Note: These codes are only for spare part purposes as the items are already included in the standard delivery.



OXEC21

IP54 padlockable transparent cover, providing protection against accidental contact.

#### Wide blade kit

Suitable for switches	Type	Order number	Weight/unit kg
OX30...1600	OXEC21	1SCA147308R1001	0.18

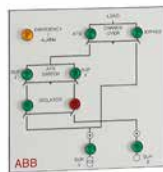
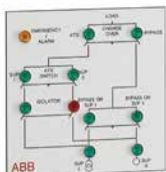

#### Mimic panels (Single/Dual Bypass)

Part Number	Description	Dimensions
01MimicDB	Mimic Panel for Dual ByPass ATS	200 x 200 x 80
01MimicSB	Mimic Panel for Single ByPass ATS	200 x 200 x 80

Note: Other options available upon request.

## Accessories

### Automatic transfer switches



OA1G01AU

Mounting on the right side of the switch: Max. 4 auxiliary contact blocks / Source 1 and Source 2 position indication (totally 8 blocks). Types \_AU have gold plated contacts for harsh environments and low operating voltages. Simultaneous action with the main contacts, IP20.

**Auxiliary contacts**

Suitable for switches	Contact functions	Installation side	Delivery batch [pcs]	Type	Order number	Weight/unit kg
OX30...1600	1NO	Right	10	OA1G10	1SCA022353R4970	0.03
OX30...1600	1NC	Right	10	OA3G01	1SCA022456R7410	0.03
OX30...1600	1NO	Right	10	OA1G10AU	1SCA022436R7910	0.03
OX30...1600	1NC	Right	10	OA3G01AU	1SCA022819R5260	0.03



OA1G10

**Auxiliary contacts** - Technical data for auxiliary contacts according to IEC 60947-5-1, for OA1G\_, OA3G\_

AC15				DC12		DC13	
Ue/[V]	Ie/[A]	Ue/[V]	Ie/[A]	P/[W]	Ie/[A]	P/[W]	
230	6	24	10	240	2	50	
400	4	72	4	290	0.8	60	
415	4	125	2	250	0.55	70	
690	2	250	0.55	140	0.27	70	
		440	0.1	44			



OA3G01

**Auxiliary contacts** - Function table for auxiliary contacts / Source 1 position (max. 2+2)

Switch position	Main contacts	OA1G10 NO	OA3G01 NC
I	closed	closed	open
0	open	open	closed
II	closed	open	closed



OA3G01AU

**Auxiliary contacts** - Function table for auxiliary contacts / Source 2 position (max. 2+2)

Switch position	Main contacts	OA1G10 NO	OA3G01 NC
I	closed	open	closed
0	open	open	closed
II	closed	closed	open

## TruONE™ part number key

Example key and product description:

**OXB1000E3S4Q54B**

ABB TruONE™ automatic transfer switch, delayed transition, 1000 amperes, IEC, 3 phase + Neutral (3ph, 4 wire), Level 4 controls, 200–480 VAC voltage area, enclosed style IP54 – bottom in/bottom out.

### ABB TruONE™ ATS

#### OX

#### ATS type

**A** Open transition I - II (without stable OFF position for load disconnection)

**B** Delayed transition I - O - II (with stable OFF position for load disconnection)

#### ATS size

30, 60, 100, 125, 160, 200, 250, 260, 315, 400, 500, 600, 630, 800, 1000, 1200, 1250, 1600

#### Standard

**E** IEC

**U** UL

#### Phase poles

**1** 1-pole

**2** 2-pole

**3** 3-pole

#### Neutral

**S** Switched Neutral

**O** Overlapping Neutral

**X** None

#### Controller

**2** Level 2 controls (DIP)

**3** Level 3 controls (LCD)

**4** Level 4 controls (Touch)

#### Voltage code

**Q** 200–480 VAC

#### Enclosure rating

**54** IP54 (IEC)

\_ (blank) Open style, no enclosure

#### Cabling direction

Open style, no enclosure

**B** Bottom entry (sources on bottom, load on top)

**T** Top entry (sources on the top, load on the bottom)

Enclosed style

**B** Bottom in / Bottom out

**D** Bottom in / Top out

**Note:** Contact ABB for more details on the available versions.

- 
- 01 Open style ATS  
UL 30-200 A  
IEC 200-250 A
- 
- 02 Open style ATS  
UL 260 A  
IEC 315-400 A
- 
- 03 Open style ATS  
UL 400-600 A  
IEC 500-800 A
- 
- 04 Open style ATS  
UL 800-1200 A  
IEC 1000-1600 A
- 
- 05 Enclosed style ATS  
IEC 200-1600 A



01



02



03

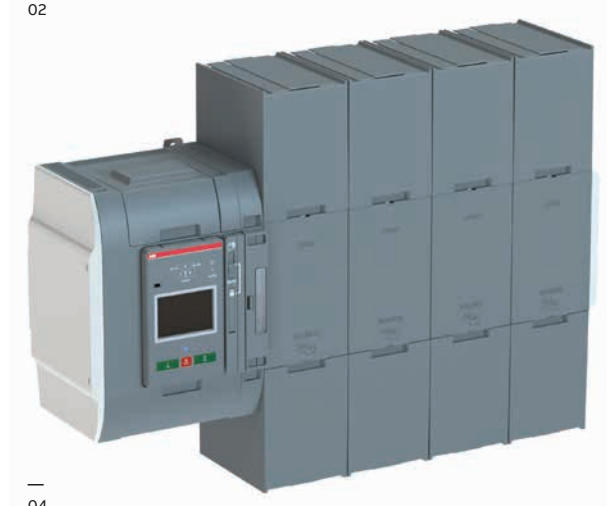

04



05

**Targeted product performance**

ATS Frame Size	30-400 A	260-800 A	800-1600 A
IEC 60947-6-1, GB 14048-11: AC-33B	200-400 A	630-800 A	1000-1600 A
GB 14048-11: AC-33iA	30-200 A	260-600 A	800-1200 A
UL1008: Emergency systems–total system load	30-200 A	260-600 A	800-1200 A
I <sub>cc</sub> (rated conditional short-circuit current)	100 kA	100 kA	100 kA
I <sub>cw</sub> (rated short-time withstand current)/Short-time current ratings, 100ms	18-30 kA	42 kA	50 kA
I <sub>cw</sub> (rated short-time withstand current)/Short-time current ratings, 500ms		30 kA	50 kA
Withstand and Close-on ratings (any breaker) 480V	42 kA	50 kA	85 kA
Withstand and Close-on ratings, with current limiting fuses	200 kA	200 kA	200 kA

## TruONE™ feature comparison

Main features in the table below. Consult ABB for more information.

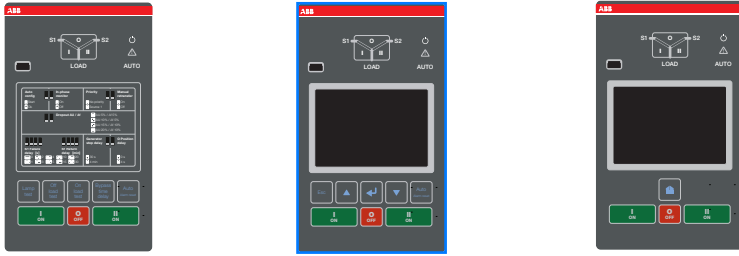

### Feature comparison

	Level 2 controls	Level 3 controls	Level 4 controls
Ampere sizes available	IEC: 200-1600 A UL: 30-1200 A	IEC: 200-1600 A UL: 30-1200 A	IEC: 200-1600 A UL: 30-1200 A
Rated voltage	200-480Vac	200-480Vac	200-480Vac
Rated frequency	50 / 60 Hz	50 / 60 Hz	50 / 60 Hz
Phase system	Single and Three	Single and Three	Single and Three
Number of poles	2, 3 and 4	2, 3 and 4	3 and 4
<b>Neutral configuration</b>			
Switched	Yes	Yes	Yes
Overlapping	No	Yes	Yes
<b>Product type</b>			
Open transition (I-II)	Yes	Yes	Yes
Delayed transition (I-O-II)	Yes	Yes	Yes
<b>Voltage and frequency settings</b>			
Pick up Voltage Source 1	Fixed 2% above drop out	81...99%, 101...119%	81...99%, 101...119%
Drop out Voltage Source 1	+/-5, 10, 15, 20%	80...98%, 102...120%	80...98%, 102...120%
Pick up Voltage Source 2	Fixed 2% above drop out	81...99%, 101...119%	81...99%, 101...119%
Drop out Voltage Source 2	+/-5, 10, 15, 20%	80...98%, 102...120%	80...98%, 102...120%
Pick up Frequency Source 1	Fixed 1% above drop out	80,5...99,5%, 100,5...119,5%	80,5...99,5%, 100,5...119,5%
Drop out Frequency Source 1	+/-5, 10 %	80...99%, 101...120%	80...99%, 101...120%
Pick up Frequency Source 2	Fixed 1% above drop out	80,5...99,5%, 100,5...119,5%	80,5...99,5%, 100,5...119,5%
Drop out Frequency Source 2	+/-5, 10 %	80...99%, 101...120%	80...99%, 101...120%
<b>Time delay settings</b>			
Override momentary Source 1 Outage, sec	0, 1, 2, 3, 4, 5, 10, 15, 20, 25, 30	0...60	0...60
Transfer from Source 1 to Source 2, sec	Fixed 2 seconds	0...3600	0...3600
Override momentary Source 2 Outage, sec	Fixed 1,5 seconds	0...60	0...60
Transfer from Source 2 to Source 1, min	0, 1, 2, 3, 4, 5, 10, 15, 20, 25, 30	0...120	0...120
Generator stop delay, min	30 secs or 4 mins	0...60	0...60
Center-OFF delay, sec	0 or 4	0...300	0...300
Pre-transfer delay S1 to S2, sec	No	0...60	0...60
Post-transfer delay S1 to S2, sec	No	0...60	0...60
Pre-transfer delay S2 to S1, sec	No	0...60	0...60
Post-transfer delay S2 to S1, sec	No	0...60	0...60
Load shed delay, sec	No	0...60	0...60
<b>Source failure detections</b>			
No voltage	Yes	Yes	Yes
Undervoltage	Yes	Yes	Yes
Overvoltage	Yes	Yes	Yes
Phase missing	Yes	Yes	Yes
Voltage unbalance	Yes	Yes	Yes
Invalid frequency	Yes	Yes	Yes
Incorrect phase sequence	Yes	Yes	Yes

## TruONE™ feature comparison

Main features in the table below. Consult ABB for more information.



### Feature comparison

	Level 2 controls	Level 3 controls	Level 4 controls
<b>Features</b>			
Controls	DIP + keys	LCD + keys	Touch + keys
LED indications for ATS, S1 and S2 status	Yes	Yes	Yes
Open transition - Standard digital inputs/outputs	0 / 1	1 / 1	2 / 1
Delayed transition - Standard digital inputs/outputs	1 / 1	2 / 1	3 / 1
Programmable digital inputs/outputs	No	Yes	Yes
Auto config (voltage, frequency, phase system)	Yes	Yes	Yes
Source priority	Source 1, No priority	Source 1/2, No priority	Source 1/2, No priority
Manual re-transfer	Yes	Yes	Yes
In-phase monitor	Yes	Yes	Yes
Genset exercising: on-load, off-load	Yes	Yes	Yes
In-built power meter module	No	No	Yes
Load shedding	No	Yes	Yes
Real time clock	No	Yes	Yes
Event log	No	Yes	Yes
Predictive maintenance	No	No	Yes
<b>Field-mount accessories</b>			
Auxiliary contacts for position indication	Yes	Yes	Yes
Digital input/output modules	No	Yes	Yes
12-24 Vdc aux supply module for controller	No	Yes	Yes
Communication modules	No	Yes	Yes
<b>Connectivity</b>			
Modbus RS485	No	Yes	Yes
Modbus/TCP	No	Yes	Yes
Profibus DP	No	Yes	Yes
ProfiNet	No	Yes	Yes
DeviceNet	No	Yes	Yes
Ethernet IP	No	Yes	Yes
IEC 61850	No	Yes	Yes
Monitoring via ABB Ability™: EDCS	No	Yes	Yes
<b>Enclosures</b>			
Open style	Yes	Yes	Yes
IP54	No	Yes	Yes
<b>For applications</b>			
Mains - Mains	Yes	Yes	Yes
Mains - Generator	Yes	Yes	Yes

## Technical data

### OTM\_C\_D products overview



#### OTM\_C20D

For Network/Network application

Fixed version with pre-defined delay times and voltage thresholds

#### Fixed version

Number of poles	Rated current (A)	Rated voltage (V)	Voltage sensing	Type	Ordering code	Weight (kg)
2	63	230:220-240	Top in	OTM63F2C20D230C	1SCA151421R1001	1.75
2	125	230:220-240	Top in	OTM125F2C20D230C	1SCA151417R1001	1.75
3	63	400:380-415	Top in	OTM63F3C20D400C	1SCA151423R1001	1.75
3	125	400:380-415	Top in	OTM125F3C20D400C	1SCA151419R1001	1.75
4	40	400:380-415	Top in	OTM40F4C20D400C	1SCA151252R1001	2.00
4	63	400:380-415	Top in	OTM63F4C20D400C	1SCA151254R1001	2.00
4	125	400:380-415	Top in	OTM125F4C20D400C	1SCA151250R1001	2.00



#### OTM\_C21D

For Network/Network and Network/Genset applications

Adjustable version with configurable transfer and back-switching delays

Adjustable over and under-voltage thresholds

#### Adjustable version

Number of poles	Rated current (A)	Rated voltage (V)	Voltage sensing	Type	Ordering code	Weight (kg)
2	63	230:220-240	Top in	OTM63F2C21D230C	1SCA151422R1001	1.75
2	125	230:220-240	Top in	OTM125F2C21D230C	1SCA151418R1001	1.75
3	63	400:380-415	Top in	OTM63F3C21D400C	1SCA151424R1001	1.75
3	125	400:380-415	Top in	OTM125F3C21D400C	1SCA151420R1001	1.75
4	40	400:380-415	Top in	OTM40F4C21D400C	1SCA151253R1001	2.00
4	63	400:380-415	Top in	OTM63F4C21D400C	1SCA151255R1001	2.00
4	125	400:380-415	Top in	OTM125F4C21D400C	1SCA151251R1001	2.00
4	40	400:380-415	Bottom in	OTM40F4CB21D400C	1SCA150580R1001	2.00
4	63	400:380-415	Bottom in	OTM63F4CB21D400C	1SCA150586R1001	2.00
4	125	400:380-415	Bottom in	OTM125F4CB21D400C	1SCA150574R1001	2.00

## Technical data

### Compact automatic transfer switches

#### Automatic transfer switches functionality

OTM_C_D products overview	OTM_C20D_	OTM_C21D_
<b>Features</b>	x	x
Rated operational voltage Ue	154 V AC - 480 V AC +/- 20% + N	
Rated frequency	50 / 60 Hz +/- 10%	
Voltage sensing precision	5%	
Frequency sensing precision	1%	
Rated impulse withstand voltage, Uimp	6 kV	
Overvoltage category	III	
Pollution degree	2	
Protection rating for the front panel	IP20	
Operating temperature	- 20...+ 60 °C	
Transportation and storage temperature	- 25...+ 80 °C	
Altitude	Max. 2000m	
Humidity With condensation	5 %...98 %	
Humidity Without condensation	5 %...90 %	
<b>Operation Types</b>		
Manual operation with handle	x	x
Local operation with front panel keypad		x
Automatic transfer switching equipment (ATSE)	x	x
<b>Applications</b>		
Transfer between two Transformers	x	x
Transfer between a Transformers and a generator		x
<b>Operation modes</b>		
Automatic transfer and back-switching operation	x	x
Automatic transfer and manual back-switching operation	x	x
<b>Source failure detections</b>		
No voltage	x	x
Undervoltage	Fixed 0.7Ue	0.7-0.95 Ue
Overvoltage	Fixed 1.3Ue	1.05-1.3 Ue
Phase missing	x	x
Voltage unbalance		x
Invalid frequency		x
<b>Configuration</b>		
By DIP switches	x	x
By rotary switches		x
Two power status display	x	x
Two switches status display	x	x
Auto status display	x	x
Alarm display	x	x

## Technical data

### Compact automatic transfer switches

#### Automatic transfer switches functionality

OTM_C_D products overview	OTM_C20D_	OTM_C21D_
<b>Time delays</b>		
Delay on transfer <sup>3)</sup>		0-30s
Back-switching delay		0-900s
Generator stop delay		30s,400s
<b>Signals input and output</b>		
Emergency Off with 24VDC signal input	x	x
Test signal input		x
Switch position signal	With Auxiliary contacts	Without Auxiliary contact
Alarm output signal		x

<sup>3)</sup> Overvoltage and undervoltage conditions

## Compact ATS

### Easy use and installation

01 Easy manual operation with the handle in case of emergency

02 DIN- rail mounting

03 Base mounting with screws

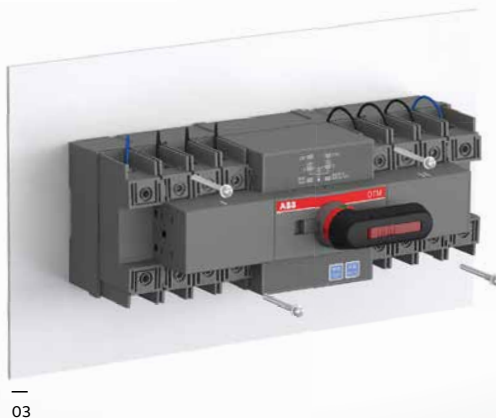

## Technical data

### Compact automatic transfer switches OTM40...125\_

#### Compact automatic transfer switches

Data according to IEC 60947-3				Switch size		
				OTM40_	OTM63_	OTM125_
Rated insulation voltage and rated operational voltage AC20/DC20	Pollution degree 3	V	800	800	800	
		Dielectric strength	50 Hz 1min.	kV	6	6
Rated impulse withstand voltage		kV	8	8	8	
Rated thermal current and rated operational current AC20/DC20	/ ambient 40°C	In open air	A	40	63	125
	/ ambient 40°C	In enclosure	A	40	63	125
	/ ambient 60°C	In enclosure	A	32	50	100
..with minimum conductor cross section	Cu	mm <sup>2</sup>	10	16	50	
Rated operational current, AC-21A	up to 500 V	A	40	63	125	
	690 V	A	40	63	125	
Rated operational current, AC-22A	up to 500 V	A	40	63	125	
	690 V	A	40	63	125	
Rated operational current, AC-23A	up to 415 V	A	40	63	90	
	500 V	A	40	60	70	
	690 V	A	40	40	50	
Rated operational current / poles in series, DC-21A	up to 48 V	A	40/1	63/1	125/1	
	110 V	A	40/2	63/2	125/2	
	220 V	A	40/4	63/4	100/4	
Rated operational current / poles in series, DC-22A	up to 48 V	A	40/1	63/1	125/1	
	110 V	A	40/2	63/2	125/2	
	220 V	A	40/4	63/4	80/4	
Rated operational current / poles in series, DC-23A	up to 48 V	A	40/1	63/1	125/1	
	110 V	A	40/2	63/2	125/2	
	220 V	A	40/4	63/4	63/4	
Rated operational power, AC-23A <sup>1)</sup>	230 V	kW	7.5	15	22	
The kW-ratings are accurate for 3-phase 1500 R.P.M. standard asynchronous motors	400 V	kW	18.5	30	45	
	415 V	kW	18.5	30	45	
	500 V	kW	22	37	45	
	690 V	kW	37	37	45	
Rated breaking capacity in category AC-23	up to 415 V	A	320	504	720	
	500 V	A	320	480	560	
	690 V	A	320	320	400	
Rated conditional short-circuit current I <sub>p</sub> (r.m.s.) and corresponding max. allowed cut-off current îc (peak) value.	I <sub>p</sub> (r.m.s.) 50 kA, 415 V	îc (peak)	kA	16.5	16.5	16.5
			Max. OFA_ fuse size	gG/aM	A/A	125/125
	I <sub>p</sub> (r.m.s.) 18 kA, 690 V	îc (peak)	kA	11	11	11
			Max. OFA_ fuse size	gG	A	125
The cut-off current îc refers to values listed by fuse manufacturers (single phase test acc. to IEC60269).	I <sub>p</sub> (r.m.s.) 50 kA, 690 V	îc (peak)	kA	10	10	10
			Max. OFA_ fuse size	gG/aM	A/A	63/63
Rated short-time withstand current	I <sub>cw</sub> (r.m.s.)	690 V 1s	kA	2.5	2.5	2.5
Rated short-time making capacity <sup>2)</sup>	I <sub>cm</sub> (peak)	690 V	kA	3.6	3.6	3.6
Power loss / pole	With rated current		W	1.6	2.8	6.3
Mechanical endurance	Number of oper. cycles <sup>3)</sup>		Cycles	10 000	10 000	10 000
Cable size	Cu-wire size suitable for terminal clamps	mm <sup>2</sup>		2.5-25/2x2.5-16	10-70	10-70
		AWG		14-4/2x14-6	8-00	8-00
Terminal tightening torque	Counter torque required		Nm	6	6	6
Operating torque	Typical for 3-pole switches		Nm	5	5	5
Weight without accessories	3-pole switch		kg	1.75	1.75	1.75

## Technical data

### Compact automatic transfer switches OTM40...125\_

#### Compact automatic transfer switches

Data according to IEC 60947-6-1				Switch size		
				OTM40_	OTM63_	OTM125_
Class of equipment				PC	PC	PC
Rated short-time withstand current	l <sub>cw</sub> (r.m.s.)	690 V 0.1s	kA	5	5	5
Conditional short-circuit current	I <sub>cc</sub> (r.m.s.)	415 V	kA	50	50	50
Corresponding fuse rating	gG/aM fuse	415 V	A	125	125	125
Rated operational current, AC-31B		up to 415 V	A	40	63	125
Rated operational current, AC-32B		up to 415 V	A	40	63	125

<sup>1)</sup> These values are given for guidance and may vary according to the motor manufacturer

<sup>2)</sup> Short circuit duration > 50ms, without fuse protection

<sup>3)</sup> Operating cycle: O - I - O - II - O

## Compact ATS

### Dimensional drawings

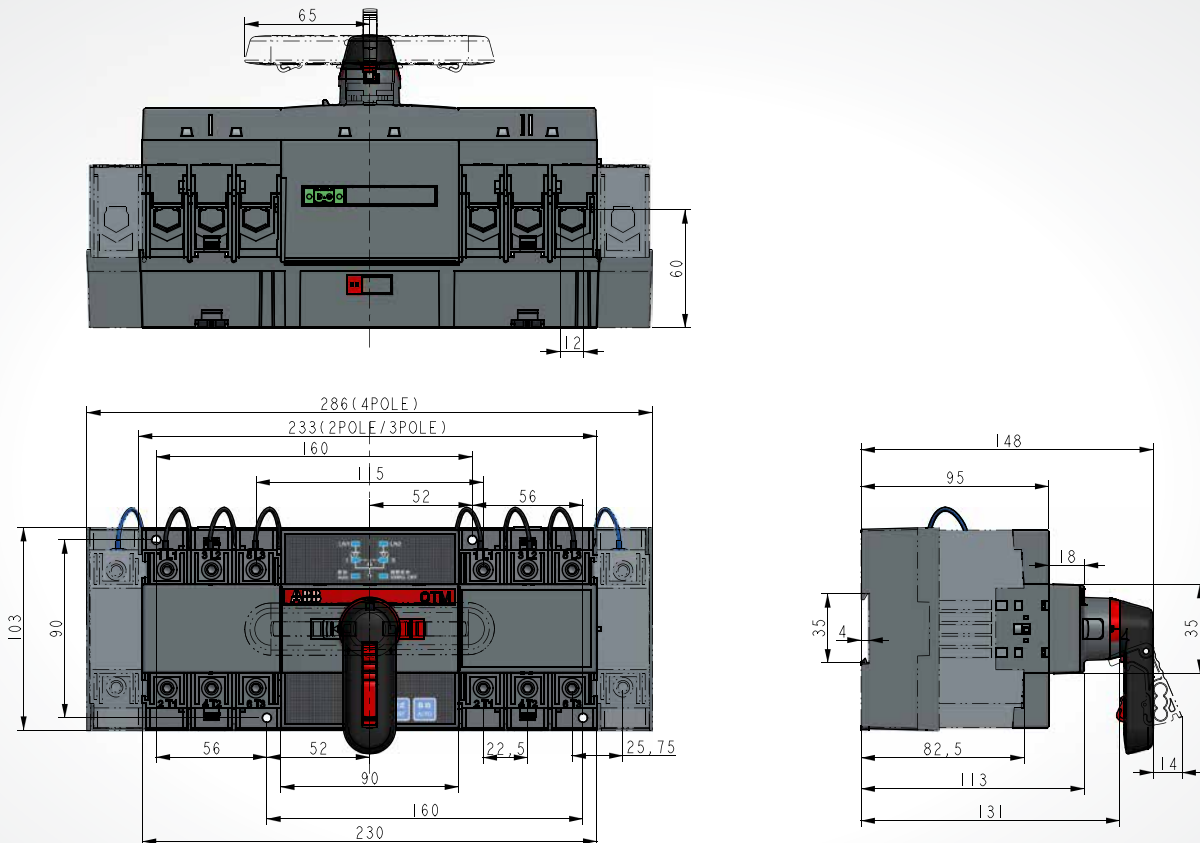

SECTION 4

## Ordering information

### Accessories

#### Handles, direct mounting

Plastic I - O - II handle.

Suitable for switches	Colour	Installation side	Type	Order number	Units/type (pcs)	Weight/unit (kg)
OTM40...125F_CM	Black	Shaft incl.	OHB65D6CM	1SCA022807R9430	1	0.12



#### Handle storage clip

The handle can be stored in the handle storage clip OTVS0. The handle storage clip can be fixed to a panel frame using the included adhesive tape.

Suitable for switches	Type	Order number	Units/type (pcs)	Weight/unit (kg)
OTM40...125F_CM	OTVS0	1SCA117524R1001	1	0.02



OA1G01  
OA7G10



OA1G10  
OA8G01

#### Auxiliary contacts

Snap-on mounting to the switch, IP 20, max. 2 blocks/ side.  $I_{th} = 16 A$ , suitable for cable cross sections max.  $2 \times 2.5 \text{ mm}^2$ . Simultaneous action with the main contacts. The type and ordering number is for one piece.

Suitable for switches	Contact function	Installation side	Type	Order number	Units/type (pcs)	Weight/unit (kg)
OTM40...125F_CM	1NO	Right	OA1G10	1SCA022353R4970	1	0.03
OTM40...125F_CM	1NC	Right	OA8G01	1SCA022744R2240	1	0.03
OTM40...125F_CM	1NO	Left	OA7G10	1SCA022673R1140	1	0.03
OTM40...125F_CM	1NC	Left	OA1G01	1SCA022353R4890	1	0.03

## Ordering information

### Accessories



OTS\_T3



OTS\_T1

#### Terminal shrouds

Transparent plastic, snap-on mounting to the switches, IP20. The full shrouding of a 3-pole change-over switch is achieved with four 3-pole shrouds.\*

Suitable for switches	Type	Order number	Units/type (pcs)	Weight/unit (kg)
<b>For three pole switches</b>				
OTM40...125F_CM	OTS125T3	1SCA022379R9680	1	0.03
<b>For fourth pole</b>				
OTPS60FP, OTPS125FP	OTS125T1	1SCA022379R9760	1	0.03



OZXT1



OZXT2...3



OZXT6

#### Terminal clamp sets

Suitable for switches	Contact function	Type	Order number	Units/type (pcs)	Weight/unit (kg)
<b>Terminal clamp sets for Al- and Cu-cables insulated versions</b>					
OTM40...125F_CM	16...50 Al / 2.5...50 Cu	OZXT1	1SCA022469R6310	3	0.06
OTM63...125F_CM	16...120 Al/Cu	OZXT2	1SCA022620R7200	3	0.21
OTM63...125F_CM	2x(16...50) Al/Cu	OZXT3	1SCA022639R0720	3	0.21
<b>Including 0.75...2.5 mm<sup>2</sup> voltage sensing connection. Voltage sensing wires are not included in the delivery</b>					
OTM40...125F_CM	16...50 Al/2.5...50 Cu	OZXT6	1SCA122537R1001	3	0.06
<b>Terminal clamp sets for Al- and Cu-cables</b>					
OTM40...125F_CM	10...70 Al/Cu	OZXL1	1SCA022439R6770	3	0.14



OMZC\_

#### Parallel connection kits

Finger protected connection bars for parallel connection of the upper or lower terminals. The bars accept additional cables, the maximum size is stated below.

Suitable for switches	Cable crosssection (mm <sup>2</sup> )	Type	Order number	Units/type (pcs)	Weight/unit (kg)
OTM40F3CM_	2.5...25/2x2.5...16	OMZC03	1SCA121324R1001	1	0.5
OTM40F4CM_	2.5...25/2x2.5...16	OMZC04	1SCA121325R1001	1	0.65
OTM40...125F3CM_	10...70	OMZC03	1SCA117037R1001	1	0.5
OTM40...125F4CM_	10...70	OMZC04	1SCA117038R1001	1	0.65

\* Terminal shrouds can also be mounted on parallel connection kits.

---

# Enclosed control products

- 088**      **Loadbreak and safety switches**
- 091**      **Switch fuses**



For more detailed product information, please refer to our online technical brochures available at: [new.abb.com/low-voltage/support/documentation](http://new.abb.com/low-voltage/support/documentation)

or contact our sales team via email [LV.enquiries@gb.abb.com](mailto:LV.enquiries@gb.abb.com)

or call 0333 999 9933

# Enclosed switches

## Switch solutions - Functionality and features

Enclosed switches are designed and used as main switches for applications, which need to be isolated from the network. The range includes front operated and side operated switch disconnectors, switch fuses and changeover switches enclosed in plastic, steel sheet or stainless steel sheet and aluminium enclosures. They are rated for utilization categories including disconnecting as well as making and breaking the load. In addition the switch fuses equipped with fuse links protects the application and the cables from overload currents and short circuits.

### Plastic enclosures

The plastic enclosures are most suitable for locations with high chemical and moisture requirements. In addition they are light and easy to install and handle.

### Steel sheet enclosures

The steel sheet enclosures are hot dip galvanized and the surface is polyester powder painted. The enclosures are durable and robust for various environments.

### Stainless steel sheet enclosures

The stainless steel sheet enclosures are made of AISI 304 stainless steel. They are used particularly in the food and beverage industry and in locations where high hygiene is required. The smooth surface does not require any painting and is easy to clean.

### Aluminium alloy enclosures

Aluminium enclosures have very good impact strength and protection against UV light. They are suitable both for indoor and outdoor use in medium to heavy-duty applications.

### Safety for personnel – reliable position indication

- Padlocking in the OFF-position with one, three or six (with the shackle L6) padlocks against unintentional start-up.
- The handle cannot be padlocked in the OFF-position if one of the contacts is not in the OFF-position.
- The cover cannot be removed if the handle is padlocked.
- Door interlock in the ON-position.
- Arc proof, short circuit durability function: Expander washers in aluminium enclosures with  $I_e > 160$  A and door locking release in large metal sheet enclosures type MSC.
- Door interlock defeatable with rectangular and pistol type handles.



## Switchgear - Loadbreak and safety switches

IP65 Double insulated enclosure



Polycarbonate enclosure 9kW ... 11kW 3 pole

Rating@415v			Dimensions (mm)			Order Code
1th A	AC22	kW	H	W	D	
32	25	9	125	100	107	S37K5N-A
40	40	11				S315KN-A
<b>Polycarbonate enclosure 9kW ... 37kW 4 pole</b>						
32	25	9	125	100	107	S47K5N-A
40	40	11				S415KN-A
63	63	22	170	140	108	S418KN-A
80	80	37				S426KN-A



Polycarbonate enclosure 9kW ... 37kW 4 pole

Rating@415v				No. Poles	Dimensions (mm)			Order Code
1th A	AC22	AC23	kW		H	W	D	
25	16	16	7.5	3 + solid neutral	150	130	60	OTP16BA3M
				4				OTP16BA4MS
				6				OTP16BA6M
32	25	20	9	3 + solid neutral	150	130	60	OTP25BA3M
				4				OTP25BA4M
				6				OTP25BA6M
40	40	23	11	3 + neutral	150	130	60	OTP32BA3M
				4				OTP32BA4M
				6				OTP32BA6M
63	63	45	22	3 + solid neutral	200	145	90	OTP45BA3M
				4				OTP45BA4M
				6				OTP45BA6M
80	80	75	37	3 + solid neutral	200	145	90	OTP63BA3M
				4				OTP63BA4M
				6				OTP63BA6M
125	125	90	45	3 + solid neutral	400	200	140	OTP125BA3U
				4				OTP125BA4U
				6				OTP125BA6U
<b>Safety switches 3 pole 16...40 amps</b>								
25	16	16	7.5	3	150	130	60	OTP16B3M
32	25	20	9	3	150	130	60	OTP16B3M
40	40	23	11	3	150	130	60	OTP32B3U

### Load Break Switches 3 - 4 pole 9...37kW

- IP65 three and four-pole switch disconnectors suitable for load break switching or isolation.
- Polycarbonate enclosure. IEC 60947-3

- IP65 rated
- Grey plastic enclosure
- Standard handle - Red/Yellow (padlockable in the off position)
- Cable entries top and bottom
- All OTP16 (excluding 3p) /25/32 all have 25/20mm reducers

## Switchgear - Loadbreak switches

IP65 Steel enclosure



- IP65 rated (not suitable for external installation)
- Powder coated textured finish (RAL 7035)
- All 3 pole switches include detachable neutral link (OT160 solid link)
- Hinged lid complete with lock
- Padlockable pistol grip handle as standard
- Removable gland plates fitted top and bottom (see below for knockout configurations)
- Spreader boxes available see below

Load break switches 3 - 4 pole 9...37kW

Rating@415v			Dimensions (mm)			No. Poles	Order Code
1 <sup>th</sup> A	AC22	AC23	H	W	D		
32	25	20	300	200	150	3 + solid neutral	OT20TPN-A
						4	OT20FP-A
40	40	23	300	200	150	3 + solid neutral	OT32TPN-A
						4	OT32FP-A
80	80	75	300	300	150	3 + solid neutral	OT63TPN-A
						4	OT63FP-A
115	100	80	400	300	150	3 + solid neutral	OT100TPN-A
						4	OT100FP-A
125	125	90	400	300	150	3 + solid neutral	OT125TPN-A
						4	OT125FP-A
160	160	135	500	400	200	3 + solid neutral	OT160TPN-A
						4	OT160FP-A
200	200	200	500	400	200	3 + solid neutral	OT200TPN-A
						4	OT200FP-A
315	315	315	500	400	200	3 + solid neutral	OT315TPN-A
						4	OT400FP-A
500	500	500	500	400	200	3 + solid neutral	OT400TPN-A
						4	OT400TPN-A
630	630	630	600	400	250	3 + solid neutral	OT630TPN-A
						4	OT630FP-A
800	800	800	600	400	250	3 + solid neutral	OT800TPN-A
						4	OT800TPN-A

Spreader boxes

Suitable for Loadbreak Switches	Spreader Box Order Code	Spreader Box Gasket Order Code
OT20, OT32, OT63, OT100, OT125	Not Required	Not Required
OT160, OT200, OT315, OT400	SRN5420K	GZ4020
OT630, OT800	SRN6425K	GZ4025
Wall Mounting Brackets (Pack of 4)		AA1206

**Auxiliary Contacts**

1 N/O	OA1G10	OA1G10
1 N/C - only for OT20-125_	OA1G01	OA1G01
1 N/C - only for OT200 and above	OA3G01	OA3G01
1 N/O - 1 N/C - OT20-125 and OT160 only	OA2G11	OA2G11
Mounting module for OA2G11 - for OT160 only	OAZX1	OAZX1

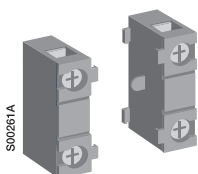

SM02E1A

## Switchgear - Switch fuses

### IP65 Steel enclosure

- IP65 rated (not suitable for external installation)
- Powder coated textured finish (RAL 7035)
- All switches are supplied with fuses and removable gland plates
- All 3 pole switches include detachable neutral link (OT160 solid link)
- Switch Fuses are internally rated IP20 on incoming terminals up to 63A
- Hinged lid complete with lock
- Padlockable pistol grip handle as standard
- Switch Fuses 100A are supplied with incoming terminal shrouds (NOT FITTED) to allow customer connections
- Spreader boxes available see below

### 3 - 4 pole 20 ... 800A

	AC23 [kW]				Dimensions (mm)			No. Poles	Fuse Type	Order Code
	1 <sup>th</sup> A	400V	500V	690V	H	W	D			
	20	7.5	11	15	300	300	150	3+detach neutral 4	A1	OS20TPN-A OS20FP-A
	32	15	18	25	300	300	150	3+detach neutral 4	A2	OS32TPN-A OS32FP-A
	63	30	37	55	400	300	150	3+detach neutral 4	A2/A3	OS63TPN-A OS63FP-A
	100	55	55	90	400	300	150	3+detach neutral 4	A2/A3	OS100TPN-A OS100FP-A
	125	55	75	110	400	300	150	3+detach neutral 4	A2/A3	OS125TPN-A OS125FP-A
	160	75	90	132	500	400	200	3 + solid neutral 4	A3/A4	OS160TPN-A OS160FP-A
	200	110	132	200	600	400	250	3+detach neutral 4	B1/B2	OS200TPN-A OS200FP-A
	315	160	220	220	600	400	250	3+detach neutral 4	B1/B4	OS315TPN-A OS315FP-A
	400	220	280	400	600	400	250	3+detach neutral 4	B1/B4	OS400TPN-A OS400FP-A
	630	355	450	560	600	600	300	3+detach neutral 4	C1/C2	OS630TPN-A OS630FP-A
800	450	560	710	600	800	300	3+detach neutral 4	C1/C2	OS800TPN-A OS800FP-A	

Note: OT630 & OT800 TPN/FP products are made to order and are non-stock items

### Spreader boxes

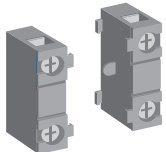
	Suitable for Loadbreak Switches		Spreader Box		Spreader Box Gasket	
	Order Code	Order Code	Order Code	Order Code	Order Code	Order Code
	OS20 - OS125	Not Required	-	Not Required	Not Required	Not Required
	OS160	SRN5420K	SRN5420K	GZ4020	GZ4020	GZ4020
	OS200 - OS400	SRN6425K	SRN6425K	GZ4025	GZ4025	GZ4025
	OS630 - OS800	SRN8530K	SRN8530K	GZ6030	GZ6030	GZ6030
	Wall Mounting Brackets (Pack of 4)			AA1206	AA1206	AA1206

### Auxiliary Contacts

1 N/O	OA1G10	OA1G10
1 N/C	OA1G01	OA1G01
1 N/O - 1 N/C	OA3G01	OA3G01
1 x CO contact - only for products OS20_/OS32_	OA2G11	OA2G11
Mounting frame to fit OA1/OA3 aux on left side of OS20_/OS32_ switch fuse (only for OS20_/OS32_	OAZX1	OAZX1

---

# Industrial plugs and sockets

<b>094</b>	<b>Plugs</b>
<b>095</b>	<b>Connectors</b>
<b>096</b>	<b>Inlets</b>
<b>099</b>	<b>Socket outlets</b>
<b>103</b>	<b>Watertight plugs and sockets</b>
<b>111</b>	<b>Modular Combi</b>



---

For more detailed product information, please refer to our online technical brochures available at: [new.abb.com/low-voltage/support/documentation](http://new.abb.com/low-voltage/support/documentation)

or contact our sales team via email [LV.enquiries@gb.abb.com](mailto:LV.enquiries@gb.abb.com)

or call 0333 999 9933

# Industrial plugs and sockets

## IEC 60309-2 “clock”

$I_e = 16\text{ A}, 32\text{ A}, 63\text{ A}, 125\text{ A}$   
 $U_e = 50\text{...}1000\text{ V}$

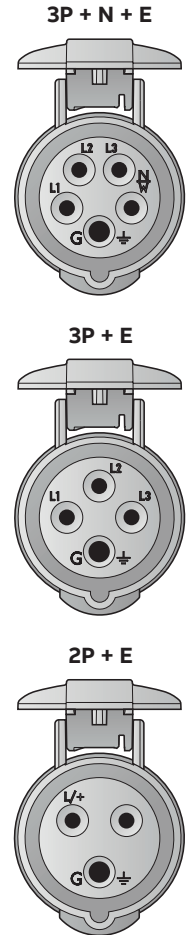
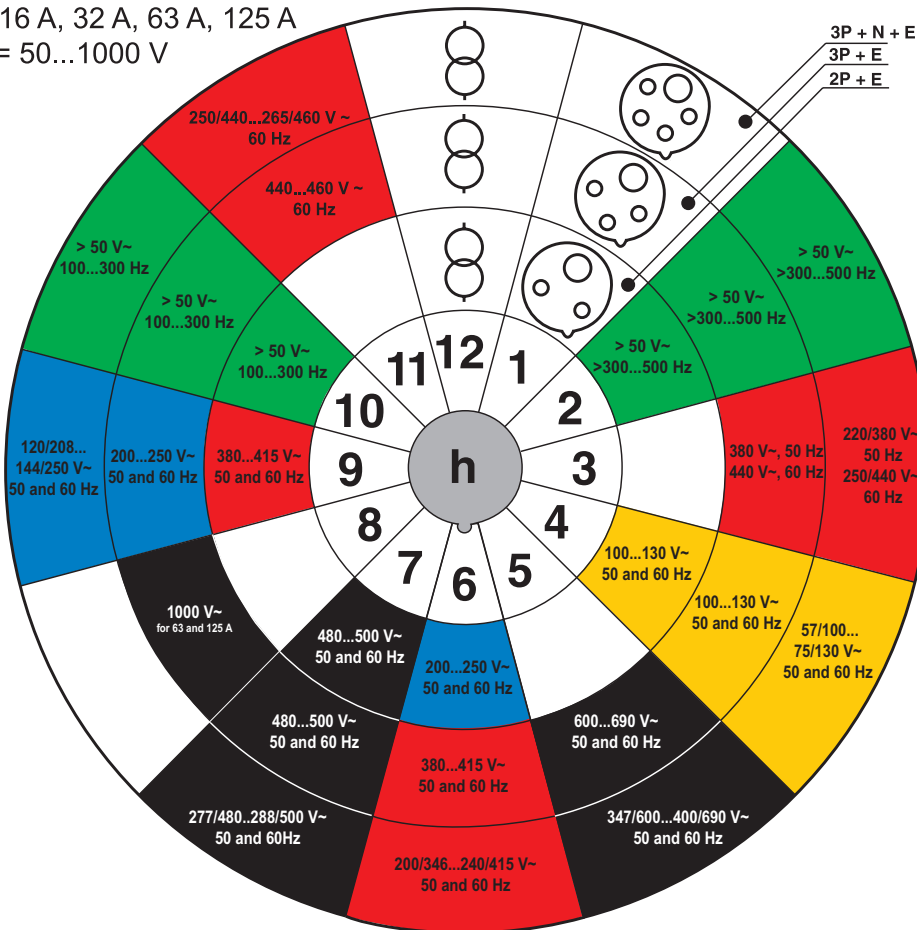

Standard voltages - Colour codes according to IEC60309-1, -2

Position of earthing sleeve according to IEC 60309-2 (clock)	2P+E	3P+E	3P+N+E
1	<input type="checkbox"/> Optional voltage (not stated below)	<input type="checkbox"/> Optional voltage (not stated below)	<input type="checkbox"/> Optional voltage (not stated below)
2	<span style="color: green;">■</span> >300...500 V~ >50 Hz	<span style="color: green;">■</span> >300...500 V~ >50 Hz	<span style="color: green;">■</span> >300...500 V~ >50 Hz
3	<input type="checkbox"/> Not used	<span style="color: red;">■</span> 380 V~ 50 Hz, 440 V 60 Hz	<span style="color: red;">■</span> 220/380 V~ 50 Hz, 250/440 V 60 Hz
4	<span style="color: yellow;">■</span> 100...130 V~ 50 and 60 Hz	<span style="color: yellow;">■</span> 100...130 V~ 50 and 60 Hz	<span style="color: yellow;">■</span> 57/100...75/130 V~ 50 and 60 Hz
5	<input type="checkbox"/> Not used	<span style="color: black;">■</span> 600...690 V~ 50 and 60 Hz	<span style="color: black;">■</span> 347/600...400/690 V~ 50 and 60 Hz
6	<span style="color: blue;">■</span> 200...250 V~ 50 and 60 Hz	<span style="color: red;">■</span> 380...415 V~ 50 and 60 Hz	<span style="color: red;">■</span> 200/346...240/415 V~ 50 and 60 Hz
7	<span style="color: black;">■</span> 480...500 V~ 50 and 60 Hz	<span style="color: black;">■</span> 480...500 V~ 50 and 60 Hz	<span style="color: black;">■</span> 277/480...288/500 V~ 50 and 60 Hz
8	<input type="checkbox"/> Not used	<span style="color: black;">■</span> 1000 V~ (for 63 A and 125 A)	<input type="checkbox"/> Not used
9	<span style="color: red;">■</span> 380...415 V~ 50 and 60 Hz	<span style="color: blue;">■</span> 200...250 V~ 50 and 60 Hz	<span style="color: blue;">■</span> 120/208...144/250 V~ 50 and 60 Hz
10	<span style="color: green;">■</span> 100...300 V~ >50 Hz	<span style="color: green;">■</span> 100...300 V~ >50 Hz	<span style="color: green;">■</span> 100...300 V~ >50 Hz
11 Mainly for marine installations	<input type="checkbox"/> Not used	<span style="color: red;">■</span> 440...460 V~ 60 Hz	<span style="color: red;">■</span> 250/440...265/460 V~ 60 Hz
12 Supply from isolating transformer	<input type="checkbox"/> Supply from isolating transformer	<input type="checkbox"/> Supply from isolating transformer	<input type="checkbox"/> Supply from isolating transformer

# Plugs

## IP44



216EP6



432EP6

### 16 A. / 32 A. Splashproof

Housing in plastic (PA). Cable entry with compression gland. Cable area 1...2.5 mm<sup>2</sup> (16A) / 2.5...6 mm<sup>2</sup> (32A)

Terminals/ Poles	Colour code	Voltage V	Frequency Hz	Type:		Pkg qty	Weight pkg (1pce) kg
				16A	32A		
<b>2P+E</b>							
3	Grey		AC	216EP1	232EP1	10	0.11 (16A) 0.21 (32A)
	Green	>300...500	>50	216EP2	232EP2		
	Yellow	100...130	50 and 60	216EP4	232EP4		
	Blue	200...250		216EP6	232EP6		
	Red	380...415		216EP9	232EP9		
	Grey	transf		216EP12	232EP12		
<b>3P+E</b>							
4	Grey		AC	316EP1	332EP1	10	0.16 (16A) 0.23 (32A)
	Green	>300...500	>50	316EP2	332EP2		
	Red	380/440	50/60	316EP3	332EP3		
	Yellow	100...130	50 and 60	316EP4	332EP4		
	Black	600...690		316EP5	332EP5		
	Red	380...415		316EP6	332EP6		
	Black	480...500		316EP7	332EP7		
	Blue	200...250		316EP9	332EP9		
	Green	100...300	>50	316EP10	332EP10		
	Red	440...460	60	316EP11	332EP11		
	Grey	transf	50 and 60	316EP12	332EP12		
	<b>3P+N+E</b>						
5	Grey		AC	416EP1	432EP1	10	0.18 (16A) 0.24 (32A)
	Green	>300...500	>50	416EP2	432EP2		
	Red	380...440	50/60	416EP3	432EP3		
	Yellow	100...130	50 and 60	416EP4	432EP4		
	Black	600...690		416EP5	432EP5		
	Red	346...415		416EP6	432EP6		
	Black	480...500		416EP7	432EP7		
	Blue	208...250		416EP9	432EP9		
	Red	440...460	60	416EP11	432EP11		

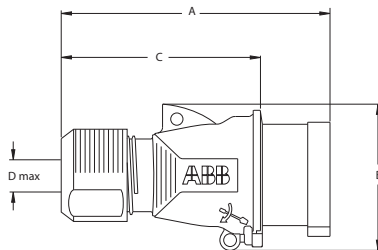

### Dimensions (mm)

Type	A	B	C	Dmax
216EP...	127	62.5	88.5	14
316EP...	144	74.5	106	17
416EP...	144	78	106	17

Type	A	B	C	Dmax
232EP...	167	82.5	121	22
332EP...	167	82.5	121	22
432EP...	167	87.5	121	22

SECTION 6

# Connectors

## IP44



216EC6



232EC9

### 16 A. / 32 A. Splashproof

Housing in plastic (PA). Cable entry with compression gland. Cable area 1...2.5 mm<sup>2</sup> (16A) / 2.5...6 mm<sup>2</sup> (32A)

Terminals/ Poles	Colour code	Voltage V	Frequency Hz	Type:		Pkg qty	Weight pkg (1pce) kg
				16A	32A		
<b>2P+E</b>							
3	Grey		AC	216EC1	232EC1	10	0.16 (16A) 0.26 (32A)
	Green	>300...500	>50	216EC2	232EC2		
	Yellow	100...130	50 and 60	216EC4	232EC4		
	Blue	200...250		216EC6	232EC6		
	Red	380...415		216EC9	232EC9		
	Grey	transf		216EC12	232EC12		
<b>3P+E</b>							
4	Grey		AC	316EC1	332EC1	10	0.21 (16A) 0.28 (32A)
	Green	>300...500	>50	316EC2	332EC2		
	Red	380/440	50/60	316EC3	332EC3		
	Yellow	100...130	50 and 60	316EC4	332EC4		
	Black	600...690		316EC5	332EC5		
	Red	380...415		316EC6	332EC6		
	Black	480...500		316EC7	332EC7		
	Blue	200...250		316EC9	332EC9		
	Green	100...300	>50	316EC10	332EC10		
	Red	440...460	60	316EC11	332EC11		
	Grey	transf	50 and 60	316EC12	332EC12		
	<b>3P+N+E</b>						
5	Grey		AC	416EC1	432EC1	10	0.23 (16A) 0.30 (32A)
	Green	>300...500	>50	416EC2	432EC2		
	Red	380...440	50/60	416EC3	432EC3		
	Yellow	100...130	50 and 60	416EC4	432EC4		
	Black	600...690		416EC5	432EC5		
	Red	346...415		416EC6	432EC6		
	Black	480...500		416EC7	432EC7		
	Blue	208...250		416EC9	432EC9		
	Red	440...460	60	416EC11	432EC11		

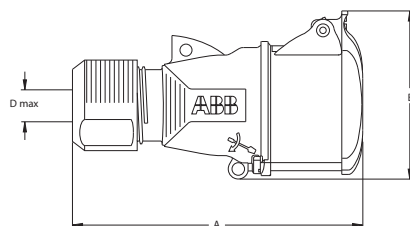

### Dimensions (mm)

Type	A	B	Dmax
216EC...	135.5	74.5	14
316EC...	155	87	17
416EC...	156	90.5	17

Type	A	B	Dmax
232EC...	182	93.5	22
332EC...	182	93.5	22
432EC...	182.5	99	22

# Inlets

for wall mounting, IP44



416BS9



432BS9

## 16 A. / 32 A. Splashproof

Housing in plastic (PA). Flexible membrane and metric threaded M20 insert for cop cable entry. Rear knock-out cable entry. Cable area 1...2.5 mm<sup>2</sup> (16A) / 2.5...6 mm<sup>2</sup> (32A)

Terminals/ Poles	Colour code	Voltage V	Frequency Hz	Type:		Pkg qty	Weight pkg (1pce) kg			
				16A	32A					
<b>2P+E</b>										
3	Grey		AC	216BS1	232BS1	10	0.15 (16A) 0.25 (32A)			
	Yellow	100...130	50 and 60	216BS4	232BS4					
	Blue	200...250		216BS6	232BS6					
	Red	380...415		216BS9	232BS9					
	Grey	transf.		216BS12	-					
<b>3P+E</b>										
4	Grey		AC	316BS1	332BS1	10	0.19 (16A) 0.27 (32A)			
	Red	380/440	50/60	-	332BS3					
	Yellow	100...130	50 and 60	316BS4	332BS4					
	Black	600...690		316BS5	332BS5					
	Red	380...415		316BS6	332BS6					
	Black	480...500		316BS7	332BS7					
	Blue	200...250		316BS9	332BS9					
	Green	100...300	>50	316BS10	332BS10					
	Red	440...460	60	316BS11	332BS11					
	<b>3P+N+E</b>									
	5	Grey		AC	416BS1			432BS1	10	0.20 (16A) 0.29 (32A)
Green		>300...500	>50	416BS2	-					
Black		600...690	50 and 60	416BS5	432BS5					
Red		346...415		416BS6	432BS6					
Blue		208...250		416BS9	432BS7					
Red		440...460	60	416BS11	432BS9					

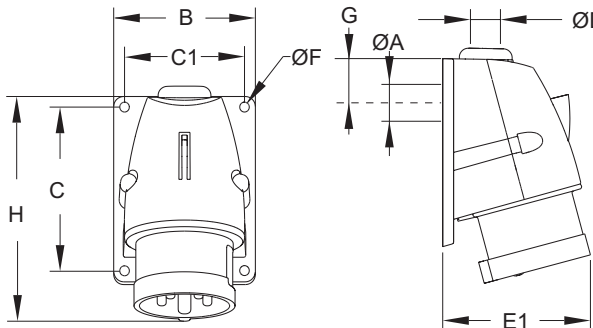

## Dimensions (mm)

Type	A	B	C	C1	Dmax	E1	F	G	H
216BS..	23	66	75	54	18/M20	72	5.5	27	110
316BS..	23	79	91	67	18/M20	78	5.5	30	124
416BS..	23	79	91	67	18/M20	81	5.5	30	125
232BS..	29	85	111	72	22/M25	94	5.5	34	153
332BS..	29	85	111	72	22/M25	94	5.5	34	153
432BS..	29	85	111	72	22/M25	96	5.5	34	154

SECTION 6

# Inlets

for panel mounting with minimized or unified straight flange, IP44



216B6

### 16 A. Splashproof

Housing in plastic (PA). Minimized flange, Cable area 1...2.5 mm<sup>2</sup>

Terminals/ Poles	Colour code	Voltage Frequency		Type: 16A	Pkg qty	Weight pkg (1pce) kg
		V	Hz			
<b>2P+E</b>						
3	Grey		AC	216B1	10	0.10
	Blue	200...250	50 and 60	216B6		
<b>3P+E</b>						
4	Grey		AC	316B1	10	0.13
	Yellow	100...130	50 and 60	316B4		
	Black	600...690		316B5		
	Red	380...415		316B6		
	Blue	200...250		316B9		
<b>3P+N+E</b>						
5	Grey		AC	416B1	10	0.14
	Red	346...415	50 and 60	416B6		
	Blue	208...250		416B9		

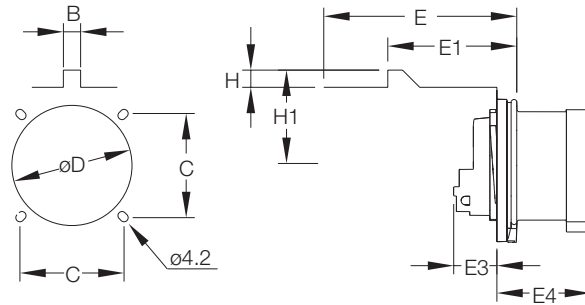

### Dimensions (mm)

Type	B	C	D	E	E1	E3	E4	H	H1
216B...	9	44-47	49	75	40.5	21.5	46.5	4	30.0
316B...	9	50-52	59	80	46.8	21.0	47.0	5	34.0
416B...	9	50-52	59	90	52.5	21.0	46.5	7	38.0

# Inlets

for panel mounting with minimized or unified straight flange, IP44



432BU6

## 16 A. / 32 A. IP44. Splashproof

Housing in plastic (PA). Unified flange, Cable area 1...2.5 mm<sup>2</sup> (16A) / 2.5...6 mm<sup>2</sup> (32A)

Terminals/ Poles	Colour code	Voltage		Frequency		Type: 16A	Type: 32A	Pkg qty	Weight pkg (1pce) kg
		V		Hz					
<b>2P+E</b>									
3	Grey				AC	-	232BU1	10	0.15
	Blue	200...250		50 and 60		-	232BU6		
<b>3P+E</b>									
4	Grey				AC	-	332BU1	10	0.17
	Black	600...690		50 and 60		-	332BU5		
	Red	380...415				-	332BU6		
	Blue	200...250				316BU9	332BU9		
<b>3P+N+E</b>									
5	Grey				AC	-	432BU1	10	0.19
	Black	600...690		50 and 60		416BU5	-		
	Red	346...415				416BU6	432BU6		

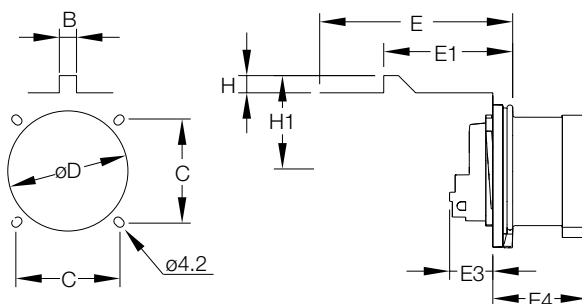

### Dimensions (mm)

Type	B	C	D	E	E1	E3	E4	H	H1
316BU...	9	60-61	59	90	52.5	21.0	46.5	7	38.0
416BU...	9	60-61	59	90	52.5	21.0	46.5	7	38.0
Type	B	C	D	E	E1	E3	E4	H	H1
232BU...	9	60-61	66	90	53.5	24.5	55.5	7	40.0
332BU...	9	60-61	66	90	53.5	24.5	55.5	7	40.0
432BU...	9	60-61	66	105	59.5	25.0	55.5	8	45.0

# Socket outlet

for wall mounting, IP44



216RS6



432RS6

**16 A. / 32 A. Splashproof**

Housing in plastic (PA). Flexible membrane and metric threaded M20 insert for cop cable entry.  
Rear knock-out cable entry. Cable area 1.5...4 mm<sup>2</sup> (16A) / 2.5...10 mm<sup>2</sup> (32A)

Terminals/ Poles	Colour code	Voltage V	Frequency Hz	Type:		Pkg qty	Weight pkg (1pce) kg		
				16A	32A				
<b>2P+E</b>									
3	Grey		AC	216RS1	232RS1	10	0.22		
	Yellow	100...130	50 and 60	216RS4	232RS4		0.30	(16A)	
	Blue	200...250		216RS6	232RS6			(32A)	
	Red	380...415		216RS9	232RS9				
	Grey	transf.		216RS12	-				
<b>3P+E</b>									
4	Grey		AC	316RS1	332RS1	10	0.24		
	Yellow	100...130	50 and 60	316RS4	332RS3		0.32	(16A)	
	Black	600...690		316RS5	332RS4			(32A)	
	Red	380...415		316RS6	332RS5				
	Black	480...500		316RS7	332RS6				
	Blue	200...250		316RS9	332RS7				
	Green	100...300	>50	316RS10	332RS9				
	Red	440...460	60	316RS11	332RS10				
	Grey	transf.	50 and 60	316RS12	332RS11				
	<b>3P+N+E</b>								
5	Grey		AC	416RS1	432RS1	10	0.26		
	Green	>300...500	>50	416RS2	-		0.34	(16A)	
	Black	600...690	50 and 60	416RS5	432RS5			(32A)	
	Red	346...415		416RS6	432RS6				
	Blue	208...250		416RS9	432RS7				
	Red	440...460	60	416RS11	432RS9				

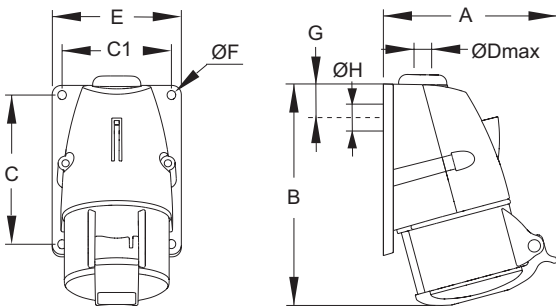

**Dimensions (mm)**

Type	A	B	C	C1	Dmax	E	F	G	H
216RS..	91	117	75	54	18/M20	66	5.5	27	23
316RS..	100	132	91	67	18/M20	79	5.5	30	23
416RS..	104	134	91	67	18/M20	79	5.5	30	23
Type	A	B	C	C1	Dmax	E	F	G	H
232RS..	118	163	111	72	22/M25	85	5.5	34	29
332RS..	116	163	111	72	22/M25	85	5.5	34	29
432RS..	121	164	111	72	22/M25	85	5.5	34	29

# Socket outlet

for panel mounting with unified angled flange, IP44



216RAU6



432RAU6

## 16 A. Splashproof

Housing in plastic (PA). Cable area 1.5...4 mm<sup>2</sup> (16A) / 2.5...10 mm<sup>2</sup> (32A)

Terminals/ Poles	Colour code	Voltage V	Frequency Hz	Type:		Pkg qty	Weight pkg (1pce) kg			
				16A	32A					
<b>2P+E</b>										
3	Grey		AC	216RAU1	232RAU1	10	0.19 (16A) 0.24 (32A)			
	Green	300...500	>50	216RAU2	-					
	Yellow	100...130	50 and 60	216RAU4	232RAU4					
	Blue	200...250		216RAU6	232RAU6					
	Red	380...415		216RAU9	-					
	Grey	transf.		216RAU12	-					
<b>3P+E</b>										
4	Grey		AC	316RAU1	332RAU1	10	0.22 (16A) 0.26 (32A)			
	Yellow	100...130	50 and 60	316RAU4	-					
	Black	600...690		316RAU5	332RAU5					
	Red	380...415		316RAU6	332RAU6					
	Black	480...500		316RAU7	332RAU7					
	Blue	200...250		316RAU9	332RAU9					
	Green	>300...500	>50	316RAU10	-					
	Red	440...460	60	316RAU11	-					
	<b>3P+N+E</b>									
	5	Grey		AC	416RAU1			432RAU1	10	0.24 (16A) 0.28 (32A)
Green		300...500	>50	416RAU2	-					
Yellow		100...130	50 and 60	416RAU4	-					
Black		600...690		416RAU5	432RAU5					
Red		346...415		416RAU6	432RAU6					
Blue		208...250		416RAU9	-					

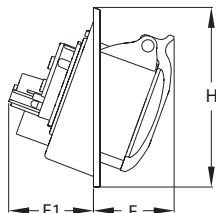
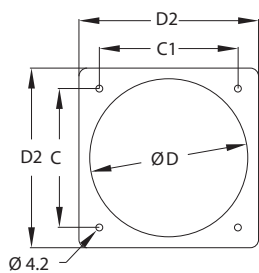

### Dimensions (mm)

Type	C	C1	D	D2	E	E1	H
216RAU..	85	85	98	110	48	48	110
316RAU..	85	85	98	110	50	48	110
416RAU..	85	85	98	110	51	50	110

Type	C	C1	D	D2	E	E1	H
232RAU...	85	85	98	110	61	53	110
332RAU...	85	85	98	110	61	53	110
432RAU...	85	85	98	110	63	54	110

## Socket outlet

for panel mounting with minimized straight flange, IP44



216R6

### 16 A. Splashproof

Housing in plastic (PA). Cable area 1.5...4 mm<sup>2</sup>

Terminals/ Poles	Colour code	Voltage		Frequency	Type: 16A	Pkg qty	Weight	
		V	Hz				pkg (1pce)	kg
<b>2P+E</b>								
3	Yellow	100...130	50 and 60		216R4	10	0.14	
	Blue	200...250			216R6			
	Red	380...415			216R9			
	Grey	transf.			216R12			
<b>3P+E</b>								
4	Grey			AC	316R1	10	0.17	
	Yellow	100...130	50 and 60		316R4			
	Black	600...690			316R5			
	Red	380...415			316R6			
	Black	480...500			316R7			
	Blue	200...250		316R9				
	Green	100...300	>50		316R10			
	Red	440...460	60		316R11			
<b>3P+N+E</b>								
5	Grey			AC	416R1	10	0.19	
	Green	>300...500		>50	416R2			
	Red	346...415			416R6			
	Blue	208...250	50 and 60		416R9			

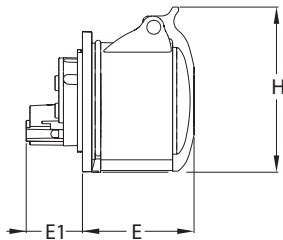
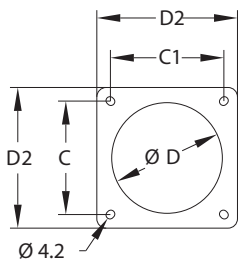

### Dimensions (mm)

Type	C	C1	D	D2	E	E1	H
216R..	44-47	44-47	49	56	56	29	73
316R..	50-52	50-52	59	66	58	30	87
416R..	50-52	50-52	59	66	60	31	89

## Socket outlet

for panel mounting with minimized angled flange, IP44



216RAM6



332RAM6

### 16 A. / 32 A. Splashproof

Housing in plastic (PA). Cable area 1.5...4 mm<sup>2</sup> (16A) / 2.5...10 mm<sup>2</sup> (32A)

Terminals/ Poles	Colour code	Voltage V	Frequency Hz	Type		Pkg qty	Weight pkg (1pce) kg			
				16A	32A					
<b>2P+E</b>										
3	Grey		AC	216RAM1	232RAM1	10	0.21			
	Grey	> 50...250	DC	232RAM3	232RAM3					
	Yellow	100...130	50 and 60	216RAM4	232RAM4					
	Blue	200...250		216RAM6	232RAM6					
	Red	380...415		216RAM9	–					
	Grey	transf.		216RAM12	–					
<b>3P+E</b>										
4	Grey		AC	316RAM1	332RAM1	10	0.22			
	Yellow	100...130	50 and 60	316RAM4	–					
	Black	600...690		316RAM5	332RAM5					
	Red	380...415		316RAM6	332RAM6					
	Black	480...500	316RAM7	332RAM7						
	Blue	200...250	316RAM9	332RAM9						
	Green	100...300	> 50	316RAM10	–					
	Red	440...460	60	316RAM11	–					
	<b>3P+N+E</b>									
	5	Grey		AC	416RAM1			432RAM1	10	0.24
		Green	>300...500	> 50	416RAM2			–		
Red		346...415	50 and 60	416RAM6	432RAM6					
Blue		208...250		416RAM9	–					

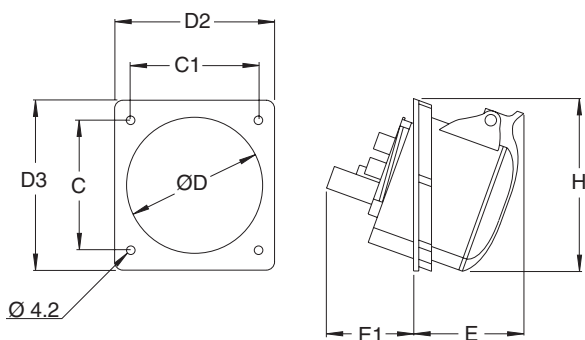

### Dimensions (mm)

Type	C	C1	D	D2	D3	E	E1	H
216RAM..	55	55	63	70	78	53	42	76
316RAM..	66	66	78	83	89	53	46	85
416RAM..	66	66	78	83	89	55	48	89

Type	C	C1	D	D2	D3	E	E1	H
232RAM...	75	75	87	93	99	61	52	98
332RAM...	75	75	87	93	99	61	52	98
432RAM...	75	75	87	93	99	64	52	101

---

## New watertight Easy and Safe

Our new IP67 Easy & Safe is a perfect choice in most applications where water and dirt can occur. They combine easy access to contact parts during installation with high protection degree while the products are in use. Electrical contacts protected against liquids and dirt retains its performance over time. High contact performance means reliability, reducing downtime and lowers maintenance costs.



# Plugs

## IP67



216EP6W



432EP6W

### 16 A. / 32 A. Watertight

Housing in plastic (PA). Cable entry with compression gland. Cable area 1...2.5 mm<sup>2</sup> (16A) / 2.5...6 mm<sup>2</sup> (32A)

Terminals/ Poles	Colour code	Voltage V	Frequency Hz	Type:		Pkg qty	Weight pkg (1pce) kg
				16A	32A		
<b>2P+E</b>							
3	Grey		AC	216EP1W	232EP1W	10	0.13 (16A) 0.23 (32A)
	Yellow	100...130	50 and 60	216EP4W	232EP4W		
	Blue	200...250		216EP6W	232EP6W		
	Red	380...415		216EP9W	232EP9W		
	Grey	transf		216EP12W	232EP12W		
<b>3P+E</b>							
4	Grey		AC	316EP1W	332EP1W	10	0.19 (16A) 0.25 (32A)
	Green	>300...500	>50	316EP2W	332EP2W		
	Red	380/440	50/60	316EP3W	332EP3W		
	Yellow	100...130	50 and 60	316EP4W	332EP4W		
	Black	600...690		316EP5W	332EP5W		
	Red	380...415		316EP6W	332EP6W		
	Black	480...500		316EP7W	332EP7W		
	Blue	200...250		316EP9W	332EP9W		
	Green	100...300	>50	316EP10W	332EP10W		
	Red	440...460	60	316EP11W	332EP11W		
	<b>3P+N+E</b>						
5	Grey		AC	416EP1W	432EP1W	10	0.21 (16A) 0.25 (32A)
	Green	>300...500	>50	416EP2W	432EP2W		
	Red	380...440	50/60	416EP3W	432EP3W		
	Yellow	100...130	50 and 60	416EP4W	432EP4W		
	Red	346...415		416EP6W	432EP6W		
	Black	480...500		416EP7W	432EP7W		
	Blue	208...250		416EP9W	432EP9W		
	Red	440...460	60	416EP11W	432EP11W		

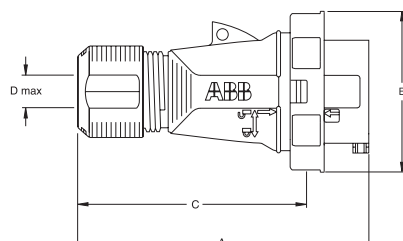

### Dimensions (mm)

Type	A	B	C	Dmax
216EP...W	134	73	100	14
316EP...W	161	81	127	17
416EP...W	158	87	125	17
Type	A	B	C	Dmax
232EP...W	183	91	141	22
332EP...W	183	91	141	22
432EP...W	183	99	141	22

# Connectors

## IP67



216EC6W



432EC6W

### 16 A. / 32 A. Watertight

Housing in plastic (PA). Cable entry with compression gland. Cable area 1...2.5 mm<sup>2</sup> (16A) / 2.5...6 mm<sup>2</sup> (32A)

Terminals/ Poles	Colour code	Voltage		Frequency Hz	Type: 16A	Type: 32A	Pkg qty	Weight pkg (1pce)	
		V						kg	
<b>2P+E</b>									
3	Grey			AC	216EC1W	232EC1W	10	0.17 (16A) 0.28 (32A)	
	Yellow	100...130		50 and 60	216EC4W	232EC4W			
	Blue	200...250			216EC6W	232EC6W			
	Red	380...415			216EC9W	232EC9W			
	Grey	transf			216EC12W	232EC12W			
<b>3P+E</b>									
4	Grey			AC	316EC1W	332EC1W	10	0.23 (16A) 0.30 (32A)	
	Green	>300...500		>50	316EC2W	332EC2W			
	Red	380/440		50/60	316EC3W	332EC3W			
	Yellow	100...130		50 and 60	316EC4W	332EC4W			
	Black	600...690			316EC5W	332EC5W			
	Red	380...415			316EC6W	332EC6W			
	Black	480...500			316EC7W	332EC7W			
	Blue	200...250			316EC9W	332EC9W			
	Green	100...300		>50	316EC10W	332EC10W			
	Red	440...460		60	316EC11W	332EC11W			
	<b>3P+N+E</b>								
5	Grey			AC	416EC1W	432EC1W	10	0.26 (16A) 0.30 (32A)	
	Green	>300...500		>50	416EC2W	432EC2W			
	Red	380...440		50/60	416EC3W	432EC3W			
	Yellow	100...130		50 and 60	416EC4W	432EC4W			
	Red	346...415			416EC6W	432EC6W			
	Black	480...500			416EC7W	432EC7W			
	Blue	208...250			416EC9W	432EC9W			
	Red	440...460		60	416EC11W	432EC11W			

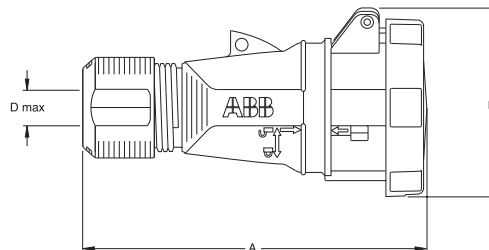

### Dimensions (mm)

Type	A	B	Dmax
216EC...W	146	81	14
316EC...W	169	88	17
416EC...W	169	92	17

Type	A	B	Dmax
232EC...W	195	98	22
332EC...W	195	98	22
432EC...W	195	104	22

# Inlets

for wall mounting, IP67



216EBS6W



432EBS6W

## 16 A. / 32 A. Watertight

Housing in plastic (PA). Cable gland included. Cable area 1...2.5 mm<sup>2</sup> (16A) / 2.5...6 mm<sup>2</sup> (32A)

Terminals/ Poles	Colour code	Voltage		Frequency	Type: 16A		Type: 32A		Pkg qty	Weight pkg (1pce) kg
		V								
<b>2P+E</b>										
3	Grey			AC	216EBS1W	232EBS1W	10	0.20 (16A) 0.26 (32A)		
	Yellow	100...130		50 and 60	216EBS4W	232EBS4W				
	Blue	200...250			216EBS6W	232EBS6W				
	Red	380...415			216EBS9W	232EBS9W				
	Grey		transf		216EBS12W	232EBS12W				
<b>3P+E</b>										
4	Grey			AC	316EBS1W	332EBS1W	10	0.23 (16A) 0.27 (32A)		
	Green	>300...500		>50	316EBS2W	332EBS2W				
	Red	380/440		50/60	316EBS3W	332EBS3W				
	Yellow	100...130		50 and 60	316EBS4W	332EBS4W				
	Black	600...690			316EBS5W	332EBS5W				
	Red	380...415			316EBS6W	332EBS6W				
	Black	480...500			316EBS7W	332EBS7W				
	Blue	200...250			316EBS9W	332EBS9W				
	Green	100...300		>50	316EBS10W	332EBS10W				
	Red	440...460		60	316EBS11W	332EBS11W				
	<b>3P+N+E</b>									
5	Grey			AC	416EBS1W	432EBS1W	10	0.25 (16A) 0.28 (32A)		
	Green	>300...500		>50	416EBS2W	432EBS2W				
	Red	380...440		50/60	416EBS3W	432EBS3W				
	Yellow	100...130		50 and 60	416EBS4W	432EBS4W				
	Red	346...415			416EBS6W	432EBS6W				
	Black	480...500			416EBS7W	432EBS7W				
	Blue	208...250			416EBS9W	432EBS9W				
	Red	440...460		60	416EBS11W	432EBS11W				

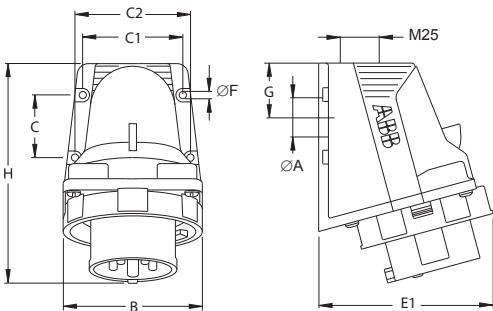

## Dimensions (mm)

Type	A	B	C	C1	C2	E1	ØF	G	H
216EBS...W	25	88.5	40	63.5	73.5	112	4.5	34.75	135
316EBS...W	25	88.5	40	63.5	73.5	108	4.5	34.75	138
416EBS...W	25	88.5	40	63.5	73.5	112	4.5	34.75	140

  

Type	A	B	C	C1	C2	E1	ØF	G	H
232EBS...W	25	91	40	63.5	73.5	106	4.5	34.75	150
332EBS...W	25	91	40	63.5	73.5	106	4.5	34.75	150
432EBS...W	25	99	40	63.5	73.5	110	4.5	34.75	152

SECTION 6

## Inlets

for panel mounting with unified straight flange, IP67

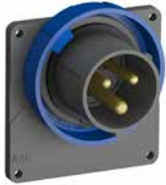

216EBU6W



432EBU6W

### 16 A. / 32 A. Watertight

Housing in plastic (PA). Cable area 1...2.5 mm<sup>2</sup> (16A) / 2.5...6 mm<sup>2</sup> (32A)

Terminals/ Poles	Colour code	Voltage		Frequency	Type: 16A	Type: 32A	Pkg qty	Weight pkg (1pce) kg
		V	Hz					
<b>2P+E</b>								
3	Grey			AC	216EBU1W	232EBU1W	10	0.11 (16A) 0.17 (32A)
	Yellow	100...130	50 and 60		216EBU4W	232EBU4W		
	Blue	200...250			216EBU6W	232EBU6W		
	Red	380...415			216EBU9W	232EBU9W		
<b>3P+E</b>								
4	Grey			AC	316EBU1W	332EBU1W	10	0.14 (16A) 0.18 (32A)
	Yellow	100...130	50 and 60		316EBU4W	332EBU3W		
	Black	600...690			316EBU5W	332EBU4W		
	Red	380...415			316EBU6W	332EBU6W		
	Black	480...500			316EBU7W	332EBU7W		
	Blue	200...250			316EBU9W	332EBU9W		
	Red	440...460	60		316EBU11W	332EBU11W		
<b>3P+N+E</b>								
5	Grey			AC	416EBU1W	432EBU1W	10	0.16 (16A) 0.19 (32A)
	Yellow	100...130	50 and 60		416EBU4W	432EBU4W		
	Red	346...415			416EBU6W	432EBU6W		
	Black	480...500			416EBU7W	432EBU7W		
	Blue	208...250			416EBU9W	432EBU9W		
	Red	440...460	60		416EBU11W	432EBU11W		

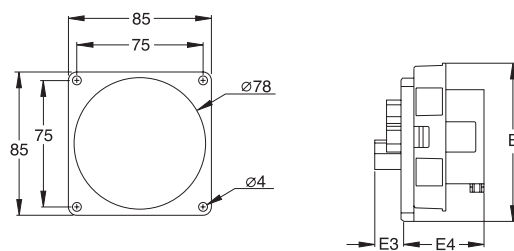

### Dimensions (mm)

Type	B	E3	E4
216EBU...W	94	17	48.5
316EBU...W	90	17	48.5
416EBU...W	93.5	17	48.5

Type	B	E3	E4
232EBU...W	91	16	58
332EBU...W	91	16	58
432EBU...W	99	16	58

## Socket outlet

for wall mounting, IP67



216ERS6W



432ERS6W

### 16 A. / 32 A. Watertight

Housing in plastic (PA). Cable gland included. Cable area 1.5...4 mm<sup>2</sup> (16A) / 2.5...10 mm<sup>2</sup> (32A)

Terminals/ Poles	Colour code	Voltage V	Frequency Hz	Type:		Pkg qty	Weight pkg (1pce) kg	
				16A	32A			
<b>2P+E</b>								
3	Grey		AC	216ERS1W	232ERS1W	10	0.24	
	Yellow	100...130	50 and 60	216ERS4W	232ERS4W		0.31	
	Blue	200...250		216ERS6W	232ERS6W			0.32
	Red	380...415		216ERS9W	232ERS9W			
	Grey	transf		216ERS12W	232ERS12W			
<b>3P+E</b>								
4	Grey		AC	316ERS1W	332ERS1W	10	0.27	
	Green	>300...500	>50	316ERB2W	332ERS2W		0.32	
	Red	380/440	50/60	316ERS3W	332ERS3W			0.32
	Yellow	100...130	50 and 60	316ERS4W	332ERS4W			
	Black	600...690		316ERS5W	332ERS5W			
	Red	380...415		316ERS6W	332ERS6W			
	Black	480...500		316ERS7W	332ERS7W			
	Blue	200...250		316ERS9W	332ERS9W			
	Green	100...300	>50	316ERS10W	332ERS10W			
	Red	440...460	60	316ERS11W	332ERS11W			
	<b>3P+N+E</b>							
5	Grey		AC	416ERS1W	432ERS1W	10	0.30	
	Green	>300...500	>50	416ERS2W	432ERS2W		0.32	
	Red	380...440	50/60	416ERS3W	432ERS3W			0.32
	Yellow	100...130	50 and 60	416ERS4W	432ERS4W			
	Red	346...415		416ERS6W	432ERS6W			
	Black	480...500		416ERS7W	432ERS7W			
	Blue	208...250		416ERS9W	432ERS9W			
	Red	440...460	60	416ERS11W	432ERS11W			

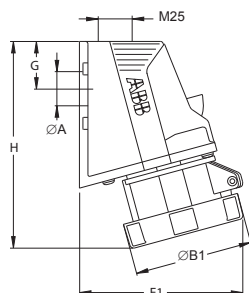
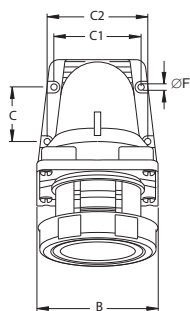

### Dimensions (mm)

Type	A	B	ØB1	C	C1	C2	E1	ØF	G	H
216ERS...W	25	88.5	73	40	63.5	73.5	112	4.5	34.75	147
316ERS...W	25	88.5	81	40	63.5	73.5	117	4.5	34.75	150
416ERS...W	25	88.5	87	40	63.5	73.5	119	4.5	34.75	151

Type	A	B	ØB1	C	C1	C2	E1	ØF	G	H
232ERS...W	25	88.5	91	40	63.5	73.5	117	4.5	34.75	163
332ERS...W	25	88.5	91	40	63.5	73.5	117	4.5	34.75	163
432ERS...W	25	88.5	99	40	63.5	73.5	120	4.5	34.75	164

## Socket outlet

for panel mounting with unified straight flange, IP67



216ERU6W



432ERU6W

### 16 A. / 32 A. Watertight

Housing in plastic (PA). Cable area 1.5...4 mm<sup>2</sup> (16A) / 2.5...10 mm<sup>2</sup> (32A)

Terminals/ Poles	Colour code	Voltage V	Frequency Hz	Type		Pkg qty	Weight pkg (1pce) kg
				Type: 16A	Type: 32A		
<b>2P+E</b>							
3	Grey		AC	216ERU1W	232ERU1W	10	0.15 (16A) 0.22 (32A)
	Yellow	100...130	50 and 60	216ERU4W	232ERU4W		
	Blue	200...250		216ERU6W	232ERU6W		
	Red	380...415		216ERU9W	232ERU9W		
<b>3P+E</b>							
4	Grey		AC	316ERU1W	332ERU1W	10	0.18 (16A) 0.23 (32A)
	Yellow	100...130	50 and 60	316ERU4W	332ERU3W		
	Black	600...690		316ERU5W	332ERU4W		
	Red	380...415		316ERU6W	332ERU6W		
	Black	480...500		316ERU7W	332ERU7W		
	Blue	200...250		316ERU9W	332ERU9W		
	Red	440...460	60	316ERU11W	332ERU11W		
<b>3P+N+E</b>							
5	Grey		AC	416ERU1W	432ERU1W	10	0.21 (16A) 0.23 (32A)
	Yellow	100...130	50 and 60	416ERU4W	432ERU4W		
	Red	346...415		416ERU6W	432ERU6W		
	Black	480...500		416ERU7W	432ERU7W		
	Blue	208...250		416ERU9W	432ERU9W		
	Red	440...460	60	416ERU11W	432ERU11W		

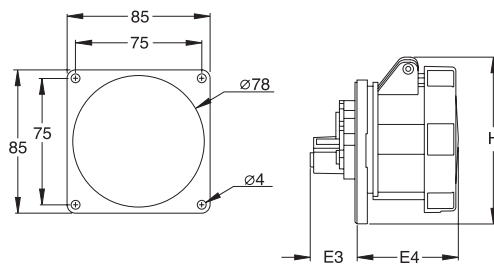

### Dimensions (mm)

Type	B	E3	E4
216ERU...W	103	27	60
316ERU...W	98	28	60
416ERU...W	99	28	60

Type	B	E3	E4
232ERU...W	98	31	70
332ERU...W	98	31	70
432ERU...W	104	32	69

# Industrial plugs and sockets for entertainment applications

## Plugs



Type EP...B, 16 A...32 A, IP44

## Connectors



Type EC...B, 16 A...32 A, IP44

## Inlets



For wall mounting, Type BS...B  
16 A...32 A, IP44

## Socket outlet



For wall mounting, Type RS...B  
16 A...32 A, IP44



For panel mounting with unified  
straight flange, Type RU...B  
16 A...32 A, IP44



For panel mounting with minimized  
angled flange, Type RAM...B  
16 A...32 A, IP44

---

# Industrial plugs and sockets

## Modular Combi

Modular Combi is a system consisting of compact units replacing outlets that traditionally has been scattered around the walls. Modular combi is a cost effective system.

Modular Combi is a cost effective system with different types of outlets, RCDs and MCBs in one location. Modular Combi is very easy to install and, thanks to the solutions and design, it saves time and money. The Modular Combi range consists of two lines, one product line in plastic,

and the other one in metal. Common for them are among other features that you only need one feeding cable, it can be mounted with an already existing 4-wire as well as 5-wire cable and that the modules are easy to modify in the future for additional needs.

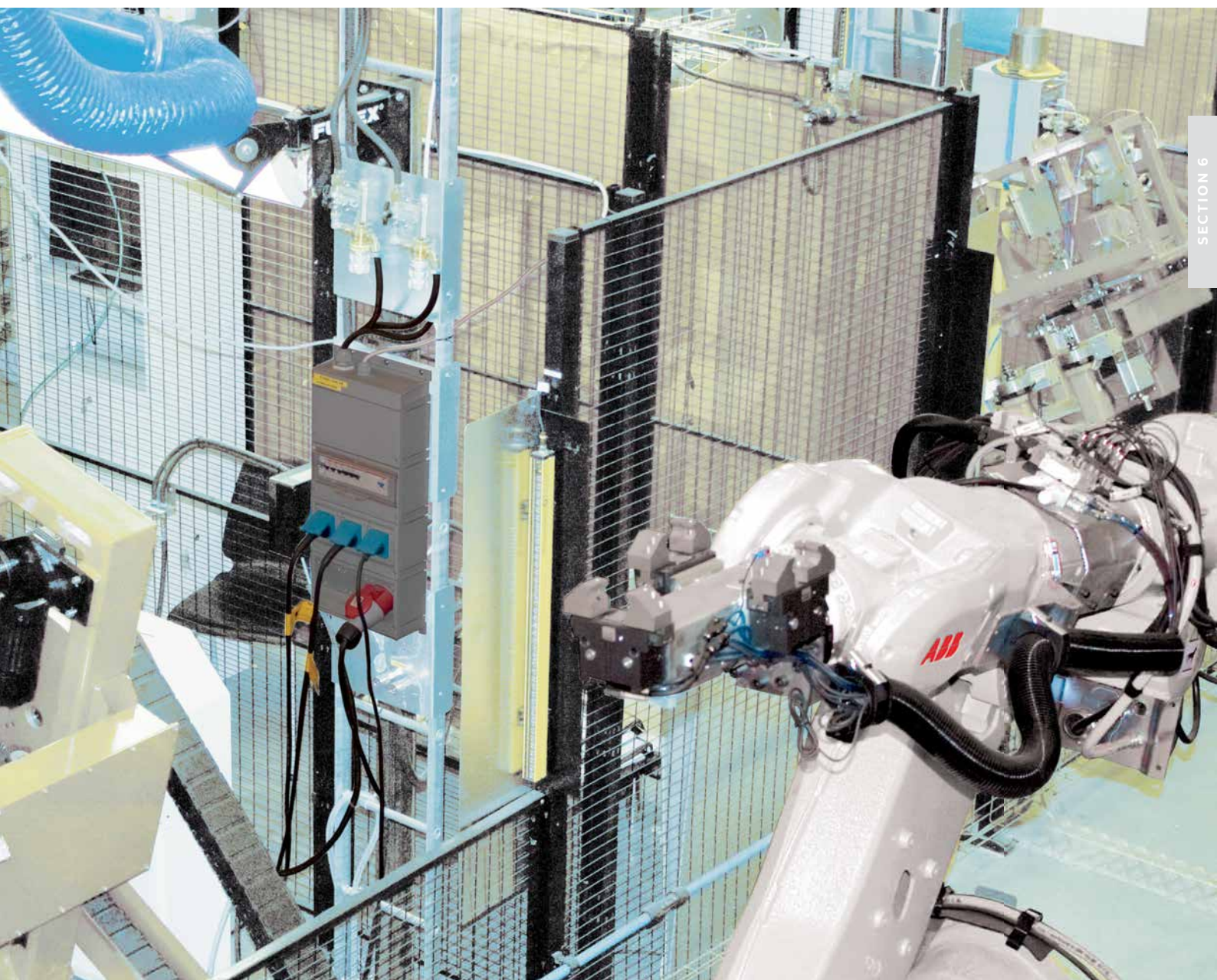

# Modular Combi Plastic

The enclosure is in aluminium with front plates of galvanised steel. Modul Combi Metal is designed for different types of single phase domestic outlets and for IEC outlets up to and including 63 A.

Operating voltage 230/400 V ~

Enclosure: Plastic (PBT)

Dimensions: According to table

Outlets: Combi Plastic is designed for different types of single phase domestic outlets and for IEC outlets up to and including 63 A.

With or without mechanical interlocked IEC outlets.

Cable entry: 4 knock-outs at the top, suitable for 2xØ 40 mm and 2xØ 25 mm

At the bottom 3xØ 47 mm

Cable area: 2x16 mm<sup>2</sup> Cu. Designed for looping

Covers: For MCB/RCD, maximum 13 modules, 2 opened and knock-outs for the rest of the modules row. DIN-rail in bottom for terminals and MCB/RCDs.

With a distance at the bottom to allow wiring behind the rail. The lid is pad lockable.



# Modular Combi Metal

The enclosure is in aluminium with front plates of galvanised steel. Modul Combi Metal is designed for different types of single phase domestic outlets and for IEC outlets up to and including 63 A.

Operating voltage 230/400 V~

Enclosure: Aluminium with front plates of galvanised steel.

Dimensions: According to table or customer order

Outlets: Combi Metal is designed for different types of single phase domestic outlets and for IEC outlets up to and including 63 A. With or without mechanical interlocked IEC outlets.

Cable entry: FL21 flange openings at top and bottom

Cable area: 2x16 mm<sup>2</sup> Cu. Designed for looping

Covers: For MCB/RCD, maximum 12 modules. DIN-rail in bottom for terminals and MCB/RCDs. With a distance at the bottom to allow wiring behind the rail. The lid is pad lockable.



---

# Enclosures and switchboards

<b>115</b>	<b>IP65 SR2 enclosures</b>
<b>117</b>	<b>IP66 SRX enclosures</b>
<b>119</b>	<b>IP66 Gemini enclosures</b>
<b>121</b>	<b>Mistral 65 Double insulated enclosures</b>
<b>124</b>	<b>Europa series IP65 enclosures</b>
<b>126</b>	<b>Europa series IP44, IP55 and IP65 thermoplastic enclosures</b>
<b>128</b>	<b>Europa series IP65 polycarbonate enclosures</b>



For more detailed product information, please refer to our online technical brochures available at: [new.abb.com/low-voltage/support/documentation](https://new.abb.com/low-voltage/support/documentation)

or contact our sales team via email [LV.enquiries@gb.abb.com](mailto:LV.enquiries@gb.abb.com)

or call 0333 999 9933

## Enclosures

### IP65 SR2 Sheet steel enclosures



Rapid selection table

Overall Dimensions			Enclosures with blind door + back plate		Kit for automation		Kit for distribution Supports for mounting modular panels										
Height mm	Width mm	Depth mm	Enclosures with blind door + back plate	with glazed door*	Blind counter door	Back plate	No. vertical mod. H=185mm	No. DIN mod. per row	Total modules	DIN Supports							
300	200	150	SRN3215K														
	300		SRN3315K														
	400		SRN3415K														
400	300	150	SRN4315K														
	300		SRN4320K														
	400	200	SRN4420K														
	600		SRN4620K														
500	300	200	SRN5320K														
	300		SRN5420K	SRN5420VK*							KC5040K	PF5040	2	14	28	KD5040K	
	500		SRN5520K														
	400		250	SRN5425K							SRN5425VK*	KC5040K	PF5040	2	14	28	KD5040K
	400		200	SRN6420K							SRN6420VK*	KC6040K	PF6040	3	14	42	KD6040K
	500			SRN6520K													
600	600	250	SRN6620K														
	400		SRN6425K	SRN6425VK*							KC6040K	PF6040	3	14	42	KD6040K	
	500		SRN6520K														
	600		SRN6625K														
	600		300	SRN6630K													
700	500	200	SRN7520K	SRN7520VK*	KC7050K	PF7050											
	500	250	SRN7525K	SRN7525VK*	KC7050K	PF7050											
800	600	250	SRN8625K	SRN8625VK*	KC8060K	PF8060	4	25	100	KD8060K							
	600	300	SRN8630K	SRN8630VK*	KC8060K	PF8060	4	25	100	KD8060K							
	800		SRN8830K														
1000	600	250	SRN10625K	SRN10625VK*	KC1060K	PF1060	5	25	125	KD1060K							
	600	300	SRN10630K	SRN10630VK*	KC1060K	PF1060	5	25	125	KD1060K							
	800		SRN10830K	SRN10830VK*	KC1080K	PF1080	5	36	180	KD1080K							
1200	600	300	SRN12630K	SRN12630VK*	KC1260K	PF1260	6	25	150	KD1260K							
	800		SRN12830K	SRN12830VK*	KC1280K	PF1280	6	36	216	KD1280K							
	800		SRN12840K														

\* No mounting plate included.



#### Technical characteristics

Conformity with Standard	IEC 62208, IEC 61439-1-2	
Degree of protection	IP65 (IEC 60529) TYPE 12 (Normativa UL)	
Degree of mechanical strength	IK10 blind door IK09 glazed door (IEC 62262)	
Certifications		
Type of material	UL LISTED CE II 3 GD	Metallic
Installation site	Indoors	
Fixing method	floor/wall	
Normal service conditions - ambient temperature	-5 a +40°C	
Operating climate (t°/Ur%)	constant	23°C/83% - 40°C/93%
	variable	23°C/98% - 40°C/98%

## SR2 Enclosures

### IP65 Sheet steel enclosures

#### Mounting plates

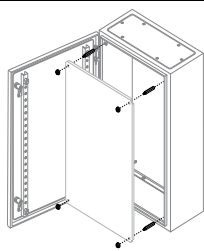

For enclosure	H (mm) x W (mm)	Order Code
SRN5420K & SRN5425K	500 x 400	PF5040
SRN6420K & SRN6425K	600 x 400	PF6040
SRN7520K & SRN7525K	700 x 500	PF7050
SRN8625K & SRN8630K	800 x 600	PF8060
SRN10625K & SRN10630K	1000 x 600	PF1060
SRN10830K	1000 x 800	PF1080
SRN12630K	1200 x 600	PF1260
SRN12830K	1200 x 800	PF1280

#### Rainhoods

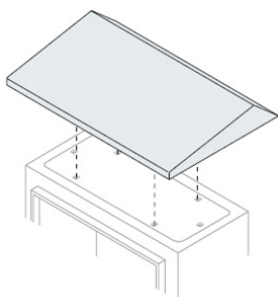

W (mm) x D (mm)	Order Code
200 x 150	TT2015K
300 x 150	TT3015K
400 x 150	TT4015K
300 x 200	TT3020K
400 x 200	TT4020K
500 x 200	TT5020K
600 x 200	TT6020K
400 x 250	TT4025K
500 x 250	TT5025K
600 x 250	TT6025K
600 x 300	TT6030K
800 x 300	TT8030K

#### Plinths

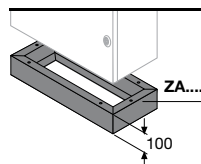

W (mm) x D (mm)	Order Code
400 x 200	ZA4020
400 x 250	ZA4025
600 x 250	ZA6025
600 x 300	ZA6030
800 x 300	ZA8030

#### IP65 Combining gasket



W (mm) x D (mm)	Order Code
400 x 200	GZ4020
400 x 250	GZ4025
600 x 250	GZ6025
600 x 300	GZ6030
800 x 300	GZ8030

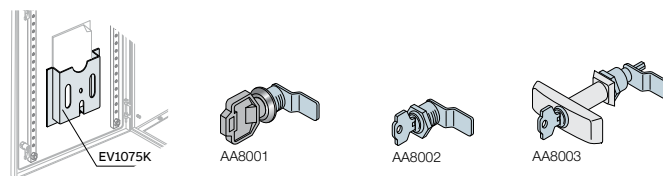

#### Accessories

Description	Order Code
Document pocket	EV1075K
N.4 wall mounting brackets	AA1206
Double tongue 7mm lock with DIN 5mm plastic key	AA8001
Lock with Yale insert & key	AA8002
T handle with Yale insert and key	AA8003
Replacement hinge kit	AA1204

## Enclosures

### IP66 SRX Sheet steel enclosures



#### Rapid selection table

Overall Dimensions			Enclosures		Kit for automation	Kit for distribution				
Height mm	Width mm	Depth mm	Enclosures with blind door + back plate	with glazed door*	Blind counter door	Back plate	No. vertical mod. H=185mm	No. DIN mod. per row	Total modules	DIN Supports
300	200	150	SRN3215X			PF3020				
	400	150	SRN3415X			PF3040				
400	300	150	SRN4315X		KC4030X	PF4030				
		200	SRN4320X							
	400	200	SRN4420X			PF4040				
	600	200	SRN4620X			PF4060				
500	400	200	SRN5420X	SRN5420VX*	KC5040X	PF5040	2	14	28	KD5040X
	500	250	SRN5520X			PF5050				
600	400	200	SRN6420X	SRN6420VX*	KC6040X	PF6040	3	14	42	KD6040X
	600	200	SRN6620X			PF6060				
		300	SRN6630X							
700	500	250	SRN7525X	SRN7525VX*	KC7050X	PF7050				
		200	SRN8620X					25	100	
	600	250	SRN8625VX*	KC8060X	PF8060	4	25	100	KD8060X	
800	300	300	SRN8630X					25	100	
	800	300	SRN8830X			PF8080				
1000	800	300	SRN10830X	SRN10830VX*	KC1080X	PF1080	5	36	180	KD1080X
1200	600	300	SRN12630X			PF1260				
	800	300	SRN12830X			PF1280				

\* No mounting plate included.



#### Technical characteristics

Conforms to	CEI EN 62208, IEC 61439-1-2
Degree of protection	IP66 (CEI EN 60529)* NEMA 4X (UL standard)*
Degree of mechanical protection	IK10 blind door IK09 glazed door (IEC 62262)
Certifications	
Type of material	AISI 304
Installation site	Indoors/outdoors
Fixing method	floor/wall
Normal service conditions	
- ambient temperature	from -25 to +55°C

\* Under certification.

## SR2 Enclosures

IP66 SRX Stainless steel enclosures

### Accessories

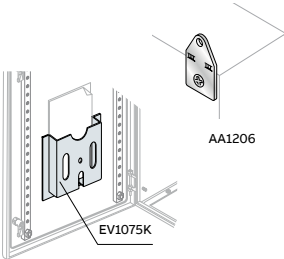
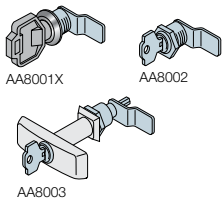
	Description	Order Code
	Document pocket	EV1075K
	Wall mounting brackets (4 off)	AA1206
	Double tongue 7mm lock with DIN 55mm plastic key	AA8001
	Lock with Yale insert & key	AA8002
	T handle with Yale insert and key	AA8003
		

#### Opaque internal mounting plate

- 20/10 thick galvanised sheet metal internal plate, complete with fixing with small parts supplied
- Depth-adjustable using a special spacer kit (to be ordered separately)

#### Opaque internal mounting plate

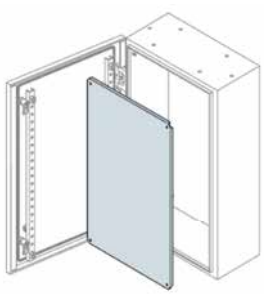
	Dimensions (mm)		Order code
	H	W	
	500	400	PF5040
	600	400	PF6040
	700	500	PF7050
	800	600	PF8060
	1000	800	PF1080

SECTION 7

# Enclosures

## Gemini



- Made of thermoplastic material, to which the co-injection moulding technique gives the same mechanical characteristics as polyester
- Extremely sturdy, with its rigid covering and expanded internal core
- IP66, IP30 with the door open afford a very high resistance to chemical and atmospheric agents
- Guarantees excellent performances even in severe operating conditions

### Rapid selection table

Size	No. of vertical mod. H=150mm	No. of DIN modules installable	External Dimensions			Internal Dimensions			Complete switchboard door		Door			
			(H) mm	(W) mm	(D) mm	(H) mm	(W) mm	(D) mm	Transparent	Opaque	Box	Transparent	Opaque	Uprights
1	2	24 (12x2)	400	335	210	300	250	180	1SL0211A00	1SL0201A00	1SL0221A00	1SL0241A00	1SL0231A00	1SL0283A00
2	3	54 (18x3)	550	460	260	450	375	230	1SL0212A00	1SL0202A00	1SL0222A00	1SL0242A00	1SL0232A00	1SL0284A00
3	4	72 (18x4)	700	460	260	600	375	230	1SL0213A00	1SL0203A00	1SL0223A00	1SL0243A00	1SL0233A00	1SL0285A00
4	4	96 (24x4)	700	580	260	600	500	230	1SL0214A00	1SL0204A00	1SL0224A00	1SL0244A00	1SL0234A00	1SL0285A00
5	5	120 (24x5)	855	585	360	750	500	330	1SL0215A00	1SL0205A00	1SL0225A00	1SL0245A00	1SL0235A00	1SL0286A00
6	6	216 (36x6)	1005	840	360	900	750	330	1SL0216A00	1SL0206A00	1SL0226A00	1SL0246A00	1SL0236A00	1SL0287A00

### Sizes available

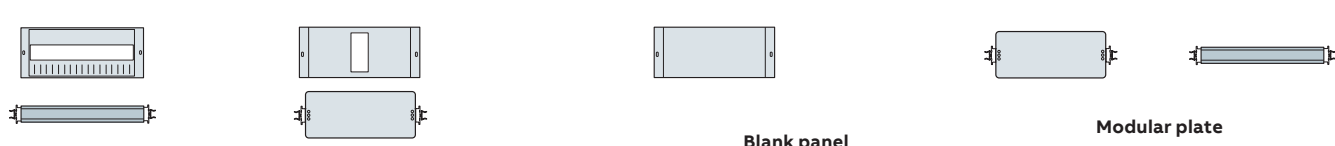
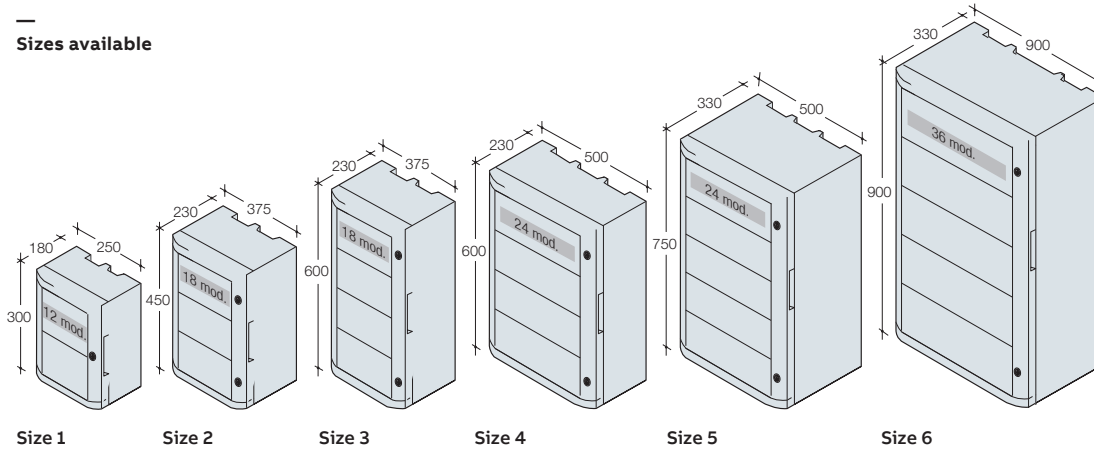

Size	DIN rail kit DIN rail+drilled panel		Kit for Tmax plate+drilled panel		Blank panel			Blank panel		
	1 mod. H=150mm	1+1/2 mod. H=225mm	1 mod. H=150mm	2 mod. H=300mm	1/2 mod. H=75mm	1 mod. H=150mm	2 mod. H=300mm	1 mod. H=150mm	2 mod. H=300mm	Blank panel DIN rail
1	1SL0307A00	-	-	-	1SL0318A00	1SL0324A00	1SL0330A00	1SL0296A00	-	1SL0290A00
2	1SL0308A00	1SL0313A00	1SL0336A00	1SL0370A00	1SL0319A00	1SL0325A00	1SL0331A00	1SL0297A00	1SL0302A00	1SL0291A00
3	1SL0308A00	1SL0313A00	1SL0336A00	1SL0370A00	1SL0319A00	1SL0325A00	1SL0331A00	1SL0297A00	1SL0302A00	1SL0291A00
4	1SL0309A00	1SL0314A00	1SL0337A00	1SL0371A00	1SL0320A00	1SL0326A00	1SL0332A00	1SL0298A00	1SL0303A00	1SL0292A00
5	1SL0309A00	1SL0314A00	1SL0337A00	1SL0371A00	1SL0320A00	1SL0326A00	1SL0332A00	1SL0298A00	1SL0303A00	1SL0292A00
6	1SL0310A00	1SL0315A00	1SL0338A00	1SL0372A00	1SL0321A00	1SL0327A00	1SL0333A00	1SL0299A00	1SL0304A00	1SL0293A00

## Gemini switchboards

### Assembly kits

#### Base plates

	Size	Box Dimensions WxHxD (mm)	Order Code
	<b>Blank metal</b>		
	1		1SL0259A00
	2		1SL0260A00
	3		1SL0261A00
	4		1SL0262A00
	5		1SL0263A00
	6		1SL0264A00
	<b>Drilled metal</b>		
	1		1SL0275A00
	2		1SL0276A00
	3		1SL0277A00
	4		1SL0278A00
	5		1SL0279A00
	6		1SL0280A00
	<b>Insulating material</b>		
	1		1SL0267A00
	2		1SL0268A00
	3		1SL0269A00
	4		1SL0270A00
	5		1SL0271A00
	6		1SL0272A00

#### Locks

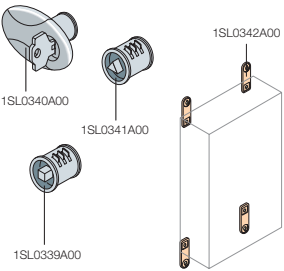
	Description	Order Code
	Lock with Yale type coded key	1SL0340A00
	Lock with triangular impression	1SL0341A00
	Lock with square impression	1SL0339A00
	Wall mounting brackets	1SL0342A00

# Mistral 65

## Double insulated enclosures

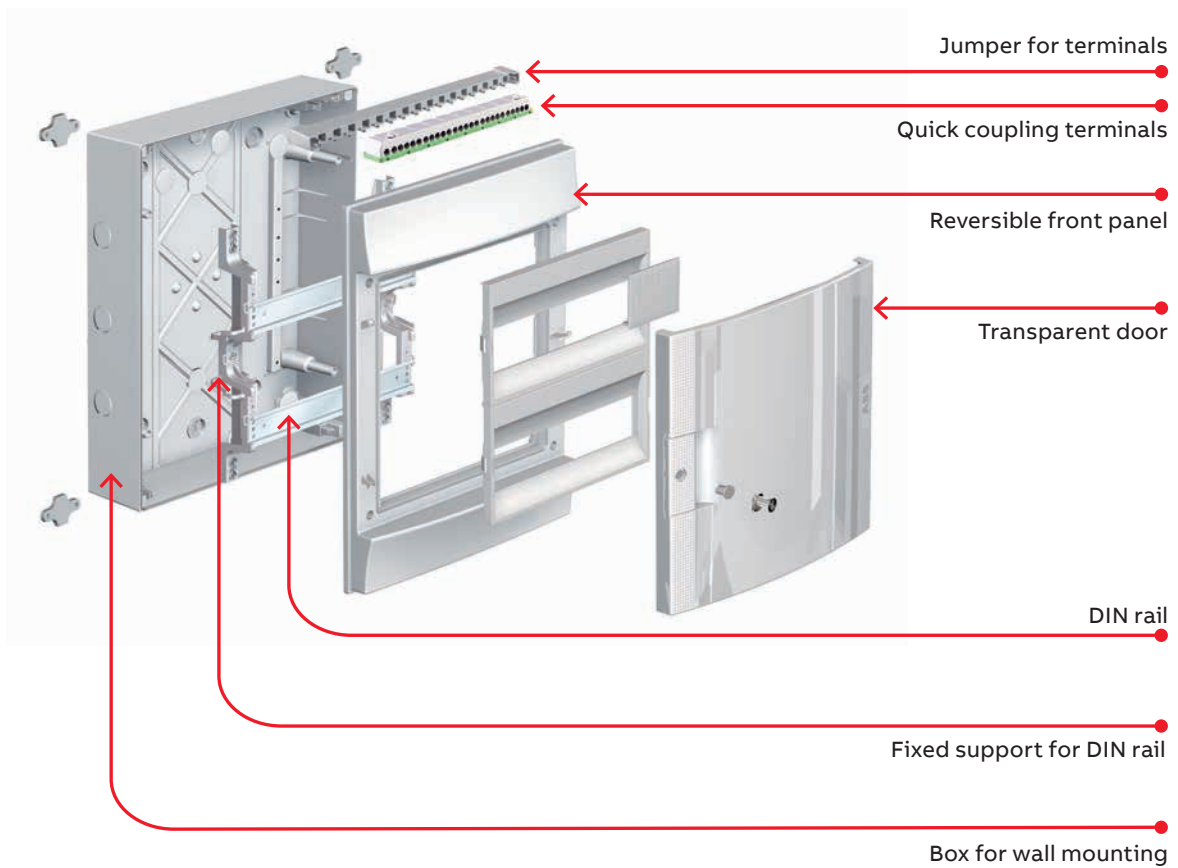
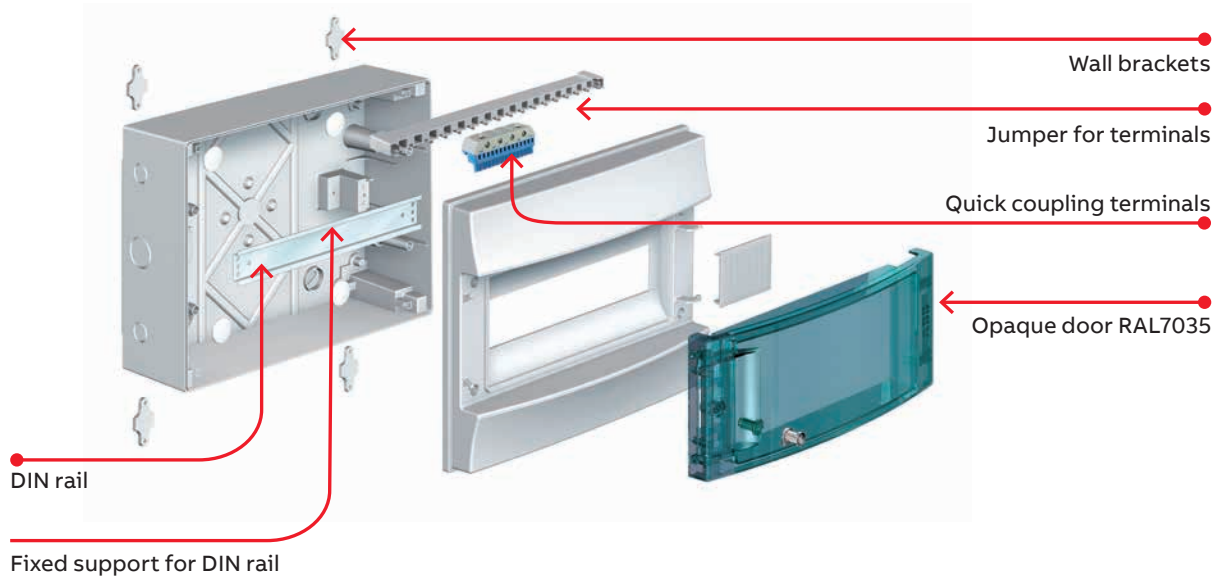

# Mistral 65

Double insulated enclosures

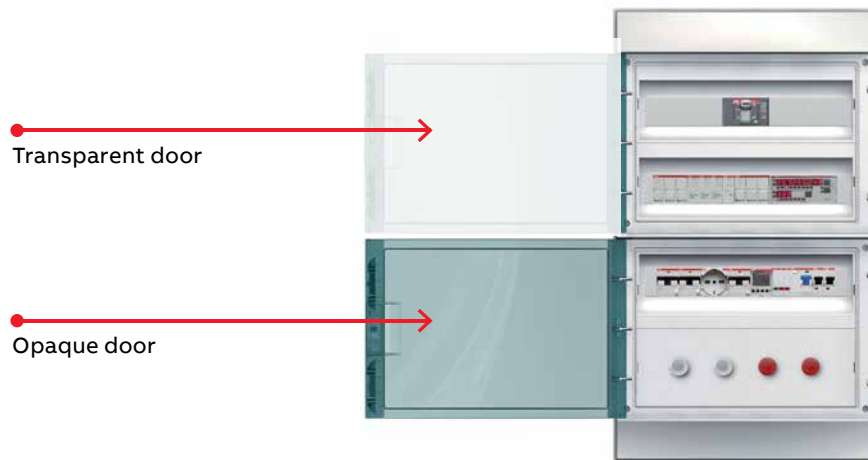

## Enclosure with opaque door

	Rows	Dimensions (mm)			Order Code
		Width	Height	Depth	
650 Opaque door 4M	1	152	202	117	1SL1200A00
650 Opaque door 8M	1	232	250	154	1SL1201A00
650 Opaque door 12M	1	320	250	155	1SL1202A00
650 Opaque door 18M	1	430	250	155	1SL1203A00
650 Opaque door 24M	2	320	435	155	1SL1204A00
650 Opaque door 36M 2F	2	430	435	155	1SL1205A00
650 Opaque door 36M 3F	3	320	435	155	1SL1206A00
650 Opaque door 48M	4	320	735	155	1SL1207A00
650 Opaque door 54M	5	430	600	155	1SL1208A00
650 Opaque door 72M	6	430	735	155	1SL1209A00

## Enclosure with transparent door

	Rows	Dimensions (mm)			Order Code
		Width	Height	Depth	
650 Transparent door 4M	1	152	202	117	1SL1200A00
650 Transparent door 8M	1	232	250	154	1SL1201A00
650 Transparent door 12M	1	320	250	155	1SL1202A00
650 Transparent door 18M	1	430	250	155	1SL1203A00
650 Transparent door 24M	2	320	435	155	1SL1204A00
650 Transparent door 36M 2F	2	430	435	155	1SL1205A00
650 Transparent door 36M 3F	3	320	435	155	1SL1206A00
650 Transparent door 48M	4	320	735	155	1SL1207A00
650 Transparent door 54M	5	430	600	155	1SL1208A00
650 Transparent door 72M	6	430	735	155	1SL1209A00

SECTION 7

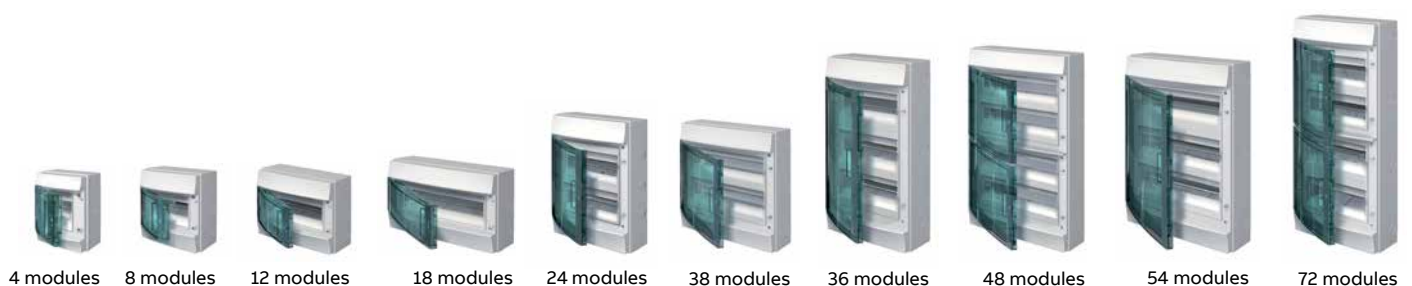

# Mistral 65

## Double insulated enclosures

### Accessories

		Order Code
	Wall fixing brackets (4 pcs) MISTRAL65	1SL1927A00
	Lock with key MISTRAL65	1SL1931A00
	Cable gland Ø 16	1SL1935A00
	Cable gland Ø 20	1SL1936A00
	Cable gland Ø 25	1SL1937A00
	Cable gland Ø 32	1SL1938A00
	Metal base plate 12M Mistral65	1SL1920A00
	Metal base plate 2x12M Mistral65	1SL1921A00
	Metal base plate 18M Mistral65	1SL1922A00
	Metal base plate 2x18M Mistral65	1SL1923A00
	Central blind panel 12M Mistral65	1SL1945A00
	Blind panel 12M Mistral65	1SL1946A00
	Central blind panel 18M Mistral65	1SL1947A00
Blind panel 18M Mistral65	1SL1948A00	

### Terminal blocks

		Order Code	
	Terminal block N 3*16mm <sup>2</sup> +3*6mm <sup>2</sup>	A	1SPE007715F0731
	Terminal block N 5*16mm <sup>2</sup> +6*6mm <sup>2</sup>	B	1SPE007715F0732
	Terminal block N 7*16mm <sup>2</sup> +9*6mm <sup>2</sup>	C	1SPE007715F0733
	Terminal block N 9*16mm <sup>2</sup> +12*6mm <sup>2</sup>	D	1SPE007715F0734
	Terminal block N 11*16mm <sup>2</sup> +15*6mm <sup>2</sup>	E	1SPE007715F0735
	Terminal block PE 3*16mm <sup>2</sup> +3*6mm <sup>2</sup>	A	1SPE007715F0741
	Terminal block PE 5*16mm <sup>2</sup> +6*6mm <sup>2</sup>	B	1SPE007715F0742
	Terminal block PE 7*16mm <sup>2</sup> +9*6mm <sup>2</sup>	C	1SPE007715F0743
	Terminal block PE 9*16mm <sup>2</sup> +12*6mm <sup>2</sup>	D	1SPE007715F0744
	Terminal block PE 11*16mm <sup>2</sup> +15*6mm <sup>2</sup>	E	1SPE007715F0745
	Terminal carrier, 8 modules		1SPE007715F0751
	Terminal carrier, 12 modules		1SPE007715F0752
	Terminal carrier, 18 modules		1SPE007715F0753

### Terminal Carrier

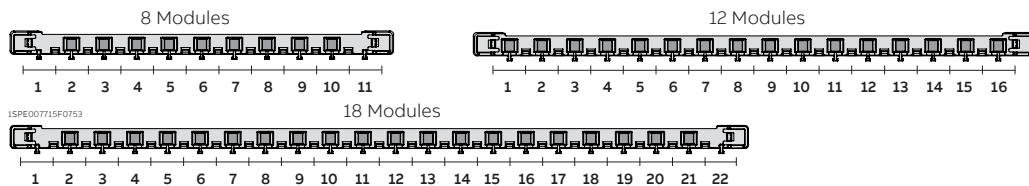

### Terminal Blocks

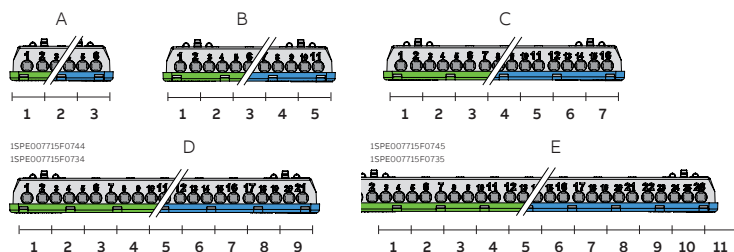

## Europa series

### Modular Units IP65



#### Technical characteristics

- Protection degree IP 65
- Insulation class II
- Available in the versions with opaque and transparent, smoky vertically hinged doors
- Available in RAL 7035 grey
- In polycarbonate material, self-extinguishing and resistant to abnormal heat and fire up to 960 °C (glow wire test) in compliance with IEC 60695-2-1 Standard
- Operating temperature from -25 °C to +115 °C
- Shock resistance 20 Joules (IK level 10)
- High resistance to UV rays
- Perfectly symmetrical switchboards with the possibility of attaching the door hinge onto the front (by means of the special articulated screws supplied) on the right or left with 140° opening
- Doors designed to take lock with coded key, code 12866
- Designed for the insertion of an extractable frame with pre-drilled panelling for mounting 100, 125 and 160 A circuit breakers
- All models (except for code 12764 and 12784) are fitted with one rigid and one bimaterial flange to facilitate insertion of conduits and cables
- Switchboards made and produced in compliance with CEI 23-48, CEI 23-49 and IEC 60 670 Standards
- Switchboards are supplied complete with:
  - 4 screw-cover caps to guarantee
  - accessories for hinging the front part
  - 1 certification plate
  - instruction sheet











Number of modules	Size (mm): W x H x D	Order Code	
		Solid Door	Clear Door
<b>IP65 Polycarbonate</b>			
4	140 x 220 x 140	12764	12784
8	205 x 220 x 140	12768	12788
12	275 x 220 x 140	12772	12792
18	380 x 570 x 140	12778	12798
24	275 x 370 x 140	12774	12794
36	275 x 570 x 140	12776	12796

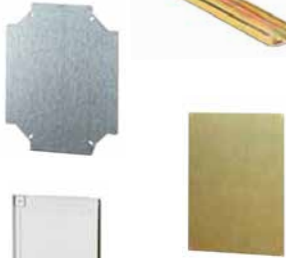

## Europa series

### Modular Units IP65

#### Accessories

	Description	Number of modules	For switchboards	Order Code
	Kit for modular for circuit breakers Circuit breakers 100, 125, 160A on DIN rail	12 modules for 1	12774 - 12794	12820
		24 modules for 2	12776 - 12796	12821
		36 modules for 3	12778 - 12798	12882
	DIN section bars Complete with screws	–	12764 - 12784	12852
		–	12768 - 12788	12854
	Base plates Aluminium plated metal	–	12772 - 12792	–
		–	12774 - 12794	12855
		–	12776 - 12796	–
		–	12778 - 12798	12856
		–	12764 - 12784	12842
		–	12768 - 12788	12844
	Base plates Insulated material	–	12772 - 12792	12845
		–	12774 - 12794	12846
		–	12776 - 12796	12847
		–	12778 - 12798	12848
		–	12764 - 12784	12832
		–	12768 - 12788	12834
	Inner doors	–	12772 - 12792	12835
		–	12774 - 12794	12836
		–	12776 - 12796	12837
		–	12778 - 12798	12838
		–	12774 - 12794	12825
		–	12776 - 12796	12826
	Modular covers	1 module	–	12861
		4 modules	–	12863
	Wall brackets	–	–	12858
	Key lock	–	–	12866

## Europa series





Junction boxes IP44, IP55 & IP65 in thermoplastic



### Technical characteristics

- Protection degree:
  - IP 44 for press-on lid boxes
  - IP 55 for screw-on lid boxes
- Boxes with press-on lids in thermoplastic material, self extinguishing in compliance with UL 94 HB Standard and resistant to abnormal heat and fire up to 650 °C (glow wire test) in compliance with IEC 60695-2-1
- Boxes with opaque screw-on lids in thermoplastic material, self-extinguishing in compliance with UL 94 V-O and resistant to abnormal heat and fire up to 960 °C (glow wire test) in compliance with IEC 695-2-1
- Boxes with screw-on covers in transparent polycarbonate material, self-extinguishing in compliance with UL 94 V-2 and resistant to abnormal heat and fire up to 960 °C (glow wire test) in compliance with IEC 60695-2-1
- Operating temperature -25 °C to +75 °C IP 44 and IP 55
- Shock resistance 6 Joules
- High resistance to heat, chemical and atmospheric agents
- Junction boxes made in compliance with CEI 23-48 and IEC60 670 Standards







### IP44, IP55 & IP65 Thermoplastic boxes

Description	Dimensions (mm)	Order Code	
		650° C	960° C
 IP 44 boxes	Ø60 - H35	00800	1SL0900A00
	Ø80 - H40	00802	1SL0901A00
	65 x 65 x 32	00808	1SL0902A00
	80 x 80 x 40	00810	1SL0903A00
 IP 55 waterproof boxes with plastic 1/4 turn screws	100x100x50	1SL0816A00	1SL0916A00
	105x70x50	1SL0820A00	1SL0920A00
	100x100x80	1SL0821A00	1SL0921A00
	153x110x66	1SL0822A00	1SL0922A00
	160x135x77	1SL0824A00	1SL0924A00
	220x170x80	1SL0826A00	1SL0926A00
 IP 65 waterproof boxes with plastic 1/4 turn screws	310x240x110	1SL0828A00	1SL0928A00
	100x100x50	1SL0846A00	1SL0946A00
	105x70x50	1SL0850A00	1SL0950A00
	100x100x80	1SL0851A00	1SL0951A00
	153x110x66	1SL0852A00	1SL0952A00
	160x137x77	1SL0854A00	1SL0954A00
 IP 65 waterproof boxes with plastic 1/4 turn screws c/w Transparent Lid	220x170x80	1SL0856A00	1SL0956A00
	310x240x110	1SL0858A00	1SL0958A00
	153x110x66	1SL0872A00	1SL0972A00
	160x135x77	1SL0874A00	1SL0974A00
	220x170x80	1SL0876A00	1SL0976A00
	310x240x110	1SL0878A00	1SL0978A00

## Europa series

Junction boxes IP44, IP55 & IP65 in thermoplastic

### IP44, IP55 & IP65 Thermoplastic boxes

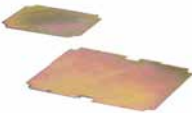
	Description	Dimensions (mm)	Order Code	
			650° C	960° C
	IP 55 waterproof boxes with steel screws	100x100x50	00816	1SL0904A00
		105x70x50	00820	1SL0905A00
		100x100x80	00821	1SL0906A00
		153x110x66	00822	1SL0907A00
	IP 65 waterproof boxes with steel screws	100x100x50	00846	1SL0908A00
		105x70x50	00850	1SL0909A00
		100x100x80	00851	1SL0910A00
		153x110x66	00852	1SL0911A00
	IP 65 waterproof boxes with plastic 1/4 turn screws	151x110x66	00 872	1SL0912A00
	IP 55 waterproof boxes with plastic 1/4 turn screws	160x135x150	1SL0830A00	1SL0930A00
		220x170x150	1SL0832A00	1SL0932A00
		310x240x160	1SL0834A00	1SL0934A00
	IP 65 waterproof boxes with plastic 1/4 turn screws	160x135x150	1SL0860A00	1SL0960A00
		220x170x150	1SL0862A00	1SL0962A00
		310x240x160	1SL0864A00	1SL0964A00
	IP 65 waterproof boxes with plastic 1/4 turn screws	160x135x150	1SL0880A00	1SL0980A00
		220x170x150	1SL0882A00	1SL0982A00
		310x240x160	1SL0884A00	1SL0984A00
	Metal base plates	160 x 135 x 77	00900	
		220 x 170 x 80	00902	
		310 x 240 x 110	00904	

## Europa series

### Junction boxes IP65 in polycarbonate



#### Technical characteristics

- Protection degree IP 65
- Insulation class II
- Self-extinguishing and resistant to abnormal heat and fire up to 960 °C (glow wire test) in compliance with IEC 60695-2-1 Standard
- Operating temperature from -25 °C to +115 °C
- Shock resistance 20 Joules (IK 10)
- High resistance to UV rays
- Boxes code 12 808, 12 812, 12 814, 12 816 and 12 818 fitted with one rigid and one bi-material flange for facilitated input of conduits and cables
- Junction boxes produced in compliance with CEI 23-48 and IEC 60 670 Standards

#### IP65 Polycarbonate enclosure

		Size (mm): H x W x D	Order Code
		220 x 140 x 140	12804
		220 x 205 x 140	12808
		220 x 275 x 140	12812
		768 x 275 x 140	12814
		776 x 275 x 140	12816
		776 x 380 x 140	12818

#### Mounting plates

Type	For Enclosure Type	Order Code
	Aluminium plated metal	12804
		12808
		12812
		12814
		12816
		12818
	Insulated	12804
		12808
		12812
		12814
		12816
		12818

#### Wall mounting brackets

For enclosure type	Order Code
	Fits all
	12858

#### DIN rails

For enclosure type	Order Code
	12804
	12808
	12812 - 12814 - 12816
	12818
	12852
	12854
	12855
	12856

---

# Enclosed control products

<b>130</b>	<b>Direct online starters</b>
<b>131</b>	<b>Star delta starters</b>
<b>132</b>	<b>Push button stations</b>
<b>132</b>	<b>Terminal boxes</b>
<b>133</b>	<b>Heating and lighting enclosures</b>



For more detailed product information, please refer to our online technical brochures available at: [new.abb.com/low-voltage/support/documentation](http://new.abb.com/low-voltage/support/documentation)

or contact our sales team via email [LV.enquiries@gb.abb.com](mailto:LV.enquiries@gb.abb.com)

or call 0333 999 9933

## Direct-on-line starters

IP66 plastic - IP55 metal enclosure

Direct on line IP66 plastic enclosure 400v up to 7.5kW (supplied without overload)

	Three Phase 400V [AC3]		Single Phase 230V [AC3]		Dimensions (mm)			Part No.	Order code
	KW	hp	KW	hp	H	W	D		
 DL205P	<b>100-250v coil</b>								
	5.5	7.5	1.5	2.0	230	106	127	DL205P	1TVC230050P5699
	7.5	10.0	2.2	3.0				DL207P	1TVC230070P5699
	<b>250-500v coil</b>								
5.5	7.5			230	106	127	DL405P	1TVC400050P5699	
7.5	10.0						DL407P	1TVC400070P5699	

Direct on line IP55 metal enclosure 400v up to 7.5kW (supplied without overload)

	Three Phase 400V [AC3]		Single Phase 230V [AC3]		Dimensions (mm)			Part No.	Order code
	KW	hp	KW	hp	H	W	D		
 DL205S	<b>100-250v coil</b>								
	5.5	7.5	1.5	2.0	184	184	165	DL205S	1TVC230050S5699
	7.5	10.0	2.2	3.0				DL207S	1TVC230070S5699
	<b>250-500v coil</b>								
5.5	7.5			184	184	165	DL405S	1TVC400050S5699	
7.5	10.0						DL407S	1TVC400070S5699	

Direct on line with Isolator IP55 metal enclosure 400v up to 7.5kW (supplied without overload)

	Three Phase 400V [AC3]		Single Phase 230V [AC3]		Dimensions (mm)			Part No.	Order code
	KW	hp	KW	hp	H	W	D		
 DI205S	<b>100-250v coil</b>								
	5.5	7.5	1.5	2.0	184	184	180	DI205S	1TVC230051S5699
	7.5	10.0	2.2	3.0				DI207S	1TVC230071S5699
	<b>250-500v coil</b>								
5.5	7.5			184	184	180	DI405S	1TVC400051S5699	
7.5	10.0						DI407S	1TVC400071S5699	

Direct on line Reversing IP55 metal enclosure 400v up to 7.5kW (supplied without overload)

	Three Phase 400V [AC3]		Single Phase 230V [AC3]		Dimensions (mm)			Part No.	Order code
	KW	hp	KW	hp	H	W	D		
 DR207S	<b>100-250v coil</b>								
	7.5	10.0	2.2	3.0	184	184	165	DR207S	1TVC230072S5699
	<b>250-500v coil</b>								
7.5	10.0			184	184	165	DR407S	1TVC400072S5699	

Note: Overload supplied separately

## Star delta starters IP55 metal enclosure



SD215S

### Star-Delta IP65 metal Enclosure 400V up to 22kW

- Star-Delta starters in metal enclosure IEC 947-4-1.
- All three phase star delta starters, are complete with push buttons, and 100-250v or 250-500v coils.
- Overload for standard motor duty must be purchased separately

### Star-Delta IP55 metal enclosure 400V up to 22kW (supplied without overload)



SD215S

Three Phase 400V [AC3]		Dimensions (mm)			Part No.	Order code
KW	hp	H	W	D		
<b>100-250v coil</b>						
15	20.0	184	284	165	SD215S	1TVC230153S5699
22.0	30.0	305	284	175	SD222S	1TVC230223S5699
<b>250-500v coil</b>						
15	20.0	184	284	165	SD415S	1TVC400153S5699
22.0	30.0	305	284	175	SD422S	1TVC400223S5699

### Star-Delta with Isolator IP55 metal enclosure 400V up to 22kW (supplied without overload)



SI215S

Three Phase 400V [AC3]		Dimensions (mm)			Part No.	Order code
KW	hp	H	W	D		
<b>100-250v coil</b>						
15	20.0	184	284	180	SI215S	1TVC230154S5699
22.0	30.0	305	284	190	SI222S	1TVC230224S5699
<b>250-500v coil</b>						
15	20.0	184	284	180	SI415S	1TVC400154S5699
22.0	30.0	305	284	190	SI422S	1TVC400224S5699

**Note:** All Direct on Line and Star Delta starters are supplied without overload fitted. Select TF42 overload based on motor rating from page 160.

## Push button stations

### Plastic IP65 enclosures

- IP65 thermoplastic control station complete with actuator, contact blocks and legend plate. Supplied fully assembled. Other variations are available on request.

#### One gang push buttons

	Description	Dimensions (mm)			Part No	Order code
		H	W	D		
	1 Way Start/Green	75	101	74	1GO	1TVC110000P3101
	1 Way Stop/Red				1RC	1TVC101000P3102

#### Emergency stops

	Description	Dimensions (mm)			Part No	Order code
		H	W	D		
	Emergency stop 30mm (twist release) - to IEC60947-5-5	75	101	92	1RSC	1TVC101000P3203
	Emergency stop 40mm (twist release) - to IEC60947-5-5	75	101	107	1RSC-EN	1TVC101000P3204
	Emergency stop 60mm (twist release) - to IEC60947-5-5	75	101	107	1RMSC50	1TVC101000P3205
	Emergency stop 40mm (with key release) - to IEC60947-5-5	75	101	122	1RMSKC	1TVC101000P3206

#### Selector switches

	Description	Dimensions (mm)			Part No	Order code
		H	W	D		
	Two-position switch	75	101	74	1H2O-I	1TVC110000P3107
	Two-position key switch (key removable both positions)				1K2O-I	1TVC110000P3108
	Three position switch				1H3I-O-II	1TVC110100P3109
	Three position key switch (key removable in all positions)				1K3I-O-II	1TVC110100P3110

#### Two gang push buttons

	Description	Dimensions (mm)			Part No	Order code
		H	W	D		
	Start/Green and Stop/Red	75	141	79	2GORC	1TVC211000P3111
	Start/Green and Red/Emergency Stop 40mm (twist release) to IEC60947-5-5	75	141	107		1TVC211000P3112

## IP55 stainless steel enclosures

### Stainless enclosures

	Description	Dimensions (mm)			Part No	Order code
		H	W	D		
	Emergency Stop 40mm (stay-put) - to EN418	100	140	100	1RSC-ENSS	1TVC100000P5015
	1 Gang empty enclosure	91	91	55	01.001001.SS1	01.001001.SS1
	2 Gang empty enclosure	152	91	55	01.001002.SS2	01.001002.SS2
	3 Gang empty enclosure	207	91	55	01.001003.SS3	01.001003.SS3

## Terminal boxes

### Plastic IP65 enclosures

#### Terminals in enclosures

	Description	No of Terms	[A] 1th	Dimensions (mm)			Part No	Order code
				H	W	D		
	Terminal box 2.5mm IP55 plastic enclosure	5	24	118	163	72	5TERM2.5	1TVC151800S2349
		10	24				10TERM2.5	1TVC151800S2347
	Terminal box 4mm IP55 plastic enclosure	5	32				5TERM4	1TVC151800S2350
		10	32				10TERM4	1TVC151800S2348

## Heating and lighting

IP65 plastic - IP55 metal enclosure

### Three & four pole heating & lighting contactors IP65 plastic enclosure



HL025P

100-250v coil (Including neutral terminal strip)

Heating AC1 Amps	Amps per pole Fluorescent Mercury	Amps per Pole Tungsten	Main Poles	Part No	Order code
25	16	16	4	HL025P	1TVC230025P5604
45	30	32	4	HL045P	1TVC230045P5604

### Three & four pole heating & lighting contactors IP55 metal enclosure



HL025S

100-250v coil (Including neutral terminal strip)

Heating AC1 Amps	Amps per pole Fluorescent Mercury	Amps per Pole Tungsten	Main Poles	Part No	Order code
25	16	16	4	HL025S	1TVC230025S5604
45	30	32	4	HL045S	1TVC230045S5604
70	40	16	3	HL063S	1TVC230063S5603
100	70	32	3	HL100S	1TVC230100S5603

### Dimensions

Enclosure	Height (mm)	Width (mm)	Depth (mm)	Part No	Order code
Plastic	230	106	127	HL025P - HL045P	
Metal	180	185	145	HL025S - HL100S	

---

# Electronic relays and controls

<b>135</b>	<b>Monitoring relays - Three phase</b>
<b>139</b>	<b>Timers</b>
<b>140</b>	<b>Power supplies</b>
<b>142</b>	<b>Pluggable interface relays</b>



For more detailed product information, please refer to our online technical brochures available at: [new.abb.com/low-voltage/support/documentation](http://new.abb.com/low-voltage/support/documentation)

or contact our sales team via email [LV.enquiries@gb.abb.com](mailto:LV.enquiries@gb.abb.com)

or call 0333 999 9933

## Measuring and monitoring relays

### Assortment overview

#### Single-phase current and voltage monitoring

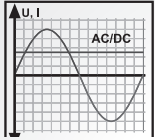

##### Current monitoring

- Monitoring of motor current consumption
- Monitoring of lighting installations and heating circuits
- Monitoring of transportation equipment overload
- Monitoring of locking devices, electromechanical brake gear and locked rotors

##### Voltage monitoring

- Speed monitoring of DC motors
- Monitoring of battery voltages and other supply networks

Please contact us for more information.

#### Three-phase monitoring

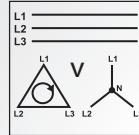

- Voltage monitoring of mobile three-phase equipment
- Protection of personnel and installations against phase reversal
- Monitoring of the supply voltage of machines and installations
- Protection of equipment against damage caused by unstable supply voltage
- Switching to emergency or auxiliary supply
- Protection of motors against damage caused by unbalanced phase voltages and phase loss

See “Ordering details - Singlefunctional” on page 149 or “Ordering details - Multifunctional” on page 150.

#### Grid feeding monitoring relays

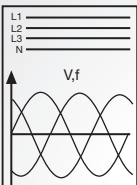

The CM-UFx range monitors all voltage and frequency parameters in a grid and ensures the safe feeding of decentral produced electrical energy into the grid.

- Monitoring of the voltage with up to 2 thresholds for over- and undervoltage
- Monitoring of the frequency with up to 2 thresholds for over- and underfrequency
- ROCOF (rate of change of frequency) and vector shift detection
- In compliance with several local standards

Please contact us for more information.

#### Insulation monitoring

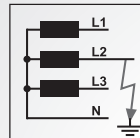

- Monitoring of electrically isolated supply mains for insulation resistance failure
- Detection of initial faults
- Protection against earth faults

Please contact us for more information.

## Measuring and monitoring relays

### Assortment overview

#### Thermistor motor protection

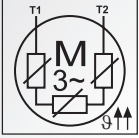

CM-MSE and CM-MSS provide full protection of motors with integrated PTC resistor sensors.

- Protection of motors against thermal overload, e. g. caused by insufficient cooling, heavy load starting conditions, undersized motors, etc.

Please contact us for more information.

#### Temperature monitoring

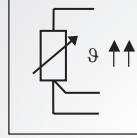

Acquisition, messaging and regulation of temperatures of solid, liquid and gaseous media in processes and machines.

- Motor and system protection
- Control panel temperature monitoring
- Frost monitoring
- Temperature limits for process variables, e.g. in the packing or electroplating industry
- Control of systems and machines like heating, air-conditioning and ventilation systems, solar collectors, heat pumps or hot water supply systems
- Monitoring of servomotors with KTY sensors
- Bearing and gear oil monitoring
- Coolant monitoring

Please contact us for more information.

#### Liquid level monitoring and control

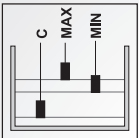

- Protection of pumps against dry running
- Protection against container overflow
- Control of liquid levels
- Detection of leaks
- Control of mixing ratios

Please contact us for more information.



# Three-phase monitoring relays

## Selection table - Multifunctional

Rated control supply voltage  $U_s$

	Type	Order code
	CM-MPS.11S	1SVR730885R1300
	CM-MPS.11P	1SVR740885R1300
	CM-MPS.21S	1SVR730885R3300
	CM-MPS.21P	1SVR740885R3300
	CM-MPS.31S	1SVR730884R1300
	CM-MPS.31P	1SVR740884R1300
	CM-MPS.41S	1SVR730884R3300
	CM-MPS.41P	1SVR740884R3300
	CM-MPS.23S	1SVR730885R4300
	CM-MPS.23P	1SVR740885R4300
	CM-MPS.43S	1SVR730884R4300
	CM-MPS.43P	1SVR740884R4300
	CM-MPN.52S	1SVR750487R8300
	CM-MPN.52P	1SVR760487R8300
	CM-MPN.62S	1SVR750488R8300
	CM-MPN.62P	1SVR760488R8300
	CM-MPN.72S	1SVR750489R8300
	CM-MPN.72P	1SVR760489R8300
<b>Phase to phase</b>		
160-300 V AC		■ ■
300-500 V AC		■ ■ ■ ■
350-580 V AC		■ ■ ■ ■ ■ ■
450-720 V AC		■ ■ ■ ■ ■ ■ ■ ■
530-820 V AC		■ ■ ■ ■ ■ ■ ■ ■ ■ ■
<b>Phase to Neutral</b>		
90-170 V AC	■ ■	
180-280 V AC	■ ■ ■ ■	■ ■
<b>Rated frequency</b>		
50/60 Hz	■ ■ ■ ■ ■ ■ ■ ■	■ ■ ■ ■ ■ ■ ■ ■
50/60/400 Hz		■ ■ ■ ■
<b>Suitable for monitoring</b>		
Single-phase mains	■ ■ ■ ■ ■ ■ ■ ■	■ ■ ■ ■ ■ ■ ■ ■
Three-phase mains	■ ■ ■ ■ ■ ■ ■ ■	■ ■ ■ ■ ■ ■ ■ ■
<b>Monitoring function</b>		
Phase failure	■ ■ ■ ■ ■ ■ ■ ■	■ ■ ■ ■ ■ ■ ■ ■
Phase sequence	sel sel sel sel sel sel sel sel	adj adj adj adj adj adj adj adj
Automatic phase sequence correction		adj adj adj adj adj adj adj adj
Overvoltage	■ ■ ■ ■ ■ ■ ■ ■	■ ■ ■ ■ ■ ■ ■ ■
Undervoltage	■ ■ ■ ■ ■ ■ ■ ■	■ ■ ■ ■ ■ ■ ■ ■
Unbalance	■ ■ ■ ■ ■ ■ ■ ■	■ ■ ■ ■ ■ ■ ■ ■
Neutral <sup>1)</sup>	■ <sup>2)</sup> ■ <sup>2)</sup> ■ <sup>2)</sup> ■ <sup>2)</sup>	■ <sup>2)</sup> ■ <sup>2)</sup>
<b>Thresholds</b>		
	adj adj adj adj adj adj adj adj	adj adj adj adj adj adj adj adj
<b>Timing functions for tripping delay</b>		
On and OFF delay	adj adj adj adj adj adj adj adj	adj adj adj adj adj adj adj adj
<b>Connection type</b>		
Push-in terminals	■ ■ ■ ■ ■ ■ ■ ■	■ ■ ■ ■ ■ ■ ■ ■
Double-chamber cage connection terminals	■ ■ ■ ■ ■ ■ ■ ■	■ ■ ■ ■ ■ ■ ■ ■

<sup>1)</sup> The external conductor voltage towards the neutral conductor is measured.  
 adj: adjustable  
 sel: selectable

## Timers

### Ordering details



The CT-D range in MDRC design with a width of only 17.5 mm fits into all domestic installation and distribution panels. The CT-D range represents a link between industry and the installation types. For maximum flexibility in operation. The devices offer 4 or 7 time ranges from 0.05 seconds up to 100 hours. Their wide input range allows the use in applications worldwide.

#### Ordering details - CT-D range

Timing function	Rated control supply voltage	Time ranges	Control input	Output	Type	Order code	Weight (1 pce) kg (lb)
Multi <sup>1)</sup>	24-240 V AC / 24-48 V DC	7 (0.05 s - 100 h)	■	1 c/o	CT-MFD.12	1SVR500020R0000	0.060 (0.132)
Multi <sup>1)</sup>	12-240 V AC/DC	7 (0.05 s - 100 h)	■	2 c/o	CT-MFD.12	1SVR500020R1100	0.065 (0.143)
ON-delay	24-240 V AC / 24-48 V DC	7 (0.05 s - 100 h)		1 c/o	CT-ERD.12	1SVR500100R0000	0.060 (0.132)
OFF-delay	24-240 V AC / 24-48 V DC	7 (0.05 s - 100 h)	■	1 c/o	CT-AHD.12	1SVR500110R0000	0.060 (0.132)
Impulse--ON	24-240 V AC / 24-48 V DC	7 (0.05 s - 100 h)		1 c/o	CT-VWD.12	1SVR500130R0000	0.060 (0.132)
Flasher starting with ON	24-240 V AC / 24-48 V DC	7 (0.05 s - 100 h)		1 c/o	CT-EBD.12	1SVR500150R0000	0.060 (0.132)
Pulse generator	24-240 V AC / 24-48 V DC	2 x 7 (0.05 s - 100 h)	■	1 c/o	CT-TGD.12	1SVR500160R0000	0.060 (0.132)
Star Delta changeover	24-240 V AC / 24-48 V DC	4 (0.05 s - 10 min)		2 c/o	CT-SAD.22	1SVR500210R0100	0.065 (0.143)



The CP-D of modular power supply units in MDRC design (modular DIN rail components) is ideally suited for installation in distribution panels. This range offers devices with output voltages of 12 V DC and 24 V DC at output currents of 0.42 A to 4.2 A. Thanks to their high thermal efficiency, these power supplies have very low power and heat dissipation and can be operated without forced cooling. All power supply units in the CP-D range are approved according to all relevant international standards.

#### Ordering details - CP-D range

Input voltage range	Rated output voltage / current	Type	Order code	Weight (1 pce) kg (lb)
90-264 V AC / 120-375 V DC	12 V DC / 0.83 A	CP-D 12/0.83	1SVR427041R1000	0.06 (0.13)
90-264 V AC / 120-375 V DC	12 V DC / 2.1 A	CP-D 12/2.1	1SVR427043R1200	0.19 (0.41)
90-264 V AC / 120-375 V DC	24 V DC / 0.42 A	CP-D 24/0.42	1SVR427041R0000	0.06 (0.13)
90-264 V AC / 120-375 V DC	24 V DC / 1.3 A	CP-D 24/1.3	1SVR427043R0100	0.19 (0.41)
90-264 V AC / 120-375 V DC	24 V DC / 2.5 A	CP-D 24/2.5	1SVR427044R0200	0.25 (0.56)
90-264 V AC / 120-375 V DC	24 V DC / 4.2 A	CP-D 24/4.2	1SVR427045R0400	0.32 (0.71)

## Power Supplies

### Ordering details – CP-T range



2CDC271.043.50.009

CP-T 24/5.0

In terms of design and functionality, the CP-T range perfectly supplements the existing products and extends the range appropriately. The devices can be supplied with a three-phase voltage as well as with two-phase mains. Here, ABB offers power supply units with 24 V DC and 48 V DC outputs with 5 A, 10 A, 20 A and 40 A and efficiency of up to 93%.

As in the case of all products, they are designed for an ambient temperature of up to 70°C. All products can be supplied within an AC supply voltage range between 340 to 575 V AC and a DC supply voltage range between 480 to 820 V DC.



2CDC271.045.50.009

CP-T 24/10.0, CP-T 48/5.0

#### Ordering details - CP-T range

Input voltage range	Rated output voltage / current	Type	Order code	Weight (1 pce) kg (lb)
340-575 V AC / 480-820 V DC	24 V DC / 5 A	CP-T 24/5.0	1SVR427054R0000	0.80 (1.77)
340-575 V AC / 480-820 V DC	24 V DC / 10 A	CP-T 24/10.0	1SVR427055R0000	1.05 (2.31)
340-575 V AC / 480-820 V DC	24 V DC / 20 A	CP-T 24/20.0	1SVR427056R0000	1.75 (3.86)
340-575 V AC / 480-820 V DC	24 V DC / 40 A	CP-T 24/40.0	1SVR427057R0000	3.20 (7.05)
340-575 V AC / 480-820 V DC	48 V DC / 5 A	CP-T 48/5.0	1SVR427054R2000	1.05 (2.31)
340-575 V AC / 480-820 V DC	48 V DC / 10 A	CP-T 48/10.0	1SVR427055R2000	1.75 (3.86)
340-575 V AC / 480-820 V DC	48 V DC / 20 A	CP-T 48/20.0	1SVR427056R2000	3.40 (7.50)



2CDC271.047.50.009

CP-T 24/20.0, CP-T 48/10.0

## Power Supplies

### Ordering details – CP-E range

#### Ordering details - C-PE range



Input voltage range function	Rated output voltage / current	Type	Order code	Weight (1 pce) kg (lb)
90-264 V AC / 120-375 V DC	24 V DC / 0.75 A	CP-E.24 / 0.75 A	1SVR427030R0000	0.15 (0.33)
90-264 V AC / 90-375 V DC	24 V DC / 1.25 A	CP-E.24 / 1.25 A	1SVR427032R1000	0.29 (0.64)
90-264 V AC / 90-375 V DC	24 V DC / 2.5 A	CP-E.24 / 2.5 A	1SVR427032R0000	0.36 (0.79)



Input voltage range function	Rated output voltage / current	Type	Order code	Weight (1 pce) kg (lb)
90-132 V AC, 180-264 V AC / 210-375 V DC	24 V DC / 5 A	CP-E.24 / 5 A	1SVR427034R0000	1.0 (2.20)
90-132 V AC, 180-264 V AC / 210-375 V DC	24 V DC / 10 A	CP-E.24 / 10 A	1SVR427035R0000	1.36 (3.01)
90-264 V AC / 120-375 V DC	24 V DC / 20 A	CP-E.24 / 20 A	1SVR427036R0000	1.90 (4.18)

## Pluggable interface relays and optocouplers

### Ordering details – CR-S range



CR-S Interface relay

2CDC 291 005 50014



CR-S Optocoupler

2CDC 291 003 50016



CR-S Interface relay

2CDC 291 005 50014

The slim pluggable interface relays and optocouplers of the CR-S Range may be used for electrical isolation, amplification and signal matching. The CR-S relays are 6.2 mm wide and therefore allow for the switching high currents on a small footprint.

#### Ordering details - CR-S range pluggable interface relays

Rated control supply voltage	Outputs	Contact ratings	Type	Order code	Pkg qty	Weight (1 pc.) kg (lb)
5 V DC	1 c/o (SPDT) standard contacts	250 V, 6 A	CR-S005VDC1R	1SVR405501R1010	10	0.005 (0.011)
12 V DC			CR-S012VDC1R	1SVR405501R2010		
24 V DC			CR-S024VDC1R	1SVR405501R3010		
48 V DC			CR-S048VDC1R	1SVR405501R4010		
60 V DC			CR-S060VDC1R	1SVR405501R5010		
5 V DC	1 c/o (SPDT) gold plated contacts	12 V, 250 mA (3W) <sup>1)</sup>	CR-S005VDC1RG	1SVR405501R1020	10	0.005 (0.011)
12 V DC			CR-S012VDC1RG	1SVR405501R2020		
24 V DC			CR-S024VDC1RG	1SVR405501R3020		
48 V DC			CR-S048VDC1RG	1SVR405501R4020		
60 V DC			CR-S060VDC1RG	1SVR405501R5020		

#### Ordering details - CR-S range pluggable optocouplers

Rated control supply voltage	Outputs	Type	Order code	Pkg qty	Weight (1 pc.) kg (lb)
24 V DC	Transistor, 100 mA - 48 V DC	CR-S024VDC1TRA	1SVR405510R3050	10	0.004 (0.009)
	MOS-FET, 2 A - 24 V DC	CR-S024VDC1MOS	1SVR405510R3060		
	Triac, 2 A - 240 V AC	CR-S024VDC1TRI	1SVR405510R3070		

#### Ordering details - CR-S range sockets

Rated control supply voltage	Connection type	Type	Order code	Pkg qty	Weight (1 pc.) kg (lb)
6-24 V DC	Screw	CR-S006/024VDC1SS	1SVR405521R1100	10	0.025 (0.055)
	Spring	CR-S006/024VDC1SZ	1SVR405521R1200		
12-24 V AC/DC	Screw	CR-S012/024VADC1SS	1SVR405521R3100	10	0.025 (0.055)
	Spring	CR-S012/024VADC1SZ	1SVR405521R3200		
48-60 V AC/DC	Screw	CR-S048/060VADC1SS	1SVR405521R5100	10	0.025 (0.055)
	Spring	CR-S048/060VADC1SZ	1SVR405521R5200		
110-125 V AC/DC	Screw	CR-S110/125VADC1SS	1SVR405521R6100	10	0.025 (0.055)
	Spring	CR-S110/125VADC1SZ	1SVR405521R6200		
220-240 V AC/DC	Screw	CR-S220/240VADC1SS	1SVR405521R7100	10	0.025 (0.055)
	Spring	CR-S220/240VADC1SZ	1SVR405521R7200		

#### Ordering details - CR-S range accessories

Version	Type	Order code	Pkg qty	Weight (1 pc.) kg (lb)
Jumper bar 20 pole, blue colour	CR-SJB20-BLUE	1SVR405598R0700	10	0.008 (0.018)
Jumper bar 20 pole, red colour	CR-SJB20-RED	1SVR405598R0800		
Jumper bar 20 pole, black colour	CR-SJB20-BLACK	1SVR405598R0900		
Separator	CR-SSEP	1SVR405599R0000	10	0.012

# Pluggable interface relays and optocouplers

## Ordering details – CR-P range



2CDC291.045.F0004

CR-P relay



2CDC291.006.S0016

CR-P optocoupler



2CDC291.006.F0011

CR-PLS



2CDC291.004.F0007

CR-PJ



2CDC291.088.F0004

CR-PLSX relay

The CR-P range offers the highest current switching in an IP67 rated relay housing. This range comprises of pluggable interface relays and optocouplers offered in 10 different control supply voltages. Additionally, gold plated contacts are available for applications where sensitive signals are to be switched. The CR-P range also includes complete versions consisting of a relay, socket, holder and functional module.

### Ordering details - CR-P range relays

Rated control supply voltage	Outputs	Contact ratings	Type	Order code	Pkg qty	Weight (1 pc.) kg (lb)
12 V DC	1 c/o (SPDT)	250 V, 16 A	CR-P012DC1	1SVR405600R4000	10	0.014 (0.031)
24 V DC			CR-P024DC1	1SVR405600R1000		
48 V DC			CR-P048DC1	1SVR405600R6000		
110 V DC			CR-P110DC1	1SVR405600R8000		
24 V AC			CR-P024AC1	1SVR405600R0000		
48 V AC			CR-P048AC1	1SVR405600R5000		
110 V AC			CR-P110AC1	1SVR405600R7000		
120 V AC			CR-P120AC1	1SVR405600R2000		
230 V AC			CR-P230AC1	1SVR405600R3000		
12 V DC			2 c/o (SPDT)	250 V, 8 A		
24 V DC	CR-P024DC2	1SVR405601R1000				
48 V DC	CR-P048DC2	1SVR405601R6000				
110 V DC	CR-P110DC2	1SVR405601R8000				
12 V AC	CR-P012AC2	1SVR405601R0200				
24 V AC	CR-P024AC2	1SVR405601R0000				
48 V AC	CR-P048AC2	1SVR405601R5000				
110 V AC	CR-P110AC2	1SVR405601R7000				
120 V AC	CR-P120AC2	1SVR405601R2000				
230 V AC	CR-P230AC2	1SVR405601R3000				

### Ordering details - CR-P range pluggable optocouplers

Rated control supply voltage (Us)	Outputs	Type	Order code	Pkg qty	Weight (1 pc.) kg (lb)
10-32 V DC	MOS-FET, 5 A - 35 V DC	CR-P024MOS1	1SVR405610R4060	10	0.011 (0.618)
	Triac, 3 A - 275 V AC	CR-P024TRI1	1SVR405610R4070		

### Ordering details - Accessories

Version	Connection terminal	Type	Order code	Pkg qty	Weight (1 pc.) kg (lb)
Logical socket with protective separation	screw	CR-PLS	1SVR405650R0000	10	0.045 (0.099)
Logical socket	screw	CR-PLSx	1SVR405650R0100		0.043 (0.095)
	spring	CR-PLC	1SVR405650R0200		0.042 (0.093)
Standard socket	screw	CR-PSS	1SVR405650R1000		0.038 (0.084)
Plastic holder for socket		CR-PH	1SVR405659R0000	10	0.002 (0.004)
Metal holder		CR-PH1	1SVR405659R0100		
Jumper bar for sockets with screw connection		CR-PJ	1SVR405658R5000		0.018 (0.040)
Marker		CR-PM	1SVR405658R0000	10	0.0002 (0.0004)

## Pluggable interface relays and optocouplers

### Ordering details – CR-M range



CR-M

2CDC291.002.F0015

The CR-M range offers the possibility of switching up to 4 different circuits with a single relay. The integrated LED and test button allow for easy testing and commissioning. This range of relays are available at a wide range of different coil voltages and are accompanied by a wide variety of functional modules. The CR-M range also includes complete versions consisting of a relay, socket, holder and functional module.

#### Ordering details - CR-M range without LED

Rated control supply voltage	Outputs	Contact ratings	Type	Order code	Pkg	Weight				
					qty	(1 pc.) kg (lb)				
12 V DC	2 c/o (SPDT)	250 V, 12 A	CR-M012DC2	1SVR405611R4000	10	0.033 (0.073)				
24 V DC			CR-M024DC2	1SVR405611R1000						
48 V DC			CR-M048DC2	1SVR405611R6000						
60 V DC			CR-M060DC2	1SVR405611R4200						
110 V DC			CR-M110DC2	1SVR405611R8000						
125 V DC			CR-M125DC2	1SVR405611R8200						
220 V DC			CR-M220DC2	1SVR405611R9000						
24 V AC			CR-M024AC2	1SVR405611R0000						
48 V AC			CR-M048AC2	1SVR405611R5000						
110 V AC			CR-M110AC2	1SVR405611R7000						
120 V AC			CR-M120AC2	1SVR405611R2000						
230 V AC			CR-M230AC2	1SVR405611R3000						
12 V DC			3 c/o (SPDT)	250 V, 10 A			CR-M012DC3	1SVR405612R4000	10	0.033 (0.073)
24 V DC							CR-M024DC3	1SVR405612R1000		
48 V DC	CR-M048DC3	1SVR405612R6000								
60 V DC	CR-M060DC3	1SVR405612R4200								
110 V DC	CR-M110DC3	1SVR405612R8000								
125 V DC	CR-M125DC3	1SVR405612R8200								
220 V DC	CR-M220DC3	1SVR405612R9000								
24 V AC	CR-M024AC3	1SVR405612R0000								
48 V AC	CR-M048AC3	1SVR405612R5000								
60 V AC	CR-M060AC3	1SVR405612R5200								
110 V AC	CR-M110AC3	1SVR405612R7000								
120 V AC	CR-M120AC3	1SVR405612R2000								
230 V AC	CR-M230AC3	1SVR405612R3000								
12 V DC	4 c/o (SPDT)	250 V, 6 A			CR-M012DC4	1SVR405613R4000	10	0.033 (0.073)		
24 V DC			CR-M024DC4	1SVR405613R1000						
48 V DC			CR-M048DC4	1SVR405613R6000						
60 V DC			CR-M060DC4	1SVR405613R4200						
110 V DC			CR-M110DC4	1SVR405613R8000						
125 V DC			CR-M125DC4	1SVR405613R8200						
220 V DC			CR-M220DC4	1SVR405613R9000						
24 V AC			CR-M024AC4	1SVR405613R0000						
48 V AC			CR-M048AC4	1SVR405613R5000						
110 V AC			CR-M110AC4	1SVR405613R7000						
120 V AC			CR-M120AC4	1SVR405613R2000						
230 V AC			CR-M230AC4	1SVR405613R3000						

## Pluggable interface relays and optocouplers

### Ordering details – CR-M range



CR-M

2CDC291.002.F0015

#### Ordering details - CR-M range with LED

Rated control supply voltage	Outputs	Contact ratings	Type	Order code	Pkg	Weight
					qty	(1 pc.)
12 V DC	2 c/o (SPDT)	250 V, 12 A	CR-M012DC2L	1SVR405611R4100	10	0.033 (0.073)
24 V DC			CR-M024DC2L	1SVR405611R1100		
48 V DC			CR-M048DC2L	1SVR405611R6100		
60 V DC			CR-M060DC2L	1SVR405611R4300		
110 V DC			CR-M110DC2L	1SVR405611R8100		
125 V DC			CR-M125DC2L	1SVR405611R8300		
220 V DC			CR-M220DC2L	1SVR405611R9100		
12 V AC			CR-M012AC2L	1SVR405611R0300		
24 V AC			CR-M024AC2L	1SVR405611R0100		
48 V AC			CR-M048AC2L	1SVR405611R5100		
110 V AC			CR-M110AC2L	1SVR405611R7100		
120 V AC			CR-M120AC2L	1SVR405611R2100		
230 V AC			CR-M230AC2L	1SVR405611R3100		
12 V DC			3 c/o (SPDT)	250 V, 10 A		
24 V DC	CR-M024DC3L	1SVR405612R1100				
48 V DC	CR-M048DC3L	1SVR405612R6100				
60 V DC	CR-M060DC3L	1SVR405612R4300				
110 V DC	CR-M110DC3L	1SVR405612R8100				
125 V DC	CR-M125DC3L	1SVR405612R8300				
220 V DC	CR-M220DC3L	1SVR405612R9100				
12 V AC	CR-M012AC3L	1SVR405612R0300				
24 V AC	CR-M024AC3L	1SVR405612R0100				
48 V AC	CR-M048AC3L	1SVR405612R5100				
110 V AC	CR-M110AC3L	1SVR405612R7100				
120 V AC	CR-M120AC3L	1SVR405612R2100				
230 V AC	CR-M230AC3L	1SVR405612R3100				
12 V DC	4 c/o (SPDT)	250 V, 6 A			CR-M012DC4L	1SVR405613R4100
24 V DC			CR-M024DC4L	1SVR405613R1100		
48 V DC			CR-M048DC4L	1SVR405613R6100		
60 V DC			CR-M060DC4L	1SVR405613R4300		
110 V DC			CR-M110DC4L	1SVR405613R8100		
125 V DC			CR-M125DC4L	1SVR405613R8300		
220 V DC			CR-M220DC4L	1SVR405613R9100		
12 V AC			CR-M012AC4L	1SVR405613R0300		
24 V AC			CR-M024AC4L	1SVR405613R0100		
48 V AC			CR-M048AC4L	1SVR405613R5100		
110 V AC			CR-M110AC4L	1SVR405613R7100		
120 V AC			CR-M120AC4L	1SVR405613R2100		
230 V AC			CR-M230AC4L	1SVR405613R3100		

## Pluggable interface relays and optocouplers

### Ordering details – CR-M range



CR-M4SS

2CDC291.009.F0011



CR-MJ

2CDC291.005.F0007

#### Ordering details - Accessories

Version	Connection terminal	Type	Order code	Pkg	Weight
				qty	(1 pc.) kg (lb)
Logical socket for 2 c/o	screw	CR-M2LS	1SVR405651R1100	10	0.055 (0.121)
Logical socket for 3 c/o		CR-M3LS	1SVR405651R2100		0.062 (0.137)
Logical socket for 2/4 c/o		CR-M4LS	1SVR405651R3100		0.066 (0.146)
Logical socket for 2 c/o	spring	CR-M2LC	1SVR405651R1200	10	0.065 (0.143)
Logical socket for 2/4 c/o		CR-M4LC	1SVR405651R3200		0.066 (0.146)
Standard socket for 2 c/o	screw	CR-M2SS	1SVR405651R1000	10	0.066 (0.146)
Standard socket for 3 c/o		CR-M3SS	1SVR405651R2000		0.068 (0.150)
Standard socket for 2/4 c/o		CR-M4SS	1SVR405651R3000		0.070 (0.154)
Standard socket for 2 c/o	fork type	CR-M2SF	1SVR405651R1300	10	0.040 (0.088)
Standard socket for 2/4 c/o		CR-M4SF	1SVR405651R3300		0.048 (0.106)
Plastic holder		CR-MH	1SVR405659R1000	10	0.003 (0.007)
Metal holder		CR-MH1	1SVR405659R1100	10	0.0005 (0.001)
Jumper bar for sockets with screw connection		CR-MJ	1SVR405658R6000	10	0.029 (0.064)
Marker		CR-MM	1SVR405658R1000	10	0.0005 (0.001)
Plug for test button replacement		CR-MP	1SVR405658R2000	100	0.001 (0.002)

---

# Motor control and protection

<b>148</b>	<b>Push buttons</b>
<b>149</b>	<b>Emergency stops, enclosures heavy duty push buttons</b>
<b>150</b>	<b>Standard and double push buttons</b>
<b>151</b>	<b>Emergency, stops and Selector switches</b>
<b>152</b>	<b>Key switches &amp; pilot lights</b>
<b>153</b>	<b>Contacts, lamp blocks and accessories</b>
<b>154</b>	<b>3-pole contactor overview</b>
<b>156</b>	<b>AF09 ... AF38 3 pole contactors</b>
<b>157</b>	<b>AF40 ... AF96 3 pole contactors</b>
<b>158</b>	<b>AF40 ... AF96 3 pole contactors</b>
<b>160</b>	<b>Overload protection</b>
<b>161</b>	<b>Limit switches</b>



For more detailed product information, please refer to our online technical brochures available at: [new.abb.com/low-voltage/support/documentation](http://new.abb.com/low-voltage/support/documentation)

or contact our sales team via email [LV.enquiries@gb.abb.com](mailto:LV.enquiries@gb.abb.com)

or call 0333 999 9933

# Pilot devices - compact 22mm

## Push buttons

Push buttons black plastic bezel

**Order example:**  
 EX1: Type CP1-10 ■ -10, to order colour red replace ■ with R: CP1-10 R-10  
 EX2: Order code 1SFA619100R101 □  
 To order red replace □ with 1: 1SFA619100R1011

**Colour Codes**

	Red	Green	Yellow	Blue	White	Black	Grey	Clear
Type ■	R	G	Y	L	W	B	U	c
Order code □	1	2	3	4	5	6	7	8

Type	Contacts		Part No	Order Code
	N/O	N/C		
Flush momentary	1	https://cdn.	CP1-10 ■ -10	1SFA619100R101 □
	2	-	CP1-10 ■ -20	1SFA619100R102 □
	-	1	CP1-10 ■ -01	1SFA619100R104 □
	-	2	CP1-10 ■ -02	1SFA619100R105 □
	1	1	CP1-10 ■ -11	1SFA619100R107 □
Flush maintained	1	-	CP2-10 ■ -10	1SFA619101R101 □
	2	-	CP2-10 ■ -20	1SFA619101R102 □
	-	1	CP2-10 ■ -01	1SFA619101R104 □
	-	2	CP2-10 ■ -02	1SFA619101R105 □
	1	1	CP2-10 ■ -11	1SFA619101R107 □
Extended momentary	1	-	CP3-10 ■ -10	1SFA619102R101 □
	2	-	CP3-10 ■ -20	1SFA619102R102 □
	-	1	CP3-10 ■ -01	1SFA619102R104 □
	-	2	CP3-10 ■ -02	1SFA619102R105 □
	1	1	CP3-10 ■ -11	1SFA619102R107 □
Extended maintained	1	-	CP4-10 ■ -10	1SFA619103R101 □
	2	-	CP4-10 ■ -20	1SFA619103R102 □
	-	1	CP4-10 ■ -01	1SFA619103R104 □
	-	2	CP4-10 ■ -02	1SFA619103R105 □
	1	1	CP4-10 ■ -11	1SFA619103R107 □

Push buttons chrome metal bezel

Type	Contacts		Part No	Order Code
	N/O	N/C		
Flush momentary	1	-	CP1-30 ■ -10	1SFA619100R301 □
	2	-	CP1-30 ■ -20	1SFA619100R302 □
	-	1	CP1-30 ■ -01	1SFA619100R304 □
	-	2	CP1-30 ■ -02	1SFA619100R305 □
	1	1	CP1-30 ■ -11	1SFA619100R307 □
Flush maintained	1	-	CP2-30 ■ -10	1SFA619101R301 □
	2	-	CP2-30 ■ -20	1SFA619101R302 □
	-	1	CP2-30 ■ -01	1SFA619101R304 □
	-	2	CP2-30 ■ -02	1SFA619101R305 □
	1	1	CP2-30 ■ -11	1SFA619101R307 □
Extended momentary	1	-	CP3-30 ■ -10	1SFA619102R301 □
	2	-	CP3-30 ■ -20	1SFA619102R302 □
	-	1	CP3-30 ■ -01	1SFA619102R304 □
	-	2	CP3-30 ■ -02	1SFA619102R305 □
	1	1	CP3-30 ■ -11	1SFA619102R307 □
Extended maintained	1	-	CP4-30 ■ -10	1SFA619103R301 □
	2	-	CP4-30 ■ -20	1SFA619103R302 □
	-	1	CP4-30 ■ -01	1SFA619103R304 □
	-	2	CP4-30 ■ -02	1SFA619103R305 □
	1	1	CP4-30 ■ -11	1SFA619103R307 □

## Pilot devices - compact 22mm

Emergency stops, enclosures and LED's

### Emergency stop buttons

	Type	Contacts		Part No	Order Code
		N/O	N/C		
	30mm Twist Release Red	0	1	CE3T-10R-01	1SFA619500R1041
		0	2	CE3T-10R-02	1SFA619500R1051
		1	1	CE3T-10R-11	1SFA619500R1071
	40mm Twist Release Red	0	1	CE4T-10R-01	1SFA619550R1041
		0	2	CE4T-10R-02	1SFA619550R1051
		1	1	CE4T-10R-11	1SFA619550R1071
	40mm Key Release Red	0	2	CE4K-10R-02	1SFA619552R1051
		1	1	CE4K-10R-11	1SFA619552R1071

### Enclosures

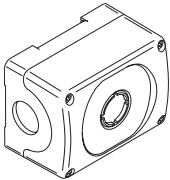
	Type	Part No	Order Code
	Enclosure 1 hole - yellow	CEPY1-0	1SFA619821R1000
	Enclosed E-Stop (twist release 2NO + 2NC)	CEPY1-1001	1SFA619821R1001
	Enclosed E-Stop with shroud (twist release)	CEPY1-2001	1SFA619821R2001
	E-Stop shroud for compact enclosure	CA1-8053	1SFA619920R8053

### Compact LED pilot lights

	Colour	Part No	Order Code
	<b>Rated voltage 24 V AC/DC</b>		
	Red	CL2-502R	1SFA619403R5021
	Green	CL2-502G	1SFA619403R5022
	Yellow	CL2-502Y	1SFA619403R5022
	Blue	CL2-502L	1SFA619403R5024
	Clear	CL2-502C	1SFA619403R5028
	<b>Rated voltage 110-130 V AC</b>		
	Red	CL2-513R	1SFA619403R5131
	Green	CL2-513G	1SFA619403R5132
	Yellow	CL2-513Y	1SFA619403R5133
	<b>Rated voltage 110-130 V DC</b>		
	Red	CL2-515R	1SFA619403R5151
	Green	CL2-515G	1SFA619403R5152
Yellow	CL2-515Y	1SFA619403R5153	
<b>Rated voltage 220 V DC</b>			
Red	CL2-520R	1SFA619403R5201	
Green	CL2-520G	1SFA619403R5202	
Yellow	CL2-520Y	1SFA619403R5203	
<b>Rated voltage 230 V AC</b>			
Red	CL2-523R	1SFA619403R5231	
Green	CL2-523G	1SFA619403R5232	
Yellow	CL2-523Y	1SFA619403R5233	
Blue	CL2-523L	1SFA619403R5234	
Clear	CL2-523C	1SFA619403R5238	
<b>Rated voltage 380-415 V AC</b>			
Red	CL2-542R	1SFA619403R5421	
Green	CL2-542G	1SFA619403R5422	

## Pilot devices - modular 22mm

### Push buttons

#### Standard push buttons black plastic bezel



Type		Part No	Order Code
Flush	Momentary Non illuminated	MP1-10 ■	1SFA611100R100 □
	Maintained	MP2-10 ■	1SFA611101R100 □
	Momentary Illuminated	MP1-11 ■	1SFA611101R110 □
	Maintained	MP2-11 ■	1SFA611101R110 □
Extended	Momentary Non illuminated	MP3-10 ■	1SFA611102R100 □
	Maintained	MP4-10 ■	1SFA611103R100 □
	Momentary Illuminated	MP3-11 ■	1SFA611102R110 □
	Maintained	MP4-11 ■	1SFA611103R110 □

#### Standard push buttons chrome plastic bezel



Type		Part No	Order Code
Flush	Momentary Non illuminated	MP1-20 ■	1SFA611100R200 □
	Maintained	MP2-20 ■	1SFA611101R200 □
	Momentary Illuminated	MP1-21 ■	1SFA611100R210 □
	Maintained	MP2-21 ■	1SFA611101R210 □
Extended	Momentary Non illuminated	MP3-20 ■	1SFA611102R200 □
	Maintained	MP4-20 ■	1SFA611103R200 □
	Momentary Illuminated	MP3-21 ■	1SFA611102R210 □
	Maintained	MP4-21 ■	1SFA611103R210 □

#### Standard push buttons metal bezel



Type		Part No	Order Code
Flush	Momentary Non illuminated	MP1-30 ■	1SFA611100R300 □
	Maintained	MP2-30 ■	1SFA611101R300 □
	Momentary Illuminated	MP1-31 ■	1SFA611100R310 □
	Maintained	MP2-31 ■	1SFA611101R310 □
Extended	Momentary Non illuminated	MP3-30 ■	1SFA611102R300 □
	Maintained	MP4-30 ■	1SFA611103R300 □
	Momentary Illuminated	MP3-31 ■	1SFA611102R310 □
	Maintained	MP4-31 ■	1SFA611103R310 □

Select your colour by replacing with a digit from the chart below

#### How to order standard operators:

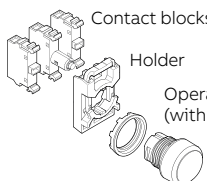
- Non-illuminated operator + holder + contact block(s)
  - Illuminated operator + holder + contact block(s) + lamp block
- 

#### Color codes

Description	Type	Order Code
Red	R	1
Green	G	2
Yellow	Y	3
Blue	L	4
White	W	5
Black	B	6
Grey	U	7
Clear	C	8

#### Contact blocks including holder with 3 blocks

Description	Type	Order Code
1 NO	MCBH-10	1SFA611605R1101
1 NC	MCBH-01	1SFA611605R1110
2 NC	MCBH-02	1SFA611605R1120
2 NO	MCBH-20	1SFA611605R1102
1 NO+1 NC	MCBH-11	1SFA611605R1111
1 NO+2 NC	MCBH-12	1SFA611605R1121
<b>Contact blocks</b>		
1 NO	MCB-10	1SFA611610R1001
1 NC	MCB-01	1SFA611610R1010
<b>Separate holder for 3 blocks</b>		
Holder	MCBH-00	1SFA611605R1100



#### Ordering example:

- Ex 1: Type CP1-10 ■ -10, to order color red replace ■ with R: CP1-10 R-10  
 Ex 2: Order code 1SFA619100R101 □, to order color red replace □ with 1: 1SFA619100R1011

## Pilot devices - modular 22mm

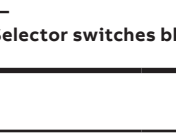

### Emergency stops and selector switches

#### Emergency stops



Type		Part No	Order Code
	30mm Red Non illuminated	Twist release MPET3-10R	1SFA611520R1001
		Pull release MPEP3-10R	1SFA611521R1001
		Key release MPEK3-11R	1SFA611522R1101
	40mm Red Non illuminated	Twist release MPET4-10R	1SFA611523R1001
		Pull release MPEP4-10R	1SFA611524R1001
		Key release MPEK4-11R	1SFA611525R1101
	40mm Red Illuminated	Twist release MPMT3-11R	1SFA611510R1101
		Pull release MPMP3-11R	1SFA611511R1101
	60mm Red Illuminated	Twist release MPMT4-11R	1SFA611513R1101
		Pull release MPMP4-11R	1SFA611514R1101

### Selector switches - black plastic bezel and chrome metal bezel

#### Selector switches black plastic bezel

Type	Part No	Order Code
	Two position BC Black Short handle	M2SS1-10B 1SFA611200R1006
	Two position AC Black Short handle	M2SS2-10B 1SFA611201R1006
	Two position spring return CB Black Short handle	M2SS3-10B 1SFA611202R1006
	Two position BC Black Long handle	M2SS4-10B 1SFA611203R1006
	Two position AC Black Long handle	M2SS5-10B 1SFA611204R1006
	Two position spring return CB Black Long handle	M2SS6-10B 1SFA611205R1006
	Three position ABC Black Short handle	M3SS1-10B 1SFA611210R1006
	Three position spring return A to B - C to B Black Short handle	M3SS2-10B 1SFA611211R1006
	Three position stay put A, spring return C to B Black Short handle	M3SS3-10B 1SFA611212R1006
	Three position stay put C, spring return A to B Black Short handle	M3SS7-10B 1SFA611216R1006
	Three position ABC Black Long handle	M3SS4-10B 1SFA611213R1006
	Three position spring return A to B - C to B Black Long handle	M3SS5-10B 1SFA611214R1006
	Three position stay put A, spring return C to B Black Long handle	M3SS6-10B 1SFA611215R1006
	Three position stay put C, spring return A to B Black Long handle	M3SS8-10B 1SFA611217R1006

#### Selector switches chrome metal bezel

Type	Part No	Order Code
	Two position BC Black Short handle	M2SS1-30B 1SFA611200R3006
	Two position AC Black Short handle	M2SS2-30B 1SFA611201R3006
	Two position spring return CB Black Short handle	M2SS3-30B 1SFA611202R3006
	Two position BC Black Long handle	M2SS4-30B 1SFA611203R3006
	Two position AC Black Long handle	M2SS5-30B 1SFA611204R3006
	Two position spring return CB Black Long handle	M2SS6-30B 1SFA611205R3006
	Three position ABC Black Short handle	M3SS1-30B 1SFA611210R3006
	Three position spring return A to B - C to B Black Short handle	M3SS2-30B 1SFA611211R3006
	Three position stay put A, spring return C to B Black Short handle	M3SS3-30B 1SFA611212R3006
	Three position stay put C, spring return A to B Black Short handle	M3SS7-30B 1SFA611216R3006
	Three position ABC Black Long handle	M3SS4-30B 1SFA611213R3006
	Three position spring return A to B - C to B Black Long handle	M3SS5-30B 1SFA611214R3006
	Three position stay put A, spring return C to B Black Long handle	M3SS6-30B 1SFA611215R3006
	Three position stay put C, spring return A to B Black Long handle	M3SS8-30B 1SFA611217R3006

## Pilot devices - modular 22mm

### Key switches, pilot lights

#### Key switches black plastic bezel

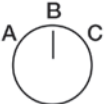
Type	Part No	Order Code
 	Two position Key release in BC positions	71/Ronis 455 Maintained 72/Ronis 421 BC 73/Ronis 3433-E M2SSK1-101 1SFA611280R1001 M2SSK1-102 1SFA611280R1002 M2SSK1-103 1SFA611280R1003
	Two position Key release in B positions	71/Ronis 455 72/Ronis 421 73/Ronis 3433-E M2SSK2-101 1SFA611281R1001 M2SSK2-102 1SFA611281R1002 M2SSK2-103 1SFA611281R1003
	Two position	71/Ronis 455 Momentary 72/Ronis 421 BC 73/Ronis 3433-E M2SSK3-101 1SFA611282R1001 M2SSK3-102 1SFA611282R1002 M2SSK3-103 1SFA611282R1003
Three position	71/Ronis 455 Maintained 72/Ronis 421 ABC 73/Ronis 3433-E M3SSK1-101 1SFA611283R1001 M3SSK1-102 1SFA611283R1002 M3SSK1-103 1SFA611283R1003	

#### Key switches chrome metal bezel

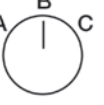
Type	Part No	Order Code
 	Two position Key release in BC positions	71/Ronis 455 Maintained 72/Ronis 421 BC 73/Ronis 3433-E M2SSK1-301 1SFA611280R3001 M2SSK1-302 1SFA611280R3002 M2SSK1-303 1SFA611280R3003
	Two position Key release in B positions	71/Ronis 455 72/Ronis 421 73/Ronis 3433-E M2SSK2-301 1SFA611281R3001 M2SSK2-302 1SFA611281R3002 M2SSK2-303 1SFA611281R3003
	Two position	71/Ronis 455 Momentary 72/Ronis 421 BC 73/Ronis 3433-E M2SSK3-301 1SFA611282R3001 M2SSK3-302 1SFA611282R3002 M2SSK3-303 1SFA611282R3003
Three position	71/Ronis 455 Maintained 72/Ronis 421 ABC 73/Ronis 3433-E M3SSK1-301 1SFA611283R3001 M3SSK1-302 1SFA611283R3002 M3SSK1-303 1SFA611283R3003	

#### Pilot lights

	Part No	Order Code0
	Red	ML-100 R 1SFA611400R1001
	Green	ML-100 G 1SFA611400R1002
	Yellow	ML-100 Y 1SFA611400R1003
	Blue	ML-100 B 1SFA611400R1004
	White	ML-100 W 1SFA611400R1005
	Clear	ML-100 C 1SFA611400R1008
	Light diffusing lens	KA1-8005 1SFA616920R8005

## Pilot devices - modular 22mm

Contacts, lamp blocks and accessories

	Part No	Order Code	
	<b>Separate holder</b>		
	Holder for 3 blocks	MCBH-00	1SFA611605R1100
	Holder for 5 blocks	MCBH-50	1SFA611601R1100
	<b>Contact blocks</b>		
	1 NO	MCB-10	1SFA611610R1001
	1 NC	MCB-01	1SFA611610R1010
	2 NC	MCB-20	1SFA611610R1020
	2 NC	MCB-02	1SFA611610R1002
	1 NO + 1 NC	MCB-11	1SFA611610R1011
	<b>Contact blocks with 3-holder included</b>		
	1 NO	MCBH-10	1SFA611605R1101
	1 NC	MCBH-01	1SFA611605R1110
	2 NO	MCBH-20	1SFA611605R1102
	2 NC	MCBH-02	1SFA611605R1120
	1 NO + 1 NC double contacts	MCBH-11	1SFA611605R1111
	2 NO + 1 NC double contacts	MCBH-21	1SFA611605R1112
	<b>Legend plate holders</b>		
	Holder black	KA1-8120	1SFA616920R8120
	Inserts without text	KA1-8121	1SFA616920R8121
	Legend plate holder for plastic enclosures	MA6-1060	1SFA611930R1060
	Inserts without text for plastic enclosures	MA6-1061	1SFA611930R1061
	<b>General accessories</b>		
	Shroud	MA1-8053	1SFA611920R8053
	Mounting tool	MA1-8015	1SFA611920R8015
	Membrane of silicone flush button	KA1-8052	1SFA616920R8052
	Blanking plug	MA1-8130	1SFA611920R8130
	Spacer	-	SK615516-1
	Spacer for emergency stop	KA1-8045	1SFA616920R8045
		<b>Empty enclosures</b>	
Empty Grey Enclosure - 1 Seat			1SFA611811R1000
Empty Grey Enclosure - 2 Seat			1SFA611812R1000
Empty Grey Enclosure - 3 Seat			1SFA611813R1000
Empty Grey Enclosure - 4 Seat			1SFA611814R1000
Empty Yellow Enclosure - 1 Seat			1SFA611821R1000
	<b>Contact blocks for enclosures</b>		
	1 NO		1SFA611610R2001
	1 NC		1SFA611610R2010
	2 NO		1SFA611610R2002
	2 NC		1SFA611610R2020
	1 NO + 1 NC		1SFA611610R2011

### 3-pole contactor overview

#### Contactors for motor control and power switching



IEC (1)	AC-3 Rated operational power	≤ 60 °C (2), 400 V	kW	4	5.5	7.5	11	15	18.5	18.5	22	30	37	45
UL/CSA	3-phase motor rating	480 V	hp	5	7.5	10	15	20	25	30	40	50	60	60
AC / DC Control supply			Type	AF09	AF12	AF16	AF26	AF30	AF38	AF40	AF52	AF65	AF80	AF96
AC Control supply			Type	AF09	AF12	AF16	AF26	AF30	AF38	AF40	AF52	AF65	AF80	AF96
DC Control supply			Type	AF09	AF12	AF16	AF26	AF30	AF38	AF40	AF52	AF65	AF80	AF96
IEC	AC-3 Rated operational current	≤ 60 °C (2), 400 V	A	9	12	18	26	32	38	40	53	65	80	96
	AC-1 Rated operational current	≤ 40 °C, 690 V	A	25	28	30	45	50	50	70	100	105	125	130
UL/CSA	General use rating	600 V	A	25	28	30	45	50	50	60	80	90	105	115
NEMA	NEMA Size			00	0	-	1	-	-	2	-	-	3	-

#### Main accessories

Auxiliary contact blocks	Front mounting	CA4-10 (1 x N.O.) CA4-01 (1 x N.C.)
	Side mounting	CAL4-11 (1 x N.O. + 1 x N.C.)
Timers	Electronic	TEF4-ON TEF4-OFF
Interlocking units <sup>(3)</sup>	Mechanical	VM4
	Mechanical / Electrical	VEM4
Connection sets	For reversing contactors	BER16-4
Surge suppressors	Varistor (AC/DC)	BER38-4
	RC type (AC)	BER65-4
	Transil diode (DC)	BER96-4

#### Overload relays

Thermal relays		Class 10 (Class 10A for TF140, TA200DU)	TF42 (0.10...38 A)	TF65 (22...67 A)	TF96 (40...96 A)
Electronic relays		Class 10E, 20E, 30E	EF19 (0.10...18.9 A)	EF19 (0.10...18.9 A) EF45 (9...45 A)	EF65 (20...70 A) EF96 (36...100 A)

#### Manual motor starters

	Thermal / magnetic protection Class 10	MS116 (0.10...32 A) lcs up to 50 kA for class 10 A	MS450 (28...50 A) lcs up to 50 kA
		MS132 (0.10...32 A) lcs up to 100 kA	MO495 (63...100 A) lcs up to 50 kA
			MS497 (22...100 A) lcs up to 100 kA
	Magnetic only types	MO132 (0.16...32 A) lcs up to 100 kA	MO496 (32...100 A) lcs up to 100 kA
Accessories	For contactor mounting	BEA16-4	BER38-4



55	75	75	90	110	132	160	200	200	250	315	400	-	475	560	-	-
75	100	100	125	150	200	250	300	350	400	500	600	-	800	900	-	-
AF116	AF116	AF146	AF190	AF205	AF265	AF305	AF370	AF400	AF460	AF580	AF750	AF1250	AF1350	AF1650	AF2050	AF2650
AF116	AF140	AF146	AF190	AF205	AF265	AF305	AF370	AF400	AF460	AF580	AF750	AF1250	AF1350	AF1650	AF2050	AF2650
AF116	AF140	AF146	AF190	AF205	AF265	AF305	AF370	AF400	AF460	AF580	AF750	AF1250	AF1350	AF1650	AF2050	AF2650
116	140	146	190	205	265	305	370	400	460	580	750	-	860	1050	-	-
160	200	225	275	350	400	500	600	600	700	800	1050	1260	1350	1650	2050	2650
160	200	200	250	300	350	400	520	550	650	750	900	1210	1350	1650	2100	2700
-	4	-	-	-	5	-	-	-	6	-	7	-	-	8	-	-

CAL19-11 (1 x N.O. + 1 x N.C.)

CAL18-11 (1 x N.O. + 1 x N.C.)

TEF4-ON TEF4-OFF

VM19 (for same size contactors)

VM750H VM750V

VM1650H

BER140-4

BER205-4

BER370-4

BEM460-30

BEM750-30

Built-in surge protection

TF140DU  
(66...142 A) ≤ 55 °C

TA200DU  
(66...200 A) ≤ 55 °C

EF146  
(54...150 A)

EF205  
(63...210 A)

EF370  
(115...380 A)

EF460  
(150...500 A)

EF750  
(250...800 A)

E1250DU  
(375...1250 A)

Short-circuit protection devices



## AF09 ... AF38 3 pole contactors





4 to 18.5kW AC/DC operated

AF09 ... AF38 contactors are mainly used for controlling 3-phase motors and power circuits up to 690 V AC and 220 V DC. These contactors are of the block type design with 3 main poles.

- Control circuit: AC or DC operated with electronic coil interface accepting a wide control voltage range (e.g. 100...250 V AC and DC), only 4 control voltage ranges covering 24...500V 50/60 Hz and 20...500 V DC

- Can manage large control voltage variations
- Reduced panel energy consumption
- Very distinct closing and opening

- Built-in surge suppression
- Add-on auxiliary contact blocks for front or side mounting and a wide range of accessories

	IEC		UL/CSA		Rated control circuit voltage		Auxiliary contacts fitted		Part Number <sup>(1)</sup>	Order Code		
	Rated operational power 400 V AC-3 kW	current ≤ 40 °C AC-1 A	3-phase motor rating 480 V hp	General use rating 600 V AC A	Uc min. ... V 50/60 Hz	Uc max. V DC						
 AF09-30-10	4	25	5	25	24...60	20...60	1	0	AF09-30-10-11	1SBL137001R1110		
					48...130	48...130	0	1	AF09-30-01-11	1SBL137001R1101		
									1	0	AF09-30-10-12	1SBL137001R1210
									0	1	AF09-30-01-12	1SBL137001R1201
									1	0	AF09-30-10-13	1SBL137001R1310
									0	1	AF09-30-01-13	1SBL137001R1301
									1	0	AF09-30-10-14	1SBL137001R1410
									0	1	AF09-30-01-14	1SBL137001R1401
	 AF26-30-00	5.5	28	7.5	28	24...60	20...60	1	0	AF12-30-10-11	1SBL157001R1110	
						48...130	48...130	0	1	AF12-30-01-11	1SBL157001R1101	
									1	0	AF12-30-10-12	1SBL157001R1210
									0	1	AF12-30-01-12	1SBL157001R1201
									1	0	AF12-30-10-13	1SBL157001R1310
									0	1	AF12-30-01-13	1SBL157001R1301
									1	0	AF12-30-10-14	1SBL157001R1410
									0	1	AF12-30-01-14	1SBL157001R1401
		7.5	30	10	30	24...60	20...60	1	0	AF16-30-10-11	1SBL177001R1110	
						48...130	48...130	0	1	AF16-30-01-11	1SBL177001R1101	
								1	0	AF16-30-10-12	1SBL177001R1210	
								0	1	AF16-30-01-12	1SBL177001R1210	
								1	0	AF16-30-10-13	1SBL177001R1310	
								0	1	AF16-30-01-13	1SBL177001R1301	
								1	0	AF16-30-10-14	1SBL177001R1410	
								0	1	AF16-30-01-14	1SBL177001R1401	
	11	45	15	45	24...60	20...60	0	0	AF26-30-00-11	1SBL237001R1100		
					48...130	48...130	0	0	AF26-30-00-12	1SBL237001R1100		
					100...250	100...250	0	0	AF26-30-00-13	1SBL237001R1300		
					250...500	250...500	0	0	AF26-30-00-14	1SBL237001R1400		
	15	50	20	50	24...60	20...60	0	0	AF30-30-00-11	1SBL277001R1100		
					48...130	48...130	0	0	AF30-30-00-12	1SBL277001R1200		
					100...250	100...250	0	0	AF30-30-00-13	1SBL277001R1300		
					250...500	250...500	0	0	AF30-30-00-14	1SBL277001R1400		
	18.5	50	25	50	24...60	20...60	0	0	AF38-30-00-11	1SBL297001R1100		
					48...130	48...130	0	0	AF38-30-00-12	1SBL297001R1200		
					100...250	100...250	0	0	AF38-30-00-13	1SBL297001R1300		
					250...500	250...500	0	0	AF38-30-00-14	1SBL297001R1400		

<sup>1)</sup> For other auxiliary contacts arrangements, please contact your ABB local sales organization.







## AF40 ... AF96 3 pole contactors

18.5 to 45kW AC/DC operated

AF40 ... AF96 contactors are mainly used for controlling 3-phase motors and power circuits up to 690 V AC and 220 V DC. These contactors are of the block type design with 3 main poles.

- Control circuit: AC or DC operated with electronic coil interface accepting a wide control voltage range (e.g. 100...250 V AC and DC), only 4 control voltage ranges covering 24...500V 50/60 Hz and 20...500 V DC

- Can manage large control voltage variations
- Reduced panel energy consumption
- Very distinct closing and opening
- Built-in surge suppression
- Add-on auxiliary contact blocks for front or side mounting and a wide range of accessories

	IEC		UL/CSA		Rated control circuit voltage		Auxiliary contacts fitted		Part Number <sup>(1)</sup>	Order Code
	Rated operational power	current $\leq 40^\circ\text{C}$	3-phase motor rating	General use rating	Uc min. ...	Uc max.				
	400 V AC-3 kW	AC-1 A	480 V hp	600 V AC A	V 50/60 Hz	V DC				
 AF40-30-00	18.5	70	30	60	24...60	–	0	0	AF40-30-00-41	1SBL347001R4100
					24...60	20...60	0	0	AF40-30-00-11	1SBL347001R1100
					48...130	48...130	0	0	AF40-30-00-12	1SBL347001R1200
					100...250	100...250	0	0	AF40-30-00-13	1SBL347001R1300
					250...500	250...500	0	0	AF40-30-00-14	1SBL347001R1400
 AF52-30-00	22	100	40	80	24...60	–	0	0	AF52-30-00-41	1SBL367001R4100
					24...60	20...60	0	0	AF52-30-00-11	1SBL367001R1100
					48...130	48...130	0	0	AF52-30-00-12	1SBL367001R1200
					100...250	100...250	0	0	AF52-30-00-13	1SBL367001R1300
					250...500	250...500	0	0	AF52-30-00-14	1SBL367001R1400
 AF65-30-00	30	105	50	90	24...60	–	0	0	AF65-30-00-41	1SBL387001R4100
					24...60	20...60	0	0	AF65-30-00-11	1SBL387001R1100
					48...130	48...130	0	0	AF65-30-00-12	1SBL387001R1200
					100...250	100...250	0	0	AF65-30-00-13	1SBL387001R1300
					250...500	250...500	0	0	AF65-30-00-14	1SBL387001R1400
 AF80-30-00	37	125	60	105	24...60	–	0	0	AF80-30-00-41	1SBL397001R4100
					24...60	20...60	0	0	AF80-30-00-11	1SBL397001R1100
					48...130	48...130	0	0	AF80-30-00-12	1SBL397001R1200
					100...250	100...250	0	0	AF80-30-00-13	1SBL397001R1300
					250...500	250...500	0	0	AF80-30-00-14	1SBL397001R1400
 AF96-30-00	45	130	60	155	24...60	–	0	0	AF96-30-00-41	1SBL407001R4100
					24...60	20...60	0	0	AF96-30-00-11	1SBL407001R1100
					48...130	48...130	0	0	AF96-30-00-12	1SBL407001R1200
					100...250	100...250	0	0	AF96-30-00-13	1SBL407001R1300
					250...500	250...500	0	0	AF96-30-00-14	1SBL407001R1400

<sup>1)</sup> For other auxiliary contacts arrangements, please contact your ABB local sales organization.

\*\* Note: larger sizes and 4 pole versions available - contact us for further information.

# AF09 ... AF96 3 pole contactors

## Main accessories

### Contactor and main accessories (other accessories available)

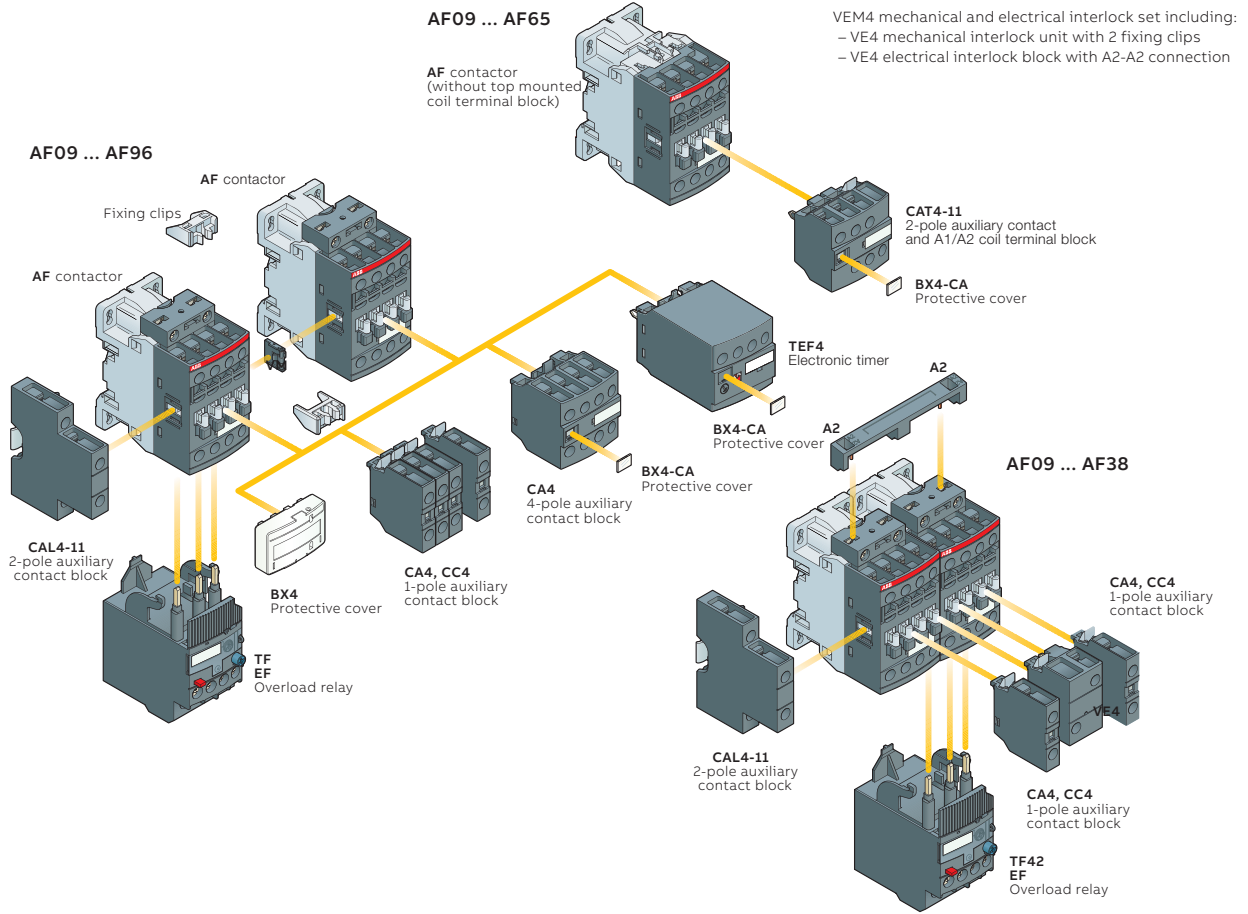

### Main accessory fitting details

Many configurations of accessories are possible depending on whether these are front-mounted or side-mounted.















Contactor types	Main poles				Built-in auxiliary contacts				Front-mounted accessories			Side-mounted accessories		
	Main poles	Built-in auxiliary contacts	Auxiliary contact blocks		Electronic timer	Electrical & mechanical interlock set (between 2 contactors)	Auxiliary contact blocks							
			1-pole CA4	1-pole CC4			Left side	Right side						
			1-pole CA4	2-pole CAT4-11	TEF4	VEM4	2-pole CAL4-11							
			1-pole CC4	4-pole CA4										
			Max. N.C. built-in and add-on N.C. auxiliary contacts: 4 N.C. max. on positions 1, 2, 3, 4 and 3 N.C. max. on positions 1 ±30°, 5											
AF09 ... AF16	3	0	0	1	4 max. or	1 or	1 or	1	- +	1	-			
AF09 ... AF16	3	0	1	0	2 max. or	1	- or	1	- +	1 +	1			
AF26 ... AF38	3	0	0	0	3 max.	-	-	- +	1 +	1 or	1			
			Max. add-on N.C. auxiliary contacts: 6 N.C. max. on positions 1, 1 ±30°, 2, 3, 4, 5											
AF40 ... AF65	3	0	0	0	4 max. or	1	1	1	- +	1 +	1			
AF80, AF96	3	0	0	0	4 max.	-	1	1	- +	1 +	1			

### Overload relays fitting details (1)

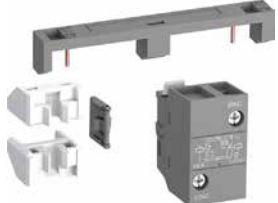
Contactor types	Thermal overload relays	Electronic overload relays
AF09 ... AF38	TF42 (0.10...38 A)	EF19 (0.10...19 A)
AF26 ... AF38	TF42 (0.10...38 A)	EF45 (9...45 A)
AF40 ... AF65	TF65 (22...67 A)	EF65 (20...70 A)
AF80, AF96	TF96 (40...96 A)	EF96 (36...100 A)

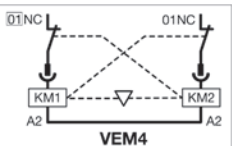
## AF09 ... AF96 3 pole contactors

### Main accessories

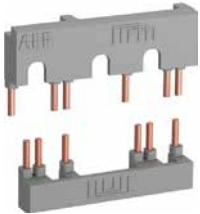
		Auxiliary contacts				Part Number <sup>(1)</sup>	Order Code
For contactors							
<b>Front-mounted instantaneous auxiliary contact blocks</b>							
	AF09 ... AF38	1	0	-	-	CA4-10	1SBN010110R1010
		1	0	-	-	CA4-10-T	1SBN010110T1010
		0	1	-	-	CA4-01	1SBN010110R1001
		0	1	-	-	- CA4-01-T	1SBN010110T1001
	AF09 ... AF16...-30-10	2	2	-	-	CA4-22M	1SBN010140R1122
	AF26 ... AF96...-30-00	2	2	-	-	CA4-22E	1SBN010140R1022
	AF09 ... AF16...-30-01	2	2	-	-	CA4-22U	1SBN010140R1322
<b>Front-mounted auxiliary contact blocks with N.O. leading contact and N.C. lagging contact</b>							
	AF09 ... AF96	-	-	1	0	CC4-10	1SBN010111R1010
		-	-	0	1	CC4-01	1SBN010111R1001
<b>Side-mounted instantaneous auxiliary contact blocks</b>							
	AF09 ... AF96	1	1	-	-	CAL4-11	1SBN010120R1011
		1	1	-	-	CAL4-11-T	1SBN010120T1011
<b>Front-mounted instantaneous auxiliary contact and A1/A2 coil terminal blocks</b>							
	AF09 ... AF16...-30-10	1	1	-	-	CAT4-11M	1SBN010151R1111
	AF26 ... AF65...-30-00	1	1	-	-	CAT4-11E	1SBN010151R1011
	AF09 ... AF16...-30-01	1	1	-	-	CAT4-11U	1SBN010151R1311
Note: CAT4 not suitable for AF..Z contactors with DC control voltage 12...20 V DC.							
<b>Mechanical interlock unit</b>							
	AF09 ... AF38					VM4	1SBN030105T1000
	AF40 ... AF96					VM96-4	1SBN033405T1000
Note: VM4 and VM96-4 include 2 fixing clips (BB4) to maintain together both contactors.							
<b>Mechanical and electrical interlock set</b>							
	AF09 ... AF16 AF26 ... AF38	0	2	-	-	VEM4	1SBN030111R1000
	Note: - VEM4 includes a VM4 mechanical interlock unit with 2 fixing clips (BB4), a VE4 electrical interlock block. VE4 block must be used with A2-A2 connection to respect the electrical connection diagram. - VEM4 not suitable for AF..Z contactors with DC control voltage 12...20 V DC.						
		Time delay range selected by switch	Auxiliary contacts		Part Number <sup>(1)</sup>	Order Code	
For contactors		Delay type					
<b>Electronic timers</b>							
	AF09 ... AF96	0.1...1 s	ON-delay	-	-	TEF4-ON	1SBN020112R1000
		1...10 s					
		10...100 s	OFF-delay	-	-	TEF4-OFF	1SBN020114R1000
Note: Rated control circuit voltage U <sub>c</sub> 24...240 V 50/60 Hz or DC.							
<b>Connecting links with manual motor starters</b>							
	AF09 ... AF16	with	MS116-0.16 ... MS116-25, MS132-0.16 ... MS132-25			BEA16-4	1SBN081306T1000
	AF26 ... AF38	with	MS116-0.16 ... MS116-16, MS132-0.16 ... MS132-10			BEA26-4	1SBN082306T1000
		with	MS116-20 ... MS116-32, MS132-12 ... MS132-32			BEA38-4	1SBN082306T2000
<b>Connection sets for reversing contactors</b>							
	AF09 ... AF16					BER16-4	1SBN081311R1000
	AF26 ... AF38					BER38-4	1SBN082311R1000
	AF40 ... AF65					BER65-4	1SBN083411R1000
	AF80 ... AF96					BER96-4	1SBN083911R1000
<b>Mechanical interlock unit</b>							
AF09 ... AF16		With or without VM4				BEY16-4	1SBN081313R2000
AF26 ... AF38		With or without VM4				BEY38-4	1SBN082713R2000
AF40 ... AF65		With or without VM96-4				BEY65-4	1SBN083413R2000
AF80 ... AF96		With or without VM96-4				BEY96-4	1SBN083913R2000

(1) For more information, refer to main catalogue "Accessories" section.

## Overload protection

### Selection

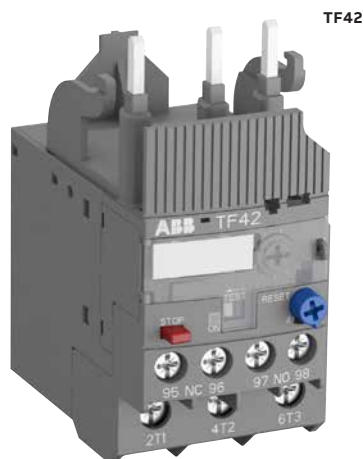

#### TF42

The TF42 thermal overload relays are economic electromechanical protection devices for the main circuit. They offer reliable protection for motors in the event of overload or phase failure. The devices have trip class 10.

The thermal overload relays are three pole relays with bimetal tripping elements. The motor current flows through the bimetal tripping elements and heats them directly and indirectly. In case of an overload (over current), the bimetal elements bent as a result of the heating. This leads to a release of the relay and a change of the contacts switching position (95-96 / 97-98).

- Manual or automatic reset selectable
- Phase loss sensitive acc. to IEC/EN 60947-4-1
- TEST and STOP function – Trip indication on the front
- Temperature compensation
- Suitable for three- and single-phase applications

#### TF42 0.10 to 38.0A

Setting range A	Short-circuit protective device	Trip class	Part No
0.10 ... 0.13	0.5 A, fuse type T7.5	10	TF42-0.13
0.13 ... 0.17	1.0 A, fuse type T	10	TF42-0.17
0.17 ... 0.23	1.0 A, fuse type T	10	TF42-0.23
0.23 ... 0.31	1.0 A, fuse type T	10	TF42-0.31
0.31 ... 0.41	2.0 A, fuse type gG	10	TF42-0.41
0.41 ... 0.55	2.0 A, fuse type gG	10	TF42-0.55
0.55 ... 0.74	4.0 A, fuse type gG	10	TF42-0.74
0.74 ... 1.00	6.0 A, fuse type gG	10	TF42-1.0
1.00 ... 1.30	6.0 A, fuse type gG	10	TF42-1.3
1.30 ... 1.70	10.0 A, fuse type gG	10	TF42-1.7
1.70 ... 2.30	10.0 A, fuse type gG	10	TF42-2.3
2.30 ... 3.10	10.0 A, fuse type gG	10	TF42-3.1
3.10 ... 4.20	20.0 A, fuse type gG	10	TF42-4.2
4.20 ... 5.70	20.0 A, fuse type gG	10	TF42-5.7
5.70 ... 7.60	35.0 A, fuse type gG	10	TF42-7.6
7.60 ... 10.0	35.0 A, fuse type gG	10	TF42-10
10.0 ... 13.0	40.0 A, fuse type gG	10	TF42-13
13.0 ... 16.0	40.0 A, fuse type gG	10	TF42-16
16.0 ... 20.0	63.0 A, fuse type gG	10	TF42-20
20.0 ... 24.0	63.0 A, fuse type gG	10	TF42-24
24.0 ... 29.0	63.0 A, fuse type gG	10	TF42-29
29.0 ... 35.0	80.0 A, fuse type gG	10	TF42-35
35.0 ... 38.0/40.0	80.0 A, fuse type gG	10	TF42-38

**Note:**

The overload in star delta starters should be fitted in the Delta loop, therefore overload rating equal to FLC x by 0.58\*

#### Overload calculation for Star Delta starters

Motor FLC	Delta Loop Setting
5	2.9
6	3.5
7	4.0
8	4.6
9	5.2
10	5.8
12	7.0
14	8.1
16	9.3
18	10.4
20	11.6
25	14.5
30	17.4
35	20.3
40	23.2
45	26.1
50	29.0
55	32.0

## Limit switches

Trustworthy detection devices



Using limit switches is the easiest way to convert mechanical movements into electrical signals. They combine different types of actuators, casings and contacts and are perfectly suited to a large variety of applications, whatever the environment.



Reliable in extreme conditions

### Ready for anything

Limit switches are designed to operate in the most difficult environments. A high degree of protection up to IP66 and the positive contact opening, guarantees reliable operation.



Continuous operation

### Keep your installation running 24h a day

Limit switches secure your uptime. Their high mechanical durability can handle up to 10 million operations with contacts that are mechanically linked to actuators.



Global availability

### Wherever you are

Easy product selection from our core offering that covers most applications. Thanks to global certification, our products can be used everywhere to ensure your peace of mind.

## Main applications

### Sustainability of detection for a wide variety of applications

Material handling equipment (cranes, ramps, elevators...) Escalators, parking barriers and automatic doors  
Machine tools and manufacturing lines.









## Limit switches





A simple core range selection covering 80% of the applications...



Width 30 mm - Plastic casing - Double insulation  - IP65

Head type	Cable inlet	Type	Order Code
 11 Plain plunger steel	Iso 16	LS32P11B11	1SBV010311R1211
	Iso 20	LS33P11B11	1SBV012211R1211
	1/2" NPT	LS35P11B11	1SBV012111R1211
 13 Roller plunger plastic	Iso 16	LS32P13B11	1SBV010313R1211
	Iso 20	LS33P13B11	1SBV012213R1211
	1/2" NPT	LS35P13B11	1SBV012113R1211
 41 Roller lever plastic	Iso 16	LS32P41B11	1SBV010341R1211
	Iso 20	LS33P41B11	1SBV012241R1211
	1/2" NPT	LS35P41B11	1SBV012141R1211
 51 Adjustable roller lever plastic	Iso 16	LS32P51B11	1SBV010351R1211
	Iso 20	LS33P51B11	1SBV012251R1211
	1/2" NPT	LS35P51B11	1SBV012151R1211
 91 Flexible rod steel	Iso 16	LS32P91B11	1SBV010391R1211
	Iso 20	LS33P91B11	1SBV012291R1211
	1/2" NPT	LS35P91B11	1SBV012191R1211

Width 40 mm - Plastic casing - Double insulation  - IP65





Head type	Cable inlet	Type	Order Code
 11 Plain plunger steel	Iso 20	LS43P11B11	1SBV010711R1211
	1/2" NPT	LS45P11B11	1SBV012411R1211
 13 Roller plunger steel	Iso 20	LS43P13B11	1SBV010713R1211
	1/2" NPT	LS45P13B11	1SBV012413R1211
 41 Roller lever plastic	Iso 20	LS43P41B11	1SBV010741R1211
	1/2" NPT	LS45P41B11	1SBV012441R1211
 51 Adjustable roller lever plastic	Iso 20	LS43P51B11	1SBV010751R1211
	1/2" NPT	LS45P51B11	1SBV012451R1211
 91 Flexible rod steel	Iso 20	LS43P91B11	1SBV010791R1211
	1/2" NPT	LS45P91B11	1SBV012491R1211

### Cable inlet:





ISO 16 (standard version) equivalent to Pg11 – Cable diameter: 4.5 mm ... 10 mm (according to cable gland manufacturer)

ISO 20 (standard version) equivalent to Pg13.5 – Cable diameter: 7 mm ... 14 mm (according to cable gland manufacturer)

Metal casing - IP66

Head type	Cable inlet	Type	Order Code
 11 Plain plunger steel	Iso 16	LS32M11B11	1SBV011911R1211
	Iso 20	LS33M11B11	1SBV013811R1211
	1/2" NPT	LS35M11B11	1SBV013711R1211
 13 Roller plunger plastic	Iso 16	LS32M12B11	1SBV011912R1211
	Iso 20	LS33M12B11	1SBV013812R1211
	1/2" NPT	LS35M12B11	1SBV013712R1211
 41 Roller lever plastic	Iso 16	LS32M41B11	1SBV011941R1211
	Iso 20	LS33M41B11	1SBV013841R1211
	1/2" NPT	LS35M41B11	1SBV013741R1211
 51 Adjustable roller lever plastic	Iso 16	LS32M51B11	1SBV011951R1211
	Iso 20	LS33M51B11	1SBV013851R1211
	1/2" NPT	LS35M51B11	1SBV013751R1211
 91 Flexible rod steel	Iso 16	LS32M91B11	1SBV011991R1211
	Iso 20	LS33M91B11	1SBV013891R1211
	1/2" NPT	LS35M91B11	1SBV013791R1211

Metal casing - IP66

Head type	Cable inlet	Type	Order Code
 11 Plain plunger steel	Iso 20	LS43M11B11	1SBV011611R1211
	1/2" NPT	LS45M11B11	1SBV013111R1211
 13 Roller plunger steel	Iso 20	LS43M13B11	1SBV011613R1211
	1/2" NPT	LS45M13B11	1SBV013113R1211
 41 Roller lever plastic	Iso 20	LS43M41B11	1SBV011641R1211
	1/2" NPT	LS45M41B11	1SBV013141R1211
 51 Adjustable roller lever plastic	Iso 20	LS43M51B11	1SBV011651R1211
	1/2" NPT	LS45M51B11	1SBV013151R1211
 91 Flexible rod steel	Iso 20	LS43M91B11	1SBV011691R1211
	1/2" NPT	LS45M91B11	1SBV013191R1211

Technical data	Plastic casing	Metal casing
Rated operational characteristics	AC-15: Ue = 400 V, Ie = 4 A ; A600	AC-15: Ue = 400 V, Ie = 4 A ; A300
	DC-13: Ue = 250 V, Ie = 0,27 A ; Q600	DC-13: Ue = 250 V, Ie = 0,27 A ; Q300
Casing material	UL-V0 thermoplastic	30 mm casing: zinc alloy / 40 mm casing: aluminium alloy
Contact types	1 N.O. + 1 N.C., snap action	
I <sub>the</sub> conventional enclosed thermal current	10 A	
Screw terminals with cable clamp	M3.5 - Screwdriver type: Pozidriv 2	

---

# Cable management products

<b>164</b>	<b>Introduction</b>
<b>167</b>	<b>Adaptaflex - Convenience packs</b>
<b>168</b>	<b>Adaptaflex - Metallic flexible conduit systems</b>
<b>178</b>	<b>Adaptaflex - Non-metallic flexible conduit systems</b>
<b>188</b>	<b>Cable glands</b>
<b>194</b>	<b>Speckon lugs</b>
<b>196</b>	<b>Cable ties</b>
<b>202</b>	<b>E-Klips - Mechanical and Electrical fixings</b>



For more detailed product information, please refer to our online technical brochures available at: [new.abb.com/low-voltage/support/documentation](http://new.abb.com/low-voltage/support/documentation)

or contact our sales team via email [LV.enquiries@gb.abb.com](mailto:LV.enquiries@gb.abb.com)

or call 0333 999 9933

# Introduction

## Company overview

Adaptaflex flexible conduit systems are used to protect critical power and data cabling. Established in 1972, Adaptaflex has developed into a leading player within the flexible conduit market.

Adaptaflex is a market-leading flexible conduit system brand that can be found all over the world. Combining innovative design with dedicated manufacture it offers customers one of the world's broadest ranges of cable protection products and solutions. With a choice of over 6000 products the range covers metallic and non-metallic flexible conduit systems for the protection of critical power and data cable.

The system solutions from Adaptaflex need to perform in a wide variety of environments, from high temperature to freezing conditions. The products are designed and tested to withstand constant vibrations, water ingress and offer corrosion and chemical resistance. Products are available in many different materials, including halogen free, low smoke and low toxicity materials. An extensive range of engineered solutions are designed to withstand the rigours of some of the most technically-demanding markets. So whatever your project involves, our experience will provide the answer, helping you to specify the correct flexible conduit system.

### Markets and industries

Adaptaflex flexible conduit systems are used to protect critical power and data cabling throughout a wide range of markets including:

- Commercial contracting
- Machinery
- Rail/Infrastructure
- Marine
- Mechanical
- Security/CCTV
- Data cabling
- Critical power

Our products are designed and engineered to meet a variety of market application requirements, providing product innovation that saves installation and component costs, improves quality and delivers integrity in the end product.



# Introduction

## Quality approvals & third party testing

### Quality approvals

The company's commitment to independent testing across a wide range of applications has led to an impressive range of certifications and quality approvals:

- BSI Kitemark
- BS EN ISO14001 Environmental standard
- IEC 61386 Conduit standard covering the performance characteristics of flexible conduits
- ISO 60529 IP69 Rated, standard with its Adaptaflex range of non metallic fittings
- Offer non-metallic conduit that is fully compliant to the new dual listed UL 1696 standard. Required for any equipment destined for export to the USA and Canada
- The Hi-Spec PEEK range, designed for the most demanding electrical applications in rail infrastructure, underground and public buildings, is the only non-metallic flexible conduit system fully compliant with both BS 6853 Class 1A requirement and LUL engineering standard 1-085

#### Industry standards

As one of the world's leading flexible conduit system manufacturers, Adaptaflex has achieved many international approvals, for our manufacturing as well as our product ranges.

Adaptaflex are able to use our experience and knowledge to ensure safety and quality levels are maintained now and in the future.

### Third party testing & approvals

#### IEC61386 Performance classification standard

Adaptaflex has achieved third party accreditation to the IEC61386 Standard from the British Standards Institution (BSI). IEC61386 conformance guarantees that products meet performance specifications for fatigue life, operating temperature, non-flame propagation, IP ratings amongst other criteria.

#### BSI Kitemark

Adaptaflex manufacture to third party accreditation through the BSI Kitemark scheme. The Kitemark is one of the world's premier symbols of trust, integrity and quality. Manufacturers with the Kitemark are an elite club of some of the world's best companies being annually tested to ensure continued compliance. Having the Kitemark associated with our products illustrates that we have satisfied the most rigorous of quality processes.

#### ISO9001 Quality standard

Adaptaflex conform to ISO 9001:2000, the internationally recognised standard for Quality Management Systems. This standard reflects the procedures and management processes throughout the whole of the company.

#### ISO14001 and ISO45001 Environmental standard

Controlling the impact of manufacturing activities on the environment is a major challenge. Again Adaptaflex lead the way by being the first conduit manufacturer to comply with this Standard.

#### Customer support

All our products are backed up by a full technical support team, sales teams, customer care team and in-house marketing specialists. All dedicated teams working together to ensure that you have the best support in the market place.



## Flexible conduit systems

### Quick selection guide



Type	Metallic conduit				Non-metallic conduit	
	Corrugated Metallic	Corrugated Metallic	Smooth Liquid-Tight Metallic	Anti-microbial Liquid Tight Metallic	Corrugated Plastic	Corrugated Plastic
Series	S	SP	SPL	SAM	PP	PA
Usage	Heavy weight conduit for commercial building, light industrial or outdoor applications	Heavy-duty industrial, confined space and moving applications	Heavy-duty industrial, marine, extreme condition and hazardous explosive area applications	Food, Beverage, Pharmaceutical, Hygienic and high temperature applications	Medium weight conduit for commercial building, light industrial or outdoor applications	Commercial building, light industrial or outdoor applications
Core material	Galvanised Steel	Galvanised Steel	Galvanised Steel	Galvanised or Stainless Steel	Polypropylene	Nylon PA6
Jacket material	None	PVC	PVC	Thermoplastic	None	None
IP rating	Up to IP40	Up to IP65	Up to IP69	Up to IP69K	Up to IP66	Up to IP69K
Temperature range	-50 to +300	-25 to +70	-20 to +105	-30 to +150	-20 to +90	-40 to +120
Flexibility	High	High	Medium	Medium	High	High
Mechanical strength	Very High?	Very High	Very High	Very High	Low	Medium
UV Resistance	Very High	Very High	Very High	High	Medium	Very High
Zero Halogen	No	No	No	Yes	Yes	Yes
Self Extinguishing	Yes	Yes	Yes	Yes	No	Yes

- This product book contains a basic selection of popular ABB Adaptaflex Conduit ranges

- Several more Conduit ranges available including Stainless Steel, Low fire hazard, Braided EMI screening, Food & Beverage specific, Hazardous Explosive Area, Accessories, etc.

- Please contact our office or visit <http://new.abb.com/low-voltage/products/conduit-fittings/adaptaflex>

## Convenience packs

Professional installer conduit systems

### LFH Convenience



Order code	Type	Conduit/fitting diameter (mm)	One-piece conduit fittings	Locknuts	IP rating
CP-AF20A	10m Black Type PA LFH Nylon 6, 20mm diameter	20	10	10	IP66
CP-AF25A	10m Black Type PA LFH Nylon 6, 25mm diameter	25	10	10	IP66

Convenience pack / Nylon Conduit with Adaptalok One-Piece, Fast Fit, Push & Twist Fittings  
Materials: Polyamide Nylon 6 / Colour: Black (BL)



### Polypropylene Convenience



Order code	Type	Conduit/fitting diameter (mm)	One-piece conduit fittings	Locknuts	IP rating
CP-AF20BS-PP	10m Grey Type PP Polypropylene conduit, 20mm diameter	20	10	10	IP54
CP-AF25BS-PP	10m Grey Type PP Polypropylene conduit, 25mm diameter	25	10	10	IP54

Convenience Pack / Type PP Polypropylene Conduit with One-Piece, Fast Fit, Push & Twist Fittings  
Materials: PP Polypropylene / Colour: Grey (GR)

### Retail / Office Convenience



Order code	Type	Conduit/fitting diameter (mm)	One-piece conduit fittings	Locknuts	IP rating
CP-AF20BS	10m Grey Type KF PVCu, 20mm diameter	20	10	10	IP66
CP-AF25BS	10m Grey Type KF PVCu, 20mm diameter	25	10	10	IP66
CP-KF20BS	10m White Type KF PVCu, 25mm diameter	20	10	10	IP66
CP-KF25BS	10m White Type KF PVCu, 25mm diameter	25	10	10	IP66

Convenience Pack / Self-Extinguishing PVC Conduit & One-Piece Fittings & Locknuts  
Materials: PVC Pliable / Colour: White (W)

## Anti-microbial metallic conduit systems

### SAMHL series - Smooth anti-microbial liquid-tight conduit

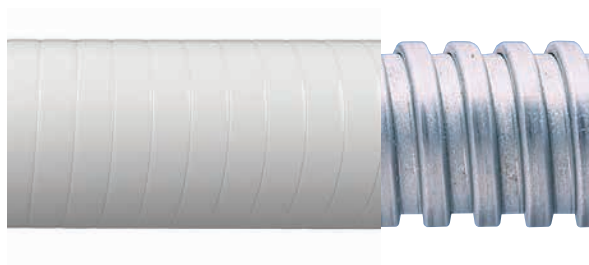

Anti-microbial liquid tight high temperature covered steel flexible conduit. Suitable for indoor splash zone areas or food processing equipment. The biocidal coating attacks bacteria that comes into contact with it, including MRSA, E.coli, etc eliminating 99% in 2 hours.

#### Features



- **Type SAMHL** - Galvanized steel core string packed with Anti-microbial protection incorporated into a FDA, EC and FSA compliant DuPont Hytrel® thermoplastic jacket
- **Type SSAMHL** - Stainless steel string with Anti-microbial protection incorporated into a FDA, EC and FSA compliant DuPont Hytrel® thermoplastic jacket
- IP40 – IP69 rated
- Temperature range up to -50°C to +130°C
- Approvals: CE, BS EN 61386-1,-23, NSF 14159-1-2014 & NSF 169-2009

#### Type SAMHL and SSAMHL - Anti-microbial liquid tight conduit



Order code		Conduit size (mm)	Diameter Dimensions (mm)			Coil lengths	
Galvanised Steel Core	Stainless Steel Core		Outside	Inside	Bend radius	Galvanised Steel Core	Stainless Steel Core
SAMHL16/25M	SSAMHL16/25M	16	17.8mm	12.5mm	50mm	25	25
SAMHL20/25M	SSAMHL20/25M	20	21.1mm	15.9mm	80mm	25	25
SAMHL25/25M	SSAMHL25/25M	25	26.4mm	21.0mm	110mm	25	25
SAMHL32/25M	SSAMHL32/25M	32	33.1mm	26.7mm	144mm	25	25
SAMHL40/25M	SSAMHL40/25M	40	41.8mm	35.4mm	180mm	25	25
SAMHL50/25M	SSAMHL50/25M	50	47.5mm	40.4mm	240mm	25	25
SAMHL63/25M	SSAMHL63/25M	63	59.7mm	51.6mm	345mm	25	25

Note: Conduit is fully cleanable and will maintain full ingress protection under normal wet cleaning conditions with associated fittings.

#### Type SAMHL

Approvals	IP rating	Appropriate fitting	Temperature range	UV resistance
   NSF 14159-1-2014 NSF 169-2009	For use with: Type SPL, SSPL and SAM		Static applications: -50°C to +130°C	-
	IP66	Type M, C45 & C90	Moving applications: -5°C to +150°C	
	IP67	Type A, B, M, C45 & C90	<b>Flexibility &amp; fatigue life</b>	High flexibility - High fatigue life
	IP68	Type M, C45 & C90 (10 bar 30mins)	<b>Fire Performance &amp; EMI Screen</b>	Self extinguishing
	IP69	Type M, C45 & C90		

#### Type SSAMHL

Approvals	IP rating	Appropriate fitting	Temperature range	UV resistance
   NSF 14159-1-2014 NSF 169-2009	For use with: Type SPL, SSPL and SAM		Static applications: -50°C to +130°C	-
	IP66	Type M, C45 & C90	Moving applications: -5°C to +150°C	
	IP67	Type A, B, M, C45 & C90		
	IP68	Type M, C45 & C90 (10 bar 30mins)		
	IP69	Type M, C45 & C90		

## Anti-microbial metallic conduit systems

### Type SAM for SAMHL series conduit



Single piece, liquid tight, high temperature Stainless Steel fitting suitable for indoor splash zone areas or food processing equipment



#### Features

- Unique single piece design
- 316 Stainless Steel
- Face seal materials adhere to FDA (Food and Drug Administration) and European Food Contact regulations
- IP67, IP68 & IP69 protection
- Approvals CE, BS EN 61386-1,-23, NSF14159-1-2014, NSF169-2009, UL514b
- Multiple thread type Metric/NPT

#### Fittings for SAMHL series conduit

METRIC Order code	Conduit size		Nominal Dimensions							Weight (g)
	METRIC (mm)	US (NPT)	B	C	D	E	F	G		
SPL16/M16/SAM	16	3/8"	7.0	32.8	30.0	31.9	14.0	10.5	9.98	
SPL20/M20/SAM	20	1/2"	10.0	35.6	32.0	35.0	18.0	14.5	11.34	
SPL25/M25/SAM	25	3/4"	14.0	43.0	38.0	41.0	23.0	18.3	16.78	
SPL32/M32/SAM	32	1"	15.0	51.5	45.0	49.0	30.0	24.1	29.94	
SPL40/M40/SAM	40	1 1/4"	16.0	53.3	57.0	61.5	38.0	32.7	39.92	
SPL50/M50/SAM	50	1 1/2"	18.0	60.2	64.0	69.0	48.0	37.7	45.36	
SPL63/M63/SAM	63	2"	20.0	71.4	80.0	87.0	61.0	49.0	52.16	

Note: Parts are maintenance free, face seal can be replaced if damaged. Parts are fully cleanable and will maintain full ingress protection under normal wet cleaning conditions.

Approvals	IP rating	Temperature range	UV resistance
  NSF 14159-1-2014 NSF 169-2009  UL514b File No. E60625	<b>For use with:</b> All liquidtight conduit <b>IP66</b> Yes <b>IP68</b> Yes (10 bar 30mins) <b>IP69</b> Yes	Static applications: -50°C to +130°C Moving applications: -5°C to +150°C	-
	<b>Flexibility &amp; fatigue life</b>		
	High flexibility - High fatigue life		
<b>Fire Performance &amp; EMI Screen</b>		Self extinguishing	

## Metallic conduit systems



### Type LFH-SPL & SPL - Adaptasteel

- Low fire hazard performance covered steel flexible conduit
- Material: Low fire hazard jacket covered galvanised steel
- Colour: Black (BL) only

#### Type LFH-SPL - Adaptasteel

	Order code	Nominal Conduit Size	Outside Diameter	US Conduit Size	Inside Diameter	Min. Bend Radius	Reel Length
	LFH-SPL16	16mm	17.0mm	3/8"	13.0mm	50mm	10, 25m
	LFH-SPL20	20mm	21.5mm	1/2"	16.9mm	80mm	10, 25m
	LFH-SPL25	25mm	26.0mm	3/4"	21.4mm	110mm	10, 25m
	LFH-SPL32	32mm	34.0mm	1"	28.1mm	145mm	10, 25m
	LFH-SPL40	40mm	44.5mm	1 1/4"	37.7mm	180mm	10m

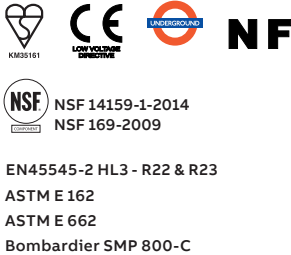
To order quote order code, colour & reel length, e.g. LFH-SPL16/BL/25M

Approvals	IP rating	Appropriate fitting	Temperature range	UV resistance
	For use with: Type SPL, SSPL and SAM		Static applications: -20°C to +90°C	High
	IP66	Type M, C45 & C90	Moving applications: -5°C to +105°C	
	IP67	Type A, B, M, C45 & C90	<b>Flexibility &amp; fatigue life</b>	
	IP68	Type M, C45 & C90 (10 bar 30mins)	Medium flexibility – Medium fatigue life	
	IP69	Type M, C45 & C90	<b>Fire performance &amp; EMI screen</b>	
			Self extinguishing	
			Halogen free	

- Liquid tight oil resistant covered steel flexible conduit
- Material: PVC covered galvanised steel
- Colour: Black (BL), Grey (GR), Orange (OR)

#### Type SPL - Adaptasteel

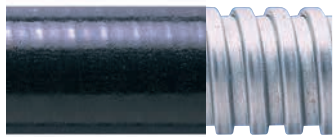
	Order code	Nominal Conduit Size	Outside Diameter	US Conduit Size	Inside Diameter	Min. Bend Radius	Reel Length
	SPL12	12mm	14.2mm	5/16"	10.0mm	45mm	10, 25, 50m
	SPL16	16mm	17.8mm	3/8"	12.5mm	50mm	10, 25, 50m
	SPL20	20mm	21.1mm	1/2"	15.9mm	80mm	10, 25, 50m
	SPL25	25mm	26.4mm	3/4"	21.0mm	110mm	10, 25, 50m
	SPL32	32mm	33.1mm	1"	26.7mm	145mm	10, 25m
	SPL40	40mm	41.8mm	1 1/4"	35.4mm	180mm	10, 25m

To order quote order code, colour & reel length, e.g. SPL12/BL/50M

Approvals	IP rating	Appropriate fitting	Temperature range	UV resistance
	For use with: Type SPL, SSPL and SAM		Static applications: -20°C to +105°C	Very high
	IP66	Type M, C45 & C90	Moving applications: -5°C to +105°C	
	IP67	Type A, B, M, C45 & C90	<b>Flexibility &amp; fatigue life</b>	
	IP68	Type M, C45 & C90 (10 bar 30mins)	Medium flexibility – Medium fatigue life	
	IP69	Type M, C45 & C90	<b>Fire performance &amp; EMI screen</b>	
			Self extinguishing	

## Metallic conduit systems

### Type A, B & M - Adaptasteel

- **Type A** Straight fitting - fixed external male thread
- For insertion into threaded entries & knockouts using a locknut (order locknuts separately)
- Materials: Nickel Plated Brass
- **Type B** Straight fitting - swivel external male thread
- For insertion into threaded entries & knockouts using a locknut (order locknuts separately)
- Materials: Nickel Plated Brass

#### Type A - Adaptasteel

	Order code	Nominal Conduit Size	US Conduit Size	Metric Thread
	SPL16/M16/A	16mm	3/8"	M16
	SPL16/M20/A	16mm	3/8"	M20
	SPL20/M20/A	20mm	1/2"	M20
	SPL25/M25/A	25mm	3/4"	M25
	SPL32/M32/A	32mm	1"	M32

#### Type B - Adaptasteel

	Order code	Nominal Conduit Size	US Conduit Size	Metric Thread
	SPL16/M16/B	16mm	3/8"	M16
	SPL16/M20/B	16mm	3/8"	M20
	SPL20/M20/B	20mm	1/2"	M20
	SPL25/M25/B	25mm	3/4"	M25
	SPL32/M32/B	32mm	1"	M32

Approvals	IP Rating	Appropriate Conduit
		
	For use with: Type SPL / SPLHC / SPUL / SPL-EF / LFH-SPL	

Approvals	IP Rating	Appropriate Conduit
		
	For use with: Type SPL / SPLHC / SPUL / SPL-EF / LFH-SPL	
	IP67	Yes

Static Applications: -65°C to +150°C  
 Moving Applications: -45°C to +150°C

**Temperature Range** **Fitting Characteristics**  
 Static Applications: -65°C to +150°C  
 Moving Applications: -45°C to +150°C



#### Type M - Adaptasteel

	Order code	Nominal Conduit Size	US Conduit Size	Bore
	SPL16/U/M	16mm	3/8"	M20
	SPL20/U/M	20mm	1/2"	M25
	SPL25/U/M	25mm	3/4"	M32
	SPL32/U/M	32mm	1"	
	SPL40/U/M	40mm	1 1/4"	
	SPL50/U/M	50mm	1 1/2"	
	SPL63/U/M	63mm	2"	

- Coupler for coupling separate lengths of liquid tight conduit
- Materials: Nickel Plated Brass, Co-Polyester Seals

Approvals	IP Rating	Appropriate Conduit
		
	For use with: Type SPL / SPLHC / SPUL / SPL-EF / LFH-SPL	
	IP66	Yes
	IP67	Yes
	IP68	Yes (10 bar 30mins)
	IP69	Yes

**Temperature Range** **Fitting Characteristics**  
 Static Applications: -65°C to +150°C  
 Moving Applications: -45°C to +150°C



## Metallic conduit systems



### Type LFH-SP & SP - Adaptasteel

- Liquid resistant enhanced low fire hazard covered steel flexible conduit
- Material: Polyolefin covered galvanised steel
- Colour: Black (BL) only

#### Type LFH-SP - Adaptasteel

	Order code	Nominal Conduit Size	Outside Diameter	Inside Diameter	Min. Bend Radius	Reel Length
	LFH- SP12	12mm	14.0mm	10.3mm	30mm	25, 50m
	LFH- SP16	16mm	17.0mm	13.0mm	35mm	10, 25, 50m
	LFH- SP20	20mm	21.5mm	16.9mm	45mm	10, 25, 50m
	LFH- SP25	25mm	26.0mm	21.4mm	55mm	10, 25, 50m
	LFH- SP32	32mm	34.0mm	28.1mm	60mm	10, 25m
	LFH- SP40	40mm	44.5mm	37.7mm	80mm	10, 25m

To order quote Order code, colour & reel length, e.g. LFH-SP16/BL/50M

Approvals	IP rating	Appropriate fitting	Temperature range	UV resistance	Fire Performance & EMI Screen
 EN45545-2 HL3 - R22 & R23	For use with: Type SP		Static applications: -25°C to +90°C	High	Self extinguishing Halogen free
	IP54	Type SP - Type A, B, C, E & F	Moving applications: -5°C to +105°C		
	IP65	Type SP - Type M & C90	<b>Flexibility &amp; fatigue life</b> High flexibility - Medium fatigue life		

- Liquid resistant general purpose covered steel flexible conduit
- Material: PVC covered galvanised steel
- Colour: Black, Grey and Orange

#### Type SP - Adaptasteel

	Order code	Nominal Conduit Size	Outside Diameter	Inside Diameter	Min. Bend Radius	Reel Length
	SP10	10mm	10.0mm	6.8mm	25mm	25, 50m
	SP12	12mm	14.0mm	10.3mm	30mm	25, 50m
	SP16	16mm	17.0mm	13.0mm	35mm	10, 25, 50m
	SP20	20mm	21.5mm	16.9mm	45mm	10, 25, 50m
	SP25	25mm	26.0mm	21.4mm	55mm	10, 25, 50m
	SP32	32mm	34.0mm	28.1mm	60mm	10, 25m
	SP40	40mm	44.5mm	37.7mm	80mm	10, 25m
	SP50	50mm	55.0mm	48.4mm	90mm	10, 25m
	SP63	63mm	64.5mm	57.5mm	115mm	10m
	SP75	75mm	79.0mm	70.0mm	150mm	10m

To order quote order code colour & reel length, e.g. SP12/BL/25M

Approvals	IP rating	Appropriate fitting	Temperature range	UV resistance
	For use with: Type SP		Static applications: -25°C to +70°C	Very high
	IP54	Type SP - Type A, B, C, E & F	Moving applications: -5°C to +90°C	
	IP65	Type SP - Type M & C90	<b>Flexibility &amp; fatigue life</b> High flexibility - Medium fatigue life	<b>Fire Performance &amp; EMI Screen</b> Self extinguishing

## Metallic conduit systems

### Type A, B, & C90 - Adaptasteel

- **Type A** - Straight fitting - fixed external male thread
- For insertion into knockouts using a locknut
- Order locknuts separately
- Materials: Nickel Plated Brass
- **Type B** - Straight fitting - fixed external male thread
- For insertion into threaded entries & knockouts using a locknut (order locknuts separately)
- Materials: Nickel Plated Brass

#### Type A - Adaptasteel

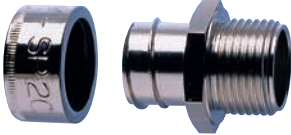
	Order code	Nominal Conduit Size	Metric Thread
	SP10/M12/A	10mm	M12
	SP12/M16/A	12mm	M16
	SP16/M16/A	16mm	M16
	SP16/M20/A	16mm	M20
	SP20/M20/A	20mm	M20
	SP25/M25/A	25mm	M25
	SP32/M32/A	32mm	M32
	SP40/M40/A	40mm	M40
	SP50/M50/A	50mm	M50
	SP63/M63/A	63mm	M63
	SP75/M75/A	75mm	M75

#### Type B - Adaptasteel

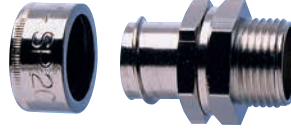
	Order code	Nominal Conduit Size	Metric Thread
	SP10/M12/B	10mm	M12
	SP12/M16/B	12mm	M16
	SP16/M16/B	16mm	M16
	SP16/M20/B	16mm	M20
	SP20/M20/B	20mm	M20
	SP25/M25/B	25mm	M25
	SP32/M32/B	32mm	M32
	SP40/M40/B	40mm	M40
	SP50/M50/B	50mm	M50

Approvals	IP Rating	Appropriate Conduit
		
	For use with: Type SP / SN / LFH-SP	
	IP54	Yes

Approvals	IP Rating	Appropriate Conduit
		
	For use with: Type / SN / LFH-SP	
	IP54	Yes

Temperature Range
Static Applications: -50°C to +300°C
Moving Applications: -45°C to +250°C

Temperature Range
Static Applications: -50°C to +300°C
Moving Applications: -45°C to +250°C

#### Type C90 - Adaptasteel

	Order code	Nominal Conduit Size	Metric Thread
	SPL16/M16/C90	16mm	M16
	SPL16/M20/C90	16mm	M20
	SPL20/M20/C90	20mm	M20
	SPL25/M25/C90	25mm	M25
	SPL32/M32/C90	32mm	M32

- Combined fitting & elbow
- For insertion into threaded entries & knockouts using a locknut (order locknuts separately)
- Materials: Nickel Plated Brass

Approvals	IP Rating	Appropriate Conduit
		
	For use with: Type SP / SN / LFH-SP	
	IP65	Yes

Temperature Range	Fitting Characteristics
Static Applications: -50°C to +300°C	
Moving Applications: -45°C to +250°C	

## Metallic conduit systems



### Type S & SS - Adaptasteel

- Inherent low fire hazard steel conduit
- Material: Stainless steel 316 - corrosion resistant

#### Type SS - Adaptasteel

	Order code	Nominal Conduit Size	Outside Diameter	Inside Diameter	Min. Bend Radius	Reel Length
	SS10	10mm	9.0mm	6.8mm	25mm	25, 50m
	SS12	12mm	13.0mm	10.3mm	30mm	10, 25, 50m
	SS16	16mm	16.0mm	13.0mm	35mm	10, 25, 50m
	SS20	20mm	20.5mm	16.9mm	45mm	10, 25, 50m
	SS25	25mm	25.0mm	21.4mm	55mm	10, 25, 50m
	SS32	32mm	32.0mm	28.1mm	60mm	10, 25m

To order quote order code & reel length, e.g. SS12/25M



Approvals	IP rating	Appropriate fitting	Temperature range	UV resistance	Fire Performance & EMI Screen
 	For use with: Type S		Static applications: -50°C to +350°C	Very high	
	IP40	Type S - Type A, B, F & C	Moving applications: -45°C to +250°C		
			<b>Flexibility &amp; fatigue life</b>		
			High flexibility - High fatigue life		

- Inherent low fire hazard steel conduit
- Material: Galvanised steel - general purpose

#### Type S - Adaptasteel

	Order code	Nominal Conduit Size	Outside Diameter	Inside Diameter	Min. Bend Radius	Reel Length
	S10	10mm	9.1mm	7.0mm	25mm	25, 50m
	S12	12mm	13.0mm	10.3mm	30mm	10, 25, 50m
	S16	16mm	16.0mm	13.0mm	35mm	10, 25, 50m
	S20	20mm	20.5mm	16.9mm	45mm	10, 25, 50m
	S25	25mm	25.0mm	21.4mm	55mm	10, 25, 50m
	S32	32mm	32.0mm	28.1mm	60mm	10, 25m
	S40	40mm	42.5mm	37.7mm	80mm	10, 25m
	S50	50mm	53.0mm	48.4mm	90mm	10, 25m
	S63	63mm	62.5mm	57.5mm	115mm	10m
	S75	75mm	77.0mm	70.0mm	150mm	10m

To order quote order code & reel length, e.g. S12/25M

Approvals	IP rating	Appropriate fitting	Temperature range	UV resistance	Fire Performance & EMI Screen
 	For use with: Type S		Static applications: -50°C to +300°C	Very high	
	IP40	Type S - Type A, B, F & C	Moving applications: -45°C to +250°C		
			<b>Flexibility &amp; fatigue life</b>		
			High flexibility - High fatigue life		

## Metallic conduit systems

Type A, B, C & F - Adaptasteel

- **Type A** - Straight fitting - fixed external male thread
- For insertion into knockouts using a locknut
- Order locknuts separately
- Material: Nickel Plated Brass
- **Type B** - Straight fitting - swivel external male thread
- For insertion into threaded entries & knockouts using a locknut (order locknuts separately)
- Material: Nickel Plated Brass

### Type A - Adaptasteel

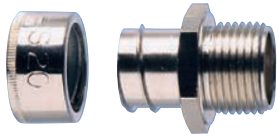
	Order code	Nominal Conduit Size	Metric Thread
	S10/M12/A	10mm	M12
	S12/M16/A	12mm	M16
	S16/M16/A	16mm	M16
	S16/M20/A	16mm	M20
	S20/M20/A	20mm	M20
	S25/M25/A	25mm	M25
	S32/M32/A	32mm	M32
	S40/M40/A	40mm	M40
	S50/M50/A	50mm	M50
	S63/M63/A	63mm	M63
	S75/M75/A	75mm	M75

### Type B - Adaptasteel

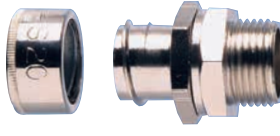
	Order code	Nominal Conduit Size	Metric Thread
	S10/M12/B	10mm	M12
	S12/M16/B	12mm	M16
	S16/M16/B	16mm	M16
	S16/M20/B	16mm	M20
	S20/M20/B	20mm	M20
	S25/M25/B	25mm	M25
	S32/M32/B	32mm	M32
	S40/M40/B	40mm	M40
	S50/M50/B	50mm	M50

Approvals	IP Rating	Appropriate Conduit
	For use with: Type S / SS	
	IP40	Yes

Temperature Range	Fitting Characteristics
Static Applications: -50°C to +300°C	
Moving Applications: -45°C to +250°C	

- Smooth entry bush
- For locking conduit into plain holes in enclosures
- Materials: Nickel Plated Brass

- Straight fitting - swivel external male thread

### Type C - Adaptasteel

	Order code	Nominal Conduit Size	Hole Size
	S10/9/C	10mm	9mm
	S12/12/C	12mm	12mm
	S16/16/C	16mm	16mm
	S20/20/C	20mm	20mm
	S25/25/C	25mm	25mm
	S32/32/C	32mm	32mm
	S40/40/C	40mm	40mm
	S50/51/C	50mm	50mm
	S63/61/C	63mm	63mm
	S75/75/C	75mm	75mm

### Type F - Adaptasteel

	Order code	Nominal Conduit Size	Metric Thread
	S20/M20/F	20mm	M20
	S25/M25/F	25mm	M25
	S32/M32/F	32mm	M32

Approvals	IP Rating	Appropriate Conduit
	For use with: Type S / SS	
	IP40	Yes

Approvals	IP Rating	Appropriate Conduit
	For use with: Type S / SS	
	IP40	Yes

Temperature Range
Static Applications: -50°C to +300°C
Moving Applications: -45°C to +250°C

Temperature Range
Static Applications: -50°C to +300°C

## Metallic conduit systems

### Type M, F - Adaptasteel & Accessories

- Straight swivel fitting - fixed external male thread
- For insertion into threaded entries & knockouts
- Locknut supplied
- Materials: Nickel Plated Brass

#### Type M - Adaptasteel

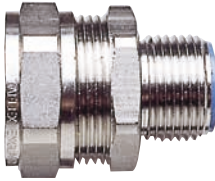
	Order code	Nominal Conduit Size	Metric Thread
	SP12/M16/M	12mm	M16
	SP16/M16/M	16mm	M16
	SP16/M20/M	16mm	M20
	SP20/M20/M	20mm	M20
	SP25/M25/M	25mm	M25
	SP32/M32/M	32mm	M32
	SP40/M40/M	40mm	M40
	SP50/M50/M	50mm	M50

Approvals	IP Rating	Appropriate Conduit
	For use with: Type SP / SN / LFH-SP	
	IP65	Yes

Temperature Range	Fitting Characteristics
Static Applications: -50°C to +150°C	
Moving Applications: -45°C to +150°C	

- Straight fitting - fixed external female thread
- For external threads and other fittings
- Materials: Nickel Plated Brass

#### Type F - Adaptasteel

	Order code	Nominal Conduit Size	Metric Thread
	SP20/M20/F	20mm	M20
	SP25/M25/F	25mm	M25
	SP32/M32/F	32mm	M32

Approvals	IP Rating	Appropriate Conduit
	For use with: Type SP / SN / LFH-SP	
	IP54	Yes

Temperature Range	Fitting Characteristics
Static Applications: -50°C to +300°C	
Moving Applications: -45°C to +250°C	

## Accessories

- Metallic locknuts
- Materials: Nickel Plated Brass, galvanised steel

#### Type LNB/LNS

	Metric Thread	Order code	
		Nickel Plated Brass	Galvanised Steel
	M12 x 1.0	LNB/M12X1	-
	M12 x 1.5	LNB/M12	-
	M16	LNB/M16	LNS/M16
	M20	LNB/M20	LNS/M20
	M25	LNB/M25	LNS/M25
	M32	LNB/M32	LNS/M32
	M40	LNB/M40	-
	M50	LNB/M50	-
	M63	LNB/M63	-
	M75	LNB/M75	-

- P-clip conduit support
- Materials: Plated steel or stainless steel construction with PVC insert

#### Type P

	Plated Steel	Stainless Steel	Nominal Conduit Size
	Order code	Order code	
	PCLIP/10	-	10
	PCLIP/12	-	12
	PCLIP/16	PCLIP/16SS	16
	PCLIP/20	PCLIP/20SS	20
	PCLIP/25	PCLIP/25SS	25
	PCLIP/32	PCLIP/32SS	32
	PCLIP/40	-	40
	PCLIP/50	-	50
	PCLIP/63	-	63
	PCLIP/75	-	75

## Metallic conduit systems

### Accessories

— **Conduit Support Clamps** **Materials: Plated Steel or Stainless Steel Construction with PVC Insert**

	Order code		Nominal conduit size (mm)
	Plated steel plated brass	Stainless Steel	
	PCLIP/10	–	10
	PCLIP/12	–	12
	PCLIP/16	SSPC16	16
	PCLIP/20	SSPC20	20
	PCLIP/25	SSPC25	25
	PCLIP/32	SSPC32	32
	PCLIP/40	SSPC40	40
	PCLIP/50	SSPC50	50
	PCLIP/63	SSPC63	63
	PCLIP/75	–	75

— **Metallic Locknuts** **Materials: Nickel plated brass, stainless steel**

	Order code		
	Metric thread	Nickel plated brass	Stainless steel
	M12 x 1.5	LNB/M12	–
	M16	LNB/M16	LNSS16
	M20	LNB/M20	LNSS20
	M25	LNB/M25	LNSS25
	M32	LNB/M32	LNSS32
	M40	LNB/M40	LNSS40
	M50	LNB/M50	LNSS50
	M63	LNB/M63	LNSS63
	M75	LNB/M75	–

— **Enlargers, Reducers, Converters**

**Materials: Nickel Plated Brass**

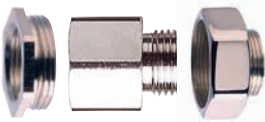
	External thread	Internal thread						
		To M10	To M12	To M16	To M20	To M25	To M32	To M40
	M16	–	B/M16-M12/R	–	B/M16-M20/E	–	–	–
	M20	B/M20-M10/R	B/M20-M12/R	B/M20-M16/R	–	B/M20-M25/E	–	–
	M25	–	–	–	B/M25-M20/R	–	B/M25-M32/E	–
	M32	–	–	–	–	B/M32-M25/R	–	–
	M40	–	–	–	–	–	B/M40-M32/R	–
	M50	–	–	–	–	–	–	B/M50-M40/R

— **Female Coupler** **Brass internal female coupler / Materials: Nickel plated brass**

	Order code	Metric thread	Order code	Metric thread
		B/M16/C	M16	B/M40/C
B/M20/C		M20	B/M50/C	M50
B/M25/C		M25	B/M63/C	M63
B/M32/C		M32	B/M75/C	M75

— **Conduit cutting tool**

Order code	Features
CUT-VICE	Cut-vice offers the ability to produce a clean cut for conduit sizes 16mm to 40mm.
	Place the conduit along the vice body and tighten the clamp. Holding the conduit and integral handle together, insert a hacksaw blade into the guide and cut. For braided conduit, wrap adhesive tape around the cutting point to secure braid. Remove tape after cutting.

— **Locknuts**

	Order code	Mounting thread	Across flats hexagon (mm)	Inner carton pack quantity
	L12	1/2" x 26 TPI	16	100
	LNB-16	M16 x 1.5	20.7	100
	LNB-20	M20 x 1.5	27	100
	LNB-25	M25 x 1.5	31.6	100
	LNB-32	M32 x 1.5	40	100
	LNB-40	M40 x 1.5	48.2	40
	LNB-50	M50 x 1.5	57.3	25
	LNB-63	M63 x 1.5	82	20

## Non-metallic conduit systems

### Type PA

#### Type PA - H

Heavy weight conduit / Materials: Polyamide (nylon) 6 / Colour: Black (BL), Grey (GR)

Order code	Nominal conduit size (mm)	NW conduit size	Conduit pitch	Outside diameter (mm)	Inside diameter (mm)	Minimum bend radius (mm)	Reel length (m)
PAFH13/BL/50M*	13	10	Fine	13.0	9.0	35	50
PAFH16/BL/50M	16	13	Fine	15.8	11.3	45	50
PACH21/BL/50M	21	17	Coarse	21.2	14.5	60	50
PACH28/BL/50M	28	23	Coarse	28.5	21.3	70	50
PACH34/BL/25M	34	29	Coarse	34.5	26.8	75	50
PACH42/BL/25M	42	36	Coarse	42.5	34.6	90	25
PACH54/BL/25M	54	48	Coarse	54.5	46.0	95	25

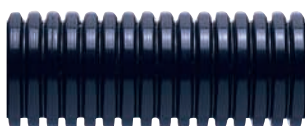

For grey color version state "GR" instead of "BL" in Part no. If interested in different coil lengths, do not hesitate to inquire  
\*These parts are not covered by the UR certification

#### Approvals



#### IP rating

#### Appropriate fitting

For use with: Type PC / ATS / Adaptalok AL / Adaptaseal / Adapting

IP40 Adapting

IP66 PC, ATS, Adaptalok AL, Adaptaseal

IP67 PC, ATS, Adaptalok AL + ALS Seal, Adaptaseal

IP68 PC, ATS, Adaptalok AL + ALS Seal, Adaptaseal

#### Temperature range

Static applications: -40°C to +120°C

Moving applications: -5°C to +120°C

#### Flexibility & fatigue life

High flexibility – High fatigue life

#### Fire performance & EMI screen

Self extinguishing

Halogen free



Very high

#### Type PA - S

Standard weight conduit / Materials: Polyamide (nylon) 6 / Colour: Black (BL), Grey (GR)

Order code	Nominal conduit size (mm)	NW conduit size	Conduit pitch	Outside diameter (mm)	Inside diameter (mm)	Minimum bend radius (mm)	Reel length (m)
PAFS10/BL/50M*	10	7.5	Fine	10.0	6.5	15	50
PAFS13/BL/50M*	13	10	Fine	13.0	9.6	25	50
PAFS16/BL/50M	16	13	Fine	15.8	11.8	35	50
PAFS21/BL/50M	21	17	Fine	21.2	16.5	45	50
PAFS28/BL/50M	28	23	Fine	28.5	22.6	50	50
PACS28/BL/50M	28	23	Coarse	28.5	21.7	50	50
PAFS34/BL/50M	34	29	Fine	34.5	28.8	60	50
PACS34/BL/50M	34	29	Coarse	34.5	27.7	60	50
PACS42/BL/25M	42	36	Coarse	42.5	35.2	65	25
PACS48/BL/25M	48	42	Coarse	48.2	40.9	70	25
PACS54/BL/25M	54	48	Coarse	54.5	46.5	75	25
PACS80/BL/10M	80	70	Coarse	79.3	67.0	160	10
PACS106/BL/10M	106	95	Coarse	106.0	91.5	210	10



For grey color version state "GR" instead of "BL" in Part no. If interested in different coil lengths, do not hesitate to inquire  
\*These parts are not covered by the UR certification

#### Approvals



#### IP rating

#### Appropriate fitting

For use with: Type PC / ATS / Adaptalok AL / Adaptaseal / Adapting

IP40 Adapting & Jumbo

IP65 Adaptalok AL Jumbo + SK Seal

IP66 PC, ATS, Adaptalok AL, Adaptaseal

IP67 PC, ATS, Adaptalok AL + ALS Seal, Adaptaseal

IP68 PC, ATS, Adaptalok AL + ALS Seal, Adaptaseal

IP69 PC, ATS, Adaptalok AL + ALS Seal, Adaptaseal

#### Temperature range

Static applications: -40°C to +120°C

Moving applications: -25°C to +150°C

#### Flexibility & fatigue life

High flexibility – High fatigue life

#### Fire performance & EMI screen

Self extinguishing

Halogen free



Very high

## Non-metallic conduit systems

### Type PA-Slit





Type PA-Slit

Slit conduit / Materials: Polyamide (nylon) 6 / Colour: Black (BL) only

Part no.	Nominal conduit size (mm)	NW conduit size	Conduit pitch	Outside diameter (mm)	Inside diameter (mm)	Minimum bend radius (mm)	Reel length (m)
PAFL13-S/BL/50M	13	10	Fine	13.0	10.0	25	50
PAFL16-S/BL/50M	16	13	Fine	15.8	11.9	35	50
PAFL21-S/BL/50M	21	17	Fine	21.2	16.8	45	50
PACL28-S/BL/50M	28	23	Coarse	28.5	22.2	50	50
PACL34-S/BL/50M	34	29	Coarse	34.5	27.9	60	50
PACL42-S/BL/25M	42	36	Coarse	42.5	35.2	65	25
PACL54-S/BL/25M	54	48	Coarse	54.5	46.9	75	25



If interested in different coil lengths, do not hesitate to inquire

Approvals	IP rating	Appropriate fitting	Temperature range	UV resistance
   	N/A		Static applications: -40°C to +120°C Moving applications: -5°C to +120°C	Very high
			<b>Flexibility &amp; fatigue life</b>	
			High flexibility – High fatigue life	
			<b>Fire performance &amp; EMI screen</b>	
			Self extinguishing	
			Halogen free	



## Non-metallic conduit systems

### Type A, C90 & 45 - Adaptalok ATS™

- Straight fitting - fixed external male thread
- For insertion into knockouts using a locknut
- Locknut supplied with metric thread
- Materials: Polyamide (Nylon) 66 / TPE
- Colours: Black (BL), Grey (GR) / Yellow (Y) Elastomer

- 45° Elbow fitting - fixed external male thread
- For insertion into knockouts using a locknut
- Locknut supplied with metric thread
- Materials: Polyamide (Nylon) 66 / TPE
- Colours: Black (BL), Grey (GR) / Yellow (Y) Elastomer

#### Type A - Adaptalok ATS™

	Order code	Nominal Conduit Size	Metric Thread
	AT13/M16/A	13mm	M16
	AT16/M16/A	16mm	M16
	AT16/M20/A	16mm	M20
	AT21/M20/A	21mm	M20
	AT21/M25/A	21mm	M25
	AT28/M25/A	28mm	M25
	AT28/M32/A	28mm	M32
	AT34/M32/A	34mm	M32
	AT34/M40/A	34mm	M40
	AT42/M40/A	42mm	M40
	AT42/M50/A	42mm	M50
	AT48/M50/A	48mm	M50
	AT54/M50/A	54mm	M50
	AT54/M63/A	54mm	M63

To order quote order code, body colour & Elastomer colour, e.g. AT21/M20/A/BLY

- 90° Elbow fitting - fixed external male thread
- For insertion into knockouts using a locknut
- Locknut supplied with metric thread
- Materials: Polyamide (Nylon) 66 / TPE
- Colours: Black (BL), Grey (GR) / Yellow (Y) Elastomer

#### Type C90 - Adaptalok ATS™





	Order code	Nominal Conduit Size	Metric Thread
	AT13/M16/C90	13mm	M16
	AT16/M16/C90	16mm	M16
	AT16/M20/C90	16mm	M20
	AT21/M20/C90	21mm	M20
	AT28/M25/C90	28mm	M25
	AT34/M32/C90	34mm	M32
	AT42/M40/C90	42mm	M40
	AT48/M50/C90	48mm	M50
	AT54/M50/C90	54mm	M50
	AT54/M63/C90	54mm	M63

To order quote order code, body colour & Elastomer colour, e.g. AT21/M20/C90/BLY

#### Type 45 - Adaptalok ATS™

	Order code	Nominal Conduit Size	Metric Thread
	AT13/M16/45	13mm	M16
	AT16/M16/45	16mm	M16
	AT16/M20/45	16mm	M20
	AT21/M20/45	21mm	M20
	AT28/M25/45	28mm	M25
	AT34/M32/45	34mm	M32
	AT42/M40/45	42mm	M40
	AT48/M50/45	48mm	M50
	AT54/M50/45	54mm	M50

To order quote order code, body colour & Elastomer colour, e.g. AT54/M50/45/BLY

Approvals	IP rating	Appropriate conduit
   	For use with: Type PA / PR / PADL / PF	
	IP40	Yes
	IP65	Yes
	IP68	Yes
	4 bar 30mins with Heavy Weight Conduits 2 bar 30mins with Standard Weight Conduits	
	IP69	Yes

#### Temperature Range

Static Applications: -50°C to +120°C

Moving Applications: -45°C to +120°C



## Non-metallic conduit systems

### Type SA, CS90 & S45 - Adaptalok ATS™

- Straight fitting - metal swivel external male thread
- For insertion into threaded entries & knockouts
- Order locknuts separately
- Materials: Polyamide (Nylon) 66, Nickel plated Brass thread/TPE
- Colours: Black (BL), Grey (GR) / Yellow (Y), Blue (B) Elastomer

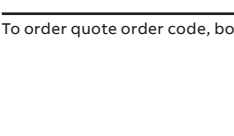

- 45° Elbow body - swivel external male thread
- For insertion into threaded entries & knockouts
- Order locknuts separately
- Materials: Polyamide (Nylon) 66, Nickel plated Brass thread/TPE
- Colours: Black (BL), Grey (GR) / Yellow (Y), Blue (B) Elastomer

#### Type SA - Adaptalok ATS™

	Order code	Nominal Conduit Size	Metric Thread
	AT13/M16/SA	13mm	M16
	AT16/M16/SA	16mm	M16
	AT21/M20/SA	21mm	M20
	AT28/M25/SA	28mm	M25
	AT34/M32/SA	34mm	M32
	AT42/M40/SA	42mm	M40
	AT48/M50/SA	48mm	M50
	AT54/M50/SA	54mm	M50
	AT54/M63/SA	54mm	M63

To order quote order code, body colour & Elastomer colour, e.g. AT16/M16/SA/BLB

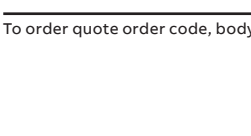

#### Type S45 - Adaptalok ATS™

	Order code	Nominal Conduit Size	Metric Thread
	AT13/M16/S45	13mm	M16
	AT16/M16/S45	16mm	M16
	AT21/M20/S45	21mm	M20
	AT28/M25/S45	28mm	M25
	AT34/M32/S45	34mm	M32
	AT42/M40/S45	42mm	M40
	AT48/M50/S45	48mm	M50
	AT54/M50/S45	54mm	M50
	AT54/M63/S45	54mm	M63



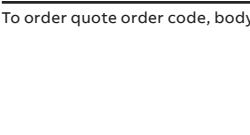

To order quote order code, body colour & Elastomer colour, e.g. AT54/M63/S45/BLB

- 90° Elbow fitting - swivel external male thread
- For insertion into threaded entries & knockouts
- Order locknuts separately
- Materials: Polyamide (Nylon) 66, Nickel Plated Brass Thread/TPE
- Colours: Black (BL), Grey (GR) / Yellow (Y), Blue (B) Elastomer

#### Type CS90 - Adaptalok ATS™

	Order code	Nominal Conduit Size	Metric Thread
	AT13/M16/CS90	13mm	M16
	AT16/M16/CS90	16mm	M16
	AT21/M20/CS90	21mm	M20
	AT28/M25/CS90	28mm	M25
	AT34/M32/CS90	34mm	M32
	AT42/M40/CS90	42mm	M40
	AT48/M50/CS90	48mm	M50
	AT54/M50/CS90	54mm	M50
	AT54/M63/CS90	54mm	M63

To order quote order code, body colour & Elastomer colour, e.g. AT16/M16/SA/BLB

Approvals	Blue Elastomer version only	IPrating	Appropriate conduit	
    			For use with: Type PA / PR / PADL / PF	
			IP40	Yes
			IP65	Yes
			IP68	Yes
				4 bar 30mins with Heavy Weight Conduits 2 bar 30mins with Standard Weight Conduits
		IP69	Yes	

Temperature Range	Fitting Characteristics
Static Applications: -50°C to +120°C	
Moving Applications: -45°C to +120°C	

## Non-metallic conduit systems

### Type A & C90 - Adaptalok

- Straight fitting - fixed external male thread
- For insertion into knockouts using a locknut
- Locknut supplied with metric thread only
- Materials: Polyamide (Nylon) 66
- Colours: Black (BL), Grey (GR)

#### Type A - Adaptalok

	Order code	Nominal Conduit Size	Metric Thread
	AL10/M12/A*	10mm	M16
	AL13/M16/A*	13mm	M16
	AL13/M20/A*	13mm	M20
	AL16/M16/A	16mm	M16
	AL16/M20/A	16mm	M20
	AL21/M20/A	21mm	M20
	AL21/M25/A	21mm	M25
	AL28/M25/A	28mm	M25
	AL28/M32/A	28mm	M32
	AL34/M32/A	34mm	M32
	AL34/M40/A	34mm	M40
	AL42/M40/A	42mm	M40
	AL42/M50/A	42mm	M50
	AL54/M50/A	54mm	M50
	AL54/M63/A	54mm	M63

\*These parts are not covered by the RU certification

- 90° Elbow fitting - fixed external male thread
- For insertion into knockouts using a locknut
- Locknut supplied with metric thread only
- Materials: Polyamide (Nylon) 66
- Colours: Black (BL), Grey (GR)

#### Type C90 - Adaptalok

	Order code	Nominal Conduit Size	Metric Thread
	AL10/M12/C90*	10mm	M12
	AL13/M16/C90*	13mm	M16
	AL16/M16/C90	16mm	M16
	AL16/M20/C90	16mm	M20
	AL21/M20/C90	21mm	M20
	AL28/M25/C90	28mm	M25
	AL34/M32/C90	34mm	M32
	AL42/M40/C90	42mm	M40
	AL54/M50/C90	54mm	M50
	AL54/M63/C90	54mm	M63

\*These parts are not covered by the RU certification

#### Approvals



#### IP rating

#### Appropriate conduit

For use with: Type PA / CP / PR / PF

IP66	Yes
IP67	Yes + ALS Seal
IP68	Yes + ALS Seal
IP69	Yes + ALS Seal

#### Temperature range

Static applications: -50°C to +120°C  
Moving applications: -45°C to +120°C

#### Fitting characteristics



## Non-metallic conduit systems

### Type 45, SA, CS90 & S45 - Adaptalok

- 45° Elbow fitting - fixed external male thread
- For insertion into knockouts using a locknut
- Locknut supplied with metric thread only
- Materials: Polyamide (Nylon) 66
- Colours: Black (BL), Grey (GR)

- 90° Elbow fitting - swivel external male thread
- For insertion into threaded entries & knockouts using a locknut. Order locknut separately
- Materials: Polyamide (Nylon) 66, nickel plated brass thread
- Colours: Black (BL), Grey (GR)

#### Type 45 - Adaptalok

	Order code	Nominal Conduit Size	Metric Thread
	AL13/M16/45*	13mm	M16
	AL16/M16/45	16mm	M16
	AL16/M20/45	16mm	M20
	AL21/M20/45	21mm	M20
	AL28/M25/45	28mm	M25
	AL34/M32/45	34mm	M32
	AL42/M50/45	42mm	M40
	AL54/M50/45	54mm	M50
	AL54/M63/45	54mm	M63

To order quote order code & body colour, e.g. AL21/M20/45/BL  
 \*These parts are not covered by the RU certification

#### Type CS90 - Adaptalok

	Order code	Nominal Conduit Size	Metric Thread
	AL13/M16/CS90*	13mm	M16
	AL16/M16/CS90	16mm	M16
	AL21/M20/CS90	21mm	M20
	AL28/M25/CS90	28mm	M25
	AL34/M32/CS90	34mm	M32
	AL42/M40/CS90	42mm	M40
	AL54/M50/CS90	54mm	M50
	AL54/M63/CS90	54mm	M63

To order quote order code & body colour, e.g. AL13/M16/CS90/BL. NPT also available  
 \*These parts are not covered by the RU certification

- Straight fitting - swivel external male thread
- For insertion into threaded entries & knockouts using a locknut. Order locknut separately
- Materials: Polyamide (Nylon) 66, nickel plated brass thread
- Colours: Black (BL), Grey (GR)

- 45° Elbow body - swivel external male thread
- For insertion into threaded entries & knockouts using a locknut. Order locknut separately
- Materials: Polyamide (Nylon) 66, nickel plated brass thread
- Colours: Black (BL), Grey (GR)

#### Type SA - Adaptalok

	Order code	Nominal Conduit Size	Metric Thread
	AL13/M16/SA*	13mm	M16
	AL16/M16/SA	16mm	M16
	AL21/M20/SA	16mm	M20
	AL28/M25/SA	28mm	M25
	AL34/M32/SA	34mm	M32
	AL42/M40/SA	42mm	M40
	AL54/M50/SA	54mm	M50
	AL54/M63/SA	54mm	M63

To order quote order code & body colour, e.g. AL13/M16/SA/BL. NPT also available  
 \*These parts are not covered by the RU certification

#### Type S45 - Adaptalok

	Order code	Nominal Conduit Size	Metric Thread
	AL13/M16/S45*	13mm	M16
	AL16/M16/S45	16mm	M16
	AL21/M20/S45	21mm	M20
	AL28/M25/S45	28mm	M25
	AL34/M32/S45	34mm	M32
	AL42/M40/S45	42mm	M40
	AL54/M50/S45	54mm	M50
	AL54/M63/S45	54mm	M63

To order quote order code & body colour, e.g. AL21/M20/45/BL  
 \*These parts are not covered by the RU certification

#### Approvals



#### IP Rating

For use with: Type PA / PI / CP / PR / PF

IP Rating	Appropriate Conduit
IP66	Yes
IP67	Yes + ALS Seal
IP68	Yes + ALS Seal
IP69	Yes + ALS Seal

#### Temperature Range

Static Applications: -50°C to +120°C  
 Moving Applications: -45°C to +120°C

## Non-metallic conduit systems

### Korifit Type KF PVCu conduits

#### Type KF - L

Lightweight conduit / Materials: PVCu / Colour: Grey (GR) only

	Order code	Nominal conduit size (mm)	NW conduit size (mm)	Conduit pitch	Outside diameter (mm)	Inside diameter (mm)	Min. bend radius (mm)	Reel length (m)
	KFL16/50M	16	13	Fine	15.8	12.1	25	50
	KFL20/50M	20	17	Fine	19.8	14.5	30	50
	KFL25/50M	25	22	Fine	24.8	19.9	40	50

#### Type KF - S

Standard weight conduit / Materials: PVCu / Colour: White (W) only

	Order code	Nominal conduit size (mm)	NW conduit size (mm)	Conduit pitch	Outside diameter (mm)	Inside diameter (mm)	Min. bend radius (mm)	Reel length (m)
	KFS16/W/50M	16	13	Fine	15.8	11.9	25	50
	KFS20/W/50M	20	17	Fine	19.8	14.3	30	50
	KFS25/W/50M	25	22	Fine	24.8	19.7	40	50

#### Type KF - M

Medium weight conduit / Materials: PVCu / Colour: Black (BL) only

	Order code	Nominal conduit size (mm)	NW conduit size (mm)	Conduit pitch	Outside diameter (mm)	Inside diameter (mm)	Min. bend radius (mm)	Reel length (m)
	KFM16/50M	16	13	Fine	15.8	11.9	25	50
	KFM20/50M	20	17	Fine	19.8	14.3	30	50
	KFM25/50M	25	22	Fine	24.8	19.7	40	50

#### Approvals



#### IP rating

#### Appropriate fitting

For use with: Korifit KC & KF

IP40

Korifit KC

IP65

Korifit KC

#### Temperature range

Static applications: -5°C to +60°C

Moving applications: -5°C to +60°C

#### Flexibility & fatigue life

Pliable - Low fatigue life

#### Fire performance & EMI screen

Self extinguishing

#### UV resistance

High

## Non-metallic conduit systems

### Type KC/A, KC/C90, KFA & Coupler - Korifit

- Straight fitting - fixed external male thread
- For insertion into threaded entries & knockouts
- Locknut supplied
- Materials: Polyamide (Nylon) 66
- Colours: Black, Grey or White

- 90° Elbow fitting - fixed external male thread
- For insertion into knockouts
- Locknut supplied
- Materials: Polyamide (Nylon) 66
- Colour: Black only

#### Type KC/A - Korifit

	Order code	Nominal Conduit Size	Metric Thread
	KC16/M16/A	16mm	M16
	KC16/M20/A	16mm	M20
	KC20/M20/A	20mm	M20
	KC25/M25/A	20mm	M25

To order quote order code & body colour, e.g. KC16/M16/A/BL

#### Type KC/C90 - Korifit

	Order code	Nominal Conduit Size	Metric Thread
	KC16/M16/C90	16mm	M16
	KC20/M20/C90	20mm	M20
	KC25/M25/C90	25mm	M25

To order quote order code & body colour, e.g. KC16/M16/C90/BL

#### Approvals



#### IP rating

For use with: Korifit Type KF

IP40

#### Appropriate conduit

Yes

#### Temperature range

Static applications: -5°C to +60°C

Moving applications: -5°C to +60°C

#### Fitting characteristics



- Straight fitting - fixed external male thread
- For insertion into threaded entries & knockouts
- Locknut supplied
- Materials: Polyamide (Nylon) 66
- Colours: Black (BL), Grey (GR) or White (W)

- Straight one piece coupler
- For coupling two corrugated flexible conduits
- Materials: Polyamide (Nylon) 66
- Colour: White (W) only

#### Type KFA - Korifit

	Order code	Nominal Conduit Size	Metric Thread
	KF16/M16/A	16mm	M16
	KF16/M20/A	16mm	M20
	KF20/M20/A	20mm	M20
	KF25/M25/A	25mm	M25

To order quote order code & body colour, e.g. KF16/M16/A/BL

#### Coupler - Korifit

	Order code	Nominal Conduit Size	NW Conduit Size
	KF2020	20mm	17

To order quote order code & body colour, e.g. KF2020/W

#### Approvals



#### IP rating

For use with: Korifit Type KF

IP65

#### Appropriate conduit

Yes

#### Temperature range

Static applications: -5°C to +60°C

Moving applications: -5°C to +60°C

#### Fitting characteristics



## Non-metallic conduit systems

### Accessories - Type LNP & AC

- Nylon locknuts
- Material: Polyamide (Nylon) 6
- Colour: Black (BL), Grey (GR)

#### Type LNP

	Order code		Metric Thread
	Black	Grey	
	LNPB/M12	–	M12
	LNPB/M16	LNPG/M16	M16
	LNPB/M20	LNPG/M20	M20
	LNPB/M25	LNPG/M25	M25
	LNPB/M32	LNPG/M32	M32
	LNPB/M40	LNPG/M40	M40
	LNPB/M50	LNPG/M50	M50
	LNPB/M63	LNPG/M63	M63

- Conduit clips
- With integral lid
- Material: Polyamide (Nylon) 66, impact modified Nylon - ST version only
- Colour: Black (BL), Grey (GR)

#### Type AC

	Order code		Impact Modified (Black only)	Nominal Conduit Size
	Black	Grey		
	ACB10	ACG10	–	10mm
	ACB13	ACG13	ACB13/ST	13mm
	ACB16	ACG16	ACB16/ST	16mm
	ACB21	ACG21	ACB21/ST	21mm
	ACB28	ACG28	ACB28/ST	28mm
	ACB34	ACG34	ACB34/ST	34mm
	ACB42	ACG42	ACB42/ST	42mm
	ACB54	ACG54	ACB54/ST	54mm

## Non-metallic conduit systems

### Accessories

- End sleeves
- Material: Polyamide (Nylon) 66
- Colour: Black (BL) only

#### End sleeves

	Order code	Nominal conduit size (mm)
	GZ9	13
	GZ11	16
	GZ13	21
	GZ21	28
	GZ29	34
	GZ36	42

For sealing cables to non-metallic conduit

- Removal tool for Adaptalok fittings
- Material: Polyamide (Nylon) 6,
- Colour: Black (BL) only

#### Removal tool for Adaptalok fittings

	Order code	Adaptalok fitting size (mm)
	AL13RT	13
	AL16RT	16
	AL21RT	21
	AL28RT	28
	AL34RT	34
	AL42RT	42
	AL54RT	54

To provide easy removal of Adaptalok & ATS Fittings

## Nylon cable glands for general purpose use



### NCG Series



NCG Series - Nylon cable gland

#### Features and benefits:

- Low profile cable glands
- Wide cable clamping range
- Corrosion resistant

Approvals & certifications	Conformity	Temperature range	
  	Conforms to:	Normal Use: -20°C to +100°C (-4°F to +212°F)	
	EN 62444	Short Term: -30°C to +150°C (-22°F to +302°F)	
	UL514B (see table for details)		
	CSA C22.2 No 18.3		
		IP Rating	Material
		IP66	Halogen free nylon construction
		IP68 (5-Bar 30 mins)	Chloroprene seals
		NEMA 4	Available in black, grey and light grey

#### Dimensions

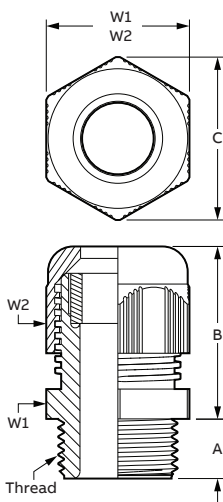
Metric thread	Part no.	Metric thread	Cable range		Nominal Dimensions (mm/in)				
			Min. (mm/in)	Max. (mm/in)	A Min	B Min	C Min	W1	W2
	NCG-M121x	M12x1.5	2.0	5.0	8.0	23.0	16.9	15.0	15.0
			0.079	0.197	0.315	0.906	0.665	0.591	0.591
	NCG-M122x (cURus)	M12x1.5	3.0	6.5	8.0	23.0	16.9	15.0	15.0
			0.118	0.256	0.315	0.906	0.665	0.591	0.591
	NCG-M161x	M16x1.5	2.0	6.0	8.0	26.5	21.9	19.0	19.0
			0.079	0.236	0.315	1.043	0.862	0.748	0.748
	NCG-M161x-L	M16x1.5	2.0	6.0	15.0	26.5	21.9	19.0	19.0
			0.079	0.236	0.591	1.043	0.862	0.748	0.748
	NCG-M162x (cURus)	M16x1.5	4.0	8.0	8.0	26.5	21.9	19.0	19.0
			0.157	0.315	0.315	1.043	0.862	0.748	0.748
	NCG-M162x-L	M16x1.5	4.0	8.0	15.0	26.5	21.9	19.0	19.0
			0.157	0.315	0.591	1.043	0.862	0.748	0.748
NCG-M163x (cURus)	M16x1.5	5.0	10.0	10.0	30.0	25.0	22.0	22.0	
		0.197	0.394	0.394	1.181	0.984	0.866	0.866	
NCG-M163x-L (cURus)	M16x1.5	5.0	10.0	15.0	30.0	25.0	22.0	22.0	
		0.157	0.315	0.591	1.043	0.862	0.748	0.748	
NCG-M201x	M20x1.5	5.0	9.0	10.0	30.0	27.0	24.0	24.0	
		0.197	0.354	0.394	1.043	1.063	0.945	0.945	
NCG-M201x-L	M20x1.5	5.0	9.0	15.0	30.0	27.0	24.0	24.0	
		0.197	0.354	0.591	1.043	1.063	0.945	0.945	

Note for colour: x in part number - B-Black (RAL 9001), G-Grey (RAL 7001), LG-Light grey (RAL 7035)

# Nylon cable glands for general purpose use

## NCG Series

### Dimensions

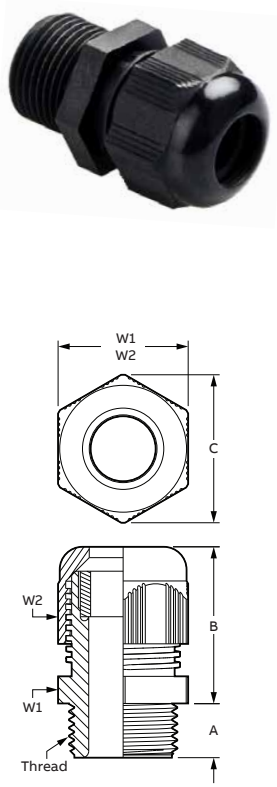
Metric thread	Part no.	Metric thread	Cable range		Nominal Dimensions (mm/in)				
			Min. (mm/in)	Max. (mm/in)	A Min	B Min	C Min	W1	W2
	NCG-M202x (cULus)	M20x1.5	6.0	12.0	10.0	30.0	27.0	24.0	24.0
			0.236	0.472	0.394	1.181	1.063	0.945	0.945
	NCG-M202x-L (cULus)	M20x1.5	6.0	12.0	15.0	30.0	27.0	24.0	24.0
			0.236	0.472	0.591	1.181	1.063	0.945	0.945
	NCG-M203x (cULus)	M20x1.5	10.0	14.0	10.0	33.5	31.0	27.0	27.0
			0.394	0.551	0.394	1.319	1.22	1.063	1.063
	NCG-M203x-L (cULus)	M20x1.5	10.0	14.0	15.0	33.5	31.0	27.0	27.0
			0.394	0.551	0.591	1.319	1.22	1.063	1.063
	NCG-M251x	M25x1.5	9.0	16.0	10.0	38.0	38.0	33.0	33.0
			0.354	0.63	0.394	1.496	1.496	1.299	1.299
	NCG-M251x-L	M25x1.5	9.0	16.0	15.0	38.0	38.0	33.0	33.0
			0.354	0.63	0.591	1.496	1.496	1.299	1.299
	NCG-M252x (cULus)	M25x1.5	11.0	17.0	8.0	38.0	32.5	29.0	29.0
			0.433	0.669	0.315	1.496	1.28	1.142	1.142
	NCG-M252x-L	M25x1.5	11.0	17.0	15.0	36.0	32.5	29.0	29.0
			0.433	0.669	0.591	1.417	1.28	1.142	1.142
	NCG-M253x (cULus)	M25x1.5	13.0	18.0	10.0	38.0	38.0	33.0	33.0
			0.512	0.709	0.394	1.496	1.496	1.299	1.299
	NCG-M253x-L	M25x1.5	13.0	18.0	15.0	38.0	38.0	33.0	33.0
			0.512	0.709	0.591	1.496	1.496	1.299	1.299
	NCG-M321x	M32x1.5	11.0	15.0	10.0	42.5	41.0	36.0	36.0
			0.433	0.591	0.394	1.673	1.614	1.417	1.417
	NCG-M321x-L	M32x1.5	11.0	15.0	15.0	42.5	36.0	36.0	36.0
			0.433	0.591	0.591	1.673	1.417	1.417	1.417
NCG-M322x (cULus)	M32x1.5	15.0	21.0	10.0	42.5	41.0	36.0	36.0	
		0.591	0.827	0.394	1.673	1.614	1.417	1.417	
NCG-M322x-L	M32x1.5	15.0	21.0	15.0	42.5	41.0	36.0	36.0	
		0.591	0.827	0.591	1.673	1.614	1.417	1.417	
NCG-M323x (cULus)	M32x1.5	18.0	25.0	15.0	42.0	47.3	42.0	42.0	
		0.709	0.984	0.591	1.654	1.862	1.654	1.654	
NCG-M401x	M40x1.5	16.0	23.0	10.0	47.5	52.4	46.0	46.0	
		0.63	0.906	0.394	1.870	2.063	1.811	1.811	
NCG-M401x-L	M40x1.5	16.0	23.0	18.0	47.5	52.4	46.0	46.0	
		0.63	0.906	0.709	1.870	2.063	1.811	1.811	
NCG-M402x (cULus)	M40x1.5	19.0	28.0	10.0	47.5	52.4	46.0	46.0	
		0.748	1.102	0.394	1.870	2.063	1.811	1.811	
NCG-M402x-L	M40x1.5	19.0	28.0	18.0	47.5	52.4	46.0	46.0	
		0.748	1.102	0.709	1.870	2.063	1.811	1.811	
NCG-M403x (cULus)	M40x1.5	22.0	32.0	18.0	52.0	60.0	53.0	53.0	
		0.866	1.26	0.709	2.047	2.362	2.087	2.087	
NCG-M501x	M50x1.5	25.0	31.0	18.0	53.5	67.8	60.0	60.0	
		0.984	1.22	0.709	2.106	2.669	2.362	2.362	
NCG-M502x (cULus)	M50x1.5	30.0	38.0	18.0	53.5	67.8	60.0	60.0	
		1.181	1.496	0.709	2.106	2.669	2.362	2.362	
NCG-M631x	M63x1.5	29.0	35.0	18.0	53.0	72.9	65.0	65.0	
		1.142	1.378	0.709	2.087	2.870	2.559	2.559	
NCG-M632x (cULus)	M63x1.5	34.0	44.0	18.0	53.0	72.9	65.0	65.0	
		1.339	1.732	0.709	2.087	2.87	2.559	2.559	
NCG-M751x (cULus)	M75x1.5	48.0	55.0	25.0	55.0	89.0	75.0	80.0	
		1.89	2.165	0.984	2.165	3.504	2.953	3.15	

Note for colour: x in part number - B-Black (RAL 9001), G-Grey (RAL 7001), LG-Light grey (RAL 7035)

## Nylon cable glands for industrial applications

### NCG Series

#### Dimensions

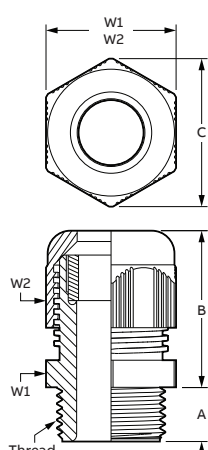
NPT thread	Part no.	NPT thread	Cable range		Nominal Dimensions (mm/in)				
			Min. (mm/in)	Max. (mm/in)	A Min	B Min	C Min	W1	W2
	NCG-0381x	3/8"	3.0	7.0	15.0	30.0	25.0	22.0	22.0
			0.118	0.276	0.591	1.181	0.984	0.866	0.866
	NCG-0382x (cURus)	3/8"	5.0	10.0	15.0	30.0	25.0	22.0	22.0
			0.197	0.394	0.591	1.181	0.984	0.866	0.866
	NCG-0501x	1/2"	5.0	9.0	15.0	30.0	27.0	24.0	24.0
			0.197	0.354	0.591	1.181	1.063	0.945	0.945
	NCG-0502x (cULus)	1/2"	6.0	12.0	15.0	30.0	27.0	24.0	24.0
			0.236	0.472	0.591	1.181	1.063	0.945	0.945
	NCG-0503x (cULus)	1/2"	10.0	14.0	11.0	33.5	30.9	27.0	27.0
			0.394	0.551	0.433	1.319	1.217	1.063	1.063
	NCG-0504x	1/2"	9.0	16.0	15.0	38.0	38.0	33.0	33.0
			0.354	0.63	0.591	1.496	1.496	1.299	1.299
	NCG-0505x	1/2"	13.0	18.0	15.0	38.0	38.0	33.0	33.0
			0.512	0.709	0.591	1.496	1.496	1.299	1.299
	NCG-0751x	3/4"	9.0	16.0	15.0	38.0	38.0	33.0	33.0
			0.354	0.63	0.591	1.496	1.496	1.299	1.299
	NCG-0752x (cULus)	3/4"	13.0	18.0	15.0	38.0	38.0	33.0	33.0
			0.512	0.709	0.591	1.496	1.496	1.299	1.299
	NCG-1001x	1"	12.0	20.0	18.0	42.0	47.3	42.0	42.0
			0.472	0.787	0.709	1.654	1.862	1.654	1.654
NCG-1002x (cULus)	1"	18.0	25.0	18.0	42.0	47.3	42.0	42.0	
		0.709	0.984	0.709	1.654	1.862	1.654	1.654	

#### Dimensions

PG thread	Part no.	PG thread	Cable range		Nominal Dimensions (mm/in)				
			Min. (mm/in)	Max. (mm/in)	A Min	B Min	C Min	W1	W2
	NCG-PG71x (cURus)	PG07	3.0	6.5	8.0	23.0	16.9	15.0	15.0
			0.118	0.256	0.315	0.906	0.665	0.591	0.591
	NCG-PG91x (cURus)	PG09	4.0	8.0	8.0	26.5	21.9	19.0	19.0
			0.157	0.315	0.315	1.043	0.862	0.748	0.748
	NCG-PG111x	PG11	3.0	7.0	8.0	29.0	25.0	22.0	22.0
			0.118	0.276	0.315	1.142	0.984	0.866	0.866
	NCG-PG112x (cURus)	PG11	5.0	10.0	8.0	29.0	25.0	22.0	22.0
			0.197	0.394	0.315	1.142	0.984	0.866	0.866
	NCG-PG131x (cULus)	PG13	6.0	12.0	10.0	29.0	27.0	24.0	24.0
			0.236	0.472	0.394	1.142	1.063	0.945	0.945
	NCG-PG161x (cULus)	PG16	10.0	14.0	10.0	33.5	30.9	27.0	27.0
			0.394	0.551	0.394	1.319	1.217	1.063	1.063
	NCG-PG211x (cULus)	PG21	13.0	18.0	11.0	37.0	38.0	33.0	33.0
			0.512	0.709	0.433	1.457	1.496	1.299	1.299
	NCG-PG291x (cULus)	PG29	18.0	25.0	11.0	42.0	47.3	42.0	42.0
			0.709	0.984	0.433	1.654	1.862	1.654	1.654
	NCG-PG361x (cULus)	PG36	22.0	32.0	13.0	52.0	60.0	53.0	53.0
			0.866	1.26	0.512	2.047	2.362	2.087	2.087
	NCG-PG421x (cULus)	PG42	30.0	38.0	13.0	53.5	67.8	60.0	60.0
			1.181	1.496	0.512	2.106	2.669	2.362	2.362
NCG-PG481x (cULus)	PG48	34.0	44.0	14.0	53.5	72.9	65.0	65.0	
		1.339	1.732	0.551	2.106	2.87	2.559	2.559	

Note for colour: x in part number - B-Black (RAL 9001), G-Grey (RAL 7001), LG-Light grey (RAL 7035)

## Nylon cable glands for industrial applications

### NCG Series

#### Dimensions

GAS thread	Part no.	GAS thread	Cable range		Nominal Dimensions (mm/in)				
			Min. (mm/in)	Max. (mm/in)	A Min	B Min	C Min	W1	W2
	NCG-G0251x	1/4"	3.0	6.5	10.0	23.0	16.9	15.0	15.0
			0.118	0.256	0.394	0.906	0.665	0.591	0.591
	NCG-G0381x	3/8"	5.0	10.0	11.0	30.0	25.0	22.0	22.0
			0.197	0.394	0.433	1.181	0.984	0.866	0.866
	NCG-G0501x	1/2"	6.0	12.0	10.0	30.0	27.0	24.0	24.0
			0.236	0.472	0.394	1.181	1.063	0.945	0.945
	NCG-G0502x	1/2"	10.0	14.0	11.0	30.0	30.9	27.0	27.0
			0.394	0.551	0.433	1.181	1.217	1.063	1.063
	NCG-G0751x	3/4"	13.0	18.0	12.0	38.0	38.0	33.0	33.0
			0.512	0.709	0.472	1.496	1.496	1.299	1.299
	NCG-G1001x	1"	18.0	25.0	13.0	42.0	47.3	42.0	42.0
			0.709	0.984	0.512	1.654	1.862	1.654	1.654

Note for colour: x in part number - B-Black (RAL 9001), G-Grey (RAL 7001), LG-Light grey (RAL 7035)

## General purpose nylon cable glands

### NSG Series



#### Features and benefits:

- Large cable clamping range
- Liquid tight mechanical grip
- Full length bushing seal, protects cable
- Corrosion resistant

#### NSG Series - Ranger® nylon cable gland

Approvals & certifications	Conformity Conforms to:	Temperature range
	UL514B	-34°C to +105°C (-29°F to +221°F)
	CSA 22.2-18	
	ANSI C33.84	
	NFPA 70 (ANSI)	
	CG293 (US Coastguard)	
		IP Rating
		Type 4X or 6 (with 5262 Series sealing rings)
		Wet and dry locations
		Material
		Halogen free nylon construction
		Thermoplastic elastomer sealing ring
		Nylon retaining ring
		Fire
		NFPA 70 (ANSI)

#### Dimensions

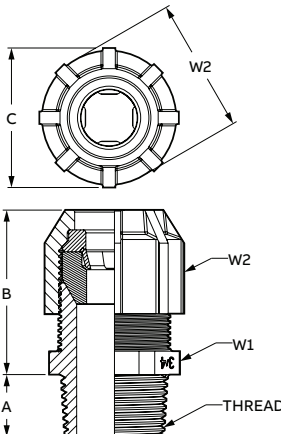
NPT thread	Part no.	NPT thread	Cable range		Nominal Dimensions (mm/in)				
			Min. (mm/in)	Max. (mm/in)	A Min	B Min	C Min	W1	W2
	2920NM	1/2"	3.18	9.53	15.49	38.48	30.71	25.91	29.31
			0.125	0.375	0.610	1.515	1.209	1.020	1.154
	2921NM	1/2"	7.87	14.22	15.49	38.48	30.71	25.91	29.31
			0.310	0.560	0.610	1.515	1.209	1.020	1.154
	2922NM	1/2"	12.70	19.05	15.49	39.27	35.61	30.96	34.24
			0.500	0.750	0.610	1.546	1.402	1.219	1.348
	2930NM	3/4"	3.18	9.53	15.88	39.70	35.61	30.96	34.24
			0.125	0.375	35.718	1.563	1.402	1.219	1.348
	2931NM	3/4"	7.87	14.22	15.88	39.70	35.61	30.96	34.24
			0.310	0.560	35.718	1.563	1.402	1.219	1.348
	2932NM	3/4"	12.70	19.05	15.88	39.70	35.61	30.96	34.24
			0.500	0.750	35.718	1.563	1.402	1.219	1.348
	2940NM	1"	7.87	14.22	17.40	42.14	41.10	37.69	34.24
			0.310	0.560	0.685	1.659	1.618	1.484	1.348
	2941NM	1"	12.70	19.05	17.40	42.14	41.10	37.69	34.24
			0.500	0.750	0.685	1.659	1.618	1.484	1.348
	2942NM	1"	17.78	24.13	17.40	42.93	42.34	38.10	41.00
			0.700	0.950	0.685	1.690	1.667	1.500	1.614

# NPG Quick-Connect™

## Cable glands



ABB's latest cable gland offering, the NPG Quick-Connect™, allows for fast and effective fitting without access to the inside of an enclosure, greatly speeding installation. The speed and ease of installation makes the NPG ideal for panel builders and volume installers of all types.

NPG Quick-Connect™ is a single-piece, corrosion resistant nylon gland suitable for non-armored, portable and tray cable types. When installed, the NPG achieves ingress protection of IP66 or IP68 (5 bar 30 mins).

### Quick-Connect™ - NPG Series - Nylon cable gland

<b>Approvals &amp; certifications</b>		<b>Conformity</b> Conforms to:
		EN 62444
		UL514B (see table for details)
		CSA C22.2 No 18.3
<b>Temperature range</b>		
Normal Use: -20°C to +100°C (-4°F to +212°F)		
Short Term: -30°C to +150°C (-22°F to +302°F)		
<b>IP Rating</b>		<b>Material</b>
IP66		Halogen free nylon (PA6) construction
IP68 (5-Bar 30 mins)		
Available in black, grey, and light grey		
Chloroprene seals		

Under normal use, NPG Quick-Connect™ glands are rated to perform from -20°C to 100°C (-4°F to 212°F), but in shorter bursts can withstand -30°C to 150°C (-22°F to 302°F).

### Dimensions

Metric thread	Part no.	Metric thread	Cable size		Hole size		Nominal Dimensions (mm/in)				
			Min. (mm/in)	Max. (mm/in)	Min. (mm/in)	Max. (mm/in)	A Min	B Min	C Min	W1	W2
	NPG-M161x (cURus)	M16	5.0 0.197	10.0 0.394	16.2 0.638	16.4 0.646	9.0 0.354	42.5 1.673	26.5 1.043	22.0 0.866	22.0 0.866
	NPG-M201x (cURus)	M20	6.0 0.236	12.0 0.472	20.2 0.795	20.4 0.803	9.0 0.354	41.5 1.634	30.3 1.193	24.0 0.945	24.0 0.945
	NPG-M202x (cURus)	M20	7.0 0.276	13.0 0.512	20.2 0.795	20.4 0.803	9.0 0.354	41.5 1.634	30.3 1.193	25.0 0.984	25.0 0.984
	NPG-M251x (cURus)	M25	11.0 0.433	17.0 0.669	25.2 0.992	25.4 1.000	9.0 0.354	43.5 1.713	36.3 1.429	29.0 1.142	29.0 1.142
	NPG-M321x (cURus)	M32	15.0 0.591	21.0 0.827	32.2 1.268	32.4 1.276	9.0 0.354	49.5 1.949	43.2 1.701	36.0 1.417	36.0 1.417

NPT thread	Part no.	NPT thread	Cable size		Hole size		Nominal Dimensions (mm/in)				
			Min. (mm/in)	Max. (mm/in)	Min. (mm/in)	Max. (mm/in)	A Min	B Min	C Min	W1	W2
	NPG-0381x	3/8"	5.0 0.197	10.0 0.394	17.65 0.695	18.85 0.742	10.0 0.394	41.2 1.673	26.5 1.043	22.0 0.866	22.0 0.866
	NPG-0501x	1/2"	6.0 0.236	12.0 0.472	21.84 0.860	23.01 0.906	10.0 0.394	39.2 1.543	30.5 1.201	24.0 0.945	24.0 0.945
	NPG-0502x	1/2"	10.0 0.394	14.0 0.551	21.84 0.860	23.01 0.906	10.0 0.394	39.8 1.689	30.5 1.201	27.0 1.063	27.0 1.063
	NPG-0751x	3/4"	13.0 0.512	18.0 0.709	27.78 1.094	28.98 1.141	10.0 0.394	41.9 1.650	39.0 1.535	33.0 1.299	33.0 1.299
	NPG-1001x	1"	18.0 0.709	25.0 0.984	34.51 1.359	35.71 1.406	10.0 1.972	50.1 1.972	47.5 1.870	42.0 1.654	42.0 1.654

Note for colour: x in part number - B-Black (RAL 9001), G-Grey (RAL 7001), LG-Light grey (RAL 7035)

## Spec-Kon® lugs

### Copper/Straight – one hole type



#### Technical information

#### Application

- Copper tin plated Metric Compression Lug for power cables for rated voltage up to 36kV. From 6 to 400mm<sup>2</sup>
- Specially designed to accommodate both stranded (class 2) and flexible (class 5) power cables according to IEC 60228

#### Characteristics

- Straight – one hole lug with die code marking to assist installation work and inspection
- Hole inspection to ease installation control
- Chamfer barrel to assist installation work

Material: Copper. Comply to EN13600

Surface: Tin plated

Certification: Comply to IEC 61238 - CE declaration

#### Copper/Straight – one hole type

Nominal X-section (mm <sup>2</sup> )	Stud bolt size	Part number	GID number	Die selection				Dimensions mm/(in)					PCs per box				
				Die code	Compression tooling		I	A	B	C	D	F					
					H-C6 240 B-IC6 240 T-C6 240	H-CK 400 B-CK 400 T-CK 400											
6	M5	6M5	7TCA302310R0017	6	6TC06M	3.8 (0.15)	28.2 (1.11)	14.0 (0.55)	10.0 (0.39)	1.2 (0.05)	6.2 (0.24)	100					
	M6	6M6	7TCA302310R0000										28.2 (1.11)	14.0 (0.55)	10.8 (0.43)	1.2 (0.05)	6.2 (0.24)
	M8	6M8	7TCA302310R0001														
10	M5	10M5	7TCA302310R0002	7	6TC07M	4.5 (0.18)	32.3 (1.27)	15.8 (0.62)	11.0 (0.43)	1.2 (0.05)	6.0 (0.24)	100					
	M6	10M6	7TCA302310R0003										32.3 (1.27)	15.8 (0.62)	11.0 (0.43)	1.2 (0.05)	6.0 (0.24)
	M8	10M8	7TCA302310R0004		32.3 (1.27)	16.5 (0.65)	13.0 (0.51)	1.1 (0.04)	8.0 (0.31)								
	M10	10M10	7TCA302310R0005							4.4 (0.17)	32.3 (1.27)	16.5 (0.65)	14.5 (0.57)	1.7 (0.07)	8.0 (0.31)		
16	M5	16M5	7TCA302310R0006	7,5	6TC075M	6.0 (0.24)	35.7 (1.41)	16.8 (0.66)	13.0 (0.51)	1.3 (0.05)	6.5 (0.26)	100					
	M6	16M6	7TCA302310R0007										35.7 (1.41)	16.8 (0.66)	13.0 (0.51)	1.3 (0.05)	6.5 (0.26)
	M8	16M8	7TCA302310R0008		35.7 (1.41)	16.8 (0.66)	13.0 (0.51)	1.2 (0.05)	6.5 (0.26)								
	M10	16M10	7TCA302310R0009							37.9 (1.49)	18.2 (0.72)	15.0 (0.59)	1.1 (0.04)	8.0 (0.31)			
25	M6	25M6	7TCA302310R0010	8,5	6TC085M	7.3 (0.29)	40.0 (1.57)	18.0 (0.71)	14.0 (0.55)	1.6 (0.06)	8.0 (0.31)	100					
	M8	25M8	7TCA302310R0011										40.0 (1.57)	18.0 (0.71)	15.5 (0.61)	1.6 (0.06)	8.0 (0.31)
	M10	25M10	7TCA302310R0012		40.0 (1.57)	18.0 (0.71)	15.5 (0.61)	1.5 (0.06)	8.0 (0.31)								
35	M6	35M6	7TCA302310R0013	11	6TC11M	8.9 (0.35)	44.0 (1.73)	19.5 (0.77)	15.5 (0.61)	2.1 (0.08)	8.5 (0.33)	100					
	M8	35M8	7TCA302310R0014										44.0 (1.73)	19.5 (0.77)	15.5 (0.61)	2.1 (0.08)	8.5 (0.33)
	M10	35M10	7TCA302310R0015		44.0 (1.73)	19.5 (0.77)	15.5 (0.61)	2.1 (0.08)	8.5 (0.33)								
	M12	35M12	7TCA302310R0016							49.5 (1.95)	25.0 (0.98)	21.5 (0.85)	1.5 (0.06)	11.5 (0.45)			
50	M6	50M6	7TCA302320R0000	12	6TC12M	9.8 (0.39)	49.0 (1.93)	21.5 (0.85)	18.0 (0.71)	2.5 (0.10)	10.0 (0.39)	50					
	M8	50M8	7TCA302320R0001										49.0 (1.93)	21.5 (0.85)	18.0 (0.71)	2.5 (0.10)	10.0 (0.39)
	M10	50M10	7TCA302320R0002		49.0 (1.93)	21.5 (0.85)	18.0 (0.71)	2.5 (0.10)	10.0 (0.39)								
	M12	50M12	7TCA302320R0003							52.5 (2.07)	25.0 (0.98)	23.0 (0.91)	1.8 (0.07)	11.0 (0.43)			
70	M6	70M6	7TCA302320R0004	14,5	6TC145M	12.2 (0.48)	56.0 (2.20)	26.0 (1.02)	20.8 (0.82)	2.9 (0.11)	11.5 (0.45)	50					
	M8	70M8	7TCA302320R0005										56.0 (2.20)	26.0 (1.02)	20.8 (0.82)	2.9 (0.11)	11.5 (0.45)
	M10	70M10	7TCA302320R0006		56.0 (2.20)	26.0 (1.02)	20.8 (0.82)	2.9 (0.11)	11.5 (0.45)								
	M12	70M12	7TCA302320R0007							56.0 (2.20)	26.0 (1.02)	20.8 (0.82)	2.8 (0.11)	11.5 (0.45)			



#### Dimensions

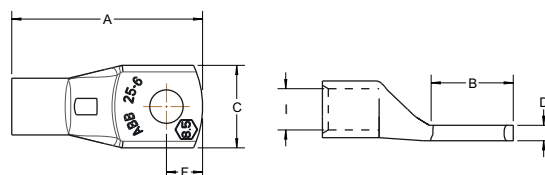

# Spec-Kon® lugs

## Copper/Straight – one hole type (continued)

Copper/Straight – one hole type (continued)

Nominal X-section (mm²)	Stud bolt size	Part number	GID number	Die selection				Compression tooling					Dimensions mm/(in)		PCs per box
				Die code	H-C6 240		H-CK 400		I	A	B	C	D	F	
					B-IC6 240	T-C6 240	B-CK 400	T-CK 400							
95	M8	95M8	7TCA302320R0008	15	6TC15M	15515M	13.5 (0.53)	62.0 (2.44)	27.5 (1.08)	24.5 (0.96)	3.1 (0.12)	13.0 (0.51)	50		
	M10	95M10	7TCA302320R0009					62.0 (2.44)	27.5 (1.08)	24.5 (0.96)	3.1 (0.12)	13.0 (0.51)			
	M12	95M12	7TCA302320R0010					62.0 (2.44)	27.5 (1.08)	24.5 (0.96)	3.0 (0.12)	13.0 (0.51)			
	M16	95M16	7TCA302320R0011					62.0 (2.44)	27.5 (1.08)	24.5 (0.96)	2.9 (0.11)	13.0 (0.51)			
120	M8	120M8	7TCA302320R0012	18	6TC18M	15518M	15.2 (0.60)	66.5 (2.62)	28.0 (1.10)	27.5 (1.08)	3.5 (0.14)	13.5 (0.53)	50		
	M10	120M10	7TCA302320R0013					66.5 (2.62)	28.0 (1.10)	27.5 (1.08)	3.5 (0.14)	13.5 (0.53)			
	M12	120M12	7TCA302320R0014					66.5 (2.62)	28.0 (1.10)	27.5 (1.08)	3.5 (0.14)	13.5 (0.53)			
	M16	120M16	7TCA302320R0015					66.5 (2.62)	28.0 (1.10)	27.5 (1.08)	3.4 (0.13)	13.5 (0.53)			
150	M8	150M8	7TCA302330R0000	21	6TC21M	15521M	16.5 (0.65)	73.0 (2.87)	33.5 (1.32)	30.5 (1.20)	4.5 (0.18)	15.5 (0.61)	20		
	M10	150M10	7TCA302330R0001					73.0 (2.87)	33.5 (1.32)	30.5 (1.20)	4.5 (0.18)	15.5 (0.61)			
	M12	150M12	7TCA302330R0002					73.0 (2.87)	33.5 (1.32)	30.5 (1.20)	4.5 (0.18)	15.5 (0.61)			
	M16	150M16	7TCA302330R0003					73.0 (2.87)	33.5 (1.32)	30.5 (1.20)	4.3 (0.17)	15.5 (0.61)			
	M20	150M20	7TCA302330R0004					76.5 (3.01)	37.0 (1.46)	30.5 (1.20)	4.3 (0.17)	15.5 (0.61)			
185	M10	185M10	7TCA302330R0005	23	6TC23M	15523M	18.6 (0.73)	75.0 (2.95)	33.5 (1.32)	33.5 (1.32)	4.6 (0.18)	16.0 (0.63)	20		
	M12	185M12	7TCA302330R0006					75.0 (2.95)	33.5 (1.32)	33.5 (1.32)	4.6 (0.18)	16.0 (0.63)			
	M16	185M16	7TCA302330R0007					75.0 (2.95)	33.5 (1.32)	33.5 (1.32)	4.4 (0.17)	16.0 (0.63)			
	M20	185M20	7TCA302330R0008					80.0 (3.15)	38.5 (1.52)	33.5 (1.32)	4.4 (0.17)	17.5 (0.69)			
240	M10	240M10	7TCA302330R0009	26		15526M	20.8 (0.82)	89.0 (3.50)	39.0 (1.54)	37.5 (1.48)	5.3 (0.21)	18.0 (0.71)	20		
	M12	240M12	7TCA302330R0010					89.0 (3.50)	39.0 (1.54)	37.5 (1.48)	5.3 (0.21)	18.0 (0.71)			
	M16	240M16	7TCA302330R0011					89.0 (3.50)	39.0 (1.54)	37.5 (1.48)	5.3 (0.21)	18.0 (0.71)			
	M20	240M20	7TCA302330R0012					89.0 (3.50)	39.0 (1.54)	37.5 (1.48)	5.2 (0.20)	18.0 (0.71)			
300	M10	300M10	7TCA302330R0013	29		15529M	23.5 (0.93)	96.5 (3.80)	39.0 (1.54)	42.5 (1.67)	5.4 (0.21)	18.0 (0.71)	10		
	M12	300M12	7TCA302330R0014					96.5 (3.80)	39.0 (1.54)	42.5 (1.67)	5.4 (0.21)	18.0 (0.71)			
	M16	300M16	7TCA302330R0015					96.5 (3.80)	39.0 (1.54)	42.5 (1.67)	5.4 (0.21)	18.0 (0.71)			
	M20	300M20	7TCA302330R0016					96.5 (3.80)	39.0 (1.54)	42.5 (1.67)	5.3 (0.21)	18.0 (0.71)			
400	M12	400M12	7TCA302330R0017	36		15536M	27.0 (1.06)	109.5 (4.31)	44.0 (1.73)	49.5 (1.95)	7.5 (0.30)	20.0 (0.79)	5		
	M16	400M16	7TCA302330R0018					109.5 (4.31)	44.0 (1.73)	49.5 (1.95)	7.5 (0.30)	20.0 (0.79)			
	M20	400M20	7TCA302330R0019					109.5 (4.31)	44.0 (1.73)	49.5 (1.95)	7.5 (0.30)	20.0 (0.79)			



Dimensions

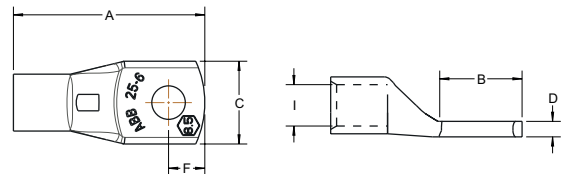

## Ty-Rap® High Performance Cable Ties

Ty-Rap® Product code structure

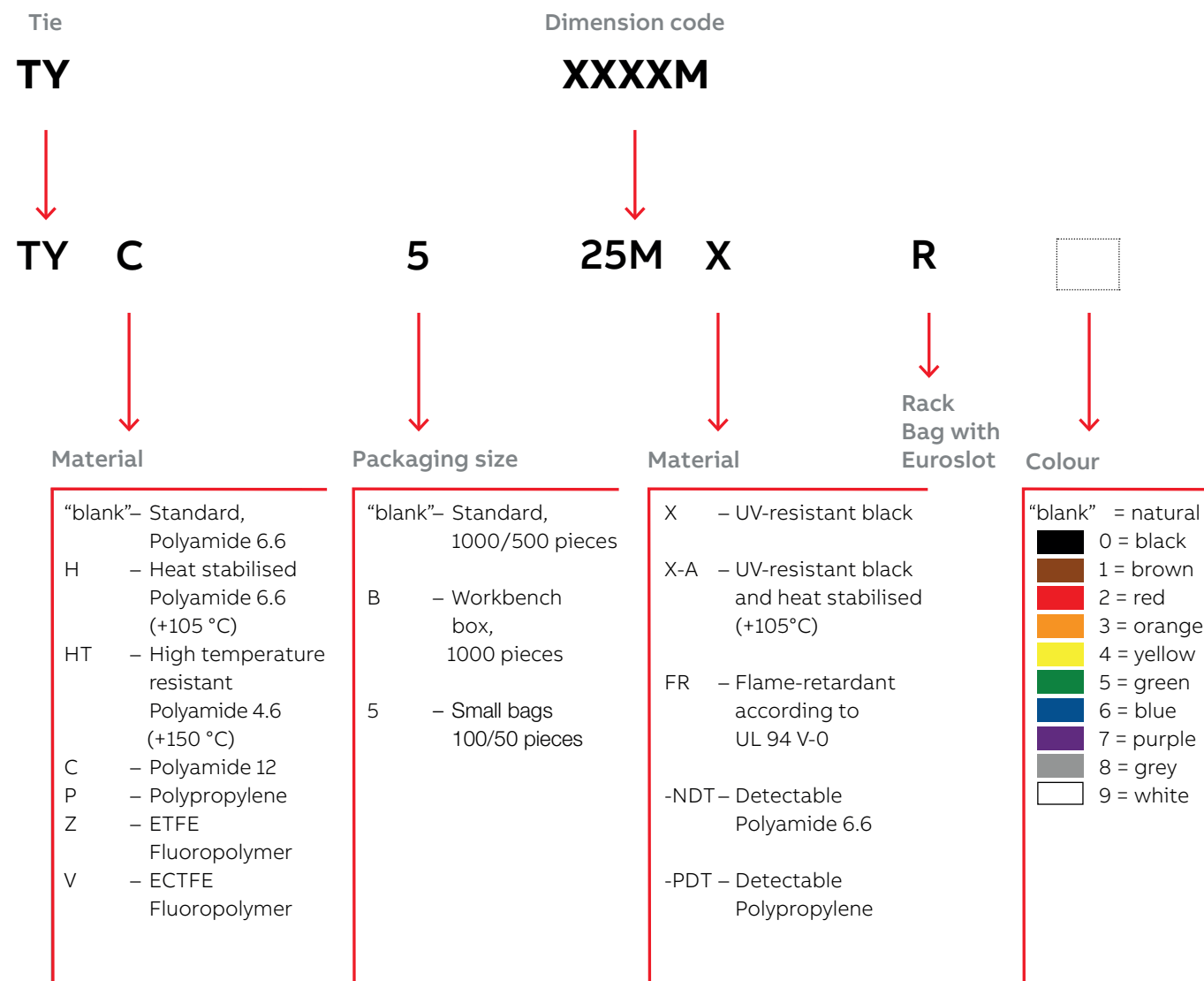

Note: Nylon (Polyamide) is inherently susceptible to environmental conditions. Ty-Rap® cable ties are moisturised to optimum performance levels at machine-side and should be stored in cool dry areas out of direct sunlight. Cable ties are packaged in plastic bags to contain moisture and should remain sealed until ready for use.

## Polyamide 6.6 cable ties - UV-resistant black - Euroslot packaging

### Ty-Rap® High Performance Cable Ties

01 Ty-Rap® High Performance Cable Ties

#### Characteristics

- UV-resistant version, especially recommended for outdoor applications
- Black version (2% carbon for military specifications)
- Packaging in small polythene bags with Euroslot, ideal for display and point-of-sales promotion (rack)
- Several lengths and 6 typical widths with a tensile strength up to 780N, to cover the most demanding applications
- Very convenient for small series production: 100 pieces (for cable ties from 2.4 mm to 4.8 mm width) or 50 pieces (for cable ties 6.9 mm width and above)

#### Technical Information

- Material - Moulding: Polyamide 6.6
- Material - Locking barb: 316 grade stainless steel
- Temperature range: -40°C to +105°C
- Colour: See colour chart below
- Flammability rating: UL 94 V-2
- Other properties: Halogen free, Silicone free

Order code	MIL Spec.	Length [mm]	Width [mm]	Thickness [mm]	Bundle ø from ... to [mm]	Min. tensile strength [N]	Quantity [pieces]	Tooling
TY5232MR	MS-3367-4	92	2.4	1.0	2 - 16	80	100	ERG50 WT193A
TY5232MR	-	203	2.4	1.0	2 - 50	80	100	
TY5234M*	-	356	2.4	1.0	2 - 102	80	100	
TY524MR	MS-3367-5	140	3.6	1.1	2 - 29	180	100	
TY5242MR	-	204	3.6	1.1	2 - 50	180	100	
TY526MR	-	284	3.6	1.1	2 - 76	130	100	
TY5244MR	-	368	3.6	1.1	2 - 103	130	100	ERG50 ERG120 WT193A
TY525MR	MS-3367-1	186	4.8	1.3	3.5 - 45	220	100	
TY5253MR	MS-3367-7	295	4.8	1.3	3.5 - 78	220	100	
TY528MR	MS-3367-2	361	4.8	1.4	3.5 - 102	220	100	ERG120 L-500-EU
TY5271MR	-	150	7.6	1.5	6 - 31	540	50	
TY5272MR	-	223	6.9	1.6	6 - 50	540	50	ERG120 L-500-EU
TY527MR	MS-3367-3	340	6.9	1.6	6 - 90	540	50	
TY5275M*	-	457	6.9	1.6	6 - 127	540	50	
TY5277M*	-	617	6.9	1.6	6 - 177	540	50	
TY529M*	MS-3367-6	771	6.9	1.6	6 - 229	540	50	

\*Product References TY5234M, TY5275M, TY5277M and TY529M have no Euroslot

01



For cable ties in a specific colour, replace \* in the Product Reference by the colour code:

0 = black, 1 = brown, 2 = red, 3 = orange, 4 = yellow, 5 = green, 6 = blue, 7 = purple, 8 = grey and 9 = white



For example: TY23M-1 defines a brown TY23M cable tie. Contact your Sales Office for product availability.

\*\* For smaller quantities, the figure "5" needs to be added to the order code immediately after "TY" - example: TY523M-2 is the same as TY23M-2 but in bags of 100

\*\* Some approvals may not be applicable to all the Product References. Contact your Sales Office for approvals limitations.

## All plastic cable ties

### Ty-Rap® Product code structure

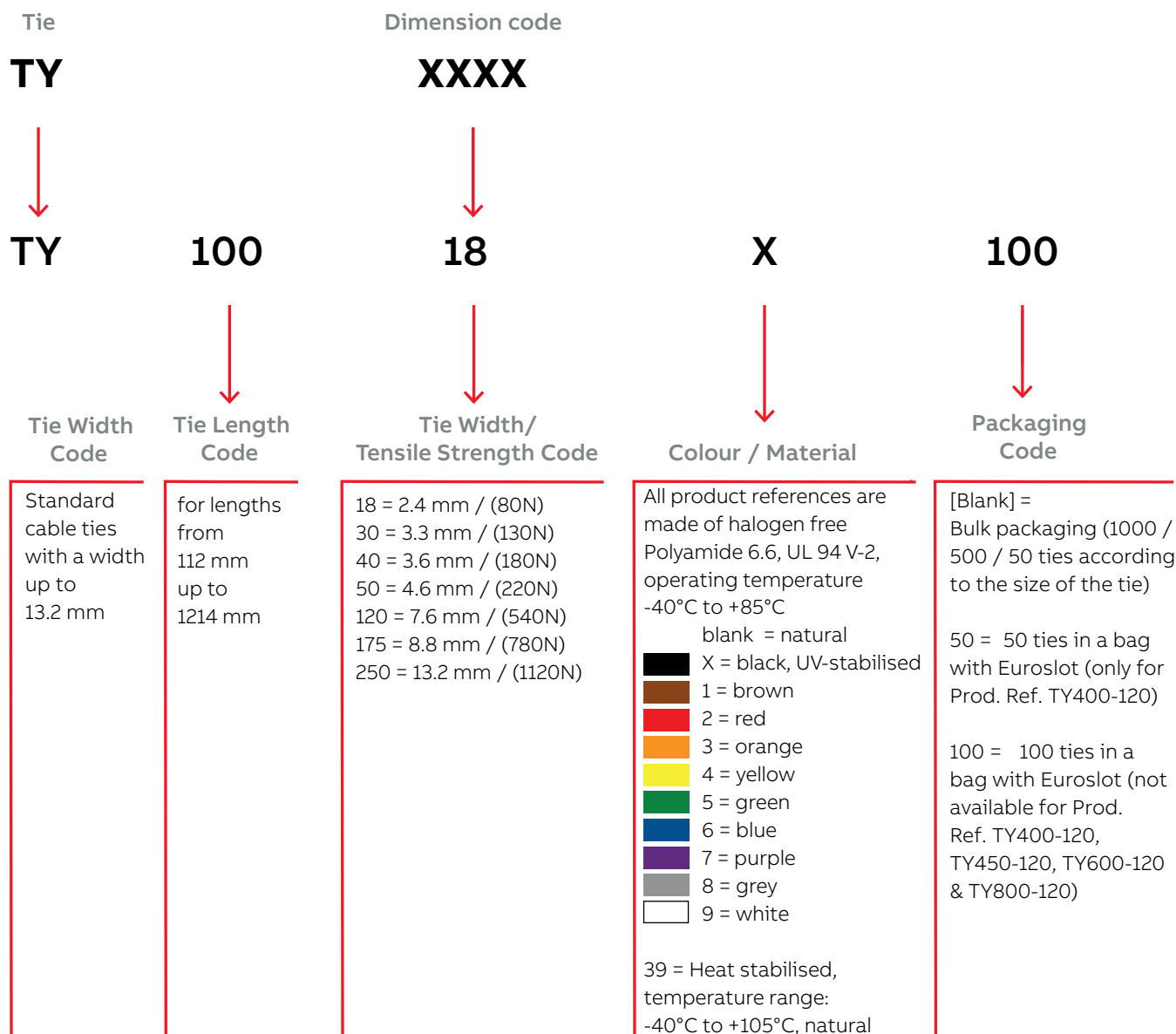

Note: Nylon (Polyamide) is inherently susceptible to environmental conditions. Ty-Rap® cable ties are moisturised to optimum performance levels at machine-side and should be stored in cool dry areas out of direct sunlight. Cable ties are packaged in plastic bags to contain moisture and should remain sealed until ready for use.

## Standard cable ties

### All-plastic cable ties

—  
01 All-plastic cable ties

#### Characteristics

State-of-the-art robotic and raw material handling equipment assures product and material integrity throughout the manufacturing process.

- The integrally formed Polyamide pawl combines low insertion and high locking strength
- A rounded, low-profile head makes for less snags
- Tails have improved two-sided finger grip design that helps the operator grasp and pull ties snug
- Sure Grip tab keeps the tail from popping out while being threaded, then holds it securely for final tightening by hand or tool
- Quick and easy pull through increases productivity, reduces operator fatigue

#### Technical Information

- Material: Polyamide 6.6 (\*)
- Temperature range: -40°C to +85°C
- Colour: Natural as standard colour (\*)
- Approvals: MIL: MS 3367-x (see table)
- Flammability rating: UL 94 V-2
- Other properties: Halogen free, Silicone free

Order code	MIL Spec.	Length [mm]	Width [mm]	Bundle ø from ... to [mm]	Min. tensile strength [N]	Quantity [pieces]	Tooling
TY100-18	MS-3367-4	112	2.4	1.6 - 25	80	1000	
TY125-18	—	136	2.4	1.6 - 32	80	1000	
TY150-18	—	163	2.4	1.6 - 38	80	1000	
TY125-30	—	143	3.3	1.6 - 32	130	1000	ERG50
TY125-40	MS-3367-5	141	3.6	1.6 - 32	180	1000	WT193A
TY200-40	—	205	3.6	1.6 - 50	180	1000	
TY300-40	—	290	3.6	1.6 - 76	180	1000	
TY400-40	—	368	3.6	1.6 - 102	180	1000	
TY125-50	—	140	4.6	1.6 - 25	220	1000	
TY175-50	MS-3367-1	186	4.6	1.6 - 44	220	1000	ERG50
TY225-50	—	226	4.6	1.6 - 57	220	1000	ERG120
TY300-50	MS-3367-7	291	4.6	1.6 - 76	220	1000	WT193A
TY400-50	MS-3367-2	366	4.6	1.6 - 102	220	1000	
TY200-120	—	219	7.6	4.8 - 50	540	500	
TY300-120	—	289	7.6	4.8 - 76	540	100	ERG120
TY400-120	MS-3367-3	375	7.6	4.8 - 102	540	50 /100	L-500-EU
TY450-120	—	457	7.6	4.8 - 123	540	50	WT3D
TY600-120	—	610	7.6	4.8 - 177	540	50	
TY800-120	MS-3367-6	706	7.6	4.8 - 203	540	50	

—  
01



\*\* Some approvals may not be applicable to all the Product References.  
Contact your Sales Office for approvals limitations.

## Ty-Met™ Stainless steel cable ties

Ball-Lock type – Standard widths, uncoated

—  
01 Stainless steel  
cable ties

### Characteristics

The Ball-Lock Type stainless steel ties from ABB are self-locking, requiring no time consuming crimping or folding operations.

- Strong self-locking mechanism (stainless steel ball), with low insertion force
- Fast, easy and reliable installation
- Heavy-duty version (12 mm & 16 mm of width), for extreme applications, indoor and outdoor
- Uncoated version, suitable for high temperature environments
- Corrosion resistant 316 grade stainless steel (marine grade) for high mechanical and chemical durability

- Applications: installation of cables and pipes in extreme conditions and hazardous areas, such as: petrochemical and food processing industries, power stations, mining, shipbuilding, offshore and other aggressive environments

### Technical Information

- Material:
  - A: 304 grade non-magnetic stainless steel
  - B: 316 grade non-magnetic stainless steel
- Temperature range: -40°C to +300°C
- Colour: Metallic
- Flammability rating: Absolutely fireproof
- Other properties: UV-resistant



—  
01

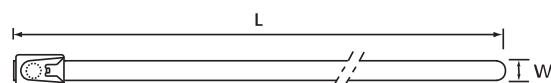

\*\* Some approvals may not be applicable to all the Product References. Contact your Sales Office for approvals limitations.

Product Ref. Stainless steel 304	Product Ref. Stainless steel 316	Length (L) [mm]	Width (W) [mm]	Material thickness [mm]	Bundle ø from ... to [mm]	Min. tensile strength [N]	Quantity [pieces]	Tooling
YLS-4.6-100A	YLS-4.6-100B	100	4.6	0.26	20-25	778	100	
YLS-4.6-125A	YLS-4.6-125B	125	4.6	0.26	20-25	778	100	
YLS-4.6-150A	YLS-4.6-150B	150	4.6	0.26	20-35	778	100	
YLS-4.6-200A	YLS-4.6-200B	200	4.6	0.26	20-50	778	100	
YLS-4.6-300A	YLS-4.6-300B	300	4.6	0.26	20-83	778	100	
YLS-4.6-360A	YLS-4.6-360B	360	4.6	0.26	20-100	778	100	
YLS-4.6-520A	YLS-4.6-520B	520	4.6	0.26	20-150	778	100	
YLS-4.6-680A	YLS-4.6-680B	680	4.6	0.26	20-200	778	100	
YLS-4.6-840A	YLS-4.6-840B	840	4.6	0.26	20-250	778	100	
YLS-4.6-1000A	YLS-4.6-1000B	1000	4.6	0.26	20-300	778	100	
YLS-4.6-1200A	YLS-4.6-1200B	1200	4.6	0.26	20-365	778	100	
YLS-4.6-1400A	YLS-4.6-1400B	1400	4.6	0.26	20-425	778	100	CT3
YLS-7.9-100A	YLS-7.9-100B	100	7.9	0.26	20-20	1112	100	CT6
YLS-7.9-125A	YLS-7.9-125B	125	7.9	0.26	20-22	1112	100	
YLS-7.9-150A	YLS-7.9-150B	150	7.9	0.26	20-35	1112	100	
YLS-7.9-200A	YLS-7.9-200B	200	7.9	0.26	20-50	1112	100	
YLS-7.9-300A	YLS-7.9-300B	300	7.9	0.26	20-83	1112	100	
YLS-7.9-360A	YLS-7.9-360B	360	7.9	0.26	20-100	1112	100	
YLS-7.9-520A	YLS-7.9-5200B	520	7.9	0.26	20-150	1112	100	
YLS-7.9-680A	YLS-7.9-680B	680	7.9	0.26	20-200	1112	100	
YLS-7.9-840A	YLS-7.9-840B	840	7.9	0.26	20-250	1112	100	
YLS-7.9-1000A	YLS-7.9-1000B	1000	7.9	0.26	20-300	1112	100	
YLS-7.9-1200A	YLS-7.9-1200B	1200	7.9	0.26	20-365	1112	100	
YLS-7.9-1400A	YLS-7.9-1400B	1400	7.9	0.26	20-425	1112	100	

## Ty-Met™ Standard cable ties

### Stainless steel cable ties

—  
01 Stainless steel  
cable ties

#### Characteristics

The Ball-Lock Type stainless steel ties from ABB are self-locking, requiring no time consuming crimping or folding operations.

- Strong self-locking mechanism (stainless steel ball), with low insertion force
- Fast, easy and reliable installation
- Heavy-duty version (12 mm & 16 mm of width), for extreme applications, indoor and outdoor
- Uncoated version, suitable for high temperature environments
- Corrosion resistant 316 grade stainless steel (marine grade) for high mechanical and chemical durability

- Applications: installation of cables and pipes in extreme conditions and hazardous areas, such as: petrochemical and food processing industries, power stations, mining, shipbuilding, offshore and other aggressive environments

#### Technical Information

- Material: 316 grade non-magnetic stainless steel
- Temperature range: -80°C to +300°C
- Colour: Metallic
- Flammability rating: Absolutely fireproof
- Other properties: UV-resistant



—  
01

Order code	Length [mm]	Width [mm]	Material thickness [mm]	Bundle ø from ... to [mm]	Min. tensile strength [N]	Quantity [pieces]	Tooling
YLS-12-200B	200	12.0	0.32	25-50	2670	50	
YLS-12-300B	300	12.0	0.32	25-83	2670	50	
YLS-12-360B	360	12.0	0.32	25-100	2670	50	
YLS-12-440B	440	12.0	0.32	25-125	2670	50	
YLS-12-520B	520	12.0	0.32	25-150	2670	50	
YLS-12-600B	600	12.0	0.32	25-175	2670	50	CT3
YLS-12-680B	680	12.0	0.32	25-200	2670	50	CT7
YLS-12-760B	760	12.0	0.32	25-225	2670	50	
YLS-12-840B	840	12.0	0.32	25-250	2670	50	
YLS-12-1000B	1000	12.0	0.32	25-300	2670	25	
YLS-12-1200B	1200	12.0	0.32	25-365	2670	25	
YLS-12-1400B	1400	12.0	0.32	25-425	2670	25	
YLS-16-200B	200	16.0	0.32	40-50	3110	50	
YLS-16-300B	300	16.0	0.32	40-80	3110	50	
YLS-16-360B	360	16.0	0.32	40-100	3110	50	
YLS-16-440B	440	16.0	0.32	40-125	3110	50	
YLS-16-520B	520	16.0	0.32	40-150	3110	50	
YLS-16-600B	600	16.0	0.32	40-185	3110	50	
LS-16-680B	680	16.0	0.32	40-200	3110	50	CT7
YLS-16-760B	760	16.0	0.32	40-225	3110	50	
YLS-16-840B	840	16.0	0.32	40-250	3110	50	
YLS-16-1000B	1000	16.0	0.32	40-300	3110	25	
YLS-16-1200B	1200	16.0	0.32	40-365	3110	25	
YLS-16-1400B	1400	16.0	0.32	40-425	3110	25	

## E-Klips mechanical and electrical fixings

### Key products

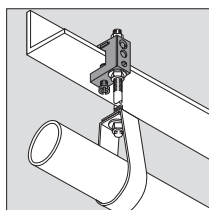

Girder clamps for threaded rod

Part Code	Order Code	Quantity (pieces)
FH65	7TCA084030R1720	25

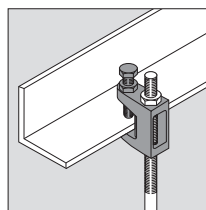

Girder clamps for threaded rod

Part Code	Order Code	Quantity (pieces)
FC-11	7TCA084220R0153	25

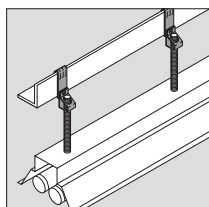

Purlin clips for threaded rod

Part Code	Order Code	Quantity (pieces)
AV155-AM6T	7TCA084030R0750	25
AV155-AM10T	7TCA084030R0742	25

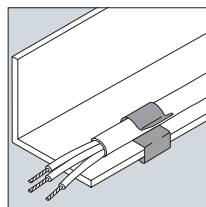

Girder clips for single cables

Part Code	Order Code	Quantity (pieces)
ECS89	7TCA084030R1714	25
ECS1011	7TCA084030R1710	25
ECS1214	7TCA084030R1711	25
ECS1519	7TCA084030R1712	25
ECS2024	7TCA084030R1713	25
ECM89	7TCA084030R1709	25
ECM1011	7TCA084030R1705	25
ECM1214	7TCA084030R1706	25
ECM1519	7TCA084030R1707	25
ECM2024	7TCA084030R1708	25
ECL89	7TCA084030R1704	25
ECL1011	7TCA084030R1700	25
ECL1214	7TCA084030R1701	25
ECL1519	7TCA084030R1702	25
ECL2024	7TCA084030R1703	25

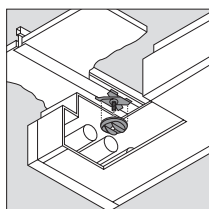

Suspended ceiling clips

Part Code	Order Code	Quantity (pieces)
JHX16S	7TCA084030R1721	25

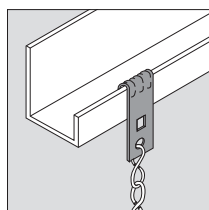

Girder clips for chain or wire

Part Code	Order Code	Quantity (pieces)
AV155	7TCA084030R1699	25

## Girder clips for conduit

Type AH-GM

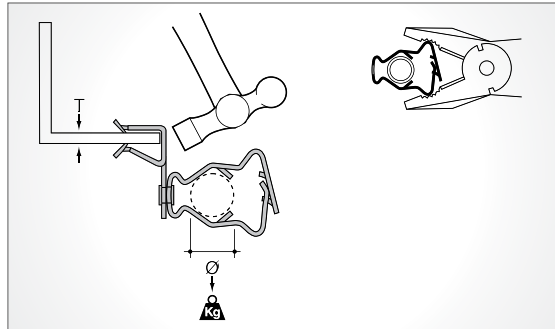
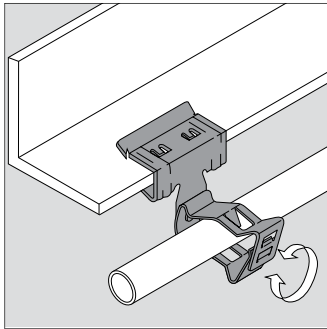

### Girder clips for conduit

Order Code	T (mm)	Ø (mm)	PG type	Load rating (kg)	Material finishes	Quantity (pieces)
AH153-GM1219	1.5-3	12-19	7/9/11	12	F8+	25
AH153-GM1926	1.5-3	19-26	13.5/16	12	F8+	25
AH153-GM2632	1.5-3	26-32	21	12	F8+	25
AH153-GM3240	1.5-3	32-40	29	12	F8+	25
AH153-GM4047	1.5-3	40-47	36	12	F8+	25
AH153-GM4757	1.5-3	47-57	36/42	12	F8+	25
AH38-GM1219	3-8	12-19	7/9/11	12	F8+	25
AH38-GM1926	3-8	19-26	13.5/16	12	F8+	25
AH38-GM2632	3-8	26-32	21	12	F8+	25
AH38-GM3240	3-8	32-40	29	12	F8+	25
AH38-GM4047	3-8	40-47	36	12	F8+	25
AH38-GM4757	3-8	47-57	36/42	12	F8+	25
AH814-GM1219	8-14	12-19	7/9/11	12	F8+	25
AH814-GM1926	8-14	19-26	13.5/16	12	F8+	25
AH814-GM2632	8-14	26-32	21	12	F8+	25
AH814-GM3240	8-14	32-40	29	12	F8+	25
AH814-GM4047	8-14	40-47	36	12	F8+	25
AH814-GM4757	8-14	47-57	36/42	12	F8+	25
AH1420-GM1219	14-20	12-19	7/9/11	12	F8+	25
AH1420-GM1926	14-20	19-26	13.5/16	12	F8+	25
AH1420-GM2632	14-20	26-32	21	12	F8+	25
AH1420-GM3240	14-20	32-40	29	12	F8+	25
AH1420-GM4047	14-20	40-47	36	12	F8+	25
AH1420-GM4757	14-20	47-57	36/42	12	F8+	25



— For more detailed product information, please refer to our online technical brochures available at: [new.abb.com/low-voltage/support/documentation](http://new.abb.com/low-voltage/support/documentation)

or contact our sales team via email [leeds.quotes@gb.abb.com](mailto:leeds.quotes@gb.abb.com)

or our technical team [leeds.tech@gb.abb.com](mailto:leeds.tech@gb.abb.com)

---

# Emergi-Lite - Emergency lighting

206	PrimEvo
210	NaveoPro
213	DALI Control Unit (DCU)
214	Guideway
215	Serenga 2
216	Aqualux
217	Ovano
221	Lutia
222	Indulux
224	MirEvo
225	Cordona
226	Camarque
227	Day-Lite Ex-cel
228	Silver-Scape
230	Navigator
231	Weatherforce
232	Horizon
233	Central Battery

## PrimEvo XT100E

Productivity and reliability



### PrimEvo XT100E

- Available at your local wholesaler
- Plug and play, maintained and non-maintained in one
- Full LED range with best price/performance ratio

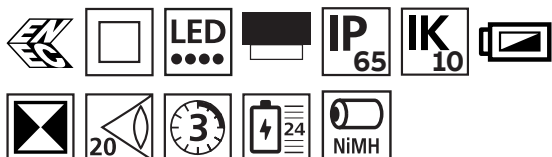

### Luminaire

Order Code	Description	Input voltage	Lamp type	Lamp output (lm)	Power consumption (VA/W)	Operation duration (hrs)	Environment temperature (°C)	Weight (kg)
XT100E*	PrimEvo Bulkhead	220 - 240 Vac, 50 Hz	2 x LED 0.5W**	110	5/2	3	0 - 40	0.6

\*configurable pictograms included  
\*\* = 1W LED

### Accessories

Order Code	Description
642 202	Recess Kit 100% - Wall/Ceiling <sup>(1)</sup>
642 102	Recess Kit 50% - Wall/Ceiling <sup>(2)</sup>
663 325	Pictogram holder with 3 legends
663 330	Pack of 3 legends for signaling (Left, right and down arrow)
642 015	Protective grid cover <sup>(3)</sup>



01



02



03

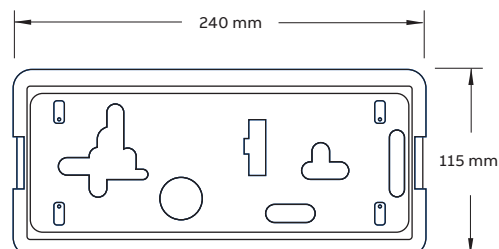
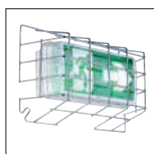

# PrimEvo XT200E

Productivity and reliability



### PrimEvo XT200E

- Available at your local wholesaler
- Plug and play, maintained and non-maintained in one
- Full LED range with best price/performance ratio



Luminaire

Order Code	Description	Input voltage	Lamp type	Lamp output (lm)	Power consumption (VA/W)	Operation duration (hrs)	Environment temperature (°C)	Weight (kg)
XT200E*	PrimEvo Exit Sign	220 - 240 Vac, 50 Hz	1 x LED 2W**	120	5.2/2.4	3	-5 - 45	0.95

\*configurable pictograms included

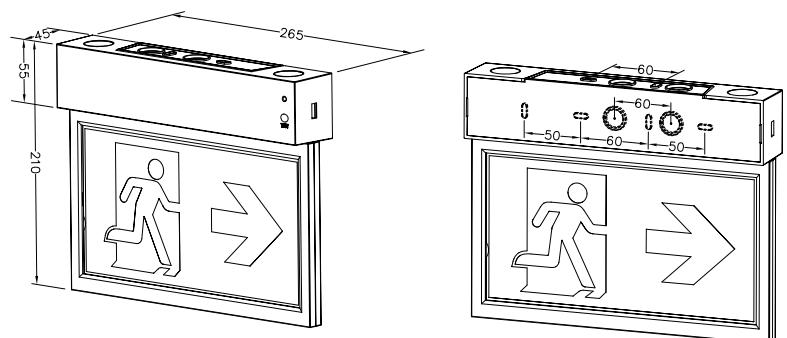

## PrimEvo RS100E & SM100E

Productivity and reliability



RS100E



SM100E

### PrimEvo RS100E & SM100E

- Available at your local wholesaler
- Plug and play, maintained and non-maintained in one
- Full LED range with best price/performance ratio

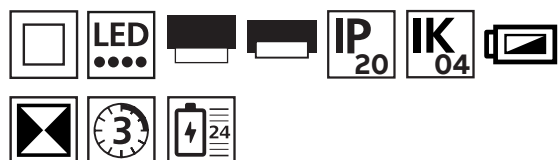

—  
Luminaire

Order Code	Description	Input voltage	Lamp type	Power consumption** (VA/W)	Operation duration (hrs)	Environment temperature (°C)	Weight (kg)
RS100E	PrimEvo Recessed downlighter	220 - 240 Vac, 50 Hz	2 x LED 1.5W*	10/4.8	3	0 - 25	0.425
SM100E	PrimEvo Surface downlighter	220 - 240 Vac, 50 Hz		9/4.5	3	0 - 25	0.425

\* = 3W LED  
\*\* maintained mode

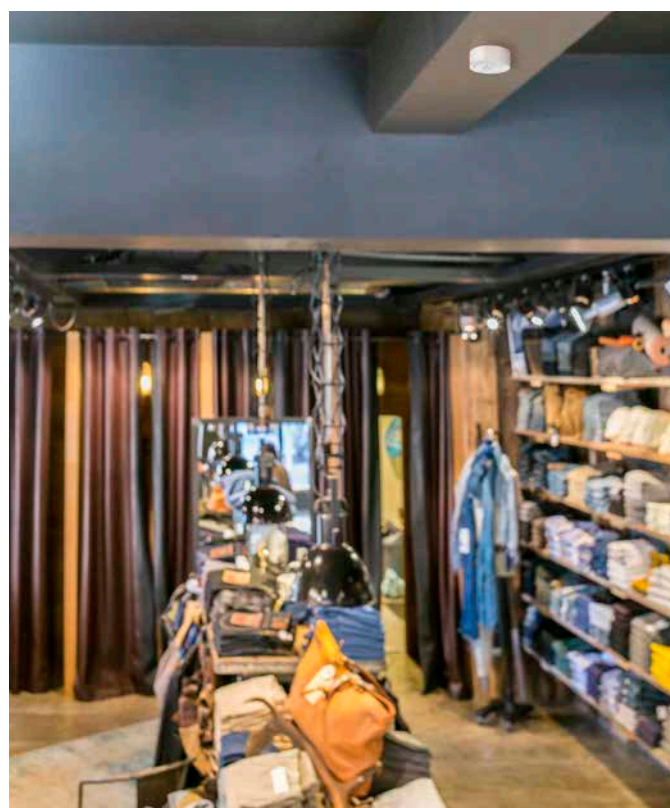

PrimEvo RS100E

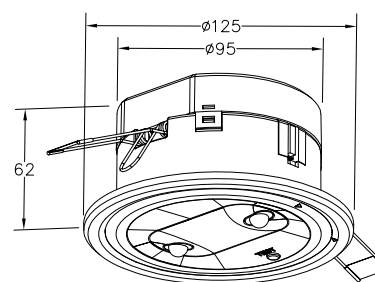

PrimEvo SM100E

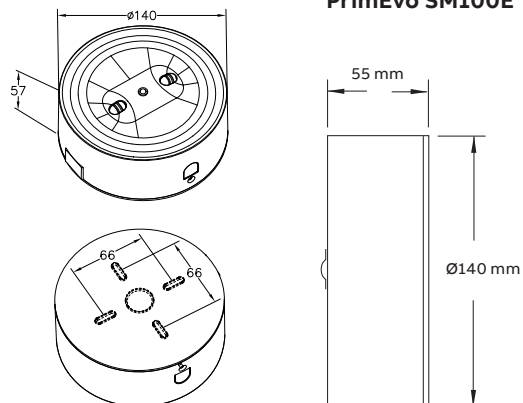

## PrimEvo Twinspot

Productivity and reliability



### PrimEvo Twinspot

- Available at your local wholesaler
- Plug and play, maintained and non-maintained in one
- Full LED range with best price/performance ratio

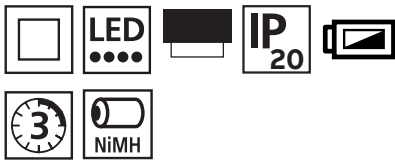

Luminaire

Order Code	Description	Input voltage	Lamp type	Lamp output (lm)	Power consumption (VA/W)	Operation duration (hrs)	Environment temperature (°C)	Weight (kg)
TW220E	PrimEvo Twinspot	220 - 240 Vac, 50 Hz	1 x LED 2W	220	15.5/6.5	3	0 - 40	0.5

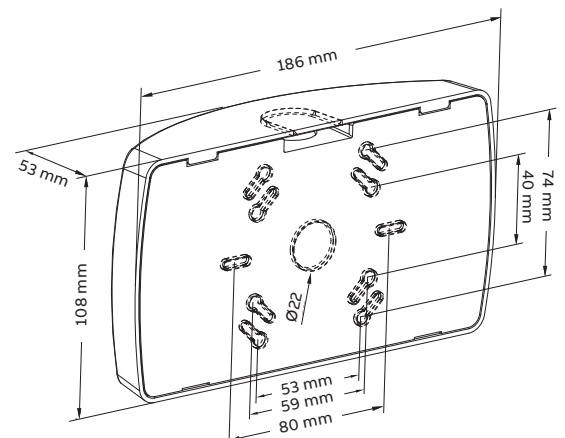

# Naveo®Pro

## The emergency lighting inspection and maintenance solution

The Naveo®Pro inspection and maintenance system provides a digital overview via the cloud – providing ready information to assist resource planning and enhance building safety. This information can be processed directly using a mobile device.

— 01 The ABB Ability™ platform is an integrated Internet platform and cloud infrastructure.

In practice, this will save you time on collecting and entering information. Utilising the ABB Ability™ platform gives you integrated cyber security for safety and reliability, enables better maintenance planning, and reduces operating costs.

### Overview in inspection and maintenance

In practice, ongoing inspection, maintenance and testing of emergency lighting is a time-consuming process with a great deal of work that has to be carried out regularly during every year that the installation is in place. These costs can be out weighed with a centralised automatic test system.

With Naveo®Pro you can concentrate on what matters: letting your emergency lighting luminaire system manage itself and reduce the amount of time monitoring it. This will quickly save you a considerable amount of money on maintenance time, allowing you to focus on problems quickly and as they happen. In figures, this could have potential savings of up to 30% on costs each and every year.

### An overview of the advantages

- Inspection and maintenance software for mobile device
- Save time in planning maintenance ahead
- 24/7 overview of all monitored buildings via google maps
- Save administration time with on-site data entry using your mobile app
- Status alerts pushed to your mobile device
- Automatic list of (replacement) parts, including article numbers
- Ensuring that intended design of the emergency lighting installation is never compromised
- Documents can be used to prove safety of building to insurance companies, e.g. Liability and Buildings Insurance

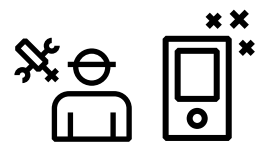

Share information with your service team  
All-in-one tool for Naveo®Pro users

**ABB Ability™ enables Intelligent Buildings**  
ABB Ability™ connects our customers to the power of the Internet of Things and, through our services and expertise, goes further by turning data insights into the direct action that "closes the loop" and generates customer value in the physical world.

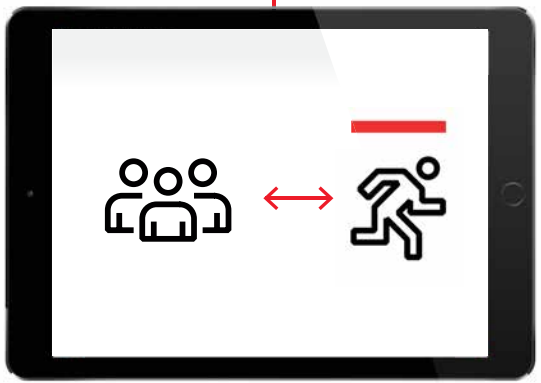

01 The Naveo®Pro architecture for emergency lighting consists of three tiers; emergency lighting luminaires, the ABB gateway and the cloud.

Connecting your emergency lighting luminaires to the ABB gateway is simple and makes real time system status information readily available and easy to process via the cloud. Having this information enables you to get status directly to your mobile device. This method of accessing controlling, and monitoring the status of your installation, makes maintenance of your installation a great deal easier.

**How does it work?**

With Naveo®Pro being connected all the time, your emergency lighting system is always fully up to date. You can easily set up the connection:

- The Gateway continuously receives all luminaires data and pushes this information to the Naveo®Pro app.
- On continuous request from the cloud the Gateway automatically sends all (test) data to the Naveo®Pro app. With Naveo®Pro you are therefore constantly in touch with your system status anytime and anywhere.
- During a visual inspection of your building you can add notes directly into the app which means you can record your visual risk assessments in one place.

01

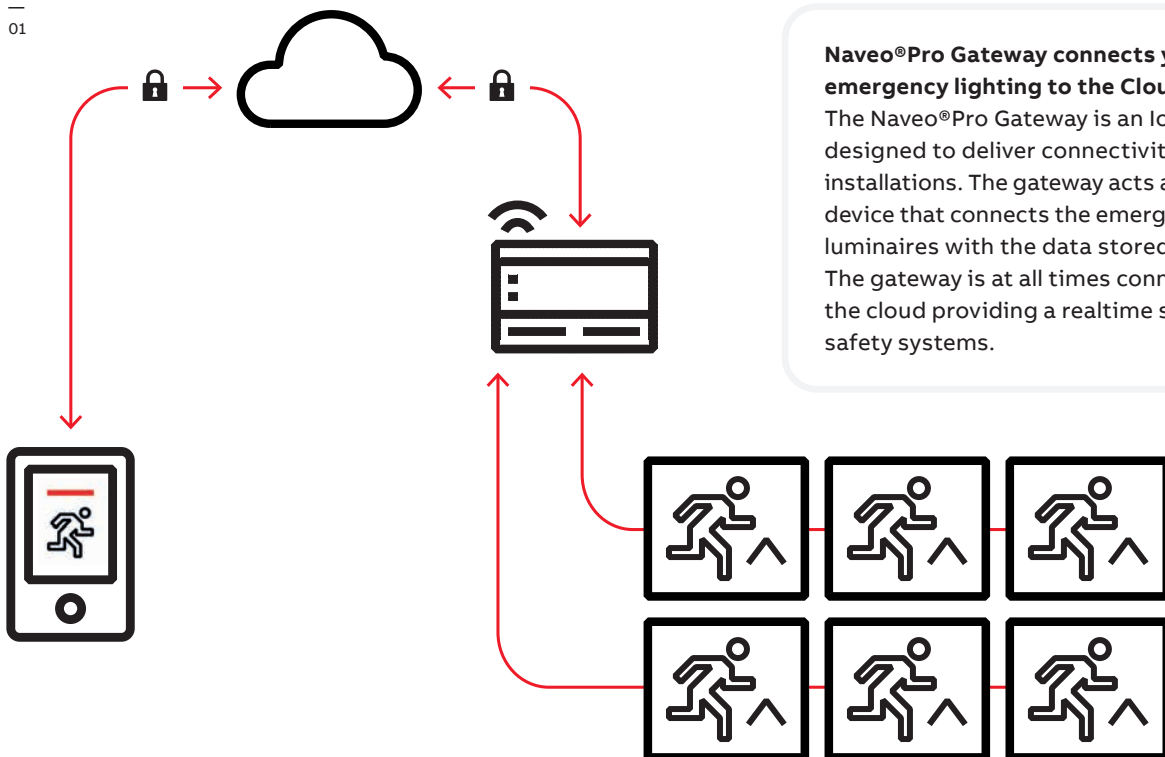

**Naveo®Pro Gateway connects your emergency lighting to the Cloud**  
 The Naveo®Pro Gateway is an IoT Gateway designed to deliver connectivity to all types of installations. The gateway acts as a networking device that connects the emergency lighting luminaires with the data stored in the cloud. The gateway is at all times connected to the cloud providing a realtime status of your safety systems.

\* Up to 500 luminaires per gateway.

# The Naveo®Pro app

Set up, maintain and fully control your entire emergency lighting installation with a new mobile app.

The Naveo®Pro App provides a real time overview of all systems, saving time, enabling better maintenance planning and enhancing building safety.

With the Naveo®Pro app, all types of emergency luminaires can be easily installed and programmed into a building in a fast and intuitive way using a QR code.

Through the ABB Ability™ platform, the system provides a digital overview via the cloud, giving instant information to assist resource planning and enhance building safety, which can be processed directly from a mobile device.

With emergency luminaire data stored in the cloud, the mobile app provides a 24/7 overview of all smart monitored buildings via Google maps. Building maps can be uploaded and overlaid onto Google maps, showing its current status and providing a clear and precise location of the emergency lighting luminaire.



**Set-Up**  
Easily install and add new devices to your building through a list or map



**Maintain**  
Defective devices are automatically detected and reported on your interface in addition to push notifications



**Test**  
Run test instantly or program them to ensure that all your devices are working properly



**Share**  
Easily share the results of tests with other people on your team

**Naveo®Pro system components**

Order Code	Description
51000040	Naveo®Pro GW 1.0
758740	Naveo®Pro Gateway mounting plate

## DALI control unit (DCU)

Productivity and reliability



### DALI emergency lighting control panel

- Ensuring building occupant safety
- Touch screen to control, test and monitor emergency lighting
- Simple to group and easy to install



### Control unit

Order code	Description	Input voltage	Lamp type	Power consumption (VA/W)	Operation / duration (hrs)	Environment temp. (°C)	Weight (kg)
ELDCS1/DALI/EL	DALI emergency control unit	220-240 AC 50 Hz	N/A	6	N/A	0 - 50	1.1

Note. The manual, pre-commissioning documents, device location record sheet, test record sheet and download software for spreadsheet are available on the ABB low voltage website  
DALI bus power supply 12V DC included

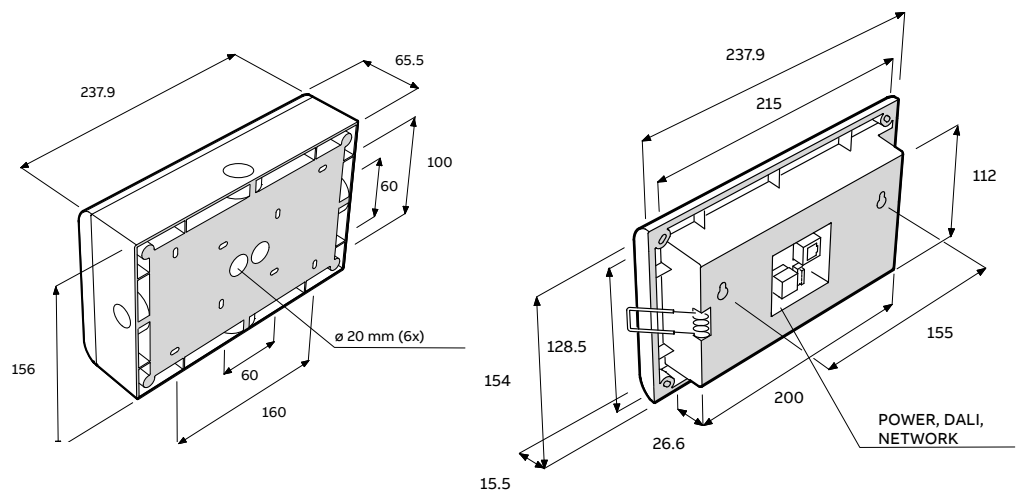

# Guideway

Innovative and stylish

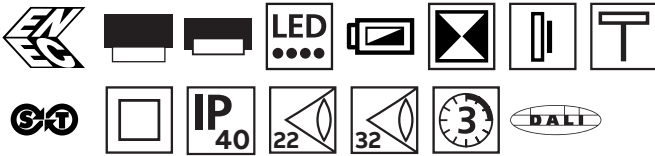

### Escape route signalisation

- Compatible with DALI control unit to control, test & monitor emergency lighting
- Clearly visible in daylight - 500 cd/m<sup>2</sup>
- Uniform light distribution
- In harmony with interior spaces
- Frameless legend design

### Luminaire

Order code	Description	Input voltage	Lamp type	Power consumption (VA/W)	Operation / duration (hrs)	Environment temp. (°C)	Weight (kg)
DAEGR3LS1-S22	REC LED SIGN M3 22M DALI	220-240 Vac, 50 Hz	LED strip 1.8W	4.2 / 4.2	M3/NM3	5 - 35	0.93
DAEGR3LS1-S32	REC LED SIGN M3 32M DALI	220-240 Vac, 50 Hz	LED strip 3.6W	6.0 / 6.0	M3/NM3	5 - 35	1.11
DAEG3LS1-S22	LED SIGN M3 22M DALI	220-240 Vac, 50 Hz	LED strip 1.8W	4.2 / 4.2	M3/NM3	5 - 35	1.11
DAEG3LS1-S32	LED SIGN M3 32M DALI	220-240 Vac, 50 Hz	LED strip 3.6W	6.0 / 6.0	M3/NM3	5 - 35	1.58

Includes back to wall mounting accessory as standard.  
60 hrs charge at first commissioning, 24 hrs re-charge thereafter.  
Maintained and non maintained

### Single sided

Part No.	Legends
<b>ISO 7010 legend format</b>	
XEN2EG32	
XEN3EG32	
XEN6EG32	
XEN5EG32	

### Flag mounted

Part No.	Legends
<b>ISO 7010 legend format</b>	
XEN602EG32	
XEN603EG32	
XEN606EG32	
XEN605EG32	

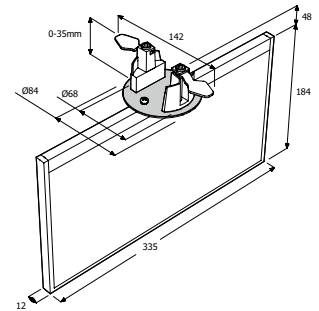
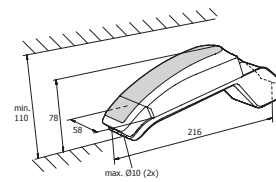

### Accessories

Order code	Description	Colour
EG-T4SG	Cover discs, 2+2 self contained	
EG-T4EG	Cover discs, 2+2 slave	

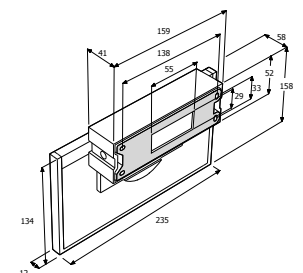
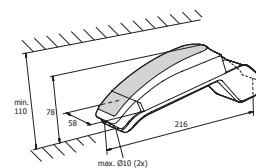

# Serenga 2

Project covering and stylish

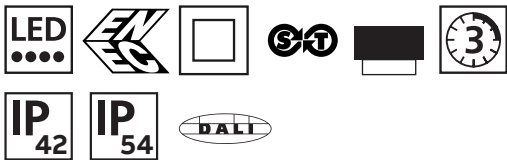

### Escape route lighting

- Compatible with DALI control unit to control, test & monitor emergency lighting
- Injection moulded - high grade polycarbonate body and geartray of aluminium die cast
- Specially designed lens for optimised light distribution
- Modular, First-Fix installation

### Luminaire

Order code	Description	Input voltage	Lamp type	Power consumption (VA/W)	Operation / duration (hrs)	Environment temp. (°C)	Weight (kg)
DASR2-DEA-M3	REC M3 DALI ESC-4MH WH	220-240 Vac, 50 Hz	2x LED 0.85W = 1,9W	4.74 / 4.0	M3/NM3	5 - 40	0.6 kg
DASR2-DAD-M3	REC M3 DALI OA-L4M WH	220-240 Vac, 50 Hz	2x LED 0.85W = 1,9W	4.74 / 4.0	M3/NM3	5 - 40	0.6 kg
DASR2-SEM3-A1	SFC M3 DALI ESC-L4M WH	220-240 Vac, 50 Hz	2 x LED 0.85W = 1.9W	4.74 / 4.0	M3/NM3	5 - 40	1.0
DASR2-SAM3-D1	SFC M3 DALI OA-L4M WH	220-240 Vac, 50 Hz	2 x LED 0.85W = 1.9W	4.74 / 4.0	M3/NM3	5 - 40	1.0

Interchangeable lenses are available.  
Maintained and non maintained

### Accessories

Order code	Description
SR2-CCAW	WH circular adaptor

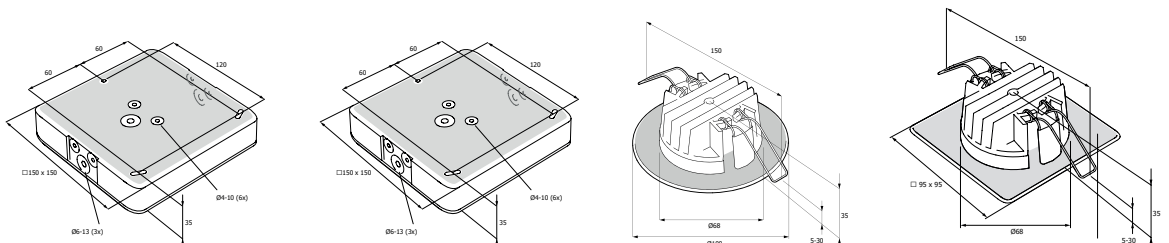

## Aqualux

Durable and high performance



### Back-lit LED exit sign

- Attractive aluminium modular enclosure
- Clear polycarbonate broad delivery diffuser
- Intelligent self-test as standard
- Complies to IEC 60598.2.22

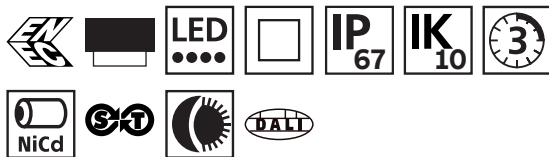

LED base unit

Order code	Description	Input voltage	Lamp type	Power consumption (VA/W)	Operation / duration (hrs)	Environment temp. (°C)	Weight (kg)
DLOW3LS60	W LED DALI M3	220-240 Vac, 50 Hz	3W LED	9.9 / 5.1	M3/NM3	0-25	2.2

### Legends

Part No.	Pictogram
XEN2W	
XEN3W	
XEN6W	
XEN5W	
XLF802W	
XLF803W	



### Accessories

Order code	Description
OW/BCM	Ceiling bracket, vertical mount
OW/BWA	Wall bracket, angled mount

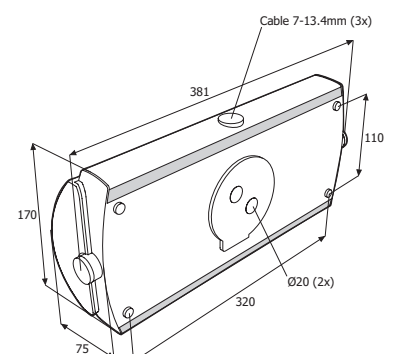

**Ovano**

Productivity and reliability



**Compact emergency exit sign, wall mount**

- Compatible with DALI control panel (DCU) to control, test & monitor emergency lighting
- Plug and play, maintained and non-maintained in one
- 25m viewing distance

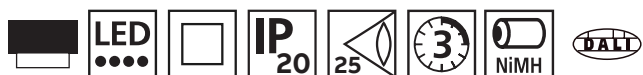

**Luminaire**

Order code	Description	Input voltage	Lamp type	Power consumption (VA/W)	Operation / duration (hrs)	Environment temp. (°C)	Weight (kg)
XT224SM/DALI*	XT224SM	220-240 AC 50/60 Hz	1 x LED 2.8W	3.5	3	-5-45	0.66

\* Configurable pictograms included  
Maintained and non maintained

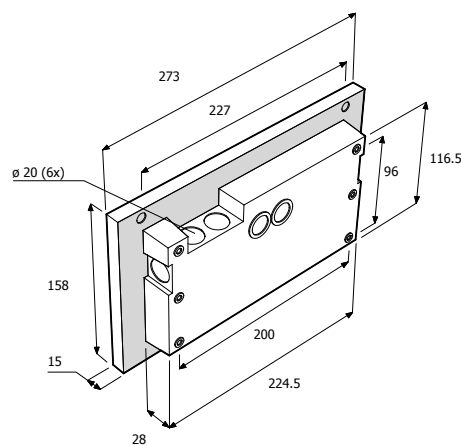

Ensure 3cm clearance above product when wall mounting

## Ovano

Productivity and reliability



### Compact emergency exit sign, surface mount

- Compatible with DALI control panel (DCU) to control, test & monitor emergency lighting
- Plug and play, maintained and non-maintained in one
- 30m viewing distance

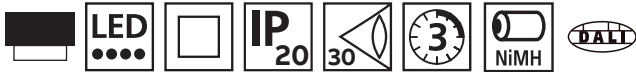

### Luminaire

Order code	Description	Input voltage	Lamp type	Power consumption (VA/W)	Operation / duration (hrs)	Environment temp. (°C)	Weight (kg)
XT230RS/DALI*	XT230RS	220-240 AC 50/60 Hz	1 x LED 2W	3.5	3	-5-45	1.24

\* Configurable pictograms included  
Maintained and non maintained

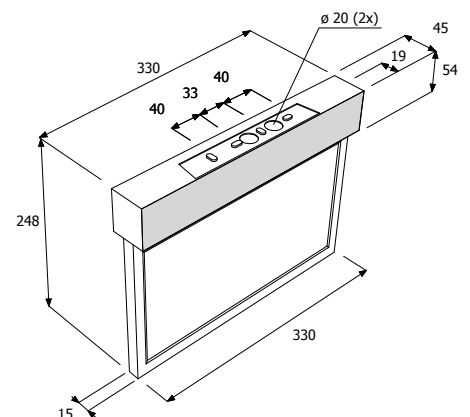

**Ovano**

Productivity and reliability



**Compact emergency exit sign, wall mount**

- Compatible with DALI control panel (DCU) to control, test & monitor emergency lighting
- Plug and play, maintained and non-maintained in one
- 25m viewing distance

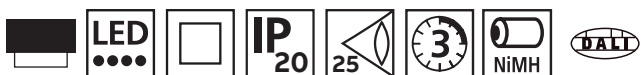

**Luminaire**

Order code	Description	Input voltage	Lamp type	Power consumption (VA/W)	Operation / duration (hrs)	Environment temp. (°C)	Weight (kg)
XT224SM/DALI*	XT224SM	220-240 AC 50/60 Hz	1 x LED 2.8W	3.5	3	-5-45	0.66

\* Configurable pictograms included  
Maintained and non maintained

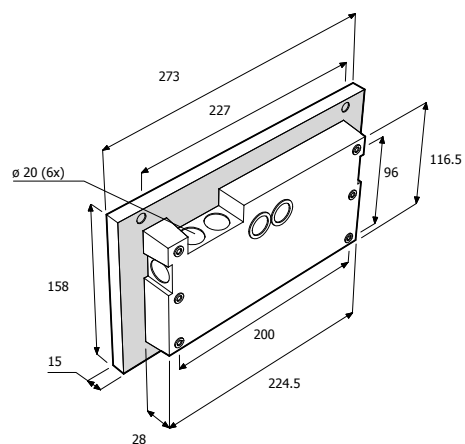

Ensure 3cm clearance above product when wall mounting

# Ovano

Productivity and reliability



XT200M3H  
Escape route version



XT201M3H  
Anti-Panic version

### Escape route lighting

- Compatible with DALI control unit to control, test & monitor emergency lighting
- Plug and play, maintained and non-maintained in one
- Compact and decorative design



### Luminaire

Order code	Description	Input voltage	Lamp type	Power consumption (VA/W)	Operation / duration (hrs)	Environment temp. (°C)	Weight (kg)
XT200M3H/DALI	Ovano XT200M3H	220-240 Vac, 50 Hz		5	M3/NM3	0 - 40	0.35
XT201M3H/DALI	Ovano XT201M3H	220-240 Vac, 50 Hz		5	M3/NM3	0 - 25	0.35

Maintained and non maintained

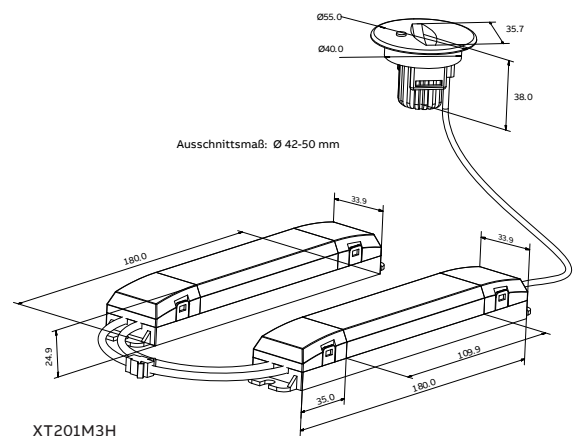
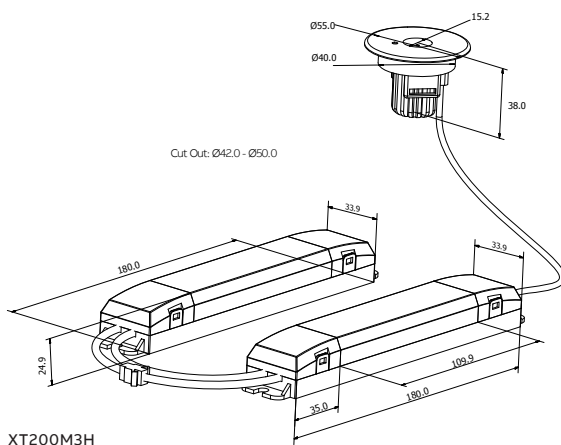

## Lutia

Reliable and Robust



### Ceiling and wall mounted luminaire

- First-fix and loop-in, loop-out systems minimise installation time
- One product concept for both wall and ceiling mounted
- Robust design developed for outdoor applications
- Complies to IEC 60598.2.22



### Luminaire

Order code	Description	Input voltage	Lamp type	Lamp output (lm)	Power consumption (VA/W)	Operation / duration (hrs)	Environment temp (°C)	Weight (kg)
STLU3LB1E	Lutia LED ESC M3 ST	230-240 Vac, 50/60 Hz	2 x 0.95W	97	6.1 / 5.5	3	-20 +40	1.6
LU1LB1E	Lutia LED ESC 230V	230-240 Vac, 50/60 Hz		206	5.6 / 5	230V	-40 +40	1.3
LTCLU1LB1E	Lutia LED ESC 230V LTC	230-240 Vac, 50/60 Hz		206	5.6 / 5	230V	-40 +40	1.3
CTLU3LB1E	Lutia LED ESC M3 CT-Naveo	230-240 Vac, 50/60 Hz		97	6.1 / 5.5	3	-20 +40	1.4

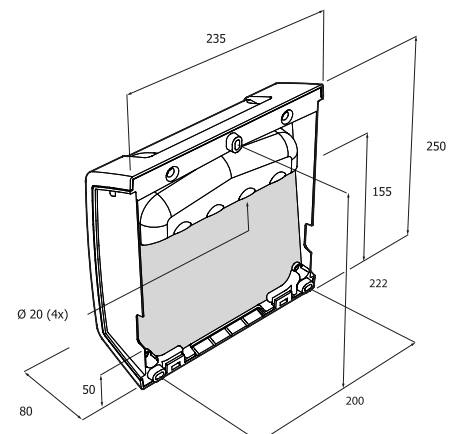

# Indulux escape route signalisation

Industrial and design



### All-in-one tubular emergency lighting

- Mounting, wiring and expanded flexibility
- Stainless steel solution resisting dust and water (IP68)
- Rapid maintenance with sliding electronic base module

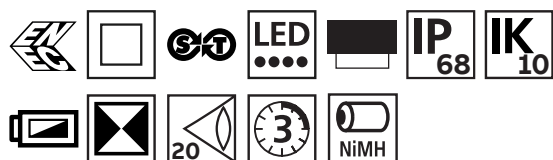

### Luminaire

Order code	Description	Input voltage	Lamp type	Lamp output (lm)	Power consumption (VA/W)	Operation / duration (hrs)	Environment temp. (°C)	Weight (kg)
CTIND3LS5	Indulux LED S/S M3 CT	220-240 AC 50Hz	1 x LED 4W	200	7.5 / 3.5	3	0-40	1.6
CTIND3LS5DS	Indulux LED D/S M3 CT	220-240 AC 50Hz	2 x LED 4W	400	15 / 7	3	0-40	2.0
IND1LS5	Indulux LED S/S 230V Slave	220-240 AC/DC 0-60Hz	1 x LED 4W	400	7 / 6.5	230V	-25-40	1.4
IND1LS5DS	Indulux LED D/S 230V Slave	220-240 AC/DC 0-60Hz	2 x LED 4W	800	14 / 13	230V	-25-40	1.4
IND1LS5DSLTC	Indulux LED D/S 230V LTC	220-240 AC 50/60Hz	2 x LED 4W	800	14 / 13	230V	-25-40	1.4
IND1LSLTC	Indulux LED S/S 230V LTC	220-240 AC 50/60Hz	1 x LED 4W	400	7 / 6.5	230V	-25-40	1.4
IND3LS5	Indulux LED S/S M3 ST	220-240 AC 50Hz	1 x LED 4W	200	7.5 / 3.5	3	0-40	1.6
IND3LS5DS	Indulux LED D/S M3 ST	220-240 AC 50Hz	2 x LED 4W	400	15 / 7	3	0-40	2.0

Configurable pictograms included

### Accessories

Order Code	Description
102601K	Indulux Cable Entry Cover Kit
102702K	Indulux Battery replacement

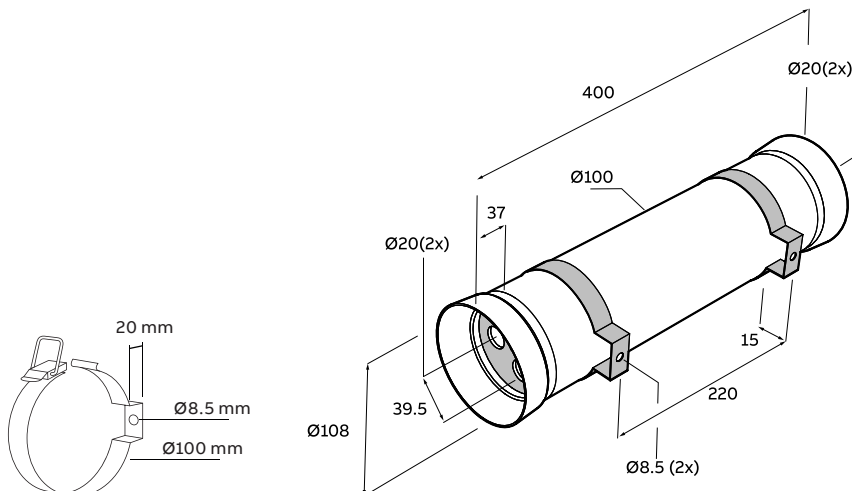

# Indulux escape route lighting

Industrial and design

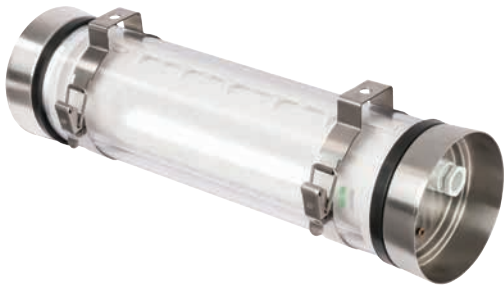

### All-in-one tubular emergency lighting

- Mounting, wiring and expanded flexibility
- Stainless steel solution resisting dust and water (IP68)
- Rapid maintenance with sliding electronic base module

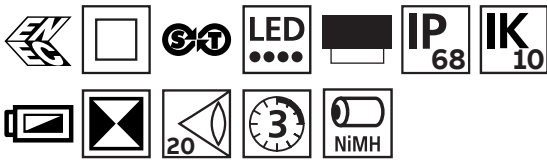

—  
Luminaire

Order code	Description	Input voltage	Lamp type	Lamp output (lm)	Power consumption (VA/W)	Operation / duration (hrs)	Environment temp. (°C)	Weight (kg)
CTIND3LS5	Indulux LED S/S M3 CT	220-240 AC 50Hz	1 x LED 4W	200	7.5 / 3.5	3	0-40	1.6
CTIND3LS5DS	Indulux LED D/S M3 CT	220-240 AC 50Hz	2 x LED 4W	400	15 / 7	3	0-40	2.0
IND1LS5	Indulux LED S/S 230V Slave	220-240 AC/DC 0-60Hz	1 x LED 4W	400	7 / 6.5	230V	-25-40	1.4
IND1LS5DS	Indulux LED D/S 230V Slave	220-240 AC/DC 0-60Hz	2 x LED 4W	800	14 / 13	230V	-25-40	1.4
IND1LS5DSLTC	Indulux LED D/S 230V LTC	220-240 AC 50/60Hz	2 x LED 4W	800	14 / 13	230V	-25-40	1.4
IND1LSLTC	Indulux LED S/S 230V LTC	220-240 AC 50/60Hz	1 x LED 4W	400	7 / 6.5	230V	-25-40	1.4
IND3LS5	Indulux LED S/S M3 ST	220-240 AC 50Hz	1 x LED 4W	200	7.5 / 3.5	3	0-40	1.6
IND3LS5DS	Indulux LED D/S M3 ST	220-240 AC 50Hz	2 x LED 4W	400	15 / 7	3	0-40	2.0

Configurable pictograms included

—  
Accessories

Order Code	Description
102601K	Indulux Cable Entry Cover Kit
102702K	Indulux Battery replacement

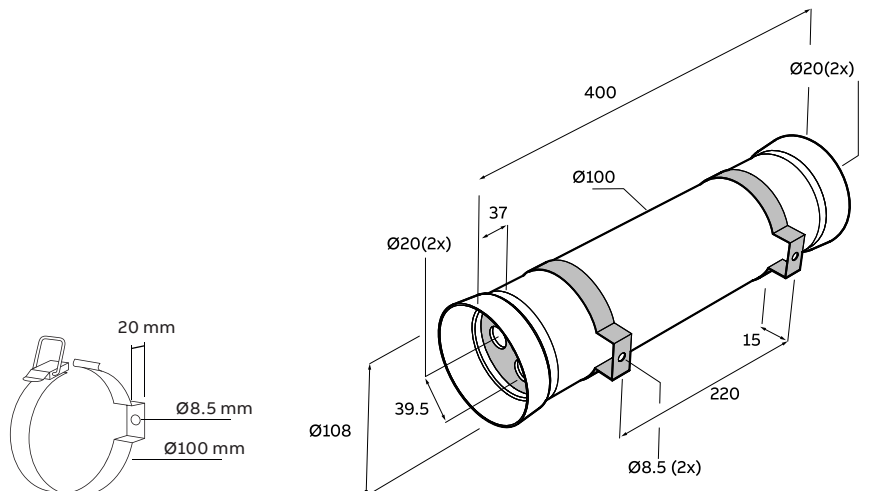

# MirEvo Twinspot

Compact & reliable



### Surface mount luminaire

- Full adjustable heads with 140° beam angle
- Available with Lithium Ferrophosphate (LiFePO4) battery technology for a longer service life
- Suitable for commercial and industrial environments

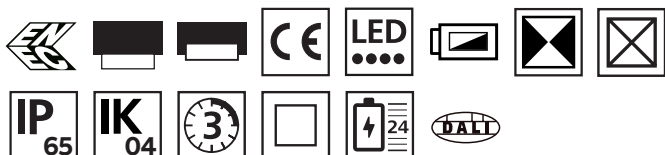

Luminaire

Order code	Description	Input voltage	Lamp type	Lamp output (lm)	Power consumption (VA/W)	Operation / duration (hrs)	Environment temp (°C)	Weight (kg)
TW500E	Twinspot 500Lm Ip65 manual test Wht	220-240 AC, 50/60 Hz	8x LED 1W	500	6 / 4.5	3	0-40	1.45
TW500ST	Twinspot 500Lm Ip65 Self-test Wht	220-240 AC, 50/60 Hz		500	5.5 / 4	3	0-40	1.45
TW500DA	Twinspot 500Lm Ip65 DALI Wht	220-240 AC, 50/60 Hz		500	5.5 / 4	3	0-40	1.45
TW500230V	Twinspot 500Lm Ip65 Slave Wht	220-240 AC, 50/60 Hz		500	7.5 / 6	-	-20 -40	1.25
TW500230VLT	Twinspot 500Lm Ip65 Slave Emex test LTC Wht	220-240 AC, 50/60 Hz		500	7.5 / 7	-	-20 -40	1.25

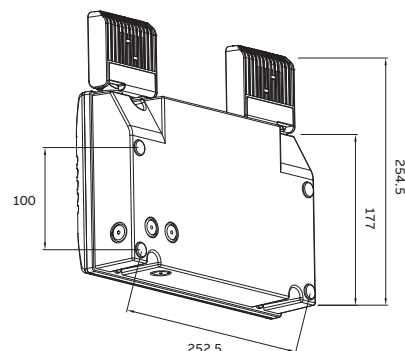

**Cordona**

Elegant LED lighting



**IP65 decorative LED luminaire**

- LED light source/optional fluorescent
- Designed for escape route and open area lighting
- Polycarbonate luminaire body with clear or translucent diffuser
- Semi-recessing accessory available
- Complies to IEC 60598.2.22 and IEC 60598-1
- Opal diffuser available

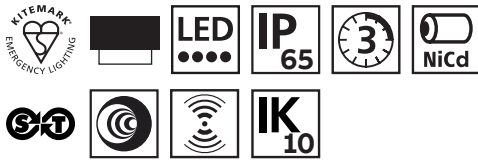

**Luminaire**

Order code	Description	Input voltage	Lamp type	Lamp output (lm)	Power consumption (VA/W)	Operation / duration (hrs)	Environment temp. (°C)	Weight (kg)
CPW1LA1	LED 2D WH/OPL-OPT HF	110-230 AC/DC 0-60Hz	1 x LED 20W	1830	20.8 / 19.5	230V	0-40	1.8
CPW1LA11	LED 2D WH/CLR-OPT HF	110-230 AC/DC 0-60Hz	1 x LED 20W	2355	20.8 / 19.5	230V	0-40	1.8
CTCPW4LA1	LED 2D M3 WH/OPL-OPT CT	220-240 AC 50/60Hz	1+1 x LED 20+2W	1830/207	25.8 / 23	3	0-30	2.2
CTCPW4LA11	LED 2D M3 WH/CLR-OPT CT	220-240 AC 50/60Hz	1+1 x LED 20+2W	2355/207	25.8 / 23	3	0-30	2.2
IR2CPW4LA1	LED 2D M3 WH/OPL-OPT IR2	220-240 AC 50/60Hz	1+1 x LED 20+2W	1830/207	25.8 / 23	3	0-30	2.2
IR2CPW4LA11	LED 2D M3 WH/CLR-OPT IR2	220-240 AC 50/60Hz	1+1 x LED 20+2W	2355/207	25.8 / 23	3	0-30	2.2
LTCCPW1LA1	LED 2D WH/OPL-OPT LTC	220-240 AC 50/60Hz	1 x LED 20W	1830	20.8 / 19.5	230V	0-40	1.9
LTCCPW1LA11	LED 2D WH/CLR-OPT LTC	220-240 AC 50/60Hz	1 x LED 20W	2355	20.8 / 19.5	230V	0-40	1.9
STCPW4LA1	LED 2D M3 WH/OPL-OPT SLFTST	220-240 AC 50/60Hz	1+1 x LED 20+2W	1830/207	25.8 / 23	3	0-30	2.2
STCPW4LA11	LED 2D M3 WH/CLR-OPT SLFTST	220-240 AC 50/60Hz	1+1 x LED 20+2W	2355/207	25.8 / 23	3	0-30	2.2



**Accessories**

Order code	Description
CPW/BZ	Semi-recessing bezel

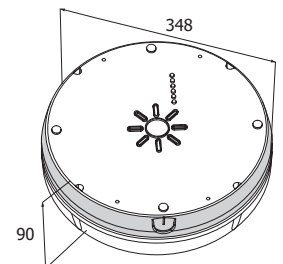

Ceiling cutout 346 mm when semi-recessing.

# Camarque

Elegant LED lighting



### Aesthetically pleasing, decorative LED luminaire

- Fire-resistant polycarbonate luminaire body with opal diffuser
- Angled and banded trim options in a range of finishes
- Semi-recessing accessory available
- Complies to IEC 60598.2.22 and IEC 60598-1



### Luminaire

Order code	Description	Input voltage	Lamp type	Lamp output (lm)	Power consumption (VA/W)	Operation / duration (hrs)	Environment temp. (°C)	Weight (kg)
CLQ1LA1	CLQ LED 2D WH/OPAL HF	110-230 AC/DC 0-60Hz	1 x LED 20W	1830	20.8 / 19.5	230V	0-40	1.7
CTCLQ4LA1	CLQ LED 2D WH/OPAL CT	220-240 AC 50/60Hz	1+1 LED 20+2W	1830/207	25.8 / 23	3	0-30	2.2
IR2CLQ4LA1	CLQ LED 2D WH/OPAL IR2	220-240 AC 50/60Hz	1+1 x LED 20+2W	1830/207	25.8 / 23	3	0-30	2.2
LTCLQ1LA1	CLQ LED 2D WH/OPAL LTC	220-240 AC 50/60Hz	1 x LED 20W	1830	20.8 / 19.5	230V	0-40	1.8
STCLQ4LA1	CLQ LED 2D WH/OPAL SLFTST	220-240 AC 50/60Hz	1+1 x LED 20+2W	1830/207	25.8 / 23	3	0-30	2.1



### Accessories

Order code	Description
CLQ/SR	Semi-recessing kit

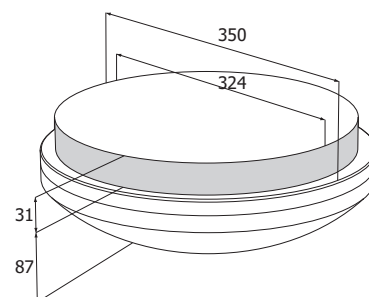

Cable entry via 20 mm hole on rear of unit. Ceiling cutout 330 mm when semi-recessing.

# Day-Lite Ex-cel

Practical and durable



### Surface mounted luminaire

- Sturdy, general use luminaire with screw-fix diffuser
- Light optimised diffuser
- LED version is suitable for fluorescent replacement requirements
- Complies to IEC 60598.2.22

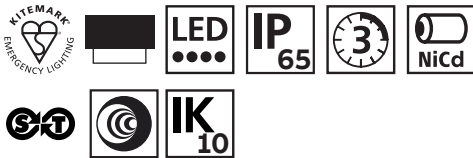

### Luminaire

Order code	Description	Input voltage	Lamp type	Lamp output (lm)	Power consumption (VA/W)	Operation / duration (hrs)	Environment temp. (°C)	Weight (kg)
CTXXW3LS1	LED 2W M3 DAYLITE WHT/OPL CT	220-240 AC 50/60Hz	1 x LED 2W	214	6.1 / 3.9	3	0-30	0.9
CTXXW3LS11	LED 2W M3 DAYLITE WHT/CLR CT	220-240 AC 50/60Hz	1 x LED 2W	251	6.1 / 3.9	3	0-30	0.9
IR2XXW3LS1	SLIM IP65 LED 2W M3 WH/OPL IR2	220-240 AC 50/60Hz	1 x LED 2W	214	6.1 / 3.9	3	0-30	0.9
IR2XXW3LS11	SLIM IP65 LED 2W M3 WH/CLR IR2	220-240 AC 50/60Hz	1 x LED 2W	251	6.1 / 3.9	3	0-30	0.9
LTCXXW1LS1	LED 2W LTC DAYLITE WHT/OPL	220-240 AC 50/60Hz	1 x LED 2W	214	4.6 / 4.4	230V	0-40	0.7
LTCXXW1LS11	LED 2W LTC DAYLITE WHT/CLR	220-240 AC 50/60Hz	1 x LED 2W	251	4.6 / 4.4	230V	0-40	0.7
STXXW3LS1	LED 2W M3 DAYLITE WHT/OPL SLFTST	220-240 AC 50/60Hz	1 x LED 2W	214	6.1 / 3.9	3	0-30	0.8
STXXW3LS11	LED 2W M3 DAYLITE WHT/CLR SLFTST	220-240 AC 50/60Hz	1 x LED 2W	251	6.1 / 3.9	3	0-30	0.8
XW8LS1	LED 1W 50V ACDC DAYLITE WHT/OPL	24-50 AC/DC 0-60Hz	1 x LED 1W	214	3.4 / 2.1	Central Battery	0-40	0.6
XW8LS11	LED 1W 50V ACDC DAYLITE WHT/CLR	24-50 AC/DC 0-60Hz	1 x LED 1W	251	3.4 / 2.1	Central Battery	0-40	0.6
XXW1LS1	LED 2W HF DAYLITE WHT/OPL	110-230 AC/DC 0-60Hz	1 x LED 2W	214	3.4 / 2.1	230V	0-40	0.6
XXW1LS11	LED 2W HF DAYLITE WHT/CLR	110-230 AC/DC 0-60Hz	1 x LED 2W	251	3.4 / 2.1	230V	0-40	0.6

Slave versions available with LTC

### Legends

Part No.	Pictogram
RSEN2X	
RSEN3X	
RSEN6X	
RSEN5X	
Arabic legend format	
RSB1X	

ISO 7010 pictogram legends are shown. Euro format & Special legends are available to order.

### Accessories

Order code	Description
XTR	Semi-recessing bezel in white

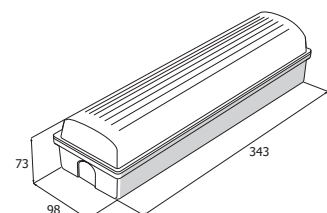

Cable entry via BESA on rear and 20 mm drill holes on rear and ends of unit. Ceiling cutout 342 mm x 95 mm when semi-recessing.

# Silver-Scape

Practical and everyday



### Recessed emergency luminaire

- Suitable for application in suspended ceilings
- Polycarbonate enclosure with wing fixings for recessed application
- Optically engineered diffuser
- Complies to IEC 60598.2.22

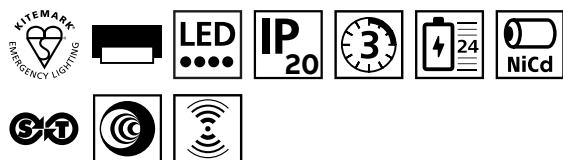

### Recessed unit

Order code	Description	Input voltage	Lamp type	Lamp output (lm)	Power consumption (VA/W)	Operation / duration (hrs)	Environment temp. (°C)	Weight (kg)
CTRRB3LS1X	RECSDB/HEAD 2W M3 LED WHT CT	220-240 AC 50/60Hz	1 x LED 2W	241	6.1 / 3.9	3	0-30	1.09
IR2RRB3LS1X	RECSDB/HEAD 2W M3 LED WHT IR2	220-240 AC 50/60Hz			6.1 / 3.9	3	0-30	1.09
LTCRRB1LS1X	LED 2W LTC SILVERSCAPE RECESS	220-240 AC 50/60Hz			4.6 / 4.4	230V	0-40	0.9
RB8LS1X	LED 2W 50V ACDC SILVERSCAPE RECESS	24-50 AC/DC 0-60Hz			3.4 / 2.1	Central Battery	0-40	0.79
RRB1LS1X	LED 2W HF SILVERSCAPE RECESS	110-230 AC/DC 0-60Hz			3.4 / 3.2	230V	0-40	0.81
STRRB3LS1X	RECSDB/HEAD 2W M3 LED WHT SLFTST	220-240 AC 50/60Hz			6.1 / 3.9	3	0-30	1.09

Slave versions available with LTC  
Order recess unit and diffuser panel separately



### Accessories

Order code	Description
RB00	Recessed diffuser panel
RB011	Rb metal diffuser trim - white
RB041	Rb metal diffuser diff trim - gold/brass
RB051	Rb metal diffuser diff trim - stainless steel
RB061	Rb metal diffuser diff trim - silver

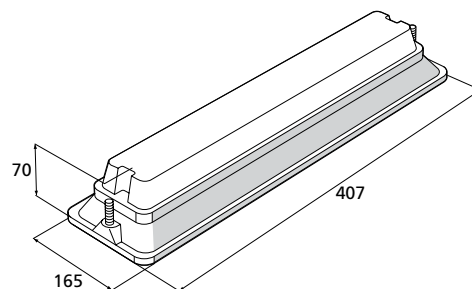

Cable entry via 20 mm knockouts on rear of unit.  
Ceiling cutout 380 mm x 136 mm.

# Silver-Scape

Practical and everyday



### Recessed emergency exit sign

- Suitable for application in suspended ceilings
- Polycarbonate enclosure with wing fixings for recessed application
- Diffuser panel with slot for exit sign legend
- Complies to IEC 60598.2.22
- Metal trims designed to fit existing Silverlite aperture

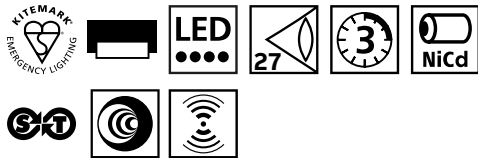

### Recessed unit

Order code	Description	Input voltage	Lamp type	Power consumption (VA/W)	Operation / duration (hrs)	Environ. temp. (°C)	Weight (kg)
CTRRB3LS1X	RECS D B/HEAD 2W M3 LED WHT CT	220-240 AC 50/60Hz	1 x LED 2W	6.1 / 3.9	3	0-30	1.09
IR2RRB3LS1X	RECS D B/HEAD 2W M3 LED WHT IR2	220-240 AC 50/60Hz	1 x LED 2W	6.1 / 3.9	3	0-30	1.09
LTCRRB1LS1X	LED 2W LTC SILVERSCAPE RECESS	220-240 AC/DC 0-60Hz	1 x LED 2W	4.6 / 4.4	230V	0-40	0.9
RB8LS1X	LED 2W 50V ACDC SILVERSCAPE RECESS	24-50 AC/DC 0-60Hz	1 x LED 1W	3.4 / 2.1	Central Battery	0-40	0.79
RRB1LS1X	LED 1W HF SILVERSCAPE RECESS	110-230 AC/DC 0-60Hz	1 x LED 2W	3.4 / 3.2	230V	0-40	0.81
STRRB3LS1X	RECS D B/HEAD 2W M3 LED WHT SLFTST	220-240 AC 50/60Hz	1 x LED 2W	6.1 / 3.9	3	0-30	1.09

Slave versions available with LTC  
Order recess unit, diffuser panel, trim and legend separately

### Legends

Single sided		Double sided	
Part no.	Pictogram	Part no.	Pictogram
XEN2A31		XEN36A32	
XEN3A31		XEN22A32	
XEN6A31		ISO 7010 pictogram legends are shown. Euro format & Special legends are available to order.	
XEN5A31			
Arabic legend format			
XB01A31			



### Accessories

Order code	Description
RE01	Recessed diffuser panel with sign panel slot
RE01P	Re plastic slot trim - white
RE04	Re metal slot trim - gold/brass
RE05	Re metal slot trim - stainless steel
RE06	Re metal slot trim - silver

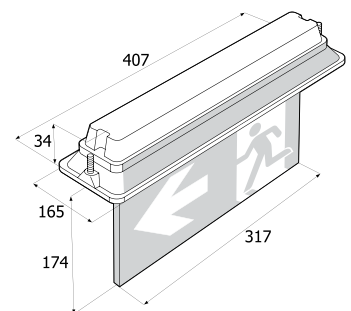

Cable entry via 20 mm knockouts on rear of unit.  
Ceiling cutout 380 mm x 136 mm.

## Navigator compact

Practical and everyday



### Compact, folded metal emergency exit sign

- Downlight panel provides additional illumination at floor level
- Available in white, gold and stainless steel colours
- Complies to IEC 60598.2.22.

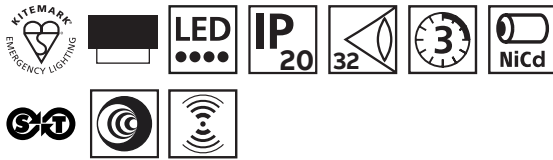

### Base unit

Order code	Description	Input voltage	Lamp type	Power consumption (VA/W)	Operation / duration (hrs)	Environment temp. (°C)	Weight (kg)
CTVVE3LS1X	LED 2W M3 NAVI COMPACT WHT CT	220-240 AC 50/60Hz	LED strip 2W	6.1 / 3.9	3	0-30	1.97
IR2VVE3LS1X	LED 2W M3 NAVI COMPACT WHT IR2	220-240 AC 50/60Hz		6.1 / 3.9	3	0-30	1.97
LTCVVE1LS1X	LED 2W LTC NAVI COMPACT WHT	220-240 AC 50/60Hz		4.6 / 4.4	230V	0-40	1.78
STVVE3LS1X	LED 2W M3 NAVI COMPACT WHT SLFTST	220-240 AC 50/60Hz		6.1 / 3.9	3	0-30	1.86
VVE1LS1X	LED 2W HF NAVI COMPACT WHT	110-230 AC/DC 0-60Hz		3.4 / 3.2	230V	0-40	1.69
VVE8LS1X	LED 1W 24-50V ACDC NAVI COMPACT WHT	24-50V		3.4 / 2.1	Central Battery	0-40	1.69

### Legends

Part no.	Pictogram
XEN2V31	
XEN3V31	
XEN6V31	
XEN5V31	
Arabic legend format	
XB01V31	

ISO 7010 pictogram legends are shown. Euro format & Special legends are available to order.



### Accessories

Order code	Description
VEBACK	Rear trim plate for a flat back when required for ceiling mounting

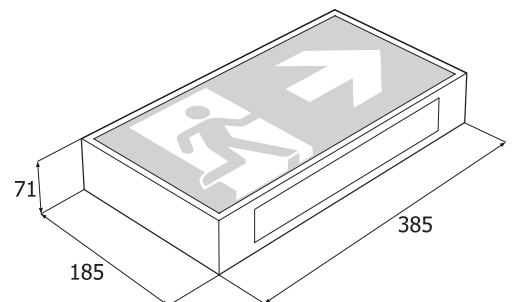

Cable entry via 20 mm knockouts on rear of unit.

# Weatherforce

Practical and durable



### Practical, robust double sided exit sign

- High grade polycarbonate enclosure with fixed legends
- Semi-recessing accessory available
- Complies to IEC 60598.2.22
- Cast aluminium base

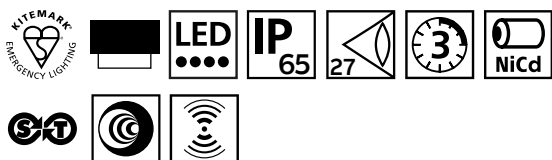

### Exit sign

Order code	Description	Input voltage	Lamp type	Lamp output (lm)	Power consumption (VA/W)	Operation / duration (hrs)	Environment temp. (°C)	Weight (kg)
CTWWA3LS1X	LED 2W M3 W/FORCE WHT/NO DIFF CT	220-240 AC 50/60Hz	1 x LED 2W	207	6.1 / 3.9	3	0-30	1.5
IR2WWA3LS1X	LED 2W M3 W/FORCE WHT/NO DIFF IR2	220-240 AC 50/60Hz	1 x LED 2W		6.1 / 3.9	3	0-30	1.5
LTCWWA1LS1X	LED 2W LTC W/FORCE WHT/NO DIFF LTC	220-240AC 50/60Hz	1 x LED 2W		4.6 / 4.4	230V	0-40	1.3
STWWA3LS1X	LED 2W M3 W/FORCE WHT/NO DIFF SLFTST	220-240 AC 50/60Hz	1 x LED 2W		6.1 / 3.9	3	0-30	1.5
WWA1LS1X	LED 2W HF W/FORCE WHT/NO DIFF	110-230 AC/DC 0-60Hz	1 x LED 2W		3.4 / 3.2	230V	0-40	1.2
WWA8LS1X	LED 1W 24-50VACDC W/FORCE WHT/NO DIFF	24-50 AC/DC 0-60Hz	1 x LED 1W		3.4 / 2.1	*CB	0-40	1.2

\*Central Battery

### Legends

ISO7010		
Part no.	Description	Pictogram
XEN2/2DV32	DV COVER 7010 ARR DN EA SIDE	
XEN3/6DV32	DV COVER 7010 ARR L 1-S, RT 2-S	
XEN5/5DV32	DV COVER 7010 ARR UP EA SIDE	

Euro		
Part no.	Description	Pictogram
XE02/2DV32	EURO PICT DV ARR DOWN/DOWN D/S	
XE03/6DV32	EURO PICT DV ARR LEFT/RGT D/S	
XE05/5DV32	EURO PICT DV ARR UP/UP D/S	
XE06/0DV32	EURO PICT DV ARR RIGHT ONE SIDE ONLY	

Arabic		
Part no.	Description	Pictogram
XB10DV32	DV LEG EXIT EN ARBC - BLNK GRN OVER	
XB11DV32	DV COVER EXIT-EN ARABIC DSD	
XB23DV32	DV DIFF EXIT EN-ARB AR L/R OVER	
XB50DV32	DV LEG EXIT EN ARBC - UP-BLNK	
XB66DV32	DV DIFF EXIT EN-ARB ARR DN D/S	

### Accessories

Order code	Description
BBZ	Semi-recessing bezel kit in white

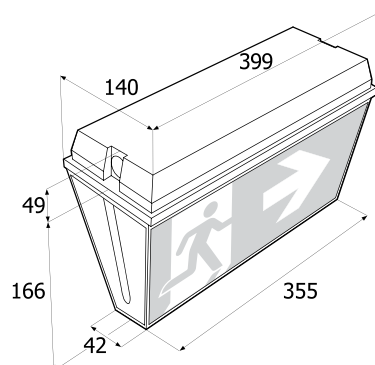

Ceiling cutout 390 mm x 130 mm when semi-recessing.

# Horizon

Traditional and versatile



### Back-lit LED exit sign

- Choice of IP40 surface mount (OH) or IP20 recessed (OZ) installation with LED lamp
- Shaped diffuser and contoured reflector
- First-Fix aluminium base with white polycarbonate luminaire body
- Clip-on legend panel
- Complies to IEC 60598.2.22

### LED base unit

Order code	Description	Input voltage	Lamp type	Power consumption / duration		Environment temp. (°C)	Weight (kg)
				(VA/W)	(hrs)		
CTOH3L261	CT 2LED SIGN M3	220-240 AC 50Hz	2 x LED 1W	9.9 / 5.1	3	0-25	1.3
IR2OH3L261	2LED M3 IR2	220-240 AC 50Hz		9.9 / 5.1	3	0-25	1.3
OH3L261	2LED SIGN M3	220-240 AC 50Hz		9.9 / 5.1	3	0-25	1.3
OH1L261HF	2XLED SIGN 230VHF	220-240 AC/DC 0-60Hz		6.8 / 3.1	230V	0-40	1.1
OH1L261LTC	2XLED SIGN 230VLTC	220-240 AC 50/60Hz		6.8 / 3.1	230V	0-40	1.1
CTOZ3L261	CT 2LED REC-SIGN M3	220-240 AC 50Hz		9.9 / 5.1	3	0-25	1.3
IR2OZ3L261	REC 2LED M3 IR2	220-240 AC 50Hz		9.9 / 5.1	3	0-25	1.3
OZ3L261	2LED REC-SIGN M3	220-240 AC 50Hz		9.9 / 5.1	3	0-25	1.3
OZ1L261HF	2XLED REC-SIGN 230VHF	220-240 AC/DC 0-60Hz		6.8 / 3.1	230V	0-40	1.1
OZ1L261LTC	2XLED REC-SIGN 230VLTC	220-240 AC 50/60Hz		6.8 / 3.1	230V	0-40	1.1
OH3L261V2	2LEDS SIGN M3 220V60HZ	220-240 AC 50/60Hz		9.9 / 5.1	3	0-25	1.3
OZ3L261V2	2LED REC-SIGN M3 60HZ	220-240 AC 50/60Hz		9.9 / 5.1	3	0-25	1.3

### Legends

Part No.	Pictogram
XEN2H	
XEN3H	
XEN6H	
XEN5H	
XLF-SN802	
XLF-SN803	
Arabic legend format	
XB01H	



### Accessories

Order code	Description
OH/BCM	Ceiling bracket, vertical mount, for back-lit sign
OH/WG	Protective wire guard

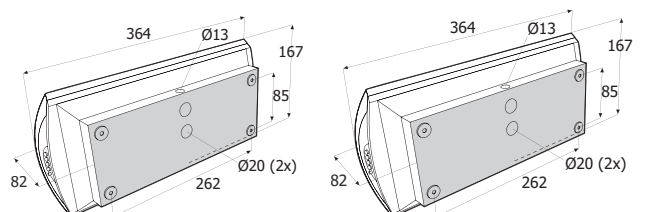

# Central battery

## Reliable emergency power solutions

Our Central Power Supply Systems division offers a choice of reliable and high quality products which are designed to meet the relevant standards and specifications for both AC/AC and AC/DC applications.



01

02

—  
01 EMEX 110  
—  
02 EMEX Mini

### EMEX – AC/AC Static inverter range: 220-230V 50/60Hz, 400V. 3ph 50/60Hz

Static inverters in this range are true passive stand-by emergency lighting units, designed and built to exceed current emergency lighting standards and technical requirements, something with which most UPS based central power products do not comply. EMEX Power, EMEX TS static inverters and EMEX Mini power systems offer a low maintenance and extremely reliable central power supply solution with low running costs and a high degree of functionality to serve individual customer needs.

- Modular design, which makes maintenance or repair a simple task
- Manufactured in the UK
- Normal mains luminaires with electronic starters/high frequency ballasts may be driven by the system (glow wire starters cannot be used in accordance with BS EN 60598.2.22)
- Ideal for task lighting projects where normal (high) lighting levels are required to minimise business disruption

- High efficiency: Low running cost. This AC/AC type of system has been designed for an inherently long service life with associated significant cost benefits over alternative emergency lighting solutions
- Cost conservancy and design:
  1. Ventilation fan life is maximised, as they will only operate when required, during 'battery charge' or 'inverter active' cycles
  2. Battery life conserved by a temperature compensated constant voltage charger circuit in conjunction with passive stand-by inverter operation
- Functional features include sub-circuit monitoring, final exit input, MCB monitoring, M/NM operation (user selectable), fire alarm input and two volt-free common alarm outputs
- MCB protection devices are used throughout the equipment, eliminating the need for fuse spares
- Digital display for battery and output metering V & I
- Fully compliant with EN 50171
- EMEX TS includes integral touch-screen with EMEX Test capability

BS EN 50171  
KM542294

The 'EMEX Power' and 'EMEX TS' static inverters, 'EMEX 110' AC/DC and 'Compact Power' product ranges are manufactured in our Leeds facility, supported by an experienced engineering, sales and commissioning team:



Contact our sales team via  
email [leeds.quotes@gb.abb.com](mailto:leeds.quotes@gb.abb.com)

or our technical team  
[leeds.tech@gb.abb.com](mailto:leeds.tech@gb.abb.com)

---

# Energy and lighting management

<b>235</b>	<b>Busch-Jaeger presence detectors</b>
<b>246</b>	<b>Wiring accessories</b>
<b>250</b>	<b>Royce Thompson</b>



---

For more detailed product information, please refer to our online technical brochures available at: [new.abb.com/low-voltage/support/documentation](http://new.abb.com/low-voltage/support/documentation)

or contact our sales team via email [LV.enquiries@gb.abb.com](mailto:LV.enquiries@gb.abb.com)

or call 0333 999 9933

# Overview

## Presence detectors

### Presence detectors 230 V

Compact devices for almost every application.



### Busch-Watchdog Presence tech

Versatile due to modular construction.



### Busch-Watchdog Presence tech BasicLINE

For small offices, toilets, pass-through areas and dedicated applications.



### Busch-Presence detectors KNX

Expertise always works. Almost unnoticed.



## Technical data

### Presence detectors 230 V



NEW



NEW

Products	Busch-Presence detector Compact, relay	Busch-Presence detector Universal, relay
Article number	6819/60-24-500 6819/60-183-500	6819/30-24-500 6819/30-183-500
Device type	Master <sup>1)</sup>	Master <sup>1)</sup>
Half- / automatic / comfort automatic mode	yes / yes / -	yes / yes / -
Detection range:		
Mounting height	2.5 m / 3 m / 4 m	2.5 m / 3 m / 4 m
sitting	5 m / 6.5 m / -	8 m / 10 m / -
walking (lateral / diagonal)	6.5 m / 8 m / 10.5 m	10 m / 12 m / 16 m
walking (frontal)	4.5 m / 6 m / 7 m	7 m / 8 m / 10 m
Sensitivity adjustment	-	-
Number of channels	1	1
<b>Load<sup>2)</sup>:</b>		
LEDi	200 VA	200 VA
LEDs with converter	200 VA	200 VA
Incandescent lamps	2300 W	2300 W
HV halogen lamps	2300 W	2300 W
LV halogen lamps with electr. transformer	2300 VA	2300 VA
Fluorescent lamps	2300 VA	2300 VA
Electr. fan engines	-	-
Inrush current max.:	165 A / 20 ms // 350 A / 200 µs	165 A / 20 ms // 350 A / 200 µs
2-stage power-off (EN15232)	-	-
PIR / individually activated	4 / -	4 / -
2 light bands / HVAC / backboard light	- / - / -	- / - / -
Intern brightness sensor	yes	yes
Remote controllable	yes, via IR service-remote control 6843	yes, via IR service-remote control 6843
False ceilings via spring brackets	yes	yes
Surface mounted	-	-
Flush-mounting	-	-
Mounting depth (fm box / ceiling mount):	- / 49 mm	- / 49 mm
Mounting Dimensions:	Ø 68 mm	Ø 68 mm
Visible height:	23 mm	23 mm
Protection class (sensor / actuator)	IP 40	IP 40

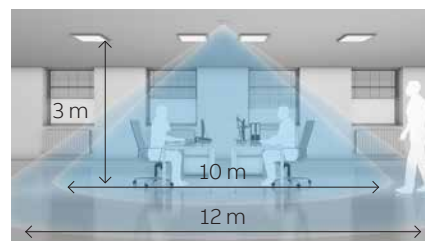
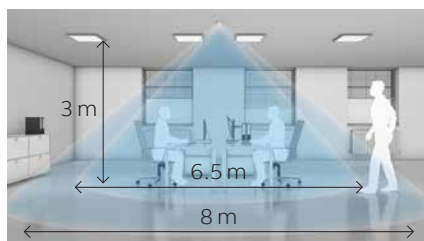

- 1 Lateral approach to the detector.
- 2 Diagonal approach to the detector.
- 3 Lateral approach to the detector.
- 4 Frontal approach to the detector.

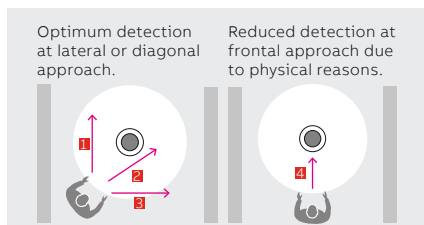

#### Technical details

The Busch-Presence detectors consist of two parts lens and 4 PIR sensors. The maximum detection range depends on the mounting site and ambient conditions.



NEW



NEW



NEW

Busch-Presence detector Compact, e-contact	Busch-Presence detector Universal, e-contact	Busch-Presence detector Corridor, relay
6817/62-24-500	6817/32-24-500	6819/50-24-500
6817/62-183-500	6817/32-183-500	6819/50-183-500
Master <sup>1)</sup>	Master <sup>1)</sup>	Master <sup>1)</sup>
yes / yes / -	yes / yes / -	yes / yes / -
2.5 m / 3 m / 4 m	2.5 m / 3 m / 4 m	2.5 m / 3 m / 4 m
5 m / 6.5 m / -	8 m / 10 m / -	- / - / -
6.5 m / 8 m / 10.5 m	10 m / 12 m / 16 m	24 m x 2.5 m / 24 m x 3 m / 24 m x 3 m
4.5 m / 6 m / 7 m	7 m / 8 m / 10 m	14 m x 2.5 m / 14 m x 3 m / 14 m x 3 m
-	-	-
1	1	1
3 - 200 VA	3 - 200 VA	200 VA
3 - 200 VA	3 - 200 VA	200 VA
3 - 200 W	3 - 200 W	2300 W
3 - 200 W	3 - 200 W	2300 W
3 - 200 VA	3 - 200 VA	2300 VA
3 - 200 VA	3 - 200 VA	2300 VA
-	-	-
165 A / 20 ms // 350 A / 200 µs	165 A / 20 ms // 350 A / 200 µs	165 A / 20 ms // 350 A / 200 µs
-	-	-
4 / -	4 / -	4 / -
- / - / -	- / - / -	- / - / -
yes	yes	yes
yes, via IR service-remote control 6843	yes, via IR service-remote control 6843	yes, via IR service-remote control 6843
yes	yes	yes
-	-	-
-	-	-
- / 36 mm	- / 36 mm	- / 49 mm
Ø 68 mm	Ø 68 mm	Ø 68 mm
23 mm	23 mm	27 mm
IP 40	IP 40	IP 40

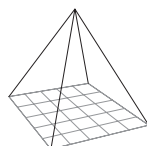
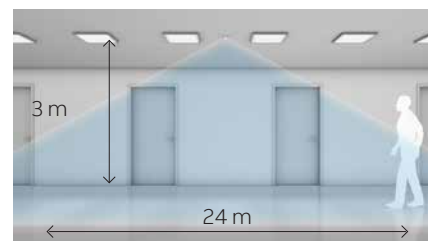
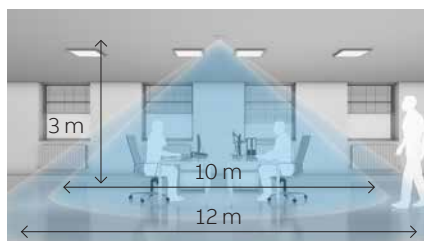
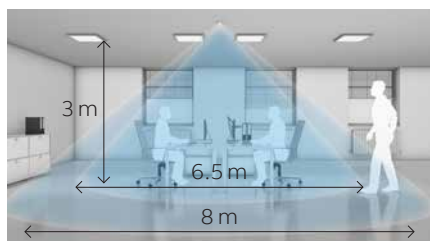

— Detection system of conventional movement detectors

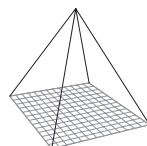

— Busch-Presence detection system

**There is no better way.**

The detection system consisting of four sensors and mirrors is far superior to conventional movement sensors. Even the smallest movement is reliably detected and triggers a response.

<sup>1)</sup> Slave version available

<sup>2)</sup> at 230 V~ main voltage

## Technical data

### Presence detectors 230 V



NEW



NEW

Products	Busch-Presence detector Universal BT, relay	Busch-Presence detector Universal BT, e-contact
Article number	6819/31-24-500 6819/31-183-500	6819/33-24-500 6819/33-183-500
Device type	Master <sup>1)</sup>	Master <sup>1)</sup>
Half- / automatic / comfort automatic mode	yes / yes / yes	yes / yes / yes
Detection range:		
Mounting height	2.5 m / 3 m / 4 m	2.5 m / 3 m / 4 m
sitting	8 m / 10 m / -	8 m / 10 m / -
walking (lateral / diagonal)	10 m / 12 m / 16 m	10 m / 12 m / 16 m
walking (frontal)	7 m / 8 m / 10 m	7 m / 8 m / 10 m
Sensitivity adjustment	yes	yes
Number of channels	1	1
<b>Load<sup>2)</sup>:</b>		
LEDi	200 VA	3 - 200 VA
LEDs with converter	200 VA	3 - 200 VA
Incandescent lamps	2300 W	3 - 200 W
HV halogen lamps	2300 W	3 - 200 W
LV halogen lamps with electr. transformer	2300 VA	3 - 200 VA
Fluorescent lamps	2300 VA	3 - 200 VA
Electr. fan engines	-	-
Inrush current max.:	165 A / 20 ms // 350 A / 200 µs	165 A / 20 ms // 350 A / 200 µs
2-stage power-off (EN15232)	-	-
PIR / individually activated	4 / 4	4 / 4
2 light bands / HVAC / backboard light	- / - / -	- / - / -
Intern brightness sensor	yes	yes
Remote controlable	yes, Smartphone APP via Bluetooth	yes, Smartphone APP via Bluetooth
False ceilings via spring brackets	yes	yes
Surface mounted	-	-
Flush-mounting	-	-
Mounting depth (fm box / ceiling mount):	- / 49 mm	- / 36 mm
Mounting Dimensions:	Ø 68 mm	Ø 68 mm
Visible height:	23 mm	23 mm
Protection class (sensor / actuator)	IP 40	IP 40

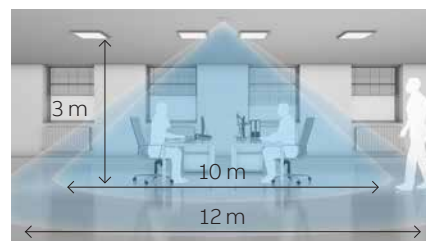
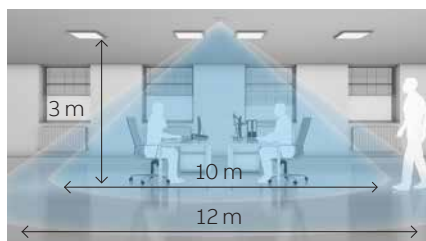



NEW



NEW



NEW

Busch-Presence detector Corridor BT, relay	Busch-Presence detector Universal BT, e-contact with sealing ring	Busch-Presence detector Universal BT, DALI
6819/51-24-500	6817/93-24-500	6819/35-24-500
6819/51-183-500	6817/93-183-500	6819/35-183-500
Master <sup>1)</sup>	Master <sup>1)</sup>	Master <sup>1)</sup>
yes / yes / yes	yes / yes / yes	yes / yes / yes
2.5 m / 3 m / 4 m	2.5 m / 3 m / 4 m	2.5 m / 3 m / 4 m
- / - / -	8 m / 10 m / -	8 m / 10 m / -
24 m x 2.5 m / 30 m x 3 m / 30 m x 3 m	10 m / 12 m / 16 m	10 m / 12 m / 16 m
18 m x 2.5 m / 20 m x 3 m / 20 m x 3 m	7 m / 8 m / 10 m	7 m / 8 m / 10 m
yes	yes	yes
1	1	2
200 VA	3 - 200 VA	200 VA
200 VA	3 - 200 VA	200 VA
2300 W	3 - 200 W	1380 W
2300 W	3 - 200 W	1380 W
2300 VA	3 - 200 VA	1380 VA
2300 VA	3 - 200 VA	1380 VA
-	-	1380 VA
165 A / 20 ms // 350 A / 200 µs	165 A / 20 ms // 350 A / 200 µs	165 A / 20 ms // 350 A / 200 µs
-	-	yes
4 / 4	4 / 4	4 / 4
- / - / -	- / - / -	- / yes / yes
yes	yes	yes
yes, Smartphone APP via Bluetooth	yes, Smartphone APP via Bluetooth	yes, Smartphone APP via Bluetooth
yes	yes	yes
-	-	-
-	-	-
- / 49 mm	- / 36 mm	- / 60 mm
Ø 68 mm	Ø 68 mm	Ø 68 mm
27 mm	23 mm	23 mm
IP 40	IP 41	IP 40

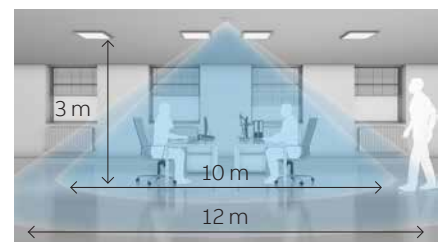
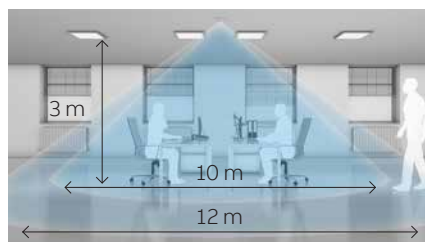
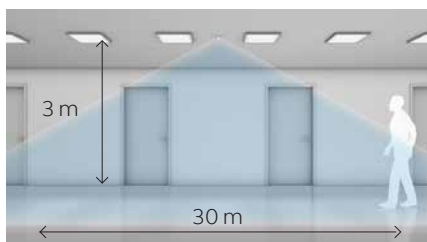

<sup>1)</sup> Slave version available  
<sup>2)</sup> at 230 V~ main voltage

## Technical data

### Presence detectors 230 V



NEW

Products	Busch-Presence detector Corridor BT, DALI
Article number	6819/55-24-500 6819/55-183-500
Device type	Master <sup>1)</sup>
Half- / automatic / comfort automatic mode	yes / yes / yes
Detection range:	
Mounting height	2.5 m / 3 m / 4 m
sitting	- / - / -
walking (lateral / diagonal)	24 m x 2,5 m / 30 m x 3 m / 30 m x 3 m
walking (frontal)	18 m x 2,5 m / 20 m x 3 m / 20 m x 3 m
Sensitivity adjustment	yes
Number of channels	2
<b>Load<sup>2)</sup>:</b>	
LEDi	200 VA
LEDs with converter	200 VA
Incandescent lamps	1380 W
HV halogen lamps	1380 W
LV halogen lamps with electr. transformer	1380 VA
Fluorescent lamps	1380 VA
Electr. engines	1380 VA
Inrush current max.:	165 A / 20 ms // 350 A / 200 µs
2-stage power-off (EN152321)	yes
PIR / individually activated	4 / 4
2 light bands / HVAC / backboard light	- / yes / yes
Intern brightness sensor	yes
Remote controlable	yes, Smartphone APP via Bluetooth
False ceilings via spring brackets	yes
Surface mounted	-
Flush-mounting	-
Mounting depth (fm box / ceiling mount):	- / 60 mm
Mounting Dimensions:	Ø 68 mm
Visible height:	27 mm
Protection class (sensor / actuator)	IP 40

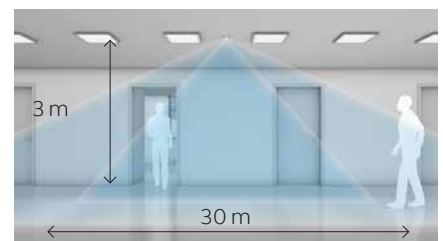



Busch-Watchdog Presence tech BasicLINE mini	Busch-Watchdog Presence tech BasicLINE	Busch-Watchdog Presence tech BasicLINE Corridor
6811 EB-500	6814 U-500	6818 U-500
Single device	Single device	Single device
- / yes / -	yes / yes / -	- / yes / -
2.5 m / 3 m / 4 m	2.5 m / 3 m / 4 m	2.5 m / 3 m / 4 m
3 m / 3.5 m / -	4 m / 4.5 m / -	4 m / 4.5 m / -
5 m / 6 m / 8 m	7 m / 8 m / 10 m	24 m / 20 m / -
ns	4 m / 3 m / 2 m	ns
yes	-	-
1	1	1
200 VA	200 VA	200 VA
200 VA	200 VA	200 VA
2000 W	2000 W	2000 W
1000 W	1000 W	1000 W
2000 VA	2000 VA	2000 VA
1000 VA	1000 VA	1000 VA
-	-	-
80 A / 20 ms	80 A / 20 ms	80 A / 20 ms
-	-	-
1 / -	1 / -	4 / -
- / - / -	- / - / -	- / - / -
yes	yes	yes
-	-	yes, via IR service-remote control 6843
yes	yes	yes
-	-	yes
-	yes	yes
180 mm	28 mm / 41 mm	18 mm / 48 mm
32 mm	65 mm	64 mm
10 mm	31 mm	57 mm
IP 40 / IP 20	IP 40	IP 40 / IP 54 <sup>3)</sup>

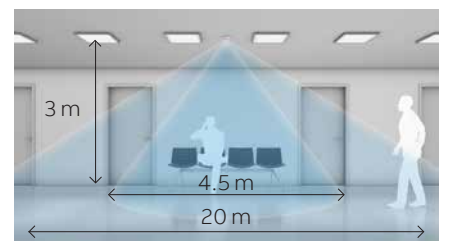
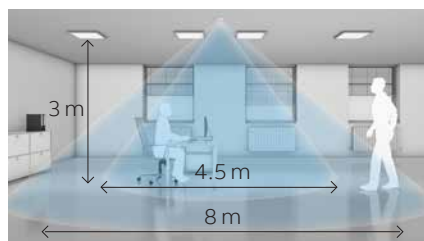
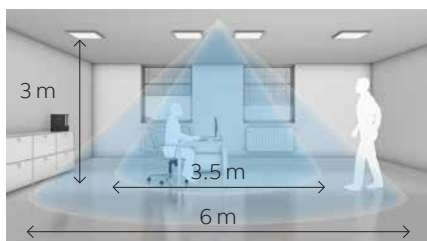

<sup>1)</sup> Slave version available  
<sup>2)</sup> at 230 V~ main voltage  
<sup>3)</sup> only with surface mount box

## Technical data

### Presence detectors 230 V



Products	Busch-Watchdog Presence tech	Busch-Watchdog Presence tech
Article number	6813-101-500 & 6401 U-102-500 6813-183-101-500 & 6401 U-102-500	6813-101-500 & 6402 U-500 6813-183-101-500 & 6402 U-500
Device type	Master <sup>1)</sup>	Master <sup>1)</sup>
Half- / automatic / comfort automatic mode	- / yes / -	- / yes / -
Detection range:		
Mounting height	2.5 m / 3 m / 4 m	2.5 m / 3 m / 4 m
sitting	8 m / 10 m / -	8 m / 10 m / -
walking (lateral / diagonal)	10 m / 12 m / 16 m	10 m / 12 m / 16 m
walking (frontal)	6 m / 7 m / 9 m	6 m / 7 m / 9 m
Sensitivity adjustment	-	-
Number of channels	1	2
<b>Load<sup>2)</sup>:</b>		
LEDi	200 VA	200 VA
LEDs with converter	200 VA	200 VA
Incandescent lamps	2300 W	2300 W
HV halogen lamps	2300 W	2300 W
LV halogen lamps with electr. transformer	2300 VA	2300 VA
Fluorescent lamps	2300 VA	2300 VA
Electr. engines	-	-
Inrush current max.:	80 A / 20 ms	80 A / 20 ms
2-stage power-off (EN152321)	-	-
PIR / individually activated	4 / -	4 / -
2 light bands / HVAC / backboard light	- / - / -	- / yes / -
Intern brightness sensor	yes	yes
Remote controlable	yes, via IR remote control 6010-25	yes, via IR remote control 6010-25
False ceilings via spring brackets	-	-
Surface mounted	yes	yes
Flush-mounting	yes	yes
Mounting depth (fm box / ceiling mount):	32 mm / -	32 mm / -
Mounting Dimensions:	-	-
Visible height:	51 mm	51 mm
Protection class (sensor / actuator)	IP 20	IP 20

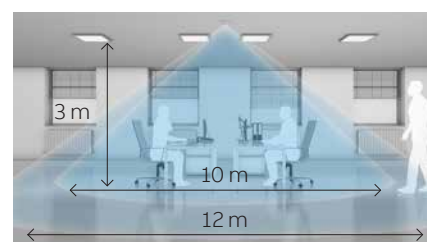
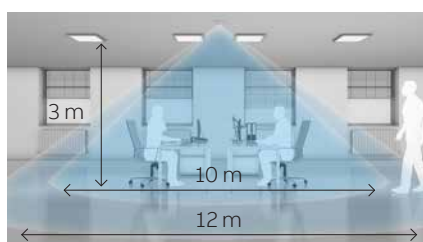



Busch-Watchdog Presence tech DualLINE	Busch-Watchdog Presence tech DualLINE
6813/11-24-500 & 6402 U-500 6813/11-183-500 & 6402 U-500	6813/11-24-500 & 6550 U-101-500 6813/11-183-500 & 6550 U-101-500
Master <sup>1)</sup>	Master <sup>1)</sup>
yes / yes / -	yes / yes / -
2.5 m / 3 m / 4 m	2.5 m / 3 m / 4 m
8 m / 10 m / -	8 m / 10 m / -
10 m / 12 m / 16 m	10 m / 12 m / 16 m
6 m / 7 m / 9 m	6 m / 7 m / 9 m
-	-
2	1
200 VA	-
200 VA	200 VA
2300 W	-
2300 W	-
2300 VA	-
2300 VA	700 VA
-	-
80 A / 20 ms	-
-	-
4 / -	4 / -
yes / - / -	- / - / -
yes	yes
yes, via IR remote control	yes, via IR remote control
6010-25	6010-25
-	-
yes	yes
yes	yes
32 mm / -	32 mm / -
-	-
51 mm	51 mm
IP 20	IP 20

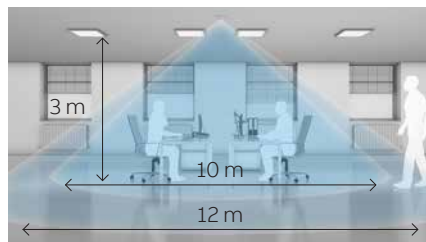
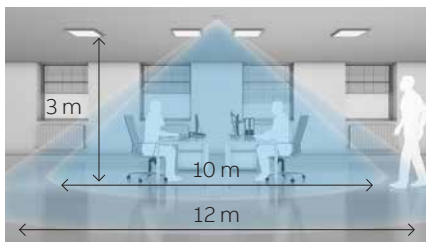

<sup>1)</sup> Slave version available  
<sup>2)</sup> at 230 V~ main voltage

## Technical data

### Busch-Watchdog outdoor



Products	Busch-Watchdog 70 MasterLINE	Busch-Watchdog 110 MasterLINE	Busch-Watchdog 220 MasterLINE	Busch-Watchdog 280 MasterLINE
Article number	6854 AGM-xxx-500	6855 AGM-xxx-500	6847 AGM-xxx-500, 6847 / 8 AGM-204-500, 6847 / 11 AGM-xxx-500	6867 AGM-xxx-500
Device type	-	-	220°	280°
Detection levels	4	4	4	4
Creep zone protection in the detection range	•	•	•	•
Coverage <sup>3</sup>	12 m frontal, 4 m lateral	12 m frontal, 4 m lateral	16 m frontal, 16 m lateral	16 m frontal, 16 m lateral
LED detection check	•	•	•	•
Light activation via break switch	•	•	•	•
Switching outputs	1 x non-isolated	1 x non-isolated	1 x non-isolated	1 x non-isolated
Back field detection	-	-	•	•
Remote operation via IR remote control, 6841-101-500	-	•	•	•
Remote parameterisable IR service remote control, 6842-101-500	-	•	•	•
Presence simulation via IR remote control	-	•	•	•
Continuous light switching (4 hours) via IR remote control	-	•	•	•
Continuous Off (4 hours) via IR remote control	•	•	•	-
Tripping delay	1 / 3 / 5 minutes	10 s to 30 minutes	10 s to 30 minutes	10 s to 30 minutes
Recommended mounting method	Screw-type terminals	Screw-type terminals	Wago screw terminals	Wago screw terminals
Twilight sensor	3 / 15 lux / ∞ (daytime operation)	3 lux / ∞ (daytime operation)	0.5 – 300 lux / ∞ (daytime operation)	0.5 – 300 lux / ∞ (daytime operation)
Mounting height	2.50 m	2.50 m	2.50 m	2.50 m
Dimensions (H x W x D)	100 x 125 x 33 mm	100 x 125 x 33 mm	115 x 125 x 141 mm	115 x 125 x 141 mm
Any type of loads	•	•	•	•
Suitable for wall and ceiling installation <sup>2</sup>	• / -	• / -	• / •	•
Additional functions	-	-	--	-

<sup>1</sup> Depending on the switch actuator used

<sup>2</sup> The use of the corner adapter 6868-xxx-500 may depend on the mounting location.

<sup>3</sup> Mounting height of 2.50 m.



<b>Busch-Watchdog 220 MasterLINE premium</b>	<b>Busch-Watchdog 220 WaveLINE</b>	<b>Busch-Watchdog 220 MasterLINE select</b>	<b>Busch-Watchdog 220 MasterLINE KNX</b>	<b>Busch-Watchdog 220 MasterLINE KNX premium</b>
6848 AGM-xxx-500	6747 AGM-xxx-500	6847 AGS-xxx-500	6179/01-xxx-500	6179/02-xxx-500
220°	220°	220°	220°	220°
4	4	1	4	4
-	•	•	•	•
16 m frontal, 16 m lateral	16 m frontal, 16 m lateral	16 m frontal, 16 m lateral	16 m frontal, 16 m lateral	16 m frontal, 16 m lateral
•	-	•	-	-
•	-	•	KNX	KNX
1 x non-isolated 1 x floating	- <sup>1</sup>	1 x non-isolated	2 movement channels	4 movement channels
•	•	-	•	•
•	-	•	-	With 6179-500
•	-	•	-	-
•	-	•	-	-
•	-	•	-	-
•	-	•	•	•
10 s to 30 minutes	10 s to 30 minutes <sup>1</sup>	10 s to 30 minutes	10 s to 18 hours	10 s to 18 hours
Wago screw terminals	Integrated battery compartment	Wago screw terminals	KNX screwless terminals	KNX screwless terminals
0.5 – 300 lux/ ∞ (daytime operation)	0.5 – 300 lux/ ∞ (daytime operation)	0.5 – 300 lux/ ∞ (daytime operation)	1 – 1,000 lux	1 – 80,000 lux
2.50 m	2.50 m	1.10 m – 1.50 m or 2.50 m	2.50 m	2.50 m
115 × 125 × 141 mm	115 × 125 × 141 mm	115 × 125 × 141 mm	115 × 125 × 141 mm	115 × 125 × 141 mm
•	-	•	-	-
•	•	•	•	•
-	-	-	3 x Twilight threshold	3 × Twilight /brightness threshold 3 × Temperature threshold 10 × Logic functions

## Wiring accessories





### Millenium wiring accessories

—  
01 ST - Stainless Steel  
02 SB - Silk Black  
03 MG - Matt Gold  
04 AG - Antique Gold

Millenium offers high quality complete sets. Each unique reference contains mechanism, frame and mounting plate; making easier the ordering, handling and installation. A reliable and complete collection with all functionality at first sight.

Millenium offers a wide and elegant choice of finishes in stainless steel AISI 304 material: from the Brush Stainless Steel, to the soft new touch given by the Silk Black, and the luxury of the sophisticated gold finishes, Matt Gold and Antique Gold.

#### 1 Gang switch rocker

	Description	Technical data	Order code
	1 gang 1 way switch	10 AX	AM10120-ST
	1 gang 2 way switch	10 AX	AM10520-ST
	Intermediate switch	10 AX	AM11920-ST
	1 gang 1 way switch	20 AX	AM11020-ST
	1 gang 2 way switch	20 AX	AM11520-ST
	1 gang 1 way double pole switch, with status indicator led	346-415	2CMA193519R1000
	1 gang 1 way double pole switch, with led for water heater	346-415	2CMA193519R1000
	1 gang 1 way push button switch	346-415	2CMA193519R1000

#### Premium switch rocker

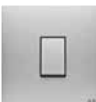
	Description	Technical data	Order code
	1 gang 1 way switch	10 AX	AM10144-ST
	1 gang 2 way switch	10 AX	AM10544-ST
	Intermediate switch	10 AX	AM11944-ST
	1 gang 1 way switch	20 AX	AM11044-ST
	1 gang 2 way switch	20 AX	AM11544-ST

#### Premium switch rocker

	Description	Technical data	Order code
	1 gang 1 way push button switch	10 A	AM43044-ST

#### 2, 3 and 4 gang switches

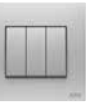
	Description	Technical data	Order code
	2 gang 1 way switch	10 A	AM10244-ST
	2 gang 2 way switch	10 AX	AM10644-ST
	2 gang 1 way switch	10 AX	AM11444-ST
	2 gang 2 way switch	20 AX	AM11644-ST
	3 gang 2 way switch	20 AX	AM112153-ST
	3 gang 2 way push button	346-415	AM43053-ST
	4 gang 2 way switch	10 AX	AM119188-ST
	4 gang 2 way switch	16 AX	M119588-ST

01

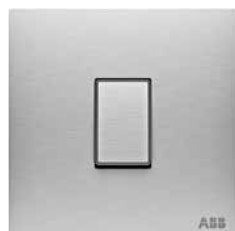

02



03





04









## Wiring accessories

### Millenium wiring accessories



#### Gang switches premium rocker

	Description	Technical data	Order code
 AM13444-ST  AM17744-ST	Fan isolator	10A 3 pole	AM13444-ST
	1 gang double pole with status indicator LED. Flush 45mm wall box	45A	AM17744-ST
			AM17744-SB
			M17744-MG
			AM17744-AG

#### Socket outlets

	Description	Technical data	Order code
	BS single pole switched socket outlet	13A SP dual earth terminals	AM23386-ST
		with child safety shutter system.	AM23386-SB
			AM23386-MG
			AM23386-AG
	BS double pole switched socket outlet	13A DP dual earth terminals	AM23786-ST
		with child safety shutter system.	AM23786-SB
			AM23786-MG
			AM23786-AG
	BS double pole switched socket outlet	13A SP dual earth terminals and LED with child safety shutter system.	AM23486-ST
			AM23486-SB
			AM23486-MG
			AM23486-AG
	BS double pole switched socket outlet with led	13A DP dual earth terminals and LED with child safety shutter system.	AM23886-ST
			AM23886-SB
			AM23886-MG
			AM23886-AG
	2 Gang BS double pole switched socket outlet	13A DP dual earth terminals and LED with child safety shutter system.	AM239147-ST
			AM239147-SB
			AM239147-MG
			AM239147-AG
	2 Gang BS double pole switched socket outlet with led.	13A DP dual earth terminals and LED with child safety shutter system.	AM240147-ST
			AM240147-SB
			AM240147-MG
			AM240147-AG





#### Telecommunications & audio

	Description	Technical data	Order code
	1 Gang telephone outlet RJ11	4 pole UTP	AM32144-ST
			AM32144-SB
			AM32144-MG
			AM32144-AG
	1 Gang telephone outlet BT master, RJ11/RJ12	4 pole UTP	AM30544-ST
			AM30544-SB
			AM30544-MG
			AM30544-AG
	1 Gang telephone outlet BT secondary, outlet RJ11/RJ12	6 pole UTP	AM30644-ST
			AM30644-SB
			AM30644-MG
			AM30644-AG

## Wiring accessories

### Millenium wiring accessories



#### Telecommunications & audio

	Description	Technical data	Order code
	1 Gang computer outlet RJ45 Cat 5e UTP	8 pole UTP	AM33144-ST
			AM33144-SB
			AM33144-MG
			AM33144-AG
	1 Gang computer outlet RJ45 Cat 6 UTP	8 pole UTP	AM33344-ST
			AM33344-SB
			AM33344-MG
			AM33344-AG
	RJ45 single adapter	For connectors type Keystone, AMP, Brand- Rex, Openet-ICS, THT Leviton, Krone	AM33544-ST
			AM33544-SB
			AM33544-MG
			AM33544-AG
	2 Gang computer outlet RJ45 Cat 5e UTP	8 pole UTP	AM33244-ST
			AM33244-SB
			AM33244-MG
			AM33244-AG
	RJ45 double adapter	For connectors type Keystone, AMP, Brand- Rex, Openet-ICS, THT Leviton, Krone	AM33444-ST
			AM33444-SB
			AM33444-MG
			AM33444-AG
	USB charger insert, 2 modules	44x44 for use in frames, 1.5mA	AMD85144-AN
	TV/Sat module	F-Type, 1 Module, 22x44 for use in frames	AMD30322-AN
		F-Type, 2 Modules, 44x44 for use in frames	AMD30344-AN
	RJ45 Data module	Cat6a, 1 Module, 22x44 for use in frames	AMD33422-AN

## Wiring accessories



### Millenium wiring accessories

#### Telecommunications & audio

	Description	Technical data	Order code
	1 Gang TV outlet	Dead-end-feeder isolated. For technical data see below	AM30144-ST
			AM30144-SB
			AM30144-MG
			AM30144-AG
	SAT outlet	F type isolated dead-end-feeder. For technical data see below	AM30344-ST
			AM30344-SB
			AM30344-MG
			AM30344-AG
	SAT Twin outlet	F type isolated dead-end-feeder. For technical data see below	AM32344-ST
			AM32344-SB
			AM32344-MG
			AM32344-AG

TV & SAT outlet technical information	Frequency (Mhz)	Insertion loss (dB) Technical data	Output return loss (dB)	Voltage resistance
	5~550	< 2.5	<16	2 KV
	550~750	< 2.5	<14	2 KV
	750~1000	< 2.5	<14	2 KV
SAT	5~550	< 0.5	<18	2 KV
	550~750	< 0.8	<18	2 KV
	750~1000	< 0.8	<16	2 KV

#### Telecommunications & audio

	Description	Technical data	Order code
	Audio outlet, 2 terminals L & R	2 terminals	AM34144-ST
			AM34144-SB
			AM34144-MG
			AM34144-AG
	Flex outlet	20A	AM55044-ST
			AM55044-SB
			AM55044-MG
			AM55044-AG

#### Dimmers

	Description	Technical data	Order code
	1 Gang double rotary dimmer	230 V~ ±10 % 50 Hz 40-250 W 40-150 VA	AM41244-ST
			AM41244-SB
			AM41244-MG
			AM41244-AG
			AM41244-AG



# Royce Thompson

## Photo-electronic controls

Royce Thompson continue to lead the way with our range of Photo Electric Controls

—  
01 Oasis 2000  
—  
02 Microstar 2000

**Royce Thompson has been at the forefront of the photo-electronic street lighting and amenity controls market since 1963.**

With our extensive experience, Royce Thompson has given street and amenity lighting engineers the 'fit and forget' products that they know and trust. After all, they want to know they have products that will ensure years of exceptional performance on key transport, infrastructure and road network projects nationwide.

—

We have continually focused on high quality and reliability, long service life and delivering goods to our customers on time whilst providing value and a service you can trust.

Today's street lighting engineers agree that a photo-electronic control located many metres in the air on street or amenity architecture must be reliable and high quality. After all, who wants to have to replace or repair products that cannot meet the service lifetime of the luminaires they are controlling. Royce Thompson photo-electronic controls ensure peace of mind and the knowledge that their superior performance mean no expensive returns have to be undertaken to replace failed equipment.

### **Royce Thompson Photocells**

A Photo-Electronic control unit or photocell is an electronic switch that is triggered according to a specific light level measured on the Lux scale. With our electronic or microprocessor technology, photocells operate in a number of ways depending on the level of accuracy required.

01



02



## Range overview

### Technical specification



Product selection guide

Type	Premium Intelligent NEMA Microprocessor Photocells				
Reference	Oasis 1000	Oasis 2000	Monostar 1000	Monostar 2000	Nightstar
Sensor Type	Filtered Silicon Photodiode	Filtered Silicon Photodiode	Filtered Silicon Photodiode	Filtered Silicon Photodiode	Filtered Silicon Photodiode
Sensor Control	Microprocessor	Microprocessor	Microprocessor	Microprocessor	Microprocessor
Std Switching level	70 Lux ON 35 Lux OFF	70 Lux ON 35 Lux OFF	70 Lux ON 35 Lux OFF	70 Lux ON 35 Lux OFF	70 Lux ON 35 Lux OFF 00:00 OFF - 05:30 ON
Operating Voltage Range	198-270 VAC 50/60 Hz	110-270 VAC 50/60 Hz	198-270 VAC 50/60 Hz	198-270 VAC 50/60 Hz	198-270 VAC 50/60 Hz
Max Lamp Load	3 x 400W Inductive (96uF) 8A	3 x 400W Inductive (96uF) 10A	2 x 250W inductive (60uF)	2 x 400W inductive (60uF)	2 x 400W Inductive (96uF)
Zero crossover voltage switching	Yes	Yes	Yes	Yes	Yes
Power consumption	0.25w	0.25w	0.5w	0.5w	0.25w
Operating Temp range	minus 20° to + 60°C	minus 20° to + 60°C	minus 20° to + 60°C	minus 20° to + 60°C	minus 20° to + 60°C
Ingress protection	IP65	IP67	IP65	IP67	IP67
Dimensions Dia x D	85.5 x 72 mm	85.5 x 72 mm	85.5 x 72 mm	81 x 75 mm	85.5 x 72 mm
MOV Surge Protection	No	Yes	NO	Yes	Yes
Options 1 - Positive & Negative Differential	Yes	Yes	Yes	Yes	Yes
Options 2 - Kit	Yes	Yes	Yes	Yes	Yes
Options 3 - Conduit	Yes	Yes	Yes	Yes	Yes
Options 4 - 110Vac	Yes	Yes	No	No	Yes
Options 5 - 48Vac	Yes	Yes	No	No	Yes
Options 6 - 24Vac	Yes	Yes	No	No	Yes
Options 7 - Reverse Acting	Yes	Yes	No	No	N/A
Options 7 - Part Night	See Nightstar	See Nightstar	See Nightstar	See Nightstar	Yes



Product selection guide

Type	Economy Photocells				
Reference	P12HE	P12RE	S300	Astro Nova City	V16
Sensor Type	Phototransistor	Phototransistor	Phototransistor	N/A	Phototransistor
Sensor Control	Discrete Components	Discrete Components	Discrete Components	Microprocessor	Discrete Components
Std Switching level	70 Lux ON Within 1:1.570 Lux OFF	70 Lux ON Within 1:1.570 Lux OFF	70 Lux ON Within 1:1.5 Lux OFF	Astronomical & Fixed Time Schedule	Adjustable Lux ON Diff 1:1.5 Lux OFF
Operating Voltage Range	220-270 VAC 50/60 Hz	220-270 VAC 50/60 Hz	220-270 VAC 50/60 Hz	220-265VAC 50/60 Hz	220-270 VAC 50/60 Hz
Max Lamp Load	2 x 250W inductive (60uF) 2000w Res	2 x 250W inductive (60uF) 2000w Res	2 x 250W inductive (60uF) 2000w Res	2 x 16A Res 10A Ind 250Vac	2200VA/ 10A Res
Zero crossover voltage switching	No	No	No	No	No
Power consumption	0.6w	0.6w	0.6w	1w	2.5w
Operating Temp range	minus 20° to + 60°C	minus 20° to + 60°C	minus 20° to + 60°C	minus 10° to + 45°C	minus 20° to + 45°C
Ingress protection	IP65 (Lens) IP54 (Casing)	IP65 (Detector) IP54 (Casing)	IP65	IP20	IP54



Miniature Intelligent Microprocessor Photocells					Two Part Remote Detector	
Microstar 2000*	Microstar Ultra HT	Nightstar Miniature	Q18	ER4N	P42E	V400
Filtered Silicon Photodiode	Filtered Silicon Photodiode	Filtered Silicon Photodiode	Filtered Silicon Photodiode	Filtered Silicon Photodiode	Phototransistor	LDR
Microprocessor	Microprocessor	Microprocessor	Microprocessor	Microprocessor	Discrete Components	Discrete Components
70 Lux ON 35 Lux OFF	70 Lux ON 35 Lux OFF	70 Lux ON 35 Lux OFF 00:00 OFF - 05:30 ON	70 Lux ON 35 Lux OFF	70 Lux ON 35 Lux OFF	70 Lux ON Within 1:1.5 Adjustable Lux ON Diff Lux OFF	70 Lux ON Within 1:1.5 Adjustable Lux ON Diff Lux OFF
198-270 VAC 50/60 Hz	198-270 VAC 50/60 Hz	198-270 VAC 50/60 Hz	198-270 VAC 50/60 Hz	198-270 VAC 50/60 Hz	198-270 VAC 50/60 Hz	198-270 VAC 50/60 Hz
3 x 400W Inductive (96uF) 10A	3 x 400W Inductive (96uF) 10A	2 x 400W Inductive (96uF)	3 x 400W Inductive (96uF) 10A	3 x 400W Inductive (96uF) 10A	2 x 250W inductive (60uF) 2000w Res	2 x 250W inductive (60uF) 2000w Res
Yes	Yes	Yes	Yes	Yes	No	No
0.25w	0.25w	0.25w	0.25w	0.25w	0.25w	0.25w
minus 20° to + 60°C	minus 20° to + 60°C	minus 20° to + 60°C	minus 20° to + 60°C	minus 20° to + 60°C	minus 20° to + 60°C	minus 20° to + 60°C
IP65 (Lens) IP54 (Casing)	IP65 (Detector) IP54 (Casing)	IP54 (Casing)	ATEX Protection	IP65 (Detector) IP54 (Casing)	IP65 (Detector) IP54 (Casing)	IP65 (Lens) IP54 (Casing)
57x31x25 mm	57x31x25 mm	57x31x25 mm	195x130x109 mm	68x75x92 mm (Controller). 25x35 mm (Detector)	77x75x74 mm (Controller). 20x52 mm (Detector)	68x75x92 mm (Controller). 68x68x86 mm (Detector)
On Request (Supplied loose)	On Request (Supplied loose)	On Request (Supplied loose)		Yes	Yes	No
Yes	Yes	Yes	Yes	Yes	Yes	(Positive only)
N/A	N/A	N/A	N/A	N/A	N/A	N/A
N/A	N/A	N/A	N/A	N/A	N/A	N/A
Yes	Yes	Yes	Yes	Yes	Yes	Yes
Yes	Yes	Yes	Yes	Yes	Yes	NO
Yes	Yes	Yes	Yes	Yes	Yes	NO
Yes	Yes	Yes	Yes	Yes	Yes	NO
Yes	Yes	Yes	Yes	Yes	Yes	NO
See Nightstar Mini	See Nightstar Mini	Yes	Yes	Yes	Yes	NO

\*Two part miniature version also available in this range - the ER12

<< continued



Type	Economy Photocells				
Reference	P12HE	P12RE	S300	Astro Nova City	V16
Dimensions Dia x D	57x31x25 mm	57x31x25 mm (Controller). 25x26 mm (Detector)	85.5 x 72 mm	65x35x88 mm	93x67x50 mm
MOV Surge Protection	No	No	No	N/A	No
Options 1 - Positive & Negative Differential	(Positive only)	(Positive only)	(Positive only)	N/A	(Positive only)
Options 2 - Kit	N/A	N/A	N/A	N/A	N/A
Options 3 - Conduit	N/A	N/A	Yes	N/A	N/A
Options 4 - 110Vac	Yes	Yes	Yes	N/A	N/A
Options 5 - 48Vac	Yes (dc only)	Yes (dc only)	Yes (dc only)	N/A	N/A
Options 6 - 24Vac	Yes (dc only)	Yes (dc only)	Yes (dc only)	N/A	N/A
Options 7- Reverse Acting	Yes (dc only)	Yes (dc only)	Yes (dc only)	N/A	N/A
Options 7- Part Night				Yes	NO

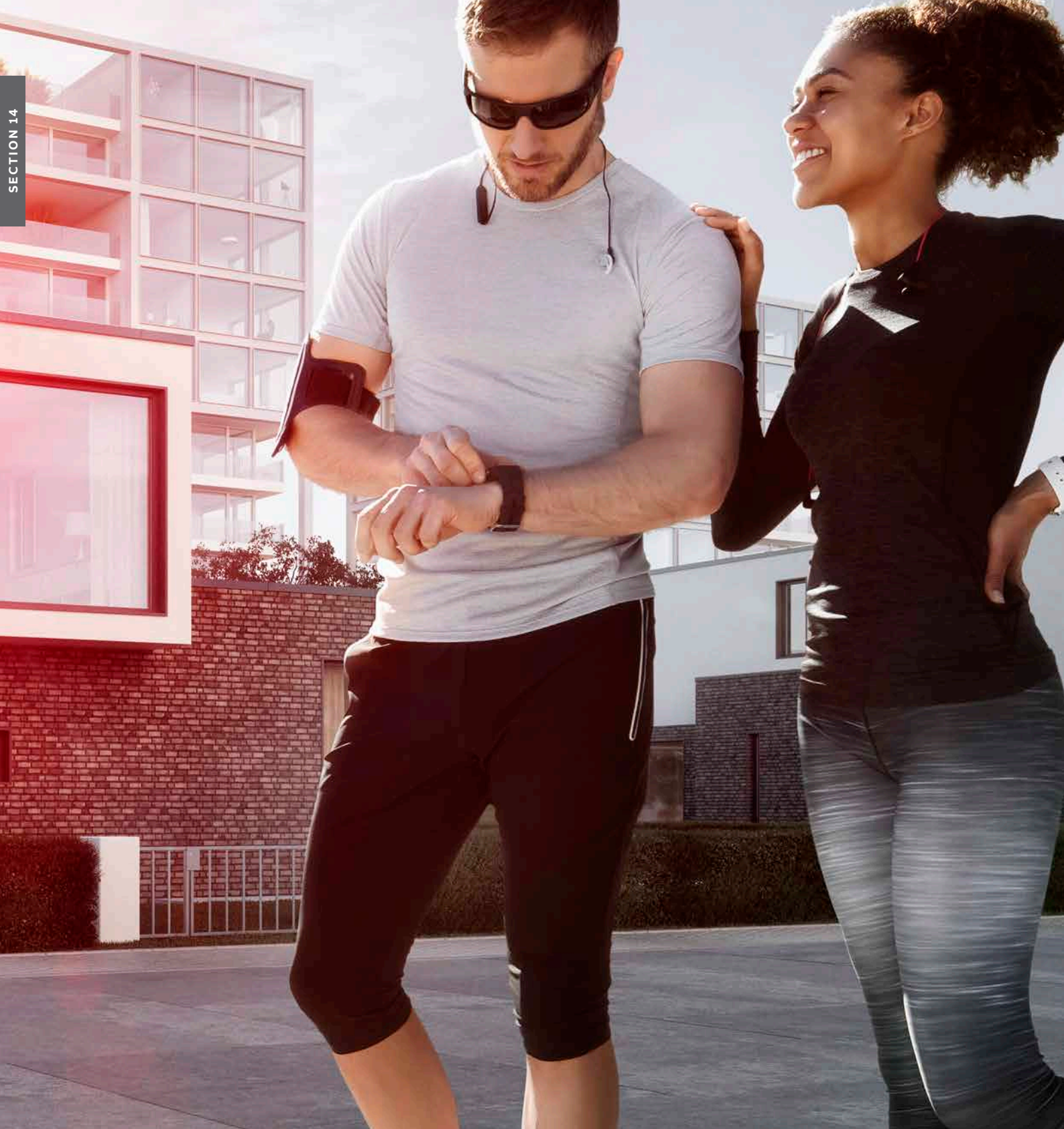

SECTION 14

---

# Smart home - Designed to make your life simpler

<b>256</b>	<b>Smarter homes</b>
<b>258</b>	<b>The range</b>
<b>273</b>	<b>Door entry systems</b>
<b>274</b>	<b>ABB-tacteo® KNX</b>
<b>276</b>	<b>ABB i-bus® KNX</b>
<b>284</b>	<b>ABB secure@home</b>



For more detailed product information, please refer to our online technical brochures available at: [new.abb.com/low-voltage/support/documentation](http://new.abb.com/low-voltage/support/documentation)

or contact our sales team via email [LV.enquiries@gb.abb.com](mailto:LV.enquiries@gb.abb.com)

or call 0333 999 9933

## Just as you like it.

### The Smart Home.

The perfect daily routine. With ABB-free@home<sup>®</sup>, the entire home can be controlled not only with switches, but now even more practically: by smartphone or tablet and via touch or voice control. This allows home automation to be managed in a way that's mobile and smart, precise and flexible. For example, if the light atmosphere needs to be changed, tapping on the touchscreen or a simple voice command moves the blinds or changes the colours of the lights. Experience the future of smart living today.

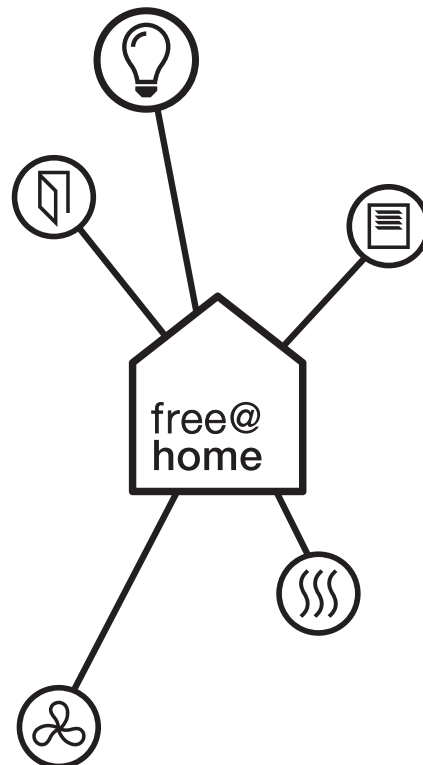

# Communicative and competent.

## The ABB partner close to you.

Advice and assistance close to you. Your electrician will be happy to explain to you in detail the advantages of ABB-free@home® in a face-to-face discussion. This will allow home automation to be planned to suit your individual requirements.

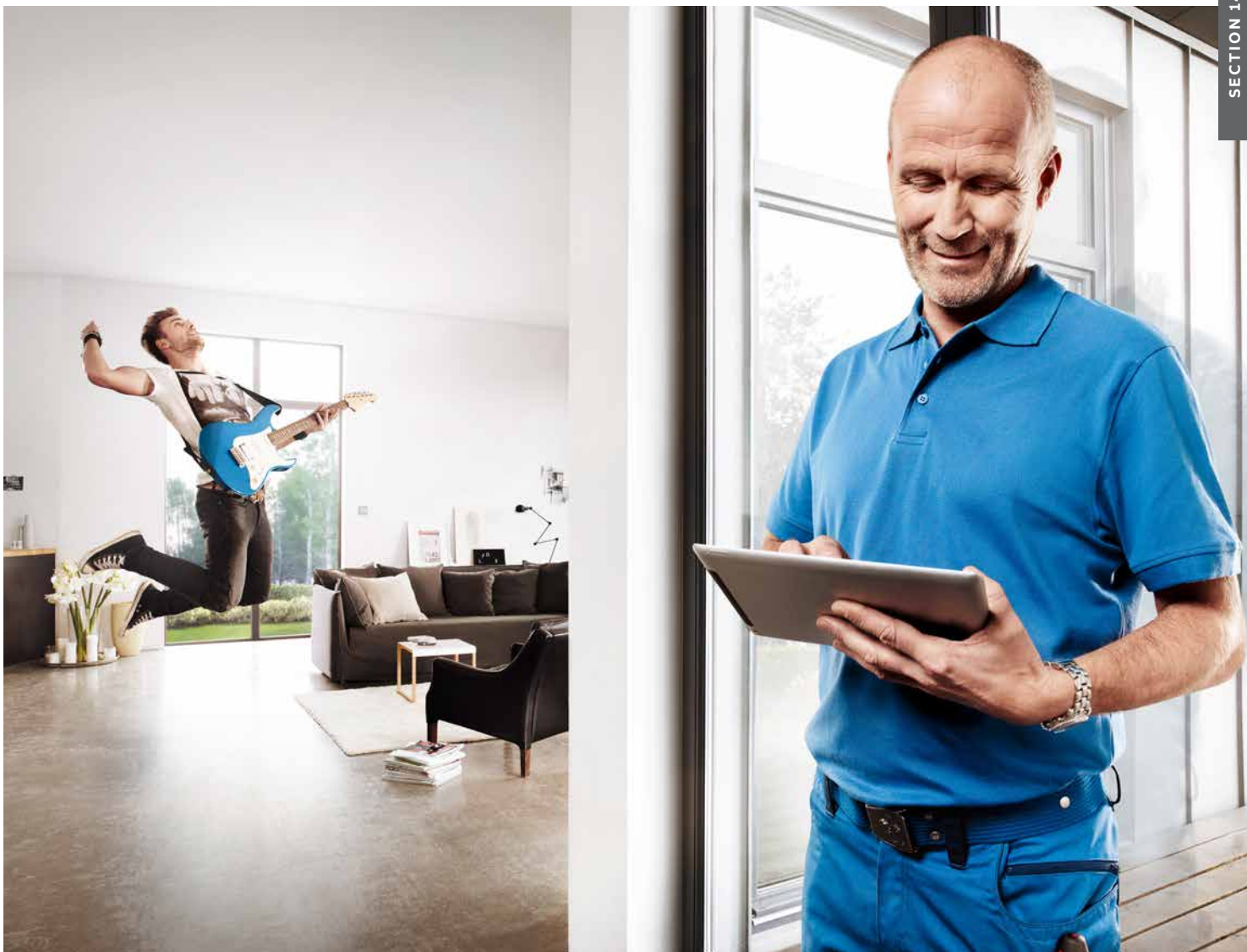

free@home  
for iOS



free@home  
for Android



### The ABB-free@home® app

The activation of the voice control in the ABB-free@home® app suffices to control the climate, lights and safety in the entire house via voice input: "Switch on the lamp in the living room", "Move all the blinds up", and whatever else you wish, without having to learn special commands, without laborious configuration. The previously defined names of rooms, floors and devices continue to be used without interruption. Everything remains in the one system for the future.

## The range

Modularity makes everything possible



### System Access Point 2.0

Article no.	SAP/S.3
Description	For commissioning and remote control of the ABB-free@home® system. With integrated free@home wireless antenna. With integrated free@home bus connection. Allows the execution of astro and time programs. Commissioning and remote control is executed via web interface or app. No additional commissioning software is required. Easy commissioning with WLAN ad-hoc mode. Connection to the home network via WLAN client mode or via CAT cable.
Dimensions (H × W × D)	107 mm × 109 mm × 30 mm
Technical data	Display elements: LED for status display Nominal voltage: 230 V~ Rated frequency: 50 Hz/60 Hz Protection type of device: IP 20



### ABB-free@homeTouch 7"

black: DP7-S-625 white: DP7-S-611
In indoor video station with 17.8 cm (7") touch display for ABB-free@home® and ABB-Welcome. For the central control of up to 16 configurable functions and display of the video image of an ABB-Welcome outdoor station. SD card slot for extension of the picture memory. Suitable as room temperature controller extension unit. For surface mounting.
155 mm × 218 mm × 29 mm
Display size: 17.8 cm (7") Display resolution: 800 × 480 Display elements: TFT touch display Protection type of device: IP 30



### ABB-free@homeTouch 4.3"

Article no.	black: DP4-1-625 white: DP4-1-611
Description	For the central control of up to 16 configurable ABB-free@home® functions. For the display of configurable system messages. A configurable primary function can be triggered with a multi-touch gesture. Capacitive touch screen with closed glass surface. With integrated room temperature controller and temperature sensor. In connection with temperature sensor DP4-T-1 the integrated room temperature controller can be fitted with a remote sensor. Suitable as room temperature controller extension unit (up to 8).
Dimensions (H × W × D)	104 mm × 143 mm × 53 mm
Technical data	Display size: 10.9 cm (4.3") Display resolution: 480 × 854 Mounting height: 8 mm Display elements: 1 LCD display Bus voltage: 24 V~ Protection class (Device): IP 30



### Installation box, FM

DP4-F
For flush-mounted and hollow-wall installation of the ABB-free@homeTouch 4.3" DP4-1-6XX. Windproof.
82 mm × 123 mm × 50 mm
Mounting depth: 50 mm



### Temperature sensor

DP4-T-1
For use as remote sensor.
Cable length: 4 m
Line type: H03 VV-F Type: NTC 10 kohm



wireless



wireless

	<b>External Antenna</b>	<b>Basic free@home radiator thermostat, wireless</b>
Article no.	SAP-1-WL	HA-S-1-WL
Description	To be used in combination with System Access Point SAP-S-2 and SAP/S.3. Transmits the wireless signal outside, in case the internal antenna of the System Access Point is shielded. With magnetic foot.	For temperature regulation of water-bearing heaters. With integrated temperature sensor, controller and actuating drive. Local operation for the switchover between comfort mode and Off. No wire laying required. Communication with the free@home system is carried out wireless. Setpoint adjustment via the free@home app or a free@home extension unit (e.g. XXXXXXX). Integrated "Window open" detection or can be linked with WBI-S-X-W
Dimensions (H x W x D)	cable lengths: 1.5 m	63 mm x 48 mm x 84 mm
Technical data		With lime protection function. With frost protection function. Noiseless running. Installation with sleeve nut M 30 x 1.5. Fits many popular valve bases (e.g. Braukmann, Heimeier, Honeywell, Junkers, MNG). The adapters for Danfoss RAV, Danfoss RA and Danfoss RAVL are included in the scope of supply. Adapters for additional valves are available as accessories. Battery included in scope supply. Battery type: 2 x AA Protection class (Device): IP 20



wireless



	<b>Comfort free@home radiator thermostat, wireless</b>	<b>Valve adapter Herz</b>
Article no.	HA-S-2-WL	AC-HA-1
Description	For temperature regulation of water-bearing heaters. With integrated temperature sensor, controller and actuating drive. Local operation for the switchover between comfort mode and Off. No wire laying required. Communication with the free@home system is carried out wireless. Setpoint adjustment via the free@home app or a free@home extension unit (e.g. XXXXXXX). Integrated "Window open" detection or can be linked with WBI-S-X-WL.	Metal adapter for installation radiator thermostat. (HA-S-X-WL). For valve bodies Herz M 28 x 1,5.
Dimensions (H x W x D)	63 mm x 48 mm x 84 mm	
Technical data	With lime protection function. With frost protection function. Noiseless running. Installation with sleeve nut M 30 x 1.5. Fits many popular valve bases (e.g. Braukmann, Heimeier, Honeywell, Junkers, MNG). The adapters for Danfoss RAV, Danfoss RA and Danfoss RAVL are included in the scope of supply. Adapters for additional valves are available as accessories. Battery included in scope supply. Battery type: 2 x AA Protection class (Device): IP 20	



### Valve adapter Herz

Article no. AC-HA-1

Description Metal adapter for installation radiator thermostat. (HA-S-X-WL). For valve bodies Herz M 28 x 1,5.



### Valve adapter Orkli

Article no. AC-HA-3

Description Metal adapter for installation radiator thermostat. (HA-S-X-WL). For valve bodies Orkli M 28 x 1,0.



wireless

### free@home window sensor, wireless

Article no. studio white matt : WBI-S-1-64-WL  
basalt black : WBI-S-1-65-WL  
stainless steel : WBI-S-1-66-WL

Description For monitoring and transmission of the current window handle position (window open, closed, tilted). The status can be visualized on the free@home panel and in the free@home app. The window sensor is installed between the available window handle and the window frame. Existing window handle is used. Suitable for window handle: 7 mm square fastener, 43 mm attachment screw separation, lifter dia. 10 and 12 mm, max. mounting plate size 34 x 77 mm (WxH). No wire laying required. Mounting accessories (square extension, screws, adapter for cams) for the window sensor are included in scope of delivery.

Dimensions (H x W x D) 168 mm x 38 mm x 13 mm

Technical data Battery included in scope supply. Battery type: CR2  
Notification in case of low battery capacity in the free@home app.  
Protection class (Device): IP 43



wireless

### free@home universal detector, wireless

Article no. studio white matt: BI-S-1-64-WL  
basalt black: BI-S-1-65-WL

Description For monitoring and transmission of the state (open, closed) of dormer windows, skylights, doors and gates. Additional connection option for an external, potential-free sensor (choice of normally closed or normally open contact). The status can be visualized on the free@home panel and in the free@home app. Isolated evaluation and monitoring of channels. The universal detector and the magnets are fixed with adhesive film or screws. Accessories (adhesive foil, screws, magnet) included in delivery.

Dimensions 118 mm x 30 mm x 22 mm

Technical data Battery type: CR2  
Notification in case of low battery capacity in the free@home app.  
External sensor max. wire length: 5 m  
External sensor terminal connection diameter: 0.14...0.5 mm<sup>2</sup> (single wire)  
Protection class (Device): IP 43

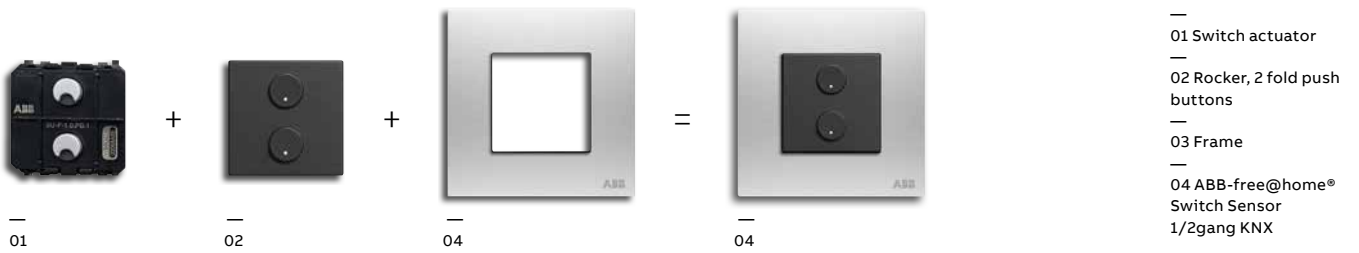

Colour options for frames and cover plates  
Millenium

Colour	Code (c)	Colour	Code (c)
anthracite	AN	matt gold	MG
antique gold	AG	silk black	SB
brushed stainless steel	ST		

Available symbols for push buttons

Symbol	Code (i)	Colour	Code (i)
No symbol		Scene	S
Light	L	Dimmer	D
Blind	B		

**Cover plate for 2 fold push buttons incl neutral symbols**

Article no. SR-2-AMAN

Description As cover for ABB-free@home® 1/2gang switches of Millenium Range.

Dimensions (H x W x D) 44 mm x 44 mm

**Cover plate for 4 fold push buttons incl neutral symbols**

SR-4-AMAN

As cover for ABB-free@home® 2/4gang switches of Millenium Range.

44 mm x 44 mm

**Cover Plate for Movement Detector**

Article no. CP-MD-AMAN

Description As cover for ABB-free@home® movement detector of Millenium Range.

Dimensions (H x W x D) 44 mm x 44 mm

**Cover Plate for Room Temperature Controller**

CP-RTC-AMAN

As cover for ABB-free@home® room thermostat RTC-F-1.PB.

44 mm x 44 mm

**Square Frame, Millenium**

Article no. AMD5144-**c**

Description As frame for ABB-free@home® sensors and rockers of Millenium Range, includes mounting frame: AMD5053.

Dimensions (H x W x D) 86 mm x 86 mm

Colours (**c**) AG, MG, SB, ST

Symbols (**i**)

**Icon for Millenium Rockers**

SBI-AMAN

Interchangeable icons for Millenium rockers, available with several icon design options (**i**) in colour anthracite.

AN

L, , S, D



---

**Sensor/Switch actuator 1/1gang**

---

Article no. SSA-F-1.1.PB.1

**Description** For switching 230 V~ devices. With 1 integrated switch actuator. Switching function is available pre-configured. Use with ABB-free@home® 2 fold push buttons.

**Dimensions (H x W x D)** 44 mm x 44 mm x 40.9 mm

**Technical data** Outputs: 1x normally open contact, potential free  
 Suitable for: resistive  
 Rated current: 10 A  
 Rated power: 2300 W  
 Suitable for: capacitive  
 Rated current: 10 AX  
 Protection class of device: IP 20  
 Mounting depth: 31.5 mm



---

**Sensor/Switch actuator 2/1gang**

---

SSA-F-2.1.PB.1

For switching 230 V~ devices. With 1 integrated switch actuator. Switching function is available pre-configured. Use with ABB-free@home® 4 fold push buttons.

44 mm x 44 mm x 40.9 mm

Outputs: 1x normally open contact, potential free  
 Suitable for: resistive  
 Rated current: 10 A  
 Rated power: 2300 W  
 Suitable for: capacitive  
 Rated current: 10 AX  
 Protection class of device: IP 20  
 Mounting depth: 31.5 mm



---

**Sensor/Switch actuator 2/2gang**

---

Article no. SSA-F-2.2.PB.1

**Description** For switching 230 V~ devices. With 1 integrated switch actuator. Switching function is available pre-configured. Use with ABB-free@home® 4 fold push buttons.

**Dimensions (H x W x D)** 44 mm x 44 mm x 40.9 mm

**Technical data** Outputs: 2x normally open contact, potential free  
 Suitable for: resistive  
 Rated current: 10 A  
 Rated power: 2 x 1200 W  
 Suitable for: capacitive  
 Rated current: 10 AX  
 Protection class of device: IP 20  
 Mounting depth: 31.5 mm



---

**Sensor/Dim actuator 1/1gang**

---

SDA-F-1.1.PB.1

For dimming 230 V~ loads. With integrated universal dimming actuator for controlling different lamps. The dimming function is available pre-configured. Use with ABB-free@home® 2 fold push buttons.

44 mm x 44 mm x 40.9 mm

Outputs: 1x dimming channel  
 Suitable for: 230 V incandescent lamps and low-voltage halogen lamps with conventional transformers or electronic transformers  
 Rated power: 10–180 W/VA  
 Suitable for: LEDi and energy-saving bulbs  
 Rated power: 2–80 W/VA  
 Protection class of device: IP 20  
 Mounting depth: 31.5 mm

**Sensor/Dim actuator 2/1gang**

Article no. SDA-F-2.1.PB.1

**Description** For dimming 230 V~ loads. With integrated universal dimming actuator for controlling different lamps. The dimming function is available pre-configured. Use with ABB-free@home® 4 fold push buttons.

**Dimensions (H x W x D)** 44 mm x 44 mm x 40.9 mm

**Technical data** Outputs: 1x dimming channel  
 Suitable for: 230 V incandescent lamps and low-voltage halogen lamps with conventional transformers or electronic transformers  
 Rated power: 10–180 W/VA  
 Suitable for: LEDi and energy-saving bulbs  
 Rated power: 2–80 W/VA  
 Protection class of device: IP 20  
 Mounting depth: 31.5 mm

**Sensor/Blind actuator 1/1gang**

Article no. SBA-F-1.1.PB.1

**Description** For controlling blind and awning motors. With integrated blind actuator. Blind function is available pre-configured. To be used with ABB-free@home® 2 fold push buttons.

**Dimensions (H x W x D)** 44 mm x 44 mm x 40.9 mm

**Technical data** Outputs: 1x Change-over contacts/normally open contact, potential-bound  
 Rated power: 920 VA  
 Rated current: 4 A  
 Suitable for: Operating mode blind  
 Protection class of device: IP 20  
 Mounting depth: 31.5 mm

**Sensor/Blind actuator 2/1gang**

Article no. SBA-F-2.1.PB.1

**Description** For controlling blind and awning motors. With integrated blind actuator. Blind function is available pre-configured. To be used with ABB-free@home® 4 fold push buttons.

**Dimensions (H x W x D)** 44 mm x 44 mm x 40.9 mm

**Technical data** Outputs: 1x Change-over contacts/normally open contact, potential-bound  
 Rated power: 920 VA  
 Rated current: 4 A  
 Suitable for: Operating mode blind  
 Protection class of device: IP 20  
 Mounting depth: 31.5 mm

**Room Temperature Controller**

Article no. RTC-F-1.PB

**Description** Room temperature control function for controlling commercially available valve drives or analogue valve drives (continuous controllers). With display of set-value temperature. Only to be used with ABB-free@home® Zenit cover plates for room thermostat.

**Dimensions (H x W x D)** 44 mm x 44 mm x 29.4 mm

**Technical data** Display elements: LCD Display showing operation modes  
 Protection class of device: IP 20  
 Mounting depth: 17.9 mm



---

**Room temperature controller**

---

Article no. RTC-F-2.1-1.PB-WL

**Description** Room temperature control function for controlling commercially available valve drives or analogue valve drives (continuous controllers). With display of set-value temperature. Only to be used with ABB-free@home® Zenit cover plates for room thermostat.

**Dimensions (H x W x D)** 44 mm x 44 mm x 29.4 mm

**Technical data** Display elements: LCD Display showing operation modes  
Protection class of device: IP 20  
Mounting depth: 17.9 mm

---



---

**Sensor unit 1gang**

---

SU-F-1.0.PB.1

For sending switching, dimming and blind commands to an ABB-free@home® actuator. To be used with ABB-free@home® 2 fold push buttons.

44 mm x 44 mm x 23.5 mm

**Control element:** Switch contacts top/ bottom  
**Display elements:** LED as light for orientation or display of switching state  
**Protection class of device:** IP 20  
**Mounting depth:** 14.1 mm

---



---

**Sensor unit 2gang**

---

Article no. SU-F-2.0.PB.1

**Description** For sending switching, dimming and blind commands to an ABB-free@home® actuator. To be used with ABB-free@home® 4 fold push buttons.

**Dimensions (H x W x D)** 44 mm x 44 mm x 23.5 mm

**Technical data** Control element: Switch contacts top/ bottom  
Display elements: LED as light for orientation or display of switching state  
Protection class of device: IP 20  
Mounting depth: 14.1 mm

---



---

**Movement detector + 1 actuator**

---

MSA-F-1.1.PB.1

With select lens for detection with animal access. Including an integrated actuator for switching 230 V~ devices. To be used with ABB-free@home® Zenit cover plates for movement detector.

44 mm x 44 mm x 47 mm

**Outputs:** 1x normally open contact, potential free  
**Suitable for:** resistive  
**Rated current:** 10 A  
**Rated power:** 2300 W  
**Suitable for:** capacitive  
**Rated current:** 10 AX  
**Detection range:** frontal 6m, lateral 3m  
**Detection angle:** 180°  
**Brightness limit value:** 1 – 500 lux  
**Protection class of device:** IP 20  
**Mounting depth:** 31.5 mm

---



---

**Movement detector**

---

Article no. MD-F-1.0.PB.1

---

Description With select lens for detection with animal access. For automatic switching of ABB-free@home® actuators dependent on movement and brightness. To be used with ABB-free@home® Zenit cover plates for movement detector.

---

Dimensions (H x W x D) 44 mm x 44 mm x 29.6 mm

---

Technical data  
Detection range: frontal 6 m, lateral 3 m  
Detection angle: 180°  
Brightness limit value: 1 – 500 lux  
Protection class of device: IP 20  
Mounting depth: 14.1 mm

---



wireless

**Sensor/Switch actuator 1/1gang, wireless**

Article no. SSA-F-1.1.PB.1-WL

**Description** For switching 230 V~ devices. With integrated actuator. Switching function is available pre-configured. To be used with ABB-free@home® Zenit cover plates for 2 fold push buttons.

**Dimensions (H x W x D)** 44 mm x 44 mm x 40.9 mm

**Technical data** Outputs: 1x normally open contact, potential free  
Suitable for: resistive  
Rated current: 10 A  
Rated power: 2300 W  
Suitable for: capacitive  
Rated current: 10 AX  
Protection class of device: IP 20  
Mounting depth: 31.5 mm



wireless

**Sensor/Switch actuator 2/1gang, wireless**

Article no. SSA-F-2.1.PB.1-WL

**Description** For switching 230 V~ devices. With integrated actuator. Switching function is available pre-configured. To be used with ABB-free@home® Zenit cover plates for 4 fold push buttons.

**Dimensions (H x W x D)** 44 mm x 44 mm x 40.9 mm

**Technical data** Outputs: 1x normally open contact, potential free  
Suitable for: resistive  
Rated current: 10 A  
Rated power: 2300 W  
Suitable for: capacitive  
Rated current: 10 AX  
Protection class of device: IP 20  
Mounting depth: 31.5 mm



wireless

**Sensor/Switch actuator 2/2gang, wireless**

Article no. SSA-F-2.2.PB.1-WL

**Description** For switching 230 V~ devices. With integrated actuator. Switching function is available pre-configured. To be used with ABB-free@home® Zenit cover plates for 4 fold push buttons.

**Dimensions (H x W x D)** 44 mm x 44 mm x 40.9 mm

**Technical data** Outputs: 2x normally open contact, potential free  
Suitable for: resistive  
Rated current: 10 A  
Rated power: 2 x 1200 W  
Suitable for: capacitive  
Rated current: 10 AX  
Protection class of device: IP 20  
Mounting depth: 31.5 mm



wireless

**Sensor/Dim actuator 1/1gang, wireless**

Article no. SDA-F-1.1.PB.1-WL

**Description** For dimming 230 V~ loads. With integrated universal dimming actuator for controlling different lamps. The dimming function is available pre-configured. To be used with ABB-free@home® Zenit cover plates for 2 fold push buttons.

**Dimensions (H x W x D)** 44 mm x 44 mm x 40.9 mm

**Technical data** Outputs: 1x dimming channel  
Suitable for: 230 V incandescent lamps and low-voltage halogen lamps with conventional transformers or electronic transformers  
Rated power: 10–180 W/VA  
Suitable for: LEDi and energy-saving bulbs  
Rated power: 2–80 W/VA  
Protection class of device: IP 20  
Mounting depth: 31.5 mm



wireless

**Sensor/Dim actuator 2/1gang, wireless**

Article no. SDA-F-2.1.PB.1-WL

**Description** For dimming 230 V~ loads. With integrated universal dimming actuator for controlling different lamps. The dimming function is available pre-configured. To be used with ABB-free@home® Zenit cover plates for 4 fold push buttons.

**Dimensions (H×W×D)** 44 mm x 44 mm x 40.9 mm

**Technical data** Outputs: 1× dimming channel  
Suitable for: 230 V incandescent lamps and low-voltage halogen lamps with conventional transformers or electronic transformers  
Rated power: 10–180 W/VA  
Suitable for: LEDi and energy-saving bulbs  
Rated power: 2–80 W/VA  
Protection class of device: IP 20  
Mounting depth: 31.5 mm



wireless

**Sensor/Blind actuator 1/1gang, wireless**

Article no. SBA-F-1.1.PB.1-WL

For controlling blind and awning motors. With integrated blind actuator. Blind function is available pre-configured. To be used in combination with ABB-free@home® Zenit cover plates for 2 fold push buttons.

Dimensions (H×W×D) 44 mm x 44 mm x 40.9 mm

Outputs: 1× Change-over contacts/normally open contact, potential bound  
Rated power: 920 VA  
Rated current: 4 A  
Suitable for: Operating mode blind  
Protection class of device: IP 20  
Mounting depth: 31.5 mm



wireless

**Sensor/Blind actuator 2/1gang, wireless**

Article no. SBA-F-2.1.PB.1-WL

**Description** For controlling blind and awning motors. With integrated blind actuator. Blind function is available pre-configured. To be used with ABB-free@home® Zenit cover plates for 4 fold push buttons.

**Dimensions (H×W×D)** 44 mm x 44 mm x 40.9 mm

**Technical data** Outputs: 1× Change-over contacts/normally open contact, potential-bound  
Rated power: 920 VA  
Rated current: 4 A  
Suitable for: Operating mode blind  
Protection class of device: IP 20  
Mounting depth: 31.5 mm



wireless

**Room Thermostat, wireless**

Article no. RTC-F-1.PB-WL

Room temperature control function for controlling commercially available valve drives or analogue valve drives (continuous controllers) in connection with HA-M-0.6.1, HA-M-0.12.1, FCA-M-2.3.1. With display of set-value temperature. To be used with ABB-free@home® Zenit cover plates for room temperature controller.

Dimensions (H×W×D) 44 mm x 44 mm x 29.4 mm

Display elements: LCD Display showing operation modes  
Protection class of device: IP 20  
Mounting depth: 17.9 mm



wireless

**Room Thermostat, wireless**

Article no. RTC-F-2.1-1.PB-WL

Description	Room temperature control function for controlling commercially available valve drives or analogue valve drives (continuous controllers) in connection with HA-M-0.6.1, HA-M-0.12.1, FCA-M-2.3.1. With display of set-value temperature. To be used with ABB-free@home® Zenit cover plates for room temperature controller.
Dimensions (H x W x D)	44 mm x 44 mm x 29.4 mm
Technical data	Display elements: LCD Display showing operation modes Protection class of device: IP 20 Mounting depth: 17.9 mm



wireless

**Sensor unit 1gang, wireless**

Article no. SU-F-1.0.PB.1-WL

Description	For sending switching, dimming and blind command to an ABB-free@home® actuator. To be used with ABB-free@home® Zenit cover plates for 2 fold push buttons.
Dimensions (H x W x D)	44 mm x 44 mm x 23.5 mm
Technical data	Control element: Switch contacts top/bottom Display elements: LED for orientation or switch state display Protection class of device: IP 20 Mounting depth: 14.1 mm



wireless

**Sensor unit 2gang, wireless**

Article no. SU-F-2.0.PB.1-WL

Description	For sending switching, dimming and blind command to an ABB-free@home® actuator. To be used with ABB-free@home® Zenit cover plates for 4 fold push buttons.
Dimensions (H x W x D)	44 mm x 44 mm x 23.5 mm
Technical data	Control element: Switch contacts top/bottom Display elements: LED for orientation or switch state display Protection class of device: IP 20 Mounting depth: 14.1 mm



wireless

**Movement detector + 1 actuator, wireless**

Article no. MSA-F-1.1.1-WL

Description	With select lens for detection with animal access. Including an integrated actuator for switching 230 V~ devices. To be used with ABB-free@home® Zenit cover plates for movement detector.
Dimensions (H x W x D)	44 mm x 44 mm x 47 mm
Technical data	Outputs: 1x normally open contact, potential free Suitable for: resistive Rated current: 10 A Rated power: 2300 W Suitable for: capacitive Rated current: 10 AX Detection range: frontal 6 m, lateral 3 m Detection angle: 180° Brightness limit value: 1 – 500 lux Protection class of device: IP 20 Mounting depth: 31.5 mm



### Binary input 2gang

Article no. BI-F-2.0.1

**Description** Conventional push-buttons or auxiliary contacts can be connected to 2 channels. The information of the contact enquiry can be used for activating ABB-free@home® actuators or for recording status information. The contact polling voltage is made available from the binary input itself. Extension of the connecting cables possible by a maximum of 10 m. Flush-mounted device for installation in a 60 mm device box or distribution box.

**Dimensions (H × W × D)** 39 mm × 40 mm × 12 mm

**Technical data** Inputs: 2  
Polling voltage: 20 V–  
Protection type of device: IP 20



### Binary input 4gang

Article no. BI-F-4.0.1

**Description** Conventional push-buttons or auxiliary contacts can be connected to 4 channels. The information of the contact enquiry can be used for activating ABB-free@home® actuators or for recording status information. The contact polling voltage is made available from the binary input itself. Extension of the connecting cables possible by a maximum of 10 m. Flush-mounted device for installation in a 60 mm device box or distribution box.

**Dimensions (H × W × D)** 39 mm × 40 mm × 12 mm

**Technical data** Inputs: 4  
Polling voltage: 20 V–  
Protection type of device: IP 20



### Fan coil actuator, MDRC

Article no. FCA-M-2.3.1

**Description** For controlling blower convectors. Supports 2-pipe and 4-pipe system for heating and cooling. The fan speed levels can be switched using a changeover or step switch function. Three contacts for switching a three-stage fan. Two contacts for activating the heating and cooling valves. With two binary inputs for connecting dewpoint and condensation contacts. The scanning voltage is provided by the device. The bus connection is provided via the enclosed bus terminal.

**Dimensions (H × W × D)** 90 mm × 108 mm × 64 mm

**Technical data** Supports 24 V and 230 V valves  
Outputs: 3x Normally open contact, potential free  
Suitable for: AC3  
Rated current: 6 A  
Output voltage: 230 V~  
Protection type of device: IP 20  
Module width: 6 MW



### Power supply

Article no. PS-M-64.1.1

**Description** Power supply with integrated choke. Fast diagnosis due to LED display for operational readiness and errors.

**Dimensions (H × W × D)** 90 mm × 72 mm × 64 mm

**Technical data** Display element: operating/overload LED  
Nominal voltage: 230 V~, +10%/-15%  
Secondary: 30 V, +2 V/-2 V  
Rated frequency: 50 Hz/60 Hz  
Outputs: 1  
Nominal current: 640 mA  
Protection type of device: IP 20  
Module width: 4 MW



### Binary input 4gang

Article no. BI-M-4.0.1

**Description** Records 10 to 230 V AC/DC signals via 4 channels. The information of the signal evaluation can be used for activating ABB-free@home® actuators or for recording status information.

**Dimensions (H × W × D)** 90 mm × 36 mm × 64 mm

**Technical data** Inputs: 4  
Protection type of device: IP 20  
Module width: 2 MW



### Switch actuator 4gang

SA-M-0.4.1

For switching 4 independent 230 V~ loads. Each contact has a manual operation function independent of auxiliary voltage for additionally displaying the contact setting.

90 mm × 72 mm × 64 mm

Outputs: 4  
Type of load: AC1  
Nominal current: 16 A, at  $\cos \phi$  0.8  
Output voltage: 230 V~  
Type of load: AC3  
Nominal current: 8 A, at  $\cos \phi$  0.45  
Protection type of device: IP 20  
Module width: 4 MW



### Switch actuator 8gang

Article no. SA-M-8.8.1

**Description** The binary inputs can be used as an interface for convenient operation of free@home systems via potential free push buttons or for reading technical binary signals. The switching outputs can be switched independently as a function of other sensors connected to the bus.

**Dimensions (H × W × D)** 90 mm × 144 mm × 64 mm

**Technical data** Inputs: 8  
Polling voltage: 32 V  
Max. cable length: ≤100m  
Outputs: 8  
Suitable for: AC1  
Rated current: 6 A, at  $\cos \phi$  0.8  
Output voltage: 230 V~  
Suitable for: AC3  
Rated current: 6 A, at  $\cos \phi$  0.45  
Protection class of device: IP 20  
Module width: 8 MW



### Blind actuator 4gang

BA-M-0.4.1

For controlling 4 independent blind or roller shutter drives. The outputs are inversely blocked.

90 mm × 72 mm × 64 mm

Outputs: 4  
Type of load: AC3  
Nominal current: 6 A, at  $\cos \phi$  0.45  
Output voltage: 230 V~  
Protection type of device: IP 20  
Module width: 4 MW



#### Dimming actuator, 4gang

Article no.	DA/M.4.210.2.1
Description	Multichannel universal dimming actuator optimised for dimming retrofit LED lamps (LEDi). Also suitable for dimming incandescent lamps, low-voltage halogen lights with conventional or electronic transformers, 230 V halogen lamps and dimmable energy-saving halogen lamps. Automatic load detection (can be deactivated). Separate N-connection per channel. Parallel connection of the outputs possible to increase the output power. Outputs can be connected in parallel in any configuration. Minimum load: 2 W.
Dimensions (H x W x D)	90 mm x 108 mm x 64 mm
Technical data	Rated voltage: 110 - 230 V~, +10 % / -10 % Rated frequency: 50 Hz - 60 Hz Outputs: 4x dimming channel Rated power: 2 - 210 W/VA Protection class (Device): IP 20 Temperature range (Device): -5 °C to 45 °C Dimensions: (L x W x D): 90 mm x 108 mm x 64 mm Mounting depth: 68 mm Module width: 6 MW



#### Dimming actuator, 6gang

Article no.	DA/M.6.210.2.1
Description	Multichannel universal dimming actuator optimised for dimming retrofit LED lamps (LEDi). Also suitable for dimming incandescent lamps, low-voltage halogen lights with conventional or electronic transformers, 230 V halogen lamps and dimmable energy-saving halogen lamps. Automatic load detection (can be deactivated). Separate N-connection per channel. Parallel connection of the outputs possible to increase the output power. Outputs can be connected in parallel in any configuration. Minimum load: 2 W.
Dimensions (H x W x D)	90 mm x 144 mm x 64 mm
Technical data	Rated voltage: 110 - 230 V~, +10 % / -10 % Rated frequency: 50 Hz - 60 Hz Outputs: 6x dimming channel Rated power: 2 - 210 W/VA Protection class (Device): IP 20 Temperature range (Device): -5 °C to 45 °C Dimensions: (L x W x D): 90 mm x 144 mm x 64 mm Mounting depth: 68 mm Module width: 8 MW

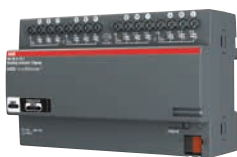

#### Heating actuator 12gang

Article no.	HA-M-0.12.1
Description	For controlling thermoelectric actuating drives in heating/cooling systems. The outputs are protected against short-circuit and overload.
Dimensions (H x W x D)	90 mm x 144 mm x 64 mm
Technical data	Outputs: 12 Type of load: resistive Nominal current: 160 mA Protection type of device: IP 20 Module width: 8 MW



#### Heating actuator 6gang

Article no.	HA-M-0.6.1
Description	For controlling thermoelectric actuating drives in heating/cooling systems. The outputs are protected against short-circuit and overload.
Dimensions (H x W x D)	90 mm x 72 mm x 64 mm
Technical data	Outputs: 6 Type of load: resistive Nominal current: 160 mA Protection type of device: IP 20 Module width: 4 MW

DOOR ENTRY SYSTEM

# Your gateway to the world

## ABB-Welcome

Your home is an expression of yourself. And with the ABB-Welcome system, you won't compromise impressive style for innovative technology. For Welcome is more than just a door video system – it is the future of home monitoring and security at your fingertips.



# ABB-tacteo® KNX

## The individual touch

Intelligent control that adapts to your individual needs.



Which functions do you need? Make a selection with our configurator.



The ABB-tacteo® KNX sensor is a capacitive control element for the intelligent building automation of high-end luxury hotels, offices and public and residential buildings.

ABB-tacteo® KNX meets all the requirements that a modern design demands – the highest levels of quality and above all comfort: from blinds, lighting and heating to media and access, everything is easy to control.

Are you an architect planning a building with maximum functionality and a personal touch? Do you desire a modern home that is as individual as you are? Design your KNX sensor with the ABB-tacteo® configurator, completely as you like. The number of functions is variable and can be determined according to your specific needs and wishes. Individually configured as required, each sensor is unique in design and function.

### Product overview

You can find the complete product range online at [abb.com/tacteo](http://abb.com/tacteo)

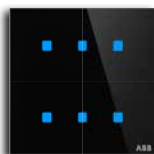

Six symbol control element

86 × 86



Four symbol control element with room temperature control

86 × 157



Room outside sensor with card reader

86 × 115



Motion detector Watch dog 180°

86 × 115



Room outside sensor with card reader and room number

86 × 157



ABB-tacteo® KNX combines maximum functionality with a personal atmosphere. For first-class hotels, residential buildings and public buildings with the highest standards of design.

## Advantages for you at a glance



### Configurator and simple ordering process

Design your KNX sensors exactly as you want them. You determine the design and functions, you can define icons and texts and also select the colours of the housing and buttons – completely in keeping with the established colour control concept. As soon as the configuration is completed and the finished sensors are saved, you will receive an individual design ID. All of your project sensors, including ID, are added to a parts list. This list allows the wholesaler to produce your personal sensors. Thanks to the design ID, the unique sensors can be retrieved and ordered again at a later date. The configurator can be found at:

tacteo-configurator.  
my.abb-livingspace.com



### Hotel access control

The ABB-tacteo® KNX range offers secure access control for the hotel and hospitality industry. The sensor performs all the management tasks of a hotel operation, which can be controlled from a central point.



### Flat and theft-proof

The frameless and extra-flat KNX sensor sits almost flush with the wall and blends harmoniously into any wall design. Peace of mind is provided by the optional removal guard, which protects the KNX sensor from theft.



### Intuitive operation

The capacitive KNX glass sensors react without any touch or contact. When moving your hand towards the sensor, the status lighting switches on automatically. On the other hand, touching the sensor with the entire palm of your hand triggers a preprogrammed function. With a tap of the finger the desired function can be activated.

## Smarter Solutions for Home and Building Automation

### ABB i-bus® KNX – Power Supply



SV/S 30.160.1.1

#### Power Supply Standard, 160 mA, MDRC

KNX power supplies generate and monitor the KNX system voltage (SELV). The bus line is decoupled from the power supply by an integrated choke.

The voltage output is short-circuit and overload protected.

The two-colour LED indicates device output status. With two-coloured status indicator and wide range input from 85...265 V AC, 50/60 Hz.

Description	Mod. width	Order details		Price 1 piece	Weight 1 piece	Pack unit
		Type code	Order code	€	kg	pc.
	4	SV/S 30.160.1.1	2CDG110144R0011		0.30	1



SV/S 30.320.1.1

#### Power Supply Standard, 320 mA, MDRC

KNX power supplies generate and monitor the KNX system voltage (SELV). The bus line is decoupled from the power supply by an integrated choke.

The voltage output is short-circuit and overload protected.

The two-colour LED indicates device output status.

With two-coloured status indicator and wide range input from 85...265 V AC, 50/60 Hz.

Description	Mod. width	Order details		Price 1 piece	Weight 1 piece	Pack unit
		Type code	Order code	€	kg	pc.
	4	SV/S 30.320.1.1	2CDG110166R0011		0.30	1



SV/S 30.640.3.1

#### Power Supply Standard, 640 mA, MDRC

KNX power supplies generate and monitor the KNX system voltage (SELV). The bus line is decoupled from the power supply by an integrated choke. The voltage output is short-circuit and overload protected.

The two-colour LED indicates device output status.

Device type SV/S 30.640.3.1 has an additional 30 V DC short-circuit and overload protected voltage output that can be used to power an additional bus line (in combination with a separate choke).

With two-coloured status indicator and wide range input from 85...265 V AC, 50/60 Hz.

Description	Mod. width	Order details		Price 1 piece	Weight 1 piece	Pack unit
		Type code	Order code	€	kg	pc.
	4	SV/S 30.640.3.1	2CDG110167R0011		0.30	1

## Smarter Solutions for Home and Building Automation

### ABB i-bus® KNX – Power Supply



SV/S 30.320.2.1

#### Power Supply with Diagnostics, 320 mA, MDRC

Compact Power Supply with integrated choke. Quick diagnostics by LED display and ETS communication objects. Analysis of the operating state and the bus line possible by means of ABB i-bus® Tool.

Description	Mod. width	Order details		Price 1 piece	Weight 1 piece	Pack unit
		Type code	Order code	€	kg	pc.
	4	SV/S 30.320.2.1	2CDG110145R0011		0.26	1



SV/S 30.640.5.1

#### Power Supply with Diagnostics, 640 mA, MDRC

Compact Power Supply with integrated choke. Quick diagnostics by LED display and ETS communication objects. Analysis of the operating state and the bus line possible by means of ABB i-bus® Tool. Additional voltage output to supply an additional line in conjunction with an additional choke.

Description	Mod. width	Order details		Price 1 piece	Weight 1 piece	Pack unit
		Type code	Order code	€	kg	pc.
	4	SV/S 30.640.5.1	2CDG110146R0011		0.26	1



SU/S 30.640.1

#### Uninterruptible Power Supply, 640 mA, MDRC

Power supply with integrated choke for supplying a bus line from an uninterrupted supply. Quick diagnostics via LED display for operational readiness, fault and battery level as well as a floating contact for a fault signal indication. The accumulator module or up to 2 rechargeable batteries can be charged in normal operation by the voltage supply. The bus voltage is provided by the batteries in the event of a mains failure.

Description	Mod. width	Order details		Price 1 piece	Weight 1 piece	Pack unit
		Type code	Order code	€	kg	pc.
	8	SV/S 30.640.5.1	GHQ6310049R0111		0.55	1



AM/S 12.1

#### Battery Module, 12 V DC, MDRC

With lead-gel battery for use in uninterruptible power supply SU/S 30.640.1 and for maintaining the bus voltage during a mains failure for 10 minutes (at full load). Connection is made via 4-core standard cable.

Description	Mod. width	Order details		Price 1 piece	Weight 1 piece	Pack unit
		Type code	Order code	€	kg	pc.
	8	AM/S 12.1	GHQ6310062R0111		0.81	1

## Smarter Solutions for Home and Building Automation

### ABB i-bus® KNX – System Infrastructure and Interfacing



LK/S 4.2

#### Line Coupler, MDRC

The line coupler is used in larger installations to connect KNX lines or areas. The lines or areas are galvanically isolated from one another. Telegrams can be filtered to simultaneously reduce the telegram traffic between lines or areas. With ETS 4 (V4.1.2 and higher) the complete group address range of the main groups 0...31 can be filtered. Within a line, the LK/S 4.2 can also be used as a line amplifier (repeater).

Description	Mod. width	Order details		Price	Weight	Pack
		Type code	Order code	1 piece	1 piece	unit
				€	kg	pc.
	2	LK/S 4.2	2CDG110171R0011		0.1	1



IPR/S 3.1.1

#### IP Router, MDRC

Connects the KNX bus with the Ethernet network. The device uses the KNXnet/IP protocol for communication (Routing and Tunneling). It can be used as a fast line and area coupler. The full filter table for main groups 0-31 is supported. KNX devices can be programmed via the LAN using ETS. For this and further clients 5 Tunneling Servers are available. The IP address can be fixed or can be received from a DHCP server. Power supply via 12...30 V DC or PoE (IEEE 802.3af class 1). The KNX Standard Communication (Multicast) can be switched off. In this case, up to 10 IPR/S 3.1.1 can communicate using unicast communication.

Description	Mod. width	Order details		Price	Weight	Pack
		Type code	Order code	1 piece	1 piece	unit
				€	kg	pc.
	2	IPR/S 3.1.1	2CDG110175R0011		0.11	1



IPR/S 3.5.1

#### IP Router Secure, MDRC

**NEW**

Connects the KNX bus with the Ethernet network and encrypts communication on the IP backbone. The device uses the KNXnet/IP Secure protocol for communication (Routing and Tunneling). It can be used as a fast line and area coupler. The full filter table for main groups 0-31 is supported. KNX devices can be programmed via the LAN using ETS. For this and further clients 5 Secure Tunneling Servers are available. The IP address can be fixed or can be received from a DHCP server. Power supply via 12...30 V DC or PoE (IEEE 802.3af class 1). The KNX Standard Communication (Multicast) can be switched off. In this case, up to 10 IPR/S 3.5.1 can communicate using unicast communication.

Available January 2019

Description	Mod. width	Order details		Price	Weight	Pack
		Type code	Order code	1 piece	1 piece	unit
				€	kg	pc.
	2	IPR/S 3.5.1	2CDG110176R0011		0.11	1

## Smarter Solutions for Home and Building Automation

### ABB i-bus® KNX – System Infrastructure and Interfacing



IPS/S 3.1.1

#### IP Interface, MDRC

Connects the KNX bus with the Ethernet network. The device uses the KNXnet/IP protocol for communication (Tunneling). KNX devices can be programmed via the LAN using ETS. For this and further clients 5 Tunneling Servers are available. The IP address can be fixed or can be received from a DHCP server. Power supply via 12..30 V DC or PoE (IEEE 802.3af class 1).

Description	Mod. width	Order details		Price 1 piece	Weight 1 piece	Pack unit
		Type code	Order code	€	kg	pc.
	2	IPS/S 3.1.1	2CDG110177R0011		0.11	1



8186/03-500

#### IP Patch Panel PoE, MDRC

For the setup of small and medium-sized network installations. For the power supply of up to 3 terminal devices such as IP telephone or IP webcams direct via the network cable. For all PoE applications of class 0 to 3, such as IP telephone, IP cameras, WLAN access points or PoE switches. External power supply via 8186/04 necessary.

Description	Mod. width	Order details		Price 1 piece	Weight 1 piece	Pack unit
		Type code	Order code	€	kg	pc.
	6	8186/03-500	2CKA008100A0344		0.28	1



8186/04-500

#### IP Power Supply PoE

For the setup of small and medium-sized network installations. For the power supply of patch panel PoE 3gang 8186/03. Nominal voltage: 100 – 240 V.

Description	Mod. width	Order details		Price 1 piece	Weight 1 piece	Pack unit
		Type code	Order code	€	kg	pc.
	6	8186/04-500	2CKA008100A0346			1

## Smarter Solutions for Home and Building Automation

### ABB i-bus® KNX – System Infrastructure and Interfacing



BE/S 8.230.2.1

#### Binary Inputs, 10 – 230 V AC/DC, MDRC

Detects AC/DC signals in the voltage range from 12...230 V. The state of the input is displayed via yellow LEDs. The binary inputs enable detection of independent input signals. The devices feature a manual operation push button for each channel. The devices are powered via the ABB i-bus® and do not require an additional power supply.

Description	Mod. width	Order details		Price 1 piece	Weight 1 piece	Pack unit
		Type code	Order code			
4-fold	2	BE/S 4.230.2.1	2CDG110091R0011	€	kg	pc.
8-fold	4	BE/S 8.230.2.1	2CDG110093R0011		0.12	1
					0.23	1



BE/S 4.20.2.1

#### Binary Inputs, Contact Scanning, MDRC

Scans floating contacts with internally generated scanning voltage. The state of the input is displayed via yellow LEDs. The binary inputs enable detection of independent input signals. The devices feature a manual operation push button for each channel. The devices are powered via the ABB i-bus® and do not require an additional power supply.

Description	Mod. width	Order details		Price 1 piece	Weight 1 piece	Pack unit
		Type code	Order code			
4-fold	2	BE/S 4.20.2.1	2CDG110090R0011	€	kg	pc.
8-fold	4	BE/S 8.20.2.1	2CDG110092R0011		0.12	1
					0.23	1

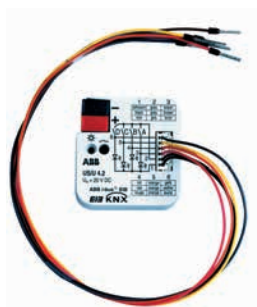

US/U 4.2

#### Universal Interface, FM

The universal interface has 2, 4 or 12 channels which can be parametrised as inputs or outputs with the ETS software. Conventional push-buttons, auxiliary contacts, LEDs and the electronic relay ER/U can be connected. The connecting cables can be extended up to 10 m. The contact scanning voltage and the supply voltage for the LEDs are made available by the device, the series resistors for the LEDs are integrated.

Description	Mod. width	Order details		Price 1 piece	Weight 1 piece	Pack unit
		Type code	Order code			
2-fold	–	US/U 2.2	GHQ6310074R0111	€	kg	pc.
4-fold	–	US/U 4.2	GHQ6310070R0111		0.06	1
12-fold	–	US/U 12.2	2CDG110065R0011		0.06	1

## Smarter Solutions for Home and Building Automation

### ABB i-bus® KNX – Outputs



SA/S 8.6.1.1

#### Switch Actuator, 6 A, MDRC

Using floating contacts it switches 4, 8 or 12 independent electrical loads. The 6 A-AC3 devices are suited for switching resistive, inductive and capacitive loads. Please note: Increased module width compared to previous generation.

Description	Mod. width	Order details		Price 1 piece	Weight 1 piece	Pack unit
		Type code	Order code			
4-fold	4	SA/S 4.6.1.1	2CDG110152R0011		0.18	1
8-fold	6	SA/S 8.6.1.1	2CDG110153R0011		0.27	1
12-fold	8	SA/S 12.6.1.1	2CDG110154R0011		0.35	1



SA/S 8.6.2.1

#### Switch Actuator with manual Operation, 6 A, MDRC

Switches 2, 4, 8 and 12 independent electrical loads using floating contacts. Every output can be operated manually and features display of the switching state. The 6 A-AC3 devices are suited for switching resistive, inductive and capacitive loads.

Description	Mod. width	Order details		Price 1 piece	Weight 1 piece	Pack unit
		Type code	Order code			
2-fold	2	SA/S 2.6.2.1	2CDG110180R0011		0.18	1
4-fold	4	SA/S 4.6.2.1	2CDG110181R0011		0.29	1
8-fold	8	SA/S 8.6.2.1	2CDG110182R0011		0.51	1
12-fold	12	SA/S 12.6.2.1	2CDG110183R0011		0.74	1



SA/S 4.10.2.1

#### Switch Actuator, 10 AX, MDRC

Switches 2, 4, 8 and 12 independent electrical loads using floating contacts. Every output can be operated manually and features display of the switching state. The 10AX-AC1 devices are especially suited for switching resistive, inductive and capacitive loads such as fluorescent lighting (AX) compliant to EN 60669.

Description	Mod. width	Order details		Price 1 piece	Weight 1 piece	Pack unit
		Type code	Order code			
2-fold	2	SA/S 2.10.2.1	2CDG110155R0011		0.18	1
4-fold	4	SA/S 4.10.2.1	2CDG110156R0011		0.29	1
8-fold	8	SA/S 8.10.2.1	2CDG110157R0011		0.51	1
12-fold	12	SA/S 12.10.2.1	2CDG110158R0011		0.74	1

## Smarter Solutions for Home and Building Automation

### ABB i-bus® KNX – Lighting Control – DALI



DG/S 1.64.1.1

#### DALI-Gateway, Basic, 1-fold, MDRC

The device is used to interface between DALI and KNX installations and incorporates the DALI power supply. One DALI output for up to 64 DALI Slaves. Control and status feedback is carried out via KNX per DALI slave (64), with lighting groups (16), together in broadcast or per scenes (16). Extensive fault and error messages are available. Self-contained emergency converter (64) acc. EN 62386-202 will be supported. By means of KNX and emergency converter, different emergency tests (e.g. function and duration test) can be triggered. Feedback is sent. Slave-, staircase-, force-, block- and scene- function are integrated. DALI telegram rate can change. For diagnostic use and individual change of the DALI address or group assignment a separate ABB i-bus® Tool is available.

Description	Mod. width	Order details		Price	Weight	Pack
		Type code	Order code	1 piece	1 piece	unit
				€	kg	pc.
	4	DG/S 1.64.1.1	2CDG110198R0011		0.133	1



DG/S 2.64.1.1

#### DALI-Gateway, Basic, 2-fold, MDRC

The device is used to interface between DALI and KNX installations and incorporates the DALI power supply. Two DALI output for up to 2 x 64 DALI Slaves. Control and status feedback is carried out via KNX per DALI slave (2 x 64), with lighting groups (2 x 16), together in two broadcasts or per scenes (2 x 16). Extensive fault and error messages are available. Self-contained emergency converter (2 x 64) acc. EN 62386-202 will be supported. By means of KNX and emergency converter, different emergency tests (e.g. function and duration test) can be triggered. Feedback is sent. Slave-, staircase-, force-, block- and scene- function are integrated. DALI telegram rate can change. For diagnostic use and individual change of the DALI address or group assignment a separate ABB i-bus® Tool is available.

Description	Mod. width	Order details		Price	Weight	Pack
		Type code	Order code	1 piece	1 piece	unit
				€	kg	pc.
	4	DG/S 2.64.1.1	2CDG110199R0011		0.15	1



DG/S 8.1

#### DALI Gateway, 8-fold, MDRC

For controlling up to 128 DALI devices. There are 8 separate, independent DALI outputs/channels available. Up to 16 DALI devices can be connected per channel. The DALI power supply is integrated in the gateway. The functions of switching, dimming, set values and fault indication for lamps and electronic ballasts are available for each output. It is possible to set the lamp burn-in time and 16 light scenes. Commissioning is simplified as no addressing or commissioning of the DALI devices is necessary.

Description	Mod. width	Order details		Price	Weight	Pack
		Type code	Order code	1 piece	1 piece	unit
				€	kg	pc.
	6	DG/S 8.1	2CDG110025R0011		0.31	1

## Smarter Solutions for Home and Building Automation

### ABB i-bus® KNX – Lighting Control



UD/S 4.210.2.1

#### LED Dimmer, 4-fold, 210 W/VA, MDRC

NEW

Multichannel universal dimming actuator optimized for dimming of retrofit LED lamps (LEDi). Also suitable for dimming of incandescent lamps, low-voltage halogen lamps with conventional or electronic transformers, 230 V incandescent halogen lamps and dimmable halogen energy-saving lamps. Automatic load detection (deactivatable). One separate N-terminal per channel. Channel bridging possible in order to increase the maximum load. Outputs can be switched in parallel as required. Minimum load: 2 W. Manual operation on the device is possible also without bus voltage or in unprogrammed state. One LED control button per channel (including status indication) for ON and OFF switching as well as for up and down dimming. Programming of the device is possible without connecting 230 V supply voltage. Comprehensive test and diagnostic functions via the i-bus® Tool. Fast parameterization in the ETS by means of copyable channel templates. With integrated bus coupler.

Rated power at 230 V ~:

- 230 V ~ incandescent and halogen lamps: 4 x 210 W/VA to 1 x 600 W/VA.
  - Dimmable 230 V ~ LEDi: 4 x 210 W/VA to 1 x 600 W/VA in trailing edge mode, 4 x 80 W/VA to 1 x 200 W/VA in leading edge mode.
  - Inductive L-transformers with LED/low-voltage halogen lamps: 4 x 210 W/VA to 1 x 600 W/VA.
  - Electronic C-transformers with LED/low voltage halogen lamps: 4 x 210 W/VA to 1 x 600 W/VA.
  - Electronic LC transformers with LED/low-voltage halogen lamps: 4 x 80 W/VA to 1 x 200 W/VA.
- Recommendation: Always use bulbs of one type and manufacturer.

Description	Mod. width	Order details		Price 1 piece	Weight 1 piece	Pack unit
		Type code	Order code			
4-fold	6	UD/S 4.210.2.1	2CKA006197A0047			1



UD/S 6.210.2.1

#### LED Dimmer, 6-fold, 210 W/VA, MDRC

NEW

Multichannel universal dimming actuator optimized for dimming of retrofit LED lamps (LEDi). Also suitable for dimming of incandescent lamps, low-voltage halogen lamps with conventional or electronic transformers, 230 V incandescent halogen lamps and dimmable halogen energy-saving lamps. Automatic load detection (deactivatable). One separate N-terminal per channel. Channel bridging possible in order to increase the maximum load. Outputs can be switched in parallel as required. Minimum load: 2 W. Manual operation on the device is possible also without bus voltage or in unprogrammed state. One LED control button per channel (including status indication) for ON and OFF switching as well as for up and down dimming. Programming of the device is possible without connecting 230 V supply voltage. Comprehensive test and diagnostic functions via the i-bus® Tool. Fast parameterization in the ETS by means of copyable channel templates. With integrated bus coupler.

Rated power at 230 V ~:

- 230 V ~ incandescent and halogen lamps: 6 x 210 W/VA to 1 x 800 W/VA.
  - Dimmable 230 V ~ LEDi: 6 x 210 W/VA to 1 x 800 W/VA in trailing edge mode, 6 x 80 W/VA to 1 x 240 W/VA in leading edge mode.
  - Inductive L-transformers with LED/low-voltage halogen lamps: 6 x 210 W/VA to 1 x 800 W/VA.
  - Electronic C-transformers with LED/low voltage halogen lamps: 6 x 210 W/VA to 1 x 800 W/VA.
  - Electronic LC transformers with LED/low-voltage halogen lamps: 6 x 80 W/VA to 1 x 240 W/VA.
- Recommendation: Always use bulbs of one type and manufacturer.

Description	Mod. width	Order details		Price 1 piece	Weight 1 piece	Pack unit
		Type code	Order code			
6-fold	8	UD/S 6.210.2.1	2CKA006197A0049			1

# Maximum protection, maximum communication

Wireless and with the highest quality standards.

ABB-secure@home is a security system design by ABB to ensure maximum protection to people and buildings. The alarm system signals every danger as intrusions, water leak (flooding) and a fire principle. Communication between central unit and devices is wireless based on radio frequency signal, in compliance with European standards EN50131 with a Grade2.



## Reliability

ABB-secure@home wireless communication operates at 868.3MHz. It is a frequency band regulated by European norms (ERCREC-70-3E) much less crowded than the traditional one of 434MHz, with a power of 25mW and considered as privileged. In addition the components are ETSI-RED (Radio Equipment Directive) 2014/53/EU compliant. The alarm system uses an ABB owner communication protocol, optimized to the best ratio distance over energy consumption and it is classified as long range wireless communication, since it supports an alarm system up to 300m in free field. The bidirectional transmission let know the status of each single component, because the sensor receives instructions from the central unit and sends back messages when the action is accomplished.



## Security

ABB-secure@home counts on a digital encrypted communication with 128 bits and it is supplied with a 65k rolling code remote control which creates unique code each time a command is sent to prevent it from being maliciously copied and replicated. Moreover the bidirectional communication let the central unit know the state of each controlled device, as battery charge state, state of functioning and if any infringement has been done. The multiple access (CSMA) transmission system, avoid interferences, disturbances and signal collisions.



- **Bidirectional**
- **Simplified commissioning**
- **Distance up to 300m**
- **128 Bit Proprietary protocol and encryption plus a unique 65k rolling code for all arming/disarming control**
- **CSMA transmission**



**Different wireless choices for ABB-free@home and ABB-secure@home**

ABB-secure@home and ABB-free@home are different systems, the first one aims at security, the second one at home automation. ABB-free@home is based on a 2.4 GHz proprietary protocol meshed network frequency with an encryption of 128bits. This frequency gives the advantage of a globally approved band, but some potential interferences such as WIFI router, microwaves, fluorescent lamps could occur. ABB-free@home wireless system solves these issues by using a meshed network, which allows to leverage on all the devices to repeat the signal, overcoming the attenuation and interference effects mentioned above.

ABB-secure@home has privileged the choice of an approved frequency in a lower band to maximize security; this choice allows one of the best performances in terms of signal propagation and, at the same time, to be able to communicate directly with every device to better ensure security and data protection with rolling codes and supervision checks. Each ABB-secure@home device communicates bidirectionally with the central unit. If needed, the repeater can repeat the signal and extend the communication distance.

**ABB-free@home**

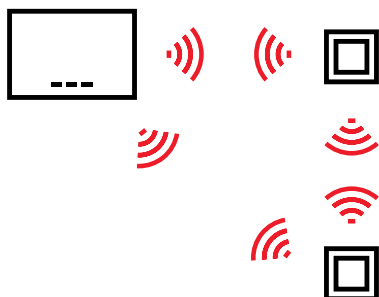

**ABB-secure@home**



ABB-secure@home wireless communication, thanks to its characteristics, can be defined secure and reliable, since it has been designed to avoid any interference, fraudulent communication issues, and to monitor the entire system status, ensuring its proper functioning.

---

# Furse - Earthing, lightning and surge protection

<b>287</b>	<b>Introduction</b>
<b>288</b>	<b>Conductors</b>
<b>291</b>	<b>Earth bonds and clamps</b>
<b>293</b>	<b>Earth electrodes</b>
<b>295</b>	<b>Earth bars</b>
<b>297</b>	<b>Electronic systems protection - Surge Protective Devices (SPDs)</b>

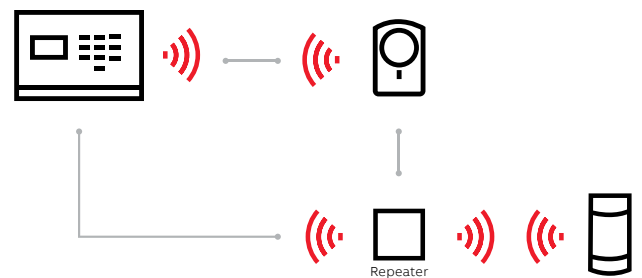

---

For more detailed product information, please refer to our online technical brochures available at: [new.abb.com/low-voltage/support/documentation](http://new.abb.com/low-voltage/support/documentation)

or contact our sales team via email [LV.enquiries@gb.abb.com](mailto:LV.enquiries@gb.abb.com)

or call 0333 999 9933

# Introduction

## Lightning protection standard IEC/BS EN 62305

Within the field of lightning protection, developing a thorough understanding of IEC/BS EN 62305 is fundamental to ensure the design and implementation of safe systems against risk from lightning.

—  
\* We hope you find this guide useful and should you require assistance or advice, please do not hesitate to contact ABB.

This guide has been developed therefore to improve understanding of lightning protection and to help industry professionals, including M&E engineers, lightning protection designers and contractors, to navigate through the principles of IEC/BS EN 62305 in a practical and pragmatic manner, considering the diverse and often complicated recommendations therein.

In conjunction with our other Furse technical material, such as CPD accredited seminars and risk assessment software, this guide is presented with the following aims:

- To briefly explain the theory and phenomenon of lightning
- To précis, and simplify where possible the four parts of IEC/BS EN 62305
- To provide an introduction to the transient overvoltage protection requirements defined within IEC60364 / BS 7671
- To outline the importance of lightning protection component performance to IEC 62561, which follows on from former product standard, BS EN 50164

All standards are open to individual interpretation. This guide therefore reflects Furse's own views on good practice and it is not the intention that these views replace, in any way, the recommendations contained in the IEC/BS EN 62305 series, but rather to be read in conjunction with the standard.

### Development of the lightning protection standard

The International Electrotechnical Commission (IEC) is the body responsible for the recommendations and maintenance of IEC 62305, through its technical committee, TC 81. This committee includes many member countries including the UK. Additionally, the UK, as part of the European Union, is one of the 28 countries with membership of CEN (Comité Européen de Normalisation), which focuses on ensuring harmonisation of design and application standards throughout its member states.

**The electrical arm of CEN is CENELEC (CLC)**, and it is this committee which is responsible for compiling and producing standards relevant to lightning protection. In 2006, a four-part suite of standards on lightning protection was compiled by CENELEC under the reference number 62305 series.

The UK's **British Standards Institution (BSI)** adopted this CENELEC standard as its own British Standard (with minor amendments), and introduced BS EN 62305 in August 2006. A second edition of each of the four parts of BS EN 62305 was introduced in 2011/2012.

British Standard, BS EN 62305, is a national standard developed from the international standard, IEC 62305 in agreement with TC/81 and CENELEC. This approach has been followed by many other countries worldwide, which have introduced their own national standards, and therefore the content of this guide shall be equally of interest to those working in the lightning protection industry in those countries.

### Scope of IEC/BS EN 62305

IEC/BS EN 62305 considers lightning protection in much greater depth and detail than historic standards, such as BS 6651. Additionally, in two key areas, Part 2: Risk management and Part 4: Electrical and electronic systems within structures, it is radically different:

- **Part 2:** presents risk management in much greater detail and complexity and defines a single risk assessment process for protection against physical damage to structures, life hazard, and protection of electronic systems
- **Part 4:** is now a key part of the core IEC/BS EN 62305 standard with implementation driven by Part 2

## Conductors

Bare conductors, hard drawn and tinned conductors

### Bare copper tape

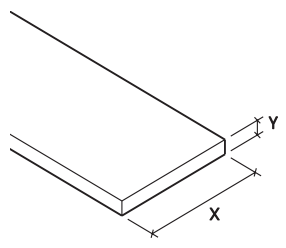
	Order Code	Conductor size (X x Y) (mm)	Order Code	Conductor size (X x Y) (mm)
 	TC005	12.5 x 1.5	TC045	31 x 3
	TC010	12.5 x 3	TC048	31.5 x 4
	TC015	20 x 1.5	TC050	31 x 6
	TC020	20 x 3	TC055	38 x 3
	TC020/100	20 x 3	TC060-FU	38 x 5
	TC025	25 x 1.5	TC065	38 x 6
	TC026	25 x 2	TC067	40 x 3
	TC030	25 x 3	TC066	40 x 4
	TC030/50	25 x 3	TC071	40 x 5
	TC030-UL	1" x 1/8"	TC068	40 x 6
	TC035	25 x 4	TC069	40 x 6.3
	TC040	25 x 6	TC070	50 x 3
	TC040-UL	1" x 1/4"	TC075	50 x 4
	TC039	30 x 2	TC078	50 x 5
	TC042	30 x 3	TC080	50 x 6
	TC044	30 x 4	TC082	50 x 6.3
	TC043	30 x 5	TC090	50 x 7

### Bare aluminium tape

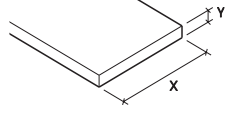
	Order Code	Conductor size (X x Y) (mm)
 	TA005	12.5 x 1.5
	TA020	20 x 3
	TA030	25 x 3
	TA042	30 x 3
	TA040	25 x 6
	TA068	40 x 6
	TA080	50 x 6

### Hard drawn copper bar

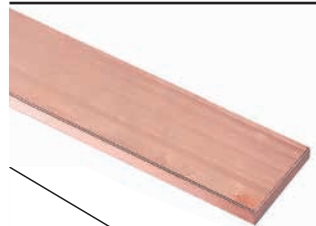
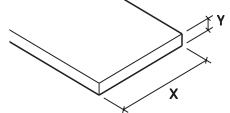
	Order Code	Overall nominal size (X x Y) (mm)
 	BA205	25 x 3
	BA210	25 x 6
	BA225	38 x 6
	BA230	50 x 6
	BA235	50 x 10
	BA240	75 x 6
	BA250-FU	100 x 6

### Bare stranded copper cable

	Order Code	Cross sectional area (mm <sup>2</sup> )
	CB006	6
	CB016	16
	CB025	25
	CB035	35
	CB050-FU	50
	CB070	70
	CB095	95
	CB120	120
	CB150-FU	150
	CB185	185
	CB240	240
	CB300-FU	300
	CB400-FU	400

Tinned soft drawn stranded copper cable	Order Code	Cross sectional area (mm <sup>2</sup> )
	CB070-T	70

Hard drawn stranded copper cable	Order Code	Cross sectional area (mm <sup>2</sup> )
	CB071	70

## Conductors

### PVC and LSOH covered conductors

#### PVC covered copper tape

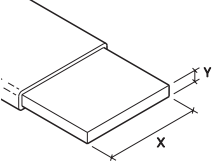
	Order Code	Conductor size (X x Y) (mm)	Colour range
 	TC100	12.5 x 1.5	Black
	TC105-FU	25 x 3	Black
	TC110	25 x 3	Green
	TC115-FU	25 x 3	Grey
	TC120-FU	25 x 3	Stone
	TC125-FU	25 x 3	White
	TC130-FU	25 x 3	Brown
	TC140-FU	25 x 6	Green
	TC145	50 x 6	Green

#### Green & yellow PVC insulated copper tape

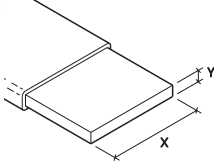
	Order Code	Conductor size (X x Y) (mm)
 	TC111-FU	25 x 3

#### PVC covered aluminium tape

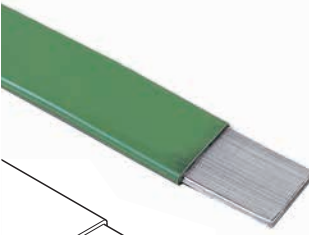
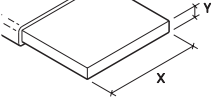
	Order Code	Conductor size (X x Y) (mm)	Colour range
 	TC100	12.5 x 1.5	Black
	TA104	20 x 3	Black
	TA105	25 x 3	Black
	TA110	25 x 3	Green
	TA115	25 x 3	Grey
	TA120	25 x 3	Stone
	TA125	25 x 3	White
	TA130	25 x 3	Brown

#### Green & yellow PVC insulated stranded copper cable

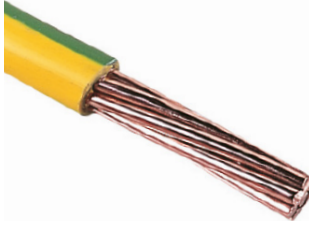
	Order Code	Cross-sectional area (mm <sup>2</sup> )
	CC016	16
	CC025	25
	CC035	35
	CC050	50
	CC070	70
	CC095	95
	CC120-FU	120
	CC150-FU	150
	CC185	185
	CC240	240
	CC300	300
	CC400-FU	400

#### LSOH covered copper tape

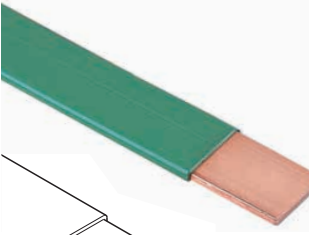
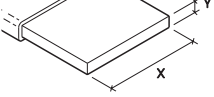
	Order Code	Conductor size (X x Y) (mm)	Colour range
 	TC910	25 x 3	Green
	TC940	25 x 6	Green
	TC980	50 x 6	Green

## Conductor network

### Conductor clips

#### Metallic tape clip

	Order Code	Conductor size (mm)
	<b>For use with bare copper</b>	
	CP210	25 x 3-4
	CP220	25 x 5-6
	<b>For use with bare aluminium</b>	
	CP110	25 x 3-4
	CP120-H	25 x 6

#### Tape clip

	Order Code	Conductor size (mm)
	<b>For use with bare copper</b>	
	CP510	20 x 3
	CP515	25 x 3
	<b>For use with bare aluminium</b>	
	CP405	20 x 3
	CP410	25 x 3
	CP415	25 x 6
<b>For use with PVC covered tape</b>		
	CP517	25 x 3

#### Metallic tape clip

	Order Code	Conductor size (mm)
	<b>For use with bare copper</b>	
	CP230	30-32 x 3-4
	CP240	38-40 x 3-4
	CP260	50 x 5-6-5

#### Non-metallic tape clip

	Order Code	Conductor size (mm)	Colour
	<b>For use with bare tape</b>		
	CP005	20 x 3	Brown
	CP010	20 x 3	Grey
	CP015	25 x 3	Brown
	CP020	25 x 3	Grey
	CP060*	38 x 5	Brown
	CP065*	50 x 6	Brown
	<b>For use with PVC covered tape</b>		
	CP025	25 x 3	Brown
	CP030	25 x 3	Black
CP035	25 x 3	Green	
CP040	25 x 3	Grey	
CP045	25 x 3	Stone	
CP050	25 x 3	White	

#### Metallic tape clip

	Order Code	Conductor size (mm)
	<b>For use with bare copper</b>	
	CP205	20 x 3
	CP216	25 x 4
	CP227	30 x 5
	CP245	38-40 x 5-6-5
	CP241	40 x 4
	CP256	50 x 4
	<b>For use with PVC covered copper</b>	
	CP215	25 x 3-4
	CP225	25 x 6
	CP265	50 x 6
	CP256	50 x 4
	<b>For use with lead covered copper</b>	
	CP305	25 x 3
	<b>For use with bare aluminium</b>	
CP105	20 x 3	
CP125	50 x 6	
<b>For use with PVC covered aluminium</b>		
CP115	25 x 3	
CP130	50 x 6	

\* Not as illustrated (drawing available on request)

## Conductor network

### Conductor clamps

#### Square tape clamp

	Order Code	Conductor size (mm)	Conductor material
	CT105-H	25 x 3	Copper
	CT110-H	25 x 6	Copper
	CT115-H	50 x 6	Copper
	CT005-H	25 x 3	Aluminium
	CT010*	25 x 6	Aluminium

\* Not as illustrated (drawing available on request)

#### Crossover tape clamp

	Order Code	Conductor size (mm)	Conductor material
	CX105-H	25 x 3	Copper
	CX005-H	25 x 3	Aluminium

#### Cable to tape square clamp

	Order Code	Conductor size	Conductor material
	CT125	25 x 3mm to 50mm <sup>2</sup>	Copper
	CT130	25 x 3mm to 70mm <sup>2</sup>	Copper
	CT135	25 x 3mm to 95mm <sup>2</sup>	Copper

#### Test/ Junction clamp

	Order Code	Max. conductor (mm)	Conductor material
	CN105-H	26 x 8	Copper
	CN005*	26 x 8	Aluminium

\* Not as illustrated (drawing available on request)

## Earth bonds and clamps

### Mechanical clamps

#### Rod to tape clamp (type A)

	Order Code	Nominal rod diameter		Max. conductor (mm)
		(in.)	(mm)	
	CR105	Ø 1/2	Ø 12.7	26 x 12
	CR105	Ø 5/8	Ø 16	26 x 12
	CR105	Ø 3/4	Ø 20	26 x 10
	CR108	Ø 5/8	Ø 16	30 x 2
	CR108	Ø 3/4	Ø 20	30 x 2
	CR110	Ø 5/8	Ø 16	40 x 12
	CR115	Ø 5/8	Ø 16	51 x 8
	CR125	Ø 3/4	Ø 20	51 x 12
	CR130	Ø 1/2	Ø 12.7	26 x 20
	CR130	Ø 5/8	Ø 16	26 x 18
	CR130	Ø 3/4	Ø 20	26 x 10
	CR130	Ø 1	Ø 25	26 x 10

#### Rod to tape clamp (type G)

	Order Code	Nominal rod diameter		Conductor range (mm <sup>2</sup> )
		(in.)	(mm)	
	CR505	Ø 3/8	Ø 9.5	6-35
	CR510-FU	Ø 1/2	Ø 12.7	16-50
	G5	Ø 5/8	Ø 16	5.2-33.6
	CR515	Ø 5/8	Ø 16	16-70
	G6	Ø 3/4	Ø 20	5.2-33.6
	CR520	Ø 3/4	Ø 20	35-95
	CR525	Ø 1	Ø 25	70-150

## Earth bonds and clamps

### Mechanical clamps

#### Rod to tape clamp (type B)

	Order Code	Nominal rod diameter		Rod type
		(in.)	(mm)	
	CR205	Ø 3/8	Ø 9.5	Copperbond
	CR215	Ø 5/8	Ø 16	Copperbond
	CR220	Ø 5/8	Ø 15	Solid copper
	CR225	Ø 3/4	Ø 20	Copperbond
	CR230	Ø 3/4	Ø 20	Solid copper

#### 'U' bolt rod clamp (type E)

	Order Code	Nominal rod / rebar diameter		Hole centres (mm)
		(in.)	(mm <sup>2</sup> )	
	CR305	Ø 5/8	Ø 16	37
	CR310	Ø 3/4	Ø 20	37
	CR315	Ø 1	Ø 25	37
	CR320*	Ø 5/8	Ø 16	37
	CR325	Ø 1 1/2	Ø 38	54
	CR330	Ø 2	Ø 50	64
	CR326	Ø 1 1/2	Ø 38	54

\* CR320 includes additional plate to allow tape to be clamped without drilling.

#### 'U' bolt rod clamp (type GUV)

	Order Code	Nominal rod / rebar diameter		Conductor range (mm <sup>2</sup> )
		(in.)	(mm)	
	CR700	Ø 5/8	Ø 16	16-95
	CR700	Ø 3/4	Ø 20	16-70
	CR705	Ø 5/8	Ø 16	70-185
	CR705	Ø 3/4	Ø 20	70-150
	CR730	Ø 5/8	Ø 16	150-300
	CR730	Ø 3/4	Ø 20	150-300
	CR710	Ø 1	Ø 25	16-70
	CR740	Ø 1	Ø 25	70-150
	CR750	Ø 1	Ø 25	150-300

#### B bond

	Order Code	Max tape width (mm)	Conductor material
	BN005	26	Aluminium
	BN113	31	Copper
	BN114	40	Copper

## Earth electrodes

### Earth rod and earth rod seal

#### Threaded copperbond earth rod



Order Code	Nominal diameter (in.)	Length (mm)
RB105	Ø 1/2	1200
RB110	Ø 1/2	1500
RB115	Ø 1/2	1800
RB125	Ø 1/2	2400
RB205-FU	Ø 5/8	1200
RB210	Ø 5/8	1500
RB215	Ø 5/8	1800
RB220-FU	Ø 5/8	2100
RB225	Ø 5/8	2400
RB235	Ø 5/8	3000
RB305	Ø 3/4	1200
RB310	Ø 3/4	1500
RB315	Ø 3/4	1800
RB320-FU	Ø 3/4	2100
RB325	Ø 3/4	2400
RB335	Ø 3/4	3000

#### Fittings

Order Code	Type (in.)
CG170	1/2 Coupling
CG270	5/8 Coupling
CG370	3/4 Coupling
ST100	1/2 Driving stud
ST200	5/8 Driving stud
ST300	3/4 Driving stud

#### Earth rod seal



Order Code	Type
<b>Earth rod seal assembly</b>	
ES300	Earth rod seal and membrane seal
<b>Earth rod seal pack</b>	
ES300-12	Seal pack for 1/2" (Ø 12.7 mm) Copperbond rod
ES300-58	Seal pack for 5/8" (Ø 14.2 mm) Copperbond rod
ES300-34	Seal pack for 3/4" (Ø 17.2 mm) Copperbond rod
ES300-15	Seal pack for Ø 15 mm solid copper rod
ES300-16	Seal pack for Ø 16 mm stainless steel rod
ES300-20	Seal pack for Ø 20 mm solid copper rod
<b>Earth rod seal tube</b>	
ES310-03	Seal tube, 300 mm length
ES310-05	Seal tube, 500 mm length
ES310-10	Seal tube, 1000 mm length
ES310-15	Seal tube, 1500 mm length
ES310-20	Seal tube, 2000 mm length
ES310-30	Seal tube, 3000 mm length
<b>Accessory spanner set</b>	
ES320	Membrane seal torque spanner set

## Earth electrodes

Inspection pits, plate, lattice, backfill materials

### FurseCEM® conductive aggregate

	Order Code	Description	Weight (kg)
	CM035	FurseCEM®	25kg
	CM040	FurseCEM® (supplied with cement)	25kg

### Bentonite moisture retaining clay

	Order Code	Description	Weight (kg)
	CM015	Bentonite powder	25kg
	CM020	Bentonite granules	25kg

### Lightweight inspection pit

	Order Code	Description
	PT205	Lightweight inspection pit with grey polymer lid
	PT309-FU	Lightweight inspection pit with black (unbranded) polymer lid
	PT110	Lightweight inspection pit with concrete lid
	PT004	5 hole earth bar
<b>Accessories for polymer lid</b>		
	AK005	6 mm Allen key
<b>Accessories for concrete lid</b>		
	JH100	M8 x 100 mm long mild steel 'J' bolt lifting hook
	AS100	M8 x 60 stainless steel Allen caphead screw (2 per lid)

### Concrete inspection pit

	Order Code	Description
	PT005	Concrete inspection pit
	<b>Accessories</b>	
	PT006	5 hole earth bar
	PT007	7 hole earth bar

### Earth plate (solid copper)

	Order Code	Size (mm)
	PE005	600 x 600 x 1.5
	PE015	900 x 900 x 1.5
	PE010	600 x 600 x 3
	PE020	900 x 900 x 3

### Earth mat (lattice copper)

	Order Code	Size (mm)
	PE110	600 x 600 x 3
	PE120	900 x 900 x 3
	PE101	300 x 300 x 3

## Earth bonds and clamps

### Earth bars

#### Earth bar

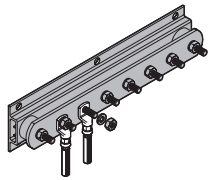

Order Code	Description	Length (mm)
<b>Copper earth bar</b>		
LK245-6	6 way	400
LK245-8	8 way	500
LK245-10	10 way	650
LK245-12	12 way	750
LK245-14	14 way	850
LK245-16	16 way	950
LK245-18	18 way	1050
LK245-20	20 way	1200
LK245-22	22 way	1300
LK245-24	24 way	1400
LK245-26	26 way	1500
LK245-28	28 way	1650
LK245-30	30 way	1750
<b>Tinned copper earth bar</b>		
LK245-6-T	6 way	400
LK245-8-T	8 way	500
LK245-10-T	10 way	650
LK245-12-T	12 way	750
LK245-14-T	14 way	850
LK245-16-T	16 way	950
LK245-18-T	18 way	1050
LK245-20-T	20 way	1200
LK245-22-T	22 way	1300
LK245-24-T	24 way	1400
LK245-26-T	26 way	1500
LK245-28-T	28 way	1650
LK245-30-T	30 way	1750

#### Earth bar with single disconnecting link

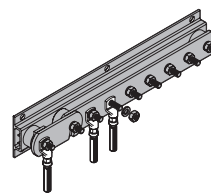

Order Code	Description	Length (mm)
<b>Copper earth bar</b>		
LK243-6	6 way	475
LK243-8	8 way	575
LK243-10	10 way	725
LK243-12	12 way	825
LK243-14	14 way	925
LK243-16	16 way	1025
LK243-18	18 way	1125
LK243-20	20 way	1275
LK243-22	22 way	1375
LK243-24	24 way	1475
LK243-26	26 way	1575
LK243-28	28 way	1725
LK243-30	30 way	1825
<b>Tinned copper earth bar</b>		
LK243-6-T	6 way	475
LK243-8-T	8 way	575
LK243-10-T	10 way	725
LK243-12-T	12 way	825
LK243-14-T	14 way	925
LK243-16-T	16 way	1025
LK243-18-T	18 way	1125
LK243-20-T	20 way	1275
LK243-22-T	22 way	1375
LK243-24-T	24 way	1475
LK243-26-T	26 way	1575
LK243-28-T	28 way	1725
LK243-30-T	30 way	1825

## Earth bonds and clamps

### Earth bars

#### Earth bar with twin disconnecting link

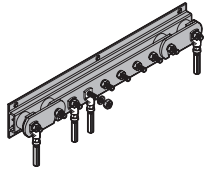

Order Code	Description	Length (mm)
<b>Copper earth bar</b>		
LK207-6	6 way	550
LK207-8	8 way	650
LK207-10	10 way	800
LK207-12	12 way	900
LK207-14	14 way	1000
LK207-16	16 way	1100
LK207-18	18 way	1200
LK207-20	20 way	1350
LK207-22	22 way	1450
LK207-24	24 way	1550
LK207-26	26 way	1650
LK207-28	28 way	1800
LK207-30	30 way	1900
<b>Tinned copper earth bar</b>		
LK207-6-T	6 way	550
LK207-8-T	8 way	650
LK207-10-T	10 way	800
LK207-12-T	12 way	900
LK207-14-T	14 way	1000
LK207-16-T	16 way	1100
LK207-18-T	18 way	1200
LK207-20-T	20 way	1350
LK207-22-T	22 way	1450
LK207-24-T	24 way	1550
LK207-26-T	26 way	1650
LK207-28-T	28 way	1800
LK207-30-T	30 way	1900

#### Earth bar accessories

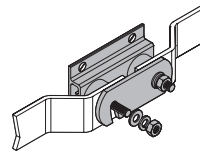



Order Code	Description
<b>Copper earth bar</b>	
LK004	Swan-neck link
LK205	Disconnecting link
<b>Tinned copper earth bar</b>	
LK004-T	Swan-neck link
LK205-T	Disconnecting link

## Electronic systems protection

### Surge protection devices (SPDs) for mains power supplies

#### Mains supplies - equipotential bonding

		Old part no.	NEW part no.	Comment	Description
 ESP 240/XXX    ESP 415/XXX		ESP 240/I/TNS	–	–	Enhanced Type 1+2 power SPD for Single Phase 240V TNS supplies, 50kA 10/350
		ESP 240/III/TNS	ESP 240T1/25/TNS	Also replaces MMP B275B/2/S	Enhanced Type 1+2 power SPD for Single Phase 240V TNS supplies, 25kA 10/350
		ESP 240 /I/TT	–	–	Enhanced Type 1+2 power SPD for Single Phase 240V TT supplies, 50kA 10/350
 ESP 240T1/XXX    ESP 415T1/XXX		ESP 240/III/TT	ESP 240T1/25/TT	Also replaces MMP B275B/1+1T/S	Enhanced Type 1+2 power SPD for Single Phase 240V TT supplies, 25kA 10/350
		ESP 415/I/TNS	ESP 415T1/25/TNS	Also replaces MMP B275B/4/S	Enhanced Type 1+2 power SPD for Three Phase 415V TNS supplies, 25kA 10/350
		ESP 415/III/TNS	ESP 415T1/12.5/TNS	Also replaces MMP 2B275A/4/S	Enhanced Type 1+2 power SPD for Three Phase 415V TNS supplies, 12.5kA 10/350
		ESP 415/I/TT	ESP 415T1/25/TT	Also replaces MMP B275B/3+1T/S	Enhanced Type 1+2 power SPD for Three Phase 415V TT supplies, 25kA 10/350
		ESP 415/III/TT	ESP 415T1/12.5/TT	Also replaces MMP 2B275A/3+1T/S	Enhanced Type 1+2 power SPD for Three Phase 415V TT supplies, 12.5kA 10/350

#### Mains supplies - DIN housing

Part no.	Description
ESP 240 D1	Enhanced Type 1+2+3 Full Mode power SPD for 240V Single Phase supplies, Din Rail mounted
ESP 415 D1	Enhanced Type 1+2+3 Full Mode power SPD for 415V 3 Phase supplies, Din Rail mounted
<b>Supplied with remote indication display</b>	
ESP 415 D1R	Enhanced Type 1+2+3 Full Mode power SPD for 3 Phase 415V supplies, LED status indication on remote display, Din Rail mounting
ESP RLA HD-4	4 Metre display lead for ESP D1R Series

#### Mains supplies (extra high maximum surge currents)

Part no.	Description
ESP 415 M2	Enhanced Type 1+2+3 Full Mode power SPD for 3 Phase 415V supplies, high surge current rating
ESP 415 M4	Enhanced Type 1+2+3 Full Mode power SPD for 3 Phase 415V supplies, very high surge current rating

#### Mains supplies & power distribution system

Part no.	Description
ESP 240 M1	Enhanced Type 1+2+3 power SPD for 240V Single Phase supplies
ESP 415 M1	Enhanced Type 1+2+3 power SPD for 415V 3 Phase supplies

## Electronic systems protection

### Surge protection devices (SPDs) for mains power supplies

#### Mains supplies - with remote display indication



Part no.	Description
ESP 415 M1R	Enhanced Type 1+2+3 power SPD for 3 Phase 415V supplies, with remote indication display
ESP 415 M2R	Enhanced Type 1+2+3 power SPD for 3 Phase 415V supplies, 12.5KA 10/350, with remote indication display
ESP 415 M4R	Enhanced Type 1+2+3 power SPD for 3 Phase 415V supplies, 25KA 10/350, with remote indication display
ESP RLA-4	4 Metre display lead for ESP M1R, M2R and M4R Series

#### Mains supplies and fused connections up to 10 amps or up to 32 amps



Part no.	Description
<b>Protectors rated at 10 amps or less</b>	
ESP 240D-10A	Enhanced mains SPD for 240V supplies up to 10A, with LED status indication
ESP 240DS-10A	Enhanced mains SPD for 240V supplies up to 10A, with LED status indication and remote signal contact
<b>Protectors rated at 32 amps or less</b>	
ESP 240D-32A	Enhanced mains SPD for 240V supplies up to 32A, with LED status indication
ESP 240DS-32A	Enhanced mains SPD for 240V supplies up to 32A, with LED status indication and remote signal contact

#### Mains supplies and fused connections up to 5 amps or up to 16 amps



Part no.	Description
<b>Protectors rated at 5 amps or less</b>	
ESP 240-5A	Enhanced mains SPD for 240V supplies up to 5A
ESP 240-5A/BX	Enhanced mains SPD for 240V supplies up to 5A, IP66 enclosure
<b>Protectors rated at 16 amps or less</b>	
ESP 240-16A	Enhanced mains SPD for 240V supplies up to 16A
ESP 240-16A/BX	Enhanced mains SPD for 240V supplies up to 16A, IP66 enclosure
ESP 240T3/SKT	Type 3 mains SPD for supplies up to 16A for installation behind socket outlets

#### Plug-in SPD for mains power supplies, with telephone and computer line protection options



Part no.	Description
ESP MC/19BK	Brackets and fixings for mounting ESP MC SPD Series To 19"
ESP MC	Plug-in power SPD with filtering for 220-240V systems up to 13A with UK plug
ESP MC/TN/RJ11	Plug-in power SPD with filtering for 220-240V systems up to 13A with UK plug and data SPD for telecom systems with RJ11 connection
ESP MC/Cat-5e	Plug-in power SPD with filtering for 220-240V systems up to 13A with UK plug and data SPD for Cat-5E computer systems with RJ45 connection

## Electronic systems protection

Surge protection devices (SPDs) for data, signal and telephone lines

Twisted pair data communication & signal lines (lower in-line resistance, higher current and higher bandwidth)

	Part no.	Description
	ESP 06E	Data SPD for 2-Wire signal lines up to 6V, 1.25A
	ESP 15E	Data SPD for 2-Wire signal lines up to 15V, 1.25A
	ESP 30E	Data SPD for 2-Wire signal lines up to 30V, 1.25A
	ESP 50E	Data SPD for 2-Wire signal lines up to 50V, 1.25A
	ESP 110E	Data SPD for 2-Wire signal lines up to 110V, 1.25A

Twisted pair data communication, signal & telecom lines - slim line, with removable protection module

	Part no.	Description	
	ESP SLTN	Data SPD for 2-Wire telephone lines up to 296V (ringing voltage)	
	<b>Slim line protectors with removable protection module, LED status indication and isolated screen</b>		
	ESP SL06L/I	Data SPD for 2-Wire signal lines up to 6V, 750mA	
	ESP SL15L/I	Data SPD for 2-Wire signal lines up to 15V, 750mA	
	ESP SL30L/I	Data SPD for 2-Wire signal lines up to 30V, 750mA	
	ESP SL50L/I	Data SPD for 2-Wire signal lines up to 50V, 750mA	
	ESP SL110L/I	Data SPD for 2-Wire signal lines up to 110V, 750mA	
	<b>Slim line, Intrinsically Safe protectors (ATEX approved) with removable protection module, LED status indication and isolated screen</b>		
	ESP SL15XL/I	Data SPD for 2-Wire signal lines up to 15V, 750mA	
	ESP SL30XL/I	Data SPD for 2-Wire signal lines up to 30V, 750mA	
<b>Slim line SPD for 4-20mA current loops with removable protection module, LED status indication and isolated screen</b>			
ESP SL30L/4-20/I	Data SPD for 4-20mA signal lines up to 30V, 75mA		

High density data, signal & telephone lines (/PT fast fit Push Terminal option)

	Part no.	Description
	ESP 06Q or ESP 06Q/PT	Data SPD for 8-Wire (4 pairs) 6V signal lines space saving design
	ESP 15Q or ESP 15Q/PT	Data SPD for 8-Wire (4 pairs) 15V signal lines space saving design
	ESP 30Q or ESP 30Q/PT	Data SPD for 8-Wire (4 pairs) 30V signal lines space saving design
	ESP 50Q or ESP 50Q/PT	Data SPD for 8-Wire (4 pairs) 50V signal lines space saving design
	ESP 110Q or ESP 110Q/PT	Data SPD for 8-Wire (4 pairs) 110V signal lines space saving design
	ESP 180Q or ESP 180Q/PT	Data SPD for 8-Wire (4 pairs) 180V signal lines space saving design
	ESP TNQ or ESP TNQ/PT	Data SPD for 4 twisted pair phone lines with a maximum (ringing) voltage of 296 volts

Three wire RTD applications

	Part no.	Description
	ESP RTD	Data SPD for three 3-Wire RTD systems
	ESP SL RTD	Slim Line Data SPD for 3-Wire RTD systems
	ESP RTDQ	Data SPD for three of 3-Wire RTD systems space saving design
	ESP RTDQ/PT	

RS485 & Fieldbus applications

	Part no.	Description
	ESP RS485	Data SPD for RS485 signalling systems
	ESP SL RS485	Slim Line Data SPD for RS485 signal lines
	ESP RS485Q	Data SPD for 8-Wire (4 pairs) RS485 signal lines space saving design
	ESP RS485Q/PT	

## Electronic systems protection

Surge protection devices (SPDs) for computer and telephone lines

### Plug-in protectors for telephone and ISDN lines

	Part no.	Description
	ESP TN/JP	Data SPD for telephone line with BT UK connection
	ESP TN/RJ11-6/6	Data SPD for 6-Wire telephone line with RJ11 connection
	ESP ISDN/RJ45-8/8	Data SPD for 8-Wire ISDN telephone line, RJ45 connector

### PSTN and ISDN telephone lines with LSA-PLUS connections

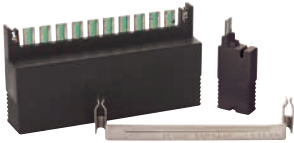
	Part no.	Description
	ESP KE10	Earth connection bar for up to 10 of ESP KT1 data SPDs for LSA-PLUS PBX systems
	ESP KT1	Data SPD for one LSA-PLUS PBX phone line, use with ESP KE10 earth bar
	ESP K10T1	Data SPD for 10 LSA-PLUS PBX telephone lines

### Computer networks up to Cat-6 cabling & PoE+

	Part no.	Description
	ESP Cat-6	Data SPD for Cat-6 1000 Base T computer networks, RJ45 connector
	ESP Cat-6/PoE	Data SPD for Cat-6 1000 Base T computer networks with Power over Ethernet, RJ45 connector

## Electronic systems protection

### Surge protection devices (SPDs) for specific systems

#### Mains supplies - wind turbine (WT) power distribution systems



Part no.	Description
ESP 690/25/WT	Type 1+2 power SPD for wind turbine systems, 25kA 10/350
ESP 690/12.5/WT	Type 1+2 power SPD for wind turbine systems, 12.5kA 10/350
ESP CE7	Connection and earthing bar for use with 3 of ESP 690/12.5/WT protectors for TNC systems
ESP CE9	Connection and earthing bar for use with 4 of ESP 690/12.5/WT protectors for TNS systems
ESP CE10	Connection and earthing bar for use with 3 of ESP 690/25/WT protectors for TNC systems
ESP CE13	Connection and earthing bar for use with 4 of ESP 690/25/WT protectors for TNS systems

#### DC photo-voltaic (PV) power distribution systems



Part no.	Description
ESP DC1000/12.5/PV	Type 1+2 power SPD for 1000Vdc PV supplies, 12.5kA 10/350 surge current rating
ESP DC550/12.5/PV	Type 1+2 power SPD for 550Vdc PV supplies, 12.5kA 10/350 surge current rating

#### Coaxial cable TV (CATV) systems



Part no.	Description
ESP CATV/F	Data SPD for Cable TV 5-860Mhz with F Type connector
ESP TV/F	Data SPD for TV 5-860Mhz with F Type connector
ESP TV/EURO	Data SPD for TV 5-860Mhz with Euro-TV connector
ESP MATV/F	Data SPD for main antenna TV MATV 5-2450Mhz with F Type connector
ESP SMATV/F	Data SPD for satellite main antenna TV SMATV 860-2450Mhz with F Type connector

#### Coaxial RF systems (for frequencies between DC and 2.7 GHz)



Part no.	Description
ESP RF 111421	RF Data SPD high performance N Type connection
ESP RF AA1421	RF Data SPD 350V GDT with 7/16 Din connection
ESP RF 441421	RF Data SPD 350V GDT with BNC connection

#### Higher performance coaxial RF systems (for frequencies between 50 MHz and 2.7 GHz)



Part no.	Description
ESP RF 111A11	RF Data SPD high performance N Type connection
ESP RF AA1A11	RF Data SPD high performance 7/16 Din connection
ESP RF 441A11	RF Data SPD high performance BNC connection

#### Closed circuit TV video lines



Part no.	Description
ESP CCTV/B	Data SPD for CCTV systems with BNC connection for Coax cable
ESP CCTV/T	Data SPD for CCTV systems with twisted pair cables

## Electronic systems protection

### Accessories

#### Weatherproof enclosures



Part no.	Description
WBX 2/G	IP66 Enclosure for 2 single stud ESP D/E/H data SPDs or ESP TN telecom SPD, grey lid
WBX 3	IP67 Enclosure for 3 single stud data SPDs or ESP Single Phase M1 mains SPD, clear lid
WBX 3/G	IP67 Enclosure for 3 single stud data SPDs, grey
WBX 4	IP66 Enclosure for ESP 415 M1, ESP 208 M1 or ESP 480 M1 or 4 single stud ESP data/telecom SPDs using CME4 earth bar, clear lid
WBX 4/GS	IP66 Enclosure for 4 single stud ESP data/telecom SPDs using CME4 earth bar, grey lid, security screws
WBX 8	IP66 Enclosure for 8 single stud ESP data/telecom SPDs using CME8 earth bar, grey lid
WBX 8/GS	IP66 Enclosure for 8 single stud ESP data/telecom SPDs using CME8 earth bar, grey lid, security screws
WBX 16/2/G	IP56 Enclosure for 1 or 2 CME16 earth bars for mounting and enclosing up to 32 of ESP single stud data/telecom SPDs, grey lid
WBX D4	IP65 Enclosure for 72mm DIN (4TE)
WBX D8	IP65 Enclosure for 144mm DIN (8TE)
WBX M2	IP67 Enclosure for ESP 415 M2 or ESP 480 M2, clear lid
WBX M4	IP67 Enclosure for ESP 415 M2 or ESP 480 M2, clear lid
WBX SLQ	IP66 Enclosure for up to 15 of ESP SL Series, or up to 6 of ESP Q Series, clear lid
WBX SLQ/G	IP66 Enclosure for up to 15 of ESP SL Series, or up to 6 of ESP Q Series, grey lid

#### Combined mounting and earthing kits



Part no.	Description
CME 4	4 Hole combined mounting & earthing kit
CME 8	8 Hole combined mounting & earthing kit
CME 16	16 Hole combined mounting & earthing kit
CME 32	32 Hole combined mounting & earthing kit

#### ABB SPD order code index

Part no.	Order code	Part no.	Order code	Part no.	Order code	Part no.	Order code
CME 16	7TCA085410R0002	ESP 30Q	7TCA085400R0107	ESP CE7	7TCA085460R0032	ESP SL110L/I	7TCA085400R0284
CME 32	7TCA085410R0003	ESP 30Q/PT	7TCA085400R0476	ESP CE9	7TCA085460R0033	ESP SL15L/I	7TCA085400R0664
CME 4	7TCA085400R0001	ESP 415 D1	7TCA085460R0105	ESP DC1000/12.5/PV	7TCA085460R0146	ESP SL15XL/I	7TCA085400R0235
CME 8	7TCA085400R0002	ESP 415 DIR	7TCA085460R0107	ESP DC550/12.5/PV	7TCA085460R0147	ESP SL30L/4-20/I	7TCA085400R0237
ESP 06E	7TCA085400R0084	ESP 415 M1	7TCA085460R0112	ESP ISDN/RJ45-8/8	7TCA085460R0171	ESP SL30L/I	7TCA085400R0234
ESP 06Q	7TCA085400R0087	ESP 415 M2	7TCA085460R0119	ESP K10T1	7TCA085400R0130	ESP SL30XL/I	7TCA085400R0236
ESP 06Q/PT	7TCA085400R0473	ESP 415 M4	7TCA085460R0124	ESP KE10	7TCA085400R0134	ESP SL50L/I	7TCA085400R0201
ESP 110E	7TCA085400R0007	ESP 415/I/TNS	7TCA085460R0101	ESP KT1	7TCA085400R0135	ESP SLTN	7TCA085400R0195
ESP 110Q	7TCA085400R0088	ESP 415/I/TT	7TCA085460R0102	ESP MATV/F	7TCA085450R0000	ESP SMATV/F	7TCA085450R0026
ESP 110Q/PT	7TCA085400R0478	ESP 415/III/TNS	7TCA085460R0103	ESP MC	7TCA085430R0003	ESP TN/JP	7TCA085400R0177
ESP 15E	7TCA085400R0095	ESP 415/III/TT	7TCA085460R0026	ESP MC/19BK	7TCA085460R0034	ESP TN/RJ11-6/6	7TCA085400R0180
ESP 15Q	7TCA085400R0098	ESP 415T1/12.5/TNS	7TCA085460R0496	ESP MC/CAT-5E	7TCA085430R0004	ESP TV/EURO	7TCA085450R0027
ESP 15Q/PT	7TCA085400R0474	ESP 415T1/12.5/TT	7TCA085460R0372	ESP MC/TN/RJ11	7TCA085430R0005	ESP TV/F	7TCA085450R0028
ESP 240 D1	7TCA085460R0086	ESP 415T1/25/TNS	7TCA085460R0369	ESP RF 111421	7TCA085450R0005	ESP RTDQ/PT	7TCA085400R0488
ESP 240 M1	7TCA085460R0089	ESP 415T1/25/TT	7TCA085460R0498	ESP RF 111A11	7TCA085450R0007	WBX 16/2/G	7TCA085410R0020
ESP 240/I/TNS	7TCA085460R0019	ESP 415M1R	7TCA085460R0115	ESP RF 441421	7TCA085450R0058	WBX 2/G	7TCA085410R0022
ESP 240/I/TT	7TCA085460R0020	ESP 415M2R	7TCA085460R0123	ESP RF 441A11	7TCA085450R0014	WBX 3	7TCA085410R0023
ESP 240/III/TNS	7TCA085460R0022	ESP 415M4R	7TCA085460R0126	ESP RF AA1421	7TCA085450R0061	WBX 3/G	7TCA085410R0024
ESP 240/III/TT	7TCA085460R0023	ESP 50E	7TCA085400R0116	ESP RF AA1A11	7TCA085450R0016	WBX 4	7TCA085410R0027
ESP 240-16A	7TCA085460R0080	ESP 50Q	7TCA085400R0118	ESP RLA HD-4	7TCA085460R0156	WBX 4/GS	7TCA085410R0028
ESP 240-16A/BX	7TCA085460R0081	ESP 50Q/PT	7TCA085400R0477	ESP RLA-4	7TCA085460R0155	WBX 8	7TCA085410R0030
ESP 240-5A	7TCA085460R0083	ESP 690/12.5/WT	7TCA085460R0308	ESP RS485	7TCA085400R0191	WBX 8/GS	7TCA085410R0031
ESP 240-5A/BX	7TCA085460R0084	ESP 690/25/WT	7TCA085460R0309	ESP RS485Q	7TCA085400R0192	WBX D4	7TCA085410R0032
ESP 240D-10A	7TCA085460R0323	ESP Cat-6	7TCA085400R0023	ESP RS485Q/PT	7TCA085400R0475	WBX D8	7TCA085410R0033
ESP 240D-32A	7TCA085460R0322	ESP Cat-6/PoE	7TCA085400R0024	ESP RTD	7TCA085460R0157	WBX M2	7TCA085410R0034
ESP 240DS-10A	7TCA085460R0317	ESP CATV/F	7TCA085400R0122	ESP RTDQ	7TCA085400R0158	WBX M4	7TCA085410R0035
ESP 240T1/25/TNS	7TCA085460R0499	ESP CCTV/B	7TCA085400R0123	ESP RTDQ/PT	7TCA085400R0488	WBX SLQ	7TCA085410R0037
ESP 240T1/25/TT	7TCA085460R0370	ESP CCTV/T	7TCA085400R0129	ESP SL RS485	7TCA085400R0193	WBX SLQ/G	7TCA085410R0036
ESP 240T3/SKT	7TCA085450R0069	ESP CE10	7TCA085460R0030	ESP SL RTD	7TCA085400R0232		
ESP 30E	7TCA085400R0104	ESP CE13	7TCA085460R0031	ESP SL06L/I	7TCA085400R0280		

---

# Jokab safety products

<b>306</b>	<b>Sentry safety relays</b>
<b>307</b>	<b>Eden safety sensors</b>
<b>308</b>	<b>Magne – Magnetic lock</b>
<b>309</b>	<b>Smile emergency stop buttons</b>



For more detailed product information, please refer to our online technical brochures available at: [new.abb.com/low-voltage/support/documentation](http://new.abb.com/low-voltage/support/documentation)

or contact our sales team via email [LV.enquiries@gb.abb.com](mailto:LV.enquiries@gb.abb.com)

or call 0333 999 9933

# Our range of safety products







ABB is the only supplier that can deliver complete safety solutions (including output devices such as contactors and frequency converters) together with automation solutions such as robotics, motors, drives and PLCs.

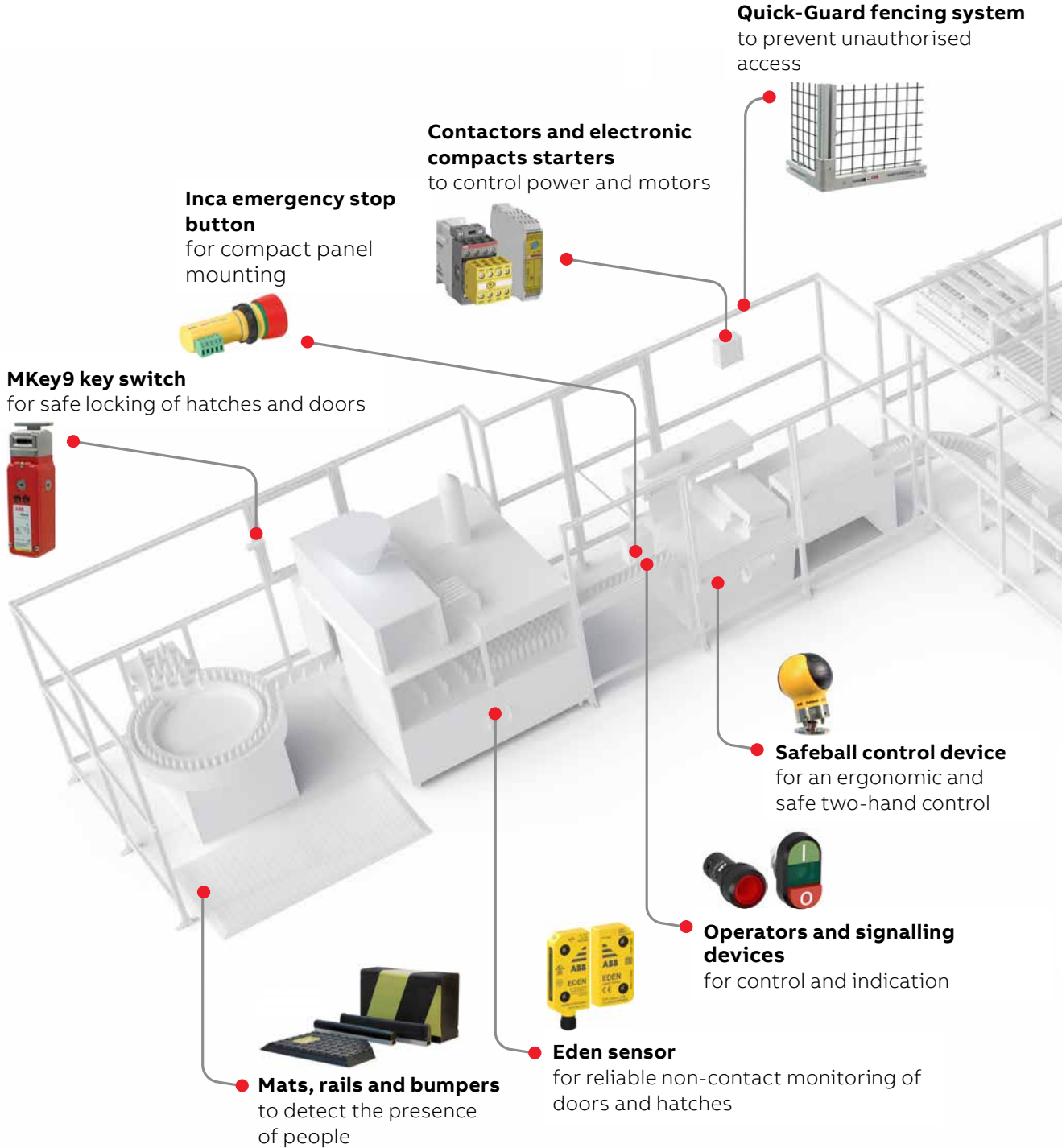
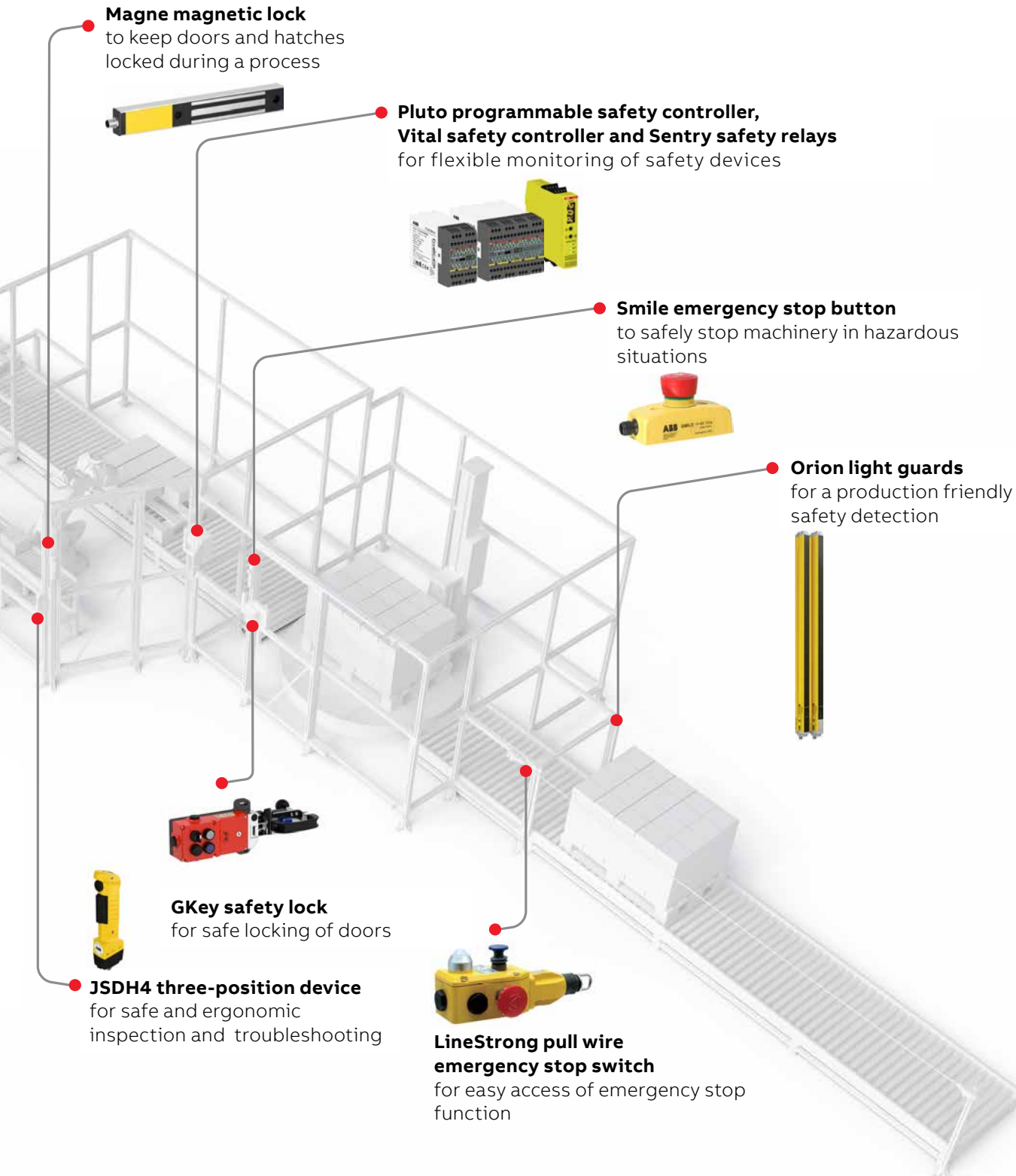

# Sentry – Safety Relays

## Ordering details

	Expansion	Safety devices	Test/Reset	Safety relay outputs	Timer function	Feature	Power supply	Type	Order code
 <p>BSR10</p> <p>2TLC172049V0201</p>	Expansion of safety controller outputs	1 channel	Manual reset (all models have auto reset) Start/Test	3 NO + 1 NC	Off-delay 0.5 s Off-delay 1.5 s	Advanced timer functions 0 – 999 s <sup>d)</sup> Configurable with display	85-265 VAC / 120-375 VDC +24 VDC		
		2 channels with equivalent contacts		4 NO					
		2 channels with antivalent contacts		2 NO + 2 delayed/delayable NO					
		OSSD outputs / PNP outputs		4 NO + 1 NC					
		Contact mats, bumpers and safety edges <sup>c)</sup>							
		Two-hand devices							
 <p>SSR32</p> <p>2TLC172064V0201</p>	Expansion of safety controller outputs	1 channel	Manual reset (all models have auto reset) Start/Test	3 NO + 1 NC	Off-delay 0.5 s Off-delay 1.5 s	Advanced timer functions 0 – 999 s <sup>d)</sup> Configurable with display	85-265 VAC / 120-375 VDC +24 VDC		
		2 channels with equivalent contacts		4 NO					
		2 channels with antivalent contacts		2 NO + 2 delayed/delayable NO					
		OSSD outputs / PNP outputs		4 NO + 1 NC					
		Contact mats, bumpers and safety edges <sup>c)</sup>							
		Two-hand devices							
 <p>USR10</p> <p>2TLC172079V0201</p>	Expansion of safety controller outputs	1 channel	Manual reset (all models have auto reset) Start/Test	3 NO + 1 NC	Off-delay 0.5 s Off-delay 1.5 s	Advanced timer functions 0 – 999 s <sup>d)</sup> Configurable with display	85-265 VAC / 120-375 VDC +24 VDC		
		2 channels with equivalent contacts		4 NO					
		2 channels with antivalent contacts		2 NO + 2 delayed/delayable NO					
		OSSD outputs / PNP outputs		4 NO + 1 NC					
		Contact mats, bumpers and safety edges <sup>c)</sup>							
		Two-hand devices							

a) These models can also be used for expansion of Pluto safe transistor outputs (-24 VDC)

b) No monitoring of two-channel fault, i.e. max Category 3 without fault exclusion.

c) The safety relay detects a short-circuit, not a change in resistance.

d) Off-delay, On-delay, Time bypass or Time reset.

e) BSR23 must be monitored by another device in order to reach higher than Category 1/PL c according to EN ISO 13849-1, for example a safety relay, a safety PLC or an Orion light guard (EDM function).

## Eden – Non-contact safety Sensors

### Adam - Ordering details

Type of safety controller	StatusBus	Info signal	Local reset	Series connection	Connector male	Type	Order code
OSSD compatible (incl. Pluto and Sentry)		x			M12-5	Adam OSSD-Info M12-5	2TLA020051R5400
		x		x	M12-8	Adam OSSD-Info M12-8	2TLA020051R5700



2TLC010048V0201

Adam DYN-Info M12-5

### Eva - Ordering details

Compatible Adam	Code description	Code level	Type	Order code
Adam DYN and OSSD	General code. (Eva is interchangeable)	Low level	Eva General code	2TLA020046R0800
	Unique code. (Prevents defeat/fraud)	High level	Eva Unique code	2TLA020046R0900



2TLC010061V0201

Eva General code

## Cables and connectors

### Cable with connectors

Connector	Female/male	Length	Special feature	Type	Order code
M12-5 *	Female	3 m		M12-C31	2TLA020056R0500
		6 m		M12-C61	2TLA020056R0000
		10 m	Harsh environment, halogen free	M12-C61HE	2TLA020056R8000
		10 m		M12-C101	2TLA020056R1000
		10 m	Harsh environment, halogen free	M12-C101HE	2TLA020056R8100
		20 m		M12-C201	2TLA020056R1400
M12-C61HE	Female + male	0.3 m		M12-C0312	2TLA020056R5800
		0.06 m		M12-C00612	2TLA020056R6300
		1 m		M12-C112	2TLA020056R2000
		3 m		M12-C312	2TLA020056R2100
		6 m		M12-C612	2TLA020056R2200
		6 m		M12-C1012	2TLA020056R2300
		10 m		M12-C1012	2TLA020056R2300



2TLC172951P0201

M12-C61



2TLC010008R0201

M12-C61HE

## Magne – Magnetic lock

### Ordering details

#### Ordering details

For a complete Magne lock both door part and frame parts are necessary. Magne 4 also requires a separate Eva sensor.

	Safe interlocking with integrated Adam	Safety signal	Extra function	Connector	Type	Order code
 Magne 3	No	–	–	M12-5 male	Magne 3X M12-5	2TLA042022R2700
	Yes	OSSD	"Locked" and "Closed" information outputs	M12-8 male	Magne 4 OSSD-Info	2TLA042022R4600

Magne 3



Magne 4

#### Door part

Description	Type	Order code
Anchor plate with permanent magnet. Delivered with cellular rubber.	Magne Anchor 32B	2TLA042023R0400
Anchor plate without permanent magnet. Delivered with cellular rubber.	Magne Anchor 32A	2TLA042023R1300

#### Eva sensor for Magne 4 models

Compatible Adam	Code description	Code level	Type	Order code
Adam DYN and OSSD	General code. (Eva is interchangeable)	Low level	Eva General code	2TLA020046R0800
	Unique code. (Prevents defeat/fraud)	High level	Eva Unique code	2TLA020046R0900

2TLC00072V0201

2TLC00072V0201

## Smile emergency stop buttons

### Ordering details

	Connection type	Feature	Type	Order code
 <p>2TLC1287F0201</p>	1 x M12-5 male	Status LED	Smile 11 EA	2TLA030051R0000
	2 x M12-5 male	Status LED	Smile 12 EA	2TLA030051R0200

Smile 12 EA

## Smile safety stop buttons

### Ordering details

	Type of safety signal	Connection type	Feature	Type	Order code
 <p>2TLC12198F0201</p>	2 NC	1 x M12-5	Status LED	Smile 11 SA	2TLA030051R0900
	* Can be adapted to DYNlink with Tina				

Smile 11 SA

## Smile reset buttons

### Ordering details

	Type of contact	Intended use	Connectors	Type	Order code
 <p>2TLC12018V0201</p>	1 NO	Most reset applications	M12-5 male	Smile 11 RA	2TLA030053R0000
	* See Pluto hardware manual for more information about the light button function				

Smile 11 RA

**Additional information**

We reserve the right to make technical changes or modify the contents of this document without prior notice. With regard to purchase orders, the agreed particulars shall prevail. ABB AG does not accept any responsibility whatsoever for potential errors or possible lack of information in this document.

We reserve all rights in this document and in the subject matter and illustrations contained therein. Any reproduction, disclosure to third parties or utilization of its contents – in whole or in parts – is forbidden without prior written consent of ABB AG.





---

**ABB Limited**

Electrification Business Area  
Tower Court  
Foleshill Enterprise Park  
Courtaulds Way  
Coventry CV6 5NX  
Tel: +44 (0) 333 999 9900  
E-Mail: LV.Enquiries@gb.abb.com  
Twitter: @ABBUKEP

**[go.abb/electrification](https://go.abb/electrification)**

Download ABB Connect now for all the information in this brochure and more!  
Visit your App store or scan a QR code below for instant access.



iTunes  
(iOS)



Google Play  
(Android)



Microsoft Store  
(Windows 10)