

User's Guide

Epic | 95Q

This household sewing machine is designed to comply with IEC/EN 60335-1, 60335-2-28, CSA C22.2 NO.68 and UL1594.

IMPORTANT SAFETY INSTRUCTIONS

When using an electrical appliance, basic safety precautions should always be followed, including the following:

Read all instructions before using this household sewing machine. Keep the instructions at a suitable place close to the machine. Make sure to hand them over if the machine is given to a third party.

DANGER –TO REDUCE THE RISK OF ELECTRIC SHOCK:

- A sewing machine should never be left unattended when plugged in. The electrical socket, to which the machine is plugged in should be easily accessible. Always unplug this sewing machine from the electric outlet immediately after using and before cleaning, removing covers, lubricating or when making any other user servicing adjustments mentioned in the instruction manual.

WARNING –TO REDUCE THE RISK OF BURNS, FIRE, ELECTRIC SHOCK, OR INJURY TO PERSON:

- Do not allow to be used as a toy. Close attention is necessary when this sewing machine is used by or near children.
- Use this sewing machine only for its intended use as described in this manual. Use only attachments recommended by the manufacturer as contained in this manual.
- Never operate this sewing machine if it has a damaged cord or plug, if it is not working properly, if it has been dropped or damaged, or dropped into water. Return the sewing machine to the nearest authorized dealer or service center for examination, repair, electrical or mechanical adjustment.
- Never operate the sewing machine with any air openings blocked. Keep ventilation openings of the sewing machine and foot control free from the accumulation of lint, dust, and loose cloth.
- Keep fingers away from all moving parts. Special care is required around the sewing machine needle.
- Always use the proper needle plate. The wrong plate can cause the needle to break.
- Do not use bent needles.
- Do not pull or push fabric while stitching. It may deflect the needle causing it to break.
- Wear safety glasses.
- Switch the sewing machine off (“0”) when making any adjustment in the needle area, such as threading needle, changing needle, threading bobbin, or changing presser foot, etc.
- Never drop or insert any object into any opening.
- Do not use outdoors.
- Do not operate where aerosol (spray) products are being used or where oxygen is being administered.
- To disconnect, turn all controls to the off (“0”) position, then remove plug from outlet.
- Do not unplug by pulling on cord. To unplug, grasp the plug, not the cord.
- The foot control is used to operate the machine. Never place other objects on the foot control.

- Do not use the machine if it is wet.
- If the LED lamp is damaged or broken, it must be replaced by the manufacturer or its service agent or a similarly qualified person, in order to avoid a hazard.
- If the cord connected with the foot control is damaged, it must be replaced by the manufacturer or its service agent or a similarly qualified person, in order to avoid a hazard.
- This sewing machine is provided with double insulation. Use only identical replacement parts. See instructions for Servicing of Double-Insulated Appliances.

SAVE THESE INSTRUCTIONS

FOR CENELEC COUNTRIES ONLY:

This appliance can be used by children aged from 8 years and above and persons with reduced physical, sensory or mental capabilities or lack of experience and knowledge if they have been given supervision or instruction concerning use of the appliance in a safe way and understand the hazards involved. Children shall not play with the appliance. Cleaning and user maintenance shall not be made by children without supervision.

The noise level under normal operating conditions is less than 80dB(A).

The machine must only be used with foot control of type FR5 manufactured by Shanghai Binao Precision Mould Co., Ltd.

FOR NON CENELEC COUNTRIES:

This sewing machine is not intended for use by persons (including children) with reduced physical, sensory or mental capabilities, or lack of experience and knowledge, unless they have been given supervision or instruction concerning use of the sewing machine by a person responsible for their safety. Children should be supervised to ensure that they do not play with the sewing machine.

The noise level under normal operating conditions is less than 80dB(A).

The machine must only be used with foot control of type FR5 manufactured by Shanghai Binao Precision Mould Co., Ltd.

SERVICING OF DOUBLE INSULATED PRODUCTS

In a double-insulated product, two systems of insulation are provided instead of grounding. No ground means is provided on a double-insulated product, nor should a means for grounding be added to the product. Servicing of a double-insulated product requires extreme care and knowledge of the system and should be done only by qualified service personnel. Replacement parts for a double-insulated product must be identical to those parts in the product. A double-insulated product is marked with the words 'DOUBLE INSULATION' or 'DOUBLE INSULATED'.



Federal Communication Commission Interference Statement

For the USA and Canada

Responsible party: Singer Sourcing Limited LLC
1714 Heil Quaker Boulevard, Suite 130, LaVergne, TN 37086

Product name: HUSQVARNA® VIKING® EPIC™ 95Q sewing machine

Model number: SFV2

This device complies with Part 15 of the FCC Rules. Operation is subject to the following two conditions: (1) This device may not cause harmful interference, and (2) this device must accept any interference received, including interference that may cause undesired operation.

To satisfy radio frequency exposure requirements, a separation distance of 8" (20 cm) or more should be maintained between this device and persons during device operation. To ensure compliance, operations at closer than this distance is not recommended. The built-in antenna used for this transmitter must not be co-located in conjunction with any other antenna or transmitter.

This equipment has been tested and found to comply with the limits for a Class B digital device, pursuant to Part 15 of the FCC Rules. These limits are designed to provide reasonable protection against harmful interference in a residential installation. This equipment generates, uses and can radiate radio frequency energy and, if not installed and used in accordance with the instructions, may cause harmful interference to radio communications. However, there is no guarantee that interference will not occur in a particular installation. If this equipment does cause harmful interference to radio or television reception, which can be determined by turning the equipment off and on, the user is encouraged to try to correct the interference by one of the following measures:

- Reorient or relocate the receiving antenna.
- Increase the separation between the equipment and receiver.
- Connect the equipment into an outlet on a circuit different from that to which the receiver is connected.
- Consult the authorized HUSQVARNA® VIKING® retailer or an experienced radio/TV technician for help.

The included interface cable should be used in order to ensure compliance with the limits for a Class B digital device.



Any changes or modifications not expressly approved by the party responsible for compliance could void the user's authority to operate this equipment.

Declaration of Conformity

For Europe

Hereby, VSM Group AB on behalf of Singer Sourcing Limited LLC (who are commonly owned by SVP-SINGER Holdings LLC, d/b/a collectively as SVP Worldwide), declares that this sewing machine is in compliance with the essential requirements and other relevant provisions of Directive 2014/53/EU. To view a copy of the Declaration of Conformity, please see RC-0309.

To satisfy radio frequency exposure requirements, a separation distance of 8" (20 cm) or more should be maintained between this device and persons during device operation. To ensure compliance, operations at closer than this distance is not recommended. The built-in antenna used for this transmitter must not be co-located in conjunction with any other antenna or transmitter.

TABLE OF CONTENTS

I	Introduction	9	Threading	31	
	Machine Overview	10	Threading the Upper Thread.....	31	
	Front	10	Automatic Needle Threader.....	33	
	Needle Area	11	Threading for Twin Needle.....	35	
	Left Side.....	11	Threading Tips and Hints.....	37	
	Right Side.....	11	Bobbin Winding.....	38	
	Rear.....	11	Winding Through the Needle.....	39	
	Accessory Tray	12	Inserting the Bobbin.....	40	
	Storing a Needle Plate.....	12	Integrated Dual Feed (IDF) System	41	
	Function Buttons.....	13	Engaging the IDF System.....	41	
	Automatic Needle Threader.....	13	Disengaging the IDF System.....	41	
	Speed – and +	13	Changing the Presser Foot.....	41	
	Stitch Re-Start	13	Attaching the Sensor One-Step		
	Reverse	13	Buttonhole Foot	42	
	Start/Stop.....	13	Changing to Straight Stitch Plate	42	
	Adjustable Laser Sewing Guidance.....	14	3	The Multi-Touch Screen	43
	FIX Function	14	Common Functions.....	44	
	Needle Stop Up/Down.....	14	OK.....	44	
	Cut Function.....	14	Cancel.....	44	
	STOP Function	14	Touch & Hold	44	
	Presser Foot Up and Extra Lift.....	14	Topbar	45	
	Presser Foot Down and Pivot.....	14	WiFi	45	
	Accessories.....	15	<i>mySewnet</i> [™]	46	
	Included Accessories	15	Wireless Firmware Update.....	46	
	Included Accessories Not in Picture.....	15	Home Screen.....	46	
	Included Presser Feet.....	16	Quick Help	47	
	Stitch Overview.....	18	Settings	47	
	Utility Stitches	18	4	WiFi & <i>mySewnet</i>[™] Services.....	49
	Stitch Menu Overview	21	WiFi Introduction	50	
	Alphabets	21	Getting Started With WiFi.....	50	
	Basic Gestures for the Multi-Touch Screen	22	Hidden Network.....	50	
	Smart Toolbox.....	22	Firmware Update Using WiFi.....	51	
2	Preparations	23	Firmware Update Using a USB Device.....	51	
	Unpacking Machine.....	24	Complimentary Software (PC and MAC).....	52	
	Connect the Power Cord and Foot		<i>mySewnet</i> [™] Services.....	53	
	Control.....	24	<i>mySewnet</i> [™] Account.....	53	
	Pack Away After Sewing.....	25	<i>mySewnet</i> [™] Cloud	54	
	USB Ports.....	25	Installation of <i>mySewnet</i> [™] Cloud Sync Tool		
	Using a USB Device	25	for Computer	55	
	Getting Started with WiFi and		Apps.....	55	
	<i>mySewnet</i> [™] Cloud	26	<i>mySewnet</i> [™] Menu	55	
	LED Lights	26	<i>mySewnet</i> [™] Blog.....	55	
	Free Arm.....	26	5	Home Screen	57
	Manual Thread Cutter	26	Home Screen— Overview.....	58	
	Thread Sensor	27	User Profile.....	59	
	Telescopic Thread Guide	27	Welcome Center.....	59	
	Spool Pins.....	27	<i>mySewnet</i> [™] Blog	59	
	Spool Caps	28	Filter <i>mySewnet</i> [™] Blog Posts.....	59	
	Threads	28	Minimize/expand <i>mySewnet</i> [™] Blog.....	59	
	Needles.....	29	Home Screen — Common Functions	60	
	Important Needle Information.....	29	Search.....	60	
	Changing the Needle.....	30			

Minimize/Expand Project files.....	60	Program – Overview.....	94
Start New	60	Create New Program.....	95
Continue	60	To Edit a Created Program	95
Load Smart Save	60	Edit Stitch or Lettering Program.....	96
Project Menu.....	60	Adjust the Entire Program.....	97
Project Viewer.....	61	Stitch Program Commands.....	97
JoyOS ADVISOR™	63	Save Program.....	98
SEWING ADVISOR™ – Overview.....	63	Sew Your Stitch Program.....	98
QUILT ADVISOR– Overview.....	66	Program Pop-Up Messages.....	98
Knowledge Center – Overview.....	67		
6 Sewing.....	69	8 Settings.....	99
Getting Started to Sew.....	70	Temporary Sewing Settings.....	100
Sewing Mode – Overview	71	<i>deLuxe</i> ™ Stitch System.....	100
What is a Stitch?	72	Sensor Presser Foot Lift.....	100
Select a Stitch or Letter	72	Automatic Thread Cutter.....	101
Load a Stitch or Letter From Another		Automatic FIX	101
Location.....	72	Stitch Limiting Options.....	101
Sewing Recommendations.....	73	Feed Teeth Options.....	102
Adjustable Laser Sewing Guidance	73	Default Sewing Settings	103
Stitch Settings	74	<i>deLuxe</i> ™ Stitch System – Default.....	103
Stitch Width.....	74	Sensor Presser Foot Lift – Default	103
Stitch Positioning.....	74	Automatic Thread Cutter – Default.....	103
Stitch Length.....	75	Automatic FIX – Default	103
Stitch Density.....	75	Free Motion Options – Default	103
Button Size	75	Machine Settings.....	104
Sew On Button.....	76	Language.....	104
Sensor Foot Pressure	76	Audio Volume	104
<i>deLuxe</i> ™ Stitch System.....	77	Audio Repeat	104
Mirroring.....	78	Machine Nickname.....	104
Save Stitch	79	Color Theme.....	104
Smart Save.....	79	Lock Screen	104
Balance	80	LED Work Light Brightness.....	104
Free Motion Options.....	81	Units.....	104
Basic Sewing Techniques.....	83	Clock Settings.....	105
Seam.....	83	Usage.....	105
Overcast.....	83	WiFi Settings.....	106
Seam and Overcast.....	83	<i>mySewnet</i> ™ Settings.....	106
Baste.....	83	Machine Information.....	106
Blind Hem	84		
Hem	84	9 File Manager	107
Buttonholes	85	File Manager – Overview.....	108
Programmable Button Sew On.....	86	File Formats	109
Laser Pictogram Stitches – Menu I.....	86	Browse File Manager.....	109
Dimensional Stitches – Menu L.....	86	Open a File or Folder.....	109
Theme Stitches – Menu M.....	87	Move Up One Folder Level	109
Embellished Stitches – Menu N	88	List/Thumbnail View	110
Tapering Stitches – Menu Q	89	<i>mySewnet</i> ™ Cloud Folder	110
Taper Satin Stitch Exercise.....	89	USB Device	110
4-Way Stitches – Menu S.....	90	Organize.....	111
8-Way Stitches – Menu T	91	Create New Folder	111
Special Stitches For Optional Presser Feet.....	91	Rename a File or Folder	111
Sewing Pop-up Messages	92	Move a File or Folder.....	111
		Copy a File or Folder	111
		Delete a File or Folder	111
		Toggle Between Edit and Filter View.....	112
7 Program	93		

Filter Files.....	112
File Manager Pop-up Messages	113

10 Maintenance 115

Cleaning the Machine Exterior.....	116
Removing the Needle Plate and Cleaning the Bobbin Area	116
Cleaning Under the Bobbin Area.....	116
Replacing the Needle Plate.....	116
Troubleshooting.....	117
Troubleshooting Connectivity	120
Service	120
Non-Original Parts and Accessories	120
Technical Specification	120

Index 121

I Introduction

Machine Overview

Front

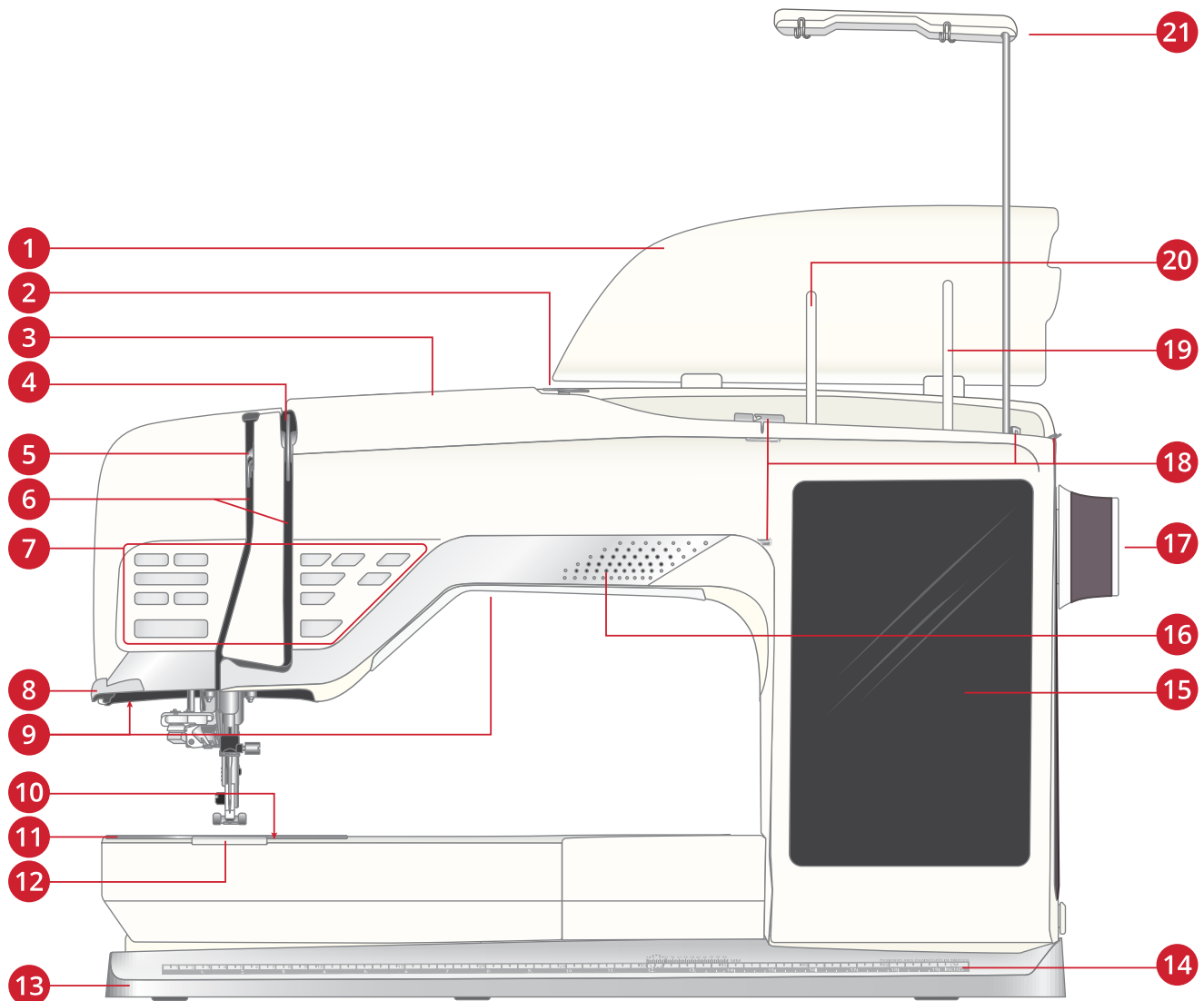

- | | |
|---|--------------------------------------|
| 1. Lid | 12. Bobbin cover |
| 2. Pre-tension thread guide | 13. Base plate |
| 3. Threading slot | 14. Built-in Ruler with button ruler |
| 4. Thread tension discs | 15. Multi-touch screen |
| 5. Thread take-up lever | 16. Speaker |
| 6. Threading slots | 17. Handwheel |
| 7. Function buttons, see Function Buttons, page 13 for detailed description | 18. Bobbin winding thread guides |
| 8. Thread cutter | 19. Auxiliary spool pin |
| 9. LED lights | 20. Main spool pin |
| 10. Bobbin cover release button | 21. Telescopic thread guide |
| 11. Needle plate | |

Needle Area

1. Automatic needle threader, see Using the Automatic Needle Threader, page 33
2. Needle holder with needle clamp screw
3. Needle thread guide
4. Integrated Dual Feed (IDF) System
5. Presser foot
6. Presser foot ankle
7. Presser foot bar

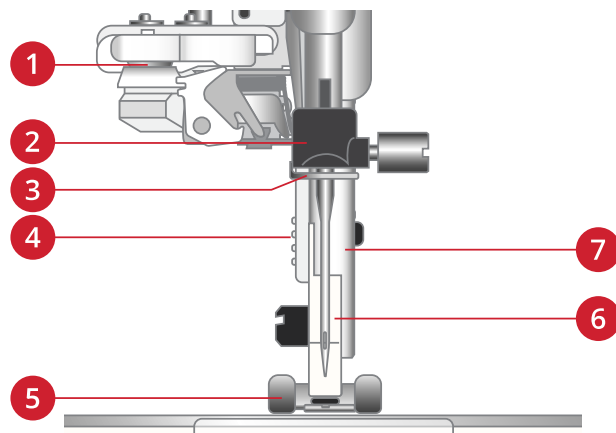

Left Side

1. Integrated Dual Feed (IDF) System

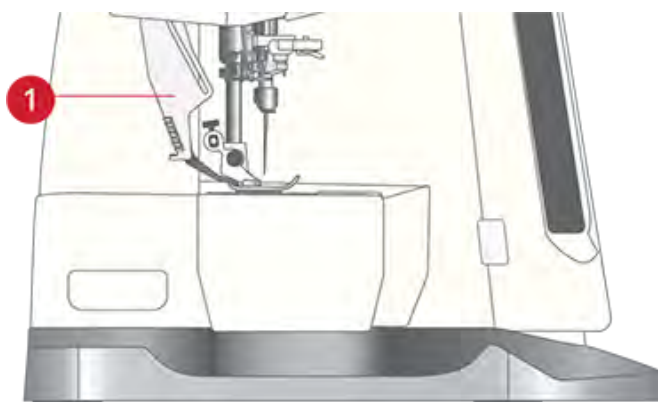

Right Side

1. Bobbin winder
2. Bobbin winding lever
3. Built-in USB ports
4. Thread cutter for bobbin winding
5. ON/OFF switch, sockets for power cord and foot control. See Connect the Power Cord and Foot Control, page 24.

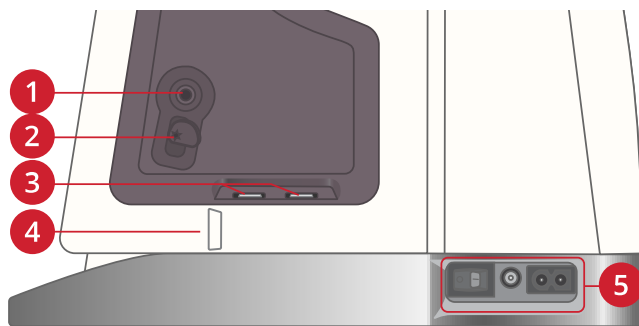

Rear

1. Handle
2. Accessory socket
3. Free arm

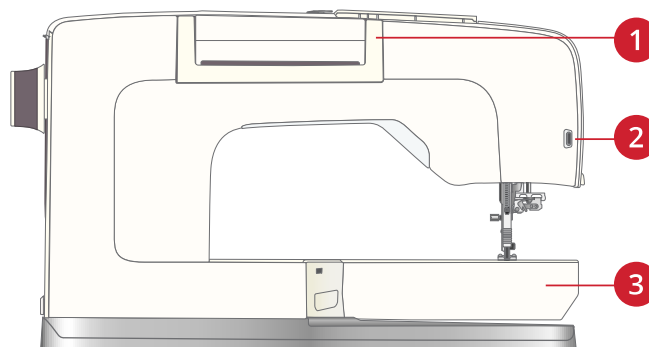

Accessory Tray

The accessory tray features special compartments for presser feet and bobbins, plus space for needles and other accessories. Store the accessories in the tray so they are easily accessible.

1. Space for accessories
2. Hook for storing the Sensor One-Step Buttonhole Foot
3. Space for needle plate
4. Space with hole for Buttonhole Foot C
5. Spaces for presser feet
6. Removable bobbin holder
7. Slot for needle packs
8. Space for seam ripper and brush
9. Extra wide space for Side-Motion Foot S

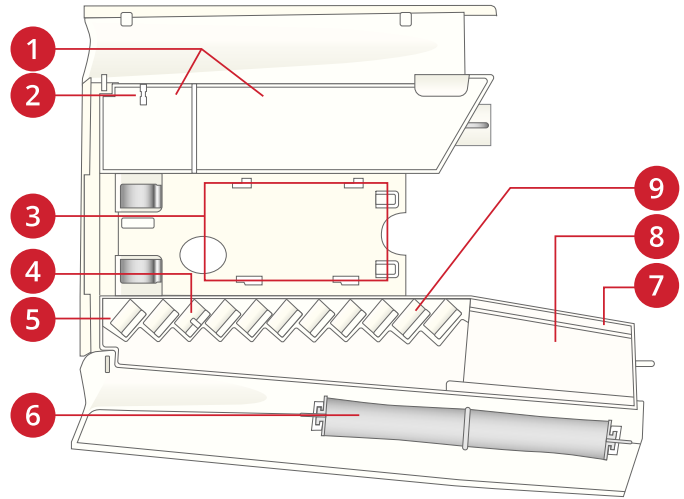

Storing a Needle Plate

Store the needle plate not in use in the bottom of your accessory tray.

1. Insert the back of the plate into the assigned holes as illustrated and lay it down.
2. Push the plate down and to the left to fasten it.
3. To remove the plate, place a finger into the hole to the left of the plate, push right and then lift the plate.

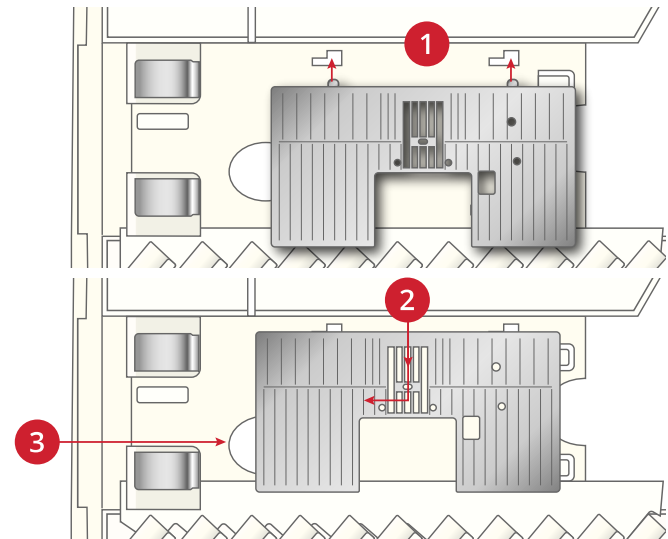

Function Buttons

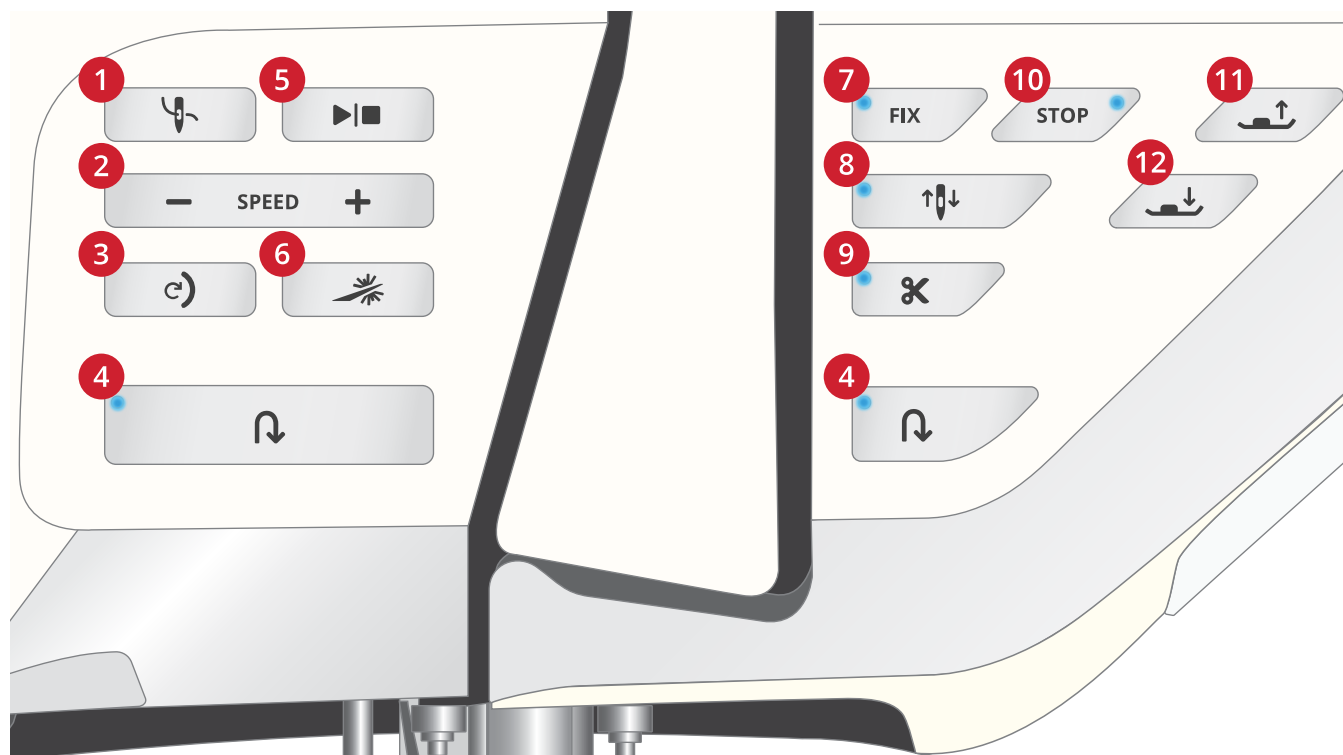

- | | | |
|------------------------------|-------------------------------------|------------------------------------|
| 1. Automatic needle threader | 5. Start/Stop | 9. Cut function |
| 2. Speed – and + | 6. Adjustable Laser Sewing Guidance | 10. STOP function |
| 3. Stitch re-start | 7. FIX function | 11. Presser foot up and extra lift |
| 4. Reverse | 8. Needle stop up/down | 12. Presser foot down and pivot |

Automatic Needle Threader

See Using the Automatic Needle Threader, page 33 to learn how to place the thread for automatic needle threading. When the thread is in place, touch this button to thread the needle automatically.

 *To prevent damage to the automatic needle threader, needle, presser foot or other attached accessories, read the instructions carefully on how to use the automatic needle threader before using it.*

Speed – and +

All stitches in your machine have a pre-set, maximum allowed sewing speed to provide a good stitch result.

Touch speed – to decrease the maximum allowed sewing speed. Touch speed + to increase the maximum allowed speed again. The machine will never sew faster than the maximum allowed sewing speed for the selected stitch. Touch speed – or + when the machine is not running and a pop-up on the screen will indicate the speed setting. You can set the speed by touching the slider in the pop-up or by touching the speed – or + buttons. If you change the speed setting while sewing no pop-up will appear.

Stitch Re-Start

When you stop sewing in the middle of a stitch, touch stitch re-start to begin sewing at the beginning of the stitch. The stitch or stitch program will remember any special settings you made.

Reverse

When reverse is active, the reverse indicator is lit. For permanent reverse, touch the reverse button once before starting to sew. The reverse indicator will be lit and the machine sews in reverse until you touch the button again to cancel. If you press the reverse button while sewing, the machine will sew in reverse for as long as you keep the button pressed.

Reverse is also used when sewing manual buttonholes, darning stitches, theme stitches and tapering stitches to step between the parts of the stitch.

Start/Stop

Touch the start/stop button to start and stop the machine sewing without using the foot control. Touch start/stop to begin and touch again to stop.

Adjustable Laser Sewing Guidance

Touch the Adjustable Laser Sewing Guidance button to activate a guidance system. A red light will be lit in front of the presser foot.

A popup will appear on screen. You can move the position of the laser guidance by touching the arrow buttons. Touch the alternative switch bar to finetune the center position "0". You can decrease or increase the brightness by touching the – or + buttons. See page 77 for more information.

Touch the laser guidance button again to deactivate.

FIX Function

FIX is used to tie off a stitch. Touch the button to turn the function on/off. The indicator next to the FIX function button is lit when the FIX function is active. When beginning to sew with FIX function active, your machine sews a few tie-off stitches and continues with the selected stitch. Touch FIX while sewing and your machine sews a few tie-off stitches and stops automatically.

You can activate automatic FIX in settings, see Automatic FIX .

Needle Stop Up/Down

Touch needle stop up/down to set the position of the needle when you stop sewing. The needle will move up or down when you touch the button. The indicator light is on when needle stop down is set.

Tip: You can also tap the foot control to raise or lower the needle once you stop sewing. Tapping the foot control does not change the set stop position.

Cut Function

Touch the cut function button and your machine cuts the upper and bobbin threads, raises the presser foot and needle, and activates the FIX function for the next start.

To cut threads at the end of a stitch or stitch program, touch the cut function button while sewing. The indicator light will flash, alerting you that a cut is requested. When the stitch or stitch program is completed, your machine cuts the upper and

bobbin threads, raises the presser foot and needle, and activates the FIX function for the next start.

Note: If automatic FIX and selective presser foot lift has been deselected in temporary sewing settings, FIX function will not be activated and presser foot will not be raised when using the cut function.



Some optional accessories are attached in the two small circular holes in the needle plate just above the bobbin cover. Do not use the cut function when an accessory is attached in these holes as that may interfere with the automatic thread cutter located under the needle plate.

STOP Function

Touch STOP when sewing to conclude a stitch or stitch program. Your machine fixes the thread and stops automatically when the stitch or stitch program has been completed. Touch STOP before starting to sew and your machine sews only one repetition of the stitch. Only one stitch is displayed on the screen. The indicator next to the STOP button is lit when the STOP function is active. To cancel the function, touch STOP again or select a new stitch. The STOP function is cancelled when the stitch is completed.

The STOP function is also used to repeat a sewn length when sewing tapering, (see Tapering Stitches – Menu Q) and when sewing manual buttonholes.

Presser Foot Up and Extra Lift

Touch the presser foot up button once to raise the presser foot. Touch again and the presser foot will raise to extra lift position, and the feed teeth will be automatically lowered to make it easier to get heavy fabric under the presser foot.

Presser Foot Down and Pivot

The presser foot is lowered automatically when you start sewing. To lower the presser foot before starting to sew, touch the presser foot down and pivot button. The presser foot will be completely lowered and the machine firmly holds the fabric. Touch presser foot down again to go to pivot position.

Accessories

Included Accessories

1. Thread net (4)
2. Universal tool
3. Seam ripper
4. Brush
5. Bobbins (9)
6. Edge/Quilting guide (used attached to presser foot ankle)
7. Multipurpose tool/Button reed
8. Thread cone holder (2)
9. Spool cap, small (2)
10. Spool cap, medium (2)
11. Spool cap, large (2)
12. Large spool holder (2)
13. Straight Stitch Plate



Included Accessories Not in Picture

- Complimentary software (PC and MAC) to download, see Complimentary Software (PC and MAC).
- Soft cover for machine
- Foot control
- Power cord
- Needles

Included Presser Feet

Note: For the best sewing results, use only presser feet designed for and compatible with your EPIC™ 95Q machine.

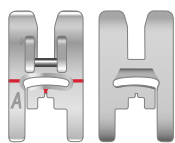

Utility Foot A for IDF System

Snapped onto the machine upon delivery. Used mainly for straight stitching and zigzag stitching with a stitch length longer than 1.0mm.

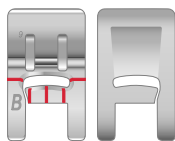

Decorative Stitch Foot B

For sewing close zigzag stitches (satin stitches) with less than 1.0mm stitch length, other utility stitches or decorative stitches, use this foot. The tunnel on the underside of the foot is designed to feed smoothly over the stitches.

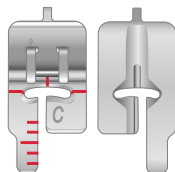

Buttonhole Foot C

For manual buttonholes. This foot has guidelines to determine buttonhole length. The middle guideline measures 1/2" (12mm) from the needle position. The two tunnels on the underside of the foot ensure smooth feeding over the buttonhole columns. The finger on the back of the foot holds cording for corded buttonholes.

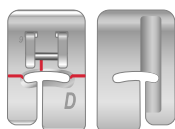

Blindhem Foot D

For blindhem stitches. The inner edge of this foot guides the fabric. The right toe of the foot is designed to ride along the hem edge.

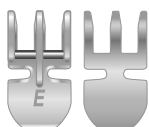

Zipper Foot E for IDF System

This foot can be snapped on either to the right or to the left of the needle. This makes it easy to sew both sides of the zipper. Move needle position to right or left to sew closer to zipper teeth or for covering large cording.

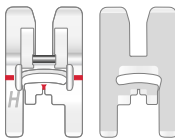

Non-Stick Glide Foot H for IDF System

This foot, with a non-stick coating underneath, is used when sewing foam, vinyl, plastic, or leather to keep these materials from sticking to the foot.

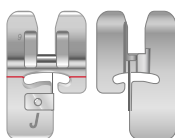

Edging Foot J for IDF System

Used for overcasting and seam/overcasting, with stitches that have a stitch width of 5.0 and 5.5mm. Stitches form over the pin which prevents puckering at the edge of the fabric.

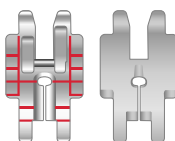

Adjustable 1/4" Foot for IDF System

Used when piecing quilt blocks. The foot has distance guideline marks 1/4" (6mm) and 1/8" (3mm) from the needle. The hole in the foot is oval shaped allowing you to adjust the needle position slightly to fit your project.



Darning Foot R

Used for free motion embroidery, free motion quilting, free motion stitching and free motion darning. When using this foot, select free motion floating in the free motion options pop-up in sewing mode.

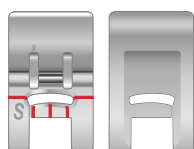

Side-Motion Foot S

Used for side-motion/omnimotion stitches.

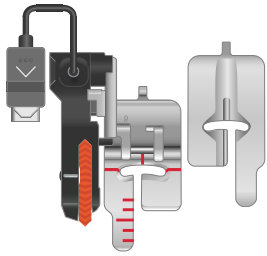

Sensor One-Step Buttonhole Foot

Plug into the machine then enter the desired buttonhole length to sew sensor one-step buttonholes. The middle guideline measures $\frac{1}{2}$ " (12mm) from the needle position. The two tunnels on the underside of the foot ensure smooth feeding over the buttonhole columns. The finger on the back of the foot holds cording for corded buttonholes.

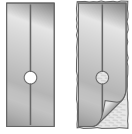



















Self-Adhesive Glide Plates



















If sewing on foam, vinyl, plastic, or leather, the material can stick to the foot and prevent the sewing machine from feeding properly. When using any of the above materials, sew on a piece of scrap fabric, to make sure the machine feeds smoothly. If not, fasten the self-adhesive glide plate to the underside of the presser foot.

Stitch Overview

Utility Stitches

Stitch	Nº	Presser foot	Name	Description
	A1	A	Straight stitch, left needle position	For all types of sewing.
	A2	A	Straight stitch, center needle position	For all types of sewing.
	A3	A	Straight stitch with reinforced tie-off	For all types of sewing. Begins and ends with forward and reverse stitches.
	A4	A	Straight stitch, right needle position	For all types of sewing.
	A5, A6, A7	A	Stretch stitch, left, center and right needle position	For seams in tricot and stretch fabrics.
	A8, A9, A10	A	Zigzag, left, center and right needle position	For sewing on lace, trims and appliqués.
	A11, A12, A13	A	Reinforced straight stitch, left, center and right needle position	Triple and elastic, for reinforced seams. For top stitch, increase the stitch length.
	A14	A	Reinforced zigzag stitch	For joining fabric edge to edge or overlapping in leather. For decorative sewing.
	A15	A	Three-step zigzag	For overcasting, mending, sewing on patches and elastic. Suitable for light and medium weight fabrics.
	A16	J	Seam/overcast stitch	Seam and overcast in one step along the edge or trim later. For light stretch and non-stretch fabrics.
	A17	J	Stretch seam/overcast stitch	Seam and overcast in one step along the edge or trim later. For medium and heavy stretch fabrics.
	A18	A	Double overlock stitch	Seam and overcast in one step along the edge or trim later. For heavy stretch and heavy woven fabrics.
	A19	A	Overlock stitch	Seam and overcast in one step along the edge or trim later. For medium stretch fabrics.
	A20	A	Flatlock stitch	Decorative hems and overlapped seams, belts and bands. For medium/heavy stretch fabrics.
	A21	D	Stretch blind hem stitch	Blind hems in medium and heavy stretch fabrics.
	A22	D	Woven blind hem stitch	Blind hems in medium and heavy woven fabrics.
	A23	A	Shell edge stitch	For edging, sewing over the edge on light woven fabrics. Sew woven fabrics on bias.
	A24	A	Four-step zigzag	For overcasting, mending, sewing on patches and elastics on loosely woven fabrics.

Stitch	Nº	Presser foot	Name	Description
	A25	B	Elastic/casing stitch	For overlapped seams in tricot. To sew casing over narrow elastic.
	A26	A	Serpentine stitch	For mending and elastic applications.
	A27	A	Elastic or smocking stitch	Sew over two rows of elastic thread for elastic shirring.
	A28	A	Bridging stitch	For joining two pieces of fabric with finished edges and for elastic shirring.
	A29	J	Three-step zigzag	For overcasting, mending, sewing on patches and elastic. Suitable for light and medium weight fabrics.
	A30	A	Two-step zigzag	For joining two pieces of lace, and for elastic shirring.
	A31	B	Bartack stitch	Reinforce pockets, shirt openings, belt loops as well as at lower end of a zipper.
	A32	B	Bartack, manual	Reinforce pockets, shirt openings, belt loops as well as at lower end of a zipper.
	A33	A	Darning stitch (forward and backward)	Darn and mend small holes in work clothes, jeans, tablecloths and linen towels. Stitch over hole, touch reverse for continuous darning and auto stop.
	A34	A	Darning stitch (side to side)	For mending small tears.
	A35	A	Reinforced darning stitch	Darn and mend work clothes, jeans, tablecloths and linen towels. Stitch over hole, touch reverse for continuous darning and auto stop.
	A36	B	Darning stitch (four-step)	A group of four stitches perfect for mending small tears. Stitch #1 and #3 are sewn in a forward motion, stitch #2 and #4 are sewn backwards. To change stitch and direction touch the reverse button. <i>Tip: Press fusible interfacing on the wrong side before mending the tear.</i>
	A37	A	Belt loop stitch	For securing belt loops.
	A38	A	Basting stitch	For temporary seams. The long stitches and reduced tension make the seams easy to unravel.
	A39	A	Straight basting stitch	To baste, press the foot control and the machine will make two stitches, stop and raise the foot. When the presser foot lifts, move the fabric to the next baste position and press the foot control. Feed teeth lowered automatically.
	A40	A	Zigzag basting	To baste, press the foot control and the machine will make two stitches, stop and raise the foot. When the presser foot lifts, move the fabric to the next baste position and press the foot control. Feed teeth lowered automatically.
	A41	A	Gathering stitch	No fix stitch in the beginning of the seam for easy gathering.
	A42	Sensor Buttonhole foot/C	Wide bartack buttonhole	For medium and heavy fabrics with extra cutting space.

Stitch	№	Presser foot	Name	Description
	A43	Sensor Buttonhole foot/C	Bartack buttonhole	For most fabric weights.
	A44	Sensor Buttonhole foot/C	Rounded bartack buttonhole	For light weight fabrics.
	A45	Sensor Buttonhole foot/C	Round end buttonhole	For blouses and children's garments.
	A46	Sensor Buttonhole foot/C	Keyhole buttonhole	Square end for tailored jackets, coats, etc.
	A47	Sensor Buttonhole foot/C	Tapered keyhole buttonhole	Tapered end for tailored garments.
	A48	Sensor Buttonhole foot/C	Decorative fashion buttonhole	For most fabric weights.
	A49	Sensor Buttonhole foot/C	Decorative fashion buttonhole	For most fabric weights.
	A50	Sensor Buttonhole foot/C	Heavy duty buttonhole	With reinforced bartacks
	A51	Sensor Buttonhole foot/C	Heavy reinforced buttonhole	For utility and heavy fabrics.
	A52	C	Medium/heavy reinforced buttonhole	For medium and heavy fabrics.
	A53	C	Medium reinforced decorative buttonhole	For medium fabrics.
	A54	Sensor Buttonhole foot/C	Heirloom buttonhole	For hand look on fine and delicate fabrics. <i>Tip: For jeans buttonholes, increase length and width of the buttonhole. Use thicker thread.</i>
	A55	Sensor Buttonhole foot/C	Rounded heirloom buttonhole	For hand look on fine and delicate fabrics.
	A56	A	Leather buttonhole (straight stitch)	For leather and suede.
	A57	A	Bound buttonhole (straight stitch)	With extra cutting space for bound buttonholes.
	A58	-	Automatic button sewing	For sewing on buttons.
	A59	B	Round eyelet	For belts, laces, etc.
	A60	B	Teardrop eyelet	For laces, embellishments.
	A61	B	Oval eyelet	For laces, embellishments.

Stitch Menu Overview

There are several different stitch menus with stitches for all purposes. For detailed description of a stitch, use the quick help function, see Quick Help.

Stitch Menu Name	Description
A — Utility Stitches	Stitches for garment sewing and mending.
B — Appliqué Stitches	For sewing appliqués with different effects.
C — Heirloom Stitches	Decorative stitches for traditional heirloom sewing. Stitches for hemstitching, smocking and sewing on laces and trims.
D — Quilt Stitches	Stitches for all types of quilting techniques.
E — Crafting Stitches	Decorative stitches to embellish crafts.
F — Decorative Stitches	For decorative sewing.
G — Vintage Stitches	A selection of quilt stitches for crazy patch quilting and decorative stitching.
H — Children Stitches	Stitches suitable for sewing on children's clothes and projects.
I — Laser Pictogram Stitches	Use the laser guidance system for this special stitch category. With the laser as a guide, you can combine different stitch elements into larger stitches to create unique embellishments.
J — Scallop Stitches	Create scallop details and finish edges with beautiful scallop stitches.
K — Omnimotion Stitches	Program these stitches into an unlimited number of combinations. Stitches are formed with side motion. The stitch width can be up to 54mm wide.
L — Dimensional Stitches	Includes three types of stitches: appliqué and pop-up stitches, combinations of these two types, and sequin stitches.
M — Theme Stitches	Each stitch number on this menu contains a group of four stitches designed to be sewn out together in random combinations. Change to the next stitch in the selected group by touching the reverse button.
N — Embellished Stitches	Decorative stitches that can be used as they are, or further embellished after sewing. Use quick help for detailed information.
O — Single Motif Stitches	Single stitches for embellishment. The machine stops after one sewn repetition.
P — Specialty Stitches	Sew special techniques including candlewicking, edging and more. Extra accessories may be needed. Use quick help for detailed information.
Q — Decorative Tapering Stitches	Decorative stitches with tapering.
R — Pictogram Stitches	Pictogram satin elements to program original satin stitch designs.
S — 4-Way Stitches	Four directional sewing and patching using the free arm.
T — 8-Way Stitches	Straight stitch and reinforced straight stitch in eight different directions without turning the fabric. Can be programmed with decorative stitches to create unique borders.

Alphabets

Stitch fonts are available in block, outline, brush line, script and Cyrillic alphabets.

Basic Gestures for the Multi-Touch Screen

Easily navigate on the multi-touch screen with the gestures described below.

1. *Touch* — Touch once on a button or setting on the screen to select.
2. *Touch & Hold* — Touch once without releasing for a few seconds to touch & hold. Used on some buttons and screen areas to access more options.
3. *Pinch/Stretch* — Touch with two fingers at the same time and without releasing increase/decrease the distance between the fingers to stretch (zoom in) or pinch (zoom out).
4. *Touch and Move* — Touch once and without releasing, move your finger to a different position on the screen.
5. *Swipe* — Touch, move and release your finger in a swift gesture to swipe. Left-right/right-left swipe is used e.g. to scroll between stitch menus. Top-bottom/bottom-top swipe is used e.g. to scroll within a stitch menu.

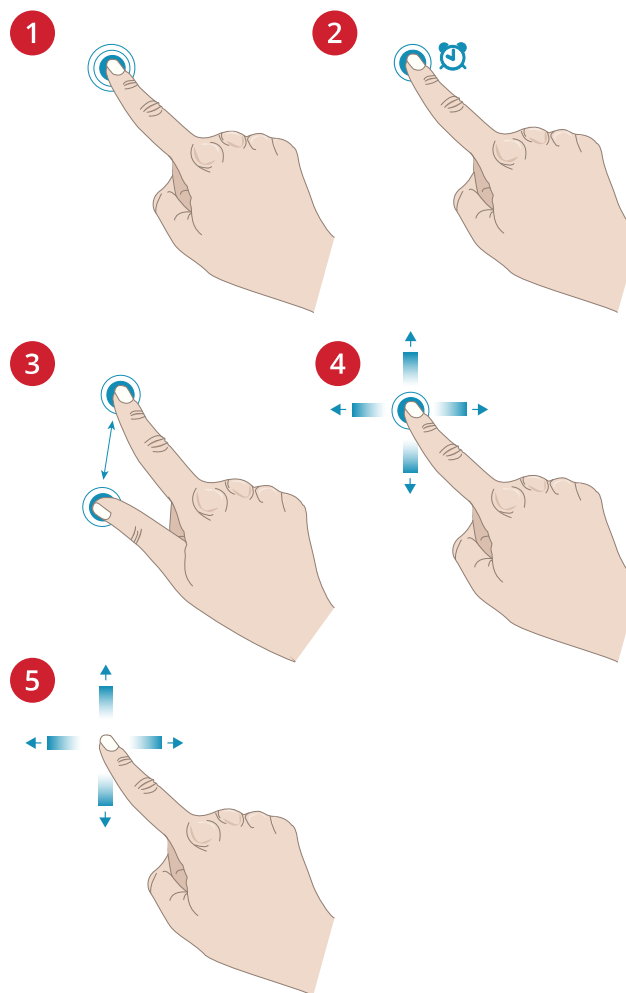

Smart Toolbox

Smart toolbox is available on a stitch or program in the sewing area. Touch & hold on a stitch program to open the smart toolbox, move your finger to highlight the option you want to use and release to select the option.

The options included in the smart toolbox varies depending on where and on what it is used. Examples of options are duplicate, delete, mirroring and edit.

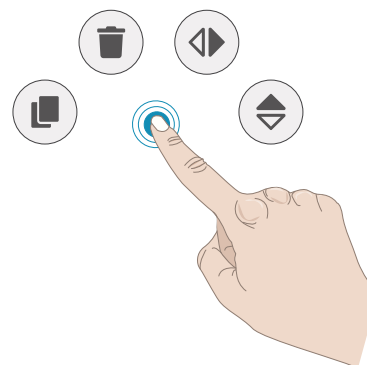

2 Preparations

Unpacking Machine

After lifting the machine out of the box and removing all packing material and the plastic bag, wipe the machine, particularly around the needle and needle plate to remove any oil before sewing.

Note: The machine is delivered with a red safety catch attached to the presser foot bar. Remove the safety catch before sewing.

Note: Your EPIC™ 95Q machine is adjusted to provide the best stitch result at normal room temperature. Extreme hot and cold temperatures can affect the sewn result.

Connect the Power Cord and Foot Control

Among the accessories you will find the power cord and the foot control.

Note: Before plugging in the foot control, check to ensure that it is type "FR5" (see underside of foot control).

- Pull out the cord from the foot control. Connect the foot control cord to the socket (1) on the bottom right side of the machine.
- Connect the power cord to the rear socket (2) on the bottom right side of the machine. Plug the cord into the wall socket.
- Press the ON/OFF switch (3) to "I" to turn on power and light.

For the USA and Canada

This sewing machine has a polarized plug (one blade wider than the other). To reduce the risk of electric shock, this plug is intended to fit in a polarized outlet only one way. If the plug does not fit fully in the outlet, reverse the plug. If it still does not fit, contact a qualified electrician to install the proper outlet. Do not modify the plug in any way.

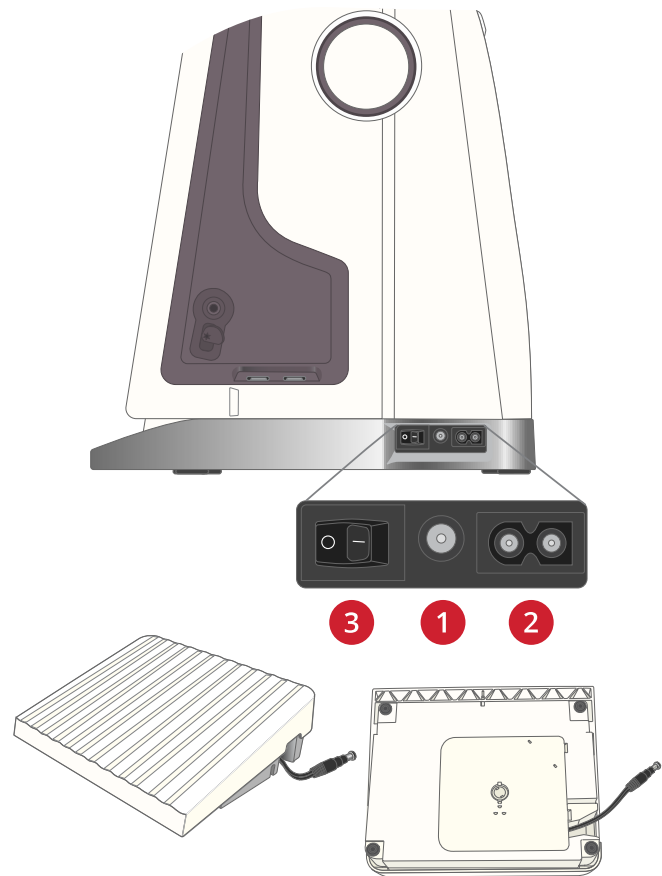

Pack Away After Sewing

1. Press the ON/OFF switch to "O".
2. Unplug the cord from the wall socket and then from the machine.
3. Unplug the foot control cord from the machine. Pull the cord gently and release. The cord will retract into the foot control.
4. Place all accessories in the accessory tray. Slide the tray on to the machine around the free arm.
5. Place the foot control in the space above the free arm.
6. Put on the soft cover.

Tip: The user's guide and power cord can be stored in the back pocket of the soft cover.

USB Ports

Your machine has two USB ports for connecting USB devices such as a memory stick. USB plugs can only be inserted one way – do not force them into the ports! To remove, carefully pull the USB device.

Note: Make sure that the USB stick you use has the format FAT32.

Using a USB Device

The external device button in file manager is only active when a device is connected to the machine USB port.

Note: Do not remove the USB device if a loading spinner is shown on the screen or while the file manager is shown. Removing the device at that time can damage the files on your USB device.

Read more in File Manager – Overview.

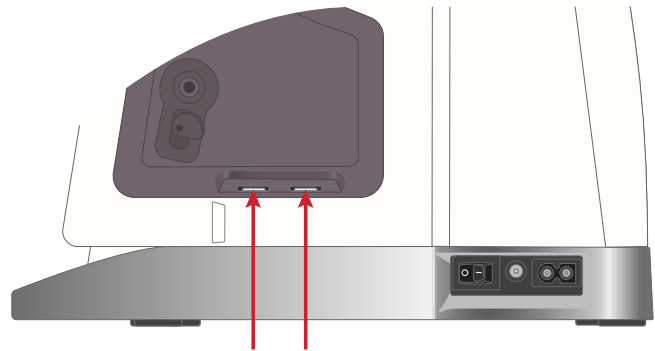

Getting Started with WiFi and mySewnet™ Cloud

Follow the steps below to connect your machine.

Connect to a Network with WiFi

Touch the WiFi button in the top left corner of the screen. Select from the list of available networks. If your network is password protected, you will be prompted to enter the password to connect.

For more information, see WiFi Introduction.



WiFi button

Connect to mySewnet™ Cloud

When you have established a WiFi connection, touch the cloud button next to the WiFi button on the screen. Touch the button to sign in. A web view opens where you can log in. If you do not have a user name and password, select Register to create an account.

For more information, see *mySewnet™* Cloud.



mySewnet™ cloud button

LED Lights

Your machine has LED lights which distribute the light evenly over the sewing area and eliminate shadows. You can adjust the brightness of the light in the settings menu, see LED Work Light Brightness .

Free Arm

To use the free arm, slide off the accessory tray. When attached, a hook keeps the accessory tray locked to the machine. Remove the tray by sliding it to the left.

Manual Thread Cutter

There are three manual thread cutters on your machine.

- The first one (A) is close to the bobbin winder spindle for cutting the thread before and after winding.
- The second one (B) is on the left side of the machine for manually cutting top and bobbin threads. Pull both threads into the cutter from the back to the front and pull down quickly.
- The third one (C) is next to the bobbin area for cutting the bobbin thread after placing the bobbin in the machine.

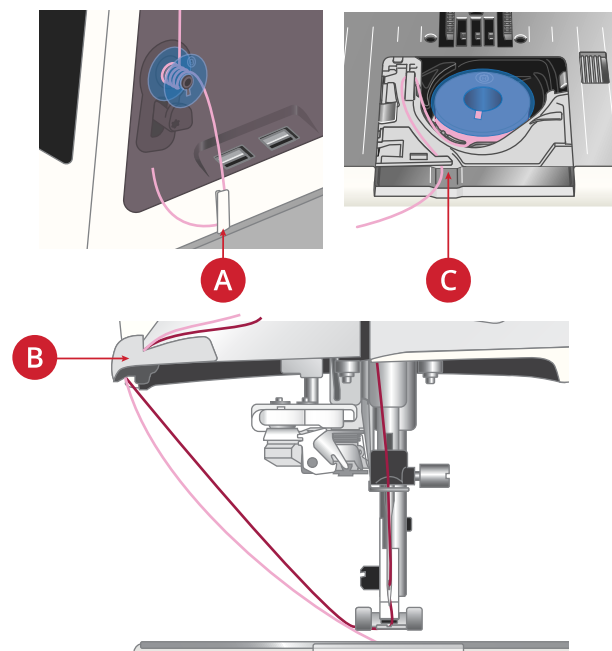

Thread Sensor

If the needle thread breaks or bobbin thread is running low, the machine stops and a pop-up appears on the screen.

If needle thread breaks: Remove the thread completely, re-thread the machine and touch OK in the pop-up.

If bobbin thread is running low: You can continue sewing without closing the pop-up before the bobbin thread runs out completely. This gives you an opportunity to plan where to stop and change the bobbin. When the bobbin is replaced with a full one, touch OK in the pop-up.

Telescopic Thread Guide

The telescopic thread guide is always used when threading your machine for sewing and bobbin winding. The telescopic thread guide helps straighten the thread, preventing it from tangling or breaking. The thread guide together with the vertical spool pins make it possible to successfully use even very large thread cones.

Extending and Retracting the Telescopic Thread Guide

Hold the telescopic thread guide by the markings as illustrated and pull it straight up until it clicks into place.

To retract, hold the thread guide by the markings and push it straight down.

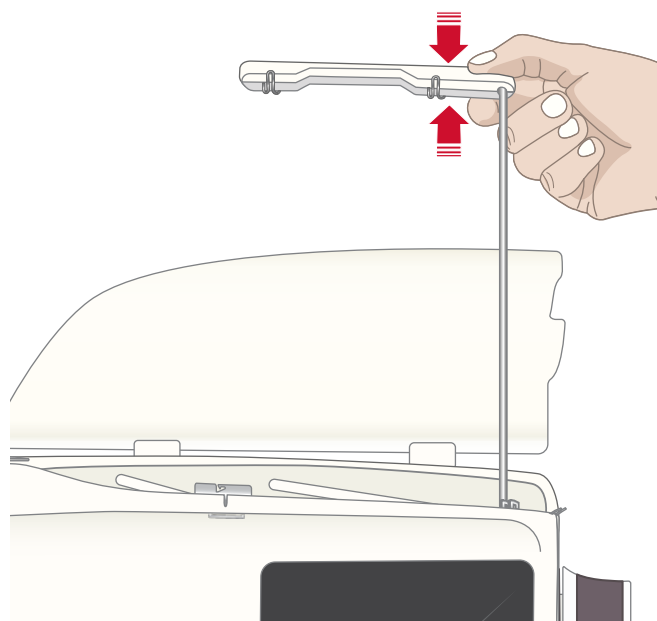

Spool Pins

Your machine has two spool pins; a main spool pin and an auxiliary spool pin. The spool pins are designed for all types of thread.

Use the main spool pin (A) when threading the upper thread and for bobbin winding through the needle. For regular sewing thread, use the main spool pin in vertical position. Place the spool pin in the horizontal position if you want to keep the machine threaded and close the lid when you have finished sewing. Remember to place the spool pin back in the vertical position when you start to sew again.

Note: Tilting the spool pins is not possible with large thread spools or cones.

You may get better results if you tilt the spool pin to the horizontal position when using small spools of specialty thread. See Threading Tips and Hints, page 37.

Use the auxiliary spool pin (B) when winding a bobbin from a second spool of thread or for a second spool when sewing with a twin needle.

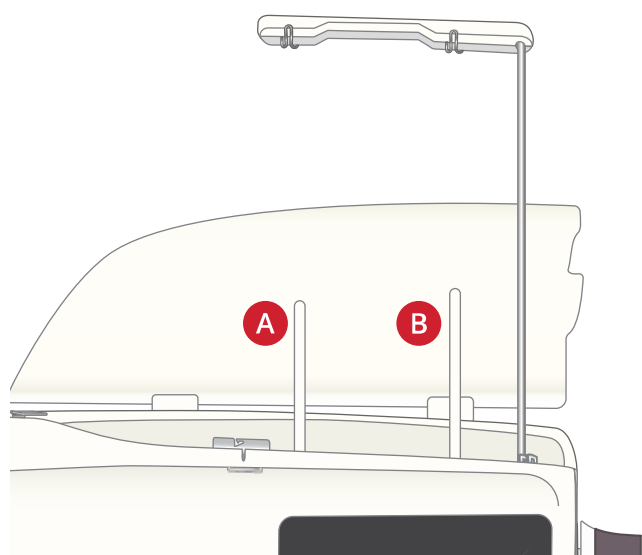

Main spool pin (A) and auxiliary spool pin (B)

Spool Caps

Spool caps in three sizes are included with your machine. For most types of thread spools, no spool cap is needed except when the thread on the spool is running low. If the thread is snagging on the top of the thread spool, place a spool cap on top. Always use a spool cap slightly larger than the thread spool to prevent the thread from snagging. The flat side of the spool cap should be pressed firmly against the spool. There should be no space between the spool cap and the thread spool.

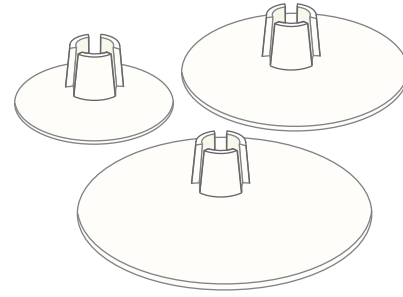

Threads

There are many threads on the market today developed for different purposes.

Your EPIC™ 95Q machine is designed for all types of threads and spool sizes. See Threading Tips and Hints, page 37 for information on achieving optimal results with different types of thread and different sizes/styles of thread spools.

All Purpose Sewing Thread

All purpose sewing thread is made of synthetic, cotton or cotton covered polyester. This type of thread is used for most sewing projects, including garments, home decor, and quilting.

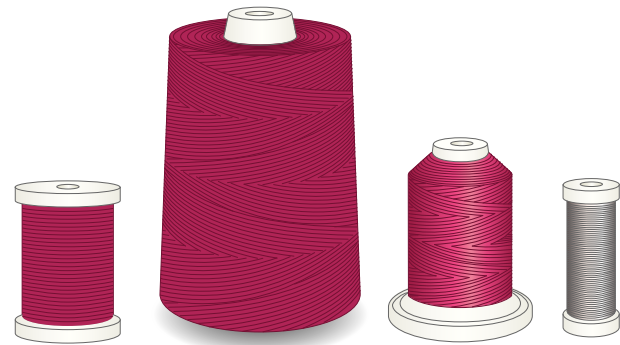

Decorative Thread

Decorative thread is made from a variety of fibers: rayon, polyester, acrylic or metallic. These threads create a smooth glossy appearance for decorative stitching.

Decorative thread is not typically used in the bobbin unless both sides of the project will be seen. A light weight bobbin thread is often used in the bobbin instead. The lighter weight thread does not build up under the stitches.

Transparent Thread

Transparent thread, also called monofilament thread, is a single clear synthetic thread. It is used for quilting and other decorative sewing. When winding a bobbin, wind at half speed and fill the bobbin half full.

Needles

The sewing machine needle plays an important role in successful sewing. Use only quality needles. We recommend needles of system 130/705H. The needle package included with your machine contains needles of the most frequently used sizes.



Be sure to match the needle to the thread you are using. Heavier threads require a needle with a larger needle eye. If the needle eye is too small for the thread the automatic needle threader may not work properly.

Universal Needle

Universal needles have a slightly rounded point and come in a variety of sizes. For general sewing in a variety of fabric types and weights.



Stretch Needle

Stretch needles have a special scarf to eliminate skipped stitches when there is a flex in the fabric. For knits, swimwear, fleece, synthetic suedes and leathers.



Embroidery Needle

Embroidery needles have a special scarf, a slightly rounded point and a slightly larger eye to avoid damage to thread and materials. Use with metallic and other specialty threads for embroidery and decorative sewing.



Denim Needle

Denim needles have a sharp point to penetrate tightly woven fabrics without deflecting the needle. For canvas, denim, microfibers.



Wing Needle

Wing needles have wide wings on the side of the needle to poke holes in the fabric when sewing entredeux and other hemstitches on natural fiber fabrics.

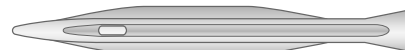

Important Needle Information

Change the needle often. Always use a straight needle with a sharp point (A).

A damaged needle (B) can cause skipped stitches, breakage or snapping of the thread. It can also damage the needle plate.

Do not use asymmetrical twin needles (C), they can damage your sewing machine.

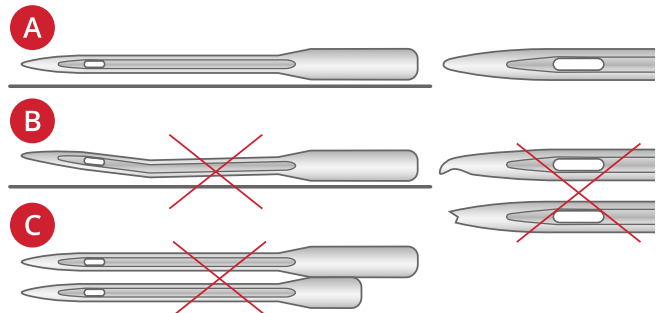

Changing the Needle

1. Use the hole in the multipurpose tool to hold the needle.
2. Loosen the needle screw with the universal tool.
3. Remove the needle.
4. Insert the new needle using the multipurpose tool. Push the new needle upwards with the flat side away from you until it will go no further.



It is very important that the needle is inserted all the way in order for the automatic needle threader to work properly.

5. Tighten the needle screw with the universal tool.



Use the rounded end of the universal tool to loosen and tighten the screw. The universal tool is magnetic and will hold the screw, making it easy to replace and less likely to be lost.

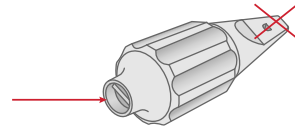
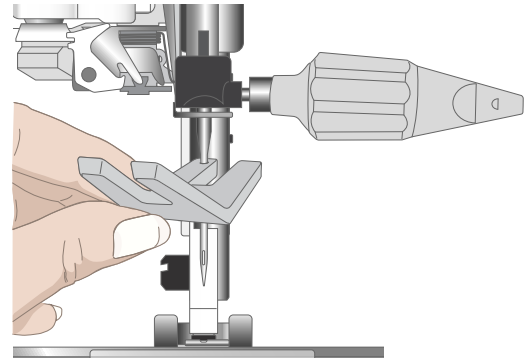

Threading

Make sure that the presser foot and needle are in the up position.

Note: When using thread cones, place a cone holder on the spool pin before placing the thread cone. This prevents the thread cone from wobbling.

Tip: When removing the thread cone from the spool pin, the cone holder might become stuck inside the thread cone. Push it out gently from the top.

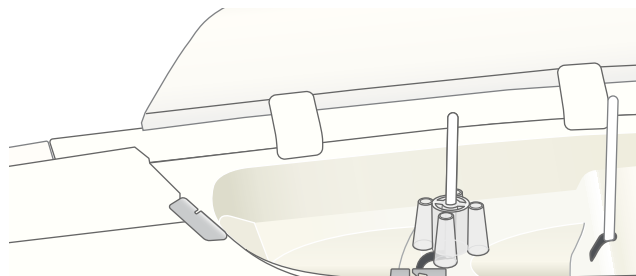

Threading the Upper Thread

For most regular thread qualities and spool sizes, threading the upper thread from the main (left) spool pin in the vertical position is recommended for optimal sewing results.

If you experience problems with the thread or sewing result, there are alternative ways to position the thread spool. See Threading Tips and Hints, page 37.

1. Hold the telescopic thread guide by the markings and pull it straight up until it clicks into place.
2. Raise both spool pins to vertical position. Place the thread spool on the main spool pin (left).

Using both hands, place the thread behind the left clip on the telescopic thread guide (A). The thread should run from right to left.

3. Hold the thread with two hands as illustrated. Floss the thread under the thread guide (B) from front to back. Pull thread back into and through threading slot (C).

Note: Continue to hold the thread lightly next to the thread guide (B) throughout the threading process. This will create a bit of tension on the thread and ensure that the thread is properly seated in the threading path.

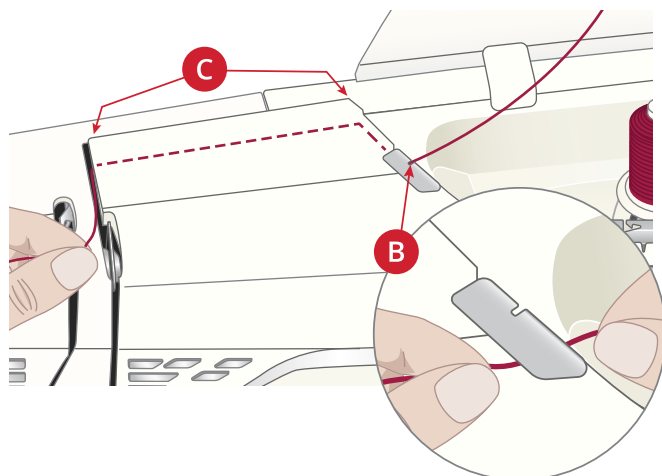
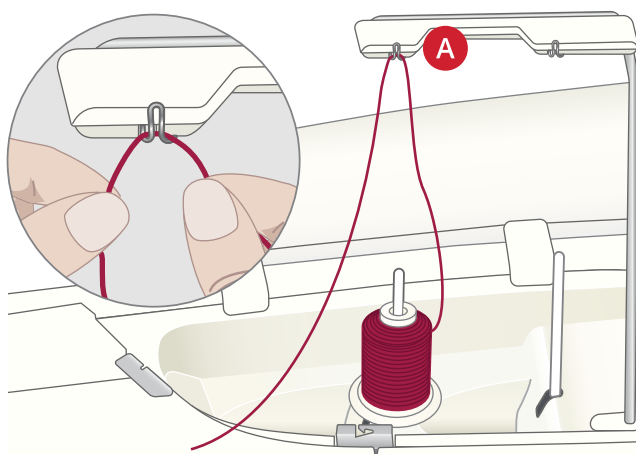
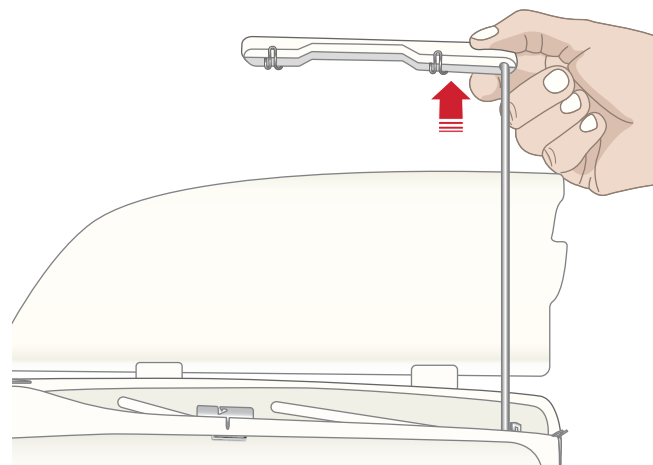

4. Pull the thread between the thread tension discs (D). Thread down through the right threading slot and then upwards through the left threading slot. Bring the thread from the right into the take-up lever (E) until it clicks into place (F), and down in the left threading slot to the last thread guide (G) just above the needle.
5. Thread the needle using the automatic needle threader or manually.



Before using the automatic needle threader, carefully read the instructions and recommendations, see Using the Automatic Needle Threader, page 33.

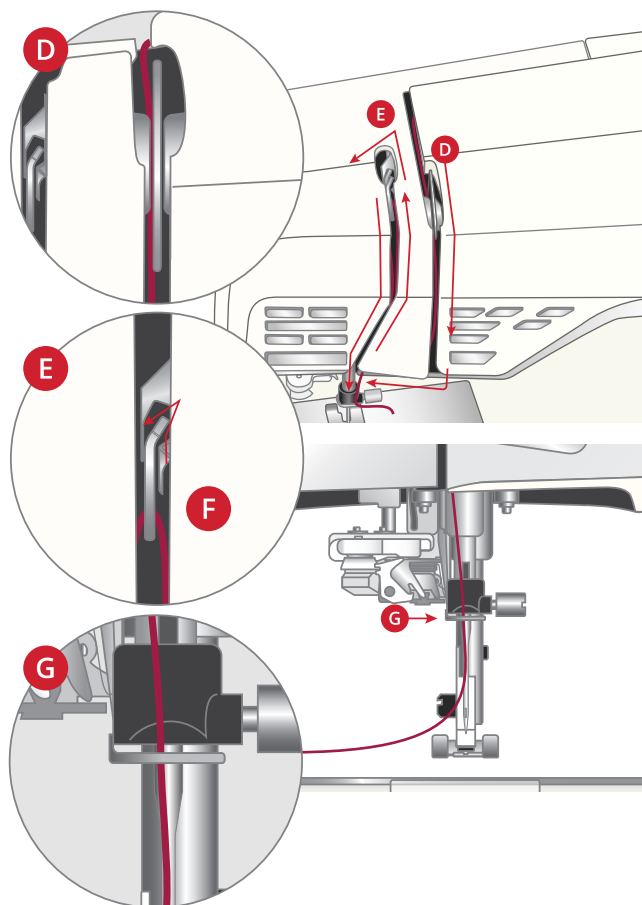

Automatic Needle Threader

Using the Automatic Needle Threader

The needle threader allows you to thread the needle automatically by simply touching a button.

 *Make sure that the needle is inserted correctly and pushed up all the way into the needle clamp before using the automatic needle threader. Check that the needle is not damaged or bent, and make sure to match the thread weight and needle size according to our recommendations in *Selecting Correct Thread/Needle Combination*, page 34.*

1. Place the thread under the hook (A) and pull it between the discs (B) until it “clicks” into place.
2. Pull the thread up to the sewing head thread cutter and cut excess thread by pulling the thread from back to front in the thread cutter.
3. Touch the automatic needle threader button on the sewing head. The presser foot is automatically lowered during the threading sequence, and will rise again when threading is finished.

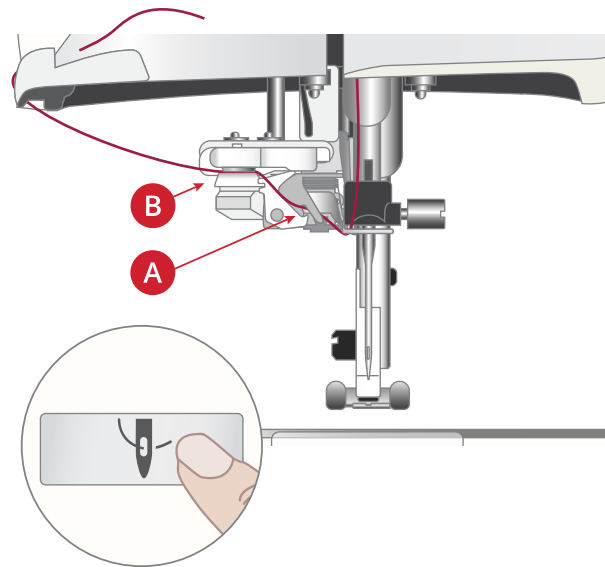

 *The needle threader is designed to be used with needles size 70-120. You cannot use the needle threader with needles size 65 or smaller, wing needles, twin needles or triple needles.*

Specialty threads such as invisible and other stretchy threads, metallic or flat metallic threads, and some heavy weight threads may not be caught correctly by the hook on the automatic needle threader. If this happens, the needle will not be threaded. Try using the automatic needle threader again or thread the needle manually.

When threading the needle manually, make sure that the needle is threaded from front to back.

The automatic needle threader cannot be used with all optional accessories available for your EPIC™ 95Q machine. To avoid damage to the needle threader and/or optional accessory we recommend using the automatic needle threader before attaching the accessory or thread the needle manually.

 *Before using the needle threader with the Sensor One-Step Buttonhole Foot attached, lift the wheel of the foot up to avoid damage to the needle threader and foot.*

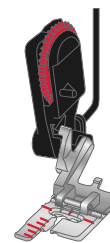

Selecting Correct Thread/Needle Combination



The combination of the thread weight and the needle size is extremely important when using the automatic needle threader. Unsuitable combinations, such as using a heavy weight thread for a fine needle, may cause damage to the needle threader.

Avoid using fine needles with heavy fabrics to reduce the risk of bending the needle. Using the automatic needle threader with a bent needle may cause damage to the needle threader.

Fabric		Thread	Needle
Woven light	Chiffon, organza, batiste, challis, crepe de chine, etc.	Light weight threads: <ul style="list-style-type: none"> • fine cotton, polyester or silk sewing thread • rayon embroidery thread 	Universal 130/705H 70/10-80/12
Woven medium	Calico, quilting fabrics, crepe, broadcloth, velvet, etc.	Medium weight threads: <ul style="list-style-type: none"> • fine/normal cotton or polyester sewing thread • rayon embroidery thread 	Universal 130/705H 80/12-90/14
Woven heavy	Denim, tweed, canvas, terrycloth, etc.	Medium/heavy weight threads: <ul style="list-style-type: none"> • normal cotton or polyester sewing thread • top stitching thread • rayon embroidery thread 	Universal 130/705H 90/14-110/18
Stretch light	Tricot, single knit jerseys, etc.	Light weight threads: <ul style="list-style-type: none"> • fine cotton or polyester sewing thread • rayon embroidery thread 	Stretch 130/705H-S 75/11
Stretch medium	Sweater knits, double knit, velour, swimwear, etc.	Medium weight threads: <ul style="list-style-type: none"> • normal cotton or polyester sewing thread • rayon embroidery thread 	Stretch 130/705H-S 90/14
Stretch heavy	Sweater knits, fleece, etc.	Medium weight threads: <ul style="list-style-type: none"> • normal cotton or polyester sewing thread • rayon embroidery thread 	Stretch 130/705H-S 90/14
Leather	Suede and leather	Medium weight threads: <ul style="list-style-type: none"> • normal cotton or polyester sewing thread • rayon embroidery thread 	Stretch 130/705H-S 90/14
Vinyl	Vinyl, faux leather and suede	Medium weight threads: <ul style="list-style-type: none"> • normal cotton or polyester sewing thread • rayon embroidery thread 	Universal 130/705H 80/12

Note: Specialty fabrics and threads may require a special needle for best stitch results. Refer to your HUSQVARNA® VIKING® retailer for more information on needle types and sizes for your sewing needs.

Threading for Twin Needle

Replace the sewing needle with a twin needle. Make sure that the presser foot and needle are in the up position.

Note: When using large thread cones on the auxiliary spool pin, place the large spool holder with the flat side up and a cone holder on the spool pin before adding the thread cone.

1. Raise both spool pins to vertical position. Place a thread spool on each spool pin.

Using both hands, place the thread from the main spool pin behind the left clip on the telescopic thread guide (A), from right to left, and then place the thread from the auxiliary spool pin behind the right clip on the telescopic thread guide (B), from right to left.

Note: Do not place the thread from the auxiliary spool pin behind both clips on the telescopic thread guide, as this will create too much thread tension.

2. Hold both threads with two hands as illustrated. Floss the threads under the thread guide (C) from front to back. Pull the threads together back into and through threading slot (D).

Note: Continue to hold the threads lightly next to the thread guide (C) throughout the threading process. This will create a bit of tension on the threads and ensure that the threads are properly seated in the threading path.

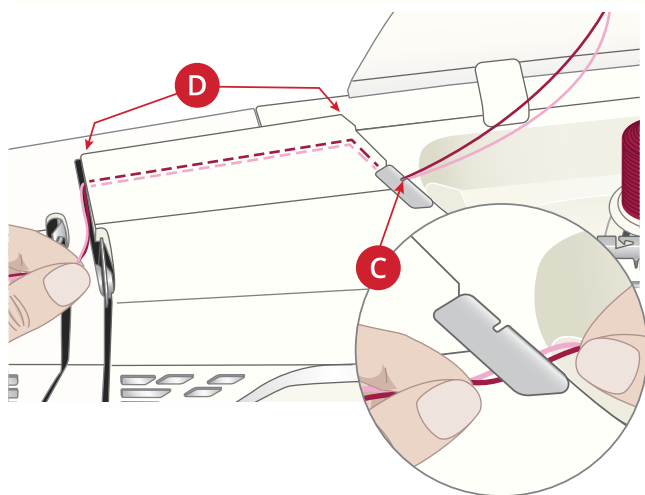
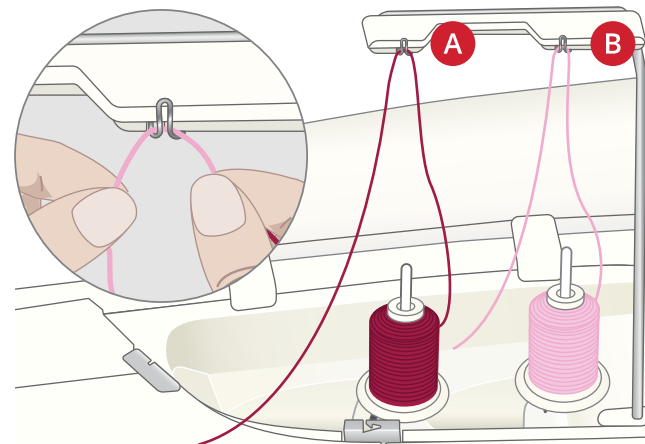
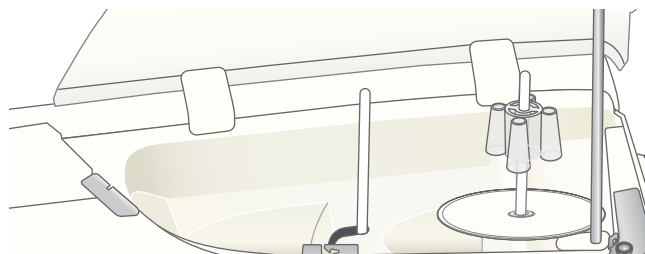

3. Pull the threads between the thread tension discs (E). Make sure that you place one thread to the left and one to the right side of the tension discs.

Thread down through the right threading slot and then upwards through the left threading slot. Bring the threads from the right into the take-up lever (F) until they click into place (G), and down in the left threading slot. One thread should be placed inside the needle thread guide (H) and the other one outside. Make sure the threads do not become twisted together.

4. Thread the twin needle manually.



Do not use the automatic needle threader for twin needle!

Note: The weight and irregular surface of specialty threads such as metallic increases the amount of friction on the thread. By reducing the tension, the risk of needle breakage and thread breakage is reduced.

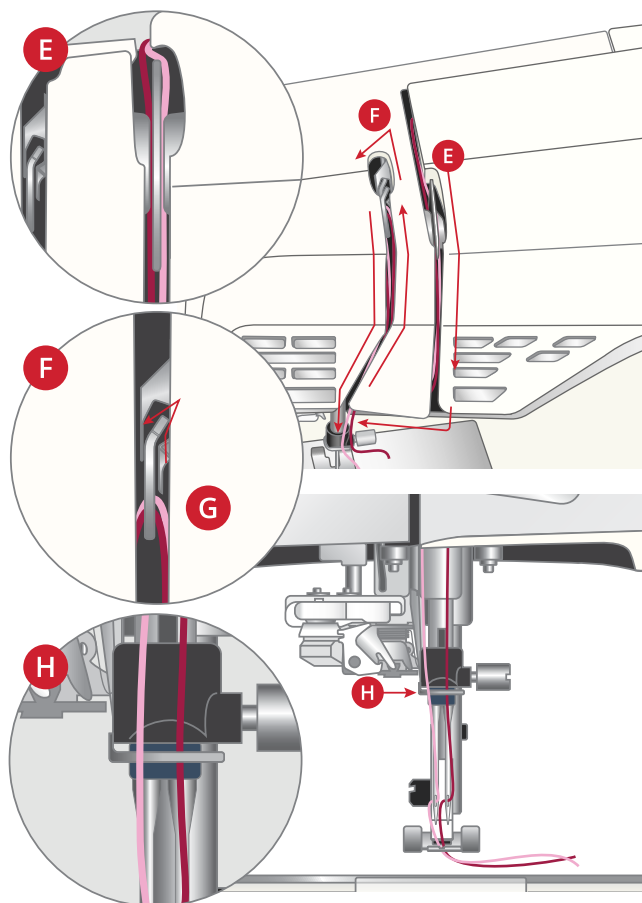

Threading Tips and Hints

There are many threads on the market today developed for different purposes. The quality and structure of the thread as well as the shape and size of the thread spool can affect the behavior of the thread. Threads can also behave differently if the spool is full or nearly empty.

If experiencing problems, try the tips and hints below.

Note: Always test sew on a scrap piece of fabric to check the sewing result.

If the Thread Spool is Pulled up on the Spool Pin

When the thread on the spool is running low, the thread can snag on the edge of the spool and pull the spool up on the spool pin. Place a spool cap on top of the thread spool to keep it in place. Always use a spool cap slightly larger than the thread spool to prevent the thread from snagging. The flat side of the spool cap should be pressed firmly against the spool. There should be no space between the spool cap and the thread spool.

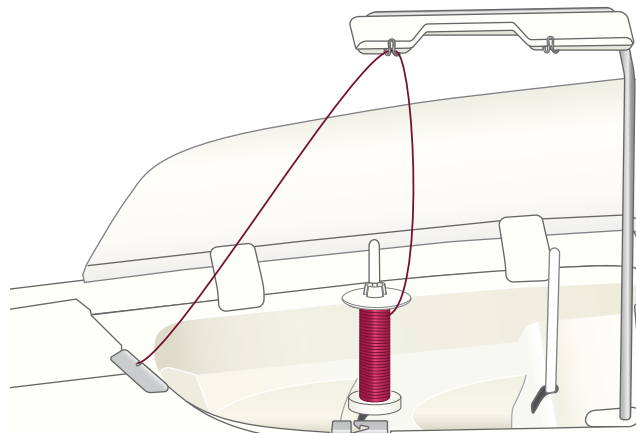

If the Thread Slides Down on the Standing Thread Spool

If the thread is of a quality that unwinds easily and slides down on the standing thread spool it can get caught under the thread spool around the spool pin and break. Place the large spool holder on the spool pin with the flat side up before placing the thread spool.

If the thread spool has the same diameter as the large spool holder, place a thread net as illustrated from below over the spool before placing it on the spool pin.

Note: To prevent snagging or increased thread tension on the thread, the thread net should cover the lower part of the thread spool only, not the top where the thread spool narrows.

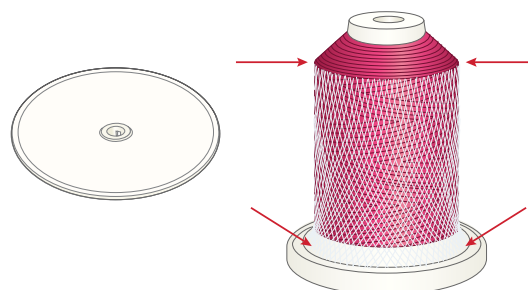

If the Thread Tangles or Curls when Unwinding from the Spool

For smaller spools of specialty thread, the main spool pin can be used in tilted position, allowing the thread to roll off the spool.

Place the thread spool on the spool pin. Do not place a spool cap on top of the spool as it may prevent the spool from rotating. Pull thread up to the telescopic thread guide and thread as described under Threading the Upper Thread, page 31.

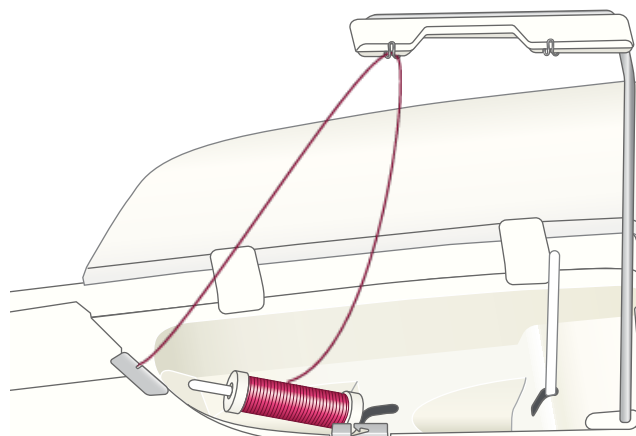

Bobbin Winding

All types of thread, including specialty threads such as invisible or other stretchy threads, metallic or flat metallic threads, should be wound directly from the auxiliary spool pin without passing the needle and presser foot.

Note: Always wind specialty threads at lower speed.

Note: When using large thread cones, place the large spool holder with the flat side up and a cone holder on the auxiliary spool pin before adding the thread cone.

1. Place a thread spool on the auxiliary spool pin.

Using both hands, pull the thread behind the right clip on the telescopic thread guide (A). The thread should run from right to left.

2. Bring the thread through bobbin winding thread guide (B) from back to front and to the right.

Bring the thread through bobbin winding thread guide (C), around the thread tension disc (D) and down through thread guide (E) as illustrated.

 *For some specialty threads, following the normal threading path will result in a bobbin that is wound too tight. If this happens, bypass thread guide (C) and thread tension disc (D) to reduce the amount of tension on the thread. Pull the thread from thread guide (B) directly to thread guide (E) instead.*

3. Place the bobbin on the bobbin winder on the lower right side of the machine. The bobbin only fits on one way, with the logo facing out.

 *The bobbins included are designed especially for your EPIC™ 95Q machine. Only use HUSQVARNÄ® VIKING® category 8 bobbins.*

Wind a few turns of thread clockwise around the bobbin and cut excess thread with the thread cutter (F).

4. Push the bobbin winding lever (G) towards the bobbin. A pop-up appears on screen. To adjust winding speed drag the slider. Stop and start the bobbin winding with the button in the pop-up.
5. When the bobbin is full, the bobbin winding lever will move back and the winding will stop automatically. The pop-up message closes. Remove the bobbin and cut the thread using the bobbin winding thread cutter (F).

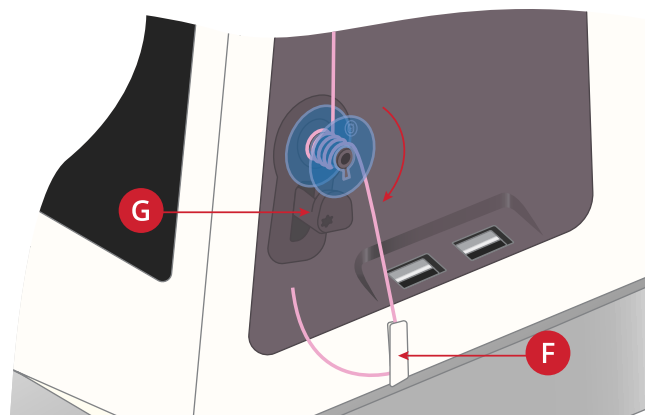
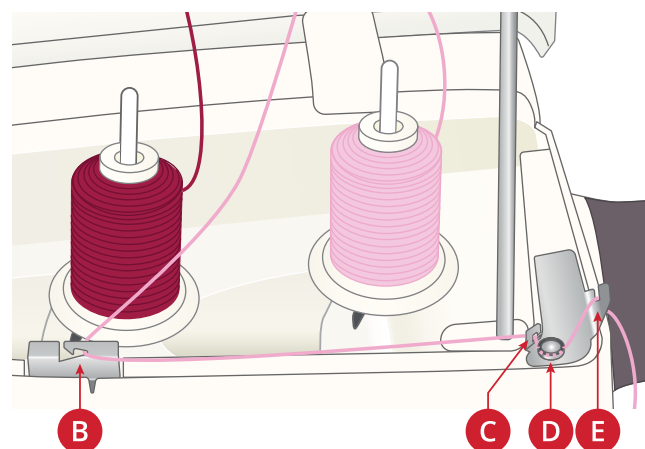
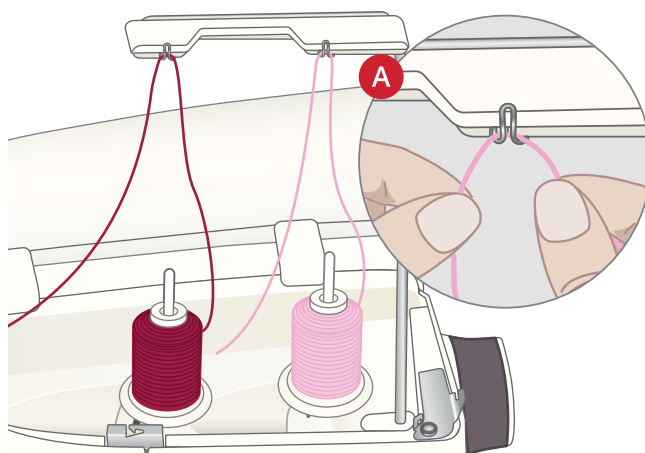
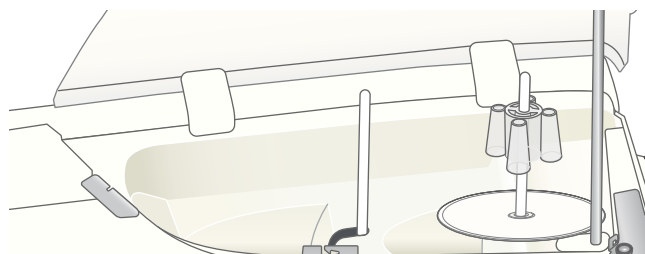

Winding Through the Needle

When using the same thread in the needle and bobbin, it is convenient to wind a new bobbin directly through the needle without having to unthread/re-thread your machine.



We do not recommend winding speciality threads such as invisible or other stretchy threads, metallic or flat metallic threads through the needle. Very heavy and coarse threads should not be wound through the needle either as the thread tension can become too high, causing the needle to break. Wind speciality threads as described under Bobbin Winding, page 38.

1. Make sure that the presser foot and needle are in the up position.
2. Thread the machine as described under Threading the Upper Thread, page 31.
3. Pull the thread from the needle, under the presser foot and up to the right.

Note: Always use a metal presser foot when bobbin winding from the needle.

4. Bring the thread from right to left into the bobbin winding thread guide (A), and from left to right through thread guide (B).
5. Bring the thread directly through bobbin winding thread guide (C).

Note: Bypass the tension disc when winding through the needle.

6. Place the bobbin on the bobbin winder on the lower right side of the machine. The bobbin only fits on one way, with the logo facing out.



The bobbins included are designed especially for your EPIC™ 95Q machine. Do not use bobbins from other machine models.

Wind a few turns of thread clockwise around the bobbin and cut excess thread with the thread cutter (D).

7. Push the bobbin winding lever (E) towards the bobbin. A pop-up appears on screen. To adjust winding speed drag the slider. Stop and start the bobbin winding with the button in the pop-up.
8. When the bobbin is full, the bobbin winding lever will move back and the winding will stop automatically. The pop-up message closes. Remove the bobbin and cut the thread using the bobbin winding thread cutter (D).

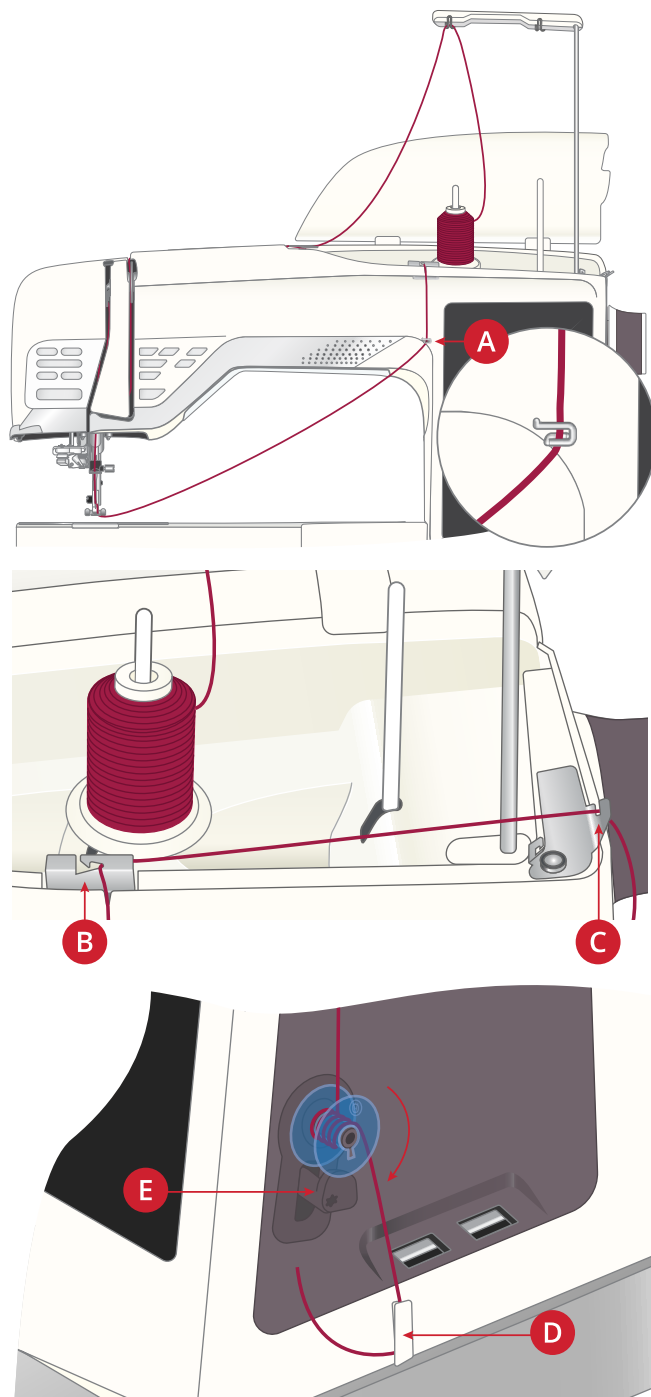

Note: If you experience difficulty winding a bobbin through the needle and you are using a large thread cone, move the cone to the auxiliary spool pin and use the right clip on the telescopic thread guide instead. Place the large spool holder with the flat side up and a cone holder on the auxiliary spool pin before adding the thread cone.

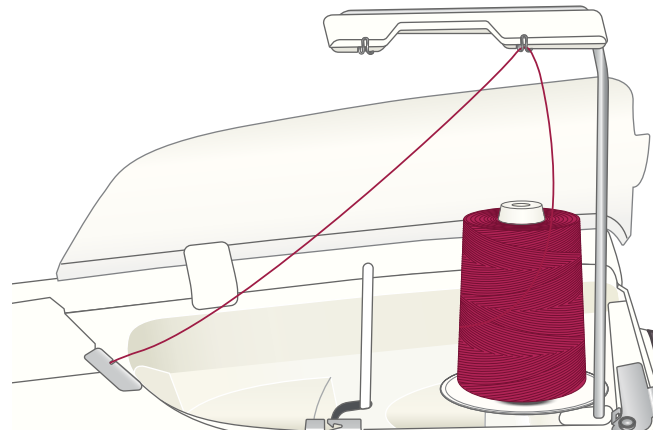

Inserting the Bobbin

 Use only the bobbins designed for your EPIC™ 95Q machine.

1. Open the bobbin cover by pushing the release button (A) to the right. Remove the cover.
2. Place the bobbin in the bobbin case. It drops in only one way with the logo facing up. The bobbin will then rotate counterclockwise when you pull the thread.
3. Place your finger on the bobbin to keep it from turning as you pull the thread firmly to the right and then to the left into the tension spring (B) until it “clicks” into place. Continue threading around (C) and to the right of the thread cutter (D).
4. Replace the bobbin cover. Pull the thread to the left to cut.

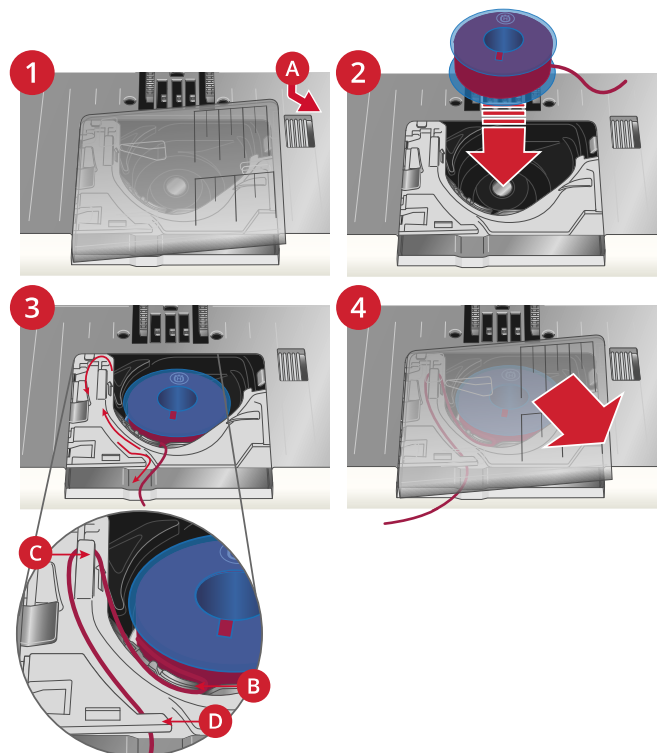

Integrated Dual Feed (IDF) System

For sewing with an even feed also on more challenging fabrics, your machine provides the ideal solution: the Integrated Dual Feed (IDF) System. The IDF System feeds the fabric from the top and bottom at the same time. The material is fed evenly, eliminating puckering on seams in light weight fabrics such as silk and rayon. The dual feed action of the IDF System prevents layers from shifting while sewing, keeping quilt layers aligned and ensuring a more perfect match when sewing plaid or striped fabrics.

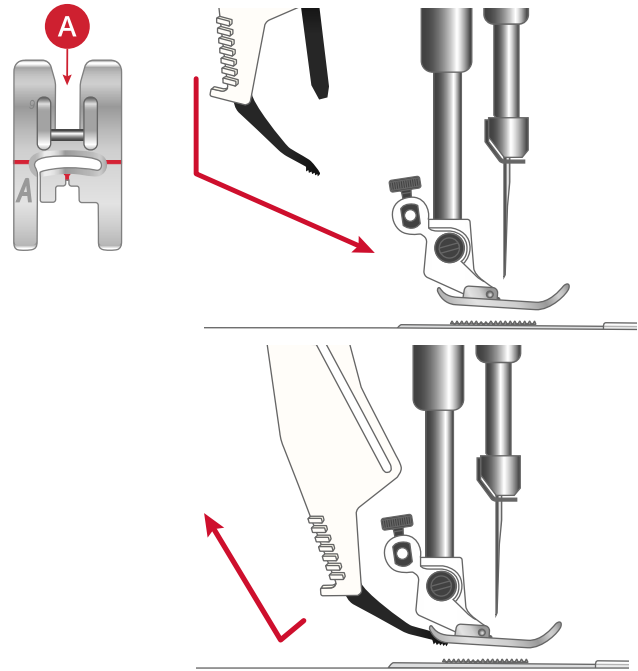

Engaging the IDF System

Important: For all work with the IDF System, use presser feet with the center back cut-out (A). Raise the presser foot to extra high position. Press the IDF System down until it engages.

Note: Your machine is equipped with an IDF sensor. You will be alerted if the IDF System isn't set according to the stitch recommendations for the selected stitch.

Disengaging the IDF System

Raise the presser foot. Hold the IDF System with two fingers at the ribbed ankle. Pull the IDF System down, then pull it away from you to release the IDF System slowly upward.

Changing the Presser Foot

1. Make sure that the needle is in the highest position. Pull the presser foot down and towards you.
2. Line up the cross pin on the foot with the gap in the presser foot ankle. Push the foot into the gap until the foot snaps into place.

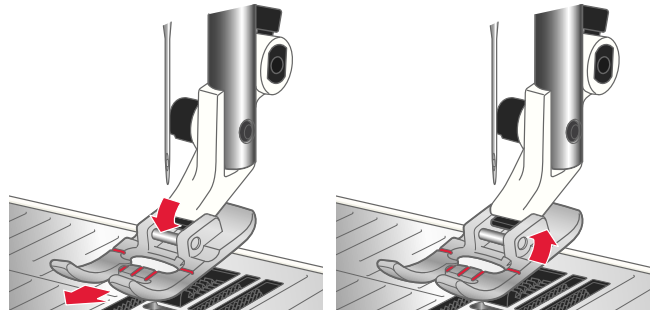

Attaching the Sensor One-Step Buttonhole Foot

1. Snap on the Sensor One-Step Buttonhole Foot.
2. Insert the plug, with the three dots facing out, into the accessory socket at the back of the sewing head.

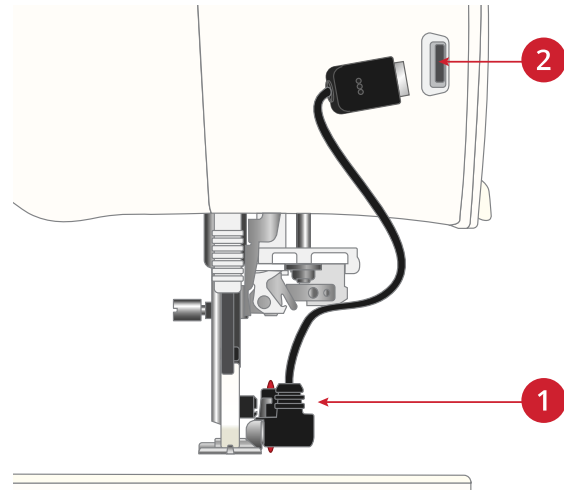

 Before using the automatic needle threader with the Sensor One-Step Buttonhole Foot attached, lift the wheel of the foot up to avoid damage to the needle threader and foot.

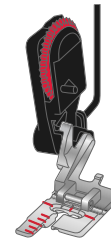

Changing to Straight Stitch Plate

The Straight Stitch Plate is used when using certain techniques in sewing mode, such as quilt piecing. The smaller hole in the Straight Stitch Plate supports the fabric closer to the needle and helps prevent the fabric from being pulled down into the bobbin area, especially at the beginning and/or end of a seam.

1. Remove the presser foot. Open the bobbin cover by pushing the release button (A) to the right. Remove the cover.
2. Make sure that the feed teeth are lowered. Place the universal tool under the needle plate as shown and gently turn the universal tool to pop off the needle plate.

Note: Lower the feed teeth by touching the presser foot up and extra lift button.

Note: When changing the needle plate, clean any lint and threads from the bobbin area.

3. With feed teeth lowered, position the Straight Stitch Plate so that it fits into the notches at the back (B). Press the Straight Stitch Plate down until it clicks into place. Replace the bobbin cover.

 To prevent needle breakage or damage to the plate, remove any accessory that is not compatible with the Straight Stitch Plate, such as twin needle.

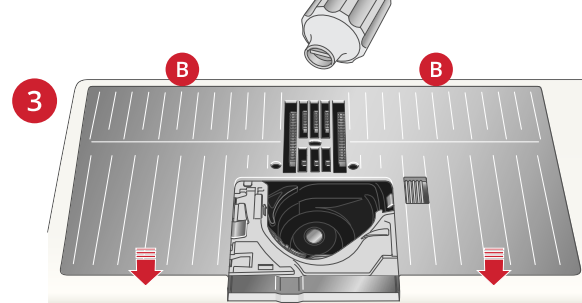
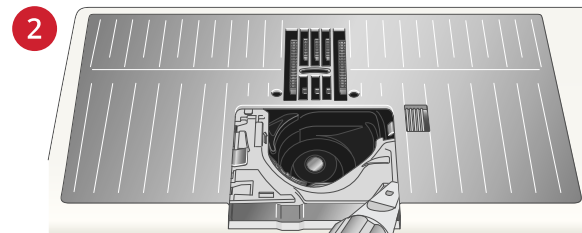
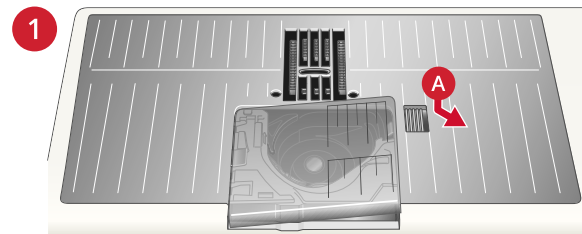

3 The Multi-Touch Screen

Common Functions

The following functions on the screen are used frequently.

OK

Confirms changes and pop-up messages and returns to previous window.



Cancel

Cancels changes and pop-up messages and returns to previous window.



Touch & Hold

Some buttons have additional functions, marked with an arrow at the lower right corner. To access those functions, touch & hold on the button for a few seconds.



Topbar

On the topbar you will find the following functions: WiFi, *mySewnet*TM, wireless firmware update, home screen, quick help and settings.

Note: All functions may not always be available at the same time.



- | | |
|----------------------------------|----------------|
| 1. WiFi | 4. Home screen |
| 2. <i>mySewnet</i> TM | 5. Quick help |
| 3. Wireless firmware update | 6. Settings |

WiFi

Touch the WiFi button in the topbar and activate WiFi. Select a network from the list of available networks. If your network is password protected, you will be prompted to enter the password in the pop-up.

You can also connect to a network with WiFi in settings.

If you do not get any signal or have a low signal strength see troubleshooting.



	WiFi is connected with high signal strength.
	WiFi is connected with medium signal strength.
	WiFi is connected with low signal strength.
	WiFi is connected but the network does not work properly.
	WiFi is disconnected. Connect to a network through the WiFi button or WiFi settings.

Read more about WiFi in the machine in the WiFi chapter.





mySewnet™

Touch the *mySewnet™* button on the topbar and touch sign in. Sign in to your *mySewnet™* account or create a new *mySewnet™* account.

When signed in you will see how much available space there is left in the *mySewnet™* cloud.

The synchronization status will be shown on the *mySewnet™* button on the topbar:

If your machine cannot connect to *mySewnet™* cloud or does not synchronize, see troubleshooting.

	All files in the machine and <i>mySewnet™</i> cloud are synchronized.
	The machine is currently synchronizing files with the <i>mySewnet™</i> cloud.
	The <i>mySewnet™</i> cloud cannot synchronize with your machine. Check if you have available space on the <i>mySewnet™</i> cloud.
	Signed in to your <i>mySewnet™</i> account but the machine has no WiFi connection. Connect the machine to a WiFi network.
	Not signed in to your <i>mySewnet™</i> account. Log in or create a <i>mySewnet™</i> account to be able to synchronize files from the machine to the <i>mySewnet™</i> cloud.

Read more about *mySewnet™* cloud in the *mySewnet™* chapter.



Wireless Firmware Update

To be able to get the latest firmware you need to connect to a network using WiFi or update through a USB device. When connected, your machine will automatically search for available firmware update. Touch the firmware update button on the topbar to download and install the latest firmware.

Read more about wireless firmware update in the section firmware update using WiFi.



Home Screen

The home screen is filled with guidance, inspiration and help. Here you'll find the JoyOS ADVISOR™ feature which includes a sewing and quilting advisor that will guide you through different techniques and automatically choose correct settings.

Get tips and inspiration through the *mySewnet™* blog, read your user's guide for instant help or find several guides and sewing instructions within the knowledge center.

Read more about the home screen.



Quick Help

Touch quick help on the topbar, then touch an icon, button or an area on the screen you want information about.

Some quick helps will refer to the built-in user's guide for more information. Touch the button to open the built-in user's guide.



Settings

Touch settings button to open the settings window.

Settings that are recommended will automatically be set when loading stitches from the JoyOS ADVISOR™ project menu. This will be indicated with an exclamation mark on the settings button. Touch the button to open settings and see which setting(s) has been changed.



4 WiFi & *mySewnet*[™] Services

WiFi Introduction

Your EPIC™ 95Q machine features WiFi which makes it possible to connect your machine wireless to the *mySewnet*™ services.





Getting Started With WiFi

Touch the WiFi button and activate WiFi. Select a network from the list of available networks. If your network is password protected, you will be prompted to enter the password in the pop-up to be able to connect.

Touch the “information” button to open an information pop-up about the network. You can also see the signal strength and if the network is password protected, indicated with a closed padlock.

You can also connect to a network with WiFi in WiFi settings.

If you do not get any signal or have a low signal strength see troubleshooting.

	WiFi is connected with high signal strength.
	WiFi is connected with medium signal strength.
	WiFi is connected with low signal strength.
	WiFi is connected but the network does not work properly.
	WiFi is disconnected. Connect to a network through WiFi button or WiFi settings.

Hidden Network

Touch the button to connect to a hidden network. A pop-up will be shown on the screen where you can enter the name of the hidden network.





Firmware Update Using WiFi

It is always recommended to install the latest firmware in your machine.

To be able to get the latest firmware wirelessly you need to connect to a network using WiFi. When connected, your machine will automatically search for available firmware update. If the machine has detected that there is a newer firmware available, the firmware update button will be visible. Touch the button to download and install the latest firmware.

When the update is completed the machine will restart automatically. Check the firmware version number in settings, machine information.

	Indication that your machine does not have the latest firmware. Touch the button to open a pop-up to download and install the latest firmware.
	A spinning wheel will be shown on the firmware update button indicating that the firmware is downloading.
	An exclamation mark will be shown on the firmware update button to notify that there is a downloaded firmware waiting to be installed.

Firmware Update Using a USB Device

Visit the HUSQVARNA® VIKING® website at www.husqvarnaviking.com and find your machine. Here you will find the available updates.

1. Download the update firmware zip file. Unzip the file and copy the file (.clo) to a USB device.

Note: Do not change the name of the file or do not copy the file into an existing folder on the USB device.

Note: Make sure that there is no old firmware update file (.clo) on the USB stick when copying the new firmware update file (.clo). The file name is not unique.

2. Make sure that the machine is turned off. Connect the USB device loaded with the new firmware version to a USB port on your machine.
3. Press and hold the reverse button, located on the right side of the sewing head, and turn on your machine with the ON/OFF switch. Release the reverse button when an update icon is shown on the screen.
4. The firmware update will be verified and installed. The machine may restart several times during the update process. Do not turn off the machine.
5. When the update is completed the machine will restart automatically. Check the software version number in settings, machine information.

Complimentary Software (PC and MAC)

A computer software package is available for your machine. It adds the following features:

- The *mySewnet*[™] cloud sync tool allows you to synchronize your content in the *mySewnet*[™] cloud and your sewing machine with a folder on your computer. Drag and drop files to the folder on your computer and the files will automatically be transferred to the *mySewnet*[™] cloud and accessible from your machine when signed in to the *mySewnet*[™] account.

Visit the HUSQVARNA® VIKING® website at www.husqvarnaviking.com to get support. Select your machine model and download the software.

More information and detailed installation instructions are available on the download page.

mySewnet™ Services

The *mySewnet™* services contains the following:

- *mySewnet™* account – A personal login-based account to access the different *mySewnet™* services.
- *mySewnet™* cloud – A cloud based service where you will save and access your personal files from three different places: the *mySewnet™* cloud folder on the machine, the *mySewnet™* cloud sync tool on your computer and the *mySewnet™* menu.
- *mySewnet™* apps – There are several apps available to download for free to your mobile device. For example, you will be able to view current machine status through the mySewMonitor app.
- *mySewnet™* menu – An entrance to all the web services available when you have a *mySewnet™* account.
- *mySewnet™* blog – A blog with the latest product news, sewing instructions and inspiration.

mySewnet™ Account

Register an account to be able to use the *mySewnet™* services. You can create your account from *mySewnet™* button or in *mySewnet™* settings.

Touch the “Register new account” button and fill in the information required.

An account can also be created through the *mySewnet™* menu at husqvarnaviking.mysewnet.com.







The screenshot displays the mySewnet™ mobile application interface. At the top, there is a dark header with the mySewnet™ logo and a question mark icon. Below the header, a notification bar reads "Not Signed In" with a warning icon and the text "Sign in to synchronize your mySewnet™ content to the machine." The main content area is titled "Sign In" and includes a sub-message: "The machine needs to be connected to a Wifi network to be able to login to a personal mySewnet™ account." There are two input fields: "Username:" and "Password:". Below these fields is a "Sign In" button. At the bottom of the form, there are two buttons: "Forgot my password" and "Register new account".

mySewnet™ Cloud

mySewnet™ cloud is a service where you save and access your personal files, projects and stitches, over the internet instead of on your computer's hard drive. It is available to all owners and users of a mySewnet™ cloud enabled machine. The mySewnet™ cloud offers a simple way to manage and access personal files from different devices:

- mySewnet™ enabled machine.
- PC or MAC
- Smartphone or tablet.

The synchronization status in your machine will be shown on the mySewnet™ button in the topbar:

	All files in the machine and mySewnet™ cloud are synchronized.
	The machine is currently synchronizing files with the mySewnet™ cloud.
	The mySewnet™ cloud cannot synchronize with your machine. Check if you have available space on the mySewnet™ cloud.
	Signed in to your mySewnet™ account but there is no connection to the mySewnet™ server.
	Not signed in to your mySewnet™ account. Log in or register a mySewnet™ account to be able to synchronize files from the machine to the mySewnet™ cloud.

If your machine cannot connect to mySewnet™ cloud or does not synchronize, see troubleshooting.

Used Space in mySewnet™ Cloud

The mySewnet™ cloud will store fonts, stitches and other files from your machine.

Touch the mySewnet™ button on the topbar or go to mySewnet™ settings. When only a small amount of space is left, your machine will alert you once. If you continue to fill the space, it will not remind you again, until the space is completely full. Delete or move files to a USB device to free space.

Note: The mySewnet™ cloud space gets activated the first time you sign in on your mySewnet™ account from the machine.



Installation of mySewnet™ Cloud Sync Tool for Computer

Install the *mySewnet*™ cloud sync tool to support synchronization of a local folder on your computer with the content stored in *mySewnet*™ cloud.

To download *mySewnet*™ cloud sync tool for your computer and get detailed installation instructions, go to cloud.mysewnet.com

Apps

There are several apps available to download for free to your mobile device. Visit our website to find and read more about our selection of apps. You can download them directly at App Store and Google Play.

mySewnet™ Menu

The *mySewnet*™ menu is the entrance to all the web services that are available when you have a *mySewnet*™ account.

You can access the menu at www.husqvarnaviking.com to access the following services:

- Account - This is where you register and handle your account.
- *mySewnet*™ cloud – Possibility to manage your personal files. The files are automatically synchronized with the *mySewnet*™ cloud folder in the EPIC™ 95Q machine and the *mySewnet*™ cloud sync tool.
- Help Center - Get help to get started with *mySewnet*™ apps and services.
- Project Creator - A web service where you create and share step-by-step instructions.

mySewnet™ Blog

In *mySewnet*™ blog you can view the latest product news, sewing instructions and get inspiration!

The machine needs to be connected to WiFi to be able to see the feed.

5 Home Screen

Home Screen— Overview

The home screen is filled with guidance, inspiration and help. Here you'll find the JoyOS ADVISOR™ feature which includes a sewing and quilting advisor that will guide you through different techniques and automatically choose correct settings.

Get tips and inspiration through the *mySewnet*™ blog, read your user's guide for instant help or find several guides and sewing instructions within the knowledge center.



1. User profile
2. Sign in/out *mySewnet*™ account
3. JoyOS ADVISOR™ feature
4. Fabric selection
5. Technique selection
6. Minimize/expand JoyOS ADVISOR™ project files
7. JoyOS ADVISOR™ project files
8. Continue JoyOS ADVISOR™ project file
9. Load smart save

- | | | |
|-----------------------------------|---------------------------|------------|
| 10. JoyOS ADVISOR™ project viewer | 13. Home screen button | 16. Search |
| 11. User's guide | 14. Edit machine nickname | |
| 12. Start new | 15. Welcome center | |

User Profile

If you're not signed in to your *mySewnet*™ account, there will be a sign in button. When you are signed in to your *mySewnet*™ account, your user name will be shown. You will receive information on for example how much time you've spent sewing on your machine.

Welcome Center

Your machine will randomly give you tips on JoyOS ADVISOR™ project files to try out.

If you click on the edit machine nickname button, you can change name of your machine.

This can be useful when owning more than one machine to distinguish one machine from another. The name will be shown on the screensaver.

You can also change your machine's nickname in machine settings.

mySewnet™ Blog

In *mySewnet*™ Blog you can view the latest product news, sewing instructions and get inspiration!

Touch on a post to read the full content.

The machine needs to be connected to WiFi to be able to see the feed.

**mySewnet*™ Blog is only available in selected regions.

If you cannot see the blog on your home screen, it's not available in your language.

Filter *mySewnet*™ Blog Posts

You can filter blog posts by:

- Sewing instructions
- What's new
- Tips & hints
- Stay connected
- *mySewnet*™ library

Minimize/expand *mySewnet*™ Blog

You can minimize *mySewnet*™ blog tab by touching minimize/expand. Touch again to expand and see the blog posts.

Home Screen — Common Functions

Search

Touch the search tab and a window will open allowing you to search within the JoyOS ADVISOR™. Enter your search and touch OK. The machine will display the search results.

You can also find the search tab in the User's Guide to enable you to search within the User's Guide.



Minimize/Expand Project files

Touch to expand the view of all available project files.

In this view, select fabric and select technique will not be visible.

Touch minimize/expand project files again to go back to default view.

Start New

Always start with selecting the fabric you will sew on. If you want to start sewing without loading any sewing technique, touch the start new button in the bottom right corner. You will enter sewing mode with the selected fabric and a straight stitch will be loaded by default. In sewing mode you can view and select all built-in stitches in the machine from the stitch menu.



Continue

If a technique is loaded and you re-enter the home screen, a continue button with the current loaded JoyOS ADVISOR™ project will be shown. In sewing you can select another fabric. Touch continue button to load the selected fabric into your current JoyOS ADVISOR™ project.

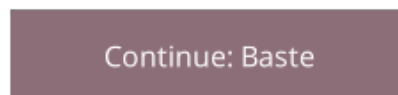

Load Smart Save

Smart save remembers and stores all sewing adjustments and settings. This makes it possible to turn off your machine and continue sewing later.

Simply go to the home screen and touch load smart save button. The machine will load the stitch and settings as it were when smart save was last performed.

Read about how to smart save.



Project Menu

In the project menu recommended stitches will be shown for the current loaded sewing technique.



Project Viewer

When loading a JoyOS ADVISOR™ project from the JoyOS ADVISOR™ feature it will be shown in the project viewer which is always accessible on the screen. When the project viewer is minimized, touch the button to expand.



JoyOS ADVISOR™ Project Viewer – Overview

1. Move the viewer on the screen to be able to reach buttons that might be hidden when following the instructions.
2. Decrease or increase the text in the viewer by touching the A- or A+ buttons.
3. Select the fabric that you will use. The stitches loaded through the project are set to fit your selected fabric.
4. To minimize, touch at the top right corner. To expand it again, touch the JoyOS ADVISOR™ project viewer button.
5. Touch the right arrow to step forward in the instruction and touch the left arrow to step backwards.
6. Information shown for each step in the instruction.
7. Every picture can be expanded by touching it in the viewer.
8. Touch the play icon to load an animation. More detailed description in animations.
9. Load the recommended stitch for the loaded technique by touching the stitch in the viewer.

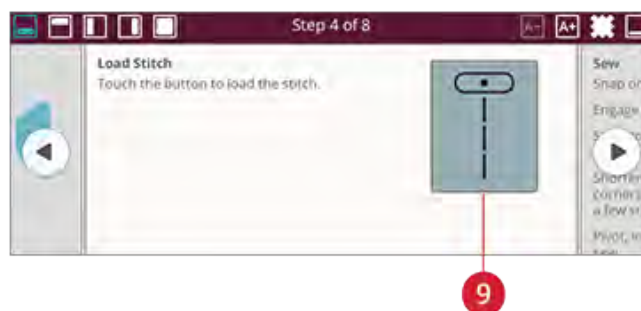
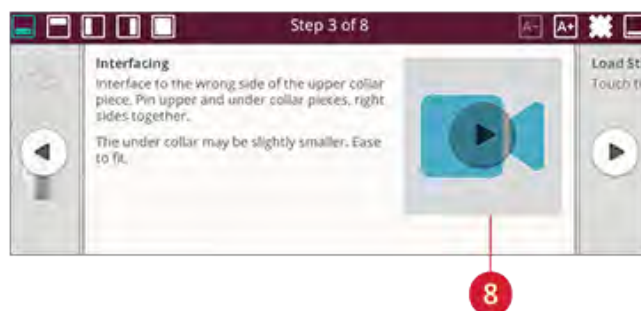

How to Play Animations

In the video player you can pause, rewind, fast forward, set the animation on repeat and turn full screen mode on/off. Touch cancel to close the video player. Touch & hold on rewind to start the animation from the beginning.

1. Watch clip/full animation
2. Rewind (Touch & hold to go to beginning)
3. Play/pause
4. Fast forward
5. Repeat on/off
6. Full screen on/off
7. Close



JoyOS ADVISOR™

SEWING ADVISOR™ – Overview

When loading a sewing technique the machine will select the best stitch and settings for your chosen fabric and project.

Depending on which choices you make, your JoyOS ADVISOR™ feature will recommend the most suitable sewing techniques.

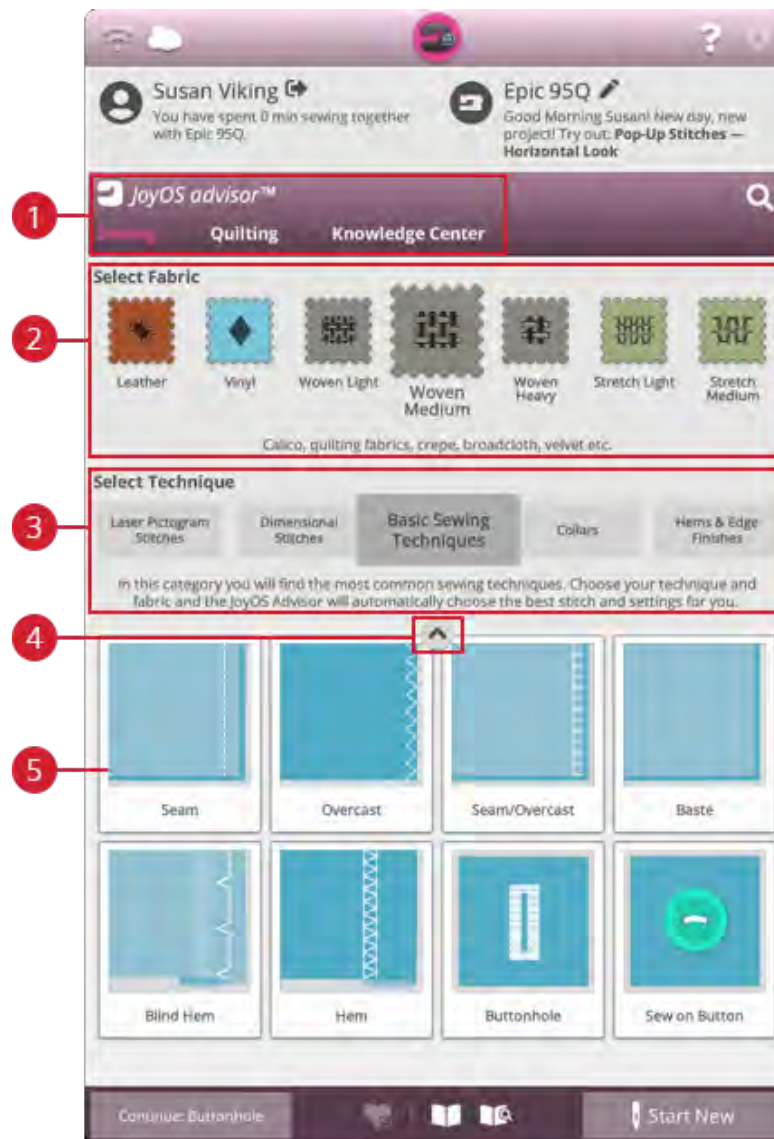

1. JoyOS ADVISOR™ feature
2. Fabric selection
3. Sewing technique groups
4. Minimize/expand JoyOS ADVISOR™ project files
5. Sewing techniques

Fabric Selection

Start your sewing by selecting the fabric that you will use. Suggested fabrics for each fabric group you can choose from are listed below.

Note: Some fabrics have excess dye which can cause discoloration on other fabrics or on your sewing machine. This discoloration may be very difficult or impossible to remove.

Fleece and denim fabric, especially red and blue, often contain excess dye.

If you suspect that your fabric/ready-to-wear garment contains a lot of excess dye, always pre-wash it before sewing to prevent discoloration of your machine.

Woven or Knit

The difference between woven and knit fabric is the way the threads are put together. Woven fabrics are made of two thread system, warp lengthwise and weft crosswise, that intersect at right angles. A knit fabric is made of one thread system with interlaced stitches. A knit fabric usually has stretch.

As a general rule, select woven in the JoyOS ADVISOR™ feature for stable fabrics that have no stretch and stretch for fabric that have stretch.

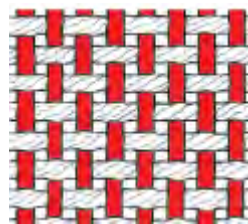

Woven fabric

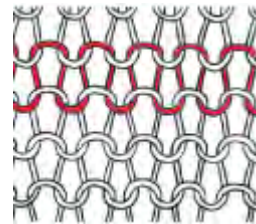

Knit fabric

Woven Fabrics

Woven Light: Chiffon, organza, batiste, challis, crepe de chine etc.

Woven Medium: Calico, quilting fabrics, crepe, broadcloth, velvet etc.

Woven Heavy: Denim, tweed, canvas, terrycloth etc.

Stretch Fabrics

Stretch Light: Tricot, single knit jerseys etc.

Stretch Medium: Sweater knits, double knit, velour, swimwear etc.

Stretch Heavy: Sweater knits, fleece etc.

Leather and Vinyl

For suede and leather. Leather is animal skin with the coat (fur) removed. Leather can be smooth or sueded and has some give.

For vinyl, faux leather and suede. Vinyl is a synthetic material which often has a woven wrong side. Vinyl can be smooth or patterned and some vinyls have stretch.

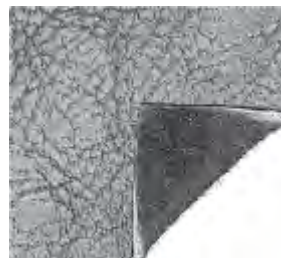

Leather fabric



Vinyl fabric

Sewing Technique Groups

After selecting a fabric, touch a sewing technique group and the JoyOS ADVISOR™ feature will recommend sewing techniques suitable for your fabric. Touch a sewing technique to load it into the JoyOS ADVISOR™ project viewer.

Example: Select woven medium and zippers to show all zipper techniques suitable for woven medium. Change fabric to stretch medium and notice that not all zipper techniques are available since all are not suitable for stretch medium.

Note: Use quick help on a sewing technique for a short description of the technique.

QUILT ADVISOR– Overview

The Quilt Advisor gives you guidance for different kinds of quilting techniques. When selecting a quilting technique the machine will show all techniques for your chosen quilting technique group.

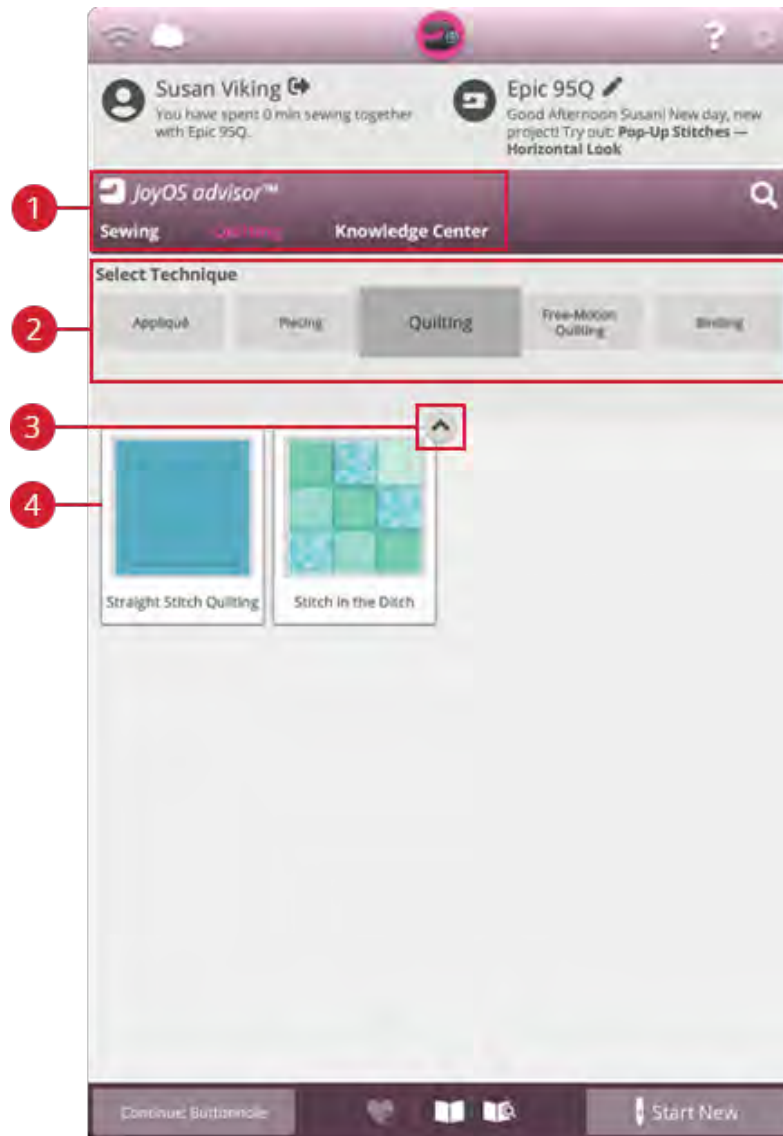

1. JoyOS ADVISOR™ feature
2. Quilting technique groups
3. Minimize/expand JoyOS ADVISOR™ project files
4. Quilting techniques

Quilting Technique Groups

Touch a quilting technique group and the JoyOS ADVISOR™ feature will show available quilting techniques in that group. Touch a quilt technique to load it into the project viewer. There are different quilting technique groups in the Quilting Advisor.

Knowledge Center – Overview

The JoyOS ADVISOR™ feature also contains a knowledge center including: stabilizer guide, quick start guide, sewing instructions, step-by-step workbook and an accessory guide.

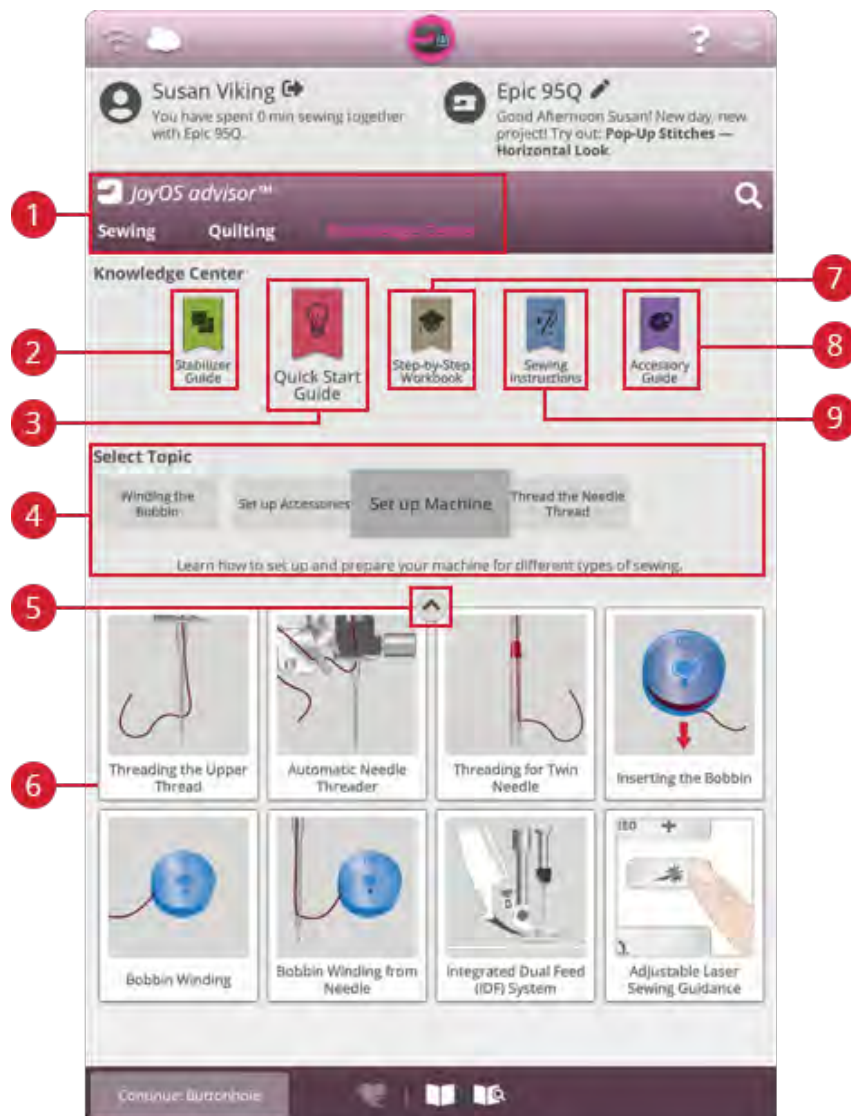

1. JoyOS ADVISOR™ feature
2. Stabilizer guide
3. Quick start guide
4. Technique groups
5. Minimize/expand JoyOS ADVISOR™ project files
6. Available techniques of chosen group
7. Step-by-step workbook
8. Accessory guide
9. Sewing instructions

Stabilizer Guide

Select a stabilizer group to view different stabilizers within the group. Touch a stabilizer to see more information about when to use it. Here you'll find an overview of different types of stabilizers.

- **Cut away:** Cut away stabilizers are stabilizers that needs to be cut away by using scissors. It will stay on the fabric to make it more stable.
- **Batting:** Use batting between your top fabric and backing to add body to your JoyOS ADVISOR™ project.
- **Water soluble stabilizer:** The stabilizers in this category are stabilizers that dissolves in water.
- **Specialty:** In this category you will find stabilizers for special uses.
- **Tear-a-away:** Tear-a-way stabilizers are temporary stabilizers. They are easy to remove.

Quick Start Guide

Here you'll find quick start guides e.g. on how to thread the machine. Select one of the topics to get guidance directly in the viewer.

Step-by-Step Workbook

Here you will find step-by-step instructions on how to use special techniques and functions. Select a topic to view the projects within that group. Touch to load it into the project viewer.

Note: Minimize/expand your project viewer to be able to view all functions when stepping through the technique.

Sewing Instructions

Here you'll find complete sewing instructions.

Accessory Guide

Here you'll find project files that shows you how to use different sort of accessories available for your machine.

6 Sewing

Getting Started to Sew

When your EPIC™ 95Q machine starts, the home screen featuring the JoyOS ADVISOR™ will be opened automatically.

Always make sure that the type of fabric you intend to sew on is selected in the JoyOS ADVISOR™ feature.

Read more about the fabric selections on page 68.

After your fabric is chosen, select a special sewing technique you would like to sew or you can touch start new. When a special sewing technique is chosen you will receive detailed instructions in the JoyOS ADVISOR™ project viewer. If you touch start new you will enter sewing mode and the straight stitch will be loaded by default. Read more about the JoyOS ADVISOR™ feature.

Sewing Mode – Overview

In sewing mode you can select stitches, adjust and sew them. Your selected stitch will be shown in actual size in the stitch field. The sewing recommendations will be shown at the top.

You can also go to program mode to create your own stitch program. Read more about how to program stitches in program on page 99.

Note: All symbols and options will not be shown at the same time.

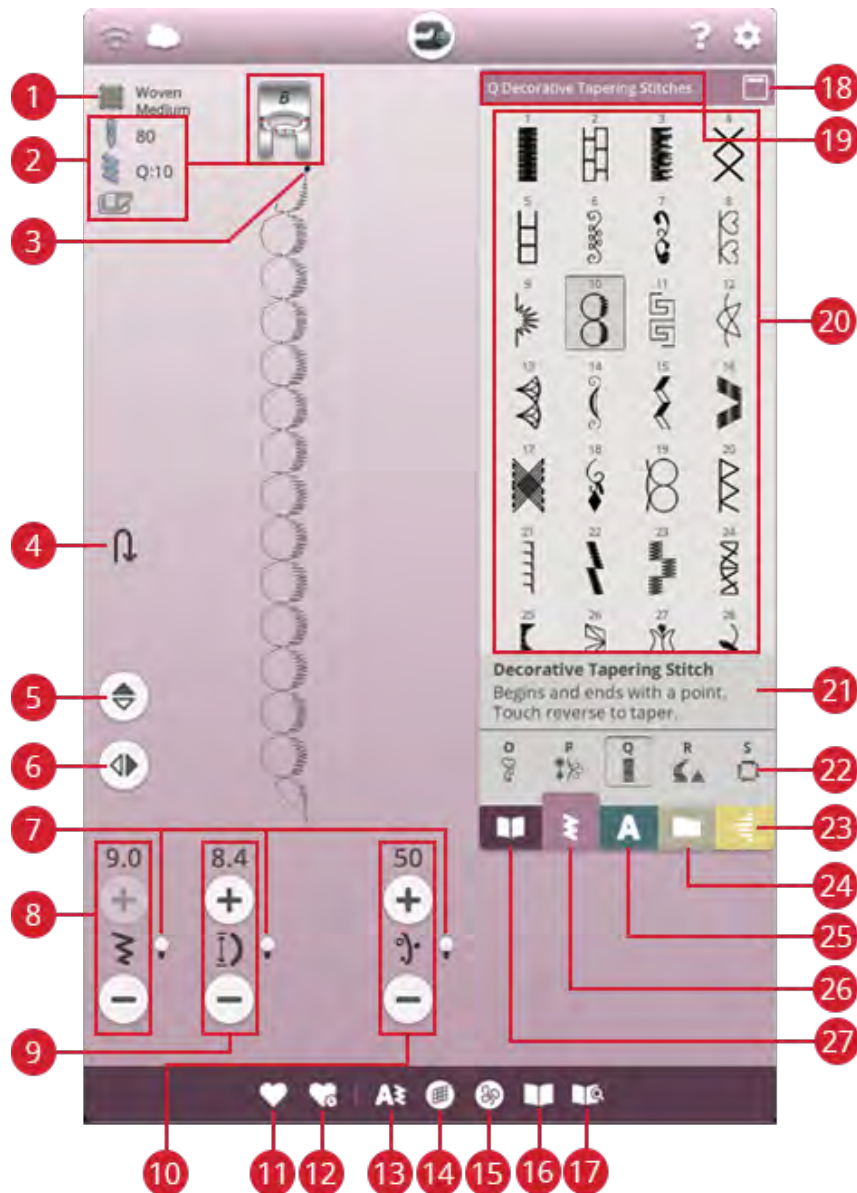

- | | | |
|------------------------------------|---|---------------------------------|
| 1. Fabric selected | 10. Thread portioning/thread tension/sensor foot pressure | 19. Stitch menu name |
| 2. Sewing recommendations | 11. Save | 20. Selection area |
| 3. Stitch start | 12. Smart save | 21. Stitch information |
| 4. Step to next part of stitch | 13. New program | 22. Stitch categories |
| 5. Mirror end to end | 14. Balance stitch | 23. Tapering menu |
| 6. Mirror side to side | 15. Free motion options | 24. File manager |
| 7. Alternative switch bar | 16. JoyOS ADVISOR™ project viewer | 25. Font menu |
| 8. Stitch width/stitch positioning | 17. User's guide | 26. Stitch menu |
| 9. Stitch length/stitch density | 18. Minimize/expand selection area | 27. JoyOS ADVISOR™ project menu |

What is a Stitch?

A stitch either consists of a single stitch as in a straight stitch, or as two individual stitches e.g. in a zigzag. Furthermore, a stitch is also the complete stitch, meaning it is made up by the total of the individual stitches in the stitch, such as a 3 step zigzag or a decorative stitch.

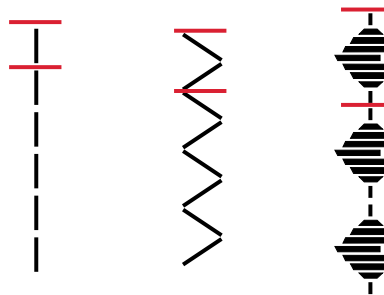

Select a Stitch or Letter

To load a stitch, open the stitch menu and touch a stitch to select it. The stitch will automatically be loaded and information will be shown in the stitch information area. Swipe up and down in the stitch menu to scroll through the stitches. Swipe left/right to scroll to and select a different stitch category. Alternatively swipe left/right in the category list and touch a category to select it.

To create text, select the font menu and touch a font to select it. When a font is selected it will automatically be loaded into program mode. Program your text by using the keyboard. Minimize the keyboard and touch OK in the program window. Your text will be loaded to sewing mode and ready to be stitched out. Learn more on how to program stitches and letters in the program chapter.

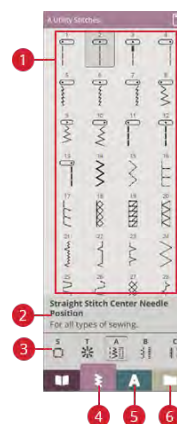

Load a Stitch or Letter From Another Location

From the file manager you can load stitches or programs that you have saved in your *mySewnet*TM cloud folder or on a USB device. Open file manager and load a stitch or program by touching & holding on the file. In file manager you will see all your saved files e.g. stitches and fonts. Learn how to organize your files in file manager.

1. Selection area
2. Stitch information
3. Stitch categories
4. Stitch menu
5. Font menu
6. File manager

Sewing Recommendations

Your machine will show the selected fabric and the active stitch. It will also show sewing recommendations which are set automatically depending on the selected fabric, active stitch and current settings. You can change the selected fabric directly, by touching the fabric icon. The following recommendations can be shown: presser foot, needle, stabilizer, IDF System and glide plates. The Straight Stitch Plate recommendation will be shown when a free motion option is selected with a straight stitch.

Tip: We recommend that you use the stabilizer guide in JoyOS ADVISOR™ for detailed information about the different stabilizers.

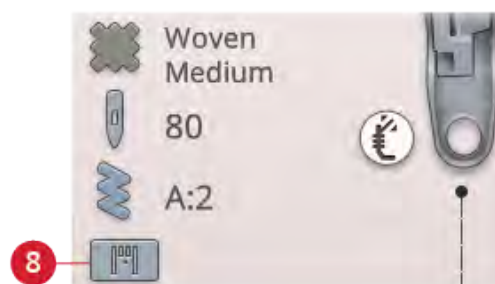
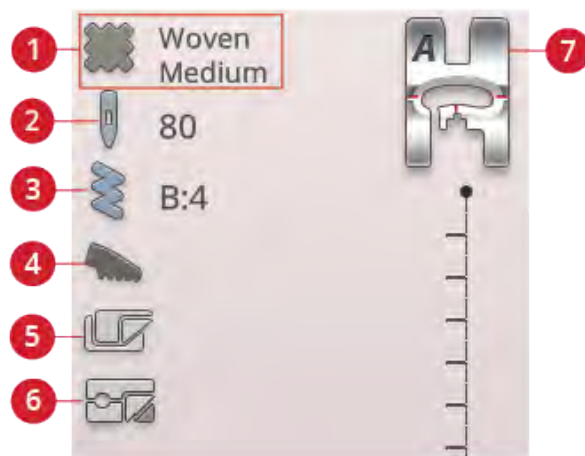

- | | |
|------------------------------|---|
| 1. Fabric selected | 6. Glide plates recommendation |
| 2. Needle recommendation | 7. Presser foot recommendation |
| 3. Stitch selected | 8. Straight Stitch Plate recommendation |
| 4. IDF System recommendation | |
| 5. Stabilizer recommendation | |

Adjustable Laser Sewing Guidance

Touch the Adjustable Laser Sewing Guidance button to activate a guidance system. A red light will be lit in front of the presser foot.

A popup will appear on screen. You can move the position of the laser guidance by touching the arrow buttons. Touch the alternative switch bar to finetune the center position "0". You can decrease or increase the brightness by touching the – or + buttons.

Touch the laser guidance button again to deactivate.

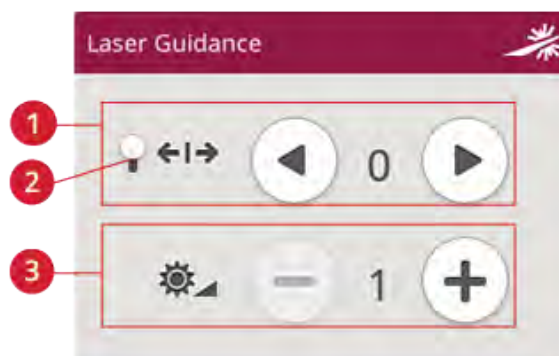

- | | |
|--|--|
| 1. Adjustable Laser Sewing Guidance Position | 3. Adjustable Laser Sewing Guidance Brightness |
| 2. Fine Tuning/Alternative Switch Bar | |

Stitch Settings

Your machine will set the recommended settings for each selected stitch. You can make your own adjustments to the selected stitch. The changes will only affect the selected stitch and will be reset to default when selecting another stitch or turning your machine off. To save your adjusted stitch, touch save.

The controls available on the screen will change depending on what stitch or program is loaded. Some stitches have more than one control, and an alternative switch bar will appear. Touch the alternative switch bar to change to an alternative control for a different stitch setting. Touch it again to change back to the previous control. The different stitch settings are described below.

Note: When trying to exceed minimum or maximum settings for width and length, a warning sound will be heard. The default setting is always shown in black numbers.

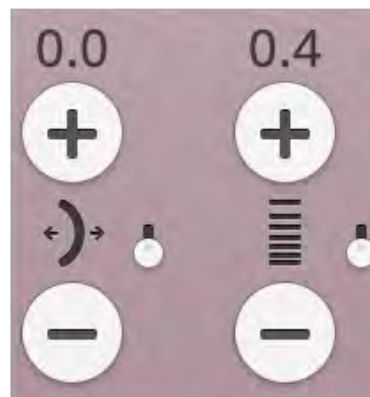

Stitch Width

Increase or decrease the stitch width using + and - in the control. The number above the control shows stitch width in mm/inch.

Changed stitch position may limit the stitch width adjustments.



Stitch Positioning

On certain stitches with a width less than 9mm it is possible to change the stitch position. Use + to move the stitch to the right and - to move the stitch to the left. The number above the control shows the needle start position in mm/inch in relation to center needle position. The machine has a maximum of 37 needle positions (for a straight stitch).

The stitch position can only be changed to the limit of the maximum stitch width. Changing the stitch positioning will also limit the stitch width adjustments.



Stitch Length

Increase or decrease the stitch length using + and – in the control. The number above the control shows the set stitch length in mm/inch. If lengthening a zigzag stitch or a decorative stitch, the entire stitch will be stretched out. If lengthening a stitch where the density can be adjusted, the entire stitch will be longer but the density of the satin stitches will remain the same.



Stitch Density

The stitch density control adjusts the density (the distance between the individual satin stitches that make up the entire stitch). The density does not affect the actual length of the entire stitch.

Touch + to decrease the density. Touch - to increase the density. The number above the control shows the distance between satin stitches in mm/inch.

Tip: Decrease the density to get different visual effects e.g. when using speciality threads.



Button Size

When sewing a buttonhole with the Sensor One-Step Buttonhole Foot, you can set the button size. Measure your button with the ruler on the front of the machine and set the button size in the button size control. Sew a test buttonhole on a fabric scrap to verify the desired length of the buttonhole.



Sew On Button

When sewing a button, you can set the number of stitch repeats. Touch the + or - in the control to increase or decrease the number of stitch repeats.



Sensor Foot Pressure

Touch + to increase or - to decrease the pressure of the presser foot on the fabric.

Note: Touch the alternative switch bar on the thread portioning/thread tension control to switch to sensor foot pressure control.

EXCLUSIVE SENSOR SYSTEM™

Thanks to the EXCLUSIVE SENSOR SYSTEM™ feature, the presser foot automatically and continuously senses and adjusts as you sew any thickness of fabric for perfect even feeding.

Go to sewing mode to see the actual setting of the sensor foot pressure for the selected fabric and adjust the presser foot pressure.



deLuxe™ Stitch System

The *deLuxe*™ stitch system has two ways to control the upper thread: thread portioning and thread tension. To get the best sewing result it will automatically use thread portioning when possible. Thread portioning automatically and continuously measures the fabric thickness to portion the correct amount of thread for the selected stitch.

When thread tension is used, the tension discs will keep the correct amount of tension on the upper thread. Some special techniques may require the use of thread tension. Deselect the *deLuxe*™ stitch system in the temporary sewing settings to ensure that thread tension is engaged. When the *deLuxe*™ stitch system is selected in temporary sewing settings the control visible in sewing mode will change between thread portioning and thread tension depending on the current settings and the loaded stitch.

Use the thread portioning/thread tension control to adjust the balance between needle thread and bobbin thread, e.g. decrease when using metallic thread and increase when using heavy weight thread. Make a few tests with different settings on a scrap piece of the fabric you are going to use and check the balance between the upper thread and the bobbin thread.

Note: When changing the value of the thread portioning/thread tension setting, the changes only affect the selected stitch. Your changed settings will be reset to default when selecting another stitch.

Tip: Increase the thread portioning/thread tension setting for best results when sewing on denim fabric with thick threads.



Thread portioning control



Thread tension control

Adjust Thread Tension/Thread Portioning

For the best stitch appearance and durability make sure the threads meet evenly between the two fabric layers.

If the bobbin thread is visible on the top side of the fabric, the thread tension/thread portioning is too tight. Reduce the thread tension/thread portioning.

If the upper thread is visible on the back side of the fabric, the thread tension/thread portioning is too loose. Increase the thread tension/thread portioning.

For decorative stitches and buttonholes the upper thread should be visible on the back side of the fabric.

Make a few tests on a scrap piece of the fabric you are going to use and check the tension.

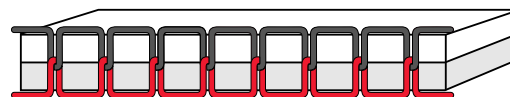

Correct tension

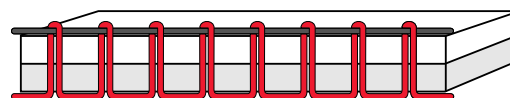

Tension too tight



Tension too loose

Mirroring

To mirror a stitch or stitch program lengthwise, touch the mirror end to end button. To mirror a stitch or stitch program sideways, touch the mirror side to side button.

Tip: Use the smart toolbox to open a shortcut for mirroring.

Note: Some stitches e.g. buttonholes cannot be mirrored.

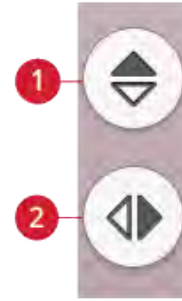

1. *Mirror end to end*
2. *Mirror side to side*

Save Stitch

To save your file, touch the save button. You can choose to save the file to the *mySewnet*[™] cloud folder or to a USB device. Previously saved stitches, programs and/or fonts are shown. Name your file and touch the OK button.

If you want to save to a folder, simply touch & hold on the folder to open it, then name your file and touch OK. To create a new folder, simply touch the create new folder button, name the folder with the keyboard and touch OK. Then touch & hold on the folder to open it and save into the new folder.

Touch the list and thumbnail view button to toggle between showing the files in a list or as thumbnail icons.

To cancel the save process, close the pop-up window by touching cancel. The save pop-up will close and you will return to sewing mode.

Read more about organizing your saved stitches in file manager on page 112.

Smart Save

If you want to stop sewing and save your current stitch and settings, touch the smart save button. A pop-up will indicate that a smart save has been done and you can now turn off the machine.

Smart save remembers and stores the stitch and settings as they were when smart save was last performed. This makes it possible to turn off your machine and continue sewing later. To load smart save, touch the load smart save button in the JoyOS ADVISOR[™] feature.

Your smart save will be saved until you touch the smart save button again and replace it.



Save button



1. Save to *mySewnet*[™] cloud folder
2. Selection area
3. File name
4. Cancel
5. Save to USB device folder
6. List and thumbnail view
7. Create new folder
8. Confirm



Smart save button



Home screen button



Load smart save button

Balance

When sewing on special fabrics or doing a special technique, the balance may need to be adjusted. To adjust the balance on the active stitch, touch the balance button in sewing mode.

Start by sewing the stitch on a piece of scrap fabric. Change the preview on the screen to match your sewn sample by using the + and - in the controls. When you sew again, the balance will be corrected.



Balance button in sewing mode



Pop-up window for balance

Free Motion Options

Choose between three free motion options: free motion spring action, free motion ruler foot, or free motion floating.

When sewing free motion with a straight stitch, use the Straight Stitch Plate for best result. Read about how to change to Straight Stitch Plate.

Note: Make sure that the IDF System is disengaged.

Free Motion Spring Action

Activate free motion spring action to set the machine in free motion spring action mode for spring action feet, e.g. the Sensor Q-Foot. The feed teeth will lower automatically.

A spring action foot will raise and lower with each stitch to hold the fabric on the needle plate while the stitch is being formed. When sewing, you need to move the fabric manually.

Sensor Q-Foot is recommended for all free motion sewing except when using specific techniques or accessories that do not support the use of Sensor Q-Foot.



The free motion spring foot icon will be shown in the sewing recommendations.

Tip: There is an optional open toe free motion spring foot that can be purchased at your local authorized retailer.

Free Motion Ruler Foot (Optional)

Activate free motion ruler foot to set the machine in free motion mode for the optional free motion ruler foot. The feed teeth will lower automatically.

The presser foot floats over the fabric while sewing.

Free Motion Options

When sewing free motion with a straight stitch, use the Straight Stitch Plate for best result.

- Free Motion Spring Action (e.g. Sensor Q-Foot)**
The spring foot will raise and lower with each stitch. Feed teeth will be lowered and thread tension will be used. Sensor Q-Foot is recommended for all free motion sewing except when using specific techniques or accessories that do not support the use of Sensor Q-Foot.
- Free Motion Ruler Foot (Optional)**
The presser foot floats over the fabric. Feed teeth will be lowered automatically.
- Free Motion Floating (e.g. R-Foot)**
The presser foot floats over the fabric at higher speed. Feed teeth will be lowered and thread tension will be used. Note: Do not use this mode when sewing with the optional Free Motion Ruler Foot.

Free Motion Floating

Activate free motion floating to set the machine in free motion floating mode for floating feet, e.g. the R-Foot. The feed teeth will lower automatically.

When sewing at low speed the presser foot will raise and lower with each stitch to hold the fabric on the needle plate while the stitch is being formed. At higher speed, the presser foot floats over the fabric while sewing. The fabric must be moved manually.

Skipped stitches can occur if your fabric moves up and down with the needle as you are stitching. Lowering the presser foot height will reduce the space between the presser foot and the fabric and eliminate the skipped stitches.

Note: Be careful not to reduce the presser foot height too much. The fabric must still move freely under the presser foot.

To adjust the presser foot height in free motion floating mode, touch the presser foot height control to make adjustments.



The free motion floating foot icon will be shown in the sewing recommendations.

Note: If free motion floating is activated, do not use a spring action foot, as this might damage the presser foot.

Note: Activate stitch width safety if the presser foot requires it.

Tip: There are optional free motion floating feet that can be purchased at your local authorized retailer.

Basic Sewing Techniques

In basic sewing techniques you will find the most commonly used sewing techniques. When you choose one of the basic sewing techniques, the recommended stitch for the chosen fabric is automatically loaded.

Seam

A seam sews two pieces of fabric together with a seam allowance that will usually be pressed open. In most cases, edges of the seam allowance are finished with an overcast stitch before sewing the seam.

Seams in stretch fabric must stretch with the fabric. The stretch stitch makes a stretchy seam that is suitable for sewing together pieces of light stretch fabric.

Your JoyOS ADVISOR™ feature will select the best stitch length and stitch width for the fabric weight and recommend the presser foot and needle.

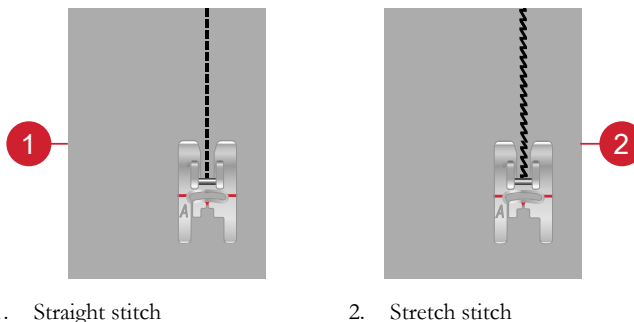

Overcast

Overcast fabric edges to prevent fraying and to help them lay flat. It is easier to overcast before the garment is sewn together.

Your JoyOS ADVISOR™ feature will select the best stitch length and stitch width for the fabric weight and recommend the presser foot and needle.

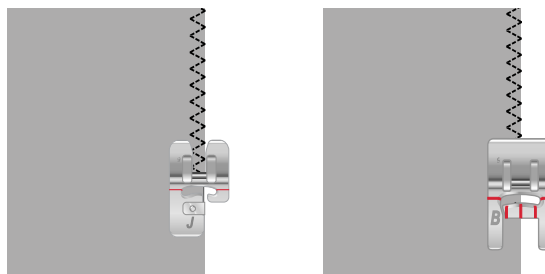

Seam and Overcast

The seam/overcast stitch sews the seam and overcasts the edges all at one time. The seam/overcast technique is perfect for stitching ribbed neckbands and cuffs. There are a number of different seam/overcast stitches in your machine.

Your JoyOS ADVISOR™ feature will select the best one for your fabric and make all adjustments automatically and recommend the presser foot and needle.

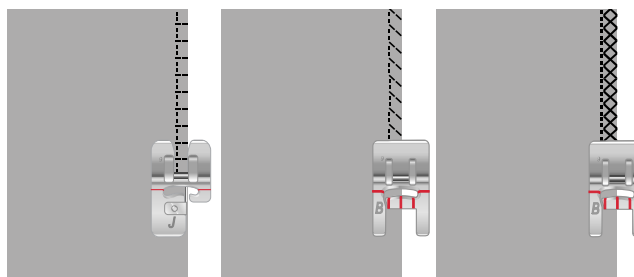

Baste

Basting is temporary stitching for fitting garments, gathering and marking. The JoyOS ADVISOR™ feature automatically sets a long stitch length and reduces the tension so the threads are easy to remove or to pull for gathering.

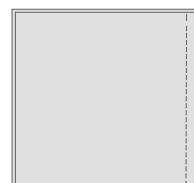

Blind Hem

The blind hem creates an invisible hem on garments. There are two types of blind hem; one is recommended for medium to heavy fabrics, the other for stretch. The blind hem is not suggested for light weight fabric, leather and vinyl.

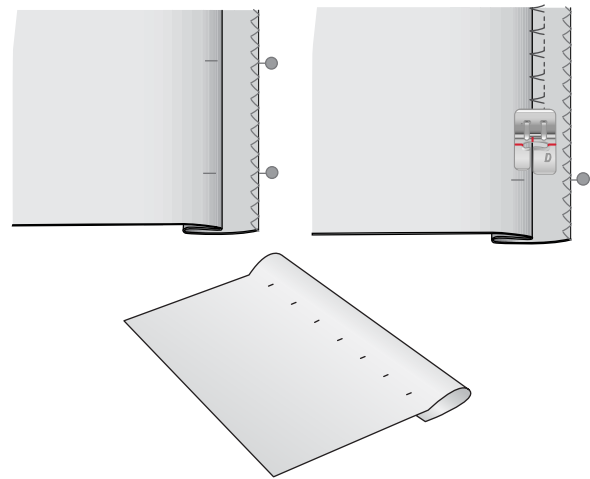

Hem

The hem technique on your JoyOS ADVISOR™ feature will select the visible or topstitch hem that is best for your fabric weight and type. For woven fabric, leather and vinyl a straight stitch is selected. For stretch fabrics, stitches that stretch are selected.

Buttonholes

The JoyOS ADVISOR™ feature will select the best buttonhole and stitch settings for your chosen fabric. Fabric should be interfaced and/or stabilized where buttonholes are to be sewn.

Tip: In your accessory tray there is a special book where you can hang your Sensor One-Step Buttonhole Foot.

Sew a test buttonhole on a fabric scrap to verify the desired length of the buttonhole.

Measure the desired distance from the fabric edge and then add the length of your buttonhole.

When sewing, place the finished fabric edge with stabilizer underneath the presser foot, facing away from you.

Use the marking on your fabric to position the starting point.

Manual Buttonhole

Manual buttonholes are recommended for woven heavy fabric. To sew a manual buttonhole, use the buttonhole foot C.

1. Sew the first column as long as you want the buttonhole to be.
2. Touch the reverse button. The machine sews the bartack and the second column.
3. When the columns are aligned, touch the reverse button to sew the second bartack.
4. Touch the STOP function to sew the same length repeatedly.

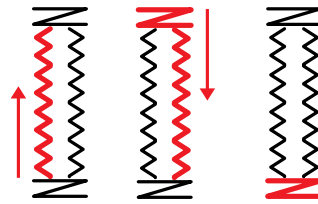

Sewing direction for buttonholes without satin stitches or satin stitch buttonholes sewn with presser foot C.

Automatic Buttonhole

When sewing buttonholes on woven light, woven medium, stretch light or vinyl fabric you can use the Sensor One-Step Buttonhole Foot. The Sensor One-Step Buttonhole Foot will sew automatic buttonholes. Read about how to attach the Sensor One-Step Buttonhole Foot on page 45.

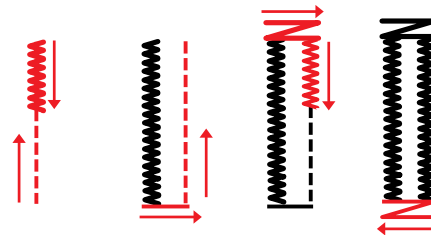

Sewing direction for satin stitch buttonholes sewn with the Sensor One-Step Buttonhole Foot.

Corded Buttonhole

Corded buttonholes are recommended when sewing buttonholes on stretch medium or stretch heavy fabric. Use gimp threads for a more stable durable and professional appearance. Use pearl cotton or a regular gimp thread. Attach the buttonhole foot C and use the finger on the back of the foot for holding the cord when sewing.

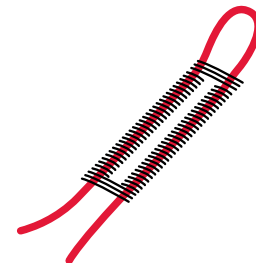

Programmable Button Sew On

Sew buttons, snaps, hooks and eyes quickly with your machine. Select sew on button in the JoyOS ADVISOR™ feature.

Note: Place the thin end of the multipurpose tool under the button when sewing on light fabrics. Use the thick end for heavier fabrics. Hold in place on the fabric with transparent tape.

Note: The recommended width of 3.0 is set for most buttons. If you sew a tiny button or a very large coat button, decrease (–) or increase (+) the stitch width until the swing of the needle sews in the holes of the button or snap.

Note: An optional Button Foot for sewing on buttons can be purchased at your local authorized dealer.

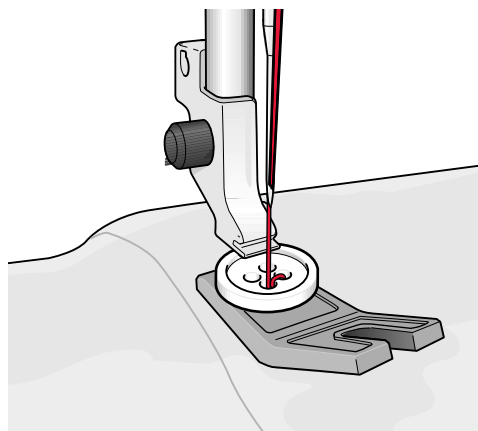

Laser Pictogram Stitches – Menu I

Menu I includes two types of pictogram stitches: motifs in pairs that can be combined into a full shape and solitary motifs that can be combined into different shapes when using mirror side to side and sewn in different directions.

The adjustable laser sewing guidance is used to get the perfect matching of patterns.

Tip: We recommend you to use your JoyOS ADVISOR™ feature and locate the laser pictogram stitches project for instructions on how to sew laser pictogram stitches and automatically get the correct settings.

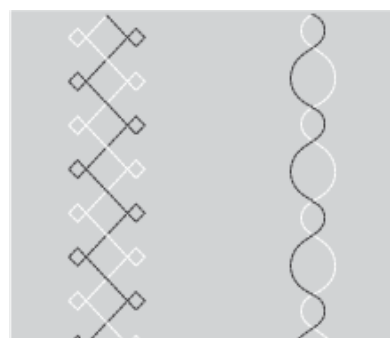

To the left: example of a solitary motif. To the right: example of motifs in pairs.

Dimensional Stitches – Menu L

Menu L – dimensional stitches includes three types of stitches: appliqué, pop-up and sequin stitches. In this menu there will also be combined appliqué and pop-up stitches. Since every stitch is unique, these stitches will give different decorative effects depending on which stitch is selected and what type of fabric you have chosen.

Tip: We recommend you to use your JoyOS ADVISOR™ feature and locate the dimensional stitches project for instructions on how to sew dimensional stitches and automatically get the correct settings.

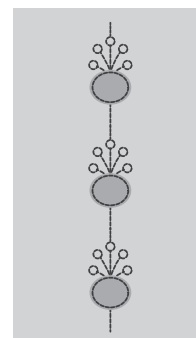

Example of appliqué stitch

Theme Stitches – Menu M

Theme stitches are beautiful combined stitches, in a group of four, designed to be sewn out together in a random combination. Touch the reverse button on the front of your machine or the reverse button on the screen to change to the next stitch in the group. If you touch the reverse button twice – quickly – you will skip the next stitch in the group.

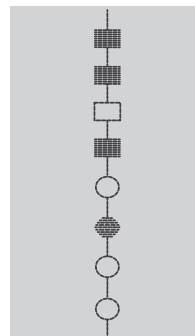

Example of theme stitch



Reverse button on the screen

Embellished Stitches – Menu N

Embellished stitches are decorative stitches where you can change the appearance of the stitch after it is sewn for a special effect. These stitches can be decorated with crystals or cut for a tassel effect.

Tassel stitches are sewn with many threads on top of each other. The threads can either be left as they are sewn or cut to create a 3D effect. The long stitches should be cut at the very edge and from the top side of the fabric. To make the cutting easy, use a seam ripper.

Tip: For heavier threads, use the optional Specialty Candlewicking Foot (part number 413 16 23-45) for easier feeding.

Crystal stitches could either be used as they are or be embellished with crystals in the sewn circles.

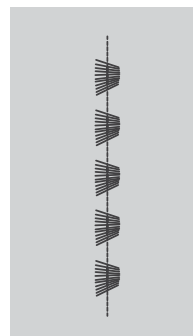

Example of tassel stitch

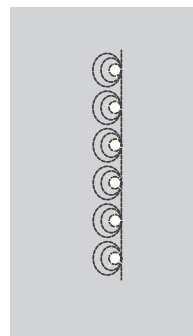

Example of crystal stitch

Tapering Stitches – Menu Q

The tapering menu will be visible when a stitch that can be tapered is selected. Touch the tapering menu to select from different angles for beginning and end tapers. The machine will sew the beginning tapered point and then continue with the selected stitch. When the desired length has been sewn, touch the reverse button. The stitch will taper to the end.

Select taper “off” to remove any tapering at the beginning or end of the stitch. If you select taper “off” on both the beginning and end, the stitch will be a regular stitch without tapering.

Taper Satin Stitch Exercise

The taper stitch automatically tapers the satin stitch for corners and points and can be used for satin stitch lettering. Try the satin stitch exercise and stitch a corner of the tapered satin stitch on a piece of stabilized fabric.

1. Select stitch Q1 in menu Q - Decorative tapering stitches.
2. Open tapering and select 45 degrees for both beginning and end.

Note: For a wider satin stitch, adjust the stitch width control.

3. Activate needle stop up/down on your machine and start to sew. The machine will sew the tapered point and then continue with a satin stitch at the selected width.
4. When the satin stitch is as long as desired, touch the reverse button. This will start the end tapering.
5. Turn your fabric to continue with the next tapered satin stitch. Activate the STOP function to repeat the previously stitched length, including the beginning and end tapers.



4-Way Stitches – Menu S

The 4-way stitch allows you to sew several sturdy stitches in four different directions. You will have different 4-way stitches to choose from. This is especially helpful when patching trouser legs on a free arm. The 4-way stitches are programmed at a fixed length and stitch width.

4-Way Stitches Exercise

Fabric: Woven heavy, two pieces, one a patch.

Select: Woven heavy on your JoyOS ADVISOR™ feature, menu S – 4-way stitches, stitch 8.

Use: Presser foot S and size 90 needle as recommended.

Sew:

1. Place the patch on the larger piece of fabric and position the top left corner of the patch under the presser foot. The machine will sew across the top from the left to the right as shown on the screen.
2. Sew across the top and touch the reverse button or the 4-way sewing direction button (reverse button on the screen) to change the sewing direction. The direction of the stitch on the screen will change. Step on the foot control. The presser foot lowers automatically.
3. Sew down the side of the patch. Continue sewing around the patch, touching the reverse button or the 4-way sewing direction button on the screen, to change the sewing direction.
4. Touch the cut function.

Tip: To sew beautiful corners with 4-way stitches, touch the STOP function before changing the sewing direction. This will complete the current stitch before changing the direction.



4-way sewing direction button (reverse button on the screen)

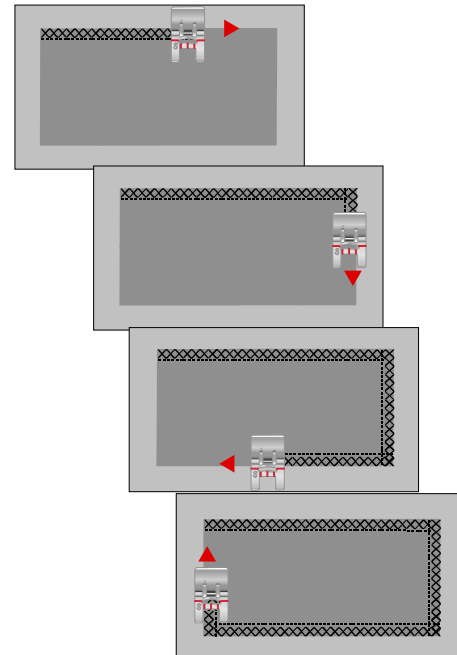

8-Way Stitches – Menu T

There are two different stitches, straight and reinforced straight stitch, in the T menu. Touch the arrows to select one of the pre-set sewing directions. To fine tune the direction of the stitch, use the stitch width and stitch length controls. Program these stitches alone or with decorative stitches from other menus to create unique stitches or borders.

8-Way Stitches Exercise

Fabric: Woven medium and stabilizer.

Select: Woven medium on your JoyOS ADVISOR™ feature, menu T - 8-way stitches.

Use: Thread your machine with decorative thread on top and bobbin thread in the bobbin. Use presser foot S and size 80 needle as recommended.

Sew:

1. Touch the program button.
2. Select stitch 1 in menu H - children stitches.
3. Select T menu and click 3 times on the straight stitch to the right.
4. Select stitch 1 in menu H.
5. Select T menu and click 3 times on the straight stitch to the right.
6. Select stitch 1 in menu H.
7. Select T menu and click 3 times on the straight stitch to the left.
8. Select stitch 1 in menu H.
9. Select T menu and click 3 times on the straight stitch to the left.
10. Touch OK to enter sewing mode again.
11. Place the fabric and stabilizer in position under the presser foot. Press the foot control to lower the presser foot and start sewing your programmed stitch.

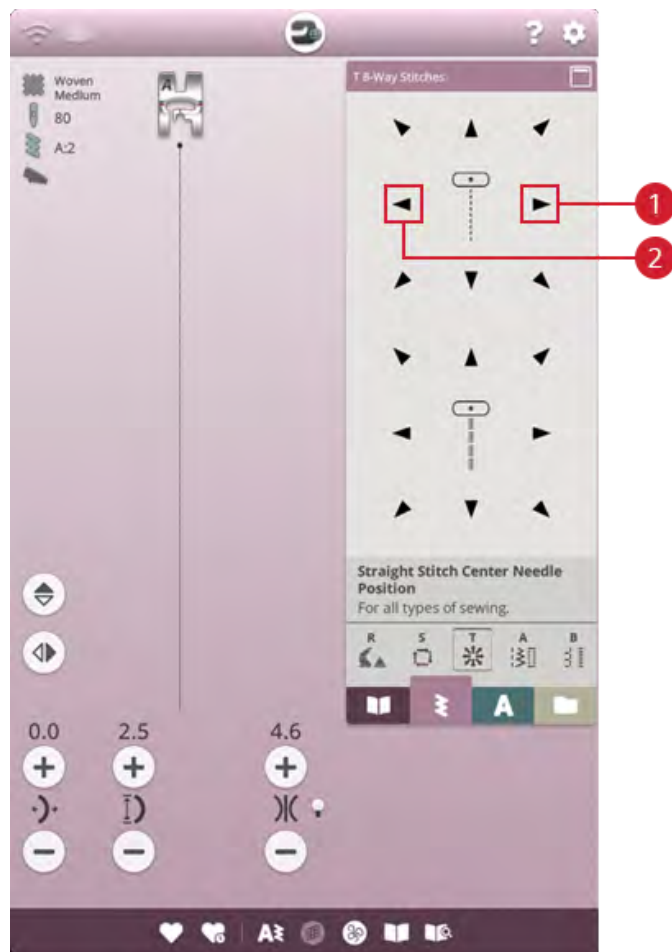

1. Straight stitch right

2. Straight stitch left

Special Stitches For Optional Presser Feet

Stitch menu P- specialty stitches, includes special stitches like candlewicking and edge stitches. These techniques may require special presser feet and accessories. This is indicated by the optional presser foot icon on the screen.

Tip: Detailed information on the current selected stitch is shown in the stitch information.



Sewing Pop-up Messages

Bobbin Thread Low

When the bobbin thread is running low, a pop-up message appears giving you notice that you will soon need to change the bobbin. This gives you an opportunity to plan when you want to change your bobbin. If you want to continue sewing without changing the bobbin, touch the foot control and do not close the pop-up.

Check Upper Thread

The machine stops automatically if the upper thread runs out or breaks. Re-thread the upper thread, close the pop-up message and start sewing.

Remove Sensor One-Step Buttonhole Foot

The Sensor One-Step Buttonhole Foot is used only for buttonholes. A pop-up message will advise you to remove the foot for all other sewing.

Cannot Use the Automatic Needle Threader

If using a twin needle, touch OK and thread it manually. If using a regular needle, touch OK and deselect twin needle in the settings. Press the automatic needle threader button again.

Twin Needle

A pop-up message will appear when you choose a stitch not suitable for twin needle.

Stitch Width Safety

When stitch width safety is activated, a pop-up message will appear when you choose a stitch not suitable for stitch width safety.

Attention!

If the machine stops and this pop-up appears on the screen you need to stop sewing. Wait a moment and touch the OK button when it is enabled. Check the needle size and condition. Check for correct threading.

7 Program

Program – Overview

You can combine stitches and/or letters and numbers to create stitch programs. Combine various decorative stitches and stitch fonts from the from the machine stitch menus, *mySewnet*TM cloud folder on the machine, or from a USB device.

You can program stitches up to approximately 500 mm (20") long. You can see how long your stitch program is at the top of the window.

Tip: You can close the program window by pressing the foot control, or by pressing the start/ stop button.

Note: Not all stitches are available to program. A pop-up message will alert you if you try to select an unavailable stitch.

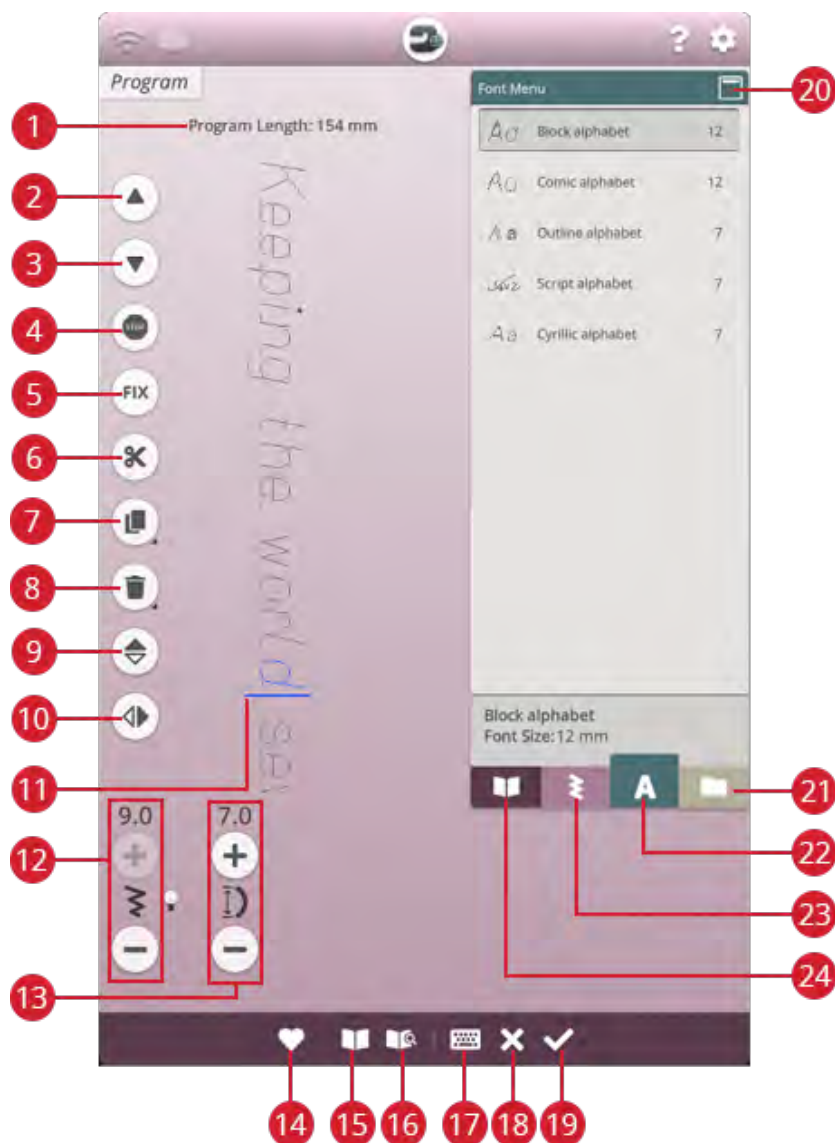

- | | | |
|---------------------------------------|--|--|
| 1. Program length | 9. Mirror end to end | 17. Open keyboard |
| 2. Step to previous stitch/go to last | 10. Mirror side to side | 18. Cancel program |
| 3. Step to next stitch/go to first | 11. Cursor | 19. OK, return to sewing mode edit |
| 4. STOP command | 12. Stitch width/Stitch positioning | 20. Minimize/expand selection area |
| 5. FIX command | 13. Stitch length/Stitch density | 21. File manager |
| 6. Thread cut command | 14. Save | 22. Font menu |
| 7. Duplicate | 15. JoyOS ADVISOR TM project viewer | 23. Stitch menu |
| 8. Delete | 16. User's guide | 24. JoyOS ADVISOR TM project menu |

Create New Program

1. To create a new program, touch the program button to open the program window.



2. Touch the stitch menu or font menu to select the stitch or a font you want to use.



Stitch menu



Font menu

3. Insert stitches from file manager or the stitch menu. The active position is shown with a cursor and the stitch or letter is highlighted. Inserted stitches or letters will be selected and placed at the cursor. Only the selected stitch or letter can be adjusted. You can move the cursor through the stitch program by using the step to previous stitch/step to next stitch arrows.



Active position is highlighted

Note: A straight line at the point of the arrows indicates go to last/go to first stitch.



Step to previous stitch/step to next stitch

4. When the font menu is selected the keyboard is opened automatically to write your text. Minimize the keyboard by touching the top right corner to be able to access the OK button.



5. Touch the OK button to load your program to sewing mode. Alternatively load your program by pressing down the foot control or touch the start/stop button on your machine. Touch cancel to undo your program and close the program window.



To Edit a Created Program

If you want to edit an already loaded program in sewing mode, touch the edit stitch program button and you will enter the program window again. Alternatively, touch & hold on the program to open the smart toolbox to access the edit button. Make your adjustments and touch OK in the program window to load it to sewing mode with your adjustments. Touch the cancel button in program to undo.



Edit Stitch or Lettering Program

Insert a Stitch or Letter

Move the cursor to the point where you want to add a stitch or letter by using the step to previous/step to next stitch button. If the step to previous arrow has an underline you will move the cursor to the end. If the step to next arrow has an underline you will move the cursor to the beginning. Touch the desired stitch in the stitch menu or in file manager to add it at the cursor position.

Touch the font menu and touch a letter to insert it at the cursor. Change to a different font style by touching another font style in the selection area. Close the keyboard at the top right corner. If you touch the stitch menu or file manager the keyboard will close automatically. You can open the keyboard again by touching the keyboard button or touching the font menu.

Adjust a Stitch or Letter

You can mirror, adjust the length, width and position or change the density of the selected stitch, in the same way you can adjust the stitch settings in sewing mode.

Touch & hold over the program on the screen to open the smart toolbox. The smart toolbox will allow you to duplicate, delete or mirror the selected stitch or letter in the program.

Delete a Stitch or Letter

If you want to delete a stitch, move the cursor to the stitch or letter you want to delete (the selected stitch or letter will be blue) and touch the delete button on the screen or in the smart toolbox. Touch & hold the delete button to delete the entire program.

Duplicate a Stitch or Letter

To duplicate a stitch, move the cursor to the stitch or letter you want to duplicate (the selected stitch or letter will be blue) and touch the duplicate button on the screen or in the smart toolbox.

Note: Make your adjustments to the stitch before duplicating and the duplicated stitch will include the adjustments.

Touch & hold to use the keypad where you can enter the exact number of copies you want to insert.

Replace a Stitch or Letter

To replace a stitch or letter, simply select it using the scroll arrows to select the stitch or letter you wish to replace and touch delete. Insert the new stitch or letter and it will be placed at the cursor.



Keyboard button

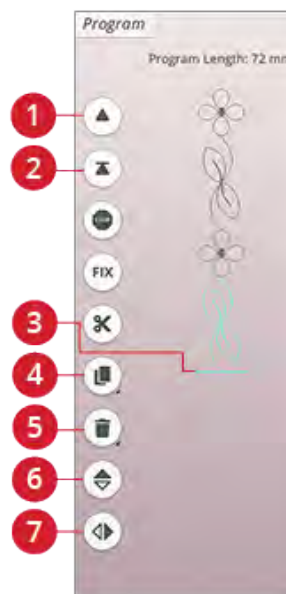

1. Step to previous stitch/go to last
2. Step to next stitch/go to first
3. Cursor
4. Duplicate
5. Delete
6. Mirror end to end
7. Mirror side to side

Adjust the Entire Program

To adjust the entire program, return to sewing mode by touching the OK button. Adjustments made here will affect the entire program. Read about the different stitch settings on page 78 in sewing mode that will adjust your entire program.



Stitch Program Commands

You can insert FIX, STOP and thread cut commands into the stitch program. These commands will be included in the stitch program and will always be performed when sewing it.

Move the cursor to the position where you want to add a command. Touch the command and an icon will be added into the programmed stitch. This confirms that the command is inserted and it also shows where the command will be performed in the stitch program.



Insert a STOP command by touching the STOP button on the screen. The STOP command will make your machine stop at the selected position in your programmed stitch. This is useful, e.g. if you want to create a stitch program with several rows.



Insert a FIX command by touching the FIX button on the screen. The FIX command will insert a tie-off at the selected position in the program. You can insert the FIX command anywhere in the program.



Insert a thread cut command by touching the thread cut button on the screen. Add a thread cut command if you want the machine to tie-off and cut the threads.



Note: If automatic thread cutter is deselected in temporary settings the machine will only fix and stop when it reaches a thread cut command.

Save Program

To save your file, touch the save button and a pop-up will appear on the screen. In the save pop-up you can choose to save the file to the *my.Sennee*TM cloud folder or to a USB device. Previously saved stitches, programs and/or fonts are shown. Name your file with the keyboard and touch the OK button.

If you want to save to a folder, simply touch & hold on the folder to open it, then name your file with the keyboard and touch OK in the pop-up to save. To create a new folder, simply touch the create new folder button, name the folder with the keyboard and touch OK. Then touch & hold on the folder to open it and save into the new folder.

Touch the list and thumbnail view button to toggle between showing the files in a list or as thumbnail icons. In list view each file is shown with the file name and file type. In thumbnail view each file is shown with file name and a thumbnail image of the file.

To cancel the save process, close the pop-up window by touching cancel. The save pop-up will close and you will return to program mode.

Learn how to organize your saved files in file manager on page 112.

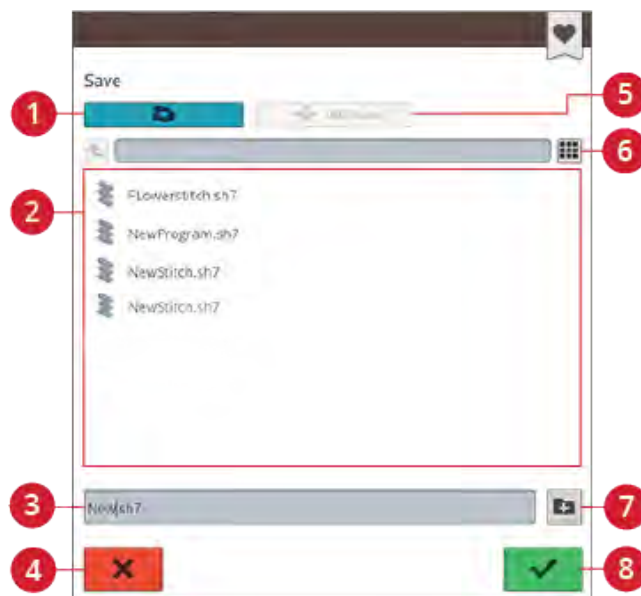

1. Save to the *my.Sennee*TM cloud folder
2. Selection area
3. File name
4. Cancel
5. Save to a USB device
6. Toggle between list and thumbnail view
7. Create new folder
8. Confirm

Sew Your Stitch Program

To sew your stitch program, load it to sewing mode by touching the OK button in the program window.



Program Pop-Up Messages

Not a Programmable Stitch

Some stitches are not possible to insert in a stitch program, for example buttonholes and special stitch menus such as theme stitches.

The Maximum Number of Stitches Has Been Reached

The stitch you are trying to add will make the stitch program too long. Your stitch program can be up to approximately 500 mm (20") long and contain up to 199 stitches and commands. If the stitch program exceeds the maximum length this pop-up message will appear.

8 Settings

Temporary Sewing Settings

Change your temporary sewing settings when you want to change a sewing related setting for your current project. Changes made to temporary sewing settings will be reset at the start of a new JoyOS ADVISOR™ project from the JoyOS ADVISOR™ feature. When turning the machine off, all changes made in temporary sewing settings will be reset to default.

The following settings can be set in temporary sewing settings:

- *deLuxe*™ stitch system
- Sensor Presser foot lift
- Automatic thread cutter
- Automatic FIX
- Stitch limiting options
- Feed teeth options

deLuxe™ Stitch System

When the *deLuxe*™ stitch system is selected your machine will automatically choose the best way to control the upper thread, thread portioning or thread tension, based on your selected stitch and settings. Thread portioning automatically and continuously measures the fabric thickness to portion the correct amount of thread for the selected stitch. When using thread tension, the tension discs will keep the correct amount of tension on the upper thread.

For best sewing results we strongly recommend you to keep this setting selected except when using specific special techniques or accessories that do not support thread portioning. Deselect the *deLuxe*™ stitch system in the temporary sewing settings to switch to thread tension.

The control for adjusting thread portioning/thread tension, visible in sewing mode, will change depending on the active stitch and whether the *deLuxe*™ stitch system is selected or not in temporary sewing settings.

Sensor Presser Foot Lift

When selected, the machine automatically raises the presser foot in the following situations:

- When stopping with the needle in the down position the presser foot will automatically raise to pivot height.
- After a cut the presser foot will be raised to lift position.

When deselected, the presser foot will stay lowered.

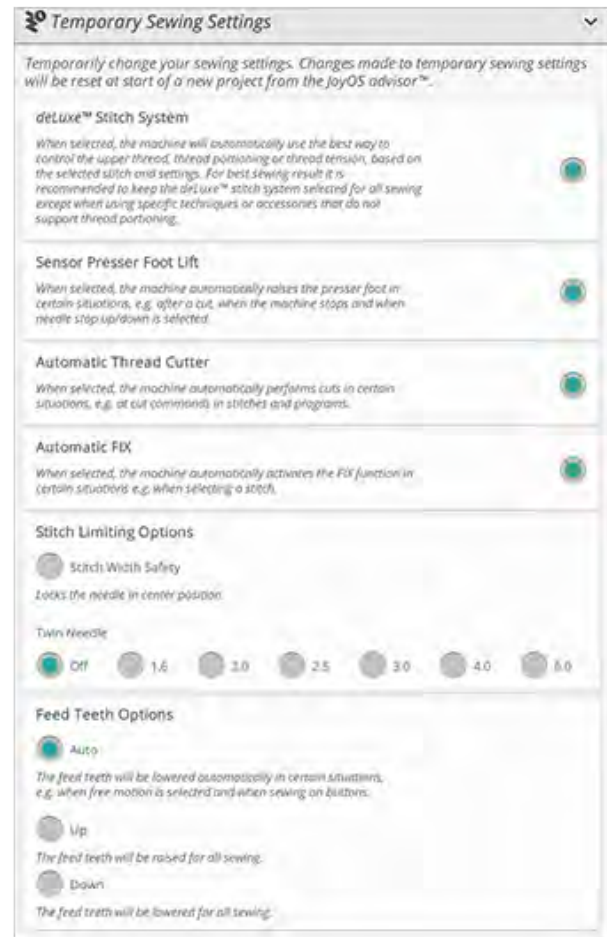

Automatic Thread Cutter

When selected, the threads are cut automatically in the following situations:

- At cut commands in stitches and programs.
- After sewing a single stitch e.g. a monogram or eyelets.

If deselected, no automatic thread cut will be performed.

Note: Deselect when using optional accessories that are attached in the two holes in the needle plate just above the bobbin cover, to prevent damage to the automatic thread cutter knife located under the needle plate.

Automatic FIX

When selected, the machine will automatically activate the FIX function after a cut has been performed and when a stitch is selected.

Stitch Limiting Options

Set the machine to either stitch width safety or select the size of the twin needle to limit the stitch width and stitch positioning. This will minimize the risk of breaking a needle when sewing with accessories that do not allow the use of the entire stitch width.

Stitch Width Safety

When selected, the machine will only allow a centered straight stitch to prevent damage to the needle, presser foot and needle plate. Select stitch width safety when using an accessory that only supports a centered needle position e.g. straight stitch presser foot. Stitch width safety will automatically be selected when the Straight Stitch Plate is attached to the machine and cannot be deselected as long as the Straight Stitch Plate is attached.

When the Straight Stitch Plate is removed you will be given the option to keep stitch width safety selected or to deselect it. When stitch width safety is activated all twin needle sizes will be disabled as they cannot be used together with stitch width safety.

Note: The settings are reset at the start of a new project from the JoyOS ADVISOR™ feature. Always make sure to remove any accessory that requires this setting or select the setting again after starting a new project.

Twin Needle

When a twin needle size is selected, the stitch width and stitch position of all stitches are limited according to the selected twin needle size to prevent damage to the needle, presser foot and needle plate. In sewing mode the stitch preview will indicate that a twin needle is selected. When a twin needle size is selected, the stitch width safety will be disabled as it cannot be used together with a twin needle.

Note: The settings are reset at the start of a new project from the JoyOS ADVISOR™ feature. Always make sure to remove any accessory that requires this setting or select the setting again after starting a new project.

Feed Teeth Options

When auto is selected (recommended) your machine automatically raises or lowers the feed teeth, depending on the stitch and other selected settings. For example, the feed teeth are lowered when sewing on buttons or when free motion sewing.

Select up and the feed teeth will be raised for all sewing.
Select down and the feed teeth will be lowered for all sewing.

Note: Regardless of which option is selected the machine will always lower the feed teeth automatically when raising the presser foot to extra lift position.

Note: The feed teeth options will automatically be reset to auto at the start of a new project from the JoyOS ADVISOR™ feature.

Default Sewing Settings

Settings made in the default sewing settings will be saved, even when turning your machine off.

deLuxe™ Stitch System – Default

When selected the *deLuxe™* stitch system will automatically be selected in the temporary sewing settings for all new projects loaded from the JoyOS ADVISOR™ feature. For more information see the description in the temporary sewing settings on page 104.

Sensor Presser Foot Lift – Default

When selected the sensor presser foot lift will automatically be selected in the temporary sewing settings for all new projects loaded from the JoyOS ADVISOR™ feature. For more information see the description in the temporary sewing settings on page 104.

Automatic Thread Cutter – Default

When selected the automatic thread cutter will automatically be selected in the temporary sewing settings for all new projects loaded from the JoyOS ADVISOR™ feature. For more information see the description in the temporary sewing settings on page 104.

Automatic FIX – Default

When selected the automatic FIX will automatically be selected in the temporary sewing settings for all new projects loaded from the JoyOS ADVISOR™ feature. For more information see the description in the temporary sewing settings on page 104.

Free Motion Options – Default

Choose between three free motion options: free motion floating, free motion ruler foot or free motion spring action. When one of the free motion options is selected the corresponding free motion mode will automatically be selected in sewing mode for all new projects loaded from the JoyOS ADVISOR™ feature.

It is recommended that you do not set an option for free motion in the default sewing settings; choose an option in sewing mode instead.

For more information see the description in the free motion options in sewing mode on page 85



Machine Settings

All settings made in the machine settings will be saved, even when turning your machine off.

Language

Select your desired language on the screen. All texts in the machine will be changed.

Audio Volume

Change the audio volume using the slider bar. All sounds in the machine will be affected when the audio volume is changed. When the slider is all the way to the left, the volume is muted.

Audio Repeat

When active, the signal for some warning alerts or attention pop-up messages will be repeated in intervals until the pop-up is closed.

Machine Nickname

Touch to select a nickname for your machine. This can be useful when owning more than one machine, to distinguish one machine from another when working in *mySewnet*TM. The name will be shown on the screensaver.

Color Theme

Change the color theme of the machine screen. Choose between four color theme options. This will change the color of the screen background, menus, and programs.

Lock Screen

If there is the possibility of bumping the screen and changing the stitch or settings while sewing, it is easy to lock the screen.

When selected, the screen is automatically locked whenever it is inactive for ten seconds. A pop-up is shown on the screen and will remain locked until you touch OK in the pop-up.

LED Work Light Brightness

Adjust the brightness of the LED lights to adapt to the light conditions in your sewing room. Simply move the slider to the right to make the LED lights brighter or to the left to make them less bright.

Units

Touch millimeter or inch to set the measurement unit you prefer.

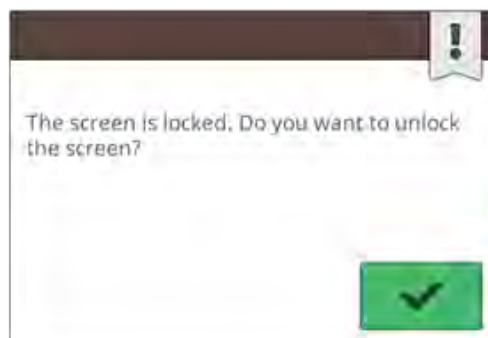
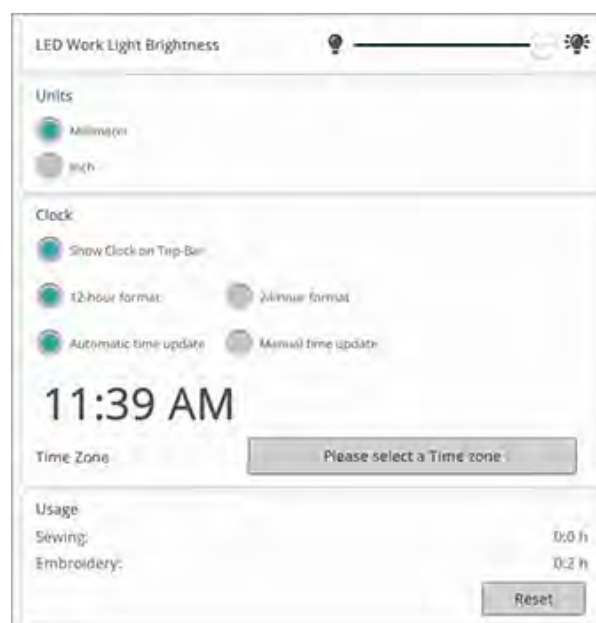

Clock Settings

In clock settings you will find the different settings connected to the clock; select how the clock should be displayed (visible on the top-bar, show a 12- or a -24 hour format) and if you want the clock to be updated automatically or be done manually.

This is also where you set your time zone. The clock is set to UTC (Coordinated Universal Time) standards. For example London is UTC time +/- 0 hours, New York is UTC -5 hours and Sydney is UTC +10 hours. Scroll through the time zones to find the time zone you are in.

Clock Functions

If you have chosen to show the clock in the top-bar, touch the clock to open further clock functions. Here, you can set an alarm, find a stopwatch and see for how long your machine has been sewing since you last reset the timer. Touch the "Reset" button to reset the Stopwatch and/or Sewing time.

Usage

Shows the number of hours sewn on the machine since you last reset the timer. You can reset the counter by touching "Reset".

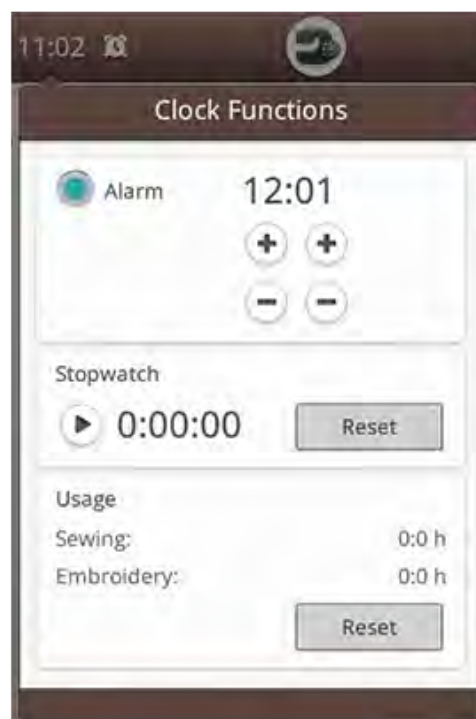

WiFi Settings

Select the WiFi settings on your machine. In WiFi settings you can activate/deactivate WiFi on your machine, search for available networks and connect. If connected to a network with Internet access the latest firmware update will always be available. When WiFi is connected and you have logged in to the *mySewnet™* cloud, all your saved files in the machine will synchronize with the *mySewnet™* cloud.

Read more about the possibilities with WiFi connection in your machine in the WiFi chapter. on page 54



mySewnet™ Settings

In the *mySewnet™* settings you can sign in to the *mySewnet™* cloud or change the user on the machine. You will also be able to create a new user. With a *mySewnet™* account you will be able to access all of the *mySewnet™* services.

Read more about the possibilities with *mySewnet™* in *mySewnet™* services.



Machine Information

Machine information contains technical machine information such as: machine serial number, machine MAC address and current firmware. In machine information you can clear user account and files.

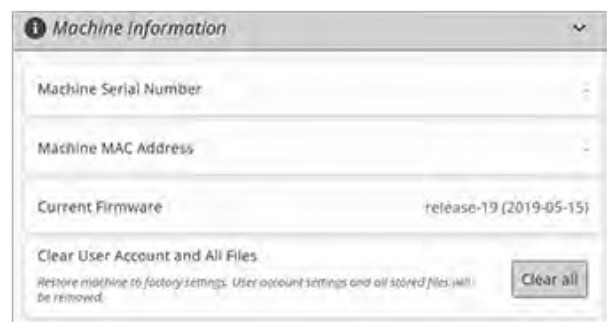

9 File Manager

File Manager – Overview

The file manager is used to open font files and stitch files. Store your saved files in the *mySewnet™* cloud folder or to a USB device connected to your machine.

You can expand the file manager window to fullscreen by touching the file manager tab again.

Touch the minimize button to minimize the file manager.

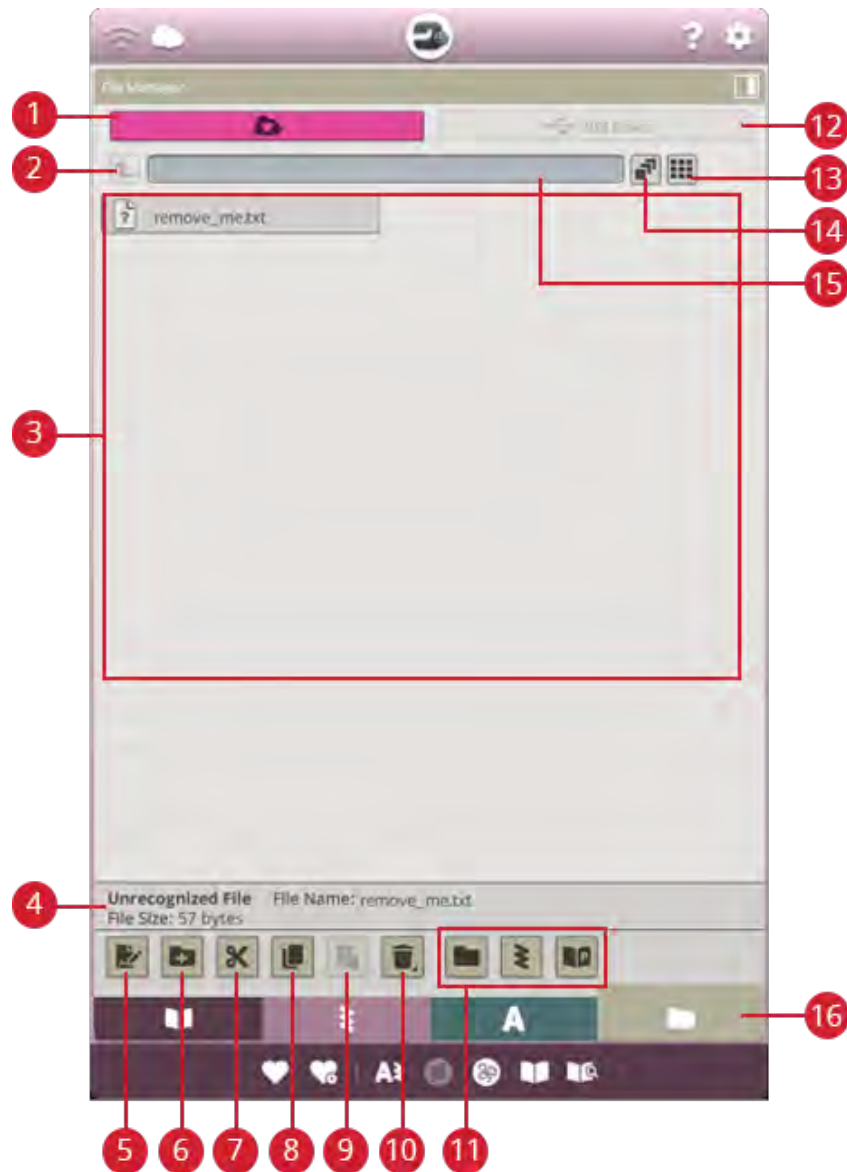

1. *mySewnet™* cloud folder
2. Move up one folder
3. Selection area
4. File information
5. Rename file or folder
6. Create new folder

7. Cut
8. Copy
9. Paste
10. Delete
11. Filter files
12. USB device

13. List/thumbnail view
14. Multi-select
15. Current folder
16. File manager

File Formats

Your machine can load the following file formats:

- .SH7 (stitch file)
- .JOS (JoyOS ADVISOR™ project files)

Browse File Manager

To open file manager, touch the file manager button. Touch the button again to enlarge the file manager on the screen.

Store your fonts and stitches in the *mySewnet™* cloud folder or to a USB device connected to the USB ports. The USB device button is only available when a USB device is connected to the machine.

To display the content, touch one of the following buttons: *mySewnet™* cloud folder or USB device. Swipe with your finger from the right to the left to scroll and view the content. The files are displayed as thumbnail images or with an icon.



File manager button with expand option



mySewnet™ cloud folder



USB device



Stitch file icon

Open a File or Folder

Touch a file to read information about the file in the file information area. Touch & hold the file to load it.

If you load a stitch font file, it will be loaded into program.

Touch & hold on a folder to open it. The content of the folder will be shown in the selection area. The path of an open folder is written in the current folder area.

Multi-Select

If you want to select several stitches or fonts at one time, touch the multi-select button. While multi-select is selected, touch the files you want to use. Copy and paste the selected files e.g. to another folder in file manager.

Note: If trying to load a combination of files/folders that is not possible to load to the same destination a pop-up message will be shown.



Move Up One Folder Level

Use the move up one folder level button to step up through the levels of folders. You can step up all the way to the first level. In the selection area you will see the files and folders for each level as you step up. Touch & hold on a folder to open it.



List/Thumbnail View

Touch the list/thumbnail view button to toggle between showing the files in a list or as thumbnail icons.



mySewnet™ Cloud Folder

Save stitches and fonts to the *mySewnet™* cloud folder on the machine. If you are signed in to a *mySewnet™* account and connected to *mySewnet™* your saved files will be synchronized automatically with the *mySewnet™* cloud. Read more about the *mySewnet™* cloud in the *mySewnet™* cloud section.



USB Device

The USB device button is only active when a USB device is connected to the machine. Touch the USB device button to display all of the connected devices. Touch a USB device to explore it.



Organize

Below are instructions on how to organize your files in file manager.

Create New Folder

Touch the create new folder button to create a new folder in the current position. Enter a name for your folder.



Rename a File or Folder

To change the name of a file or folder, touch to select it and then touch the rename file or folder button. Enter the new name for a file or folder.



Move a File or Folder

Use cut and paste to move file(s) or folder(s) to another location.

Select the file(s) or folder(s) and then touch the cut button. Open the folder where you want to place the selection. Touch the paste button. The file(s) or folder(s) is removed from its original location and now stored in the new folder.

Note: Activate multi-select to be able to select and move more than one file and/ or folder the same time.



Cut



Paste

Copy a File or Folder

Use copy and paste to copy file(s) or folder(s) to another location.

Select the file(s) or folder(s), then touch the copy button. Open the folder where you want to place the selection. Touch the paste button. The file(s) or folder(s) is now stored in the new folder and the original file(s) or folder(s) still exists in the previous folder.

Note: Activate multi-select to be able to select and move more than one file and/ or folder at the same time.



Copy



Paste

Delete a File or Folder

To delete a file or folder, select it and touch the delete button. A pop-up message will appear so that you can confirm the deletion. If a folder is deleted, all files within the folder are deleted as well.

To delete all files and folders shown in the active folder, touch & hold the delete button for a few seconds. A pop-up message will appear so that you can confirm the deletion of all content.



Toggle Between Edit and Filter View

If you expand file manager on the screen, all buttons used for organizing are shown at the same time in the lower part of file manager.

If file manager is not expanded on the screen, touch the toggle switch to toggle between showing the buttons for editing and buttons for filtering. If a filter button has been selected and the switch is set to edit view, an exclamation mark appears to remind you that files have been filtered and as a result all files in current folder may not be visible on the screen.



Filter Files

If you have a lot of content in a folder you can filter specific files in the current view. Touch one or several of the filter buttons to only show, e.g. stitches. The content shown in the selection area will change depending on the selected button (s).

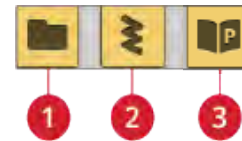

1. Filter folders
2. Filter stitches
3. Filter project creator files

File Manager Pop-up Messages

Delete File or Folder

When deleting a file or folder, you will need to confirm the deletion in the pop-up message that appears on screen. This will prevent you from deleting anything by mistake.

Folder Already Exists

You cannot create a new folder with the same name as another folder on the same level. Create your folder on a different level or enter a different name for the folder.

Available Space is Low

When only a small amount of space is left, your machine will alert you one time. If you continue to fill the space, it will not remind you again, until the space is completely full. Move your files to a USB device by using the cut and paste functions to free up space.

The Combination of Selected File Types Cannot be Loaded

Some file combinations can not be loaded to the same destination using multi-select.

10 Maintenance

Cleaning the Machine Exterior

To keep your sewing machine operating well, clean it often. No lubrication (oiling) is needed.

Wipe the exterior surface of your machine with a soft cloth to remove any dust or lint built up.

Wipe the screen with a clean, soft and slightly damp microfiber cloth.

Removing the Needle Plate and Cleaning the Bobbin Area

 Lower the feed teeth by touching the presser foot up and extra lift button. Turn off the machine.

Remove the presser foot. Open the bobbin cover by pushing the release button (A) to the right. Remove the cover. Place the universal tool under the needle plate as shown and gently turn the universal tool to pop off the needle plate. Clean the feed teeth with the brush that is included with the accessories.

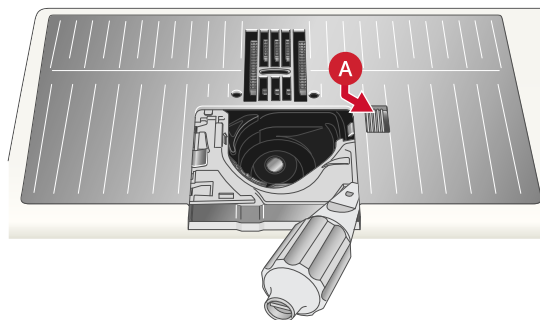

Cleaning Under the Bobbin Area

Clean the area under the bobbin case after sewing several projects or any time you notice an accumulation of lint in the bobbin case area.

Remove the bobbin case holder (A) covering the front part of the bobbin case by lifting it up. Remove the bobbin case (B) by lifting it up. Clean with the brush.

 Use caution when cleaning around the automatic thread cutter knife (C).

Put the bobbin case and the bobbin case holder back in place.

Note: Do not blow air into the bobbin case area. The dust and lint will be blown into your machine.

Note: Regularly clean the lint and threads from the bobbin area. Check the area when changing the needle plate.

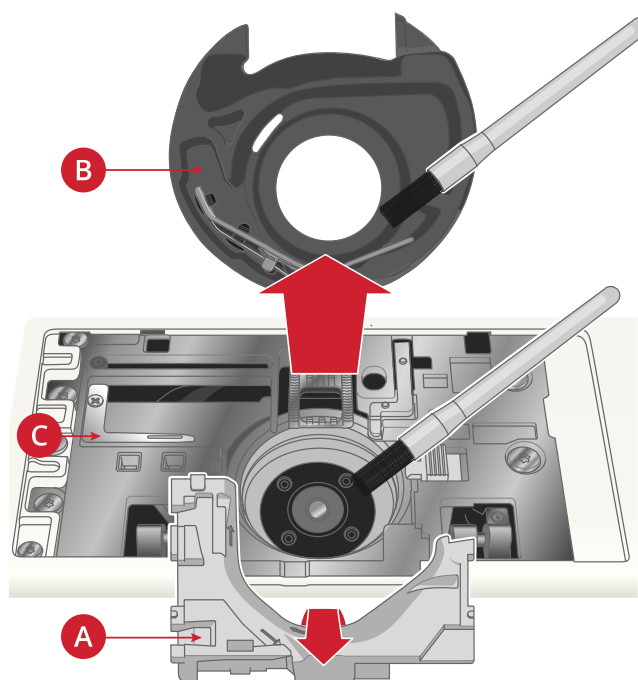

Replacing the Needle Plate

With feed teeth lowered, position the needle plate so that it fits into the notches at the back (D). Press the needle plate down until it clicks into place. Replace the bobbin cover.

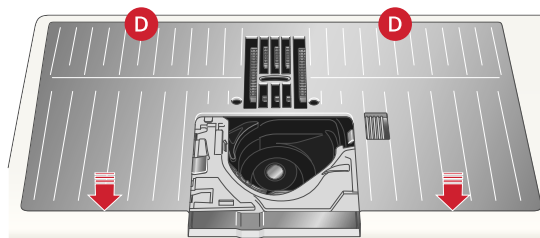

Troubleshooting

In this troubleshooting guide you will find solutions to the problems you may have with your machine. For further information please contact your local authorized HUSQVARNA® VIKING® retailer who will be happy to help you.

General Problems

Bobbin alarm does not work	Clean lint from bobbin area and use only the original HUSQVARNA® VIKING® category 8 bobbins, designed especially for this model.
Thread cutter does not cut the thread	Remove needle plate and clean lint from bobbin area. Enable automatic thread cutter in the settings menu.
Fabric does not feed	Make sure the machine is not set for free motion sewing. Make sure the feed teeth are not set to down in the settings menu.
Wrong stitch, irregular or narrow stitch	Deactivate twin needle or stitch width safety in the settings menu.
The needle breaks	Insert needle correctly as described, see Changing the Needle, page 30. Use a needle suitable for selected fabric. See Selecting Correct Thread/Needle Combination, page 34.
The machine will not sew	Check that all plugs are securely inserted into the machine and the wall socket.
Poor sewing result	Use only accessories designed for your EPIC™ 95Q machine. Follow the on-screen recommendations.
The sewing machine screen and/or function buttons do not respond to touch	The sockets and function buttons on the machine can be sensitive to static electricity. If the screen does not respond to touch, turn the machine OFF and then ON again. If the problem persists, contact your authorized HUSQVARNA® VIKING® retailer.
When sewing in heavy and/or dense fabrics the machine emits a distinct sound different from the sound normally generated when sewing.	The sound is not an indication of malfunction. The machine is equipped with a pulsating needle piercing feature that helps the needle to penetrate heavy and/or dense fabrics. The sound is caused when the presser foot and fabric lift with the needle. Increase the presser foot pressure to prevent the foot from lifting. If the sound does not seem to be related to the pulsating needle piercing feature, contact your authorized HUSQVARNA® VIKING® retailer for service.

The Automatic Needle Threader Does Not Work Properly

The needle eye is too small for the thread	Use a larger needle size or lighter weight thread. See Selecting Correct Thread/Needle Combination, page 34
Are you using a specialty thread such as an “invisible” or other stretchy thread, metallic or flat metallic thread or heavy weight thread?	Specialty threads may not be caught correctly by the hook on the automatic needle threader. If this happens, the needle will not be threaded. Try using the automatic needle threader again or thread the needle manually.
Pop-up message: The automatic needle threader is not in its home position. Touch OK to calibrate.	The needle threader has shifted from its home position, possibly due to something snagging on it during sewing. Touch OK to calibrate the needle threader and continue sewing.

Pop-up message: The calibration of the automatic needle threader has failed. Touch OK to calibrate again. If the automatic needle threader still does not calibrate correctly, please contact your local authorized service center.	Shown if the machine fails to calibrate the needle threader when turning on the machine. Remove anything that may be blocking the needle threader and touch OK.
Pop-up message: The automatic needle threader seems to be blocked and cannot return to its home position. Touch OK to move the automatic needle threader to position for manual cleaning.	If using thread that is too thick for the needle, the automatic needle threader may not be able to pull the thread through the needle eye. Touch OK to go to manual cleaning. A new pop-up message with further instructions will appear. If you cannot identify the problem or are unable to remove the thread, touch cancel.
Pop-up message: Gently remove any thread that has been stuck in the automatic needle threader or needle eye and touch OK to return the automatic needle threader to its home position.	If using thread that is too thick for the needle, the automatic needle threader may not be able to pull the thread through the needle eye. Remove the thread carefully so as not to damage the small hook that runs through the needle eye. Once the thread is removed, touch OK.
Pop-up message: The automatic needle threader is not in its home position. Further sewing is disabled to prevent damage to the machine. Press the automatic needle threader button on your machine for possibility to try manual cleaning again or contact your local authorized service center.	Contact your authorized HUSQVARNA® VIKING® retailer for service.
Pop-up message: The automatic needle threader cannot return to its home position. Further sewing is disabled to prevent damage to the machine. Please contact your local authorized service center.	Contact your authorized HUSQVARNA® VIKING® retailer for service.

The Machine Skips Stitches

Did you insert the needle properly?	Insert needle correctly as described, see Changing the Needle, page 30.
Did you insert a wrong needle?	Use needle system 130/705 H. Use a needle suitable for selected fabric and thread. See Selecting Correct Thread/Needle Combination, page 34.
Is the needle bent or blunt?	Insert a new needle.
Did you thread the machine properly?	Remove the thread completely and rethread the machine, see Threading the Upper Thread, page 31.
Is the correct presser foot used?	Attach correct presser foot.
Is the needle too small for the thread?	Change the needle.
Is the fabric moving up and down with the needle when free motion sewing?	Attach Sensor Q-Foot. Optional since the Sensor Q-Foot does not come with sewing only machines.

Needle Thread Breaks

Did you insert the needle properly?	Insert needle correctly, see Changing the Needle, page 30.
Did you insert a wrong needle?	Use needle system 130/705 H. Use a needle suitable for selected fabric and thread. See Selecting Correct Thread/Needle Combination, page 34.
Is the needle bent or blunt?	Insert a new needle.
Did you thread the machine properly?	Remove the thread completely and rethread the machine, see Threading the Upper Thread, page 31.

Does the thread slide down and get caught under the thread spool?	Place the large spool holder with the flat side up under the spool on the spool pin, or for larger spools use a thread net over the spool. See Threading Tips and Hints, page 37.
Is the needle too small for the thread?	Change the needle to the proper size for the thread.
Are you using poor thread with slubs or thread which has become dry?	Change to a new high quality thread purchased from an authorized HUSQVARNA® VIKING® retailer.
If using a spool cap on top of the spool, is it too small so the thread snags at the top of the spool?	Attach a spool cap slightly larger than the actual thread spool.
Is the best spool pin position used?	Try a different spool pin position (vertical or horizontal).
Is the needle plate hole damaged?	Change the needle plate.
Is the thread tension too high for selected thread?	Lower the thread tension in small increments until problem is solved.

Bobbin Thread Breaks

Is the correct bobbin used?	Use only bobbins especially designed for the EPIC™ 95Q machine.
Did you insert the bobbin properly?	Check the bobbin thread.
Is the needle plate hole damaged?	Change the needle plate.
Is the bobbin area full of lint?	Clean lint from bobbin area and use only the original bobbins approved for this model.
Is the bobbin wound correctly?	Wind a new bobbin.

The Seam Has Uneven Stitches

Is the thread tension correct?	Check needle thread tension. Remove the thread completely and rethread the machine, see Threading the Upper Thread, page 31.
Is the thread you are using thick or slubbed?	Change the thread.
Is the bobbin thread evenly wound?	Check bobbin winding.
Is a correct needle used?	Insert a proper needle correctly as described, see Changing the Needle, page 30. Use a needle suitable for selected fabric. See Selecting Correct Thread/Needle Combination, page 34.

The Machine Does Not Feed or Feeds Irregularly

Did you thread the machine properly?	Remove the thread completely and rethread the machine, see Threading the Upper Thread, page 31.
Has sewing lint collected between the feed teeth?	Remove the needle plate and clean the feed teeth with the brush.
Is the free motion setting on?	Turn off free motion setting in sewing mode.
Are the feed teeth set to down?	Make sure the feed teeth are not set to down in the settings menu.
Is the correct presser foot used?	Attach correct presser foot.

Troubleshooting Connectivity

The Machine Cannot Connect to a WiFi Network

The machine will not connect to a WiFi network	<p>Make sure that WiFi is enabled on your machine. Touch the WiFi button on the top bar or go to WiFi settings.</p> <p>Make sure that the machine detects a signal from your WiFi network. If there is no signal, move the machine closer to the WiFi router.</p> <p>Make sure you have selected your WiFi network.</p>
The machine has no Internet connection	Make sure that your WiFi router has access to the Internet.
The WiFi network is password protected	Make sure that you have selected your WiFi network and entered the correct password. If you do not know the password, contact the administrator of your network.

The Machine Cannot Synchronize with the *mySewnet*TM Cloud

The machine cannot synchronize files with the <i>mySewnet</i> TM cloud	<p>Make sure that you have a working WiFi connection.</p> <p>Make sure that you have signed in to your <i>mySewnet</i>TM account. New <i>mySewnet</i>TM accounts are registered in the machine or at husqvarnaviking.mysewnet.com</p> <p>Make sure that there is available space on the <i>mySewnet</i>TM cloud.</p> <p>If the <i>mySewnet</i>TM cloud is not accessible although you have checked the WiFi connection, the server could temporarily be unavailable. Please try again later.</p>
---	--

Service

Have Your Sewing Machine Serviced Regularly by Your Local Authorized Retailer!

If you have followed this troubleshooting information and still have problems, contact your retailer. It may be helpful to bring the fabric, thread and stabilizer you are using with you. If you have a stitch out that shows the problem, please bring that as well. A sewing sample will often give better information than words and help your technician diagnose the problem.

Non-Original Parts and Accessories

The warranty does not cover any defect or damage caused by use of non-original accessories or parts.

Technical Specification

Sewing Speed 1050 stitches/minute maximum	Rated Voltage 100–120V / 200–240V, 50–60Hz	Nominal Consumption <100W
Light Led Lights	Foot Control Model FR5	Safety Class II (Europe)
WiFi Module Frequency: 2.4 band / 802.11 b/g/n Transmitting power: +17 dBm Receiver sensitivity: -97 dBm	Machine Dimensions Length: 590 mm Width: 290 mm Height: 360 mm	Net Weight Machine only: 14 kg

The technical specifications and this user's guide can be changed without prior notice.

Index

4-Way Stitches – Menu S	90
4-Way Stitches Exercise	90
8-Way Stitches – Menu T	91

A

Accessories	15
Accessory guide	67
Accessory socket	11
Accessory Tray	12
Active position	95
Adjust a Stitch or Letter	96
Adjust the Entire Program	97
Adjust Thread Tension/Thread Portioning	77
Adjustable ¼" Foot for IDF System	16
Adjustable Laser Sewing Guidance	13
All Purpose Sewing Thread	28
Alphabets	21
Alternative switch bar	71
Apps	55
Attaching the Sensor One-Step Buttonhole Foot	42
Attention!	92
Audio Repeat	104
Audio Volume	104
Automatic Buttonhole	85
Automatic FIX	100–101
Automatic FIX – Default	103
automatic needle threader	92
Automatic needle threader	11, 13
Automatic Needle Threader	33
Automatic thread cutter	100
Automatic Thread Cutter	101
Automatic Thread Cutter – Default	103
Auxiliary spool pin	10
Available Space is Low	113
Available techniques of chosen group	67

B

Balance	80
Balance stitch	71
Base plate	10
Basic Gestures for the Multi-Touch Screen	22
Basic Sewing Techniques	83
Baste	83
Blind Hem	84
Blindhem Foot D	16
bobbin case	116
bobbin case holder	116
Bobbin cover	10
Bobbin cover release button	10
Bobbin Thread Breaks	119
Bobbin Thread Low	92

bobbin winder	38
Bobbin winder	11
Bobbin Winding	38
Bobbin winding lever	11
Bobbin winding thread guides	10
Bobbins	15
Browse File Manager	109
Brush	15
Built-in Ruler with button ruler	10
Built-in USB ports	11
Button reed	15
Button Size	75
Buttonhole Foot C	16
Buttonholes	85

C

Cancel	44, 79, 98
Cancel program	94
Cannot Use the Automatic Needle Threader	92
Changing the Needle	30
Changing the Presser Foot	41
Changing to Straight Stitch Plate	42
Check Upper Thread	92
Cleaning the Bobbin Area	116
Cleaning the Machine Exterior	116
Cleaning Under the Bobbin Area	116
clear user account	106
Close	62
Common Functions	44
Complimentary Software (PC and MAC)	52
Confirm	79, 98
Connect the foot control cord	24
Connect the power cord	24
Connect to a Network with WiFi	26
Connect to <i>mySewnet</i> ™ Cloud	26
Continue	60
Copy	108, 111
Copy a File or Folder	111
Corded Buttonhole	85
Create	
New Program	95
Create new folder	79, 98, 108
Create New Folder	111
current firmware	106
Current folder	108
Cursor	94, 96
Cut	108, 111
Cut function	13

D

Darning Foot R	16
----------------------	----

Decorative Stitch Foot B	16
Decorative Thread.....	28
Default Sewing Settings.....	103
Delete	94, 96, 108
Delete a File or Folder	111
Delete a Stitch or Letter	96
Delete File or Folder.....	113
<i>deLuxe</i> [™] stitch system	100
<i>deLuxe</i> [™] Stitch System.....	77, 100
<i>deLuxe</i> [™] Stitch System – Default.....	103
Denim Needle	29
Dimensional Stitches – Menu L.....	86
Duplicate.....	94, 96
Duplicate a Stitch or Letter	96

E

Edge/Quilting guide.....	15
Edging Foot J for IDF System.....	16
Edit Stitch or Lettering Program.....	96
Embellished Stitches – Menu N.....	88
Embroidery Needle	29
EXCLUSIVE SENSOR SYSTEM [™] EXCLUSIVE SENSOR SYSTEM.....	76
Extra wide space for Side-Motion Foot S	12

F

Fabric selected.....	71
Fabric selection.....	63
Fabric Selection	64
Fast forward.....	62
FAT32.....	25
Feed teeth options.....	100
Feed Teeth Options.....	102
File Formats.....	109
File information.....	108
File manager.....	71–72, 94, 108–109
File Manager – Overview.....	108
File Manager Pop-up Messages.....	113
File name.....	79, 98
Filter files	108
Filter Files.....	112
Filter folders.....	112
Filter project creator files.....	112
Filter stitches.....	112
Firmware Update Using a USB Device	51
Firmware Update Using WiFi.....	51
FIX command.....	94, 97
FIX function	13
Folder Already Exists.....	113
Font menu	71–72, 94
Free arm.....	11
Free Arm.....	26
free motion floating.....	81

Free motion options	71
Free Motion Options.....	81
Free Motion Options – Default	103
free motion spring action.....	81
Full screen on/off.....	62
Function buttons	10
Function Buttons	13

G

General Problems	117
Getting Started to Sew	70
Getting Started With WiFi	50
Getting Started with WiFi and <i>mySewnet</i> [™] Cloud	26
Glide plates recommendation.....	73
go to first.....	94, 96
go to last	94, 96

H

Handle	11
Handwheel.....	10
Hem	84
Hidden Network.....	50
high signal strength.....	50
Home Screen.....	46
Home Screen— Overview.....	58
Hook for storing the Sensor One-Step Buttonhole Foot	12

I

Important Needle Information.....	29
Included Accessories	15
Included Presser Feet.....	16
Insert a Stitch or Letter	96
Inserting the Bobbin.....	40
Installation of <i>mySewnet</i> [™] Cloud Sync Tool for Computer ..	55
Integrated Dual Feed (IDF) System.....	11

J

JoyOS ADVISOR [™] feature.....	100
JoyOS ADVISOR [™] project	100
JoyOS ADVISOR [™] project files	109
JoyOS ADVISOR [™] project menu	71, 94
JoyOS ADVISOR [™] project viewer.....	71, 94
JoyOS ADVISOR [™] Project Viewer – Overview	61

K

keyboard.....	94–95
keypad.....	96

Knit fabric	64
Knowledge Center – Overview.....	67

L

Language	104
Large spool holder	15
Leather.....	64
LED lights	10, 104
LED Lights.....	26
LED Work Light Brightness.....	104
Left Side.....	11
Lid	10
List and thumbnail view	79
List/thumbnail view	108
List/Thumbnail View	110
Load a Stitch or Letter From Another Location.....	72
Load Smart Save	60
Lock Screen	104

M

Machine Information.....	106
machine MAC address	106
Machine Overview	10
machine serial number	106
Machine Settings.....	104
Main spool pin.....	10
Manual Buttonhole.....	85
Manual Thread Cutter.....	26
medium signal strength	50
microfiber cloth	116
Minimize/expand selection area.....	71, 94
Mirror end to end	71, 78, 94, 96
Mirror side to side.....	71, 78, 94, 96
Mirroring.....	78
Move a File or Folder.....	111
Move up one folder	108
Move Up One Folder Level	109
multi-select	111
Multi-select	108
Multi-Select.....	109
Multi-touch screen	10
Multipurpose tool	15
<i>mySewnet</i> [™]	46, 54
<i>mySewnet</i> [™] account.....	53, 120
<i>mySewnet</i> [™] Account.....	53
<i>mySewnet</i> [™] cloud.....	53, 120
<i>mySewnet</i> [™] Cloud	54
<i>mySewnet</i> [™] cloud folder.....	53, 108–109
<i>mySewnet</i> [™] Cloud Folder	110
<i>mySewnet</i> [™] cloud sync tool.....	53
<i>mySewnet</i> [™] menu.....	53
<i>mySewnet</i> [™] Menu	55
<i>mySewnet</i> [™] Services	53

<i>mySewnet</i> [™] Settings.....	106
--	-----

N

Needle Area.....	11
Needle Combination.....	34
Needle holder with needle clamp screw.....	11
Needle plate.....	10
Needle recommendation	73
Needle stop up/down.....	13
Needle Thread Breaks.....	118
Needle thread guide.....	11
Needles	29
New program.....	71
New Program.....	95
Non-Original Parts and Accessories	120
Non-Stick Glide Foot H for IDF System.....	16
Not a Programmable Stitch.....	98

O

OK.....	44, 94
ON/OFF switch.....	11, 24
Open a File or Folder	109
Organize.....	111
Overcast.....	83

P

Pack Away After Sewing.....	25
Paste	108, 111
<i>Pinch/Stretch</i>	22
Play/pause	62
Pre-tension thread guide.....	10
Presser foot.....	11
Presser foot ankle.....	11
Presser foot bar	11
Presser foot down and pivot	13
Presser foot recommendation.....	73
Presser foot up and extra lift	13
Program – Overview	94
Program length.....	94
Program Pop-Up Messages.....	98
Programmable Button Sew On.....	86
Project Menu.....	60
Project Viewer.....	61

Q

quick help	65
Quick Help	47
Quick start guide.....	67
Quick Start Guide	68

QUILT ADVISOR– Overview.....	66
Quilting technique groups.....	66
Quilting techniques	66

R

Rear.....	11
release button.....	116
Removable bobbin holder.....	12
Remove Sensor One-Step Buttonhole Foot	92
Removing the Needle Plate	116
Rename a File or Folder	111
Rename file or folder	108
Repeat on/off	62
Replace a Stitch or Letter.....	96
Replacing the Needle Plate.....	116
Reverse	13
Rewind.....	62
Right Side	11

S

Save.....	71, 94, 98
Save Stitch	79
Save to a USB device	98
Save to <i>mySewnet</i> TM cloud folder	79
Save to the <i>mySewnet</i> TM cloud folder.....	98
Save to USB device.....	79
Seam.....	83
Seam ripper.....	15
Select a Stitch or Letter	72
Selecting Correct Thread	34
Selection area	71, 79, 98, 108
Self-Adhesive Glide Plates	17
sensor foot pressure	71
Sensor Foot Pressure	76
Sensor One-Step Buttonhole Foot	17, 92
Sensor Presser foot lift.....	100
Sensor Presser Foot Lift.....	100
Sensor Presser Foot Lift – Default	103
Service	120
Settings	47
Sew On Button.....	76
Sew Your Stitch Program.....	98
SEWING ADVISOR TM – Overview.....	63
Sewing instructions	67
Sewing Instructions	68
Sewing Mode – Overview.....	71
Sewing Pop-up Messages.....	92
Sewing recommendations	71
Sewing Recommendations	73
Sewing technique groups	63
Sewing Technique Groups	65
Sewing techniques	63
Side-Motion Foot S	16

Slot for needle packs.....	12
Smart save	71
Smart Save.....	79
Smart Toolbox.....	22
Space for accessories.....	12
Space for needle plate	12
Space for seam ripper and brush.....	12
Space in <i>mySewnet</i> TM Cloud.....	54
Space with hole for Buttonhole Foot C	12
Spaces for presser feet.....	12
Speaker	10
Special Stitches For Optional Presser Feet	91
Speed – and +	13
Spool cap.....	15
Spool Caps.....	28
Spool Pins	27
Stabilizer guide	67
Stabilizer Guide	68
Stabilizer recommendation.....	73
Start New	60
Start/Stop.....	13
Step to next part of stitch	71
step to next stitch.....	95
Step to next stitch	94, 96
Step to previous stitch.....	94–96
Step-by-step workbook	67
Step-by-Step Workbook	68
Stitch categories.....	71–72
stitch density	71
Stitch density.....	94
Stitch Density.....	75
stitch file.....	109
Stitch information	71–72
Stitch length.....	71, 94
Stitch Length.....	75
Stitch limiting options	100
Stitch Limiting Options.....	101
Stitch menu.....	71–72, 94
Stitch menu name.....	71
Stitch Menu Overview	21
Stitch Overview	18
stitch positioning.....	71
Stitch positioning.....	94
Stitch Positioning.....	74
Stitch Program Commands	97
Stitch re-start.....	13
Stitch selected.....	73
Stitch Settings.....	74
Stitch start	71
Stitch width.....	71, 94
Stitch Width.....	74
Stitch Width Safety.....	92, 101
STOP command.....	94, 97
STOP function	13
Storing a Needle Plate.....	12
Straight Stitch Plate	15
Straight Stitch Plate recommendation	73
Stretch Fabrics.....	64

Stretch Needle.....	29
<i>Swipe</i>	22

T

Taper Satin Stitch Exercise.....	89
Tapering menu.....	71
Tapering Stitches – Menu Q.....	89
Technical Specification.....	120
Technique groups.....	67
telescopic thread guide.....	31
Telescopic thread guide.....	10
Telescopic Thread Guide.....	27
Temporary Sewing Settings.....	100
The Automatic Needle Threader Does Not Work Properly.....	117
The Combination of Selected File Types Cannot be Loaded.....	113
The Machine Cannot Connect to a WiFi Network.....	120
The Machine Cannot Synchronize with the <i>mySewnet</i> [™] Cloud.....	120
The Machine Does Not Feed or Feeds Irregularly.....	119
The Machine Skips Stitches.....	118
The Maximum Number of Stitches Has Been Reached.....	98
The Seam Has Uneven Stitches.....	119
Theme Stitches – Menu M.....	87
Thread cone holder.....	15
thread cut command.....	97
Thread cut command.....	94
Thread cutter.....	10
Thread cutter for bobbin winding.....	11
Thread net.....	15
Thread portioning.....	71, 77, 100
Thread Sensor.....	27
Thread Slides Down on the Standing Thread Spool.....	37
Thread Spool is Pulled up on the Spool Pin.....	37
Thread take-up lever.....	10
Thread Tangles or Curls when Unwinding.....	37
thread tension.....	71, 100
Thread tension.....	77
Thread tension discs.....	10
Threading.....	31
Threading for Twin Needle.....	35
Threading slot.....	10
Threading slots.....	10
Threading the Upper Thread.....	31
Threading Tips and Hints.....	37
Threads.....	28
To Edit a Created Program.....	95
Toggle Between Edit and Filter View.....	112
Toggle between list and thumbnail view.....	98
Topbar.....	45
<i>Touch</i>	22
<i>Touch & Hold</i>	22, 44
<i>Touch and Move</i>	22
Transparent Thread.....	28
Troubleshooting.....	117

Troubleshooting Connectivity.....	120
Twin Needle.....	92, 102

U

Universal Needle.....	29
universal tool.....	116
Universal tool.....	15
Unpacking Machine.....	24
Unplug the cord.....	25
Unplug the foot control cord.....	25
USB device.....	108–109
USB Device.....	110
USB Ports.....	25
User's guide.....	71
Using a USB Device.....	25
Using the Automatic Needle Threader.....	33
Utility Foot A for IDF System.....	16
Utility Stitches.....	18

V

Vinyl.....	64
------------	----

W

Watch clip/full animation.....	62
What is a Stitch?.....	72
WiFi.....	45, 120
WiFi Introduction.....	50
WiFi router.....	120
WiFi settings.....	120
WiFi Settings.....	106
Winding Through the Needle.....	39
Wing Needle.....	29
Wireless Firmware Update.....	46
Woven fabric.....	64
Woven Fabrics.....	64
Woven or Knit.....	64

Z

Zipper Foot E for IDF System.....	16
-----------------------------------	----

You have purchased a modern, updatable sewing machine. As we regularly release firmware updates, it is possible that there may be some differences between the machine firmware and the firmware described in the user's guide. Consult your local authorized HUSQVARNA® VIKING® retailer, and be sure to visit our website at www.husqvarnaviking.com for the latest updates of the firmware and the user's guide.

We reserve the right to change the machine equipment and the assortment of accessories without prior notice, or make modifications to the performance or design. Such modifications, however, will always be to the benefit of the user and the product.

INTELLECTUAL PROPERTY

Patents protecting this product are listed on a label positioned underneath the Sewing Machine.

DESIGNER EPIC, EXCLUSIVE SENSOR SYSTEM, 122, MYSEWNET, VIKING, and KEEPING THE WORLD SEWING & Design are trademarks of KSIN Luxembourg II, S.a. r.l.

HUSQVARNA and the "crowned H-mark" are trademarks of Husqvarna AB. All trademarks are used under license by VSM Group AB.



Please note that on disposal, this product must be safely recycled in accordance with relevant National legislation relating to electrical/electronic products. Do not dispose of electrical appliances as unsorted municipal waste, use separate collection facilities. Contact your local government for information regarding the collection systems available. When replacing old appliances with new ones, the retailer may be legally obligated to take back your old appliance for disposal free of charge.

If electrical appliances are disposed of in landfills or dumps, hazardous substances can leak into the groundwater and get into the food chain, damaging your health and well-being.

Manufacturer

VSM GROUP AB, **SVP Worldwide**

Drottninggatan 2, SE-56184, Huskvarna, SWEDEN



www.husqvarnaviking.com