



U.S. Department of Transportation
National Highway Traffic Safety
Administration



[reserved for final report no.]

July 2018

Draft CAFE Model Documentation

DRAFT

Notice

This document is disseminated under the sponsorship of the Department of Transportation in the interest of information exchange. The United States Government assumes no liability for its contents or use thereof.

REPORT DOCUMENTATION PAGE

Form Approved
OMB No. 0704-0188

Public reporting burden for this collection of information is estimated to average one hour per response, including the time for reviewing instructions, searching existing data sources, gathering and maintaining the data needed, and completing and reviewing the collection of information. Send comments regarding this burden estimate or any other aspect of this collection of information, including suggestions for reducing this burden, to Washington Headquarters Services, Directorate for Information Operations and Reports, 1215 Jefferson Davis Highway, Suite 1204, Arlington, VA 22202-4302, and to the Office of Management and Budget, Paperwork Reduction Project (0704-0188), Washington, DC 20503.

1. AGENCY USE ONLY (Leave blank)	2. REPORT DATE reserved for final report date	3. REPORT TYPE Operational Handbook
----------------------------------	--	--

4. TITLE AND SUBTITLE CAFE Model Documentation	5. FUNDING NUMBERS reserved for final report funding numbers
6. AUTHOR(S) Mark Shaulov, Dan Bogard, Coralie Cooper, Kevin Green, Brianna Jean, Ryan Keefe, Donald Pickrell, and John Van Schalkwyk	

7. PERFORMING ORGANIZATION NAME(S) AND ADDRESS(ES) U.S. Department of Transportation CAFE Program Office John A. Volpe National Transportation Systems Center Cambridge, MA 02142	8. PERFORMING ORGANIZATION REPORT NUMBER
---	--

9. SPONSORING/MONITORING AGENCY NAME(S) AND ADDRESS(ES) U.S. Department of Transportation National Highway Traffic Safety Administration Fuel Economy Division 1200 New Jersey Ave, SE Washington, DC 20590	10. SPONSORING/MONITORING AGENCY REPORT NUMBER reserved for final report no.
--	---

11. SUPPLEMENTARY NOTES

12a. DISTRIBUTION/AVAILABILITY STATEMENT This document is available to the public through the National Technical Information Service, Springfield, Virginia 22161.	12b. DISTRIBUTION CODE
---	------------------------

13. ABSTRACT (Maximum 200 words)
The Volpe National Transportation Systems Center (Volpe Center) of the United States Department of has developed a modeling system to assist the National Highway Traffic Safety Administration (NHTSA) in the evaluation of potential new Corporate Average Fuel Economy (CAFE) standards. Given externally-developed inputs, the modeling system estimates how manufacturers could apply additional fuel-saving technologies in response to new CAFE or CO₂ standards, and estimates how doing so would impact vehicle costs and fuel economy levels; vehicle sales volumes and fleet turnover; and national-scale automotive manufacturing employment, highway travel, fatalities, fuel consumption, and CO₂ and other emissions. Based on these impacts, the system calculates costs and benefits from private and social perspectives.

14. SUBJECT TERMS Corporate Average Fuel Economy standards, CO ₂ standards, GHG standards, vehicles, fuel-saving technology, fuel savings, costs, effects, benefits.	15. NUMBER OF PAGES reserved for final page count
	16. PRICE CODE

17. SECURITY CLASSIFICATION OF REPORT Unclassified	18. SECURITY CLASSIFICATION OF THIS PAGE Unclassified	19. SECURITY CLASSIFICATION OF ABSTRACT Unclassified	20. LIMITATION OF ABSTRACT
---	--	---	----------------------------

DRAFT

ENGLISH TO METRIC

<p>LENGTH (APPROXIMATE)</p> <p>1 inch (in) = 2.5 centimeters (cm)</p> <p>1 foot (ft) = 30 centimeters (cm)</p> <p>1 yard (yd) = 0.9 meter (m)</p> <p>1 mile (mi) = 1.6 kilometers (km)</p>	<p>LENGTH (APPROXIMATE)</p> <p>1 millimeter (mm) = 0.04 inch (in)</p> <p>1 centimeter (cm) = 0.4 inch (in)</p> <p>1 meter (m) = 3.3 feet (ft)</p> <p>1 meter (m) = 1.1 yards (yd)</p> <p>1 kilometer (km) = 0.6 mile (mi)</p>
<p>AREA (APPROXIMATE)</p> <p>1 square inch (sq in, in²) = 6.5 square centimeters (cm²)</p> <p>1 square foot (sq ft, ft²) = 0.09 square meter (m²)</p> <p>1 square yard (sq yd, yd²) = 0.8 square meter (m²)</p> <p>1 square mile (sq mi, mi²) = 2.6 square kilometers (km²)</p> <p>1 acre = 0.4 hectare (he) = 4,000 square meters (m²)</p>	<p>AREA (APPROXIMATE)</p> <p>1 square centimeter (cm²) = 0.16 square inch (sq in, in²)</p> <p>1 square meter (m²) = 1.2 square yards (sq yd, yd²)</p> <p>1 square kilometer (km²) = 0.4 square mile (sq mi, mi²)</p> <p>10,000 square meters (m²) = 1 hectare (ha) = 2.5 acres</p>
<p>MASS - WEIGHT (APPROXIMATE)</p> <p>1 ounce (oz) = 28 grams (gm)</p> <p>1 pound (lb) = 0.45 kilogram (kg)</p> <p>1 short ton = 2,000 pounds (lb) = 0.9 tonne (t)</p>	<p>MASS - WEIGHT (APPROXIMATE)</p> <p>1 gram (gm) = 0.036 ounce (oz)</p> <p>1 kilogram (kg) = 2.2 pounds (lb)</p> <p>1 tonne (t) = 1,000 kilograms (kg) = 1.1 short tons</p>
<p>VOLUME (APPROXIMATE)</p> <p>1 teaspoon (tsp) = 5 milliliters (ml)</p> <p>1 tablespoon (tbsp) = 15 milliliters (ml)</p> <p>1 fluid ounce (fl oz) = 30 milliliters (ml)</p> <p>1 cup (c) = 0.24 liter (l)</p> <p>1 pint (pt) = 0.47 liter (l)</p> <p>1 quart (qt) = 0.96 liter (l)</p> <p>1 gallon (gal) = 3.8 liters (l)</p> <p>1 cubic foot (cu ft, ft³) = 0.03 cubic meter (m³)</p> <p>1 cubic yard (cu yd, yd³) = 0.76 cubic meter (m³)</p>	<p>VOLUME (APPROXIMATE)</p> <p>1 milliliter (ml) = 0.03 fluid ounce (fl oz)</p> <p>1 liter (l) = 2.1 pints (pt)</p> <p>1 liter (l) = 1.06 quarts (qt)</p> <p>1 liter (l) = 0.26 gallon (gal)</p> <p>1 cubic meter (m³) = 36 cubic feet (cu ft, ft³)</p> <p>1 cubic meter (m³) = 1.3 cubic yards (cu yd, yd³)</p>
<p>TEMPERATURE (EXACT)</p> <p>$[(x-32)(5/9)]\text{ }^{\circ}\text{F} = y\text{ }^{\circ}\text{C}$</p>	<p>TEMPERATURE (EXACT)</p> <p>$[(9/5)y + 32]\text{ }^{\circ}\text{C} = x\text{ }^{\circ}\text{F}$</p>

QUICK INCH - CENTIMETER LENGTH CONVERSION

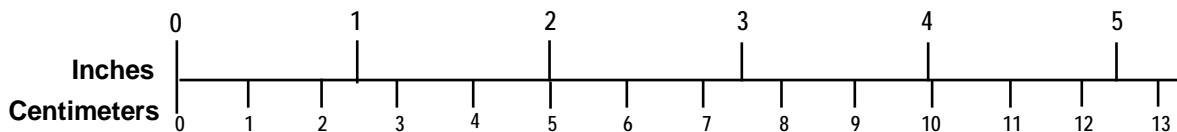

QUICK FAHRENHEIT - CELSIUS TEMPERATURE CONVERSION

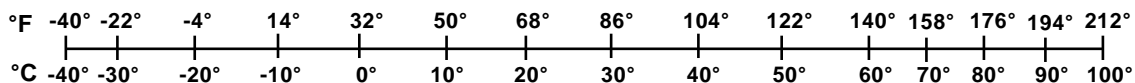

For more exact and or other conversion factors, see NIST Miscellaneous Publication 286, Units of Weights and Measures. Price \$2.50 SD Catalog No. C13 10286

Updated 6/17/98

PREFACE

The United States Department of Transportation (DOT's) Volpe National Transportation Systems Center (Volpe Center) has developed and, since 2002, steadily applied, expanded, and refined a modeling system to assist the National Highway Traffic Safety Administration (NHTSA) in the evaluation of potential new Corporate Average Fuel Economy (CAFE) standards and, more recently, to assist the U.S. Environmental Protection Agency (EPA) in the evaluation of related potential new standards regarding new vehicle carbon dioxide (CO₂) emissions. Given externally-developed inputs, the modeling system estimates how manufacturers could apply additional fuel-saving technologies in response to new CAFE or CO₂ standards, and estimates how doing so would impact vehicle costs, fuel economy levels, and CO₂ emission rates; vehicle sales volumes and fleet turnover; and national-scale automotive manufacturing employment, highway travel, fatalities, fuel consumption, and CO₂ and other emissions. Based on these impacts, the system calculates costs and benefits from private and social perspectives.

This draft report documents the design and function of the CAFE Model as of July 2018; specifies the content, structure, and meaning of inputs and outputs; and provides instructions for the installation and use of the modeling system.

The authors of this report are Mark Shaulov, Dan Bogard, Coralie Cooper, Kevin Green, Brianna Jean, Ryan Keefe, Donald Pickrell, and John Van Schalkwyk.

The authors acknowledge the technical contributions of NHTSA staff who have been involved in guiding recent changes to the modeling system, including Larry Blincoe, Jane Doherty, Hannah Fish, Ryan Hagen, Maurice Hicks, Thomas Kang, Ken Katz, Vinay Nagabhushana, Ryan Posten, Gregory Powell, Sean Puckett, Rebecca Schade, Brian Seymour, Jim Tamm, Seiar Zia, and Steve Wood. The authors further acknowledge former DOT executives and staff who guided and participated in the development of earlier versions of the modeling system, including Julie Abraham, Gregory Ayres, Noble Bowie, John Brewer, Peter Feather, David Friedman, Walter Gazda, Phil Gorney, Carol Hammel-Smith, Ryan Harrington, Ron Medford, Amandine Muskus, Steve Kratzke, Shoshana Lew, Kristina Lopez-Bernal, José Mantilla, Joe Mergel, Arthur Rypinski, Dan Smith, Katie Thomson, Kevin Vincent, Kenneth William, Lixin Zhao, and Stephen Zoepf.

The authors further acknowledge the technical contributions of individuals who have reviewed detailed results of the model (and/or earlier versions of the model) and/or provided specific suggestions regarding the model's design. Among these individuals are Ayman Moawad, Steve Plotkin, Aymeric Rousseau, and Michael Wang of the Department of Energy's (DOE's) Argonne National Laboratory; Jeff Alson, Kevin Bolon, William Charmley, Ben Ellies, Chet France, David Haugen, Lisa Heinzerling, Gloria Helfand, Ari Kahan, Robin Moran, Margo Oge, Richard Rykowski, and Todd Sherwood of the U.S. Environmental Protection Agency (EPA); John Maples of DOE's Energy Information Administration (EIA); Gary Rogers of FEV Engine Technology, Inc.; David Boggs, Anrico Casadei, Scott Ellsworth, and Sandy Stojkovski of Ricardo, Inc.; Jamie Hulan of Transport Canada; and Jonathan Rubin of the University of Maine.

Contents

Contents	iii
Tables	vii
Figures.....	ix
Abbreviations	x
Chapter One Introduction.....	1
Chapter Two System Design.....	3
Section 1 Overall Structure (System Overview).....	3
Section 2 Representation of Market Data	5
S2.1 Initial State of the Fleet.....	5
S2.2 Vehicle Classifications.....	10
S2.3 Manufacturer-Specific Attributes	13
Section 3 Regulatory Scenario Definition.....	16
Section 4 Evaluation of Vehicle Technologies	19
S4.1 Technology Classes.....	21
S4.2 Technology Pathways	22
S4.2.1 Engine-Level Pathways.....	23
S4.2.2 Transmission-Level Pathways	25
S4.2.3 Vehicle-Level Electrification Pathways.....	27
S4.2.4 Platform-Level and Other Vehicle-Level Pathways	28
S4.2.5 Relationship Between Technology Pathways	29
S4.3 Technology Applicability	31
S4.4 Technology Evaluation and Inheriting.....	32
S4.5 Technology Supersession.....	33
S4.6 Technology Fuel Economy Improvements	35
S4.6.1 Fuel Economy Adjustments	38
S4.7 Technology Cost Tables.....	39
S4.7.1 Implicit Cost Adjustments	42
S4.7.2 Battery Costs.....	46
S4.8 Application of Mass Reduction Technology	47
Section 5 Compliance Simulation	52
S5.1 CAFE Compliance Calculations	54
S5.1.1 Calculation of Vehicle’s Fuel Economy	55
S5.1.2 Calculation of the CAFE Standard.....	57
S5.1.3 Calculation of the CAFE Rating	58
S5.1.4 Calculation of the CAFE Credits and Fines.....	60
S5.2 CO ₂ Compliance Calculations.....	61
S5.2.1 Calculation of Vehicle’s CO ₂ Rating	62
S5.2.2 Calculation of the CO ₂ Standard.....	64

DRAFT – July 2018

S5.2.3	Calculation of the CO ₂ Rating	65
S5.2.4	Calculation of the CO ₂ Credits and Credit Value	66
S5.3	Compliance Simulation Algorithm	68
S5.3.1	Determination of “Best Next” Technology Solution	70
S5.3.2	Calculation of Effective-Cost.....	72
S5.4	Dynamic Fleet Share and Sales Response	76
S5.5	Credit Transfers and Carry Forward	80
S5.5.1	Evaluation and Application of Credits.....	81
S5.5.2	Credit Usage Strategy	84
Chapter Three	Calculation of Effects.....	86
Section 1	Vehicle Lifetimes	87
S1.1	Dynamic Scrappage Model	89
S1.2	Static Scrappage Model	91
Section 2	Vehicle Use and Total Lifetime Mileage	92
Section 3	Fuel Consumption	96
Section 4	Greenhouse Gas Emissions	100
Section 5	Air Pollutant Emissions.....	104
Section 6	Vehicle Safety Effects	107
Section 7	Private versus Social Costs and Benefits	109
S7.1	Increases in New Vehicle Prices	110
S7.2	The Value of Fuel Consumed	110
S7.3	Benefits from Additional Driving	111
S7.4	The Value of Extended Refueling Range	113
S7.5	Changes in Performance and Utility	114
S7.6	Socially-Valued Costs and Benefits.....	115
S7.6.1	The “Social Value” of Fuel Consumed.....	115
S7.6.2	Social Costs of Market Externalities.....	116
S7.6.3	Social Costs of Added Driving	117
S7.6.4	Social Costs of Environmental Impacts	120
S7.6.5	Discounting of Social Costs and Benefits.....	122
S7.7	Consumer-Valued Costs and Benefits	123
S7.7.1	The Value of “Rebound Miles”	123
S7.7.2	Ownership Costs	124
S7.7.3	Calculating Vehicle Payback	128
S7.7.4	Discounting of Consumer Costs and Benefits	130
Section 8	Fleet Analysis Calculations.....	132
Appendix A	Model Inputs.....	134
A.1	Market Data File	135
A.1.1	Manufacturers Worksheet	135

DRAFT – July 2018

A.1.2	Vehicles Worksheet.....	136
A.1.3	Engines Worksheet.....	138
A.1.4	Transmissions Worksheet.....	139
A.2	Technologies File.....	141
A.2.1	Cost Adjustment Factors	142
A.3	Parameters File.....	144
A.3.1	Economic Values.....	144
A.3.2	Vehicle Age Data	145
A.3.3	Fuel Prices	146
A.3.4	Fuel Economy Data	146
A.3.5	Fleet Analysis Values	146
A.3.6	Historic Fleet Data.....	147
A.3.7	Scrappage Model Values.....	147
A.3.8	Safety Values.....	147
A.3.9	Credit Trading Values	148
A.3.10	ZEV Credit Values	148
A.3.11	DFS Model Values	149
A.3.12	Employment Values	149
A.3.13	Emission Costs	149
A.3.14	Fuel Properties.....	150
A.3.15	Fuel Import Assumptions	150
A.3.16	Upstream Emissions.....	151
A.3.17	Tailpipe Emissions	151
A.4	Scenarios File.....	152
A.4.1	Target Functions.....	153
Appendix B	Model Outputs	156
B.1	Technology Utilization Report	157
B.2	Compliance Report	158
B.3	Societal Effects and Societal Costs Reports	160
B.4	Annual Societal Effects and Annual Societal Costs Reports.....	164
B.5	Annual Societal Effects Summary and Annual Societal Costs Summary Reports.....	168
B.6	Consumer Costs Report	172
B.7	Vehicles Report.....	173
Appendix C	CAFE Model Software Manual	177
C.1	Warnings.....	177

C.2	Notice.....	177
C.3	Installation and System Requirements.....	178
C.4	CAFE Model Graphical User Interface	179
C.4.1	CAFE Model Window.....	180
C.4.2	Modeling Settings Window	182
C.4.2.1	General Compliance Settings Panel	182
C.4.2.2	I/O Settings Panel	183
C.4.2.3	Runtime Settings Panel.....	186
C.4.3	Session View	188
C.4.3.1	Session View Layout	189
C.4.3.2	Interacting with the Session View	192
C.4.4	Model Outputs	198
C.5	CAFE Model Usage Examples	200
C.5.1	Example 1 – Configuring for Standard Compliance Modeling.....	200
C.5.2	Example 2 – Configuring for “CO-2 Compliance” Modeling	206
C.6	Known Issues	209

Tables

Table 1. Fuel Types.....	8
Table 2. Regulatory Classes.....	10
Table 3. Technology Classes Overview.....	11
Table 4. Safety Classes	12
Table 5. Vehicle Classes	12
Table 6. Designation of Manufacturer Parameters by Vehicle Style.....	14
Table 7. Target Functions	16
Table 8. CAFE Model Technologies (1).....	19
Table 9. CAFE Model Technologies (2).....	20
Table 10. Vehicle Technology Classes	21
Table 11. Engine Technology Classes	22
Table 12. Technology Pathways	23
Table 13. Technology Pathway Compatibility Logic	30
Table 14. Technology Supersession Logic	34
Table 15. Transmission Cost “Back-out” Logic	44
Table 16. Engine Cost “Back-out” Logic	45
Table 17. Beta Coefficients.....	78
Table 18. Credit Transfer Preference.....	82
Table 19. Survival Rates and Miles Driven Categories	87
Table 20. Input Files	134
Table 21. Manufacturers Worksheet.....	135
Table 22. Vehicles Worksheet	136
Table 23. Engines Worksheet	138
Table 24. Transmissions Worksheet	139
Table 25. Global Parameters.....	141
Table 26. Technology Definitions	141
Table 27. Technology Assumptions	141
Table 28. Technology Costs	142
Table 29. Cost Synergies	143
Table 30. Economic Values Worksheet.....	144
Table 31. Vehicle Age Data Worksheet	145
Table 32. Forecast Data Worksheet	146
Table 33. Fuel Economy Data Worksheet	146
Table 34. Fleet Analysis Values Worksheet	146
Table 35. Historic Fleet Data Worksheet.....	147
Table 36. Scrappage Model Values Worksheet.....	147
Table 37. Safety Values Worksheet.....	147
Table 38. Credit Trading Values Worksheet	148
Table 39. ZEV Credit Values Worksheet	148
Table 40. DFS Model Values Worksheet	149
Table 41. Employment Values Worksheet	149
Table 42. Emission Costs Worksheet	149
Table 43. Fuel Properties Worksheet.....	150
Table 44. Fuel Import Assumptions Worksheet	150

DRAFT – July 2018

Table 45. Upstream Emissions Worksheets.....	151
Table 46. Tailpipe Emissions Worksheets.....	151
Table 47. Scenarios Worksheet.....	152
Table 48. Target Functions (1).....	154
Table 49. Target Functions (2).....	155
Table 50. Output Files.....	156
Table 51. Technology Utilization Report	157
Table 52. Compliance Report	158
Table 53. Societal Effects Report	161
Table 54. Societal Costs Report.....	163
Table 55. Annual Societal Effects Report.....	164
Table 56. Annual Societal Costs Report	167
Table 57. Annual Societal Effects Summary Report	168
Table 58. Annual Societal Costs Summary Report	171
Table 59. Consumer Costs Report	172
Table 60. Vehicles Report.....	174
Table 61. CAFE Model System Requirements.....	178

Figures

Figure 1. Basic Structure of Input File Defining the Fleet’s Initial State	6
Figure 2. Engine-Level Paths.....	24
Figure 3. Transmission-Level Paths	26
Figure 4. Vehicle-Level (Electrification) Paths	27
Figure 5. Platform-Level and Vehicle-Level (Other) Paths.....	29
Figure 6. Technology Pathways Diagram.....	30
Figure 7. Automatic Transmission Path (Subset)	43
Figure 8. Compliance Simulation	52
Figure 9. Compliance Simulation Algorithm.....	69
Figure 10. Determination of “Best Next” Technology Solution.....	71
Figure 11. Warnings Dialog Box	179
Figure 12. CAFE Model Splash Screen	180
Figure 13. CAFE Model Window.....	181
Figure 14. CAFE Model File Menu	181
Figure 15. CAFE Model Toolbar.....	181
Figure 16. General Compliance Settings Panel	183
Figure 17. I/O Settings Panel (1)	184
Figure 18. I/O Settings Panel (2)	185
Figure 19. I/O Settings Panel (3)	186
Figure 20. Runtime Settings Panel.....	188
Figure 21. CAFE Model Session View.....	189
Figure 22. Session View - Modeling Progress.....	190
Figure 23. Session View - Vehicle Scatter Plot.....	191
Figure 24. Session View - Compliance Summary Chart	192
Figure 25. Initiating Chart Filtering.....	193
Figure 26. Chart Filtering Activated.....	194
Figure 27. Chart Filtering Completed.....	195
Figure 28. Manufacturer Filtering Examples.....	196
Figure 29. Compliance Summary Chart - Rotated View	197
Figure 30. Vehicle Scatter Plot - Zoomed View.....	198
Figure 31. Select Standard Compliance Model	200
Figure 32. Select Input Files	201
Figure 33. Save Modeling Settings.....	202
Figure 34. New Compliance Model Session Created	203
Figure 35. Save New Session.....	204
Figure 36. “demo” Session Saved.....	204
Figure 37. Modeling Progress from the Compliance Model	205
Figure 38. Compliance Model Completed.....	205
Figure 39. Open “demo” Session.....	206
Figure 40. Enable Compliance with CO ₂ Standards.....	207
Figure 41. Modeling Progress for Compliance with CO ₂ Standards	208

Abbreviations

<i>2b3</i>	light truck 2b3 regulatory class
<i>a</i>	age of a vehicle model (produced in model year, <i>MY</i> , during calendar year, <i>CY</i>)
<i>AC</i>	air conditioning
<i>ADEAC</i>	advanced cylinder deactivation
<i>ADSL</i>	advanced diesel engine
<i>AERO</i>	aero drag reduction technology
<i>AERO0</i>	baseline aero
<i>AERO10</i>	aero drag reduction, level 2 (10% reduction)
<i>AERO15</i>	aero drag reduction, level 3 (15% reduction)
<i>AERO20</i>	aero drag reduction, level 4 (20% reduction)
<i>AERO5</i>	aero drag reduction, level 1 (5% reduction)
<i>AMT</i>	automated manual (<i>i.e.</i> , clutch) transmission
<i>ANL</i>	Argonne National Laboratory
<i>AT</i>	automatic transmission
<i>AT10</i>	10-speed automatic transmission
<i>AT10L2</i>	10-speed automatic transmission, level 2
<i>AT5</i>	5-speed automatic transmission
<i>AT6</i>	6-speed automatic transmission
<i>AT6L2</i>	6-speed automatic transmission, level 2
<i>AT6L3</i>	6-speed automatic transmission, level 3
<i>AT7</i>	7-speed automatic transmission
<i>AT8</i>	8-speed automatic transmission
<i>AT8L2</i>	8-speed automatic transmission, level 2
<i>AT8L3</i>	8-speed automatic transmission, level 3
<i>AT9</i>	9-speed automatic transmission
<i>BEV</i>	battery electric vehicle
<i>BEV200</i>	200-mile battery electric vehicle
<i>BISG</i>	belt mounted integrated starter/generator
<i>BTU</i>	British thermal unit
<i>C</i>	the category of the vehicle (derived from vehicle’s <i>VC</i> and <i>RC</i>)
<i>CAFE</i>	Corporate Average Fuel Economy
<i>CAFE_{RC}</i>	unadjusted manufacturer’s CAFE rating in regulatory class <i>RC</i>
<i>CAFE’_{RC}</i>	CAFE rating achieved by a manufacturer in regulatory class <i>RC</i>
<i>CC_{FT}</i>	fraction of each fuel type’s mass that represents carbon
<i>C_{Earned}</i>	compliance category where credits are earned
<i>CEGR1</i>	cooled exhaust gas recirculation, level 1 (2.0409 bar)
<i>CH₄</i>	methane
<i>CISG</i>	crank mounted integrated starter/generator
<i>CNG</i>	compressed natural gas engine
<i>CNG</i>	compressed natural gas fuel type
<i>CO</i>	carbon monoxide
<i>CO₂</i>	carbon dioxide
<i>CO₂</i>	carbon dioxide

DRAFT – July 2018

<i>CO2CreditsInRC</i>CO ₂ credits transferred or carried into regulatory class <i>RC</i>
<i>CO2CreditsOutRC</i>CO ₂ credits transferred or carried out of regulatory class <i>RC</i>
<i>CO2CreditsRC</i>CO ₂ credits earned by a manufacturer in regulatory class <i>RC</i>
<i>CO2RatingRC</i>CO ₂ rating achieved by a manufacturer in regulatory class <i>RC</i>
<i>CO2STDRC</i>CO ₂ standard in regulatory class <i>RC</i>
<i>ΔCompliance</i>change in manufacturer’s cost of compliance
<i>CONV</i>conventional powertrain (non-electric)
<i>CPM</i>cost-per-mile
<i>CreditsInRC</i>CAFE credits transferred or carried into regulatory class <i>RC</i>
<i>CreditsOutRC</i>CAFE credits transferred or carried out of regulatory class <i>RC</i>
<i>CreditsRC</i>CAFE credits earned by a manufacturer in regulatory class <i>RC</i>
<i>CUsed</i>compliance category where credits are used
<i>CVT</i>continuously variable transmission
<i>CVTL2A</i>CVT, level 2 (upgrade from CVT path)
<i>CVTL2B</i>CVT, level 2 (upgrade from automatic path)
<i>ΔCW</i>amount by which a vehicle’s <i>CW</i> is reduced (in lbs)
<i>CW</i>vehicle’s curb weight
<i>CY</i>calendar year
<i>D</i>diesel fuel type
<i>DC</i>Domestic Car regulatory class
<i>DCT</i>dual-clutch transmission
<i>DCT6</i>6-speed dual clutch transmission
<i>DCT8</i>8-speed dual clutch transmission
<i>DEAC</i>cylinder deactivation
<i>DFS</i>Dynamic Fleet Share
<i>DFS/SR</i>Dynamic Fleet Share and Sales Response model
<i>DOE</i>U.S. Department of Energy
<i>DOHC</i>double overhead camshaft engine
<i>DOT</i>U.S. Department of Transportation
<i>DPM10</i>diesel particulate matter
<i>DR</i>discount rate
<i>DS</i>emissions from vehicle operation (<i>i.e.</i> , “tailpipe” or “downstream”)
<i>DSLI</i>diesel engine improvements
<i>E</i>electricity fuel type
<i>E85</i>ethanol/gasoline blend with up to 85% ethanol
<i>ED_{FT}</i>energy density of a specific fuel type
<i>EffCost</i>effective cost of a technology
<i>EISA</i>Energy Independence and Security Act
<i>EPA</i>U.S. Environmental Protection Agency
<i>EPCA</i>Energy Policy and Conservation Act
<i>EPS</i>electric power steering
<i>F</i>fuel economy improvement factor (for ANL simulated technology)
<i>FC</i>fuel consumption improvement factor (for “add-on” technology)
<i>FCV</i>fuel cell vehicle
<i>FE</i>fuel economy rating of a vehicle
<i>FFV</i>flex-fuel vehicle

DRAFT – July 2018

$\Delta Fines$	change in manufacturer’s fines owed
$Fines_{RC}$	CAFE civil penalties owed by a manufacturer in regulatory class RC
FP	vehicle’s footprint
FS	percentage of miles driven by a vehicle on a specific fuel type
FT	fuel type a vehicle operates on
G	gasoline fuel type
GAP	gap between laboratory and on-road fuel economy
$\Delta GCWR$	amount by which a vehicle’s $GCWR$ is reduced (in lbs)
$GCWR$	gross combined weight rating
GDP	gross domestic product
GGE	gasoline gallon equivalents
gpm	gallons per mile
$\Delta GVWR$	amount by which a vehicle’s $GVWR$ is reduced (in lbs)
$GVWR$	gross vehicle weight rating
GW	glider weight
H	hydrogen fuel type
HCR	high compression ratio engine
$HCR1$	high compression ratio engine, level 1
$HCR2$	high compression ratio engine, level 2
HP	vehicle’s horsepower
$HWFET$	highway fuel economy test
$IACC$	improved accessories
IC	Imported Car regulatory class
kWh	kilowatt-hour
LDB	low drag brakes
$LDT1$	class-1 light duty truck ($GVWR < 6,000$ lbs)
$LDT1/2a$	combination of class-1 and class-2a light duty trucks
$LDT2a$	class-2a light duty truck ($6,001$ lbs $< GVWR < 8,500$ lbs)
$LDT2b$	class-2b light duty truck ($8,501$ lbs $< GVWR < 10,000$ lbs)
$LDT2b/3$	combination of class-2b and class-3 light duty trucks
$LDT3$	class-3 light duty truck ($10,001$ lbs $< GVWR < 14,000$ lbs)
LDV	light duty passenger vehicle
LFP	labor force participation
LR	learning rate multiplier for battery cost of a technology
LT	Light Truck regulatory class
$LT2b3$	Light Truck 2b3 regulatory class
$LUBEFR$	improved low friction lubricants and engine friction reduction technology
$LUBEFR1$	LUBEFR, level 1
$LUBEFR2$	LUBEFR, level 2
$LUBEFR3$	LUBEFR, level 3
M	a vector of manufacturers
MD_{FT}	mass density of a specific fuel type
mpg	miles per gallon
MR	mass reduction technology
$MR0$	baseline mass
$MR1$	mass reduction, level 1 (5% reduction in glider weight)

DRAFT – July 2018

<i>MR2</i>	mass reduction, level 2 (7.5% reduction in glider weight)
<i>MR3</i>	mass reduction, level 3 (10% reduction in glider weight)
<i>MR4</i>	mass reduction, level 4 (15% reduction in glider weight)
<i>MR5</i>	mass reduction, level 5 (20% reduction in glider weight)
<i>MSRP</i>	manufacturer suggested retail price
<i>MT</i>	manual (<i>i.e.</i> , clutch) transmission
<i>MT5</i>	5-speed manual transmission
<i>MT6</i>	6-speed manual transmission
<i>MT7</i>	7-speed manual transmission
<i>MTBE</i>	methyl tertiary butyl ether
<i>MY</i>	model year
<i>N₂O</i>	nitrous oxide
<i>NHTSA</i>	National Highway Traffic Safety Administration
<i>N_{MY,CY}</i>	number of surviving vehicles of model year <i>MY</i> in calendar year <i>CY</i>
<i>NO_x</i>	oxides of nitrogen
<i>OCC</i>	off-cycle credit
<i>OHV</i>	overhead valve engine
<i>PB</i>	payback period
<i>PC</i>	Passenger Car regulatory class
<i>PEF</i>	petroleum equivalency factor
<i>PHEV</i>	plug-in hybrid/electric vehicle
<i>PHEV30</i>	30-mile plug-in hybrid/electric vehicle
<i>PHEV50</i>	50-mile plug-in hybrid/electric vehicle
<i>PM</i>	particulate matter
<i>Price_{FT}</i>	price of fuel type <i>FT</i>
<i>Quads</i>	quadrillion British thermal units
<i>RC</i>	regulatory class
<i>RIA</i>	regulatory impact analysis
<i>ROLL</i>	low rolling resistance tires technology
<i>ROLL0</i>	baseline tires
<i>ROLL10</i>	low rolling resistance tires, level 1 (10% reduction)
<i>ROLL20</i>	low rolling resistance tires, level 2 (20% reduction)
<i>Sales_{RC}</i>	total manufacturer sales volume in regulatory class <i>RC</i>
<i>SAX</i>	secondary axle disconnect
<i>SC</i>	safety class
<i>scf</i>	standard cubic foot
<i>SGDI</i>	stoichiometric gasoline direct injection
<i>SHEV</i>	strong hybrid/electric vehicle
<i>SHEVP2</i>	P2 strong hybrid/electric vehicle
<i>SHEVPS</i>	power split strong hybrid/electric vehicle
<i>SOHC</i>	single overhead camshaft engine
<i>SO_x</i>	sulfur oxides
<i>SS12V</i>	12V micro-hybrid (stop-start)
<i>STD_{RC}</i>	CAFE standard in regulatory class <i>RC</i>
<i>SURV</i>	average survival rate of a vehicle
<i>SUV</i>	sport utility vehicle

DRAFT – July 2018

T_{CO2} vehicle's CO₂ target
 T_{FE} vehicle's fuel economy target
 $TURBO1$ turbocharging and downsizing, level 1 (1.5271 bar)
 $TURBO2$ turbocharging and downsizing, level 2 (2.0409 bar)
 TW test weight
 $UDDS$ urban dynamometer driving schedule
 US emissions from fuel production and distribution (*i.e.*, “upstream”)
 V a vector of vehicle models
 $\Delta ValueCO2Credits$ change in manufacturer's value of CO₂ credits
 $ValueCO2Credits_{RC}$... value of CO₂ credits in regulatory class RC
 VC vehicle class
 VCR variable compression ratio engine
 VMT vehicle miles traveled
 VOC volatile organic compounds
 VVL variable valve lift
 VVT variable valve timing
 ΔW percent reduction of glider weight (for MR technology)
 ZEV zero emission vehicle

Chapter One Introduction

The Energy Policy and Conservation Act (EPCA), as amended by the Energy Independence and Security Act of 2007 (EISA), requires the U.S. Department of Transportation (DOT), to promulgate and enforce Corporate Average Fuel Economy (CAFE) standards. The Department has delegated this responsibility to the National Highway Traffic Safety Administration (NHTSA, an agency within DOT), which has been administering these standards since 1975.

The Volpe National Transportation Systems Center (Volpe Center) provided technical support to the Department in connection with the establishment of the CAFE program in the 1970s, and has continued to provide such support since that time. The Volpe Center is a Federal fee-for-service organization within DOT.

In 2002, the Volpe Center began developing a new modeling system to support NHTSA's analysis of options for future CAFE standards. Objectives included, but were not limited to, the following: the ability to utilize detailed projections of light vehicle fleets to be produced for sale in the United States, the ability to efficiently estimate how manufacturers could apply available technologies in response to CAFE standards, the ability to quickly, systematically, and reproducibly evaluate various options for future CAFE standards, and the ability to estimate a range of outcomes (in particular, changes in fuel consumption and emissions) resulting from such standards.

Since 2002, the Volpe Center has made many changes to this modeling system. Some changes were made in response to comments submitted to NHTSA in connection with CAFE rulemakings, and in response to a formal peer review of the system. Some changes were made based on observations by NHTSA and Volpe Center technical staff. As NHTSA began evaluating attribute-based CAFE standards (*i.e.*, standards under which CAFE requirements depend on the mix of vehicles produced for U.S. sale), significant changes were made to enable evaluation of such standards. At the same time, the system was expanded to provide the ability to perform uncertainty analysis by randomly varying many inputs. Later, the system was further expanded to provide automated statistical calibration of attribute-based standards, through implementation of Monte Carlo techniques, as well as automated estimation of stringency levels that meet specified characteristics (such as maximizing estimated net benefits to society).

In 2007, NHTSA and Volpe Center staff worked with technical staff of the U.S. Environmental Protection Agency (EPA) on major changes to the range of fuel-saving technologies accommodated by the model, as well as the logical pathways for applying such technologies. In 2008, NHTSA and Volpe Center staff collaborated on further revisions, particularly with respect to the representation of available fuel-saving technologies, support for the reexamination of which was provided by Ricardo, Inc. In support of the 2010 rulemaking, a multi-year technology application feature was introduced into the modeling system. In 2011, a feature to evaluate voluntary overcompliance has been added as well.

In 2014, the system was adapted and expanded to allow NHTSA and Volpe Center staff to perform analysis in support of the medium duty rulemaking. As such, a new regulatory class, covering class 2b and class 3 pickups and vans, was introduced into the modeling system. To better illustrate the behavior of the industry, a feature allowing technologies to be inherited between vehicle platforms,

DRAFT – July 2018

engines, and transmissions has been reintroduced into the modeling system as the primary mode of operation. In 2016, the modeling system was further refined to allow simultaneous analysis of light duty and medium duty fleets, accounting for potential interaction between shared platforms, engines, and transmissions. Additionally, in 2016, the modeling system has undergone a major overhaul to allow for integration of vehicle simulation results from Argonne National Laboratory's Autonomie model.

For the 2018 NPRM, covering model years 2020 to 2025, the system was further enhanced to include additional modeling features. Principal among them are: the ability to simulate separate compliance by domestic and imported car fleet (an explicit EPCA requirement), the ability to dynamically adjust the sales forecast of the light duty fleet and the passenger car to light truck fleet share as part of compliance simulation, the ability to dynamically adjust the scrappage rates of on-road vehicle fleet for post-compliance calculations, and the ability to account for vehicles' safety performance over time. The system was also modified to be able to simulate compliance with Environmental Protection Agency (EPA) carbon dioxide (CO₂) standards, including a number of programmatic elements unique to that program that do not exist under CAFE.

Chapter Two System Design

Section 1 Overall Structure (System Overview)

The basic design of the CAFE Model developed by the Volpe Center is as follows: the system first estimates how manufacturers might respond to a given regulatory scenario, and from that potential compliance solution, the system estimates what impact that response will have on fuel consumption, emissions, and economic externalities. A regulatory scenario involves specification of the form, or shape, of the standards (*e.g.*, flat standards, or linear or logistic attribute-based standards), scope of passenger car and truck regulatory classes, and stringency of the CAFE and CO₂ standards for each model year to be analyzed.

Manufacturer compliance simulation and the ensuing effects estimation, collectively referred to as compliance modeling, encompass numerous subsidiary elements. Compliance simulation begins with a detailed initial forecast, provided by the user, of the vehicle models offered for sale during the simulation period. The compliance simulation then attempts to bring each manufacturer into compliance with the standards defined by the regulatory scenario contained within an input file developed by the user; for example, a regulatory scenario may defined CAFE or CO₂ standards that increase in stringency by 4 percent per year for 5 consecutive years. The model applies various technologies to different vehicle models in each manufacturer's product line in order to simulate how each manufacturer might make progress toward compliance with the specified standard. Subject to a variety of user-controlled constraints, the model applies technologies based on their relative cost-effectiveness, as determined by several input assumptions regarding the cost and effectiveness of each technology, the cost of compliance (determined by CAFE-related civil penalties or value of CO₂ credits, depending on the compliance program being evaluated), and the value of avoided fuel expenses. For a given manufacturer, the compliance simulation algorithm applies technologies either until the manufacturer runs out of cost-effective technologies, until the manufacturer exhausts all available technologies, or, if the manufacturer is assumed to be willing to pay civil penalties, until paying civil penalties becomes more cost-effective than increasing vehicle fuel economy. At this stage, the system assigns an incurred technology cost and updated fuel economy to each vehicle model, as well as any civil penalties incurred by each manufacturer. This compliance simulation processes is repeated for each model year available during the study period.

This point marks the system's transition between compliance simulation and effects calculations. At the conclusion of the compliance simulation for a given regulatory scenario, the system contains multiple copies of the updated fleet of vehicles, corresponding to each model year analyzed. For each model year, the vehicles' attributes, such as fuel types (*e.g.*, diesel, electricity), fuel economy values, and curb weights, have all been updated to reflect the application of technologies in response to standards throughout the study period. For each vehicle model in each of the model year specific fleets, the system then estimates the following: lifetime travel, fuel consumption, carbon dioxide and criteria pollutant emissions, the magnitude of various economic externalities related to vehicular travel (*e.g.*, noise), and energy consumption (*e.g.*, the economic costs of short-term increases in petroleum prices). The system then aggregates model-specific results to produce an overall representation of modeling effects for the entire industry.

DRAFT – July 2018

Different categorization schemes are relevant to different types of effects. For example, while a fully disaggregated fleet is retained for purposes of compliance simulation, vehicles are grouped by type of fuel and regulatory class for the energy, carbon dioxide, criteria pollutant, and safety calculations. Therefore, the system uses model-by-model categorization and accounting when calculating most effects, and aggregates results only as required for efficient reporting.

Section 2 Representation of Market Data

In order to evaluate a manufacturer for compliance, the CAFE modeling system reads in and stores various engineering characteristics and technology information attributable to each vehicle, engine, and transmission produced by that manufacturer. This information provides the model with an overall view of the initial state of a manufacturer’s fleet. The data that makes up this initial fleet is referred to as the “market data” or the “market forecast”, and is entered into the modeling system as a user provided input file.¹

Along with the engineering characteristics and technology information, the market data input also defines various classifications the model needs to use in order to properly “bin” vehicles for compliance simulation and effects calculations. The vehicle classifications, discussed further below, are assigned by the user and are then used by the modeling system when, *e.g.*, determining whether to apply a passenger car or light truck functional standard to a vehicle.

Since compliance modeling within the system relies heavily on the initial fleet defined by the user, and all other results flow from compliance modeling, the initial fleet may be properly considered the foundation of any modeling exercise. The following section provides a general overview of the initial state of the fleet, highlighting some of the most significant inputs, while Section A.1 of Appendix A describe the suitable structure and content the user should use when setting up a market data input file for CAFE Model analysis.

S2.1 Initial State of the Fleet

The fleet’s initial state is developed using information contained in the manufacturers, vehicles, engines, and transmissions worksheets of the market data input file. The set of worksheets uses identification codes to link vehicle models with their engines and transmissions. Each worksheet also identifies the manufacturer that is associated with a particular vehicle, engine, or transmission. Figure 1 provides a simplified example illustrating the basic structure and interrelationship of these four worksheets, focusing primarily on structurally important inputs. The identification codes make it possible to account for the use of specific engines or transmissions across multiple vehicle models. Additionally, inputs assign each vehicle model to a specific vehicle platform, where multiple vehicle models may reference and share that same platform.²

Having the CAFE Model treat engines, transmissions, and platforms as separate entities allows the modeling system to concurrently evaluate technology improvements on multiple vehicles that may share a common engine, transmission, or platform. In addition, sharing also enables realistic propagation, or “inheriting”, of previously applied technologies from, *e.g.*, an upgraded engine down to the users of that engine, which have not yet realized the benefits of these upgrades.

¹ However, as discussed below, when applying the newly-introduced Dynamic Fleet Share and Sales Response model, the CAFE Model only makes use of production volume inputs specified for the first model year to be simulated explicitly; for ensuing model years, production volumes are estimated endogenously using this set of first-year estimates as a starting point.

² Unlike engines and transmissions, vehicle platforms are not presently defined on a separate worksheet. Instead, the modeling system relies on the data provided in the vehicles worksheet to extract the relevant information for a specific platform.

Manufacturers Worksheet

Code	Manufacturer	Prefer Fines
101	Mfr1	N
102	Mfr2	Y
103	Mfr3	N

Vehicles Worksheet

Code	Manufacturer	Model	Platform	Engine	Transmission	Reg. Class	FE	Sales	Technologies
101	Mfr1	Veh1	P101	101	101	PC	31.1	2,075	MR1
102	Mfr1	Veh2	P101	101	102	PC	26.5	2,538	MR1
103	Mfr1	Veh3	P102	102	101	LT	22.4	3,187	MRO
201	Mfr2	Veh4	P201	201	201	PC	26.1	8,461	MRO
202	Mfr2	Veh5	P201	201	203	PC	26.7	6,668	MRO
203	Mfr2	Veh6	P201	201	202	LT	22.2	781	MRO
204	Mfr2	Veh7	P202	202	202	LT	21.9	9,936	MR2
301	Mfr3	Veh8	P301	301	301	PC	32.5	8,409	MR1
302	Mfr3	Veh9	P302	302	301	LT	21.3	5,968	MR1

Engines Worksheet

Code	Manufacturer	Fuel	Config.	Cylinders	Technologies
101	Mfr1	G	I	4	DOHC
102	Mfr1	G	V	6	SOHC
201	Mfr2	G	V	6	DOHC
202	Mfr2	D	V	8	DOHC,ADSL
301	Mfr3	G	I	4	DOHC,TURBO1
302	Mfr3	G	V	8	DOHC

Transmissions Worksheet

Code	Manufacturer	Type	Gears	Technologies
101	Mfr1	AT	7	AT7
102	Mfr1	MT	5	MT5
201	Mfr2	DCT	6	DCT6
202	Mfr2	AT	6	AT6
203	Mfr2	MT	6	MT6
301	Mfr3	AT	8	AT8

Figure 1. Basic Structure of Input File Defining the Fleet’s Initial State³

In Figure 1 above, each vehicle model is shown as always having an engine and a transmission. However, this may not always be the case. In particular, battery electric vehicles (BEVs) and fuel cell vehicles (FCVs) do not make use of a traditional combustion engine or transmission. Instead, both rely on electric powertrains, having advanced, custom-built transmissions packaged with the powertrain. The system assumes that BEVs and FCVs are the sole users of their respective transmissions (*i.e.*, the transmissions are not shared by any other vehicle) and that no further improvements may be possible on those transmissions. As such, for modeling simplicity, the system assumes that these vehicles do not have an engine or a transmission and the associated

³ Note: For simplicity and illustration purposes, some column headers and data elements shown in Figure 1 were renamed, abbreviated, or combined.

“Engine” and “Transmission” codes should be left blank. Similarly, plug-in hybrid/electric vehicles (PHEVs) and power-split strong-hybrid electric vehicles (SHEVPSs) also assume the use of an advanced, custom-built transmission that is unique to the specific vehicle. For modeling simplicity, the system assumes that these vehicles do not have a transmission assigned to them as well.⁴

Figure 1 describes the basic relationship between different worksheets in a simplified manner; the structure and contents of the actual market data input file is significantly more involved. However, while the modeling system may load additional information provided in the input file (as outlined in Section A.1 of Appendix A), the model does not currently use all of that information. The system currently makes use of inputs essential for compliance simulation, such as vehicle’s fuel economy, curb weight or footprint, production volumes (or sales), and initial technology utilization. The CAFE Model uses fuel economy ratings to calculate corresponding CO₂ ratings, and uses the latter as the basis for simulating compliance with CO₂ standards.⁵

When defining a vehicle’s fuel economy for compliance purposes, the value supplied should be specified as a “rated” value, absent any adjustments, credits, special provisions for alternative fuels, or petroleum equivalency factors that NHSTA may otherwise apply to adjust the vehicle’s fuel economy rating. That is, the vehicle’s fuel economy must represent the weighted harmonic average of the values measures on the “city” (UDDS) and “highway” (HWFET) drive cycles⁶, as defined by the following equation:

$$FE = \frac{0.55}{FE_{City}} + \frac{0.45}{FE_{Highway}} \quad (1)$$

Where:

- 0.55 : the portion of total miles a vehicle is assumed to travel under city driving conditions,
- 0.45 : the portion of total miles a vehicle is assumed to travel under highway driving conditions,
- FE_{City} : the fuel economy rating of a vehicle as measured on the city (UDDS) cycle,
- $FE_{Highway}$: the fuel economy rating of a vehicle as measured on the highway (HWFET) cycle, and
- FE : the combined city and highway fuel economy rating of a vehicle.

Additionally, the fuel economy rating must be defined for an appropriate fuel type (appearing in the input file in the columns corresponding to the fuel types used), as well as reported as individual components in the case of dual-fuel vehicles (*i.e.*, flex-fuel and plug-in hybrid/electric vehicles). Furthermore, the associated fuel share, for each fuel type where a fuel economy value exists, must

⁴ The handling of transmissions (definition and assignment) with regard to hybrid/electric vehicles may be updated in the future release of the CAFE Model.

⁵ The conversion of a vehicle’s fuel economy to an equivalent CO₂ rating is discussed in Section S5.2.1 below.

⁶ UDDS and HWFET drive schedules are described at <https://www.epa.gov/vehicle-and-fuel-emissions-testing/dynamometer-drive-schedules>.

also be defined. For single fuel vehicles, the accompanying fuel share should be specified at 100%, while for dual fuel vehicles, the fuel share represents the assumed portion of miles, on average, a vehicle is expected to travel when operating on a given fuel. For example, inputs could be set to indicate that a 30-mile plug-in hybrid/electric vehicle might be expected to travel 53% of its total miles using electricity and the remaining 47% using gasoline.

The fuel economy and fuel share values are assigned in the vehicles worksheet under the “Fuel Economy” section, for each supported fuel type within the modeling system. Presently, the model supports six fuel types, as defined in Table 1, for specifying the vehicle and engine fueling options, for defining fuel-specific inputs (*e.g.*, fuel prices and emission factors), and for estimating the various modeling effects (such as amount of fuel consumed and greenhouse gas and air pollutant emissions) attributed to a vehicle when operating on a specific type of fuel. As noted above, the individual fuel types appearing in Table 1 may be combined, in the case of dual-fuel vehicles, to be interpreted by the modeling system as FFVs (flex-fuel vehicles) or PHEVs.

Table 1. Fuel Types

Fuel Type	Abbr.	Description
Gasoline	G	The vehicle operates on gasoline fuel
E85	E85	The vehicle operates on E85 fuel (ethanol/gasoline blend with up to 85% ethanol)
Diesel	D	The vehicle operates on diesel fuel
Electricity	E	The vehicle operates on electricity
Hydrogen	H	The vehicle operates on hydrogen fuel
CNG	CNG	The vehicle operates on compressed natural gas fuel

On the engines worksheet, the user must also indicate the fuel type that an engine uses from among the choices described in Table 1. However, since a combustion engine cannot operate on electricity or hydrogen, those are not considered to be valid options for use on an engine. Since, as illustrated by Figure 1, each of the vehicles references a particular engine, the fuel type used by an engine must be a subset of the fuel economies defined on a vehicle. That is, if an engine is listed as operating on gasoline, the vehicle that uses that engine would specify a fuel economy and fuel share values for gasoline fuel type as well. In the case of FFVs and PHEVs, the engine would still be listed as operating on gasoline, while for a vehicle, the fuel economies and fuel shares for gasoline and either E85 or electricity would be specified.

When calculating a manufacturer’s required or achieved CAFE and CO₂ ratings, the modeling system relies on the vehicle’s fuel economy, footprint, and production volumes. The production volumes – or, as they are referred to within the context of the model, vehicle sales⁷ – are defined for the initial fleet starting with the model year for which all of the other vehicle, engine, and transmission attributes are specified. In other words, if the initial fleet covers vehicles from model year 2016, the first year where sales are defined must also be for model year 2016. The vehicle sales are then extended for a number of model years, covering the intended study period a user wishes to analyze during compliance simulation. The default modelling settings rely on the system’s built-in Dynamic Fleet Share and Sales Response model (or, DFS/SR model). Disabling

⁷ A manufacturer’s compliance is based on production-weighted CAFE and CO₂ ratings. The system assumes every vehicle model produced for sale in the U.S. is sold in the same year it is produced.

the DFS/SR model allows a user to specify the future sales of individual vehicle models as a static input.

The vehicle curb weight and footprint values are provided to the modeling system as inputs for each vehicle model available for simulation. Curb weight is measured in pounds (*lbs.*) and is defined as the actual or the manufacturer's estimated weight of the vehicle in operational status with all standard equipment, and weight of fuel at nominal tank capacity. Footprint is defined as the average of front and rear track widths (averaged, then rounded to the nearest tenth of an inch) multiplied by the vehicle's wheelbase (rounded to the nearest tenth of an inch), divided by 144, then rounded to nearest square foot, as demonstrated in the following equation:

$$FP = \text{ROUND} \left(\frac{\text{ROUND} \left(\frac{TW_{Front} + TW_{Rear}}{2}, 1 \right) \times Wheelbase}{144}, 1 \right) \quad (2)$$

Where:

- TW_{Front} : the lateral distance between the centerlines of the front base tires at ground, including the camber angle, specified in inches, rounded to one decimal place (the front track width),
- TW_{Rear} : the lateral distance between the centerlines of the rear base tires at ground, including the camber angle, specified in inches, rounded to one decimal place (the rear track width),
- $Wheelbase$: the longitudinal distance between front and rear wheel centerlines, specified in inches, and rounded to one decimal place,
- 144 : the conversion factor from square inches to square feet, and
- FP : the vehicle's footprint, specified in sq. ft., rounded to one decimal place.

While past versions of the modeling system used calculated vehicle footprint using inputs specifying vehicle track widths and wheelbase, the system currently makes use of inputs specifying footprint directly, and does not make use of any inputs specifying these linear dimensions. Although the user may specify any value as the curb weight or the footprint, and the modeling system will not strictly enforce any specific guidelines (other than requiring both values be greater than 1), the definitions provided above should be used.

From here, the vehicles' curb weights, footprints, and sales volumes may be used to calculate a manufacturer's standard (or the required CAFE value)⁸, while the vehicles' fuel economies and sales are used to calculate a manufacturer's CAFE rating (or the achieved CAFE value) for each fleet (domestic cars, imported cars, and light trucks). Additionally, the CAFE Model uses the same vehicles' attributes to calculate the accompanying CO₂ standard and rating for a manufacturer,

⁸ The vehicle curb weight or footprint may be used when calculating an attribute-based standard for a manufacturer (for example, when the standard is defined using a linear footprint based functional form). Under an attribute-based standard, the model first calculates vehicle specific targets, which differ based on the vehicles' attributes, then the system obtains a sales weighted average based on those calculated targets.

applying the necessary fuel economy to CO₂ conversions as necessary. The precise details of how the modeling system calculates these values is discussed in Section 5 below.

In order for the modeling system to accurately account for the level of technological progression of the input fleet, and to gauge the potential for further fuel economy increases, the initial technology utilization should be specified for each vehicle model, engine, and transmission appearing in the market data input file. In the input file, technology utilization may be identified by column names corresponding to specific technologies supported within the model. The user would assign the appropriate usage states based on the engineering characteristics of the accompanying vehicles, engines, and transmissions. A value of “USED” would indicate that a particular technology is used in the input fleet, a value of “SKIP” would designate a technology as unavailable, and blank (or unassigned) value specifies that a technology is available for application by the model. As stated above, some of the detailed information appearing in the market data file is not used for actual analysis; however, this information is useful when populating the state of technological progression of the initial fleet. For example, if an engine’s “Valvetrain Design” column reads “DOHC” (dual overhead cam) for a specific engine, the corresponding “DOHC” column should be set to “USED”. Similarly, if a value of “T” (implying turbocharger) is shown in the engine’s “Aspiration” column, at the least, the “TURBO1” column for that engine should be set to “USED”. Likewise, on the transmission side, if the “Type” and “Num. Gears” columns are set to “A” and “8”, respectively, the analogous “AT8” column for the transmission should be set to “USED”. The complete list of technologies available for application, as well as the way these technologies are evaluated within the modeling system, is discussed in greater detail in Section 4 below.

As mentioned above, the user’s translation of vehicle attributes and engineering characteristics to actual technology assignments specified as model inputs determine the model’s treatment of vehicles’ potential for further fuel economy increases. At present, other than simply checking for the presence of certain data, the CAFE Model does not perform any form of validation on technology inputs supplied by the user.

S2.2 Vehicle Classifications

The CAFE Model defines and utilizes various vehicle classification schemes necessary for compliance modeling. The different classifications may be used when performing compliance simulation or when calculating modeling effects. The vehicle classifications are specified by the user as part of the initial fleet preparation within the market data input file. Principal among them is the vehicle’s regulatory class assignment.

The modeling system supports regulatory classes necessary for performing compliance simulation of light duty vehicles as well as class 2b and 3 medium duty vehicles. The exact list of supported regulatory classes is outlined the following table:

Table 2. Regulatory Classes

Regulatory Class	Abbr.	Description
Domestic Car	DC	Vehicles are regulated as domestic passenger automobiles
Imported Car	IC	Vehicles are regulated as imported passenger automobiles
Light Truck	LT	Vehicles are regulated as light duty trucks

Light Truck 2b/3	2B3	Vehicles are regulated as medium duty trucks
------------------	-----	--

When assigning regulatory classes to vehicles, the user would update the “Regulatory Class” column in the vehicles worksheet using the abbreviations listed in Table 2 above. The vehicle’s assigned class would then be used by the modeling system to determine which functional standard to apply to a specific vehicle when calculating its target, and to “bin” vehicles together when evaluating a manufacturer’s standard and CAFE rating for each regulatory class. To represent actual CAFE regulations, regulatory classes should be assigned consistent with 40 CFR Chapter V. Since EPA has not adopted EPCA/EISA’s requirement that domestic and imported passenger car fleets comply separately with CO₂ standards, the modeling system combines domestic and imported cars into a single “Passenger Car” fleet when it is configured to evaluate the CO₂ compliance program.

In addition to the regulatory classes, the market data input file also contains two sets of classifications for linking vehicles to their respective vehicle technology and engine technology classes.⁹ The technology classes allow the modeling system to identify an appropriate set of available technologies, along with their costs and improvements, for application on specific vehicle models. Section 4 below describes the technology classes and application of vehicle technologies within the model in greater detail. Conversely, this section provides a general overview and outlines the relationship between vehicle models and technology classes.

Table 3. Technology Classes Overview

Category	Technology Classes
Vehicle Technology Classes	SmallCar, SmallCarPerf, MedCar, MedCarPerf, SmallSUV, SmallSUVPerf, MedSUV, MedSUVPerf, Pickup, PickupHT, Truck 2b/3, Van 2b/3
Engine Technology Classes	2C1B, 3C1B, 4C1B, 4C2B, 5C1B, 6C1B, 6C1B_ohv, 6C2B, 6C2B_ohv, 8C2B, 8C2B_ohv, 10C2B, 10C2B_ohv, 12C2B, 12C4B, 16C4B

In order for the modeling system to properly evaluate technologies for application on any given vehicle, the vehicle technology class and the engine technology class must both be assigned to a value listed in Table 3 above. The system would then use the vehicle’s “Technology Class” assignment to determine the applicability of various technologies on a vehicle, as well as to obtain the numerous logical assumptions, fuel consumption improvements, and non-engine cost tables pertaining to specific technologies. Additionally, to obtain the cost tables of engine technologies, the model would utilize the vehicle’s “Engine Technology Class” assignment.

As with all values within the input fleet, technology class assignments are specified at the user’s discretion. However, in general, vehicle technology classes should be assigned based on the vehicle’s body style, size (footprint and curb weight), and performance characteristics, while engine technology classes should be assigned based on the number of cylinders, number of banks, and the degree of turbocharging and downsizing used by an engine assigned to the vehicle. For

⁹ Users may enter technology class assignments under the “Technology Class” and “Engine Technology Class” columns on the vehicles worksheet of the market data input file.

DRAFT – July 2018

battery electric and fuel cell vehicles, since those vehicles do not include an engine, the engine technology class does not have to be assigned (may be left blank in the input).

The last vehicle classification assigned in the market data input file is the vehicle’s safety class. The safety class is used by the model during effects calculations when estimating the impact of changes in vehicle’s curb weight and reduction or increases in total vehicle travel on vehicle related fatal and non-fatal crashes. The user would update the “Safety Class” column in the vehicles worksheet using the abbreviations listed in Table 4 below:

Table 4. Safety Classes

Safety Class	Abbr.	Description
Passenger Car	PC	Vehicles use safety coefficients denoted for passenger automobiles
Light Truck/SUV	LT	Vehicles use safety coefficients denoted for light trucks and sport utility vehicles
Minivan/CUV	CM	Vehicles use safety coefficients denoted for minivans and crossover utility vehicles

The modeling system uses the vehicle safety class assignments in conjunction with the coefficients defined in the safety values worksheet of the parameters input file (described in Section A.3.7 of Appendix A) based, in part, on NHTSA’s staff analysis of vehicle mass, size, and safety, as documented in the 2018 preamble and Preliminary Regulatory Impact Analysis (RIA) proposing new CAFE and CO₂ standards. Therefore, safety class assignments should be defined in a way that match the original vehicle assignments used in NHTSA’s study.

In addition to the aforementioned classes assigned to each vehicle as part of the initial input fleet, the modeling system also defines an additional vehicle classification internally. Namely, the model assigns a general “vehicle class” to each vehicle based on that vehicle’s style and GVWR as outlined in Table 5, below. For light duty passenger vehicles (LDVs), the assignment is based strictly on the vehicle’s body style, where any vehicles that are identified in the market data input file as: convertible, coupe, hatchback, sedan, or wagon are assigned to the LDV class. For all truck classes (LDT1 to LDT3), the assignment is based on the gross vehicle weight rating (GVWR), as defined by the ranges shown in the table below, irrespective of the vehicle’s body style.

Table 5. Vehicle Classes

Vehicle Class	Description
LDV	Vehicle is classified as a light duty passenger vehicle
LDT1	Vehicle is classified as a class-1 light duty truck, with its GVWR ranging from 0 to 6,000 pounds
LDT2a	Vehicle is classified as a class-2a light duty truck, with its GVWR ranging from 6,001 to 8,500 pounds
LDT2b	Vehicle is classified as a class-2b light duty truck, with its GVWR ranging from 8,501 to 10,000 pounds
LDT3	Vehicle is classified as a class-3 light duty truck, with its GVWR ranging from 10,001 to 14,000 pounds

During analysis, the modeling system may combine some of the classes listed in the table above when referencing certain input parameters to perform specific calculations on aggregate sets of vehicles. Specifically, vehicles belonging to the LDT1 and LDT2a classes may be binned together,

forming a single LDT1/2a class, while LDT2b and LDT3 classes are binned into LDT2b/3 class. The system uses the vehicle class assignments as part of the Dynamic Fleet Share and Sales Response modeling and during the effects calculations. Both of these topics are addressed in upcoming sections of this document.

S2.3 *Manufacturer-Specific Attributes*

While the vehicles, engines, and transmissions worksheets define various attributes and engineering characteristics of the input fleet, the “manufacturers” worksheet defines “global” parameters attributable to the specific manufacturer required for compliance simulation and effects calculations. Section A.1.1 of Appendix A describes the structure and content of the manufacturers worksheet, while this section provides details for the most significant portions necessary for compliance modeling.

For each manufacturer, the user defines several parameters that the modeling system may use when estimating the value of the reduction in fuel consumption (or value of fuel saved) attributable to application of vehicle technologies. These parameters, which are defined based on the varying styles of the vehicle, are: the manufacturer-specific discount rate, the payback period, and the post-compliance payback period. The actual calculation, which makes use of these parameters and as it applies for compliance simulation, is described in Section 5, below.

The payback period represents the number of years required for an initial investment to be repaid in the form of future benefits or cost savings, and is defined from the perspective of the manufacturer, based on the manufacturer’s assumption of consumer’s purchasing behavior. In particular, the payback period represents the maximum number of years of cumulative fuel savings that consumers are expected to consider in their initial purchasing decision—this is modeled as an offset to the technology costs outlaid by manufacturers to achieve the fuel savings, as it is the amount they can transfer to consumers without reducing demand for a specific vehicle model. The post-compliance payback period (listed under the “Payback Period (OC)” section in the manufacturers worksheet) represents the payback period (in years) that the modeling system should use after the manufacturer reaches compliance. That is, the same calculation for measuring the value of fuel saved is employed, however, once the manufacturer achieves compliance, the model will begin using an alternative threshold for number of years for a technology to pay back as part of that calculation. It will only apply those technologies with upfront technology costs that pay back within that time frame – those technologies with costs that manufacturers assume can be passed onto consumers of the consumer of that vehicle model without reducing demand. Lastly, the discount rate is the rate at which consumers discount cost of future fuel prices, which is again defined from the perspective of the manufacturer.

In order to distinguish between varying consumer behavior when purchasing different styles of vehicles (*e.g.*, a new car vs a new pickup truck), the inputs are segregated into and defined separately by vehicle style. With the exception of vehicles regulated as 2b/3 trucks, for which the parameters defined under the “2b/3 Trucks” column are used, Table 6, below, correlates the column names used for defining the parameters in the market data input file with the body styles of vehicles that make use of those parameters for valuing fuel savings:

Table 6. Designation of Manufacturer Parameters by Vehicle Style

Column Name	Vehicle Styles
Cars	Convertible, Coupe, Hatchback, Sedan, Wagon
Vans/SUVs	Sport Utility, Minivan, Van, Passenger Van, Cargo Van
Pickups	Pickup

The inputs provided for all of the aforementioned parameters are user-defined. Therefore, the modeling system exercises no control on the actual values supplied, and simply makes use of them during compliance simulation. However, note that the use of manufacturer-specific discount rates and post-compliance payback periods is contentious, and will be removed from the modeling system in the future. Thus, users should not rely on these inputs, instead, leaving the “Discount Rate” section blank and having the values in the “Payback Period” and “Payback Period (OC)” sections identically defined.

The manufacturers worksheet also allows users to control a manufacturer’s preference for paying CAFE civil penalties, instead of applying technologies deemed to be not cost-effective, for each model year analyzed during the study period. If fine preference option is enabled for a particular model year (set to “Y”), the system would only apply technology to a manufacturer as long as it is considered cost-effect. Conversely, if fine preference is disabled (set to “N”), the system would continue to apply technology until compliance is achieved or the manufacturer runs out of viable technology solutions.

Lastly, the user may define credit banks for each manufacturer, representing the compliance credits accrued for each regulatory class during model years up to five years prior to the start of the study period. The current version of the CAFE Model, as well as the market data input file used for analysis, provides a section for including banked credits between model years 2010 and 2015. However, during analysis, the system would only consider banked credits starting with model year 2011.¹⁰

To allow for compliance flexibilities, the credit banks from the input fleet may implicitly incorporate trades between manufacturers.¹¹ Furthermore, the banks may also be adjusted for implicit fleet transfers and credit carry forward occurring within the same manufacturer. The current version of the modeling system does not explicitly simulate credit operations outside of the model years covered during the study period. Hence, these inputs provide the means to simulate the potential that “older” credits may actually be available for application during the study period, and should reflect proper estimated adjustments when assuming any transferring or trading of CAFE credits (*i.e.*, adjustments necessary to preserve gallons) or CO₂ credits.

¹⁰ The market data input fleet, used for compliance modeling with the current version of the CAFE Model, includes a baseline vehicle fleet defined for model year 2016. The first model year evaluated during the study period is, by extension, 2016. Therefore, the first model year for which bank credits may be used is 2011.

¹¹ For example, for a trade involving manufacturer A’s transfer of 1 million light truck credits to manufacturer B in model year 2013, inputs should deduct 1 million credits from manufacturer A’s MY 2013 light truck balance, and add these (after any required adjustment) to manufacturer B’s MY 2013 light truck balance.

Section 3 Regulatory Scenario Definition

Each time the modeling system is used, it evaluates one or more regulatory scenarios, which are defined in the “scenarios” input file provided by the user. Each scenario describes the overall scope of the CAFE and CO₂ compliance programs in terms of each programs’ coverage, the functional form and stringency of the standards applicable to passenger cars, lights trucks, and class 2b/3 trucks, applicability of multi-fuel vehicles, as well as other miscellaneous settings that may have an impact on compliance. The system is normally used to examine and compare at least two scenarios, where the first scenario is identified as the baseline, providing a reference set of results to which results for any other scenarios are compared. The full details pertaining to the structure and content of the scenarios input file are described in Section A.4 of Appendix A. This section, however, focuses on the specification of the functional form of the standard, the calculation of the fuel economy and CO₂ targets, and additional parameters defined within the scenario that may influence the calculated required or achieved levels.

Considering that the standards are evaluated and set independently for a given class of vehicles, the regulatory scenario definition outlines the scope and applicability of the compliance program separately for each regulatory class. However, since vehicles that are regulated as domestic and imported passenger automobiles under the CAFE compliance program adhere to the same standard, the scenario provides a combined definition for both of these classes as “Passenger Car”. Additionally, since the CO₂ program does not distinguish between domestic and imported cars for compliance purposes, this combined definition of the passenger car standards is applicable as well.

For each regulatory class, the scenario definition specifies the function and coefficients in each model year, which the system may use when calculating the vehicle’s fuel economy and CO₂ targets. The CAFE Model supports multiple functional forms for use during analysis, as outlined in the following table:

Table 7. Target Functions

Function	Description	Coefficients
1	Flat standard	A
2	Logistic area-based function	A - D
3	Logistic weight-based function	A - D
4	Exponential area-based function	A - C
5	Exponential weight-based function	A - C
6	Linear area-based function	A - D
7	Linear weight-based function	A - D
8	Linear work-factor-based function ¹²	A - H
206	Dual linear area-based function	A - H
207	Dual linear weight-based function	A - H
208	Dual linear work-factor-based function ¹²	A - I

¹² While the modeling system does not prohibit the use of a particular target function for any given regulatory class, the work-factor-based functions (8 and 208) should only be used in conjunction with the “Light Truck 2b/3” regulatory class.

The specification for all target functions may be found in Section A.4.1 of Appendix A. As an example, function 206, which has been used during the most recent analysis, is defined here for the reader’s consideration:

$$T_{FE} = \text{MIN} \left[\text{MAX} \left(\frac{1}{A}, \text{MIN} \left(\frac{1}{B}, C \times FP + D \right) \right), \text{MAX} \left(\frac{1}{E}, \text{MIN} \left(\frac{1}{F}, G \times FP + H \right) \right) \right] \quad (3)$$

Where:

- A* : the *A* coefficient, specified in mpg (miles per gallon), representing the ceiling or the lower bound asymptote of the target function,
- B* : the *B* coefficient, specified in mpg, representing the floor or the upper bound asymptote of the target function,
- C* : the *C* coefficient, specified as the change in gpm (gallons per mile) over change in square feet, representing the slope of the target function,
- D* : the *D* coefficient, specified in gpm, representing the y-intercept of the target function,
- E* : the *E* coefficient, specified in mpg, representing the ceiling or the lower bound asymptote of the “backstop” target function,
- F* : the *F* coefficient, specified in mpg, representing the floor or the upper bound asymptote of the “backstop” target function,
- G* : the *G* coefficient, specified as the change in gpm over change in square feet, representing the slope of the “backstop” target function,
- H* : the *H* coefficient, specified in gpm, representing the y-intercept of the “backstop” target function,
- FP* : the vehicle’s footprint, specified in sq. ft., as defined in Equation (2) above, and
- T_{FE}* : the calculated vehicle fuel economy target, in gpm.

For target function 206, as defined by Equation (3), coefficients *A* - *D* specify the “core” of the target function, while coefficients *E* - *H* provide a “backstop” for that function, preventing the targets from decreasing below a certain predefined point. On rare occasions, the coefficients defining the target function in a future model year may change sufficiently enough to intersect with the target function of a preceding year, thus, causing the calculated targets for some vehicles to be lower in a future model year, while still resulting in a higher overall standard. To prevent the targets of any individual vehicle from unintentionally decreasing between model years, the system implements a set of backstop coefficients for some of the available target functions.

Each function defined in Table 7 produces vehicle targets on a gallon per mile basis (gpm), which are later used when calculating the value of the CAFE standard for compliance with the CAFE program. To support compliance with the CO₂ program, the modeling system calculates CO₂ vehicle targets from the gpm targets obtained in Equation (3). The CO₂ target calculation is, hence, defined by the following:

$$T_{CO2} = T_{FE} \times CO2Factor_{RC} + CO2Offset_{RC} \quad (4)$$

Where:

- RC* : the regulatory classification of a vehicle,
- T_{FE}* : the calculated vehicle fuel economy target, in gallons per mile,
- CO2Factor_{RC}*: the CO₂ factor to use for converting between fuel economy values and CO₂ values,
- CO2Offset_{RC}* : the absolute amount, in grams per mile, by which to shift the CO₂ target after conversion from fuel economy, and
- T_{CO2}* : the calculated vehicle CO₂ target, in grams per mile.

The *CO2Factor* and *CO2Offset* variables are specified in the scenario definition for each regulatory class. As mentioned above, for vehicles regulated as domestic or imported cars, scenario definition values associated with the combined Passenger Car class will be used.

In addition to the function and variable coefficients, the scenario definition includes additional parameters that may have an impact on compliance. When complying with the CAFE program, vehicles regulated as domestic passenger automobiles are subject to a minimum domestic car standard that is no less than 92% of the combined Passenger Car standard computed for the entire industry during a specific model year. Since the minimum domestic car standards are calculated and established during analysis of future model years, and since the fleet distribution may change by the time the standards take effect, during evaluation of standards set by the past rulemakings these minimum standards are represented in absolute terms as miles per gallon, while for the future model years, they are specified as percentages. To support this, the scenario definition includes the “Min (mpg)” and “Min (%)” variables, defining the lower bounds for the minimum domestic car standard.

When complying with the CO₂ program, the calculated CO₂ ratings may be adjusted by some amount during analysis, based on the mix of vehicles present within a manufacturer’s product line. The CO₂ compliance program includes manufacturer incentives to encourage adoption of alternative fuel and advanced vehicle technologies. Specifically, the CO₂ program defines production multipliers, which are used to scale the sales volumes of CNGs, PHEVs, BEVs, and FCVs when computing the manufacturer’s CO₂ rating toward compliance with CO₂ standards. To accomplish this, the scenario definition includes the “EPA Multiplier 1” and “EPA Multiplier 2” variables, where the former applies to the production multipliers of CNGs and PHEVs, and the latter includes BEVs and FCVs.

Lastly, the scenario definition specifies a series of air conditioning and off-cycle credit caps, defined separately for each compliance program, which influence the amount of adjustment or credit a manufacturer may claim toward compliance. The caps are specified in grams per mile of CO₂ and serve to limit the application of the associated value defined for each manufacturer in the input fleet.

The calculation of the standards and ratings for CAFE and CO₂ compliance programs are described in Section 5, below.

Section 4 Evaluation of Vehicle Technologies

A vehicle technologies input file provides a set of possible improvements available for the vehicle fleet within the modeling system. The inputs for vehicle technologies, referred to below simply as “technologies”, are defined by the user in the technology input file for the modeling system. As part of the technology definition, the input file includes: additional cost associated with application of the technology, an improvement factor (in terms of percent reduction of fuel consumption), the initial year that the technology may be considered for application, whether it is applicable to a given class of vehicle, as well as other miscellaneous assumptions outlining additional technology characteristics. Section A.2 of Appendix A describes all technology attributes in greater detail.

Internally, the modeling system assigns additional properties for each technology defining the application schedule (further specifying when a technology may be considered for application) and the application level (controlling the scope of a technology’s applicability). The application schedule determines whether a technology may be applied during a vehicle’s redesign year only, during a vehicle’s refresh or redesign years, or if the technology is defined as part of the baseline input fleet and is not available for application during modeling. The application level indicates whether the technology is vehicle-level, in which case it may be applied directly to individual vehicles, or if the technology is platform, engine, or transmission-level, in which case it will be applied to all vehicles that share a common platform, engine, or transmission, respectively.

The following two tables outline all technologies available within the modeling system, along with their application levels and schedules:

Table 8. CAFE Model Technologies (1)

Technology	Application Level	Application Schedule	Description
SOHC	Engine	Baseline Only	Single Overhead Camshaft Engine
DOHC	Engine	Baseline Only	Double Overhead Camshaft Engine
LUBEFR1	Engine	Baseline Only	Improved Low Friction Lubricants and Engine Friction Reduction
LUBEFR2	Engine	Baseline Only	LUBEFR, Level 2
LUBEFR3	Engine	Baseline Only	LUBEFR, Level 3
VVT	Engine	Refresh/Redesign	Variable Valve Timing
VVL	Engine	Redesign Only	Variable Valve Lift
SGDI	Engine	Redesign Only	Stoichiometric Gasoline Direct Injection
DEAC	Engine	Redesign Only	Cylinder Deactivation
TURBO1	Engine	Redesign Only	Turbocharging and Downsizing, Level 1 (1.5271 bar)
TURBO2	Engine	Redesign Only	Turbocharging and Downsizing, Level 2 (2.0409 bar)
CEGR1	Engine	Redesign Only	Cooled Exhaust Gas Recirculation, Level 1 (2.0409 bar)
HCR1	Engine	Redesign Only	High Compression Ratio Engine, Level 1
HCR2	Engine	Redesign Only	High Compression Ratio Engine, Level 2
VCR	Engine	Redesign Only	Variable Compression Ratio Engine
ADEAC	Engine	Redesign Only	Advanced Cylinder Deactivation
ADSL	Engine	Redesign Only	Advanced Diesel
DSL1	Engine	Redesign Only	Diesel Engine Improvements
CNG	Engine	Baseline Only	Compressed Natural Gas Engine

In Table 8, above, note that SOHC and DOHC engine technologies are defined as baseline-only. These technologies are used to inform the modeling system of the input engine’s configuration in

DRAFT – July 2018

order to correctly map an input vehicle model to an identically specified set of simulation results contained within the simulation database produced by Argonne National Laboratory (the ANL simulation database and associated vehicle mappings are discussed in the sections that follow). Note that all levels of LUBEFR and CNG engine technologies are defined as baseline-only as well. While they may be present in the input fleet, these technologies are not applicable by the modeling system.

Table 9. CAFE Model Technologies (2)

Technology	Application Level	Application Schedule	Description
MT5	Transmission	Baseline Only	5-Speed Manual Transmission
MT6	Transmission	Redesign Only	6-Speed Manual Transmission
MT7	Transmission	Redesign Only	7-Speed Manual Transmission
AT5	Transmission	Baseline Only	5-Speed Automatic Transmission
AT6	Transmission	Refresh/Redesign	6-Speed Automatic Transmission
AT6L2	Transmission	Refresh/Redesign	6-Speed Automatic Transmission, Level 2
AT6L3	Transmission	Refresh/Redesign	6-Speed Automatic Transmission, Level 3
AT7	Transmission	Baseline Only	7-Speed Automatic Transmission
AT8	Transmission	Refresh/Redesign	8-Speed Automatic Transmission
AT8L2	Transmission	Refresh/Redesign	8-Speed Automatic Transmission, Level 2
AT8L3	Transmission	Refresh/Redesign	8-Speed Automatic Transmission, Level 3
AT9	Transmission	Baseline Only	9-Speed Automatic Transmission
AT10	Transmission	Refresh/Redesign	10-Speed Automatic Transmission
AT10L2	Transmission	Refresh/Redesign	10-Speed Automatic Transmission, Level 2
CVTL2B	Transmission	Refresh/Redesign	CVT, Level 2 (Upgrade from Automatic Path)
DCT6	Transmission	Refresh/Redesign	6-Speed Dual Clutch Transmission
DCT8	Transmission	Refresh/Redesign	8-Speed Dual Clutch Transmission
CVT	Transmission	Baseline Only	Continuously Variable Transmission
CVTL2A	Transmission	Refresh/Redesign	CVT, Level 2 (Upgrade from CVT Path)
EPS	Vehicle	Refresh/Redesign	Electric Power Steering
IACC	Vehicle	Refresh/Redesign	Improved Accessories - Level 1
CONV	Vehicle	Baseline Only	Conventional Powertrain (Non-Electric)
SS12V	Vehicle	Redesign Only	12V Micro-Hybrid (Stop-Start)
BISG	Vehicle	Redesign Only	Belt Mounted Integrated Starter/Generator
CISG	Vehicle	Redesign Only	Crank Mounted Integrated Starter/Generator
SHEVP2	Vehicle	Redesign Only	P2 Strong Hybrid/Electric Vehicle
SHEVPS	Vehicle	Redesign Only	Power Split Strong Hybrid/Electric Vehicle
PHEV30	Vehicle	Redesign Only	30-mile Plug-In Hybrid/Electric Vehicle
PHEV50	Vehicle	Redesign Only	50-mile Plug-In Hybrid/Electric Vehicle
BEV200	Vehicle	Redesign Only	200-mile Electric Vehicle
FCV	Vehicle	Redesign Only	Fuel Cell Vehicle
LDB	Vehicle	Refresh/Redesign	Low Drag Brakes
SAX	Vehicle	Refresh/Redesign	Secondary Axle Disconnect
ROLL0	Vehicle	Baseline Only	Baseline Tires
ROLL10	Vehicle	Refresh/Redesign	Low Rolling Resistance Tires, Level 1 (10% Reduction)
ROLL20	Vehicle	Refresh/Redesign	Low Rolling Resistance Tires, Level 2 (20% Reduction)
MR0	Platform	Baseline Only	Baseline Mass
MR1	Platform	Redesign Only	Mass Reduction, Level 1 (5% Reduction in Glider Weight)
MR2	Platform	Redesign Only	Mass Reduction, Level 2 (7.5% Reduction in Glider Weight)
MR3	Platform	Redesign Only	Mass Reduction, Level 3 (10% Reduction in Glider Weight)
MR4	Platform	Redesign Only	Mass Reduction, Level 4 (15% Reduction in Glider Weight)
MR5	Platform	Redesign Only	Mass Reduction, Level 5 (20% Reduction in Glider Weight)
AERO0	Vehicle	Baseline Only	Baseline Aero

AERO5	Vehicle	Refresh/Redesign	Aero Drag Reduction, Level 1 (5% Reduction)
AERO10	Vehicle	Redesign Only	Aero Drag Reduction, Level 2 (10% Reduction)
AERO15	Vehicle	Redesign Only	Aero Drag Reduction, Level 3 (15% Reduction)
AERO20	Vehicle	Redesign Only	Aero Drag Reduction, Level 4 (20% Reduction)

In Table 9, above, note that MT5, AT5, AT7, AT9, and CVT transmission technologies are defined as baseline-only. Additionally, CONV, ROLL0, MR0, and AERO0 technologies are listed as baseline-only as well. As is the case with DOHC and SOHC engine technologies, the baseline technologies appearing in Table 9 are present in order to allow the CAFE Model to correctly map an input vehicle to a vehicle available in the Argonne simulation database.

The modeling system defines several technology classes and pathways for logically grouping all available technologies for application on a vehicle. Technology classes provide costs and improvement factors shared by all vehicles with similar body styles, curb weights, footprints, and engine types, while technology pathways establish a logical progression of technologies on a vehicle.

S4.1 Technology Classes

The modeling system defines two types of technology classes: vehicle technology classes and engine technology classes. The system utilizes vehicle technology classes as a means for specifying common technology input assumptions for vehicles that share similar characteristics. Predominantly, these classes signify the degree of applicability of each of the available technologies to a specific class of vehicles, as well as determine the set of results from the Argonne simulation database that is tailored for application on vehicles with a specific technology class. For a handful of technologies that were not included in the Argonne simulation, the technology classes also allow the modeling system to obtain the improvement factors attributed to those “*add-on*” technologies. Furthermore, for each technology, the vehicle technology classes also define the amount by which the vehicle’s weight may decrease (resulting from application of mass reducing technology), and the additional cost associated with application of non-engine-level technologies.

The model supports twelve vehicle technology classes as shown in Table 10:

Table 10. Vehicle Technology Classes

Class	Description
SmallCar	Small passenger cars
SmallCarPerf	Small performance passenger cars
MedCar	Medium to large passenger cars
MedCarPerf	Medium to large performance passenger cars
SmallSUV	Small sport utility vehicles and station wagons
SmallSUVPerf	Small performance sport utility vehicles and station wagons
MedSUV	Medium to large sport utility vehicles, minivans, and passenger vans
MedSUVPerf	Medium to large performance sport utility vehicles, minivans, and passenger vans
Pickup	Light duty pickups and other vehicles with ladder frame construction
PickupHT	Light duty pickups with high towing capacity
Truck 2b/3	Class 2b and class 3 pickups
Van 2b/3	Class 2b and class 3 cargo vans

Of the twelve vehicle technology classes shown in the table above, the ten relating to the light duty vehicle fleet include simulation results produce by Argonne National Laboratory. For the current version of the CAFE Model, which is used for evaluating compliance with the light-duty standards, the “Truck 2b/3” and “Van 2b/3” classes, do not include any actual simulation data.

Since the costs attributed to application of engine-level technologies vary based upon the engine configuration (*i.e.*, the engine’s valvetrain design and the number of engine cylinders and banks), the model defines separate engine classes for specifying input costs for these technologies. The modeling system provides sixteen engine technology classes as shown in Table 11:

Table 11. Engine Technology Classes

Class	Description
2C1B	SOHC/DOHC engine with 2 cylinders and 1 bank
3C1B	SOHC/DOHC engine with 3 cylinders and 1 bank
4C1B	SOHC/DOHC engine with 4 cylinders and 1 bank
4C2B	SOHC/DOHC engine with 4 cylinders and 2 banks
5C1B	SOHC/DOHC engine with 5 cylinders and 1 bank
6C1B	SOHC/DOHC engine with 6 cylinders and 1 bank
6C1B_ohv	OHV engine with 6 cylinders and 1 bank
6C2B	SOHC/DOHC engine with 6 cylinders and 2 banks
6C2B_ohv	OHV engine with 6 cylinders and 2 banks
8C2B	SOHC/DOHC engine with 8 cylinders and 2 banks
8C2B_ohv	OHV engine with 8 cylinders and 2 banks
10C2B	SOHC/DOHC engine with 10 cylinders and 2 banks
10C2B_ohv	OHV engine with 10 cylinders and 2 banks
12C2B	SOHC/DOHC engine with 12 cylinders and 2 banks
12C4B	SOHC/DOHC engine with 12 cylinders and 4 banks
16C4B	SOHC/DOHC engine with 16 cylinders and 4 banks

Once the inputs for technology classes are defined, the user assigns each vehicle in the input fleet to appropriate vehicle and engine technology classes. The model then uses the technology class assignments to obtain the appropriate applicability states, improvement factors, and costs associated with each technology, as well as the relevant Argonne simulation results for each individual vehicle.

S4.2 Technology Pathways

The modeling system defines technology pathways for grouping and establishing a logical progression of technologies on a vehicle. Each pathway (or path) is evaluated independently and in parallel, with technologies on these paths being iterated in sequential order. As the model traverses each path, the costs and fuel economy improvements are accumulated on an incremental basis with relation to the preceding technology. The system stops examining a given path once a combination of one or more technologies results in a “best” technology solution for that path.¹³

¹³ Within the context of the compliance simulation, “best” is defined from a manufacturer’s perspective. The system assumes that the manufacturer will seek to progress through the technology pathways in a manner that minimizes effective costs, which include (a) vehicle price increases associated with added technologies, (b) changes in the cost of compliance (such as reductions in civil penalties owed for noncompliance with CAFE standards), and (c) the value vehicle purchasers are estimated to place on the fuel economy improvement.

After evaluating all paths, the model selects the most cost-effective solution among all pathways. This “parallel path” approach allows the modeling system to progress through technologies in any given pathway without being unnecessarily prevented from considering technologies in other paths.

The modeling system incorporates nineteen technology pathways for evaluation as shown in Table 12. Similar to individual technologies, each path carries an intrinsic application level that denotes the scope of applicability of all technologies present within that path, and whether the pathway is evaluated on one vehicle at a time, or on a collection of vehicles that share a common platform, engine, or transmission.

Table 12. Technology Pathways

Technology Pathway	Application Level
Basic Engine Path	Engine
Turbo Engine Path	Engine
High Compression Ratio (HCR) Engine Path	Engine
Variable Compression Ratio VCR Engine Path	Engine
Advanced Cylinder Deactivation (ADEAC) Engine Path	Engine
Diesel Engine Path	Engine
Alternative Fuel Engine Path	Engine
Manual Transmission Path	Transmission
Automatic Transmission Path	Transmission
Sequential Transmission Path	Transmission
Continuously Variable Transmission (CVT) Path	Transmission
Electric Improvements Path	Vehicle
Electrification Path	Vehicle
Hybrid/Electric Path	Vehicle
Advanced Hybrid/Electric Path	Vehicle
Dynamic Load Reduction (DLR) Path	Vehicle
Low Rolling Resistance Tires (ROLL) Path	Vehicle
Aerodynamic Improvements (AERO) Path	Vehicle
Mass Reduction (MR) Path	Platform

S4.2.1 Engine-Level Pathways

The technologies that make up the seven Engine-Level paths available within the model are presented in Figure 2, below. Note that the baseline-only technologies (SOHC, DOHC, and CNG) are grayed out. As mentioned earlier, these technologies are used to inform the modeling system of the input engine’s configuration, and are not otherwise applicable during the analysis. Note that the OHV technology is not supported within the model, even as a baseline-only technology. Considering that vehicles with OHV engines are rare within the input fleet, these vehicles were not included as part of Argonne’s simulation. In the absence of simulation data, in order to achieve the closest possible vehicle mapping, when setting up the input fleet, OHV engines should be identified as using the SOHC technology. Lastly, the three baseline-only LUBEFR technologies listed in Table 8 are excluded from the figure below.

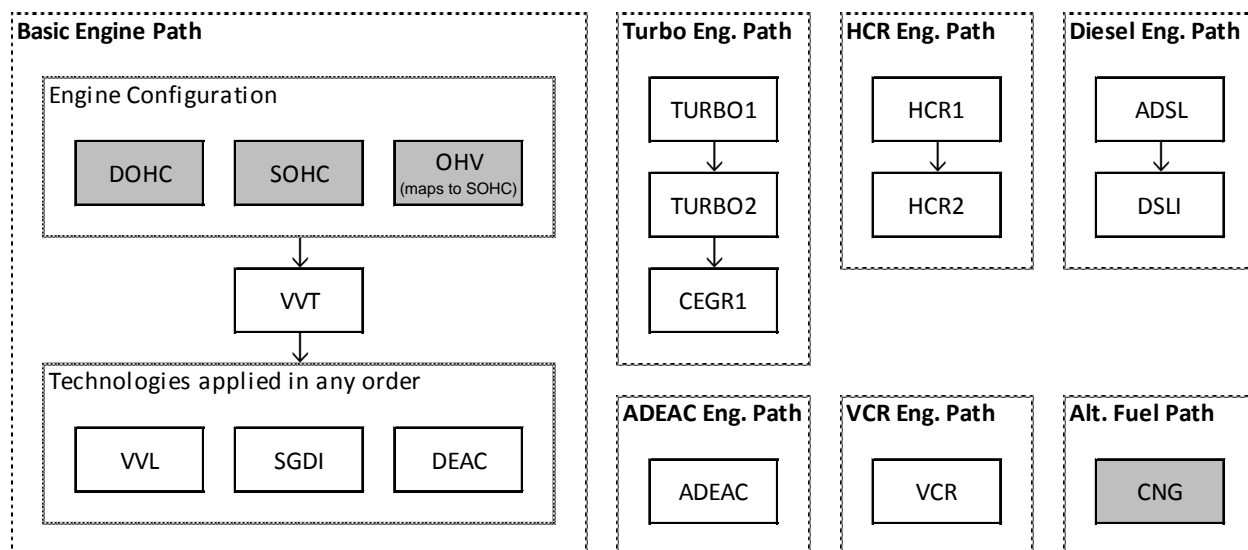

Figure 2. Engine-Level Paths

For all pathways, the technologies are evaluated and applied to a vehicle in sequential order, as shown, from top to bottom. However, if a technology is deemed ineffective, the system will bypass it, and skip ahead to the next available technology. If the modeling system applies a technology that resides later in the pathway, it will “backfill” anything that was previously skipped in order to fully account for costs and fuel economy improvements, each of which are evaluated and applied on an incremental basis. For any technology that is already present on a vehicle (either from the input fleet or previously applied by the model), the system skips over those technologies as well and proceeds to the next. These skipped technologies, however, will not be applied again during backfill.

The Basic Engine path begins with SOHC and DOHC technologies defining the initial configuration of the vehicle’s engine. Since these technologies are not available during modeling, the system evaluates this pathway starting with VVT technology. For all vehicles evaluated by the model, VVT is considered to be a *prerequisite* technology, where application of all other technologies is prohibited until the vehicle’s engine is upgraded to include VVT. Given that the Argonne simulation database assumes VVT to be the starting point (or baseline state) for an engine, the modeling system enforces this constraint in order to avoid erroneous mappings of vehicles that are defined in the input fleet without VVT technology already applied.

Once the VVT technology condition is satisfied, the system may continue to progress down the Basic Engine path. At this point, the model may select one of VVL, SGDI, or DEAC technologies, based on whichever is most cost-effective for application to a vehicle at the time of evaluation. Since these technologies are not mutually exclusive, the system may continue to examine the remainder of available Basic Engine technologies after applying the selected one to a vehicle. Since application of VVL, SGDI, and DEAC technologies is strictly based on their cost-effectiveness, their order in which these technologies are applied is not immediately apparent, and may change from vehicle to vehicle, given the varying technology profiles of different vehicles. However, whether the model picks one order of application (*e.g.*, VVL, SGDI, DEAC) over another (*e.g.*, DEAC, SGDI, VVL), the resulting net cost and fuel economy improvement will be the same.

For the remaining engine-level paths, the technologies are evaluated sequentially, starting at the root of each pathway (*e.g.*, TURBO1), as illustrated in Figure 2, above. However, as stated earlier, each technology pathway is evaluated independently and in parallel. This means the modeling system may evaluate and apply technology on each of these pathways (*e.g.*, TURBO1 technology on the Turbo Engine path) prior to exhausting the Basic Engine path.

With the exception of the Basic Engine path, all of the engine-level pathways available within the model are mutually exclusive. This denotes that if a vehicle is using an engine technology from one of the paths (*e.g.*, HCR1), all other pathways will be disabled on that engine. Additionally, once the model transitions beyond the Basic Engine pathway, applying one of the more advanced engine technologies, all unused technologies on the Basic Engine path will be backfilled (as necessary) and permanently disabled from future applications. This ensures that the model retains proper mapping of vehicles to the Argonne simulation database and that it does not inadvertently “downgrade” a vehicles during analysis.

S4.2.2 Transmission-Level Pathways

The technologies that make up the four Transmission-Level paths defined by the modeling system are shown in Figure 3, below. The baseline-only technologies (MT5, AT5, AT7, AT9, and CVT) are grayed and are only used to signify the initial configuration of the vehicle’s transmission. For simplicity, all manual transmissions with five forward gears or fewer should be assigned the MT5 technology in the input fleet. Similarly, all automatic transmissions with five forward gears or fewer should be assigned the AT5 technology.

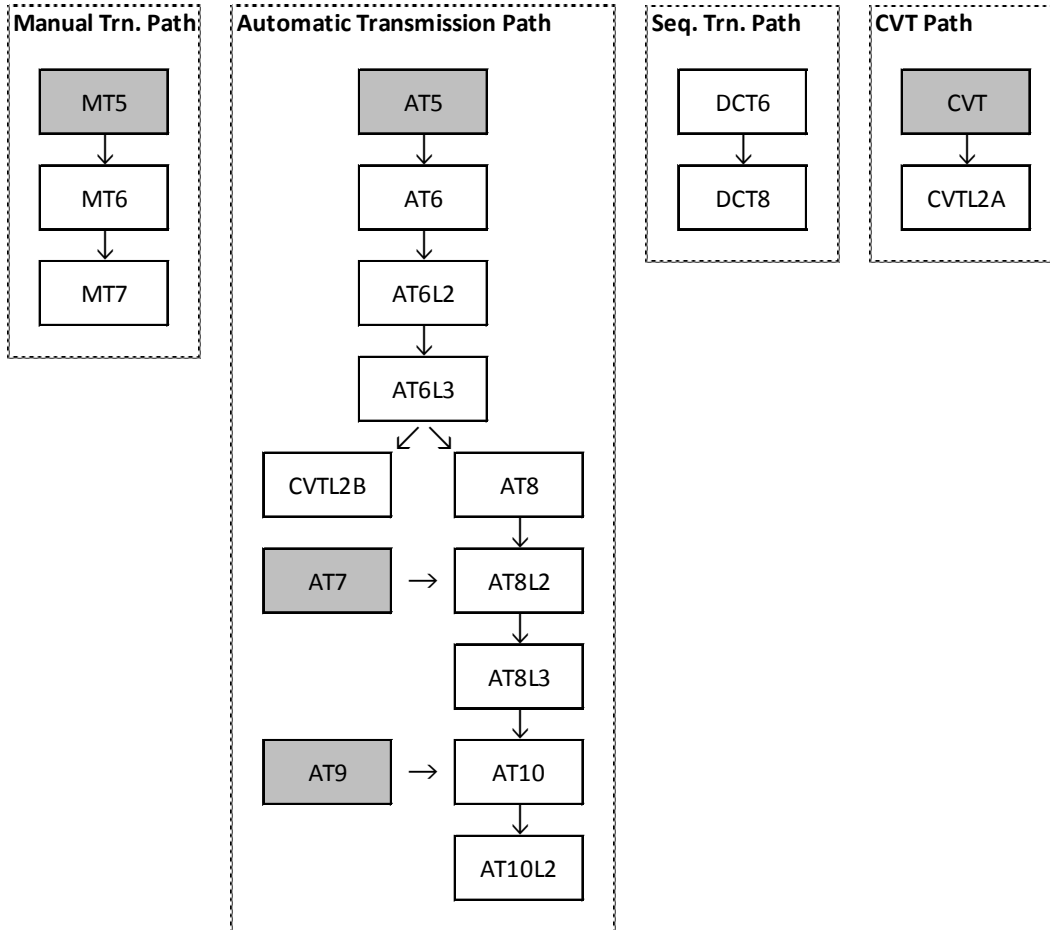

Figure 3. Transmission-Level Paths

Given the definition of incremental costs and fuel economy improvements utilized during the analysis, the system assumes that all manual transmissions with seven or more gears are mapped to the MT7 technology. Moreover, all dual-clutch (DCT) or auto-manual (AMT) transmissions with five or six forward gears should be mapped to the DCT6 technology, and all DCTs or AMTs with seven or more forward gears should be mapped to DCT8. These transmission technology utilization assignments, however, are defined within the input fleet, and are not enforced by the modeling system.

The Automatic Transmission path begins with AT5 technology. As the model progresses through this pathway, it encounters a choice between CVTL2B and AT8 technologies. Whenever a technology pathways forks into two or more branch points, all of the branches are treated as mutually exclusive. The system evaluates all technologies forming the branch, and selects the most costs-effective for application, while disabling the remaining.¹⁴ In the case of the Automatic Transmission path, that means if a vehicle continues with application of the CVTL2B technology,

¹⁴ When evaluating branches in the path, in order to avoid bias between “earlier” technologies on one branch (e.g., CVTL2B) and “later” technologies on the other (e.g., AT10), the system simultaneously evaluates all technologies from both branches, selecting the most costs-effective for application.

the remaining automatic technologies starting with AT8 will be disabled. Likewise, if the vehicle applies the AT8 or later technology, the CVTL2B technology will be disabled.¹⁵

To accommodate certain transmission configurations that are not explicitly available for evaluation by the modeling system, the Automatic Transmission path allows the model to begin traversal midway or toward the end of this pathway. Specifically, vehicles that begin with AT7 or AT9 transmissions may only advance to AT8L2 and later or AT10 and later, respectively, as portrayed in Figure 3 above.

The technology progression within the Manual Transmission, Sequential Transmission, and CVT paths is straightforward. In all cases, the system begins evaluation at the root of the pathway (either at MT5, DCT6, or CVT), and progresses down until the end of that pathway (ending at either MT7, DCT8, or CVTL2A).

All of the transmission pathways defined within the model are mutually exclusive. This signifies that if a vehicle is using a transmission technology from one of the paths (e.g., AT6), all other pathways will be disabled on that transmission.

S4.2.3 Vehicle-Level Electrification Pathways

The technologies that are included on the four Vehicle-Level paths pertaining to the electrification and hybrid/electric improvements defined within the modeling system are illustrated in Figure 4 below. As shown in the Electrification path, the baseline-only CONV technology is grayed out. This technology is used to denote whether a vehicle comes in with a conventional powertrain (i.e., a vehicle that does not include any level of hybridization) and to allow the model to properly map to simulation results found in the Argonne database.

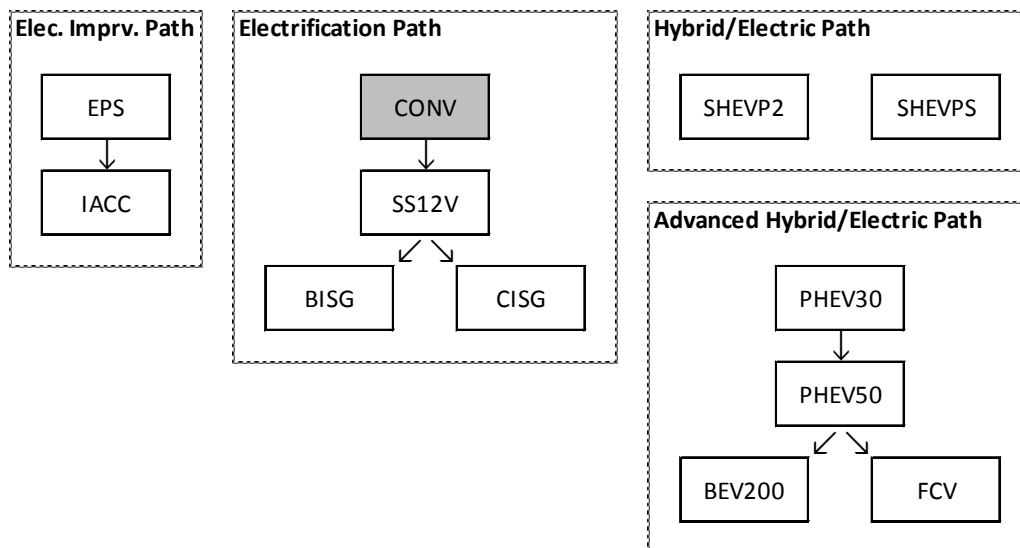

Figure 4. Vehicle-Level (Electrification) Paths

¹⁵ The CAFE Model does not currently simulate the potential that a manufacturer might, for example, replace an existing (conventional) automatic transmission with a CVT, and later replace that CVT with a different (also conventional) automatic transmission.

Since CONV is a baseline-only technology, the model begins evaluation of the Electrification path starting with SS12V. Afterwards, the model encounters a choice between BISG and CISG technologies. As discussed earlier, the branch points are treated as mutually exclusive within the model, where the system evaluates both of these technologies, selecting the more costs-effective for application. Likewise, the Advanced Hybrid/Electric path begins with PHEV30, leading to a choice between BEV200 and FCV technologies. As before, the model evaluates both technologies, selecting one for application, while disabling the other.

Similar to other pathways, the progression of technologies on the Electric Improvements path starts with EPS and progresses to IACC. Technologies on the Hybrid/Electric path (SHEVP2 and SHEVPS) are defined as stand-alone and mutually exclusive. When the modeling system applies one of those technologies, the other one is immediately disabled from future application.

As with Engine- and Transmission-Level pathways, the Vehicle-Level electrification paths are evaluated in parallel, where, for example, the model may immediately evaluate PHEV30 technology prior to having to apply more basic technologies, such as SS12V or SHEVPS. Unlike the other pathways, however, these Vehicle-Level paths are not defined as mutually exclusive. Instead, these paths are treated by the model as pseudo-sequential and superseding. This indicates that the intended order of progression among these paths is starting with the Electrification path, going through the Hybrid/Electric path, and ending at the Advanced Hybrid/Electric path. As the vehicle progresses through these pathways, each time the model applies a technology from the succeeding path, all technologies on the preceding paths are superseded (*i.e.*, replaced and disabled) and are no longer available for future application. If the model skips ahead to a later technology (*e.g.*, PHEV30), the technologies on preceding paths will be superseded as well.¹⁶

Unlike the rest of the Vehicle-Level electrification paths, the Electrification Improvements path is not part of the aforementioned pseudo-sequential progression of pathways. This path is evaluated independently; however, the EPS technology listed therein will be superseded once either BISG or CISG technologies in the Electrification path are applied. Additionally, the entire Electrification Improvements path will be disabled once the vehicle advances to either Hybrid/Electric pathway.

S4.2.4 Platform-Level and Other Vehicle-Level Pathways

The technologies that are included on the single Platform-Level path as well as the three remaining Vehicle-Level paths provided by the model are displayed in Figure 5 below. The baseline-only technologies (MR0, AERO0, and ROLL0) are grayed and are only used to signify the initial configuration of the vehicle. In each case, as with other baseline-only technologies, these are used to allow for appropriate vehicle mapping to the Argonne simulation database.

¹⁶ Additional supersession logic utilized within the model is discussed in Section S4.5 below.

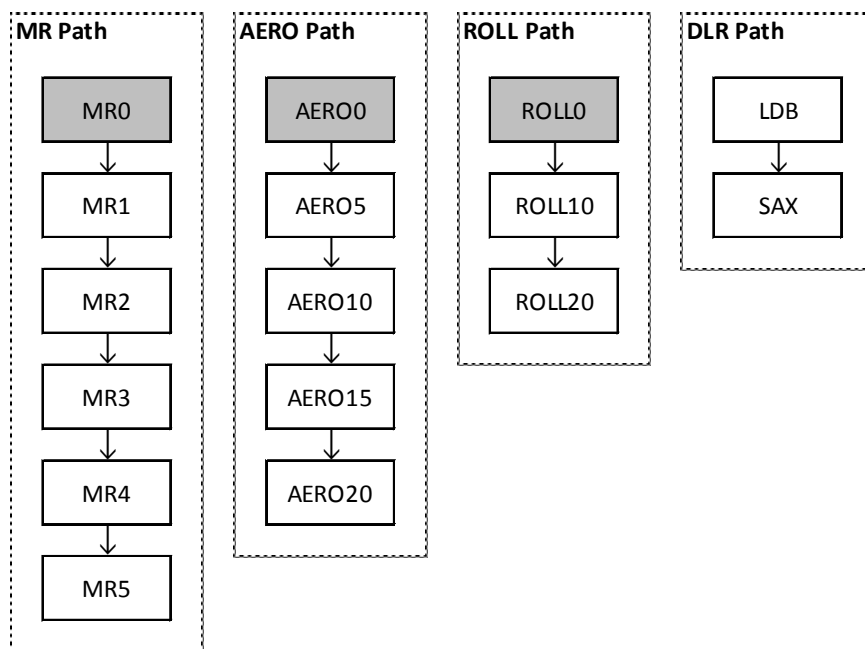

Figure 5. Platform-Level and Vehicle-Level (Other) Paths

All of the pathways shown in Figure 5 follow a direct progression of technologies. As before, the model begins evaluation at the root of the path (e.g., AERO5), and advances sequentially until reaching the end of the pathway (e.g., AERO20). Unlike other pathways, however, when the model evaluates technologies on the Mass Reduction, AERO, and ROLL paths, the system does not backfill technologies that were previously bypassed due to being considered ineffective. In these cases, backfilling is not required, since these technologies are defined in terms of absolute costs and fuel economy improvements over the root of each respective pathway.

Each path in Figure 5 above is evaluated independent of the other, having no additional dependencies or interactions among them (i.e., application of a technology from any path does not disable any other pathway).

S4.2.5 Relationship Between Technology Pathways

Even though the model evaluates each technology path independently some of the pathways are interconnected, as described in the preceding sections, to allow for additional logical progression and incremental accounting of technologies. For example, the SHEVPS technology on the Hybrid/Electric path is defined within the model as incremental over the VVT technology on the Basic Engine path, the AT5 technology on the Automatic Transmission path, and the CISG technology on the Electrification path. For that reason, whenever the system evaluates the SHEVPS technology for application on a vehicle, it needs to ensure that all of the aforementioned technologies (as well as their predecessors) have been properly accounted for on that vehicle. The model achieves this by performing internal cost and fuel economy adjustments in order to bring a vehicle to a predefined *reference* state. The specifics of the way the modeling system performs these adjustments, as well as which of the technologies are affected, are addressed in the sections below.

Of the nineteen technology pathways present in the model, all Engine paths, the Automatic Transmission path, the Electrification path, and both Hybrid/Electric paths are logically linked for incremental technology progression. This relationship between pathways is illustrated in Figure 6 below.

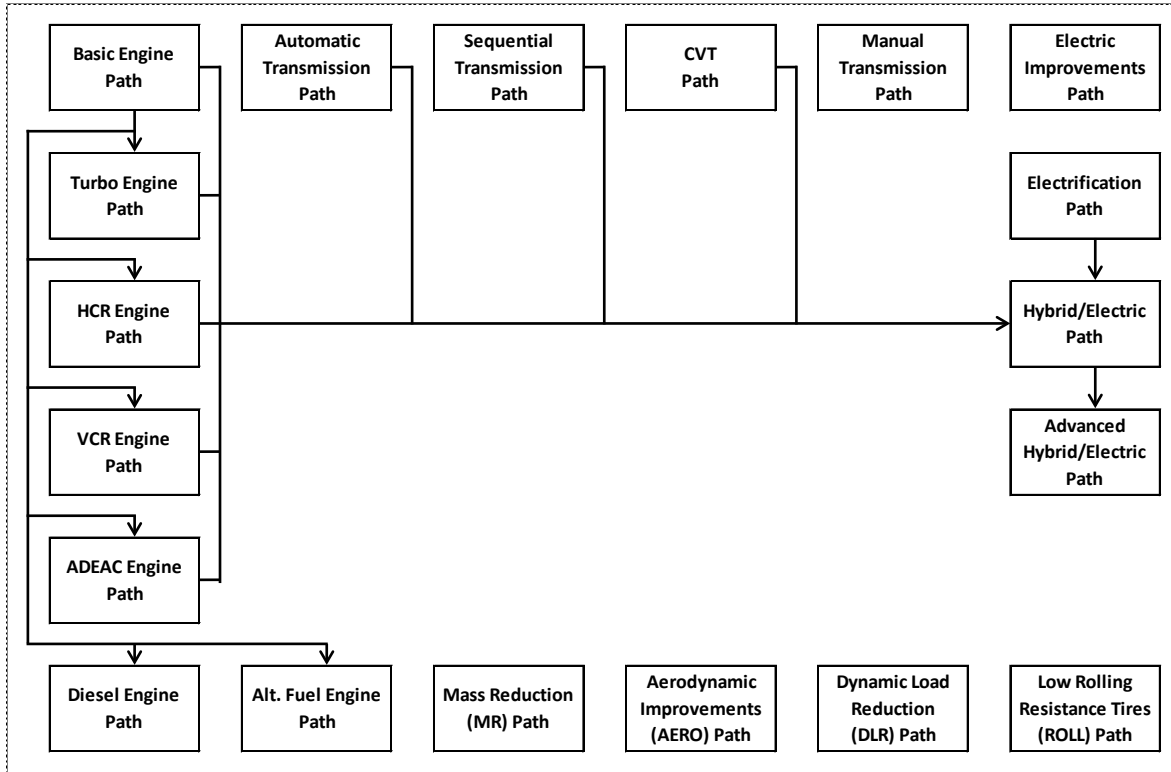

Figure 6. Technology Pathways Diagram

Some of the technology pathways, as defined in the CAFE model and shown in the diagram above, may not be compatible with a vehicle given its state at the time of evaluation. For example, a vehicle with a 6-speed automatic transmission will not be able to get improvements from a Manual Transmission path. For this reason, the system implements logic to explicitly disable certain paths whenever a constraining technology from another path is applied on a vehicle. On occasion, not all of the technologies present within a pathway may produce compatibility constraints with another path. In such a case, the system will selectively disable a conflicting pathway (or part of the pathway) as required by the incompatible technology. In the preceding sections, this was referred to as mutual exclusivity of paths. The full and precise logic for conflicting and mutually exclusive pathways defined within the model is shown in the table below:

Table 13. Technology Pathway Compatibility Logic

Technology Pathway	Conflicting Pathways Disabled in the Model
Turbo, HCR, VCR, and ADEAC Engine Paths	Turbo, HCR, VCR, and ADEAC Engine Paths ** (** excluding the path to which this criteria applies) Alt. Fuel Engine Path Diesel Engine Path
Alt. Fuel Engine Path	All Paths are disabled **

DRAFT – July 2018

	(** if a vehicle uses any technology on the Alternative Fuel Engine path, presently this only includes CNG, the model prohibits any further technology application to that vehicle)
Diesel Engine Path	Turbo, HCR, VCR, and ADEAC Engine Paths Alt. Fuel Engine Path Both Hybrid/Electric Paths
Manual Transmission Path	All Other Transmission Paths Electrification Path Both Hybrid/Electric Paths
Automatic Transmission Path Sequential Transmission Path CVT Path	All Other Transmission Paths
Electrification Path	Electric Improvements Path ** (** only EPS technology is disabled, and only if BISG or CISG is used)
Hybrid/Electric Paths (including adv. H/E)	Turbo, HCR, VCR, and ADEAC Engine Paths ** (** except if SHEVP2-only is used) Alt. Fuel Engine Path Diesel Engine Path Manual Transmission Path Electric Improvements Path

In addition to the logic described in Table 13, for any interlinked technology pathways shown in Figure 6 above, the system also disables all preceding technology paths whenever a vehicle transitions to a succeeding pathway. For example, if the model applies SHEVPS technology on a vehicle, the system disables all Engine paths, the Manual Transmission path, and Electric Improvements path (as defined in the table above), as well as the Basic Engine path, all other Transmission paths, and the Electrification path (all of which precede the Hybrid/Electric pathway).¹⁷

S4.3 Technology Applicability

The modeling system determines the applicability of each technology on a vehicle, engine, transmission, or platform using the combination of technology input assumptions and the technology utilization settings defined in the input fleet (as specified in the market data input file).¹⁸

For each vehicle technology class (discusses above), the technology input assumptions provide the *Applicable*, *Year Available*, and *Year Retired* fields that control the scope of applicability of each technology. If the *Applicable* field is set to **FALSE** for a specific technology, that technology will not be available for evaluation. Conversely, if this field is set to **TRUE**, the technology will be available for application. Furthermore, the *Year Available* and *Year Retired* fields determine the minimum and maximum model years during which the technology may be considered by the modeling system. If the *Year Retired* field is not specified (left as blank in the technologies input file), the technology is assumed to be available indefinitely. Additionally, technology phase-in

¹⁷ The only notable exception to this rule occurs whenever SHEVP2 technology is applied on a vehicle. This technology may be present in conjunction with any engine-level technology, and as such, the Basic Engine path is not disabled upon application of SHEVP2 technology, even though this pathway precedes the Hybrid/Electric path.

¹⁸ The technology utilization section is described in Sections A.1.2, A.1.3, and A.1.4 of Appendix A.

caps may limit the availability of technologies if a particular penetration rate is reached for a vehicle’s manufacturer in a model year being evaluated.

In the market data input file, the worksheets describing each vehicle model, engine, and transmission selected for simulation provide the *Technology Information* sections that are used to define the initial technology utilization state of the input fleet. Each of the CAFE model technologies listed in Table 8 and Table 9 above are referenced on these worksheets as appropriate, based on the application-level of the technology. The user determines which technologies are initially present in the input fleet, given the characteristics of each vehicle, engine, and transmission. Since the modeling system relies heavily on the *Technology Information* settings, these sections must accurately and completely represent the initial state of each vehicle, platform, engine, and transmission in order to avoid potential modeling errors.

Lastly, the logical restrictions imposed by the technology pathways described above further restrict the applicability of technologies should any compatibility issues arise during modeling.

S4.4 Technology Evaluation and Inheriting

Once the system determines the applicability of all technologies, it may begin evaluating them for application on a vehicle. As stated before, the system examines each pathway sequentially, bypassing and backfilling technologies whenever necessary. The model considers and applies redesign-based technologies (as defined in Table 8 and Table 9 above and listed as “Redesign Only”) whenever a vehicle is at a redesign, while refresh-based technologies (listed as “Refresh/Redesign”) may be considered during a vehicle’s refresh or redesign years.

When the system evaluates platform, engine, or transmission-level technologies, since the technology being analyzed directly modifies a shared vehicle component¹⁹, the resultant improvements must be considered on all vehicles that utilize a common platform, engine, or transmission simultaneously. During modeling, the system elects a “leader” vehicle, with all technology improvements being realized on that vehicle first, and afterwards, propagated down to the remainder of the vehicles (known as the “followers”) that share the leader’s platform, engine, or transmission. As such, new technologies are initially evaluated and applied to a leader vehicle during its refresh or redesign year (as appropriate for a specific technology). Any follower vehicles that share the same redesign and/or refresh schedule as the leader apply these technology improvements during the same model year. The rest of the followers inherit technologies from a leader vehicle during a follower’s refresh year (for engine- and transmission-level technologies), or during a follower’s redesign year (for platform-level technologies).

The system dynamically assigns a leader vehicle for each platform, engine, and transmission during analysis, based on the following criteria:

¹⁹ For the purposes of CAFE modeling, a vehicle component is defined as any major vehicle block that maintains its own production line and is utilized on multiple vehicles at a time. Vehicle platforms, engines, and transmissions are all considered to be vehicle components from the model’s perspective.

- 1) For vehicle platforms only, the system first determines which of the shared vehicles have the highest degree of platform-level technology utilization,²⁰
- 2) From the filtered list of vehicles, the system selects a vehicle model with the highest production volumes (averaged across all analysis years) as the leader,
- 3) If multiple vehicles are selected (that is, they all have the same average production volumes), the vehicle with the highest MSRP is then chosen as the leader.

Note that, since platforms, engines, and transmissions do not always encompass the same set of vehicles, a vehicle chosen as the leader of an engine may not necessarily be selected as a leader of a platform or a transmission.

Since vehicle-level technologies affect only one vehicle at a time, all technology improvements are applied immediately to just the one vehicle model during its refresh or redesign year.

S4.5 Technology Supersession

As the modeling system progresses through the various technology pathways, it may encounter technologies that serve the same function on a vehicle, but represent upgraded or more advanced version of one another. For example, TURBO2 technology is an upgraded version of TURBO1, however, both may not simultaneously exist on the same vehicle. The system may also encounter technologies that represent entirely different powertrain designs, and may need to completely remove a large set of conflicting technologies that may already exists on a vehicle. For example, application of SHEVPS requires replacing the engine and transmission of a vehicle with unique version optimized for a power-split hybrid. Additionally, as discussed earlier, some technology pathways are defined as mutually exclusive and may not be concurrently applied to a vehicle.

In order for users to diagnose the various technology application choices the CAFE Model made during compliance modeling, and to allow for incremental evaluation and application of one or more vehicle technologies on a vehicle, the modeling system includes a logical concept of *technology supersession*. In essence, when a previously applied technology is superseded on a vehicle by the model, it is removed from that vehicle, and replaced by another, typically more advanced technology. The system internally keeps tracks of each superseded technology, which is later reflected in the reports produced by the model.²¹

The following table provides a list of technologies that may supersede one or more other technologies:

²⁰ Unlike engines and transmissions, the vehicle platforms are not discretely defined in the market data input file. Instead, technology utilization of platform-level technologies is attributed to individual vehicles. Therefore, on occasion, vehicles that share a common platform may begin the analysis with varying degrees of platform-level technologies. For this reason, the system begins the leader selection process by first filtering for vehicles with the highest utilization of these technologies.

²¹ Modeling reports are discussed in greater detail in Appendix B.

Table 14. Technology Supersession Logic

Technology	Superseded Technologies
TURBO1	LUBEFR1, LUBEFR2, LUBEFR3, DEAC
TURBO2	LUBEFR1, LUBEFR2, LUBEFR3, DEAC, TURBO1
CEGR1	LUBEFR1, LUBEFR2, LUBEFR3, DEAC, TURBO1, TURBO2
HCR1	LUBEFR1, LUBEFR2, LUBEFR3, VVL, DEAC
HCR2	LUBEFR1, LUBEFR2, LUBEFR3, HCR1
VCR	LUBEFR1, LUBEFR2, LUBEFR3, DEAC
ADEAC	LUBEFR1, LUBEFR2, LUBEFR3, DEAC
ADSL	LUBEFR1, LUBEFR2, LUBEFR3, VVT, VVL, SGDI, DEAC
DSL1	LUBEFR1, LUBEFR2, LUBEFR3, VVT, VVL, SGDI, DEAC
MT6	MT5
MT7	MT5, MT6
AT6	AT5
AT6L2	AT5, AT6
AT6L3	AT5, AT6, AT6L2
AT8	AT5, AT6, AT6L2, AT6L3, AT7
AT8L2	AT5, AT6, AT6L2, AT6L3, AT7, AT8
AT8L3	AT5, AT6, AT6L2, AT6L3, AT7, AT8, AT8L2
AT10	AT5, AT6, AT6L2, AT6L3, AT7, AT8, AT8L2, AT8L3, AT9
AT10L2	AT5, AT6, AT6L2, AT6L3, AT7, AT8, AT8L2, AT8L3, AT9, AT10
CVTL2B	AT5, AT6, AT6L2, AT6L3
DCT8	DCT6
CVTL2A	CVT
SS12V	CONV
BISG	CONV, SS12V
CISG	CONV, SS12V
SHEVP2	All transmission technologies (except AT8), CONV, SS12V, BISG, CISG
SHEVPS	All engine and transmission technologies (except DOHC and SOHC), CONV, SS12V, BISG, CISG
PHEV30	All engine and transmission technologies (except DOHC and SOHC), CONV, SS12V, BISG, CISG, SHEVP2, SHEVPS
PHEV50	All engine and transmission technologies (except DOHC and SOHC), CONV, SS12V, BISG, CISG, SHEVP2, SHEVPS, PHEV30
BEV200	All engine and transmission technologies (including DOHC and SOHC), CONV, SS12V, BISG, CISG, SHEVP2, SHEVPS, PHEV30, PHEV50
FCV	All engine and transmission technologies (including DOHC and SOHC), CONV, SS12V, BISG, CISG, SHEVP2, SHEVPS, PHEV30, PHEV50
ROLL10	ROLL0
ROLL20	ROLL0, ROLL10
MR1	MR0
MR2	MR0, MR1
MR3	MR0, MR1, MR2
MR4	MR0, MR1, MR2, MR3
MR5	MR0, MR1, MR2, MR3, MR4
AERO5	AERO0
AERO10	AERO0, AERO5
AERO15	AERO0, AERO5, AERO10
AERO20	AERO0, AERO5, AERO10, AERO15

When a technology is superseded, the model typically needs to account for the cost and fuel economy improvement discrepancies that may arise during technology supersession. This cost and

fuel economy accounting differs based on the technology being applied and the technologies being superseded, and is described in detail in Sections S4.6.1 and S4.7.1 below.

S4.6 Technology Fuel Economy Improvements

For virtually all of the technologies analyzed within the CAFE Model, the fuel economy improvements were derived from a database containing detailed vehicle simulation results, analyzed at Argonne National Laboratory using the Autonomie model. In order to incorporate the results of the Argonne database, while still preserving the basic structure of the CAFE Model's technology subsystem, it was necessary to translate the points in the database into corresponding locations defined by the technology pathways, described in Section S4.2 above. By recognizing that most of the pathways are unrelated, and are only logically linked to allow for incremental technology progression, it is possible to condense the paths into a smaller number of groups and branches based on the specific technology. Additionally, to allow for technologies present on the Basic Engine path to be evaluated and applied in any order, as simulated in the Argonne database, a unique group was established for each of these technologies. As such, we define following technology groups: engine cam configuration (CONFIG), VVT engine technology (VVT), VVL engine technology (VVL), SGDI engine technology (SGDI), DEAC engine technology (DEAC), non-basic engine technologies (ADVENG)²², transmission technologies (TRANS), electrification and hybridization (ELEC), low rolling resistance tires (ROLL), mass reduction levels (MR), and aerodynamic improvements (AERO).²³ The combination of technologies along each of these groups forms a unique technology state vector and defines a unique technology combination that corresponds to a single point in the database for each technology class evaluated within the modeling system.

As an example, a technology state vector describing a vehicle with a SOHC engine, variable valve timing (only), a 6-speed automatic transmission, a belt-integrated starter generator, mass reduction (level 1), aerodynamic improvements (level 2), and rolling resistance (level 1) would be specified as SOHC;VVT;;;;AT6;BISG;MR1;AERO20;ROLL10.²⁴ By assigning each unique technology combination a state vector such as the one in the example, the CAFE Model can then assign each vehicle in the analysis fleet an initial state that corresponds to a point in the database. From there, it is relatively simple to obtain a fuel economy improvement factor for any new combination of technologies and apply that factor to the fuel economy of a vehicle in the analysis fleet.

Once a vehicle is assigned (or mapped) to an appropriate technology state vector (from one of approximately 150 thousand unique combinations, which is defined in the Argonne simulation database as CONFIG;VVT;VVL;SGDI;DEAC;ADVENG;AT10;ELEC;ROLL;MR;AERO), adding a new technology to the vehicle simply represents progress from one state vector to another.

²² The ADVENG group includes all technologies found in the following pathways: Turbo, HCR, VCR, ADEAC, and Diesel path; however, this group does not include the Alt. Fuel path, since CNG technology is not present in the Argonne simulation database.

²³ Since none of the technologies within the Dynamic Load Reduction path were simulated by Argonne, this pathway is not represented by the technology group combination.

²⁴ In the example technology state vector, the series of semicolons between VVT and AT6 correspond to the engine technologies which are not included as part of the combination.

Thus, the formula for calculating a vehicle’s fuel economy for each technology represented within the Argonne database is defined as:

$$FE_{New} = FE \times \frac{F_{Prev}}{F_{New}} \quad (5)$$

Where:

- FE : the original fuel economy for the vehicle, in mpg,
- F_{Prev} : the fuel economy improvement factor associated with the technology state vector before application of any new candidate technologies,
- F_{New} : the fuel economy improvement factor associated with the technology state vector after application of new candidate technologies, and
- FE_{New} : the resulting fuel economy for the same vehicle, in mpg.

The fuel economy improvement factor is defined in a way that captures the incremental improvement of moving between points in the database, where each point is defined uniquely as a combination of up to 11 distinct technologies describing, as mentioned above, the engine’s cam configuration, multiple distinct combinations of engine technologies, transmission, electrification type, low rolling resistance tires, mass reduction level, and level of aerodynamic improvement.

In addition to the technologies found in the Argonne simulation database, the modeling system also provides support for a handful of “*add-on*” technologies that were required for CAFE modeling, but were not explicitly simulated by Argonne. These technologies are: DSLI, EPS, IACC, LDB, and SAX. For calculating fuel economy improvements attributable to these technologies, the model uses the fuel consumption improvement factors, FC , as defined in the technologies input file.²⁵ Since VVT is defined as a prerequisite technology, it may also need be applied by the model during analysis. However, since it is considered a reference point within the Argonne database, it would be impossible for the model to calculate the vehicle’s fuel economy improvements using Equation (5) above. Instead, the model relies on the fuel consumption improvement factor when evaluating the VVT technology as well.

The FC factor is defined on a gallons-per-mile basis and represents a percent reduction in vehicle’s fuel consumption value. The formula to find the resulting increase in fuel economy of a vehicle with fuel consumption reduction factors from one or more add-on technologies is defined as:

$$FE_{New} = FE \times \prod_{i=0}^n \frac{1}{(1 - FC_i)} \quad (6)$$

Where:

- FE : the original fuel economy for the vehicle, in mpg,

²⁵ The technologies input file is further described in Section A.2 of Appendix A.

- FC_i : the fuel consumption improvement factors attributed to the 0 -th to n -th “add-on” candidate technologies, and
 FE_{New} : the resulting fuel economy for the same vehicle, in mpg.

As the model evaluates and backfills multiple technologies at a time, it is possible that a combination of Argonne simulated and add-on technologies may be applied to a vehicle in a single operation. In such a case, Equations (5) and (6) above combine to become:

$$FE_{New} = FE \times \frac{F_{Prev}}{F_{New}} \times \prod_{i=0}^n \frac{1}{(1 - FC_i)} \quad (7)$$

Where:

- FE : the original fuel economy for the vehicle, in mpg,
 F_{Prev} : the fuel economy improvement factor associated with the technology state vector before application of any new candidate technologies,
 F_{New} : the fuel economy improvement factor associated with the technology state vector after application of new candidate technologies,
 FC_i : the fuel consumption improvement factors attributed to the 0 -th to n -th “add-on” candidate technologies, and
 FE_{New} : the resulting fuel economy for the same vehicle, in mpg.

For some technologies, the modeling system may convert a vehicle or a vehicle’s engine from operating on one type of fuel to another. For example, application of Advanced Diesel (ADSL) technology converts a vehicle from gasoline operation to diesel operation. In such a case, the aforementioned Equations (5), (6), and (7) still apply, however, in each case, the FE_{New} value is assigned to the vehicle’s new fuel type, while the fuel economy on the original fuel is discarded.

Moreover, whenever the modeling system converts a vehicle model to a 30-mile Plug-In Hybrid/Electric Vehicle (PHEV30), that vehicle is assumed to operate simultaneously on gasoline and electricity fuel types. In this case, the model obtains two sets of fuel economy improvement factors, F_{New} and $F2_{New}$, from the Argonne simulation database for estimating the FE_{New} values on gasoline and electricity, respectively. In the case of electricity, since no reference fuel economy exists prior to conversion to PHEV30, the $F2_{New}$ value is defined as an improvement over FE_{Prev} value on gasoline. That is, for calculating the fuel economy on electricity when upgrading a vehicle to PHEV30, Equation (5) becomes:

$$FE_{New,E} = FE_G \times \frac{F_{Prev}}{F2_{New}} \quad (8)$$

Where:

- FE_G : the original fuel economy for the vehicle, in mpg, when operating on gasoline,
 F_{Prev} : the fuel economy improvement factor associated with the technology state vector before application of any new candidate technologies,

- $F2_{New}$: the fuel economy improvement factor associated with the technology state vector after application of new candidate technologies, and
- $FE_{New,E}$: the resulting fuel economy for the same vehicle, in mpg, when operating on electricity.

Just as no reference fuel economy on electricity exists on a vehicle prior to application of PHEV30 technology, a reference fuel economy improvement factor would not exist in the Argonne database either. For this reason, Equation (8) above uses F_{Prev} factor when calculating the new vehicle fuel economy on electricity. Since both FE_G and F_{Prev} refer to the same reference state, Equation (8) mathematically applies and produces accurate results with regard to the Argonne simulation database.²⁶

Additionally for PHEVs, the *Secondary FS* field, defined in the technologies input file, specifies the assumed amount of miles driven by the vehicle when operating on electricity. The vehicle's overall rated fuel economy is then defined as the average of the fuel economies on gasoline and electricity, weighted by the fuel shares.²⁷ As the system transitions to PHEV50, the same calculation applies, however, this time, the $F2_{New}$ value is defined as a fuel economy improvement factor over FE_E (or, fuel economy on electricity).

When the system further improves the vehicle, converting it from a PHEV50 to a 200-mile Electric Vehicle (BEV200), the gasoline fuel component is removed, while the electric-operated portion remains. In this case, the F_{Prev} value, obtained from the simulation database, represents a fuel economy improvement factor over FE_E on PHEV50's electricity component. Similarly, when a vehicle is converted to a Fuel Cell Vehicle (FCV) instead of BEV200, the same conversion logic applies, except the final fuel economy, FE_{New} , is defined on hydrogen fuel type.

S4.6.1 Fuel Economy Adjustments

When the modeling system evaluates the fuel economy improvement associated with application of a technology, it may, on occasion, be necessary to adjust the improvement factor based on whether a conflicting technology was removed (or superseded) during evaluation. For the technologies that are listed in the Argonne simulation database, the fuel economy improvement is derived from the factors defined for each unique technology combination or state vector. As defined in Equation (5) above, each time the improvement factor for a new state vector is added to a vehicle's existing fuel economy, the factor associated with the old technology combination is entirely removed. In that sense, application of technologies obtained from the Argonne database is "self-correcting" within the model.

However, the system still needs to perform fuel economy adjustments (or corrections) in the event that some add-on technologies that were present on a vehicle were superseded during analysis. For

²⁶ Readers are invited to validate the calculations presented by this and other equations for accuracy.

²⁷ The overall fuel economy for PHEVs is the rated value achieved by the vehicle assuming on-road operation specified by the *Secondary FS* field. For compliance purposes, the vehicle's overall fuel economy is determined by the *Multi-Fuel* and the *PHEV Share* parameters defined in the scenarios input file. The scenarios input file is further discussed in Section A.4 of Appendix A.

each of the technologies affected, this section describes the logical constraints imposed by the model during such fuel economy corrections.

When the system evaluates BISG or CISG (mild hybrid) technologies for application on a vehicle, it assumes that the fuel efficiency attributed to EPS is already included as part of Argonne’s simulation of those technologies. Additionally, the model operates under the assumption that Argonne’s simulation of vehicles with hybrid/electric powertrains (mild hybrid and greater) include fuel economy improvements over a conventional powertrain without any electric improvements (namely, excluding the benefits of EPS and IACC). As such, in order to avoid double-counting of fuel economy improvements, the model negates the fuel consumption improvement factor, *FC*, for the add-on EPS technology (if EPS is present on the vehicle) prior to applying BISG or CISG. If EPS is not used on a vehicle at the time of evaluation, no additional adjustments would be necessary.

As the modeling system evaluates strong hybrid/electric technologies (SHEVP2 or SHEVPS), it assumes that the fuel efficiency of EPS and IACC technologies are accounted for in Argonne’s simulation results. As with application of BISG and CISG, the system avoids double-counting by negating the *FC* factors of EPS and IACC technologies, for whichever is present on a vehicle at the time of evaluation. However, if a vehicle that is being upgraded to a strong hybrid already includes either BISG or CISG technology, the EPS correction would not be required, as the model would have previously performed this adjustment as described in the preceding paragraph. In such a case, the system would only negate the *FC* factor of IACC technology.

Lastly, when the model evaluates PHEV30 for application, the same correction logic described for strong hybrids applies (*i.e.*, EPS and IACC are part of simulation results and must be negated). If, however, the vehicle being upgraded begins with SHEVP2 or SHEVPS, the EPS and IACC corrections would not be required.

Notice that, even though the technology pathways on which the mild, strong, and plug-in hybrids are listed are interlinked for incremental technology progression, the fuel economy adjustments are required for each of these technologies nonetheless. This occurs because the modeling system is allowed to jump ahead to the root of a more advanced path prior to exhausting the preceding pathways. Therefore, some of the corrections that would have been applied by a preceding technology would not have necessarily been resolved.

S4.7 Technology Cost Tables

The technology input assumptions, as defined in the technologies input file, provide a fully “learned-out” table of year-by-year technology costs, as specified by the *Cost Table* section. As mentioned earlier, the costs for engine-level technologies are specified for each engine technology class, while the costs for all other technologies are defined for each vehicle technology class.

For most of the technologies, the costs provided are defined incrementally over a preceding technology and are used as is. However, for all technologies on the Mass Reduction path, the input costs are specified on per pound basis, where the base cost value is multiplied by the amount of pounds by which a vehicle’s glider weight is reduced, in order to obtain the full cost of applying

the technology. Additionally, for Low Rolling Resistance Tires, Aerodynamic Improvements, and Mass Reduction paths, the costs for each technology are specified as absolute over the root of the respective pathway (*i.e.*, ROLL0, AERO0, or MR0).

The modeling system also incorporates cost adjustment factors to provide accounting corrections for some technology costs defined within the technology input assumptions. Since the Basic Engine path (see Figure 2 above) converges from DOHC and SOHC technologies, and since the base input costs are defined for the DOHC engine, the system necessitates the use of these adjustments in order to offset the costs of some technologies used on engines with SOHC or OHV²⁸ valvetrain designs. Given that the engine technology cost tables are defined independently for each engine technology class, at present, the cost adjustments for only a few engine technologies are required to be specified in the technologies input file. During evaluation of technology costs, the system considers the cost adjustment factors only when all of the technologies that make up the “adjustments combination” are either used or selected for application on a vehicle. For example, a cost adjustment factor defined for a “SOHC;VVL” technology combination, as listed in the input assumptions, will only be applicable to vehicles that use an SOHC engine, whenever VVL technology is selected for application. To allow the same learning effect to be applied to the cost adjustments as found in the main cost tables, the system accepts cost adjustment factors on a year-by-year basis.

Taking the above into consideration, the cost attributed to application of one or more technologies in each model year is represented by the following equation:

$$TechCost_{MY} = \sum_{i=0}^n Cost_{MY,i} + \sum_{i=0}^n CostAdj_{MY,i} \quad (9)$$

Where:

- MY* : the model year for which to calculate costs of selected candidate technologies,
- Cost_{MY,i}* : the base cost attributed to application of the *0-th* to *n-th* candidate technologies in model year *MY*,
- CostAdj_{MY,i}* : the cost adjustment attributed to application of the *0-th* to *n-th* candidate technologies, wherever applicable, in model year *MY*, and
- TechCost_{MY}* : the resulting net technology cost attributed to all selected candidate technologies in model year *MY*.

As stated earlier, for most technologies, the base cost defined in Equation (9) simply represents the incremental technology cost from a preceding technology within the same path. For some technologies, however, this cost value would also need to include additional implicit cost adjustments pertaining to the resolution of various technology constrains and dependencies arising within the model during evaluation of certain technologies. Note that these implicit cost

²⁸ As previously discussed, the modeling system does not explicitly define OHV technology for analysis. Instead, OHV engines are mapped to SOHC technology in the input fleet. That said, for added flexibility and more accurate representation of technology costs, the system still accommodates separate cost tables for OHV engines.

adjustments, which are addressed in detail in Section S4.7.1 below, are different from the ones defined in the equation above. The cost adjustments shown in Equation (9), and as described above, are necessary for adjusting DOHC costs for SOHC and OHV engines.

As stated above, technologies appearing on the Low Rolling Resistance Tires, Aerodynamic Improvements, and Mass Reduction paths are defined as absolute costs with respect to their initial technologies. This indicates that whenever the model calculates the cost of a new technology on a vehicle from one of these pathways, it simultaneously negates the cost of the previously utilized technology on the same vehicle from the same pathway. For ROLL and AERO technologies, Equation (9) from above reduces to:

$$TechCost_{MY} = Cost_{MY,New} - Cost_{MY,Prev} \quad (10)$$

Where:

- MY : the model year for which to calculate the cost of selected candidate technology,
- $Cost_{MY,New}$: the base cost attributed to application of the new candidate technology in model year MY , for which the cost is defined on an absolute basis,
- $Cost_{MY,Prev}$: the base cost associated with the previously utilized technology on a vehicle in model year MY , for which the cost is defined on an absolute basis, and which will be removed after application of the candidate technology, and
- $TechCost_{MY}$: the resulting net cost attributed to application of the new candidate technology in model year MY .

For mass reduction technologies, since the cost is also specified on per pound basis, Equation (10) is further expanded to become:

$$TechCost_{MY} = (GW_{Ref} \times \Delta W_{New} \times Cost_{MY,New}) - (GW_{Ref} \times \Delta W_{Prev} \times Cost_{MY,Prev}) \quad (11)$$

Where:

- MY : the model year for which to calculate the cost of selected mass reduction technology,
- GW_{Ref} : the estimated *reference* weight of the vehicle's glider,²⁹
- ΔW_{New} : the percent reduction of the vehicle's reference glider weight, GW_{Ref} , attributed to application of the new mass reduction technology,
- $Cost_{MY,New}$: the base cost attributed to application of the new mass reduction technology in model year MY , for which the cost is defined on an absolute basis,

²⁹ When defining the reference glider weight, GW_{Ref} , for a vehicle, the model backs out any mass reduction technology that may be present on that vehicle in the input fleet. The calculation of the *reference* glider weight is described further in Section S4.8 below.

- ΔW_{Prev} : the percent reduction of the vehicle’s reference glider weight, GW_{Ref} , attributed to the previously utilized mass reduction technology,
- $Cost_{MY,Prev}$: the base cost associated with the previously utilized technology on a vehicle in model year MY , for which the cost is defined on an absolute basis, and which will be removed after application of the new mass reduction technology, and
- $TechCost_{MY}$: the resulting net cost attributed to application of the new mass reduction technology in model year MY .

The percent reduction of vehicle’s glider weights, ΔW_{New} and ΔW_{Prev} , are specified for each mass reduction technology in the input assumptions.

Along with the base *Cost Table*, the input assumptions also define the *Maintenance and Repair Cost Table*, which is also specified for each model year and accounts for the learning effect, wherever applicable. The *Maintenance and Repair Cost Table* identifies the changes in the amount buyers are expected to pay for maintaining a new vehicle³⁰, as well as the increases in non-warranty repair costs attributed to application of additional technology. Although listed in the input assumptions, the *Stranded Capital Table* is not supported within the current version of the CAFE Model.³¹

S4.7.1 Implicit Cost Adjustments

When the CAFE Model evaluates the additional cost associated with application of technology, it may, on occasion, be necessary to adjust the base cost value depending on whether a conflicting technology was removed (or superseded) or a missing prerequisite technology was added (or implicitly backfilled³²) during evaluation. The system performs these implicit cost adjustments (or corrections) to ensure that regardless of the sequence in which technologies are applied to a vehicle, the resultant accumulated cost remains consistent. For each of the technologies affected, this section describes the logical constraints imposed by the model during such cost corrections.

As illustrated in Figure 3 and discussed in Section S4.2.2 above, the AT8L2 and AT10 transmission technologies each serve as convergence points for two other technologies on the Automatic Transmission path. The model may reach AT8L2 from either the baseline-only AT7 technology or from the AT8 technology; while AT10 may be reached via either AT8L3 or the baseline-only AT9 technologies. However, costs for any given technology may be defined incrementally over exactly one preceding technology in the input assumptions. Conversely, a technology may have multiple succeeding technologies for which it serves as the basis for

³⁰ The maintenance costs may lead to increases in cost to consumers, such as for advanced diesel engines, or in cost saving to consumers, such as for electric vehicles. In the case of electric vehicles, the cost savings result from avoiding traditional vehicle maintenance such as engine oil changes.

³¹ Further discussion of the technology cost input assumptions can be found in Section A.2 of Appendix A.

³² In this context, implicit backfill differs from a typical backfill of technologies. In a traditional sense, the model explicitly selects, analyzes, and backfills technologies during evaluation, within the same path, that were previously skipped due to being cost-ineffective. Implicit backfill, however, occurs whenever the model evaluates a technology on given pathway, where the cost of that technology may be defined as incremental over some other technologies found on one or more different paths.

incremental costs. For the Automatic Transmission path, the incremental cost accounting, for a subset of technologies for which incremental cost progression is not immediately apparent from the technology input assumptions, is illustrated by Figure 7 below.

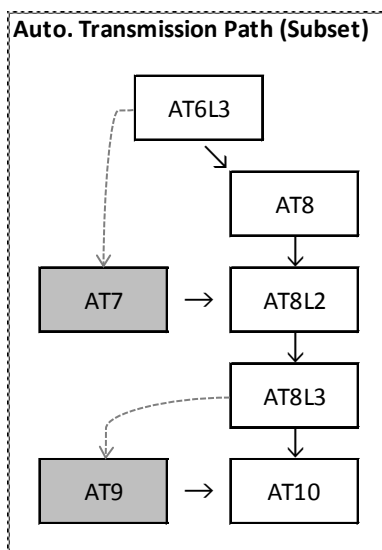

Figure 7. Automatic Transmission Path (Subset)

In the figure above, the short solid arrows indicate the sequence in which technologies are evaluated by the model (along with the incremental cost accounting for most of these technologies), while the long and curved dashed arrows signify the incremental cost progression for some “special case” technologies. Hence, while the baseline-only AT7 technology does not have a preceding technology, the cost for AT7 is specified as being incremental over AT6L3 in the input assumptions. Similarly, the cost for baseline-only AT9 technology is specified incrementally over AT8L3.

With the progression of technologies and technology costs established per above, the system may use the input assumptions provided by the user, along with internally defined implicit cost adjustment logic, to accurately account for the costs of all automatic transmission technologies. For technologies that do not serve as converging points, the cost is defined simply as being incremental over the preceding technology. For AT8L2, the cost is defined as incremental over AT8. However, if the vehicle using AT7 transmission, the model needs to adjust the costs prior to upgrading to AT8L2. To do this, the system backs out the cost of AT7 transmission (moving it back to AT6L3), then adds in the cost of AT8 transmission (thus making the vehicle appear as having AT8 and being prime for advancement to the next technology). Likewise, for AT10, the cost is defined as incremental over AT8L3. When converting from AT9, however, the modeling system backs out the cost of AT9 (effectively making the vehicle appear as AT8L3), before upgrading to AT10.³³

³³ For the “special case” cost accounting to work correctly, the costs for all transmission technologies (with the exception of MT5 and AT5) should be provided in the input assumptions defined in the technologies input file. However, while the incremental logic is inherent to the modeling system, the cost inputs are defined by the user.

When a vehicle initially transitions from a Basic Engine path to use one of the more advanced engine technologies – namely, TURBO1, HCR1, VCR, ADEAC, or ADSL – the model assumes that the costs of these technologies are specified incrementally over VVT. For this reason, the system negates the costs associated with VVL, SGDI, and DAEC, for whichever technology was present on a vehicle at the time the vehicle’s engine was upgraded. For the remainder of the advanced engine technologies, *e.g.*, TURBO2, this type of cost adjustment is not required, since TURBO2 is assumed to be defined incrementally over TURBO1.

As the modeling system evaluates BISG or CISG (mild hybrid) technologies for application on a vehicle, it assumes that electric power steering, represented by EPS technology, is also included as part of the mild hybrid package. Since the costs of these mild hybrid technologies are defined incrementally over SS12V (which is assumed not to include EPS), in order to avoid double-counting of technology costs, the model negates the cost of EPS technology (if EPS is present on the vehicle) prior to applying BISG or CISG. If EPS is not used on a vehicle at the time of evaluation, no additional adjustments would be necessary.

Similarly to mild hybrids, when the CAFE Model evaluates strong hybrid/electric technologies (SHEVP2 or SHEVPS), it assumes that EPS and IACC are both included as part of the strong hybrid/electric package. In addition to this, for cost accounting purposes, SHEVP2 is defined incrementally over AT5³⁴ and BISG technologies, whereas SHEVPS is specified as incremental over VVT, AT5, and CISG. To avoid double-counting of technology costs, the system performs implicit adjustments, backing out the costs of “extra” technologies, while also adding back the costs of some other required technologies.

The system begins adjusting the costs by negating the entire accumulated cost of the transmission the vehicle was using (prior to application of SHEVP2 or SHEVPS) back to AT5. For example, if the vehicle was using AT9 transmission at the time of evaluation, the combined incremental cost of: AT6, AT6L2, AT6L3, AT8, AT8L2, AT8L3, and AT9 would be backed out. Table 15 below shows the exact list of transmission technologies whose costs will be backed out upon application of a strong hybrid/electric technology. Note that the system backs out the cost of the transmission regardless of whether it was present in the input fleet or applied during analysis.

Table 15. Transmission Cost “Back-out” Logic

Technology	Technologies Backed Out
AT6	AT6
AT6L2	AT6, AT6L2
AT6L3	AT6, AT6L2, AT6L3
AT7	AT6, AT6L2, AT6L3, AT7
AT8	AT6, AT6L2, AT6L3, AT8
AT8L2	AT6, AT6L2, AT6L3, AT8, AT8L2
AT8L3	AT6, AT6L2, AT6L3, AT8, AT8L2, AT8L3
AT9	AT6, AT6L2, AT6L3, AT8, AT8L2, AT8L3, AT9

³⁴ During analysis, the system assumes that any vehicle converted to SHEVP2 will be paired with an AT8 transmission. Even though, when converting to SHEVP2, all transmission related costs are negated back to AT5, the model assumes that the SHEVP2 technology includes any additional cost necessary to account for the difference between AT5 and AT8 transmissions in the input assumptions. This correlates to the simulated results in the Argonne database and is reflected in all outputs produced by the model.

DRAFT – July 2018

AT10	AT6, AT6L2, AT6L3, AT8, AT8L2, AT8L3, AT10
AT10L2	AT6, AT6L2, AT6L3, AT8, AT8L2, AT8L3, AT10, AT10L2
CVTL2B	AT6, AT6L2, AT6L3, CVTL2B
CVT	CVT
CVTL2A	CVT, CVTL2A
DCT6	DCT6
DCT8	DCT6, DCT8

Once the vehicle’s transmission costs are accounted for, the model continues by remedying the costs of mild hybrid technologies, ensuring that the incremental progression from BISG to SHEVP2 or CISG to SHEVPS is observed. As with application of BISG and CISG, the costs of EPS and IACC technologies are negated, assuming the relevant technology is present on a vehicle at the time of evaluation. However, if a vehicle that is being upgraded to a strong hybrid already includes either BISG or CISG technology, the EPS correction would not be required, as the model would have previously performed this adjustment as discussed above. Furthermore, if an “incorrect” mild hybrid is used at the time of evaluation (*i.e.*, CISG is used while SHEVP2 is being analyzed; or, BISG is used while SHEVPS is considered), the system would “swap” the costs of BISG and CISG. For example, in the case of conflicting BISG/SHEVPS pairing, the model would negate the cost of BISG, then add in the cost of CISG. Lastly, if a vehicle does not include a mild hybrid technology, the system would add in the cost of BISG or CISG as appropriate (*i.e.*, BISG is added if SHEVP2 is examined; CISG is added if SHEVPS is evaluated), as well as the cost of SS12V, if it is not already in use on a vehicle.

Additionally for SHEVPS, the system finalizes adjusting the costs by negating all engine technology costs back to VVT. At the time of evaluation, if the vehicle was using a technology from any of: Turbo, HCR, VCR, ADEAC, or Diesel Engine paths, the associated costs of required technologies, as shown in Table 16, would be backed out. For example, if the vehicle was using TURBO2, the combined incremental cost of TURBO1 and TURBO2 would be backed out. If, however, the vehicle was using HCR1, only the incremental cost of HCR1 would be backed out.

Table 16. Engine Cost “Back-out” Logic

Technology	Technologies Backed Out
TURBO1	TURBO1
TURBO2	TURBO1, TURBO2
CEGR1	TURBO1, TURBO2, CEGR1
HCR1	HCR1
HCR2	HCR1, HCR2
VCR	VCR
ADEAC	ADEAC

Since the technologies from the Basic Engine path were “resolved” (as described earlier) when the vehicle was converted to a more advanced engine, *e.g.*, TURBO1, the costs of the Basic Engine technologies would not need to be negated. If, however, the highest level of technology utilization achieved by the vehicle’s engine is entirely within the Basic Engine pathway, the costs associated with VVL, SGDI, and DAEC would be backed out, for whichever technology was present on a vehicle at the time SHEVPS was evaluated for application.

When the model evaluates PHEV30, it assumes that the cost is defined as incremental over SHEVPS. If the vehicle being upgraded is already using SHEVPS, the system does not need to

perform any additional cost adjustments. Conversely, if the vehicle is using SHEVP2 at the time of evaluation, the system would begin by first removing the cost attributed to SHEVP2 technology. From there, the system would follow a similar conversion logic as described for SHEVPS above (*i.e.*, negating the cost of BISG and any required engine technology), before finally adding in the cost of SHEVPS. However, if the vehicle does not use either strong hybrid/electric technology, the model would utilize the same conversion logic as for SHEVPS (*i.e.*, negating the cost of any required engine and transmission technology; removing EPS, IACC, and BISG as needed; adding in SS12V and CISG if not used), then add in the cost of SHEVPS.

S4.7.2 Battery Costs

For some of the technologies evaluated within the CAFE Model, the system provides the ability to separately account for costs related to varying vehicle battery sizes, depending on the overall configuration of the vehicle (*i.e.*, engine, transmission, electrification, hybridization, and other various body level improvements). As with fuel economy improvement factors (discussed earlier), the battery costs were derived from a vehicle simulation database produced using the Autonomie model at Argonne National Laboratory. Thus, the system relies on the same unique technology state vector assignment of a vehicle (as defined in Section S4.6 above) when progressing from one technology to the next.

The CAFE Model includes discrete accounting of battery costs during analysis whenever a vehicle evaluates for application or already includes a technology from the Electrification, Hybrid/Electric, or Advanced Hybrid/Electric paths. As an example, consider a vehicle that utilizes a combination of technologies defined by the state vector: DOHC;VVT;;;;;AT6;CONV;MR1;AERO0;ROLL0. When this vehicle progresses to **BISG** technology (from the Electrification path), the model calculates battery costs for the resulting combination, which now includes Belt-integrated Starter/Generator. Alternatively, consider a vehicle with a technology state vector that already includes an Advanced Hybrid/Electric technology as: PHEV30;MR2;AERO10;ROLL20. When the vehicle applies **MR3** technology, the model still calculates battery costs attributed to the new technology state vector, since the resulting combination includes PHEV30. In the latter example, however, the model would produce an incremental change in cost in order to capture the effect of different battery size requirements between a 30-mile plug-in hybrid/electric vehicle with a level-2 mass reduction and a level-3 mass reduction.

Since the Argonne simulation results provide a single cost value for each technology combination, the modeling system accommodates an additional table of learning rate multipliers defined within the technologies input file. Together, the two combine to produce a fully learned-out cost value for each technology state vector during each model year, as defined by the following equation:

$$BatteryCost_{MY} = BatteryCost_{New} \times LR_{MY,New} - BatteryCost_{Prev} \times LR_{MY,Prev} \quad (12)$$

Where:

MY : the model year for which to calculate the battery cost of the selected candidate technologies,

BatteryCost_{New} : the base battery cost associated with the technology state vector after application of the selected candidate technologies,

- $LR_{MY,New}$: the learning rate multiplier associated with the technology state vector after application of the selected candidate technologies in model year MY ,
- $BatteryCost_{Prev}$: the base battery cost associated with the technology state vector before application of the selected candidate technologies,
- $LR_{MY,Prev}$: the learning rate multiplier associated with the technology state vector before application of the selected candidate technologies in model year MY , and
- $BatteryCost_{MY}$: the resulting battery cost associated with the technology state vector attributed to application of the selected candidate technologies in model year MY .

The learning rate multipliers, $LR_{MY,New}$ and $LR_{MY,Prev}$, are defined in the technology input assumptions for each Electrification, Hybrid/Electric, and Advanced Hybrid/Electric technology.

Once the model obtains the battery cost attributable to a technology, the total cost from application of that technology may be calculated by combining the results of Equation (12) with one of the Equations (9), (10), or (11) as:

$$TotalCost_{MY} = TechCost_{MY} + BatteryCost_{MY} \quad (13)$$

Where:

- MY : the model year for which to calculate the total cost of the selected candidate technologies,
- $TechCost_{MY}$: the non-battery cost attributed to application of the selected candidate technologies in model year MY ,
- $BatteryCost_{MY}$: the battery cost associated with the technology state vector attributed to application of the selected candidate technologies in model year MY , and
- $TotalCost_{MY}$: the resulting total cost attributed to application of the selected candidate technologies in model year MY .

S4.8 Application of Mass Reduction Technology

Each time the modeling system evaluates a mass reduction technology for application, the curb weight of a vehicle is reduced by some percentage, as defined in the technology input assumptions, with respect to that vehicle’s *reference* glider weight. Within the model, the glider weight is defined as the portion of the vehicle’s curb weight that is eligible for mass reduction and does not include engine, transmission, or interior safety systems.³⁵ From there, the reference glider weight is obtained by backing out any mass reduction technology from the vehicle’s glider, which may already be present on an initial vehicle configuration as specified in the input fleet. The calculation for the reference glider weight is then defined by the following:

³⁵ The definition of the glider weight within the CAFE Model is specified in a way that matches the vehicle simulation results from Argonne National Laboratory’s Autonomie model.

$$GW_{Ref} = \frac{CW_0 \times \Delta GS}{1 - \Delta W_{Max}} \quad (14)$$

Where:

- CW_0 : the initial curb weight of the vehicle as defined in the input fleet,
- ΔGS : the assumed average share of the vehicle’s total curb weight attributable to its glider, as defined in the technology input assumptions for each technology class,
- ΔW_{Max} : the percent reduction associated with the maximum level of mass reduction technology initially in use on the vehicle, as defined in the input fleet, and
- GW_{Ref} : the calculated reference glider weight of the vehicle.

As an example, consider an input vehicle is defined as having MR3, with an initial curb weight of 3600 pounds. Assuming ΔW for MR3 technology is 10% and ΔGS is 50%³⁶, the glider weight of the vehicle is calculated as 1800 pounds and, as defined by Equation (14), the reference glider weight becomes: $3600 * 50\% / (1 - 10\%)$, or 2000 pounds.³⁷

Once the reference glider weight has been determined for each vehicle, the system may calculate the changes in vehicles’ curb weights attributed to application of mass reduction technology. Since the progression of technologies available within the Mass Reduction path is specified on an absolute basis (*i.e.*, the preceding technology is removed when a new one is added, as described in Sections S4.2.4 and S4.7), the modeling system calculates the change in curb weight as the difference between percent reduction attributed to the new candidate technology and the percent reduction of the greatest mass reduction technology in use on a vehicle. This calculation is better demonstrated by the following equation:

$$\Delta CW = GW_{Ref} \times (\Delta W_{New} - \Delta W_{Prev}) \quad (15)$$

Where:

- GW_{Ref} : the reference glider weight of the vehicle, as calculated in Equation (14) above,
- ΔW_{New} : the percent reduction of the vehicle’s reference glider weight, GW_{Ref} , attributed to application of the new mass reduction technology,
- ΔW_{Prev} : the percent reduction of the vehicle’s reference glider weight, GW_{Ref} , attributed to the previously utilized mass reduction technology, and
- ΔCW : the amount by which a vehicle’s curb weight is reduced as a result of applying new mass reduction technology.

³⁶ The values for ΔW and ΔGS are both defined in the technology input assumptions, as discussed in Section A.2 of Appendix A. For the current analysis, the glider share, ΔGS , is defined at 50%, while weight reduction, ΔW , attributable to MR3 technology is defined at 10%.

³⁷ The CAFE Model necessitates the use of a reference glider weight in order to correlate to the simulation results found in the Argonne database, where all vehicle sizing for mass reduction application is based on the glider weight using the same methodology as defined in Equation (11). In other words, since Argonne modeling assumes each vehicle simulated begins with a base weight without any mass reduction, the vehicles analyzed by the CAFE Model must also be brought back to a pre-mass reduction state.

From here, the vehicle’s new curb weight is obtained by subtracting the change in weight from its original curb weight, as:

$$CW_{New} = CW - \Delta CW \quad (16)$$

Where:

- CW : the original curb weight of the vehicle before application of new mass reduction technology,
- ΔCW : the amount by which a vehicle’s curb weight is reduced as a result of applying new mass reduction technology, and
- CW_{New} : the resulting curb weight of the vehicle after application of new mass reduction technology.

In addition to affecting the vehicle’s curb weight, application of mass reduction technology may also influence the vehicle’s new payload and towing capacities by way of adjusting the gross vehicle weight rating (GVWR) and gross combined weight rating (GCWR) values. With the exception of pickups (the vehicles for which the vehicle style column in the input fleet is set to “Pickup”), the GVWR and GCWR changes are presently not calculated within the model for all light duty vehicles (*i.e.*, vehicles regulated as passenger cars or light trucks). For light duty pickups, however, the GVWR value is reduced by the same amount as the curb weight (as shown in Equation (17) below), while GCWR does not change.

$$GVWR_{New} = GVWR - \Delta CW \quad (17)$$

Where:

- $GVWR$: the original gross vehicle weight rating before application of new mass reduction technology,
- ΔCW : the amount by which a vehicle’s GVWR is reduced as a result of applying new mass reduction technology, and
- $GVWR_{New}$: the resulting GVWR of the vehicle after application of new mass reduction technology.

For 2b/3 vehicles (*i.e.*, vehicles regulated as 2b/3 trucks), the degree by which GVWR and GCWR are affected is controlled in the scenarios input file through the *Payload Return* and *Towing Return* parameters. The modeling system uses these parameters when calculating changes in vehicle’s GVWR and GCWR as shown in the following formulas:

$$\Delta GVWR = \text{MAX} \left(8501, \text{MIN} \left(GVWR - (1 - P) \times \Delta CW, CW_{New} \times \left(\frac{GVWR}{CW} \right)_{MAX} \right) \right) \quad (18)$$

Where:

- $GVWR$: the original GVWR of the vehicle before application of new mass reduction technology,
- ΔCW : the amount by which a vehicle’s curb weight is reduced as a result of applying new mass reduction technology, as defined in Equations (15) above,
- CW_{New} : the curb weight of the vehicle after application of new mass reduction technology, as defined in Equations (16) above,
- P : the percentage of curb weight reduction returned to payload capacity,
- $\left(\frac{GVWR}{CW}\right)_{MAX}$: the limiting factor, defined for each input vehicle, preventing GVWR from increasing beyond levels observed among the majority of similar vehicles,
- 8501 : the minimum GVWR at which a vehicle may be classified as a 2b/3 truck for regulatory purposes, and which is used to prevent 2b/3 vehicles from crossing into the light duty category, and
- $\Delta GVWR$: the amount by which a vehicle’s GVWR is reduced as a result of applying new mass reduction technology.

$$\Delta GCWR = \text{MIN} \left(\begin{array}{l} GCWR - (1 - T) \times \Delta GVWR, \\ GVWR_{new} \times \left(\frac{GCWR}{GVWR}\right)_{MAX} \end{array} \right) \quad (19)$$

Where:

- $GCWR$: the original GCWR of the vehicle before application of new mass reduction technology,
- $\Delta GVWR$: the amount by which a vehicle’s GVWR is reduced as a result of applying new mass reduction technology, as defined in Equations (18) above,
- $GVWR_{New}$: the GVWR of the vehicle after application of new mass reduction technology, as defined in Equations (20) below,
- T : the percentage of GVWR reduction returned to towing capacity,
- $\left(\frac{GCWR}{GVWR}\right)_{MAX}$: the limiting factor, defined for each input vehicle, preventing GCWR from increasing beyond levels observed among the majority of similar vehicles, and
- $\Delta GCWR$: the amount by which a vehicle’s GCWR is reduced as a result of applying new mass reduction technology.

As with the calculation of the vehicle’s new curb weight, the new GVWR and GCWR are obtained by subtracting $\Delta GVWR$ and $\Delta GCWR$ from the vehicle’s original GVWR and GCWR, as:

$$GVWR_{New} = GVWR - \Delta GVWR \quad (20)$$

Where:

- $GVWR$: the original GVWR of the vehicle before application of new mass reduction technology,

DRAFT – July 2018

- $\Delta GVWR$: the amount by which a vehicle's GVWR is reduced as a result of applying new mass reduction technology, and
 $GVWR_{New}$: the resulting GVWR of the vehicle after application of new mass reduction technology.

$$GCWR_{New} = GCWR - \Delta GCWR \quad (21)$$

Where:

- $GCWR$: the original GCWR of the vehicle before application of new mass reduction technology,
 $\Delta GCWR$: the amount by which a vehicle's GCWR is reduced as a result of applying new mass reduction technology, and
 $GCWR_{New}$: the resulting GCWR of the vehicle after application of new mass reduction technology.

Section 5 Compliance Simulation

Having determined the applicability of technologies on each vehicle model, platform, engine, and transmission, the modeling system begins compliance simulation processing, iteratively evaluating each of the defined scenarios, model years, and manufacturers. As shown in Figure 8 below, compliance simulation follows a series of nested loops, or stages, progressing from one stage to the next, performing the necessary tasks, and then returning back to the previous stage for further processing. This process concludes when all available manufacturers, model years, and scenarios have been analyzed.

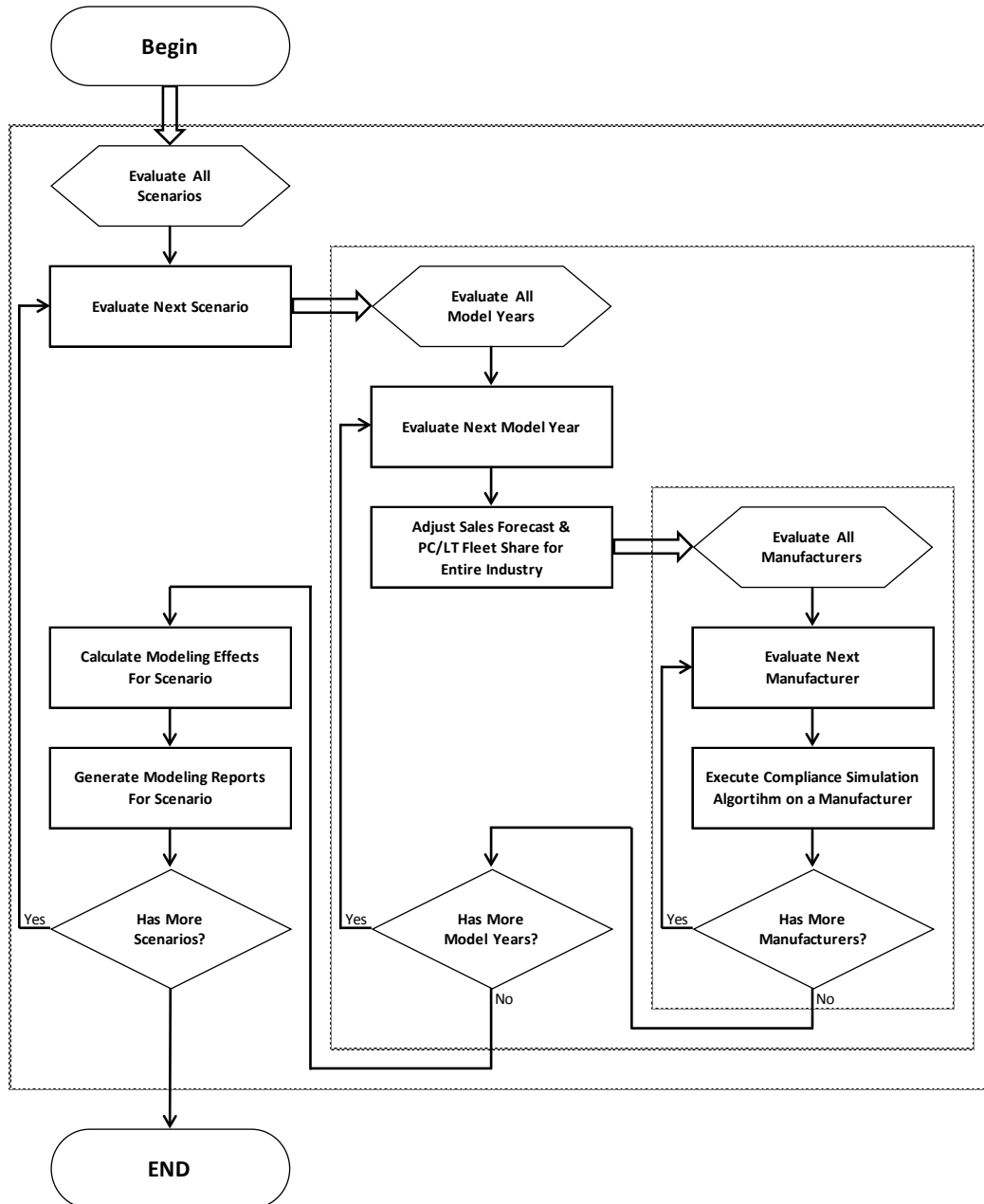

Figure 8. Compliance Simulation

Compliance simulation begins with evaluation of all of the regulatory scenarios defined in the scenarios input file. For each scenario, the system examines all model years available during the study period. In each model year, the system prepares the input fleet for analysis by calculating the forecast of sales for that year as well as by adjusting the share of passenger cars and light trucks with respect to the overall fleet's volume.³⁸ Afterwards, the model allocates new sales and fleet shares to each vehicle model for all manufacturers. Once the new sales forecast is allocated to each manufacturer, compliance simulation proceeds to analyzing all manufacturers defined in the input fleet. For each manufacturer, the *compliance simulation algorithm* (discussed below) is executed to determine a manufacturer's compliance state and, if necessary, apply additional technology to bring the manufacturer into compliance. After evaluating all manufacturers for a given model year, compliance simulation repeats the process with the next model year. Once all model years are exhausted, the system finalizes the evaluation of an active scenario by calculating modeling effects (discussed in Chapter Three below) and generating modeling reports. This process then repeats for the next available scenario. After the system evaluates all scenarios, the compliance simulation process concludes.

In order to ascertain the compliance state of a manufacturer during compliance simulation, the modeling system continuously calculates the required and achieved levels attained by the manufacturer during each model year being evaluated. The CAFE Model supports compliance with standards defined by either the CAFE or the CO₂ program. Accordingly, the manufacturer's required and achieved levels computed by the model translate to either CAFE standard and rating or CO₂ standard and rating. However, while compliance may only be evaluated against only one compliance program at a time, in order to gauge the impact of one program upon another, the system simultaneously calculates all compliance metrics, as applicable to each program, during analysis.

In addition to calculating the required and achieved CAFE and CO₂ levels, the system also calculates credits earned by a manufacturer, where positive values represent overcompliance with a given standard, while negative values indicate a shortfall, or noncompliance. During analysis, the model may offset negative credits earned by transferring credits from a different regulatory class or carrying credits forward from an earlier model year. Likewise, if positive credits are earned, they may be transferred to a different regulatory class or carried forward to some later model year. To allow for this, the model maintains separate accounting of *credits in* and *credits out* values, where each value is updated (as necessary) when a credit transaction is executed.³⁹ Collective the credits earned, transferred or carried in, and transferred or carried out represent the net credits attributed to a manufacturer. Lastly, when evaluating compliance with the CAFE program, the model also calculates civil penalties (or fines) incurred by a manufacturer for non-compliance based on the fine rate defined in the regulatory scenario and the net credits accumulated by the manufacturer.

The calculation of all aforementioned compliance metrics (standard, rating, credits, and fines) for both compliance programs are described in detail in the following two sections.

³⁸ Calculation of sales forecast and PC/LT share is only performed if the “Dynamic Fleet Share and Sales Response” option is enabled through the CAFE Model's GUI (refer to Appendix C for more GUI options).

³⁹ Credit transfers and carry forward are discussed in greater detail in Section S5.5 below.

S5.1 CAFE Compliance Calculations

When evaluating compliance with the CAFE program, the modeling system calculates the values for the standard (or the required CAFE value), CAFE rating (or the achieved CAFE value), credits earned (or for noncompliance, shortfall), and civil penalties (or fines) for each manufacturer. To determine the impact of technology application on a manufacturer’s fleet, the model repeatedly performs all of the calculations before, during, and after each successive technology application. Since manufacturers are required to attain compliance independently in each class of vehicles, the standard, CAFE rating, credits, and fines are computed separately for each regulatory class.

Before the modeling system may begin compliance calculations for a manufacturer, an updated fuel economy target and fuel economy value (or rating) must be obtained for each vehicle model defined within the manufacturer’s product line. The fuel economy target is calculated based on the user-supplied functional form, as described in Section 3 above, and is applicable irrespective of the fuel source the vehicle uses. The fuel economy rating, however, may be composed of one or more values corresponding to the different fuel types the vehicle operates on (*i.e.*, flex-fuel or plug-in hybrid/electric vehicles). Prior to calculating the CAFE rating, the model computes a “combined” or average fuel economy value by harmonically averaging the individual components. Furthermore, as discussed in Section S2.1, the vehicle fuel economy value provided in the input fleet excludes all form of external credits and adjustments. When evaluating a manufacturer’s compliance, in order to account for the credits accrued from vehicles that makes use of alternative fuels, the system applies a petroleum equivalency factor for any fuel type wherever appropriate. The calculation of the vehicle’s “rated” and “compliance” fuel economy values is described in the next section.

In order to fully capture the incremental effect arising from technology application, the modeling system maintains the full precision of the vehicle’s fuel economy target and rating values (*i.e.*, both are kept unrounded). When the standard is calculated (as specified by Equations (27) and (28) below), the resulting value is rounded to one decimal place (for light duty vehicles) or two decimal places (for medium duty vehicles). However, for the achieved CAFE value (as shown in Equations (31) and (32) further below), the vehicle fuel economy rating is rounded prior to use (to either one or two decimal places), while the CAFE rating remains unrounded until it is used for calculating the amount of CAFE credits earned by a manufacturer.

In each case, the rounding of any “mpg” value for compliance purposes is applied according to the following two equations. For light duty regulatory classes (DC, IC, LT), the equation is:

$$mpg = \text{ROUND}(mpg, 1) \tag{22}$$

While for the medium duty regulatory class (LT2b3), rounding is applied as:

$$mpg = \frac{100}{\text{ROUND}(100/mpg, 2)} \tag{23}$$

For light duty regulatory classes, the fuel economy standards are set and regulated on a mile-per-gallon basis (mpg). Thus, with the exception of the vehicle target (which is specified as gpm), all fuel economy related calculations are computed in mpg as well. However, for the medium duty regulatory class, the standards are set on a gallon-per-100-mile basis. To display a comparable unit of measure for all fuel economy related values produced in the model’s outputs, the modeling system converts and stores the standard and CAFE values for 2b/3 vehicles as mpg. Therefore, as shown in Equation (23) the *mpg* value is first converted from miles/gallon to gallons/100-miles, rounded to two decimal places, and then converted back to miles/gallon. The resulting value adheres to the rounding precision required when setting the standards for the medium duty vehicles on a gallon-per-100-mile basis. However, in each case, the mpg value reported by the system will appear as unrounded.

S5.1.1 Calculation of Vehicle’s Fuel Economy

As discussed in Section S2.1, the vehicle fuel economy value defined in the manufacturer’s input fleet represents a “rated” value, which specified for any fuel type the vehicle operates on. All fuel economy improvements associated with technology application are initially applied to this rated value. Then, when determining the compliance state of a manufacturer, the rated value is converted to a “compliance” value by applying a petroleum equivalency factor to select fuel types. During analysis, the modeling system uses the rated and compliance fuel economy values to produce the associated CAFE ratings for a manufacturer – one without the use of credits and adjustments, and the other with all credits and adjustments taken into account. At the end of the analysis, the system outputs both sets of the fuel economy values in the modeling reports.

As mentioned above, the fuel economy rating may be comprised of one or more subcomponents. Before it can be used for calculating the CAFE rating, an average value must be obtained. For single-fuel vehicles (*i.e.*, vehicles operating exclusively on a single source of fuel), this equates to the fuel economy rating on the specific fuel, while for dual-fuel vehicles, the fuel economy value is computed by harmonically averaging the individual components from the different fuel types, subject to the “Multi-Fuel”, “FFV Share”, and “PHEV Share” settings specified in the scenario definition. For all vehicles, the average fuel economy calculation may be generalized by the following equation:

$$FE = \sum_{FT} \frac{FS_{FT}}{FE_{FT}} \quad (24)$$

Where:

- FT* : the fuel type the vehicle operates on,
- FS_{FT}* : the percent share of miles driven by a vehicle when operating on fuel type *FT*,
- FE_{FT}* : the fuel economy rating of the vehicle when operating on fuel type *FT*, and
- FE* : the average fuel economy rating of the vehicle, aggregated across all fuel types the vehicle operates on.

In Equation (24), when evaluating dual-fuel vehicles, the “Multi-Fuel” setting specified in the scenario definition may be configured to have the model ignore secondary fuel economy

components when calculating the average fuel economy value.⁴⁰ In such a case, the system assumes that the vehicle operates exclusively on gasoline fuel for compliance purposes only. Additionally for dual-fuel vehicles, the fuel share value, FS_{FT} , may represent either the vehicle’s “on-road” share of miles or a specific regulatory value applicable for compliance purposes, as defined by the “FFV Share” and “PHEV Share” settings. Refer to Section A.4 of Appendix A for definitions of each of these scenario settings.

The value obtained from Equation (24) represents the average rated fuel economy of a vehicle. To obtain the average fuel economy value to use for compliance, the above equation is modified as in the following:

$$FE' = \sum_{FT} \frac{FS_{FT}}{(FE_{FT} \times PEF_{FT})} \quad (25)$$

Where:

- FT : the fuel type the vehicle operates on,
- FS_{FT} : the percent share of miles driven by a vehicle when operating on fuel type FT ,
- FE_{FT} : the fuel economy rating of the vehicle when operating on fuel type FT ,
- PEF_{FT} : the petroleum equivalency factor of fuel type FT , and
- FE' : the average fuel economy rating of the vehicle, adjusted by the petroleum equivalency factor and aggregated across all fuel types the vehicle operates on.

In Equation (25), the petroleum equivalency factor, PEF_{FT} , varies depending on the associated fuel type. For gasoline and diesel fuels, this value is not applicable, and is thus interpreted as “1” in the equation above. For E85, hydrogen, and CNG fuel types, the PEF_{FT} is defined as: $1 / 0.15$. For electricity fuel type, PEF_{FT} varies depending on whether the vehicle is a BEV or a PHEV and is calculated as a “reference scalar” multiplied by the ratio of energy densities of electricity to gasoline, as shown in the equation below:

$$PEF_E = Scalar \times \frac{ED_E}{ED_G} \quad (26)$$

Where:

- Scalar*: the reference scalar for computing the petroleum equivalency factor of electricity, specified in kWh/gallon, where this value is 82.049 for BEVs (*i.e.*, if a vehicle operates exclusively on electricity at the time of calculation) and 73.844 for PHEVs (*i.e.*, the vehicle operates on a combination of gasoline and electricity at the time of calculation),
- ED_E : the energy density of electricity, specified in BTU/kWh, as defined in the parameters input file,

⁴⁰ Within the context of the modeling system, for FFVs and PHEVs, gasoline is always assumed to be the primary fuel source for the vehicle, regardless of the actual on-road use.

- ED_G : the energy density of gasoline, specified in BTU/gallon, as defined in the parameters input file, and
 PEF_E : the petroleum equivalency factor of electricity.

S5.1.2 Calculation of the CAFE Standard

The modeling system calculates the value of the CAFE standard using a sales-weighted harmonic average of the fuel economy targets applicable to each vehicle model of a specific regulatory class. This defines the manufacturer’s required fuel economy standard for regulatory class RC and is represented by the following equation:

$$STD_{RC} = \frac{\sum_{i \in V_{RC}} Sales_i}{\sum_{i \in V_{RC}} (Sales_i \times T_{FE,i})} \quad (27)$$

Where:

- V_{RC} : a vector containing all vehicle models in regulatory class RC ,
 $Sales_i$: the sales volume for a vehicle model i ,
 $T_{FE,i}$: the fuel economy target (in gpm) applicable to a vehicle model i ,⁴¹ and
 STD_{RC} : the calculated fuel economy standard attributable to a manufacturer in regulatory class RC .

Equation (27) universally applies to an attribute-based standard (*i.e.*, a functional form where a different fuel economy target is computed for each vehicle based on, for example, its footprint) as well as a flat standard (*i.e.*, a functional form where each vehicle model has the same fuel economy target). However, for a flat standard, since with a common target the sales volumes of individual vehicle models cancel out, Equation (27) is reduced to the following:

$$STD_{RC} = T_{FE} \quad (28)$$

As stated in Section 3 above, vehicles regulated as domestic passenger automobiles are subject to a minimum domestic car standard, as specified in the scenario definition. Thus, for the Domestic Car class, the calculation of the standard is further refined as:

$$STD'_{DC} = \text{MAX}(Min_{Mpg}, Min_{\%} \times STD_{PCAvg}, STD_{DC}) \quad (29)$$

Where:

- Min_{Mpg} : the minimum CAFE standard that each manufacturer must attain, specified as a flat-standard in miles per gallon,
 $Min_{\%}$: the minimum CAFE standard that each manufacturer must attain, specified as a percentage of the combined Passenger Car standard, STD_{PCAvg} ,
 STD_{PCAvg} : the average Passenger Car standard (for the DC and IC classes) calculated across all manufacturers defined in the input fleet,

⁴¹ Refer to Section 3 above for description and calculation of the vehicle’s fuel economy target.

- STD_{DC} : the fuel economy standard attributable to a manufacturer in the Domestic Car regulatory class, before adjusting for the minimum domestic car standard, and
- STD'_{DC} : the calculated fuel economy standard attributable to a manufacturer in the Domestic Car regulatory class, after adjusting for the minimum domestic car standard.

Since the minimum domestic car standard is applicable to vehicles regulated as domestic passenger automobiles, the Min_{Mpg} and $Min\%$ variables are specified in the scenario definition for the Passenger Car class only. The STD_{PCAvg} value from Equation (29) is calculated by harmonically averaging the standards for the Domestic Car and Imported Car regulatory classes across all manufacturers defined in the input fleet, as shown in the following equation:

$$STD_{PCAvg} = \frac{\sum_{i \in M} (Sales_{i,DC} + Sales_{i,IC})}{\sum_{i \in M} \left(\frac{Sales_{i,DC}}{STD_{i,DC}} + \frac{Sales_{i,IC}}{STD_{i,IC}} \right)} \quad (30)$$

Where:

- M : a vector containing all manufacturers defined within the input fleet,
- $Sales_{i,DC}$: the sales volume for all vehicle models regulated as domestic passenger automobiles for a manufacturer i ,
- $Sales_{i,IC}$: the sales volume for all vehicle models regulated as imported passenger automobiles for a manufacturer i ,
- $STD_{i,DC}$: the fuel economy standard attributable to a manufacturer i in the Domestic Car regulatory class, before adjusting for the alternative minimum standard,
- $STD_{i,IC}$: the fuel economy standard attributable to a manufacturer i in the Imported Car regulatory class,
- STD_{PCAvg} : the average Passenger Car standard (for the DC and IC classes) calculated across all manufacturers defined in the input fleet.

As described above, the values calculated by Equations (27), (28), and (29) are rounded to produce the final standard for a manufacturer.

S5.1.3 Calculation of the CAFE Rating

Similar to the calculation of the standard, the CAFE rating is computed by taking a sales-weighted harmonic average of the individual fuel economies attained by each vehicle model for a specific regulatory class. The system first calculates the achieved CAFE value without any adjustments or credits that are supplied for each manufacturer in the input fleet or the off-cycle credits accrued through technology application. Within the context of the modeling system, and as reported in the model outputs, this value is referred to as the “2-cycle” CAFE rating, and is calculated for each regulatory class RC as:

$$CAFE_{RC} = \frac{\sum_{i \in V_{RC}} Sales_i}{\sum_{i \in V_{RC}} \frac{Sales_i}{FE_i}} \quad (31)$$

Where:

- V_{RC} : a vector containing all vehicle models in regulatory class RC ,
- $Sales_i$: the sales volume for a vehicle model i ,
- FE_i : the “rated” average fuel economy (in mpg) attained by a vehicle model i , as calculated by Equation (24), and
- $CAFE_{RC}$: the calculated corporate average fuel economy (CAFE) achieved by a manufacturer in regulatory class RC , before application of FFV credits, off-cycle credits, or adjustments for improvements in air conditioning efficiency.

In addition to the 2-cycle CAFE rating, the modeling system also calculates the CAFE rating to use for compliance by applying any credit or adjustment available to the manufacturer. For each regulatory class, this calculation is defined by the following equation:

$$CAFE'_{RC} = \frac{CO2Factor_{RC}}{\frac{\sum_{i \in V_{RC}} Sales_i}{\sum_{i \in V_{RC}} \frac{Sales_i}{FE'_i}} + FFVCredits_{RC}} - \text{MIN} \left(\frac{ACEffAdj_{RC}}{ACEffCap_{RC}} \right) - \text{MIN} \left(\frac{OCCredits_{RC}}{OCCap_{RC}} \right) \quad (32)$$

Where:

- $CO2Factor_{RC}$: the CO₂ factor to use for converting between fuel economy values and CO₂ values,
- V_{RC} : a vector containing all vehicle models in regulatory class RC ,
- $Sales_i$: the sales volume for a vehicle model i ,
- FE'_i : the “compliance” average fuel economy (in mpg) attained by a vehicle model i , as calculated by Equation (25), and
- $FFVCredits_{RC}$: the credits associated with production of flex-fuel vehicles in regulatory class RC ,
- $ACEffAdj_{RC}$: the amount of adjustments associated with improvements in air conditioning efficiency, specified in grams per mile of CO₂, a manufacturer has accumulated toward compliance with the CAFE standard in regulatory class RC ,
- $ACEffCap_{RC}$: the maximum amount of AC efficiency adjustments, specified in grams per mile of CO₂, a manufacturer may claim toward compliance with the CAFE standard in regulatory class RC ,
- $OCCredits_{RC}$: the amount of off-cycle credits, specified in grams per mile of CO₂, a manufacturer has accumulated toward compliance with the CAFE standard in regulatory class RC ,
- $OCCap_{RC}$: the maximum amount of off-cycle credits, specified in grams per mile of CO₂, a manufacturer may claim toward compliance with the CAFE standard in regulatory class RC ,

DRAFT – July 2018

$CAFE'_{RC}$: the CAFE rating achieved by a manufacturer in regulatory class RC , after application of FFV credits, off-cycle credits, or adjustments for improvements in air conditioning efficiency.

The $CO2Factor_{RC}$, $ACEffCap_{RC}$, and $OCCap_{RC}$ variables are specified in the scenario definition for each regulatory class. The $FFVCredits_{RC}$, $ACEffAdj_{RC}$, and $OCCredits_{RC}$ variables are specified in the input fleet for each manufacturer, in each regulatory class. In addition to the off-cycle credits provided in the input fleet, a manufacturer may also accrue $OCCredits_{RC}$ during analysis, whenever a technology that specifies off-cycle credits in the technology input assumptions is applied to a vehicle.

Although not explicitly shown, in Equations (31) and (32), the FE_i and FE'_i values are rounded as described in Equations (22) and (23) above, before they are used to calculate the associated CAFE ratings.

S5.1.4 Calculation of the CAFE Credits and Fines

Once the standard and CAFE values have been computed, the model may proceed to determine the degree of noncompliance for a manufacturer by first calculating the CAFE credits, then using these credits to obtain the amount of CAFE civil penalties owed by a manufacturer. Within each regulatory class RC , the amount of CAFE credit created (noncompliance causes credit creation to be negative, which implies the use of CAFE credits or the payment of civil penalties) is calculated by taking the difference between the standard and the CAFE value attributable to a specific regulatory class, then multiplying the result by the number of vehicles in that class. The calculation of credits earned differs depending on the regulatory class being evaluated by the model. For light duty regulatory classes, the calculation of CAFE credits is expressed as follows:

$$Credits_{RC} = (\text{ROUND}(CAFE'_{RC}, 1) - STD_{RC}) \times Sales_{RC} \times 10 \quad (33)$$

Where:

$Sales_{RC}$: the sales volume of all vehicle models attributable to a manufacturer in regulatory class RC ,
 STD_{RC} : the standard attributable to a manufacturer in regulatory class RC ,
 $CAFE'_{RC}$: the CAFE rating achieved by a manufacturer in regulatory class RC , and
 $Credits_{RC}$: the calculated amount of credits earned by a manufacturer in regulatory class RC , where 1 credit is equal to one-tenth of a vehicle mpg.

For the medium duty regulatory class, credits are computed as:

$$Credits_{RC} = \left(\frac{100}{STD_{RC}} - \text{ROUND} \left(\frac{100}{CAFE'_{RC}}, 2 \right) \right) \times Sales_{RC} \times 100 \quad (34)$$

Where:

- $Sales_{RC}$: the sales volume of all vehicle models attributable to a manufacturer in regulatory class RC ,
- STD_{RC} : the standard attributable to a manufacturer in regulatory class RC ,
- $CAFE'_{RC}$: the CAFE rating achieved by a manufacturer in regulatory class RC , and
- $Credits_{RC}$: the calculated amount of credits earned by a manufacturer in regulatory class RC , where 1 credit is equal to one-tenth-thousand of a vehicle gpm.

The credits produced by Equations (33) and (34) may be positive or negative, where positive values represent overcompliance with a given standard, while negative values indicate a shortfall, or noncompliance. If a manufacturer is at a shortfall in specific regulatory class, the modeling system may transfer available credits from a different regulatory class within the same model year, or carry credits forward from an earlier model year within the same regulatory class. As mentioned earlier, the modeling system keeps track of credits transferred or carried into or out of a specific regulatory class. A combination of credits earned, transferred or carried in, and transferred or carried out form the net credits attributed to a manufacturer, which are used to calculate CAFE civil penalties and assess the degree of noncompliance (or if the net credits are positive, signify that the manufacturer has attained compliance). The calculation for CAFE civil penalties, or fines, in each regulatory class is given by the following:

$$Fines_{RC} = \text{MIN}(Credits_{RC} + CreditsIn_{RC} - CreditsOut_{RC}, 0) \times FineRate_{RC} \quad (35)$$

Where:

- $Credits_{RC}$: the amount of credits earned by a manufacturer in regulatory class RC ,
- $CreditsIn_{RC}$: the amount of credits transferred or carried into regulatory class RC ,
- $CreditsOut_{RC}$: the amount of credits transferred or carried out of regulatory class RC ,
- $FineRate_{RC}$: the fine rate, specified in dollars, to apply per one credit of shortfall, and
- $Fines_{RC}$: the calculated amount of CAFE civil penalties owed by a manufacturer in regulatory class RC .

In the equation above, the $FineRate_{RC}$ is specified in the scenario definition, separately for each regulatory class and model year.

S5.2 CO₂ Compliance Calculations

When the CAFE Model is configured to evaluate compliance with the CO₂ program, it calculates the values for the CO₂ standard and rating, as well as the CO₂ credits earned for each manufacturer. As with the CAFE compliance calculations, the model repeatedly performs all of the CO₂ computations before, during, and after each successive technology application, independently for each regulatory class. Since the CO₂ compliance program does not differentiate between domestic and imported passenger automobiles, all compliance calculations are performed on the: Passenger Car (combined DC and IC), Light Truck, and Light Truck 2b/3 regulatory classes.

During analysis, the modeling system evaluates and applies all technology improvements on a vehicle’s fuel economy rating. The system maintains (keeps track of and updates) the fuel economies for each vehicle model, converting them the equivalent CO₂ ratings, only as required for compliance calculations. Likewise, the model first calculates the vehicle’s fuel economy target before converting it to an equivalent CO₂ target, as defined by Equation (4), described in Section 3 above. Thus, before the system may carry out the CO₂ compliance calculations, it obtains the updated CO₂ target and CO₂ value (or rating) for each vehicle model in the manufacturer’s fleet. Similar to the vehicle’s fuel economy and manufacturer’s CAFE rating, the model calculates and reports CO₂ values unrounded, only rounding to a whole gram-per-mile when either value is used for compliance.

S5.2.1 Calculation of Vehicle’s CO₂ Rating

The modeling system uses a vehicle’s fuel economy value to calculate a corresponding CO₂ rating for each fuel type the vehicle operates on. Since battery-electric and fuel-cell vehicles (BEVs and FCVs) do not release CO₂ emissions during operation, the CO₂ rating for these vehicles is assumed to be zero through model year 2025. Similarly, for plug-in hybrid/electric vehicles (PHEVs), the CO₂ rating when operating on electricity is assumed to be zero as well, while the CO₂ rating on gasoline is computed from the associated fuel economy value. Beginning in model year 2026, the CO₂ rating of a vehicle when operating on electricity or hydrogen is computed by taking into account the differences between the upstream emissions associated with electric operation and gasoline operation of a comparable vehicle. Thus, for model years 2026 and later, the vehicle’s CO₂ rating when operating on electricity or hydrogen fuel types is calculated as follows:

$$CO2Rating_{FT} = \left(\frac{1}{FE_{FT}} \times \frac{ED_G \times 1000 \times 0.534}{ED_E \times 0.935} \right) - \left(T_{CO2} \times \frac{2478}{CO2Factor_{RC}} \right) \quad (36)$$

Where:

- FT* : the fuel type the vehicle operates on (either electricity or hydrogen),
- FE_{FT}* : the fuel economy rating of the vehicle, specified in miles per gallon, when operating on fuel type *FT*,
- ED_G* : the energy density of gasoline, specified in BTU/gallon, as defined in the parameters input file,
- ED_E* : the energy density of electricity, specified in BTU/kWh, as defined in the parameters input file,
- 1000* : the conversion factor from kilowatt-hours (kWh) to watt-hours,
- 0.534* : the assumed average upstream emissions rate of electricity (in grams/watt-hour), used for regulatory purposes,
- 0.935* : the assumed electricity transmission losses between generation source and the wall,
- T_{CO2}* : the calculated vehicle CO₂ target, in grams per mile,
- 2478* : the assumed upstream CO₂ emissions of a gallon of gasoline, used for regulatory purposes,
- CO2Factor_{RC}* : the CO₂ factor to use for converting between fuel economy values and CO₂ values, and

DRAFT – July 2018

$CO2Rating_{FT}$: the CO₂ rating of the vehicle, specified in grams per mile, when operating on fuel type FT .

For all other fuel types, the vehicle's CO₂ rating is defined by the following equation:

$$CO2Rating_{FT} = \frac{CO2Content_{FT}}{FE_{FT}} \quad (37)$$

Where:

FT : the fuel type the vehicle operates on,
 $CO2Content_{FT}$: the mass (in grams) of CO₂ released by using a gallon of fuel type FT ,
 FE_{FT} : the fuel economy rating of the vehicle, specified in miles per gallon, when operating on fuel type FT , and
 $CO2Rating_{FT}$: the CO₂ rating of the vehicle, specified in grams per mile, when operating on fuel type FT .

For vehicles operating on compressed natural gas (CNG), since the model assumes the fuel economy rating is specified as gasoline-gallon equivalent (or GGE), the $CO2Content_{FT}$ in the equation above refers to the mass of CO₂ released by using a gallon of gasoline. For each applicable fuel type, the modeling system calculates the $CO2Content_{FT}$ using the inputs specified in the parameters file as:

$$CO2Content_{FT} = MD_{FT} \times CC_{FT} \times \left(\frac{44}{12}\right) \quad (38)$$

Where:

FT : the fuel type the vehicle operates on,
 MD_{FT} : the mass density of a fuel type FT , specified in grams per gallon in the parameters input file,
 CC_{FT} : the percentage of each fuel type's mass that represents carbon, specified in the parameters input file,
 $\left(\frac{44}{12}\right)$: the ratio of the molecular weight of carbon dioxide to that of elemental carbon, and
 $CO2Content_{FT}$: the mass (in grams) of CO₂ released by using a gallon of fuel type FT .

Similar to a vehicle's fuel economy value, the CO₂ rating (as calculated in Equations (36) and (37)) may be comprised of one or more subcomponents corresponding to each fuel type the vehicle uses (*i.e.*, flex-fuel or plug-in hybrid/electric vehicles). Before it can be used for calculating a manufacturer's CO₂ rating, a combined or average CO₂ value for each vehicle must be obtained. For single-fuel vehicles, this equates to the CO₂ rating on the specific fuel, while for dual-fuel vehicles, the combined CO₂ value is computed by averaging the individual components from the different fuel types. For all vehicles, the average CO₂ calculation may be generalized by the following equation:

$$CO2Rating = \sum_{FT} (FS_{FT} \times CO2Rating_{FT}) \quad (39)$$

Where:

- FT : the fuel type the vehicle operates on,
- FS_{FT} : the percent share of miles driven by a vehicle when operating on fuel type FT ,
- $CO2Rating_{FT}$: the CO₂ rating of the vehicle when operating on fuel type FT , and
- $CO2Rating$: the average CO₂ rating of the vehicle, aggregated across all fuel types the vehicle operates on.

Similar to the calculation of the average fuel economy rating (defined in Equation (24) above), the average CO₂ rating for dual-fuel vehicles depends on the “Multi-Fuel”, “FFV Share”, and “PHEV Share” settings specified in the scenario definition. Using these settings, the model may be optionally configured to assume that dual-fuel vehicles (FFVs and PHEVs) operate exclusively on gasoline fuel for compliance purposes, and to also tune the assumed fuel share, FS_{FT} , to use when calculating the average CO₂ rating.

While the CAFE compliance program makes provisions for including the petroleum equivalency factor (PEF) when computing the fuel economy rating to use for compliance purposes (see Section S5.1.1 above), the CO₂ program does not include such adjustments. Therefore, the CO₂ rating produced by Equation (39) may be used for calculating a manufacturer’s sales-weighted average CO₂ rating.

S5.2.2 Calculation of the CO₂ Standard

The CAFE Model calculates the value of the CO₂ standard using a sales-weighted average of the CO₂ targets applicable to each vehicle model of a specific regulatory class. This defines the manufacturer’s required CO₂ standard for regulatory class RC and is represented by the following equation:

$$CO2STD_{RC} = \frac{\sum_{i \in V_{RC}} (Sales_i \times EPAMultiplier_{RC} \times T_{CO2,i})}{\sum_{i \in V_{RC}} (Sales_i \times EPAMultiplier_{RC})} \quad (40)$$

Where:

- V_{RC} : a vector containing all vehicle models in regulatory class RC ,
- $Sales_i$: the sales volume for a vehicle model i ,
- $EPAMultiplier_{RC}$: a production multiplier used to scale the sales volumes of CNGs, PHEVs, BEVs, and FCVs when computing a manufacturer’s CO₂ standard toward compliance with CO₂ standards for regulatory class RC ,

- $T_{CO_2,i}$: the CO₂ target (in grams per mile) applicable to a vehicle model i ,⁴²
and
 $CO2STD_{RC}$: the calculated CO₂ standard attributable to a manufacturer in regulatory class RC .

Equation (40) universally applies to an attribute-based standard (*i.e.*, a functional form where a different CO₂ target is computed for each vehicle based on, for example, its footprint) as well as a flat standard (*i.e.*, a functional form where each vehicle model has the same CO₂ target). However, for a flat standard, since with a common target the sales volumes of individual vehicle models cancel out, Equation (40) is reduced to the following:

$$CO2STD_{RC} = T_{CO_2} \quad (41)$$

Since under the CO₂ compliance program, all passenger automobiles are regulated under a single class, the calculation of the CO₂ standard is not subject to a minimum domestic car standard. Lastly, the values calculated by Equations (40) and (41) are rounded a whole number to produce the final CO₂ standard for a manufacturer.

S5.2.3 Calculation of the CO₂ Rating

Similar to the calculation of the standard, the CAFE Model calculates the manufacturer's CO₂ rating by taking a sales-weighted average of the individual CO₂ ratings attained by each vehicle model for a specific regulatory class. During calculation, the modeling system additionally applies any credit or adjustment available to the manufacturer. The calculation for a manufacturer's CO₂ rating for each regulatory class is, hence, defined by the following equation:

$$CO2Rating_{RC} = \frac{\sum_{i \in V_{RC}} (Sales_i \times EPAMultiplier_{RC} \times CO2Rating_i)}{\sum_{i \in V_{RC}} (Sales_i \times EPAMultiplier_{RC})} - \text{MIN} \left(\begin{matrix} ACEffAdj_{RC}, \\ ACEffCap_{RC} \end{matrix} \right) - \text{MIN} \left(\begin{matrix} ACLeakageAdj_{RC}, \\ ACLeakageCap_{RC} \end{matrix} \right) - \text{MIN} \left(\begin{matrix} OCCredits_{RC}, \\ OCCap_{RC} \end{matrix} \right) \quad (42)$$

Where:

- V_{RC} : a vector containing all vehicle models in regulatory class RC ,
 $Sales_i$: the sales volume for a vehicle model i ,
 $EPAMultiplier_{RC}$: a production multiplier used to scale the sales volumes of CNGs, PHEVs, BEVs, and FCVs when computing a manufacturer's CO₂ rating toward compliance with CO₂ standards for regulatory class RC ,
 $CO2Rating_i$: the average CO₂ rating (in grams per mile) attained by a vehicle model i , as calculated by Equation (39), and
 $ACEffAdj_{RC}$: the amount of adjustments associated with improvements in air conditioning efficiency, specified in grams per mile of CO₂, a

⁴² Refer to Section 3 above for description and calculation of the vehicle's CO₂ target.

- manufacturer has accumulated toward compliance with the CO₂ standard in regulatory class *RC*,
- ACEffCap_{RC}* : the maximum amount of AC efficiency adjustments, specified in grams per mile of CO₂, a manufacturer may claim toward compliance with the CO₂ standard in regulatory class *RC*,
- ACLeakageAdj_{RC}* : the amount of adjustments associated with improvements in air conditioning leakage, specified in grams per mile of CO₂, a manufacturer has accumulated toward compliance with the CO₂ standard in regulatory class *RC*,
- ACLeakageCap_{RC}* : the maximum amount of AC leakage adjustments, specified in grams per mile of CO₂, a manufacturer may claim toward compliance with the CO₂ standard in regulatory class *RC*,
- OCCredits_{RC}* : the amount of off-cycle credits, specified in grams per mile of CO₂, a manufacturer has accumulated toward compliance with the CO₂ standard in regulatory class *RC*,
- OCCap_{RC}* : the maximum amount of off-cycle credits, specified in grams per mile of CO₂, a manufacturer may claim toward compliance with the CO₂ standard in regulatory class *RC*,
- CO2Rating_{RC}* : the CO₂ rating achieved by a manufacturer in regulatory class *RC*, taking into consideration the application of EPA multipliers, off-cycle credits, and adjustments for improvements in air conditioning efficiency and leakage.

The *EPAMultiplier_{RC}*, *ACEffCap_{RC}*, *ACLeakageCap_{RC}*, and *OCCap_{RC}* variables are specified in the scenario definition for each regulatory class. As described in Section 3, *EPAMultiplier_{RC}* corresponds to the “EPA Multiplier 1” or “EPA Multiplier 2” variable, where the former applies to the production multipliers of CNGs and PHEVs, while the latter includes BEVs and FCVs. The *ACEffAdj_{RC}*, *ACLeakageAdj_{RC}*, and *OCCredits_{RC}* variables are specified in the input fleet for each manufacturer, in each regulatory class. In addition to the off-cycle credits provided in the input fleet, a manufacturer may also accrue *OCCredits_{RC}* during analysis, whenever a technology that specifies off-cycle credits in the technology input assumptions is applied to a vehicle.

Although not explicitly shown, in Equation (42), the *CO2Rating_i* value is rounded to a whole number before it is used to calculate the manufacturer’s *CO2Rating_{RC}*.

S5.2.4 Calculation of the CO₂ Credits and Credit Value

Using the CO₂ standard and rating values computed in the preceding sections, the CAFE Model calculates the amount of CO₂ credits earned by a manufacturer. The CO₂ credits may then be used to determine the degree of noncompliance for a manufacturer. Within each regulatory class *RC*, the amount of CO₂ credit created (noncompliance causes credit creation to be negative) is calculated by taking the difference between the standard and the CO₂ rating attributable to a specific regulatory class, then multiplying the result by the number of vehicles and the assumed lifetime VMT in that class. For each regulatory class *RC*, the calculation of CO₂ credits is expressed as follows:

$$CO2Credits_{RC} = \frac{(CO2STD_{RC} - ROUND(CO2Rating_{RC})) \times Sales_{RC} \times VMT_{RC}}{1,000,000} \quad (43)$$

Where:

- $Sales_{RC}$: the sales volume of all vehicle models attributable to a manufacturer in regulatory class RC ,
- VMT_{RC} : the assumed average lifetime vehicle miles traveled by typical vehicle models in regulatory class RC ,
- $1,000,000$: the conversion factor from grams to metric tons,
- $CO2STD_{RC}$: the CO₂ standard attributable to a manufacturer in regulatory class RC ,
- $CO2Rating_{RC}$: the CO₂ rating achieved by a manufacturer in regulatory class RC , and
- $CO2Credits_{RC}$: the calculated amount of CO₂ credits earned by a manufacturer in regulatory class RC , where 1 credit is equal to one metric ton.

The credits produced by Equation (43) may be positive or negative, where positive values represent overcompliance with a given standard, while negative values indicate a shortfall, or noncompliance. If a manufacturer is at a shortfall in specific regulatory class, the modeling system may transfer available credits from a different regulatory class within the same model year, or carry credits forward from an earlier model year within the same regulatory class. As mentioned earlier, the modeling system keeps track of credits transferred or carried into or out of a specific regulatory class. A combination of credits earned, transferred or carried in, and transferred or carried out form the net credits attributed to a manufacturer, which are used to assess the degree of noncompliance (or if the net credits are positive, signify that the manufacturer has attained compliance). Even though the CO₂ compliance program does not allow the use of civil penalties to offset shortfalls, but instead mandates that all manufacturers must attain compliance, the modeling system may still produce results where some manufacturers are shown as noncompliant. This situation is more likely to arise under particularly stringent regulatory scenarios, if a manufacturer runs out of available technologies for application prior to reaching compliance.

In addition to the CO₂ credits earned, the modeling system also calculates the value of the net credits accumulated by a manufacturer as shown in the following equation:

$$ValueCO2Credits_{RC} = (CO2Credits_{RC} + CO2CreditsIn_{RC} - CO2CreditsOut_{RC}) \times CO2CreditValue_{RC} \quad (44)$$

Where:

- $CO2Credits_{RC}$: the amount of CO₂ credits earned by a manufacturer in regulatory class RC ,
- $CO2CreditsIn_{RC}$: the amount of CO₂ credits transferred or carried into regulatory class RC ,
- $CO2CreditsOut_{RC}$: the amount of CO₂ credits transferred or carried out of regulatory class RC ,
- $CO2CreditValue_{RC}$: the valuation of CO₂ credits, specified in dollars, to apply per one credit of shortfall, and

ValueCO2Credits_{RC} : the calculated value of CO₂ credits attributable to a manufacturer in regulatory class *RC*.

In the equation above, the *CO2CreditValue_{RC}* is specified in the scenario definition, separately for each regulatory class and model year. The *ValueCO2Credits_{RC}*, as calculated for a manufacturer in each regulatory class, is later used when calculating the effective cost of a technology application whenever the CAFE Model is configured to evaluate compliance with the CO₂ program.

S5.3 Compliance Simulation Algorithm

As the modeling system evaluates a manufacturer for compliance, the compliance simulation algorithm begins the process of applying technologies based on the CAFE or CO₂ standards applicable during the current model year. This involves repeatedly evaluating the degree of noncompliance, identifying the “best next” technology (described in the following section) available on each of the parallel technology paths, and selecting the best among these for application. Figure 9 provides an overview of this process.

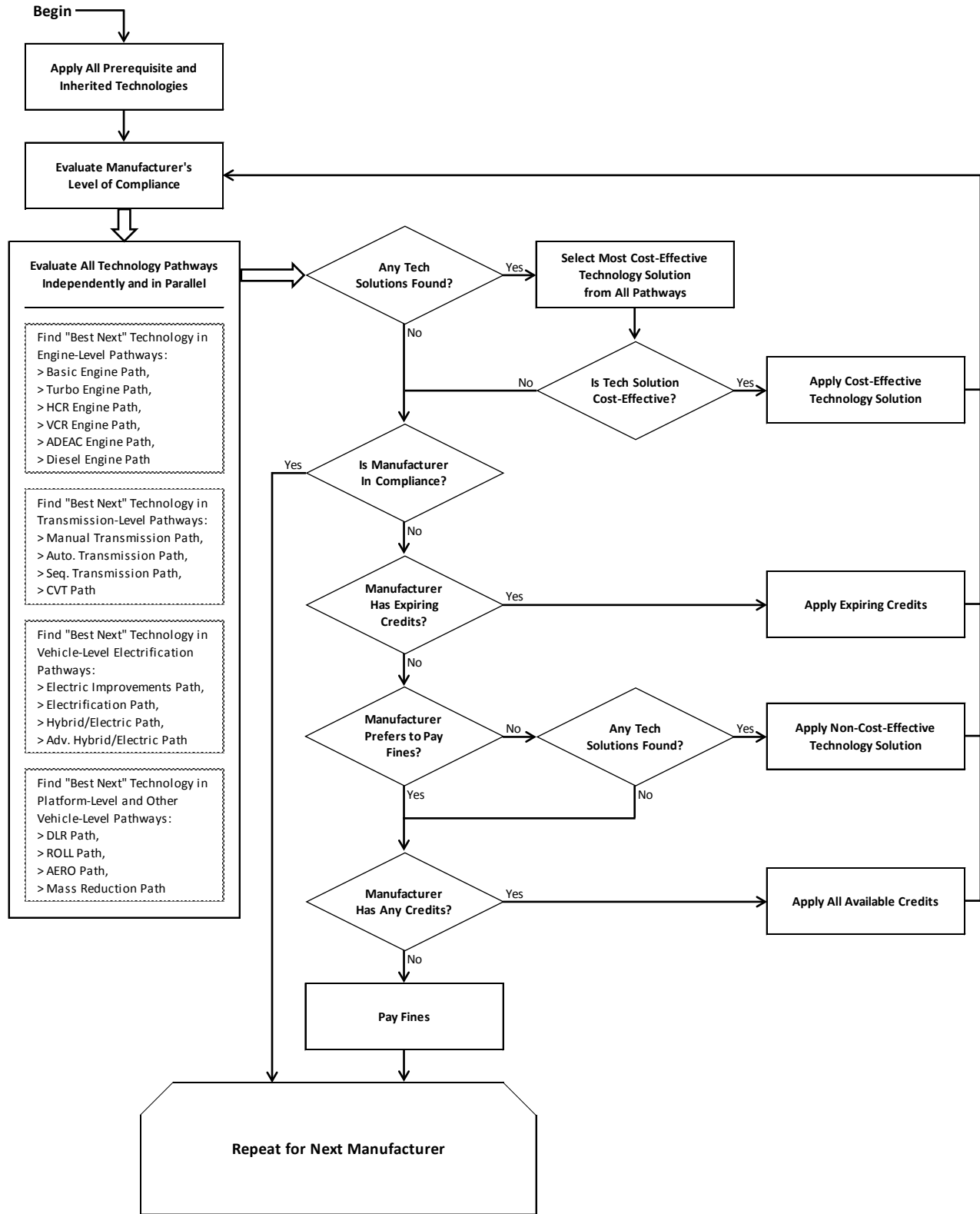

Figure 9. Compliance Simulation Algorithm

The algorithm first finds the best next applicable technology solution in each of the technology pathways. If a technology solution is found, the model selects the best option from among these. For any technology solution determined to be cost-effective (as defined below), the modeling system applies the selected technologies to the affected vehicles, regardless of whether the manufacturer is in compliance. Afterwards, the algorithm reevaluates the manufacturer's degree of noncompliance and applies available credits (CAFE or CO₂, depending on the compliance program being evaluated), which were generated during preceding model years and which are do to expire during the analysis year⁴³. After applying expiring credits, if a manufacturer has not attained compliance, the algorithm proceeds to evaluate and apply non-cost-effective (*aka*, ineffective) technologies on an as-needed basis. If a manufacturer is assumed to be unwilling to pay fines, the algorithm finds and applies additional technology solutions until compliance is achieved, reevaluating the manufacturer's degree of noncompliance after every successive technology application. Conversely, if a manufacturer is assumed to prefer to pay fines, the algorithm stops applying additional technology to this manufacturer's product line once no more cost-effective solutions are encountered. In either case, once all viable technology solutions have been exhausted, if a manufacturer still has not reached compliance, the algorithm uses the remainder of available credits, before generating fines for noncompliance.

In the case of the CAFE compliance program, “fines” refer to the CAFE civil penalties. However, since the CO₂ compliance program does not allow fine payment, the algorithm assumes that every manufacturer is unwilling to pay fines and continues to apply technology until compliance is achieved or the manufacturer exhausts all technologies during the analysis year.

At the root of the compliance simulation algorithm is the way the modeling system determines the best next technology solution and the way it calculates the effective cost of that solution. These topics are addressed in the following two sections.

S5.3.1 Determination of “Best Next” Technology Solution

When selecting the “best next” technology solution within a given path, the algorithm considers technologies in the order defined by the technology pathways (as discussed above). If the phase-in limit for a specific technology has been reached, the algorithm proceeds to the next technology within the same path. If the phase-in limit has not been reached, the algorithm determines whether or not the technology remains applicable to any sets of vehicles, evaluates the effective cost of applying the technology to each such set, and identifies the application that would yield the lowest effective cost.

As shown in Figure 10 below, the algorithm repeats this process for each technology path, and then selects the technology application yielding the lowest effective cost. As discussed above, the algorithm operates subject to expectations of each manufacturer's preference to pay fines within the model year being evaluated. However, the effective cost is calculated, as described in the following section, irrespective of the fine payment settings.

⁴³ Within the context of the CAFE Model, analysis year refers to the model year currently being evaluated by the modeling system.

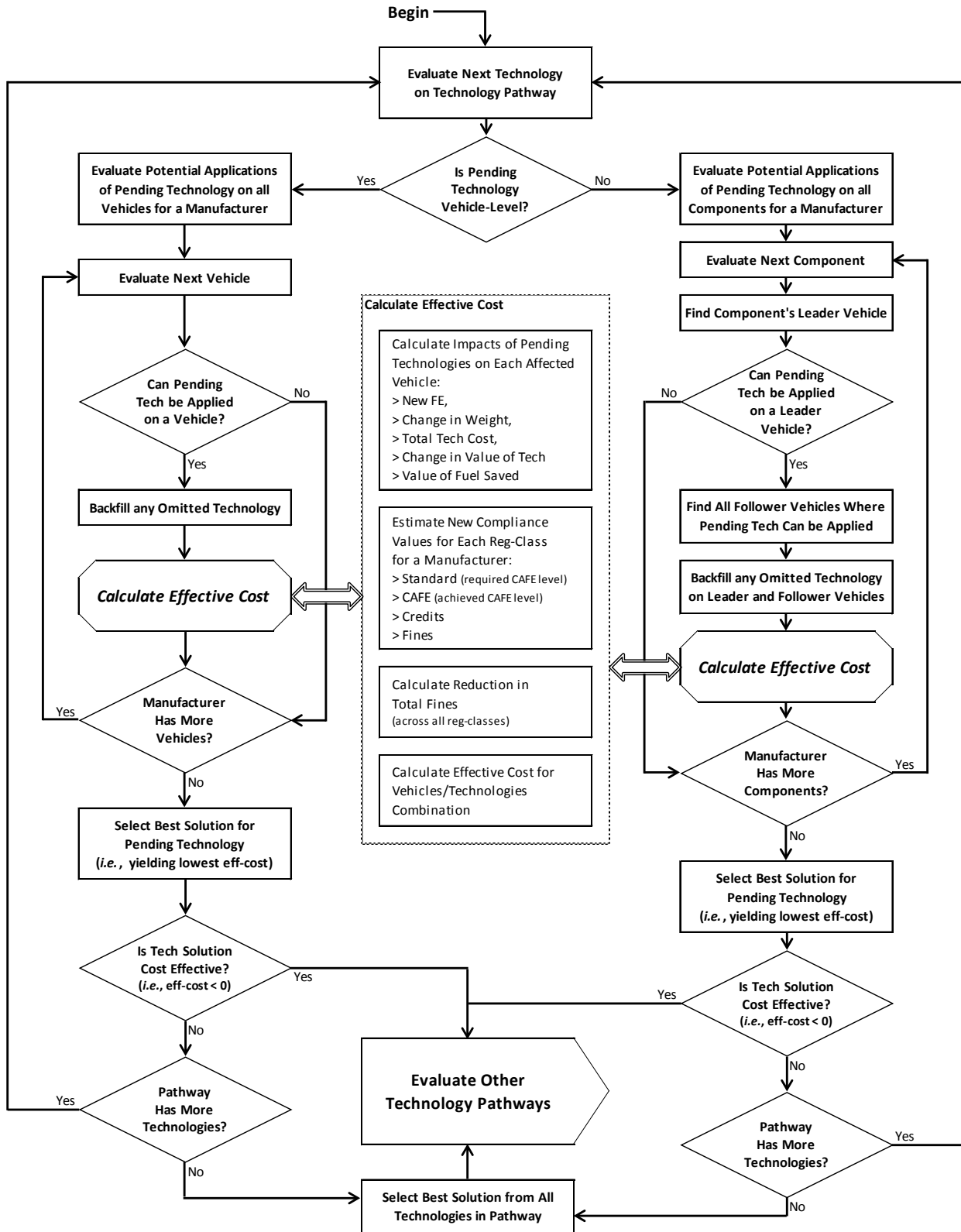

Figure 10. Determination of “Best Next” Technology Solution

Note, in the diagram above, a “component” is any platform, engine, or transmission produced by a manufacturer, where application of a technology is evaluated on a vehicle designated as a leader of that component. Any follower vehicles of the same component, for which a candidate technology is available for application in the same analysis step as the leader vehicle, will also be evaluated during technology application.

S5.3.2 Calculation of Effective-Cost

Whenever the compliance simulation algorithm is evaluating the potential application of candidate technologies, it considers the effective cost of applying those technologies on a subset (or group) of vehicles selected by the algorithm, and chooses the option that yields the lowest effective cost.⁴⁴ The effective cost is used for evaluating the relative attractiveness of different technology applications, and not for actual cost accounting. This calculation can span multiple model years, if the algorithm selects a candidate technology that was left unused on a vehicle during its last redesign or refresh cycle. For example, if the technology was enabled for application in a previous year and not used, then it can remain as a candidate to be applied and then carried forward to the current model year. The effective cost obtained from application of a set of one or more candidate technologies on a group of vehicles is defined by the following equation:

$$EffCost = \frac{TechCost_{Total} - FuelSavings_{Total} - \Delta Compliance}{AffectedSales_{Total}} \quad (45)$$

Where:

- AffectedSales_{Total}* : the total sales volume of all vehicles selected for evaluation,
- TechCost_{Total}* : the total cost off all candidate technologies evaluated on a group of selected vehicles,
- FuelSavings_{Total}* : the value of the reduction in fuel consumption (or fuel savings) resulting from application off all candidate technologies evaluated a group of selected vehicles,
- ΔCompliance* : the change in manufacturer’s cost of compliance in the analysis year, which depending on the compliance program being evaluated, corresponds to the CAFE fines or value of CO₂ credits, and
- EffCost* : the calculated effective cost attributed to application of all candidate technologies evaluated on a group of selected vehicles.

In the above equation, the affected sales may span multiple vehicle models if the algorithm choses, *e.g.*, to apply an engine-level technology to multiple vehicles that share the same engine. Additionally, as stated above, if a candidate technology that was left unused from a vehicle’s last redesign or refresh is selected for application, the affected sales will include multiple model years

⁴⁴ Such groups can span regulatory classes. For example, if the algorithm is evaluating a potential upgrade to a given engine, that engine might be used by a station wagon, which is regulated as a passenger car, and a minivan, which is regulated as a light truck. If the manufacturer’s passenger car fleet complies with the corresponding standard, the algorithm accounts for the fact that upgrading this engine will incur costs and realize fuel savings for both of these vehicle models, but will only yield a change in compliance for the light truck fleet.

ranging from the vehicle model’s last redesign or refresh year to the analysis year being evaluated. Furthermore, when multiple vehicles are selected for evaluation, with the varying redesign and refresh schedules, the range of model years may differ for each vehicle model. For example, consider that the modeling system is evaluating a manufacturer’s compliance during model year 2025. The algorithm proceeds to select an engine-level technology for application on a leader vehicle that is being redesigned in model year 2020.⁴⁵ Then, any follower vehicle that shares the same engine and is redesigned or refreshed between model years 2020 and 2025 (inclusive) may also be selected for application by the algorithm, starting with its last redesign or refresh year (whichever is greater).⁴⁶

For all selected vehicle models, covering a given range of model years, the affected sales are calculated as shown in the following equation:

$$AffectedSales_{Total} = \sum_{i \in V} \left(\sum_{j=BaseMY}^{MY} Sales_{i,j} \right) \quad (46)$$

Where:

- V : a vector containing a subset of vehicle models selected by the compliance simulation algorithm from a manufacturer’s entire product line, on which to evaluate the potential application of candidate technologies,
- $BaseMY$: the first model year of the potential application of candidate technologies, which represents the last redesign or refresh year of vehicle model i ,
- MY : the model year being analyzed for compliance, corresponding to the last model year for which to evaluate the potential application of candidate technologies,
- $Sales_{i,j}$: the sales volume of a vehicle model i during model year j , and
- $AffectedSales_{Total}$: the total sales volume of all vehicles selected for evaluation.

In addition to the affected sales, the compliance simulation algorithm first calculates each of the components in Equation (45) independently, prior to calculating the effective cost. Similar to the calculation of affected sales, with the exception of the $\Delta Compliance$ portion, each of these components spans a subset of selected vehicle models, covering a given range of model years. The calculations for $TechCost_{Total}$ and $ValueLoss_{Total}$ are given by the two equation below:

$$TechCost_{Total} = \sum_{i \in V} \left(\sum_{j=BaseMY}^{MY} (TechCost_{i,j} \times Sales_{i,j}) \right) \quad (47)$$

⁴⁵ As shown in Table 8 above, with the exception of VVT, all engine-level technologies are initially applicable during a vehicle’s redesign year.

⁴⁶ As discussed in Section S4.4, engine-level technologies are applicable to a follower vehicle during that vehicle’s redesign or refresh year.

Where:

- $V, BaseMY, MY$: variables as defined in Equation (46) above,
 $Sales_{i,j}$: the sales volume of a vehicle model i during model year j ,
 $TechCost_{i,j}$: the net cost attributed to all candidate technologies for a vehicle model i during model year j , as defined by Equations (9) through (13) in Section S4.7 above, and
 $TechCost_{Total}$: the total cost off all candidate technologies aggregated for a subset of selected vehicles.

The value for the fuel savings, $FuelSavings_{Total}$ in Equation (45), is calculated by taking the difference between the fuel cost attributed to each vehicle model immediately before and after application of candidate technologies, aggregated across all vehicle models as follows:⁴⁷

$$FuelSavings_{Total} = \sum_{i \in V} \left(\sum_{j=BaseMY}^{MY} \left((FuelCost_{i,j} - FuelCost'_{i,j}) \times Sales_{i,j} \right) \right) \quad (48)$$

Where:

- $V, BaseMY, MY$: variables as defined in Equation (46) above,
 $Sales_{i,j}$: the sales volume of a vehicle model i during model year j ,
 $FuelCost_{i,j}$: the “fuel cost” for a vehicle model i during model year j , before application of candidate technologies,
 $FuelCost'_{i,j}$: the “fuel cost” for a vehicle model i during model year j , after application of candidate technologies,
 $FuelSavings_{Total}$: the value of the reduction in fuel consumption (or fuel savings) resulting from application off all candidate technologies aggregated for a subset of selected vehicles

In Equation (48), the $FuelCost_{i,j}$ and $FuelCost'_{i,j}$ values refer to an assumed cost a typical vehicle purchaser expects to spend on refueling a new vehicle model over a specific number of years, which is defined from the manufacturer’s perspective in the input fleet as the “payback period”. In each case, the fuel cost is given by the following equation:

$$FuelCost_{veh,MY} = \sum_{FT} \left(\sum_{a=0}^{PB} \left(\frac{SURV_{veh,a} \times VMT_{veh,a} \times FS_{veh,FT} \times Price_{FT,MY}}{(1 + DR)^a \times (1 - GAP_{FT}) \times FE_{veh,FT}} \right) \right) \quad (49)$$

Where:

- veh : the vehicle for which to calculate the fuel cost,
 MY : the model year being evaluated for compliance,

⁴⁷ This is not necessarily the actual value of the fuel savings, but rather the increase in vehicle price the manufacturer is assumed to expect to be able impose without losing sales.

- FT* : the fuel type the vehicle operates on (refer to Table 1 above for fuel types supported by the model),
- PB* : a “payback period”, or number of years in the future the consumer is assumed to take into account when considering fuel savings,
- SURV_{veh,a}* : the probability that a vehicle of a given age *a* will remain in service,
- VMT_{veh,a}* : the average number of miles driven in a year by a vehicle at a given age *a*,
- Price_{FT,MY}* : the price of the specific fuel type in model year *MY*,
- DR* : the discount rate the consumer is assumed to take into account when considering fuel savings,⁴⁸
- GAP_{FT}* : the relative difference between on-road and laboratory fuel economy for a specific fuel type,
- FS_{veh,FT}* : the percent share of miles driven by a vehicle when operating on fuel type *FT*,
- FE_{veh,FT}* : the fuel economy rating of the vehicle when operating on fuel type *FT*, excluding any credits, adjustments, and the petroleum equivalency factors, and
- FuelCost_{veh,MY}* : the fuel cost attributed to a vehicle during model year *MY*.

As discussed in Section A.3 of Appendix A, *SURV_{veh,a}*, *VMT_{veh,a}*, *Price_{FT,MY}*, and *GAP_{FT}* are all specified in the parameters input file, while the values for *DR* and *PB* are specified in the market data input file (see Section A.1.1 in Appendix A).

The last component of the effective cost calculation, $\Delta Compliance$, differs based on the compliance program the modeling system is configured to evaluate during analysis. In the case of the CAFE program, this value represents the change in CAFE civil penalties (or fines), aggregated for each affected regulatory class, corresponding to the subset of vehicles selected by the compliance simulation algorithm. The calculation for the change in fines is defined as follows:

$$\Delta Fines = \sum_{RC \in V} \left(\sum_{j=BaseMY}^{MY} (Fines_{RC,j} - Fines'_{RC,j}) \right) \quad (50)$$

Where:

- V*, *BaseMY*, *MY* : variables as defined in Equation (46) above,
- RC* : the regulatory class obtained from a subset of vehicle models selected for evaluation,
- Fines_{RC,j}* : the fines owed by a manufacturer in regulatory class *RC* during model year *j*, before application of candidate technologies,
- Fines'_{RC,j}* : the fines owed by a manufacturer in regulatory class *RC* during model year *j*, after application of candidate technologies,

⁴⁸ As mentioned earlier, this value for the discount rate (defined for each manufacturer in the input fleet) will be removed from a future version of the model and should not be used during analysis.

$\Delta Fines$: the change in manufacturer’s fines in the analysis year, resulting from application of candidate technologies on a subset of selected vehicles.

In the equation above, the fines owed (before and after application of technologies) are calculated as defined by Equation (35) in Section S5.1.4.

When the CAFE Model is configured to evaluate the CO₂ compliance program, $\Delta Compliance$ from Equation (45) denotes the change in the value of CO₂ credits, aggregated for each affected regulatory class, and is given by the following calculation:

$$\Delta ValueCO2Credits = \sum_{RC} \left(\sum_{j=BaseMY}^{MY} \left(\begin{array}{l} \text{MIN}(ValueCO2Credits_{RC,j}, 0) \\ -\text{MIN}(ValueCO2Credits'_{RC,j}, 0) \end{array} \right) \right) \quad (51)$$

Where:

- $V, BaseMY, MY$: variables as defined in Equation (46) above,
- RC : the regulatory class obtained from a subset of vehicle models selected for evaluation,
- $ValueCO2Credits_{RC,j}$: the value of CO₂ credits attributed to a manufacturer in regulatory class RC during model year j , before application of candidate technologies,
- $ValueCO2Credits'_{RC,j}$: the value of CO₂ credits attributed to a manufacturer in regulatory class RC during model year j , after application of candidate technologies,
- $\Delta ValueCO2Credits$: the change in manufacturer’s value of CO₂ credits in the analysis year, resulting from application of candidate technologies on a subset of selected vehicles.

In the equation above, the values of CO₂ credits (before and after application of technologies) are calculated as defined by Equation (44) in Section S5.2.4. Additionally in the above equation, since the change in the value of CO₂ credits should only capture the change in manufacturer’s cost of compliance, rather than the full change in value of the credits, the compliance simulation algorithm applies a ceiling at 0 (zero) to each calculated value of the CO₂ credits.

S5.4 Dynamic Fleet Share and Sales Response

When evaluating a manufacturer’s fleet for compliance, the CAFE Model may be configured to rely on a user-supplied static fleet forecast, which may be based on a combination of manufacturer compliance data, public data sources, and proprietary forecasts. In such a case, the modeling system uses predefined sales volumes for each vehicle model available within the input fleet, for each model year analyzed during the study period. During analysis, any increases in vehicle costs, and associated fuel economy levels, resulting from technology application will not yield changes in the mix of vehicles available for sale. Furthermore, with the static forecast, the model assumes that any project growth in vehicles’ sales volumes is embedded into the input fleet.

As an alternative to the static forecast, users may enable the “Dynamic Fleet Share and Sales Response” option (or, DFS/SR model) within the CAFE Model’s user interface to dynamically adjust the fleet forecast during modeling for each analysis year.⁴⁹ The purpose of the Sales Response model is to allow the CAFE modeling system to estimate new vehicle sales in a given future model year, accounting for the impact of a regulatory scenario’s stringency on new vehicle prices. Additionally, the Dynamic Fleet Share model modifies the share of light duty passenger cars (LDV) and class 1/2a trucks (LDT1/2a) with respect to the overall vehicle market.⁵⁰ Since the attributed-based standards defined for the CAFE and CO₂ compliance programs utilized within the modeling system rely upon a fixed forecast, the DFS/SR model needs calculate the new vehicle sales for any future model year prior to performing compliance calculations on that year. Thus, when the DFS/SR option is enabled, before beginning analysis of each new model year, the modeling system updates the sales volumes of all vehicle models within the input fleet. The model achieves this by calculating the new total vehicles sales (via the Sales Response portion of the DFS/SR model), computing the shares of the LDV and LDT1/2a fleets (using the Dynamic Fleet Share component of the model), then combining these results to produce the updated vehicle fleet.

The Sales Response model is estimated using lagged values of vehicle sales and average price increases from the years preceding the analysis year⁵¹ by one and two years. Additionally, the model uses quarterly changes in the U.S. GDP growth rate for the model year being evaluated, as well as values of the quarterly estimates of U.S. labor force participation during the model year being analyzed and the year immediately preceding the analysis year. For the lagged sales volumes occurring before the start of analysis (*i.e.*, prior to the first model year evaluated), the Sales Response model relies on the observed total industry sales defined in the “Fleet Analysis Values” sheet of the parameters input file (see Section A.3.5 of Appendix A). Since the lagged fleet does not incur additional cost of compliance, the average vehicle price increases before the start of analysis are assumed to be zero. After the first model year is evaluated, the lagged values correspond to those that were produced by the CAFE Model itself. Utilizing the Sales Response model, the total industry sales calculated for any given model year is defined by the following equation:

$$Sales_{MY} = \frac{\left(\beta_0 + \beta_1 \times GDP_{MY} + \beta_2 \times LFP_{MY} - \beta_3 \times LFP_{MY-1} + \beta_4 \times Sales_{MY-1} \div 1e6 + \beta_5 \times Sales_{MY-2} \div 1e6 + \beta_6 \times (RegCost_{MY-1} - RegCost_{MY-2}) \right)}{1,000,000} \quad (52)$$

Where:

⁴⁹ Refer to the CAFE Model’s Software Manual (available from within the model’s Help menu and in Appendix C below) for instruction on how to toggle the “Dynamic Fleet Share and Sales Response” option.

⁵⁰ As discussed in the RIA, the CAFE Model calculates the fleet shares based on the vehicle classification (or body style) of a vehicle (per Table 5 above), rather than its regulatory class assignment. This is done to account for the large-scale shift in recent years to crossover utility vehicles that have model variants in both the passenger car and light truck regulatory classes.

⁵¹ Within the context of the CAFE Model, analysis year refers to the model year currently being evaluated by the modeling system.

DRAFT – July 2018

- $\beta_0 - \beta_6$: set of beta coefficients, as defined by Table 17 below, used for tuning the Sales Response model,
- GDP_{MY} : the estimated quarterly change in the gross domestic product growth rate in model year MY ,
- LFP_{MY} : the estimated quarterly labor force participation in model year MY ,
- LFP_{MY-1} : the estimated quarterly labor force participation in the year immediately preceding model year MY ,
- $Sales_{MY-1}$: total industry sales (aggregated across all manufacturers and vehicle models) for the year immediately preceding model year MY ,
- $Sales_{MY-2}$: total industry sales (aggregated across all manufacturers and vehicle models) for the year preceding model year MY by two years,
- $RegCost_{MY-1}$: the average price increase of a new vehicle model for the year immediately preceding model year MY ,
- $RegCost_{MY-2}$: the average price increase of a new vehicle model for the year preceding model year MY by two years, and
- $Sales_{MY}$: the calculated total industry sales for model year MY .

In the equation above, the GDP growth rate and the labor force participation values are specified in the parameters input file, while the beta coefficients are provided in Table 17 below.

Table 17. Beta Coefficients

Coefficient	Value
β_0	0.5090738477
β_1	0.1488134968
β_2	0.0002462322
β_3	0.0002292395
β_4	0.6117051252
β_5	0.2047812576
β_6	0.0001719814

The Dynamic Fleet Share (DFS) model is defined by a series of difference equations that determine the relative share of LDV and LDT1/2a fleets based on the average horsepower, curb weight, and fuel economy associated with the specific vehicle class, the previous year’s fleet share of that class, as well as the current and past fuel prices of gasoline. As with the Sales Response model, the DFS portion utilizes lagged values from one and two years preceding the analysis year when estimating the share of the fleet during the model year being evaluated. For the lagged horsepower, curb weight, and fuel economy values occurring before the start of analysis, the DFS model uses the pre-calculated “seed” values defined in the “DFS Model Values” sheet of the parameters input file.⁵² After the first model year is evaluated, the lagged values correspond to those that were calculated during analysis by the modeling system. The Dynamic Fleet Share model begins by calculating the natural log of the new shares during model year MY , independently for each vehicle class VC , as specified by the following equation:

⁵² Refer to Section A.3.10 of Appendix A for more information regarding the input parameters used for the Dynamic Fleet Share model.

$$\ln(\text{Share}_{VC,MY}) = \left(\begin{array}{l} \beta_C \times (1 - \beta_{Rho}) + \beta_{Rho} \times \ln(\text{Share}_{VC,MY-1}) + \\ \beta_{FP} \times (\ln(\text{Price}_{Gas,MY} \times 100) - \beta_{Rho} \times \ln(\text{Price}_{Gas,MY-1} \times 100)) + \\ \beta_{HP} \times (\ln(\text{HP}_{VC,MY-1}) - \beta_{Rho} \times \ln(\text{HP}_{VC,MY-2})) + \\ \beta_{CW} \times (\ln(\text{CW}_{VC,MY-1}) - \beta_{Rho} \times \ln(\text{CW}_{VC,MY-2})) + \\ \beta_{MPG} \times (\ln(\text{FE}_{VC,MY-1} \times 0.8) - \beta_{Rho} \times \ln(\text{FE}_{VC,MY-2} \times 0.8)) + \\ \beta_{Dummy} \times (\ln(0.423453) - \beta_{Rho} \times \ln(0.423453)) \end{array} \right) \quad (53)$$

Where:

- $\beta_c - \beta_{Dummy}$: set of beta coefficients, as defined in the “DFS Model Values” sheet of the parameters input file, used for tuning the Dynamic Fleet Share model,
- $\text{Share}_{VC,MY-1}$: the share of the total industry fleet classified as vehicle class VC in the year immediately preceding model year MY ,
- $\text{Price}_{Gas,MY}$: the fuel price of gasoline fuel, in dollars per gallon, in model year MY ,
- $\text{Price}_{Gas,MY-1}$: the fuel price of gasoline fuel, in dollars per gallon, in the year immediately preceding model year MY ,
- 100 : the conversion factor from dollars per gallon to cents per gallon,
- $\text{HP}_{VC,MY-1}$: the average horsepower of all vehicle models belonging to vehicle class VC in the year immediately preceding model year MY ,
- $\text{HP}_{VC,MY-2}$: the average horsepower of all vehicle models belonging to vehicle class VC in the year preceding model year MY by two years,
- $\text{CW}_{VC,MY-1}$: the average curb weight of all vehicle models belonging to vehicle class VC in the year immediately preceding model year MY ,
- $\text{CW}_{VC,MY-2}$: the average curb weight of all vehicle models belonging to vehicle class VC in the year preceding model year MY by two years,
- $\text{FE}_{VC,MY-1}$: the average fuel economy rating of all vehicle models (excluding credits, adjustments, and petroleum equivalency factors) belonging to vehicle class VC in the year immediately preceding model year MY ,
- $\text{FE}_{VC,MY-2}$: the average fuel economy rating of all vehicle models (excluding credits, adjustments, and petroleum equivalency factors) belonging to vehicle class VC in the year preceding model year MY by two years,
- 0.8 : an adjustment factor corresponding to the on-road gap of gasoline fuel,
- 0.423453 : a dummy coefficient, and
- $\ln(\text{Share}_{VC,MY})$: the natural log of the calculated share of the total industry fleet classified as vehicle class VC in model year MY .

Once the initial LDV and LDT1/2a fleet shares are calculated (as a natural log), obtaining the final shares for a specific vehicle class is simply a matter of taking the exponent of the initial value, and normalizing the result at one (or 100%). This calculation is demonstrated by the following:

$$\text{Share}_{VC,MY} = \frac{e^{\ln(\text{Share}_{VC,MY})}}{e^{\ln(\text{Share}_{LDV,MY})} + e^{\ln(\text{Share}_{LDT1/2a,MY})}} \quad (54)$$

Where:

- $\ln(Share_{VC,MY})$: the natural log of the calculated share of the total industry fleet classified as vehicle class VC in model year MY ,
- $\ln(Share_{LDV,MY})$: the natural log of the calculated share of the total industry fleet classified as light duty passenger vehicles (LDV) in model year MY ,
- $\ln(Share_{LDT1/2a,MY})$: the natural log of the calculated share of the total industry fleet classified as class 1/2a light duty truck (LDT1/2a) in model year MY , and
- $Share_{VC,MY}$: the calculated share of the total industry fleet classified as vehicle class VC in model year MY .

The last step of the Dynamic Fleet Share and Sales Response model involves combining the results obtained in Equations (52) and (54), and scaling the sales volumes of each individual vehicle model present within the input fleet, as follows:

$$Sales_{veh,MY} = Sales_{veh,MY-1} \times \frac{Share_{VC,MY} \times Sales_{MY}}{Share_{VC,MY-1} \times Sales_{MY-1}} \quad (55)$$

Where:

- $Sales_{veh,MY-1}$: the sales volume of vehicle model veh in the year immediately preceding model year MY ,
- $Share_{VC,MY-1}$: the share of the total industry fleet classified as vehicle class VC in the year immediately preceding model year MY ,
- $Sales_{MY-1}$: total industry sales (aggregated across all manufacturers and vehicle models) for the year immediately preceding model year MY
- $Share_{VC,MY}$: the share of the total industry fleet classified as vehicle class VC in model year MY ,
- $Sales_{MY}$: total industry sales (aggregated across all manufacturers and vehicle models) for model year MY , and
- $Sales_{veh,MY}$: the calculated sales volume of vehicle model veh in model year MY .

In Equation (55), the $Share_{VC,MY-1}$ and $Share_{VC,MY}$ values are obtained based on the vehicle class assignment of the vehicle being evaluated. For example, if a vehicle is classified as LDT1, the corresponding shares for LDT1/2a class will be used.

S5.5 Credit Transfers and Carry Forward

During analysis, the compliance simulation algorithm may, as necessary, apply credits generated by a manufacturer in some compliance category in order to offset a shortfall of another compliance category. Here, a compliance category is defined as a combination of a manufacturer, model year, and regulatory class in which credits may be earned or used. The current version of the CAFE Model supports two forms credit usage:

- 1) Credit carry forward: where credits earned by a manufacturer during some previous model year are carried forward into the analysis year, within the same regulatory class, for up to five years;
- 2) Credit transfers: where credits earned by a manufacturer in one regulatory class are transferred to another regulatory class, during the same model year, subject to a maximum transfer cap for any given year.

Whenever the modeling system initiates a credit transfer or credit carry forward operation for a manufacturer, that operation forms a new “credit transaction” for the affected compliance categories. Each transaction is subsequently recorded in a model log file upon successful completion. The modeling system performs these credit transactions regardless of whether the system is configured to evaluate compliance with the CAFE program or the CO₂ program. However, since the denomination and applicability of credits is specific to each compliance program, the system accumulates and maintains CAFE and CO₂ credits independent of one another.

The CAFE Model relies on the configuration options found in the “Credit Trading Values” sheet of the parameters input file for controlling the behavior of credit carry forward and credit transfer operations. For example, a user may elect to increase the caps for credit transfers in any of the listed model years, allowing the modeling system to transfer additional credits into a specific compliance category. Additionally, a user may disable one or both of the credit usage options within the parameters file, to have the model ignore a specific form of credit usage during analysis altogether. Although options for enabling credit trades between manufacturers and carrying credits backward into the preceding model years are listed in the parameters file, the modeling system currently ignores these settings. Section A.3.9 of Appendix A provides additional information on the available credit trading configuration options.

Some of the credit usage options defined in the parameters file may not be applicable when the CAFE Model is configured to evaluate CO₂ standards. Specifically, since the CO₂ program allows for unlimited amount of fleet transfers, the transfer caps defined in the input file are not applicable. Likewise, since the CO₂ credits are denominated as metric tons and may be carried forward and transferred without requiring any form of fuel-preserving adjustment, the assumed lifetime VMT parameter is not applicable when evaluating the CO₂ compliance program as well.

S5.5.1 Evaluation and Application of Credits

As described in Section S5.3, if a manufacturer is noncompliant after exhausting all cost-effective technology solutions, the algorithm carries forward and transfers as much expiring credits as available in order to attain compliance. If the amount of expiring credits carried forward into the analysis year does not cover the entire shortfall of one or more regulatory classes, the algorithm proceeds to apply additional ineffective technologies, then carries forward and transfers the remainder of available credits. As it examines credit deficits in each compliance category attributable to a manufacturer (*i.e.*, regulatory class and analysis year), the compliance simulation algorithm carries forward and transfers credits from other compliance categories in a specific order of precedence. The algorithm completes each step, described in the list below, for all regulatory classes, before moving on to the next step:

DRAFT – July 2018

- 1) The algorithm begins by carrying forward credits into the analysis year, within the same regulatory class (*e.g.*, LT-2017 to LT-2021), starting with oldest generated credits first;
- 2) The algorithm then carries forward and transfers credits earned in a previous model year of one regulatory class, into the analysis year of another regulatory class (*e.g.*, DC-2017 to LT-2021), again, starting with the oldest available credits first; however, since direct credit carry forward is restricted to within the same regulatory class only, this step results in two credit transactions, where credits are first carried forward into the analysis year for the originating regulatory class, then transferred into the final destination class (*e.g.*, carry forward: DC-2017 to DC-2021, then transfer: DC-2021 to LT-2021);
- 3) Lastly, if one or more of the regulatory classes has a surplus of credits during the analysis year, while some other regulatory classes are at a deficit, the algorithm concludes with transferring credits between regulatory classes (*e.g.*, DC-2021 to LT-2021).

The modeling system follows the same logical evaluation of credits whether it is configured to evaluate compliance with the CAFE standards or the CO₂ standards. With the CAFE compliance program, however, fleet transfers may occur between DC and IC, DC and LT, or IC and LT classes, while for the CO₂ program, fleet transfers are defined as simply between PC and LT regulatory classes. In the case of the CAFE program, the algorithm has a predefined preference for the source regulatory class (where credits are earned) when transferring into a destination regulatory class (where credits are used). The model's credit transfer preference for each class is summarized by the following table:

Table 18. Credit Transfer Preference

Regulatory Class	Source Regulatory Class
Domestic Car	Imported Car, Light Truck
Imported Car	Light Truck, Domestic Car
Light Truck	Imported Car, Domestic Car
Light Truck 2b/3	N/A (fleet transfers not allowed)

When transferring credits into the Imported Car or Light Truck regulatory class, the algorithm considers credits originating in the Domestic Car class only after exhausting credits from the other classes. Considering that the minimum domestic car standard cannot be met via fleet transfers (though, credit carry forward is allowed), the algorithm prefers to bank as much credits earned by the Domestic Car fleet during the analysis year, in order to be able to utilize those credits for carry forward during later years. When transferring credits into the Domestic Car regulatory class, the algorithm prefers to begin by transferring credits earned in the Imported Car fleet, then if needed, transferring credits from the Light Truck fleet. Fleet transfers under the CAFE program require the use of an adjustment factor in order to preserve total gallons consumed. Since the calculated DC/IC adjustment factor is closer to one than the DC/LT factor, the model favors using Imported Car credits first.

The adjustment factor used by the algorithm when transferring credits between regulatory classes under the CAFE compliance program is calculated by using the assumed lifetime VMT, the CAFE standard, and the CAFE rating attributed to compliance categories where credits are earned and where credits are used, according to the following equation:

$$AdjFactor = \frac{VMT_{C_{Used}} \times CAFE_{C_{Earned}} \times STD_{C_{Earned}}}{VMT_{C_{Earned}} \times CAFE_{C_{Used}} \times STD_{C_{Used}}} \quad (56)$$

Where:

- C_{Earned} : the compliance category where credits are earned,
- C_{Used} : the compliance category where credits are used,
- $VMT_{C_{Earned}}$: the assumed average lifetime vehicle miles traveled by typical vehicle models in a regulatory class corresponding to the compliance category where credits are earned,
- $VMT_{C_{Used}}$: the assumed average lifetime vehicle miles traveled by typical vehicle models in a regulatory class corresponding to the compliance category where credits are used,
- $CAFE_{C_{Earned}}$: the CAFE rating achieved by a manufacturer in a regulatory class corresponding to the compliance category where credits are earned,
- $CAFE_{C_{Used}}$: the CAFE rating achieved by a manufacturer in a regulatory class corresponding to the compliance category where credits are used,
- $STD_{C_{Earned}}$: the calculated fuel economy standard attributable to a manufacturer in a regulatory class corresponding to the compliance category where credits are earned,
- $STD_{C_{Used}}$: the calculated fuel economy standard attributable to a manufacturer in a regulatory class corresponding to the compliance category where credits are used, and
- $AdjFactor$: the adjustment factor to use when transferring credits between compliance categories with different regulatory classes.

As stated above, the purpose of the adjustment factor defined by Equation (56) is to preserve total gallons when transferring credits between compliance categories of different regulatory classes.

As described in previous sections, the modeling system keeps track of total credits carried forward or transferred into a regulatory class and carried forward or transferred out of a regulatory class during each model year. Each time a credit transaction is executed by the compliance simulation algorithm, the total amount of credits carried forward or transferred out of a compliance category (where credits were earned) will be added to an associated “credits out” variable, while credits carried forward or transferred into a compliance category (where credits are used) will be added to an accompanying “credits in” variable. During each credit transaction, the amount of “out” credits will not exceed the amount of credits earned by a manufacturer; likewise, the amount of “in” credits will not exceed the minimum of the amount of credits earned by a manufacturer in a “source” compliance category or the amount of credits required in a “destination” compliance category. Collectively, the credits earned, “in”, and “out” form the “net credits” which will be used to by the algorithm to determine the degree of a manufacturer’s noncompliance in each regulatory class, whether the net credits result in the fines owed (under the CAFE program) or the value of CO₂ credits (under the CO₂ program).⁵³

⁵³ Refer to Equations (35) and (43) above for calculations of CAFE fines and value of CO₂ credits.

When carrying forward credits, the compliance simulation algorithm may equally rely upon the credit banks defined within the input fleet as well as the credits generated as part of compliance modeling. Thus, for earlier model years evaluated during the study period, credits carried forward into the analysis year are likely to originate prior to the first year analyzed. Additionally, if a manufacturer is able to achieve compliance for several consecutive model years without requiring the use of credits, it is likely that “banked” or earned credits will remain unused and may expire.

S5.5.2 Credit Usage Strategy

When generating and using credits, the CAFE Model anticipates that, with each successive model year, the standards (or the required levels) for CAFE and CO₂ would typically become more stringent, while the potential for meeting these standards through technology application would generally become more difficult. This difficulty in meeting the standards arises since, considering the vehicle redesign and refresh schedules, manufacturers have a limited set of vehicles available for improvement during each model year. Using credits aggressively in earlier years, instead of improving vehicle fuel economies, and thereby foregoing the improvements to a manufacturer’s CAFE or CO₂ rating, results in higher shortfalls in all subsequent years, while simultaneously reducing the overall amount of “banked” credits. The higher shortfalls, in turn, force a manufacturer to apply additional technologies (to a set of vehicles being redesigned or refreshed) in a future model year, or use even more credits, further reducing the credit bank. In the later years, the more aggressive the model is with using the credits, the more challenging compliance for a manufacturer becomes. While multiyear modeling alleviates some of these concerns, by allowing the compliance simulation algorithm to “look back” to a preceding year and applying a technology that was left as a candidate, doing so may not always result in a cost-optimal solution. This occurs since, once the algorithm uses credits in an earlier year, further application of technology during the same year leads to a “loss” of credits, while the compliance state of a manufacturer remains the same.

For this reason, the model employs a more conservative strategy of applying technology solutions for compliance in the earlier years (when doing so is more like to decrease the shortfall of future model years), and only using credits as necessary (when a manufacturer runs out of available technology solutions). This credit use strategy varies slightly, depending on the compliance program and the manufacturer the model is presently evaluating. Under the CAFE compliance program, for manufacturers that are willing to pay civil penalties, the model would only apply technologies, provided it is cost-effective to do so, and consume existing credits more aggressively. Alternatively, for manufacturers that are unwilling to pay CAFE civil penalties, or if the CAFE Model is evaluating compliance with the CO₂ program (where fine payment is not an option), the model would apply as much technology as possible, only using credits that will expire during the analysis year or if a manufacturer has run out of available technology solutions.⁵⁴

When the CAFE Model is configured to evaluate compliance with the CO₂ standards, since the CO₂ program allows for unlimited credit transfers between fleets, the modeling system attempts to achieve compliance with the passenger car and light truck fleets simultaneously. To accomplish

⁵⁴ Credit usage will be revisited in a future release of the CAFE Model in order to optimize the compliance simulation algorithm’s decision between applying technologies and using credits with respect to lowering the total cost of compliance.

this, the CAFE Model allows for CO₂ credits to be transferred, from a fleet that is in compliance to another that is at a deficit, during the same year that the credits are earned. The system, then, reevaluates and transfers CO₂ credits, each time and on an as-needed basis, after each successive application of technologies to a group of vehicles. This implementation allows the system to more realistically simulate a manufacturer's response to a cumulative CO₂ standard at each year, which while being defined independently for passenger cars and light trucks, is likely to be interpreted by manufacturers as a de facto single standard.

Chapter Three Calculation of Effects

This chapter describes the way the CAFE modeling system estimates the effects of potential new CAFE or CO₂ standards on energy use, as well as on emissions of greenhouse gases and other air pollutants. These effects on energy use and emissions are calculated based on the fuel economy of individual vehicle models that manufacturers make in response to the standards. The modeling system estimates all effects separately for each individual vehicle model and vintage (or model year) over its expected life span in the U.S. vehicle fleet. A vehicle model's life span extends from the initial model year when it is produced and sold, through the year when vehicles produced during that model year have reached the maximum age assumed in the CAFE Model.⁵⁵ This chapter also describes the way these energy use and environmental impacts are translated into estimates of economic benefits or costs, and identifies which of these economic impacts are borne privately by vehicle owners and by society as a whole.

Although these effects are calculated for individual vehicle models, vintages, and future calendar years over their respective lifetimes, they are typically reported at the aggregate level for all vehicle models in a regulatory class produced during each model year affected by a proposed standard. Cumulative impacts for each regulatory class and model year over its expected life span are reported both in undiscounted terms and as their present value discounted to the calendar year defined within the parameters input file. Additionally, all effects calculated for the regulatory scenario considered to be the “baseline” are reported by the modeling system on an absolute basis (*e.g.*, total amount of fuel consumed or total miles driven), while for scenarios considered to be the “action alternatives”, the effects are reported as incremental and are specified as the difference between the action alternative and the baseline scenario.

⁵⁵ We adopt the simplifications that vehicle model years and calendar years are identical, and that all vehicles produced during a model year are sold and placed into service during the corresponding calendar year.

Section 1 Vehicle Lifetimes

The number of vehicles of a specific model and model year (or vintage) that remain in service during each subsequent calendar year is calculated by multiplying the number originally produced by estimates of the proportion expected to remain in service at each age up to an assumed maximum lifetime. The modeling system applies survival rates in two different ways, depending upon whether the user elects to use the dynamic survival model (described below) or the static scrappage rates that appear in the parameters input file. The static survival rates vary by age of vehicle and differentiate between cars, vans and SUVs, light duty pickups, and medium duty trucks (class 2b and 3). The categories used to specify the survival rates (as provided in the parameters input file) are based on a combination of vehicle style (applicable to light duty vehicles) and regulatory class (for medium duty vehicles), and are described by the following table:

Table 19. Survival Rates and Miles Driven Categories

Category	Description
Cars	Vehicles with styles defined as: convertible, coupe, hatchback, sedan, or wagon
Vans/SUVs	Vehicles with styles defined as: SUV, minivan, or van
Pickups	Vehicles with styles defined as: pickup
2b/3 Trucks	Vehicles that regulated as medium duty trucks

The number of vehicles of a given model produced during a specific model year that remain in use during a future calendar year is defined by the following equation:

$$N_{MY,CY} = SURV_{MY,C,a} \times Sales_{MY} \tag{57}$$

Where:

- MY* : the production year of the vehicle for which to calculate the number of surviving units of that vehicle model,
- CY* : the calendar year during which to calculate the number of surviving vehicles,
- C* : the category of the vehicle for which to calculate the number of surviving units of that vehicle model,
- SURV_{MY,C,a}*: the probability that vehicles produced in model year *MY* and belonging to a specific category *C* will remain in service at a given age *a*,
- Sales_{MY}* : the forecast number of new vehicles of a specific vehicle model produced and sold during model year *MY*, and
- N_{MY,CY}* : the resultant number of vehicles produced during model year *MY* that remain in use during a future calendar year *CY*.

The age, *a*, of a vehicle model produced in model year, *MY*, during calendar year, *CY*, is defined as:

$$a = CY - MY^{56} \quad (58)$$

Although the modeling system calculates the number of surviving vehicles for each individual vehicle model, it aggregates these results for reporting purposes to obtain the total on-road fleet that remains in service in each calendar year, for each model year of production. Since all effects calculated by the model are output by fuel type (as discussed in Sections B.3 through B.5 of Appendix B) the model further separates the on-road fleet for a given model year based on the individual fuel types represented within the input fleet. Hence, the total surviving fleet apportioned to each type of fuel used by all vehicle models produced in a specific model year during each calendar year is calculated by summing the number of each individual vehicle model that remains in service during a specific calendar year as follows:

$$Fleet_{MY,CY,FT} = \sum_{i \in V} (FS_{i,MY,FT} \times N_{i,MY,CY}) \quad (59)$$

Where:

- V : a vector containing all vehicle models produced during model year MY ,
- MY : the production year of all vehicles for which to calculate the surviving on-road fleet,
- CY : the calendar year during which to calculate the surviving on-road fleet,
- FT : the fuel type that all vehicles produced in model year MY operate on,
- $FS_{i,MY,FT}$: the percent share of miles driven by vehicle model i , produced in model year MY , when operating on fuel type FT ,
- $N_{i,MY,CY}$: the number of vehicles, of vehicle model i , produced during model year MY that remain in use during a future calendar year CY , and
- $Fleet_{MY,CY,FT}$: the resultant number of all vehicle models produced during model year MY that remain in use during calendar year CY , allotted to fuel type FT .

Lastly, the total on-road fleet of all surviving vehicle models, attributed to each specific fuel type (FT) produced in model year MY over their expected lifetimes is calculated by summing the number of surviving vehicle models across the individual calendar years as follows:

$$Fleet_{MY,FT} = \sum_{CY} Fleet_{MY,CY,FT} \quad (60)$$

The calendar year CY in the equation above ranges between the model year MY when the vehicle model was produced until MY plus the maximum survival age of that vehicle.

⁵⁶ We define a vehicle's age to be 0 during the year when it is produced and sold; that is, when $CY=MY$. Thus, for example, a model year 2005 vehicle is defined to be 10 years old during calendar year 2015. Because we do not attempt to forecast *changes* in the proportion of vehicles produced during future model years that are expected to survive to each age, a vehicle's age depends only on the difference between its model year (MY) and the calendar year (CY) for which these calculations are performed, and not on their specific values.

In addition to the static scrappage schedule that appears in the parameters file, the CAFE Model currently accommodates another scrappage model: a Dynamic Scrappage Model, which allows vintage, new vehicle price, relative cost per mile, and the GDP growth rate to affect retirement rates. In contrast, the static schedules presume constant scrappage rates for all vintages under all new vehicle prices, new vehicle fuel economies, and macroeconomic conditions. The application of both scrappage rates follow the logic described above, despite the different origin of the rates themselves. The Dynamic Scrappage Model is presented in Section S1.1, while a description of the static survival rates used is presented in Section S1.2.

S1.1 Dynamic Scrappage Model

The dynamic scrappage model was developed from a series of registration counts by vehicle classification, vintage, and age under certain economic conditions. The model predicts historical values well, but because of the sparseness of data for older vehicles, it does not project remaining fleet shares that align with historical values beyond a certain age. For this reason, an exponential decay function is used to ensure that the final fleet share converges to the observed historical final fleet share for vehicles of a given classification. It is assumed that vehicles live up to 40 years, before a vehicle of that model year is completely scrapped. The share of each model of vintage MY and category C , remaining at age a , is defined by the following if ($a < DecayStarts_C$), or if the age is less than the age when the decay is set to start in the parameters input file for a given vehicle category:

$$SURV_{MY,C,a} = (1 - SCRAP_{MY,C,a}) \times \sum_{i \in C} N_{i,MY,a-1} \quad (61)$$

Where:

- MY : the production year for which to estimate the survival rate,
- C : the category for which to estimate the survival rate,
- $SCRAP_{MY,C,a}$: the probability that each vehicle model of a vintage MY , belonging to a specific category C , will be scrapped by a given age a , conditional on survival to the preceding age, $a-1$,
- $N_{i,MY,a-1}$: the number of vehicles of category C , produced during model year MY that remain in use for the previous age, $a-1$, and
- $SURV_{MY,C,a}$: the calculated probability that vehicles produced in model year MY and belonging to a specific category C will remain in service at a given age a .

In Equation (61) above, $SCRAP_{MY,C,a}$ is defined by the following equation:

$$SCRAP_{MY,C,a} = \frac{e^{\sum_{i \in IV} (\beta_{C,i} \times X_{MY,C,a,i})}}{1 + e^{\sum_{i \in IV} (\beta_{C,i} \times X_{MY,C,a,i})}} \quad (62)$$

Where:

- MY : the production year for which to estimate the probability of scrappage,
- C : the category of vehicles for which to estimate the probability of scrappage,

- IV : the set of independent variables for which coefficients are defined as inputs for the scrappage model in the parameters input file,
- $B_{C,i}$: a vector of coefficient values for a given vehicle category C and independent variable i , as defined in the parameters input file,
- $X_{MY,C,a,i}$: vector of independent variable values for a given vintage MY , category C , age a , and independent variable i , as defined in the inputs, or calculated within the model simulation, and
- $SCRAP_{MY,C,a}$: the resultant probability that each vehicle model of a vintage MY , belonging to a specific category C , will be scrapped by a given age a .

If, however, ($a \geq DecayStarts_C$), then the share of each vehicle model of vintage MY and category C remaining at age, a , is defined by the following:

$$SURV_{MY,C,a} = e^{(Rate_{MY,C} \times T_{MY,C,a})} \times \sum_{i \in C} N_{i,MY,a-1} \quad (63)$$

As in Equation (61), $N_{i,MY,a-1}$ is the number of vehicles of category C , produced during model year MY that remain in use for the previous age, $a-1$.

T is the period since the decay function has been applied, and can be defined by the following equation:

$$T = (a - DecayStarts_C + 1) \quad (64)$$

And finally, $Rate_{MY,C}$ is the rate of population decline necessary to ensure that the fleet surviving at the final age 40 equals the category-specific final survival share specified as an input to the scrappage model, and is defined by the equation below:

$$Rate_{MY,C,a} = \frac{\ln\left(\frac{(FinalSurvival_C)}{(Population_{MY,C,a=DecayStarts_C})}\right)}{40 - DecayStarts_C} \quad (65)$$

Where:

- $FinalSurvival_C$: the final share of the fleet of category C , observed to remain in the historical data at the last age tracked in the scrappage model (age 40); this is an input in the parameters file,
- $DecayStarts_C$: the age at which the decay function is set to begin for a vehicle of category C (this is an input defined in the parameters file), and
- $Population_{MY,C,a=DecayStarts_C}$: the number of vehicles of a vintage MY and category C remaining at the age when the decay function is set to begin for a vehicle of that category.

The inputs to the scrappage model are further described in Section A.3.7 of Appendix A. This includes a description of the independent variable set used in the Dynamic Scrappage Model, the final survival share, and the age at which the decay function begins.

S1.2 Static Scrappage Model

The static survival rates are explicitly defined by vehicle age, and for each vehicle category defined in Table 19 above, in the parameters input file as described in Section A.3.2 of Appendix A. These values are assumed to be constant for all vintages. Thus, when using static survival rates during analysis, Equation (57) above may simplify as follows:

$$N_{MY,CY} = SURV_{C,a} \times Sales_{MY} \quad (66)$$

These rates are based on analysis of registration data used to support the 2017-2021 final standards and the 2022-2025 augural standards. That analysis shows the maximum ages of passenger automobiles and light and medium duty trucks are estimated to be 30 years and 37 years, respectively.⁵⁷

⁵⁷ These are defined as the ages when the number of vehicles of a model year that remain in service has declined to fewer than 2% of those originally produced.

Section 2 Vehicle Use and Total Lifetime Mileage

The CAFE Model employs the widely-documented relationship between vehicle age and declining average vehicle use to estimate the number of miles that individual vehicle models are driven annually and in total over their expected lifetimes. Separate schedules of average annual miles driven, by vehicle age, were developed for cars, vans and SUVs, pickups, and medium duty trucks (class 2b and 3), as discussed in Section A.3.2 of Appendix A. As with the survival rates described in the preceding section, the categories used to specify the mileage schedules are based on a combination of vehicle style (applicable to light duty vehicles) and regulatory class (for medium duty vehicles).

Two adjustments are applied to these mileage schedules to forecast the average number of miles that vehicles produced during future model years will be driven each year over their expected lifetimes. First, the estimates of annual miles driven by cars and trucks are adjusted to reflect assumed future growth in average vehicle use.⁵⁸ Second, the estimates of average annual miles driven by each vehicle at each age are further adjusted by applying the estimated elasticity of vehicle use with respect to fuel cost per mile to the difference in inflation-adjusted fuel price per gallon between the base calendar year, when the VMT survey was taken, and each subsequent calendar year. This adjustment employs a combination of actual historic fuel prices for the calendar years prior to start of the modeling analysis, forecasts for calendar years as reported in the U.S. Energy Information Administration’s Annual Energy Outlook (AEO), and extrapolations of gasoline prices beyond the last year provided by AEO. The elasticity (or a fuel economy rebound effect) as well as the VMT growth assumptions are provided as inputs to the model and are further described in Section A.3.1 of Appendix A.

The average number of miles driven by a vehicle model when operating on each individual fuel type produced in a specific model year that survives during each calendar year is defined by the following:

$$MI_{MY,CY,FT} = FS_{MY,FT} \times VMT_{C,a} \times (1 + r)^{CY-BaseCY} \times \left(1 + \varepsilon \times \left(\frac{CPM_{MY,CY}}{CPM_{a,BaseCY}} - 1 \right) \right) \quad (67)$$

Where:

- MY* : the production year of the vehicle for which to calculate the miles driven,
- CY* : the calendar year during which to calculate the vehicle’s miles driven,
- FT* : the fuel type that the vehicle produced in model year *MY* operates on (refer to Table 1 above for fuel types supported by the model),
- FS_{MY,FT}* : the percent share of miles driven by the vehicle, produced in model year *MY*, when operating on fuel type *FT*,
- VMT_{C,a}* : the average annual miles that vehicles belonging to a specific category *C* drive at a given age *a*,

⁵⁸ The user defines a secular increase in the average number of miles cars and trucks are driven each year, independent of fuel prices or other conditions that may influence travel behavior. This value is nominally set to zero, but may be modified by the user.

DRAFT – July 2018

- BaseCY* : the base calendar year for VMT usage data corresponding to the year when the VMT survey was taken,
r : the rate of growth in VMT beginning in the base year *BaseCY*,
 ε : the elasticity of annual vehicle use with respect to fuel cost per mile,
CPM_{MY,CY} : the fuel cost per mile attributed to the vehicle produced in model year *MY* during calendar year *CY*,
CPM_{a,BaseCY}: the average fuel cost per mile of all historic vehicles that were age *a* during the base calendar year *BaseCY*, and
MI_{MY,CY,FT} : the resultant number of miles driven in a year by the vehicle produced in model year *MY*, during calendar year *CY*, when operating on fuel type *FT*.

The value of fuel cost per mile attributed to each vehicle model depends on both the price per gallon of fuel (or gasoline gallon equivalent, GGE, in the case of electricity, hydrogen, and CNG) during calendar year *CY* as well as the actual fuel economy that the vehicle produced in model year *MY* achieves in on-road driving. For most vehicles that operate exclusively on a single fuel type (typically, gasoline or diesel) the cost per mile is calculated from just that one fuel component. However, for dual fuel vehicles (such as PHEVs and FFVs), the cost per mile is a weighted sum of individual fuel components on which the vehicle operates. The cost per mile for each vehicle model is then defined by the following equation:

$$CPM_{MY,CY} = \sum_{FT} \left(FS_{MY,FT} \times \frac{Price_{FT,CY}}{FE_{MY,FT} \times (1 - GAP_{FT})} \right) \quad (68)$$

Where:

- MY* : the production year of the vehicle for which to calculate the cost per mile,
CY : the calendar year during which to calculate the vehicle’s cost per mile,
FT : the fuel type that the vehicle produced in model year *MY* operates on,
FS_{MY,FT} : the percent share of miles driven by the vehicle, produced in model year *MY*, when operating on fuel type *FT*,
FE_{MY,FT} : the fuel economy rating of the vehicle, produced in model year *MY*, when operating on fuel type *FT*,
GAP_{FT} : the relative difference between on-road and laboratory fuel economy for a specific fuel type,
Price_{FT,CY}: the inflation-adjusted price per gallon (or GGE) of the specific fuel type in calendar year *CY*, and
CPM_{MY,CY}: the calculated fuel cost per mile attributed to the vehicle produced in model year *MY*, during calendar year *CY*.

Each vehicle’s fuel economy rating is assumed to be determined during the model year when it is produced, and to remain fixed throughout its lifetime. However, its actual on-road fuel economy is assumed to fall short of that rating by the on-road fuel economy “gap” (a model input specified in the parameters input file).

Similar to the cost per mile equation for the vehicle produced during model year MY , the value of fuel cost per mile averaged across all historic vehicles that were age a during the calendar year $BaseCY$ when the VMT survey was taken is represented by the following equation:

$$CPM_{a,BaseCY} = \sum_{FT} \left(FS_{BaseCY-a,FT} \times \frac{Price_{FT,BaseCY}}{FE_{BaseCY-a,FT} \times (1 - GAP_{FT})} \right) \quad (69)$$

Where:

- $BaseCY$: the base calendar year for VMT usage data corresponding to the year when the VMT survey was taken,
- $BaseCY - a$: the model year during which the historic vehicles were produced when they were age a in the base calendar year $BaseCY$,
- FT : the fuel type that historic vehicles operated on (in aggregate) in model year $BaseCY - a$,
- $FS_{BaseCY-a,FT}$: the percentage share of total miles that all historic vehicles traveled in model year $BaseCY - a$ when operating on fuel type FT ,
- $FE_{BaseCY-a,FT}$: the sales-weighted average fuel economy rating that all historic vehicles achieved in model year $BaseCY - a$ when operating on fuel type FT ,
- GAP_{FT} : the relative difference between on-road and laboratory fuel economy for a specific fuel type,
- $Price_{FT,CY}$: the inflation-adjusted price per gallon (or GGE) of the specific fuel type in calendar year $BaseCY$, and
- $CPM_{a,BaseCY}$: the calculated average fuel cost per mile of all historic vehicles that were age a during the base calendar year $BaseCY$.

Since the mileage accumulation schedule used in Equation (67) is based on the VMT survey that was conducted during the calendar year $BaseCY$, the elasticity of annual vehicle use correlates the cost per mile of a new vehicle model of age a during each calendar year CY to the cost per mile of a typical historic vehicle that was of the same age during the base calendar year $BaseCY$. The CPM of a historic vehicle is hence calculated using the fuel prices of the base VMT calendar year, while the CPM of a new vehicle model is obtained using the fuel price forecasts in the calendar years corresponding to the vehicle's model year and age. This relationship between the new and existing vehicles reflects the fuel economy rebound effect, which occurs because buyers of new vehicles respond to the reduction in their operating costs – resulting from higher fuel economy of new vehicles – by driving slightly more during a particular calendar year.

Equation (67) specifies the average number of miles driven by a single surviving vehicle model produced in model year MY during calendar year CY , when operating on fuel type FT . The total number of miles driven by all vehicles of that model is calculated by multiplying the average annual miles driven by the number of vehicles produced in model year MY that remain in service during calendar year CY . Thus, the total miles driven on each fuel type by all surviving vehicles that were originally produced during a specific model year is calculated as:

$$MI'_{MY,CY,FT} = N_{MY,CY} \times MI_{MY,CY,FT} \quad (70)$$

Where:

- MY : the production year of the vehicle for which to calculate the miles driven,
- CY : the calendar year during which to calculate the vehicle's miles driven,
- FT : the fuel type that the vehicle produced in model year MY operates on,
- $N_{MY,CY}$: the number of vehicles produced during model year MY that remain in use during a future calendar year CY as defined in Equation (57) above,
- $MI_{MY,CY,FT}$: the number of miles driven in a year by a single vehicle model produced in model year MY , during calendar year CY , when operating on fuel type FT , as defined in Equation (67) above, and
- $MI'_{MY,CY,FT}$: the resultant number of miles driven in a year by all surviving vehicles, of a specific vehicle model, produced in model year MY , during calendar year CY , when operating on fuel type FT .

Although the modeling system calculates the number of miles driven for each individual vehicle model, it aggregates these results across all vehicle models for reporting purposes. The total miles driven on each type of fuel by all vehicle models produced in a specific model year during each calendar year is calculated by summing the mileage calculated for each individual vehicle model as shown in the following equation:

$$Miles_{MY,CY,FT} = \sum_{i \in V} MI'_{i,MY,CY,FT} \quad (71)$$

Where:

- V : a vector containing all vehicle models produced during model year MY ,
- MY : the production year of all vehicles for which to calculate the miles driven,
- CY : the calendar year during which to calculate the miles driven by all vehicle models,
- FT : the fuel type that all vehicles produced in model year MY operate on,
- $MI'_{i,MY,CY,FT}$: the number of miles driven in a year by all surviving vehicles, of vehicle model i , produced in model year MY , during calendar year CY , when operating on fuel type FT , as defined in Equation (70) above, and
- $Miles_{MY,CY,FT}$: the resultant number of miles driven in a year by all surviving vehicles (for all vehicle models) produced in model year MY , during calendar year CY , when operating on a specific fuel type FT .

From here, the total number of miles driven on each type of fuel by all surviving vehicle models produced in model year MY over their expected lifetimes is calculated by summing the number of miles across the individual calendar years as follows:

$$Miles_{MY,FT} = \sum_{CY} Miles_{MY,CY,FT} \quad (72)$$

Section 3 Fuel Consumption

Fuel consumption by vehicles of each model and vintage during a future year depends on the total mileage that the surviving vehicles are driven during that year, as well as on the fuel efficiency they obtain in actual driving. The fuel economy levels that new vehicles achieve in real-world driving falls significantly short of the rated fuel economy levels that are used to assess manufacturers’ compliance with CAFE or CO₂ standards.

The number of gallons of each type of fuel (or GGE for electricity, hydrogen, and CNG) consumed by a vehicle produced in a specific model year that survives during each calendar year is calculated as shown in the following equation:

$$G_{MY,CY,FT} = \frac{MI_{MY,CY,FT}}{(1 - GAP_{FT}) \times FE_{MY,FT}} \quad (73)$$

Where:

- MY* : the production year of the vehicle for which to calculate the number of gallons (or GGE) of fuel consumed,
- CY* : the calendar year during which to calculate the number of gallons (or GGE) of fuel consumed by the vehicle,
- FT* : the fuel type that the vehicle produced in model year *MY* operates on,
- FE_{MY,FT}* : the fuel economy rating of the vehicle, produced in model year *MY*, when operating on fuel type *FT*,
- GAP_{FT}* : the relative difference between on-road and laboratory fuel economy for a specific fuel type,
- MI_{MY,CY,FT}*: the average number of miles driven in a year by a vehicle produced in model year *MY*, during calendar year *CY*, when operating on fuel type *FT*, as defined in Equation (67) above, and
- G_{MY,CY,FT}* : the resultant number of gallons (or GGE) of fuel consumed in a year by the vehicle produced in model year *MY*, during calendar year *CY*, when operating on fuel type *FT*.

Similar to the mileage accumulation equations discussed in the previous section, the fuel consumption equation above estimates the number of gallons consumed by a single surviving vehicle model produced in model year *MY* during calendar year *CY*. The total number of gallons (or GGE) consumed by all surviving vehicles of that model is defined as follows:

$$G'_{MY,CY,FT} = N_{MY,CY} \times G_{MY,CY,FT} \quad (74)$$

Where:

- MY* : the production year of the vehicle for which to calculate the number of gallons (or GGE) of fuel consumed,
- CY* : the calendar year during which to calculate the number of gallons (or GGE) of fuel consumed by the vehicle,

DRAFT – July 2018

- FT : the fuel type that the vehicle produced in model year MY operates on,
- $N_{MY,CY}$: the number of vehicles produced during model year MY that remain in use during a future calendar year CY as defined in Equation (57) above,
- $G_{MY,CY,FT}$: the amount of gallons of fuel consumed in a year by a single vehicle model produced in model year MY , during calendar year CY as defined in Equation (73) above, and
- $G'_{MY,CY,FT}$: the resultant amount of gallons (or GGE) of fuel consumed in a year by all surviving vehicles, of a specific vehicle model, produced in model year MY , during calendar year CY , when operating on fuel type FT .

Although the modeling system calculates fuel consumption for each individual vehicle model, it aggregates these results across all vehicle models for reporting purposes. The total consumption of each type of fuel by all vehicle models produced in a specific model year during each calendar year is calculated by summing the fuel consumptions of each individual vehicle model as shown in the following equation:

$$Gallons_{MY,CY,FT} = \sum_{i \in V} G'_{i,MY,CY,FT} \quad (75)$$

Where:

- V : a vector containing all vehicle models produced during model year MY ,
- MY : the production year of all vehicles for which to calculate the number of gallons (or GGE) of fuel consumed,
- CY : the calendar year during which to calculate the number of gallons (or GGE) of fuel consumed by all vehicle models,
- FT : the fuel type that all vehicles produced in model year MY operate on,
- $G'_{i,MY,CY,FT}$: the amount of gallons (or GGE) of fuel consumed in a year by all surviving vehicles, of vehicle model i , produced in model year MY , during calendar year CY , when operating on a specific fuel type FT as defined in Equation (74) above, and
- $Gallons_{MY,CY,FT}$: the resultant amount of gallons (or GGE) of fuel consumed in a year by all surviving vehicles (for all vehicle models) produced in model year MY , during calendar year CY , when operating on fuel type FT .

From here, the total consumption of each type of fuel by all surviving vehicle models produced in model year MY over their expected lifetimes is calculated by summing the amount of gallons consumed across the individual calendar years as follows:

$$Gallons_{MY,FT} = \sum_{CY} Gallons_{MY,CY,FT} \quad (76)$$

The total annual consumption of each fuel by all vehicle models will differ depending on the standard that prevailed during the model year when they were originally produced. This is reflected in the outputs produced by the model, when comparing the differences of total gallons of fuel consumed between various regulatory scenarios.

In addition to calculating fuel consumption in terms of amount of gallons (or GGE) consumed for each fuel type, the modeling system also calculates corresponding energy consumption in quadrillion British thermal units (or Quads) attributable to each fuel type analyzed within the model, reporting these quantities on a total and incremental basis. For non-liquid fuel types (electricity, hydrogen, and CNG), the CAFE model also estimates energy consumption in native units of that fuel type (kilowatt-hours, or kWh, for electricity and standard cubic feet, or scf, for hydrogen and CNG).⁵⁹

For liquid fuel types (gasoline, e85, and diesel), the conversion of energy consumption to quadrillion BTUs is calculated within the model by simply multiplying the amount of gallons of the specific fuel consumed by the energy density of that fuel type and scaling the result from BTUs to Quads. The system computes amount of Quads consumed by each individual vehicle model as well as overall consumption across all surviving vehicle models, for any given calendar year and/or model year. Thus, the equation for calculating Quads takes general form as shown:

$$Quads_{FT} = \frac{Gallons_{FT} \times ED_{FT}}{1e15} \quad (77)$$

Where:

- FT* : the fuel type that one or more vehicles produced in a specific model year operate on,
- Gallons_{FT}*: the amount of gallons of fuel type *FT* consumed by one or more vehicle models,
- ED_{FT}* : the energy density of fuel type *FT*, and
- Quads_{FT}* : the energy consumption expressed as quadrillion BTUs for fuel type *FT*.

For electricity, hydrogen, and CNG fuel types, since their consumption is measured in gasoline gallon equivalents, the conversion to Quads is calculated by multiplying the amount of GGE by the energy density of gasoline. Equation (77) above then becomes:

$$Quads_{FT} = \frac{Gallons_{FT} \times ED_{Gasoline}}{1e15} \quad (78)$$

Where:

- FT* : the fuel type that one or more vehicles produced in a specific model year operate on,
- Gallons_{FT}*: the amount of gallons of fuel type *FT* consumed by one or more vehicle models,
- ED_{Gasoline}* : the energy density of gasoline, and
- Quads_{FT}* : the energy consumption expressed as quadrillion BTUs for fuel type *FT*.

⁵⁹ When reporting amounts of fuel and energy consumption, the system converts all units into thousands. Thus, liquid fuel consumed is reported in thousands of gallons, electricity in mW-h, and hydrogen and CNG in Mcf.

Additionally for electricity, hydrogen, and CNG, the conversion from GGE to native units (kWh or scf) is calculated by multiplying the amount of gallons consumed by the ratio of the energy density of gasoline to the energy density of a specific fuel type. As with the calculation of energy use in Quads, the system computes consumption of kilowatt-hours and standard cubic feet for each individual vehicle model and total consumption for all surviving vehicle models. Hence, for electricity, the equation is defined as:

$$KWH = Gallons_{FT} \times \frac{ED_{Gasoline}}{ED_{FT}} \quad (79)$$

While for hydrogen and CNG, the equation is as follows:

$$SCF = Gallons_{FT} \times \frac{ED_{Gasoline}}{ED_{FT}} \quad (80)$$

Where:

$Gallons_{FT}$: the amount of gasoline gallon equivalents of *Electricity*, *Hydrogen*, or *CNG* fuel types (denoted by the *FT* subscript) consumed by one or more vehicle models,

$ED_{Gasoline}$: the energy density of gasoline fuel,

ED_{FT} : the energy density of *Electricity*, *Hydrogen*, or *CNG* fuel types,

KWH : the amount of kilowatt-hours of *Electricity* fuel type consumed by one or more vehicle models (Equation (79)), and

SCF : the amount of standard cubic feet of *Hydrogen* or *CNG* fuel types consumed by one or more vehicle models (Equation (80)).

Section 4 Greenhouse Gas Emissions

Fuel consumption changes attributed to imposing new standards result in the associated changes in emissions of carbon dioxide (CO₂), the primary greenhouse gas emitted during the refining, distribution, and combustion of transportation fuels. Lowering overall fuel consumption reduces total carbon dioxide emissions directly, while increasing the amount of fuel consumed naturally leads to increases in quantity of carbon dioxide emitted into the atmosphere. This occurs given that the largest source of these emissions from transportation activity is fuel used by the internal combustion engines.

The CAFE Model calculates CO₂ emissions from vehicle operation (also referred to as “tailpipe” or “downstream” emissions) by multiplying the number of gallons of a specific fuel consumed by the carbon content per gallon of that fuel type, and then applying the ratio of carbon dioxide emissions generated per unit of carbon consumed during the combustion process.⁶⁰ Hence, the total emissions of carbon dioxide resulting from fuel consumption by all surviving vehicle models produced in a specific model year during each calendar year, attributed to vehicle operation on each fuel type, are calculated as:

$$CO2_{MY,CY,FT}^{DS} = \frac{Gallons_{MY,CY,FT} \times MD_{FT} \times CC_{FT} \times (44/12)}{1e6} \quad (81)$$

Where:

<i>MY</i>	: the production year of all vehicles for which to calculate downstream carbon dioxide emissions,
<i>CY</i>	: the calendar year during which to calculate the amount of carbon dioxide emitted by all vehicle models during operation,
<i>FT</i>	: the fuel type that all vehicles produced in model year <i>MY</i> operate on,
<i>Gallons_{MY,CY,FT}</i>	: the amount of gallons of fuel consumed in a year by all surviving vehicle models produced in model year <i>MY</i> during calendar year <i>CY</i> , when operating on fuel type <i>FT</i> ,
<i>MD_{FT}</i>	: the mass density of a fuel type <i>FT</i> (an input parameter specified in grams per unit of fuel type, which is either gallons, kWh, or scf),
<i>CC_{FT}</i> (⁴⁴ / ₁₂)	: the fraction of each fuel type’s mass that represents carbon, : the ratio of the molecular weight of carbon dioxide to that of elemental carbon ⁶¹ ,
<i>1e6</i>	: the conversion factor from grams to metric tons, and

⁶⁰ The carbon content for each type of fuel is specified as an input to the model in the parameters input file (further discussed in Section A.3.11 of Appendix A). Although the model does not explicitly account for incomplete conversion of carbon to carbon dioxide, input values specifying carbon content can be adjusted accordingly (*i.e.*, reduced to 99-99.5% of actual carbon content). Since electricity and hydrogen fuel types do not cause CO₂ emissions to be emitted during vehicle operation, the carbon content for these fuel types should be set to zero in the input file.

⁶¹ This ratio measures the mass of carbon dioxide that is produced by complete combustion of mass of carbon contained in each gallon of fuel.

$CO2_{MY,CY,FT}^{DS}$: the total downstream emissions of carbon dioxide (denominated in metric tons) resulting from fuel consumption by all surviving vehicle models produced in model year MY , during calendar year CY , when operating on fuel type FT .

Vehicles operating on electricity or hydrogen are assumed to generate no CO₂ emissions during vehicle use. For vehicles operating on CNG, since mass density is specified in grams per scf, the generated CO₂ emissions are calculated using amount of scf of CNG instead of amount of gallons consumed by all vehicle models. Thus, Equation (81) above becomes:

$$CO2_{MY,CY,CNG}^{DS} = \frac{SCF_{MY,CY,CNG} \times MD_{CNG} \times C_{CNG} \times (44/12)}{1e6} \quad (82)$$

As with the model’s calculations of miles driven and fuel consumption, estimates of annual CO₂ emissions from fuel use are summed over the calendar years that vehicles produced during each model year are projected to remain in use to obtain estimates of lifetime emissions. Specifically, lifetime CO₂ emissions from fuel consumption by vehicle models produced during model year MY when operating on fuel type FT is defined by the following:

$$CO2_{MY,FT}^{DS} = \sum_{CY} CO2_{MY,CY,FT}^{DS} \quad (83)$$

The total volume of fuel consumed also affects carbon dioxide emissions from refining and distributing liquid fuels (gasoline, diesel, and e85). Carbon dioxide emissions occur during the production of petroleum-based fuels as a result of energy use for petroleum extraction, transportation, storage, and refining, as well as during storage and distribution of refined fuel. Producing the chemical feedstocks or agricultural products from which non-petroleum fuels such as ethanol are derived also entails energy use and generates CO₂ emissions, as does refining, storing, and distributing those fuels. Generating electricity for use by PHEVs and BEVs, or hydrogen for use by FCVs, using fossil energy sources such as coal or natural gas also produces CO₂ emissions. Additionally, extracting natural gas from wells, as well as production (consisting of compression, cooling, and dehydration) and storage of CNG, also produces CO₂ emissions.

The CAFE Model calculates the amount of carbon dioxide emitted at each stage of fuel production and distribution (which are also referred to as “upstream” emissions) using aggregate estimates of emissions from all stages of these processes per unit of fuel energy supplied. These estimates are first converted to grams per quadrillion BTUs, then multiplied by the amount of Quads of each fuel type consumed to estimate total carbon dioxide emissions from production and distribution of various fuel types. Hence, the total CO₂ emissions resulting from producing and distributing of fuel consumed by all surviving vehicles of a specific model year for each calendar year and fuel type is given by:

$$CO2_{MY,CY,FT}^{US} = \frac{Quads_{MY,CY,FT} \times CO2_{FT} \times 1e9}{1e6} \quad (84)$$

Where:

- MY* : the production year of all vehicles for which to calculate upstream carbon dioxide emissions,
- CY* : the calendar year during which to calculate carbon dioxide upstream emissions attributed to the fuel consumption of vehicle models,
- FT* : the fuel type that all vehicles produced in model year *MY* operate on,
- Quads_{MY,CT,FT}*: the amount of quadrillion BTUs of energy consumed in a year by all surviving vehicle models produced in model year *MY*, during calendar year *CY*, when operating on fuel type *FT*,
- CO2_{FT}* : overall emissions of carbon dioxide from all stages of feedstock production and distribution of fuel type *FT* (an input parameter specified in grams per million-Btu; the input value is multiplied by *1e9* in order to convert it into grams per Quad),
- 1e6* : the conversion factor from grams to metric tons, and
- CO2^{US}_{MY,CY,FT}*: the total upstream emissions of carbon dioxide (denominated in metric tons) resulting from production and distribution of each fuel type *FT* used by all surviving vehicle models produced in model year *MY*, during calendar year *CY*.

Annual CO₂ emissions generated by production and distribution of each fuel type *FT* are then summed over the lifetimes of all vehicle models produced during each model year *MY* as such:

$$CO2_{MY,FT}^{US} = \sum_{CY} CO2_{MY,CY,FT}^{US} \quad (85)$$

Finally, downstream CO₂ emissions from fuel consumption are combined with upstream emissions generated during the fuel supply process to yield total CO₂ emissions from fuel production and consumption by vehicles produced in a specific model year, during each calendar year, as well as summed over their expected lifetimes. For each fuel type the surviving vehicle models operate on, the calculation for total CO₂ emissions can be generalized as:

$$CO2_{MY,FT} = CO2_{MY,FT}^{DS} + CO2_{MY,FT}^{US} \quad (86)$$

Where:

- MY* : the production year of all vehicles for which to calculate total carbon dioxide emissions,
- FT* : the fuel type that all vehicles produced in model year *MY* operate on,
- CO2^{DS}_{MY,FT}*: the downstream emissions of carbon dioxide for model year *MY* and fuel type *FT* as calculated by either of Equations (81), (82), or (83),
- CO2^{US}_{MY,FT}*: the upstream emissions of carbon dioxide for model year *MY* and fuel type *FT* as calculated by either of Equations (84) or (85), and
- CO2_{MY,FT}* : the total emissions of carbon dioxide (denominated in metric tons) resulting from production and consumption of fuel type *FT* used by all surviving

DRAFT – July 2018

vehicle models produced in a model year *MY*, during each calendar year or over the entire vehicle lifetimes.

Section 5 Air Pollutant Emissions

Imposing new standards can result in higher or lower emissions of criteria air pollutants, by-products of fuel combustion that are also emitted during the production and distribution of fuel. Criteria pollutants that are emitted in significant quantities by motor vehicles include carbon monoxide, various hydrocarbon compounds, nitrogen oxides, sulfur dioxide, and fine particulate matter.

As discussed in the sections above, changes in vehicle fuel economies and fuel prices may lead to associated changes in the total number of miles driven and the total amount of fuel consumed during each calendar year. Typically, reduction in the cost per mile of travel will lead to additional vehicle miles driven (as a consequence of the rebound effect) while also decreasing the overall fuel consumption. In contrast, increasing the cost per single mile driven will generally produce the opposite effect. The amount of emissions of most criteria pollutants produced during vehicle operation (or, “tailpipe” or “downstream” emissions) directly correlates to the number of miles driven by vehicle models, since federal standards regulate permissible emissions of these pollutants on a per-mile basis. Additionally, similar to carbon dioxide emissions, the overall volume of fuel consumed by vehicle models influences the total emissions of criteria pollutants resulting from production and distribution of a given fuel. Thus, increases in vehicle fuel economies as a result of imposing more stringent standards is likely to result in higher downstream and lower upstream emissions, while deregulation leading to less stringent standards may produce lower downstream and higher upstream emissions.

The CAFE Model calculates emissions of criteria pollutants resulting from vehicle operation by multiplying the number of miles driven by vehicles of a model year during each calendar year they remain in service by per-mile emission rates for each pollutant, which are listed in the parameters input file by model year and vehicle age. These emission rates differ among the various classes of vehicles (as defined by Table 5 in Section S2.2 above) when operating on specific fuel types. The modeling system accepts emission rate tables defined for gasoline and diesel fuel types, where the gasoline rates are also used for vehicles operating on E85.⁶² Additionally, vehicles operating on electricity (PHEVs and BEVs), hydrogen (FCV), and CNG are assumed to generate no emissions of criteria air pollutants during vehicle use.

Total emissions of any given criteria air pollutant from the use of all surviving vehicle models produced in a specific model year during each calendar year, attributed to vehicle operation on each fuel type, is defined as follows:

$$E_{MY,CY,FT}^{DS} = \frac{\sum_{i \in V} MI'_{i,MY,CY,FT} \times E_{i,MY,a,FT}}{1e6} \quad (87)$$

⁶² Given that no reliable sources of information for criteria emissions resulting from vehicle operation are available for E85 fuel, and since overall utilization of E85 by all vehicle models is insignificant when compared to overall vehicle fuel consumption, the modeling system assumes a simplification that emissions generated from vehicle operation on E85 fuel are equivalent to that of gasoline.

Where:

- V : a vector containing all vehicle models produced during model year MY ,
- MY : the production year of all vehicles for which to calculate downstream emissions of a given pollutant,
- CY : the calendar year during which to calculate the amount of a given pollutant emitted by all vehicle models during operation,
- FT : the fuel type that all vehicles produced in model year MY operate on,
- a : the age of the vehicle produced in model year MY during calendar year CY (as defined by Equation (58) above),
- $MI'_{i,MY,CY,FT}$: the number of miles driven in a year by all surviving vehicles of model i produced in model year MY , during calendar year CY , when operating on fuel type FT ,
- $E_{i,MY,a,FT}$: the per-mile rate at which vehicles of model i and model year MY emit a given pollutant at age a , when operating on a specific fuel type FT ,
- $1e6$: the conversion factor from grams to metric tons, and
- $E^{DS}_{MY,CY,FT}$: the total downstream emissions of a specific pollutant (denominated in metric tons) resulting from fuel consumption by all surviving vehicle models produced in model year MY , during calendar year CY , when operating on fuel type FT .

As with CO₂ emissions, annual emissions of each criteria air pollutant are summed over the calendar years that vehicle models originally produced during each model year are expected to be in service, in order to produce estimates of their total lifetime emissions. Thus, lifetime emissions of each air pollutant for each fuel type is defined as:

$$E^{DS}_{MY,FT} = \sum_{CY} E^{DS}_{MY,CY,FT} \quad (88)$$

Emissions of criteria air pollutants that occur during production and distribution of various fuel types are estimated using the same methodology employed for calculating carbon dioxide emissions, as discussed in the previous section and defined by equation (84) above. The modeling system uses aggregate estimates of emissions of criteria air pollutants from all stages of fuel production and distribution, which are specified in the parameters input file and are weighted by the user-defined fuel import assumptions. Thus, the total emissions of any given criteria air pollutant from producing and distributing of fuel consumed by all surviving vehicle models of a specific model year for each calendar year and fuel type is given by:

$$E^{US}_{MY,CY,FT} = \frac{Quads_{MY,CY,FT} \times E_{FT} \times 1e9}{1e6} \quad (89)$$

Where:

- MY : the production year of all vehicles for which to calculate upstream emissions of a given pollutant,

DRAFT – July 2018

- CY* : the calendar year during which to calculate upstream emissions of a given pollutant attributed to the fuel consumption of vehicle models,
- FT* : the fuel type that all vehicles produced in model year *MY* operate on,
- $Quads_{MY,CT,FT}$: the amount of quadrillion BTUs of energy consumed in a year by all surviving vehicle models produced in model year *MY*, during calendar year *CY*, when operating on fuel type *FT*,
- E_{FT} : overall emissions of a given pollutant from all stages of feedstock production and distribution of fuel type *FT* (an input parameter specified in grams per million-Btu; the input value is multiplied by $1e9$ in order to convert it into grams per Quad),
- $1e6$: the conversion factor from grams to metric tons, and
- $E_{MY,CY,FT}^{US}$: the total upstream emissions of a specific pollutant (denominated in metric tons) resulting from production and distribution of each fuel type *FT* used by all surviving vehicle models produced in model year *MY*, during calendar year *CY*.

Emissions of each criteria pollutant attributable to producing and distributing each fuel type *FT* consumed over the lifetimes of all vehicle models produced during model year *MY* are then summed as:

$$E_{MY,FT}^{US} = \sum_{CY} E_{MY,CY,FT}^{US} \quad (90)$$

Finally, total emissions of each criteria pollutant over the lifetimes of all vehicles of model year *MY* are the sum of downstream emissions that occur as a result of their lifetime use, and upstream emissions from producing and distributing the fuel they consume during each calendar year or over their lifetimes. As with the calculation of total carbon dioxide emissions, the equation for total criteria pollutants attributed to all surviving vehicle models when operating on a given fuel type, is a specific model year, is generalized as follows:

$$E_{MY,FT} = E_{MY,FT}^{DS} + E_{MY,FT}^{US} \quad (91)$$

Where:

- MY* : the production year of all vehicles for which to calculate total emissions of a given pollutant,
- FT* : the fuel type that all vehicles produced in model year *MY* operate on,
- $E_{MY,FT}^{DS}$: the downstream emissions of a given criteria pollutant for model year *MY* and fuel type *FT* as calculated by either of Equations (87) or (88),
- $E_{MY,FT}^{US}$: the upstream emissions of a given criteria pollutant for model year *MY* and fuel type *FT* as calculated by either of Equations (89) or (90), and
- $E_{MY,FT}$: the total emissions of a given criteria pollutant (denominated in metric tons) resulting from production and consumption of fuel type *FT* used by all surviving vehicle models produced in model year *MY*, during each calendar year or over the entire vehicle lifetimes.

Section 6 Vehicle Safety Effects

As discussed in Section 2 above, vehicle miles traveled may increase or decrease due to the fuel economy rebound effect, resulting from changes in vehicle fuel efficiency and cost of fuel, as well as the assumed future growth in average vehicle use. The number of total lifetime miles traveled by all vehicle models has direct correlation to vehicle-related crashes, including those that result in fatalities. Since the use of mass reducing technology is present within the model, safety impacts may also be observed whenever a vehicle’s curb weight decreases with respect to some reference point. Thus, in addition to computing total fatalities related to vehicle use, the modeling system also estimates changes in fatalities due to potential reduction in a vehicle’s curb weight. Consequently, the modeling system computes total fatalities attributed to vehicle use of all surviving vehicle models produced in a specific model year during each calendar year, attributed to vehicle operation on each fuel type, as follows:

$$F_{MY,CY,FT} = \sum_{i \in V} \left(\frac{MI'_{i,MY,CY,FT}}{1e9} \times \text{MAX}(28.58895 + \text{FixedEffect}_{MY}, 2) \times \left(1 + \text{Effect}_{SC_i,CW_i} \times \frac{T_{SC_i} - CW_i}{100} \right) \right) \quad (92)$$

Where:

- V : a vector containing all vehicle models produced during model year MY ,
- MY : the production year of all vehicles for which to calculate downstream emissions of a given pollutant,
- CY : the calendar year during which to calculate the vehicle related fatalities,
- FT : the fuel type that all vehicles produced in model year MY operate on,
- SC_i : the safety class that a vehicle model i belongs to,
- CW_i : the curb weight of a vehicle model i , in model year MY ,
- $MI'_{i,MY,CY,FT}$: the number of miles driven in a year by all surviving vehicles, of vehicle model i , produced in model year MY , during calendar year CY , when operating on fuel type FT , as defined in Equation (70) above,
- $1e9$: the conversion factor from miles to billion miles,
- 28.58895 : the estimated number of vehicle related fatalities per billion miles traveled during model year 1975,
- FixedEffect_{MY} : the estimated additional number of vehicle related fatalities per billion miles traveled during model year MY ,
- $\text{Effect}_{SC_i,CW_i}$: the percentage by which fatalities change for every 100 lbs. that a vehicle’s curb weight is reduced for vehicles within a safety class SC_i and with a curb weight CW_i ,
- T_{SC_i} : the boundary, in lbs., between small and large weight effects associated with vehicle model i ,
- 100 : the conversion factor from lbs. to hundreds of lbs., and
- $F_{MY,CY,FT}$: the resultant fatalities associated with all surviving vehicles (for all vehicle models) produced in model year MY , during calendar year CY , when operating on a specific fuel type FT .

DRAFT – July 2018

The $FixedEffect_{MY}$, $Effect_{SC_i,CW_i}$, and T_{SC_i} variables are specified as inputs to the model, which are defined in the parameters input file, while the safety class categorizations of vehicle models, SC_i , are applied in the input fleet. The “MAX” function bounds the MY fatality component at 2 (the lowest observed value in the fatality data), to ensure that per mile rates never turn negative.

Total fatalities attributed to all surviving vehicle models produced during model year MY over their expected lifetimes are accumulated across the individual calendar years as follows:

$$F_{MY,FT} = \sum_{CY} F_{MY,CY,FT} \quad (93)$$

In addition to using inputs to estimate the future involvement of modeled vehicles in crashes involving fatalities, the model also applies inputs defining other accident-related externalities estimated on a dollar per mile basis, as discussed below in S7.6.3.

Section 7 Private versus Social Costs and Benefits

Improving the fuel efficiency of new vehicles produces a wide range of benefits and costs, many of which affect buyers of those vehicles directly. Depending upon how manufacturers attempt to recoup the costs they incur for improving the fuel efficiency of selected models, buyers are likely to face higher prices for some – and perhaps even most – new vehicle models. Purchasers of models whose fuel economy is improved benefit from lower fuel expenditures, from any increase in the range they can travel before needing to refuel, and from the added driving they do as a result of the rebound effect. Depending on the technology manufacturers use to improve fuel economy and its consequences for vehicle power and weight, these benefits may be partly offset by a slight decline in the performance of some new models.

At the same time, the reduction in fuel production and use resulting from improved fuel economy produces certain additional benefits and costs to society as a whole. Potential social benefits from reduced fuel use include any value that society or the U.S. economy attaches to saving fuel over and above its private value to new vehicle buyers, lower emissions of air pollutants and greenhouse gases generated from fuel production, distribution, and consumption, and reduced economic costs associated with U.S. imports of crude petroleum and refined fuel. By causing some additional driving through the rebound effect, improving fuel economy can also increase a variety of social costs, including the economic value of health effects and property damages caused by increased air pollution, the value of time delays to motorists from added traffic congestion, added costs of injuries and property damage resulting from more frequent traffic accidents, and economic costs from higher levels of traffic noise.

As with the calculation of modeling effects, the CAFE Model estimates and reports all private and social costs and benefits on an absolute basis for the scenario identified as the baseline. Hence, in almost all cases, all of the reported values for the baseline scenario should be interpreted as “costs” resulting from final vehicle fuel economy levels. For the action alternatives, the system calculates these values on an absolute basis as well, however, reporting the results as incremental changes over the baseline scenario. These incremental changes may be, in most cases, interpreted as “benefits” (*e.g.*, reduction in lifetime fuel costs correlates to fuel savings) whenever the fuel economy values of vehicle models go up, on average, due to the action alternative standards being more stringent than the baseline. Conversely, the same incremental changes may be interpreted as “disbenefits” (or costs borne privately or by society, such as increases in fuel costs are reflected in added fuel expenditures) if, on average, the vehicle fuel economy decreases from the reduced stringency of the action alternative standards with respect to the baseline scenario.

For simplicity, we assume that new regulation typically increases in stringency, and therefore leads to higher fuel economy levels. Thus, the following sections discuss the way each of the benefits and costs can result from potentially improving the fuel economy of new vehicles, while also presenting all calculations on an absolute basis (*i.e.*, assuming the full amount of gallons consumed and miles traveled, which results from vehicle’s final fuel economy, rather than utilizing incremental fuel consumption or increases in VMT). Section 0 of Appendix A provides examples of specific unit economic values and other parameters used to estimate the aggregate value of these various benefits and costs.

S7.1 Increases in New Vehicle Prices

Depending upon how manufacturers attempt to recover the costs they incur in complying with ensuing standards, purchase prices for some new models are likely to increase. Since we assume that manufacturers fully recover all costs they incur for installing fuel economy technologies in the form of higher prices for some models, the total increase in vehicle sales prices has already been accounted for in estimating technology costs to manufacturers. Nevertheless, the total value of these price increases represent a cost of the regulation from the viewpoint of buyers of vehicle models whose prices rise.

In addition to increases in the prices paid by buyers who elect to purchase these models even at the higher price points, higher prices result in losses in welfare or consumer surplus to buyers who decide to purchase different models instead. These losses are extremely complex to estimate if prices change for a large number of models, and in any case are likely to be small even in total. Thus, we do not attempt to estimate their value.

S7.2 The Value of Fuel Consumed

The modeling system estimates the economic value of fuel consumed by new vehicles based on the total amount of gallons that each surviving vehicle model consumes at a given age as well as over its entire lifetime. The value of fuel consumed from the buyer’s perspective, or the retail fuel costs, is computed multiplying the forecast of future retail fuel prices at a specific calendar year by the number of gallons of fuel consumed at that year. Thus, the retail fuel costs associated with the total consumption of a particular type of fuel by all vehicle models produced in a specific model year that survive during each calendar year is given by the following:

$$FuelCost_{MY,CY,FT} = Gallons_{MY,CY,FT} \times Price_{FT,CY} \times Scale \quad (94)$$

Where:

- MY* : the production year of all vehicles for which to calculate the private value of fuel consumed,
- CY* : the calendar year during which to calculate the private value of fuel consumed by all vehicle models,
- FT* : the fuel type that all vehicles produced in model year *MY* operate on,
- Gallons_{MY,CY,FT}* : the amount of gallons (or GGE) of fuel consumed in a year by all surviving vehicle models produced in model year *MY*, during calendar year *CY*, when operating on fuel type *FT*,
- Price_{FT,CY}* : the inflation-adjusted retail price per gallon (or GGE) of the specific fuel type in calendar year *CY*,
- Scale* : the percentage by which to scale the private consumer benefits (a runtime option defined in the CAFE Model’s GUI), and
- FuelCost_{MY,CY,FT}* : the resultant private value of fuel consumed (or the retail fuel costs) in a year by all surviving vehicle models produced in model year *MY*, during calendar year *CY*, when operating on fuel type *FT*.

From here, the value of fuel consumed for each type of fuel by all surviving vehicle models produced in model year *MY* over their expected lifetimes is calculated by summing the fuel costs across the individual calendar years as follows:

$$FuelCost_{MY,FT} = \sum_{CY} FuelCost_{MY,CY,FT} \quad (95)$$

In addition to the retail fuel costs, the modeling system also estimates the fuel tax costs paid by the purchasers of new vehicle models during each calendar year. For all vehicle models produced in a specific model year that survive during each calendar year, the calculation of fuel taxes for each fuel type is defined by the following:

$$FuelTax_{MY,CY,FT} = Gallons_{MY,CY,FT} \times Tax_{FT,CY} \times Scale \quad (96)$$

Where:

- MY* : the production year of all vehicles for which to calculate the fuel tax costs,
- CY* : the calendar year during which to calculate the fuel tax costs,
- FT* : the fuel type that all vehicles produced in model year *MY* operate on,
- Gallons_{MY,CY,FT}* : the amount of gallons (or GGE) of fuel consumed in a year by all surviving vehicle models produced in model year *MY*, during calendar year *CY*, when operating on fuel type *FT*,
- Tax_{FT,CY}* : the inflation-adjusted fuel tax per gallon (or GGE) of the specific fuel type in calendar year *CY*,
- Scale* : the percentage by which to scale the private consumer, and
- FuelTax_{MY,CY,FT}* : the resultant fuel tax costs associated with the total fuel consumed in a year by all surviving vehicle models produced in model year *MY*, during calendar year *CY*, when operating on fuel type *FT*.

The fuel tax costs for each type of fuel by all surviving vehicle models produced in model year *MY* over their expected lifetimes is calculated by summing the fuel costs across the individual calendar years as follows:

$$FuelTax_{MY,FT} = \sum_{CY} FuelTax_{MY,CY,FT} \quad (97)$$

S7.3 Benefits from Additional Driving

The fuel economy rebound effect results in additional benefits to new vehicle buyers in the form of consumer surplus from the increased driving it produces. These benefits arise from the value to drivers and passengers of the social and economic opportunities made available to them by additional traveling. As evidenced by the fact that they elect to make more frequent or longer trips when improved fuel economy reduces the cost of driving, the benefits from this additional travel exceed the costs drivers and their passengers incur in making more frequent or longer trips. The amount by which these benefits from additional travel exceed its cost to them, which has been

reduced by improved fuel economy, represents the increase in consumer surplus associated with additional rebound effect driving. The full “Drive Value” described below includes both this consumer surplus and the cost of driving those additional miles.

The system estimates the consumer surplus using the conventional approximation of one half of the product of the decline in fuel cost per mile driven and the resulting change in the annual number of miles traveled, with respect to the fuel cost and mileage associated with a typical historical vehicle of the same age. The cost of travel for those miles is simply the cost of the gallons consumed. For all vehicle models produced in a specific model year that survive during each calendar year, when operating on a specific type of fuel, the value of the benefits from additional driving is calculated as:

$$DriveValue_{MY,CY,FT} = \sum_{i \in V} \left(\left(FS_{i,MY,FT} \times VMT_{C,a} \times N_{i,MY,CY} - MI'_{i,MY,CY,FT} \right) \times \left(\frac{CPM_{a,BaseCY} + CPM_{i,MY,CY}}{2} \right) \right) \quad (98)$$

Where:

- V : a vector containing all vehicle models produced during model year MY ,
- MY : the production year of all vehicles for which to calculate the value of additional driving,
- CY : the calendar year during which to calculate the value of additional driving by all vehicle models,
- FT : the fuel type that all vehicles produced in model year MY operate on,
- C : the category of the vehicle for which to obtain the VMT,
- $FS_{i,MY,FT}$: the percent share of miles driven by vehicle model i , produced in model year MY , when operating on fuel type FT ,
- $VMT_{C,a}$: the average annual miles that vehicles belonging to a specific category C drive at a given age a ,
- $N_{i,MY,CY}$: the number of vehicles, of vehicle model i , produced during model year MY that remain in use during a future calendar year CY , as defined in Equation (57) above,
- $MI'_{i,MY,CY,FT}$: the number of miles driven in a year by all surviving vehicles, of vehicle model i , produced in model year MY , during calendar year CY , when operating on fuel type FT , as defined in Equation (70) above,
- $BaseCY$: the base calendar year for VMT usage data corresponding to the year when the VMT survey was taken,
- $CPM_{a,BaseCY}$: the average fuel cost per mile of all historic vehicles that were age a during the base calendar year $BaseCY$,
- $CPM_{i,MY,CY}$: the fuel cost per mile attributed to the vehicle model i , produced in model year MY , during calendar year CY , and
- $DriveValue_{MY,CY,FT}$: the resultant value of the benefits from additional driving attributed to all surviving vehicle models produced in model year MY , during calendar year CY , when operating on fuel type FT .

Since the VMT schedules specified in the parameters input file are defined based on what a typical historical vehicle traveled during each age of its life at the year the VMT survey was taken, the mileage accumulation associated with that historical vehicle, as shown in Equation (98), is not required to be adjusted by the VMT growth rate or the rebound effect. However, since the modeling system is attempting to estimate the cumulative drive value for the new vehicle models produced and sold during model year *MY*, the VMT attributed to the historic vehicle is then multiplied by the share of miles driven and the number of surviving vehicles associated with the vehicle model for which the value of additional driving is being calculated.

The value of the benefits from additional driving for each type of fuel by all surviving vehicle models produced in model year *MY* over their expected lifetimes is calculated by summing the drive values across the individual calendar years as follows:

$$DriveValue_{MY,FT} = \sum_{CY} DriveValue_{MY,CY,FT} \quad (99)$$

S7.4 The Value of Extended Refueling Range

Manufacturers' efforts to improve the fuel economy of selected new vehicle models will also increase their driving range per tank of fuel. By reducing the frequency with which drivers typically refuel their vehicles, and by extending the upper limit of the range they can travel before requiring refueling, improving fuel economy thus provides some additional benefits to their owners.⁶³ No direct estimates of the value of extended vehicle range are readily available, so the CAFE Model calculates the reduction in the annual number of required refueling events that results from improved fuel economy. The change in required refueling frequency for vehicle models with improved fuel economy reflects the increased driving associated with the rebound effect, as well as the increased driving range stemming from higher fuel economy.

For vehicles that operate on non-liquid fuel types (electricity, hydrogen, and CNG), the modeling system adopts a simplification that there is no benefit or penalty associated with refueling those vehicles. Thus, the refuel value is assumed to be zero for those fuel types. For vehicles that operate on gasoline, diesel, or E85, the modeling system estimates the refueling value based on the assumed amount of time required for vehicle owners to detour to a fueling station, pay for fuel, and return to route, and the amount of time necessary to refuel a portion of the vehicle's fuel tank. For all vehicle models produced in a specific model year that survive during each calendar year, when operating on a specific type of fuel, the refuel value is calculated as follows:

$$RefuelValue_{MY,CY,FT} = \sum_{i \in V} \left(\left(\frac{\left(RefuelTime_{FT} + \frac{FuelTank_i \times RefuelVolume}{7.5} \right)}{60} \right) \times \left(\frac{G'_{i,MY,CY,FT}}{FuelTank_i \times RefuelVolume} \right) \times TravelValue \right) \quad (100)$$

⁶³ If manufacturers instead respond to improved fuel economy by reducing the size of fuel tanks to maintain a constant driving range, the resulting savings in costs will presumably be reflected in lower sales prices.

Where:

- V : a vector containing all vehicle models produced during model year MY ,
- MY : the production year of all vehicles for which to calculate the refueling value,
- CY : the calendar year during which to calculate the refueling value of vehicle models,
- FT : the fuel type that all vehicles produced in model year MY operate on,
- $RefuelTime_{FT}$: the fixed component of average refueling time in minutes, which includes the time required for vehicle owners to detour to a fueling station, pay for fuel of type FT , and return to route,
- $RefuelVolume$: the average tank volume refilled during a refueling stop,
- $FuelTank_i$: the fuel tank capacity of vehicle model i ,
- 7.5 : the average refueling rate, in gallons per minute, at the pumping station,
- 60 : the conversion factor from minutes to hours,
- $TravelValue$: the amount that the driver of a vehicle would be willing to pay to reduce the time required to make a trip,
- $G'_{i,MY,CY,FT}$: the amount of gallons of fuel consumed in a year by all surviving vehicles, of vehicle model i , produced in model year MY , during calendar year CY , when operating on a specific fuel type FT as defined in Equation (74) above, and
- $RefuelValue_{MY,CY,FT}$: the resultant value of refueling attributed to all surviving vehicle models produced in model year MY , during calendar year CY , when operating on fuel type FT .

From here, the refueling value attributed to all surviving vehicle models produced in model year MY over their expected lifetimes, when operating on each type of fuel, is calculated by summing the refueling values across the individual calendar years as follows:

$$RefuelValue_{MY,FT} = \sum_{CY} RefuelValue_{MY,CY,FT} \quad (101)$$

S7.5 Changes in Performance and Utility

The system currently assumes that the costs and effects of fuel-saving technologies reflect the application of these technologies in a manner that holds vehicle performance and utility constant. Therefore, the system currently does not estimate changes in vehicle performance or utility.

S7.6 Socially-Valued Costs and Benefits

S7.6.1 The “Social Value” of Fuel Consumed

In addition to valuing fuel consumption from a buyer’s perspective, the CAFE Model also estimates the economic value of fuel consumed by new vehicle models from the viewpoint of society. Unlike the fuel related expenditures borne by vehicle buyers themselves, however, the *pre-tax* price per gallon is used in assessing the value of fuel consumed *to the economy as a whole*. This is because any changes in payments of state and federal taxes by purchasers of fuel will be exactly offset by the associated changes in spending on the construction and maintenance of streets and highways that fuel taxes are mainly used to finance, and thus do not reflect a net savings in resources to the economy. Hence, the societal value of fuel consumption is computed as the difference of retail fuel costs incurred by vehicle buyers and the fuel tax costs resulting from refueling those vehicle models. The pre-tax fuel costs associated with the total consumption of a particular type of fuel by all vehicle models produced in a specific model year that survive during each calendar year is, therefore, given by the following:

$$PreTaxFuelCost_{MY,CY,FT} = FuelCost_{MY,CY,FT} - FuelTax_{MY,CY,FT} \quad (102)$$

Where:

- MY* : the production year of all vehicles for which to calculate the private value of fuel consumed,
- CY* : the calendar year during which to calculate the private value of fuel consumed by all vehicle models,
- FT* : the fuel type that all vehicles produced in model year *MY* operate on,
- FuelCost_{MY,CY,FT}* : the private value of fuel consumed (or the retail fuel costs) in a year by all surviving vehicle models produced in model year *MY*, during calendar year *CY*, when operating on fuel type *FT*,
- FuelTax_{MY,CY,FT}* : the fuel tax costs associated with the total fuel consumed in a year by all surviving vehicle models produced in model year *MY*, during calendar year *CY*, when operating on fuel type *FT*, and
- PreTaxFuelCost_{MY,CY,FT}* : the resultant social value of fuel consumed (or the pre-tax fuel costs) in a year by all surviving vehicle models produced in model year *MY*, during calendar year *CY*, when operating on fuel type *FT*.

The value of fuel consumed for each type of fuel by all surviving vehicle models produced in model year *MY* over their expected lifetimes is calculated by summing the fuel costs across the individual calendar years as follows:

$$PreTaxFuelCost_{MY,FT} = \sum_{CY} PreTaxFuelCost_{MY,CY,FT} \quad (103)$$

S7.6.2 Social Costs of Market Externalities

Importing petroleum into the United States is widely believed to impose significant costs on households and businesses that are not reflected in the market price for imported oil, and thus are not borne by consumers of refined petroleum products. These costs, also referred to as “market externalities”, include three components: (1) higher costs for oil imports resulting from the combined effect of U.S. import demand and OPEC market power on the world oil price; (2) the risk of reductions in U.S. economic output and disruption of the domestic economy caused by sudden reductions in the supply of imported oil; and (3) costs for maintaining a U.S. military presence to secure imported oil supplies from unstable regions, and for maintaining the Strategic Petroleum Reserve (SPR) to cushion against price increases.

The social costs of market externalities resulting from imposing new standards is estimated by assuming that the total volume of fuel consumed by new vehicle models during each future year is translated directly into a corresponding amount of U.S. oil imports during that same year. The market externalities associated with the total consumption of a given type of fuel by all vehicle models produced in a specific model year that survive during each calendar year are calculated as follows:

$$Externalities_{MY,CY,FT} = \left(\frac{Gallons_{MY,CY,FT} \times}{ImportAssumptions_{CY,FT}} \right) \times \left(\frac{Monopsony_{CY} +}{PriceShock_{CY} +} \right) MilitarySecurity_{CY} \quad (104)$$

Where:

- MY* : the production year of all vehicles for which to calculate the market externalities,
- CY* : the calendar year during which to calculate the market externalities associated with fuel consumption of all vehicle models,
- FT* : the fuel type that all vehicles produced in model year *MY* operate on,
- Gallons_{MY,CY,FT}* : the amount of gallons (or GGE) of fuel consumed in a year by all surviving vehicle models produced in model year *MY* during calendar year *CY*, when operating on fuel type *FT*,
- ImportAssumptions_{CY,FT}* : the fuel import assumptions for fuel type *FT*, during calendar year *CY*, as defined by Equation (105) below,
- Monopsony_{CY}* : the “monopsony” component of economic costs of oil imports, specified in \$/gallon in the parameters input file,
- PriceShock_{CY}* : the price shock component of economic costs of oil imports, specified in \$/gallon in the parameters input file,
- MilitarySecurity_{CY}* : the military security component of economic costs of oil imports, specified in \$/gallon in the parameters input file, and
- Externalities_{MY,CY,FT}* : the resultant social costs of market externalities associated with all surviving vehicle models produced in model year *MY*, during calendar year *CY*, when operating on fuel type *FT*.

The fuel import assumptions used in the equation above are specified in the parameters input file, separately by various categories, for each type of fuel and for a subset of calendar years. The fuel import assumption categories define the shares of savings or reductions of crude oil imports and domestic refining of imported crude resulting from the potential reductions of total consumption of fuel by new vehicle models. The calendar years are explicitly defined at either 5 or 10 year increments (*e.g.*, 2005, 2015, 2020), with the modeling system using the closest available year for any calendar year that is not explicitly defined in the inputs. For example, import assumptions specified in the inputs for calendar year 2020 would be used when estimating social costs of market externalities during calendar years 2018 through 2022.

$$ImportAssumptions_{CY,FT} = \begin{pmatrix} ReducedImports_{CY,FT} + \\ ReducedRefining_{CY,FT} \times \\ ReducedRefImports_{CY,FT} \end{pmatrix} \quad (105)$$

Where:

- CY* : the calendar year during which to calculate the market externalities associated with fuel consumption of all vehicle models,
- FT* : the fuel type for which to calculate the market externalities associated with fuel consumption of all vehicle models,
- ReducedImports_{CY,FT}* : the assumed value for share of fuel savings leading to lower fuel imports for fuel type *FT*, during calendar year *CY*,
- ReducedRefining_{CY,FT}* : the assumed value for share of fuel savings leading to reduced domestic fuel refining for fuel type *FT*, during calendar year *CY*,
- ReducedRefImports_{CY,FT}*: the assumed value for share of reduced domestic refining from imported crude for fuel type *FT*, during calendar year *CY*,
- ImportAssumptions_{CY,FT}*: the calculated import assumptions for fuel type *FT*, during calendar year *CY*.

From here, the lifetime social costs of market externalities attributed to all surviving vehicle models produced in model year *MY* over their expected lifetimes, when operating on each type of fuel, are calculated as follows:

$$Externalities_{MY,FT} = \sum_{CY} Externalities_{MY,CY,FT} \quad (106)$$

S7.6.3 Social Costs of Added Driving

The CAFE Model estimates the way that additional driving associated with the fuel economy rebound effect may contribute to increased traffic congestion, motor vehicle accidents, and highway noise. Additional vehicle use can contribute to traffic congestion and delays partly by increasing recurring congestion on heavily-traveled facilities during peak travel periods, depending on how the additional travel is distributed over the day and on where it occurs. Added

driving can also increase the frequency of incidents such as collisions and disabled vehicles that cause prolonged delays, although the extent to which it actually does will again depend partly on when and where the added travel occurs. Finally, added vehicle use from the rebound effect may also increase traffic noise, which causes inconvenience, irritation, and potentially even discomfort to occupants of other vehicles, pedestrians and other bystanders, and residents or occupants of surrounding property.

The modeling system calculates the total congestion, accident, and noise costs (or, collectively referred to as external costs) by multiplying the total miles driven by new vehicle models during each calendar year by the assumed amount of dollar per vehicle-mile associated with each of these external “vehicle usage” costs. While the form of the calculation remains the same, each of these variables is estimated and reported separately by the modeling system. The external costs associated with the total miles traveled by all vehicle models produced in a specific model year that survive during each calendar year, when operating on a given fuel type, are calculated as follows:

$$ExternalCosts_{MY,CY,FT} = Miles_{MY,CY,FT} \times ExternalCost \quad (107)$$

Where:

- MY* : the production year of all vehicles for which to calculate the congestion, accident, or noise costs,
- CY* : the calendar year during which to calculate the congestion, accident, or noise costs associated with total miles driven by all vehicle models,
- FT* : the fuel type that all vehicles produced in model year *MY* operate on,
- Miles_{MY,CY,FT}* : the number of miles driven in a year by all surviving vehicles produced in model year *MY*, during calendar year *CY*, when operating on a specific fuel type *FT*,
- ExternalCost* : one of either the congestion, accident, or noise components of external costs associated with additional vehicle use due to the “rebound” effect, specified in \$/vehicle-mile in the parameters input file, and
- ExternalCosts_{MY,CY,FT}*: the resultant congestion, accident, or noise costs associated with all surviving vehicle models produced in model year *MY*, during calendar year *CY*, when operating on fuel type *FT*.

Then, each of the lifetime external costs attributed to all surviving vehicle models produced in model year *MY* over their expected lifetimes, when operating on each type of fuel, are aggregated as follows:

$$ExternalCosts_{MY,FT} = \sum_{CY} ExternalCosts_{MY,CY,FT} \quad (108)$$

In addition to the aforementioned external vehicle usage costs, the modeling system also computes costs associated with the cleanup of fatal and non-fatal crashes, attributed to increases in total miles driven and application of mass reduction technology. For each model year and calendar year, the social cost associated with fatal crashes for all surviving vehicle models, when operating on a specific fuel type, are calculated according to the following equation:

$$FatalityCosts_{MY,CY,FT} = F_{MY,CY,FT} \times FatalityCost \quad (109)$$

Where:

- MY* : the production year of all vehicles for which to calculate the social costs of fatal crashes,
- CY* : the calendar year during which to calculate the social costs of fatal crashes associated with all vehicle models,
- FT* : the fuel type that all vehicles produced in model year *MY* operate on,
- F_{MY,CY,FT}* : the fatalities associated with all surviving vehicles produced in model year *MY*, during calendar year *CY*, when operating on a specific fuel type *FT*, as calculated in Equation (92) above,
- FatalityCost* : the social costs arising from vehicle fatalities, specified in \$/fatality in the parameters input file, and
- FatalityCosts_{MY,CY,FT}*: the resultant fatality costs associated with travel by all surviving vehicle models produced in model year *MY*, during calendar year *CY*, when operating on fuel type *FT*.

The fatality costs resulting from all surviving vehicle models produced in model year *MY* over their expected lifetimes, when operating on each type of fuel, are summed over each calendar year as follows:

$$FatalityCosts_{MY,FT} = \sum_{CY} FatalityCosts_{MY,CY,FT} \quad (110)$$

The non-fatal crash costs, from added driving and mass reduction, estimated by the modeling system are, then, calculated by applying a scaling factor defined in the parameters input file to the fatal crashes costs calculated in the equations above. The same scaling factor applies whether the modeling system is estimating non-fatal crash costs attributed to vehicle models during a specific calendar year, or cumulative costs over the vehicle’s lifetime. This calculation may be generalized as follows:

$$NonFatalCrashCosts_{FT} = FatalityCosts_{FT} \times NonFatalCostsScalar \quad (111)$$

Where:

- FT* : the fuel type that all vehicles produced in a specific model year operate on,

- FatalityCosts_{FT}* : the fatality costs associated with travel by all surviving vehicle models produced in a specific model year during a specific calendar year, when operating on fuel type *FT*,
- NonFatalCostsScalar* : a scaling factor used for estimating social costs arising from non-fatal vehicle crashes,
- NonFatalCrashCosts_{FT}*: the resultant non-fatal crash costs associated with travel by all surviving vehicle models produced in a specific model year during a specific calendar year, when operating on fuel type *FT*.

S7.6.4 Social Costs of Environmental Impacts

The modeling system estimates the economic costs associated with emissions of criteria pollutants, including carbon monoxide, volatile organic compounds, nitrogen oxides, sulfur dioxide, and fine particulates, using estimates of the economic damage costs per metric ton of emissions of each of these pollutants. As indicated previously, emissions of criteria pollutants can rise or fall whenever vehicle’s fuel economy changes. Thus, the economic costs of these emissions can increase or decline in response to new fuel economy or CO₂ standards. The emission damage costs attributed to all vehicle models produced in a specific model year that survive during each calendar year, when operating on a given fuel type, are calculated as follows:

$$EmissionCosts_{MY,CY,FT} = E_{MY,CY,FT} \times EmissionCost \quad (112)$$

Where:

- MY* : the production year of all vehicles for which to calculate the social costs associated with emissions of a given pollutant,
- CY* : the calendar year during which to calculate the social costs associated with emissions of a given pollutant attributed to all vehicle models,
- FT* : the fuel type that all vehicles produced in model year *MY* operate on,
- E_{MY,CY,FT}* : the total upstream and downstream emissions of a specific pollutant attributed to all surviving vehicle models produced in model year *MY*, during calendar year *CY*, when operating on fuel type *FT*, as calculated by Equations (87), (89), and (91),
- EmissionCost* : the economic costs arising from emissions for a given pollutant, specified in \$/metric ton in the parameters input file, and
- EmissionCosts_{MY,CY,FT}* : the resultant social costs of emission damage caused by a given pollutant, attributed to all surviving vehicle models produced in model year *MY*, during calendar year *CY*, when operating on fuel type *FT*.

The lifetime emission costs for a given pollutant, attributed to all surviving vehicle models produced during model year *MY*, when operating on fuel type *FT*, are summed across all calendar years as:

$$EmissionCosts_{MY,FT} = \sum_{CY} EmissionCosts_{MY,CY,FT} \quad (113)$$

The CAFE Model estimates the social cost of damage caused by carbon dioxide emissions by multiplying the total amount of CO₂ emitted by surviving vehicle models by the estimated value of damages per unit of emissions during each calendar year. Additionally, the modeling system uses the per unit cost of CO₂ to estimate the global warming potential (GWP) damages caused by methane and nitrous oxide emissions, by applying a GWP scalar before computing the damage costs arising from those criteria pollutants.

The damage costs caused by carbon dioxide emissions, attributed to all vehicle models produced in a specific model year that survive during each calendar year, when operating on a given fuel type, are calculated as follows:

$$CO2Costs_{MY,CY,FT} = CO2_{MY,CY,FT} \times CO2Cost_{CY} \quad (114)$$

Where:

- MY* : the production year of all vehicles for which to calculate the social costs associated with carbon dioxide emissions,
- CY* : the calendar year during which to calculate the social costs associated with carbon dioxide emissions attributed to all vehicle models,
- FT* : the fuel type that all vehicles produced in model year *MY* operate on,
- CO2_{MY,CY,FT}* : the total upstream and downstream emissions of carbon dioxide attributed to all surviving vehicle models produced in model year *MY*, during calendar year *CY*, when operating on fuel type *FT*, as calculated by Equations (82), (84), and (86),
- CO2Cost_{CY}* : the economic costs arising from carbon dioxide damage during calendar year *CY*, specified in \$/metric ton in the parameters input file, and
- CO2Costs_{MY,CY,FT}*: the resultant social costs of emission damage caused by carbon dioxide, attributed to all surviving vehicle models produced in model year *MY*, during calendar year *CY*, when operating on fuel type *FT*.

The global warming potential damage costs from methane and nitrous oxide emissions, attributed to all vehicle models produced in a specific model year that survive during each calendar year, when operating on a given fuel type, are calculated as follows:

$$EmissionCosts_{MY,CY,FT} = E_{MY,CY,FT} \times CO2Cost_{CY} \times Scalar_{GWP} \quad (115)$$

Where:

- MY* : the production year of all vehicles for which to calculate the social costs associated with methane or nitrous oxide emissions,

DRAFT – July 2018

CY	: the calendar year during which to calculate the social costs associated with methane or nitrous oxide emissions attributed to all vehicle models,
FT	: the fuel type that all vehicles produced in model year MY operate on,
$E_{MY,CY,FT}$: the total upstream and downstream emissions of a specific pollutant attributed to all surviving vehicle models produced in model year MY , during calendar year CY , when operating on fuel type FT , as calculated by Equations (87), (89), and (91),
$CO2Cost_{CY}$: the economic costs arising from carbon dioxide damage during calendar year CY , specified in \$/metric ton in the parameters input file,
$Scalar_{GWP}$: the global warming potential scalar specified in the parameters input file for methane and nitrous oxide pollutants, and
$EmissionCosts_{MY,CY,FT}$: the resultant social costs of GWP damage caused by methane or nitrous oxide pollutants, attributed to all surviving vehicle models produced in model year MY , during calendar year CY , when operating on fuel type FT .

The lifetime emission costs for carbon dioxide, methane, and nitrous oxide are calculated as other emissions shown in Equation (113), by summing across the individual calendar years.

S7.6.5 Discounting of Social Costs and Benefits

Along with calculating the “undiscounted” social costs and benefits described in the preceding sections, the CAFE Model also estimates discounted annual and lifetime valuations of these variables, measured from the perspective of society as a whole. The modeling system applies present year discounting, using one or more discount rates defined in the parameters input file, with all costs and benefits being discounted to a user-specified calendar year (also defined in the parameters file).⁶⁴ Hence, the discounted costs or benefits, of each variable, attributed to all vehicle models produced in a specific model year that survive during each calendar year, when operating on a given fuel type, are calculated as follows:

$$DiscCosts_{MY,CY,FT} = Cost_{MY,CY,FT} \times (1 + DR)^{-\text{MAX}(CY - \text{Base}CY, 0)} \quad (116)$$

Where:

MY	: the production year of all vehicles for which to calculate the discounted social costs,
CY	: the calendar year during which to calculate the discounted social costs associated with all vehicle models,
FT	: the fuel type that all vehicles produced in model year MY operate on,

⁶⁴ With the exception of CO₂ costs, for discounting of all social costs and benefits, the CAFE Model uses the discount rates specified on the “Economic Values” worksheet, as discussed in Section A.3.1 of Appendix A. For discounting of CO₂ costs, the system uses a separate discount rate value, as defined on the “Emission Costs” worksheet, described in Section A.3.13 of Appendix A.

- BaseCY* : the calendar year where all costs and benefits are discounted to,
DR : the discount rate to apply to future costs and benefits,
Cost_{MY,CY,FT} : the costs or benefits, as calculated in the preceding sections, to discount, and
DiscCost_{MY,CY,FT} : the resultant discounted costs or benefits, attributed to all surviving vehicle models produced in model year *MY*, during calendar year *CY*, when operating on fuel type *FT*.

As shown in the equation above, if the base calendar year, *BaseCY*, used for discounting is greater than the calendar year, *CY*, for which the costs are being discounted, the modeling system assumes that those costs and benefits remains undiscounted.

The lifetime discounted social costs or benefits for each variable are calculated by aggregating across the annual values for each model year *MY* and fuel type *FT* as follows:

$$DiscCosts_{MY,FT} = \sum_{CY} DiscCosts_{MY,CY,FT} \quad (117)$$

S7.7 Consumer-Valued Costs and Benefits

S7.7.1 The Value of “Rebound Miles”

In addition to the value of additional driving, discussed in Section S7.3 above, the CAFE Model estimates the value of “rebound miles,” which is based on the final cost per mile associated with a vehicle and the change in the annual number of miles traveled between the analysis vehicle and a typical historical vehicle of the same age. For all vehicle models produced in a specific model year that survive during each calendar year, when operating on a specific type of fuel, the value of the benefits from additional driving is calculated as:

$$ReboundCost_{MY,CY,FT} = \sum_{i \in V} \left(\left(MI'_{i,MY,CY,FT} - FS_{i,MY,FT} \times VMT_{C,a} \times N_{i,MY,CY} \right) \times \left(CPM_{i,MY,CY} \times Scale \right) \right) \quad (118)$$

Where:

- V* : a vector containing all vehicle models produced during model year *MY*,
MY : the production year of all vehicles for which to calculate the value of rebound miles,
CY : the calendar year during which to calculate the value of rebound miles by all vehicle models,
FT : the fuel type that all vehicles produced in model year *MY* operate on,
C : the category of the vehicle for which to obtain the VMT,
FS_{i,MY,FT} : the percent share of miles driven by vehicle model *i*, produced in model year *MY*, when operating on fuel type *FT*,

- $VMT_{C,a}$: the average annual miles that vehicles belonging to a specific category C drive at a given age a ,
- $N_{i,MY,CY}$: the number of vehicles, of vehicle model i , produced during model year MY that remain in use during a future calendar year CY , as defined in Equation (57) above,
- $MI'_{i,MY,CY,FT}$: the number of miles driven in a year by all surviving vehicles, of vehicle model i , produced in model year MY , during calendar year CY , when operating on fuel type FT , as defined in Equation (70) above,
- $CPM_{i,MY,CY}$: the fuel cost per mile attributed to the vehicle model i , produced in model year MY , during calendar year CY ,
- Scale* : the percentage by which to scale the private consumer benefits (a runtime option defined in the CAFE Model's GUI), and
- $ReboundCost_{MY,CY,FT}$: the resultant value of the rebound miles attributed to all surviving vehicle models produced in model year MY , during calendar year CY , when operating on fuel type FT .

As with the calculation of drive value (defined by Equation (98) in a preceding section), the base VMT schedules represent the annual mileage accumulation of a typical historic vehicle at each age of its life. Thus, $VMT_{C,a}$ in Equation (118) is not required to be adjusted for annual growth or rebound effect when computing the total miles traveled by a historic vehicle. As with the drive value, the modeling system is estimating the cost of rebound miles for vehicle models produced and sold during model year MY , and thus the VMT attributed to a historic vehicle is multiplied by the share of miles driven and the number of surviving units of the vehicle for which the rebound cost is being computed.

Unlike the costs and benefits computed from the social perspective, which are then reported separately for each fuel type, the modeling systems outputs the consumer-valued variables as totals across all fuels. Thus, the value of rebound miles traveled by all surviving vehicle models produced in model year MY , during calendar year CY is aggregated as follows:

$$ReboundCost_{MY,CY} = \sum_{FT} ReboundCost_{MY,CY,FT} \quad (119)$$

Afterwards, the value of rebound miles in model year MY over the expected lifetimes of all vehicle models is calculated by summing the rebound costs across the individual calendar years as follows:

$$ReboundCost_{MY} = \sum_{CY} ReboundCost_{MY,CY} \quad (120)$$

S7.7.2 Ownership Costs

The CAFE Model estimates additional ownerships costs that consumers incur either as part of a new vehicle purchase or during the lifetime of a vehicle model. Depending on the variable being calculated, the ownership costs may occur entirely at the point of sale (*i.e.*, during the model year the vehicle was purchased), over some number of years after purchase, or during the lifetime of

the vehicle. In each case, however, these costs are computed relative to the MSRP of a new vehicle. Since a purchaser of a new vehicle model does not expect their vehicle to be scrapped prior to the end of its useful life (or, likewise, before reselling it for a different model), the modeling system does not apply survival weighting when calculating ownership costs. Instead, the system computes these costs under the assumption that the entire number of units initially produced during a specific model year remain in use during each future calendar year.

When computing taxes and fees attributed to the sale of a new vehicle model, we assume that all costs to the buyer of that vehicle are borne upfront. Therefore, the system apportions these costs to vehicle age 0 (zero), with the lifetime costs having the same value as that at age zero. The total taxes and fees for a given model produced during a specific model year are, hence, calculated as in the following equation:

$$TaxesAndFees_{MY} = \sum_{i \in V} (Sales_{i,MY} \times MSRP_{i,MY} \times TaxesAndFees) \quad (121)$$

Where:

- V : a vector containing all vehicle models produced during model year MY ,
- MY : the production year of all vehicles for which to calculate the taxes and fees,
- $Sales_{i,MY}$: the number of units of vehicle model i produced for sale during model year MY ,
- $MSRP_{i,MY}$: the MSRP of a vehicle model i that is produced for sale during model year MY ,
- $TaxesAndFees$: the average percentage of the vehicle’s MSRP the consumer pays in taxes and fees when purchasing a new vehicle (an input value specified in the parameters input file),
- $TaxesAndFees_{MY}$: the resultant total taxes and fees paid by purchasers of new vehicle models during model year MY .

The modeling system estimates the costs that buyers incur for financing new vehicle purchases during each calendar year, extending up to the length of the financing term (as defined in the parameters input file). We assume that some of the new vehicle models will be financed at the time of sale and that purchasers will finance a certain percentage of the value of the MSRP. For simplicity, we apply a single estimate that represents a weighted combination of consumers that elect to finance their new vehicles and the amount of the MSRP they are willing to finance. Thus, the financing costs attributed to all vehicle models produced in a specific model year that survive during each calendar year (up to the length of the term), are calculated as:

$$Financing_{MY,CY} = \sum_{i \in V} \left(\left(\frac{Sales_{i,MY} \times MSRP_{i,MY} \times \left(\frac{r \times Share}{1 - \left(1 + \frac{r}{12}\right)^{-Term}} - \frac{Share}{12} \right)}{\left(\frac{Term}{12} - a, 1 \right)} \right) \right) \quad (122)$$

Where:

- V : a vector containing all vehicle models produced during model year MY ,
- MY : the production year of all vehicles for which to calculate the financing cost,
- CY : the calendar year during which to calculate the financing cost attributed to all vehicle models,
- $Sales_{i,MY}$: the number of units of vehicle model i produced for sale during model year MY ,
- $MSRP_{i,MY}$: the MSRP of a vehicle model i that is produced for sale during model year MY ,
- $Term$: the average length of time (in months) used by consumers to finance a new vehicle purchase,
- r : the average interest rate used by consumers to finance a new vehicle purchase,
- $Share$: the percentage of consumers that choose to finance their new vehicle purchase,
- $Financing_{MY,CY}$: the resultant total financing costs paid by purchasers of new vehicle models in model year MY , during calendar year CY .

The financing term, $Term$, interest rate, r , and percent share financed, $Share$, in the equation above are all input values specified in the parameters input file.

Since no additional costs occur after the loan amount is repaid in full, the system assigns a cost of zero to each calendar year beyond the length of the term. Since the input value for the financing term is specified in months, the system makes the determination of whether to calculate financing costs at a given calendar year based on the whether a vehicle's age, a , at a corresponding calendar year exceeds the number of whole years required to pay back the loan amount. This decision can be expressed by the following:

$$a < \text{CEILING}\left(\frac{Term}{12}\right) \quad (123)$$

Here, a is the vehicle age corresponding to the calendar year during which the costs of financing are calculated, while $Term$ is the financing term as defined in the preceding equation.

The financing costs calculated at each vehicle age for all vehicle models produced in model year MY are summed over the individual calendar years to obtain the cumulative financing costs paid by purchasers of new vehicle models. Since the modeling system only computes the annual financing costs up to the length of the term, the later calendar years in the summation have a value of zero, and have no impact on the computation of the lifetime costs of financing. Hence, this calculation is expressed by the following:

$$Financing_{MY} = \sum_{CY} Financing_{MY,CY} \quad (124)$$

More expensive vehicles will require more expensive collision and comprehensive (*e.g.*, fire and theft) car insurance. Actuarially fair insurance premiums for these components of value-based insurance will be the amount an insurance company will pay out in the case of an incident type weighted by the risk of that type of incident occurring. We expect that the same driver in the same vehicle type will have the same risk of occurrence for the entirety of a vehicle’s life, so that the share of the value of a vehicle paid out should be constant over the life of that vehicle. However, since the value of vehicle models is expected to decline at some depreciation rate with each subsequent calendar year, the absolute amount paid in value-related insurance also declines as the vehicle depreciates. Thus, the cost to insure all vehicle models produced in a specific model year that survive during each calendar year, is given by the following equation:

$$Insurance_{MY,CY} = \sum_{i \in V} \left(Sales_{i,MY} \times \frac{MSRP_{i,MY} \times 0.0183}{(1 + Depreciation)^a} \right) \quad (125)$$

Where:

- V : a vector containing all vehicle models produced during model year MY ,
- MY : the production year of all vehicles for which to calculate the insurance cost,
- CY : the calendar year during which to calculate the insurance cost attributed to all vehicle models,
- $Sales_{i,MY}$: the number of units of vehicle model i produced for sale during model year MY ,
- $MSRP_{i,MY}$: the MSRP of a vehicle model i that is produced for sale during model year MY ,
- 0.0183 : the share of MSRP paid on collision and comprehensive insurance,
- $Depreciation$: the typical depreciation rate of a new vehicle (an input value specified in the parameters input file),
- $Insurance_{MY,CY}$: the resultant total insurance costs paid by purchasers of new vehicle models in model year MY , during calendar year CY .

The lifetime financing costs accrued by consumers for purchasing new vehicle models produced during model year MY are aggregated across each calendar year as follows:

$$Insurance_{MY} = \sum_{CY} Insurance_{MY,CY} \quad (126)$$

In order to estimate whether increases in total cost of ownership (TCO) to vehicle buyers are repaid over some number of years, the CAFE Model computes all of the aforementioned ownership costs using the vehicle’s initial and final MSRPs. The initial MSRP is based on what is provided to the system in the input fleet (before application of any technologies), while the final MSRP is calculated during analysis, considering the regulatory costs incurred by each vehicle model. In either case, the initial or final vehicle MSRP is substituted into each of the above equations to obtain the associated ownership cost. From here, the vehicle’s payback and payback TCO, as discussed in the following section, may be calculated.

S7.7.3 Calculating Vehicle Payback

Using the various consumer-valued costs and benefits calculated during analysis, the CAFE Model estimates the number of years required for additional investments in fuel economy improving technologies to be paid back in the form of fuel savings realized by purchasers of new vehicle models. The system estimates the payback period for each vehicle model independently, as well as computing the average industry-wide payback using the accumulated totals for costs and fuel savings across all vehicles.

Two methodologies are employed in calculating the payback periods: in the first, the payback calculation only considers the accumulated regulatory costs versus the associated fuel savings; while for the second, the modeling system estimates the payback period based on the total cost of ownership (TCO), which also takes into account additional maintenance and repair costs associated with new technology application, as well as changes in ownership costs related to potential increases in a vehicle’s MSRP. In both cases, the CAFE Model assumes that all costs stemming from application of vehicle technologies (along with fine payments for non-compliance, wherever applicable) are borne in the first year of a vehicle’s life (designated by vehicle age zero), with the annual changes to the fuel and ownership costs, occurring during each ensuing calendar year, being iteratively aggregated until their net sum reaches or exceeds the costs of the original technology investment. The calendar year or, equivalently, the vehicle age at which the “sum of changes” outweighs the technology-related costs is then interpreted as the length of time necessary for payback to occur. For each vehicle model, the payback periods may be obtained based on the following two equations, where the payback is determined from:

$$(RegCost_{MY}) \leq \sum_{CY} (FuelCost_{ref,MY,CY} - FuelCost_{MY,CY} + ReboundCost_{MY,CY}) \quad (127)$$

And payback TCO is decided on:

$$\left(\begin{matrix} RegCost_{MY} + \\ MRCost_{MY} \end{matrix} \right) \leq \sum_{CY} \left(\begin{matrix} TaxesAndFees_{ref,MY,CY} - TaxesAndFees_{MY,CY} + \\ Financing_{ref,MY,CY} - Financing_{MY,CY} + \\ Insurance_{ref,MY,CY} - Insurance_{MY,CY} + \\ FuelCost_{ref,MY,CY} - FuelCost_{MY,CY} + ReboundCost_{MY,CY} \end{matrix} \right) \quad (128)$$

Where:

- MY : the production year of a vehicle for which to calculate the payback periods,
- CY : the range of calendar years, extending from the model year, MY , during which the vehicle was produced and up to 40 years,
- $FuelCost_{ref,MY,CY}$: the value of fuel consumed in a year by a vehicle model at its “initial” or reference state, which was produced in model year MY , during calendar year CY ,

DRAFT – July 2018

- $FuelCost_{MY,CY}$: the value of fuel consumed in a year by a vehicle model at its “final” state, which was produced in model year MY , during calendar year CY ,
- $ReboundCost_{MY,CY}$: the value of the rebound miles attributed to a vehicle model produced in model year MY , during calendar year CY ,
- $TaxesAndFees_{ref,MY,CY}$: the taxes and fees paid for a vehicle model at its “initial” or reference state, which was produced during model year MY , during calendar year CY ,
- $TaxesAndFees_{MY,CY}$: the taxes and fees paid for a vehicle model at its “final” state, which was produced during model year MY , during calendar year CY ,
- $Financing_{ref,MY,CY}$: the financing costs paid for a vehicle model at its “initial” or reference state, which was produced during model year MY , during calendar year CY ,
- $Financing_{MY,CY}$: the financing costs paid for a vehicle model at its “final” state, which was produced during model year MY , during calendar year CY ,
- $Insurance_{ref,MY,CY}$: the insurance costs paid for a vehicle model at its “initial” or reference state, which was produced during model year MY , during calendar year CY ,
- $Insurance_{MY,CY}$: the insurance costs paid for a vehicle model at its “final” state, which was produced during model year MY , during calendar year CY ,
- $RegCost_{MY}$: the regulatory cost incurred by a vehicle, from application of technologies and fine payment, in model year MY , and
- $MRCost_{MY}$: the additional maintenance and repair cost attributed to all technologies applied to a vehicle in model year MY .

In the two equations above, the fuel costs (for initial and final vehicle) are calculated similar to what is shown in Equation (94) in Section S7.2 above. While Equation (94) defines the fuel costs for all vehicles in aggregate, it may easily be adapted for an individual vehicle model, by using the amount of gallons of fuel consumed by that vehicle. Likewise, all other variables that make up Equations (127) and (128) were previously computed for the industry as a whole (for all vehicle models), and may be modified to instead represent the associated costs for a single vehicle model. Additionally, for the variables based on the “initial” vehicle state (shown with the *ref* subscript), the values were calculated based on the vehicle configuration (*e.g.*, fuel economy) as was read in from the input fleet, before application of new technologies by the CAFE Model. Conversely, the values calculated for the “final” vehicle state were based on the vehicle configuration after application of any new technologies during analysis. Lastly, some of the annual values were estimated for a limited range of calendar years (*e.g.*, $TaxesAndFees_{MY,CY}$, as discussed in the preceding section). For those variables, a value of zero would be used for calendar years during which the calculation is not applicable.

In Equations (127) and (128) above, as previously stated, the regulatory and maintenance and repair costs (appearing on the left hand side of the equations) occur during the first year of a vehicle’s life. The changes in ownership costs and expenditures related to fuel use (right hand side

of the equations) are accumulated over the life of a vehicle model, by summing their values over the individual calendar years. The CAFE Model estimates that the payback and payback TCO occur at the first calendar year where the cumulative sum of ownership and fuel costs (right hand side) reaches or surpasses the regulatory and maintenance/repair costs (left hand side). Then, the payback period is the difference between the resulting calendar year, *CY*, and the model year being evaluated, *MY*. If the changes in ownership and fuel costs, aggregated over the entire life of the vehicle model, do not outweigh the regulatory and maintenance/repair costs incurred by the vehicle at its first year, the system assumes that the initial investment in fuel improving technologies does not payback. In such a case, the CAFE Model produces a payback value of “99” in the modeling reports.

Along with calculating the payback periods for each vehicle model, the modeling system also estimates the associated values for the industry as a whole. In the case of the industry, the methodology employed by Equations (127) and (128) applies; however, the system uses aggregate measures of each variable (*e.g.*, total fuel cost for all vehicle models) during the calculation of the payback and payback TCO.

S7.7.4 Discounting of Consumer Costs and Benefits

The CAFE Model estimates discounted annual and lifetime costs and benefits calculated during analysis, measuring their valuations from the perspective of a vehicle buyer. The system applies discounting to the model year during which a new vehicle model was produced for sale, using one or more discount rates defined in the parameters input file. Thus, the discounted costs or benefits, of each variable, attributed to all vehicle models produced in a specific model year that survive during each calendar year are calculated as:

$$DiscCosts_{MY,CY} = Cost_{MY,CY} \times (1 + DR)^{-a} \tag{129}$$

Where:

- MY* : the production year of all vehicles for which to calculate the discounted consumer costs,
- CY* : the calendar year during which to calculate the discounted consumer costs associated with all vehicle models,
- DR* : the discount rate to apply to future costs and benefits,
- Cost_{MY,CY}* : the costs or benefits, as calculated in the preceding sections, to discount, and
- DiscCost_{MY,CY}*: the resultant discounted costs or benefits, attributed to all surviving vehicle models produced in model year *MY*, during calendar year *CY*.

The lifetime discounted consumer costs or benefits for each variable are calculated by aggregating across the annual values for each model year *MY* and fuel type *FT* as follows:

$$DiscCosts_{MY} = \sum_{CY} DiscCosts_{MY,CY} \tag{130}$$

Section 8 Fleet Analysis Calculations

In addition to calculating modeling effects associated with new standards for the model years evaluated during the study period, the CAFE Model also estimates these effects for the “historic” model years (*i.e.*, those occurring before the first analysis year is evaluated, starting in 1975) and the “future” model years (*i.e.*, those occurring after the last analysis year is evaluated, ending at the last year defined in the “Forecast of Sales” section on the “Fleet Analysis Values” worksheet of the parameters input file). For example, if the model years covered during the study period are 2016 through 2032 and the last forecast year is 2050, the effects of historic years evaluated include model years 1975 to 2015, while the effects of future years include model years 2033 to 2050. Extending the effects calculations to include historic and future model years allows the model system to produce a complete overview of effects and social costs and benefits resulting from the entire on-road light duty vehicle fleet over a substantial number of calendar years.

When estimating the effects and social costs and benefits attributed to historic model years, the modeling system uses the average fuel economy ratings and the on-road fleet distribution as the starting point for calculations. Both of these sets of data are provided as inputs to the CAFE Model in the parameters input file (refer to Sections A.3.5 and A.3.6 of Appendix A for more information). From here, the system estimates all effects as previously described in the above sections. However, since the historic fleet does not include fuel economy and sales volumes at the vehicle-level, the system follows a simplified approach for estimating historic effects by using aggregate values for all calculations.

For effects and costs of future model years, the system projects the fuel economy levels and sales volumes attained by each vehicle model during the last analysis year (*e.g.*, 2032) into each subsequent future year evaluated. For the vehicles’ fuel economy ratings, we apply a constant growth rate (year after year), assuming that the manufacturers are likely to deploy emerging and previously unutilized cost-effective technologies on their fleets. For simplicity, the same fuel economy growth rate is applied uniformly to each vehicle model, since the aggregation of fuel consumption and mileage accumulation values to the industry level obfuscates the efficiency of individual vehicles. Thus, for each future model year evaluated, the project fuel economy of each vehicle model, when operating on a given fuel type, is calculated as follows:

$$FE_{MY,FT} = FE_{MaxMY,FT} \times (1 + r_{RC})^{MY - MaxMY} \quad (131)$$

Where:

- MY* : the production year of a vehicle for which to calculate the projected fuel economy rating,
- MaxMY* : the last model year evaluated during compliance simulation,
- RC* : the regulatory class of a vehicle for which to calculate the projected fuel economy rating,
- FT* : the fuel type that all vehicles produced in model year *MY* operate on,
- r_{RC}* : the fuel economy growth rate to apply to a vehicle model’s fuel economy rating,

DRAFT – July 2018

- $FE_{MaxMY,FT}$: the fuel economy rating that a specific vehicle model attained in model year $MaxMY$, when operating on fuel type FT , and
- $FE_{MY,FT}$: the projected fuel economy rating that a specific vehicle model is assumed to attain in a future model year MY , when operating on fuel type FT .

In the equation above, the fuel economy growth rate, r_{RC} , may differ between the baseline scenario and all action alternatives. The individual values for the growth rates may be specified by the user in the parameters input file.

In addition to the vehicle fuel economy ratings, the modeling system also projects the sales volumes for each vehicle model, using static aggregate forecasts defined for each model year on the “Fleet Analysis Values” worksheet of the parameters input file. The sales volumes of future model years are obtained by taking the ratio between the forecast of sales of some future year and the associated sales forecast at the last analysis year evaluated, then multiplying the result by the final sales volumes attributed to each vehicle model during the last analysis year. For each future model year evaluated, the calculation of the project sales volumes of each vehicle model may be stated as follows:

$$Sales_{MY} = \frac{Forecast_{MY,RC}}{Forecast_{MaxMY,RC}} \times Sales_{MaxMY} \quad (132)$$

Where:

- MY : the production year of a vehicle for which to calculate the projected sales volume,
- $MaxMY$: the last model year evaluated during compliance simulation,
- RC : the regulatory class of a vehicle for which to calculate the projected sales volume,
- $Forecast_{MY,RC}$: the forecast of sales for vehicles belonging to regulatory class RC , in model year MY ,
- $Forecast_{MaxMY,RC}$: the forecast of sales for vehicles belonging to regulatory class RC , in model year $MaxMY$,
- $Sales_{MaxMY}$: the sales volume attributed to a specific vehicle model in model year $MaxMY$, and
- $Sales_{MY}$: the sales volume projected for a specific vehicle model in model year MY .

Once the fuel economy ratings and sales volumes for each vehicle model are estimated for a specific future model year, the resulting fleet of vehicles forms the basis for calculating the surviving on-road vehicle fleet, the amount of gallons of fuel consumed, and the number of miles driven at each vehicle age. As with the calculation of effects and social costs and benefits for each model year evaluated during the study period, this “future fleet” is used directly by the model to estimate the associated effects and costs stemming from potential fuel economy improvements in future model years. Thus, the calculation of all modeling effects, costs, and benefits is performed exactly as described in the preceding sections.

Appendix A Model Inputs

The CAFE Model utilizes a set of data files used as input to the analysis. All input files are specified in Microsoft® Excel format and are outline in Table 20 below. The user can define and edit all inputs to the system.

Table 20. Input Files

Input File	Contents
Market Data (Manufacturers Worksheet)	Contains an indexed list of manufacturers available during the study period, along with manufacturer’s willingness to pay fines and other manufacturer-specific modeling settings.
Market Data (Vehicles Worksheet)	Contains an indexed list of vehicle models available during the study period, along with sales volumes, fuel economy levels, prices, regulatory classification, references to specific engines and transmissions used, and settings related to technology applicability.
Market Data (Engines Worksheet)	Contains an indexed list of engines available during the study period, along with various engine attributes and settings related to technology applicability.
Market Data (Transmissions Worksheet)	Contains an indexed list of transmissions available during the study period, along with various transmission attributes and settings related to technology applicability.
Technologies	Specifies estimates of the availability and cost of various technologies, specific to various vehicle and engine categories.
Parameters	Provides inputs used to calculate travel demand, fuel consumption, carbon dioxide and criteria pollutant emissions (upstream and downstream), and economic externalities related to highway travel and petroleum consumption.
Scenarios	Specifies coverage, structure, and stringency of CAFE and CO ₂ standards for scenarios to be simulated.

A.1 Market Data File

The market data input file contains four worksheets: Manufacturers, Vehicles, Engines and Transmissions. Taken together, the manufacturers, vehicle models, engines, and transmissions worksheets provide the “initial state” historical and/or forecast data for the vehicle fleet. The sections below describe each worksheet in greater detail. The market data input file may contain additional information, which was used as a reference for building the input fleet, and may not necessarily be loaded or used by the modeling system.

A.1.1 Manufacturers Worksheet

The manufacturers input worksheet contains a list of all manufacturers that produce vehicle models offered for sale during the study period. Each manufacturer has a unique code and is represented by a unique manufacturer name. For each manufacturer, the manufacturer code, name, payback period, AC and off-cycle credits, FFV credits, and whether the manufacturer prefers to pay CAFE fines must all be specified, as these affect the model’s ability to evaluate the manufacturer for compliance. The banked credits (CAFE and CO₂) are not required for compliance; however, omitting these is likely to produce higher cost of compliance for each manufacturer. Lastly, the usage of ZEV credits within the model is presently experimental.

Table 21. Manufacturers Worksheet

Category	Column	Units	Definition/Notes
General	Manufacturer Code	integer	Unique number assigned to each manufacturer.
	Manufacturer Name	text	Name of the manufacturer.
	Discount Rate	number	Represents the manufacturer specific discount rate, which factors into the effective cost calculation. The discount rates are specified per class and style of a vehicle.
	Payback Period	number	The number of years required for an initial investment to be repaid in the form of future benefits or cost savings. The payback periods are specified per class and style of a vehicle.
	Payback Period (OC)	number	The payback period to use after the manufacturer reached compliance.
AC and Off-Cycle Credits	AC Efficiency	grams/mile	The adjustment factor associated with improvements in air conditioning efficiency a manufacturer may claim toward compliance with either EPA's CO-2 standards or NHTSA's CAFE standards. The adjustment factor is specified in and is applied as grams/mile of CO-2.
	AC Leakage	grams/mile	The adjustment factor associated with improvements in air conditioning leakage a manufacturer may claim toward compliance with EPA's CO-2 standards. The adjustment factor is specified in and is applied as grams/mile of CO-2.
	Off-Cycle Credits	grams/mile	The amount of initial off-cycle credits a manufacturer may claim toward compliance with either EPA's CO-2 standards or NHTSA's CAFE standards. The credit value is specified in and is applied as grams/mile of CO-2.
Banked Credits (credits)	PC-2010 to PC-2015	credits	Represents the manufacturer's available credits, banked from model years preceding the start of analysis, specified for each regulatory class between model years 2010 and 2015.
	LT-2010 to LT-2015	credits	
	2B3-2010 to 2B3-2015	credits	
Banked CO-2 Credits (credits; metric-tons)	PC-2010 to PC-2015	credits (metric-tons)	Represents the manufacturer's available CO-2 credits, banked from model years preceding the start of analysis, specified for each regulatory class between model years 2010 and 2015.
	LT-2010 to LT-2015	credits (metric-tons)	
	2B3-2010 to 2B3-2015	credits (metric-tons)	
FFV Credits (mpg)	PC-2015 to PC-2019	mpg	Represents the manufacturer's available FFV credits towards CAFE compliance, specified for each regulatory class between model years 2015 and 2019.
	LT-2015 to LT-2019	mpg	
	2B3-2015 to 2B3-2019	mpg	
ZEV Credits	CA+S177 Sales (%)	zevs	The percentage of manufacturer's total fleet assumed to be sold in California and S177 states.

DRAFT – July 2018

	CA+S177 ZEV (%)	zevs	The percentage of manufacturer's ZEV credits assumed to be generated in California and S177 states.
Prefer Fines	PF-2015	text	Represents whether the manufacturer prefers to pay civil penalties instead of applying non cost-effective technologies in each of the specified model years. - Y = pay fines instead of applying ineffective technologies - N = apply ineffective technologies instead of paying fines
	PF-2016	text	
	...	text	
	PF-2031	text	
	PF-2032	text	

A.1.2 Vehicles Worksheet

The vehicles worksheet contains information regarding each vehicle model offered for sale during the study period. Each vehicle model is represented as a single row of input data. Data in Table 22 lists the different columns of information specified in the vehicle models worksheet. The vehicle code must be a unique number assigned to each vehicle model.

Table 22. Vehicles Worksheet

Category	Column	Units	Definition/Notes
General	Vehicle Code	integer	Unique number assigned to each vehicle.
	Manufacturer	text	The manufacturer of the vehicle.
	Brand	text	The brand name of the vehicle.
	Model	text	Name of the vehicle model.
	Nameplate	text	The nameplate of the vehicle.
	Platform	text	The platform of the vehicle.
	Engine Code	integer	The engine code of the engine that the vehicle uses.
	Transmission Code	integer	The transmission code of the transmission that the vehicle uses.
Fuel Economy	Fuel Economy (by Fuel Type ⁶⁵)	mpg	The CAFE fuel economy rating of the vehicle for each fuel type.
	Fuel Share (by Fuel Type ⁶⁵)	percentage	The percent share that the vehicle runs on each fuel type. This value indicates the amount of miles driven by the vehicle on each fuel type. The sum of all fuel shares for any given vehicle must add up to one.
Sales	MY2015	units	Vehicle's projected production for sale in the US.
	MY2016	units	
	...		
	MY2031	units	
	MY2032	units	
MSRP	MSRP	dollars	Vehicle's projected average MSRP (sales-weighted, including options).
Vehicle Information	Origin	text	D = domestic; I = imported
	Style	text	Vehicle style.
	Structure	text	Vehicle structure (ladder or unibody).
	Drive	text	Vehicle drive (A=all-wheel drive, F=front-wheel drive, R=rear-wheel drive, 4=four-wheel drive).
	Footprint	sq. feet	The vehicle footprint; wheelbase times average track width.
	Curb Weight	pounds	Total weight of the vehicle, including batteries, lubricants, and other expendable supplies, but excluding the driver, passengers, and other payloads (SAE J1100).
	GVWR	pounds	Gross Vehicle Weight Rating; weight of loaded vehicle, including passengers and cargo.
	GCWR	pounds	Gross Combined Weight Rating; weight of loaded vehicle, including passengers and cargo, as well as the mass of the trailer and cargo in the trailer.
	Max GVWR/CW	proportion	Maximum ratio of GVWR to Curb Weight allowed for the vehicle. During application of mass reduction technology, vehicle's GVWR will be adjusted such that its GVWR/CW ratio does not exceed this value.

⁶⁵ For each vehicle, fuel economies and fuel shares are reported independently for each of the following fuel types: gasoline, E85, diesel, electricity, hydrogen, and CNG. If the vehicle does not use a specific fuel type, the associated fuel economy and fuel share values will be zero. Along with the “Fuel Economy” section defined for each fuel type independently, the vehicles worksheet also includes the “Primary Fuel Type”, “Primary Fuel Economy”, “Secondary Fuel Type”, and “Secondary Fuel Economy” columns. These columns, however, **ARE NOT** utilized by the CAFE Model during runtime and are presented for reference only. For the market data input file used during the current analysis of CAFE and CO₂ standards, the fuel economy information provided by these columns should typically correlate with the data presented in the “Fuel Economy” section as described in Table 22.

DRAFT – July 2018

	Max GCWR/GVWR	proportion	Maximum ratio of GCWR to GVWR allowed for the vehicle. During application of mass reduction technology, vehicle's GVWR will be adjusted such that its GVWR/CW ratio does not exceed this value.
	Fuel Capacity	gallons	The capacity of the vehicle's fuel tank in gallons of diesel fuel or gasoline; MJ (LHV) of other fuels (or chemical battery energy).
	Dealership Employment Hours	hours	The average employment hours originating at US dealerships for a single vehicle unit of a specific model.
	US Assembly Employment Hours	hours	The average employment hours associated with US assembly and manufacturing of a single vehicle unit of a specific model.
	Percent US Content	percentage	The percentage of vehicle's content (parts and labor) originating in the US.
Vehicle Powertrain	Vehicle Power	hp	Maximum horsepower produced by the vehicle's engine or motor.
	Vehicle Power (RPM)	rpm	The RPM at which vehicle's maximum horsepower is attained.
	Vehicle Torque	lb-ft	Maximum torque produced by the vehicle's engine or motor.
	Vehicle Torque (RPM)	rpm	The RPM at which vehicle's maximum torque is attained.
Refresh/Redesign	Refresh Years	model year	List of previous and future refresh years of the vehicle, separated by a semicolon.
	Redesign Year	model year	List of previous and future redesign years of the vehicle, separated by a semicolon.
Regulatory Classification	Regulatory Class	text	The regulatory assignment of the vehicle. - PC = the vehicle should be regulated as a passenger automobile - LT = the vehicle should be regulated as a light truck - LT2b3 = the vehicle should be regulated as a class 2b/3 truck
	Technology Class	text	The technology class assignment of the vehicle.
	Engine Technology Class	text	The engine technology class assignment of the vehicle.
	Safety Class	text	The safety class assignment of the vehicle. - PC = the vehicle belongs to a passenger automobile safety class - LT = the vehicle belongs to a light truck/SUV safety class - CM = the vehicle belongs to a light CUV/minivan safety class
	ZEV Candidate	text	Indicates whether a vehicle is a preferred candidate for ZEV technology application. The modeling system will attempt to upgrade ZEV candidates to a PHEV or a BEV in order to meet the ZEV requirement.
Technology Applicability	EPS	text	<blank> = the technology is not used on the vehicle USED = the technology is used on the vehicle SKIP = the technology is not applicable to the vehicle
	CONV	text	
	IACC	text	
	SS12V	text	
	BISG	text	
	CISG	text	
	SHEVP2	text	
	SHEVPS	text	
	PHEV30	text	
	PHEV50	text	
	BEV200	text	
	FCV	text	
	LDB	text	
	SAX	text	
	ROLL0	text	
	ROLL10	text	
	ROLL20	text	
	MR0	text	
	MR1	text	
	MR2	text	
	MR3	text	
	MR4	text	
	MR5	text	
AERO0	text		
AERO5	text		
AERO10	text		
AERO15	text		
AERO20	text		

When defining a vehicle’s fuel economy, for single fuel vehicles, only one fuel economy value, along with the analogous fuel share, must be specified. For multi-fuel vehicles (*i.e.*, FFVs and PHEVs), the fuel economy and fuel share values on each fuel must be specified. The fuel share should correspond to the on-road miles traveled by a vehicle when operating on a given fuel. Additionally, the sum of fuel shares across all used fuel types must add up to 100%.

The applicability of technologies considered on a vehicle model basis (as opposed, for example, on an engine basis) can be controlled for each vehicle model by using the *Technology Applicability* category. Since the modeling system relies heavily on these settings when determining the initial usage and availability of technology to a vehicle, this section must be complete and accurate in order to avoid modeling errors.

A.1.3 Engines Worksheet

Similar to the vehicles input sheet, the engines worksheet contains a list of all engines used in vehicle models offered for sale during the study period. The engine code is a unique number assigned to each such engine. This code is referenced in the engine code field on the vehicles worksheet. As in the vehicles worksheet, the *Technology Applicability* for any engine technology must be complete and accurate for any specific engine. Table 23 lists all columns available on the engines worksheet.

Table 23. Engines Worksheet

Category	Column	Units	Definition/Notes
General	Engine Code	integer	Unique number assigned to each engine.
	Manufacturer	text	The manufacturer of the engine.
	Fuel	text	One or more fuel types with which the engine is compatible. - G = gasoline - D = diesel - G+E85 = flex fuel engine, running on gasoline and E85 - CNG = compressed natural gas
	Engine Oil Viscosity ⁶⁶	text	Ratio between the applied shear stress and the rate of shear, which measures the resistance of flow of the engine oil (as per SAE Glossary of Automotive Terms).
	Cycle ⁶⁶	text	Combustion cycle of the engine.
	Air/Fuel Ratio ⁶⁶	number	Weighted (FTP+highway) air/fuel ratio (mass).
	Fuel Delivery System ⁶⁶	text	The mechanism that delivers fuel to the engine.
	Valvetrain Design	text	Design of the total mechanism from camshaft to valve of an engine that actuates the lifting and closing of a valve (per SAE Glossary of Automotive Terms).
	Valve Actuation/Timing ⁶⁶	text	Valve opening and closing points in the operating cycle (SAE J604). - F = fixed - VVT = variable valve timing - ICP = intake cam phasing VVT - DCP = dual cam phasing VVT - CCP = coupled cam phasing VVT
	Valve Lift ⁶⁶	text	The manner in which the valve is raised during combustion (per SAE Glossary of Automotive Terms). - F = fixed - VVL = variable valve lift - DVVL = discrete VVL - CVVL = continuous VVL
	Displacement	liters	Total volume displaced by a piston in a single stroke.
	Configuration	text	Configuration of the engine.
Cylinders	integer	Number of engine cylinders.	

⁶⁶ Some of the engine configuration columns are specified for reference and are not used by the modeling system. Instead, the values in these columns are used to inform the initial utilization of engine-level technologies as specified in the technology applicability section.

DRAFT – July 2018

	Valves/Cylinder ⁶⁶	integer	Number of valves per cylinder.
	Deactivation ¹	text	Indicates whether the engine includes a cylinder deactivation mechanism. - Y = cylinder deactivation applied - N = cylinder deactivation not applied
	Aspiration	text	Breathing or induction process of the engine (per SAE Glossary of Automotive Terms). - NA = naturally aspirated - S = supercharged - T = turbocharged - T2 = twin-turbocharged - T4 = quad-turbocharged - ST = supercharged and turbocharged
	Compression Ratio (Min) ⁶⁶	number	Minimum compression ratio of an engine.
	Compression Ratio (Max) ⁶⁶	number	Maximum compression ratio of an engine.
Technology Applicability	SOHC	text	<blank> = the technology is not used on the engine USED = the technology is used on the engine SKIP = the technology is not applicable to the engine
	DOHC	text	
	OHV	text	
	LUBEFR1	text	
	LUBEFR2	text	
	LUBEFR3	text	
	VVT	text	
	VVL	text	
	SGDI	text	
	DEAC	text	
	TURBO1	text	
	TURBO2	text	
	CEGR1	text	
	CEGR2	text	
	HCR1	text	
	HCR2	text	
	VCR	text	
	ADEAC	text	
ADSL	text		
DSLI	text		
CNG	text		

A.1.4 Transmissions Worksheet

Similar to the vehicles and engines input sheets, the transmissions worksheet contains a list of all transmissions used in vehicle models offered for sale during the study period. The transmission code is a unique number assigned to each such transmission. This code is referenced in the transmission code field on the vehicles worksheet. As in the vehicles and engines worksheets, the *Technology Applicability* for any transmission technology must be complete and accurate for any specific transmission.

Table 24. Transmissions Worksheet

Category	Column	Units	Definition/Notes
General	Transmission Code	integer	Unique number assigned to each transmission.
	Manufacturer	text	The manufacturer of the transmission.
	Type	text	Type of the transmission. - M or MT = manual transmission - A or AT = automatic transmission (torque converter) - AMT = automated manual transmission (single clutch w/ torque interrupt) - DCT = dual clutch transmission - CVT = belt or chain CVT
	Number of Forward Gears	integer	Number of forward gears the transmission has.
Technology Applicability	MT5	text	<blank> = the technology is not used on the transmission USED = the technology is used on the transmission SKIP = the technology is not applicable to the transmission
	MT6	text	
	MT7	text	
	AT5	text	
	AT6	text	

DRAFT – July 2018

AT6L2	text
AT6L3	text
AT7	text
AT8	text
AT8L2	text
AT8L3	text
AT9	text
AT10	text
AT10L2	text
DCT6	text
DCT8	text
CVT	text
CVTL2A	text
CVTL2B	text

A.2 Technologies File

The technologies input file contains assumptions regarding the cost and applicability of different vehicle, platform, engine, and transmission-level technologies available during the study period, as well as fuel consumption benefits attributable to “add-on” technologies. As described in Section S4.1 above, input assumptions are defined for the twelve vehicle technology classes listed in Table 10 and sixteen engine technology classes listed in Table 11.

In addition to the inputs defined for each technology, the input file also includes a “Parameters” worksheet defining global settings that affect applicability of all technologies. Presently, this worksheet contains limited settings, and not all of the parameters defined therein are used directly by the CAFE Model. Table 25 shows the contents of the parameters worksheet.

Table 25. Global Parameters

Category	Column	Units	Definition/Notes
Global Parameters	Model Years Covered	integer	Defines a range of model years for which various technology related cost fields are defined. These values are only used internally within the technologies input file and are not loaded by the model.
Other	Tech Class	text	Technology class for which a parameter is specified.
	Glider Share	number	Assumed average glider share for each technology class.

Input assumptions that are common among all technology classes are listed on a separate technologies definitions tab. Table 26 shows the contents of a technologies definitions tab for all classes while Table 27 and Table 28 shows the contents of the technology assumptions tabs.

Table 26. Technology Definitions

Category	Column	Units	Definition/Notes
General	Index ⁶⁷	integer	Unique index assigned to each technology.
	Name	text	Name of the technology.
	Technology Description ⁶⁷	text	Description of the technology.
	Technology Pathway ⁶⁷	text	The path within which the technology progresses. For most technologies, the incremental costs and fuel consumption improvements are accrued over the preceding technology within the same path.
Off-Cycle Credits	Phase-in Cap	percentage	Percentage of the entire fleet to which the technology may be applied.
	DC OCC	grams/mile	Amount of off-cycle credit that the vehicles incur as a result of applying the technology. Specified in grams per mile of CO2 for each regulatory class.
	IC OCC		
	LT OCC		
Other	2b3 OCC		
Other	ZEV Credits	zevs	Amount of ZEV credits a vehicle will generate upon application of the technology.

The technology assumptions inputs listed in Table 27 are specified for each technology and are replicated for each of the defined vehicle technology classes as individual worksheets.

Table 27. Technology Assumptions

Category	Column	Units	Definition/Notes
General	Index ⁶⁷	integer	Unique index assigned to each technology.
	Name	text	Name of the technology.
	Technology Pathway ⁶⁷	text	The path within which the technology progresses.

⁶⁷ Some of the technology-specific attributes are hard-coded into the model and listed in the technologies input file for reference. These value are not loaded by the model.

DRAFT – July 2018

Availability	Applicable	boolean	TRUE = the technology is available for applicability in a technology class FALSE = the technology is not available for applicability in a technology class
	Year Avail.	model year	First year the technology is available for applicability.
	Year Retired	model year	Last year the technology is available for applicability.
FC Improvements	FC	percentage	Fuel consumption improvement estimate of a technology. This value is applicable only to "add-on" technologies; that is, those technologies that are not explicitly defined in the Argonne simulation database.
	Secondary FC	percentage	This value is not applicable for the current analysis.
	Secondary FS	percentage	Percentage of miles a vehicle is expected to travel on its secondary fuel after applying a dual-fuel technology (applicable when a vehicle is being converted into a plug-in HEV or another form of dual fuel vehicle).
Misc Attributes	Electric Range	number	Indicates what the range, in miles, of an electric vehicle would be when operating on a battery, as a result of applying the technology (applies to PHEV and EV technologies only).
	Electric Power	hp	Indicates what the power of an electric vehicle would be when operating on a battery, as a result of applying the technology (applies to PHEV and EV technologies only).
	Delta Weight (%)	percentage	Percentage by which the vehicle's weight changes as a result of applying the technology.
	Delta Weight (lbs)	number	Amount of pounds by which the vehicle's weight changes as a result of applying the technology.
	Consumer Valuation	dollars	Consumer welfare loss associated with application of the technology.

The technology costs inputs shown in Table 28 are specified for each technology, for each of the defined vehicle technology classes as well as each of the defined engine technology classes. For vehicle technology classes, the cost inputs of transmission-, platform-, and vehicle-level technologies are listed on the same worksheets as the technology assumptions. For engine-level technologies, the cost inputs are defined on separate worksheets corresponding to the engine technology classes.

Table 28. Technology Costs

Category	Column	Units	Definition/Notes
General	Index ⁶⁷	integer	Unique index assigned to each technology.
	Name	text	Name of the technology.
	Technology Pathway ⁶⁷	text	The path within which the technology progresses.
Cost Table	C-2015	dollars	Table of learned out cost estimates for the technology, per model year.
	C-2016	dollars	
	...		
	C-2031	dollars	
	C-2032	dollars	
Battery Cost Learning Rates Table	BCL-2015	dollars	Table of scalars and learning rates associated with battery cost estimates for the current technology, per model year.
	BCL-2016	dollars	
	...		
	BCL-2031	dollars	
	BCL-2032	dollars	
Maintenance and Repair Cost Table	M/R-2015	dollars	Table of learned out maintenance and repair cost estimates for the technology, per model year.
	M/R-2016	dollars	
	...		
	M/R-2031	dollars	
	M/R-2032	dollars	
Stranded Capital Table	SC-1	dollars	Penalty costs associated with replacing (or superseding) a technology early.
	SC-2	dollars	
	...		
	SC-9	dollars	
	SC-10	dollars	

A.2.1 Cost Adjustment Factors

The technologies input file contains an additional worksheet (named “Cost Synergies”) for specifying the cost adjustment factors used for adjusting the base cost of a technology. The detailed

DRAFT – July 2018

description and applicability of these adjustment factors is described in Section S4.7 above. Table 29 shows the contents of the Cost Synergies worksheet.

Table 29. Cost Synergies

Category	Column	Units	Definition/Notes
General	Technologies	text	Combination of technologies to which the cost synergy applies.
	Engine Class	text	Engine technology class to which the cost synergy applies.
Adjustment Factors by Model Year	2015	dollars	Amount by which to offset the technology cost whenever application of a technology results in a vehicle using all technologies specified in the "technologies" column. A separate synergy value may be specified for each technology cost class and model year.
	2016	dollars	
	...		
	2031	dollars	
	2032	dollars	

A.3 Parameters File

The parameters input file contains a variety of input data and assumptions used to estimate various impacts of the simulated response of the industry to CAFE standards. This file contains a series of worksheets, the contents of which are summarized below. When the CAFE Model calculates the modeling effects, since all of the results are aggregated and reported as a combined Passenger Car regulatory class (where having a “domestic” vs “imported” distinction is not relevant), all of the worksheets that disaggregate input data by regulatory class also provide a single input for the combined passenger car fleet. The only exception is the “Credit Trading Values” worksheet, which presently separates the input assumptions for each regulatory class (*i.e.*, DC, IC, LT, LT2b3).

A.3.1 Economic Values

The Economic Values worksheet contains an estimate of the magnitude of the “rebound effect”, as well as the rates used to compute the economic value of various direct and indirect impacts of CAFE and CO₂ standards, and the discount rate to apply when calculating present value of benefits. As mentioned above, the user can define and edit all inputs. For example, although the economic values in Table 30 were obtained from various sources of information, the system does not require that the user rely on these sources.

Table 30. Economic Values Worksheet

Category	Model Characteristic	Units	Definition/Notes
Economic Values	Social Discount Rates	percentage	A semicolon separated list of one or more social discount rates, which is the percent rate by which the dollar value of a benefit or cost is reduced when its receipt or payment is postponed by one additional year into the future.
	Base Year for Discounting	percentage	The calendar year to use for "present year" discounting. If a base year value is used, social discounting is assumed, with all costs and benefits being discounted to that year. If no value is specified, private discounting is implied, with all costs and benefits being discounted to the model year being analyzed.
	Consumer Discount Rates	percentage	A semicolon separated list of one or more consumer discount rates.
	Rebound Effect	percentage	Average elasticity of demand for travel. That is, the percent change in average annual VMT per vehicle resulting from a percent change in fuel cost per mile driven.
	<i>Annual Growth Rate for Average VMT per Vehicle</i>	<i>various</i>	Annual growth rate for average VMT per vehicle.
	Base Year for Average Annual Usage Data	model year	Base year for annual growth rate for average VMT per vehicle.
	Growth Rate at Low Fuel Price	percentage	Annual growth rate for average VMT per vehicle, when using low fuel prices.
	Growth Rate at Average Fuel Price	percentage	Annual growth rate for average VMT per vehicle, when using average fuel prices.
	Growth Rate at High Fuel Price	percentage	Annual growth rate for average VMT per vehicle, when using high fuel prices.
	"Gap" between Test and On-Road MPG (by Fuel Type)	percentage	Difference between a vehicle's EPA fuel economy rating and its actual on-road fuel economy.
	Fixed Component of Average Refueling Time in Minutes (by Fuel Type)	minutes	Average refueling time a spent by a consumer refueling the vehicle tank or recharging the vehicle electric battery.
	Average Tank Volume Refueled	percentage	Average tank volume refilled during a refueling stop.
	Value of Travel Time per Vehicle	\$/hour	Amount that the driver of a vehicle would be willing to pay to reduce the time required to make a trip.
	<i>External Costs from Additional Vehicle Use Due to "Rebound" Effect</i>	<i>\$/vehicle-mile</i>	Estimates intended to represent costs per vehicle-mile of increased travel compared to approximately current levels, assuming current distribution of travel by hours of the day and facility types.
	Congestion	\$/vehicle-mile	Congestion component of external costs from additional vehicle use.
	Accidents	\$/vehicle-mile	Accidents component of external costs from additional vehicle use.
Noise	\$/vehicle-mile	Noise component of external costs from additional vehicle use.	

DRAFT – July 2018

Ownership and Operating Costs	<i>various</i>	Ownership and operating costs associated with purchase of new vehicles.
Taxes & Fees (% of final vehicle MSRP)	percentage	Average percentage of the vehicle's final MSRP the consumer pays in taxes and fees when purchasing a new vehicle.
Financing Term (months)	months	Average length of time used by consumers to finance a new vehicle purchase.
Financing Interest (%)	percentage	Average interest rate used by consumers to finance a new vehicle purchase.
Share Financed (%)	percentage	Percentage of consumers that choose to finance their new vehicle purchase.
Vehicle Depreciation (%)	percentage	Typical depreciation rate of a new vehicle.
Relative Value Loss (% of final vehicle MSRP)	percentage	This option is not used in this version of the model.
Resale Value	percentage	This option is not used in this version of the model.
Economic Costs of Oil Imports	<i>\$/gallon</i>	Economic costs of oil imports attributed to various market externalities, specified per calendar year.
"Monopsony" Component	\$/gallon	Demand cost for imported oil, determined by a complex set of factors, including the relative importance of U.S. imports in the world oil market and demand to its world price among other participants in the international oil market.
Price Shock Component	\$/gallon	Expected value of cost to U.S. economy from reduction in potential output resulting from risk of significant increases in world petroleum price. This includes costs resulting from inefficiencies in resource use caused by incomplete adjustments to industry output levels and mixes of production input when world oil price changes rapidly.
Military Security Component	\$/gallon	Cost to taxpayers for maintaining a military presence to secure the supply of oil imports from potentially unstable regions of the world and protect the nation against their interruption.
Macroeconomic Parameters	<i>various</i>	Defines various additional macroeconomic parameters, specified per calendar year.
Interest Rate	number	Interest rate in the specific calendar year.
GDP Growth Rate	number	GDP growth rate in the specific calendar year.
Labor Force Participation	k. jobs	Labor force participation, specified in thousands of jobs, in the specific calendar year.

A.3.2 Vehicle Age Data

The Vehicle Age Data worksheet contains age-specific (*i.e.*, vintage-specific) estimates of the survival rate and annual accumulated mileage applicable to different vehicle categories.

Table 31. Vehicle Age Data Worksheet

Category	Model Characteristic	Units	Definition/Notes
Vehicle Age Data	Survival Rates	proportion	The baseline proportion of original vehicle sales that remain in service by vehicle age (year 1 to 30 for cars, 1 to 37 for trucks). The baseline survival rates are ignored if the Dynamic Scrappage setting is enabled during analysis.
	Miles Driven	miles	Average annual miles driven by surviving vehicles by vehicle age (year 1 to 30 for cars, 1 to 37 for trucks). If the Dynamic Scrappage setting is enabled during analysis, the full schedule of miles driven (1 to 40 years) will be evaluated.

Separate survival fractions and annual miles driven are used for different categories of vehicles. These categories include: cars, vans/SUVs, pickups, and class 2b/3 trucks. The survival fractions measure the proportion of vehicles originally produced during a model year that remain in service at each age, by which time only a small fraction typically remain in service. If the Dynamic Scrappage runtime option is enabled within the CAFE Model’s GUI, the baseline survival rates defined in the input file will be overridden when the system calculates the modeling effects. However, the “live” fuel and CO₂ savings displayed in the model’s GUI during runtime will still be calculated using the survival rates defined in the parameters input file.

A.3.3 Fuel Prices

The Fuel Prices worksheet contains historic and estimates of future fuel prices, which are used when calculating pre-tax fuel outlays and fuel tax revenues.

Table 32. Forecast Data Worksheet

Category	Model Characteristic	Units	Definition/Notes
Fuel Prices	Retail Fuel Prices (low, average, high)	\$/fuel unit	Forecast of retail fuel prices by calendar year starting with CY-1975, specified for each fuel type in dollars per applicable fuel unit. For gasoline, diesel, and E85, fuel prices are in \$/gallon; for electricity, \$/kwh; for hydrogen and CNG, \$/scf.
	Fuel Taxes	\$/fuel unit	Forecast of fuel taxes by calendar year starting with CY-1975, specified for each fuel type in dollars per applicable fuel unit.

A.3.4 Fuel Economy Data

The Fuel Economy Data worksheet contains historic fuel economy levels for passenger cars, light trucks, and class 2b/3 trucks, for each fuel type. The associated fuel shares are also provided. This worksheet must include “rated” fuel economy data (without any fuel economy credits or adjustments, as defined in the main body of this document), starting with model year 1975 and extending through the first model year evaluated during the study period. For the current analysis, the model first year evaluated is 2016; hence, the range of historic fuel economy (and fuel share) values must be defined for model years 1975 through 2016.

Table 33. Fuel Economy Data Worksheet

Category	Model Characteristic	Units	Definition/Notes
Fuel Economy Data	Fuel Economy (by Fuel Type and Fleet)	mpg	Historic fuel economy levels for each available fuel type and fleet type.
	Fuel Share (by Fuel Type and Fleet)	percentage	Historic fuel shares for each available fuel type and fleet type.

A.3.5 Fleet Analysis Values

The Fleet Analysis Values worksheet contains fine tuning parameters for performing fleet analysis calculations. The Forecast of Sales contains projected vehicle production for sale in the U.S. between model years 2014 and 2050 and is used to estimate additional car and truck fleet values, beyond what is available on the Historic Fleet Data worksheet (discussed below). When fleet analysis option is used, the system evaluates modeling effects for historic and forecast model years, producing outputs typically required for the EIS.

Table 34. Fleet Analysis Values Worksheet

Category	Model Characteristic	Units	Definition/Notes
Fleet Analysis Values	Fuel Economy Growth Rates		
	Baseline Scenario (by Fleet Type)	percentage	Growth rates used to estimate additional fuel economy growth beyond the last model year covered during the study period for the baseline scenario.
	Action Alternatives (by Fleet Type)	percentage	Growth rates used to estimate additional fuel economy growth beyond the last model year covered during the study period for the action alternatives.
	CAFE Start Year (by Fleet Type)	model year	This option is not used in this version of the model.
	Forecast of Sales (by Fleet Type)	units	The forecast of total industry sales by model year. The first model year specified should be immediately following the last model year from the Historic Fleet Data. Forecast of Sales are used to scale individual vehicle sales, after the last compliance model year, in order to evaluate the fuel use and environmental effects of future years during Fleet Analysis.

A.3.6 Historic Fleet Data

The Historic Fleet Data worksheet provides historic data of vehicles remaining on the road, specified by model year for each vehicle age, for the car, class 1/2a truck, and class 2b/3 truck fleets. The period of years covered is between 1975 and 2015.

Table 35. Historic Fleet Data Worksheet

Category	Model Characteristic	Units	Definition/Notes
Historic Fleet Data	Fleet Data (by Fleet Type)	units	Historic car and truck fleet data for each fleet type and model year, specified by vehicle age.

A.3.7 Scrappage Model Values

The Scrappage Model Values worksheet contains fine tuning parameters for dynamically calculating the proportion of vehicles scrapped during each calendar year. When the Dynamic Scrappage option is used in the model, the system replaces the survival rates defined on Vehicle Age worksheet with the ones obtain using the Dynamic Scrappage Model.

Table 36. Scrappage Model Values Worksheet

Category	Model Characteristic	Units	Definition/Notes
Scrappage Model Values	Estimate Scrappage	boolean	Indicates whether to estimate scrappage for vehicles with a specific style.
	Beta Coefs	number	Beta coefficients used to estimate scrappage.
	<i>Historic Fleet Data by Model Year and Vehicle Style in CY-2016</i>	<i>various</i>	Historic fleet information, which serves as the "seed" data for the dynamic scrappage model.
	Model Year	model year	Model year vintages on the road in calendar year 2016 (ages 0-39).
	Initial Fleet	units	Initial on-road fleet (at age 0) of a specific vintage and vehicle type.
	On-road Fleet	units	Surviving on-road fleet of a specific vintage and vehicle type during calendar year 2016.
	Lag Scrappage	number	The natural log of the scrappage rate for calendar year 2015.
	Lag2 Scrappage	number	The natural log of the scrappage rate for calendar year 2014.
	Lag3 Scrappage	number	The natural log of the scrappage rate for calendar year 2013.
	PC Share	percentage	The share of the on-road fleet that is regulated as passenger car. The remaining share is regulated as light truck.
	Fuel Economy	mpg	Average fuel economy for a specific vintage and vehicle type at age 0.
	Horsepower	hp	Average horsepower for a specific vintage and vehicle type at age 0.
	Curb Weight	lbs.	Average curb weight for a specific vintage and vehicle type at age 0.
Transaction Price	dollars	Average transaction price for a specific vintage at age 0.	

A.3.8 Safety Values

The Safety Values worksheet contains parameters for estimating fatalities due to changes in total vehicle miles traveled and decreases in vehicle weight.

Table 37. Safety Values Worksheet

Category	Model Characteristic	Units	Definition/Notes
Safety Values	PC Threshold	lbs.	The boundary between small and large weight effects by safety class.
	LT/SUV Threshold	lbs.	
	CUV/Minivan Threshold	lbs.	
	<i>Parameters</i>	<i>various</i>	Safety parameters for a specific class and weight category.
	Change per 100 lbs.	percentage	Change per 100 lbs.

DRAFT – July 2018

	Base per billion miles	number	Base fatalities per billion miles.
	Adjustment for new FMVSS	percentage	Adjustment for new FMVSS.
	<i>Safety Costs</i>	<i>various</i>	Safety related costs.
	Fatality Costs	dollars	Social costs arising from vehicle fatalities.
	Non-Fatal Costs Scalar	dollars	Social costs arising from non-fatal vehicle crashes.
	Growth Rate	percentage	Annual growth rate for fatality costs per vehicle.
	Base Year for Annual Growth	model year	Base year for annual growth rate for fatality costs per vehicle.
	<i>Fatality Estimates for the Historic Fleet</i>	<i>various</i>	Coefficients for a "new" safety model, specified by model year. Applicable to the historic as well as modeled fleet.
	Initial Rate	number	This option is not used in this version of the model.
	Fixed Effect	number	The fixed amount by which vehicle-related fatality incidents are offset during a specific model year, starting from a base value of 28.58895 in model year 1975.

A.3.9 Credit Trading Values

The Credit Trading Values worksheet contains fine tuning parameters for enabling credit transfers and credit carry forward within the model.

Table 38. Credit Trading Values Worksheet

Category	Model Characteristic	Units	Definition/Notes
Credit Trading Values	<i>Credit Trading Options</i>		
	Trade credits between manufacturers	boolean	This option is not used in this version of the model.
	Transfers credits between regulatory classes	boolean	Whether to allow credit transfers between regulatory classes within the same manufacturer and model year.
	Carry credits forward into future model years	boolean	Whether to allow carrying of credits forward into the analysis year from earlier model years within the same manufacturer and compliance category.
	Maximum number of years to carry forward	integer	Maximum number of model years to look forward.
	Carry credits backward into past model years	boolean	This option is not used in this version of the model.
	Maximum number of years to carry backward	integer	This option is not used in this version of the model.
	Transfer Caps (mpg)	mpg	Transfer caps corresponding to the maximum amount of credits that may be transferred into a compliance category for each model year. The cap from the latest model year is carried forward for all subsequent years.
	Assumed Lifetime VMT by Regulatory Class	miles	Assumed lifetime VMT to use when credits are transferred between compliance categories.
	<i>Additional Runtime Options</i>		
Maximum Expiring Credit Years to Consider	integer	The modeling system will attempt to use available credits before they expire. This setting indicates maximum number of model years to consider when using expiring credits.	

A.3.10 ZEV Credit Values

The ZEV Credit Values worksheet contains parameters allowing the modeling system to target the ZEV requirements of CA+S177 states during compliance simulation. Presently, usage of ZEV credits within the CAFE Model should be considered as experimental.

Table 39. ZEV Credit Values Worksheet

Category	Model Characteristic	Units	Definition/Notes
ZEV Credit Values	ZEV Requirement (%)	percentage	Minimum percentage of zero emission vehicle (ZEV) credits that a manufacturer must generate in order to meet the ZEV requirement in each specified model year.
	Max Credits from PHEV (%)	percentage	Maximum percentage of ZEV credits that a manufacturer may generate from PHEVs in order to meet the ZEV requirement in each specified model year.

A.3.11 DFS Model Values

The DFS Model Values worksheet contains fine tuning parameters for utilizing the Dynamic Fleet Share and Sales Response model (DFS/SR) within the CAFE modeling system. When enabled, the DFS/SR model adjusts the production volumes and fleet shares in future model years as a response to increasing fuel economies and costs of vehicle models.

Table 40. DFS Model Values Worksheet

Category	Model Characteristic	Units	Definition/Notes
DFS Model Values	<i>Seed Values (per Model Year)</i>	<i>various</i>	Fleet-specific seed values for the Dynamic Fleet Share and Sales Response model, specified for LDV and LDT1/2 fleets and for model years 2014 and 2015.
	Share of Total Fleet	percentage	Observed share of either LDV or LDT1/2 fleets versus the total light duty fleet, during a specific model year.
	Fuel Economy	mpg	Average fuel economy for a specific fleet, during a specific model year.
	Horsepower	hp	Average horsepower for a specific fleet, during a specific model year.
	Curb Weight	lbs.	Average curb weight for a specific fleet, during a specific model year.
	<i>Coefficients</i>	number	Fleet-specific coefficients for the Dynamic Fleet Share and Sales Response model, specified for LDV and LDT1/2 fleets.
	Constant	number	Specifies the NEMS "constant" coefficient.
	Rho	number	Specifies the NEMS "rho" coefficient.
	FP	number	Specifies the NEMS "fuel price" coefficient.
	HP	number	Specifies the NEMS "horsepower" coefficient.
	CW	number	Specifies the NEMS "curb weight" coefficient.
	MPG	number	Specifies the NEMS "mpg" coefficient.
Dummy	number	Specifies the NEMS "dummy" coefficient.	

A.3.12 Employment Values

The Employment Values worksheet is used for defining input assumptions necessary for calculating total US labor hours for each vehicle model, as well as changes in US labor years (or jobs) as a result of additional manufacturer revenue.

Table 41. Employment Values Worksheet

Category	Model Characteristic	Units	Definition/Notes
Employment Values	OEM Revenue per Employee	dollars	Manufacturer's revenue per employee.
	Supplier Revenue per Employee	dollars	Manufacturer supplier's revenue per employee.
	RPE Markup	number	Retail price estimate markup applied to technology costs.
	Annual Labor Hours	hours	Annual labor hours per employee.
	US Assembly/Manufacturing Jobs Multiplier	number	Multiplier to apply to US final assembly to get US direct automotive manufacturing labor hours.
	Global Multiplier	number	Multiplier to apply to all labor hours.

A.3.13 Emission Costs

The Emission Costs Worksheet contains emission damage costs arising from various pollutants.

Table 42. Emission Costs Worksheet

Category	Model Characteristic	Units	Definition/Notes
Emission Costs	<i>Emission Damage Costs</i>	<i>\$/metric-ton</i>	Costs arising from emission damage, other than CO-2.
	Carbon Monoxide	\$/metric-ton	Economic costs arising from Carbon Monoxide damage.
	Volatile Organic Compounds	\$/metric-ton	Economic costs arising from Volatile Organic Compounds damage.
	Nitrogen Oxides	\$/metric-ton	Economic costs arising from Nitrous Oxides damage.
	Particulate Matter	\$/metric-ton	Economic costs arising from Particulate Matter damage.
	Sulfur Dioxide	\$/metric-ton	Economic costs arising from Sulfur Oxides damage.

DRAFT – July 2018

	Methane	\$/metric-ton	Economic costs arising from Methane damage, specified as GWP-scalar of CO-2 Costs.
	Nitrous Oxide	\$/metric-ton	Economic costs arising from Nitrous Oxide damage, specified as GWP-scalar of CO-2 Costs.
	CO-2 Damage	various	Costs arising from CO-2 emission damage.
	CO-2 Discount Rates	percentage	Discount rates to apply to low, average, high, or very high Carbon Dioxide estimates.
	Cost of CO-2	\$/metric-ton	Economic costs arising from Carbon Dioxide damage, by calendar year; estimates for low, average, high, or very high growth rates are provided.

A.3.14 Fuel Properties

The Fuel Properties worksheet contains estimates of the physical properties of gasoline, diesel, and other types of fuels. The fuel properties are used to calculate the changes in vehicular carbon dioxide emissions that are likely to result from reduced motor fuel use.

Table 43. Fuel Properties Worksheet

Category	Model Characteristic	Units	Definition/Notes
Fuel Properties	Energy Density	BTU/unit	Amount of energy stored in a given system or region of space per unit volume, specified by fuel type.
	Mass Density	grams/unit	Mass per unit volume, specified by fuel type.
	Carbon Content	percentage by weight	Average share of carbon in fuel, specified by fuel type.
	SO ₂ Emissions	grams/unit	Sulfur Oxides emissions rate of gasoline and diesel fuels.
	Fuel Import Assumptions	N/A	These values have been moved and expanded to be represented by calendar year.

The “Fuel Import Assumptions” portion defined on the Fuel Properties worksheet is no longer used. The fuel import assumptions have been expanded to account for multiple calendar years evaluated throughout the analysis, and moved to a separate worksheet (discussed in the following section).

A.3.15 Fuel Import Assumptions

The Fuel Import Assumptions worksheet contains certain assumptions about the effects of reduced fuel use on different sources of petroleum feedstocks and on imports of refined fuels. These assumptions about the response of petroleum markets to reduced fuel use are used to calculate the changes in “upstream” emissions (from petroleum extraction and refining and from fuel storage and distribution) that are likely to result from reduced motor fuel use. The import assumptions are defined for select calendar years evaluated by the model, specified at either 5 or 10 year increments.

Table 44. Fuel Import Assumptions Worksheet

Category	Model Characteristic	Units	Definition/Notes
Fuel Import Assumptions	Calendar Year (1975-2050)	calendar year	The calendar year for which fuel import assumptions are defined.
	Share of Fuel Savings Leading to Lower Fuel Imports	percentage	Assumed value for share of fuel savings leading to lower fuel imports.
	Share of Fuel Savings Leading to Reduced Domestic Fuel Refining	percentage	Assumed value for share of fuel savings leading to reduced domestic fuel refining.
	Share of Reduced Domestic Refining from Domestic Crude	percentage	Assumed value for share of reduced domestic refining from domestic crude.
	Share of Reduced Domestic Refining from Imported Crude	percentage	Assumed value for share of reduced domestic refining from imported crude.

A.3.16 Upstream Emissions

The Upstream Emissions worksheets contain emission factors for greenhouse gas and criteria pollutant emissions from petroleum extraction and transportation, and from fuel refining, storage, and distribution. The upstream emissions are separated into a set of six worksheets corresponding to each fuel type supported within the model. For each fuel type, the upstream emissions are defined for select calendar years evaluated by the model, specified at either 5 or 10 year increments. For gasoline, e85, and diesel fuels, the emissions are separated by stages of production and distribution, as well as aggregated as “subtotals” according to the associated fuel import assumptions described in the preceding section. For electricity, hydrogen, and CNG fuel types, only the total emissions in each calendar year are provided.

Table 45. Upstream Emissions Worksheets

Category	Model Characteristic	Units	Definition/Notes
UE_Gasoline, UE_Ethanol85, UE_Diesel	Calendar Year (1975-2050)	grams/mil BTU	The calendar year for which upstream emissions attributable to a particular fuel type are defined. This field also contains subtotals from all stages of fuel production and distribution used by the modeling system during analysis.
	Petroleum Extraction	grams/mil BTU	Total emissions by stage of fuel production and distribution from petroleum extraction, specified by pollutant and fuel type.
	Petroleum Transportation	grams/mil BTU	Total emissions by stage of fuel production and distribution from petroleum transportation, specified by pollutant and fuel type.
	Petroleum Refining	grams/mil BTU	Total emissions by stage of fuel production and distribution from petroleum refining, specified by pollutant and fuel type.
	Fuel TS&D	grams/mil BTU	Total emissions by stage of fuel production and distribution from refined fuel transportation, storage, and delivery, specified by pollutant and fuel type.
UE_Electricity, UE_Hydrogen, UE_CNG	Calendar Year (1975-2050)	grams/mil BTU	The calendar year for which upstream emissions attributable to a particular fuel type are defined. This field also represents the total upstream emissions from all stages of production and distribution used by the modeling system during analysis.

A.3.17 Tailpipe Emissions

The Tailpipe Emissions worksheets contain emission factors for greenhouse gas and criteria pollutant emissions resulting from vehicle operation. The tailpipe emissions are defined for gasoline and diesel fuel types only, and are specified for each model year, vehicle age, and vehicle class (LDV, LDT1/2a, and LDT2b/3). For simplicity, vehicles operating on gasoline and e85 fuels utilize the tailpipe emissions provided on the TE_Gasoline worksheet, vehicles operating on diesel fuel use the emissions specified on the TE_Diesel worksheet, while vehicles operating on the remainder of the fuel types (*e.g.*, electricity) are assumed not to generate any emissions during on-road use.

Table 46. Tailpipe Emissions Worksheets

Category	Model Characteristic	Units	Definition/Notes
TE_Gasoline & TE_Diesel	Emission Rates (by Fuel Type and Fleet)	grams/mile	Vehicle emission rates from gasoline or diesel operation. Emission rates are specified for each fleet (LDV, LDT1/2a, and LDT2b/3), for historic and future model years, and for each vehicle age.

A.4 Scenarios File

The scenarios file provides one or more worksheets that begin with “SCEN_” and are identified as CAFE regulatory scenarios, which are defined in terms of the design and stringency of the CAFE program. Internally, the system numbers these scenarios as 0, 1, 2 ..., based on the order in which they appear in the input file. The first worksheet is assigned to “Scenario 0”, and is identified as the baseline scenario to which all others are compared. While the CAFE Model evaluates domestic and imported passenger automobiles as separate regulatory classes (as defined in Table 2 above), since NHTSA and EPA define a common functional standard for Domestic Car and Imported Car regulatory classes, the scenario definition provides a common “Passenger Car” sub-section describing the regulatory requirements applicable to those classes. As discussed above, the “Regulatory Class” column on the vehicles worksheet is used to indicate whether the vehicle is regulated as a Domestic Car (DC), Imported Car (IC), Light Truck (LT), or Light Truck 2b/3 (2b3), where DC and IC vehicles would utilize the “Passenger Car” portion of the scenario definition.

Within each scenario worksheet, the specifications for each regulatory class are defined separately, using the parameters described in Table 47 below.

Table 47. Scenarios Worksheet

Category	Column	Units	Definition/Notes
Function Definition	Function	integer	Functional form to use for computing the vehicle target.
	A - J (function coefficients)	number	Coefficients associated with the functional form to use for computing the vehicle target.
	CO2 Factor	number	The CO-2 factor to use for converting between fuel consumption targets and CO-2 targets. If not specified, this setting will default to a value of 8887.
	CO2 Offset	number	Absolute amount (in grams/mile) by which to shift the CO-2 targets after conversion from fuel economy.
	EPA Multiplier 1	number	Production multiplier, used to scale the sales volumes of CNGs and PHEVs when computing the manufacturer CO-2 rating toward compliance with EPA's CO-2 standards. This value must be between 1 and 10. If not specified, this setting will default to a value of 1.
	EPA Multiplier 2	number	Production multiplier, used to scale the sales volumes of BEVs and FCVs when computing the manufacturer CO-2 rating toward compliance with EPA's CO-2 standards. This value must be between 1 and 10. If not specified, this setting will default to a value of 1.
	Min (mpg)	mpg	Minimum CAFE standard that each manufacturer must attain, specified as a flat-standard in miles/gallon, or 0 if not applicable.
	Min (%)	percentage	Minimum CAFE standard that each manufacturer must attain, specified as a percentage of the average requirement under the function-based standard, or 0 if not applicable.
Supplemental Options	Fine Rate	\$/credit	The CAFE fine rate for non-compliance in dollars per one credit of shortfall.
	Credit Value	\$/credit	Value of a single CAFE credit. This setting is intended for future expansion and is not used in this version of the model.
	CO2 Credit Value	\$/credit	Value of a single CO-2 credit.
	Multi-Fuel	integer	The applicability of multi-fuel vehicles for compliance calculations (does not apply to single-fuel vehicles): 0 = only gasoline fuel economy value is considered (gasoline fuel share is assumed to be 100%); 1 = for Gasoline/Ethanol-85 vehicles, only the gasoline fuel economy value is considered (gasoline fuel share is assumed to be 100%); for Gasoline/Electricity vehicles, both fuel economy values are considered; 2 = for Gasoline/Ethanol-85 and Gasoline/Electricity vehicles, both fuel economy values are considered.
	FFV Share	percentage	The statutory fuel share to use for compliance for flex-fuel vehicles (FFVs), whenever the Multi-Fuel mode is 2. This fuel share applies only to vehicles operating on gasoline and ethanol-85 fuel types. If not specified or set to 0, the vehicle's assumed on-road fuel share will be used for compliance.
PHEV Share	percentage	The statutory fuel share to use for compliance for plug-in hybrid/electric vehicles (PHEVs), whenever the Multi-Fuel mode is either 1 or 2. This fuel share applies	

DRAFT – July 2018

		only to vehicles operating on gasoline and electricity fuel types. If not specified or set to 0, the vehicle's assumed on-road fuel share will be used for compliance.
CAFE - AC Efficiency Cap	grams/mile	Maximum amount of credits, in grams/mile of CO-2, associated with improvements in air conditioning efficiency a manufacturer may claim toward compliance with NHTSA's CAFE standards.
CAFE - Off-Cycle Cap	grams/mile	Maximum amount of off-cycle credits, in grams/mile of CO-2, a manufacturer may claim toward compliance with NHTSA's CAFE standards.
CO2 - AC Efficiency Cap	grams/mile	Maximum amount of credits, in grams/mile of CO-2, associated with improvements in air conditioning efficiency a manufacturer may claim toward compliance with EPA's CO-2 standards.
CO2 - AC Leakage Cap	grams/mile	Maximum amount of credits, in grams/mile of CO-2, associated with improvements in air conditioning leakage a manufacturer may claim toward compliance with EPA's CO-2 standards.
CO2 - Off-Cycle Cap	grams/mile	Maximum amount of off-cycle credits, in grams/mile of CO-2, a manufacturer may claim toward compliance with EPA's CO-2 standards.
SHEV Tax Credit	dollar	Amount of Federal tax credits a buyer receives for purchasing a strong hybrid/electric vehicle (SHEV).
PHEV Tax Credit	dollar	Amount of Federal tax credits a buyer receives for purchasing a plug-in hybrid/electric vehicle (PHEV).
EV Tax Credit	dollar	Amount of Federal tax credits a buyer receives for purchasing a pure electric vehicle (EV).
TW Function	integer	The functional form to use for computing the vehicle's test weight.
Payload Return	percentage	Percentage of curb weight reduction returned to payload capacity. This setting applies whenever mass reduction technology is installed to a vehicle. For example, if payload return is 0%, the vehicle's payload capacity remains the same; if payload return is 100%, the vehicle's reduction in curb weight goes entirely to payload.
Towing Return	percentage	Percentage of GVWR reduction returned to towing capacity. This setting applies whenever mass reduction technology is installed to a vehicle. For example, if towing return is 0%, the vehicle's towing capacity remains the same; if towing return is 100%, the vehicle's reduction in GVWR goes entirely to towing.
Credit Carry Fwd	integer	Maximum number of years to carry forward. If a value is specified, this setting overrides the value present in the parameters file. If not specified or set to 0, the default value from the parameters file will be used.

A.4.1 Target Functions

The CAFE Model supports various function types for defining the fuel economy target function (as well as the associated CO₂ target function) for use during analysis, as outlined by Table 7 in Section 3 above. Equation (3) (also in Section 3) provides the detailed description of the functional form commonly used during the most recent analysis. Table 48 and Table 49 below, however, present summarized descriptions of all functional forms supported within the modeling system. In each case, the CAFE Model first calculates the fuel economy target for a given vehicle model, then converts it to an associated CO₂ target, as described by Equation (4) in Section 3 above.

Table 48. Target Functions (1)

Function	Description	Specification
1	Flat standard. A: mpg	$T_{FE} = \frac{1}{A}$
2	Logistic area-based function. A: mpg ("ceiling") B: mpg ("floor") C: square feet ("midpoint") D: square feet ("width")	$T_{FE} = \frac{1}{A} + \left(\frac{1}{B} - \frac{1}{A}\right) \times \frac{e^{\left(\frac{FP-C}{D}\right)}}{1 + e^{\left(\frac{FP-C}{D}\right)}}$
3	Logistic weight-based function. A: mpg ("ceiling") B: mpg ("floor") C: pounds ("midpoint") D: pounds ("width")	$T_{FE} = \frac{1}{A} + \left(\frac{1}{B} - \frac{1}{A}\right) \times \frac{e^{\left(\frac{CW-C}{D}\right)}}{1 + e^{\left(\frac{CW-C}{D}\right)}}$
4	Exponential area-based function. A: mpg ("ceiling") B: mpg (should be > A) C: square feet (determines "height")	$T_{FE} = \frac{1}{A} - \frac{e^{\left(\frac{1-FP}{C}\right)}}{B}$
5	Exponential weight-based function. A: mpg ("ceiling") B: mpg (should be > A) C: pounds (determines "height")	$T_{FE} = \frac{1}{A} - \frac{e^{\left(\frac{1-CW}{C}\right)}}{B}$
6	Linear area-based function. A: mpg ("ceiling") B: mpg ("floor") C: change in gpm / change in square feet ("slope" of the function) D: gpm ("y-intercept")	$T_{FE} = \text{MAX}\left(\frac{1}{A}, \text{MIN}\left(\frac{1}{B}, C \times FP + D\right)\right)$
7	Linear weight-based function. A: mpg ("ceiling") B: mpg ("floor") C: change in gpm / change in pounds ("slope" of the function) D: gpm ("y-intercept")	$T_{FE} = \text{MAX}\left(\frac{1}{A}, \text{MIN}\left(\frac{1}{B}, C \times CW + D\right)\right)$
8	Linear work-factor-based function. General coefficients A: 'xwd' coefficient; additional offset, in lbs, applicable to 4-wheel drive vehicles only B: weighting multiplier for payload vs. towing capacity Coefficients for gasoline vehicles C: change in gpm / change in work-factor ("slope" of the function) D: gallons per 100-miles ("y-intercept") Coefficients for diesel vehicles E: change in gpm / change in work-factor ("slope" of the function) F: gallons per 100-miles ("y-intercept") Coefficients for CNG vehicles G: change in gpm / change in work-factor ("slope" of the function) H: gallons per 100-miles ("y-intercept")	$T_{FE} = \begin{pmatrix} G \times WF + H, \\ E \times WF + F, \\ C \times WF + D \end{pmatrix}$ <p>The target function uses different coefficients, depending on the fuel type the vehicle operates on. WF is the work-factor, calculated as follows:</p> $WF = \left(GVWR - CW + \begin{pmatrix} A, \\ 0 \end{pmatrix}\right) \times B + (GCWR - GVWR) \times (1 - B)$ <p>For the work-factor equation, the A coefficient is only used for 4-wheel drive vehicles. For all other vehicles, a value of zero (0) is used.</p>

Table 49. Target Functions (2)

Function	Description	Specification
206	<p>Dual linear area-based function.</p> <p>Primary function coefficients A: mpg ("ceiling") B: mpg ("floor") C: change in gpm / change in square feet ("slope" of the function) D: gpm ("y-intercept")</p> <p>Secondary function coefficients E: mpg ("ceiling") F: mpg ("floor") G: change in gpm / change in square feet ("slope" of the function) H: gpm ("y-intercept")</p>	$T_{FE} = \text{MIN} \left(\begin{array}{l} \text{MAX} \left(\frac{1}{A}, \text{MIN} \left(\frac{1}{B}, C \times FP + D \right) \right), \\ \text{MAX} \left(\frac{1}{E}, \text{MIN} \left(\frac{1}{F}, G \times FP + H \right) \right) \end{array} \right)$
207	<p>Dual linear weight-based function.</p> <p>Primary function coefficients A: mpg ("ceiling") B: mpg ("floor") C: change in gpm / change in pounds ("slope" of the function) D: gpm ("y-intercept")</p> <p>Secondary function coefficients E: mpg ("ceiling") F: mpg ("floor") G: change in gpm / change in pounds ("slope" of the function) H: gpm ("y-intercept")</p>	$T_{FE} = \text{MIN} \left(\begin{array}{l} \text{MAX} \left(\frac{1}{A}, \text{MIN} \left(\frac{1}{B}, C \times CW + D \right) \right), \\ \text{MAX} \left(\frac{1}{E}, \text{MIN} \left(\frac{1}{F}, G \times CW + H \right) \right) \end{array} \right)$
208	<p>Dual linear work-factor-based function.</p> <p>Primary function coefficients A-H: refer to function 8 above</p> <p>Secondary function coefficients I: the model year whose function serves as the "floor" for this function</p>	<p>For this target function, the CAFE Model calculates the target function in a series of steps.</p> <ol style="list-style-type: none"> 1) The model uses supplied coefficients A-H and target function 8 defined above to calculate the initial target for the vehicle, 2) Then, a secondary "floor" target for the vehicle is calculated based on the function defined in the model year given by coefficient I (typically, the target function defined for model year I should be 1, 8, or 208), 3) Lastly, the model takes the minimum of the targets calculated in steps 1) and 2) to obtain the final target for a given vehicle model. <p>The above steps can be summarized by the following equation:</p> $T_{FE} = \text{MIN}(f(8, A \dots H), f(I))$

Appendix B Model Outputs

The system produces ten output files in comma separated values (CSV) format. The system places all files in the “reports” folder, located in the user selected output path (for example: **C:\CAFE Model\test-run\reports-csv**). Table 50 lists the available output types and a brief summary of their contents. All of the modeling reports are stored as plain text (without any additional formatting), in a “database-like” style, for each scenario and model year examined during analysis. As discussed earlier, the first scenario appearing in the scenarios file is assigned to Scenario 0 and is treated as the baseline. The action alternatives are then assigned to Scenario 1, 2, and so on, in order of appearance. For all modeling reports, the baseline scenario always shows absolute values, while, for the majority of reports, the action alternatives include relative changes compared to the baseline, as discussed in the sections below.

Table 50. Output Files

Output File	Contents
Technology Utilization Report	Contains manufacturer-level and industry-wide technology application and penetration rates for each technology, model year, and scenario analyzed. The results are disaggregated by regulatory class, as well as combined over the entire fleet.
Compliance Report	Contains manufacturer-level and industry-wide summary of compliance model results for each model year and scenario analyzed. The results are disaggregated by regulatory class, as well as combined over the entire fleet.
Societal Effects Report	Contains industry-wide summary of energy and emissions effects for each model year and scenario analyzed. The results are disaggregated by regulatory class and fuel type, as well as combined across all fuels and over the entire fleet.
Societal Costs Report	Contains industry-wide summary of consumer and social costs for each model year and scenario analyzed. The results are disaggregated by regulatory class and fuel type, as well as combined across all fuels and over the entire fleet.
Annual Societal Effects Report	This output file is similar to the <i>Societal Effects Report</i> , except it further disaggregates the results by vehicle age.
Annual Societal Costs Report	This output file is similar to the <i>Societal Costs Report</i> , except it further disaggregates the results by vehicle age.
Annual Societal Effects Summary Report	This output file is similar to the <i>Annual Societal Effects Report</i> , except it aggregates the results by calendar year. Note, the <i>Societal Effects Report</i> produces results for each <u>model year</u> considered during analysis (e.g., 2016-2025). Conversely, the summary report summarizes the annual results by <u>calendar year</u> (e.g., 1975-2050).
Annual Societal Costs Summary Report	This output file is similar to the <i>Annual Societal Costs Report</i> , except it aggregates the results by calendar year. Note, the <i>Societal Costs Report</i> produces results for each <u>model year</u> considered during analysis (e.g., 2016-2025). Conversely, the summary report summarizes the annual results by <u>calendar year</u> (e.g., 1975-2050).
Consumer Costs Report	Contains industry-wide summary of consumer-related costs for each model year and scenario analyzed, using discounting from the consumer’s perspective. The results are disaggregated by regulatory class, as well as combined over the entire fleet.
Vehicles Report	Contains disaggregate vehicle-level summary of compliance model results, providing a detailed view of the final state of each vehicle examined by the model, for each model year and scenario analyzed.

The remainder of this section discusses the contents of the output files.

B.1 Technology Utilization Report

The *Technology Utilization Report* contains manufacturer-level and industry-wide technology application and penetration rates for each technology. The application rates represent the amount of technology that was applied by the modeling system during analysis while the penetration rates represent the amount of technology that was either on the vehicle initially at the start of the analysis, or applied by the modeling system during analysis. If a technology was present on or applied to a vehicle, but later superseded during the modeling process by another technology (for example, AT8 superseding AT6), the superseded technology on that vehicle will not count toward the penetration or application rates.

The following table lists the contents of the *Technology Utilization Report*.

Table 51. Technology Utilization Report

Column	Units	Contents
Scenario	integer	Unique index of the scenario, where 0 represents the baseline, while 1 and above represent the action alternatives.
Scenario Name	text	A short name describing the key features of the scenario.
Model Year	model year	Model years analyzed during the study period.
Manufacturer	text	Manufacturers analyzed during the study period. A value of "TOTAL" is used to represent industry-wide results.
Reg-Class	text	The regulatory class for which the application and penetration rates are reported. When multiple regulatory classes are present in the output, a value of "TOTAL" is used to represent the sum across all classes.
Technology	text	The technology for which the application and penetration rates are reported.
App-Rate	number	The application rate of the technology, specified as a proportion of total sales. The application rates represent the amount of technology that was applied by the modeling system during analysis. If a technology was applied to a vehicle, but later superseded during the modeling process by another technology (for example, AT6 superseding AT5), the superseded technology on that vehicle will not count toward the application rate.
Pen-Rate	number	The penetration rate of the technology, specified as a proportion of total sales. The penetration rates represent the amount of technology that was either on the baseline vehicle at the start of the analysis, or applied by the modeling system during analysis. If a technology was present on or applied to a vehicle, but later superseded during the modeling process by another technology (for example, AT6 superseding AT5), the superseded technology on that vehicle will not count toward the penetration rate.
Incr.AR	number	The incremental application rate of the technology, which represents the difference between the action alternative and the baseline scenario, where the application rate from the baseline scenario is subtracted from that of the action alternative.
Incr.PR	number	The incremental penetration rate of the technology, which represents the difference between the action alternative and the baseline scenario, where the application rate from the baseline scenario is subtracted from that of the action alternative.

B.2 Compliance Report

The *Compliance Report* contains manufacturer-level and industry-wide summary of compliance model results for each model year and scenario analyzed. The results are reported by regulatory class, as well as aggregated for the entire fleet. Most of the metrics, which are reported independently by model year, are further summed (or averaged) over the entire analysis period. The report provides various cost values associated with the rule, represented as “totals” across all vehicle models, as well as “averages” per single vehicle unit. The following table lists the contents of the *Compliance Report*.

Table 52. Compliance Report

Column	Units	Contents
Scenario	integer	Unique index of the scenario, where 0 represents the baseline, while 1 and above represent the action alternatives.
Scenario Name	text	A short name describing the key features of the scenario.
Model Year	model year	Model years analyzed during the study period. A value of "TOTAL" is used to represent the sums (or averages) across all model years for some of the outputs, where applicable.
Manufacturer	text	Manufacturers analyzed during the study period. A value of "TOTAL" is used to represent industry-wide results.
Reg-Class	text	The regulatory class for which the compliance results are reported. When multiple regulatory classes are present in the output, a value of "TOTAL" is used to represent the sums (or averages) across all regulatory classes for some of the outputs, where applicable.
Sales	units	Total production of vehicles for sale for a specific model year, manufacturer, and regulatory class (as well as sum across any of the attributes, where applicable).
Jobs	units	Total US jobs associated with the sale of all units of a specific vehicle model in a specific model year. This includes: jobs required for vehicle manufacture and assembly originating at US plants, jobs associated with the sale of new vehicle models at US dealerships, and additional direct US jobs resulting from vehicle fuel economy improvements.
Prelim-Stnd	mpg	Preliminary value of the required CAFE standard (before the "alternative minimum CAFE standard", as outlined in the scenarios input section, is applied).
Standard	mpg	The value of the required CAFE standard.
CAFE (2-cycle)	mpg	The value of the achieved CAFE standard, using a 2-bag test cycle, not including the adjustment for improvements in air conditioning efficiency or off-cycle credits.
CAFE	mpg	The value of the achieved CAFE standard, including the adjustment for improvements in air conditioning efficiency and off-cycle credits. This value reflects whether a manufacturer is in compliance with the CAFE standards.
CO-2 Standard	grams/mile	The value of the required CO-2 standard.
CO-2 Rating	grams/mile	The value of the achieved CO-2 standard, including the adjustment for improvements in air conditioning efficiency, air conditioning leakage, and off-cycle credits. This value reflects whether a manufacturer is in compliance with the CO-2 standards.
Off-Cycle Credits	grams/mile	Amount of off-cycle credits accrued by a manufacturer toward compliance with either EPA's CO-2 or NHTSA's CAFE standards. This value is specified in grams/mile of CO-2 and represents the maximum cumulative adjustment aggregated from all technologies utilized by the manufacturer in its fleet for which the CO-2 and fuel economy benefit is not captured on the test cycle. However, the actual amount of credit applied to a manufacturer's CO-2 and CAFE ratings is bound by the maximum allowable cap as defined by the compliance scenario in a specific model year.
AC Efficiency	grams/mile	Adjustment factor associated with improvements in air conditioning efficiency accrued by a manufacturer toward compliance with either EPA's CO-2 or NHTSA's CAFE standards. This value is specified in grams/mile of CO-2 and represents the maximum cumulative adjustment aggregated from all AC efficiency improvement technologies utilized by the manufacturer in its fleet. However, the actual adjustment factor applied to a manufacturer's CO-2 and CAFE ratings is bound by the maximum allowable cap as defined by the compliance scenario in a specific model year.
AC Leakage	grams/mile	Adjustment factor associated with improvements in air conditioning leakage accrued by a manufacturer toward compliance with EPA's CO-2 standards. This value is specified in grams/mile of CO-2 and represents the maximum cumulative adjustment aggregated from all AC leakage improvement technologies utilized by the manufacturer in its fleet. However, the actual adjustment factor applied to a manufacturer's CO-2 rating is bound by the maximum allowable cap as defined by the compliance scenario in a specific model year.
Average CW	lbs.	Average curb weight of analyzed vehicles.
Average FP	sq.ft.	Average footprint of analyzed vehicles.
Average WF	lbs.	Average work-factor of analyzed vehicles. This value is reported only when the vehicles analyzed are subject to the work-factor based functional standards.
ZEV Target	zevs	Amount of ZEV credits required in order to meet the CA+S177 state's zero-emission vehicle standards.

DRAFT – July 2018

ZEV Credits	zevs	Amount of ZEV credits generated for compliance with the CA+S177 state's zero-emission vehicle standards.
Tech Cost	dollars ¹	Total amount of technology costs accumulated by a manufacturer across all vehicle models.
Fines	dollars ¹	Total amount of fines owed by a manufacturer in a specific model year and regulatory class.
Reg-Cost	dollars ¹	Total amount of regulatory costs accumulated by a manufacturer across all vehicle models. The regulatory costs are based on the combination of technology costs accrued within a specific regulatory class and total fines owed by the manufacturer (across all regulatory classes), distributed based on a vehicle's relative target shortfall.
Maint/Repair Cost	dollars ¹	Total amount of maintenance and repair costs accumulated by a manufacturer across all vehicle models.
Avg Tech Cost	dollars ¹	Average technology costs per single vehicle unit.
Avg Fines	dollars ¹	Average fines paid per single vehicle unit.
Avg Reg-Cost	dollars ¹	Average regulatory costs per single vehicle unit.
Avg Maint/Repair Cost	dollars ¹	Average maintenance and repair costs per single vehicle unit.
Credits Earned	credits ²	Total CAFE credits accumulated by the manufacturer for a specific model year and regulatory class. Manufacturers earn compliance credits whenever their achieved value of the CAFE standard is above the required value of the CAFE standard (in mpg).
Credits Out	credits ²	Total CAFE credits transferred out of a specific regulatory class (such as from domestic passenger cars to light trucks) or carried forward from a previous model year.
Credits In	credits ²	Total CAFE credits transferred into a specific regulatory class or carried forward into the present model year.
CO-2 Credits Earned	metric-tons	Total CO-2 credits accumulated by the manufacturer for a specific model year and regulatory class. Manufacturers earn compliance credits whenever their achieved value of the CO-2 standard is above the required value of the CO-2 standard (in mpg).
CO-2 Credits Out	metric-tons	Total CO-2 credits transferred out of a specific regulatory class (such as from passenger cars to light trucks) or carried forward from a previous model year.
CO-2 Credits In	metric-tons	Total CO-2 credits transferred into a specific regulatory class or carried forward into the present model year.

In the above table, note that:

- (1) For the baseline scenario, all costs are specified as absolutes; for the action alternatives, all costs are incremental and are specified as the difference between the action alternative and the baseline scenario, where the value from the baseline scenario is subtracted from that of the action alternative.
- (2) For light duty vehicles (those regulated as domestic cars, imported cars, and light trucks), one credit equates to one mile per 10 gallons. For medium duty vehicles (those regulated as class-2b/3 trucks), one credit equates to one gallon per 10k miles.

B.3 Societal Effects and Societal Costs Reports

The *Societal Effects Report* contains industry-wide summary of energy and emissions effects, while the *Societal Costs Report* contains corresponding industry-wide summary of consumer and social costs for each model year and scenario analyzed. The results are reported by regulatory class, as well as aggregated for the entire fleet. Most of the metrics, which are reported independently by model year, are further summed (or averaged) over the entire analysis period.

The *Societal Effects Report* also disaggregates energy and emissions effects by fuel type, as well as providing aggregate totals across all fuels. The report contains calculated levels of energy consumed by fuel type in quads, thousands of gallons, and thousands of native units during the full useful life of all vehicles sold in each model year. For liquid fuel types (gasoline, diesel, and E85), amount of gallons consumed is specified in their native units (*e.g.*, gallons of E85). For non-liquid fuel types (electricity, hydrogen, CNG), amount of gallons consumed is specified in gasoline equivalent gallons. Additionally, energy consumption in native units is specified for electricity in mW-h, and for hydrogen and CNG in Mcf. Full useful life travel (in thousands of miles) and average fuel economy levels are also presented to provide a basis for comparison. The rated fuel economy levels reported are not comparable to the value of achieved CAFE standard shown in the compliance report. The values contained in the Societal Effects Report are computed as total VMT divided by total gallons (with the effect of the on-road gap backed out), and do not incorporate some of the compliance-related credits or adjustments.

The *Societal Effects Report* also presents estimates of full fuel cycle carbon dioxide and criteria pollutant emissions by fuel type. As shown in Table 53 below, carbon dioxide emissions are reported in million metric tons of carbon-equivalent emissions (one metric ton of carbon dioxide is equivalent to 12/44 of a metric ton of carbon), and all criteria pollutants are reported in metric tons. For the baseline scenario, VMT, energy use, fatalities, and all emissions are specified as absolutes. For the action alternatives, these values are incremental and are specified as the difference between the action alternative and the baseline scenario, where the value from the baseline scenario is subtracted from that of the action alternative.

The *Societal Costs Report* contains monetized consumer and social costs including fuel expenditures, travel and refueling value, economic and external costs arising from additional vehicle use, as well as owner and societal costs associated with emissions damage. In all cases, these costs are calculated for the fleet of vehicles sold in each model year over their full useful lives, discounted using the rate specified in the parameters input file, and reported in thousands of constant dollars. Chapter Three, Section 6 of the primary text discusses these types of costs and benefits in greater detail, and Appendix A discusses corresponding input assumptions.

In the *Societal Costs Report*, for the baseline scenario, all costs are specified as absolutes. For the action alternatives, all costs are incremental and are specified as the difference between the action alternative and the baseline scenario. Table 53 below lists the full contents of the *Societal Effects Report* and Table 54 lists the full contents of the *Societal Costs Report*.

DRAFT – July 2018

Table 53. Societal Effects Report

Column	Units	Contents
Scenario	integer	Unique index of the scenario, where 0 represents the baseline, while 1 and above represent the action alternatives.
Scenario Name	text	A short name describing the key features of the scenario.
Model Year	model year	Model years analyzed during the study period. A value of "TOTAL" is used to represent the sums (or averages) across all model years for some of the outputs, where applicable.
Reg-Class	text	The regulatory class for which the societal effects are reported. When multiple regulatory classes are present in the output, a value of "TOTAL" is used to represent the sums (or averages) across all regulatory classes for some of the outputs, where applicable.
Fuel Type	text	The fuel type for which the societal effects are reported. A value of "TOTAL" is used to represent the sums (or averages) across all fuel types for some of the outputs, where applicable.
Rated FE	mpg	The average fuel economy rating of vehicles. Note, this value is not comparable to the value of achieved CAFE standard shown in the compliance report; this value is computed as total VMT divided by total gallons (with the effect of the on-road gap backed out), and does not incorporate some of the compliance credits.
On-road FE	mpg	The average on-road fuel economy rating of vehicles.
Fuel Share	ratio	The average fuel share, indicating the amount of miles driven by all vehicles on each fuel type.
Curb Weight	lbs.	Average curb weight of analyzed vehicles.
Footprint	sq.ft.	Average footprint of analyzed vehicles.
Work Factor	lbs.	Average work-factor of analyzed vehicles. This value is reported only when the vehicles analyzed are subject to the work-factor based functional standards.
Sales	units	Total production of vehicles for sale for a specific model year, regulatory class, and fuel type (as well as sum across any of the attributes, where applicable).
kVMT	miles (k)	Thousands of miles traveled by all vehicles over their lifetime for a specific model year, regulatory class, and fuel type.
Quads	quads	Energy used by all vehicles over their lifetime for a specific model year, regulatory class, and fuel type.
kGallons	gallons (k)	Amount of gallons of liquid fuel consumed, or amount of gasoline equivalent gallons of fuel consumed (for non-liquid fuel types), by all vehicles over their lifetime for a specific model year, regulatory class, and fuel type.
kUnits	varies	Amount of energy consumed by all vehicles over their lifetime for a specific model year, regulatory class, and fuel type, where the units of measure vary based on fuel type. For liquid fuel types (gasoline, e85, diesel, b20, LNG, LPG), the units are specified in thousands of gallons; for electricity, the units are specified in mW-h; for hydrogen and CNG, the units are specified in Mcf.
Fatalities	units	Amount of fatalities resulting from reduction in vehicle curb weight and increases in VMT due to the rebound effect, aggregated over the lifetime of all vehicles for a specific model year, regulatory class, and fuel type.
CO (t)	metric-tons	Amount of Carbon Monoxide emissions generated from domestic crude petroleum extraction, transportation, and refining, from gasoline transportation, storage, and distribution, and from vehicle operation, aggregated over the lifetime of all vehicles for a specific model year, regulatory class, and fuel type.
VOC (t)	metric-tons	Amount of Volatile Organic Compounds emissions generated from domestic crude petroleum extraction, transportation, and refining, from gasoline transportation, storage, and distribution, and from vehicle operation, aggregated over the lifetime of all vehicles for a specific model year, regulatory class, and fuel type.
NOx (t)	metric-tons	Amount of Nitrogen Oxides emissions generated from domestic crude petroleum extraction, transportation, and refining, from gasoline transportation, storage, and distribution, and from vehicle operation, aggregated over the lifetime of all vehicles for a specific model year, regulatory class, and fuel type.
SO2 (t)	metric-tons	Amount of Sulfur Dioxide emissions generated from domestic crude petroleum extraction, transportation, and refining, from gasoline transportation, storage, and distribution, and from vehicle operation, aggregated over the lifetime of all vehicles for a specific model year, regulatory class, and fuel type.
PM (t)	metric-tons	Amount of Particulate Matter (diameter of ~2.5 micrometers) emissions generated from domestic crude petroleum extraction, transportation, and refining, from gasoline transportation, storage, and distribution, and from vehicle operation, aggregated over the lifetime of all vehicles for a specific model year, regulatory class, and fuel type.
CO2 (mmt)	million metric-tons	Amount of Carbon Dioxide emissions generated from domestic crude petroleum extraction, transportation, and refining, from gasoline transportation, storage, and distribution, and from vehicle operation, aggregated over the lifetime of all vehicles for a specific model year, regulatory class, and fuel type.
CH4 (t)	metric-tons	Amount of Methane emissions generated from domestic crude petroleum extraction, transportation, and refining, from gasoline transportation, storage, and distribution, and from vehicle operation, aggregated over the lifetime of all vehicles for a specific model year, regulatory class, and fuel type.
N2O (t)	metric-tons	Amount of Nitrous Oxide emissions generated from domestic crude petroleum extraction, transportation, and refining, from gasoline transportation, storage, and distribution, and from vehicle operation, aggregated over the lifetime of all vehicles for a specific model year, regulatory class, and fuel type.
Acetaldehyde (t)	metric-tons	Amount of Acetaldehyde emissions generated from domestic crude petroleum extraction, transportation, and refining, from gasoline transportation, storage, and distribution, and from vehicle operation, aggregated over the lifetime of all vehicles for a specific model year, regulatory class, and fuel type.
Acrolein (t)	metric-tons	Amount of Acrolein emissions generated from domestic crude petroleum extraction, transportation, and refining, from gasoline transportation, storage, and distribution, and from vehicle operation, aggregated over the lifetime of all vehicles for a specific model year, regulatory class, and fuel type.

DRAFT – July 2018

Benzene (t)	metric-tons	Amount of Benzene emissions generated from domestic crude petroleum extraction, transportation, and refining, from gasoline transportation, storage, and distribution, and from vehicle operation, aggregated over the lifetime of all vehicles for a specific model year, regulatory class, and fuel type.
Butadiene (t)	metric-tons	Amount of 1,3-Butadiene emissions generated from domestic crude petroleum extraction, transportation, and refining, from gasoline transportation, storage, and distribution, and from vehicle operation, aggregated over the lifetime of all vehicles for a specific model year, regulatory class, and fuel type.
Formaldehyde (t)	metric-tons	Amount of Formaldehyde emissions generated from domestic crude petroleum extraction, transportation, and refining, from gasoline transportation, storage, and distribution, and from vehicle operation, aggregated over the lifetime of all vehicles for a specific model year, regulatory class, and fuel type.
DPM10 (t)	metric-tons	Amount of Diesel Particulate Matter (diameter of ~10 micrometers) emissions generated from domestic crude petroleum extraction, transportation, and refining, from gasoline transportation, storage, and distribution, and from vehicle operation, aggregated over the lifetime of all vehicles for a specific model year, regulatory class, and fuel type.
MTBE (t)	metric-tons	Amount of Methyl Tertiary Butyl Ether emissions generated from domestic crude petroleum extraction, transportation, and refining, from gasoline transportation, storage, and distribution, and from vehicle operation, aggregated over the lifetime of all vehicles for a specific model year, regulatory class, and fuel type.

DRAFT – July 2018

Table 54. Societal Costs Report

Column	Units	Contents
Scenario	integer	Unique index of the scenario, where 0 represents the baseline, while 1 and above represent the action alternatives.
Scenario Name	text	A short name describing the key features of the scenario.
Model Year	model year	Model years analyzed during the study period. A value of "TOTAL" is used to represent the sums (or averages) across all model years for some of the outputs, where applicable.
Reg-Class	text	The regulatory class for which the societal costs are reported. When multiple regulatory classes are present in the output, a value of "TOTAL" is used to represent the sums (or averages) across all regulatory classes for some of the outputs, where applicable.
Fuel Type	text	The fuel type for which the societal costs are reported. A value of "TOTAL" is used to represent the sums (or averages) across all fuel types for some of the outputs, where applicable.
Disc-Rate	number	Social discount rate applied to future benefits. A value of 0 indicates undiscounted costs.
Pre-Tax Fuel Costs	dollars (k)	Total pre-tax fuel expenditures accumulated across all vehicles over their lifetime for a specific model year, regulatory class, and fuel type.
Fuel Tax Cost	dollars (k)	Total fuel tax revenues accumulated across all vehicles over their lifetime for a specific model year, regulatory class, and fuel type.
Retail Fuel Costs	dollars (k)	Total retail fuel expenditures (pre-tax fuel cost + fuel tax cost) accumulated across all vehicles over their lifetime for a specific model year, regulatory class, and fuel type.
Drive Value	dollars (k)	Benefits from the additional driving that results from improved fuel economy, accumulated across all vehicles over their lifetime for a specific model year, regulatory class, and fuel type.
Refuel Value	dollars (k)	Benefits from reduced refueling frequency due to the extended vehicle range and improved fuel economy, accumulated across all vehicles over their lifetime for a specific model year, regulatory class, and fuel type.
Market Externalities	dollars (k)	Economic costs of oil imports not accounted for by price, accumulated across all vehicles over their lifetime for a specific model year, regulatory class, and fuel type.
Congestion Costs	dollars (k)	Congestion costs from additional vehicle use, accumulated across all vehicles over their lifetime for a specific model year, regulatory class, and fuel type.
Accident Costs	dollars (k)	Accident costs from additional vehicle use, accumulated across all vehicles over their lifetime for a specific model year, regulatory class, and fuel type.
Noise Costs	dollars (k)	Noise costs from additional vehicle use, accumulated across all vehicles over their lifetime for a specific model year, regulatory class, and fuel type.
Fatality Costs	dollars (k)	Costs attributed to vehicle-related fatalities resulting from additional vehicle use and reduction in vehicle curb weight, accumulated across all vehicles over their lifetime for a specific model year, regulatory class, and fuel type.
Non-Fatal Crash Costs	dollars (k)	Costs attributed to non-fatal vehicle-related crashes resulting from additional vehicle use and reduction in vehicle curb weight, accumulated across all vehicles over their lifetime for a specific model year, regulatory class, and fuel type.
CO Damage Costs	dollars (k)	Owner and societal costs arising from Carbon Monoxide damage, aggregated over the lifetime of all vehicles for a specific model year, regulatory class, and fuel type.
VOC Damage Costs	dollars (k)	Owner and societal costs arising from Volatile Organic Compounds damage, aggregated over the lifetime of all vehicles for a specific model year, regulatory class, and fuel type.
NOx Damage Costs	dollars (k)	Owner and societal costs arising from Nitrogen Oxides damage, aggregated over the lifetime of all vehicles for a specific model year, regulatory class, and fuel type.
SO2 Damage Costs	dollars (k)	Owner and societal costs arising from Sulfur Dioxide damage, aggregated over the lifetime of all vehicles for a specific model year, regulatory class, and fuel type.
PM Damage Costs	dollars (k)	Owner and societal costs arising from Particulate Matter damage, aggregated over the lifetime of all vehicles for a specific model year, regulatory class, and fuel type.
CO2 Damage Costs	dollars (k)	Owner and societal costs arising from Carbon Dioxide damage, aggregated over the lifetime of all vehicles for a specific model year, regulatory class, and fuel type.
CH4 Damage Costs	dollars (k)	Owner and societal costs arising from Methane damage, aggregated over the lifetime of all vehicles for a specific model year, regulatory class, and fuel type.
N2O Damage Costs	dollars (k)	Owner and societal costs arising from Nitrous Oxide damage, aggregated over the lifetime of all vehicles for a specific model year, regulatory class, and fuel type.

B.4 Annual Societal Effects and Annual Societal Costs Reports

The *Annual Societal Effects Report* and the *Annual Societal Costs Report* contain similar results as the *Societal Effects Report* and the *Societal Costs Report*, except these outputs further disaggregate the results by vehicle age. Table 55 lists the full contents of the *Annual Societal Effects Report* and Table 56 lists the full contents of the *Annual Societal Costs Report*. The annual reports produce results as absolutes (*i.e.*, non-incremental) for the baseline and action alternatives.

Table 55. Annual Societal Effects Report

Column	Units	Contents
Scenario	integer	Unique index of the scenario, where 0 represents the baseline, while 1 and above represent the action alternatives.
Scenario Name	text	A short name describing the key features of the scenario.
Model Year	model year	Model years analyzed during the study period. When "Fleet Analysis" option is enabled during modeling, the range of years is extended to include historic and future model years.
Age	integer	The vehicle's vintage, ranging from 0 to 39, where 0 corresponds to a vehicle's first year on the road.
Calendar Year	calendar year	Calendar years analyzed for the effects calculations.
Reg-Class	text	The regulatory class for which the societal costs are reported. When multiple regulatory classes are present in the output, a value of "TOTAL" is used to represent the sums (or averages) across all regulatory classes for some of the outputs, where applicable.
Fuel Type	text	The fuel type for which the societal costs are reported. A value of "TOTAL" is used to represent the sums (or averages) across all fuel types for some of the outputs, where applicable.
Fleet	units	Total on-road fleet for a specific model year, vehicle age, regulatory class, and fuel type.
kVMT	miles (k)	Thousands of miles traveled by all vehicles for a specific model year, vehicle age, regulatory class, and fuel type.
Quads	quads	Energy used by all vehicles for a specific model year, vehicle age, regulatory class, and fuel type.
kGallons	gallons (k)	Amount of gallons of liquid fuel consumed, or amount of gasoline equivalent gallons of fuel consumed (for non-liquid fuel types), by all vehicles for a specific model year, vehicle age, regulatory class, and fuel type.
kUnits	varies	Amount of energy consumed by all vehicles for a specific model year, vehicle age, regulatory class, and fuel type, where the units of measure vary based on fuel type. For liquid fuel types (gasoline, e85, diesel, b20, LNG, LPG), the units are specified in thousands of gallons; for electricity, the units are specified in mW-h; for hydrogen and CNG, the units are specified in Mcf.
Fatalities	units	Amount of fatalities resulting from reduction in vehicle curb weight and increases in VMT due to the rebound effect, aggregated for all vehicles for a specific model year, vehicle age, regulatory class, and fuel type.
CO Upstream (t)	metric-tons	Amount of Carbon Monoxide emissions generated from domestic crude petroleum extraction, transportation, and refining, from gasoline transportation, storage, and distribution, aggregated for all vehicles for a specific model year, vehicle age, regulatory class, and fuel type.
VOC Upstream (t)	metric-tons	Amount of Volatile Organic Compounds emissions generated from domestic crude petroleum extraction, transportation, and refining, from gasoline transportation, storage, and distribution, aggregated for all vehicles for a specific model year, vehicle age, regulatory class, and fuel type.
NOx Upstream (t)	metric-tons	Amount of Nitrogen Oxides emissions generated from domestic crude petroleum extraction, transportation, and refining, from gasoline transportation, storage, and distribution, aggregated for all vehicles for a specific model year, vehicle age, regulatory class, and fuel type.
SO2 Upstream (t)	metric-tons	Amount of Sulfur Dioxide emissions generated from domestic crude petroleum extraction, transportation, and refining, from gasoline transportation, storage, and distribution, aggregated for all vehicles for a specific model year, vehicle age, regulatory class, and fuel type.
PM Upstream (t)	metric-tons	Amount of Particulate Matter (diameter of ~2.5 micrometers) emissions generated from domestic crude petroleum extraction, transportation, and refining, from gasoline transportation, storage, and distribution, aggregated for all vehicles for a specific model year, vehicle age, regulatory class, and fuel type.
CO2 Upstream (mmt)	million metric-tons	Amount of Carbon Dioxide emissions generated from domestic crude petroleum extraction, transportation, and refining, from gasoline transportation, storage, and distribution, aggregated for all vehicles for a specific model year, vehicle age, regulatory class, and fuel type.
CH4 Upstream (t)	metric-tons	Amount of Methane emissions generated from domestic crude petroleum extraction, transportation, and refining, from gasoline transportation, storage, and distribution, aggregated for all vehicles for a specific model year, vehicle age, regulatory class, and fuel type.
N2O Upstream (t)	metric-tons	Amount of Nitrous Oxide emissions generated from domestic crude petroleum extraction, transportation, and refining, from gasoline transportation, storage, and distribution, aggregated for all vehicles for a specific model year, vehicle age, regulatory class, and fuel type.
Acetaldehyde Upstream (t)	metric-tons	Amount of Acetaldehyde emissions generated from domestic crude petroleum extraction, transportation, and refining, from gasoline transportation, storage, and distribution, aggregated for all vehicles for a specific model year, vehicle age, regulatory class, and fuel type.

DRAFT – July 2018

Acrolein Upstream (t)	metric-tons	Amount of Acrolein emissions generated from domestic crude petroleum extraction, transportation, and refining, from gasoline transportation, storage, and distribution, aggregated for all vehicles for a specific model year, vehicle age, regulatory class, and fuel type.
Benzene Upstream (t)	metric-tons	Amount of Benzene emissions generated from domestic crude petroleum extraction, transportation, and refining, from gasoline transportation, storage, and distribution, aggregated for all vehicles for a specific model year, vehicle age, regulatory class, and fuel type.
Butadiene Upstream (t)	metric-tons	Amount of 1,3-Butadiene emissions generated from domestic crude petroleum extraction, transportation, and refining, from gasoline transportation, storage, and distribution, aggregated for all vehicles for a specific model year, vehicle age, regulatory class, and fuel type.
Formaldehyde Upstream (t)	metric-tons	Amount of Formaldehyde emissions generated from domestic crude petroleum extraction, transportation, and refining, from gasoline transportation, storage, and distribution, aggregated for all vehicles for a specific model year, vehicle age, regulatory class, and fuel type.
DPM10 Upstream (t)	metric-tons	Amount of Diesel Particulate Matter (diameter of ~10 micrometers) emissions generated from domestic crude petroleum extraction, transportation, and refining, from gasoline transportation, storage, and distribution, aggregated for all vehicles for a specific model year, vehicle age, regulatory class, and fuel type.
MTBE Upstream (t)	metric-tons	Amount of Methyl Tertiary Butyl Ether emissions generated from domestic crude petroleum extraction, transportation, and refining, from gasoline transportation, storage, and distribution, aggregated for all vehicles for a specific model year, vehicle age, regulatory class, and fuel type.
CO Tailpipe (t)	metric-tons	Amount of Carbon Monoxide emissions generated from vehicle operation, aggregated for all vehicles for a specific model year, vehicle age, regulatory class, and fuel type.
VOC Tailpipe (t)	metric-tons	Amount of Volatile Organic Compounds emissions generated from vehicle operation, aggregated for all vehicles for a specific model year, vehicle age, regulatory class, and fuel type.
NOx Tailpipe (t)	metric-tons	Amount of Nitrogen Oxides emissions generated from vehicle operation, aggregated for all vehicles for a specific model year, vehicle age, regulatory class, and fuel type.
SO2 Tailpipe (t)	metric-tons	Amount of Sulfur Dioxide emissions generated from vehicle operation, aggregated for all vehicles for a specific model year, vehicle age, regulatory class, and fuel type.
PM Tailpipe (t)	metric-tons	Amount of Particulate Matter (diameter of ~2.5 micrometers) emissions generated from vehicle operation, aggregated for all vehicles for a specific model year, vehicle age, regulatory class, and fuel type.
CO2 Tailpipe (mmt)	million metric-tons	Amount of Carbon Dioxide emissions generated from vehicle operation, aggregated for all vehicles for a specific model year, vehicle age, regulatory class, and fuel type.
CH4 Tailpipe (t)	metric-tons	Amount of Methane emissions generated from vehicle operation, aggregated for all vehicles for a specific model year, vehicle age, regulatory class, and fuel type.
N2O Tailpipe (t)	metric-tons	Amount of Nitrous Oxide emissions generated from vehicle operation, aggregated for all vehicles for a specific model year, vehicle age, regulatory class, and fuel type.
Acetaldehyde Tailpipe (t)	metric-tons	Amount of Acetaldehyde emissions generated from vehicle operation, aggregated for all vehicles for a specific model year, vehicle age, regulatory class, and fuel type.
Acrolein Tailpipe (t)	metric-tons	Amount of Acrolein emissions generated from vehicle operation, aggregated for all vehicles for a specific model year, vehicle age, regulatory class, and fuel type.
Benzene Tailpipe (t)	metric-tons	Amount of Benzene emissions generated from vehicle operation, aggregated for all vehicles for a specific model year, vehicle age, regulatory class, and fuel type.
Butadiene Tailpipe (t)	metric-tons	Amount of 1,3-Butadiene emissions generated from vehicle operation, aggregated for all vehicles for a specific model year, vehicle age, regulatory class, and fuel type.
Formaldehyde Tailpipe (t)	metric-tons	Amount of Formaldehyde emissions generated from vehicle operation, aggregated for all vehicles for a specific model year, vehicle age, regulatory class, and fuel type.
DPM10 Tailpipe (t)	metric-tons	Amount of Diesel Particulate Matter (diameter of ~10 micrometers) emissions generated from vehicle operation, aggregated for all vehicles for a specific model year, vehicle age, regulatory class, and fuel type.
MTBE Tailpipe (t)	metric-tons	Amount of Methyl Tertiary Butyl Ether emissions generated from vehicle operation, aggregated for all vehicles for a specific model year, vehicle age, regulatory class, and fuel type.
CO Total (t)	metric-tons	Amount of Carbon Monoxide emissions generated from domestic crude petroleum extraction, transportation, and refining, from gasoline transportation, storage, and distribution, and from vehicle operation, aggregated for all vehicles for a specific model year, vehicle age, regulatory class, and fuel type.
VOC Total (t)	metric-tons	Amount of Volatile Organic Compounds emissions generated from domestic crude petroleum extraction, transportation, and refining, from gasoline transportation, storage, and distribution, and from vehicle operation, aggregated for all vehicles for a specific model year, vehicle age, regulatory class, and fuel type.
NOx Total (t)	metric-tons	Amount of Nitrogen Oxides emissions generated from domestic crude petroleum extraction, transportation, and refining, from gasoline transportation, storage, and distribution, and from vehicle operation, aggregated for all vehicles for a specific model year, vehicle age, regulatory class, and fuel type.
SO2 Total (t)	metric-tons	Amount of Sulfur Dioxide emissions generated from domestic crude petroleum extraction, transportation, and refining, from gasoline transportation, storage, and distribution, and from vehicle operation, aggregated for all vehicles for a specific model year, vehicle age, regulatory class, and fuel type.
PM Total (t)	metric-tons	Amount of Particulate Matter (diameter of ~2.5 micrometers) emissions generated from domestic crude petroleum extraction, transportation, and refining, from gasoline transportation, storage, and distribution,

DRAFT – July 2018

		and from vehicle operation, aggregated for all vehicles for a specific model year, vehicle age, regulatory class, and fuel type.
CO2 Total (mmt)	million metric-tons	Amount of Carbon Dioxide emissions generated from domestic crude petroleum extraction, transportation, and refining, from gasoline transportation, storage, and distribution, and from vehicle operation, aggregated for all vehicles for a specific model year, vehicle age, regulatory class, and fuel type.
CH4 Total (t)	metric-tons	Amount of Methane emissions generated from domestic crude petroleum extraction, transportation, and refining, from gasoline transportation, storage, and distribution, and from vehicle operation, aggregated for all vehicles for a specific model year, vehicle age, regulatory class, and fuel type.
N2O Total (t)	metric-tons	Amount of Nitrous Oxide emissions generated from domestic crude petroleum extraction, transportation, and refining, from gasoline transportation, storage, and distribution, and from vehicle operation, aggregated for all vehicles for a specific model year, vehicle age, regulatory class, and fuel type.
Acetaldehyde Total (t)	metric-tons	Amount of Acetaldehyde emissions generated from domestic crude petroleum extraction, transportation, and refining, from gasoline transportation, storage, and distribution, and from vehicle operation, aggregated for all vehicles for a specific model year, vehicle age, regulatory class, and fuel type.
Acrolein Total (t)	metric-tons	Amount of Acrolein emissions generated from domestic crude petroleum extraction, transportation, and refining, from gasoline transportation, storage, and distribution, and from vehicle operation, aggregated for all vehicles for a specific model year, vehicle age, regulatory class, and fuel type.
Benzene Total (t)	metric-tons	Amount of Benzene emissions generated from domestic crude petroleum extraction, transportation, and refining, from gasoline transportation, storage, and distribution, and from vehicle operation, aggregated for all vehicles for a specific model year, vehicle age, regulatory class, and fuel type.
Butadiene Total (t)	metric-tons	Amount of 1,3-Butadiene emissions generated from domestic crude petroleum extraction, transportation, and refining, from gasoline transportation, storage, and distribution, and from vehicle operation, aggregated for all vehicles for a specific model year, vehicle age, regulatory class, and fuel type.
Formaldehyde Total (t)	metric-tons	Amount of Formaldehyde emissions generated from domestic crude petroleum extraction, transportation, and refining, from gasoline transportation, storage, and distribution, and from vehicle operation, aggregated for all vehicles for a specific model year, vehicle age, regulatory class, and fuel type.
DPM10 Total (t)	metric-tons	Amount of Diesel Particulate Matter (diameter of ~10 micrometers) emissions generated from domestic crude petroleum extraction, transportation, and refining, from gasoline transportation, storage, and distribution, and from vehicle operation, aggregated for all vehicles for a specific model year, vehicle age, regulatory class, and fuel type.
MTBE Total (t)	metric-tons	Amount of Methyl Tertiary Butyl Ether emissions generated from domestic crude petroleum extraction, transportation, and refining, from gasoline transportation, storage, and distribution, and from vehicle operation, aggregated for all vehicles for a specific model year, vehicle age, regulatory class, and fuel type.

DRAFT – July 2018

Table 56. Annual Societal Costs Report

Column	Units	Contents
Scenario	integer	Unique index of the scenario, where 0 represents the baseline, while 1 and above represent the action alternatives.
Scenario Name	text	A short name describing the key features of the scenario.
Model Year	model year	Model years analyzed during the study period. When "Fleet Analysis" option is enabled during modeling, the range of years is extended to include historic and future model years.
Age	integer	The vehicle's vintage, ranging from 0 to 39, where 0 corresponds to a vehicle's first year on the road.
Calendar Year	calendar year	Calendar years analyzed for the effects calculations.
Reg-Class	text	The regulatory class for which the societal costs are reported. When multiple regulatory classes are present in the output, a value of "TOTAL" is used to represent the sums (or averages) across all regulatory classes for some of the outputs, where applicable.
Fuel Type	text	The fuel type for which the societal costs are reported. A value of "TOTAL" is used to represent the sums (or averages) across all fuel types for some of the outputs, where applicable.
Disc-Rate	number	Social discount rate applied to future benefits. A value of 0 indicates undiscounted costs.
Pre-Tax Fuel Cost	dollars (k)	Total pre-tax fuel expenditures accumulated across all vehicles for a specific model year, vehicle age, regulatory class, and fuel type.
Fuel Tax Cost	dollars (k)	Total fuel tax revenues accumulated across all vehicles for a specific model year, vehicle age, regulatory class, and fuel type.
Retail Fuel Costs	dollars (k)	Total retail fuel expenditures (pre-tax fuel cost + fuel tax cost) accumulated across all vehicles for a specific model year, vehicle age, regulatory class, and fuel type.
Drive Value	dollars (k)	Benefits from the additional driving that results from improved fuel economy, accumulated across all vehicles for a specific model year, vehicle age, regulatory class, and fuel type.
Refuel Value	dollars (k)	Benefits from reduced refueling frequency due to the extended vehicle range and improved fuel economy, accumulated across all vehicles for a specific model year, vehicle age, regulatory class, and fuel type.
Market Externalities	dollars (k)	Economic costs of oil imports not accounted for by price, accumulated across all vehicles for a specific model year, vehicle age, regulatory class, and fuel type.
Congestion Costs	dollars (k)	Congestion costs from additional vehicle use, accumulated across all vehicles for a specific model year, vehicle age, regulatory class, and fuel type.
Accident Costs	dollars (k)	Accident costs from additional vehicle use, accumulated across all vehicles for a specific model year, vehicle age, regulatory class, and fuel type.
Noise Costs	dollars (k)	Noise costs from additional vehicle use, accumulated across all vehicles for a specific model year, vehicle age, regulatory class, and fuel type.
Fatality Costs	dollars (k)	Costs attributed to vehicle-related fatalities resulting from additional vehicle use and reduction in vehicle curb weight, accumulated across all vehicles for a specific model year, vehicle age, regulatory class, and fuel type.
Non-Fatal Crash Costs	dollars (k)	Costs attributed to non-fatal vehicle-related crashes resulting from additional vehicle use and reduction in vehicle curb weight, accumulated across all vehicles for a specific model year, vehicle age, regulatory class, and fuel type.
CO Damage Costs	dollars (k)	Owner and societal costs arising from Carbon Monoxide damage, aggregated for all vehicles for a specific model year, vehicle age, regulatory class, and fuel type.
VOC Damage Costs	dollars (k)	Owner and societal costs arising from Volatile Organic Compounds damage, aggregated for all vehicles for a specific model year, vehicle age, regulatory class, and fuel type.
NOx Damage Costs	dollars (k)	Owner and societal costs arising from Nitrogen Oxides damage, aggregated for all vehicles for a specific model year, vehicle age, regulatory class, and fuel type.
SO2 Damage Costs	dollars (k)	Owner and societal costs arising from Sulfur Dioxide damage, aggregated for all vehicles for a specific model year, vehicle age, regulatory class, and fuel type.
PM Damage Costs	dollars (k)	Owner and societal costs arising from Particulate Matter damage, aggregated for all vehicles for a specific model year, vehicle age, regulatory class, and fuel type.
CO2 Damage Costs	dollars (k)	Owner and societal costs arising from Carbon Dioxide damage, aggregated for all vehicles for a specific model year, vehicle age, regulatory class, and fuel type.
CH4 Damage Costs	dollars (k)	Owner and societal costs arising from Methane damage, aggregated for all vehicles for a specific model year, vehicle age, regulatory class, and fuel type.
N2O Damage Costs	dollars (k)	Owner and societal costs arising from Nitrous Oxide damage, aggregated for all vehicles for a specific model year, vehicle age, regulatory class, and fuel type.

B.5 Annual Societal Effects Summary and Annual Societal Costs Summary Reports

The *Annual Societal Effects Summary Report* and the *Annual Societal Costs Summary Report* contain similar results as the *Annual Societal Effects Report* and the *Annual Societal Costs Report*, except these outputs aggregate the results by calendar year, by summing across results at each vehicle age. Table 57 lists the full contents of the *Annual Societal Effects Report* and Table 58 lists the full contents of the *Annual Societal Costs Report*. The annual summary reports produce results as absolutes (*i.e.*, non-incremental) for the baseline and action alternatives.

Table 57. Annual Societal Effects Summary Report

Column	Units	Contents
Scenario	integer	Unique index of the scenario, where 0 represents the baseline, while 1 and above represent the action alternatives.
Scenario Name	text	A short name describing the key features of the scenario.
Calendar Year	calendar year	Calendar years analyzed for the effects calculations.
Reg-Class	text	The regulatory class for which the societal costs are reported. When multiple regulatory classes are present in the output, a value of "TOTAL" is used to represent the sums (or averages) across all regulatory classes for some of the outputs, where applicable.
Fuel Type	text	The fuel type for which the societal costs are reported. A value of "TOTAL" is used to represent the sums (or averages) across all fuel types for some of the outputs, where applicable.
MY Count	integer	Number of distinct model years represented within a specific calendar year. If model year count is 40, the entire population of vehicle models is assumed to be on-road during the specific calendar year.
Average Age	number	The average age of vehicles for a specific calendar year, regulatory class, and fuel type.
Fleet	units	Total on-road fleet for a specific calendar year, regulatory class, and fuel type.
kVMT	miles (k)	Thousands of miles traveled by all vehicles for a specific calendar year, regulatory class, and fuel type.
Quads	quads	Energy used by all vehicles for a specific calendar year, regulatory class, and fuel type.
kGallons	gallons (k)	Amount of gallons of liquid fuel consumed, or amount of gasoline equivalent gallons of fuel consumed (for non-liquid fuel types), by all vehicles for a specific calendar year, regulatory class, and fuel type.
kUnits	varies	Amount of energy consumed by all vehicles for a specific calendar year, regulatory class, and fuel type, where the units of measure vary based on fuel type. For liquid fuel types (gasoline, e85, diesel, b20, LNG, LPG), the units are specified in thousands of gallons; for electricity, the units are specified in mW-h; for hydrogen and CNG, the units are specified in Mcf.
Fatalities	units	Amount of fatalities resulting from reduction in vehicle curb weight and increases in VMT due to the rebound effect, aggregated for all vehicles for a specific calendar year, regulatory class, and fuel type.
CO Upstream (t)	metric-tons	Amount of Carbon Monoxide emissions generated from domestic crude petroleum extraction, transportation, and refining, from gasoline transportation, storage, and distribution, aggregated for all vehicles for a specific calendar year, regulatory class, and fuel type.
VOC Upstream (t)	metric-tons	Amount of Volatile Organic Compounds emissions generated from domestic crude petroleum extraction, transportation, and refining, from gasoline transportation, storage, and distribution, aggregated for all vehicles for a specific calendar year, regulatory class, and fuel type.
NOx Upstream (t)	metric-tons	Amount of Nitrogen Oxides emissions generated from domestic crude petroleum extraction, transportation, and refining, from gasoline transportation, storage, and distribution, aggregated for all vehicles for a specific calendar year, regulatory class, and fuel type.
SO2 Upstream (t)	metric-tons	Amount of Sulfur Dioxide emissions generated from domestic crude petroleum extraction, transportation, and refining, from gasoline transportation, storage, and distribution, aggregated for all vehicles for a specific calendar year, regulatory class, and fuel type.
PM Upstream (t)	metric-tons	Amount of Particulate Matter (diameter of ~2.5 micrometers) emissions generated from domestic crude petroleum extraction, transportation, and refining, from gasoline transportation, storage, and distribution, aggregated for all vehicles for a specific calendar year, regulatory class, and fuel type.
CO2 Upstream (mmt)	million metric-tons	Amount of Carbon Dioxide emissions generated from domestic crude petroleum extraction, transportation, and refining, from gasoline transportation, storage, and distribution, aggregated for all vehicles for a specific calendar year, regulatory class, and fuel type.
CH4 Upstream (t)	metric-tons	Amount of Methane emissions generated from domestic crude petroleum extraction, transportation, and refining, from gasoline transportation, storage, and distribution, aggregated for all vehicles for a specific calendar year, regulatory class, and fuel type.
N2O Upstream (t)	metric-tons	Amount of Nitrous Oxide emissions generated from domestic crude petroleum extraction, transportation, and refining, from gasoline transportation, storage, and distribution, aggregated for all vehicles for a specific calendar year, regulatory class, and fuel type.
Acetaldehyde Upstream (t)	metric-tons	Amount of Acetaldehyde emissions generated from domestic crude petroleum extraction, transportation, and refining, from gasoline transportation, storage, and distribution, aggregated for all vehicles for a specific calendar year, regulatory class, and fuel type.

DRAFT – July 2018

Acrolein Upstream (t)	metric-tons	Amount of Acrolein emissions generated from domestic crude petroleum extraction, transportation, and refining, from gasoline transportation, storage, and distribution, aggregated for all vehicles for a specific calendar year, regulatory class, and fuel type.
Benzene Upstream (t)	metric-tons	Amount of Benzene emissions generated from domestic crude petroleum extraction, transportation, and refining, from gasoline transportation, storage, and distribution, aggregated for all vehicles for a specific calendar year, regulatory class, and fuel type.
Butadiene Upstream (t)	metric-tons	Amount of 1,3-Butadiene emissions generated from domestic crude petroleum extraction, transportation, and refining, from gasoline transportation, storage, and distribution, aggregated for all vehicles for a specific calendar year, regulatory class, and fuel type.
Formaldehyde Upstream (t)	metric-tons	Amount of Formaldehyde emissions generated from domestic crude petroleum extraction, transportation, and refining, from gasoline transportation, storage, and distribution, aggregated for all vehicles for a specific calendar year, regulatory class, and fuel type.
DPM10 Upstream (t)	metric-tons	Amount of Diesel Particulate Matter (diameter of ~10 micrometers) emissions generated from domestic crude petroleum extraction, transportation, and refining, from gasoline transportation, storage, and distribution, aggregated for all vehicles for a specific calendar year, regulatory class, and fuel type.
MTBE Upstream (t)	metric-tons	Amount of Methyl Tertiary Butyl Ether emissions generated from domestic crude petroleum extraction, transportation, and refining, from gasoline transportation, storage, and distribution, aggregated for all vehicles for a specific calendar year, regulatory class, and fuel type.
CO Tailpipe (t)	metric-tons	Amount of Carbon Monoxide emissions generated from vehicle operation, aggregated for all vehicles for a specific calendar year, regulatory class, and fuel type.
VOC Tailpipe (t)	metric-tons	Amount of Volatile Organic Compounds emissions generated from vehicle operation, aggregated for all vehicles for a specific calendar year, regulatory class, and fuel type.
NOx Tailpipe (t)	metric-tons	Amount of Nitrogen Oxides emissions generated from vehicle operation, aggregated for all vehicles for a specific calendar year, regulatory class, and fuel type.
SO2 Tailpipe (t)	metric-tons	Amount of Sulfur Dioxide emissions generated from vehicle operation, aggregated for all vehicles for a specific calendar year, regulatory class, and fuel type.
PM Tailpipe (t)	metric-tons	Amount of Particulate Matter (diameter of ~2.5 micrometers) emissions generated from vehicle operation, aggregated for all vehicles for a specific calendar year, regulatory class, and fuel type.
CO2 Tailpipe (mmt)	million metric-tons	Amount of Carbon Dioxide emissions generated from vehicle operation, aggregated for all vehicles for a specific calendar year, regulatory class, and fuel type.
CH4 Tailpipe (t)	metric-tons	Amount of Methane emissions generated from vehicle operation, aggregated for all vehicles for a specific calendar year, regulatory class, and fuel type.
N2O Tailpipe (t)	metric-tons	Amount of Nitrous Oxide emissions generated from vehicle operation, aggregated for all vehicles for a specific calendar year, regulatory class, and fuel type.
Acetaldehyde Tailpipe (t)	metric-tons	Amount of Acetaldehyde emissions generated from vehicle operation, aggregated for all vehicles for a specific calendar year, regulatory class, and fuel type.
Acrolein Tailpipe (t)	metric-tons	Amount of Acrolein emissions generated from vehicle operation, aggregated for all vehicles for a specific calendar year, regulatory class, and fuel type.
Benzene Tailpipe (t)	metric-tons	Amount of Benzene emissions generated from vehicle operation, aggregated for all vehicles for a specific calendar year, regulatory class, and fuel type.
Butadiene Tailpipe (t)	metric-tons	Amount of 1,3-Butadiene emissions generated from vehicle operation, aggregated for all vehicles for a specific calendar year, regulatory class, and fuel type.
Formaldehyde Tailpipe (t)	metric-tons	Amount of Formaldehyde emissions generated from vehicle operation, aggregated for all vehicles for a specific calendar year, regulatory class, and fuel type.
DPM10 Tailpipe (t)	metric-tons	Amount of Diesel Particulate Matter (diameter of ~10 micrometers) emissions generated from vehicle operation, aggregated for all vehicles for a specific calendar year, regulatory class, and fuel type.
MTBE Tailpipe (t)	metric-tons	Amount of Methyl Tertiary Butyl Ether emissions generated from vehicle operation, aggregated for all vehicles for a specific calendar year, regulatory class, and fuel type.
CO Total (t)	metric-tons	Amount of Carbon Monoxide emissions generated from domestic crude petroleum extraction, transportation, and refining, from gasoline transportation, storage, and distribution, and from vehicle operation, aggregated for all vehicles for a specific calendar year, regulatory class, and fuel type.
VOC Total (t)	metric-tons	Amount of Volatile Organic Compounds emissions generated from domestic crude petroleum extraction, transportation, and refining, from gasoline transportation, storage, and distribution, and from vehicle operation, aggregated for all vehicles for a specific calendar year, regulatory class, and fuel type.
NOx Total (t)	metric-tons	Amount of Nitrogen Oxides emissions generated from domestic crude petroleum extraction, transportation, and refining, from gasoline transportation, storage, and distribution, and from vehicle operation, aggregated for all vehicles for a specific calendar year, regulatory class, and fuel type.
SO2 Total (t)	metric-tons	Amount of Sulfur Dioxide emissions generated from domestic crude petroleum extraction, transportation, and refining, from gasoline transportation, storage, and distribution, and from vehicle operation, aggregated for all vehicles for a specific calendar year, regulatory class, and fuel type.
PM Total (t)	metric-tons	Amount of Particulate Matter (diameter of ~2.5 micrometers) emissions generated from domestic crude petroleum extraction, transportation, and refining, from gasoline transportation, storage, and distribution, and from vehicle operation, aggregated for all vehicles for a specific calendar year, regulatory class, and fuel type.
CO2 Total (mmt)	million metric-tons	Amount of Carbon Dioxide emissions generated from domestic crude petroleum extraction, transportation, and refining, from gasoline transportation, storage, and distribution, and from vehicle operation, aggregated for all vehicles for a specific calendar year, regulatory class, and fuel type.

DRAFT – July 2018

CH4 Total (t)	metric- tons	Amount of Methane emissions generated from domestic crude petroleum extraction, transportation, and refining, from gasoline transportation, storage, and distribution, and from vehicle operation, aggregated for all vehicles for a specific calendar year, regulatory class, and fuel type.
N2O Total (t)	metric- tons	Amount of Nitrous Oxide emissions generated from domestic crude petroleum extraction, transportation, and refining, from gasoline transportation, storage, and distribution, and from vehicle operation, aggregated for all vehicles for a specific calendar year, regulatory class, and fuel type.
Acetaldehyde Total (t)	metric- tons	Amount of Acetaldehyde emissions generated from domestic crude petroleum extraction, transportation, and refining, from gasoline transportation, storage, and distribution, and from vehicle operation, aggregated for all vehicles for a specific calendar year, regulatory class, and fuel type.
Acrolein Total (t)	metric- tons	Amount of Acrolein emissions generated from domestic crude petroleum extraction, transportation, and refining, from gasoline transportation, storage, and distribution, and from vehicle operation, aggregated for all vehicles for a specific calendar year, regulatory class, and fuel type.
Benzene Total (t)	metric- tons	Amount of Benzene emissions generated from domestic crude petroleum extraction, transportation, and refining, from gasoline transportation, storage, and distribution, and from vehicle operation, aggregated for all vehicles for a specific calendar year, regulatory class, and fuel type.
Butadiene Total (t)	metric- tons	Amount of 1,3-Butadiene emissions generated from domestic crude petroleum extraction, transportation, and refining, from gasoline transportation, storage, and distribution, and from vehicle operation, aggregated for all vehicles for a specific calendar year, regulatory class, and fuel type.
Formaldehyde Total (t)	metric- tons	Amount of Formaldehyde emissions generated from domestic crude petroleum extraction, transportation, and refining, from gasoline transportation, storage, and distribution, and from vehicle operation, aggregated for all vehicles for a specific calendar year, regulatory class, and fuel type.
DPM10 Total (t)	metric- tons	Amount of Diesel Particulate Matter (diameter of ~10 micrometers) emissions generated from domestic crude petroleum extraction, transportation, and refining, from gasoline transportation, storage, and distribution, and from vehicle operation, aggregated for all vehicles for a specific calendar year, regulatory class, and fuel type.
MTBE Total (t)	metric- tons	Amount of Methyl Tertiary Butyl Ether emissions generated from domestic crude petroleum extraction, transportation, and refining, from gasoline transportation, storage, and distribution, and from vehicle operation, aggregated for all vehicles for a specific calendar year, regulatory class, and fuel type.

DRAFT – July 2018

Table 58. Annual Societal Costs Summary Report

Column	Units	Contents
Scenario	integer	Unique index of the scenario, where 0 represents the baseline, while 1 and above represent the action alternatives.
Scenario Name	text	A short name describing the key features of the scenario.
Calendar Year	calendar year	Calendar years analyzed for the effects calculations.
Reg-Class	text	The regulatory class for which the societal costs are reported. When multiple regulatory classes are present in the output, a value of "TOTAL" is used to represent the sums (or averages) across all regulatory classes for some of the outputs, where applicable.
Fuel Type	text	The fuel type for which the societal costs are reported. A value of "TOTAL" is used to represent the sums (or averages) across all fuel types for some of the outputs, where applicable.
Disc-Rate	number	Social discount rate applied to future benefits. A value of 0 indicates undiscounted costs.
Pre-Tax Fuel Cost	dollars (k)	Total pre-tax fuel expenditures accumulated across all vehicles for a specific calendar year, regulatory class, and fuel type.
Fuel Tax Cost	dollars (k)	Total fuel tax revenues accumulated across all vehicles for a specific calendar year, regulatory class, and fuel type.
Retail Fuel Costs	dollars (k)	Total retail fuel expenditures (pre-tax fuel cost + fuel tax cost) accumulated across all vehicles for a specific calendar year, regulatory class, and fuel type.
Drive Value	dollars (k)	Benefits from the additional driving that results from improved fuel economy, accumulated across all vehicles for a specific calendar year, regulatory class, and fuel type.
Refuel Value	dollars (k)	Benefits from reduced refueling frequency due to the extended vehicle range and improved fuel economy, accumulated across all vehicles for a specific calendar year, regulatory class, and fuel type.
Market Externalities	dollars (k)	Economic costs of oil imports not accounted for by price, accumulated across all vehicles for a specific calendar year, regulatory class, and fuel type.
Congestion Costs	dollars (k)	Congestion costs from additional vehicle use, accumulated across all vehicles for a specific calendar year, regulatory class, and fuel type.
Accident Costs	dollars (k)	Accident costs from additional vehicle use, accumulated across all vehicles for a specific calendar year, regulatory class, and fuel type.
Noise Costs	dollars (k)	Noise costs from additional vehicle use, accumulated across all vehicles for a specific calendar year, regulatory class, and fuel type.
Fatality Costs	dollars (k)	Costs attributed to vehicle-related fatalities resulting from additional vehicle use and reduction in vehicle curb weight, accumulated across all vehicles for a specific calendar year, regulatory class, and fuel type.
Non-Fatal Crash Costs	dollars (k)	Costs attributed to non-fatal vehicle-related crashes resulting from additional vehicle use and reduction in vehicle curb weight, accumulated across all vehicles for a specific calendar year, regulatory class, and fuel type.
CO Damage Costs	dollars (k)	Owner and societal costs arising from Carbon Monoxide damage, aggregated for all vehicles for a specific calendar year, regulatory class, and fuel type.
VOC Damage Costs	dollars (k)	Owner and societal costs arising from Volatile Organic Compounds damage, aggregated for all vehicles for a specific calendar year, regulatory class, and fuel type.
NOx Damage Costs	dollars (k)	Owner and societal costs arising from Nitrogen Oxides damage, aggregated for all vehicles for a specific calendar year, regulatory class, and fuel type.
SO2 Damage Costs	dollars (k)	Owner and societal costs arising from Sulfur Dioxide damage, aggregated for all vehicles for a specific calendar year, regulatory class, and fuel type.
PM Damage Costs	dollars (k)	Owner and societal costs arising from Particulate Matter damage, aggregated for all vehicles for a specific calendar year, regulatory class, and fuel type.
CO2 Damage Costs	dollars (k)	Owner and societal costs arising from Carbon Dioxide damage, aggregated for all vehicles for a specific calendar year, regulatory class, and fuel type.
CH4 Damage Costs	dollars (k)	Owner and societal costs arising from Methane damage, aggregated for all vehicles for a specific calendar year, regulatory class, and fuel type.
N2O Damage Costs	dollars (k)	Owner and societal costs arising from Nitrous Oxide damage, aggregated for all vehicles for a specific calendar year, regulatory class, and fuel type.

B.6 Consumer Costs Report

The *Consumer Costs Report* contains summary of consumer-related costs for each model year and scenario analyzed, using discounting from the consumer’s perspective. The results are reported by regulatory class, as well as aggregated for the entire fleet. Most of the metrics, which are reported independently by model year, are further summed (or averaged) over the entire analysis period. For the baseline scenario, all costs are specified as absolutes, while for the action alternatives, all costs are incremental and are specified as the difference between the action alternative and the baseline scenario. Table 59 lists the full contents of the *Consumer Costs Report*.

Table 59. Consumer Costs Report

Column	Units	Contents
Scenario	integer	Unique index of the scenario, where 0 represents the baseline, while 1 and above represent the action alternatives.
Scenario Name	text	A short name describing the key features of the scenario.
Model Year	model year	Model years analyzed during the study period. A value of "TOTAL" is used to represent the sums (or averages) across all model years for some of the outputs, where applicable.
Reg-Class	text	The regulatory class for which the consumer costs are reported. When multiple regulatory classes are present in the output, a value of "TOTAL" is used to represent the sums (or averages) across all regulatory classes for some of the outputs, where applicable.
Disc-Rate	number	Consumer discount rate applied to future benefits. This value dictates the rate at which all associated costs are discounted. A value of 0 indicates that the costs are undiscounted.
Payback	number	Number of years before increases in vehicles' average costs are repaid.
Payback TCO	number	Number of years before increases in vehicles' average total costs of ownership are repaid.
Tech Cost	dollars (k)	Total amount of technology costs accumulated across all vehicle models.
Reg Cost	dollars (k)	Total amount of regulatory costs accumulated across all vehicle models.
Maint/Repair Cost	dollars (k)	Total amount of maintenance and repair costs accumulated across all vehicle models.
Value Loss	dollars (k)	Total consumer welfare loss associated with application of additional vehicle technologies, accumulated across all vehicle models.
Relative Value Loss	dollars (k)	The calculation of this value has been temporarily removed from this version of the model.
Init Taxes/Fees	dollars (k)	Total initial taxes and fees attributable to an unaltered vehicle state, before any new technology application, accumulated across all vehicle models.
Taxes/Fees	dollars (k)	Total taxes and fees associated with a new vehicle purchase accumulated across all vehicle models.
Init Financing	dollars (k)	Total initial financing costs attributable to an unaltered vehicle state, before any new technology application, accumulated across all vehicle models.
Financing	dollars (k)	Total costs associated with financing a new vehicle purchase accumulated across all vehicle models.
Init Insurance	dollars (k)	Total initial insurance costs attributable to an unaltered vehicle state, before any new technology application, accumulated across all vehicle models over their lifetime.
Insurance	dollars (k)	Total insurance costs accumulated across all vehicle models over their lifetime.
Init Retail Fuel Costs	dollars (k)	Total retail fuel expenditures attributable to an unaltered vehicle state, before any new technology application, accumulated across all vehicle models over their lifetime.
Retail Fuel Costs	dollars (k)	Total retail fuel expenditures accumulated across all vehicle models over their lifetime.
Rebound Fuel Costs	dollars (k)	Total retail fuel expenditures from the additional driving that results from improved fuel economy, accumulated across all vehicle models over their lifetime.
Drive Value	dollars (k)	Total benefits from the additional driving that results from improved fuel economy, accumulated across all vehicle models over their lifetime.
Avg Tech Cost	dollars	Average technology costs per single vehicle unit.
Avg Reg Cost	dollars	Average regulatory costs per single vehicle unit.
Avg Maint/Repair Cost	dollars	Average maintenance and repair costs per single vehicle unit.
Avg Value Loss	dollars	Average consumer welfare loss per single vehicle unit.
Avg Relative Value Loss	dollars	The calculation of this value has been temporarily removed from this version of the model.
Avg Taxes/Fees	dollars	Average technology costs per single vehicle unit.
Avg Financing	dollars	Average vehicle financing costs per single vehicle unit.
Avg Insurance	dollars	Average vehicle insurance costs per single vehicle unit.
Avg Retail Fuel Costs	dollars	Average retail fuel expenditures per single vehicle unit.

B.7 Vehicles Report

The *Vehicles Report* contains disaggregate vehicle-level summary of compliance model results, providing a detailed view of the final state of each vehicle examined by the model, for each model year and scenario analyzed. The report includes basic vehicle characteristics (such as vehicle code, manufacturer, engine and transmission used, curb weight, footprint, and sales volumes), fuel economy information (before and after the analysis), final technology utilization, and cost metrics associated with application of additional technology.

The vehicle's fuel economy and CO₂ ratings prior to the start of the analysis as well as at the end of each compliance model year are presented. The fuel economy and CO₂ values are specified per fuel type (wherever applicable) in addition to the overall values, which are used for compliance purposes. For multi-fuel vehicles, the multiple fuel economy and CO₂ ratings are combined according to the statutory requirements. For flex-fuel vehicles (those that operate on gasoline and E85), only the gasoline fuel economy rating is considered for compliance. For plug-in hybrid/electric vehicles (PHEVs operating on gasoline and electricity), the overall fuel economy rating is harmonically averaged based on the share of each fuel type, while the CO₂ rating includes the portion of gasoline operation. The vehicle's fuel share indicates the amount of miles driven by the vehicle on each fuel type. For vehicles operating on a single fuel (*e.g.*, gasoline, diesel, or electricity), only the fuel share for that fuel type is specified. For vehicles operating on multiple fuels (FFVs and PHEVs), the fuel shares are specified for gasoline and E85 or for gasoline and electricity.

The *Vehicles Report* provides initial and final sales volumes as well as initial and final MSRPs. The initial sales and MSRP represent the starting values as obtained from the input file, and do not reflect changes associated with the modeling analysis. The final sales volumes are specified by model year and will match the initial values, unless the Dynamic Fleet Share and Sales Response model is enabled. The final MSRPs are specified by model year as well, and incorporate additional costs arising from technology application or fine payment. Table 60 below list the full contents of the *Vehicles Report*.

DRAFT – July 2018

Table 60. Vehicles Report

Column	Units	Contents
Scenario	integer	Unique index of the scenario, where 0 represents the baseline, while 1 and above represent the action alternatives.
Scenario Name	text	A short name describing the key features of the scenario.
Model Year	model year	Model years analyzed during the study period.
Manufacturer	text	Manufacturers analyzed during the study period.
Veh Index	integer	Unique index assigned to each vehicle by the modeling system during runtime.
Veh Code	integer	Index of the vehicle (unique per manufacturer), as read from the input file.
Brand	text	Vehicle brand.
Model	text	Vehicle model.
Name Plate	text	Vehicle nameplate.
Platform	text	Name of the platform used by a vehicle.
Plt Version	text	Revision of the platform used by a vehicle. This field lists the platform version as "baseline", if the vehicle is using an original and unmodified platform. Alternatively, this field shows the model year, signifying the revision of the initial platform that the vehicle has inherited.
Powertrain	text	Vehicle's powertrain type in a specific model year. Available options are: Conventional, MHEV for mild hybridization (including 12 volt micro-hybrid and belt- or crank-mounted integrated starter/generator), SHEV for strong hybrid/electric vehicle, PHEV for plug-in hybrid/electric vehicle, BEV for battery electric vehicle, and FCV for fuel cell vehicle.
Veh Power Initial	HP	Initial power rating of a vehicle.
Veh Power	HP	Final power rating of a vehicle.
Eng Code	integer	Index of the engine used by a vehicle.
Eng Fuel Initial	text	Fuel used by the starting engine, before any modifications were made by the modeling system. Available options are: G for gasoline, D for diesel, and CNG for compressed natural gas.
Eng Type Initial	text	Brief information about the starting engine, before any modifications were made by the modeling system. The field includes: engine horsepower, displacement, configuration, number of cylinders, and aspiration.
Eng Version	text	Revision of the engine used by a vehicle. This field lists the engine version as "baseline", if the vehicle is using an original and unmodified engine. Alternatively, this field shows the model year, signifying the revision of the initial engine that the vehicle has inherited.
Eng Fuel	text	Fuel used by the engine in a specific model year.
Eng Type	text	Brief information about the engine in a specific model year. At present, only the aspiration of the engine is shown, since other attributes are assumed to remain unchanged.
Trn Code	integer	Index of the transmission used by a vehicle.
Trn Type Initial	text	Brief information about the starting transmission, before any modifications were made by the modeling system. This field includes: transmission type (A=automatic, M=manual, CVT=continuously variable transmission, AMT=automated manual transmission, DCT=dual-clutch transmission) and number of gears (if applicable).
Trn Version	text	Revision of the transmission used by a vehicle. This field lists the transmission version as "baseline", if the vehicle is using an original and unmodified transmission. Alternatively, this field shows the model year, signifying the revision of the initial transmission that the vehicle has inherited.
Trn Type	text	Brief information about the transmission in a specific model year. This field includes: transmission type (A=automatic, M=manual, CVT=continuously variable transmission, S=sequential transmission (AMT or DCT), HEV=unique transmission on a hybrid/electric vehicle) and number of gears (if applicable).
FE Primary Initial	mpg	Vehicle's initial fuel economy rating when operating on its primary fuel type. This represents the starting value as read from the input file.
FE Secondary Initial	mpg	Vehicle's initial fuel economy rating when operating on its secondary fuel type (if applicable). This represents the starting value as read from the input file.
FE Initial	mpg	Vehicle's overall initial fuel economy rating, before any modifications were made by the modeling system. For FFVs (gasoline/E85) and PHEVs (gasoline/electricity), the overall fuel economy rating may be harmonically averaged based on the share of each fuel type, according to the "Multi-Fuel" setting defined in the scenarios input file.
Fuel Initial	text	All fuel types initially used by the vehicle, before any modifications were made by the modeling system.
FS Initial	ratio	Vehicle's initial fuel share, indicating the amount of miles driven by the vehicle on each fuel type. Only the fuel types on which the vehicle operates are reported. This represents the starting value as read from the input file.
FE Primary Rated	mpg	Vehicle's fuel economy rating when operating on its primary fuel type, in a specific model year, taking into account the effect of technology additions made by the modeling system. This value does not include adjustment for improvements in air conditioning or off-cycle credits.
FE Secondary Rated	mpg	Vehicle's fuel economy rating when operating on its secondary fuel type (if applicable), in a specific model year, taking into account the effect of technology additions made by the modeling system. This value does not include adjustment for improvements in air conditioning or off-cycle credits.
FE Rated	mpg	Vehicle's overall fuel economy rating in a specific model year, taking into account the effect of technology additions made by the modeling system. For FFVs (gasoline/E85) and PHEVs (gasoline/electricity), the overall fuel economy rating may be harmonically averaged based on the share of each fuel type, according to

DRAFT – July 2018

		the "Multi-Fuel" setting defined in the scenarios input file. This value does not include adjustment for improvements in air conditioning or off-cycle credits.
FE Primary Compliance	mpg	Vehicle's fuel economy rating when operating on its primary fuel type, in a specific model year, taking into account the effect of technology additions made by the modeling system, adjusted for improvements in air conditioning and off-cycle credits.
FE Secondary Compliance	mpg	Vehicle's fuel economy rating when operating on its secondary fuel type (if applicable), in a specific model year, taking into account the effect of technology additions made by the modeling system, adjusted for improvements in air conditioning and off-cycle credits.
FE Compliance	mpg	Vehicle's overall fuel economy rating in a specific model year, taking into account the effect of technology additions made by the modeling system, adjusted for improvements in air conditioning and off-cycle credits. For FFVs (gasoline/E85 and diesel/B20) and PHEVs (gasoline/electricity), the overall fuel economy rating may be harmonically averaged based on the share of each fuel type, according to the "Multi-Fuel" setting defined in the scenarios input file. This value is used for compliance purposes.
Fuel	text	All fuel types used by the vehicle in a specific model year.
Fuel Share	ratio	Vehicle's fuel share, indicating the amount of miles driven by the vehicle on each fuel type in a specific model year. Only the fuel types on which the vehicle operates are reported.
CO2 Primary Initial	grams per mile	Vehicle's initial CO2 rating when operating on its primary fuel type. This value is calculated based on the FE Primary Initial value.
CO2 Secondary Initial	grams per mile	Vehicle's initial CO2 rating when operating on its secondary fuel type (if applicable). This value is calculated based on the FE Secondary Initial value.
CO2 Initial	grams per mile	Vehicle's overall initial CO2 rating, before any modifications were made by the modeling system. For FFVs (gasoline/E85) and PHEVs (gasoline/electricity), the overall fuel economy rating may be harmonically averaged based on the share of each fuel type, according to the "Multi-Fuel" setting defined in the scenarios input file.
CO2 Primary Rated	grams per mile	Vehicle's CO2 rating when operating on its primary fuel type, in a specific model year, taking into account the effect of technology additions made by the modeling system. This value is calculated based on the FE Primary value.
CO2 Secondary Rated	grams per mile	Vehicle's CO2 rating when operating on its secondary fuel type, in a specific model year, taking into account the effect of technology additions made by the modeling system. This value is calculated based on the FE Secondary value.
CO2 Rated	grams per mile	Vehicle's overall CO2 rating in a specific model year, taking into account the effect of technology additions made by the modeling system. For FFVs (gasoline/E85) and PHEVs (gasoline/electricity), the overall fuel economy rating may be harmonically averaged based on the share of each fuel type, according to the "Multi-Fuel" setting defined in the scenarios input file.
Veh Class	text	Vehicle's general classification (passenger vehicle: LDV; light duty truck: LDT1, LDT2a, LDT2b, LDT3; medium duty truck: MDT4, MDT5, MDT6; heavy duty truck: HDT7, HDT8). Only the passenger vehicle and light duty truck classifications are supported by the modeling system.
Reg Class	text	Vehicle's regulatory class (PassengerCar, LightTruck, or LightTruck2b3).
Tech Class	text	Vehicle's technology class (used for technology selection and application).
Eng Tech Class	text	Vehicle's engine technology class (used for determining costs of engine-level technologies).
Safety Class	text	Vehicle's safety class (PC=Passenger Car, CM=CUV/Minivan, LT=Light Truck/SUV; used for safety calculations).
Redesign State	text	Vehicle's redesign state, whether the vehicle is being redesigned in the current model year.
Refresh State	text	Vehicle's refresh state, whether the vehicle is being refreshed in the current model year.
Platform Leader	text	A flag indicating whether a vehicle serves as the leader of the engine (E), transmission (T), and/or platform (P) that it uses. During modeling, engine, transmission, and platform technologies are first applied to a leader vehicle during the leaders redesign or refresh, and subsequently inherited on all other vehicles during their redesign/refresh years.
Sales Initial	units	Vehicle's production volumes in a specific model year. This represents the starting value as read from the input file.
Sales	units	Vehicle's final production volumes in a specific model year. If modeling options for sales mixing are used (such as the Dynamic Fleet Share Model), this value will differ from the initial production volumes; otherwise, this value will be the same the initial one.
MSRP Initial	dollars	Vehicle's initial MSRP value in a specific model year. This represents the starting value as read from the input file.
MSRP	dollars	Vehicle's final MSRP value in a specific model year, including additional costs arising from technology application or fine payment.
k.Labor Hours	hours (k)	Thousands of employment hours associated with the production of the vehicle models in a specific model year.
CW Initial	lbs.	Vehicle's initial curb weight. This represents the starting value as read from the input file.
CW	lbs.	Vehicle's final curb weight in a specific model year, taking into account any mass reduction technology applied by the modeling system.
TW Initial	lbs.	Vehicle's initial test weight, before any modifications were made by the modeling system.
TW	lbs.	Vehicle's final test weight in a specific model year, taking into account any mass reduction technology applied by the modeling system.
GVWR Initial	lbs.	Vehicle's initial GVWR, before any modifications were made by the modeling system.
GVWR	lbs.	Vehicle's final GVWR in a specific model year, taking into account any mass reduction technology applied by the modeling system.

DRAFT – July 2018

GCWR Initial	lbs.	Vehicle's initial GCWR, before any modifications were made by the modeling system.
GCWR	lbs.	Vehicle's final GCWR in a specific model year, taking into account any mass reduction technology applied by the modeling system.
Footprint	sq.ft.	Vehicle's initial footprint. This represents the starting value as read from the input file. The vehicle's footprint does not change during the analysis.
Work Factor	lbs.	Vehicle's work factor in a specific model year. This value is reported only for vehicles that are subject to the work-factor based functional standard.
FE Target	gallons per mile	Vehicle's fuel economy target in a specific model year.
CO2 Target	grams per mile	Vehicle's CO-2 target in a specific model year.
ZEV Credits	zevs	Amount of ZEV credits generated by a vehicle due to its full or partial operation on fuel types that do not generate downstream emissions. At present, PHEV's, EV's, and FCVs are ZEV credit generating vehicles.
Tech Cost	dollars	Unit costs accumulated by the vehicle model from technology application in a specific model year.
Price Increase	dollars	Increase in vehicle price accumulated by the vehicle model from technology application and fine payment in a specific model year.
Tax Credit	dollars	Amount of Federal tax credits a buyer receives for purchasing this vehicle. Tax credits are specified for strong hybrid, plug-in hybrid, and electric vehicles, only when the applicable "Tax Credit" settings are defined in the scenarios input file.
Value Loss	dollars	Total loss in value to the consumer based on application of certain technologies.
Rel. Value Loss	dollars	The calculation of this value has been temporarily removed from this version of the model.
Maint/Repair Cost	dollars	Unit maintenance and repair costs accumulated by the vehicle model from technology application in a specific model year.
Taxes/Fees Initial	dollars	Taxes & fees paid by the consumers for purchasing a new vehicle model in a specific model year, calculated for a vehicle model at its initial state, before application of any technologies.
Taxes/Fees	dollars	Taxes & fees paid by the consumers for purchasing a new vehicle model in a specific model year.
Financing Initial	dollars	Financing costs paid by the consumers for purchasing a new vehicle model in a specific model year, calculated for a vehicle model at its initial state, before application of any technologies.
Financing	dollars	Financing costs paid by the consumers for purchasing a new vehicle model in a specific model year.
Insurance Initial	dollars	Insurance costs paid by the consumers for purchasing a new vehicle model in a specific model year, calculated for a vehicle model at its initial state, before application of any technologies.
Insurance	dollars	Insurance costs paid by the consumers for purchasing a new vehicle model in a specific model year.
Payback	years	The number of years before the cost attributed to application of additional technologies on a specific vehicle model will pay back in the form of fuel savings.
Payback TCO	years	The number of years before the "total cost of ownership" attributed to application of additional technologies on a specific vehicle model will pay back in the form of fuel savings.
FC TechKey	string	A combination of technologies represented within the Argonne Simulation Database that are used on a specific vehicle model. The "FC TechKey" value does not include "add-on" technologies.
Technology (multiple columns)	text	<p>The utilization of technologies on a vehicle model in a specific model year. The following define the utilization codes used by the modeling system:</p> <ul style="list-style-type: none"> U = technology was initially in use on a base vehicle before modeling began A = technology was applied to a vehicle by the modeling system I = technology was applied to a leader of a vehicle's engine, transmission, or platform by the modeling system, and later inherited on a current follower vehicle US = technology was in use on a base vehicle, but was later superseded when another technology was applied by the modeling system AS = technology was applied to a vehicle by the modeling system, but was later superseded when another technology was applied IS = technology was inherited on a vehicle by the modeling system, but was later superseded when another technology was applied P = technology has exceed its phase-in threshold in the current model year, and thus was not applied by the modeling system X = technology is not available for application on a vehicle in the current model year <blank> = technology is available for application on a vehicle in the current model year, but the modeling system has not yet applied it

Appendix C CAFE Model Software Manual

C.1 Warnings

This software was developed for analysis by U.S. Department of Transportation staff of potential fuel economy requirements.

This software uses input files containing detailed information regarding vehicles manufactured for sale in the United States and creates output files containing similarly detailed information regarding such vehicles. If input files containing information in any way (*e.g.*, based on entitlement under 5 U.S.C 552 to confidential treatment) protected from disclosure to the public are used, some output files created by this software must also be protected from disclosure to the public.

C.2 Notice

The CAFE Model software is a U.S. government work not subject to copyright pursuant to 17 USC 105; however, some of the third-party works used by the software are subject to usage agreements, as described below.

The button controls in the application toolbar of the CAFE Model use images from the Glaze Icon Set (version 0.4.6, released on 3/06/2006) obtained from <http://www.notmart.org>. All icons and/or images within the Glaze Icon Set are distributed under the GNU Lesser General Public License (LGPL), version 2.1. The version 2.1 of the GNU LGPL may be obtained from: <http://www.gnu.org/licenses/old-licenses/lgpl-2.1.html>.

If users of the CAFE Model have any questions about this notice, please contact the current administrators of the CAFE Model project.

C.3 Installation and System Requirements

The CAFE Model runs on IBM-compatible computers using the Microsoft® Windows operating system. Although the software does not have strict hardware requirements, beyond what is needed to run the operating system, a dual core Intel compatible processor, with at least 2 GB of physical memory (RAM) is strongly recommended. The software has been developed and tested on computers using Windows 7/10 and Windows Server 2012, but may operate properly on machines using other versions of Windows, as long as a compatible Microsoft® .NET Framework is installed.

The CAFE Model software additionally utilizes Microsoft® Excel to read input files needed for modeling. As such, a compatible version Excel must be installed on the system. The current version of the model software was tested for proper operation having Excel versions 2010 and later installed on the user’s system. The CAFE Model was developed using the Microsoft® .NET Framework, version 4.6.1. If the Framework is not already present, it must be installed. Instructions for downloading and installing the .NET framework are available on the Internet at <https://www.microsoft.com/en-us/download/details.aspx?id=49981>.

Based on the characteristics of machines used in the development of this software, the following table provides a summary of system requirements:

Table 61. CAFE Model System Requirements

Dual Core Intel compatible processor (64-bit Quad Core processor recommended)
2 GB RAM (8 GB recommended)
60 MB hard drive space for installation (additional disk space will be required during runtime) ⁶⁸
Microsoft® Windows 7/10
Microsoft® .NET Framework 4.6.1
Microsoft® Excel 2010 or later

Once the system requirements have been met, the latest version of the CAFE Model may be obtained by contacting NHTSA or Volpe Center staff.

The current version of the software is packaged as a stand-alone executable and does not require installation. To operate the model, place the “CAFE Model.exe” file on the desktop and execute it.⁶⁹

⁶⁸ Depending on how the model is operated (*e.g.*, number of scenarios to be evaluated, types of output and log files to be produced), outputs from a single execution of the model can easily exceed 1 gigabyte.

⁶⁹ The CAFE Model files provided may be in a zip archive, which will need to be extracted using a zip utility such as WinZip (www.winzip.com) or 7Zip (www.7-zip.org).

C.4 CAFE Model Graphical User Interface

The CAFE Model Graphical User Interface (GUI) provides users with a set of tools necessary to set up and run multiple modeling test scenarios, which are commonly referred to as CAFE Model sessions. Each CAFE Model session can be configured independently, each with its own set of model inputs and settings. Once configured, the session may be saved for future runs, or executed immediately.⁷⁰ When the model runs, the system displays the progress of the compliance modeling process in the main model window.

The model GUI consists of two primary screens: the main **CAFE Model** window and the **Modeling Settings** window. The **CAFE Model** window is used for managing the modeling sessions, while the **Modeling Settings** window is used to configure them.

To run the modeling system, click on the **CAFE Model** executable file located on the desktop. When the application launches, a **Warnings** dialog box is displayed (Figure 11). The user must read and understand the warnings listed prior to using the modeling system.

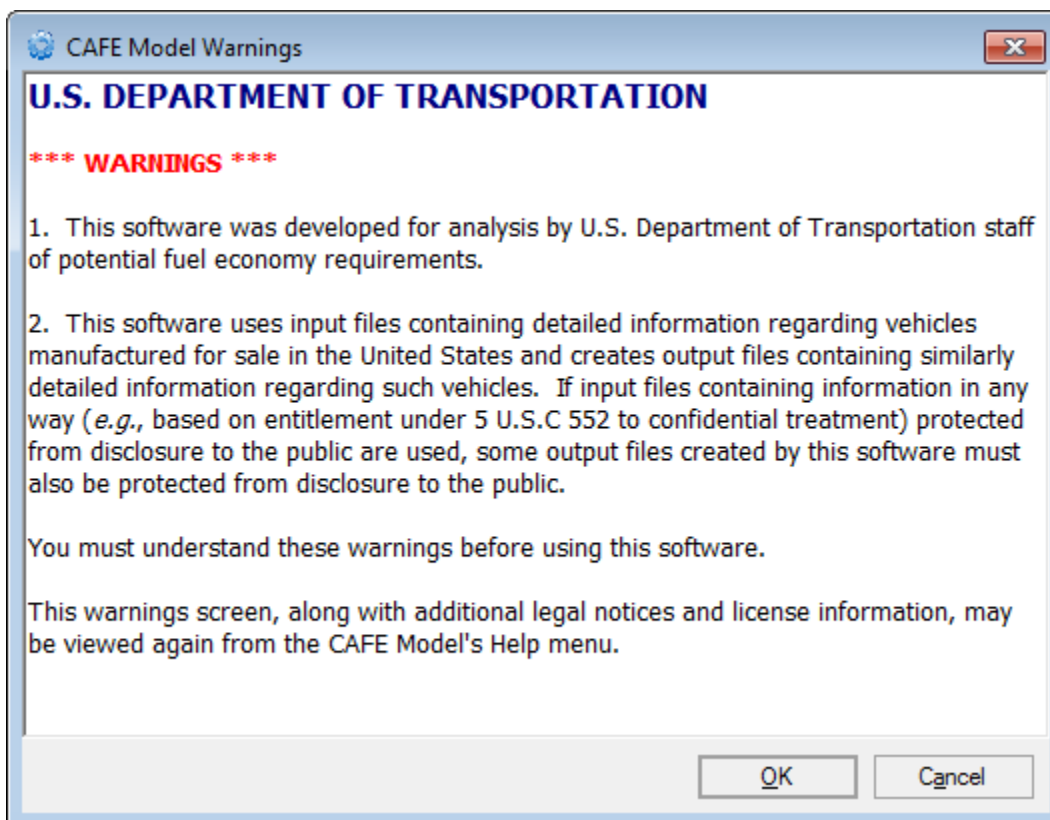

Figure 11. Warnings Dialog Box

⁷⁰ It is recommended that users save the sessions prior to running them in order to assign a meaningful title to each session. Doing so will cause the model to create an output file folder with the same name.

After clicking the **OK** button in the **Warnings** dialog box, a **Splash Screen** window appears (Figure 12), prompting the user to wait for model resources to load.

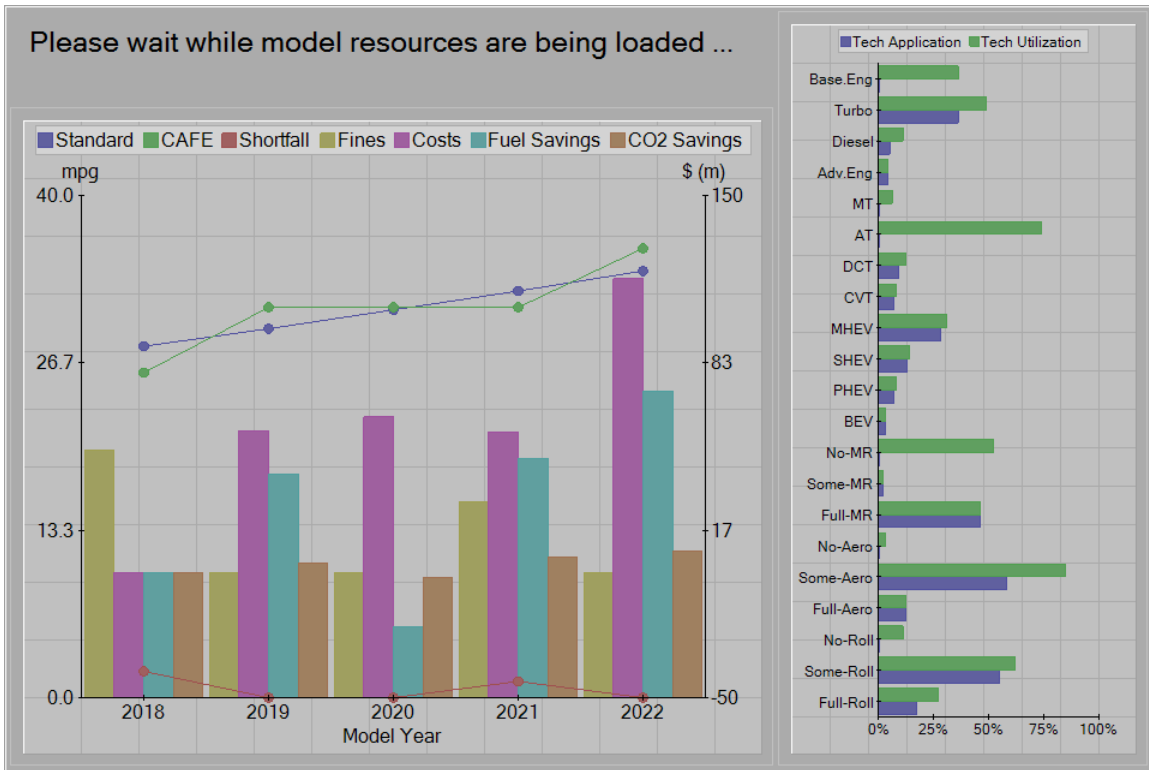

Figure 12. CAFE Model Splash Screen

Once the model resources are completely loaded, the main **CAFE Model** window, described below, opens.

C.4.1 CAFE Model Window

The main **CAFE Model** window (Figure 13) is used to create, configure, and manage CAFE modeling sessions. The main window also controls the model operation, allowing users to start and stop modeling simulation.

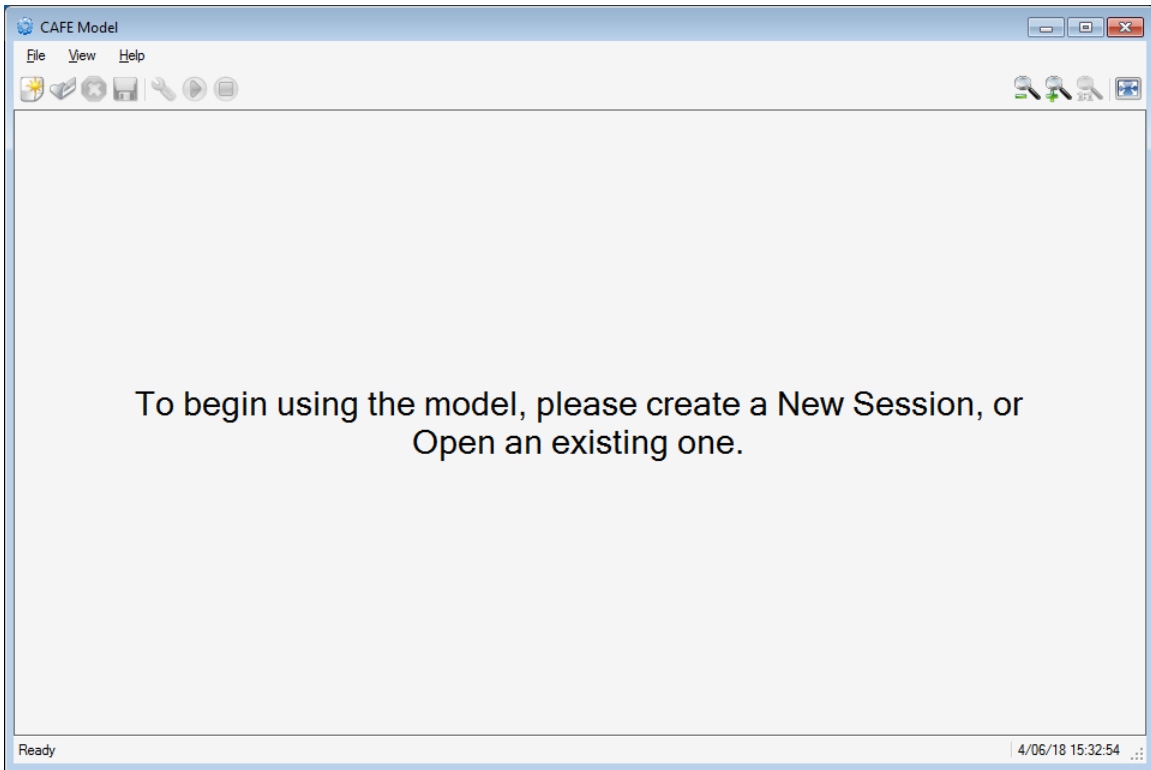

Figure 13. CAFE Model Window

When the model first starts up, most of the menu items and toolbar icons are disabled, until a new session is created, or an existing one is opened.

All of the options required for operation of the model GUI may be accessed using a file-menu (Figure 14), with most commonly used shortcuts also available on the model toolbar (Figure 15). For user convenience, most of the menu entries may also be controlled using keyboard shortcuts.

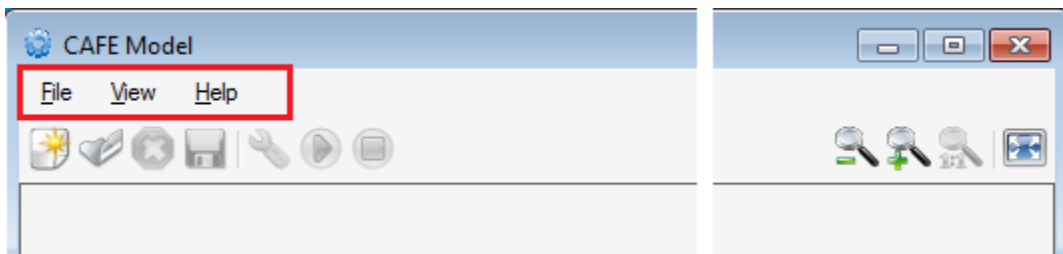

Figure 14. CAFE Model File Menu

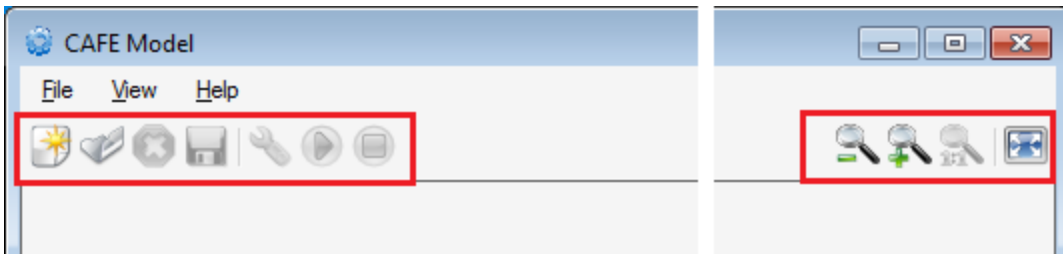

Figure 15. CAFE Model Toolbar

Some of the most commonly used file menus are:

- **File > New Session:** Creates a new *CAFE Model Session* and displays the **Modeling Settings** window to the user.
- **File > Open Session:** Opens an existing *CAFE Model Session*.
- **File > Close Session:** Closes the currently open *CAFE Model Session*.
- **File > Save Session:** Saves the open *CAFE Model Session*.
- **File > Start Modeling:** Begins CAFE simulation modeling for the currently open *CAFE Model Session*.
- **File > Stop Modeling:** Suspends CAFE simulation modeling.
- **File > Exit:** Exits the **CAFE Model**. If a *CAFE Model Session* is still opened, it will be closed prior to exiting the model.
- **View > Modeling Settings:** Displays the **Modeling Settings** window, where all modeling options and settings may be configured.
- **View > Output Location:** Opens a Windows Explorer window and browses to the location where the output files and reports of the current session are written to.
- **View > Argonne Simulation Results:** Opens a Windows Explorer window and browses to the location where vehicle simulation results produced at Argonne National Laboratory using the *Autonomie* model are located.

Users are encouraged to explore all of the additional file menus available within the model. For analysis involving many model runs, work flow can be accelerated and configuration errors reduced considerably by saving a session, reopening it, making desired modifications (*e.g.*, selecting a different version of an input file, or changing a run-time option), and saving (before running) the modified session under a new name.

The description for the menus listed above, as well as all other menu and toolbar items are also displayed within the model GUI's status bar when the user points to that item with a mouse.

C.4.2 Modeling Settings Window

The **Modeling Settings** window contains multiple panels for configuring all of the runtime options available to the model. The user can operate this window to set up a new session, or modifying an existing one, before starting the modeling process. Each of the available configuration panels is outlined in the sections below.

C.4.2.1 General Compliance Settings Panel

The **General Compliance Settings** panel (Figure 16) is used to specify what type of modeling the user would like to run. Each model is tailored to different type of analysis, using its own set of assumptions and configuration settings. Presently, only one model type is available:

- **Standard Compliance Model:** The *Standard Compliance Model* is the default mode of operation for the CAFE modeling system. This model type is used to evaluate technology costs and benefits in response to the required CAFE standards defined in the modeling scenarios.

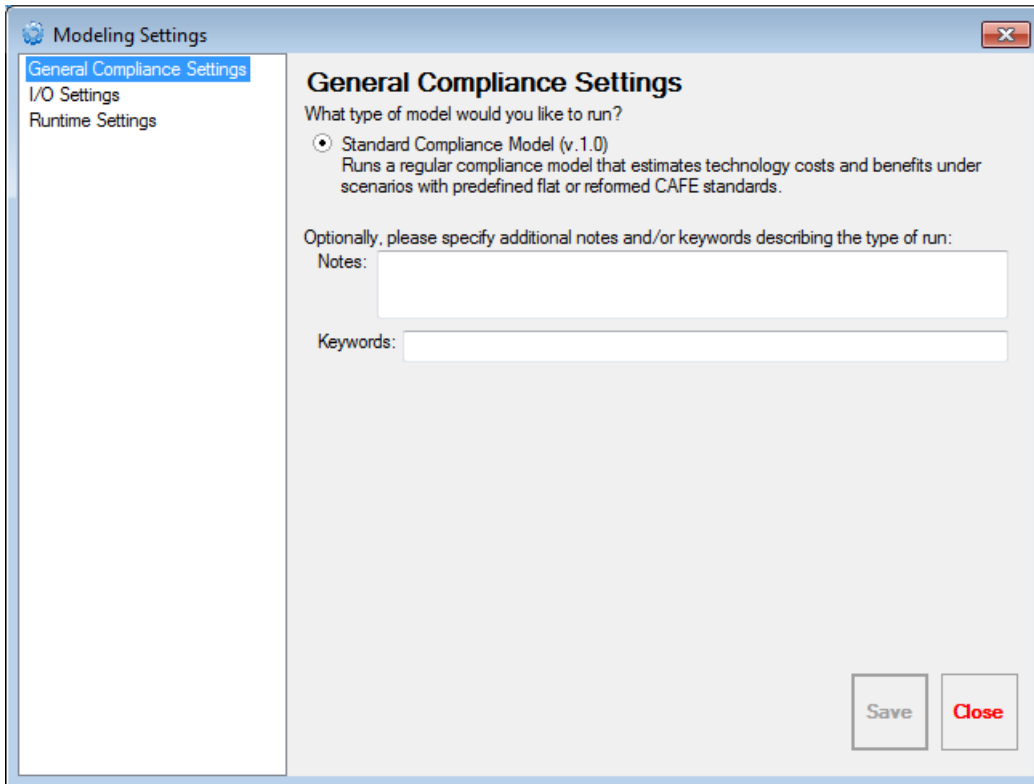

Figure 16. General Compliance Settings Panel

The notes and keywords portions are optional and may be specified by the user for diagnostic or information purposes. These are reflected in the summary log file produced by the system and do not affect the actual modeling process.

At present, as shown in Figure 16 above, the current version of the modeling system only supports the *Standard Compliance Model*. Future development may reintroduce additional types of analysis, such as Monte-Carlo simulation.

C.4.2.2 I/O Settings Panel

On the **I/O Settings** panel (Figure 17), the user can select the input data files for use with the modeling system as well as the location where modeling results will be saved.

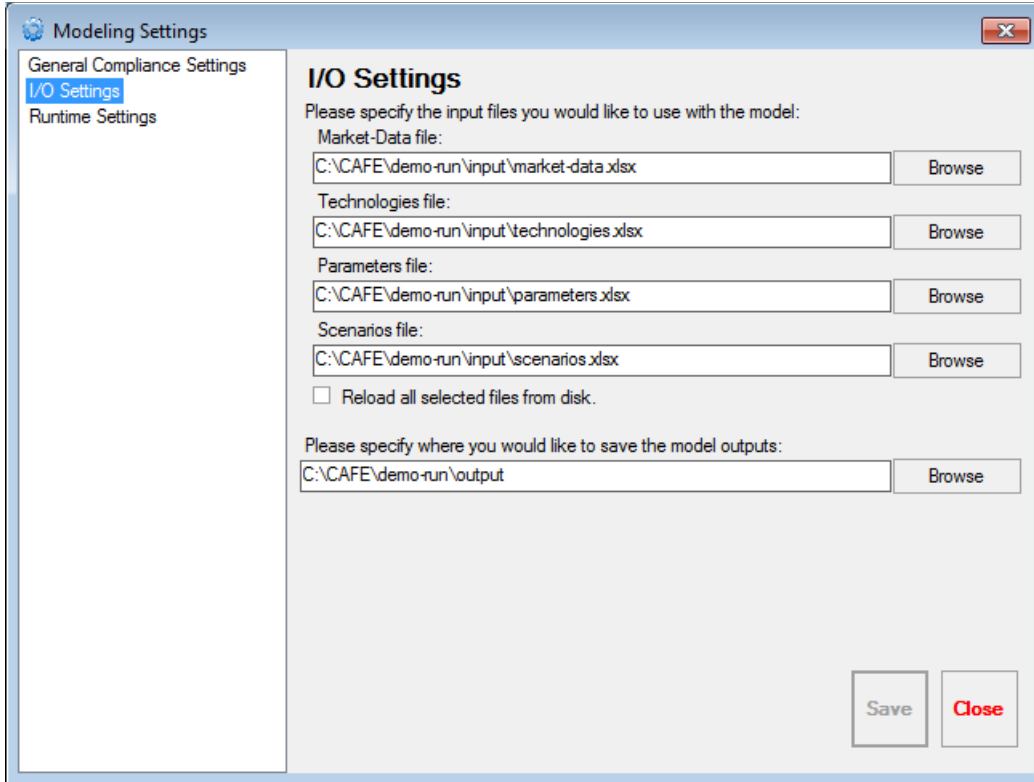

Figure 17. I/O Settings Panel (1)

Input and output locations may be entered by typing the paths into the appropriate textboxes, browsing for a specific file or folder path, or dragging-and-dropping an input file or an output folder directly onto the **I/O Settings** panel. Multiple input files may be selected and dragged-and-dropped onto the panel simultaneously. In this case, the modeling system automatically determines if the correct files were chosen by reading the “Title” field from a specific Excel file’s metadata, and populating the required inputs accordingly. As shown in Figure 18 below, when the user drags-and-drops multiple input files, the **Modeling Settings** window blocks, requiring the user to wait until all files are processed.

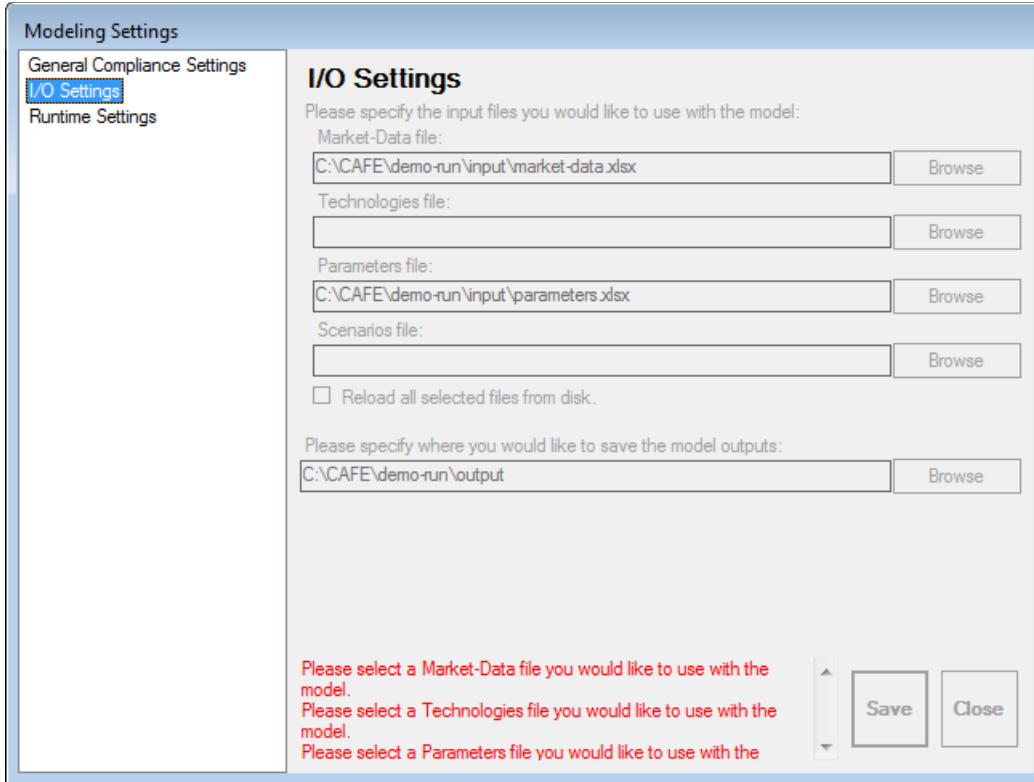

Figure 18. I/O Settings Panel (2)

When manually entering input files, the model will use the selected file’s metadata information to attempt to verify if an appropriate file was used. If incorrect file path is entered, an error message will be displayed (Figure 19).

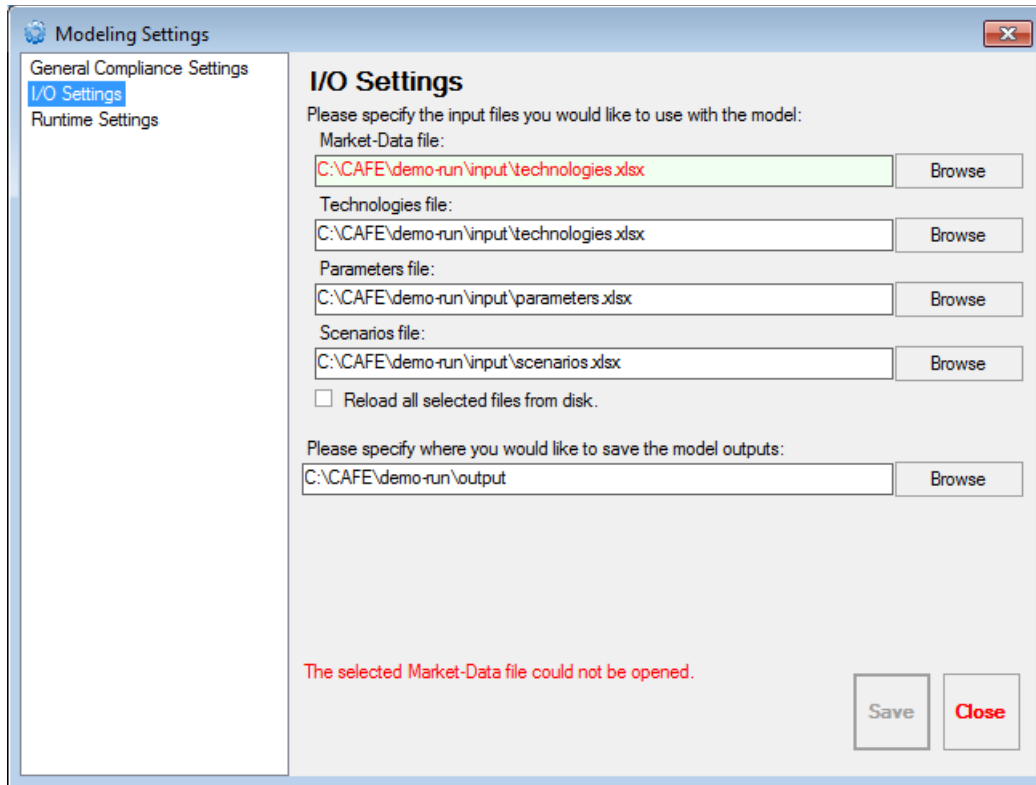

Figure 19. I/O Settings Panel (3)

As mentioned above, the system’s ability to validate an input file stems from it reading the “Title” field located in the file’s metadata. The input files used for analysis and which were distributed with the modeling system already include appropriate metadata information. However, if the user wishes to create new versions, other than adhering to the file structure described in the model’s documentation, each input file must specify the “Title” field in its metadata, according to the following list⁷¹:

- **CAFE Market Data:** Indicates that the file should be treated as a *Market-Data* input file.
- **CAFE Technologies:** Indicates that the file should be treated as a *Technologies* input file.
- **CAFE Parameters:** Indicates that the file should be treated as a *Parameters* input file.
- **CAFE Scenarios:** Indicates that the file should be treated as a *Scenarios* input file.

C.4.2.3 Runtime Settings Panel

The **Runtime Settings** panel (Figure 20) provides additional modeling options to further customize the model behavior, beyond what is available in the input files. The following describe the options that may be toggle from the model’s GUI by the user:

⁷¹ Users are advised to refer to Microsoft® Excel’s documentation for help on setting the title information for Excel files.

- ***Compliance Program to Enforce:*** Specifies the compliance program the model should enforce when evaluating a manufacturer’s compliance state. If *CAFE* option is selected, the model will seek compliance with NHTSA’s CAFE standards. If *CO-2* option is selected, the system will seek compliance with EPA’s CO₂ standards.
- ***Fuel Price Estimates:*** Specifies whether to use the low, average, or high fuel price estimates from the parameters input file. By default, average fuel price estimates are used.
- ***CO₂ Price Estimates:*** Specifies whether to use low, average, high, or very-high carbon dioxide cost estimates from the parameters input file. By default, average CO₂ price estimates are used.
- ***Begin technology application starting in:*** Specifies the starting model year when the system will begin evaluating technologies for application on vehicles. Prior to this year, the system will only determine manufacturers’ compliance levels, generate available credits and fines owed, and use expiring credits (if credit trading option is enabled) to offset compliance shortfalls as needed. Any non-expiring banked credits available prior to start of the analysis (which are specified as input for each manufacturer) will not be used for model years prior to this starting year.
- ***Allow Credit Trading:*** Specifies whether the model should allow manufacturers to transfer credits between passenger car and light truck fleets and to carry-forward credits forward from previous model years into the analysis year. (The model currently does not simulate either credit “carry-back” or trading between different manufacturers.)
- ***Last credit trading year:*** Specifies the last model year during which credits may be transferred or carried forward. A value of 2020 indicates that manufacturers may transfer and carry forward credits through and including model year 2020.
- ***Perform Fleet Analysis Calculations:*** Specifies whether the model should perform fleet analysis calculations, evaluating modeling effects for historic and forecast model years (before the first compliance model year as well as after the last compliance model year).
- ***Enable Dynamic Fleet Share and Sales Response:*** Specifies whether the model should dynamically adjust the sales forecast and the PC/LT fleet share during each analysis year, based on the sales forecast from the preceding model years, the average vehicle fuel economy and other attributes, the information about gasoline fuel prices during the analysis and preceding years, as well as other macro-economic parameters.
- ***Enable Dynamic Scrappage:*** Specifies whether the model should dynamically adjust scrappage rates based on the final industry state. This option is used when calculating final modeling effects as a response to additional technology application and increased technology costs, after modeling of a compliance scenario has concluded. When this option is enabled, the system estimates the survival rates of existing and new vehicle models in calendar years beginning with the first analysis year evaluated. For example, if the range of model years evaluated by the CAFE model is between 2016 and 2025, the first analysis is 2016, and the survival rates will be adjusted starting with calendar year 2016 as well.

- **Scale Consumer Benefits:** Specifies whether the model should scale the private consumer benefits by a specific percentage during the effects calculations. Valid values are between 0 and 100.

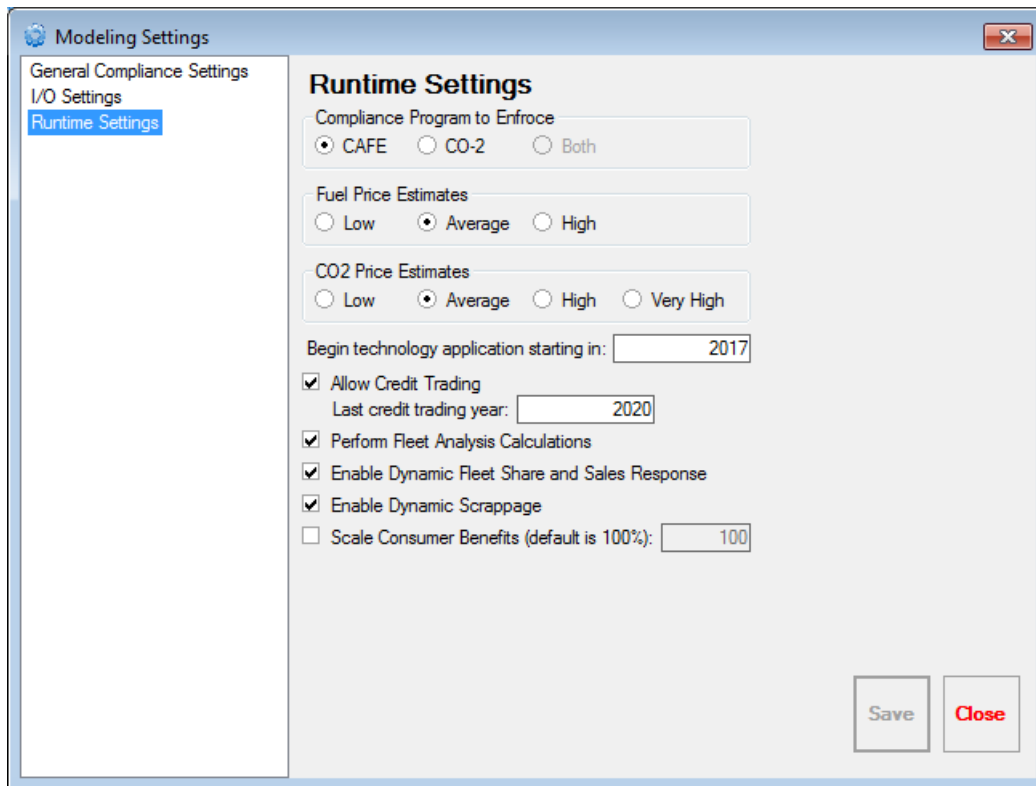

Figure 20. Runtime Settings Panel

The modeling system has been rigorously tested with both the “*Enable Dynamic Fleet Share and Sales Response*” and the “*Enable Dynamic Scrappage*” options enabled. It is advised to keep these two runtime settings enabled during analysis. If, however, users wish to disable either or both of these features, the model will revert to using the static sales forecast, as specified in the market-data input file, and/or the static survival rates tables, as defined in the parameters input file.

C.4.3 Session View

When a new session is created, or an existing one opened, the main **CAFE Model** window changes to present the user with several charts detailing the progress of the compliance modeling process. This is referred to as the modeling system’s **Session View** (Figure 21).

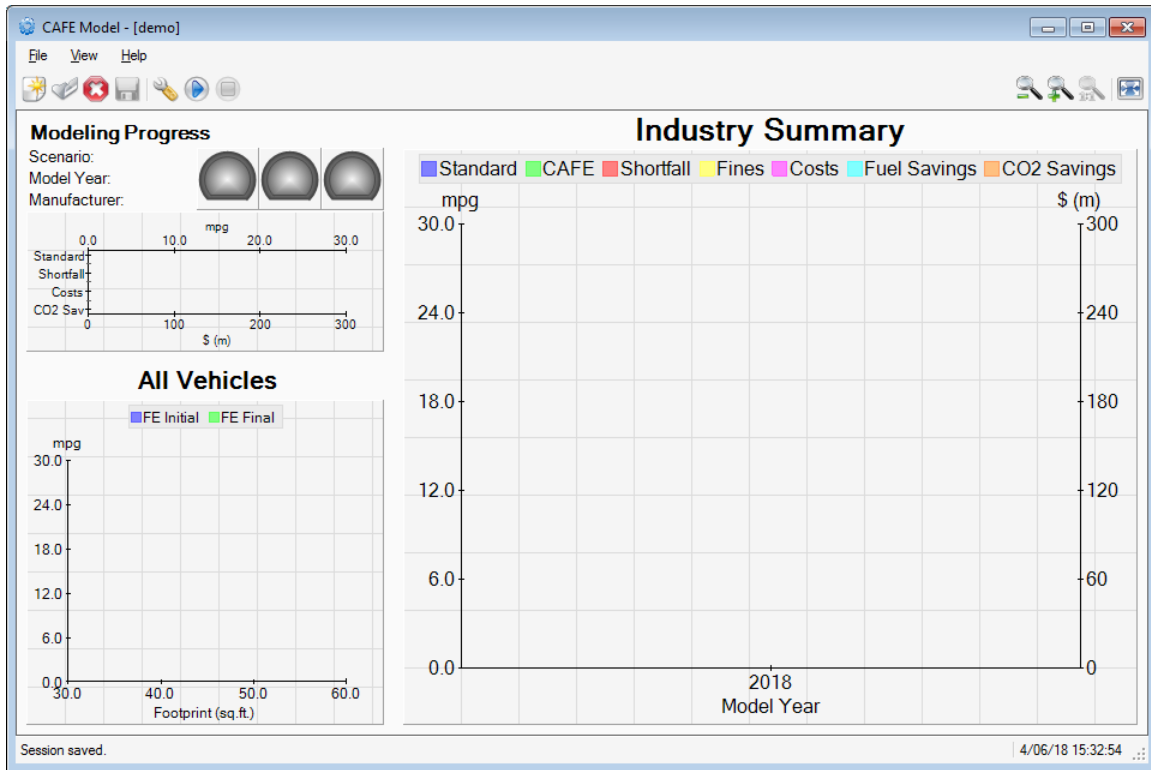

Figure 21. CAFE Model Session View

C.4.3.1 Session View Layout

The top-left corner of the model’s **Session View** shows the progress of compliance modeling, displaying the current scenario, model year, and manufacturer being evaluated (Figure 22). Additionally, this portion highlights the “*in-progress*” compliance state of the manufacturer being examined during the current analysis year. The manufacturer’s standard (or required CAFE value), CAFE (or achieved CAFE value), and shortfall (the difference between the required and achieved CAFE values) are displayed along the top axis, labeled “mpg”. The fines owed, accumulated technology costs, fuel savings, and CO₂ savings attributable to the manufacturer are displayed along the bottom axis, labeled “\$ (m)”. As the model progresses, these values change as more technologies are applied to a manufacturer or the model switches to a different manufacturer, model year, or scenario.⁷²

⁷² If some of the labels or data are not clearly visible, the **CAFE Model** window may be resized until more information comes into view.

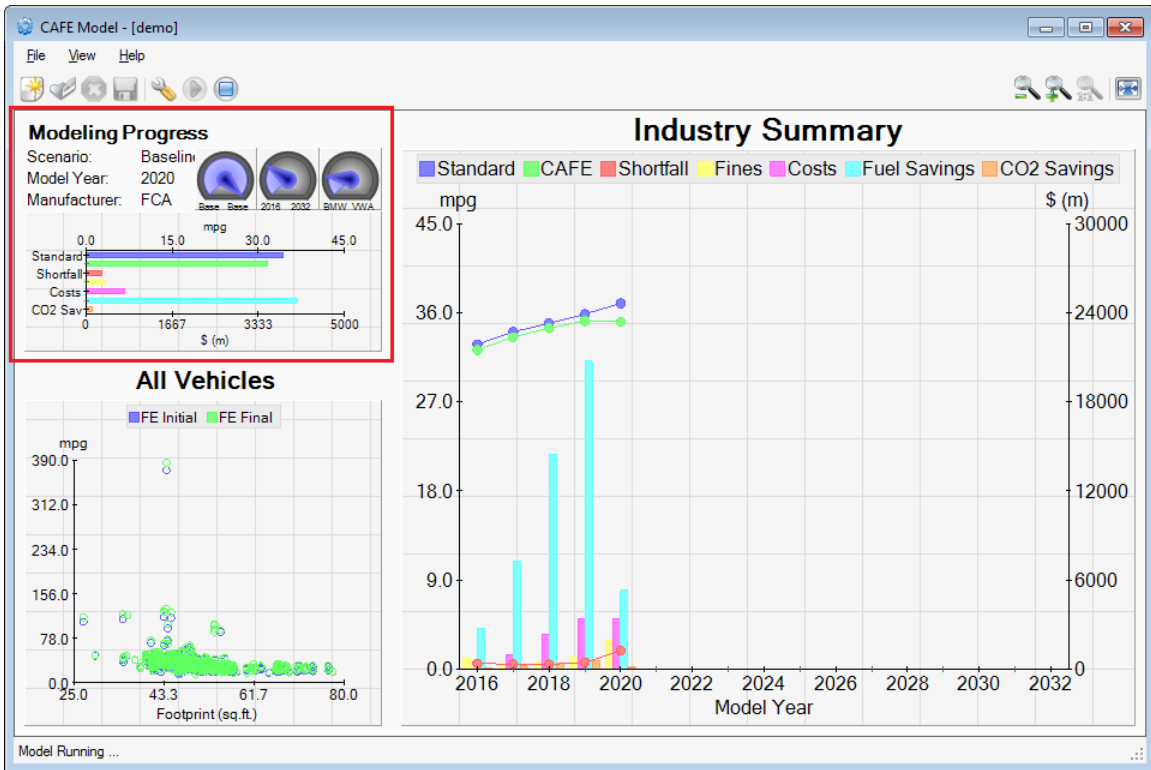

Figure 22. Session View - Modeling Progress

The bottom-left corner of the model’s **Session View** shows the *Vehicle Scatter Plot*, with initial and final fuel economy levels displayed for the scenario, model year, and either the entire industry or the selected manufacturer being evaluated (Figure 23). The category axis displays the range of footprints that represent all modeled vehicles, while the values axis shows the mpg level achieved by those vehicles. The user may interact with the *Vehicle Scatter Plot*, which is discussed in the following section, to filter the chart’s view between each analyzed manufacturer and the entire industry.

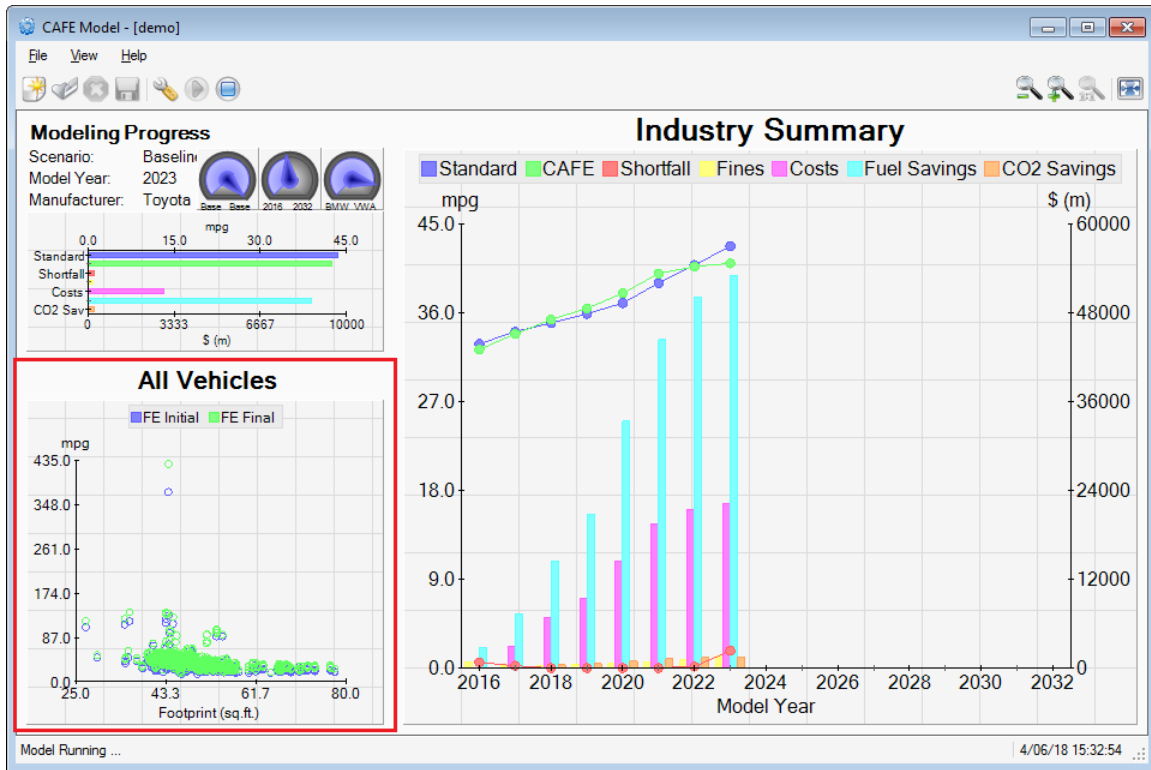

Figure 23. Session View - Vehicle Scatter Plot

The right side of the model’s **Session View** shows the “*by-model-year*” *Compliance Summary Chart* for the scenario being evaluated. As with the *Vehicle Scatter Plot*, the user may filter the view between each manufacturer and the entire industry.

The category axis, labeled “Model Year”, displays the range of model years evaluated as part of the analysis. The standard, CAFE, and shortfall values attained for each model year are displayed along the left values axis, labeled “mpg”, while fines owed, accumulated technology costs, fuel savings, and CO₂ savings are displayed along the right values axis, labeled “\$ (m)”. When modeling begins, most of the values along the Model Year axis will be empty. As the system progress through each year, additional information will be presented.

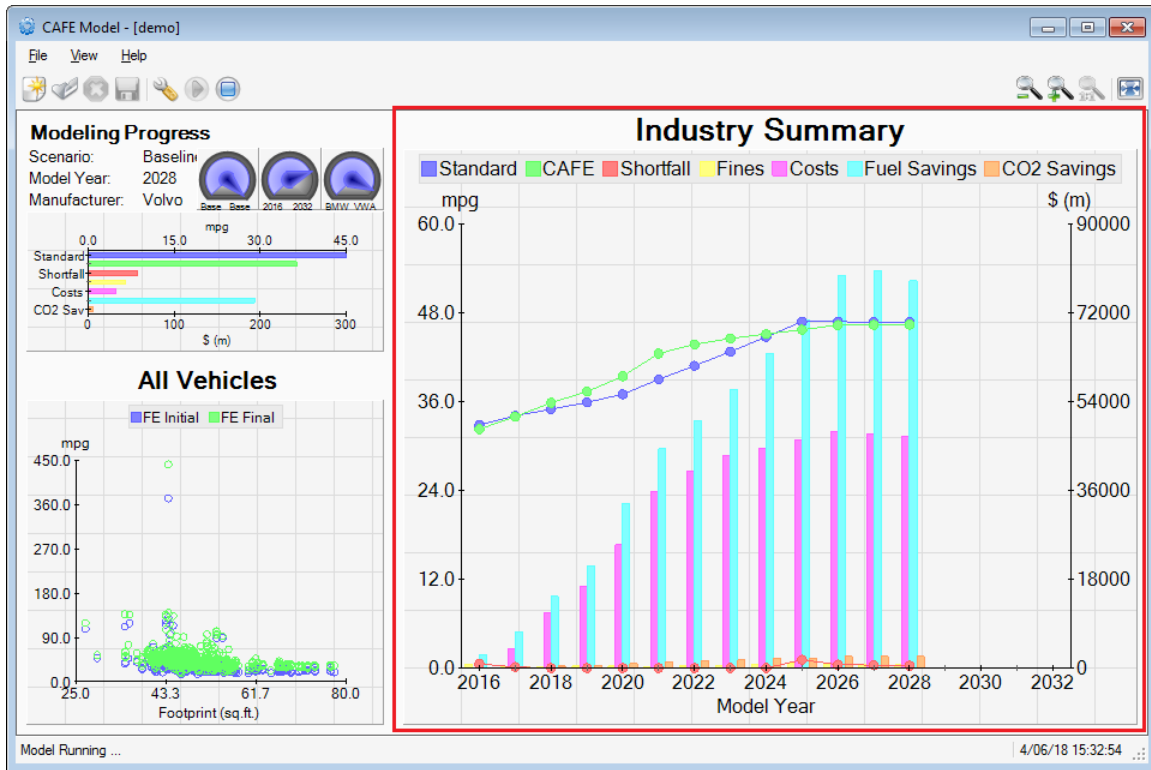

Figure 24. Session View - Compliance Summary Chart

C.4.3.2 Interacting with the Session View

Each of the available charts in the **Session View** may be interacted with to change the appearance of information presented to the user. For example, as mentioned above, the user may filter the *Vehicle Scatter Plot* to display fuel economy information for a specific manufacturer or for the entire industry. Additionally, the user may filter the chart's view to display data for a specific regulatory class or for the combined fleet. When filtering by regulatory classes, if a particular class is not available within the selected manufacturer or industry, it will be omitted during filtering. By default, the model begins with each chart showing combined fleet information.

Filtering is initiated by pressing on the chart's area with the left mouse button, then dragging the mouse left or right (to filter between regulatory classes), or up or down (to filter between manufacturers). As the mouse is dragged across the chart's surface area, a directional arrow appears and the chart begins to fade and move out of view (Figure 25).

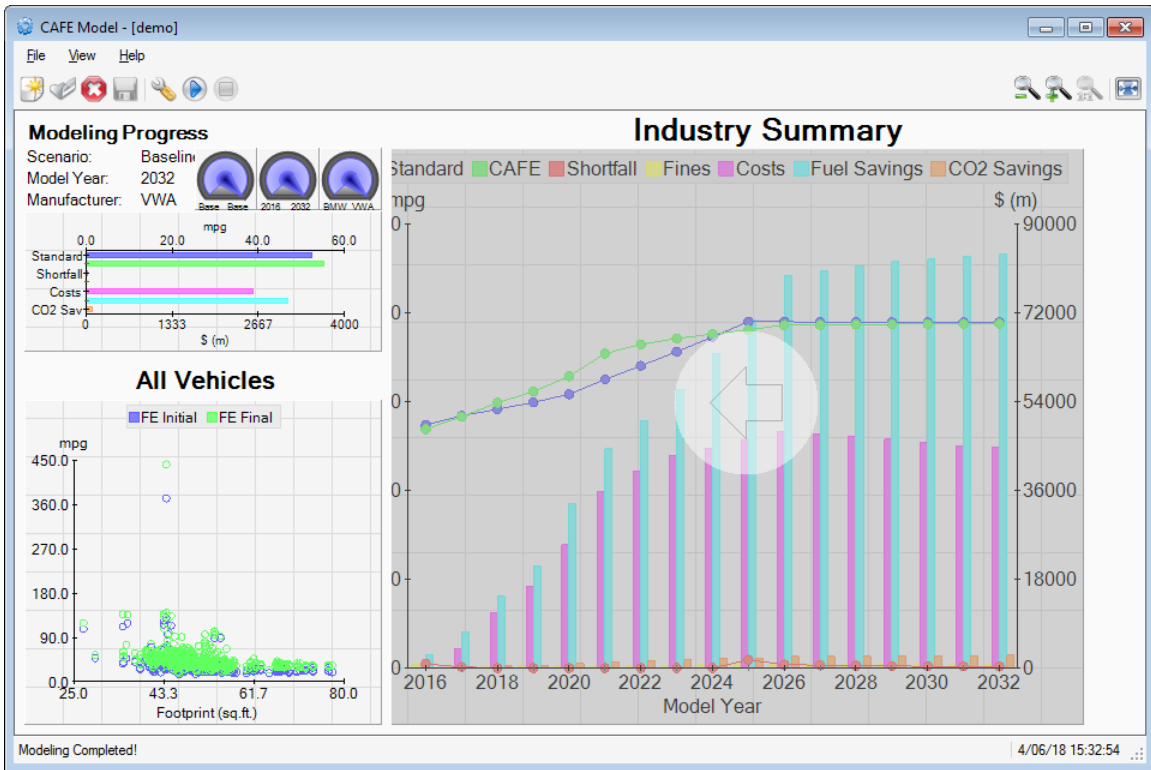

Figure 25. Initiating Chart Filtering

When the mouse is dragged an appropriate distance (roughly a quarter of the chart’s size), chart filtering becomes “activated”. This is indicated by the directional arrow becoming highlighted (Figure 26). Once the mouse is released, the chart is swiped out of view, then swiped back with the new filter applied. If mouse is released prior to activation, the chart bounces back into view without applying a new filter.

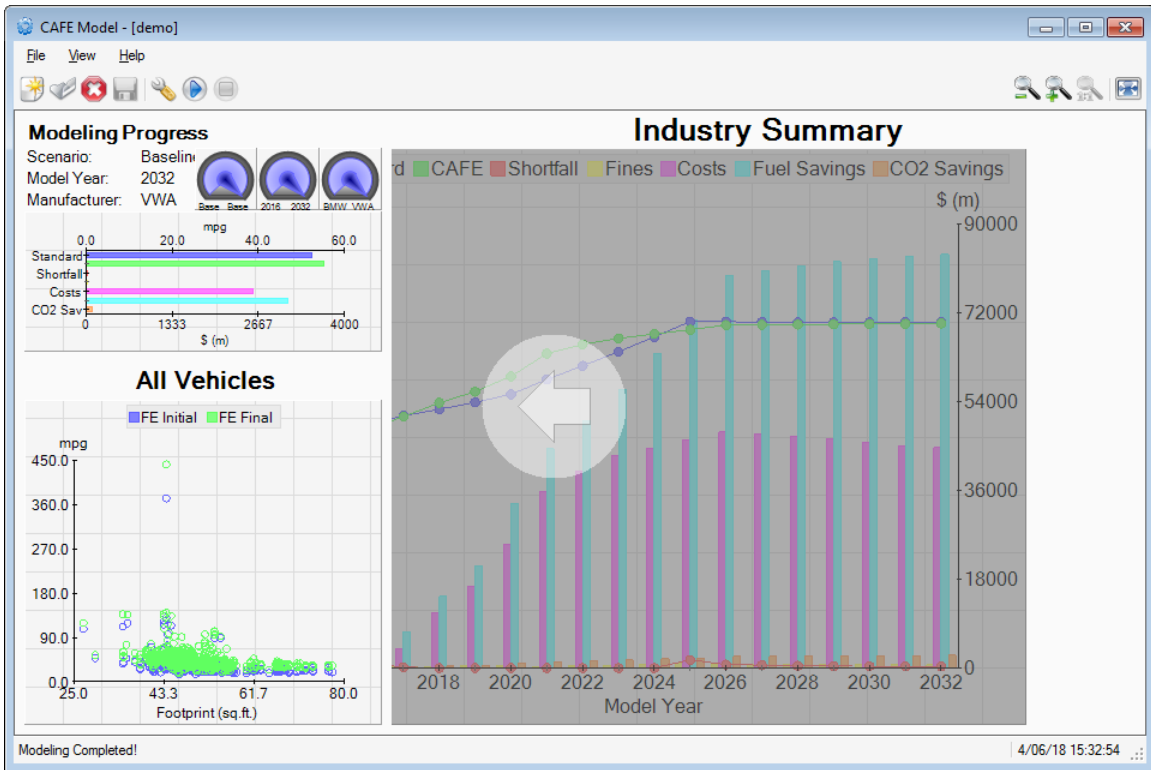

Figure 26. Chart Filtering Activated

Notice, as show in Figure 27, the *Compliance Summary Chart* has changed to include “(PC)” in its title and the data presented differs from the last view.

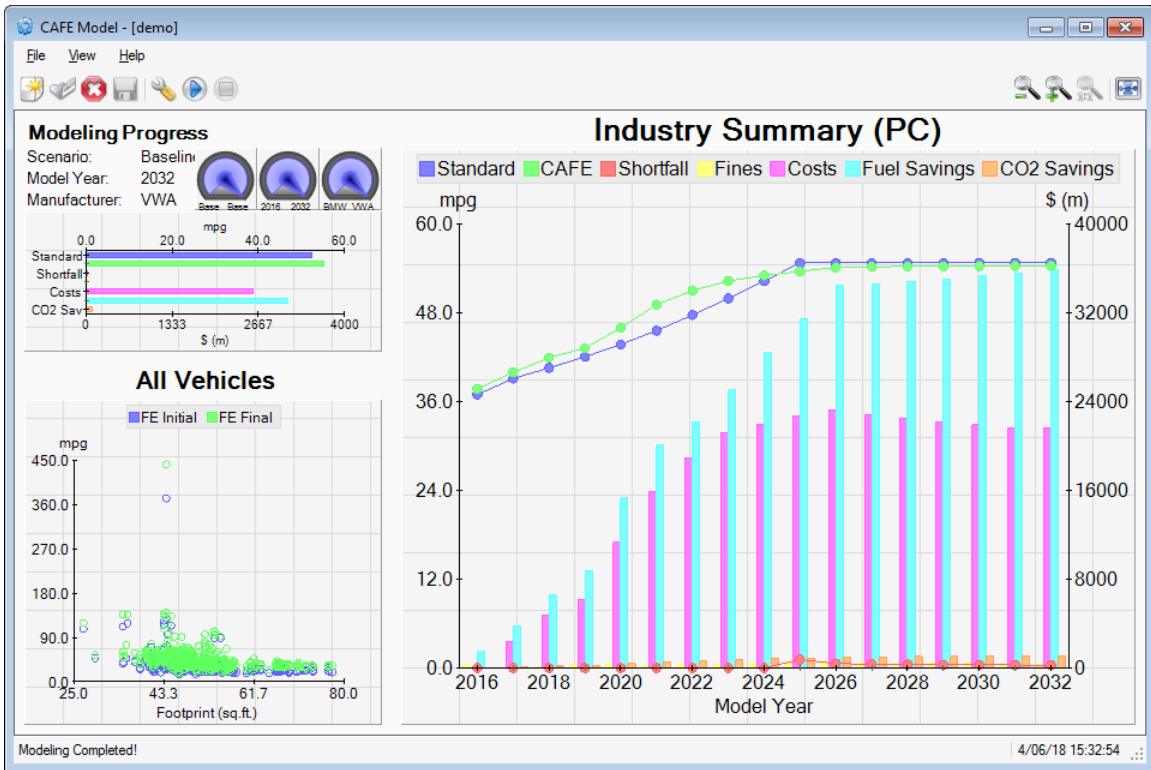

Figure 27. Chart Filtering Completed

When filtering the chart’s view by manufacturer and industry (up or down), the model cycles through each available manufacturer, the entire industry, and the current manufacturer being evaluated. When filtering for the current manufacturer, the chart’s title displays an asterisk next to the manufacturer’s name. As modeling progresses, the compliance information will be updated as more technology is added to the current manufacturer, or the modeling system switches to analyzing another manufacturer, model year, or scenario.

Figure 28 shows a comparison of different views when filtering by manufacturer. Notice the asterisk next to VWA. This indicates the data for the current manufacturer being evaluated is shown.⁷³

⁷³ If the compliance modeling process has completed, the asterisk next to the manufacturer’s name represents the last manufacturer analyzed.

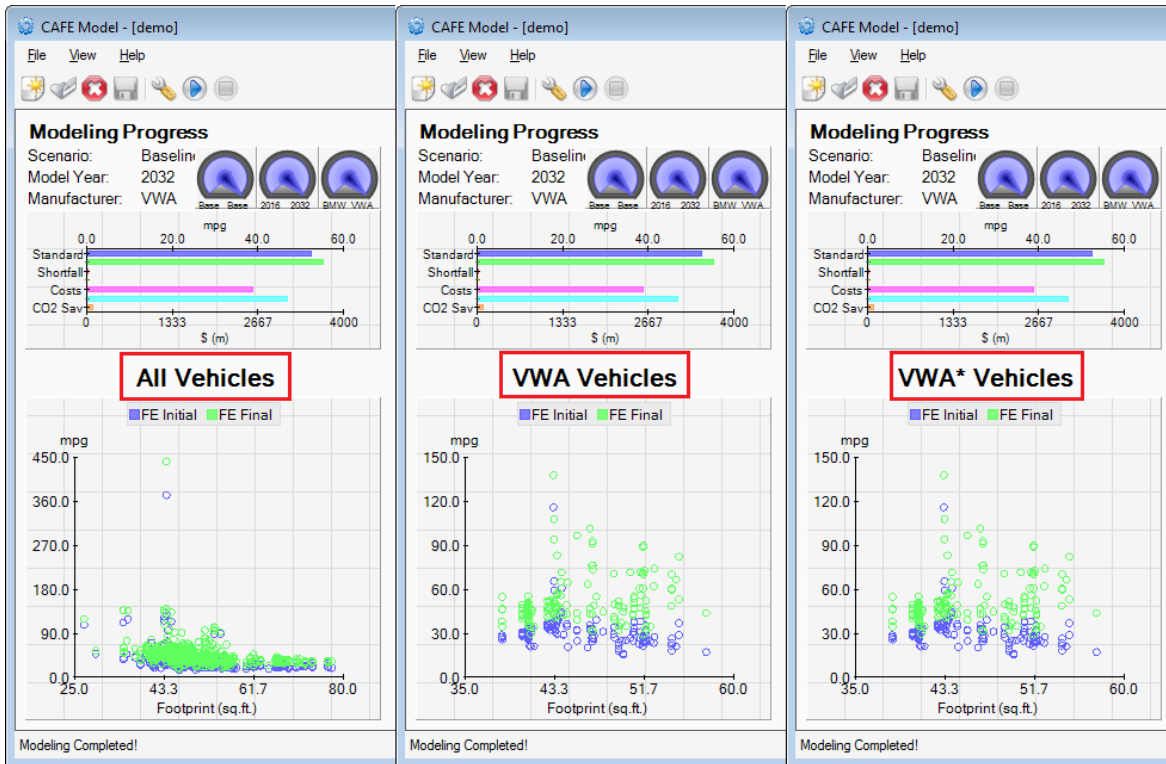

Figure 28. Manufacturer Filtering Examples

All of the charts provided support filtering by regulatory class, however, only the *Vehicle Scatter Plot* and the *Compliance Summary Chart* support filtering by manufacturer. Filtering may also be triggered by using the keyboard’s arrow keys, pressing the left or right arrows (to filter by regulatory class) or up or down keys (to filter by manufacturer).

The *Vehicle Scatter Plot* and the *Compliance Summary Chart* may be rotated to provide an alternative view of the data. In Figure 29, the chart was rotated 90 degrees, with the chart’s plot data realigned as shown.⁷⁴ Rotation is activated by pressing on the chart’s area with the right mouse button, then dragging the mouse left or right. As the mouse is dragged, the chart’s display area begins to rotate. Once the mouse button is released, the chart completes the rotation, clockwise or counterclockwise, and snaps into view at the nearest 90 degree angle.

⁷⁴ The rotation feature may not necessarily be practical (or meaningful) for the charts currently available within the CAFE Model. This feature is intended for future expansion.

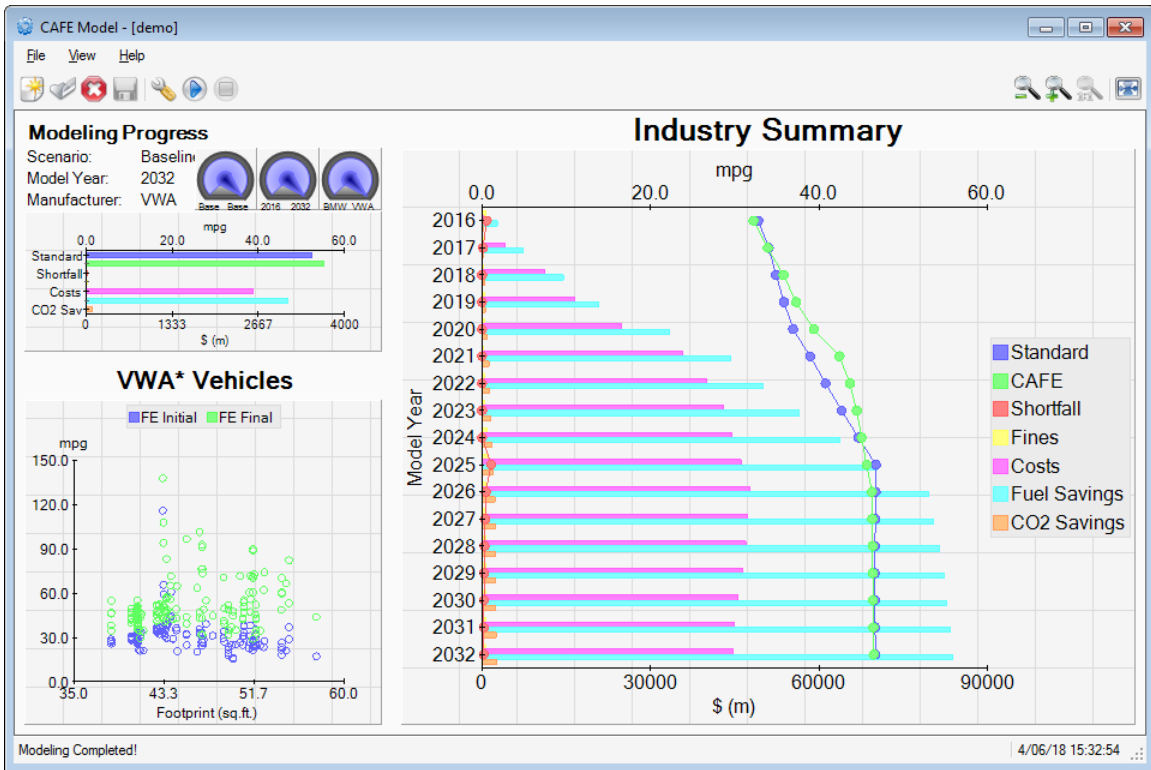

Figure 29. Compliance Summary Chart - Rotated View

The *Vehicle Scatter Plot* and the *Compliance Summary Chart* may also be “zoomed” or “expanded” by double clicking on the chart’s area (Figure 30). This expands the selected chart to fit the entire contents of the model’s **Session View**, allowing for easier interpretation of the data.

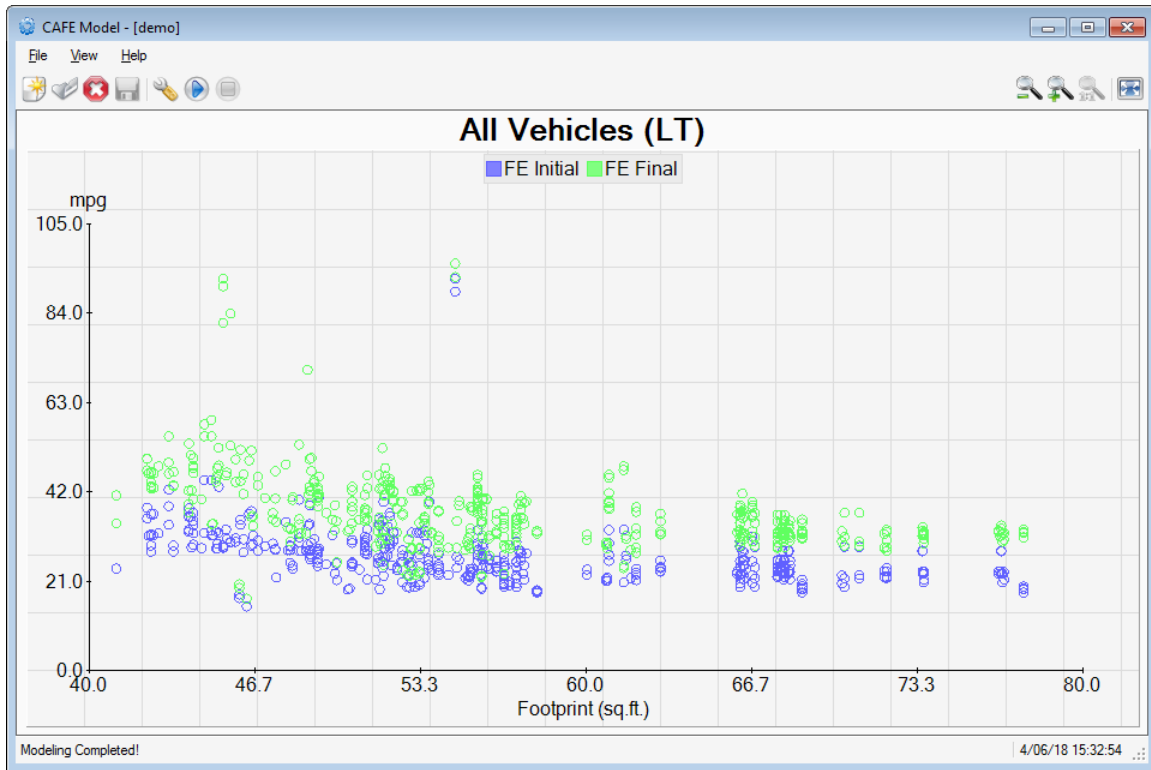

Figure 30. Vehicle Scatter Plot - Zoomed View

Only the current scenario being evaluated, or the last scenario analyzed if modeling has completed, is available for viewing within the model’s **Session View**. However, users may interact with each chart while the compliance modeling process is still running as well as after modeling concludes.

C.4.4 Model Outputs

During runtime, the CAFE Model produces several outputs, located in the user selected output path. Different types of modeling outputs are split into separate folders and are categorized as follows:

- **logs**: Contains a “summary” file describing the various settings used during modeling, as well as the log files tracing through the step-by-step applications of technologies, based on the compliance decisions the model made during analysis. A separate tracing log is generated for each compliance scenario.
- **reports-csv**: Contains the various modeling reports the CAFE Model produced during analysis.
- **debug-logs**: Contains additional log files used during debugging of the model. At present, this folder provides log files for tracing through the credit transfer and credit carry forward transactions executed by the model on behalf of each manufacturer, for each compliance scenario.

The system generates ten modeling reports (in CSV format) during runtime. The contents of these reports are discussed in greater detail in the Appendix section of the CAFE Model Documentation. The following provides an overview of the available modeling reports:

- **Technology Utilization Report:** Provides manufacturer-level and industry-wide technology application and penetration rates for each technology, model year, and scenario analyzed. The results are disaggregated by regulatory class, as well as combined over the entire fleet.
- **Compliance Report:** Provides manufacturer-level and industry-wide summary of compliance model results for each model year and scenario analyzed. The results are disaggregated by regulatory class, as well as combined over the entire fleet.
- **Societal Effects Report:** Provides industry-wide summary of energy and emissions effects for each model year and scenario analyzed. The results are disaggregated by regulatory class and fuel type, as well as combined across all fuels and over the entire fleet.
- **Societal Costs Report:** Provides industry-wide summary of consumer and social costs for each model year and scenario analyzed. The results are disaggregated by regulatory class and fuel type, as well as combined across all fuels and over the entire fleet.
- **Annual Societal Effects Report:** This output file is similar to the *Societal Effects Report*, except it further disaggregates the results by vehicle age.
- **Annual Societal Costs Report:** This output file is similar to the *Societal Costs Report*, except it further disaggregates the results by vehicle age.
- **Annual Societal Effects Summary Report:** This output file is similar to the *Annual Societal Effects Report*, except it aggregates the results by calendar year. Note, the *Societal Effects Report* produces results for each model year considered during analysis (e.g., 2016-2025). Conversely, the summary report summarizes the annual results by calendar year (e.g., 1975-2050).
- **Annual Societal Costs Summary Report:** This output file is similar to the *Annual Societal Costs Report*, except it aggregates the results by calendar year. Note, the *Societal Costs Report* produces results for each model year considered during analysis (e.g., 2016-2025). Conversely, the summary report summarizes the annual results by calendar year (e.g., 1975-2050).
- **Consumer Costs Report:** Provides industry-wide summary of consumer-related costs for each model year and scenario analyzed, using discounting from the consumer's perspective. The results are disaggregated by regulatory class, as well as combined over the entire fleet.
- **Vehicles Report:** Provides a detailed view of the final state of each vehicle examined by the model, for each model year and scenario analyzed.

C.5 CAFE Model Usage Examples

This section provides examples for configuring and running the CAFE Model sessions using various model types.

C.5.1 Example 1 – Configuring for Standard Compliance Modeling

This example demonstrates the steps necessary for configuring the modeling system to perform a regular *Compliance Model* run.

- Run the CAFE Model by clicking on the **CAFE Model** executable.⁷⁵ Read through the **Warnings** dialog box, and then click the **OK** button. Wait for the main **CAFE Model** window to appear.
- Select **File > New Session** to create a new modeling session. The **Modeling Settings** window appears. Note the errors at the bottom of the window; these indicate that the input files have not yet been selected.
- On the **General Compliance Settings** panel, select the *Standard Compliance Model* as shown in Figure 31 below.⁷⁶

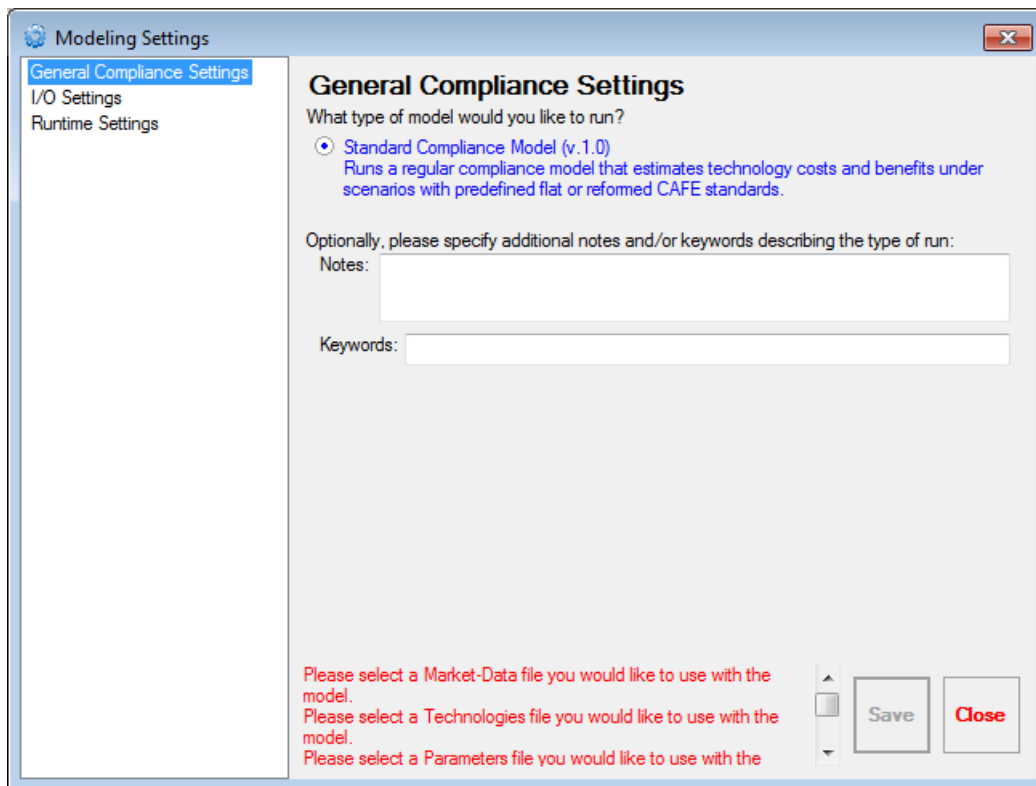

Figure 31. Select Standard Compliance Model

⁷⁵ If the model was just downloaded, it is most likely located on the user's desktop.

⁷⁶ As discussed earlier, the current version of the modeling system only supports the *Standard Compliance Model*.

- Click on the **I/O Settings** panel to select the input files to use for modeling and the location for output files (Figure 32). Note that once all the input files have been selected appropriately, the error messages disappear.

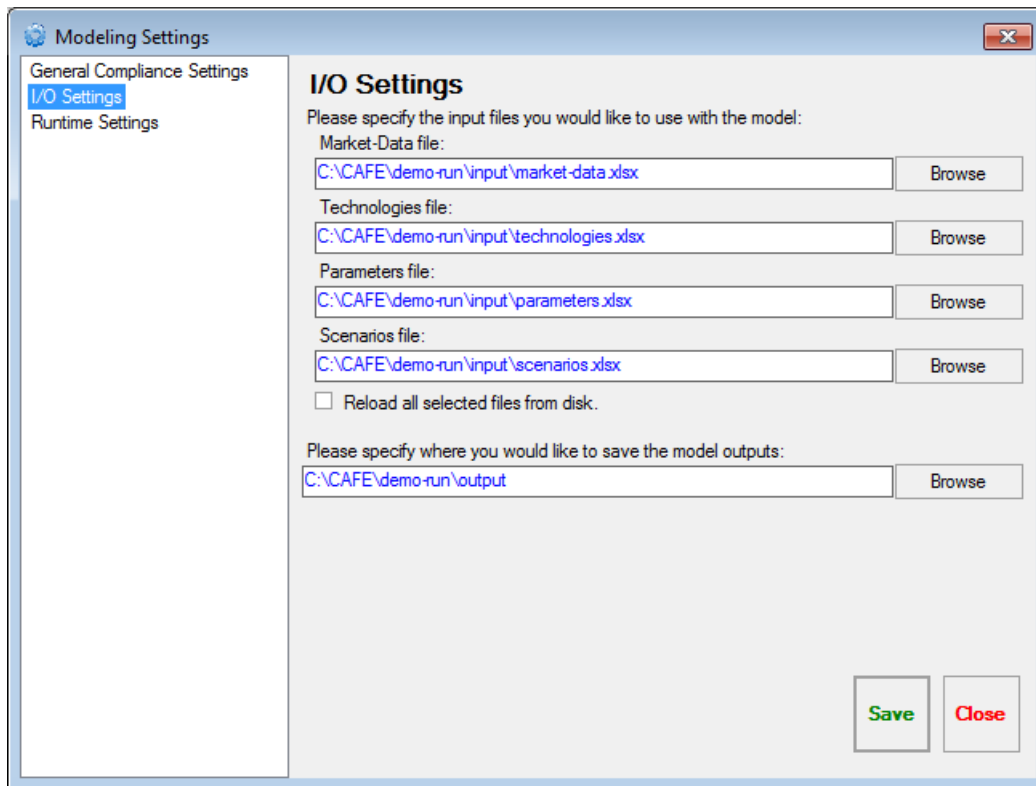

Figure 32. Select Input Files

- The **Runtime Settings** panel is not used for this exercise.
- Click the **Save** button to save the modeling settings and load the input files (Figure 33).

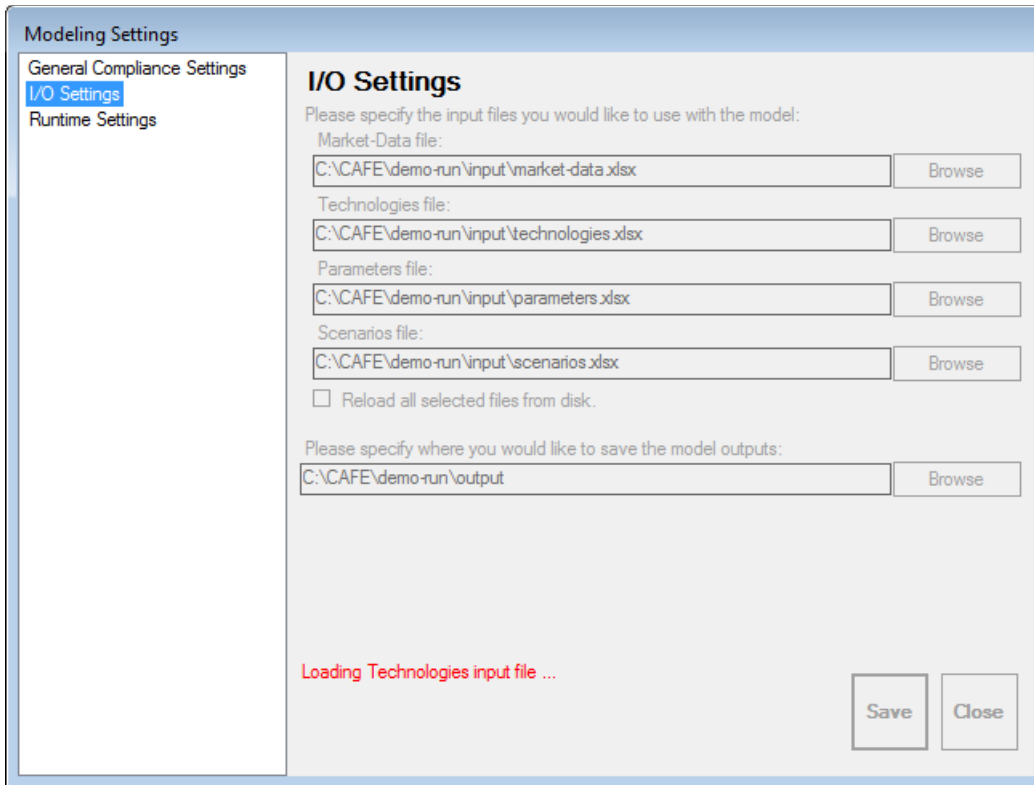

Figure 33. Save Modeling Settings

- Once loading completes, click the **Close** button to return the main **CAFE Model** window. A new *Compliance Model* session, titled “Session 1” has now been created (Figure 34).

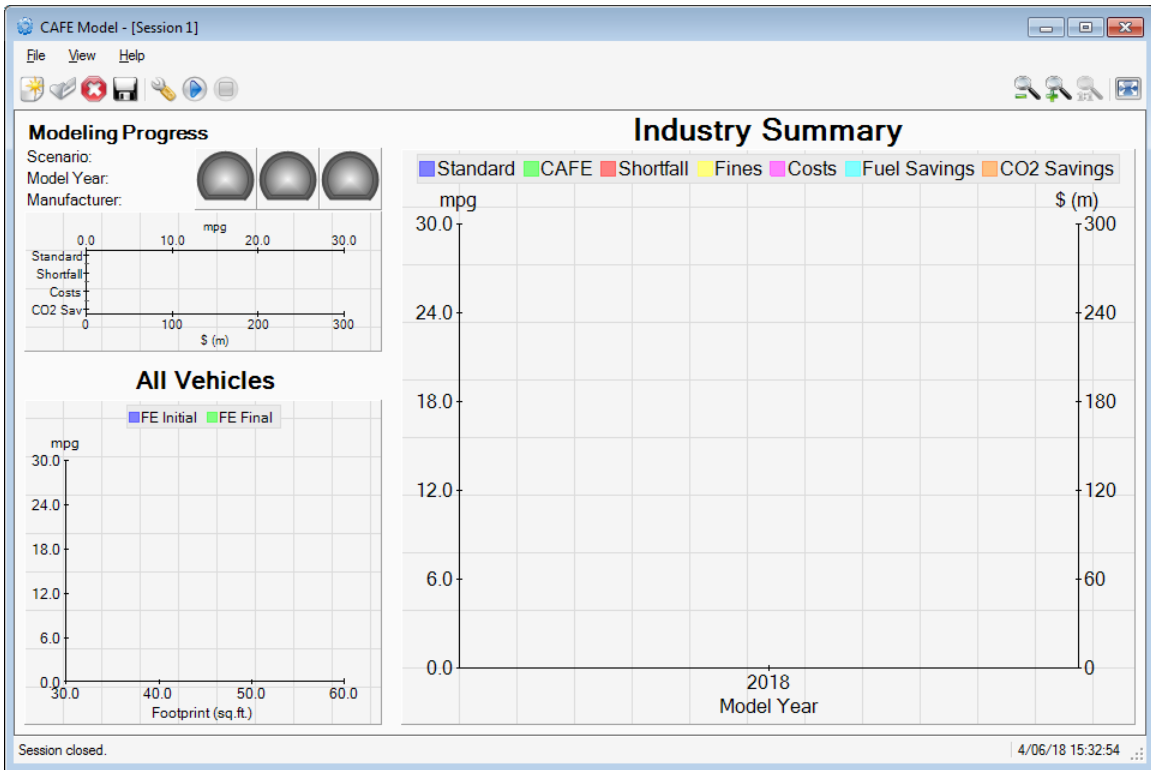
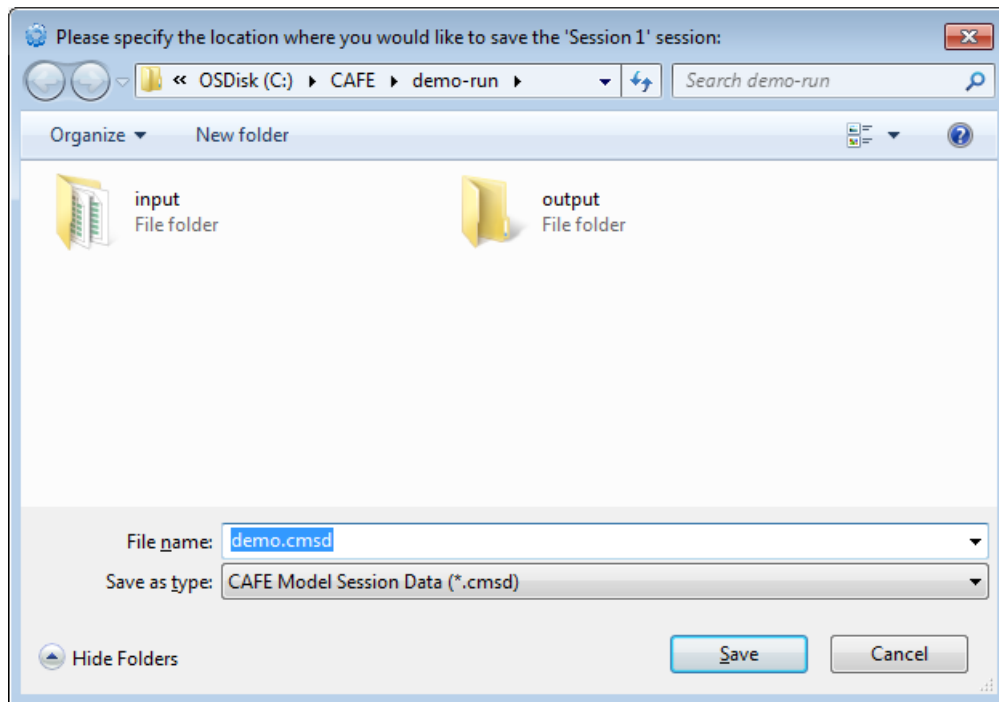

Figure 34. New Compliance Model Session Created

- Save the new session by selecting **File > Save Session As...**. Enter “demo.cmsd” in the dialog box that appears, and click the **Save** button (Figure 35).⁷⁷



⁷⁷ Based on the user’s system configuration, the window in Figure 16 may look different.

Figure 35. Save New Session

- After the session has been saved, notice the title of the session has changed to “demo” (Figure 36).

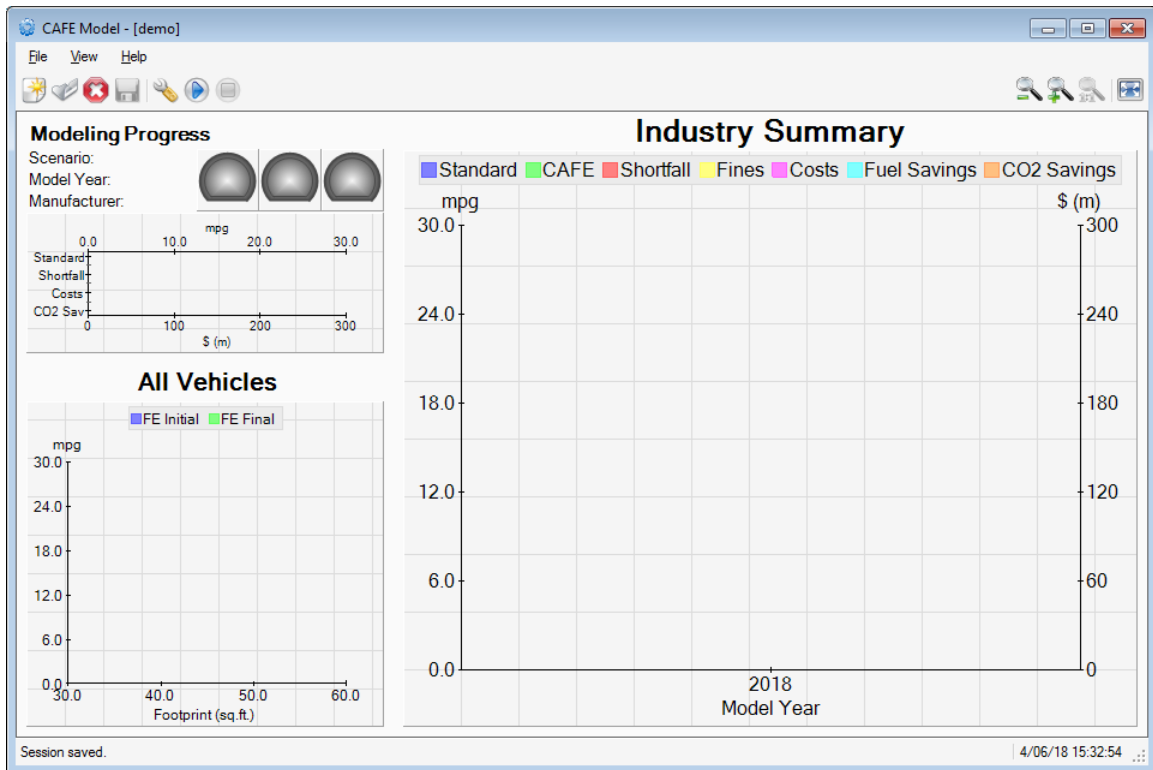

Figure 36. “demo” Session Saved

- Select **File > Start Modeling** to start the compliance modeling process. As the model runs, the progress of the *Compliance Model* is displayed in the **CAFE Model’s Session View** (Figure 37).

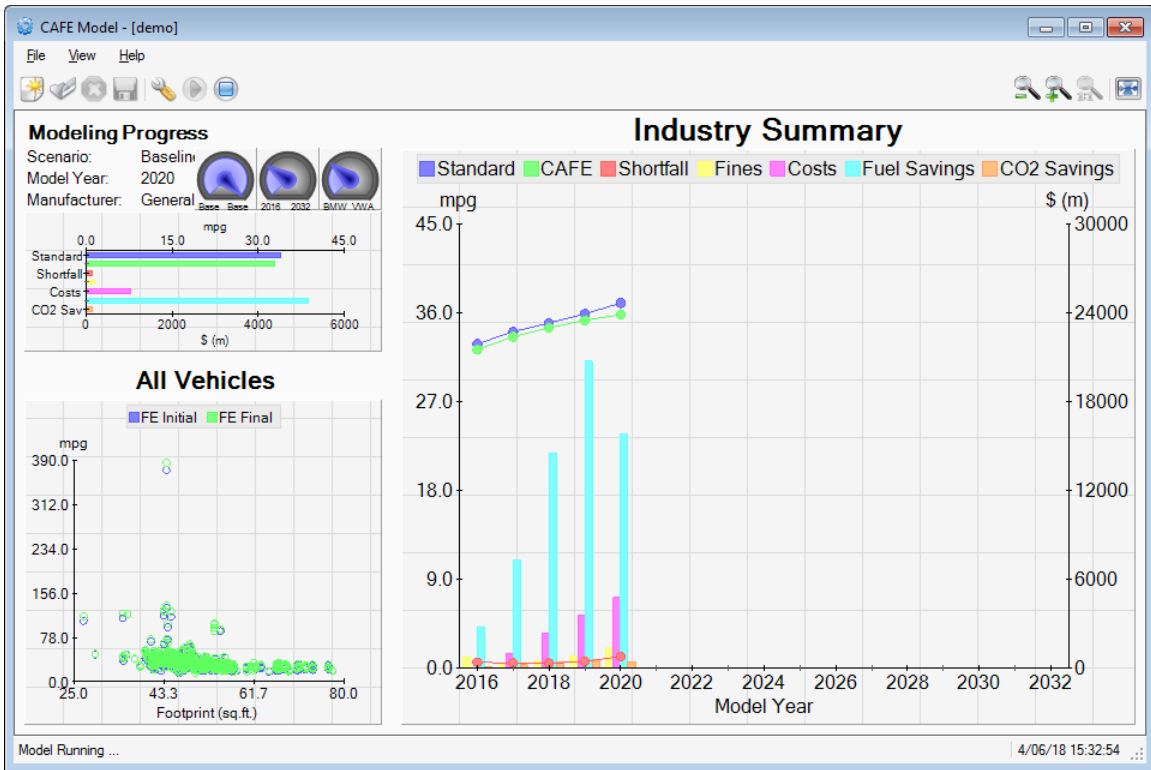

Figure 37. Modeling Progress from the Compliance Model

- After modeling has completed, the “Modeling Completed!” message appears at the bottom of the main CAFE Model window (Figure 38).

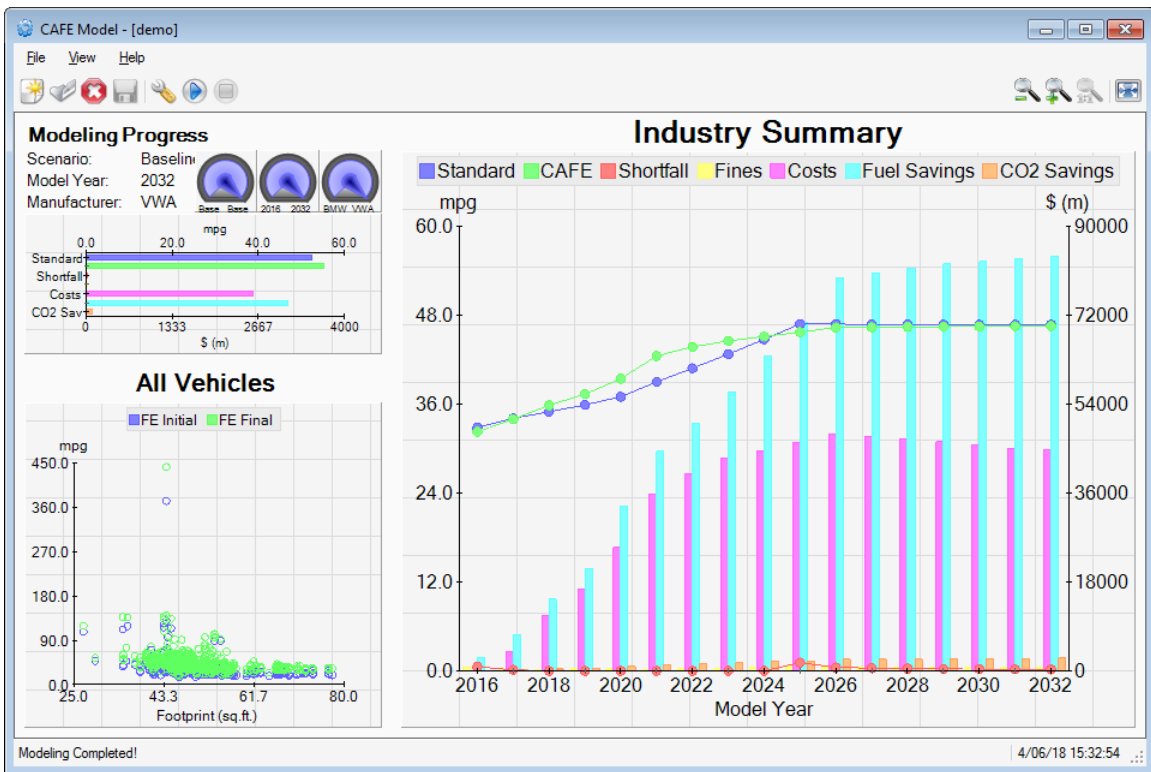

Figure 38. Compliance Model Completed

- Select **View > Output Location** to open Windows Explorer and browse to the location where model outputs for the “demo” session are saved.
- Exit the session by selecting **File > Close Session**.
- Exit the **CAFE Model** by selecting **File > Exit**, or proceed to the next example.

C.5.2 Example 2 – Configuring for “CO-2 Compliance” Modeling

This example demonstrates how to take an existing session created in Example 1 – Configuring for Standard Compliance Modeling, and modify it to evaluate compliance with EPA’s CO₂ standards.

- Run the CAFE Model by clicking on the **CAFE Model** executable. Read through the **Warnings** dialog box, and then click the **OK** button. Wait for the main **CAFE Model** window to appear.
- Select **File > Open Session** to open an existing modeling session. Select “demo.cmsd” in the dialog box that appears, and click the **Open** button (Figure 39).⁷⁸

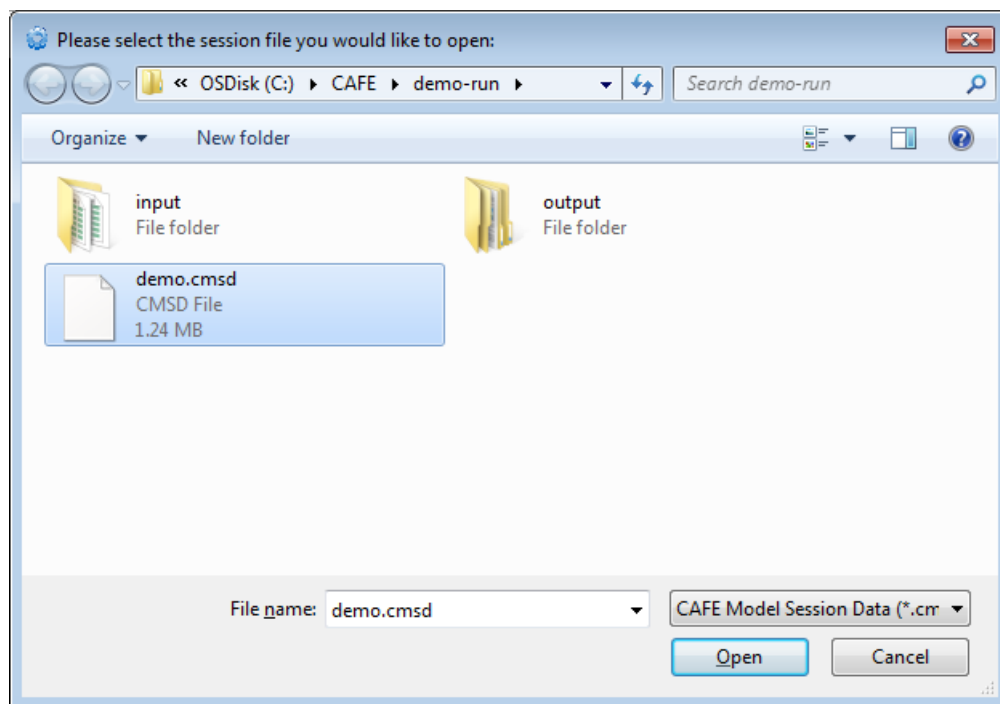

Figure 39. Open “demo” Session

- Once the session has been loaded, select **View > Modeling Settings** to bring up the **Modeling Settings** window.
- Click on the **Runtime Settings** panel and select the *CO-2* option from the *Compliance Program to Enforce* section as shown in Figure 40.

⁷⁸ Based on the user’s system configuration, the window in Figure 20 may look different.

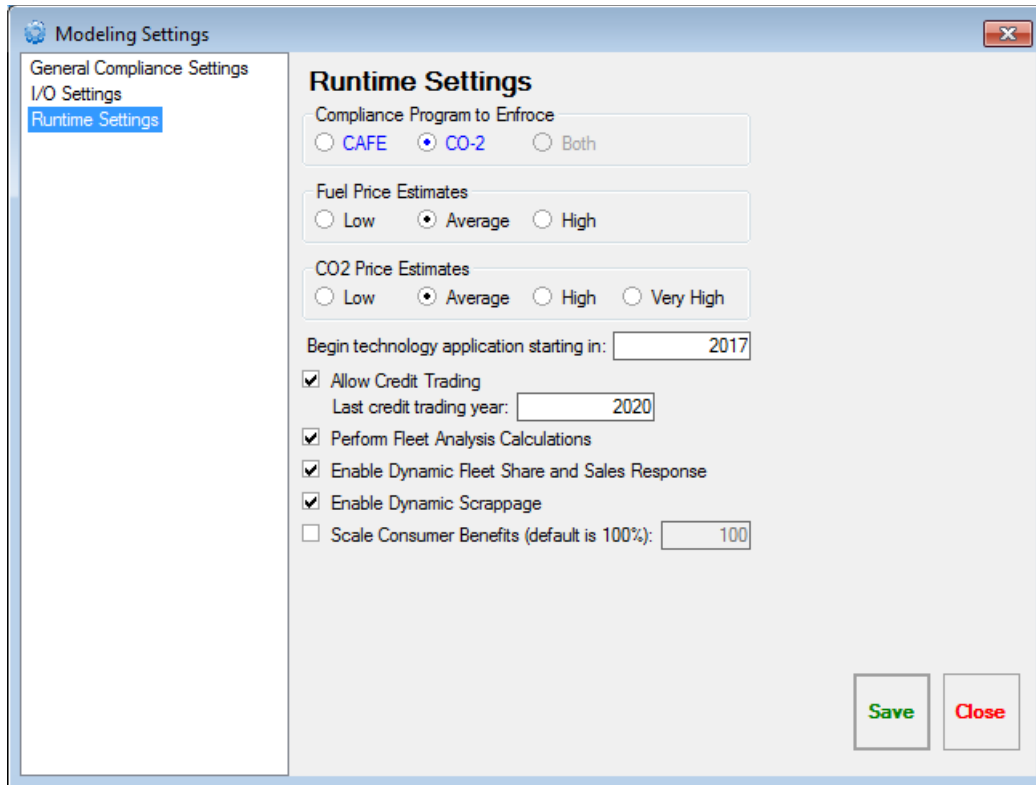

Figure 40. Enable Compliance with CO₂ Standards

- The rest of the panels are not used for this exercise.
- Click the **Save** button to save the updated modeling settings; then click **Close**, once saving completes.
- To prevent overwriting results from the “demo” session, select **File > Save Session As...** to save the modified session with a new name. For this example, the session was saved as “demo-co2.cmsd”.
- Select **File > Start Modeling** to start the modeling process. As the model runs, the progress of the *Compliance Model* is displayed in the **CAFE Model’s Session View**.
- Notice that the compliance-related information displayed in the model’s charts have changed from “CAFE” to “CO₂” and the units have been updated from “mpg” to “g/mi” (Figure 41).

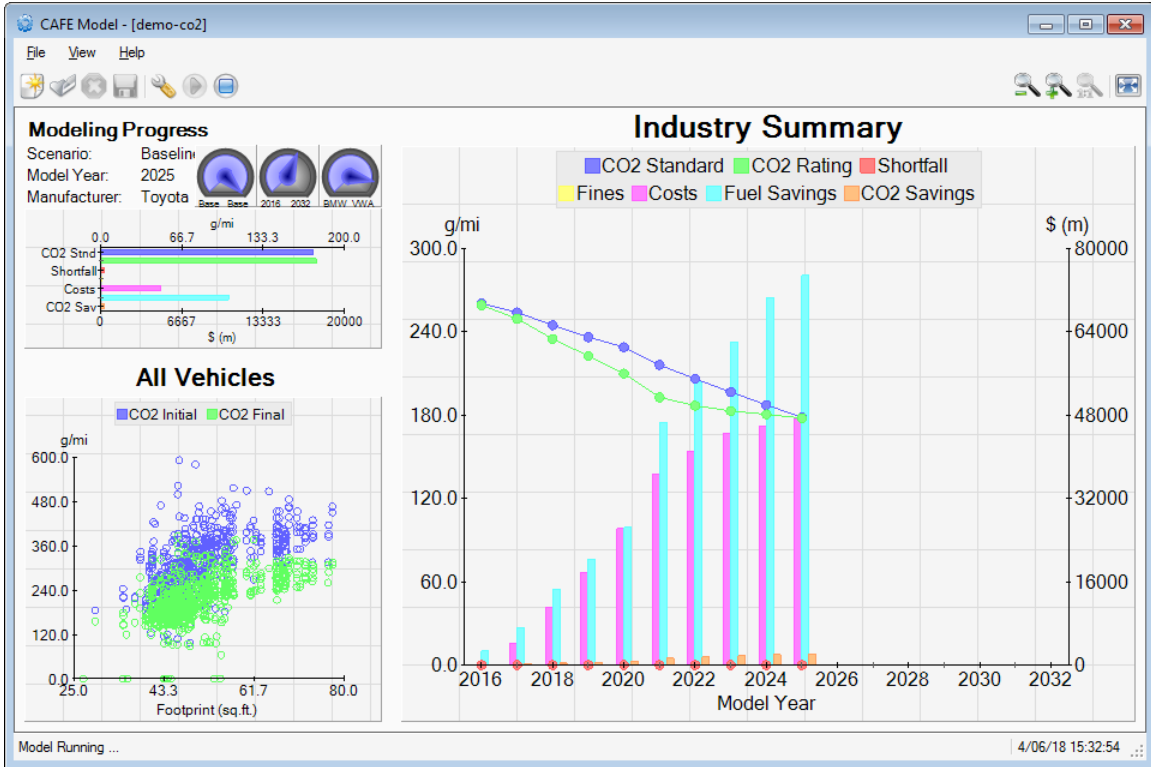

Figure 41. Modeling Progress for Compliance with CO₂ Standards

- After modeling has completed, the “Modeling Completed!” message appears at the bottom of the main CAFE Model window. Select **File > Exit** to exit the model.

C.6 Known Issues

The following outlines some of the known issues within the CAFE Model’s user interface and provides possible workarounds. This list, however, is not comprehensive.

- When interacting with the **Modeling Settings** window, if the user’s DPI setting (also known as text scaling) is set to anything other than 100%, the contents of this window will appear misaligned and on top of each other. Users are advised to temporarily change the DPI setting back to 100% when interacting with the model. This is especially prevalent for users with high resolution monitors.
- The description for the menu or toolbar item shown in the model’s status bar may get “stuck” on rare occasions. To reset the status bar message, either open an existing session or close it if one is already opened. The “stuck” description should now disappear.
- The model may sometimes display minor visual artifacts when interacting with the charts in the model’s **Session View**.
- The modeling progress area of the **Session View** (top-left), may show clipped text for current scenario or manufacturer. The text is obstructed by the dial displaying the scenario progress. Users may resize the **CAFE Model** window or change the zoom level, by selecting **View > Zoom Out**, until the text is no longer clipped.



U.S. Department of Transportation
**National Highway Traffic Safety
Administration**

U.S. Department of Transportation
Volpe National
Transportation System Center
Cambridge, MA 02142-1093

