

CC600/CC6000

Customer Concierge

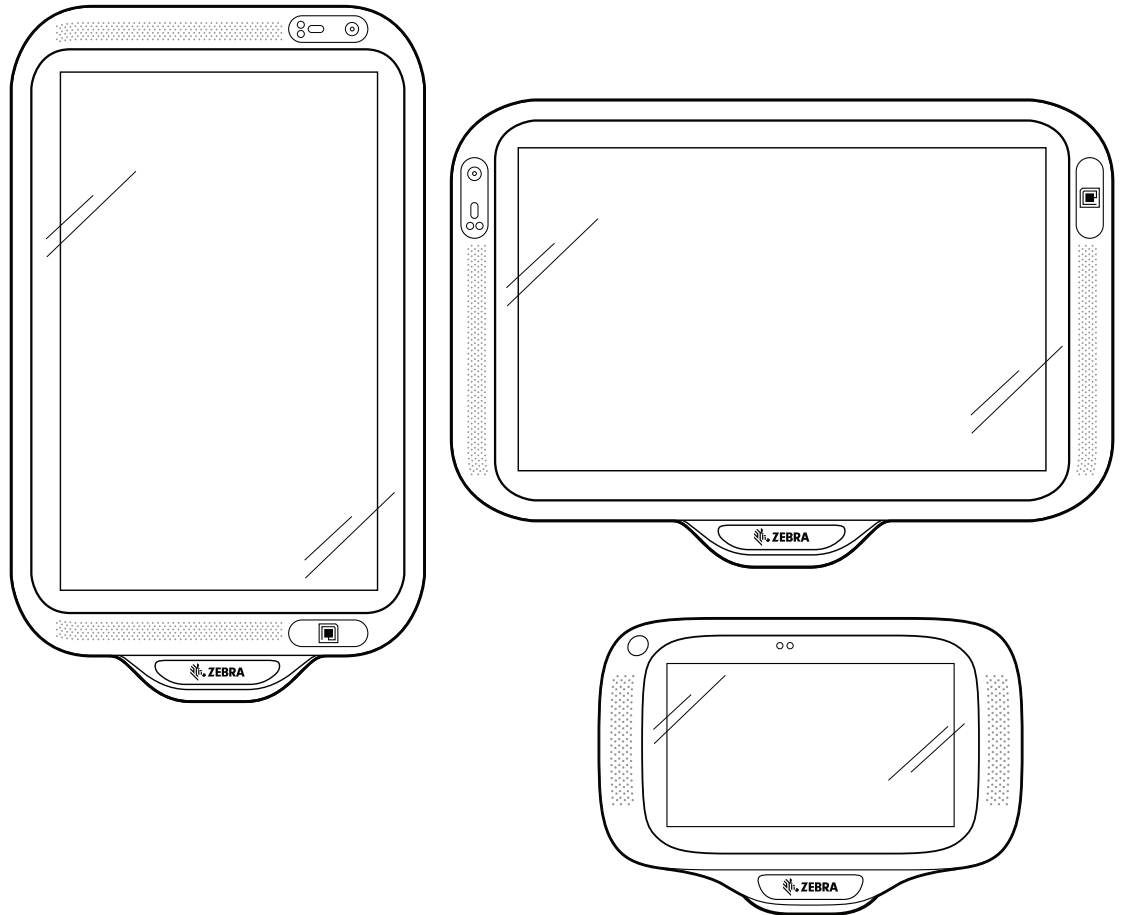

ZEBRA

User Guide
for Android™ 8.1.0 Oreo

Copyright

ZEBRA and the stylized Zebra head are trademarks of Zebra Technologies Corporation, registered in many jurisdictions worldwide. All other trademarks are the property of their respective owners. ©2019 Zebra Technologies Corporation and/or its affiliates. All rights reserved. Google™, Android, Google Play™ and other marks are trademarks of Google LLC; Oreo is a trademark of Mondelez International, Inc. group. All other trademarks are the property of their respective owners.

COPYRIGHTS & TRADEMARKS: For complete copyright and trademark information, go to www.zebra.com/copyright.

WARRANTY: For complete warranty information, go to www.zebra.com/warranty.

END USER LICENSE AGREEMENT: For complete EULA information, go to www.zebra.com/eula.

Terms of Use

- Proprietary Statement

This manual contains proprietary information of Zebra Technologies Corporation and its subsidiaries (“Zebra Technologies”). It is intended solely for the information and use of parties operating and maintaining the equipment described herein. Such proprietary information may not be used, reproduced, or disclosed to any other parties for any other purpose without the express, written permission of Zebra Technologies.

- Product Improvements

Continuous improvement of products is a policy of Zebra Technologies. All specifications and designs are subject to change without notice.

- Liability Disclaimer

Zebra Technologies takes steps to ensure that its published Engineering specifications and manuals are correct; however, errors do occur. Zebra Technologies reserves the right to correct any such errors and disclaims liability resulting therefrom.

- Limitation of Liability

In no event shall Zebra Technologies or anyone else involved in the creation, production, or delivery of the accompanying product (including hardware and software) be liable for any damages whatsoever (including, without limitation, consequential damages including loss of business profits, business interruption, or loss of business information) arising out of the use of, the results of use of, or inability to use such product, even if Zebra Technologies has been advised of the possibility of such damages. Some jurisdictions do not allow the exclusion or limitation of incidental or consequential damages, so the above limitation or exclusion may not apply to you.

Revision History

Changes to the original guide are listed below:

Change	Date	Description
-01 Rev A	6/2019	Initial Release

Table of Contents

Copyright	2
Terms of Use	2
Revision History	2
About This Guide	8
Introduction	8
Configurations	8
Software Versions	9
Chapter Descriptions	9
Notational Conventions	10
Related Documents	10
Service Information	10
Provide Documentation Feedback	11
Getting Started	12
Introduction	12
Features	12
Accessing Device Settings	16
Setting the Date and Time	17
Display Settings	17
Setting the Screen Brightness	17
Setting Night Light	18
Setting Screen Timeout	18
Ambient Display	19
Setting Font Size	19
Setting Touch Panel Mode	20
General Sound Settings	20
Wake-Up Sources	22

Using the Device	23
Introduction	23
Google Mobile Services	23
Home Screen	23
Customizing the Home Screen	24
Status Bar	25
Managing Notifications	27
Setting App Notifications	28
Quick Access Panel	29
Editing Icons on Quick Settings	31
App Shortcuts and Widgets	31
Folders	32
Home Screen Wallpaper	33
Using the Touchscreen	33
Keyboards	34
Keyboard Configuration	34
Using the Enterprise Keyboard	34
Using the Android and Gboard Keyboards	36
Do Not Disturb Feature	37
Limit Sounds	37
Silence Sounds During Certain Times	38
Silence Sounds During Events and Meetings	39
Turn Sounds Back On	39
Override Do Not Disturb for Specific Apps	39
Apps	40
Accessing Apps	43
Switching Between Recent Apps	45
Un-Locking the Screen	46
Interactive Sensor Technology	51
Transferring Files with a Host Computer via USB	51
Transferring Files	52
Transferring Photos	52
Disconnect from the Host Computer	53
Applications	54
Introduction	54
Camera	54
Taking Photos	54
Recording Videos	55
Photo Settings	57
Adding a Contact	60

Table of Contents

Editing Contacts	60
Deleting Contacts	60
DataWedge Demonstration	62
Scanner Selection	64
Diagnostic Tool	65
Settings	68
System Test Information	68
WLAN Test Information	68
Bluetooth Test Information	68
Files	69
Gallery	71
Working with Albums	73
Sharing an Album	73
Working with Photos	74
Working with Videos	76
Photos	78
Working with Albums	80
Working with Photos	81
Working with Videos	83
PTT Express Voice Client	84
PTT Express User Interface	84
PTT Audible Indicators	85
PTT Notification Icons	85
Enabling PTT Communication	85
Selecting a Talk Group	86
PTT Communication	86
Creating a Group Call	86
RxLogger	87
RxLogger Utility	88
SimulScan Demo	89
Printing the Sample Forms	90
Using the Postal, Transportation and Logistics Example	91
Using the Manufacturing Example	93
Creating a Demo Customization	95
Default Templates	96
Settings	96
Advanced Settings	97
Sound Recorder	98
Wireless	100
Introduction	100

Table of Contents

Sharing the Mobile Data Connection	100
Configuring the Access Point Name	102
Data Usage	103
Setting Data Usage Warning	104
Wireless Local Area Networks	105
Scanning and Connecting to a Wi-Fi Network	105
Removing a Wi-Fi Network	107
Bluetooth	107
Adaptive Frequency Hopping	107
Security	108
Bluetooth Profiles	108
Bluetooth Power States	109
Bluetooth Radio Power	110
Discovering Bluetooth Device(s)	110
Changing the Bluetooth Name	110
Selecting Profiles on the Bluetooth Device	111
Unpairing a Bluetooth Device	111
Near Field Communications (CC6000 Only)	111
Reading NFC Cards	112
Sharing Information Using NFC	113
Cast	114
Accessories	115
Introduction	115
Accessories	115
3.5 mm Audio Adapter (CC6000 Only)	116
Connecting a Headset to the 3.5 mm Audio Adapter (CC6000 Only)	116
USB I/O Hub	117
Connect USB Cables	118
External USB Cable	120
Audio Headset Connection	120
Maintenance and Troubleshooting	121
Introduction	121
Maintaining the Device	121
Cleaning Instructions	121
Approved Cleanser Active Ingredients	121
Harmful Ingredients	122
Device Cleaning Instructions	122
Special Cleaning Notes	122

Table of Contents

Cleaning Materials Required	122
Cleaning Frequency	122
Cleaning the Device	123
Housing	123
Display	123
Camera and Exit Window	123
Troubleshooting	124
Technical Specifications	126
Introduction	126
Technical Specifications	126
CC6000	126
CC600	128
Decode Distances	130
CC6000 - SE4710 Scan Engine	130
CC600 - SE2100 Scan Engine	131

Index

About This Guide

Introduction

This guide provides information about using the CC600 and CC6000 Customer Concierge interactive kiosk and accessories.



NOTE: Screens and windows pictured in this guide are samples and can differ from actual screens.

Configurations

This guide covers the configurations listed in [Table 1](#) and [Table 2](#).

Table 1 *CC600 Device Configurations*

Configuration	Description	Front Camera	Scan Engine
CC600-5-3200LNWW	5 inch, OS: Android™ 8.1.0 Oreo, 32GB, Ethernet/Wi-Fi, Imager, Worldwide Configuration	No	SE2100
CC600-5-3200LNNA	5 inch, OS: Android™ 8.1.0 Oreo, 32GB, Ethernet/Wi-Fi, Imager, North America Configuration	No	SE2100
CC600-5-3200LNIN	5 inch, OS: Android™ 8.1.0 Oreo, 32GB, Ethernet/Wi-Fi, Imager, India Configuration	No	SE2100

Table 2 *CC6000 Device Configurations*

Configuration	Description	Front Camera	Scan Engine
CC6000-10-3200LCWW	10 inch, OS: Android™ 8.1.0 Oreo, 32GB, Landscape, Imager, Worldwide Configuration	No	SE4710
CC6000-10-3200PCWW	10 inch, OS: Android™ 8.1.0 Oreo, 32GB, Portrait, Imager, Worldwide Configuration	Yes	SE4710

Table 2 CC6000 Device Configurations (Continued)

Configuration	Description	Front Camera	Scan Engine
CC6000-10-3200LCNA	10 inch, OS: Android™ 8.1.0 Oreo, 32GB, Portrait, Imager, North America Configuration	Yes	SE4710
CC6000-10-3200PCNA	10 inch, OS: Android™ 8.1.0 Oreo, 32GB, Portrait, Imager, North America Configuration	Yes	SE4710
CC6000-10-3200LNNA	10 inch, OS: Android™ 8.1.0 Oreo, 32GB, Landscape, Imager, North America Configuration	No	SE4710

Software Versions

To determine the current software versions:

1. Swipe down from the top to open Quick Settings.
2. Touch **⚙️ > System**.
3. Touch **About phone**.
4. The following information displays:
 - Status
 - SWComponents
 - Legal Informaiton
 - Model
 - Android version
 - Android security patch level
 - Kernel version
 - Build Fingerprint
 - Build number

To determine the device serial number, touch **About phone > Status. Serial number** displays.

Chapter Descriptions

Topics covered in this guide are as follows:

- [Getting Started](#) provides information on getting the device up and running for the first time.
- [Using the Device](#) provides information for operating the device.
- [Applications](#) provides information on using applications installed on the device.
- [Wireless](#) provides information on the various wireless options.
- [Accessories](#) provides information for using the accessories for the device.
- [Maintenance and Troubleshooting](#) includes instructions on cleaning and provides troubleshooting solutions for potential problems during device operation.
- [Technical Specifications](#) provides the technical specifications for the device.

Notational Conventions

The following conventions are used in this document:

- “Device” refers to all configurations of the CC600 Customer Concierge and CC6000 Customer Concierge.
- **Bold** text is used to highlight the following:
 - Dialog box, window and screen names
 - Drop-down list and list box names
 - Check box and radio button names
 - Icons on a screen
 - Key names on a keypad
 - Button names on a screen.
- Bullets (•) indicate:
 - Action items
 - Lists of alternatives
 - Lists of required steps that are not necessarily sequential.
- Sequential lists (e.g., those that describe step-by-step procedures) appear as numbered lists.

Related Documents

- CC600/CC6000 Customer Concierge Quick Start Guide for Android Version 8.1, p/n MN-003314-xx.
- CC600/CC6000 Customer Concierge Integrator Guide for Android Version 8.1, p/n MN-003411-xx.

For the latest version of this guide and all guides, go to: www.zebra.com/support.

Service Information

If you have a problem with your equipment, contact Customer Support for your region. Contact information is available at: zebra.com/support.

When contacting support, please have the following information available:

- Serial number of the unit (found on manufacturing label)
- Model number or product name (found on manufacturing label)
- Software type and version number
- IMEI number.

Customer Support responds to calls by email or telephone within the time limits set forth in support agreements.

If the problem cannot be solved by Customer Support, the user may need to return the equipment for servicing and will be given specific directions. We are not responsible for any damages incurred during shipment if the approved shipping container is not used. Shipping the units improperly can possibly void the warranty. Remove the SIM card and/or microSD card from the device before shipping for service.

If the device was purchased from a business partner, contact that business partner for support.

Provide Documentation Feedback

If you have comments, questions, or suggestions about this guide, send an email to EVM-Techdocs@zebra.com.

Getting Started

Introduction

This chapter provides information to get the device up and running for the first time.

Features



NOTE: Although the orientations differ, the features on the CC6000 landscape and portrait devices are the same.

Figure 1 CC6000 Front View

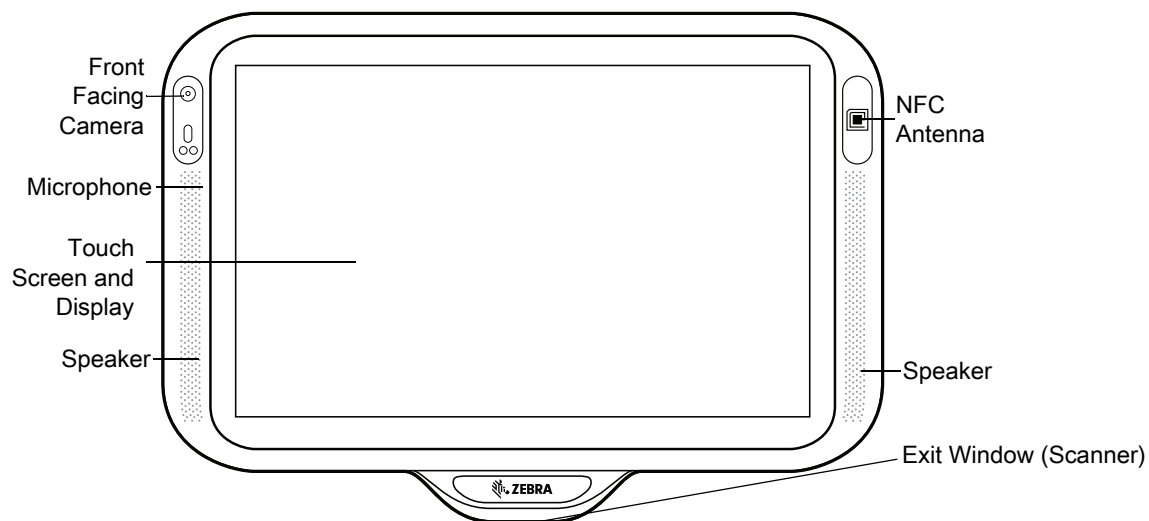

Figure 2 CC6000 Back View

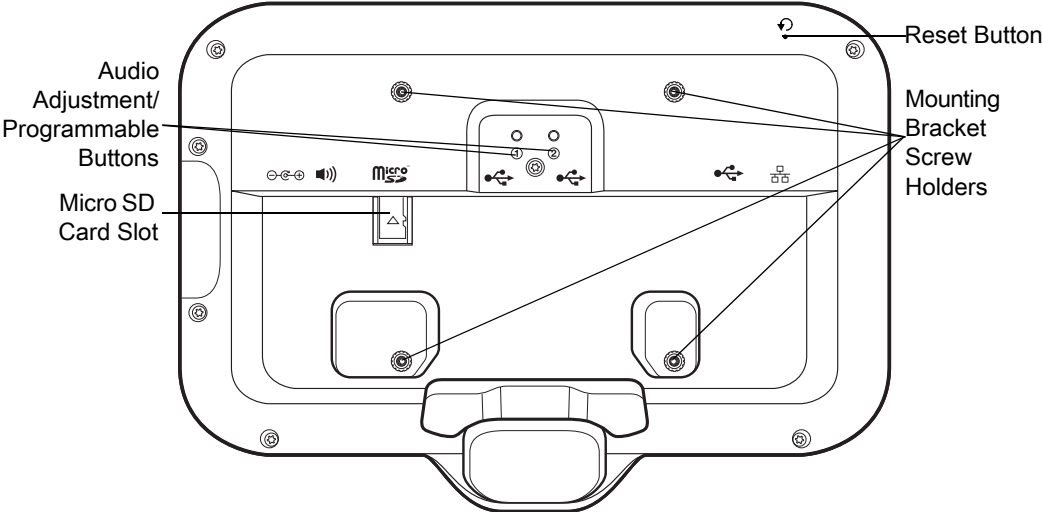

Figure 3 CC6000 Power and Cable Ports

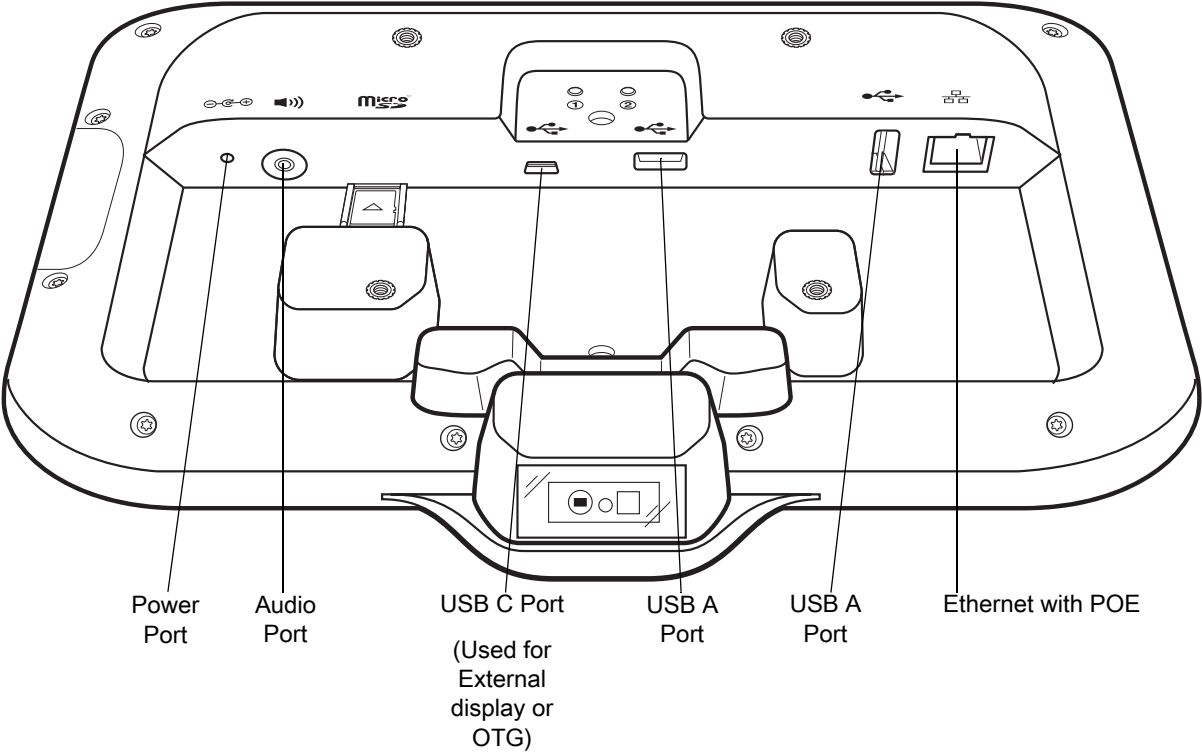

Figure 4 CC6000 Back With Bracket View

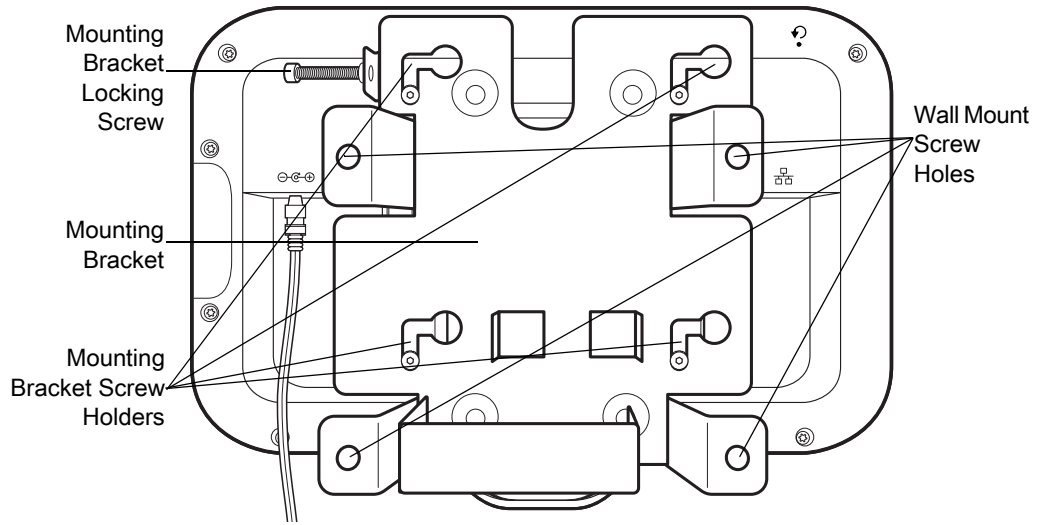

Figure 5 CC600 Front Views

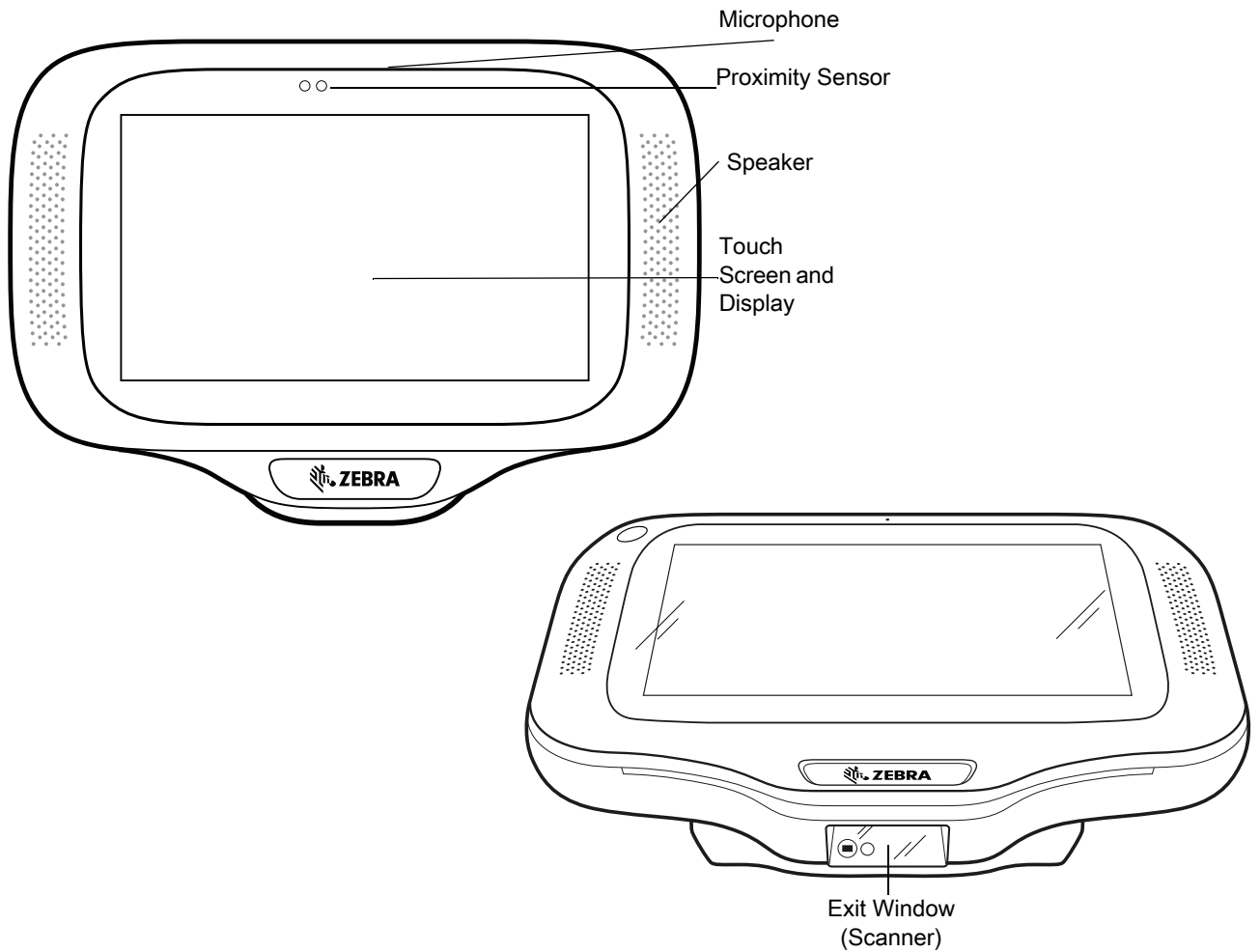

Figure 6 CC600 Back View

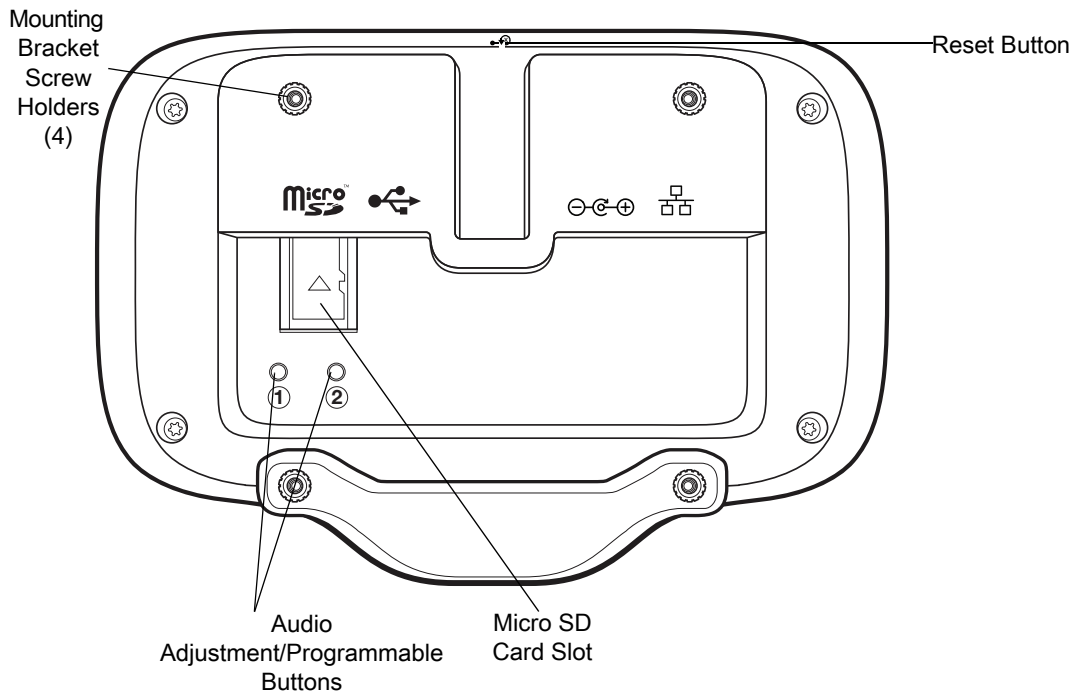

Figure 7 CC600 Power and Cable Ports

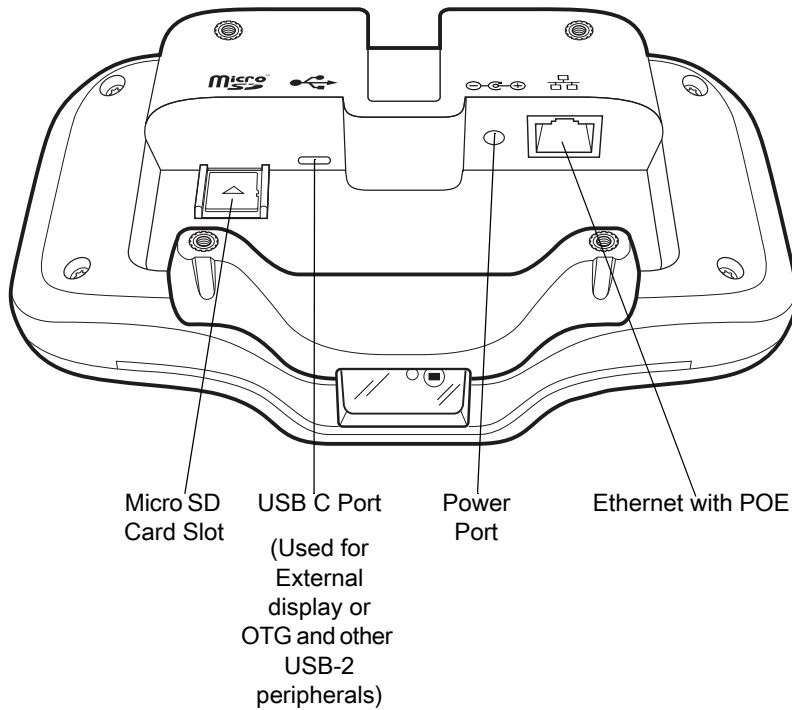

Figure 8 CC600 Back With Bracket View

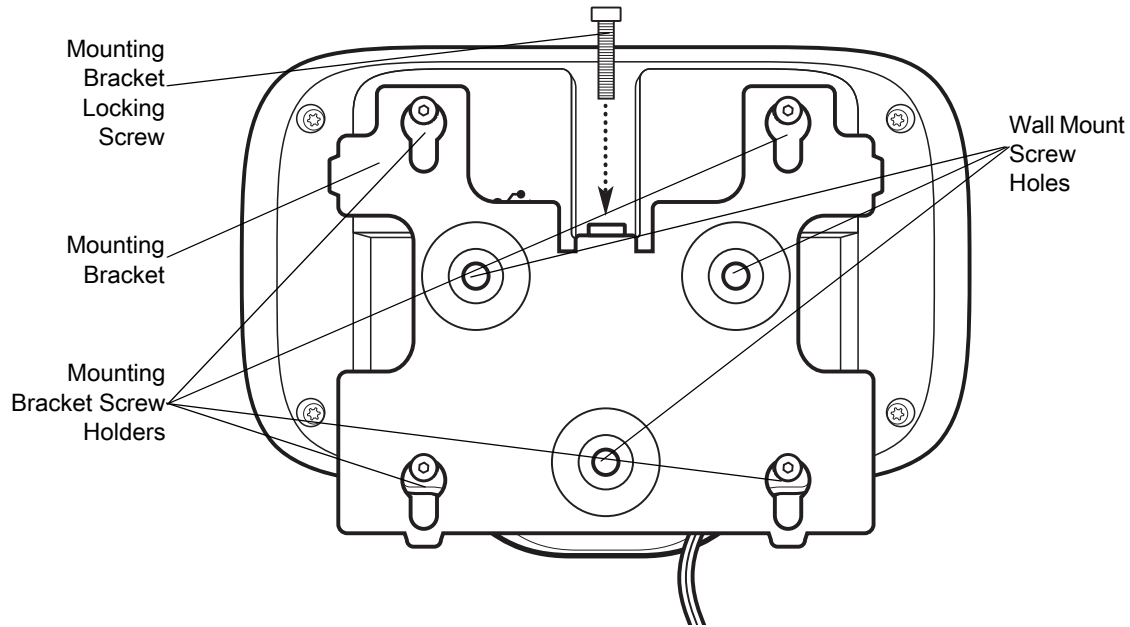



Table 3 Feature Descriptions

Item	Function
Touch Screen and Display	Displays all information needed to operate the device.
Exit Window (Scanner)	Provides data capture using the imager and reads a barcode. Note: To read a barcode, a scan-enabled app is required on the device.
Speaker	Provides audio output for video and music playback. Provides audio in speaker-phone mode.
NFC Antenna	Reads NFC tags. (CC6000 Only)
Proximity Sensor	Identifies the proximity of a user for turning up the display.
Microphone	Use for communications in Speakerphone mode.
Front Facing Camera	Captures still photos and videos. Note: Select CC6000 devices only.
Interface Connectors	See Figure 3 and Figure 7 .
Volume Up/Down Button	Increase and decrease audio volume (programmable).
External Display	Designated for USB-C port utilization.

Accessing Device Settings

To access device settings:

1. Swipe up from the bottom of the screen to display the **App** screen.

2. From the **App** screen swipe up from the bottom of the screen and touch .



or

1. Swipe down from the top of the screen and touch .

Setting the Date and Time

The user is only required to set the time zone or set the date and time if the wireless LAN does not support Network Time Protocol (NTP).

To set the date and time:

1. Swipe down from the top to open Quick Settings and then touch .
2. Touch **System > Date & time**.
3. Touch **Automatic date & time** to disable automatic date and time synchronization.
4. Touch **Set date**.
5. In the calendar, set today's date.
6. Touch **OK**.
7. Touch **Set time**.
8. Touch the hour.
9. Touch the green circle, drag to the current hour and then release.
10. Touch the minutes.
11. Touch the green circle, drag to the current minute and then release.
12. Touch **AM** or **PM**.
13. Touch **OK**.
14. Touch **Select time zone**.
15. Select the current time zone from the list.
16. Touch  to return to the **Home** screen.

Display Settings

Use Display settings to change the screen brightness, enable night light, change the background image, set sleep time and change font size.

Setting the Screen Brightness

To manually set the screen brightness:

1. Swipe down with two fingers from the top to open the Quick Access panel.

- Slide the icon to adjust the screen brightness level.

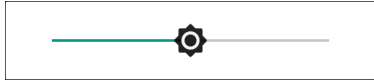

Figure 9 Brightness Slider



Setting Night Light



The Night Light setting tints the screen amber, making the screen easier to look at in low light.

To enable night light:

- Swipe down from the top of the screen to open Quick Settings and then touch .
- Touch **Display**.
- Touch **Night Light**.
- Touch **Schedule**.
- Select one of the schedule values:
 - None (default)
 - Turns on at custom time
 - Turns on from sunset to sunrise.
- Touch **Status**.
By default, **Night Light** is disabled. Toggle the switch to enable.
- Adjust the tint using the **Intensity** slider.
- Touch  to return to the **Home** screen.

Setting Screen Timeout



To set the screen sleep time:

- Swipe down from the top to open the Quick Settings panel and then touch .
- Touch **Display > Advanced > Sleep**.
- Select one of the sleep values.
 - 15 seconds
 - 30 seconds
 - 1 minute
 - 2 minutes
 - 5 minutes
 - 10 minutes
 - 30 minutes
- Touch  to return to the **Home** screen.

Ambient Display

The Ambient display setting wakes the screen when you receive notifications.

To disable ambient display:

1. Swipe down from the top to open the Quick Settings panel and then touch .
2. Touch **Display > Advanced**.
3. Touch **Ambient display**.
4. In the **When to show** section, touch **New notifications** to enable or disable.
5. Touch  to return to the **Home** screen.

Setting Font Size

To set the size of the font in system apps:



1. Swipe down from the top to open the Quick Settings panel and then touch .
2. Touch **Display > Advanced**.
3. Touch **Font size**.

Figure 10 Font Settings



4. Touch the green dot and slide left or right to select a font size.
5. Touch  to return to the **Home** screen.

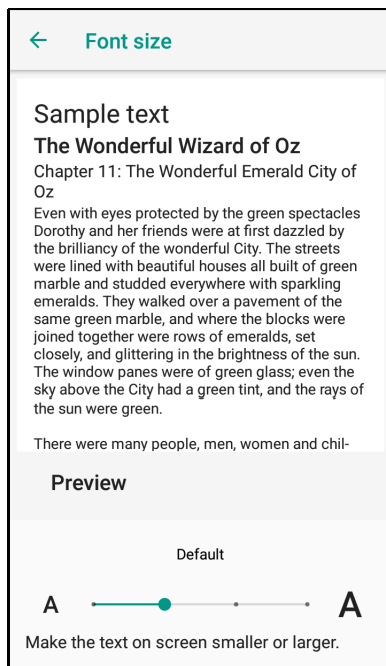

Setting Touch Panel Mode

The device display is able to detect touches using a finger, or a gloved finger.



NOTE: A glove can be made of medical latex, leather, cotton, or wool. For optimal performance use a Zebra certified stylus.

To configure the touch panel mode:

1. Swipe down from the top to open the Quick Settings panel and then touch .
2. Touch **Display**.
3. Touch **Advanced**.
4. Touch **Touch panel mode**.
5. Select an option to choose the method by which the screen reacts to touch:
 - Glove and Finger (Screen Protector off) to use a finger or a gloved finger on the screen without a screen protector.
 - Glove and Finger (Screen Protector on) to use a finger or a gloved finger on the screen with a screen protector.
6. Touch  to return to the **Home** screen.

General Sound Settings

Use the Sound settings to configure media and alarm volumes.

To access sound settings:





1. Swipe down from the top to open the Quick Settings panel and then touch .
2. Touch **Sound**.
3. Touch an option to set sounds.

Figure 11 Sound Screen - Zebra Volume Controls and Advanced Settings

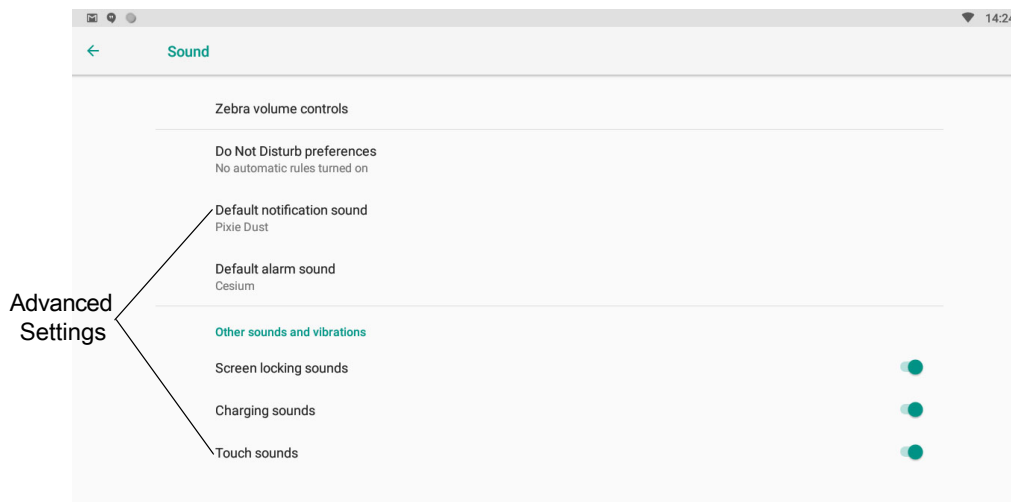

Zebra Volume Controls

- **Ring volume** - Controls the ringtone volume.
- **Media volume** - Controls the music, games, and media volume.
- **Alarm volume** - Controls the alarm clock volume.
- **Notifications volume** - Controls the notification volume.
- **Scanner volume** - Controls the scanner volume.
- Volume presets
 -  - Mutes the ring, notifications, and scanner so that the device does not make sounds.
 -  - All sounds except media and alarms are silenced.
 -  - Enables all sounds at the user defined levels.

Do Not Disturb Preferences

- Touch **Priority only allows** to set the priorities for the following:
 - Reminders - Switch on or off.
 - Events - Switch on or off.
 - Alarms - This is always enabled.
 - Messages - Choose to allow messages from anyone, contacts only, starred contacts only, or none. To star contacts, use the Contacts app.
 - Repeat callers - Switch on or off.
- Touch **Block visual disturbances**:
 - Block when screen is on - Switch on or off. This option prevents notifications from displaying over the screen (peeking) while you are actively using the device.
 - Block when screen is off - Switch on or off. This option prevents notifications from turning on the screen or pulsing the LED light when a new notification is received while you are not using the device.
- Touch **Automatic rules** - Switch on or off. This option allows you to choose when to automatically silence the device. Touch a default rule, such as Weekend or Weeknight, or create your own rule. To create your own rule tap **Add more** and then **Time rule**.

Advanced Sound Settings

- Touch **Default notification sound** to select a sound to play for all system notifications. Touch a sound in the list, then touch **OK**.

Figure 12 Default Notification Sounds

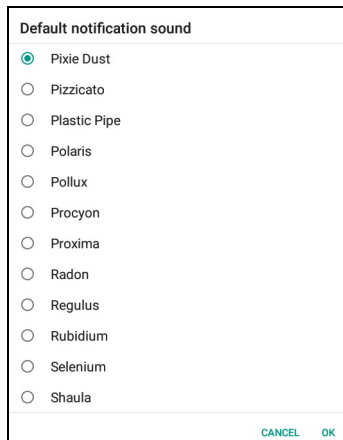

- Touch **Default alarm sound** to select a sound to play for alarms. Touch a sound in the list, then touch **OK**.

Figure 13 Default Alarm Sounds

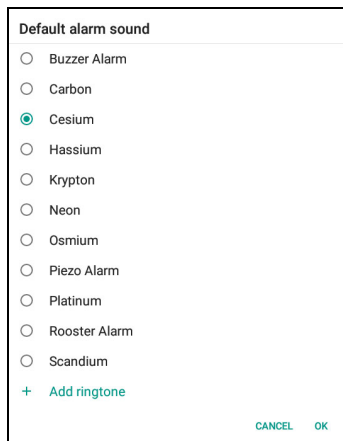

- **Other sounds**
 - Screen locking sounds - Switch on or off. - Play a sound when locking and unlocking the screen.
 - Touch sounds - Switch on or off. Play a sound when making screen selections (enabled by default).

Wake-Up Sources

By default the device wakes from suspend mode when the user touches the display or scans an item.

Using the Device

Introduction

This chapter explains the buttons, status icons, and controls on the device, and provides basic instructions for using the device including resetting the device and entering data.

Google Mobile Services



NOTE: This section applies to Google Mobile Services (GMS) devices only.

Devices with GMS contain apps and services that provide additional functionality.

GMS includes:

- Apps - GMS adds a variety of Google apps and associated widgets including Chrome, Gmail, Drive, and Maps.
- Services:
 - Speech to Text - Allows for free format speech to text in many languages for both connected and disconnected network. Launch by touching the microphone icon on the keyboard.
 - TalkBack Service - Provides spoken feedback on various parts of the user interface. To enable, go to **Settings > Accessibility**.
 - Network Location Provider - Adds a location provider which uses mobile network tower information and Wi-Fi access point information to provide a location. To enable, go to **Settings > Location access**.
 - Widevine DRM - Enables Digital Rights Management (DRM) so that protected streaming video content can be played. Enable DRM Info from the Google Play™ store.
 - Google Cloud Messaging - Allows the device to receive data from the server and other devices on the same connection.
 - Backup and Restore - Allows the users settings and apps to be backed up to a Google server and subsequently restored from that server after a factory reset.
- Google Accounts - Create and use a Google account to synchronize mail, files, music, photos, contacts and calendar events.

Home Screen

When the device powers on, the **Home** screen displays. Depending on the configuration, the **Home** screen may appear different. Contact your system administrator for more information.

After a suspend, screen time-out, or restart, the **Home** screen displays with the lock slider. Touch the screen and slide up to unlock. For screen locking information see [Un-Locking the Screen on page 46](#).



NOTE: By default, non-GMS devices do not have icons on the **Home** screen. Icons are shown below for example only. **Home** screen icons can be configured by the user and may look different than shown.

Figure 14 Home Screen



Table 4 Home Screen Features

	Item	Description
1	Status Bar	Displays the time, status icons (right side), and notification icons (left side). For more information see Status Icons on page 26 and Managing Notifications on page 27 .
2	Widgets	Launches stand-alone apps that run on the Home screen.
3	Shortcut Icons	Opens apps installed on the device.
4	Folder	Contains apps.
5	All Apps	Opens the APPS window.

The Home screen provides four additional screens to place widgets and shortcuts. Swipe the screen left or right to view the additional screens.

Customizing the Home Screen

To customize the **Home** screen:

1. Touch and hold anywhere on the **Home** screen until the options appear.

2. Touch **HOME SETTINGS**.
3. Touch the **Allow Home screen rotation** switch.
4. Touch .
5. Rotate the device.

Figure 15 Rotated Home Screen

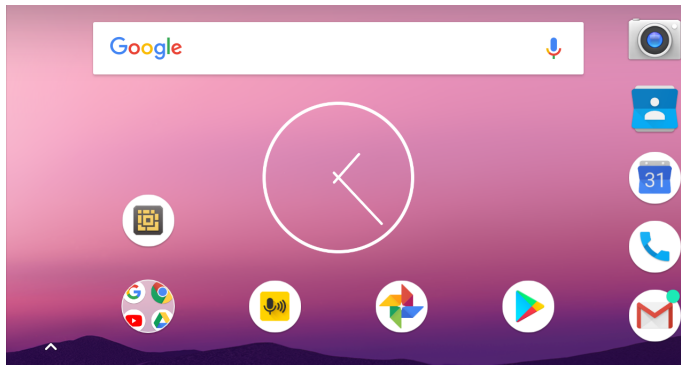

Status Bar

The Status bar displays the time, notification icons (left side), and status icons (right side).



NOTE: Some Status icons may not appear in the Status bar if there are too many icons to display.

Figure 16 Notification and Status Icons















If there are more notifications than can fit in the Status bar, two dots display indicating that more notifications exist. Swipe down from the Status bar to open the Notification panel and view all notifications and status.

Table 5 Notification Icons







Icon	Description
..	More notifications are available for viewing.
	Data is syncing.
	Indicates an upcoming event. Non-GMS devices only.
	Indicates an upcoming event. GMS devices only.
	Open Wi-Fi network is available.
	Song is playing.

Table 5 *Notification Icons (Continued)*

Icon	Description
	Problem with sign-in or sync has occurred.
	Device is uploading data.
	Device is downloading data when animated and download is complete when static.
	Device is connected via USB cable.
	Device is connected to or disconnected from virtual private network (VPN).
	Preparing internal storage by checking it for errors.
	USB debugging is enabled on the device.
	Headset is connected to the device.
	PTT Express Voice client status. See the PTT Express PTT Notification Icons on page 85 for a complete list.
	Indicates that RxLogger app is running.
	Indicates the RS6000 is connected to the device.
	Indicates the RS507 or RS6000 is connected to the device in HID mode.



Status Icons

Table 6 *Status Icons*

Icon	Description
	Alarm is active.
	All sounds, except media and alarms, are silenced and vibrate mode is active.
	Do Not Disturb mode active.
	Airplane Mode is active. All radios are turned off.
	Bluetooth is on.
	The device is connected to a Bluetooth device.
	Connected to a Wi-Fi network.

¹Cellular network icon that appears is dependent upon the carrier/network.

Table 6 Status Icons (Continued)

Icon	Description
	Not connected to a Wi-Fi network or no Wi-Fi signal.
	Connected to an Ethernet network.
	Speakerphone enabled.

¹Cellular network icon that appears is dependent upon the carrier/network.

Managing Notifications

Notification icons report the arrival of new messages, calendar events, alarms, and ongoing events. When a notification occurs, an icon appears in the Status bar with a brief description. See [Table 5 on page 25](#) for a list of possible notification icons and their description. Open the Notification panel to view a list of all the notifications.

To open the Notification panel, drag the Status bar down from the top of the screen.

Figure 17 Notification Panel

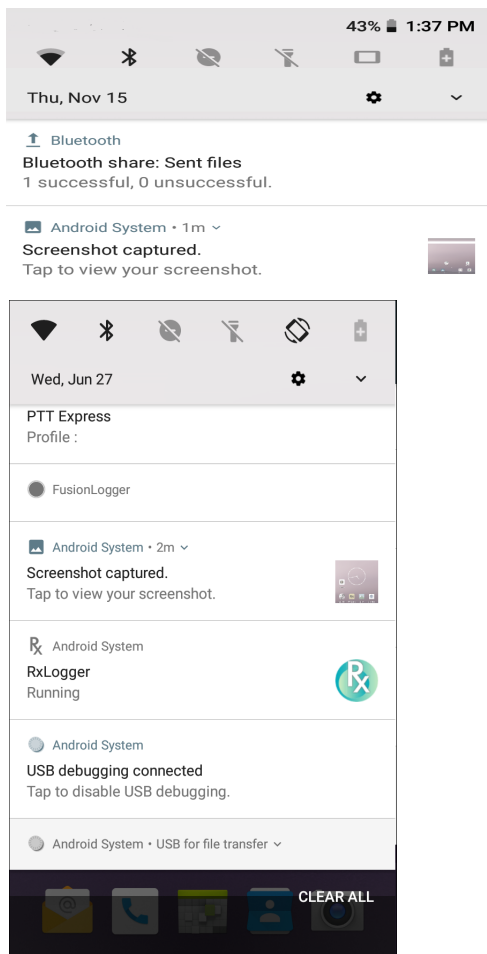

To respond to a notification, open the Notification panel and then touch a notification. The Notification panel closes and the corresponding app opens.

To clear all notifications, open the Notification panel and then touch **CLEAR ALL**. All event-based notifications are removed. Ongoing notifications remain in the list.

To close the Notification panel, swipe the Notification panel up.

Setting App Notifications

To set notification settings for a specific app:

1. Swipe down from the Status bar to open the Quick Settings bar and then touch .
2. Touch **Apps & notifications > Notifications > App notifications**.
3. Select an app.
4. Select an available option:
 - **On / Off** - Select to turn all notifications from this app **On** (default) or **Off**.
 - **Allow notification dot** - Do not allow this app to add a notification dot to the app icon.
 - **Allow interruptions** - Do not allow notifications from this app to make sound, vibrate, or pop notifications on the screen.
 - **Override Do Not Disturb** - Allow these notifications to interrupt when Do Not Disturb is set to Priority Only.
 - **Categories** - Do not allow specific types of notifications from this app.
 - **Additional settings in the app** - Open the app settings.



NOTE: To change the notification settings for an app, slide the notification slightly left or right and touch .

Viewing Notification Settings for All Apps

To view the notification settings for all apps:

1. Swipe down from the Status bar to open the Quick Settings bar and then touch .
2. Touch **Apps & Notifications**.
3. Scroll down to **Notifications** to view how many apps have notifications turned off.
4. To set or view notifications settings for a specific app, see [Setting App Notifications on page 28](#).

Controlling Lock Screen Notifications

To control whether notifications can be seen when the device is locked:

1. Swipe down from the Status bar to open the Quick Settings bar and then touch .
2. Touch **Apps & notifications > Notifications**.
3. Touch **On the lock screen** and select one of the following:
 - **Show all notification content** (default)
 - **Don't show notifications at all**.

Blink Light

The Charging/Notification LED lights blue when an app, such as email and VoIP, generates a programmable notification or to indicate when the device is connected to a Bluetooth device. By default, LED notifications are enabled.

To change the notification setting:

1. Swipe down from the Status bar to open the Quick Settings bar and then touch .
2. Touch **Apps & notifications > Notifications**.
3. Touch **Blink light** to toggle the notification on or off.

Quick Access Panel

Use the Quick Access panel to access frequently used settings (for example, Airplane mode).

Figure 18 Quick Settings Bar

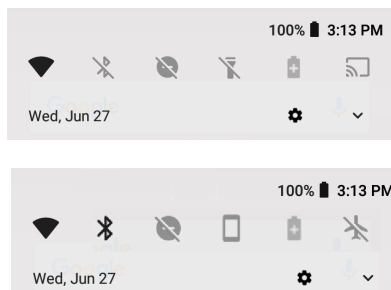

To see the full Quick Access panel:

- If the device is locked, swipe down once.
- If the device is unlocked, swipe down once with two fingers, or twice with one finger.
- If the Quick Settings bar is open, touch the Down arrow.

Figure 19 Quick Access Panel

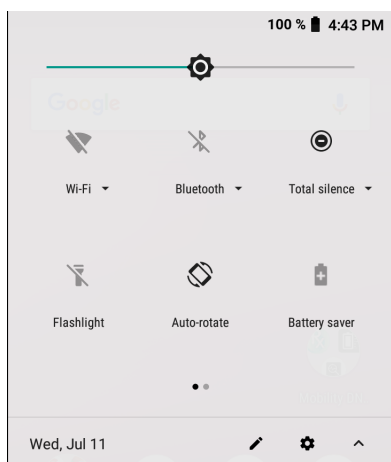

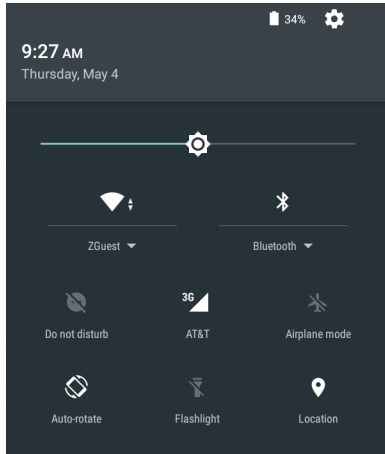

NOTE: Not all icons are pictured. Icons may vary.

To change a setting, touch the icon:

- Display brightness - Use the slider to decrease or increase the brightness of the screen.
- Wi-Fi network - Turn Wi-Fi on or off. To open Wi-Fi settings, touch the Wi-Fi network name.
- Bluetooth settings - Turn Bluetooth on or off. To open Bluetooth settings, touch **Bluetooth**.
- Battery power - Not applicable.
- Battery saver - Not applicable.
- Invert colors - Invert the display colors.
- Do not disturb - Control how and when to receive notifications.
- Airplane mode - Turn Airplane mode on or off. When Airplane mode is on the device does not connect to Wi-Fi or Bluetooth.
- Auto-rotate - Lock the device's orientation in portrait or landscape mode or set to automatically rotate.
- Flashlight - Turn flashlight on or off. Turn camera flash on or off.



The thermal protection safety feature for the camera provides the following behavior if the temperature range is 40°C or above:

- If the flashlight is kept on for a certain period of time, it is automatically turned off and cannot be turned back on for a period of time until it has cooled off.
- During the cooling off period, the camera cannot be turned on. If the user attempts to use the camera, a message displays indicating to try again after a period of time.
- Location - Enable or disable locationing feature.
- Hotspot - Turn on to share the device's mobile data connection with other devices.
- Data Saver - Turn on to prevent some apps from sending or receiving data in the background.
- Night Light - Tint the screen amber to make it easier to look at the screen in dim light. Set Night Light to turn on automatically from sunset to sunrise, or at other times.
- Nearby - Helps find and interact with services and devices close to the device.
- Cast - Share phone content on Chromecast or a television with Google Cast built-in. Touch cast screen to display a list of devices, then touch a device to begin casting.
- Screenshot - Takes a snapshot of the current screen.



Editing Icons on Quick Settings

The first several setting tiles from the Quick Access panel become the Quick Settings bar.



To move a setting tile:

1. Open the Quick Access panel.
2. Touch .
3. Touch and drag a setting tile to another location.
4. Release the tile.
5. Touch  to save tiles and return to the Quick Access panel.

To add a setting tile:

1. Open the Quick Access panel.
2. Touch .
3. Slide the Quick Settings panel up to reveal additional tiles.
4. Touch and drag a setting tile from the **Drag to add tiles** area to the main area.
5. Release the tile.
6. Touch  to save tiles and return to Quick Access panel.

To remove a setting tile:

1. Open the Quick Access panel.
2. Touch .
3. Touch and drag a setting tile to the **Drag here to remove** area.
4. Release the tile.
5. Touch  to save tiles and return to Quick Access panel.

App Shortcuts and Widgets

App shortcuts placed on the Home screen allow quick and easy access to apps. Widgets are self-contained apps placed on the Home screen to access frequently used features.

Adding an App Shortcut to the Home Screen

To add an app shortcut to the Home screen:

1. Go to the desired Home screen.
2. Swipe up from the bottom of the screen.
3. Scroll through the list to find the app icon.
4. Touch and hold the icon until the Home screen appears.
5. Position the icon on the screen and then release.

Adding a Widget to the Home Screen

To add a widget to the Home screen:

1. Go to the desired Home screen.
2. Touch and hold until the menu appears.
3. Touch **WIDGETS**.
4. Scroll through the list to find the widget.
5. Touch and hold the widget until the Home screen appears.
6. Position the widget on the screen and then release.

Moving Items on the Home Screen

To move app shortcuts or widgets on the Home screen:

1. Touch and hold the item until it floats on the screen.
2. Drag the item to a new location. Pause at the edge of the screen to drag the item onto an adjacent Home screen.
3. Lift finger to place the item on the Home screen.

Removing an App Shortcut or Widget from the Home Screen

To remove an app shortcut or widget from the Home screen:

1. Go to the desired Home screen.
2. Touch and hold the app shortcut or widget icon until it floats on the screen.
3. Drag the icon to **X Remove** at the top of the screen and then release.

Folders

Use **Folders** to organize similar applications together. Tap the folder to open and display items in the folder.

Creating a Folder

There must be at least two app icons on the Home screen.

To create a folder:

1. Go to the desired Home screen.
2. Touch and hold one app icon.
3. Drag the icon and stack on top of another icon.
4. Lift and release.

Naming Folders

To name a folder:

1. Touch the folder.

Figure 20 Open Folder

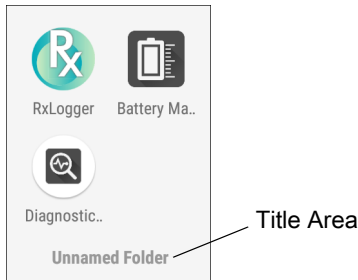

2. Touch the title area and enter a folder name using the keyboard.
3. Touch  on the keyboard.
4. Touch anywhere on the Home screen to close the folder. The folder name appears under the folder.

Removing a Folder

To remove a folder:

1. Touch and hold the folder icon until it enlarges.
2. Drag the folder to **X Remove** and release.

Home Screen Wallpaper

To change the Home screen wallpaper:

1. Touch and hold the screen until the menu appears.
2. Touch **WALLPAPERS**.
3. Touch **Photos** or **Gallery** to select a photo or select one of the pre-installed wallpapers.
4. Touch **Set wallpaper**.

Using the Touchscreen

Use the multi-tap sensitive screen to operate the device.

- Tap - Tap to:
 - Select items on the screen.
 - Type letters and symbols using the on-screen keyboard.
 - Press on-screen buttons.
- Tap and Hold - Tap and hold:
 - An item on the Home screen to move it to a new location or to the trash.
 - An item in Apps to create a shortcut on the Home screen.
 - The Home screen to open a menu for customizing the Home screen.
 - An empty area on the Home screen until the menu appears.

- Drag - Tap and hold an item for a moment and then move finger on the screen until reaching the new position.
- Swipe - Move finger up and down or left and right on the screen to:
 - Unlock the screen.
 - View additional Home screens.
 - View additional app icons in the Launcher window.
 - View more information on an app's screen.
- Double-tap - Tap twice on a web page, map, or other screen to zoom in and out.
- Pinch - In some apps, zoom in and out by placing two fingers on the screen and pinching them together (to zoom out) or spreading them apart (to zoom in).

Keyboards

The device provides the following types of keyboards:

- Android Keyboard - Non-GMS devices only.
- Enterprise Keyboard.



NOTE: By default the Enterprise Keyboard is disabled.

Keyboard Configuration



Enabling Keyboards

To enable keyboards:

1. Swipe down from the Status bar to open the Quick Settings bar and then touch .
2. Touch **System > Languages & input > Virtual keyboard > Manage keyboards**.
3. Touch a keyboard to enable.

Switching Between Keyboards

To switch between keyboards, touch in a text box to display the current keyboard.

- On the Android or Gboard keyboards, touch and hold .
- On the Enterprise keyboard, touch .

Using the Enterprise Keyboard

The Enterprise Keyboard contains the following keyboards:

- Numeric
- Alpha
- Special characters
- Data capture.

Numeric Tab

To access the numeric keyboard, touch the **123** tab. The keys displayed vary on the app being used. For example, an arrow displays in **Contacts**, however **Done** displays in **Email** account setup.

Figure 21 Numeric Keyboard

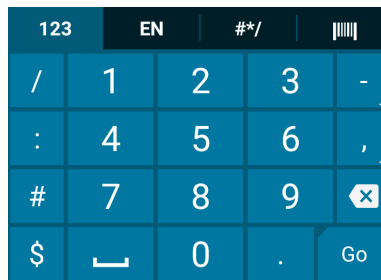
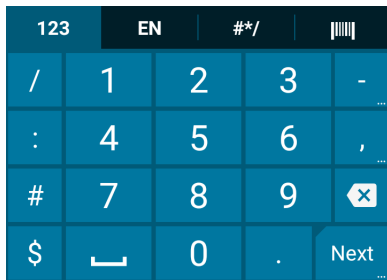

Alpha Tab

To access the alpha keyboard, touch the EN tab.

Figure 22 Alpha Keyboard



Additional Character Tab

To access additional characters, touch the #*/ tab.

Figure 23 Symbols Keyboard

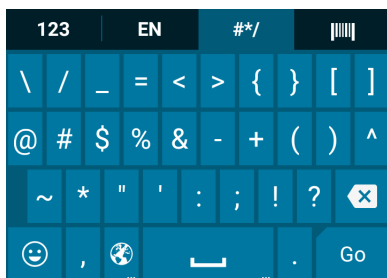

Touch 😊 to enter emoji icons in a text message.

Figure 24 Emoji Keyboard

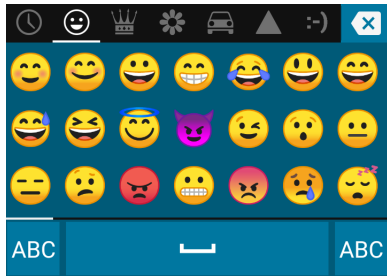

Touch **ABC** to return to the Symbols keyboard.

Scan Tab

The Scan tab provides an easy data capture feature for scanning barcodes.

Figure 25 Scan Keyboard

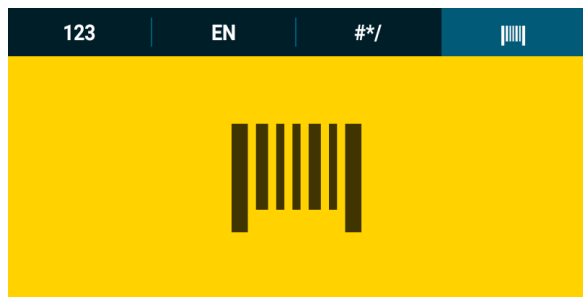

Using the Android and Gboard Keyboards

Use the Android or Gboard keyboards to enter text in a text field. To configure the keyboard settings, touch and hold , (comma) and then select **Android keyboard settings**.

Editing Text

Edit entered text and use menu commands to cut, copy, and paste text within or across apps. Some apps do not support editing some or all of the text they display; others may offer their own way to select text.

Entering Numbers, Symbols, and Special Characters

To enter numbers and symbols:

- Touch and hold one of the top-row keys until a menu appears then select a number or special character.
- Touch the Shift key once for a single capital letter. Touch the Shift key twice to lock in uppercase. Touch the Shift key a third time to unlock Capslock.
- Touch **?123** to switch to the numbers and symbols keyboard.
- Touch the **=\<** key on the numbers and symbols keyboard to view additional symbols.

To enter special characters, touch and hold a number or symbol key to open a menu of additional symbols. A larger version of the key displays briefly over the keyboard.

Do Not Disturb Feature

This mode mutes the device so that it does not make sounds or vibrate.

For example, use Do Not Disturb to:

- Automatically limit sounds at night or during events
- Mute interruptions other than alarms
- Get alerted to messages only from favorite contacts.

Limit Sounds

Mute the device completely, or let through the important alarms or important calls.

Total Silence

To completely mute the device so that it does not make a sound or vibrate, choose **Total silence**.

In Total silence mode:

- Alarms do not make noise.
- Device does not vibrate or make sounds when receiving a message, or notification.
- Sounds from music, videos, games, and other media are muted.



NOTE: All alarms are silenced in Total silence mode.

1. Swipe down with two fingers from the Status bar to open the Quick Access panel.
2. Touch **Do not disturb > Total silence**.
3. Choose **Until you turn it off** or select a time period.
4. Touch **Done**.

When Total Silence is on,  appears in the quick access panel and the Status bar.

To turn off Total Silence, open quick access panel and touch **Total silence**.

Alarms Only

To mute the device so that the user hears alarms, choose **Alarms only**. This option does not mute sounds from music, videos, games, or other media.

1. Swipe down with two fingers from the status bar to open the quick access panel.
2. Touch **Do not disturb > Alarms only**.
3. Choose **Until you turn it off** or select a time period.
4. Touch **Done**.

When Alarms Only is on,  appears in the quick access panel and the Status Bar.

To turn off Alarms Only, open the Quick Access panel and touch **Alarms only**.





NOTE: To quickly turn on Alarms Only, with the screen on, press and hold the Volume Down button until the volume is all the way down. Then, press Volume Down again to turn on Alarms Only.

To turn off Alarms Only, press either the Volume Up or Volume Down button and the touch **END NOW** in the alert message.

Priority Notifications Only

To only be interrupted by important notifications, choose **Priority only**. This option does not mute sounds from music, videos, games, or other media.

Before turning on Priority Only mode, set the notification priorities:

1. Swipe down from the status bar to open the quick settings bar and then touch .
2. Touch  **Sound > Do not disturb > Priority only allows**.
3. Set priorities.
 - **Alarms**: Disabled by default.
 - **Reminders** and **Events**: Switch on or off.
 - **Messages** and **Calls**: Choose **From anyone**, **From contacts only**, **From starred contacts only**, or **none**. To star contacts, use the **Contacts** applications.
 - **Repeat callers**: Choose whether to let the device ring if the same person calls again within 15 minutes.

After setting notification priorities, turn on Priority Only mode to limit interruptions. The priority notifications make a sound or vibrate based on the current ringer volume, but other notifications will be silenced.

1. Swipe down with two fingers from the status bar to open the quick access panel.
2. Touch **Do not disturb > Priority only**.
3. Choose **Until you turn it off** or select a time period.
4. Tap **Done**.

When Priority Only is on,  appears in the quick access panel and the Status Bar.

To turn off Priority Only, open quick access panel and touch **Priority only**.

Automatically Block Sounds

Automatically silence the device during certain times or events, turn sounds back on, and override Do Not Disturb mode.

Silence Sounds During Certain Times

To automatically silence the device during certain times, like at night or on weekends:

1. Swipe down from the Status bar to open the Quick Settings bar and then touch .
2. Touch **Sound > Do Not Disturb preferences**.
3. Touch a default **Weekend** or **Weeknight**. Or, to make a new rule, touch **Add more > Time rule**.
4. Enter a rule name.
5. Touch **OK**.



6. Edit the new rule:
 - **Rule name** - Rename the rule.
 - **Days, Start time, and End time** - Set the rule's schedule.
 - **Do Not Disturb preferences** - Choose whether the rule uses **Alarms only**, **Priority only**, or **Total silence**.
 - **Alarm can override end time** - Allow the alarm to continue to make sound until the next alarm begins.
7. Touch the On/Off switch at the top to turn on the rule.

Silence Sounds During Events and Meetings

To automatically silence the device during events or meetings, set an event rule.

1. Swipe down from the Status bar to open the Quick Settings bar and then touch .
2. Touch **Sound > Do Not Disturb preferences**.
3. To edit the default rule, touch **Event**. Or, to create a new rule, touch **Add rule > Event rule**.
4. Edit the rule settings.
 - **Rule name** - Rename the rule.
 - **During events for** - Select which Google Calendar events the rule uses.
 - **Where reply is** - Set to: **Yes, Maybe, or Not replied, Yes or Maybe, or Yes**.
 - **Do Not Disturb preferences** - Choose whether the rule uses **Priority only**, **Alarms only**, or **Total silence**.
5. Touch the On/Off switch at the top to turn on the rule.

Turn Sounds Back On

When the device is in Do Not Disturb mode, Alarms only or Priority only display as , or Total silence displays as .

To turn off Do Not Disturb, either:

- In the Quick Access panel, touch **Alarms only**, **Priority only**, or **Total silence**.
- Press the Volume Down button and touch **End Now**.

Override Do Not Disturb for Specific Apps

To let through notifications from specific apps:

1. Swipe down from the Status bar to open the Quick Settings bar and then touch .
2. Touch **Apps & notifications > Notifications > App notifications**.
3. Touch an app.
4. Touch **Override Do Not Disturb**.

Apps

The **APPS** screen displays icons for all installed apps. The table below lists the apps installed on the device. Refer to the device Integrator Guide for Android Version 8.1 for information on installing and uninstalling apps.

Table 7 Apps













Icon	Description
	Battery Manager - Not applicable.
	Battery Swap – Not applicable.
	Bluetooth Pairing Utility – Use to pair the RS507 Hands-free Imager with the device by scanning a barcode.
	Calculator - Provides the basic and scientific arithmetic functions.
	Calendar - Use to manage events and appointments. GMS devices onlyGMS/GMS-Restricted only.
	Calendar - Use to manage events and appointments. Non-GMS devices onlyAOSP only.
	Camera - Take photos or record videos. For more information see Camera on page 54 .
	Chrome - Use to access the Internet or intranet. GMS devices onlyGMS/GMS-Restricted only.
	Chromium - Use to access the Internet or intranet. AOSP only.
	Clock - Use to schedule alarms for appointments or as a wake-up.
	Contacts - Use to manage contact information. See Contacts on page 60 for more information.
	DataWedge - Enables data capture using the imager.
	Device Central - Use to display detailed information about the device and connected peripherals.

Table 7 Apps (Continued)













Icon	Description
	Diagnostic Tool - Use to diagnose the device.
	Drive - Upload photos, videos, documents, and other files to personal storage site. GMS/GMS-Restricted only.
	DWDemo - Provides a way to demonstrate the data capture features using the imager. See DataWedge Demonstration on page 62 for more information.
	Email - Use to send and receive email. Non-GMS devices only.AOSP only.
	Enterprise Browser - Industrial browser that provides everything needed to quickly build device apps for barcode scanning, signature capture, payment processing, printing and most other enterprise applications. For more information, refer to techdocs.zebra.com/enterprise-browser/ .
	ET5X User Guide - Opens the on-device User Guide for the device.
	Files - Organize and manage files on the device. See Files on page 69 for more information.
	Gallery - Use to view photos stored on the devicemicroSD card. For more information, see Gallery on page 71 for more information. Non-GMS devices onlyAOSP only.
	Gmail - Use to send and receive email using a Google email account. GMS devices onlyGMS/GMS-Restricted only.
	Google - Launches Google search app. GMS devices onlyGMS/GMS-Restricted only.
	Hangouts - Use to communicate with friends using text messages and photos. GMS devices onlyGMS/GMS-Restricted only.
	Keep - Use to create, edit, and share notes. GMS devices onlyGMS/GMS-Restricted only.
	License Manager - Use to manage software licenses on the device.
	Maps - Use to see your location on a map (with public transit, traffic, or satellite overlays). Search for any business or place of interest. Provides turn-by-turn navigation with voice guidance, traffic-avoidance, and alternate routes, for drivers, cyclists, walkers, and users of public transportation. GMS devices onlyGMS/GMS-Restricted only.

Table 7 Apps (Continued)















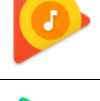

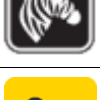
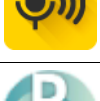

Icon	Description
	MSRN - Use to verify authenticity of the paired Snap-on MSR and to provision the Snap-on MSR. See device Touch Computer Integrator Guide for Android Version 8.1 for more information.
	Music - Play music stored on the device microSD card. Non-GMS devices only AOSP only.
	Notes - Use to take and save notes. Non-GMS devices only AOSP only
	Photos - Use to sync photos with Google account. For more information, see Photos on page 78 for more information. GMS devices only GMS/GMS-Restricted only.
	Play Movies & TV - View movies and video on your device. GMS devices only GMS/GMS-Restricted only.
	Play Music - Use to listen to music. GMS devices only GMS/GMS-Restricted only.
	Play Store - Download music, movies, books, and Android apps and games from the Google Play Store. GMS devices only GMS/GMS-Restricted only.
	Print Station - Use to print labels and receipts directly to a Zebra ZPL printer via USB, Bluetooth, or WLAN.
	PTT Express - Use to launch PTT Express client for VoIP communication.
	RxLogger - Use to diagnose device and app issues. See the device Integrator Guide for Android Version 8.1 for more information.
	RxLogger Utility - Use to view, backup, and archive RxLogger data.
	Search - Use to search the Web. Requires an Internet connection. Non-GMS devices only AOSP only.
	Settings - Use to configure the device.
	Sound Recorder - Use to record audio.

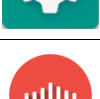
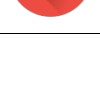
Table 7 Apps (Continued)

Icon	Description
	StageNow - Allows the device to stage a device for initial use by initiating the deployment of settings, firmware, and software.
	Tap & Pair - Use to pair the device with a Zebra Bluetooth printer.
	Velocity - Opens the Ivanti (formerly Wavelink) terminal emulation app.
	Voice Search - Use to perform searches by asking questions. GMS devices only/GMS/GMS-Restricted only.
	Worry Free Wifi Analyzer - A diagnostic intelligent app. Use to diagnose surrounding area and display network stats, such as coverage hole detection, or AP in vicinity. Refer to the Worry Free Wi-Fi Analyzer Administrator Guide for Android.
	YouTube - Use to view videos on the YouTube™ web site. GMS devices only/GMS/GMS-Restricted only.
	Zebra Bluetooth - Use to configure Bluetooth logging.
	Zebra Utilities - Use to print barcode labels and receipts directly to a Zebra printer via Bluetooth or WLAN.

Accessing Apps

All apps installed on the device are accessed using the **APPS** window.

1. On the Home screen, swipe up from the bottom of the screen.

Figure 26 APPS Window Example

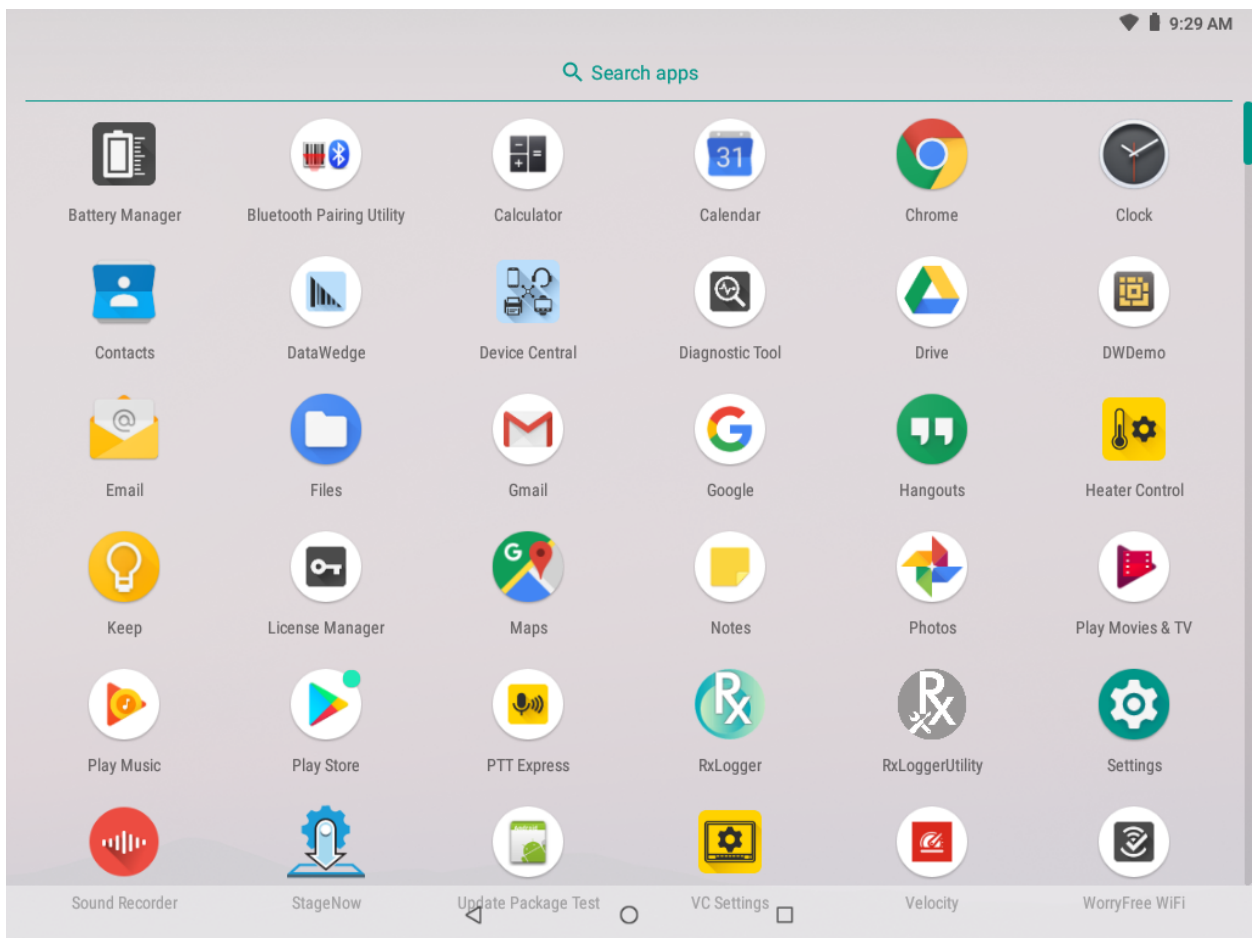
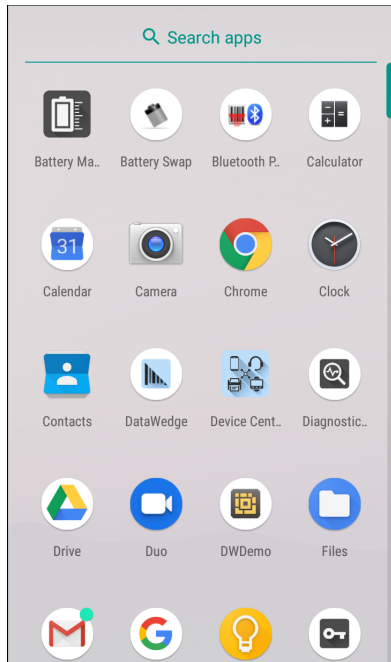

2. Slide the **APPS** window up or down to view more app icons. Touch an icon to open the app.

Switching Between Recent Apps

To switch between recent apps:



1. Touch . A window appears on the screen with icons of recently used apps.

Figure 27 Recently Used Apps



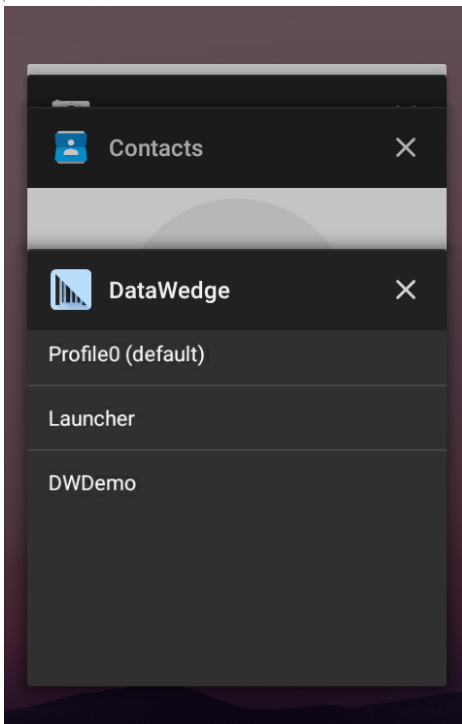
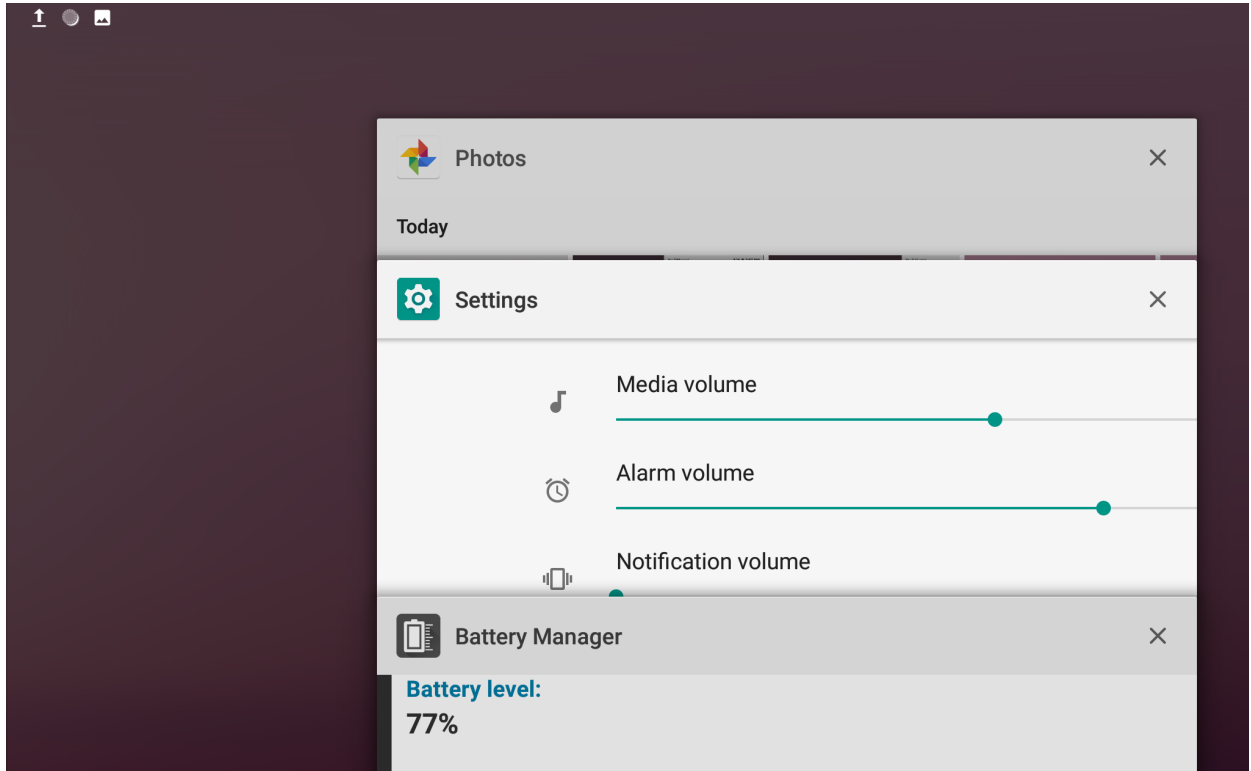

2. Slide the window up and down to view all recently used apps.
3. Swipe left or right to remove app from the list and force close the app.
4. Touch an icon to open it or touch  to return to the current screen.

Un-Locking the Screen

Use the Lock screen to protect access to data on the device. Some email accounts require locking the screen. Refer to the device Integrator Guide for Android Version 8.1 for information on setting up the locking feature.

When locked, a pattern, PIN, or password is required to unlock the device. Press the Power button to lock the screen. The device also locks after a pre-defined time-out.

Press and release the Power button to wake the device. The Lock screen displays. Swipe the screen up to unlock. If the Pattern screen unlock feature is enabled, the Pattern screen appears instead of the Lock screen. If the PIN or Password screen unlock feature is enabled, enter the PIN or password after unlocking the screen.

Figure 28 Lock Screen

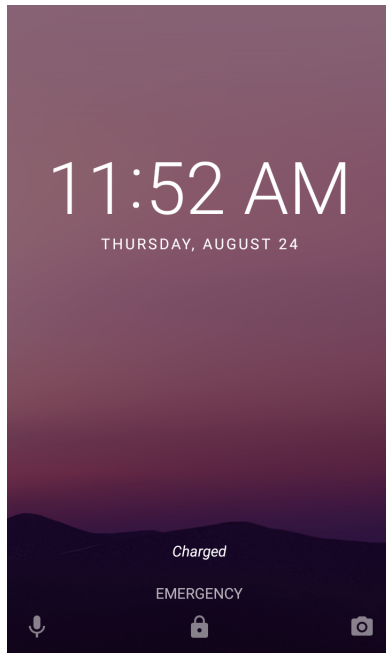
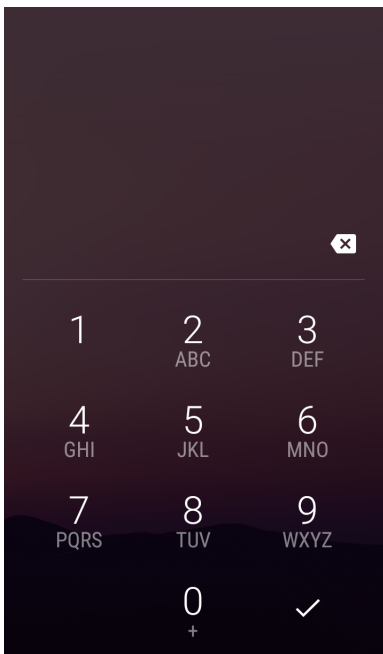

Figure 29 PIN Screen



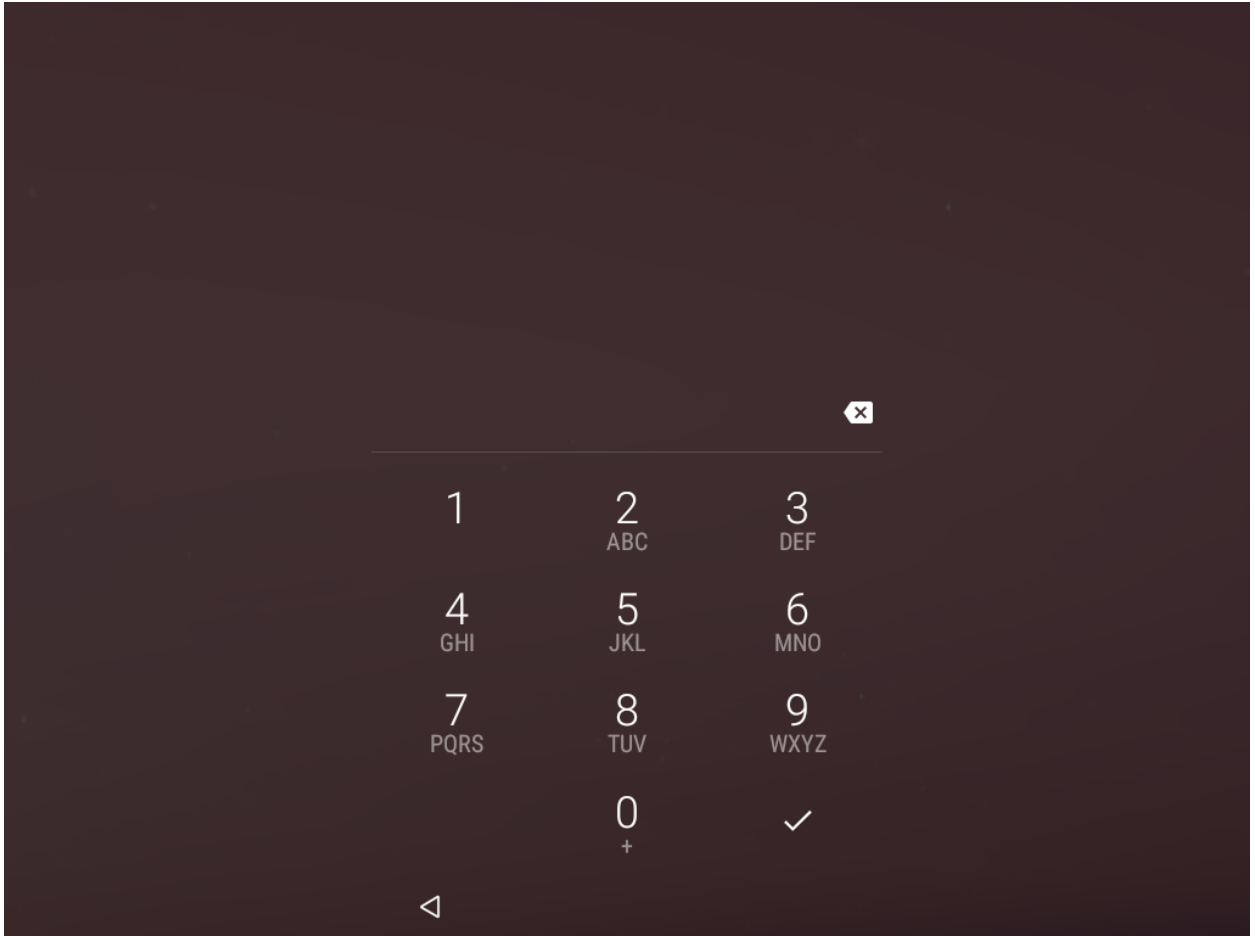

Figure 30 Pattern Screen

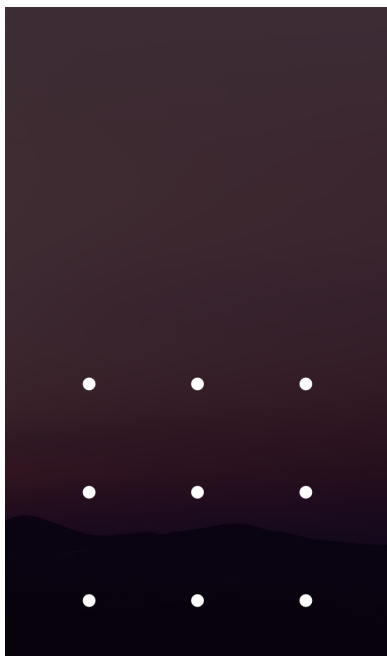
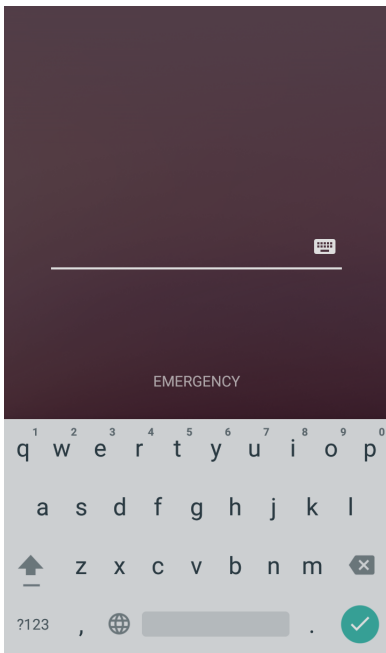
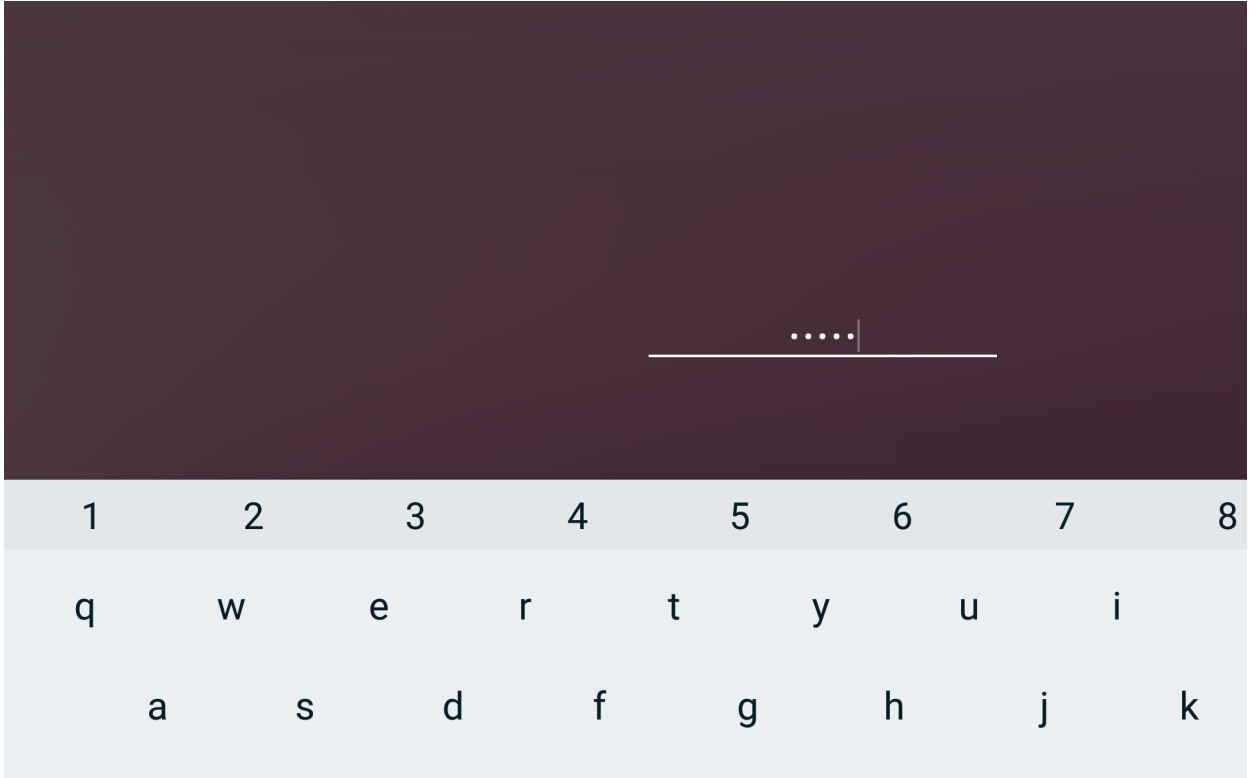



Figure 31 Password Screen





Transferring Files with a Host Computer via USB

Connect the device to a host computer using a USB cable or a USB cradle to transfer files between the device and the host computer.

When connecting the device to a host computer, follow the host computer's instructions for connecting and disconnecting USB devices, to avoid damaging or corrupting files.

Transferring Files



NOTE: Use Transfer files to copy files between the device (internal memory or microSD card) and the host computer.

1. Connect a USB cable to the device or place the device into a USB cradle.

2. Pull down the Notification panel and touch **USB charging this device**.
By default, **Charge this device** is selected.

Figure 32 Use USB to Dialog Box

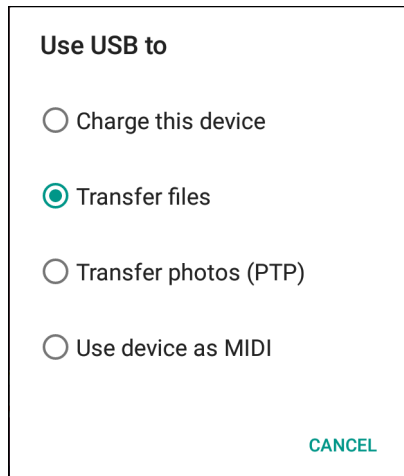

3. Touch **Transfer files**.
4. On the host computer, open a file explorer application.
5. Locate the **device** as a portable device.
6. Open the **SD card** or the **Internal storage** folder.
7. Copy files to and from the device or delete files as required.

Transferring Photos

To transfer photos using Photo Transfer Protocol:



NOTE: Use Photo Transfer Protocol (PTP) to copy photos from either the microSD card or internal memory to the host computer.

1. Connect USB cable to the device or place the device into a USB cradle. See [Accessories](#) for setup information.
2. Pull down the Notification panel and touch **USB charging this device**.
3. Touch **Transfer photos (PTP)**.
4. On the host computer, open a file explorer application.
5. Open the **SD card** or the **Internal storage** folder.
6. Copy or delete photos as required.

Disconnect from the Host Computer

To disconnect the device from the host computer:



CAUTION: Carefully follow the host computer's instructions to unmount the microSD card and disconnect USB devices correctly to avoid losing information.

1. On the host computer, unmount the device.
2. Remove the USB cable from the device or remove the device from the cradle.

Applications

Introduction

This section describes the applications installed on the device.

Camera

This section provides information for taking photos and recording videos using the integrated digital cameras.



NOTE: The device saves photos and videos on the microSD card, if installed and the storage path is changed manually. By default, or if a microSD card is not installed, the device saves photos and videos on the internal storage.

Taking Photos





NOTE: See [Photo Settings on page 57](#) for camera setting descriptions.

1. Swipe up from the bottom of the Home screen and touch **Camera**.

Figure 33 Camera



2. If necessary, touch the Camera Mode icon and touch .
3. To switch between the rear camera and front camera (if available), touch .
4. Frame the subject on the screen.
5. To zoom in or out, press two fingers on the display and pinch or expand fingers. The zoom controls appear on the screen.
6. Touch an area on the screen to focus. The focus circle appears. The two bars turn green when in focus.
7. Touch .
 - The camera takes a photo and a shutter sound plays.
 - The photo momentarily displays as a thumbnail in the lower left corner.

Recording Videos

1. Swipe up from the bottom of the Home screen and touch **Camera**.

2. Touch the camera mode menu and touch .

Figure 34 Video Mode







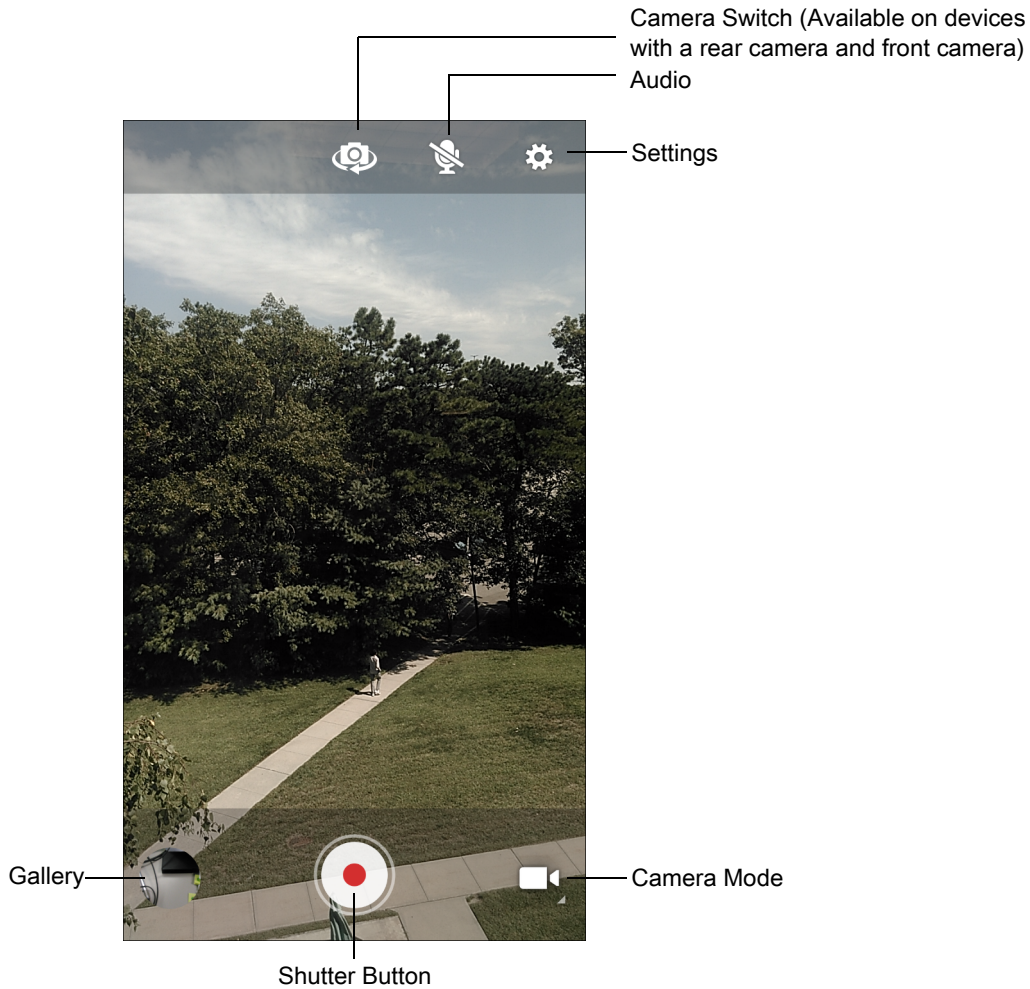









3. To switch between the rear camera and front camera (if available), touch .
4. Point the camera and frame the scene.
5. To zoom in or out, press two fingers on the display and pinch or expand fingers. The zoom controls appear on the screen.
6. Touch  to start recording.
The video time remaining appears in the top left of the screen.
7. Touch  to the end recording.
The video momentarily displays as a thumbnail in the lower left corner.

Photo Settings





In Photo mode, photo settings appear on screen. Touch  to display the photo settings options.

Rear Camera

- **Flash** - Select whether the camera relies on its light meter to decide whether a flash is necessary, or to turn it on or off for all shots.
 -  **Off** - Disable flash.
 -  **Auto** - Adjust flash automatically depending upon light meter (default).
 -  **On** - Enable flash upon taking a photo.
 -  **Torch** - Turn flash on continuously.
- **Picture size** - The size (in pixels) of the photo to: **13M pixels** (default), **8M pixels**, **5M pixels**, **3M pixels**, **HD 1080**, **2M pixels**, **1.3M pixels**, **HD720**, **1M pixels**, **WVGA**, **VGA** or **QVGA**.
- **Picture quality** - Set the picture quality setting to: **Low**, **Standard** (default) or **High**.
- **Countdown timer** - Select **Off** (default), **2 seconds**, **5 seconds** or **10 seconds**.
- **Storage** – Set the location to store the photo to: **Phone** or **SD Card**.
- **Face Detection** - Select to turn face detection **Off** (default) or **On**.
- **ISO** - Set camera sensitivity to light to: **Auto** (default), **ISO Auto (HJR)**, **ISO100**, **ISO200**, **ISO400**, **ISO800** or **ISO1600**.
- **Exposure** - Set the exposure settings to: **+2**, **+1**, **0**(default), **-1** or **-2**.
- **White balance** - Select how the camera adjusts colors in different kinds of light, to achieve the most natural-looking colors:
 -  **Incandescent** - Adjust the white balance for incandescent lighting.
 -  **Fluorescent** - Adjust the white balance for florescent lighting.
 -  **Auto** - Adjust the white balance automatically (default).
 -  **Daylight** - Adjust the white balance for daylight.
 -  **Cloudy** - Adjust the white balance for a cloudy environment.
- **Chroma Flash** - Sets the camera to take two pictures, one with flash and one without flash. The two images are combined to produce a final image with the sharpness and clarity and bright color tones from a picture with the flash, coupled with the natural colors of a picture without a flash. Options: **Off** (default) or **On**.
- **Redeye reduction** - Helps eliminate redeye effect. Options: **Disabled** (default), or **Enable**.
- **Focus mode** - Set the camera focus to **CAF** (Continuous Auto Focus).
- **Focus mode** - Touch to select the camera focus setting. Options: **Auto**, **Infinity**, **Macro** or **CAF** (Continuous Auto Focus) (default). **ZSL** option must be set to **Off**.
- **ZSL** - Set the camera to immediately take a picture when the button is pressed (default – enabled).
- **Anti Banding** - Allows the camera to avoid problems caused by artificial light sources that are not constant. These sources cycle (flicker) fast enough to go unnoticed to the human eye, appearing continuous. The camera's eye (its sensor) can still see this flicker. Options: **Auto** (default), **60 Hz**, **50 Hz**, or **Off**.

Front Camera







- **Selfie Flash** - Turns screen white to help produce a little extra light in dimmer settings. Options: **Off** (default), or **On**.
- **Picture size** - Set the size (in pixels) of the photo to: **5M pixels** (default), **HD720**, **1M pixels**, **WVGA**, **VGA**, or **QVGA**.
- **Picture quality** - Set picture quality setting to: **Low**, **Standard** (default) or **High**.

- **Countdown timer** - Set to: **Off** (default), **2 seconds**, **5 seconds** or **10 seconds**.
- **Storage** – Set location to store the photo to: **Phone** or **SD Card**.
- **Face Detection** - Select to turn face detection **Off** (default) or **On**.
- **ISO** - Set how sensitive the camera is to light. Options: **Auto** (default), **ISO Auto (HJR)**, **ISO100**, **ISO200**, **ISO400**, **ISO800** or **ISO1600**.
- **Exposure** - Touch to adjust the exposure settings. Options: **+2**, **+1**, **0** (default), **-1** or **-2**.
- **White balance** - Select how the camera adjusts colors in different kinds of light, to achieve the most natural-looking colors:
 -  **Incandescent** - Adjust the white balance for incandescent lighting.
 -  **Fluorescent** - Adjust the white balance for florescent lighting.
 -  **Auto** - Adjust the white balance automatically (default).
 -  **Daylight** - Adjust the white balance for daylight.
 -  **Cloudy** - Adjust the white balance for a cloudy environment.
- **Redeye reduction** - Helps eliminate redeye effect. Options: **Disabled** (default), or **Enable**.
- **ZSL** - Set the camera to immediately take a picture when the button is pressed (default – enabled)
- **Selfie Mirror** - Options: **Disable** (default), or **Enable**.
- **Anti Banding** - Allows the camera to avoid problems caused by artificial light sources that are not constant. These sources cycle (flicker) fast enough to go unnoticed to the human eye, appearing continuous. The camera's eye (its sensor) can still see this flicker. Options: **Auto** (default), **60 Hz**, **50 Hz**, or **Off**.





Video Settings

In Video mode, video settings appear on screen. Touch  to display the video settings options.

Rear Camera

- **Flash** - Select whether Rear-facing Camera relies on its light meter to decide whether a flash is necessary, or to turn it on or off for all shots.
 -  **Off** - Disable flash (default).
 -  **Torch** - Turn flash on continuously.
- **Video quality** - Set video quality to: **HD 1080p** (default), **HD 720p**, or **SD 480p**.
- **Video duration** - Set to: **30 seconds (MMS)**, or **30 minutes** (default).
- **Storage** – Set the location to store the photo to: **Phone** (default) or **SD Card**.
- **White balance** - Select how the camera adjusts colors in different kinds of light, to achieve the most natural-looking colors.
 -  **Incandescent** - Adjust the white balance for incandescent lighting.
 -  **Fluorescent** - Adjust the white balance for florescent lighting.
 -  **Auto** - Adjust the white balance automatically (default).
 -  **Daylight** - Adjust the white balance for daylight.
 -  **Cloudy** - Adjust the white balance for a cloudy environment.
- **Image Stabilization** - Set to reduce blurry videos due to device movement. Options: **On** or **Off** (default).

Front Camera

- **Video quality** - Set video quality to: **HD1080HD 720p** (default), **HD720**, or **SD 480p**.
- **Video duration** - Set to: **30 seconds (MMS)** or **30 minutes** (default).
- **Storage** – Set the location to store the photo to: **Phone** (default) or **SD Card**.
- **White balance** - Select how the camera adjusts colors in different kinds of light, to achieve the most natural-looking colors.
 -  **Incandescent** - Adjust the white balance for incandescent lighting.
 -  **Fluorescent** - Adjust the white balance for florescent lighting.
 -  **Auto** - Adjust the white balance automatically (default).
 -  **Daylight** - Adjust the white balance for daylight.
 -  **Cloudy** - Adjust the white balance for a cloudy environment.
- **Image Stabilization** - Set to reduce blurry videos due to device movement. Options: **On** or **Off** (default).

Contacts

Use the **Contacts** app to manage contacts.

From a Home or Apps screen, touch **Contacts** to open to the main list of contacts. Contacts are listed in alphabetical order. Swipe up or down to scroll through the list.

Adding a Contact

1. In the **Contacts** app, touch .
2. If there are more than one account with contacts, touch the one to use.
3. Type the contact's name and other information. Touch a field to start typing, and swipe down to view all categories.
4. To open a menu with preset labels, such as Home or Work for an email address, touch the label to the right of the item of contact information. Or, to create your own label, touch **Custom** in the menu.
5. Touch the check mark next to **Add New Contact**.

Editing Contacts

1. In the **Contacts** app, touch a contact name to edit.
2. Touch .
3. Edit the contact information.
4. Touch **SAVE**.

Deleting Contacts

1. In the **Contacts** app, touch a contact name to delete.
2. Touch .

3. Touch **Delete**.
4. Touch **DELETE** to confirm.

DataWedge Demonstration



NOTE: DataWedge is enabled on the Home screen. To disable this feature, go to the DataWedge settings and disable the **Launcher** profile.

Use **DataWedge Demonstration** to demonstrate data capture functionality.

Figure 35 DataWedge Demonstration Window

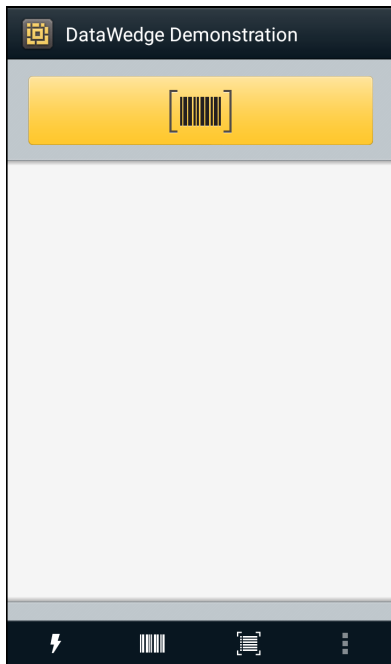

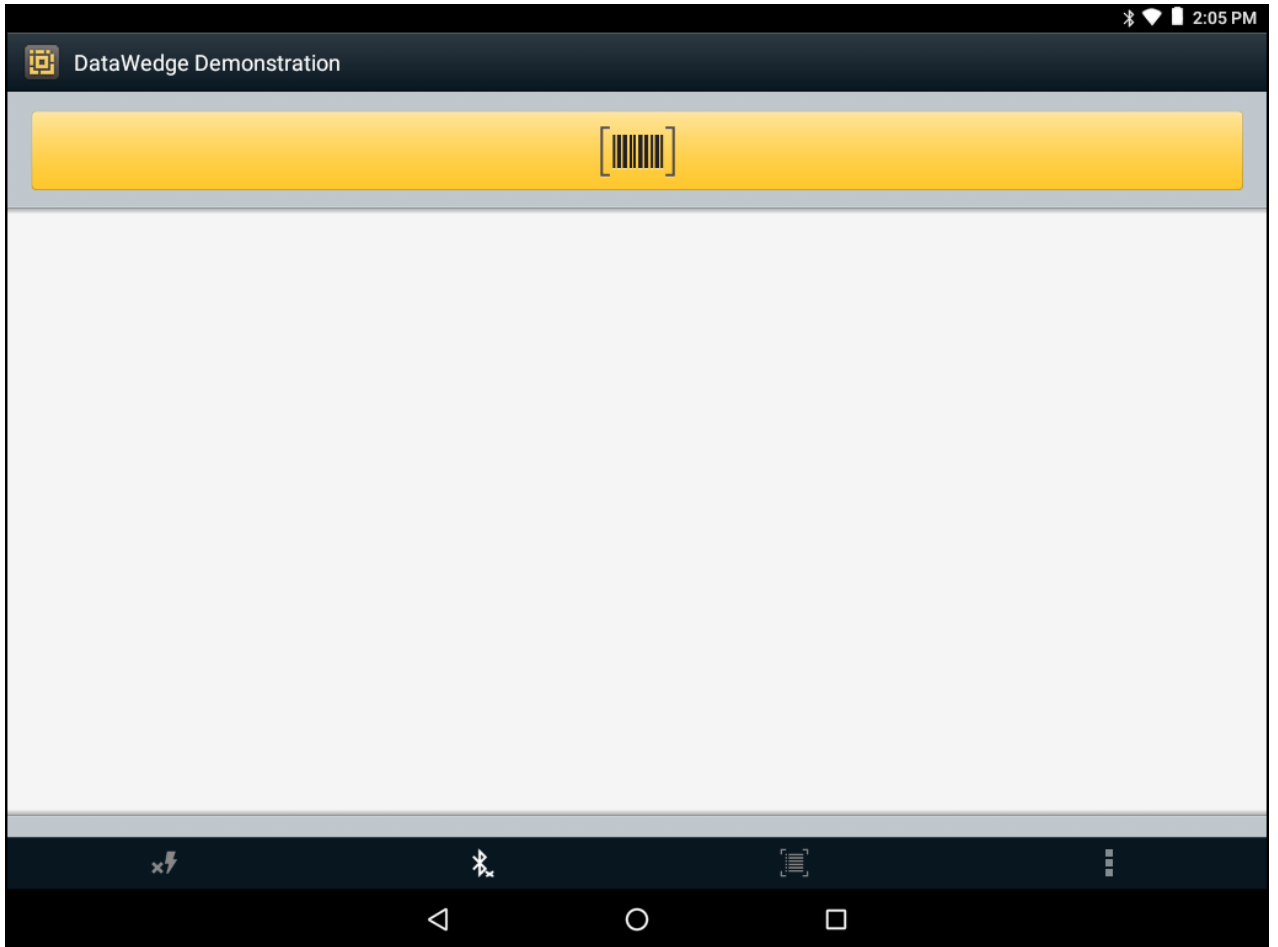

Table 8 *DataWedge Demonstration Icons*











	Icon	Description
Illumination		Imager illumination is on. Touch to turn illumination off.
		Imager illumination is off. Touch to turn illumination on.
Data Capture		The data capture function is through the internal imager.
Data Capture		Indicates a USB scanner is connected to the device.
		Indicates a USB scanner is not connected to the device.

Table 8 *DataWedge Demonstration Icons (Continued)*

	Icon	Description
		An RS507 or RS6000 Bluetooth imagerBluetooth scanner is connected.
		An RS507 or RS6000 Bluetooth imagerBluetooth scanner is not connected.
		The data capture function is through the rear camera.
Scan Mode		Imager is in picklist mode. Touch to change to normal scan mode.
		Imager is in normal scan mode. Touch to change to picklist mode.
		Opens a menu to view the application information or to set the application DataWedge profile.



NOTE: See the device Integrator Guide for Android Version 8.1 for information on DataWedge configuration.

Scanner Selection

To select a scanner, touch  > **Settings** > **Scanner selection**.

Either press the programmable button or touch the yellow scan button to capture data. The data appears in the text field below the yellow button. Touch the Data Capture icon to select the data capture mode.

Press the scanner trigger button or touch the on-screen yellow scan button to capture data. The data appears in the text field below the yellow button.

Diagnostic Tool

The **Diagnostic Tool** is a utility that determines the health of the device. Use the Diagnostic Tool to troubleshoot the device.

1. Swipe up from the bottom of the Home screen and touch .

Figure 36 Diagnostic Tool



2. Touch **RUN TEST**. The app tests all enabled subsystems (by default, only System tests). See [Settings on page 67](#) to enable subsystem tests.

Figure 37 Test Passed Screen

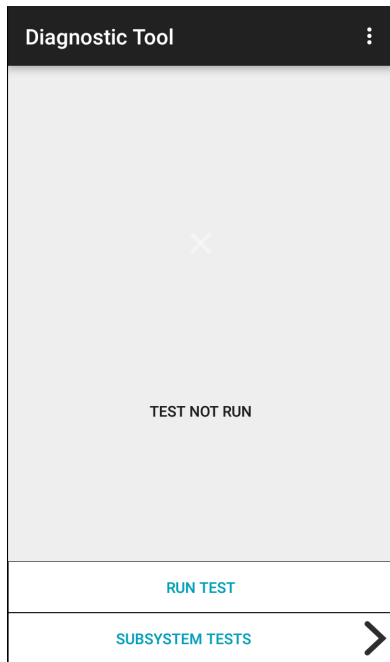
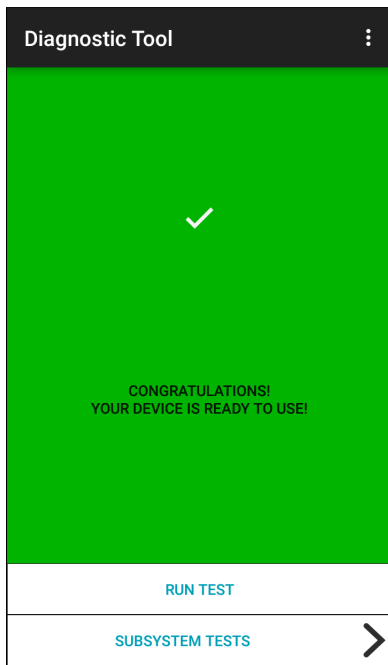
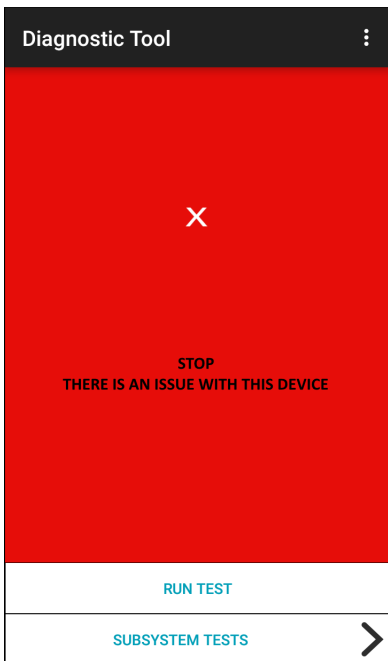

Figure 38 Test Failed Screen



3. To view each subsystem test, touch **Subsystem Tests**.

Figure 39 Subsystem Screen

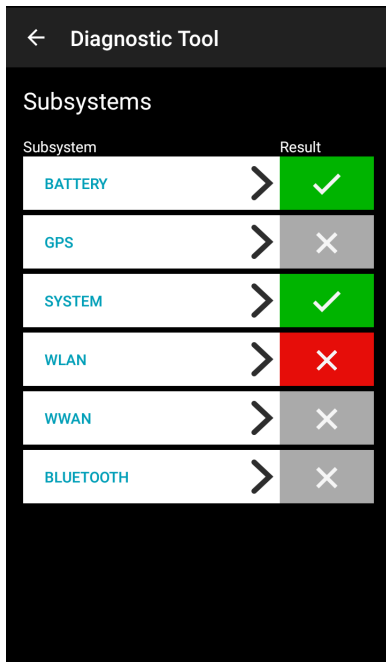



Table 9 Subsystem Test Result Indicators

Status Icon	Description
✓	Test passed.
✗	Test failed.
✗	Test not supported or not enabled.

4. Touch one of the subsystems to view details.

Settings

By default only System tests are enabled. To enable other tests:

1. Touch  > **Settings**.
2. Touch to the left of the test name. A green box with a checkmark appears.
3. Touch **SAVE**.
4. Touch **Yes** to confirm.
5. Touch .

System Test Information

Use the System Test to determine if the CPU or memory loads are too high, there are too many processes running on the device, or storage on the device is almost full.

The System Test obtains the following information:

- **CPU Load** - Amount of CPU being used
- **Free Physical Memory** - Amount of RAM available
- **Free Storage** - Amount of internal Flash memory available
- **Process Count** - Number of processes currently running.

WLAN Test Information

If the WiFi radio is not present or disabled, skip this test. This test determines if the device's WLAN configuration is correct or whether there is any connection with an access point or network.

The WLAN test obtains the following information:

- **WLAN Enabled** - WLAN radio is enabled or disabled
- **WLAN Status** - Current status of association with the access point
- **ESSID** - Name of the wireless network
- **BSSID** - MAC address of the connected access point
- **MAC Address** - Device's MAC address
- **Signal** - Strength of the Wi-Fi signal (in dBm)
- **IP Address** - IP address of the device.

Bluetooth Test Information

The Bluetooth Test obtains the following information:

- **Enabled** - Whether the Bluetooth radio is enabled or disabled
- **Status** - Whether the device is paired to another Bluetooth device
- **Connectable/Discoverable** - Whether the device is discoverable or able to connect
- **Address** - Bluetooth radio MAC address
- **Name** - Bluetooth name for the device.

Files

Use the **Files** app to view and manage files on the device.

To open **Files**, swipe up from the bottom of the screen and touch .

Figure 40 Files Screen



- Touch and hold an item to open the File Operations menu. Select an option:

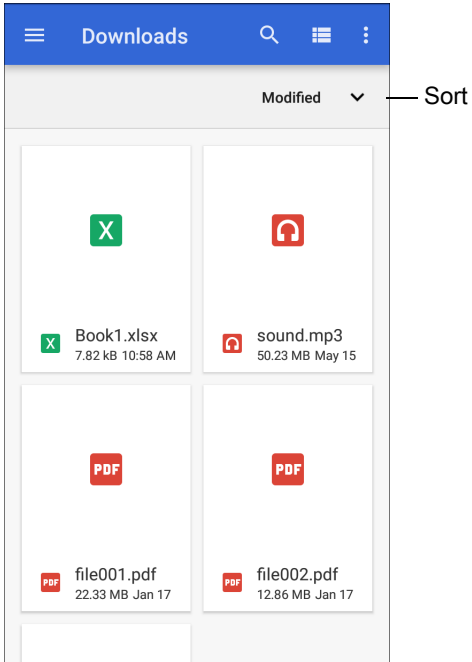
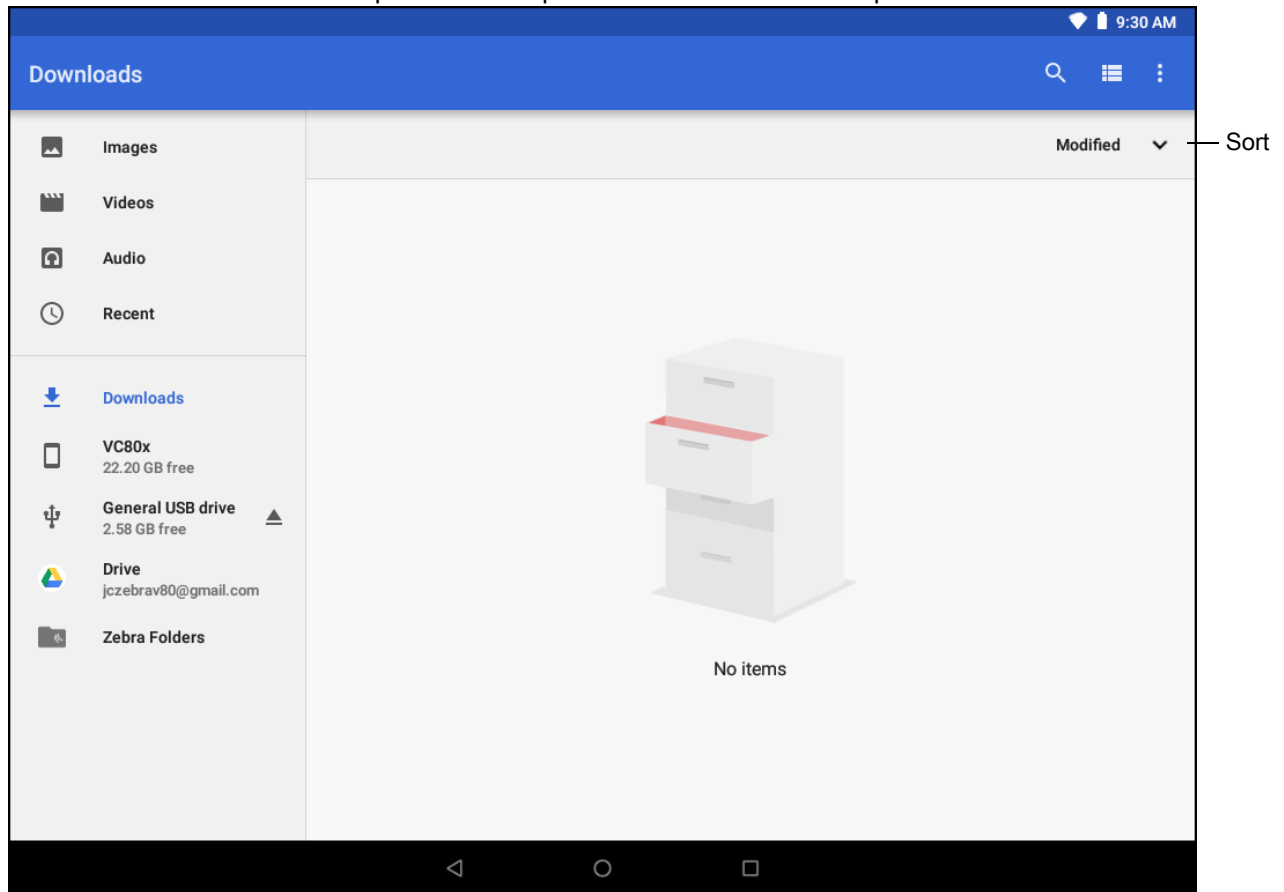

- - Share the file with other devices.
- - Delete the file.
- - View additional options.
 - **Open with** - Select which app is used to open the file.
 - **Select all** - Select all folders and files.
 - **Copy to...** - Copy the file.
 - **Move to...** - Move the file or folder to a new location.
 - **Compress** - Compress the selected file(s) into a ZIP file.
 - **Rename** - Rename the file.
- Touch the Sort drop-down to sort files by name, type, size, or date.
- - View all file locations.
- - Search for a specific file on the device.
- - Change the folder to display items as a list / grid.
- - Open the options menu.
 - **New Window** - Create a new Files window.
 - **New Folder** - Create a new folder.
 - **Select all** - Select all folders and files.
 - **Show/Hide internal storage** - Show or hide internal storage.

Gallery



NOTE: The device supports the following image formats: jpeg, gif, png and bmp.

The device supports the following video formats: H.263, H.264 and MPEG4 Simple Profile.

Available on device with AOSP only.

Use Gallery to:

- View photos
- Play videos
- Perform basic editing of photos
- Set photos as wallpaper
- Set photos as a contact photo
- Share photos and videos.

Gallery presents all photos and videos stored on the microSD card and internal memory.

To open **Gallery**, swipe up from the bottom of the Home screen and touch **Gallery**, or in the camera app touch the thumbnail image at the bottom left.

By default, **Gallery** opens to the **Timeline** view.

Figure 41 Gallery - Timeline View







Touch  > **Albums** to view photos sorted by albums or  > **Videos** to view only videos.

Figure 42 Gallery — Albums View

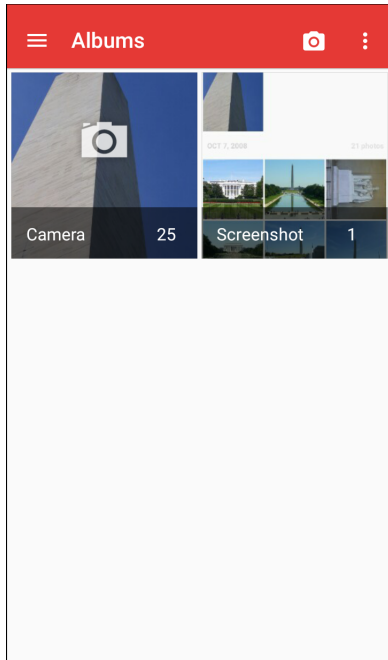

- Touch an album to open it and view its contents. The photos and videos in the album are displayed in chronological order.
- Touch a photo or video in an album to view it.
- Touch  > **Timeline** to return to the default **Gallery** screen.

Working with Albums

Albums are groups of images and videos in folders. Touch an album to open it. The photos and videos are listed in a chronologically ordered grid. The name of the album displays at the top of the screen.

Figure 43 Photos Inside an Album



Swipe up or down to scroll through the images.

Sharing an Album

1. Swipe up from the bottom of the Home screen and touch **Gallery**.
2. Touch and hold an album to highlight it.
3. Touch other albums as required.
4. Touch . The Share menu opens.
5. Touch the app to use to share the selected albums.
6. Follow the instructions within the selected app.

Getting Album Information

1. Swipe up from the bottom of the Home screen and touch **Gallery**.
2. Touch and hold an album to highlight it.
3. Touch .
4. Touch **Details**.

Deleting an Album

To delete an album and its contents:

1. Swipe up from the bottom of the Home screen and touch **Gallery**.
2. Touch and hold an album to highlight it.
3. Check other albums to delete.
4. Touch .
5. In the **Delete selected item?** menu, touch **OK** to delete the album.

Working with Photos

Use **Gallery** to view photos on the device and edit and share photos.

Viewing and Browsing Photos

To view a photo:

1. Swipe up from the bottom of the Home screen and touch **Gallery**.
2. Touch an album to open it.
3. Touch a photo.

Figure 44 Photo Example

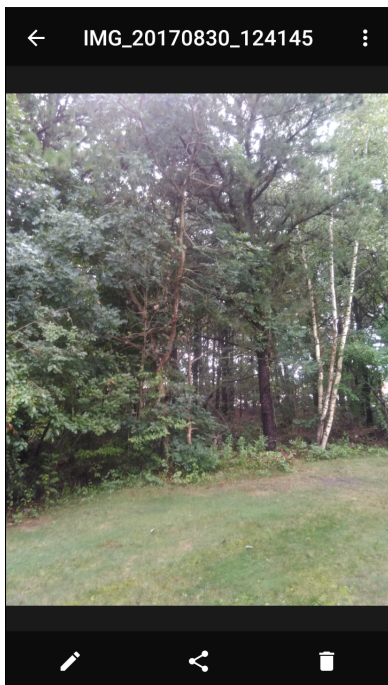

4. Swipe left or right to view the next or previous photo in the album.
5. Turn the device to view the photo in upright (portrait) or sideways (landscape) orientation. The photo is displayed (but not saved) in the new orientation.
6. Touch the photo to view the controls.

7. Double-tap the screen to zoom in or pinch two fingers together or spread them apart to zoom in or out.
8. Drag the photo to view parts that are not in view.

Cropping a Photo





1. In **Gallery**, touch a photo to view the controls.
2. Touch  >  > . The cropping tool appears.
3. Use the cropping tool to select the portion of the photo to crop.
 - Drag from the inside of the cropping tool to move it.
 - Drag an edge of the cropping tool to resize it to any proportion.

Figure 45 Cropping Tool

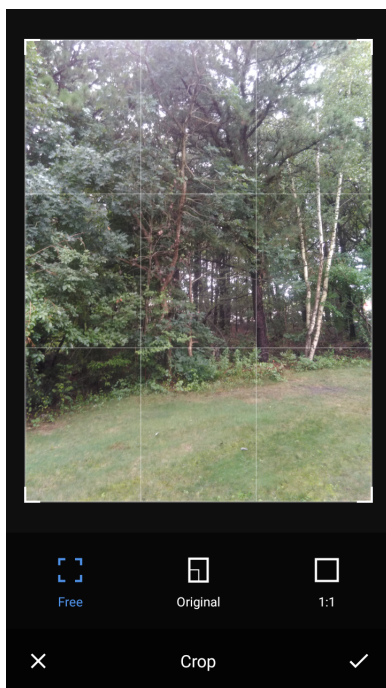

4. Touch  > **SAVE** to save a copy of the cropped photo. The original version is retained.

Setting a Photo as a Contact Icon

1. Swipe up from the bottom of the Home screen and touch **Gallery**.
2. Touch an album to open it.
3. Touch a photo to open it.
4. Touch .
5. Touch **Set picture as**.
6. Touch **Contact photo**.
7. In **Contacts**, touch a contact.
8. Touch the white box and crop the photo accordingly.

9. Touch **SAVE**.

Sharing a Photo

1. Swipe up from the bottom of the Home screen and touch **Gallery**.
2. Touch an album to open it.
3. Touch a photo to open it.
4. Touch .
5. Touch the app to use to share the selected photo.
6. Follow the instructions within the selected app.

Deleting a Photo

1. Swipe up from the bottom of the Home screen and touch **Gallery**.
2. Touch an album to open it.
3. Touch a photo to open it.
4. Touch .
5. Touch **OK** to delete the photo.

Working with Videos

Use **Gallery** to view and share videos.

Watching Videos

1. Swipe up from the bottom of the Home screen and touch **Gallery**.
2. Touch an album to open it.
3. Touch a video.
4. Touch  to play.
5. Touch the screen to view the playback controls.

Sharing a Video

1. Swipe up from the bottom of the Home screen and touch **Gallery**.
2. Touch an album to open it.
3. Touch a video to open it.
4. Touch . The Share menu appears.
5. Touch the app to use to share the selected video.
6. Follow the instructions within the selected app.

Deleting a Video

1. Swipe up from the bottom of the Home screen and touch **Gallery**.
2. Touch an album to open it.
3. Touch a video to open it.
4. Touch .
5. Touch **OK**.

Photos



NOTE: The device supports the following image formats: jpeg, gif, png, and bmp.

The device supports the following video formats: H.263, H.264, and MPEG4 Simple Profile.

Available on device with GMS only.

Use **Photos** to:

- View photos
- Play videos
- Perform basic editing of photos
- Set photos as wallpaper
- Set photos as a contact photo
- Share photos and videos.

Photos presents all photos and videos stored on the microSD card and internal memory.

To open **Photos**, swipe up from the bottom of the Home screen and touch **Photos**.

By default, **Photos** opens to the photos view.

Figure 46 Photos View

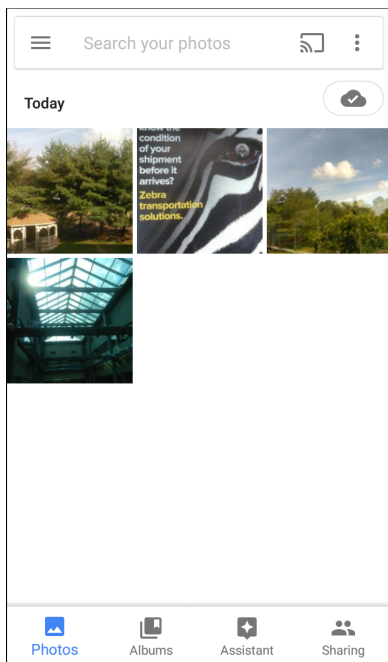

Touch **Albums** to view photos sorted by albums.

Figure 47 Albums View

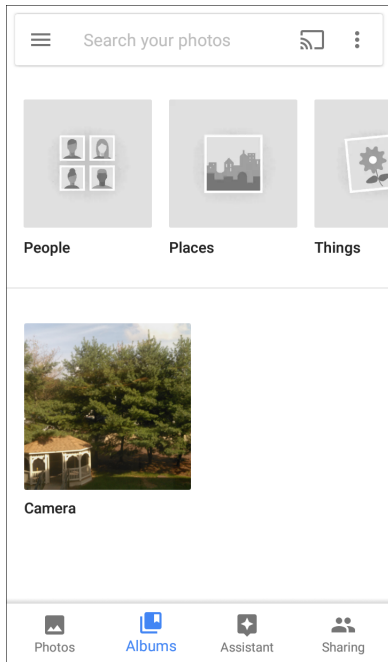

- Touch an album to view its contents. The photos and videos in the album appear in chronological order.
- Touch a photo or video in an album to view it.
- Touch ← to return to the main screen.

Working with Albums

Albums are groups of images and videos in folders. Touch an album to open it. The photos and videos are listed in a chronologically ordered grid. The name of the album displays at the top of the screen.

Figure 48 Photos Inside an Album

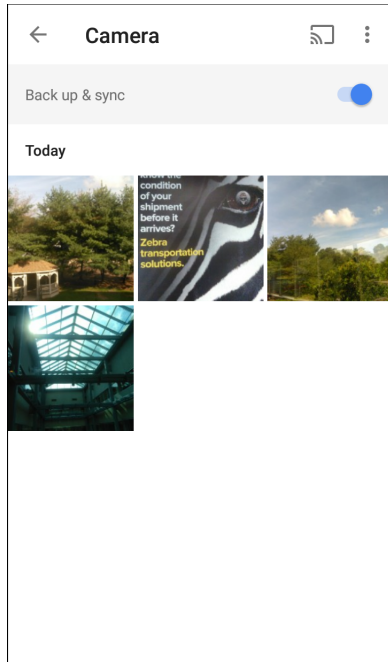

Swipe up to scroll through the images.

Sharing an Album

1. Swipe up from the bottom of the Home screen and touch **Photos**.
2. Touch **Albums**.
3. Touch an album.
4. Touch **⋮** > **Select**.
5. Select all photos in the album.
6. Touch **🔗**. The Share menu opens.
7. Touch an app to share the selected albums.
8. Follow the instructions within the selected app.

Deleting an Album

To delete an album and its contents:

1. Swipe up from the bottom of the Home screen and touch **Photos**.
2. Touch **Albums**.
3. Touch an album.

4. Touch **⋮** > **Select**.
5. Select all photos in the album.
6. Touch **🗑️**.
7. Touch **Move to trash** to delete the album.

Working with Photos

Use **Photos** to view photos on the internal memory and the microSD card.

Viewing and Browsing Photos

1. Swipe up from the bottom of the Home screen and touch **Photos**.
2. Touch a photo.

Figure 49 Photo Example

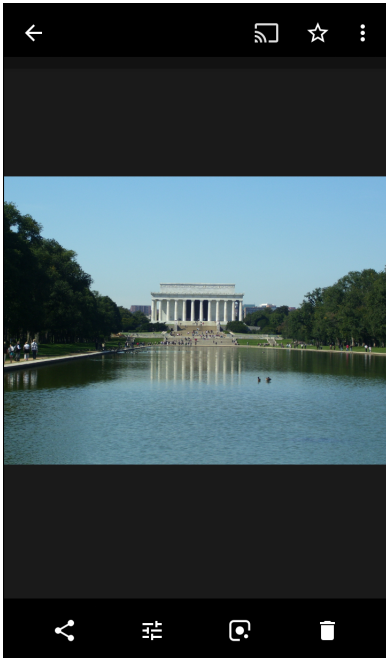

3. Swipe left or right to view the next or previous photo in the album.
4. Turn the device to view the photo in upright (portrait) or sideways (landscape) orientation. The photo is displayed (but not saved) in the new orientation.
5. Touch the photo to view the controls.
6. Double-tap the screen to zoom in, or pinch two fingers together or spread them apart to zoom in or out.
7. Drag the photo to view parts that are not in view.

Cropping a Photo

1. Swipe up from the bottom of the Home screen and touch **Photos**.
2. Touch a photo to view the controls.



3. Touch  > . The cropping tool appears.

Figure 50 Cropping Tool



4. Use the cropping tool to select the portion of the photo to crop.
 - Drag from the inside of the cropping area to move it.
 - Drag an edge of the cropping area to resize it to any proportion.
5. Touch **DONE**.
6. Touch **SAVE** to save a copy of the cropped photo. The original version is retained.

Setting a Photo as a Contact Icon

1. Swipe up from the bottom of the Home screen and touch **Photos**.
2. Touch the photo to open it.
3. Touch  > **Use as**.
4. Touch **Contact photo**.
5. In the **Contacts** app, touch a contact.
6. Touch the white box and crop the photo accordingly.
7. Touch **Done**.

Sharing a Photo

1. Swipe up from the bottom of the Home screen and touch **Photos**.
2. Touch an album to open it.
3. Touch a photo to open it.

4. Touch .
5. Touch the app to use to share the selected photo.
6. Follow the instructions within the selected app.

Deleting a Photo

1. Swipe up from the bottom of the Home screen and touch **Photos**.
2. Touch a photo to open it.
3. Touch .
4. Touch **MOVE TO TRASH**.

Working with Videos

Use **Photos** to view and share videos.

Watching a Video

1. Swipe up from the bottom of the Home screen and touch **Photos**.
2. Touch a video to play.
3. Touch the screen to view the playback controls.

Sharing a Video

1. Swipe up from the bottom of the Home screen and touch **Photos**.
2. Touch a video to open it.
3. Touch . The Share menu appears.
4. Touch the app to use to share the selected video.
5. Follow the instructions within the selected app.

Deleting a Video

1. Swipe up from the bottom of the Home screen and touch **Photos**.
2. Touch a video to open it.
3. Touch .
4. Touch **MOVE TO TRASH** to delete the video.

PTT Express Voice Client



NOTE: PTT Express Voice Client enables Push-To-Talk (PTT) communication between disparate enterprise devices. Leveraging existing Wireless Local Area Network (WLAN) infrastructure, PTT Express delivers simple PTT communication without requiring voice communication server.

- **Group Call:** Press and hold the PTT (Talk) button to start communicating with other voice client users.
- **Private Response:** Double-press the PTT button to respond to the originator of the last broadcast or to make a Private Response.

PTT Express User Interface

Figure 51 PTT Express Default User Interface

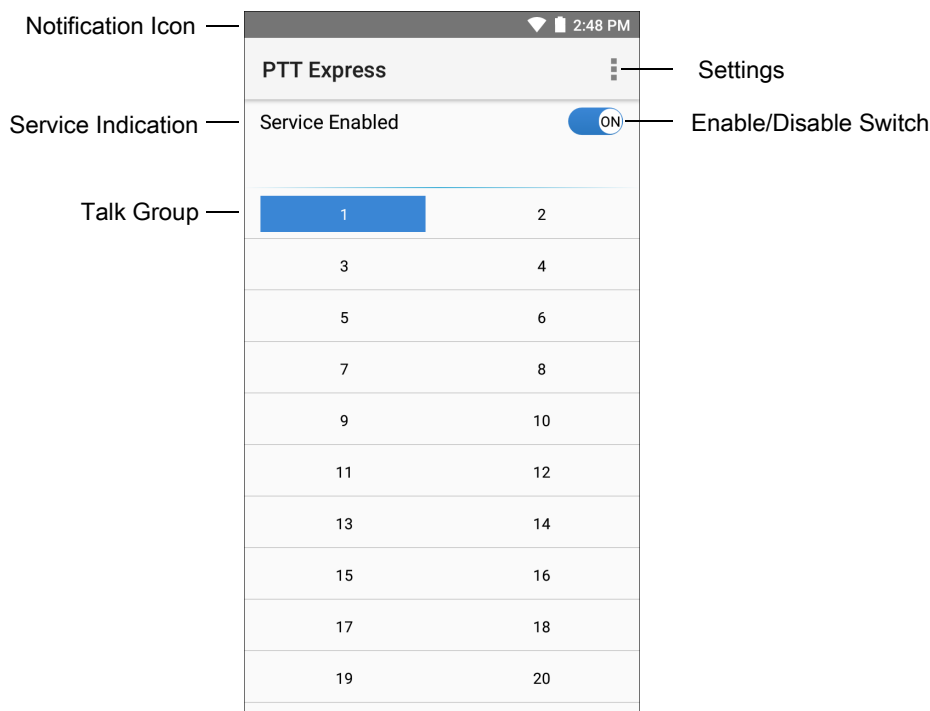

Table 10 PTT Express Default User Interface Descriptions

Item	Description
Notification Icon	Indicates the current state of the PTT Express client.
Service Indication	Indicates the status of the PTT Express client. Options: Service Enabled , Service Disabled or Service Unavailable .
Talk Groups	Lists all 32 Talk Groups available for PTT communication.
Settings	Opens the PTT Express Settings screen.
Enable/Disable Switch	Turns the PTT service on and off.

PTT Audible Indicators







The following tones provide helpful cues when using the voice client.

- **Talk Tone:** Double chirp. Plays when the Talk button is depressed. This is a prompt for the user to start talking.
- **Access Tone:** Single beep. Plays when another user just finished a broadcast or response. The user is now able to initiate a Group Broadcast or Private Response.
- **Busy Tone:** Continuous tone. Plays when the Talk button is depressed and another user is already communicating on the same talkgroup. Plays after the maximum allowed talk time is reached (60 seconds).
- **Network Tone:**
 - Three increasing pitch beeps. Plays when PTT Express acquires the WLAN connection and the service is enabled.
 - Three decreasing pitch beeps. Plays when PTT Express loses the WLAN connection or the service is disabled.

PTT Notification Icons

Notification icons indicate the current state of the PTT Express Voice client.

Table 11 PTT Express Icon Descriptions

Status Icon	Description
	The PTT Express Voice client is disabled.
	The PTT Express Voice client is enabled but not connected to a WLAN.
	The PTT Express Voice client is enabled, connected to a WLAN, and listening on the Talk Group indicated by the number next to the icon.
	The PTT Express Voice client is enabled, connected to a WLAN, and communicating on the Talk Group indicated by the number next to the icon.
	The PTT Express Voice client is enabled, connected to a WLAN, and in a private response.
	The PTT Express Voice client is enabled and muted.
	The PTT Express Voice client is enabled but it is not able to communicate due to a VoIP telephony call in progress.

Enabling PTT Communication

1. Swipe up from the bottom of the Home screen and touch .

2. Slide the **Enable/Disable Switch** to the **ON** position. The button changes to **ON**.

Selecting a Talk Group

One of 32 Talk Groups can be selected by PTT Express users. However, only one talk group may be enabled at a time on the device. Touch one of the 32 Talk Groups. The selected Talk Group is highlighted.

Creating a Group Call

1. Press and hold the PTT button (or the Talk button on the headset) and listen for the talk tone.
If you hear a busy tone, release the button and wait a moment before making another attempt. Ensure that PTT Express and the WLAN are enabled.
2. Start talking after hearing the talk tone.





NOTE: Holding the button for more than 60 seconds (default) drops the call, allowing others to make Group calls. Release the button when finished talking to allow others to make calls.

Responding with a Private Response

The Private Response can only be initiated once a Group Call has been established. The initial Private Response is made to the originator of the Group Call.

1. Wait for an access tone.
2. Within 10 seconds, double-press the PTT button, and listen for the talk tone.
3. If you hear a busy tone, release the button and wait a moment before making another attempt. Ensure that PTT Express and the WLAN are enabled.
4. Start talking after the talk tone plays.
5. Release the button when finished talking.

Disabling PTT Communication

1. Swipe up from the bottom of the Home screen and touch .
2. Slide the **Enable/Disable Switch** to the **OFF** position. The button changes to **OFF**.
3. Touch .

RxLogger

RxLogger is a comprehensive diagnostic tool that provides app and system metrics. Create custom plug-ins that work seamlessly with this tool. RxLogger diagnoses device and application issues, and tracks information for: CPU load, memory load, memory snapshots, power states, wireless logging, cellular logging, TCP dumps, Bluetooth logging, logcat, ANR dumps, etc. All logs and files generated are saved in flash storage on the device (internal or external).

Figure 52 RxLogger



RxLogger Utility

RxLogger Utility is a data monitoring application for viewing logs in the device while RxLogger is running. Access the logs and RxLogger Utility features in the App View or the Overlay View.

In the App View, view logs in the RxLogger Utility.

Figure 53 RxLogger Utility App View

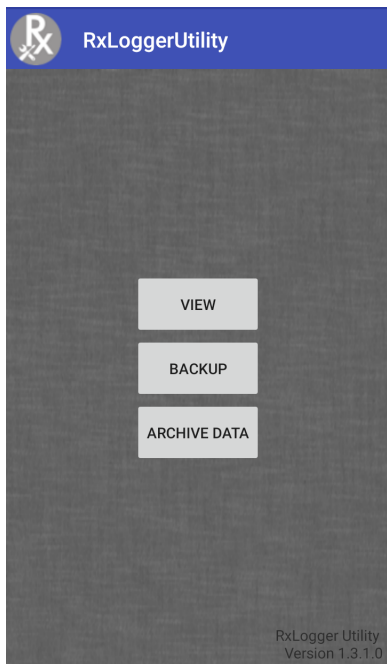

Refer to the device Integrator Guide for detailed information on the RxLogger Utility.

Sound Recorder

Use **Sound Recorder** to record audio messages.

Recordings are saved on the microSD card (if installed) or the internal storage and are available in the Music application (non-GMS devices) or the Play Music application (GMS devices).

Figure 54 Sound Recorder Application

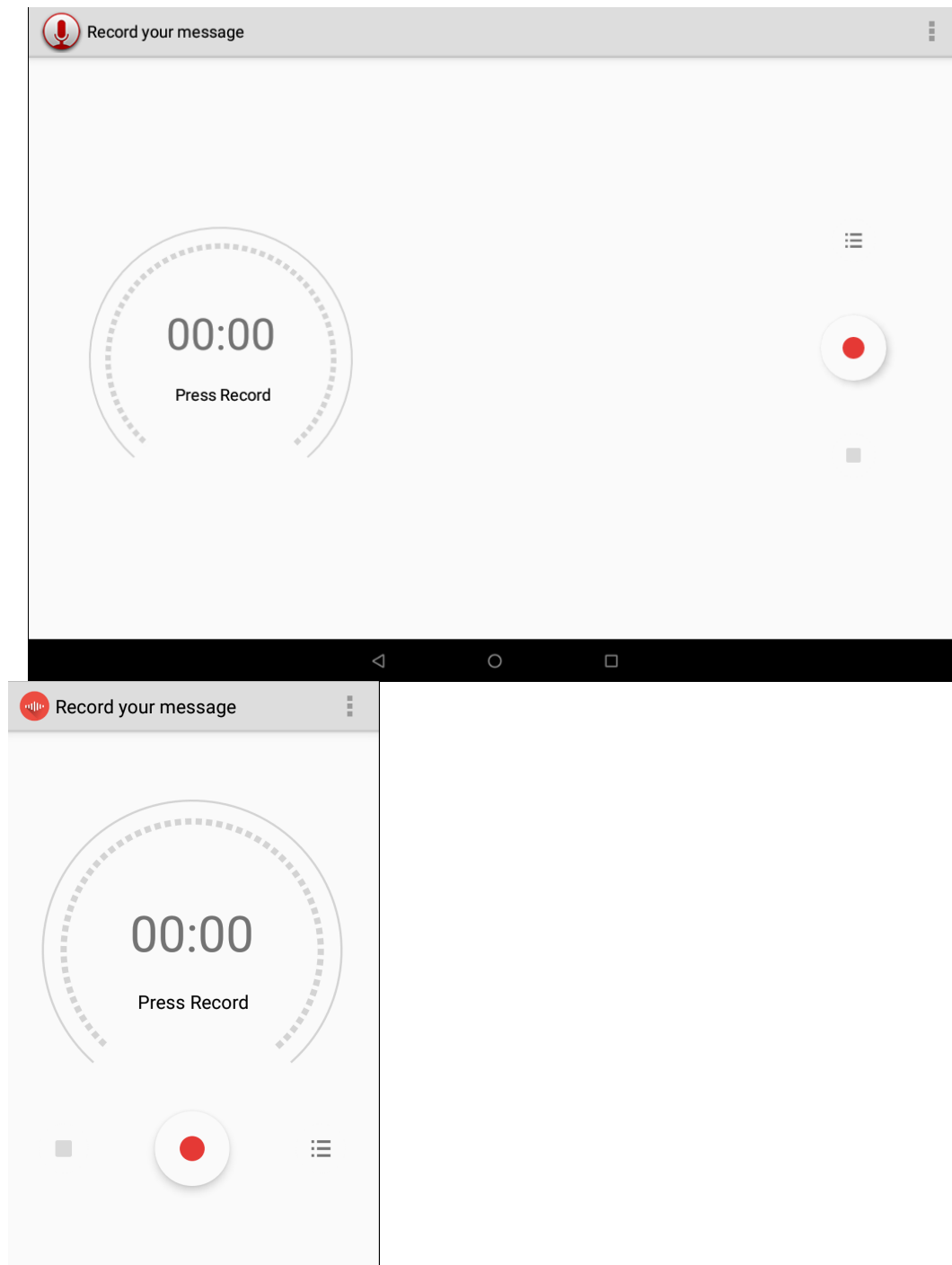

Touch  to open options menu.

- **File type** - Select the file type for the recording file.
 - AMR
 - 3GPP
 - AAC
 - WAV
 - AMR-WR
 - AMR-WB-3GPP.
- **Storage location** - Select the location for the recording file.
 - Phone storage
 - SD card.

Data Capture

Introduction

The device supports data capture using:

- Integrated Imager
- Integrated Camera
- DS2278 Digital Scanner
- DS2208 Digital Scanner
- DS8178 Digital Scanner
- DS8108 Digital Scanner.

Integrated Imager

The device with an integrated 2D imager has the following features:

- Omnidirectional reading of a variety of barcode symbologies, including the most popular linear, postal, PDF417, Digimarc, and 2D matrix code types.
- The ability to capture and download images to a host for a variety of imaging applications.
- Advanced intuitive laser aiming cross-hair and dot aiming for easy point-and-shoot operation.

The imager uses imaging technology to take a picture of a barcode, stores the resulting image in memory, and executes state-of-the-art software decoding algorithms to extract the barcode data from the image.

Operational Modes

The device with an integrated imager supports two modes of operation, listed below. Activate each mode by pressing the Scan button.

- Decode mode - The device attempts to locate and decode enabled barcodes within its field of view. The imager remains in this mode as long as the user holds the scan button, or until it decodes a barcode.



NOTE: To enable Pick List Mode, configure in DataWedge or set in an application using a API command.

- Pick List mode - Selectively decode a barcode when more than one barcode is in the device's field of view by moving the aiming crosshair or dot over the required barcode. Use this feature for pick

lists containing multiple barcodes and manufacturing or transport labels containing more than one barcode type (either 1D or 2D).

Digital Camera

The device with an integrated camera based barcode scanning solution has the following features:

- Omnidirectional reading of a variety of barcode symbologies, including the most popular linear, postal, QR, PDF417, and 2D matrix code types.
- Cross-hair reticle for easy point-and-shoot operation.
- Picklist mode to decode a particular barcode from many in the field of view.

The solution uses the advanced camera technology to take a digital picture of a barcode, and executes state-of-the-art software decoding algorithms to extract the data from the image.

Scanning Considerations

Typically, scanning is a simple matter of aim, scan, and decode, with a few quick trial efforts to master it. However, consider the following to optimize scanning performance:

- **Range:** Scanners decode best over a particular working range — minimum and maximum distances from the barcode. This range varies according to barcode density and scanning device optics. Scan within range for quick and constant decodes; scanning too close or too far away prevents decodes. Move the scanner closer and further away to find the right working range for the barcodes being scanned.
- **Angle:** Scanning angle is important for quick decodes. When laser beams reflect directly back into the scanner from the barcode, this specular reflection can blind the scanner. To avoid this, scan the barcode so that the beam does not bounce directly back. Do not scan at too sharp an angle; the scanner needs to collect scattered reflections from the scan to make a successful decode. Practice quickly shows what tolerances to work within.
- Hold the device farther away for larger symbols.
- Move the device closer for symbols with bars that are close together.



NOTE: Scanning procedures depend on the app and device configuration. An app may use different scanning procedures from the one listed above.

Scanning with the Internal Imager



IMPORTANT: To read a barcode, a scan-enabled app is required on the device.

The device contains the DataWedge app that allows the user to enable the imager, decode the barcode data, and display the barcode content.

To scan a barcode using the DataWedge app:



1. Swipe up from the bottom of the screen to display the **App** screen.
2. Touch  to open the DataWedge Demonstration app.
3. Touch  to turn on the red decode illumination.
4. Present a barcode. Use the LED dot within the illumination to position the barcode in the correct field of view. (The aiming dot increases visibility in bright lighting conditions.)

Figure 64 Correct and Incorrect Scanning

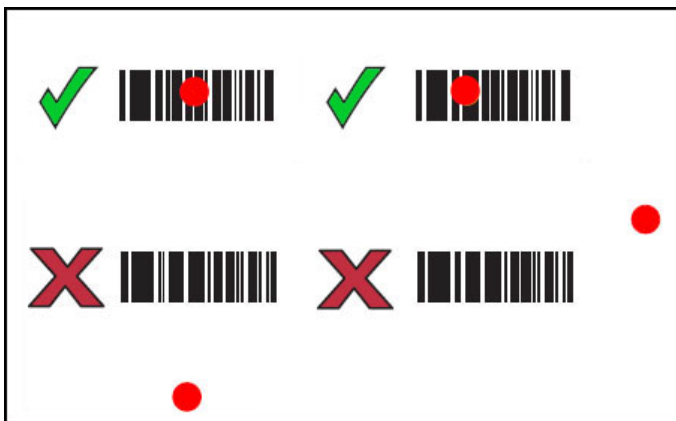

Figure 65 Pick List Mode with Multiple Barcodes



NOTE: When the device is in Picklist mode, the imager does not decode the barcode until the aiming dot touches the barcode.

- The barcode content data displays in the **DataWedge Presentation** screen field.

Figure 66 DataWedge Presentation Screen

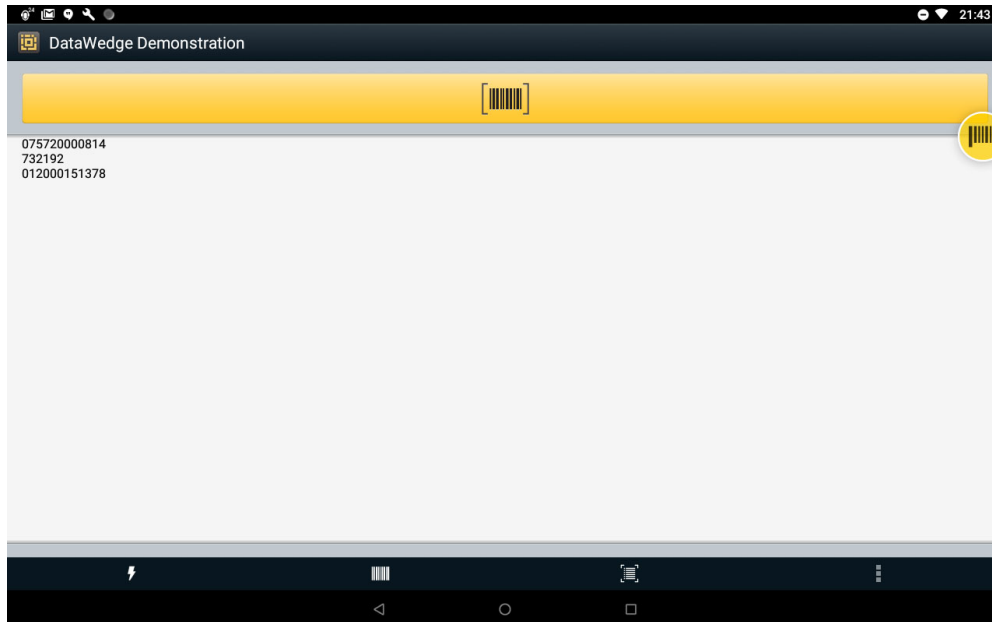

Scanning with Integrated Camera

To capture bar code data:



NOTE: When capturing bar code data in poor lighting, turn on Illumination mode in the DataWedge app. See the device Integrator Guide for detailed information on configuring DataWedge.

- Ensure that an app is open on the device and a text field is in focus (text cursor in text field).
- Aim the camera at a bar code.
- Press and hold the Scan button. By default, a preview window appears on the screen. The Decode light emitting diode (LED) lights red to indicate that data capture is in process.



NOTE: When Picklist mode is enabled, move the device until the bar code is centered under the red target on the screen.

- Move the device until the bar code is visible on the screen.
- The Decode LED lights green, a beep sounds and the device vibrates, by default, to indicate the bar code was decoded successfully.
- The captured data appears in the text field.

Scanning with the DS2208 Corded Scanner

The DS2208 digital scanner is in hands-free (presentation) mode when it is placed in the gooseneck Intellistand. In this mode, the digital scanner operates in continuous (constant-on) mode, where it automatically decodes a bar code presented in its field of view.

When the digital scanner is not used for a user-definable period of time, it enters a low power mode in which the LEDs are turned off or illumination blinks at a low duty cycle until the digital scanner detects an image change (e.g. motion).

To scan with the DS2208:

1. Place the aiming pattern over the bar code. See [DS22X8 Aiming on page 109](#).

Figure 67 DS2208 Aiming Pattern on Bar Code

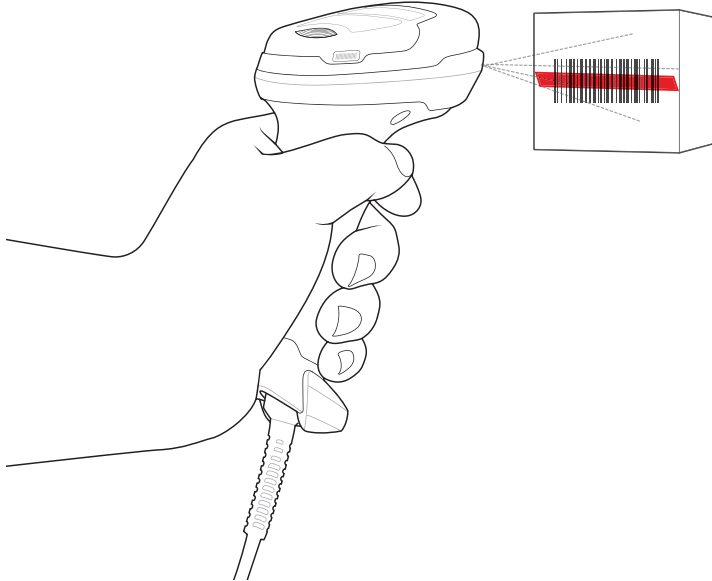

2. Press and hold the trigger until either:
 - a. The digital scanner reads the bar code. The digital scanner beeps, the LED flashes, and the scan line turns off.
 - or
 - b. The digital scanner does not read the bar code and the scan line turns off.
3. Release the trigger.
4. The captured data appears in the text field.

Scanning with the DS2278 Cordless Scanner

2D bar codes have made their way to the Point of Sale (POS), appearing on everything from customer purchased items to printed and electronic coupons and loyalty cards. 1D scanners cannot capture the new 2D codes, leading to exceptions that slow down the check-out process. The DS2278 digital imager scanner scans both 1D and 2D bar codes and does not compromise performance or features.

Hand-Held Scanning

To scan with the DS2278:

1. Pair the DS2278 with the device. See [Pairing a Bluetooth Scanner on page 117](#) for more information.
2. Ensure that an app is open on the device and a text field is in focus (text cursor in text field).

3. Point the DS2278 at a barcode.

Figure 68 DS2278 Aiming Pattern on Bar Code - Hand-Held Mode

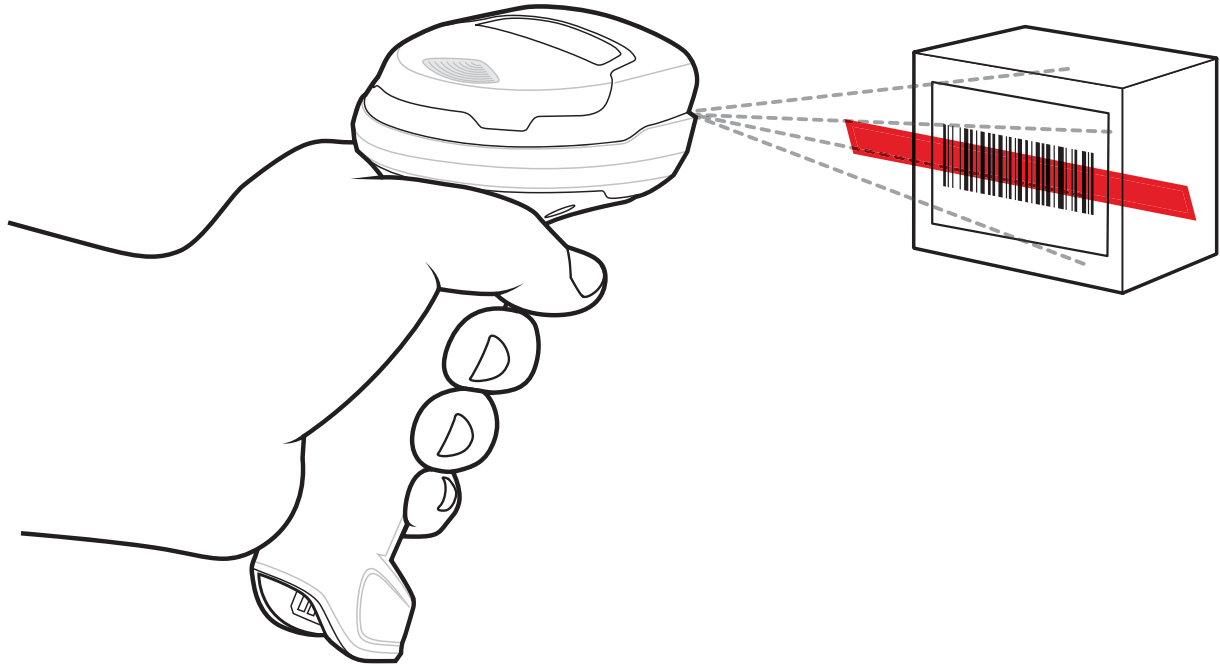

4. Press and hold the trigger until either:
 - a. The digital scanner reads the bar code. The digital scanner beeps, the LED flashes, and the scan line turns off.
 - or
 - b. The digital scanner does not read the bar code and the scan line turns off.
5. Release the trigger.
6. The captured data appears in the text field.

Hands-Free Scanning

The digital scanner is in hands-free (presentation) mode when it sits in the CR2278-PC cradle. During idle conditions the digital scanner operates in object detection mode, where it automatically wakes up to decode a bar code presented in the field of view. In object detection mode it is normal for the illumination LEDs to be dimly lit.

To scan:

1. Pair the cradle with the device. See [Pairing a Bluetooth Scanner on page 117](#) for more information.
2. Ensure that an app is open on the device and a text field is in focus (text cursor in text field).
3. Ensure all connections are secure (see appropriate host chapter).

- Point the DS2278 at a barcode.

Figure 69 DS2278 Aiming Pattern on Bar Code - Hands-Free Mode

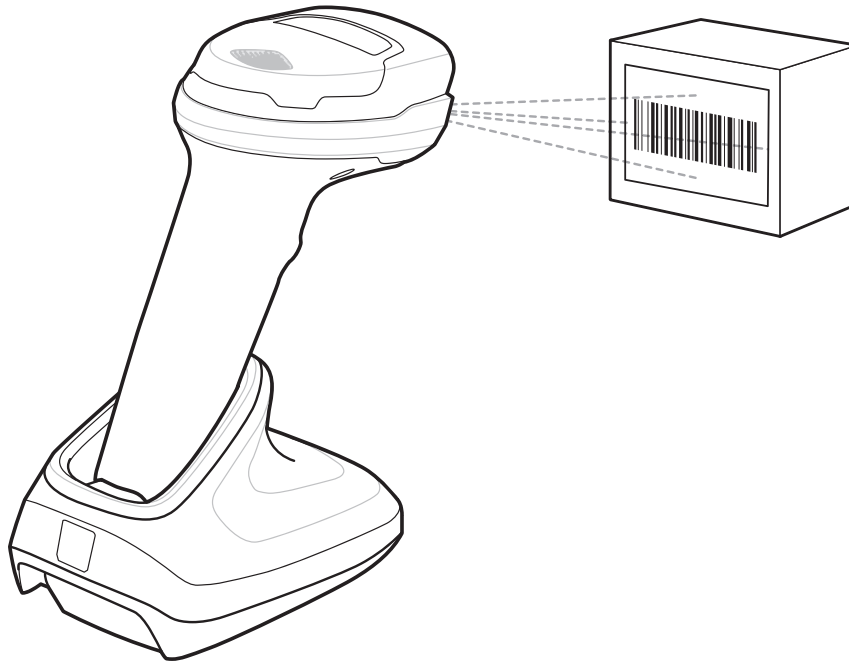

- Upon successful decode, the digital scanner beeps and the LED flashes green. See the Product Reference Guide for more information about beeper and LED definitions.
- The captured data appears in the text field.

DS22X8 Aiming

When scanning, the digital scanner projects a red scan line which allows positioning the bar code within its field of view, omnidirectionally.

Figure 70 Scanning Orientation with Aiming Line



The aiming line is smaller when the digital scanner is closer to the symbol and larger when it is farther from the symbol. Scan symbols with smaller bars or elements (mil size) closer to the digital scanner, and those with larger bars or elements (mil size) farther from the digital scanner.

The digital scanner beeps to indicate that it successfully decoded the bar code. For more information on beeper and LED definitions, refer to the Product Reference Guide.

Scanning with the DS8108 Corded Scanner

The DS8108 digital scanner is in Hands-free (presentation) mode when it is placed in the Intellistand. In this mode, the digital scanner operates in continuous (constant-on) mode, where it automatically decodes a bar code presented in its field of view.

When the digital scanner is not used for a user-definable period of time, it enters a low power mode in which the LEDs are turned off or illumination blinks at a low duty cycle until the digital scanner detects an image change (e.g. motion).

To scan with the DS8108:

1. Place the aiming dot over the bar code. See [DS81X8 Aiming](#) below.

Figure 71 DS8108 Aiming Dot on Bar Code

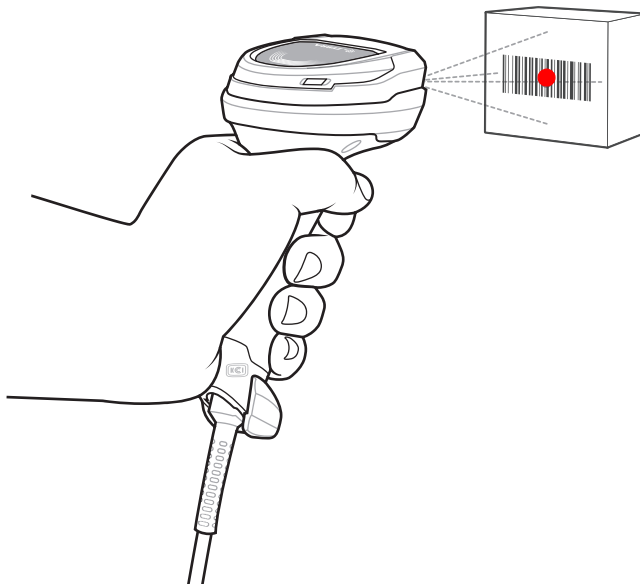

2. Press and hold the trigger until either:
 - a. The digital scanner reads the bar code. The digital scanner beeps, the LED flashes, and the scan line turns off.
 - or
 - b. The digital scanner does not read the bar code and the scan line turns off.
3. Release the trigger.

Scanning with the DS8178 Bluetooth Scanner



NOTE: The standard digital scanner emits a red illumination with a red aim dot. The Healthcare configuration emits a white illumination with a green aim dot.

Hand-Held Scanning

1. Aim the digital scanner at a barcode and pull the trigger to decode.

Figure 72 DS8178 Aiming Dot on Barcode - Hand-Held Mode

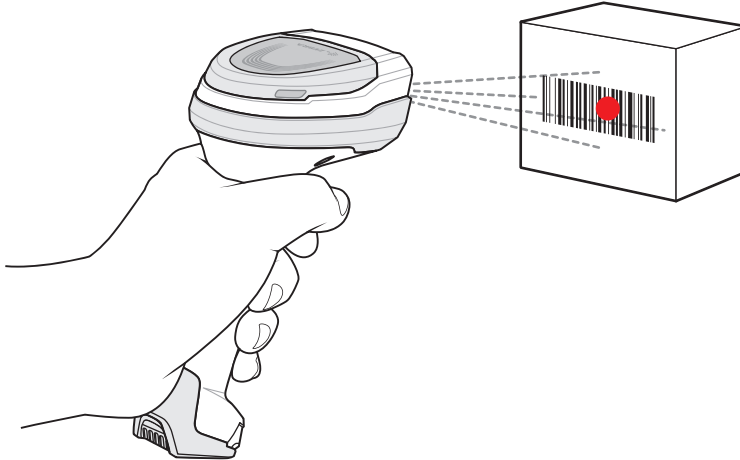

2. Press the trigger until the digital scanner beeps, indicating the bar code is successfully decoded. Refer to the Product Reference Guide for more information on beeper and LED definitions.
3. The captured data appears in the text field.

Hands-Free Scanning

The scanner is in hands-free (presentation) mode when it sits in the CR8178-PC cradle. During idle conditions the scanner operates in object detection mode, where it automatically wakes up to decode a bar code presented in the field of view. In object detection mode it is normal for the illumination LEDs to be dimly lit.

To scan:

1. Pair the DS8178 with the device. See [Pairing a Bluetooth Scanner on page 117](#) for more information.
2. Ensure that an app is open on the device and a text field is in focus (text cursor in text field).
3. Ensure all connections are secure.
4. Point the DS8178 at a barcode.

Figure 73 DS8178 Aiming Dot on Bar Code - Hands-Free Mode

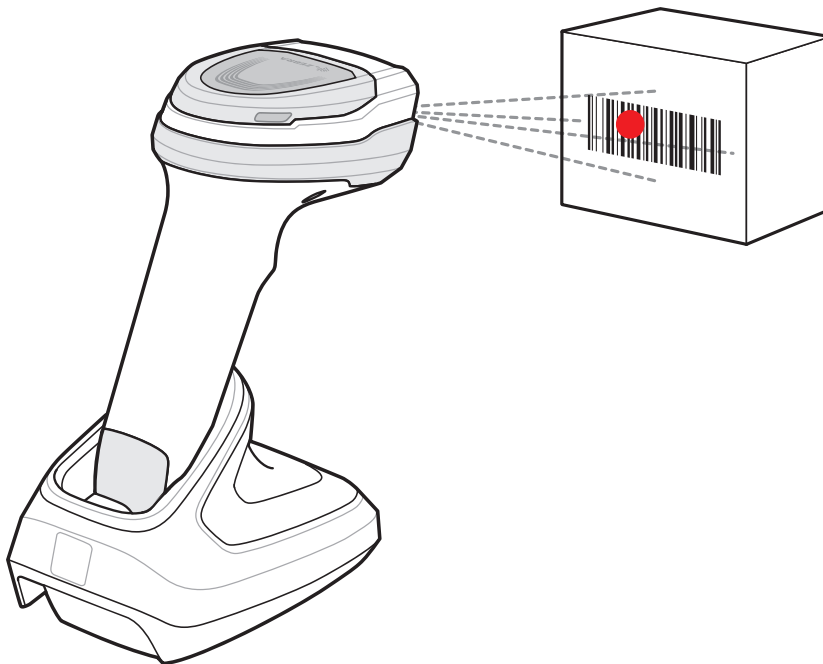

5. Upon successful decode, the scanner beeps and the LED flashes green. Refer to the Product Reference Guide for more information about beeper and LED definitions.
6. The captured data appears in the text field.

DS81X8 Aiming

When scanning, the digital scanner projects a red LED dot which allows positioning the bar code within its field of view.

To scan a bar code, center the symbol and ensure the entire symbol is within the rectangular area formed by the illumination LEDs.

The digital scanner can also read a bar code presented within the aiming dot not centered. The top examples in [Figure 75](#) show acceptable aiming options, while the bottom examples can not be decoded.

Figure 74 Scanning Orientation with Aiming Dot

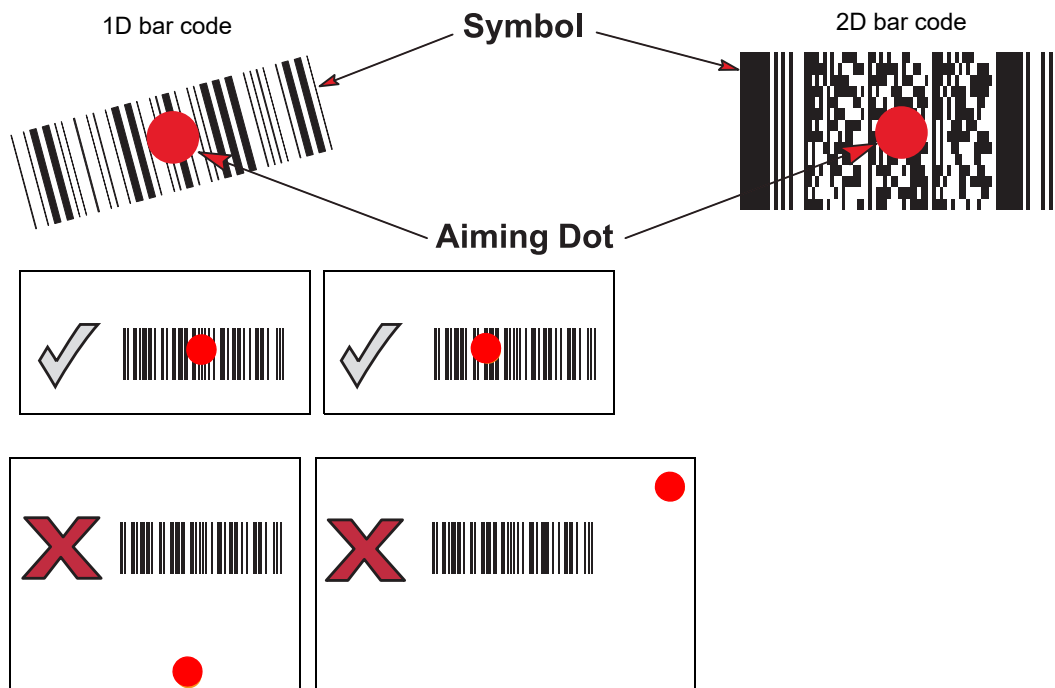

The aiming dot is smaller when the digital scanner is closer to the symbol and larger when it is farther from the symbol. Scan symbols with smaller bars or elements (mil size) closer to the digital scanner, and those with larger bars or elements (mil size) farther from the digital scanner.

The digital scanner beeps to indicate that it successfully decoded the bar code. Refer to the Product Reference Guide for more information.

Pairing Using Near Field Communication

The device provides the ability to pair the imagers using NFC.

To pair using NFC:

1. Ensure that the imager is in SSI mode. Refer to the imager Product Reference Guide for more information.
2. Ensure that NFC is enabled on the device.
3. Align the NFC icon on the RS6000 with the NFC antenna on the device.

The RS6000 Status LED blinks blue indicating that the RS6000 is attempting to establish connection with the device. When connection is established, the Status LED turns off and the RS6000 emits a single string of low/high beeps.

A notification appears on the Notification panel and the  icon appears in the Status bar.

Pairing in HID Mode Using Near Field Communication (CC6000 Only)

The device provides the ability to pair the CC6000 in HID mode using NFC.



NOTE: CC6000 Only.

To pair in HID mode using NFC:

1. Ensure that NFC is enabled on the device.
2. Ensure that Bluetooth is enabled on the device.
3. Place the RS6000 in Human Interface Device (HID) mode. If the RS6000 is already in HID mode, skip to step 4.
 - a. Remove the battery from the RS6000.
 - b. Press and hold the Restore key.
 - c. Install the battery onto the RS6000.
 - d. Keep holding the Restore key for about five seconds until a chirp is heard and the Scan LEDs flash green.
 - e. Scan the barcode below to place the RS6000 in HID mode.

Figure 75 RS6000 Bluetooth HID Barcode

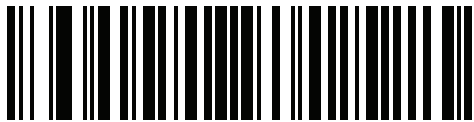

4. Remove the battery from the RS6000.
5. Re-install the battery into the RS6000.
6. Align the NFC icon on the RS6000 with the NFC antenna on the device.

The RS6000 Status LED blinks blue indicating that the RS6000 is attempting to establish connection with the device. When connection is established, the Status LED turns off and the RS6000 emits a single string of low/high beeps.

A notification appears on Notification panel and the **A** icon appears in the Status bar.

Figure 76 Align NFC Antennas

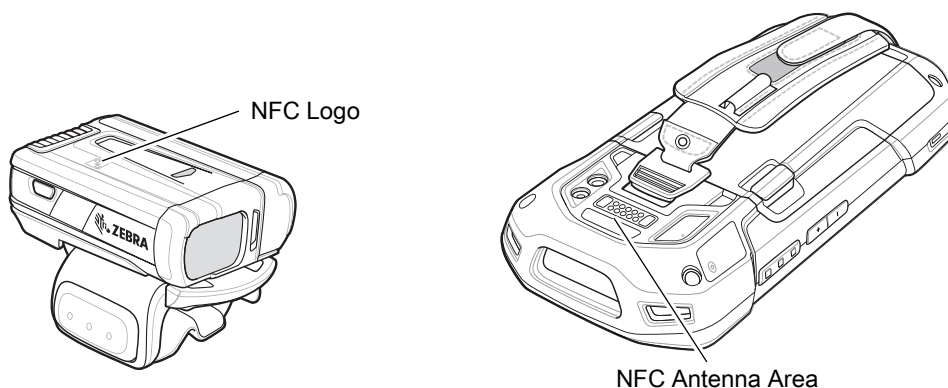

Pairing Using Simple Serial Interface

To pair the RS507/RS507X or RS6000 with the device using SSI.

1. Swipe up from the bottom of the Home screen and touch .

Figure 77 Bluetooth Pairing Utility



2. Using the RS507/RS507X or RS6000, scan the barcode on the screen.

The RS507/RS507X or RS6000 emits a string of high/low/high/low beeps. The Scan LED flashes green indicating that the RS507/RS507X or RS6000 is attempting to establish connection with the device. When connection is established, the Scan LED turns off and the RS507/RS507X or RS6000 emits one string of low/high beeps.

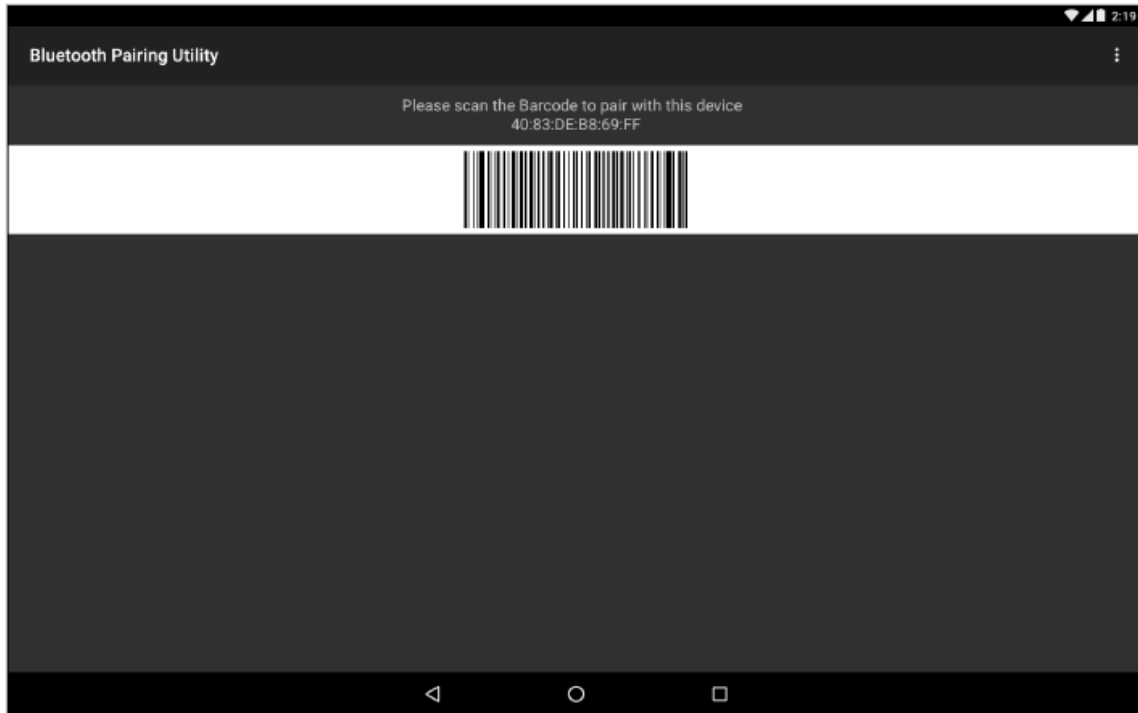
A notification appears on the Notification panel and the  icon appears in the Status bar.

Pairing Using Bluetooth Human Interface Device

To pair the RS507/RS507X or RS6000 with the device using Human Interface Device (HID):

1. Ensure that Bluetooth is enabled on both devices.
2. Ensure that the Bluetooth device to discover is in discoverable mode.
3. Ensure that the two devices are within 10 meters (32.8 feet) of one another.
4. Place the RS507/RS507X or RS6000 in HID mode. If the RS507/RS507X or RS6000 is already in HID mode, skip to step 5.
 - a. Remove the battery from the RS507/RS507X or RS6000.

- b. Press and hold the Restore key.
- c. Install the battery onto the RS507/RS507X or RS6000.
- d. Keep holding the Restore key for about five seconds until a chirp is heard and the Scan LEDs flash green.
- e. Scan the barcode below to place the RS507/RS507X or RS6000 in HID mode.

Figure 78 RS507 Bluetooth HID Barcode



Figure 79 RS6000 Bluetooth HID Barcode

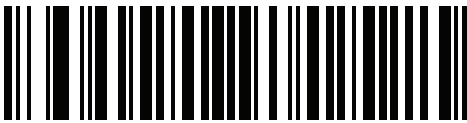

5. Remove the battery from the RS507/RS507X or RS6000.
6. Re-install the battery into the RS507/RS507X or RS6000.
7. Swipe down from the Status bar to open the Quick Access panel and then touch .
8. Touch **Bluetooth**.
9. Touch **Pair new device**. The device begins searching for discoverable Bluetooth devices in the area and displays them under **Available devices**.
10. Scroll through the list and select RS507/RS507X or RS6000.

The device connects to the RS507/RS507X or RS6000 and **Connected** appears below the device name. The Bluetooth device is added to the **Paired devices** list and a trusted (“paired”) connection is established.

A notification appears on Notification panel and the  icon appears in the Status bar.

Pairing a Bluetooth Scanner

Connect the scanner to the device using one of the following methods:

- Simple Serial Interface (SSI) mode
- Bluetooth Human Interface Device (HID) mode.

Pairing Using Bluetooth Human Interface Device

To pair the scanner with the device using HID:

1. Remove the battery from the scanner.
2. Replace the battery.

3. After the scanner reboots, scan the barcode below to place the scanner in HID mode.

Figure 80 Bluetooth HID Classic Barcode



4. On the device, swipe down from the Status bar to open the Quick Access panel and then touch .
5. Touch **Bluetooth**.
6. Touch **Pair new device**. The device begins searching for discoverable Bluetooth devices in the area and displays them under **Available devices**.
7. Scroll through the list and select XXXXX xxxxxx, where XXXXX is the scanner and xxxxxx is the serial number.



The device connects to the scanner, the scanner beeps once and **Connected** appears below the device name. The Bluetooth device is added to the **Paired devices** list and a trusted (“paired”) connection is established.

DataWedge



DataWedge is a utility that adds advanced barcode scanning capability to any application without writing code. It runs in the background and handles the interface to built-in barcode scanners. The captured barcode data is converted to keystrokes and sent to the target application as if it was typed on the keypad.

To configure DataWedge refer to the device Integrator Guide or Product Reference Guide.

Enabling DataWedge

1. Swipe up from the bottom of the Home screen and touch .
2. Touch  > **Settings**.
3. Touch the **DataWedge enabled** checkbox. A blue checkmark appears in the checkbox indicating that DataWedge is enabled.
4. Touch

Disabling DataWedge

1. Swipe up from the bottom of the Home screen and touch .
2. Touch  > **Settings**.
3. Touch the **DataWedge enabled** checkbox. A blue checkmark disappears from the checkbox indicating that DataWedge is disabled.
4. Touch

Wireless

Introduction

This section provides information on the wireless features:

- Wireless Local Area Network (WLAN)
- Bluetooth
- Near Field Communications (NFC - CC6000 Only)

Sharing the Mobile Data Connection

The **tethering & portable hotspot** settings allows sharing the mobile data connection with a single computer via USB tethering or Bluetooth tethering. Share the data connection with up to eight devices at once, by turning it into a portable Wi-Fi hotspot. While the device is sharing its data connection, an icon displays at the top of the screen and a corresponding message appears in the notification list.

Enabling Bluetooth Tethering

Use Bluetooth tethering to share the data connection with a host computer.

Configure the host computer to obtain its network connection using Bluetooth. For more information, see the host computer's documentation.

1. Pair the device with the host computer.
2. Swipe down from the Status bar to open the Quick Access panel and then touch .
3. Touch **Networking & Internet**.
4. Touch **Hotspot & tethering**.
5. Touch the **Bluetooth tethering** switch to enable.

The host computer is now sharing the device's data connection.

To stop sharing the data connection, touch the **Bluetooth tethering** switch again.

Enabling Wi-Fi Hotspot

To enable the Wi-Fi Hotspot:

1. Swipe down from the Status bar to open the Quick Access panel and then touch .
2. Touch **Network & Internet**.

3. Touch **Hotspot & tethering**.
4. Touch the **Wi-Fi hotspot** switch to enable.
After a moment, the device starts broadcasting its Wi-Fi network name (SSID). Connect to it with up to eight computers or other devices. The Hotspot icon appears in the Status bar.



To stop sharing the data connection, touch the **Portable Wi-Fi hotspot** switch again.

Configuring the Wi-Fi Hotspot

1. Swipe down from the Status bar to open the Quick Access panel and then touch .
2. Touch **Network & Internet**.
3. Touch **Hotspot & tethering**.
4. Touch **Set up Wi-Fi hotspot**.

Figure 64 Set up Wi-Fi Hotspot Dialog Box

Set up Wi-Fi hotspot

Network name
AndroidAP_7412

Security
WPA2 PSK

Password
.....

The password must have at least 8 characters.

Show password

Select AP Band
2.4 GHz Band

Select Hotspot timeout

CANCEL **SAVE**

5. In the **Network name** text field, edit the name for the hotspot.
6. Touch the **Security** option and select a security method from the drop-down list.
 - **None**
 - **WPA2 PSK**.



NOTE: If **None** is selected in the **Security** option, a password is not required.





7. In the **Password** text field, enter a password, if required.
8. In the **Select AP Band** drop-down list, select **2.4 GHz Band** or **5 GHz Band**.
9. Touch **Save**.

Configuring the Access Point Name



NOTE: Many service provider Access Point Name (APN) data are pre-configured in the device. The APN information for all other service providers must be obtained from the wireless service provider.

To use the data on a network, configure the APN information:

1. Swipe down with two fingers from the status bar to open the quick access panel and then touch .
2. Touch **Network & Internet > Mobile network > Advanced**.
3. Touch **Access Point Names**.
4. Touch an APN name in the list to edit an existing APN or touch  to create a new APN.
5. Touch each APN setting and enter the appropriate data obtained from the wireless service provider.
6. When finished, touch  > **Save**.
7. Touch the radio button next to the APN name to start using it.
8. Touch .

Data Usage

Data usage refers to the amount of data uploaded or downloaded by the device during a given period. Depending on the wireless plan, you may be charged additional fees when your data usage exceeds your plan's limit.

To monitor your data usage:

1. Swipe down from the Status bar to open the Quick Access panel and then touch .
2. Touch **Mobile network > Data usage > Data saver**.



CAUTION: The usage displayed on the data usage settings screen is measured by your device. Your carrier's data usage accounting may differ. Usage in excess of your carrier plan's data limits can result in steep overage charges. The feature described here can help you track your usage, but is not guaranteed to prevent additional charges.

Data usage settings allow:

- Set the data usage warning level.
- Set a data usage limit.
- View or restrict data usage by app.
- Identify mobile hotspots and restrict background downloads that may result in extra charges.

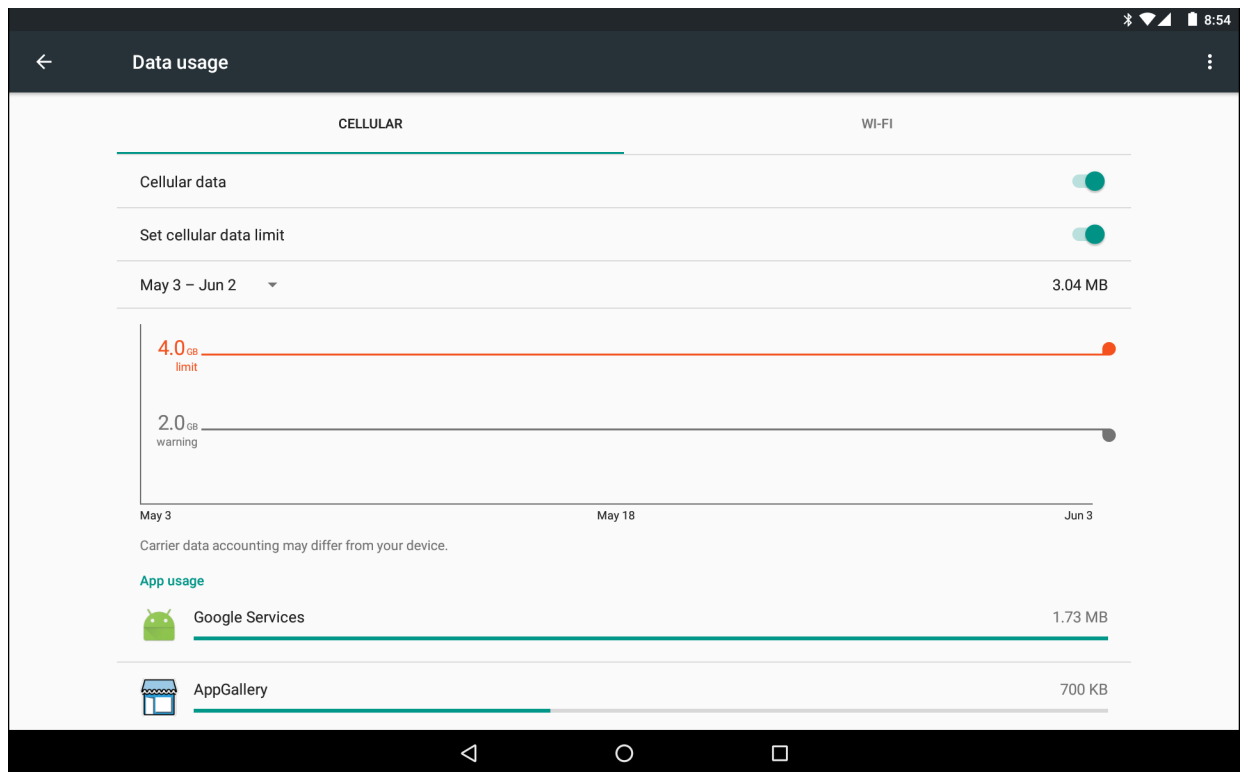

By default, the data usage settings screen displays the mobile data settings. That is, the data network or networks provided by your carrier.

Figure 65 Data Usage Screen





Setting Data Usage Warning

To set a warning alert when the device has used a certain amount of mobile data:

1. Swipe down from the Status bar to open the Quick Access panel and then touch .
2. Touch **Data usage**.
3. Touch **Mobile data usage** >  > **Set data warning**.
4. Touch **Data warning**.
5. Enter a number. To switch between megabytes (MB) and gigabytes (GB), touch the down arrow.
6. Touch **SET**.

When the usage reaches the set level, a notification appears.

Setting Data Limit

1. Swipe down from the Status bar to open the Quick Access panel and then touch .
2. Touch **Data usage**.
3. Touch **Mobile data usage** >  > **Set data limit**.
4. Touch **OK**.

5. Touch **Data limit**.
6. Enter a number. To switch between megabytes (MB) and gigabytes (GB), touch the down arrow.
7. Touch **Set**.

When the limit is reached, data automatically turns off and a notification appears.

Wireless Local Area Networks

Wireless local area networks (WLANs) allow the device to communicate wirelessly inside a building. Before using the device on a WLAN, the facility must be set up with the required hardware to run the WLAN (sometimes known as infrastructure). The infrastructure and the device must both be properly configured to enable this communication.

Refer to the documentation provided with the infrastructure (access points (APs), access ports, switches, Radius servers, etc.) for instructions on how to set up the infrastructure.

Once the infrastructure is set up to enforce the chosen WLAN security scheme, use the **Wireless & networks** settings to configure the device to match the security scheme.

The device supports the following WLAN security options:

- Open
- Wireless Equivalent Privacy (WEP)
- Wi-Fi Protected Access (WPA)/WPA2 Personal (PSK)
- Extensible Authentication Protocol (EAP).
 - EAP-FAST - with MSCHAPV2 and GTC authentication.

The **Status** bar displays icons that indicate Wi-Fi network availability and Wi-Fi status. See [Status Bar on page 25](#) for more information.

Scanning and Connecting to a Wi-Fi Network

To scan and connect to a Wi-Fi network:

1. Swipe down from the Status bar to open the Quick Access panel.

Figure 66 Quick Access Panel

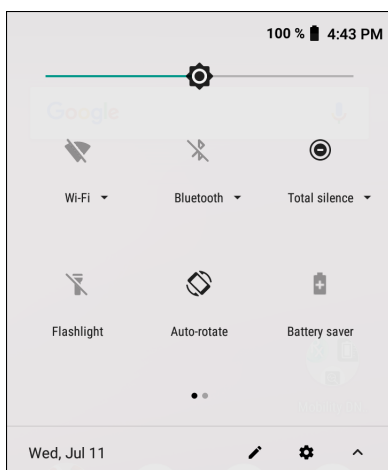

2. Touch **Wi-Fi** to open the **Wi-Fi** screen. The device searches for WLANs in the area and lists them.

Figure 67 Wi-Fi Screen

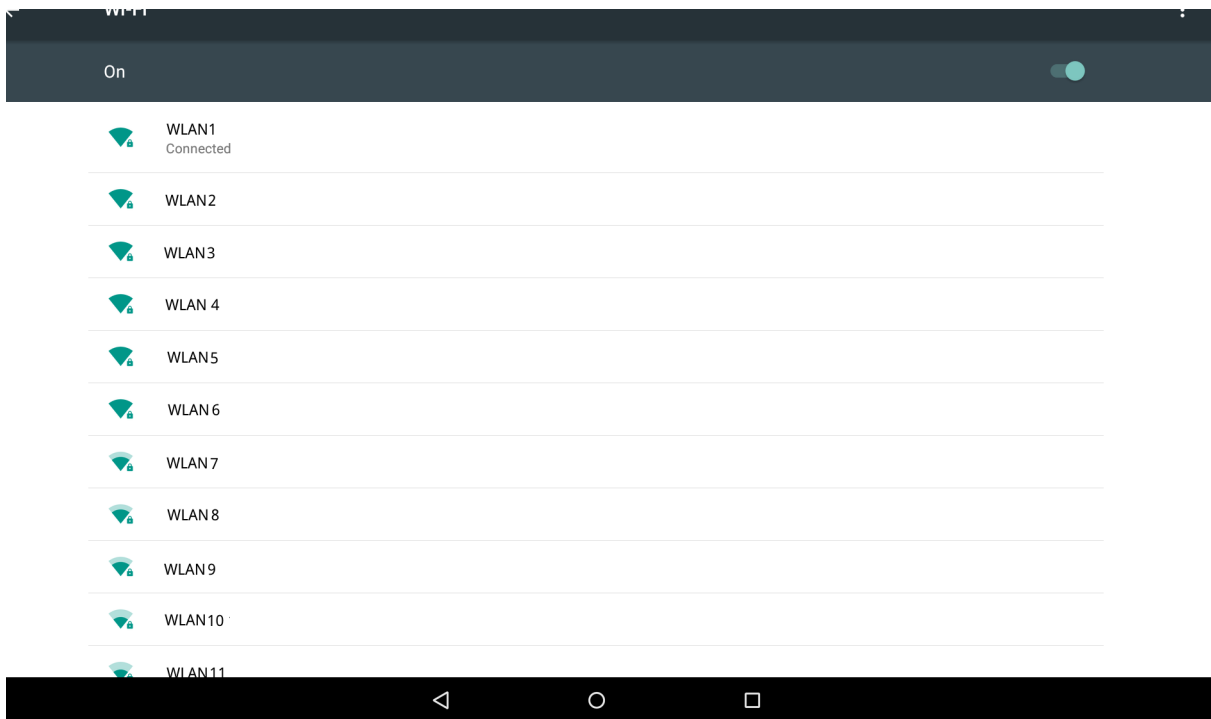
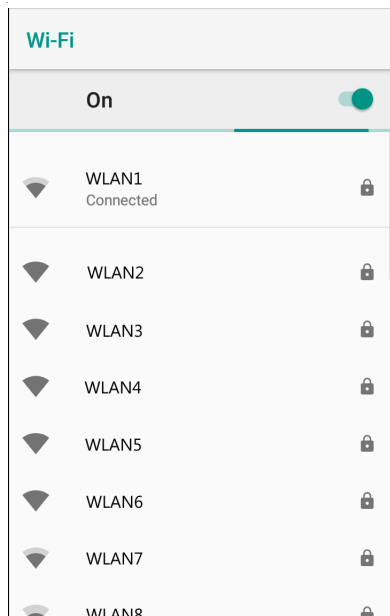

3. Scroll through the list and select the desired WLAN network.
4. For open networks, touch profile once or press and hold and then select **Connect to network** or for secure networks enter the required password or other credentials then touch **Connect**. See the system administrator for more information.

The device obtains a network address and other required information from the network using the dynamic host configuration protocol (DHCP) protocol. To configure the device with a fixed internet protocol (IP) address, Refer to the device Integrator Guide for more information.

- In the Wi-Fi setting field, **Connected** appears indicating that the device is connected to the WLAN.

Removing a Wi-Fi Network

To remove a remembered or connected network:

- Swipe down from the status bar to open the quick access panel and then touch .
- Touch **Network & Internet > W-Fi**.
- Scroll down to the bottom of the list and touch **Saved networks**.
- Touch the name of the network.
- In the dialog box, touch **FORGET**.
- Touch .

Bluetooth

Bluetooth devices can communicate without wires, using frequency-hopping spread spectrum (FHSS) radio frequency (RF) to transmit and receive data in the 2.4 GHz Industry Scientific and Medical (ISM) band (802.15.1). Bluetooth wireless technology is specifically designed for short-range (10 m (32.8 ft)) communication and low power consumption.

Devices with Bluetooth capabilities can exchange information (e.g., files, appointments, and tasks) with other Bluetooth enabled devices such as printers, access points, and other mobile devices.

The device supports Bluetooth Low Energy. Bluetooth Low Energy is targeted at applications in the healthcare, fitness, security, and home entertainment industries. It provides reduced power consumption and cost while maintaining standard Bluetooth range.

Adaptive Frequency Hopping

Adaptive Frequency Hopping (AFH) is a method of avoiding fixed frequency interferers, and can be used with Bluetooth voice. All devices in the piconet (Bluetooth network) must be AFH-capable in order for AFH to work. There is no AFH when connecting and discovering devices. Avoid making Bluetooth connections and discoveries during critical 802.11b communications. AFH for Bluetooth consists of four main sections:

- Channel Classification - A method of detecting an interference on a channel-by-channel basis, or pre-defined channel mask.
- Link Management - Coordinates and distributes the AFH information to the rest of the Bluetooth network.
- Hop Sequence Modification - Avoids interference by selectively reducing the number of hopping channels.
- Channel Maintenance - A method for periodically re-evaluating the channels.

When AFH is enabled, the Bluetooth radio “hops around” (instead of through) the 802.11b high-rate channels. AFH coexistence allows enterprise devices to operate in any infrastructure.

The Bluetooth radio in this device operates as a Class 2 device power class. The maximum output power is 2.5 mW and the expected range is 10 m (32.8 ft). A definition of ranges based on power class is difficult to obtain due to power and device differences, and whether in open space or closed office space.



NOTE: It is not recommended to perform Bluetooth wireless technology inquiry when high rate 802.11b operation is required.

Security

The current Bluetooth specification defines security at the link level. Application-level security is not specified. This allows application developers to define security mechanisms tailored to their specific need. Link-level security occurs between devices, not users, while application-level security can be implemented on a per-user basis. The Bluetooth specification defines security algorithms and procedures required to authenticate devices, and if needed, encrypt the data flowing on the link between the devices. Device authentication is a mandatory feature of Bluetooth while link encryption is optional.

Pairing of Bluetooth devices is accomplished by creating an initialization key used to authenticate the devices and create a link key for them. Entering a common personal identification number (PIN) in the devices being paired generates the initialization key. The PIN is never sent over the air. By default, the Bluetooth stack responds with no key when a key is requested (it is up to user to respond to the key request event). Authentication of Bluetooth devices is based-upon a challenge-response transaction. Bluetooth allows for a PIN or passkey used to create other 128-bit keys used for security and encryption. The encryption key is derived from the link key used to authenticate the pairing devices. Also worthy of note is the limited range and fast frequency hopping of the Bluetooth radios that makes long-distance eavesdropping difficult.

Recommendations are:

- Perform pairing in a secure environment
- Keep PIN codes private and do not store the PIN codes in the device
- Implement application-level security.

Bluetooth Profiles

The device supports the Bluetooth services listed in the table below:

Table 12 *Bluetooth Profiles*

Profile	Description
Service Discovery Protocol (SDP)	Handles the search for known and specific services as well as general services.
Serial Port Profile (SPP)	Allows use of RFCOMM protocol to emulate serial cable connection between two Bluetooth peer devices. For example, connecting the device to a printer.
Object Push Profile (OPP)	Allows the device to push and pull objects to and from a push server.
Advanced Audio Distribution Profile (A2DP)	Allows the device to stream stereo-quality audio to a wireless headset or wireless stereo speakers.
Audio/Video Remote Control Profile (AVRCP)	Allows the device to control A/V equipment to which a user has access. It may be used in concert with A2DP.
Personal Area Network (PAN)	Allows the use of Bluetooth Network Encapsulation Protocol to provide L3 networking capabilities over a Bluetooth link. Only PANU role is supported.
Human Interface Device Profile (HID)	Allows Bluetooth keyboards, pointing devices, gaming devices and remote monitoring devices to connect to the device.
Headset Profile (HSP)	Allows a hands-free device, such as a Bluetooth headset, to place and receive calls on the device.
Hands-Free Profile (HFP)	Allows car hands-free kits to communicate with the device in the car.

Table 12 *Bluetooth Profiles (Continued)*

Profile	Description
Phone Book Access Profile (PBAP)	Allows exchange of Phone Book Objects between a car kit and a mobile device to allow the car kit to display the name of the incoming caller; allow the car kit to download the phone book so the user can initiate a call from the car display.
Out of Band (OOB)	Allows exchange of information used in the pairing process. Pairing is completed using the Bluetooth radio, but requires information from the OOB mechanism. Using OOB with NFC enables pairing when devices simply get close, rather than requiring a lengthy discovery process.
Out of Band (OOB)	Allows exchange of information used in the pairing process. Pairing is completed using the Bluetooth radio, but requires information from the OOB mechanism.
Symbol Serial Interface (SSI)	Allows for communication with Bluetooth Imager.
File Transfer Profile (FTP)	Provides the capability to browse, manipulate and transfer files in file system of another system. Uses GOEP as a basis.
Generic Attribute Profile (GATT)	Provides profile discovery and description services for Bluetooth Low Energy protocol. It defines how attributes are grouped together into sets to form services.
HID Over GATT Profile (HOGP)	Defines the procedures and features used by Bluetooth low energy HID Devices using GATT and Bluetooth HID Hosts using GATT.
Scan Parameters Profile (ScPP)	Provides devices with information to assist them in managing their connection idle timeout and advertising parameters to optimize for power consumption and/or reconnection latency.
Message Access Profile (MAP)	Defines the features and procedures used by devices that exchange message objects.
Dial Up Networking (DUN)	Provides a standard to access the Internet and other dial-up services over Bluetooth.
Generic Access Profile (GAP)	Use for device discovery and authentication.
OBject EXchange (OBEX)	Facilitates the exchange of binary objects between devices.
Generic Object Exchange Profile (GOEP)	Provides a basis for other data profiles. Based on OBEX.
Generic Audio/Video Distribution Profile (GAVDP)	Provides the basis for A2DP and VDP, the basis of the systems designed for distributing video and audio streams using Bluetooth technology.

Bluetooth Power States

The Bluetooth radio is off by default:



- Suspend - When the device goes into suspend mode, the Bluetooth radio stays on.
- Airplane Mode - When the device is placed in Airplane Mode, the Bluetooth radio turns off. When Airplane mode is disabled, the Bluetooth radio returns to the prior state. When in Airplane Mode, the Bluetooth radio can be turned back on if desired.

Bluetooth Radio Power

Turn off the Bluetooth radio to save power or if entering an area with radio restrictions (e.g., an airplane). When the radio is off, other Bluetooth devices cannot see or connect to the device. Turn on the Bluetooth radio to exchange information with other Bluetooth devices (within range). Communicate only with Bluetooth radios in close proximity.



Enabling Bluetooth

To enable Bluetooth:

1. Swipe down from the Status bar to open the Quick Access panel.
2. Touch  to turn Bluetooth on.
3. Touch .

Disabling Bluetooth

To disable Bluetooth:

1. Swipe down from the Status bar to open the Quick Access panel.
2. Touch  to turn Bluetooth off.
3. Touch .



Discovering Bluetooth Device(s)

The device can receive information from discovered devices without pairing. However, once paired, the device and a paired device exchange information automatically when the Bluetooth radio is on. To find Bluetooth devices in the area:

1. Ensure that Bluetooth is enabled on both devices.
2. Ensure that the Bluetooth device to discover is in discoverable mode.
3. Ensure that the two devices are within 10 meters (32.8 feet) of one another.
4. Swipe down from the Status bar to open the Quick Access panel.
5. Touch **Bluetooth**.
6. Touch **MORE SETTINGS**. The **Bluetooth** screen appears.
7. Touch **Pair new device**. The device begins searching for discoverable Bluetooth devices in the area and displays them under **Available devices**.
8. Scroll through the list and select a device. The Bluetooth pairing request dialog box appears.
9. Touch **Pair** on both devices.
10. The Bluetooth device is added to the **Paired devices** list and a trusted (“paired”) connection is established.

Changing the Bluetooth Name

By default, the device has a generic Bluetooth name that is visible to other devices when connected.

1. Swipe down from the Status bar to open the Quick Access panel and then touch .
2. Touch **Connected devices > Bluetooth**.
3. If Bluetooth is not on, move the switch to turn Bluetooth on.
4. Touch **Device name**.
5. Enter a name and touch **RENAME**.
6. Touch .



Connecting to a Bluetooth Device

Once paired, connect to a Bluetooth device.

1. Swipe down from the Status bar to open the Quick Access panel and then touch .
2. Touch **Connected device > Bluetooth**.
3. In the list, touch the unconnected Bluetooth device.
When connected, **Connected** appears below the device name.



Selecting Profiles on the Bluetooth Device

Some Bluetooth devices have multiple profiles. To select a profile:

1. Swipe down from the Status bar to open the Quick Access panel and then touch .
2. Touch **Connected Devices > Bluetooth**.
3. In the **Paired Devices** list, touch  next to the device name.
4. Turn on or off a profile to allow the device to use that profile.
5. Touch .

Unpairing a Bluetooth Device

To unpair a Bluetooth device and erase all pairing information:

1. Swipe down from the Status bar to open the Quick Access panel and then touch .
2. Touch **Connected devices > Bluetooth**.
3. In the **Paired Devices** list, touch  next to the device name.
4. Touch **FORGET**.
5. Touch .

Near Field Communications (CC6000 Only)

NFC/HF RFID is a short-range wireless connectivity technology standard that enables secure transaction between a reader and a contactless smartcard. The technology is based on ISO/IEC 14443 type A and B (proximity) and ISO/IEC 15693 (vicinity) standards, using the HF 13.56 MHz unlicensed band. The device supports the following operating modes:

- Reader mode
- Peer-to-Peer communication
- Card Emulation mode.

Using NFC, the device can:

- Read contactless cards such as contactless tickets, ID cards and ePassport.
- Read and write information to contactless cards such as SmartPosters and tickets, as well as devices with NFC interface such as vending machines.
- Read information from supported medical sensors.
- Pair with supported Bluetooth devices such as printers, ring scanners (ex. RS6000), and headsets (ex. HS3100).
- Exchange data with another NFC device.
- Emulate contactless card such as payment, ticket, or SmartPoster.

The device NFC antenna is positioned to read NFC cards from the top of the device while the device is being held.

The device NFC antenna is located on the back of the device, near the Interface Connector.

Reading NFC Cards

To read NFC cards:

1. Launch an NFC enabled application.
2. Hold device as shown.

Figure 68 Reading Cards

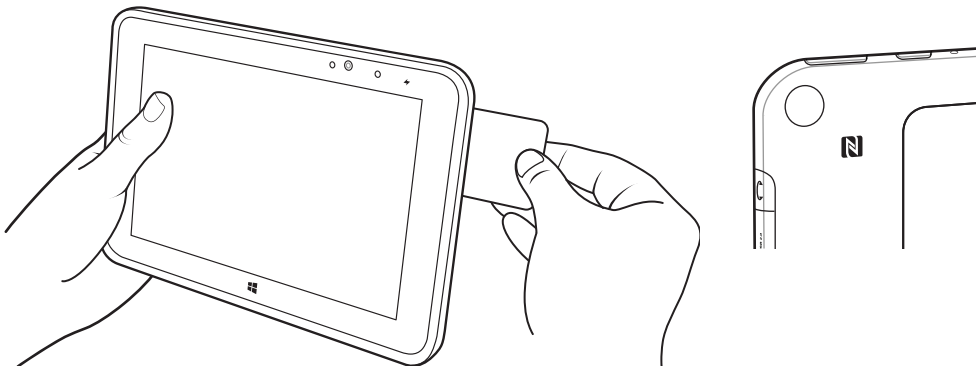

Accessories

Introduction

This chapter provides information for using the accessories for the device.

Accessories

This table lists the accessories available for the device.

Table 13 *Accessories*

Accessory	Part Number	Description
Mounting Plates		
CC600 Wall Mount	21-118517-01R	CC600 Wall Mounting Kit
CC600 Pole Mount	21-118517-02R	CC600 Pole Mounting Kit
CC6000 Wall Mounting Kit	KT-152097-03	CC6000 Wall Mounting Kit with Power Supply Storage
CC6000 Wall Mounting Kit	KT-152097-01	100mm VESA
CC6000 Wall Mounting Kit	KT-152098-03	Slimmer, CC6000 specific mount
CC6000 Pole Mounting Kit	KT-152096-03	100mm VESA Includes additional storage shelf to hold power supply Modified over KT0152096-02 to better hold Level VI power supply.
CC6000 Pole Mounting Kit	KT-152096-01	100mm VESA
Charge and Communication Cables		
USB-C Cable	CBL-TC2X-USBC-01	Used to communicate with CC6000 via the USB OTG port.
USB-C Cable	CBL-TC5X-USBC2A-01	Used to communicate with CC6000 via the USB OTG port.
Power Supplies		

Table 13 *Accessories (Continued)*

Accessory	Part Number	Description
DC Line Cord	CBL-DC-383A1-01	Used with Power Supply (PWR-BUA5V16W0WW) Cable length is 6 ft
Power Supply	PWR-BUA5V16W0WW	100-240VAC, 5.4V, 3A, 16W Meets US DOE Level VI efficiency standard Replaces PWRS-14000-249R
AC Line Cord	50-16000-182R	Used with 50-14000-147R/50-14000-249R?PWRS-14000-249R/PWR-BUA5V16W0WW

3.5 mm Audio Adapter (CC6000 Only)

The 3.5 mm Audio Adapter snaps onto the back of the device and removes easily when not in use. When attached to the device the 3.5 mm Audio Adapter allows a user to connect a wired headset to the device.

Connecting a Headset to the 3.5 mm Audio Adapter (CC6000 Only)

1. Connect the Quick Disconnect connect of the headset to the Quick Disconnect connector of the 3.5 mm Quick Disconnect Adapter Cable.

Figure 70 Connect Headset to Adapter Cable

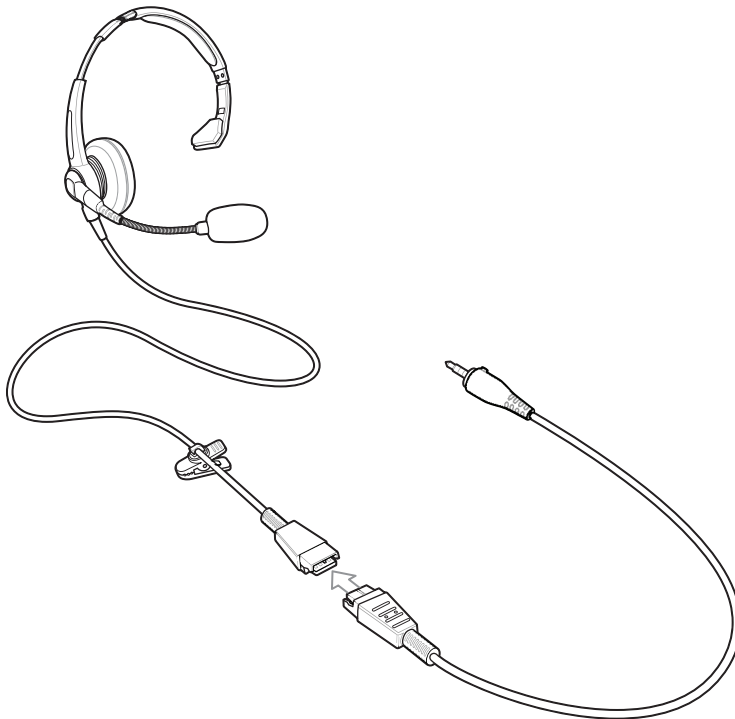

2. Connect the audio jack of the 3.5 mm Quick Disconnect Adapter Cable to the 3.5 mm Audio Adapter.

Figure 71 Connect Adapter Cable to Audio Adapter

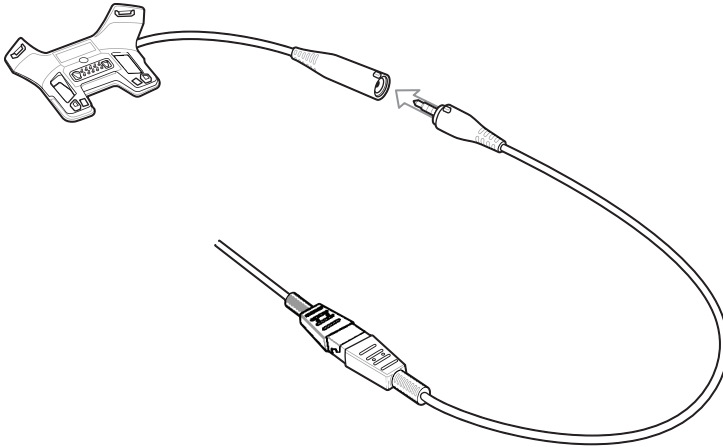

USB I/O Hub

The USB I/O Hub:

- provides power to a vehicle cradle
- provides USB hub for three USB devices (such as printers)
- provides a powered USB port for charging another device.

The cradle is powered by the vehicle's 12V or 24V electrical system. The operating voltage range is 9V to 32V and supplies a maximum current of 3A to the vehicle cradle and 1.5 A to the four USB ports simultaneously.

Refer to the device Integrator Guide for Android 8.1 Oreo for information on installing the USB I/O Hub.

Figure 72 USB I/O Hub

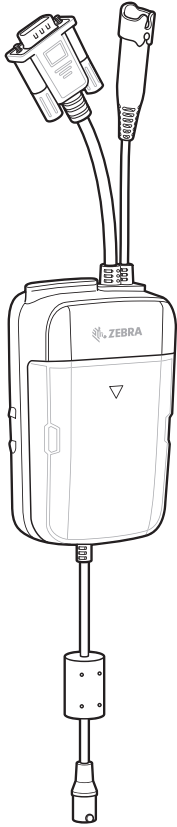

Connect USB Cables

The USB I/O Hub provides three USB ports for connecting devices such as printers to a device in the vehicle cradle. To connect USB cables:

1. Slide the cable cover down and remove.

Figure 73 Remove Cover

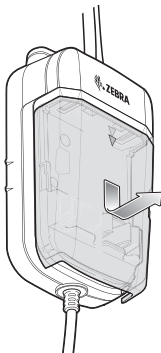

2. Insert the USB cable connector into one of the USB ports.

3. Place each cable into the cable holder.

Figure 74 Connect USB Cable

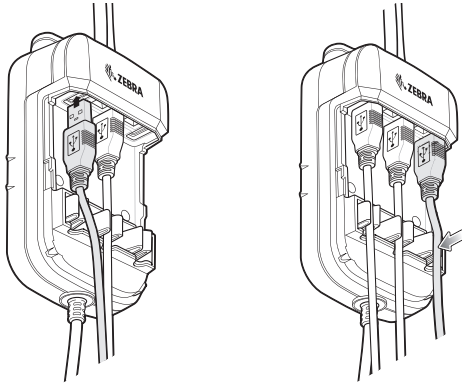

4. Align the cable cover onto the USB I/O Hub. Ensure that the cables are within the cover opening.

Figure 75 Replace Cover

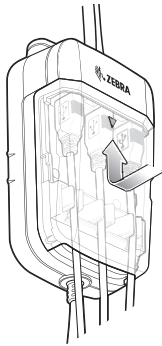

5. Slide cable cover up to lock into place.

External USB Cable

The USB I/O Hub provides a USB port for charging external devices such as cell phones. This port is for charging only.

1. Open the USB Access Cover.
2. Insert the USB cable connector into the USB port.

Figure 76 Insert External USB Cable

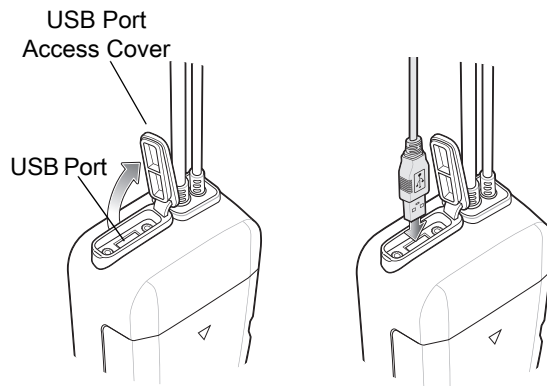

Audio Headset Connection

The USB I/O Hub provides audio connection to the device in a vehicle cradle.

Depending upon the headset, connect the headset and audio adapter to the Headset connector.

Figure 77 Connect Audio Headset

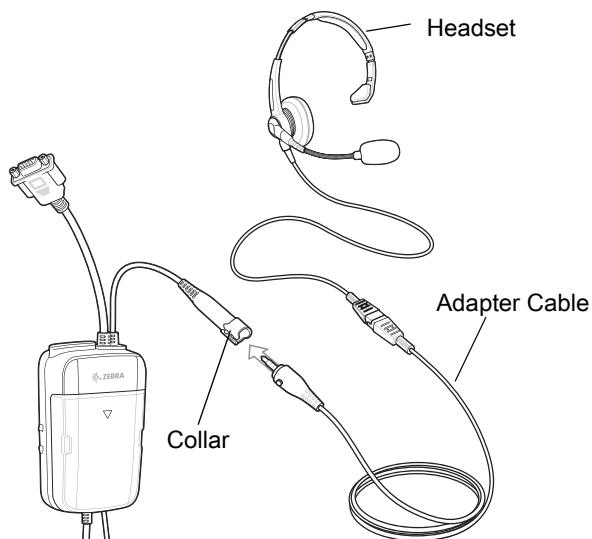

Maintenance and Troubleshooting

Introduction

This chapter includes instructions on cleaning and storing the device, and provides troubleshooting solutions for potential problems during operation.

Maintaining the Device

For trouble-free service, observe the following tips when using the device:

- In order to avoid scratching the screen, use plastic-tipped pens intended for use with a touch-sensitive screen. Never use an actual pen or pencil or other sharp object on the surface of the device screen.
- The touch-sensitive screen of the device is glass. Do not drop the device or subject it to strong impact.
- Protect the device from temperature extremes. Do not leave it on the dashboard of a car on a hot day, and keep it away from heat sources.
- Do not store the device in any location that is dusty, damp, or wet.
- Use a soft lens cloth to clean the device. If the surface of the device screen becomes soiled, clean it with a soft cloth moistened with an approved cleanser.

Cleaning Instructions



CAUTION: Always wear eye protection.

Read warning label on alcohol product before using.

If you have to use any other solution for medical reasons please contact the Global Customer Support Center for more information.



WARNING: Avoid exposing this product to contact with hot oil or other flammable liquids. If such exposure occurs, unplug the device and clean the product immediately in accordance with these guidelines.

Approved Cleanser Active Ingredients

100% of the active ingredients in any cleaner must consist of one or some combination of the following: isopropyl alcohol, bleach/sodium hypochlorite¹ (see important note below), hydrogen peroxide, ammonium chloride or mild dish soap.



- Use pre-moistened wipes and do not allow liquid cleaner to pool.

¹When using sodium hypochlorite (bleach) based products always follow the manufacturer's recommended instructions: use gloves during application and remove the residue afterwards with a damp alcohol cloth or a cotton swab to avoid prolonged skin contact while handling the device.

Due to the powerful oxidizing nature of sodium hypochlorite the metal surfaces on the device are prone to oxidation (corrosion) when exposed to this chemical in the liquid form (including wipes). In the event that these type of disinfectants come in contact with metal on the device, prompt removal with an alcohol-dampened cloth or cotton swab after the cleaning step is critical.

Harmful Ingredients

The following chemicals are known to damage the plastics on the device and should not come in contact with the device: acetone; ketones; ethers; aromatic and chlorinated hydrocarbons; aqueous or alcoholic alkaline solutions; ethanolamine; toluene; trichloroethylene; benzene; carbolic acid and TB-lysoform.

Many vinyl gloves contain phthalate additives, which are often not recommended for medical use and are known to be harmful to the housing of the device.

Device Cleaning Instructions

Do not apply liquid directly to the device. Dampen a soft cloth or use pre-moistened wipes. Do not wrap the device in the cloth or wipe, but gently wipe the unit. Be careful not to let liquid pool around the display window or other places. Allow the unit to air dry before use.



NOTE: For thorough cleaning, it is recommended to first remove all accessory attachments, if applicable.

Special Cleaning Notes

The device should not be handled while wearing vinyl gloves containing phthalates, or before hands are washed to remove contaminant residue after gloves are removed.

If products containing any of the harmful ingredients listed above are used prior to handling the device, such as hand sanitizer that contain ethanolamine, hands must be completely dry before handling the device to prevent damage to the device.



IMPORTANT: When using cleaning/disinfectant agents on the device, it is important to follow the directions prescribed by the cleaning/disinfectant agent manufacturer.

Cleaning Materials Required

- Alcohol wipes
- Lens tissue
- Cotton-tipped applicators
- Isopropyl alcohol
- Can of compressed air with a tube.

Cleaning Frequency

The cleaning frequency is at the customer's discretion due to the varied environments in which the mobile devices are used and may be cleaned as frequently as required. When dirt is visible, it is recommended to clean the mobile device to avoid build up of particles which make the device more difficult to clean later on.

For consistency and optimum image capture, it is recommended to clean the camera window periodically especially when used in environments prone to dirt or dust.

Cleaning the Device

Housing

Thoroughly wipe the housing, including all buttons and triggers, using an approved alcohol wipe.

Display

The display can be wiped down with an approved alcohol wipe, but care should be taken not to allow any pooling of liquid around the edges of the display. Immediately dry the display with a soft, non-abrasive cloth to prevent streaking.

Camera and Exit Window

Wipe the camera and exit window periodically with a lens tissue or other material suitable for cleaning optical material such as eyeglasses.

Troubleshooting

The following tables provides typical problems that might arise and the solution for correcting the problem.

Table 14 *Troubleshooting the Device*

Problem	Cause	Solution
During data communication with a host computer, no data transmitted, or transmitted data was incomplete.	Device disconnected from host computer during communication.	Reattach the communication cable and re-transmit.
	Incorrect cable configuration.	See the system administrator.
	Communication software was incorrectly installed or configured.	Perform setup.
During data communication over Wi-Fi, no data transmitted, or transmitted data was incomplete.	Wi-Fi radio is not on.	Turn on the Wi-Fi radio.
	You moved out of range of an access point.	Move closer to an access point.
During data communication over Bluetooth, no data transmitted, or transmitted data was incomplete.	Bluetooth radio is not on.	Turn on the Bluetooth radio.
	You moved out of range of another Bluetooth device.	Move within 10 meters (32.8 feet) of the other device.
No sound.	Volume setting is low or turned off.	Adjust the volume.
Device shuts off.	Device is inactive.	The display turns off after a period of inactivity. Set this period to 15 seconds, 30 seconds, 1, 2, 5, 10 or 30 minutes.
Tapping the window buttons or icons does not activate the corresponding feature.	The device is not responding.	Reset the device.
A message appears stating that the device memory is full.	Too many files stored on the device.	Delete unused memos and records. If necessary, save these records on the host computer (or use an SD card for additional memory).
	Too many applications installed on the device.	Remove user-installed applications on the device to recover memory. Select ⚙️ > Storage > FREE UP SPACE > REVIEW RECENT ITEMS . Select the unused program(s) and tap FREE UP .

Table 14 *Troubleshooting the Device (Continued)*

Problem	Cause	Solution
The device does not decode with reading barcode.	Scanning application is not loaded.	Load a scanning application on the device or enable DataWedge. See the system administrator.
	Unreadable barcode.	Ensure the symbol is not defaced.
	Distance between exit window and barcode is incorrect.	Place the device within proper scanning range.
	Device is not programmed for the barcode.	Program the device to accept the type of barcode being scanned. Refer to the EMDK or DataWedge application.
	Device is not programmed to generate a beep.	If the device does not beep on a good decode, set the application to generate a beep on good decode.
Device cannot find any Bluetooth devices nearby.	Too far from other Bluetooth devices.	Move closer to the other Bluetooth device(s), within a range of 10 meters (32.8 feet).
	The Bluetooth device(s) nearby are not turned on.	Turn on the Bluetooth device(s) to find.
	The Bluetooth device(s) are not in discoverable mode.	Set the Bluetooth device(s) to discoverable mode. If needed, refer to the device's user documentation for help.
Cannot unlock device.	User enters incorrect password.	If the user enters an incorrect password eight times, the user is requested to enter a code before trying again. If the user forgot the password, contact system administrator.

Technical Specifications

Introduction

This chapter provides technical specifications and decode distances for the CC600 and CC6000.

Technical Specifications



WARNING: Do not use this product with any power supply other than an Enterprise Grade with 5.4VDC/3A; 110/220v with support for integrated 802.3at Power-over-Ethernet (PoE). Significant damage to the device can occur if a different power supply is used.

CC6000

Table 15 *CC6000 Technical Specifications*

Item	Description
Physical Characteristics	
Dimensions	Landscape: 10.9 in. x 7.9 in. x 1.4 in. 27.8 cm x 20.1 cm x 3.6 cm Portrait: 7.2 in. x 11.6 in. x 1.4 in. 18.3 cm x 29.6 cm x 3.6 cm
Weight	2.16 lbs./980g
Display	10.1 inch PCAP multi-touch
Active Screen Area	217 mm W x 136 mm H
Aspect Ratio	16:10
Resolution	1280x800 at 60 Hz
Keypad	Virtual
Connectivity	USB host: 2 Full Size USB 2.0 Type A ports for accessory USB OTG: 1 USB-C OTG Ethernet Gigabit compatible: RJ45 External Audio In: 3.5 mm connector
Audio	Audio Two microphones; two front firing speakers (2W total)
Expansion Capabilities	Micro SD card slot, supports class 2 to class 10 and UHS-1 SD cards

Table 15 CC6000 Technical Specifications (Continued)

Item	Description
Power	Enterprise grade power supply: 5.4VDC/3A; 110/220V Support for integrated 802.3at Power-over-Ethernet (PoE)
Performance Characteristics	
Display Brightness	300 nits
CPU	Qualcomm Snapdragon™ 660
OS	Android Oreo, Google GMS
Memory	RAM: 4GB Internal Storage: 32GB
User Environment	
Operating Temperature	0°C to 40°C (32°F to 104°F)
Storage Temperature	-40°C to 70°C (-40°F to 158°F)
Humidity	5% to 95% non-condensing
Management	
Management Tools	Integrates with industry standard Mobile Device Management (MDM) solutions to configure settings and provide remote software updates
Data Capture/Output	
Integrated Scanner	1D/2D Zebra SE4710 decoded scanner
Front Camera	5 MP
Video	1080p
Networks	
WLAN	Dual band 802.11 a/b/g/n/ac/d/h/r/k/w/i (2.4 GHz and 5.2 GHz support)
WPAN	Bluetooth 5.0; integrated antenna
Ethernet	Gigabit Ethernet on RJ45 interface, with activity LEDs
Peripherals and Accessories	
Accessories	Country specific AC line cord. Additional accessories can be integrated using USB and Bluetooth interface
Mounting Options	Integrated standard VESA mount; conforms to the VESA 100 mm x 100 mm mounting standard for attachment of third party, off-the-shelf mounting solutions; four (4) M4 x 8 mm max insert distance
2D Imager Engine (SE4710) Specifications	
Field of View	Horizontal - 42.0° Vertical - 28.0°
Image Resolution	1280 horizontal X 800 vertical pixels
Roll	360°
Pitch Angle	+/- 60° from normal
Skew Tolerance	+/- 60° from normal
Ambient Light	Sunlight: 1,000 ft. candles (10,764 lux)

Table 15 *CC6000 Technical Specifications (Continued)*

Item	Description
Focal Distance	From front of engine: 19.4 cm (7.6 in.)
Aiming Element	610 nm amber LED dot
Illumination System	Red LED

CC600

Table 16 *CC600 Technical Specifications*

Item	Description
Physical Characteristics	
Dimensions	6.6 in. x 4.6 in. x 1.4 in. 16.9 cm x 11.6 cm x 3.5 cm
Weight	0.70 lbs./320 g
Display	5.0 inch PCAP multi-touch
Active Screen Area	110 mm W x 62 mm H
Aspect Ratio	16:10
Resolution	1280x720 at 60 Hz
Keypad	Virtual
Connectivity	USB OTG: 1 USB-C OTG Ethernet Gigabit compatible: RJ45
Audio	Two microphones, one front firing speaker (2W total)
Expansion Capabilities	Micro SD card slot, supports class 2 to class 10 and UHS-1 SD cards
Power	Enterprise grade power supply: 5.4VDC/3A; 110/220V Support for integrated 802.3at Power-over-Ethernet (PoE)
Performance Characteristics	
Display Brightness	480 nits
CPU	Qualcomm Snapdragon™ 660
OS	Android Oreo, Google GMS
Memory	RAM: 4GB Internal Storage: 32GB
User Environment	
Operating Temperature	0°C to 40°C (32°F to 104°F)
Storage Temperature	-40°C to 70°C (-40°F to 158°F)
Humidity	5% to 95% non-condensing
Management	
Management Tools	Integrates with industry standard Mobile Device Management (MDM) solutions to configure settings and provide remote software updates
Data Capture/Output	

Table 16 *CC600 Technical Specifications (Continued)*

Item	Description
Integrated Scanner	1D/2D Zebra SE2100 scanner
Networks	
WLAN	Dual band 802.11 a/b/g/n/ac/d/h/r/k/w/i (2.4 GHz and 5.2 GHz support)
WPAN	Bluetooth 5.0; integrated antenna
Ethernet	Gigabit Ethernet on RJ45 interface, with activity LEDs
Peripherals and Accessories	
Accessories	Additional accessories can be integrated using USB and Bluetooth interface
Mounting Options	Integrated standard VESA mount; conforms to the VESA 75 mm x 75 mm mounting standard for attachment of third party, off-the-shelf mounting solutions; four (4) M4 x 8 mm max insert distance
2D Imager Engine (SE2100) Specifications	
Field of View	Horizontal - 41.5° Vertical - 31.7°
Image Resolution	640 horizontal x 480 vertical pixels
Roll	360°
Pitch Angle	+/- 60° from normal
Skew Tolerance	+/- 60° from normal
Ambient Light	Sunlight: 1,000 ft. candles (10,764 lux)
Focal Distance	From front of engine: 10.7 cm (4.2 inches)
Aiming Element	None
Illumination System	Ultra white LED

Table 17 *Data Capture Supported Symbologies*

Item	Description
1D Barcodes	Code 128, EAN-8, EAN-13, GS1 DataBar Expanded, GS1 128, GS1 DataBar Coupon, UPCA, Interleaved 2 of 5, UPC Coupon Code
2D Barcodes	PDF-417, QR Code, Digimarc, DotCode (CC6000 only)

Decode Distances

CC6000 - SE4710 Scan Engine

Table 18 lists the typical distances for selected barcode densities when scanning with the CC6000. The minimum element width (or “symbol density”) is the width in mils of the narrowest element (bar or space) in the symbol.

Table 18 *CC6000 - Decode Ranges*

Barcode Type	Near Distance	Far Distance
	Typical	Typical
4 mil Code 39	3.3 in / 8.4 cm	8.8 in / 22.4 cm
5 mil Code 128	2.8 in / 7.1 cm	8.2 in / 20.8 cm
5 mil Code 39	2.0 in / 5.08 cm	13.5 in / 34.3 cm
5mil PDF417	3.1 in / 7.9 cm	7.5 in / 19.0 cm
10 mil Data Matrix	2.9 in / 7.4 cm	10.1 in / 25.7 cm
100% UPCA	1.8 in / 4.6 cm*	24.0 in / 60.9 cm
20.0mil Code 39	2.0 in / 5.08 cm*	26 in / 66.0 cm

*Limited by width of barcode in field of view.

Note: Photographic quality barcode at 15° tilt pitch angle under 30 fcd ambient illumination.

CC600 - SE2100 Scan Engine

Table 19 lists the typical distances for selected barcode densities when scanning with the CC600. The minimum element width (or “symbol density”) is the width in mils of the narrowest element (bar or space) in the symbol.

Table 19 *CC600 - Decode Ranges*

Barcode Type	Near Distance	Far Distance
	Typical	Typical
5 mil Code 128	2.0 in / 51mm	4.8 in / 122 mm
5 mil Code 39	1.7 in / 43 mm	5.8 in / 147 mm
6.6 mil PDF417	1.6 in / 41 mm	4.9 in / 124 mm
10 mil Data Matrix	1.2 in / 30 mm	4.9 in / 124 mm
100% UPCA	2.0 in / 51 mm	10.6 in / 269 mm
20.0 mil Code 39	2.1 in / 53 mm*	13.6 in / 345 mm
10.0 mil QR Code	1.1 in / 28 mm	5.2 in / 132 mm
*Limited by width of barcode in field of view.		
Note: Photographic quality barcode at 15° tilt pitch angle under 30 fcd ambient illumination.		

Index

A

adaptive frequency hopping	107
alarms only	37
albums	73, 80
deleting	74, 80
getting information	73
sharing	73, 80
working with	73, 80
ambient display setting	19
apn	102
approved cleanser	121
approved cleanser active ingredients	121
apps	40
accessing	43
adding shortcuts	31
Camera	54
DataWedge Demonstration	62
Diagnostic Tool	65
Files	69
Gallery	71
Photos	78
PTT Express	84
RxLogger	87
RxLogger Utility	88
shortcuts	31
SimulScan Demo	89
Sound Recorder	98
automatically block sounds	38

B

Bluetooth	100, 107
change name	110
disabling	110
discovering devices	110
enabling	110
PIN	108
power states	109
profiles	108
security	108
bluetooth	107

C

camera	40, 54
front camera photo settings	58
front camera video settings	60
photo settings	57
rear camera photo settings	58
rear camera video settings	59
recording videos	55
taking photos	54
video settings	59
camera settings	57, 59
cast	114
change Bluetooth name	110
cleaning	121, 122
camera and exit window	123
display	123
frequency	122
housing	123
instructions	121
materials	122
cleaning instructions	122
connect to WLAN	105
contacts	60
adding	60
deleting	60
editing	60

D

DataWedge Demonstration	62
decode ranges	130, 131
Diagnostic Tool	65
bluetooth test information	68
settings	68
system test information	68
wlan test information	68
diagnostic tool	
settings	68
disable Bluetooth	110
disconnect host computer	53
discover Bluetooth devices	110

Display settings 17
do not disturb feature 37

E

EAP 105
edit apn 102
enable Bluetooth 110

F

feature descriptions
 touch screen 16
file transfer 52
Files 69
folders 32
 creating 32
 naming 32
 removing 33
font size 19

G

Gallery 71
 cropping photos 75
 deleting albums 74
 deleting photos 76
 deleting videos 77
 getting album information 73
 setting photos as contact icons 75
 sharing albums 73
 sharing photos 76
 sharing videos 76
 viewing photos 74
 watching videos 76
 working with albums 73
 working with photos 74
 working with videos 76
general sound setting 20
Google
 mobile services 23

H

harmful ingredients 122
Home screen 23
home screen
 moving items 32
home screen wallpaper 33

I

interactive sensor technology 51

K

keyboards 34
 additional character tab 35
 alpha tab 35
 configuration 34
 editing text 36
 entering numbers, symbols, and special characters .
 36
 numeric tab 35

L

lock screen notifications 28

M

maintenance 121
 approved cleanser active ingredients 121
 clean camera and exit window 123
 clean display 123
 clean housing 123
 cleaning frequency 122
 cleaning instructions 121
 cleaning materials required 122
 device cleaning instructions 122
 harmful ingredients 122
 maintaining the device 121
 special cleaning notes 122
managing notifications 27

N

near field communication 100
near field communications 111
NFC 111
 reading cards 112
 sharing information 113
notational conventions 10
notifications
 lock screen 28
 managing 27
 priority notifications only 38

P

photo transfer 52
Photos 78
 cropping 81
 deleting 83
 deleting albums 80
 deleting videos 83
 setting as contact icons 82
 sharing 82
 sharing albums 80

sharing videos	83	general sound	20
viewing and browsing	81	home screen wallpaper	33
watching videos	83	limit sounds	37
working with	81	override do not disturb for specific apps	39
working with albums	80	priority notifications only	38
working with videos	83	sharing information using NFC	113
photos		SimulScan Demo	89
camera settings	57	advanced settings	97
cropping	75	creating a demo customization	95
deleting	76	default templates	96
setting as contact icons	75	printing sample forms	90
sharing	76	settings	96
taking	54	using the manufacturing example	93
viewing	74	using the postal, transportation and logistics example	91
working with	74	software version	9
PTT Express		software versions	9
audible indicators	85	Sound Recorder	98
disabling communication	86	status bar	25
enabling communication	85	symbolologies	129
group calls	86		
notification icons	85	T	
private response	86	touch screen	16
talk groups	86	transferring files using USB	51
user interface	84	troubleshooting	124
Voice Client	84		
PTT-Express		U	
PTT communication	86	USB	51
Q		V	
quick access panel	29	vehicle cradle	117
quick settings		videos	
edit icons	31	camera settings	59
		deleting	77, 83
R		recording	55
reading NFC cards	112	sharing	76, 83
remove wi-fi	107	watching	76, 83
RxLogger	87	working with	76, 83
RxLogger Utility	88		
		W	
S		WEP	105
screen font size	19	widgets	31
screen rotation	18	adding	32
security	105	wi-fi network	105
setting		wireless local area network	100
camera	57, 59	WLAN	100
settings		WPA	105
ambient display	19		
automatically block sounds	38		
camera photos	57		
camera videos	59		
display	17		
do not disturb	37		

