



Sync.

Smart Home Alarm

Installation Manual

IA-310

IA-320

IA-330

IA-340

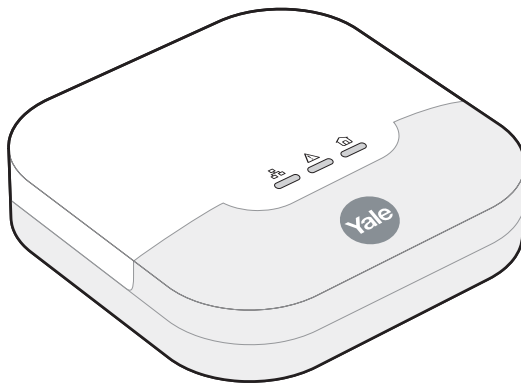

Thank you for choosing the Yale Sync Smart Home Alarm.

This simple to install system has been designed with the user in mind, just follow these simple steps:

Register your product guarantee. Please visit the registration web page and insert the product details. Register your product to get products news and updates.



- 1. Go to Yale web site
www.yale.co.uk/product-registration**
- 2. Complete product information form**
- 3. Activate your guarantee**

Installation Service

Want us to install this product ?

Why not call Yale Smart Security Partners and let a professional installer take care of the rest.

Choose your package online at
www.yalestore.co.uk/installation



Choose your package.



Agree a Date & Time



Enjoy your professionally installed Yale product!

Install your system in a few easy steps. Please read through all of the steps shown below and then follow the detailed instructions in the following pages. See your product box for kit content information

1 Unboxing

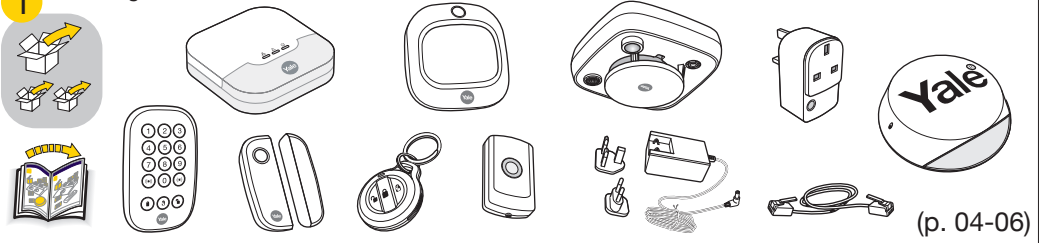

2 Location planning

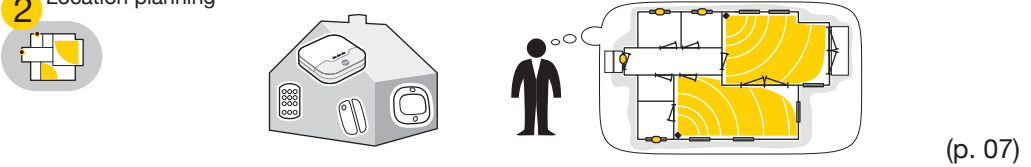

3 App. download

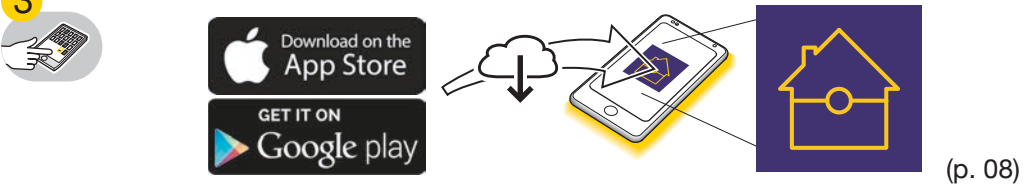

4 Smart Hub Installation

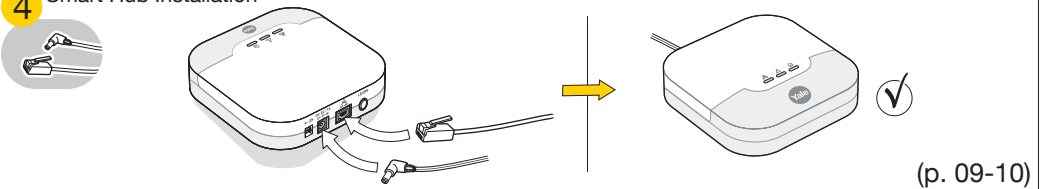

5 Device activation

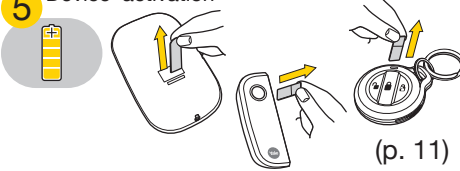

i Battery install / replacement

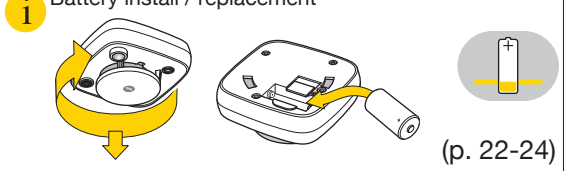

6 System setup

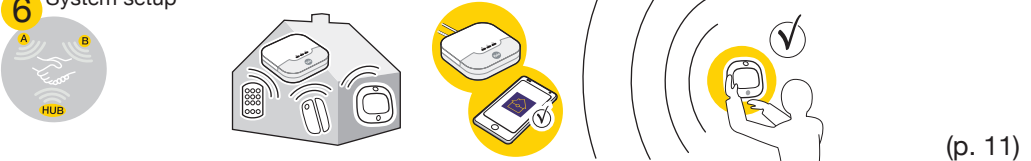

7 Installation

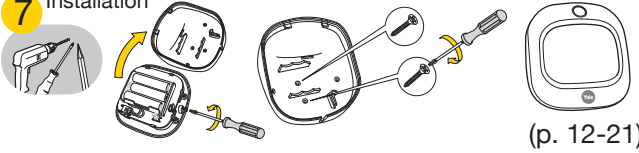

8 App. setup / operations



All the devices in this kit are pre-paired for easy installation. If you are adding more devices (purchased separately to this kit) you will need to pair these into the system separately (see page 18)



1

Smart Hub
IA-HUB

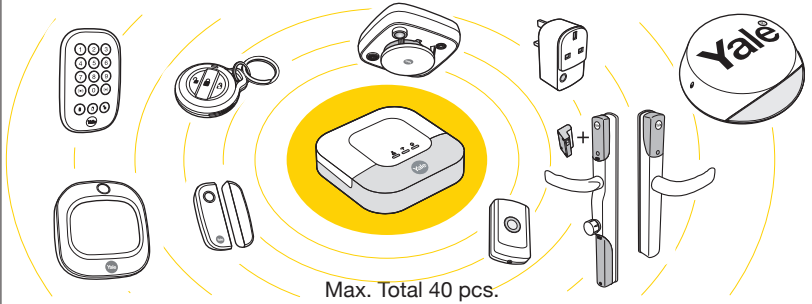

Keypad
AC-KP

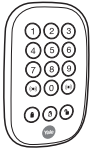

How to Disarm	+ PIN CODE
How to Part-Arm	
How to Full-Arm	



Panic buttons press/hold
>3sec.<

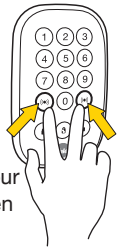

Panic Buttons can activate your alarm immediately - even when the system is disarmed.

Door/Window
Contact
AC-DC

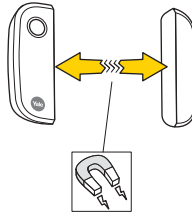
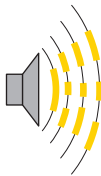

Motion Detector
AC-PIR

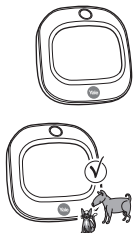

Motion Detector
Pet Friendly
AC-PETPIR

AC-PIR

~ 1.8
2.1m

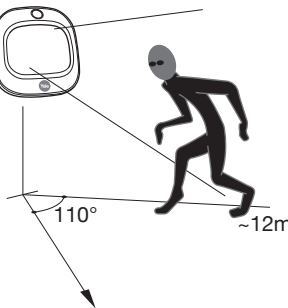

AC-PETPIR

~ 1.8
2.1m

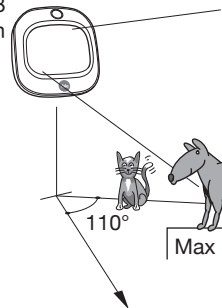

Max < 27 kg

All the devices in this kit are pre-paired for easy installation. If you are adding more devices (purchased separately to this kit) you will need to pair these into the system separately (see page 18)

1



Keyfob
AC-KF

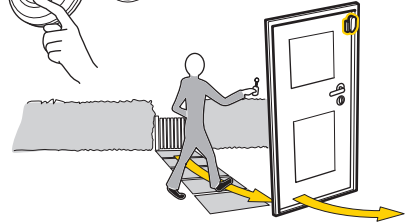

Panic Button
AC-PB

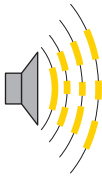

>3sec.<
Hold



Smoke Detector
+ Motion / Heat
Detection
AC-PSD

Smoke detection

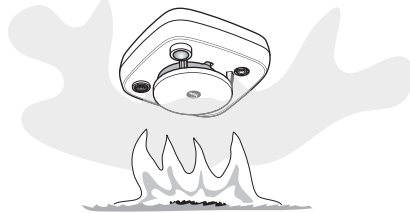
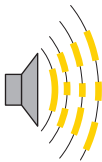

PIR / Heat detection function

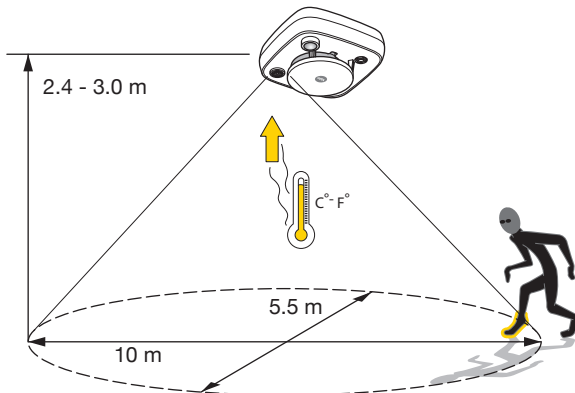

Temperature Detection

The Temperature Sensor will transmit temperature signals regularly according to setting. The factory default interval is 10min

- The Smoke Detector will also send temperature signal when temperature changes by +/- 2°C.
- You can also press the Test Button once to transmit a temperature signal manually.
- The temperature detection range is about -10°C ~ 50°C. (14°F ~ 122°F)

(06)



1

All the devices in this kit are pre-paired for easy installation. If you are adding more devices (purchased separately to this kit) you will need to pair these into the system separately (see page 18)

Smart Plug
AC-PS

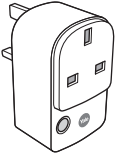

ON / OFF

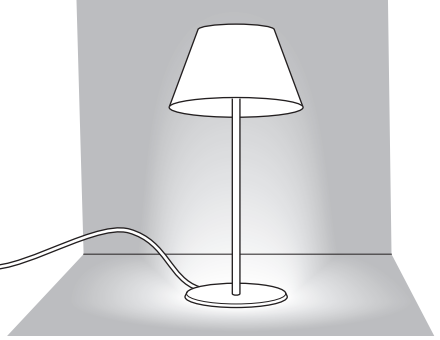
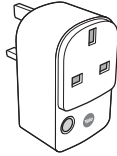

Conexis L1
Smart Lock
+
Sync Lock
Module AC-LM

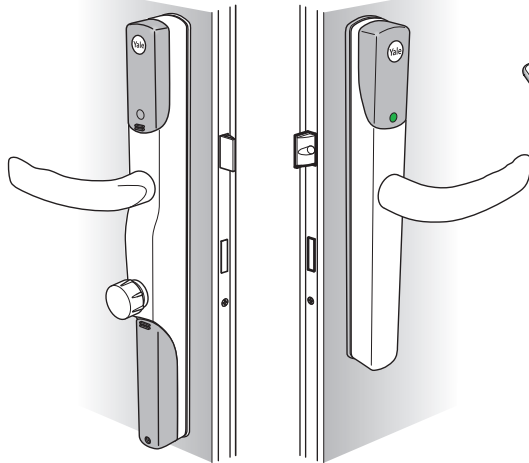
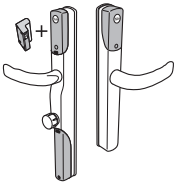

i

Most of the devices are provided with either internal or external security tamper mechanism, please make sure the tamper spring is fully compressed when you install the devices.

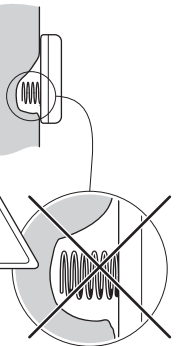
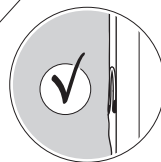
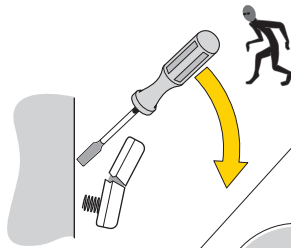
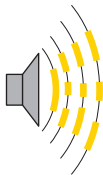

Plan your system: Before beginning the installation process, take some time to plan your system, decide where you want to locate the devices.

2

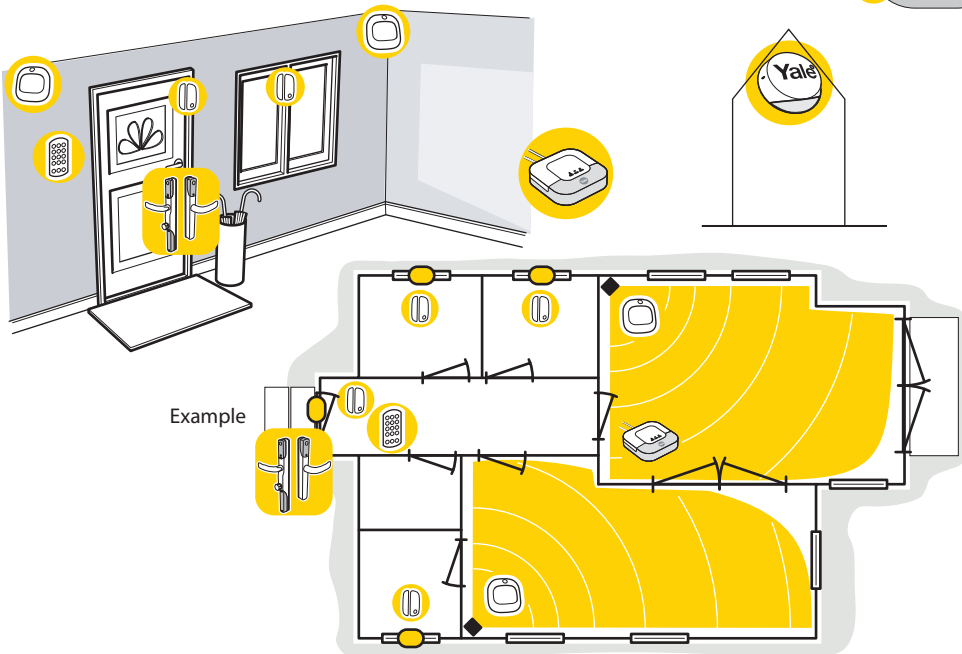

Example

Location tips:

- 1. Keypad should be accessible from a protected entry/exit point. Ensure that the Keypad is not visible from the outside of the premises.
- 2. Mount Door/Window Contacts as high as possible on the door / window frame.
- 3. PIR Motion Detectors should be located in the corner of the room to maximise coverage. Do not point directly at a source of heat (eg.fires or boilers), facing a window or a door protected by a Door/Window Contact. Avoid installing directly above radiators.
- 4. If you have Pets that may climb on furniture, avoid using PET PIR Motion detectors as this can cause false alarms. Instead replace with additional Door/ Window Contacts.
- 5. Mount the external siren as high as possible on an external wall.

Plan Your home

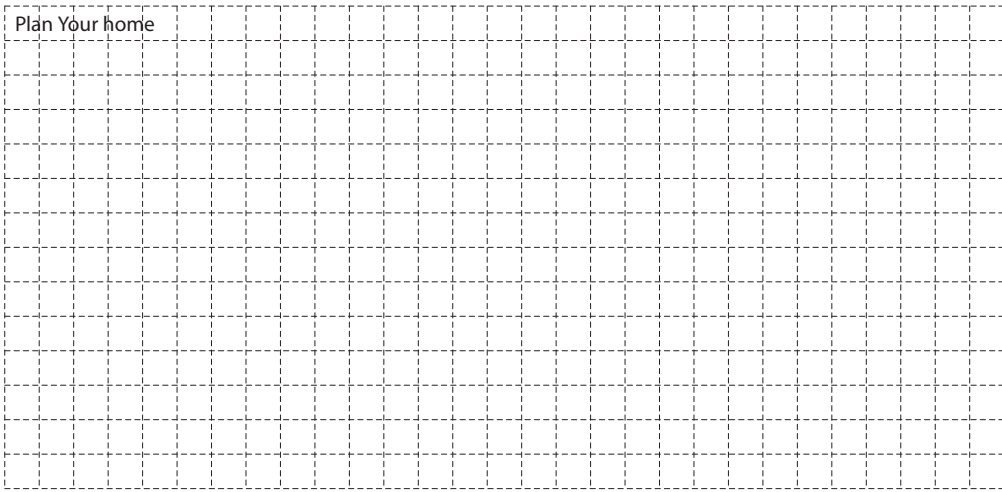



3

Yale Smart Living Home

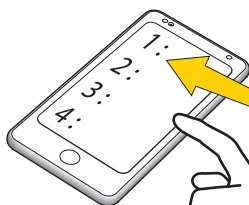
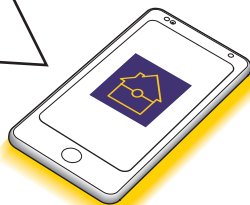

Serial No.

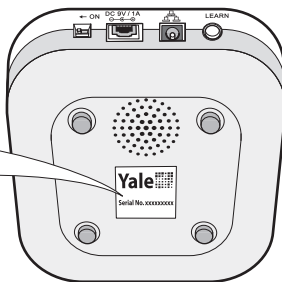

i

Please register the hub within one hour of power up, otherwise the app "authentication error" will appear. Re-boot the hub(including switch off/on the back up battery) and start the process again if necessary.



Smart Hub connection

4

1

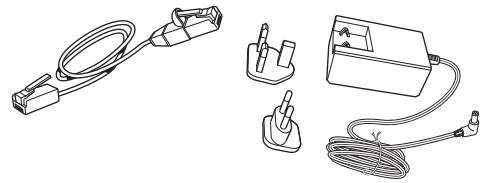
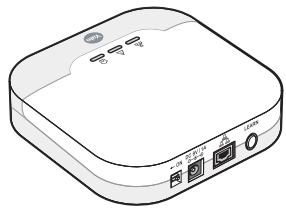

2

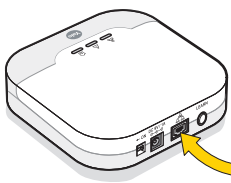

3

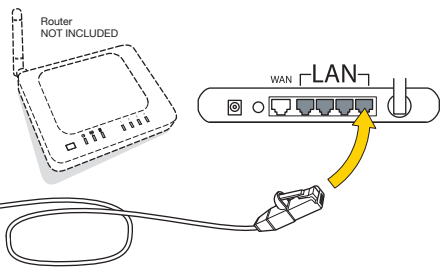



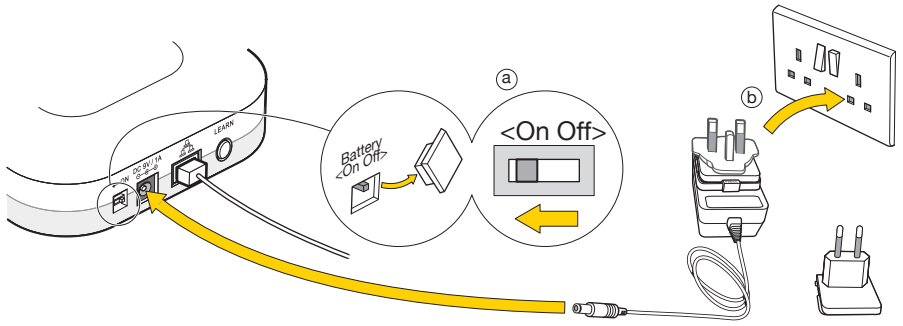

4

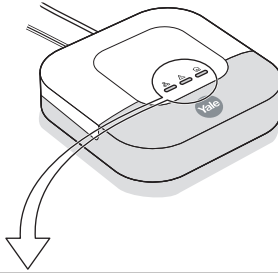
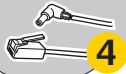

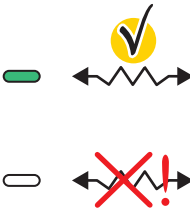
Smart Hub connection

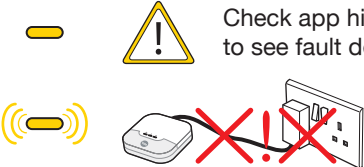

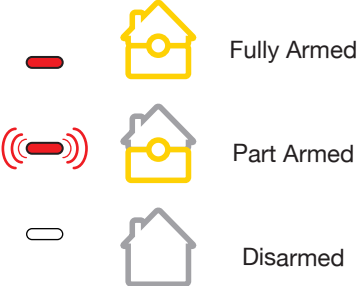
<p>Network</p>  <p>Shows server connection status</p>	 
<p>Fault Status</p>  <p>Shows fault status and AC failure warning</p>	 <p>Check app history log to see fault details.</p> <p>System normal.</p>
<p>Alarm Mode</p>  <p>Shows arming status</p>	 <p>Fully Armed</p> <p>Part Armed</p> <p>Disarmed</p>

Re-boot

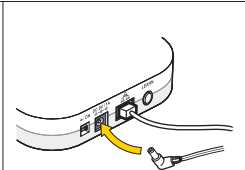
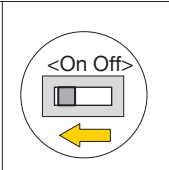
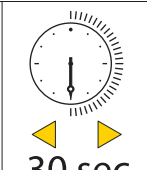
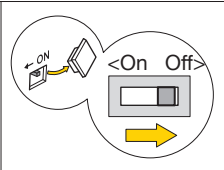
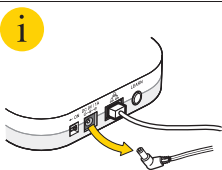

5 6



5

Remove battery strips

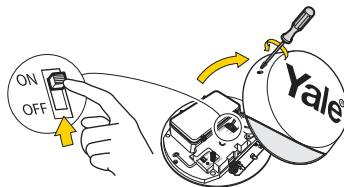
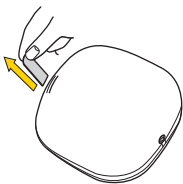

Test your planned location of components

~ 200 m



Press button to test connection

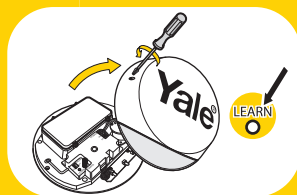

6

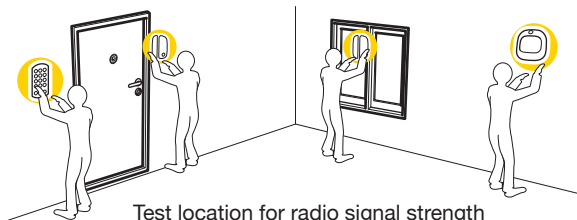

Test location for radio signal strength

Installation



7

1

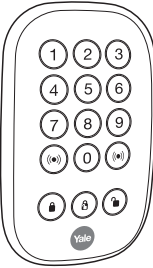

2

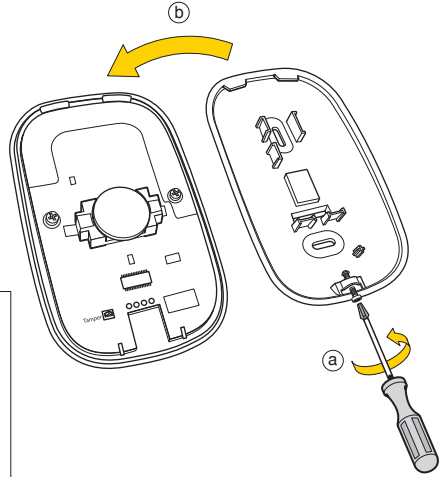

3

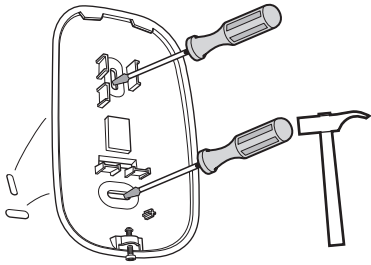

4

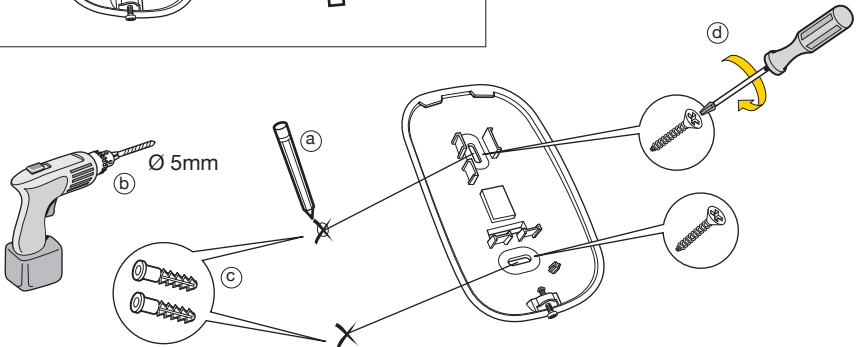

5

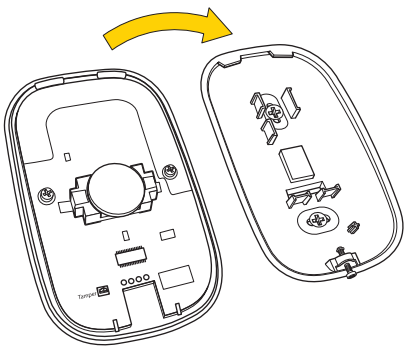

6

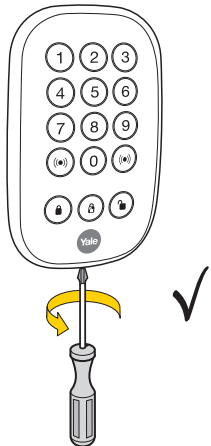

Installation

7

1

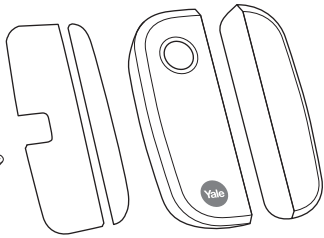

2

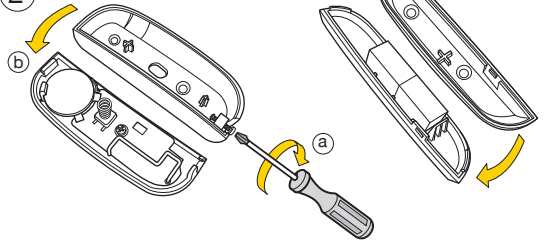

3

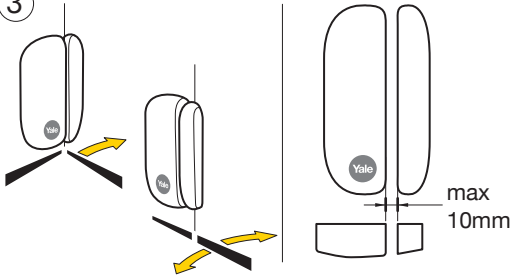

4

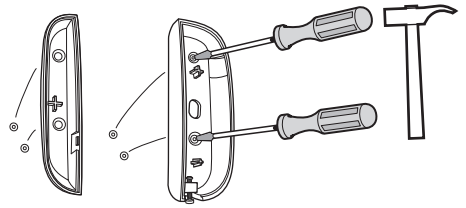

5

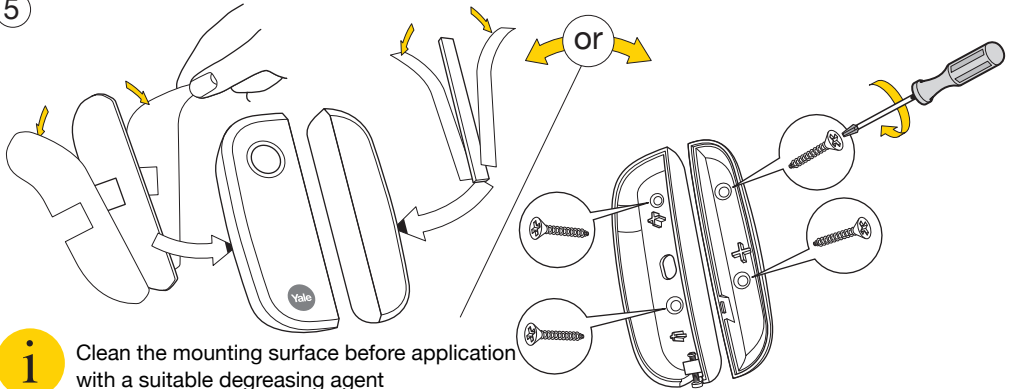

i Clean the mounting surface before application with a suitable degreasing agent

6

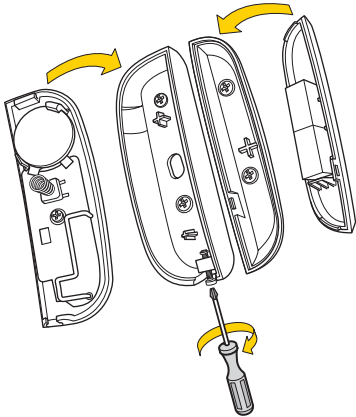

7





7

1



Pair / Test button

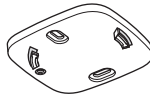

2

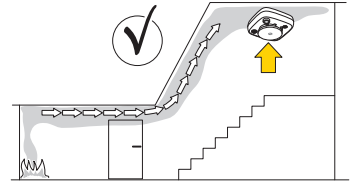

3

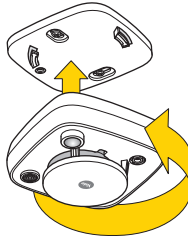
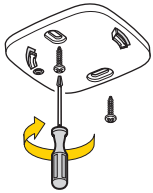

Minimum 60cm

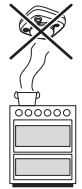
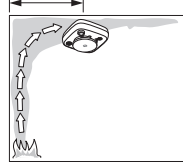

1



Pair / Test button



2

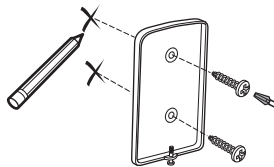
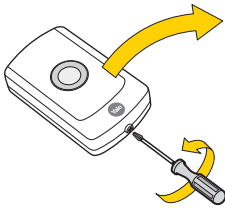

Ø 5mm

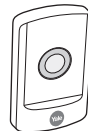

Installation

7

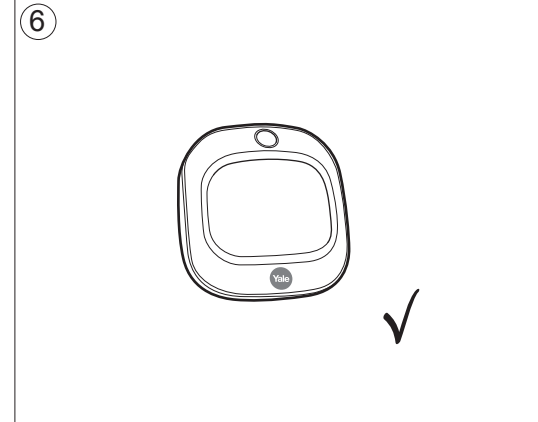
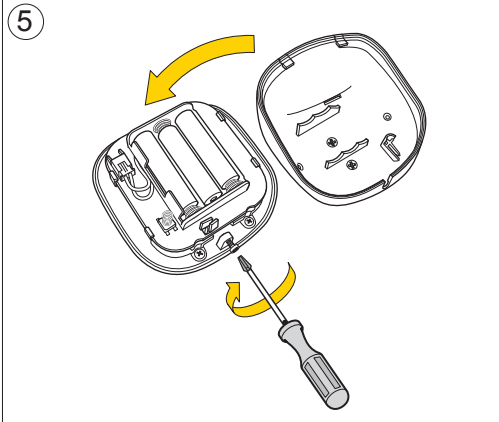
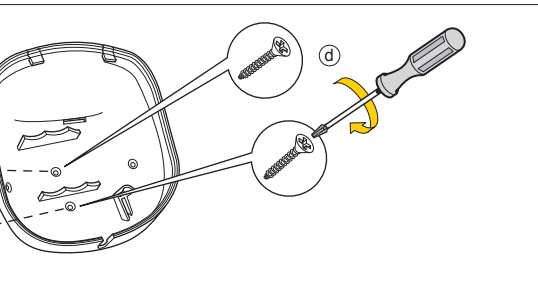
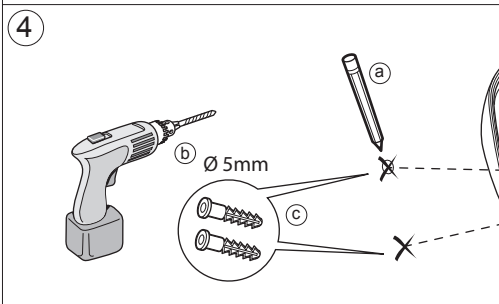
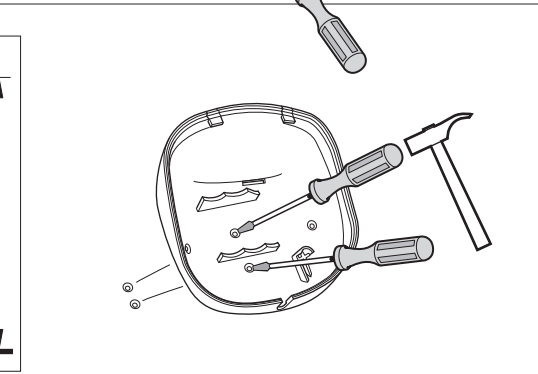
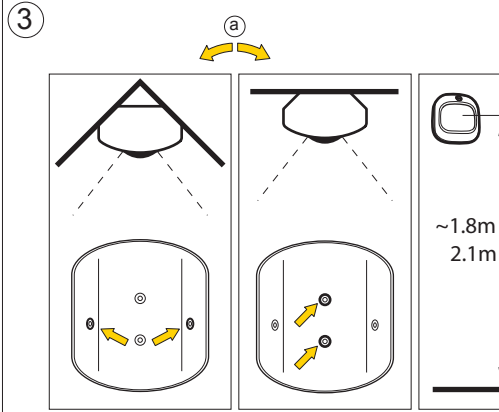
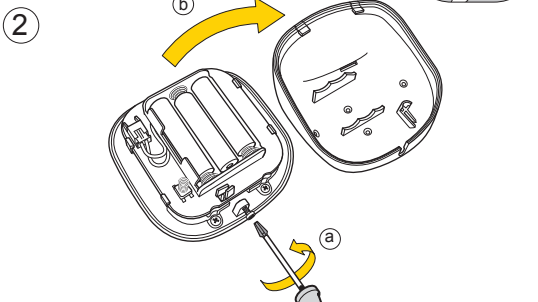
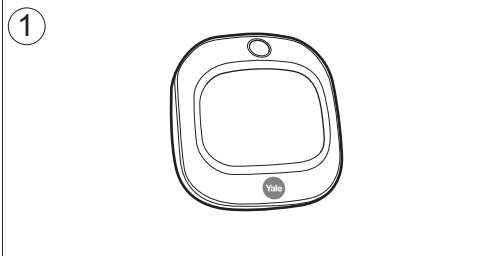



7

①

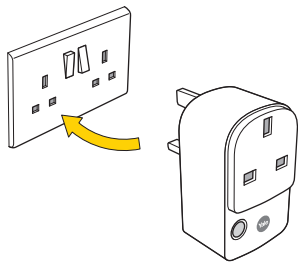

②

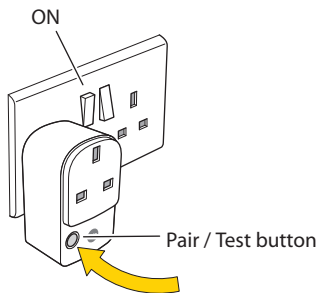

Installation

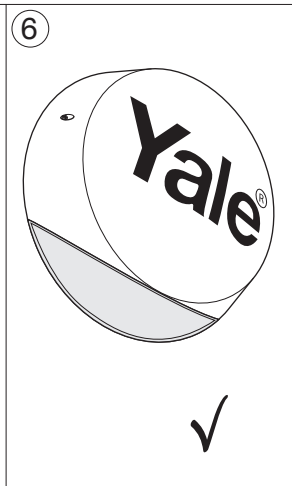
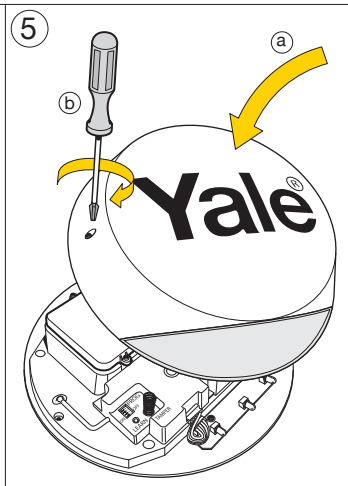
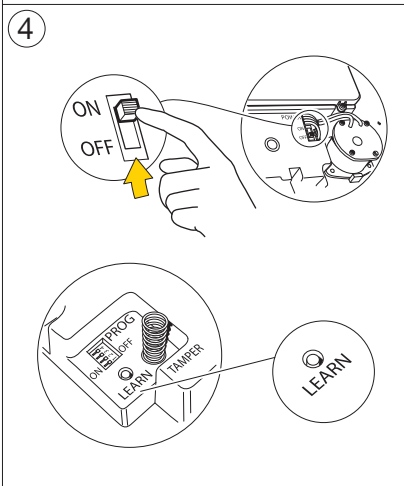
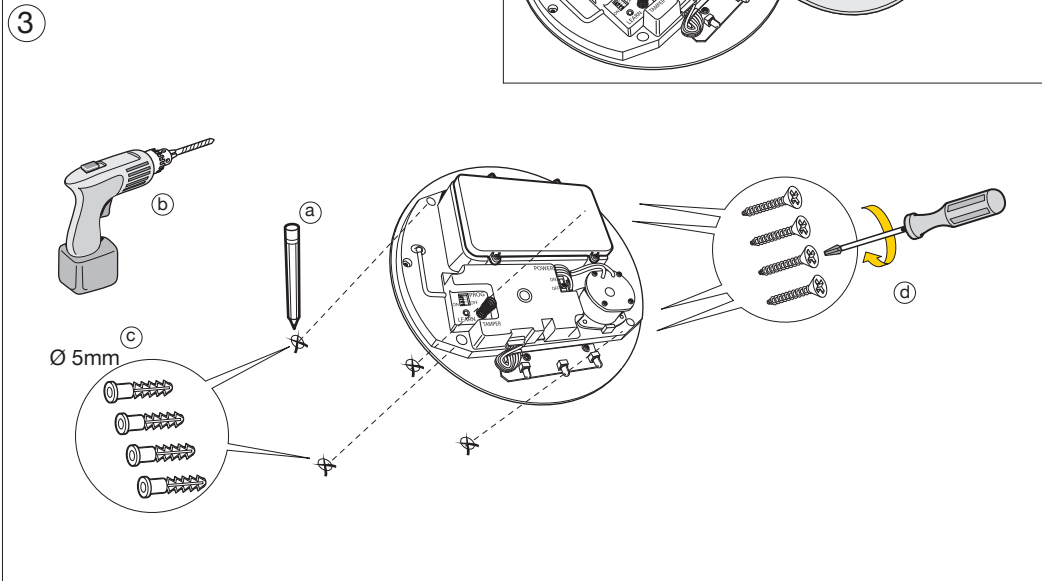
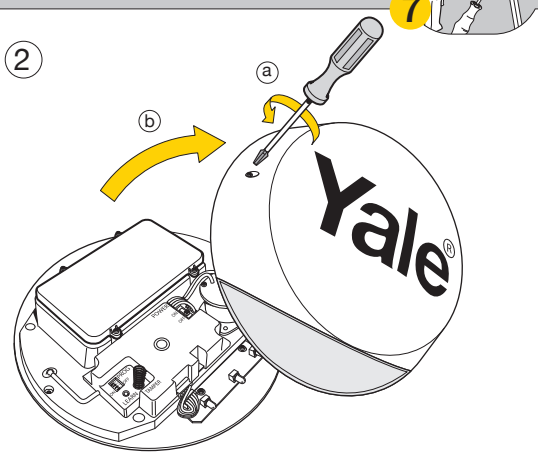
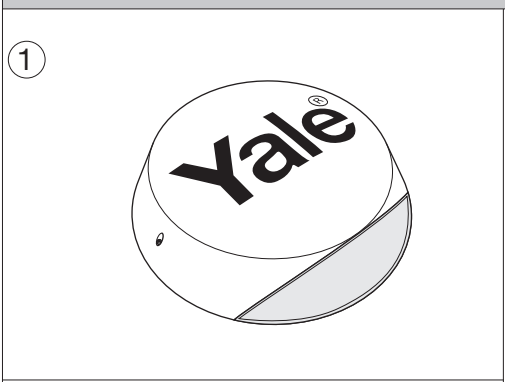



8

All devices in the kit are pre-linked to the Smart Hub. If you want to add more devices, you can do this by using the “Add device” section in the Smart Living Home app.

①

Go to the app menu and select Add Device, then activate learning mode.

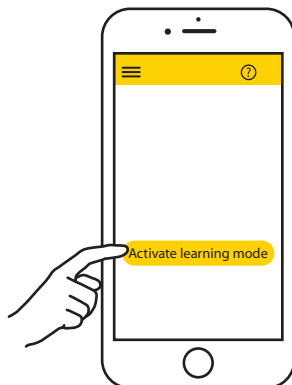

②

Press the learn button on the device you want to add, the Smart Hub will beep when the device is added. You will then see the new device on your app screen.

~ 200 m

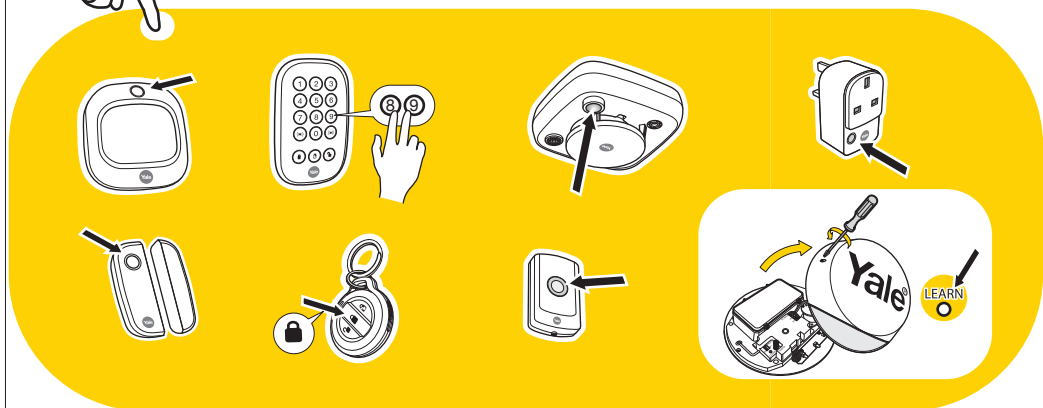
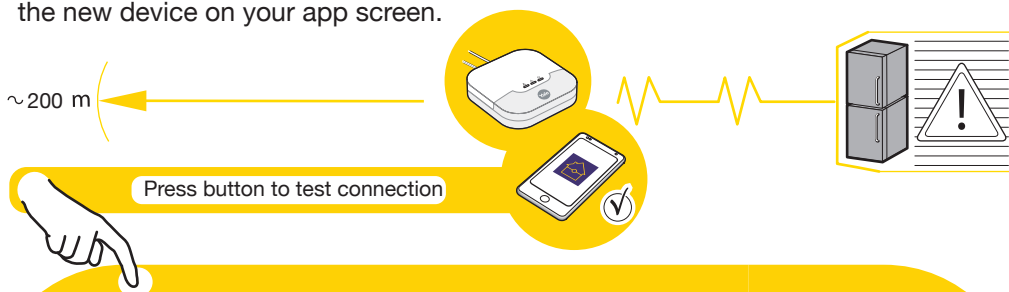

③

Exit Learning mode after you have added all the additional devices.



You can change the device behaviour settings to select the required action when the system is fully armed or part armed.

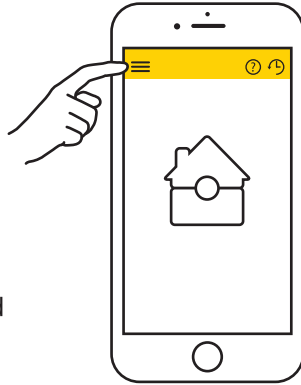

















Go to the App menu

Settings > Alarm settings > Devices

In your device list, go into the settings for each device and select the required device mode.

i 4 different settings are available for PIR Motion Detectors and Door/Window Contacts. Devices are pre-set to Entry. When the system is armed first users will have 30 seconds to exit the building. If the system is already armed, triggering any sensors will cause an entry countdown to begin.

 Part armed mode is usually used to protect the perimeter or a specific zone of the house (eg. ground floor) while you are free to be inside or in another part of the house (eg. upstairs)

			
Burglar			
Entry			
Home Omit			
Home Access			

Key



Sensor Ignored



Instant Siren



Triggers Countdown



8

Changing your Key Pad PIN

You can modify the existing PIN code using the app. You can set up to 10 sets of 4 digit PIN numbers in the app.

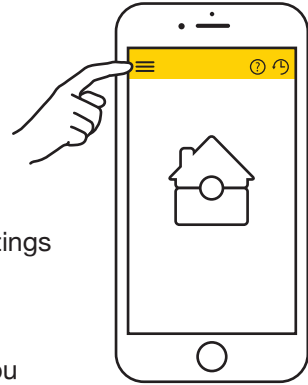

Go to app menu

Settings > Alarm Settings > Key Pad PIN code settings

Adding new users

To add more users to control your alarm system you can add a new account in the app.

Go to app menu

Settings > User Settings > Account Management

Managing Alert Notification

You can manage the different type of notifications, choose to have all events or burglar only reported via email. You can also add phone numbers to receive an SMS notification when burglar event is reported.

Go to app menu

Settings > User Settings > Notification settings
Settings

i If you want to know more about your Home App features, check our app manual sections within the app. (select the ? at top right of the screen you need help with)

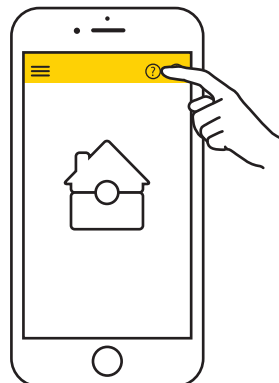

Changing batteries



i The smart hub will start to emit an intermittent beep to indicate that the batteries need changing on one of your devices. The hub will continue to beep until the batteries on this device have been replaced.

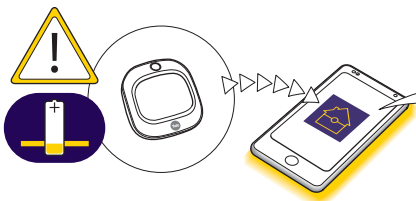

LOW BATTERY

The App will display a low battery message under the relevant device when batteries are running low.

Please make sure the system is disarmed before changing devices batteries.

AC-KP

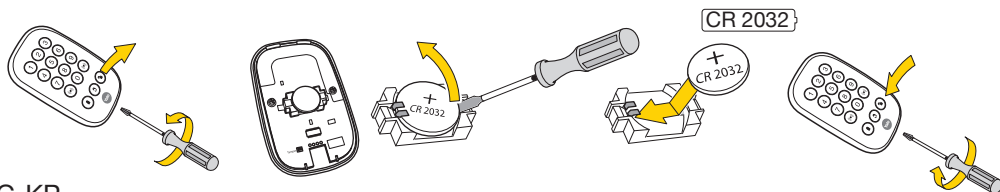

AC-DC

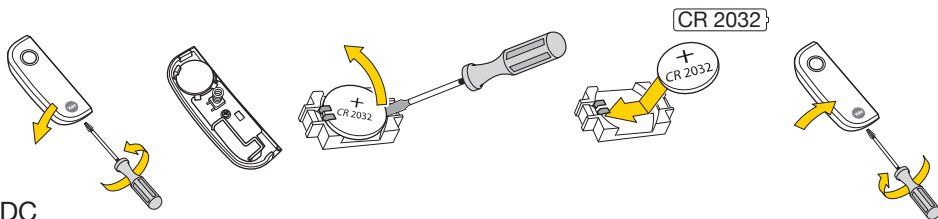

AC-PIR

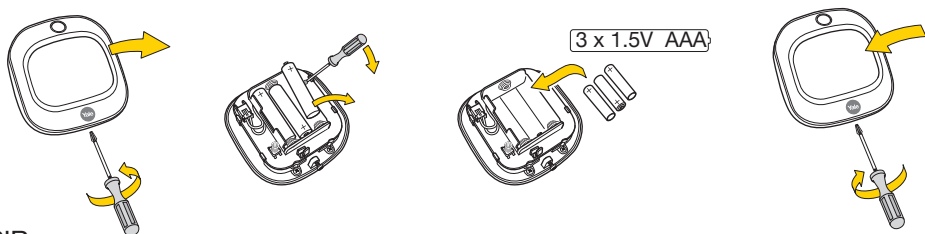

AC-PB

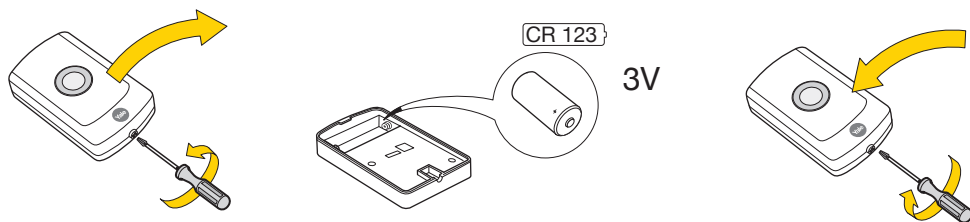

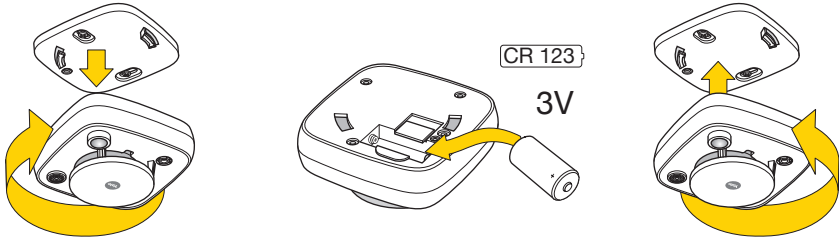

AC-PSD

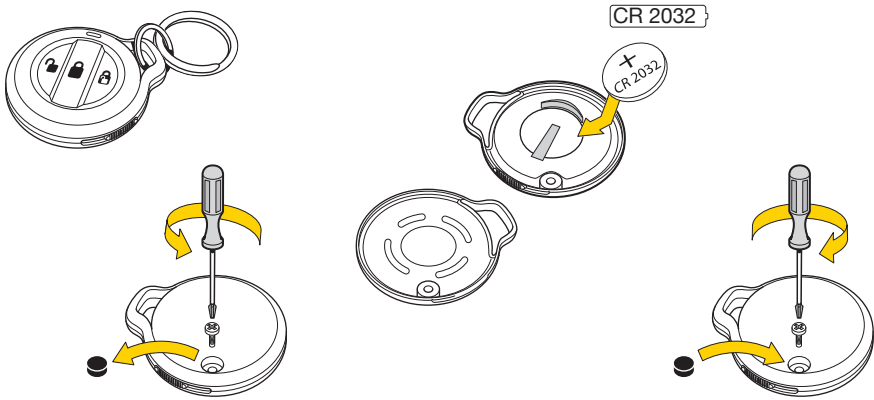

AC-KF

i When batteries start getting low the siren will produce a series of audible beeps and flashing when arming and disarming.

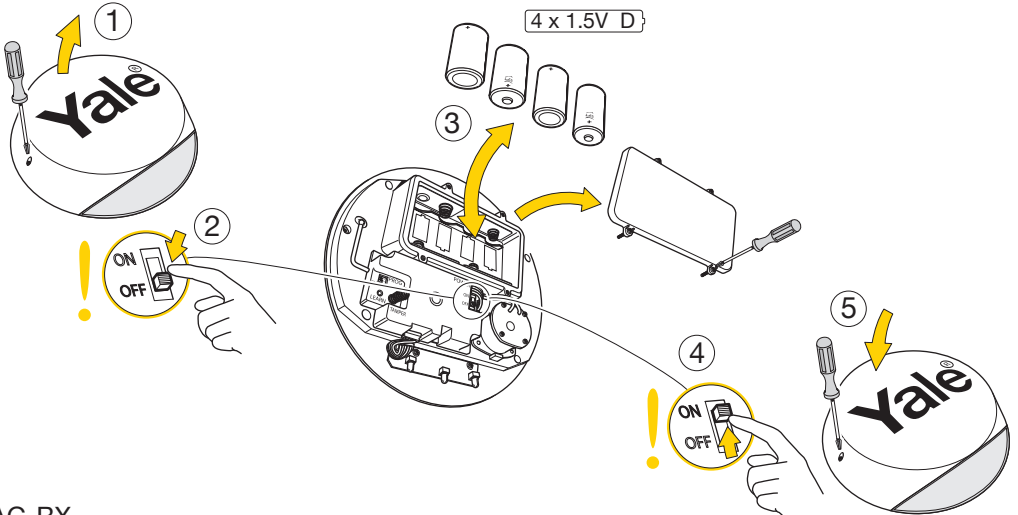

AC-BX

Congratulations you have completed the Yale Sync Smart Home Alarm installation.

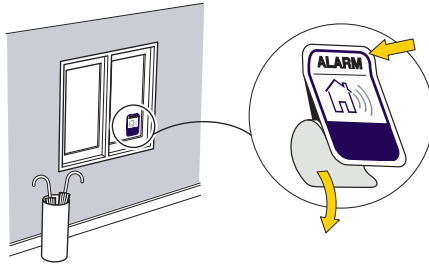

Hereby, ASSA ABLOY Ltd., School Street, Willenhall, West Midlands, England WV13 3PW declares that the radio equipment type IA-310, IA-320, IA-330, IA-340 is in compliance with Directive 2014/53/EU. The full text of the EU declaration of conformity is available at the following internet address:
www.yale.co.uk/declaration-of-conformity

The smart phone feature requires our central server. Yale offers no guarantee on the availability of our server. Yale cannot guarantee limitless availability of our free server. We would contact individual users via e-mail should this situation change. Alarm Notification functions must only be used with people who have consented to being contacted by the system. Information and illustrations are subject to changes within this document. Yale reserved the right to alter the specifications and product design at any time without notice.

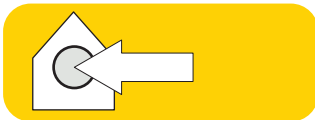

All devices
Housings ABS/polycarbonate



-10°C to 40°C



70%

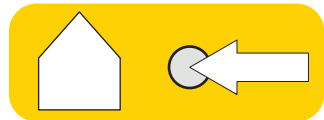

Outdoor Siren



-20°C to 50°C



95%



Customer Support

At Yale, we know the importance of providing security products that are easy to install and use.

However, should you have any questions or experience a problem with your purchase, please visit www.yale.co.uk/help



YaleUK



YaleSecurity



YaleSecurityUK



PACKAGING



FR

THE YALE BRAND, with its unparalleled global reach and range of products, reassures more people in more countries than any other consumer locking solution.

THE ASSA ABLOY GROUP is the world's leading manufacturer and supplier of locking solutions, dedicated to satisfying end-user needs for security, safety and convenience.

An ASSAABLOY Group brand

ASSA ABLOY