

# PDM 08

User Manual



## Summary

1. The PDM 08 .....	3
2. Connections.....	4
2.1 AMP connectors .....	5
2.2 Surlok connector.....	5
2.3 Rosenberger LVDS connector .....	6
3. Standard compliances .....	6
4. Installation .....	7
5. Status LEDs .....	7
6. Inputs.....	8
6.1 Analog Inputs.....	9
6.2 Digital Inputs.....	9
7. Power Outputs.....	11
7.1 Power Outputs protections .....	13
7.2 High Power Output 1 Protection diode .....	13
7.3 Freewheeling protection diode .....	14
8. Powering .....	15
9. Other devices.....	16
9.1 Display .....	16
9.2 GPS .....	17
10. Software Race Studio 3.....	18
11. PDM08 Configuration .....	18
11.1 Channels and Variables .....	19
11.2 Input Channels Configuration.....	20
11.3 Analog inputs configuration .....	21
11.4 Digital inputs configuration .....	22
11.5 Other internal sensors and channels.....	23
11.6 Math channels configuration .....	23
11.7 Status variables configuration .....	24
11.8 Trigger commands.....	26
11.9 Power Outputs configuration .....	27
11.10 Power Output related channels .....	29
11.11 PWM.....	31

11.12	Square Wave.....	33
12.	ECU Connection and configuration .....	34
13.	CAN2 Stream configuration.....	35
14.	CAN Expansions configuration .....	36
15.	Icons manager configuration.....	37
16.	Display configuration.....	39
17.	Shift Lights and Alarms configuration.....	41
17.1	Shift Lights .....	41
17.2	Alarm LEDs configuration .....	42
18.	SmartyCam stream setting .....	44
19.	Managing a track with Race Studio 3 .....	45
20.	ECU Driver builder  .....	47
21.	The device window .....	53
	Online measure values forcing .....	54
22.	CAN Output configuration.....	56
	Appendix A – Connectors and Pinout.....	57
	Appendix B – Mechanical Drawings .....	58

## 1. The PDM 08

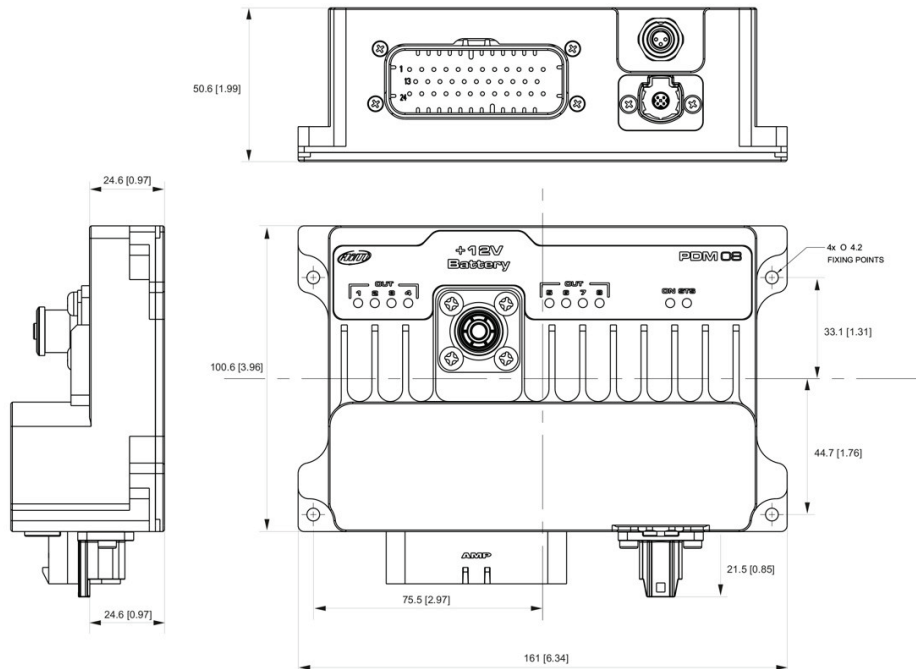

The PDM 08 is a multifunctional integrated device, designed to manage a good number of important features in a modern race car:

- **Power Module:** it powers the different electrical devices in the vehicle such as solenoid, pumps, fans, lights, and electronic devices such the ECU.
- **Dash controller:** the dash, in installations with the PDM 08, becomes a very simple and inexpensive device, connected to the PDM through a 1.5 GHz LVDS cable.
- **Automatic Lap Timer:** thanks to the high precision GPS Module and a huge database of thousands of maps all over the world, the lap time is automatically calculated, shown in the display and recoded for future evaluations
- **Datalogger:** the PDM08 has a huge 4 gigabytes not volatile memory, that allows to record not only all the data coming from the sensors, from the ECU, from the expansions, but also all the current consumption of all the Power Outputs. The data are correlated with the position on the track, with the map of the track and, eventually, with the images recorded by the video camera SmartyCam

The PDM 08 should only be configured and installed by qualified personnel as to ensure the correct wiring and connections for all the inputs and outputs. High levels of current are present and can result in overheating and may cause risk of damage or injury to personnel and/or equipment, if not installed correctly.



## 2. Connections

The PDM 08 has 5 connectors:

- 1 Surlok Power Connector to connect to the +V battery
- 1 Rosenberger LVDS connector to connect the display (6" or 10")
- 1 35 pins AMP connectors
- 1 3 pins Binder connector for the connection to the USB port

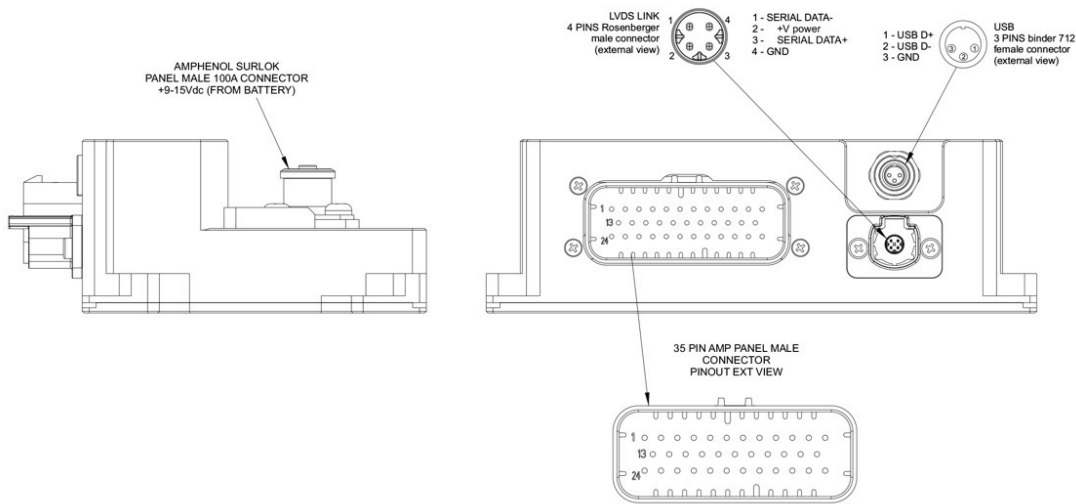

PIN	DESCRIPTION	PIN	DESCRIPTION
1	Power out 1	19	CAN2H
2	Power out 2	20	CH IN 3
3	CAN AiM H	21	CH IN 4
4	Power out 3	22	+5VREF
5	CAN ECU L	23 ●	Power out 8
6	Power out 4	24 ●	LIN
7	Power out 5	25	IGN
8	CH IN 1	26	+VB out CAN
9	Power out 6	27	GND
10	CH IN 2	28	Speed 1 IN
11	Power out 7	29	Speed 2 IN
12 ●	Power out 8	30	CH IN 5
13	Power out 1	31	+5VREF
14	+VB ext CAN	32	+VB out
15	CAN AiM L	33	CH IN 6
16	CAN ECU H	34	GND
17	GND	35	GND
18	CAN2L		

● High Power Out 8 has internal serie diode

Loom wires and connectors pin selection are very important. Be sure to select wire size according to load current specification.

## 2.1 AMP connectors

---

35 PIN AMP PANEL MALE  
CONNECTOR  
PINOUT EXT VIEW

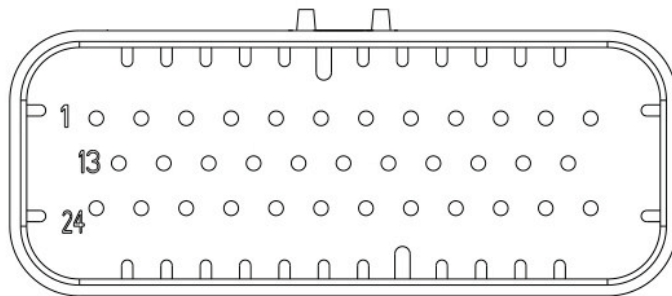

PDM 08 connector mate with AMP 776164-1 (black).

Connector terminal: AMP 770520-3. This is the gold-plated version rated up to 17A.

Wire sizes qualified for this terminal are: 20AWG, 18AWG, 16AWG.

## 2.2 Surlok connector

---



Connection to POWER is made by a Surlok connector, Amphenol SLPRATPSO.

This connector is rated up to 120A and can manage wire from 16mm<sup>2</sup> to 25mm<sup>2</sup>. Mating part code is SLPPA25BSO and both are IP67.

An advantage of this type of connection, is that the user does not require any special tools to make a connection or disconnection between the two. As they feature an automatic quick lock and press-to-release function

## 2.3 Rosenberger LVDS connector

---



PDM has an external high-speed link used to manage remote display. This link is realized by AIM custom cable (FCCA 682000). Link transmits to remote display the TFT information and the status LEDs activity. On the other side receives from remote display light sensor data and push buttons status. Same link is used also to power the remote display making a simple and reliable connection. Rosenberger connectors allow high immunity noise levels and IP67 class connection.

### **Mechanical data**

Mating cycles  $\geq 25$   
Engagement force  $\leq 30$  N  
Engagement force waterproof  $\leq 40$  N  
Disengagement force  $\geq 5$  N  
Retention force latch  $\geq 110$  N  
Retention force primary lock  $\geq 80$  N  
Retention force secondary lock  $\geq 60$  N  
Polarization feature effectiveness  $\geq 80$  N

### **Environmental data**

Temperature range  $-40$  °C to  $+105$  °C  
Thermal shock IEC 60068-2-14  
Vibration IEC 60068-2-64  
Mechanical shock IEC 60068-2-27  
Temperature and humidity USCAR 2-4 5.6.2 Dry heat IEC 60068-2-2

## 3. Standard compliances

---

PDM complies with the following standards:

- ECE Regulation No.10 Add.9 Rev.5
- IEC 61000-4-2 exceeds level 4 - 30 kV (air discharge) - 30 kV (contact discharge)
- ISO10605 – C = 330 pF, R = 330  $\Omega$  - 30 kV (air discharge) - 30 kV (contact discharge)
- ISO 7637-2:
  - Pulse 1: VS = -150 V
  - Pulse 2a: VS = +112 V
  - Pulse 3a: Vs = -220 V

- Pulse 3b:  $V_s = +150\text{ V}$
- Formerly pulses 5a and 5b
- ISO 16750-2 - Tests A and B

## 4. Installation

---

A PDM manages current values that may be rather high, and its temperature strictly depends upon the total load current. It must be installed in an aerated area and far from hot parts.

## 5. Status LEDs

---

The PDM 08 has 8 status LEDs, one for every power output:



- GREEN: the output is enabled, and its status is OK
- RED: the output status is in alarm mode i.e. short circuit, open load, etc...
- OFF: the output is not active.

There are also 2 additional LEDs: ON and STS (Status).

ON is green when PDM is active.

STS may be:

- GREEN: everything is OK.
- YELLOW SOLID:
  - Ext battery voltage value is between 9V and 11V or between 15V and 16V
  - Internal temperature of PDM is between 70°C and 85°C
- RED SOLID:
  - Ext battery voltage value is between 8V and 9V or over 16V
  - Internal temperature of PDM is over 85°C
  - Any of internal peripheral not working properly
- RED BLINKING:
  - Ext battery voltage value is under 8V. This causes power outputs to be disabled to avoid system malfunction.

## 6. Inputs

---

The PDM08 has the following input channels:

- **1 Ignition input:**

**IGNITION INPUT:** this is a special input, only digital and not programmable by user. It is active HIGH (internal pulldown hardwired) and when activated by external voltage, switch ON the PDM. Some functionality, for example display, are IGN dependent. This means that when IGN is active, also display is switched ON. Ignition could be used in user configuration as condition for other signals.

### Ignition Input Example application:

IGN connected to Main switch and CH\_IN6 connected to Hazard switch. With IGN active (+12V) all functions on PDM are enabled. With IGN off (disconnected or tied to GND) and Hazard switch active (+12V) PDM enables only outs related to HAZARD function (typically front and rear directions lamps in hazard blinking mode).

- **6 channels (CH\_IN1 - CH\_IN6):** can be both analog and digital in dependence upon the configuration (please, refer to the paragraph "Input channels configuration).

If they are configured as analog, a 2KOhm pull-up can be activated.

If they are configured as digital, it is possible to activate an internal pull-up or pull-down depending on whether they are closed to ground or closed to VBatt.

**The input channel CH\_IN6, when connected to VBatt, can activate the PDM without turning on the display. This can be useful for activating the Hazard, or keeping a fan on even with the engine off until the temperature reaches a correct value etc.**

- **2 speed inputs**

## 6.1 Analog Inputs

---

The Analog Inputs may acquire any source in the different ranges:

0-50 mV

0-500 mV

0-5V

0-12V

In case an input is configured as Analog Input, you may enable an internal 2kOhm pull up resistance, as shown in the following picture:

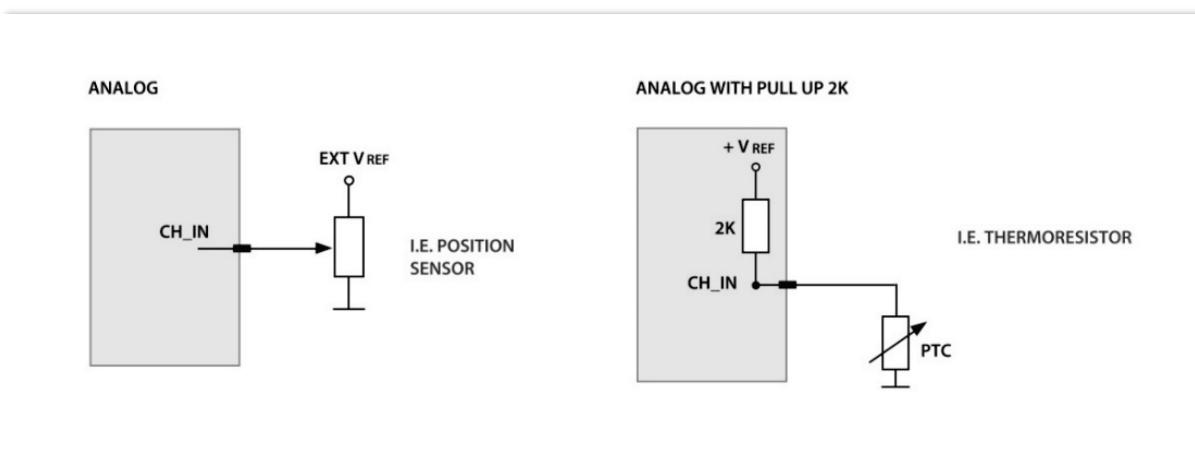

## 6.2 Digital Inputs

---

In case an input is configured as **Digital input**, it is possible to enable an internal pull-up or pull-down resistance, depending on whether they are closed to ground or closed to VBatt, as shown in the following picture

DIGITAL PULL UP

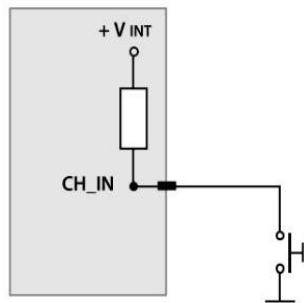

I.E. SWITCH  
TO GND

DIGITAL PULL DOWN

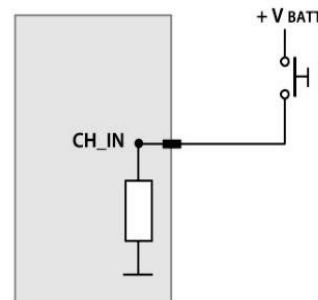

I.E. SWITCH  
TO BATT

Most of the time, a Digital Input is connected to a pushbutton: the PDM offers different ways of managing it. As explained in the “Digital Input Configuration” paragraph, it is possible to manage the input in order to produce momentary, toggle or multistable channels

- **Momentary:** the channel is active when the pushbutton is closed
- **Toggle:** the channel is activated the first time you close the circuit and deactivated the second time the circuit is closed as shown here below
- **Multistable:** Each time the connected button is pressed, the channel value changes from 0 to N (this value depends on the configuration), then returns to 0.

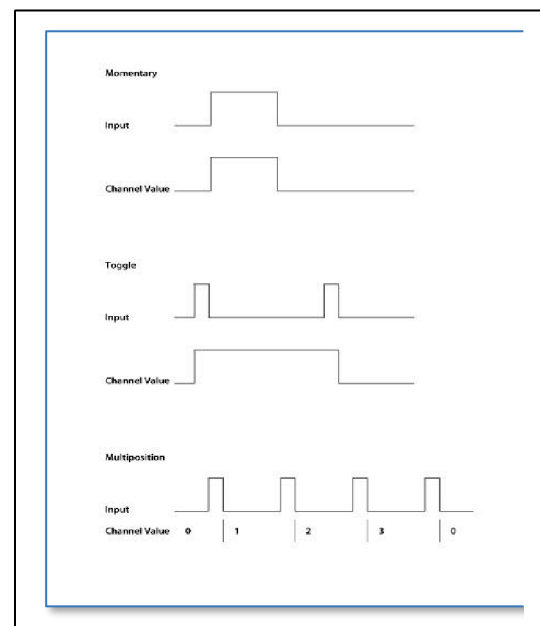

## 7. Power Outputs

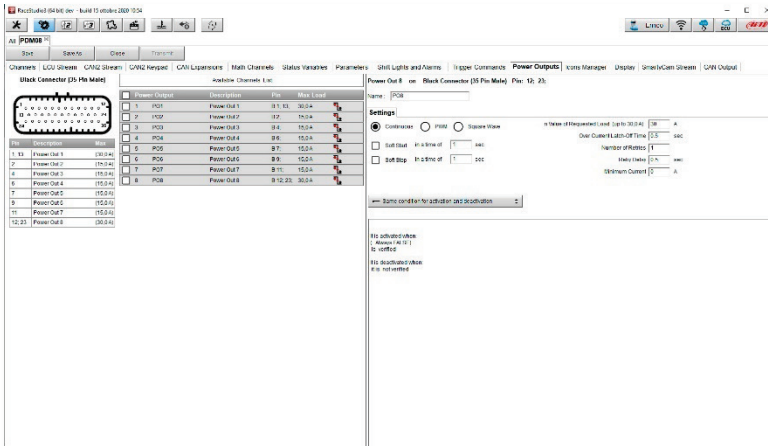

The PDM08 has 8 High Side power outputs

The max current that the PDM 08 may load is 100A.

**Please, note that high level of continuous current can overheat the PDM if not properly installed.**

The outputs are divided into the following groups:

- **H1**: capable of delivering a maximum current of 25A continuous and up to 100A inrush current.
- **H2-H7**: capable of delivering a maximum current of 15A continuous and up to 100A inrush current.
- **H8**: capable of delivering a maximum current of 20A continuous and up to 100A inrush current.

**H8 has a diode series to prevent reverse current from load. This output could be used for example to directly drive a Starter.**

All power outputs have an internal freewheeling diode that allow to connect high inductive loads, i.e. Solenoids

All the outputs can be activated as **PWM**, with variable duty cycle with a fixed frequency of 100 Hz

All outputs can then be managed as a square wave, with configurable Time ON and Time OFF, from 0.1 to 10 sec

The management parameters of each single output are:



Name :

**Settings**

Soft Start in a time of  sec

Soft Stop in a time of  sec

PWM based on frequency of 100 Hz

Maximum Value of Requested Load (up to 15.0 A)  A

Over Current Latch-Off Time  sec

Number of Retries

Retry Delay  sec

Minimum Current  A

Check Open Load in Off State

← Same condition for activation and deactivation ⇅

For every output user can set:

- **MAX continuous current:** this is the trip level of cut off current. After Over Current Latch-off Time the output will be disabled
- **Over Current Latch-off Time:** during this period, we allow current over MAX selected by user
- **Number of Retries:** after latch-off occurred, pdm retries to activate out up to this setting value
- **Retry Delay:** time between retries
- **Minimum current:** this is the low level of current allowed. Lower value activates the alarms for Open load
- **Soft Start and Soft Stop** are useful to reduce high inrush current. These settings perform a first stage activation with PWM going from 0 to 100% and viceversa in deactivation. User could also set a duration time for this mode. In case of PWM mode selected on this out, soft start reaches user PWM value.

## 7.1 Power Outputs protections

---

Every output is protected against:

- over voltage
- under voltage
- short circuit
- over current
- over temperature

Please, refer to the paragraph “Power Output related channels” for further information

Every output channel has two related channels showing Status and Current.

The High-Power Output 8 has an internal diode in series

All power outputs have an internal freewheeling diode protection

## 7.2 High Power Output 1 Protection diode

---

H8 output of PDM is a dedicated output protected by a series diode. This diode could be very useful to power devices that, when activated, can generate a current toward the PDM. Of course, H8 output could anyway be used as a standard High Side output.

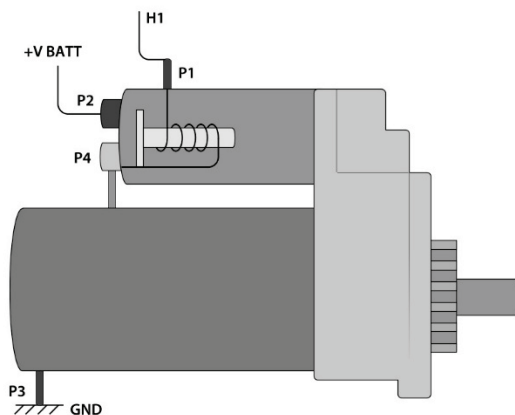

A typical example of a device that needs such a protection is the starter motor. During the starter activation, a current flow from the PDM output to P1 of Starter. From P1 current goes to GND through the internal aux solenoid to P4 and then through the main solenoid to P3. During this phase, the internal aux solenoid closes the main switch of starter, connecting P2 to P4.

The starter motor now is activated and its rotation switches ON the vehicle Engine.

When the engine is ON, PDM out must be disabled. Internal diode block reverse current that would flow from P4 (shorted to P2) to P1 and finally to PDM out.

Without internal series diode, this reverse current flows into PDM out and keeps the starter motor engaged.

### 7.3 Freewheeling protection diode

All the Power Outputs have an internal freewheeling protection diode. The picture here down shows what happens when a power output turns off a high inductive load:

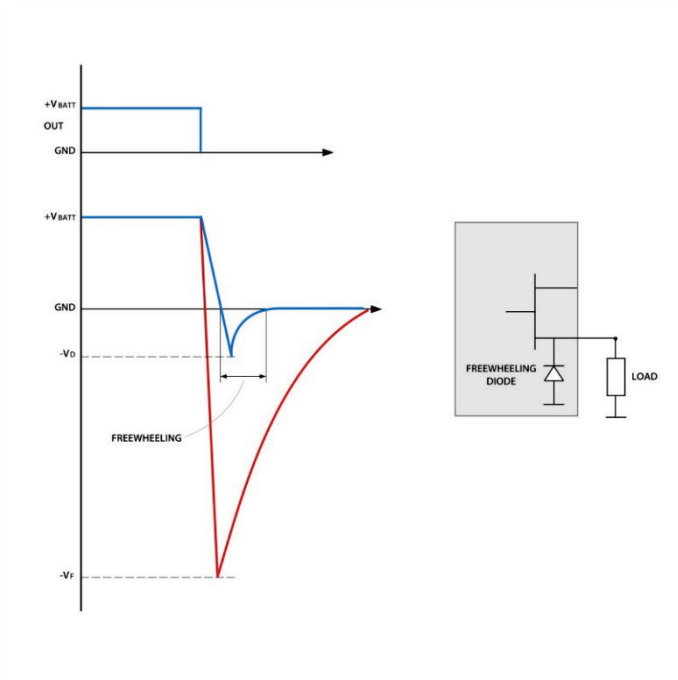

The red line is the negative voltage spike without diode. Blue one is the clamped voltage with diode.  $-V_f$  could reach very high value:  $-350V$ ,  $-400V$  are typical of solenoid loads.  $-V_d$  is limited to  $-1V$  by internal freewheeling diode.

As indicated in picture, voltage level is clamped to very low value. This action protects Power Mosfet inside PDM avoiding complete output destruction.

## 8. Powering

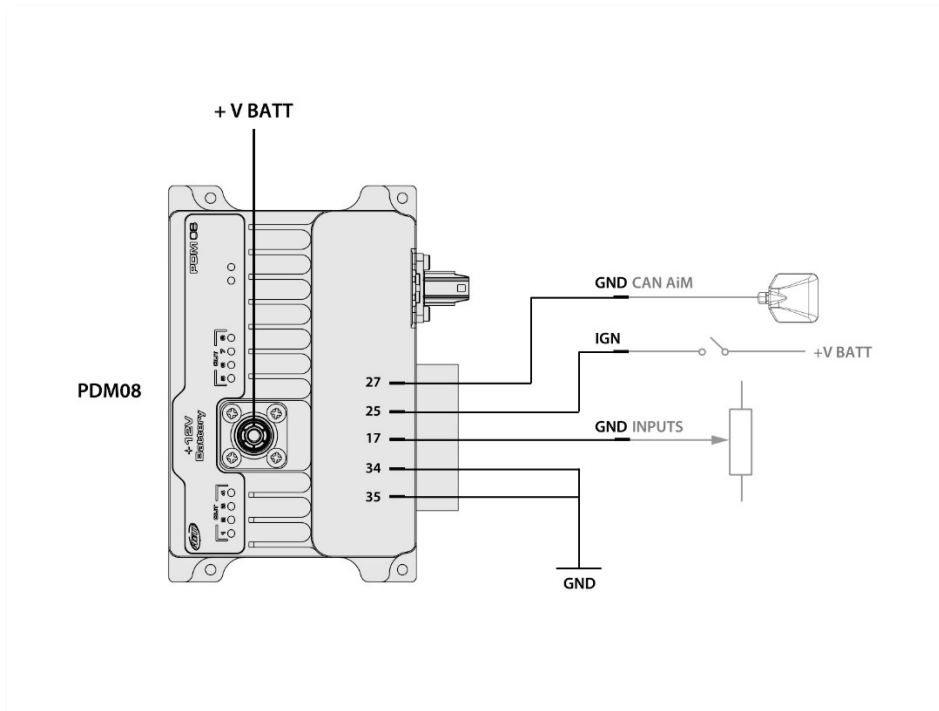

The Surlok connector (+V BATT) is dedicated to the connection to the PLUS connector of the battery. It is rated up to 120A continuous current. All current sourced from PDM to the loads flow here.

Internally all GND pins are tied together but they are split in different pins, to eventually simplify the loom connection.

The PDM08 may be turned ON in two distinct ways:

- Connect the IGN input to a switch: in this case the system, and all the devices, are powered
- Connect input channel CH\_IN6 to VBatt, leaving the IGN input OFF. In this case, the display is not turned ON, and you may choose which devices you wish to activate. This may be useful for activating the Hazard or keeping a fan ON even with the engine OFF until the temperature decreases till a defined value.

## 9. Other devices

---

The PDM 08 may manage some external devices:

- Display
- Mirror camera
- GPS

### 9.1 Display

---

The PDM08 supports one display. It may be 10" or 6"



The connection is through a dedicated high frequency LVDS cable to connect to the Rosenberger connector at the side of the PDM:



Please, refer to the section “Display Configuration” for configuring it

## 9.2 GPS



Gps 08 module is supplied with a standard male 712 Binder 5 pin plug, that needs to connect to Can0H (Aim Expansion Can ) (3) and Can0 L (15) with ground (27) , +VBext(14) and +Vbout (26)

A 1 mt patch cable with a female 712 Binder inline socket is in the kit and should be wired as shown in the following image.



EXP  
5 PINS binder 712  
female connector  
(external view)

- 1 - AIM CAN High
- 2 - Ground
- 3 - + Vb-output CAN
- 4 - AIM CAN Low
- 5 - +Vb-ext CAN

35 PIN AMP PANEL MALE  
CONNECTOR  
PINOUT EXT VIEW

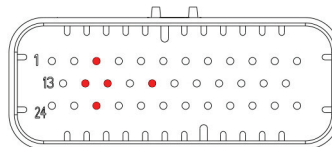

Please, refer to the dedicated chapter that explains how to use the GPS 08 module.

## 10. Software Race Studio 3



Aim Software Race Studio 3 lets you execute the following activities:

- Configure your PDM 08
- Transmit a new version of the firmware to your PDM 08
- Look ONLINE at all the data, power consumption, temperatures, Output status while your PDM 08 is installed on your vehicle
- Manage the tracks database, to automatically calculate the Lap Time and other correlated features.
- Download all the data and look at them in data Analysis

Please, download our RaceStudio3 software here:

<https://www.aim-sportline.com/en/sw-fw-download.htm>

After the installation, you will see The RaceStudio3 icon on your PC:



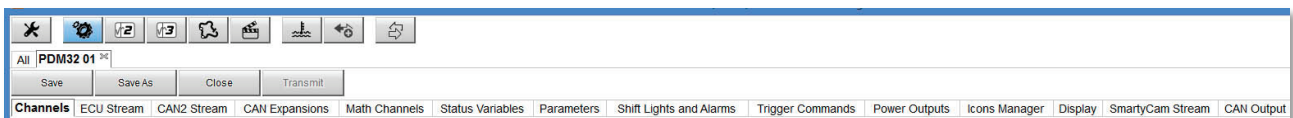

Please run the software for stating the configuration of your PDM08.

The top line of the PC shows some icons

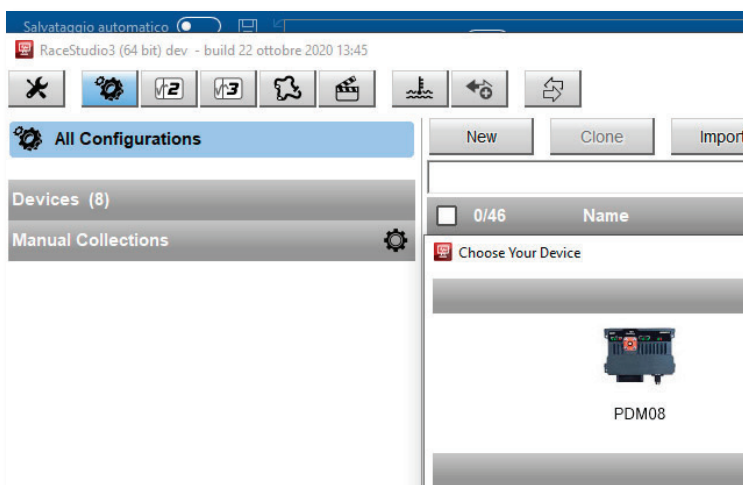

## 11. PDM08 Configuration



- click  “Configurations” icon and the configurations page appears
- click “New” and a new configuration panel appears: please, select “PDM08”.

Now you must follow the TABS to configure all the aspects of the PDM08:

Channels: to configure all the digital, analog and internal inputs

<b>Channels</b>	to configure all the digital, analog and internal inputs
<b>ECU Stream</b>	To select the protocol for connecting your PDM08 to the ECU of the vehicle
<b>CAN2 Stream</b>	To select the protocol for communicating with other devices through the CAN 2
<b>CAN Expansion</b>	To manage other AIM devices, such as: RIO 02 <a href="https://www.aim-sportline.com/download/technical-sheets/aim_rio02_102.pdf">https://www.aim-sportline.com/download/technical-sheets/aim_rio02_102.pdf</a> GPS08 <a href="https://www.aim-sportline.com/en/products/gps08-module/index.htm">https://www.aim-sportline.com/en/products/gps08-module/index.htm</a> SmartyCam <a href="https://www.aim-sportline.com/en/products/smartycam-hd-rev2.1/index.htm">https://www.aim-sportline.com/en/products/smartycam-hd-rev2.1/index.htm</a>
<b>Math Channels</b>	In case you need to produce a channel that is a mathematical computation of other channels
<b>Status Variables</b>	In case you need to manage a Boolean channel depending upon other channels and inputs
<b>Parameters</b>	General purpose parameters
<b>Shift Lights and alarms</b>	Only if a display is connected
<b>Trigger commands</b>	A way for activating some special functionalities, such as page change, alarm shut etc.
<b>Power Outputs</b>	Power outputs configuration
<b>Display</b>	Display configuration
<b>Icon Manager</b>	Icon configuration
<b>CAN Output</b>	Configuration of the CAN out messages
<b>SmartyCam Stream</b>	Configuration of the data to be transmitted to the SmartyCam <a href="https://www.aim-sportline.com/en/products/smartycam-hd-rev2.1/index.htm">https://www.aim-sportline.com/en/products/smartycam-hd-rev2.1/index.htm</a>

## ***11.1 Channels and Variables***

---

The activity of the PDM is based on the value of a whole series of variables, which can be divided in:

- Input channels: i.e. both analog and digital values, dependent on sensors or buttons, which can be directly connected to the inputs or via CAN connections
- Status variables, i.e. variables, defined by the user, which assume different status based on configurable formulas
- Power Outputs. Activations towards the outputs, based on the defined conditions, the value of the status variables and the input channels.



## 12.2 Input Channels Configuration

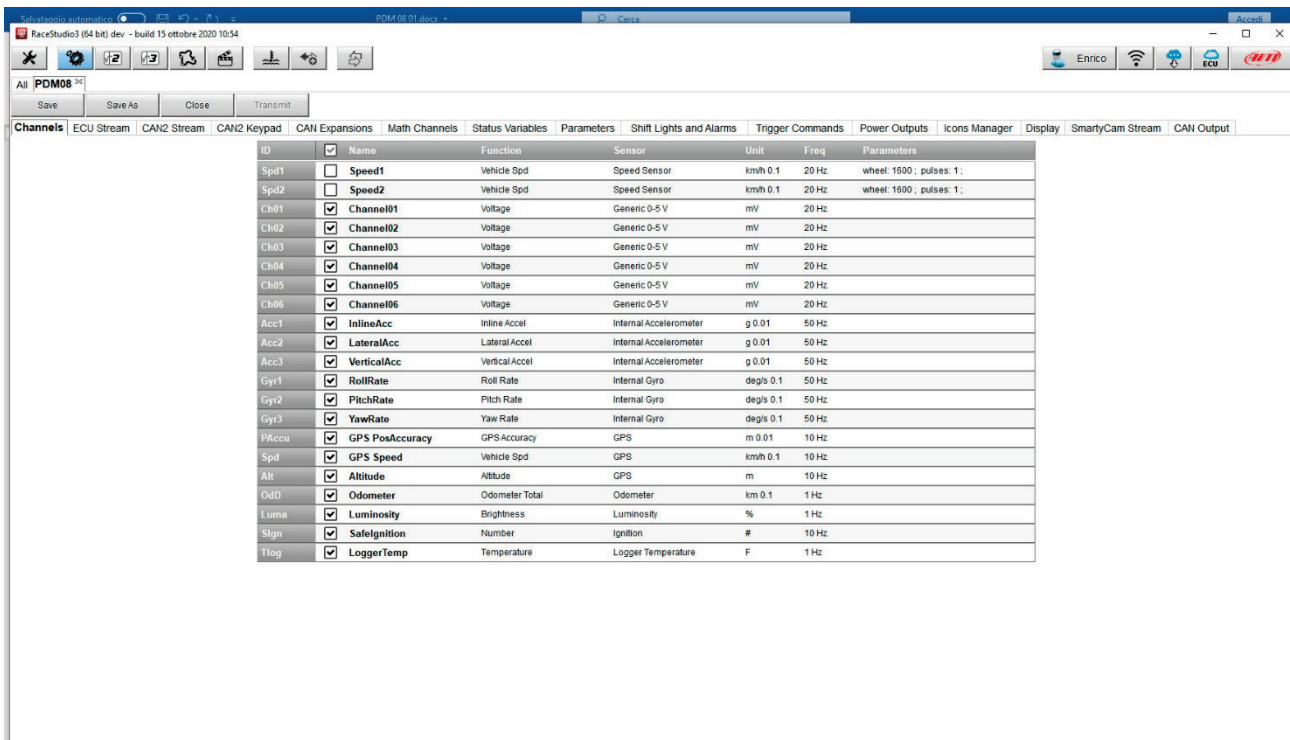

The PDM08 has the following input channels:

- 6 channels (CH\_IN1 - CH\_IN6) can be both analog and digital. If they are configured as analog, a 2KOhm pull-up can be activated. If they are configured as digital, it is possible to activate an internal pull-up or pull-down depending on whether they are closed on the ground or closed at VBatt.
- 2 speed inputs

The input **channel CH IN6**, when connected to VBatt, can activate the PDM without turning on the display. This can be useful for activating the Hazard, or keeping a fan on even with the engine off until the temperature reaches a correct value etc.

**IGNITION INPUT:** this is a special input, only digital and not programmable by user. It is active HIGH (internal pulldown hardwired) and when activated by external voltage, switch ON the PDM. Some functionality, for example display, are IGN dependent. This means that when IGN is active, also display is switched ON. Ignition could be used in user configuration as condition for other

- 1 Ignition input:

**Ignition Input Example application:**

- IGN connected to Main switch and CH\_IN6 connected to Hazard switch. With IGN active (+12V) all functions on PDM are enabled. With IGN off (disconnected or tied to GND) and Hazard switch active (+12V) PDM enables only outs related to HAZARD function (typically front and rear directions lamps in hazard blinking mode).

Typically, analog sensors are pressure sensors, potentiometers, etc... while digital inputs are used for managing pushbuttons, that may eventually be used for activating the power outputs.

### 11.3 Analog inputs configuration

In the following image you see two different channels configuration windows, for analog or digital input.

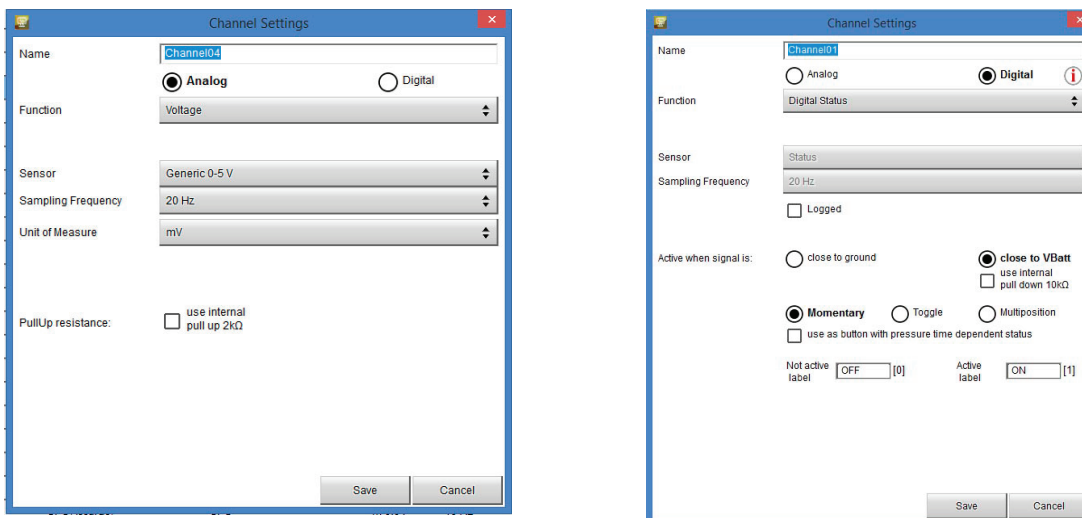

Selecting “Analog” options to be set are:

- Channel name
- Function: this parameter is useful in the data analysis process
- Sensor type
- Measure unit
- Sampling frequency
- Display precision: it configures how many decimal digits will be shown on the display

It is possible to enable an internal 2kohm pull-up, as shown in the following picture:

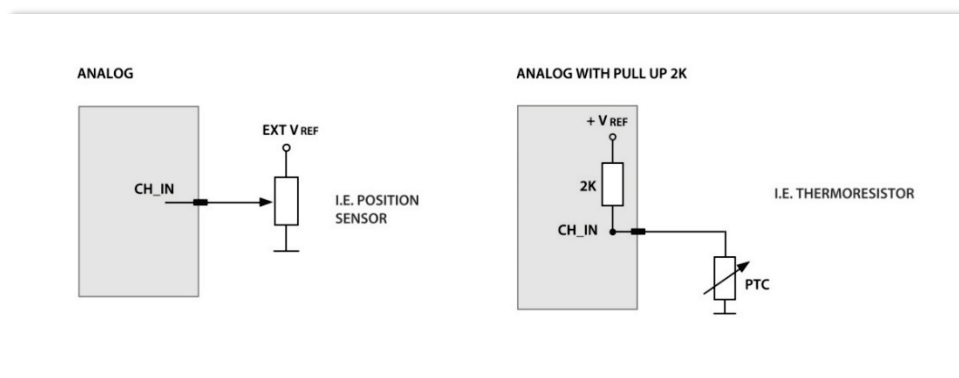

## 11.4 Digital inputs configuration

To use an input as “**Digital Input**” its parameters must be configured as follows:

- **Working mode:** a digital input can work in two different ways:
  - o The pushbutton closes to ground (with or without pull up resistor – left image below)
  - o The pushbutton closes to VBattery (with or without pull down resistor – right image below)
- **Active/Not Active labels:** according to the status a Digital channel may assume the values 0/1, High/Low, ON/OFF, Closed/Open, True/False etc...

The two different labels can be defined and eventually shown on the display, used by Math channels, Icons Management, alarm managements and in general, any time a digital channel is required; the labels appear in Device page too.

Signal Type: can be momentary, toggle or multistable

- **momentary:** the channel is active when the pushbutton is closed
- **toggle:** the channel is activated the first time you close the circuit and deactivated the second time the circuit is closed as shown here below
- **Multistable:** Each time the connected button is pressed, the channel value changes from 0 to N (this value depends on the configuration), then returns to 0.

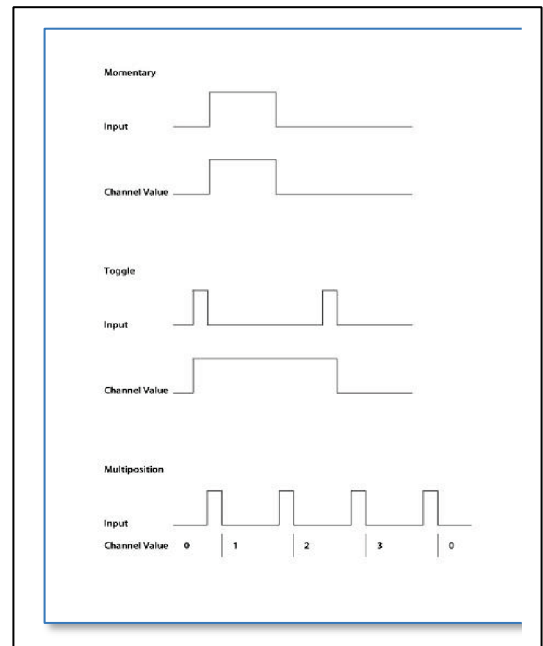

**Logged:** if active, the system records the digital values, else they can be used and shown but they are not recorded.

The status and labels associated to a every single digital input may be dependent upon the time of activation (Time Dependent).

It is possible to enable an internal pull-up resistor, in case the digital input is closed to ground, or an internal pull-down resistor, in case the input is closed to battery, as shown in the here down image.

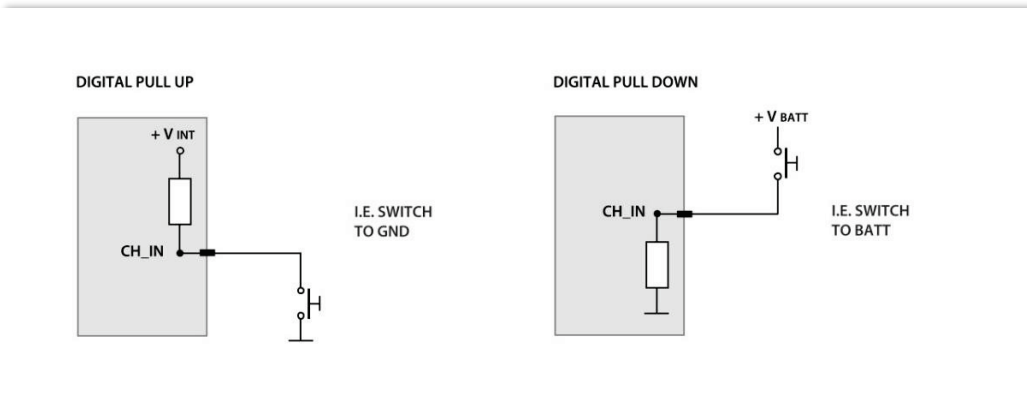

### 11.5 Other internal sensors and channels

The PDM offers other internal sensors, that may be used for activating some features or simply for better understanding the vehicle behavior in data analysis:

- **IMU 9 Axis:** it features 3 axis accelerometer, 3 axis magnetometer, 3 axis gyros.
- **Internal temperature** sensor
- **Brightness** sensor (only with a display connected)
- **Safelgnition:** it is ON when the PDM is activated by the IGN input. It is OFF when the PDM is activated by CH\_IN6
- **POTotCurrent:** it indicates the sum of all the currents drawn by the Power Outputs
- **GPS information** (only when the GPS module is connected)

### 11.6 Math channels configuration

The math channels are useful to create some channels depending upon the input data:

BIAS	$CH1/(CH1 + CH2)$	The BIAS computes which channel between two is prevailing (typically used for suspensions or brakes)
Bias with threshold	$CH1 / (CH1 + CH2)$	As above, but computed only when the two channels exceed a user configurable threshold
Calc gear		it calculates the gear position using engine RPM and vehicle speed
Precalculated gear		To be used when the Load/Shaft ratio is already known
Linear correction	$VALUE = a * CH + b$	
SUM	$Value = CH1 + CH2$	
Division per integer	$Value = CH1 / a$	

### 11.7 Status variables configuration

---

Status Variables are internal math channels that “generally” have only two different values: 1 (TRUE) or 0 (FALSE). They may be useful for simplifying complex configurations, where it is required to evaluate if to activate alarms, LEDs, Icons etc.

The Status variables have different working modes, to be selected by the user:

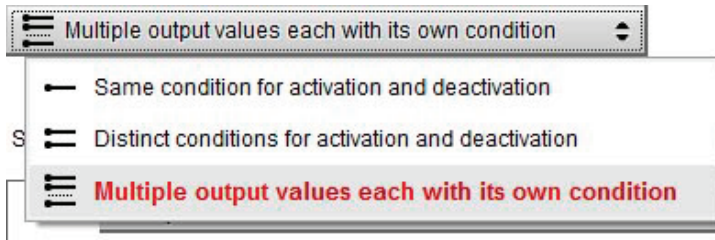

This is the simplest way for managing a Status variable: it becomes ON when a condition is verified, else it becomes OFF. In the following example, the Status variable AlarmWatertemp is TRUE when the water temperature increases above 100°C, and is reset to FALSE when the temperatures goes down 100°C.

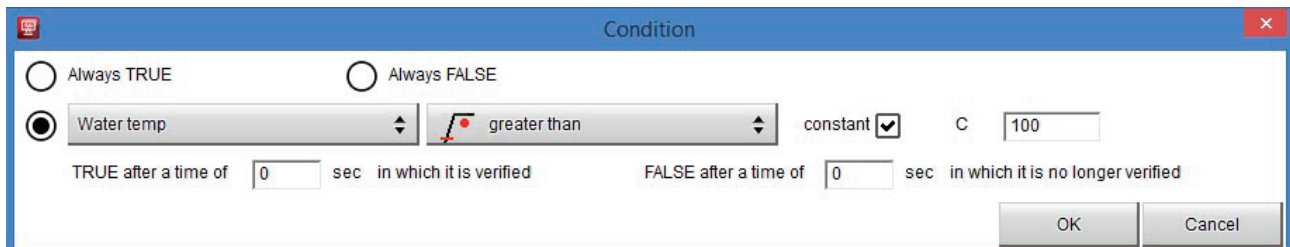

It may be useful to have two different conditions for activating and deactivating a Status variable. For example, we need to turn ON a Status variable ON when Water Temperature reaches 100°C and the RPM are higher than 2000, and we must turn it OFF when the Water Temperature goes below 80°C.

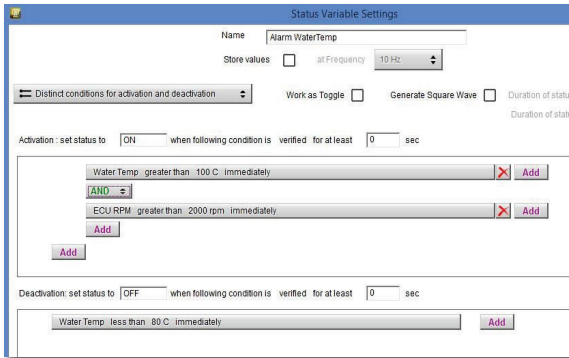

It is possible to associate a LABEL to Status Variable value:

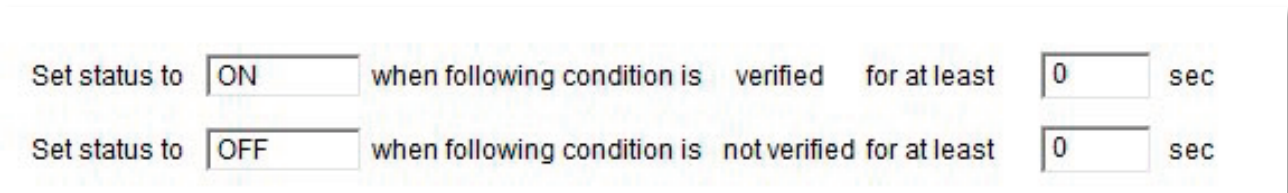

And use this label per every further control or indication in the display.

A Status variable may also be activated in two different special ways:

**As Toggle:** the Status variable is set to TRUE (1) the first time the condition swaps from FALSE to TRUE and remains TRUE till when the same condition swaps again from FALSE to TRUE.

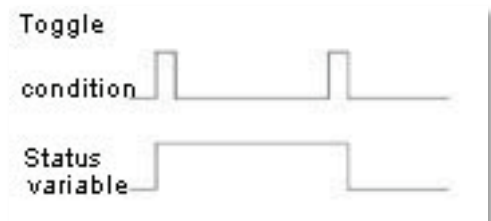

**As Square Wave:** The Status variable may generate a Square wave, for which it is possible to set both ON time and OFF time, whenever the activation condition is valid.

This is the only case in which the Status variable assumes more than 2 values. An example may be the management of a rotary switch, connected to an analog input, as shown in the following picture:

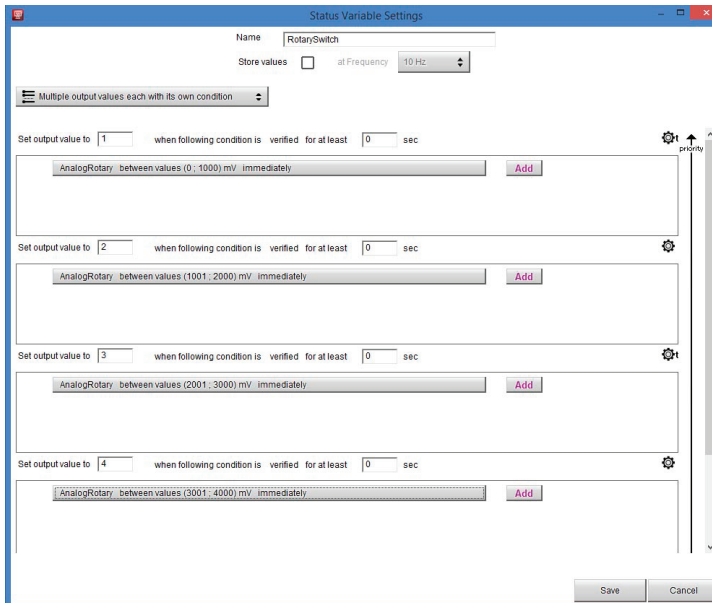

The Status Variable assumes, in this example, the values 1,2,3, 4.. in dependence upon a defined condition.

## 11.8 Trigger commands

The “Trigger Commands” execute some specific actions on your PDM32.  
The commands available up to now are:

- set next/previous page
- reset alarms
- activate pushbutton 1-4

You may define the condition that activates a Trigger Command.

To add a new command:

- Press “+Add New Command” (1)
- The “Create new Output Command” panel appears
- Set the condition for activating the trigger command.

As an example, let us activate the mirror camera when the gear is in reverse. As you see, it is very simple:

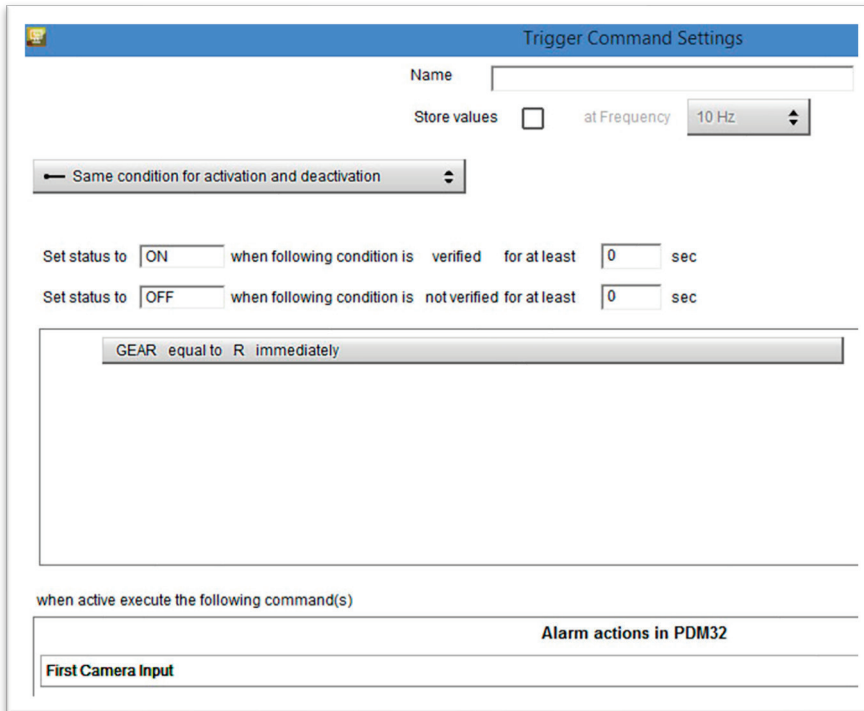

The screenshot shows the 'Trigger Command Settings' window. It includes a 'Name' field, a 'Store values' checkbox, and a frequency dropdown set to '10 Hz'. A dropdown menu is set to 'Same condition for activation and deactivation'. Below are two rows for setting status to 'ON' or 'OFF' based on condition verification, each with a '0' second timer. A large text area contains the condition 'GEAR equal to R immediately'. At the bottom, a section titled 'Alarm actions in PDM32' lists 'First Camera Input'.

### 11.9 Power Outputs configuration

Every Power Output may be configured in order to generate an output of three different shapes:

- Continuous
- PWM
- Square Wave

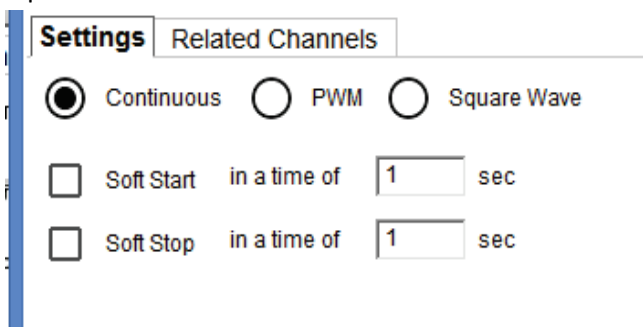

The screenshot shows the 'Settings' tab of a configuration window. It features three radio buttons for 'Continuous' (selected), 'PWM', and 'Square Wave'. Below are two checkboxes for 'Soft Start' and 'Soft Stop', each with an input field set to '1' and the unit 'sec'.

- A **Continuous Output** is a constant current generation, whose value depends upon the device connected and the limit set by the user, as indicated in the Power Output Chapter.
- A **PWM output** is an output in frequency (100 Hz for all), where the duty cycle is depending upon some conditions.  
In this case too, the soft start and soft stop are available.
- The **square wave mode** offers the possibility to define the frequency and duty cycle of the output and is used when the wave frequency is very low.



### Soft Start and Soft Stop activation modes are available

A **Soft Start** prevents the sudden current flow in the circuit during the start. It is useful to protect the devices or electronic components from the damage caused by instantaneous high input current.

It is possible to define both the timings in which the current arises (or decreases) from 0 to 100% (and vice versa)

### Power Output Activation and Deactivation

The conditions for activating and deactivating every output of the PDM 08 are completely configurable. First of all, it is possible to select one of the two modes:

Same condition for both activating and deactivating.

Different conditions for activating and for deactivating

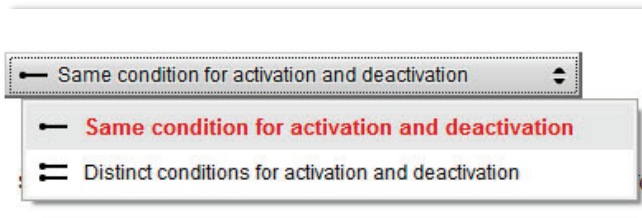

- **Same Condition.** It means that the Output is turned OFF when the defined condition is not valid anymore. Example: Turn the fan ON when the water temperature reaches 100°C. In this case, the fan is turned OFF when the water temperature decreases and reaches 99.9°C
- **Distinct Conditions.** It means that the condition that turns the output OFF is to be specified. Example: Turn the fan ON when the water temperature reaches 100°C and turn it OFF when the water temperature reaches 80°C. In this case, the fan is turned OFF only when, after having reached 100°C, the water temperature decreases and reaches 80°C

Activation and deactivation conditions must be verified for a period set by the user:

Set status to	<input type="text" value="ON"/>	when following condition is	verified	for at least	<input type="text" value="0"/>	sec
Set status to	<input type="text" value="OFF"/>	when following condition is	not verified	for at least	<input type="text" value="0"/>	sec

**Example:** Turn the fan ON when the water temperature reaches 100°C and turn the fan OFF when the condition is not verified anymore

**Example:** Turn the fan ON when the water temperature reaches 100°C and turn the fan OFF when the water temperature decreases under 80°C

## 11.10 Power Output related channels

Every Power Output has two associated channels:

**The Status**

**The Instant Current drawing in it.**

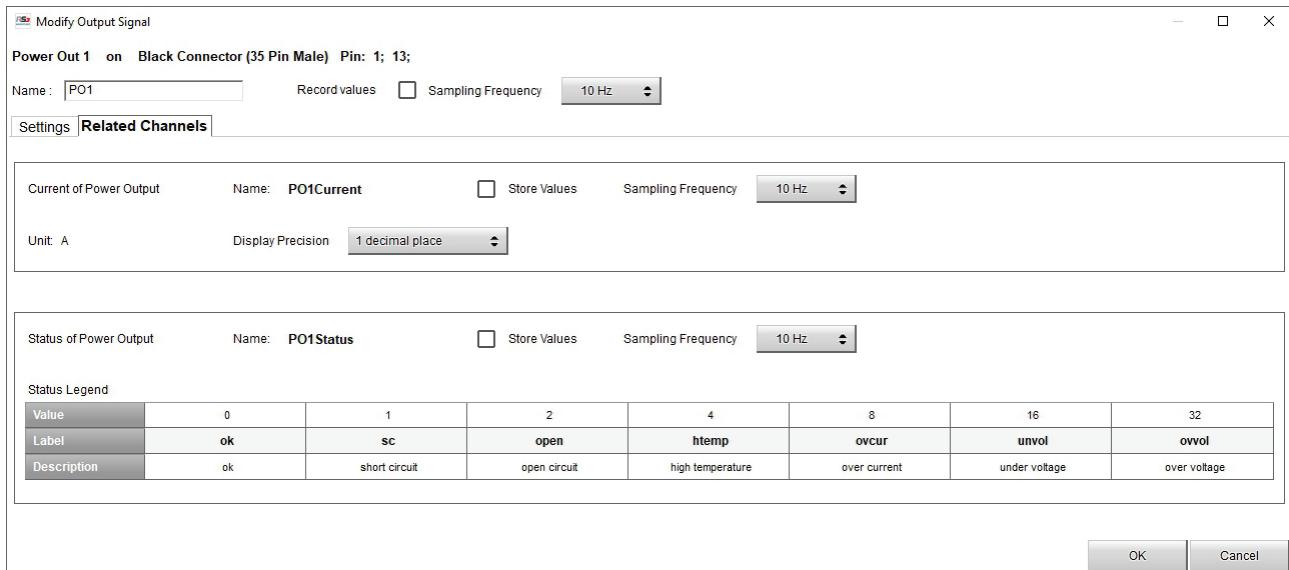

The Status of a Power Output may assume different values:

OK	
SC	Short cut
OPEN	Open circuit
HTEMP	High temperature
OVERCUR	Over current
UNVOLT	Under voltage
OVERVOLT	Over voltage

You may use the two associated channels as any other channel. For example, if you wish to turn an Icon ON on the display in case of a shortcut:

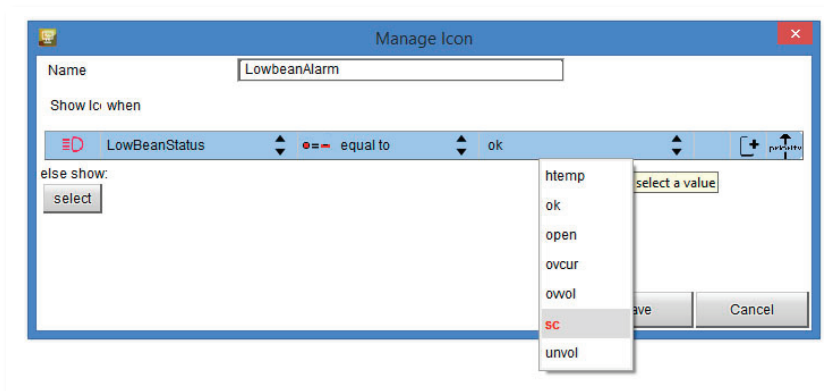

Here down an example shows how power out supervisor works.

At ON instant the output is activated. During the time T1, the output can source an inrush current higher than user set value: the PDM does not check the overcurrent but only the Short circuit.

The supervisor continuously checks the current value after T1. In case the current value is higher than user MAX Value selected, timer starts count. If timer value reaches the overcurrent Latch-off time selected (T2), the output is disabled.

After Retry Delay, if Number of retries is different from zero, the output will be enabled again, and supervisor starts current check again. This will be repeated in case of overcurrent until the Number of retries set by the user is reached. After that out will be disabled.

In case the output is disabled, PDM led indicator becomes red. The Output is re-enabled when the activating condition switches from ON to OFF and ON again.

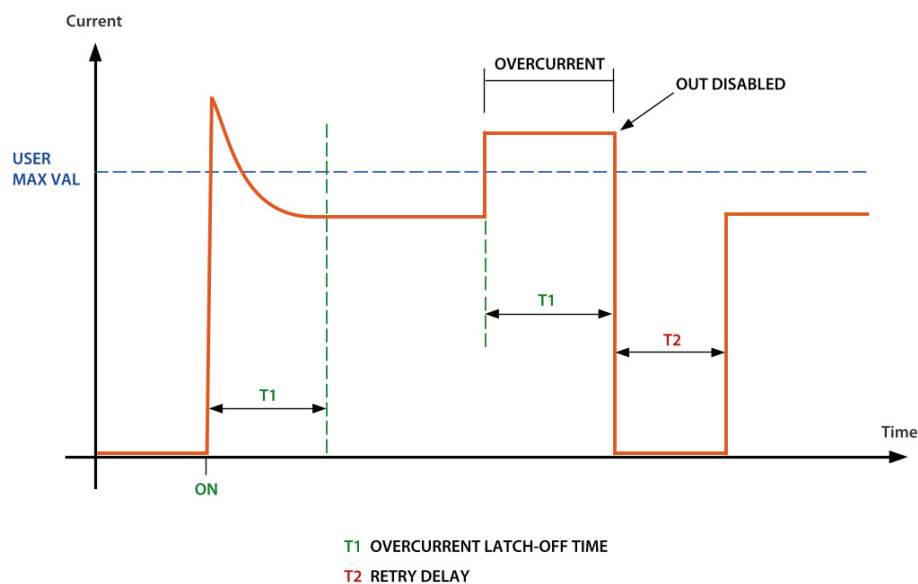

As already stated, in order to check the Open Load Status, you have to:

- Define the minimum current, under which the Open Load Status is detected
- In case of L(ow) and M(edium) outputs, you may also set a flag for enabling the Check Open Load also in OFF state. If you enable this check, a very low current constantly flows through the output. Please note that, sometimes (LED lamps, for example), is enough for activating the connected device

### 11.11 PWM

Typical uses of PWM are:

- Fan speed control
- Water pump speed control (useful to maintain water temp close to ideal value)
- Led and Bulb Lamp dimming (i.e. DRL dimming related to low beam status)

The PWM functionality is managed in two different ways:

The Outputs may manage a 100 HZ PWM

To configure a PWM output, with the duty cycle depending upon some conditions, please:

- Set the Power Output as PWM

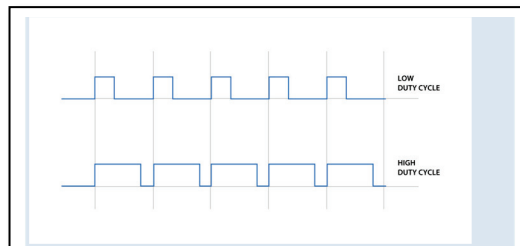
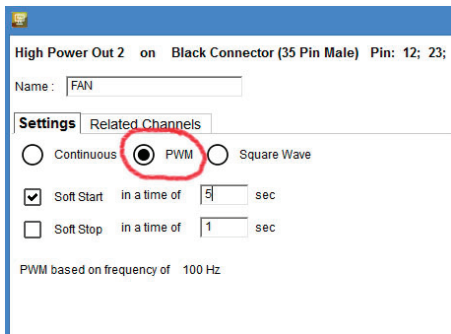

The Duty Cycle in a PWM Output is the ratio between ON and ON+OFF status of the output. The higher is the ratio, the higher is the energy that the output gives. If you connect a lamp or a fan to a PWM output, you may, changing the duty cycle, change the brightness (of the lamp) or the speed (of the fan).

- Define the logics that manage the different duty cycles

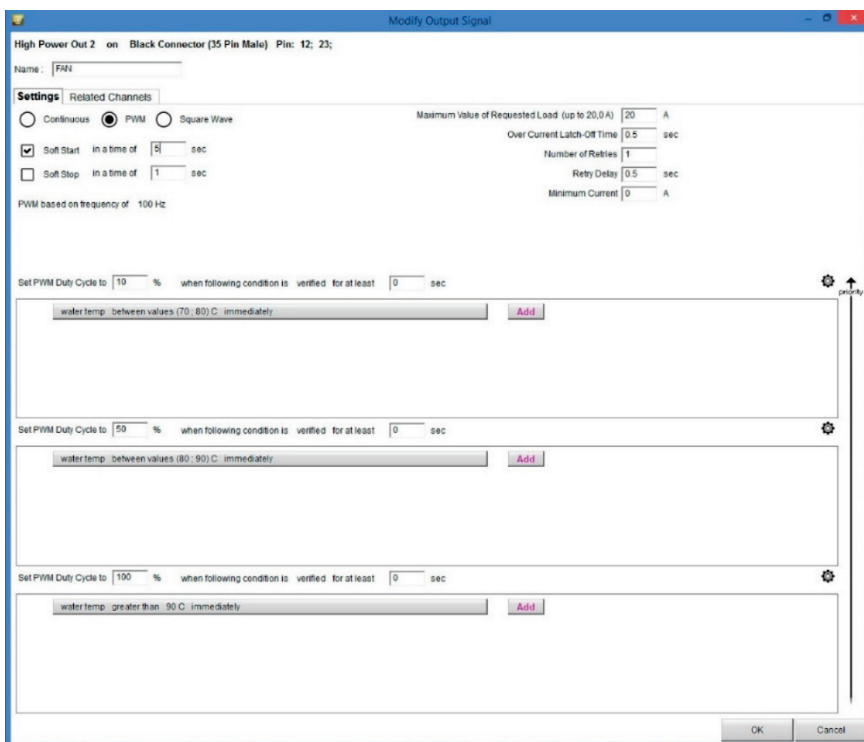

In this example, we correlate the duty cycle of the Power Output FAN to the Water temperature:  
 In the range 70°C – 80°C the duty cycle is 10%  
 In the range 80°C – 90°C the duty cycle is 50%  
 If the water temperature is higher than 90°C, the duty cycle is 100%.  
 The time for passing from one level to the next one is set at 5 seconds.

## 11.12 Square Wave

The last way for managing the Power Output is the Square Wave, that may be useful for managing slow blinking

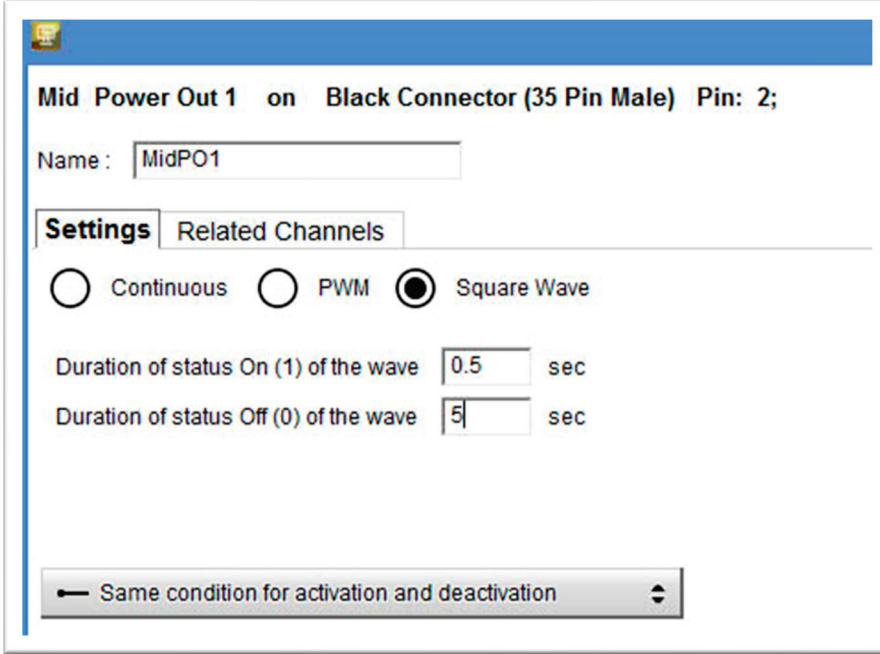

The screenshot shows a configuration window for a power output channel. At the top, it reads "Mid Power Out 1 on Black Connector (35 Pin Male) Pin: 2;". Below this, there is a text input field for "Name" containing "MidPO1". There are two tabs: "Settings" (selected) and "Related Channels". Under the "Settings" tab, there are three radio button options: "Continuous", "PWM", and "Square Wave". The "Square Wave" option is selected. Below the radio buttons, there are two input fields for timing: "Duration of status On (1) of the wave" with a value of "0.5" and "sec", and "Duration of status Off (0) of the wave" with a value of "5" and "sec". At the bottom, there is a dropdown menu currently set to "Same condition for activation and deactivation".

As shown in the above image, you may define the form of the wave, specifying how long the signal remains ON and how long it remains OFF.

## 12. ECU Connection and configuration

The PDM32 can be connected to your vehicle ECU, through CAN or RS232 connection. A wide database of more than 1500 protocols is available and documented in our web site:

<https://www.aim-sportline.com/en/documentation-stock-ecu-connections.htm>

and

<https://www.aim-sportline.com/en/documentation-racing-ecu-connections.htm>

for stock or racing ECUs.

In case you have a CAN based ECU, and its protocol is not in the database, you may anyway develop it, using the ECU Driver Builder function (see paragraph).

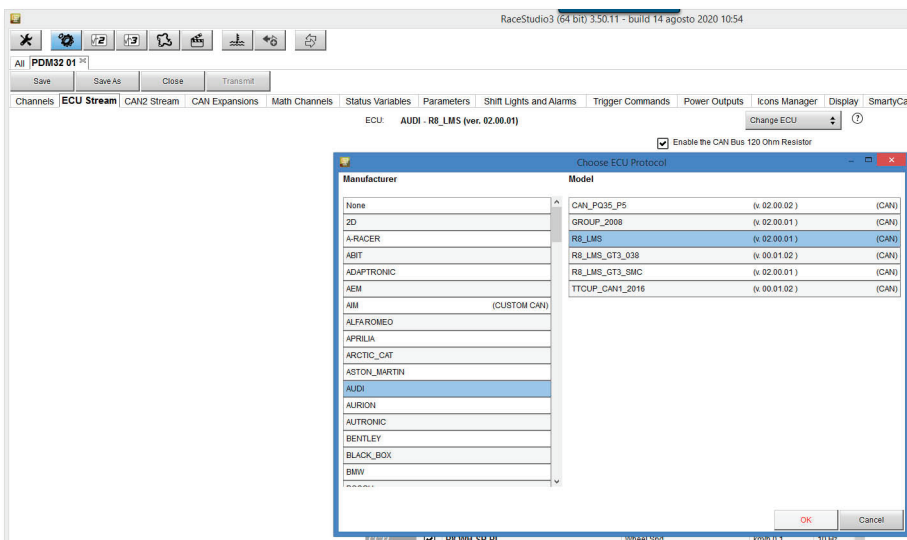

There are two parameters that need to be set:

- **“Enable the CAN Bus 120 Ohm Resistor”**: the CAN Bus needs two 120-ohm resistors at its two extremes. In case your PDM is the only device connected to the ECU, the 120 Ohm should be enabled, else, very easily, in the existing network it is already present, and should be disabled.
- **“Silent on CAN Bus”**: Usually, the ECU expects an Acknowledge signal when transmits a message, and, as default, the PDM transmits this signal. Sometimes, and particularly when there are other devices in the network, the PDM should not transmit it: in this case, please, enable this flag, to make the PDM remain completely silent.

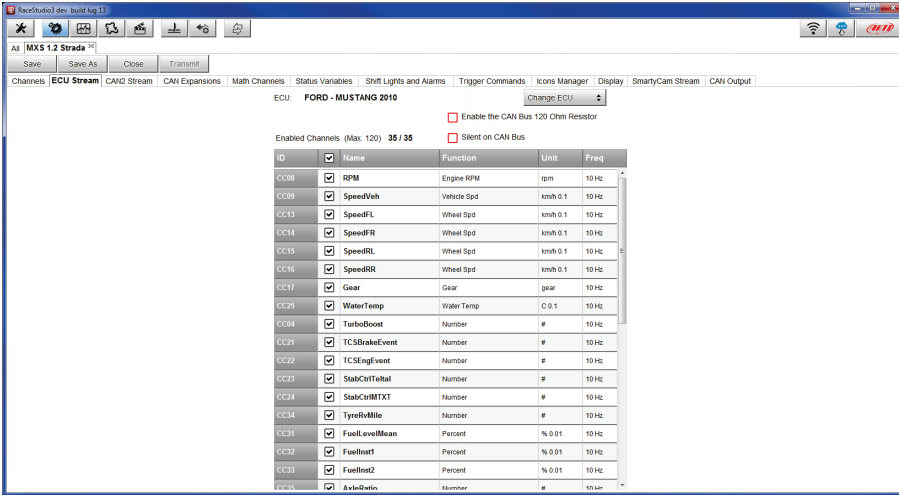

### 13. CAN2 Stream configuration

This page works exactly like ECU Stream one. Here you can find additional CAN modules. To load your additional module CAN protocol:

- enter "CAN2 Stream" tab
- press "Change protocol" button
- select "Manufacturer" and "Model" (in the example (MEGALINE/PADDLESHIFT))
- press OK

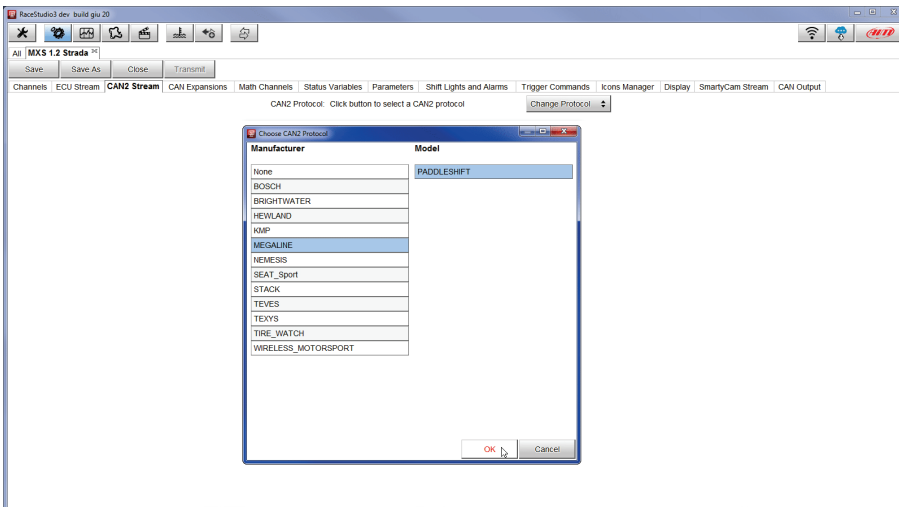



## 14. CAN Expansions configuration

The PDM 08 can be connected to various AiM CAN expansions:

- LCU-One CAN
- Channel Expansions
- TC Hub
- RIO\_02a
- Shift Light Module
- GS Dash
- Memory Module
- Expansion power Module (coming soon)

At the very first connection configuration this page shows up:

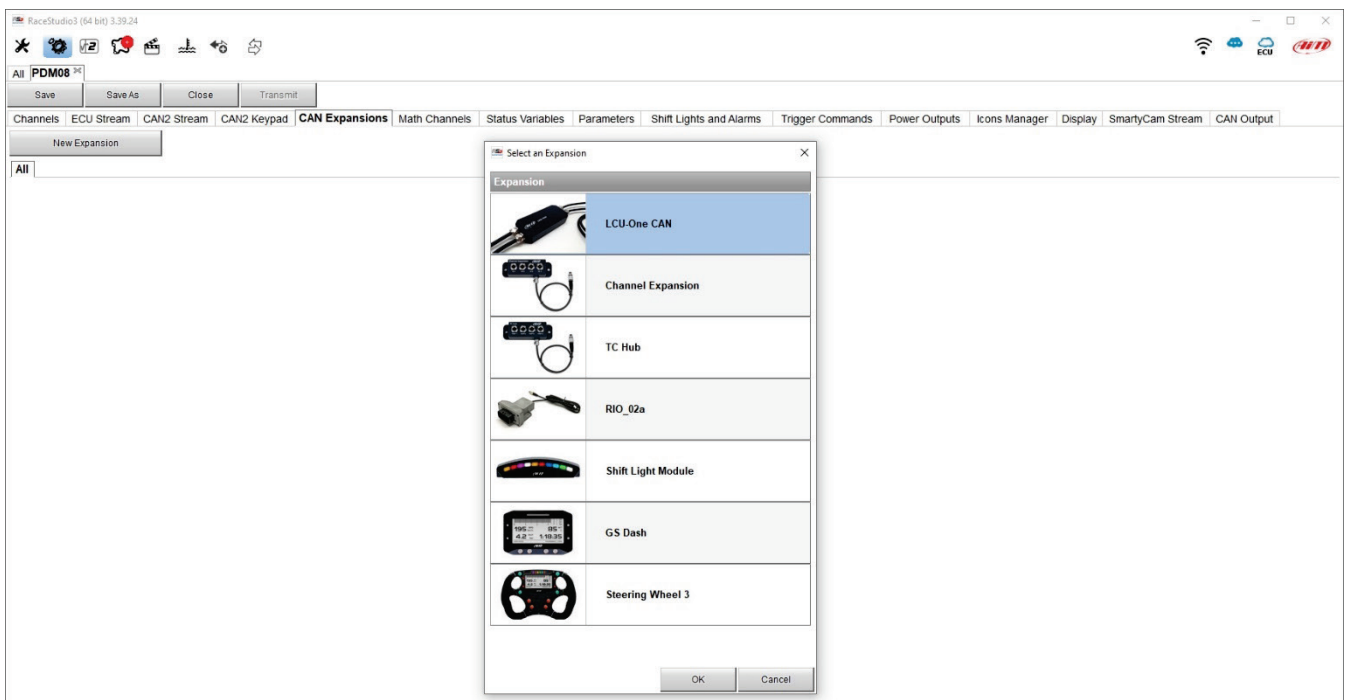

Here you can select the CAN expansion you want to set. Select it and press OK. Each expansion needs to be set filling in the related panel.

**Please note:** for any further information about AiM Channel expansion refer to the related user manual you can download from AiM website [www.aim-sportline.com](http://www.aim-sportline.com) documentation area, products section.

## 15. Icons manager configuration

The “Icon” is a set of images, each one of them to be shown on every page is desired, in dependence upon a certain condition that, when exists, triggers the proper image.



For example:

- the first image has to be shown when the signal TurnRight is TRUE
- the second when the signal Turnleft is TRUE
- the third when the signal Hazard is TRUE
- the fourth when no signal is TRUE

Not all the display pages offer the possibility to show Icons, but our technicians are working for offering more pages with this feature.

To configure an icon:

press “Add New Icon”

“Manage Icon” panel shows up

press “Select” to see the panel showing all images

select the image you want to set

the software comes back to “Manage Icon” panel

set the image conditions according to the channel they are related to

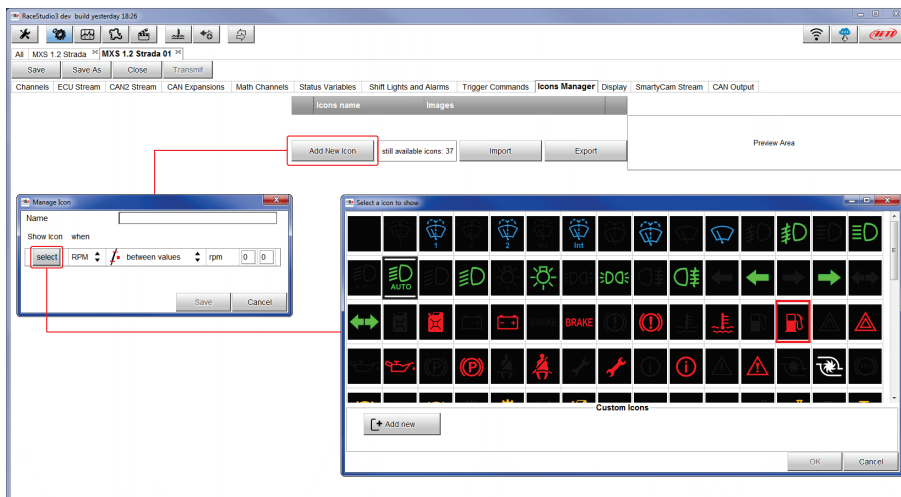

It is possible to use custom images pushing the “Add New” pushbutton. They must be 64x64 pixels png format.

Once all Icons set “Icons page” shows the icons summary and mousing over an Icon the related panel shows up on the right of the page as shown here below.



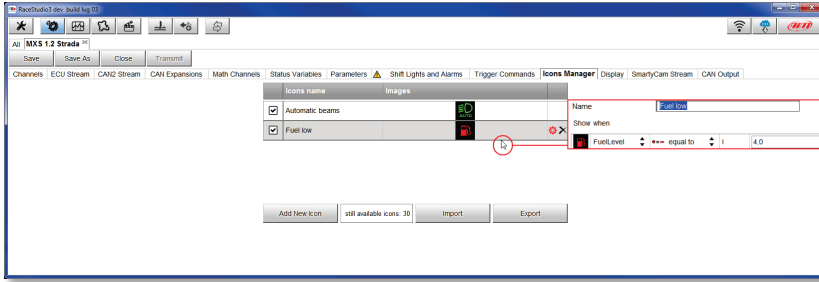

## 16. Display configuration

The PDM 08 may manage two different displays:  
The 6" and the 10".



You have to select which display you wish to connect through the proper software page:

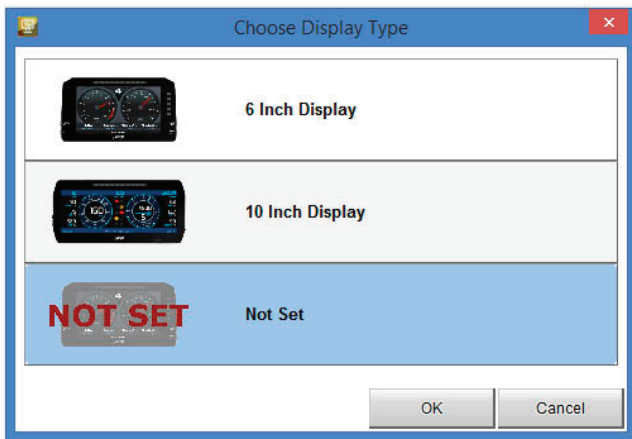

Then you may proceed with the display configuration, in order to have a maximum of 8 pages available.

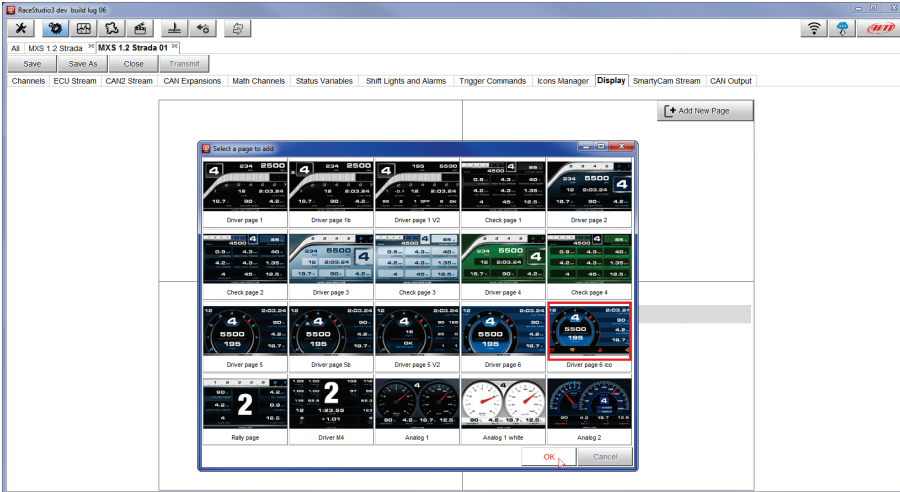

When the page has been selected two setting panels appears bottom of the page:

- on the left a panel that shows as many rows as the fields to be set
- on the right a panel shows the channels group you can set in that field and all the channels in it included; you can drag and drop the channel you want to set in the desired field or double click on it

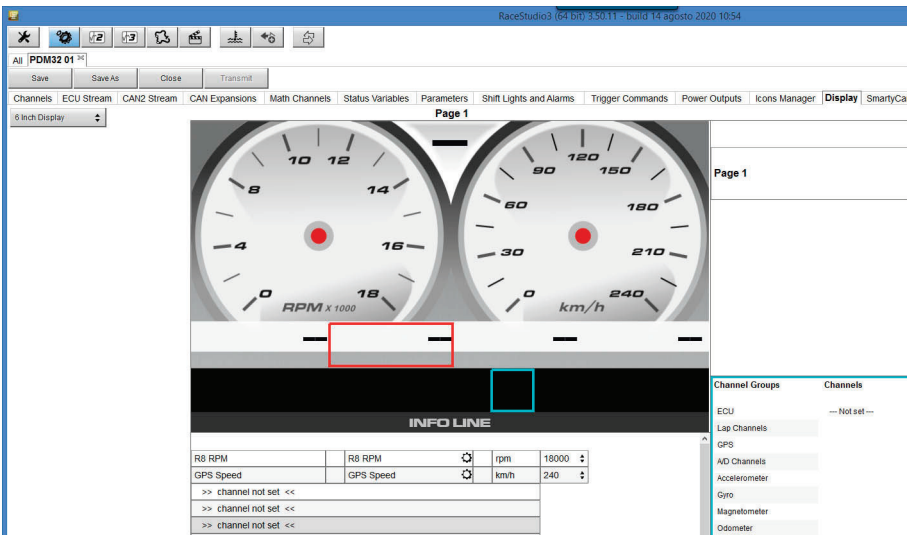

## 17. Shift Lights and Alarms configuration

In this page you can set shift lights and set the alarm LEDs of your PDM dash, both 6" and 10".



### 17.1 Shift Lights

On top you can set your dash, both 6" and 10" shift lights working mode.

Available options are:

- Shift Lights, for helping in changing gear

and

- Predictive Time, for easily understanding if the actual lap is faster or slower than the reference lap.



You may configure:

- At which RPM the single LED turns ON
- The sequence mode of the LEDs enabling the desired option:
  - a LED stays ON if its threshold is exceeded
  - a LED stays ON until another LED with higher threshold turns on or
- Link the shift lights to the engaged gear enabling the related checkbox.

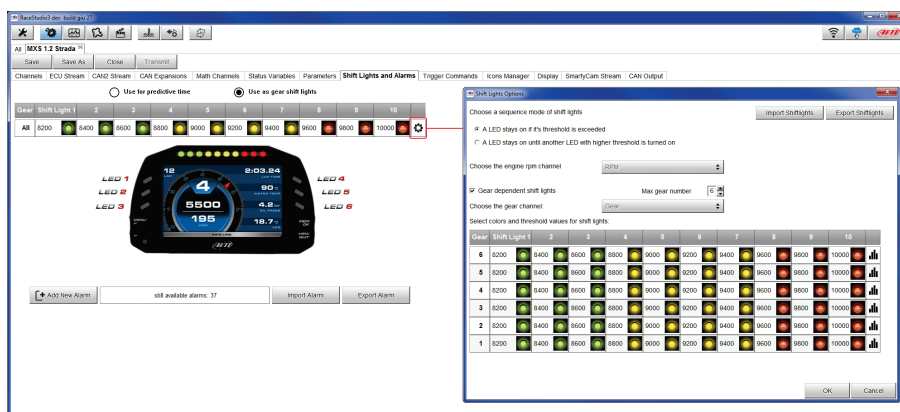



In this case the LEDs colours are fixed in:

Green, if the lap time is improving

RED, if the lap time is worse than in the reference lap.

You can define the threshold at which one LED is turned ON.

Assuming you fill in "0.10 sec" and your lap time is improving of 0.30 sec toward the reference lap, your MXS 1.2 Strada will switch on 3 LEDs green; if, on the contrary, your lap time is worsening the LEDs will switch on red.

**Please note:** this option only works if an optional GPS Module is connected.

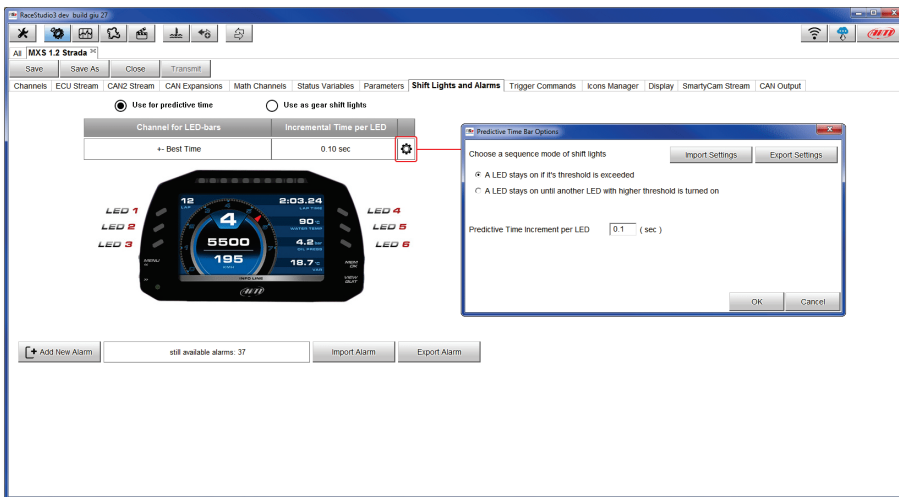

## 17.2 Alarm LEDs configuration

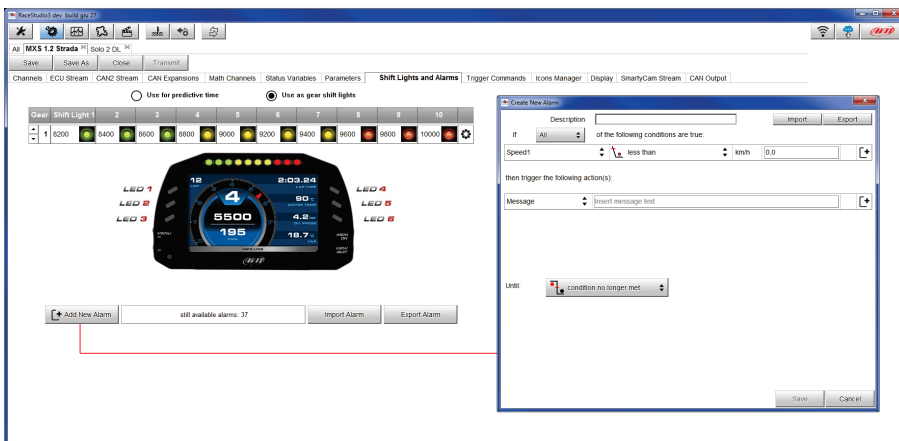

To set the new alarm:

- Define the Alarm name (1)
- You may use a combination of conditions for setting an Alarm and choose if the conditions are to be ALL valid, or just one of them.
- decide which action is to be triggered (5) among displaying a message or a timed popup message, display a measure, switch a LED on or activate an output signal (CAN output page, see the related paragraph)
- decide the alarm ending condition ("Until" – 6) among: condition no longer met, the device is turned off, a button is pushed, or data are downloaded
- "+" buttons you find right of the panel are to add new alarms (the top one) or to add new actions to an alarm (bottom one)
- when all operations have been performed press "Save" in "Create New Alarm Panel and you will come back to "Shift Lights and Alarm" page

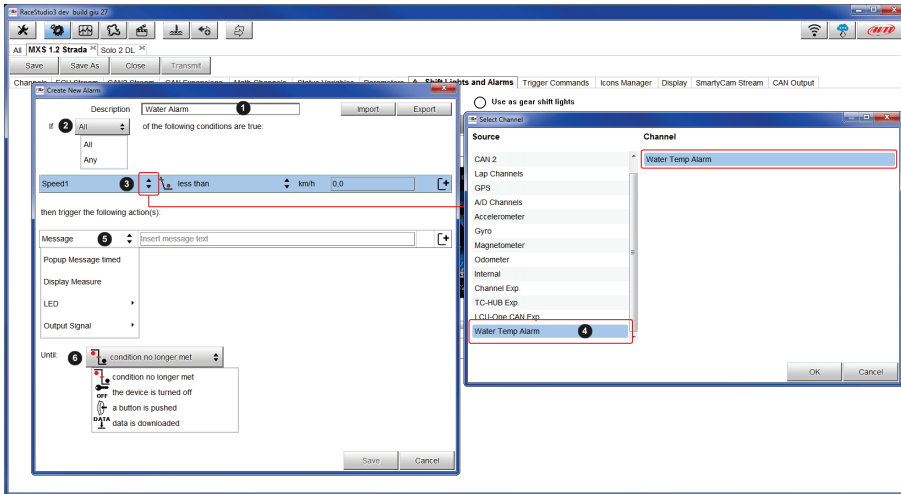



## 18. SmartyCam stream setting

The PDM 32 can be connected to AiM SmartyCam to show the data you wish on SmartyCam video. To set each channel:

- click on it and a setting panel shows up
- it shows all channels and/or sensors that fits the selected function
- in case you do not find the channel or the sensor in the list enable “Enable all channels for functions” checkbox and all channels/sensors will be shown

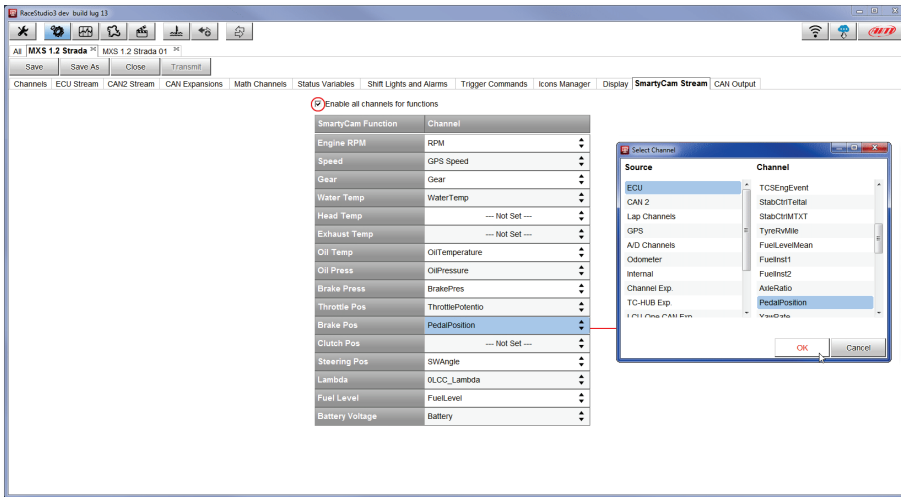

## 19. Managing a track with Race Studio 3

A huge database with more than 4500 tracks, constantly updated, is available. You may transmit them to your PDM32. Press “Tracks” icon.

**Note:** the GPS08 Module is needed.



The main page is divided in three columns. on the **left**:

- on top, the filters that allow to collect many tracks following customized criteria; by default, all tracks are shown (light blue “All Tracks” filter in the image below).
- bottom left, the connected devices (in the image, “MXS 1.2 Strada ID 5302808”)

The column **in the middle** shows:

- on top a fast search bar, that allows to select the tracks which satisfy your personal research criteria; by pressing “?” a pop-up window explains research criteria (highlighted in red below), where:
  - long name is the name you see in bold in each track box
  - short name is the track name shown on the display of your MXS 1.2 Strada and is the name you find top right of each track box
  - track city is the name of the city the track is located in
- all the tracks listed in Race Studio 3 database. It automatically updates at start up if a connection to the Internet is available.

The column on the **Right** shows:

- the data sheet of the selected track.

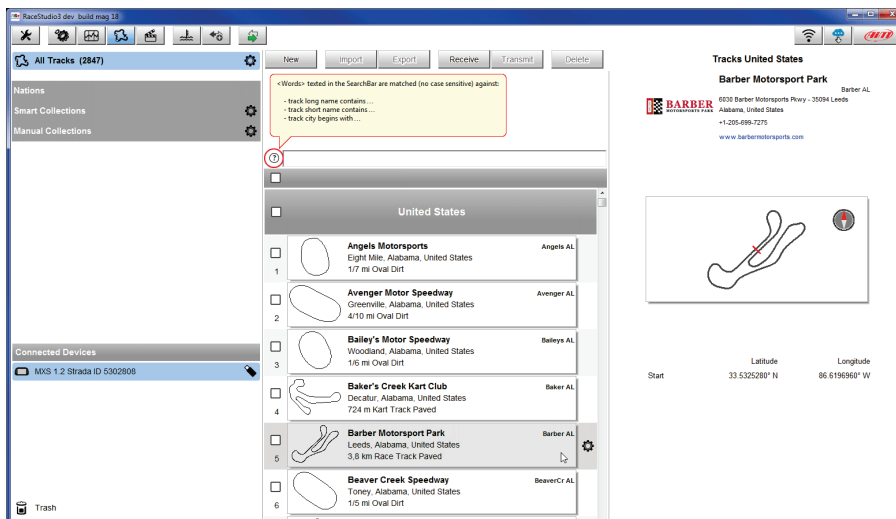

When your PDM is connected it is shown on the left bottom part of the page as said before. Clicking on it all the tracks it contains are shown in the right column of the page.

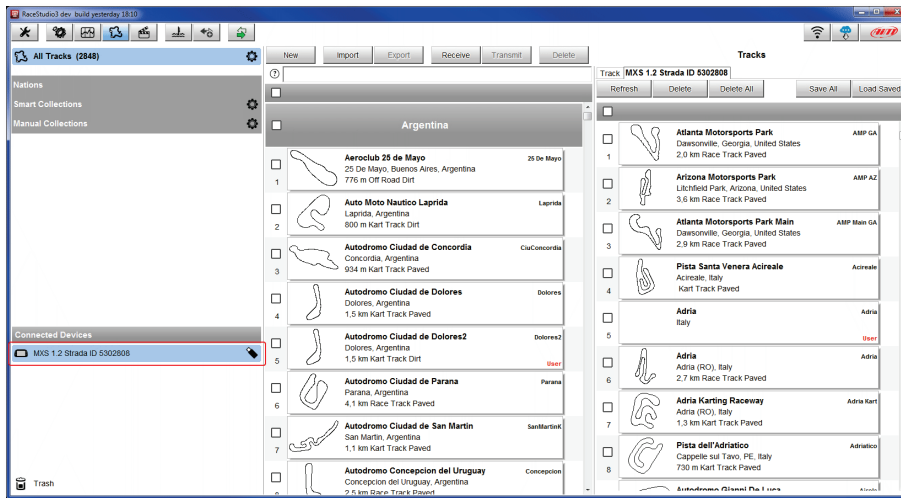

The page keyboards are used to manage the tracks.

The keyboard you find above the central column allows you to:

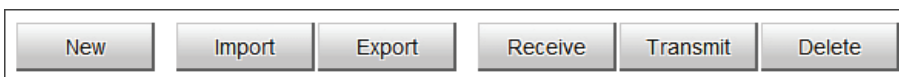

- **New:** create a new track
- **Import:** import one or more tracks you stored in your MXS 1.2 Strada or in another external device
- **Export:** export one or more tracks to a specific PC folder or to another peripheral device
- **Receive:** receive from your connected MXS 1.2 Strada the tracks you created (if no device is connected the button is disabled)
- **Transmit:** transmit one or more tracks from the PC to your connected MXS 1.2 Strada (if no device is connected the button is disabled)
- **Delete:** delete one or more tracks from Race Studio 3 Database

The keyboard you find above the right column allows you to:

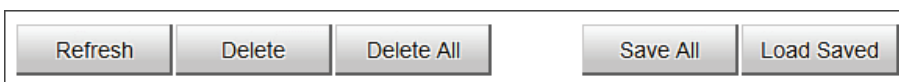

- **Refresh:** refresh the track list stored in your connected PDM 32
- **Delete:** delete one or more tracks from your PDM 32 memory
- **Delete All:** delete all tracks stored in your PDM 32 memory
- **Save all:** save all the tracks stored in your connected PDM 32; it creates a zip file you can load to another AiM device
- **Load Saved:** load the tracks you previously saved in your connected PDM 32 memory

## 20. ECU Driver builder

In case your vehicle ECU is not included in Race Studio 3 software, you can use CAN Driver builder to create your own CAN protocol.

You may use the CAN Driver Builder for producing a protocol that may be managed both on CAN 1 and on CAN2.

In order to activate the DriverBuilder, press the following pushbutton:

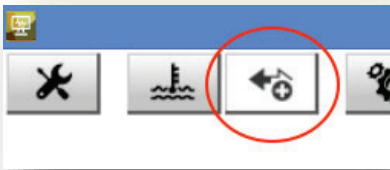

The main page is shown:

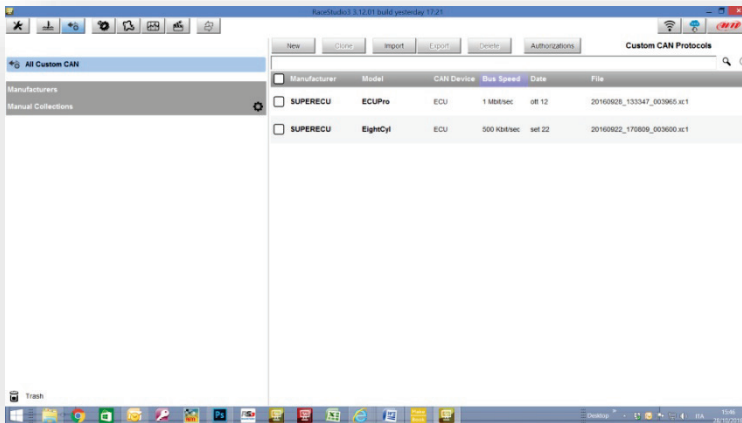

and the following pushbuttons are available:

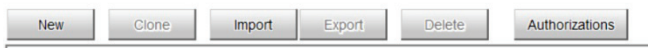

Press "NEW" for creating a new protocol.

This window appears:

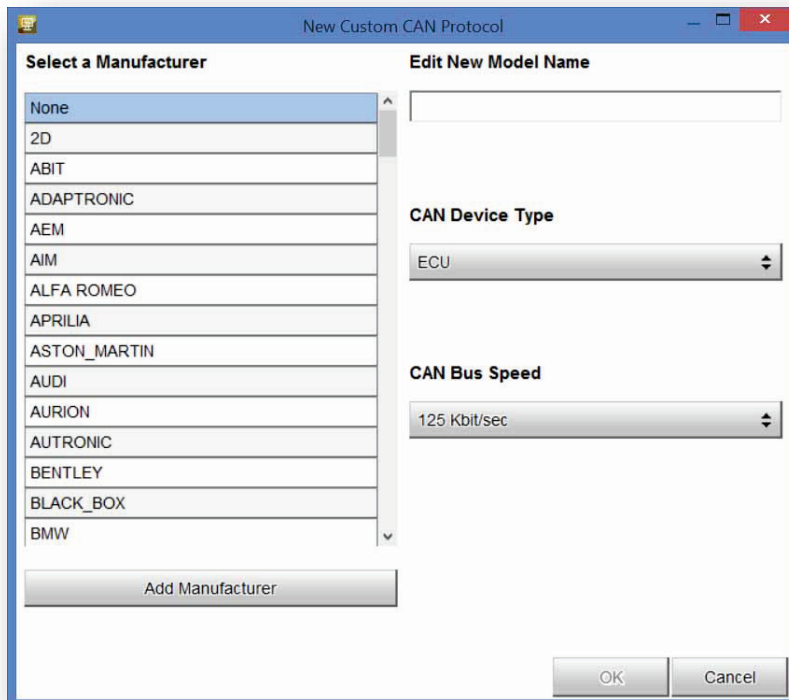

Here you can set:

- the Device manufacturer and the Model name, for then being able to select the new protocol, that you will find in the Protocols Database. In case the Device Manufacturer is not in the list, you can add it.
- the Device Type: it can be ECU (in this case it can be managed only in CAN1 of the Aim Loggers/dashes) or Another CAN device ( in this case it can be managed both in CAN1 and in CAN2)
- the CAN bus speed

After having set the proper fields, this page appears:

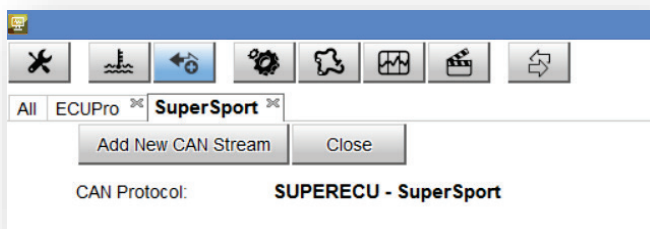

You have two pushbuttons:

- 1) Add New can Stream
- 2) CLOSE

After having eventually defined the Password and the License Code, you can start creating the Protocol. Click on "ADD NEW CAN STREAM" and the new window appears:

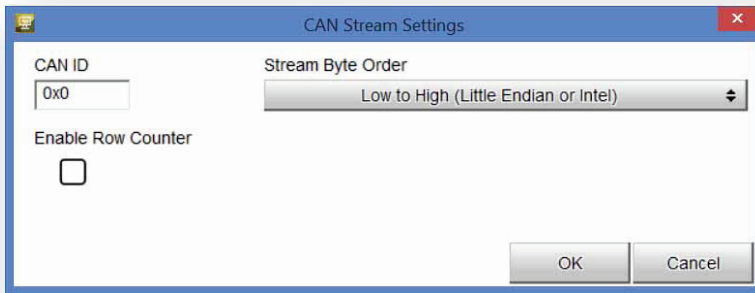

The fields to be set are:

- CAN ID
  - Stream Byte Order. This last can be Little or Big Endian, in dependence upon the processor of the device.
- Here an example of the different formats:

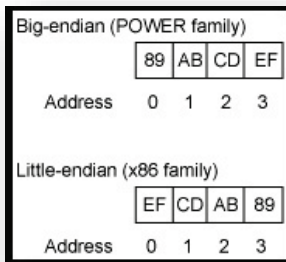

- Row Counter Enable: This field is used when we have to define a multiplexed stream, that is to say a stream where the format depends upon a field, called Row Counter.

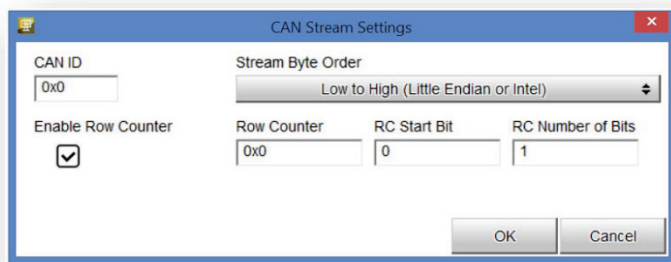

After having set the different parameters, you click OK and a new window appears:

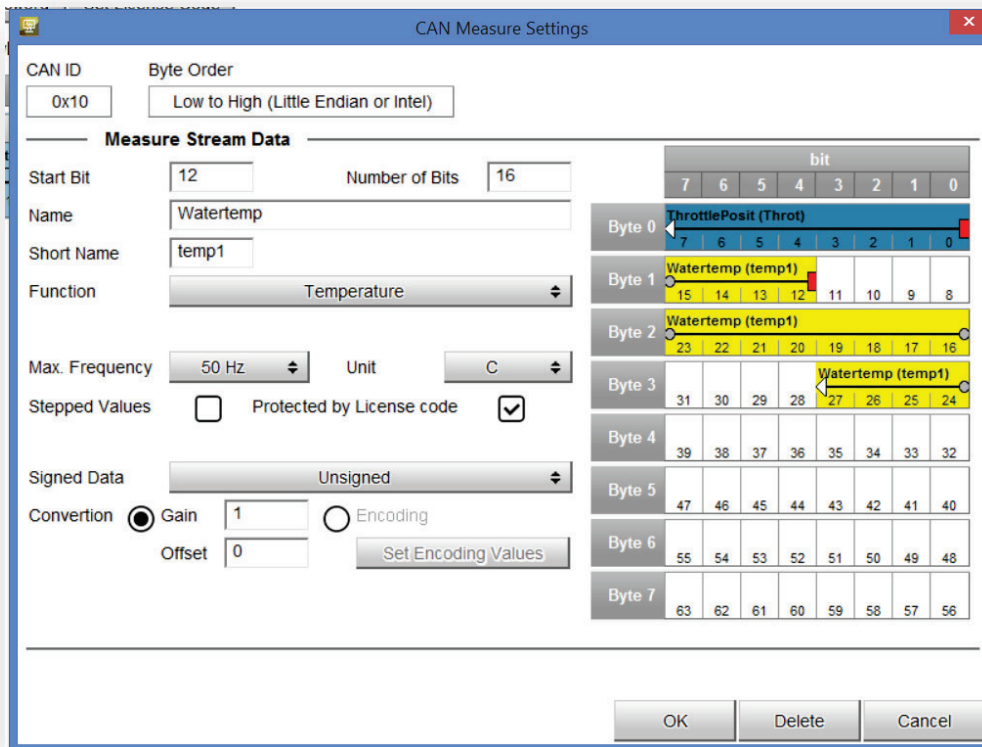

This page is used for defining a single channel.

You have to define:

- Start Bit
- Number of Bits
- Name - to be used in Analysis
- Short Name – to be used on the display
- Function
- Max Acquisition Frequency
- Unit of Measure
- Protection ( in this case, the License Code you have previously set is used
- Stepped Value - this field is used in Analysis: if a value is Stepped, it is not interpolated (for example, the Gear Number, that is to be shown at fixed values).
- Conversion : for every channel you can define a Gain and an Offset (  $Output = Input\ Value \times Gain + Offset$ ) or an Encoding. In this case, a conversion table is to be defined per every value of the field:

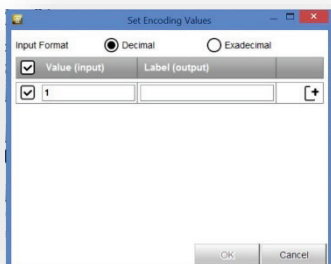

After having set all the parameters, the data stream is shown:

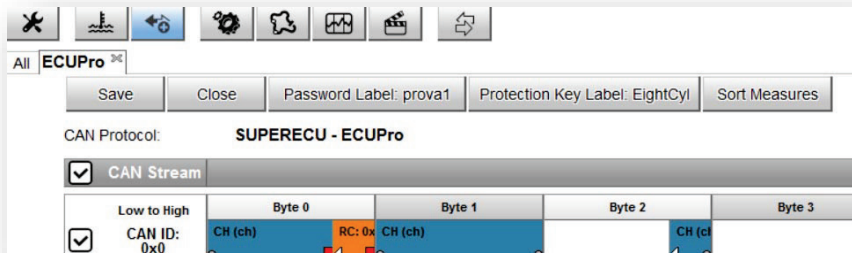

Five pushbuttons are available:

- 1) SAVE
- 2) CLOSE
- 3) Password: for changing the password associated to the protocol
- 4) Protection key: for managing the protection key used for crypting and hiding some fields of the protocol
- 5) Sort Measures: used for changing the order in which you will see the fields in the final protocol, that will be available in the protocol database and used like any other protocol

For adding a channel, please double click in the desired position of the stream.

For modifying a channel, click on it.

For adding another stream, click on the "+" at the right of the stream.

For Sorting the measures in the stream, please, push the pushbutton and the window will appear:

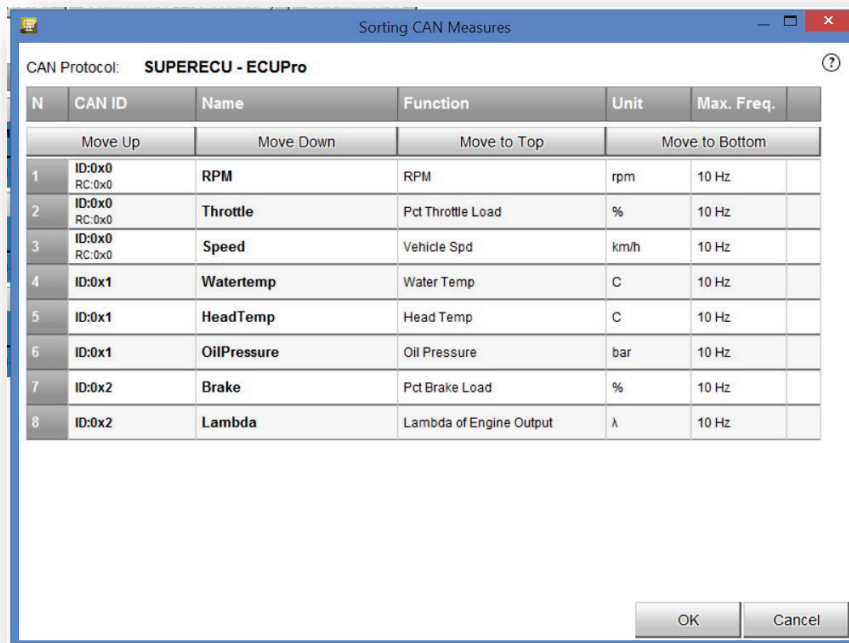

You can click on a field and move it up and down, dragging and dropping it.



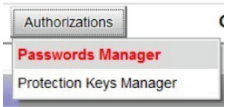

CAN Driver Builder offers TWO different Authorizations:

- **Protocol Password:** the password that you are supposed to have in your PC for EDITING the protocol
- **Measure Protection Key:** the key that you are supposed to have in your PC for using, seeing in online, downloading and seeing in Analysis the measures defined as "locked" in your protocol.

The "locked" measures cannot be shown on the display, but are recorded like any other measure. If you download the data into a PC with the Measure Protocol Key installed, the locked measures are completely visible, else they are hidden and crypted.

At the end, "Save" and exit. You will find the new protocol among all the others in the database.

## 21. The device window

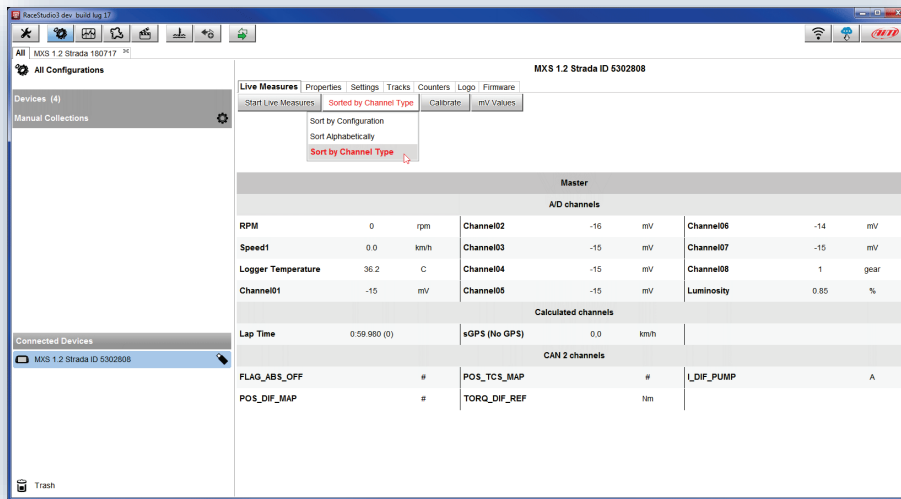

Clicking your PDM 32 bottom left of the software page you enter the device window and have these options:

- **Live Measures:** to check all PDM 32 channels; here you can:
  - start live measures
  - sort the channel visualization as you prefer: as managed by the firmware (sort by configuration), alphabetically, by channel type (they will be shown by device then by channel type and at the end by measure type)
  - calibrate sensors that need the calibration
  - show the measure in Mv
- **Properties:** to name your device, fill in racer's and vehicle name or number, championship and venue type (generic or qualifying testing, warm up, race, test type)
- **Settings** to:
  - set date
  - enable/disable daylight time
  - set time format and time zone
- **Tracks:** to manage the tracks stored in the device memory
- **Counters:** to set reset the device odometers
- **Logo:** transmit/receive the logo that shows up when switching MXS 1.2 Strada on; supported image format are JPEG or BMP; always use the most recent Windows™ versions (Windows8 or Windows10) whose graphic libraries are more updated
- **Firmware:** to check or update your PDM 32 firmware version.

## Online measure values forcing

In the Online Interface, it is possible to force the values of every channel:

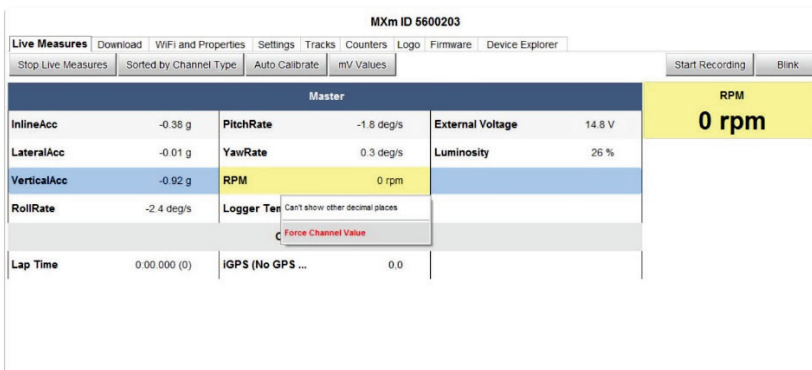
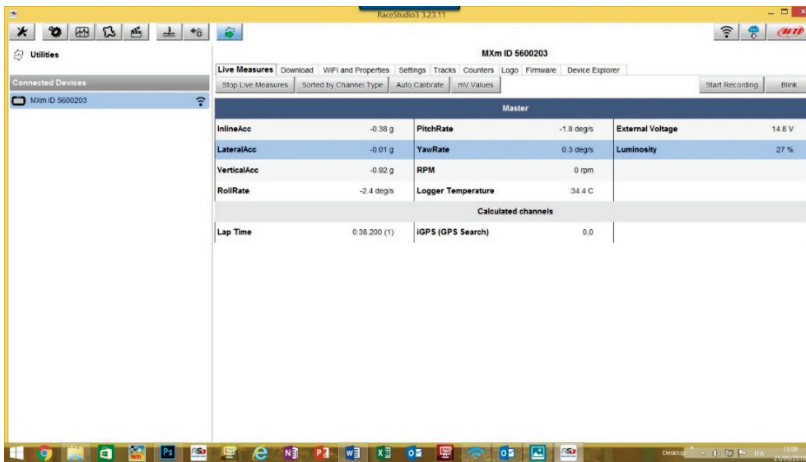

If you select a channel, RPM, for example, and click on the right small icon that appears near the value, you may force the value of that channel.

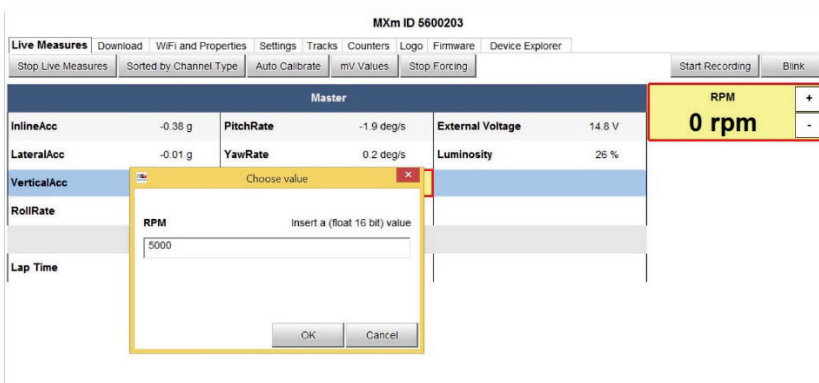

The forced channels are shown surrounded by a red frame.

Here, for example, RPM has been forced to the value 5000.

MXm ID 5600203				
Live Measures				
Download		WiFi and Properties		Settings
Tracks		Counters		Logo
Firmware		Device Explorer		
Stop Live Measures		Sorted by Channel Type		Auto Calibrate
mV Values		Stop Forcing		
				Start Recording
				Blink
Master				
InlineAcc	-0.38 g	PitchRate	-1.9 deg/s	External Voltage
LateralAcc	-0.01 g	YawRate	0.2 deg/s	Luminosity
VerticalAcc	-0.92 g	<b>RPM</b>	<b>5000 rpm</b>	
RollRate	-2.4 deg/s	Logger Temper...	34.2 C	
Calculated channels				
Lap Time	0.37.540 (1)	iGPS (GPS Sea...	0.0	

Then, you may move it up and down using the pushbuttons “+” and “-”.

This feature may be useful for testing, for example, Icons behavior, alarms, Power Outputs, harnesses.

MXm ID 6500100				
Live Measures				
Download		WiFi and Properties		Settings
Tracks		Counters		Logo
Firmware		Device Explorer		
Stop Live Measures		Sorted by Channel Type		Auto Calibrate
mV Values		Stop Forcing		
				Start Recording
				Blink
VerticalAcc	-0.92 g	Oil Pressure	-2.65 bar	Wat AlarmCurr...
RollRate	-0.4 deg/s	Logger Tempe...	33.7 C	<b>Water temp</b>
PitchRate	0.8 deg/s	Channel03	-290.0 C	<b>103.6 C</b>
YawRate	5.4 deg/s	<b>Water temp</b>	103.6 C	
ECU channels				
PedalPosition	---	ErrorCode4	#	InletAirTemp
ThrottlePosition	---	ErrorCode5	#	EngineCoolantT
BrakeSwitch	#	ErrorCode6	#	EngineHour
AWDActivation	#	ErrorCodeSw	#	EPSInputForce
OverrideSW	#	ManifoldAirPre...	---	EPSOutputForce
ErrorCode1	#	Engine Speed	---	Battery
ErrorCode2	#	Vehicle Speed	---	EPSCurrent
ErrorCode3	#	EPSTemp	---	Gear
Calculated channels				
Oil Pr Ala	1 #	Wat Alarm	1 #	iGPS (GPS Go...
Oil Pres Status	1 #	Lap Time	0.00.000 (0)	

In the above configuration, for example, a Power Output is turned ON when the Water temperature reaches 100°C. If you force its value at 100°C, and, using the “+” and “-” pushbuttons, you move this value up and down and you may see the alarm being turned ON and OFF.

## 22. CAN Output configuration

You may configure your device to transmit a CAN data stream, both on CAN1 and CAN2, containing the channels required.

To add a payload:

- press “+Add new Payload” and “Set CAN Header details” appears.
- fill in ID CAN (hex), available options are:
  - 11 bits (normal address)
  - 29 bits (extended address)
- select the payload max bytes number (DLC), from 1 to 8 bytes
- select the byte order according to the used processor, available options are:
  - Little endian for Intel compatible processor
  - Big Endian for Motorola processor
- set the sampling frequency among 1,2, 5, 10 or 20 Hz

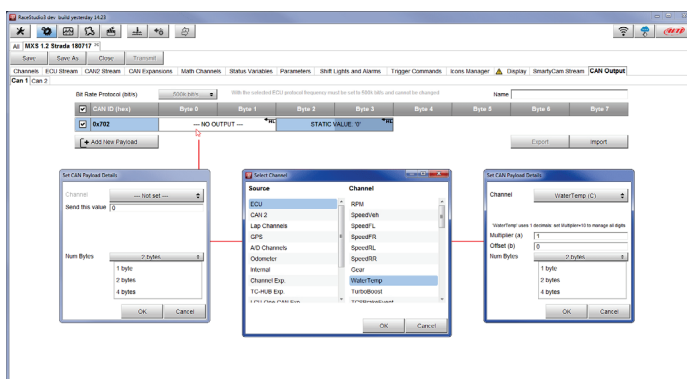
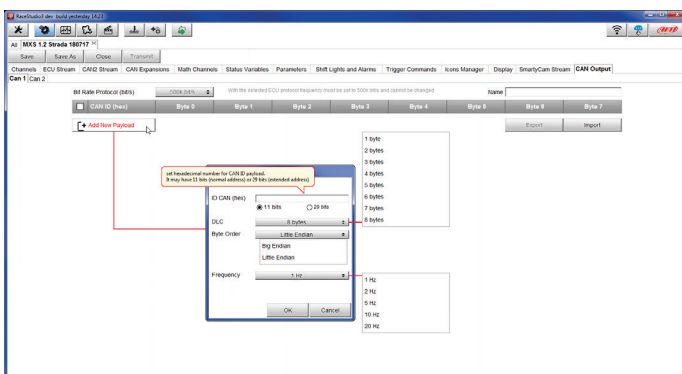

When all channels set your configuration is finished:

- press “Save” on the page top keyboard
- press “Transmit” to transmit the configuration to the PDM 32



## Appendix A – Connectors and Pinout

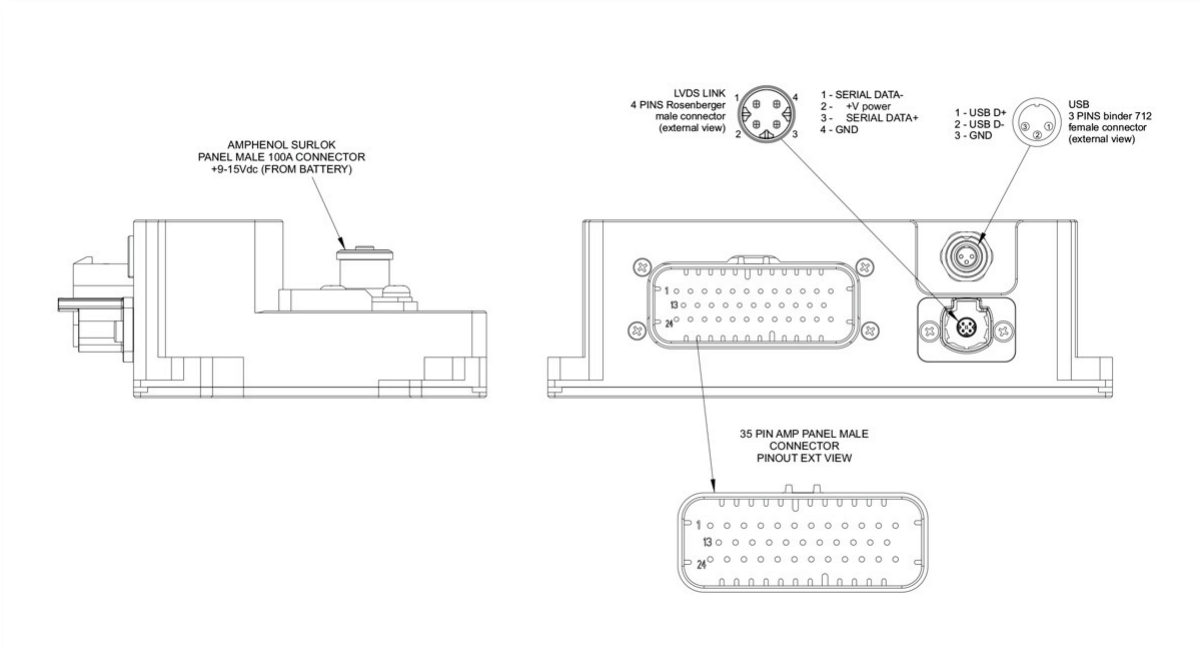

PIN	DESCRIPTION	PIN	DESCRIPTION
1	Power out 1	19	CAN2H
2	Power out 2	20	CH IN 3
3	CAN AiM H	21	CH IN 4
4	Power out 3	22	+5VREF
5	CAN ECU L	23 ●	Power out 8
6	Power out 4	24	LIN
7	Power out 5	25	IGN
8	CH IN 1	26	+VB out CAN
9	Power out 6	27	GND
10	CH IN 2	28	Speed 1 IN
11	Power out 7	29	Speed 2 IN
12 ●	Power out 8	30	CH IN 5
13	Power out 1	31	+5VREF
14	+VB ext CAN	32	+VB out
15	CAN AiM L	33	CH IN 6
16	CAN ECU H	34	GND
17	GND	35	GND
18	CAN2L		

● High Power Out 8 has internal serie diode

## Appendix B – Mechanical Drawings

