

Lenovo[™]

ThinkPad[®]

ThinkPad P40 Yoga, ThinkPad S3, ThinkPad
Yoga 14, and ThinkPad Yoga 460 User Guide

ThinkPad

Note: Before using this information and the product it supports, be sure to read and understand the following:

- *Safety, Warranty, and Setup Guide*
- *Regulatory Notice*
- “Important safety information” on page vi
- Appendix E “Notices” on page 163

The *Safety, Warranty, and Setup Guide* and the *Regulatory Notice* have been uploaded to the Web site. To refer to them, go to <http://www.lenovo.com/UserManuals> and follow the instructions on the screen.

Third Edition (January 2016)

© Copyright Lenovo 2015, 2016.

LIMITED AND RESTRICTED RIGHTS NOTICE: If data or software is delivered pursuant a General Services Administration “GSA” contract, use, reproduction, or disclosure is subject to restrictions set forth in Contract No. GS-35F-05925.

Contents

Read this first	v	Stand mode	19
Important safety information	vi	Tablet mode	20
Conditions that require immediate action	vii	Tent mode	21
Service and upgrades	vii	Using the special buttons	23
Power cords and power adapters	viii	Using the special keys	23
Extension cords and related devices	ix	ThinkPad Pen Pro	26
Plugs and outlets	ix	Using the keyboard	27
Power supply statement	ix	Using the multi-touch screen	29
External devices	x	Using the ThinkPad pointing device	32
General battery notice	x	TrackPoint pointing device	32
Notice for built-in rechargeable battery	x	Trackpad	33
Notice for non-rechargeable coin-cell battery	xi	Trackpad touch gestures	34
Heat and product ventilation	xi	Customizing the ThinkPad pointing device	35
Electrical current safety information	xii	Replacing the cap of the TrackPoint pointing stick	35
Liquid crystal display (LCD) notice	xiii	Power management	36
Using headphones or earphones	xiii	Checking the battery status	36
Additional safety information	xiii	Using the ac power	36
		Charging the battery	37
Chapter 1. Product overview	1	Maximizing the battery life	37
Locating computer controls, connectors, and indicators	1	Managing the battery power	37
Front view	1	Power-saving modes	38
Right-side view	2	Connecting to the network	39
Left-side view	4	Ethernet connections	39
Bottom view	5	Wireless connections	39
Rear view	6	Using an external display	42
Status indicators	6	Connecting an external display	42
Locating important product information	8	Choosing a display mode	43
Machine type and model label	8	Changing display settings	43
FCC ID and IC Certification information	8	Using the NVIDIA Optimus Graphics feature	43
Labels for the Windows operating systems	9	Using audio features	43
Features	10	Using the camera	44
Specifications	11	Using a flash media card	45
Operating environment	11		
Lenovo programs	12	Chapter 3. Enhancing your computer	47
Accessing Lenovo programs	12	Finding ThinkPad options	47
An introduction to Lenovo programs	12	ThinkPad OneLink+ Dock	47
Chapter 2. Using your computer	15	Chapter 4. You and your computer	49
Registering your computer	15	Accessibility and comfort	49
Frequently asked questions	15	Ergonomic information	49
Getting help about the Windows operating system	16	Comfort	50
Operating modes	17	Accessibility information	50
Enabling the operating modes	17	Traveling with your computer	53
Rotating the computer display	17	Travel tips	53
Notebook mode	18	Travel accessories	53

Chapter 5. Security	55	A software problem	107
Using passwords	55	Problems with ports and connectors	107
Typing passwords	55		
Power-on password	55	Chapter 9. Recovery overview	109
Supervisor password	56	Recovery overview for the Windows 7 operating system	109
Hard disk passwords	57	Creating and using recovery media	109
Hard disk security	59	Performing backup and recovery operations	110
Setting the security chip	60	Using the Rescue and Recovery workspace	111
Using the fingerprint reader	61	Creating and using a rescue medium	112
Notice on deleting data from your storage drive	64	Reinstalling preinstalled programs and device drivers	112
Using firewalls	64	Solving recovery problems	113
Protecting data against viruses	64	Recovery overview for the Windows 10 operating system	114
Chapter 6. Advanced configuration	67	Resetting your computer	114
Installing a new operating system	67	Using advanced startup options	114
Installing the Windows 7 operating system	67	Recovering your operating system if Windows 10 fails to start	114
Installing the Windows 10 operating system	68	Creating and using a recovery USB drive	115
Installing device drivers	69	Chapter 10. Replacing devices	117
Using the ThinkPad Setup program	70	Static electricity prevention	117
Main menu	70	Disabling the built-in battery	117
Config menu	71	Installing or replacing the micro SIM card	118
Date and Time menu	76	Replacing the keyboard	120
Security menu	76	Replacing the base cover assembly	124
Startup menu	82	Replacing the memory module	127
Restart menu	84	Replacing the internal storage drive	129
Updating the UEFI BIOS	85	Replacing the button I/O card	131
Using system management	85	Replacing the ac power card	133
Chapter 7. Preventing problems	87	Replacing the speaker assembly	137
General tips for preventing problems	87	Replacing the coin-cell battery	139
Making sure device drivers are current	88	Chapter 11. Getting support	143
Taking care of your computer	89	Before you contact Lenovo	143
Cleaning the cover of your computer	90	Getting help and service	143
Chapter 8. Troubleshooting computer problems	93	Using diagnostic programs	144
Diagnosing problems	93	Lenovo Support Web site	144
Troubleshooting	93	Calling Lenovo	144
Computer stops responding	93	Purchasing additional services	145
Spills on the keyboard	94	Appendix A. Regulatory information	147
Error messages	94	Location of the UltraConnect wireless antennas	147
Beep errors	96	Wireless related information	147
Memory module problems	96	Wireless-radio compliance information	149
Networking problems	96	Locating wireless regulatory notices	149
Problems with the keyboard and other pointing devices	98	Certification related information	149
Problems with the display and multimedia devices	99	Export classification notice	150
Battery and power problems	103		
Problems with drives and other storage devices	106		

Electronic emission notices.	150	Japan recycling statements	153
Federal Communications Commission Declaration of Conformity	150	Recycling information for Brazil	154
Industry Canada Class B emission compliance statement	150	Battery recycling information for the European Union	154
European Union - Compliance to the Electromagnetic Compatibility Directive	151	Battery recycling information for Taiwan.	155
German Class B compliance statement	151	Battery recycling information for the United States and Canada.	155
Korea Class B compliance statement	152	Recycling information for China	155
Japan VCCI Class B compliance statement.	152	Appendix C. Restriction of Hazardous Substances Directive (RoHS)	157
Japan compliance statement for products which connect to the power mains with rated current less than or equal to 20 A per phase	152	European Union RoHS	157
Japan notice for ac power cord	152	China RoHS.	158
Lenovo product service information for Taiwan	152	Turkish RoHS	158
Eurasian compliance mark	152	Ukraine RoHS	159
Brazil audio notice	152	India RoHS	159
Appendix B. WEEE and recycling statements	153	Appendix D. ENERGY STAR model information	161
Important WEEE information	153	Appendix E. Notices	163
		Trademarks	164

Read this first

Be sure to follow the important tips given here to get the most use and enjoyment out of your computer. Failure to do so might lead to discomfort or injury, or cause your computer to fail.

Protect yourself from the heat that your computer generates.



When your computer is turned on or the battery is charging, the base, the palm rest, and some other parts may become hot. The temperature they reach depends on the amount of system activity and the level of charge in the battery.

Extended contact with your body, even through clothing, could cause discomfort or even a skin burn.

- Avoid keeping your hands, your lap, or any other part of your body in contact with a hot section of the computer for any extended time.
- Periodically take hands from using the keyboard by lifting your hands from the palm rest.

Protect yourself from the heat generated by the ac power adapter.



When the ac power adapter is connected to an electrical outlet and your computer, it generates heat.

Extended contact with your body, even through clothing, may cause a skin burn.

- Do not place the ac power adapter in contact with any part of your body while it is in use.
- Never use it to warm your body.

Prevent your computer from getting wet.



To avoid spills and the danger of electrical shock, keep liquids away from your computer.

Protect the cables from being damaged.



Applying strong force to cables may damage or break them.

Route communication lines, or the cables of an ac power adapter, a mouse, a keyboard, a printer, or any other electronic device, so that they cannot be walked on, tripped over, pinched by your computer or other objects, or in any way subjected to treatment that could interfere with the operation of your computer.

Protect your computer and data when moving it.

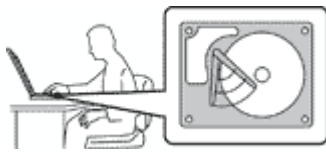

Before moving a computer equipped with an internal storage drive, do one of the following:

- Turn it off.
- Put it in sleep mode.
- Put it in hibernation mode.

This will help to prevent damage to the computer, and possible loss of data.

Handle your computer gently.



Do not drop, bump, scratch, twist, hit, vibrate, push, or place heavy objects on your computer, display, or external devices.

Carry your computer carefully.



- Use a quality carrying case that provides adequate cushioning and protection.
- Do not pack your computer in a tightly packed suitcase or bag.
- Before putting your computer in a carrying case, ensure that it is off, in sleep mode, or in hibernation mode. Do not put a computer in a carrying case while it is turned on.
- Do not carry your computer in the notebook mode, stand mode, tablet mode, or tent mode. Carry your computer with the display closed only.

Important safety information

Note: Read the important safety information first.

This information can help you safely use your notebook computer. Follow and retain all information included with your computer. The information in this document does not alter the terms of your purchase agreement or the Lenovo® Limited Warranty. For more information, see “Warranty Information” in the *Safety, Warranty, and Setup Guide* that comes with your computer.

Customer safety is important. Our products are developed to be safe and effective. However, personal computers are electronic devices. Power cords, power adapters, and other features can create potential safety risks that can result in physical injury or property damage, especially if misused. To reduce these risks, follow the instructions included with your product, observe all warnings on the product and in the operating instructions, and review the information included in this document carefully. By carefully following the information contained in this document and provided with your product, you can help protect yourself from hazards and create a safer computer work environment.

Note: This information includes references to power adapters and batteries. In addition to notebook computers, some products (such as speakers and monitors) ship with external power adapters. If you have such a product, this information applies to your product. In addition, computer products contain a coin-sized internal battery that provides power to the system clock even when the computer is unplugged, so the battery safety information applies to all computer products.

Conditions that require immediate action

Products can become damaged due to misuse or neglect. Some product damage is serious enough that the product should not be used again until it has been inspected and, if necessary, repaired by an authorized servicer.

As with any electronic device, pay close attention to the product when it is turned on. On very rare occasions, you might notice an odor or see a puff of smoke or sparks vent from your product. Or you might hear sounds like popping, cracking or hissing. These conditions might merely mean that an internal electronic component has failed in a safe and controlled manner. Or, they might indicate a potential safety issue. However, do not take risks or attempt to diagnose the situation yourself. Contact the Customer Support Center for further guidance. For a list of Service and Support phone numbers, see the following Web site:
<http://www.lenovo.com/support/phone>

Frequently inspect your computer and its components for damage or wear or signs of danger. If you have any question about the condition of a component, do not use the product. Contact the Customer Support Center or the product manufacturer for instructions on how to inspect the product and have it repaired, if necessary.

In the unlikely event that you notice any of the following conditions, or if you have any safety concerns with your product, stop using the product and unplug it from the power source and telecommunication lines until you can speak to the Customer Support Center for further guidance.

- Power cords, plugs, power adapters, extension cords, surge protectors, or power supplies that are cracked, broken, or damaged.
- Signs of overheating, smoke, sparks, or fire.
- Damage to a battery (such as cracks, dents, or creases), discharge from a battery, or a buildup of foreign substances on the battery.
- A cracking, hissing or popping sound, or strong odor that comes from the product.
- Signs that liquid has been spilled or an object has fallen onto the computer product, the power cord or power adapter.
- The computer product, power cord, or power adapter has been exposed to water.
- The product has been dropped or damaged in any way.
- The product does not operate normally when you follow the operating instructions.

Note: If you notice these conditions with a product (such as an extension cord) that is not manufactured for or by Lenovo, stop using that product until you can contact the product manufacturer for further instructions, or until you get a suitable replacement.

Service and upgrades

Do not attempt to service a product yourself unless instructed to do so by the Customer Support Center or your documentation. Only use a Service Provider who is approved to repair your particular product.

Note: Some computer parts can be upgraded or replaced by the customer. Upgrades typically are referred to as options. Replacement parts approved for customer installation are referred to as Customer Replaceable Units, or CRUs. Lenovo provides documentation with instructions when it is appropriate for customers to install options or replace CRUs. You must closely follow all instructions when installing or replacing parts. The Off state of a power indicator does not necessarily mean that voltage levels inside a product are zero. Before you remove the covers from a product equipped with a power cord, always ensure that the power is turned off and that the product is unplugged from any power source. If you have any questions or concerns, contact the Customer Support Center.

Although there are no moving parts in your computer after the power cord has been disconnected, the following warnings are required for your safety.

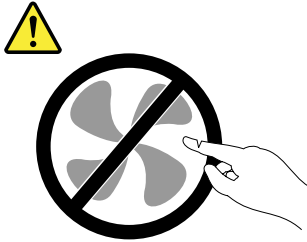

CAUTION:

Hazardous moving parts. Keep fingers and other body parts away.

CAUTION:



Before replacing any CRUs, turn off the computer and wait three to five minutes to let the computer cool before opening the cover.

Power cords and power adapters



DANGER

Use only the power cords and power adapters supplied by the product manufacturer.

The power cords shall be safety approved. For Germany, it shall be H05VV-F, 3G, 0.75 mm², or better. For other countries, the suitable types shall be used accordingly.

Never wrap a power cord around a power adapter or other object. Doing so can stress the cord in ways that can cause the cord to fray, crack, or crimp. This can present a safety hazard.

Always route power cords so that they will not be walked on, tripped over, or pinched by objects.

Protect power cords and power adapters from liquids. For instance, do not leave your power cord or power adapter near sinks, tubs, toilets, or on floors that are cleaned with liquid cleansers. Liquids can cause a short circuit, particularly if the power cord or power adapter has been stressed by misuse. Liquids also can cause gradual corrosion of power cord terminals and/or the connector terminals on a power adapter, which can eventually result in overheating.

Always connect power cords and signal cables in the correct order and ensure that all power cord connectors are securely and completely plugged into receptacles.

Do not use any power adapter that shows corrosion at the ac input pins or shows signs of overheating (such as deformed plastic) at the ac input pins or anywhere on the power adapter.

Do not use any power cords where the electrical contacts on either end show signs of corrosion or overheating or where the power cord appears to have been damaged in any way.

To prevent possible overheating, do not cover the power adapter with clothing or other objects when the power adapter is plugged into an electrical outlet.

Extension cords and related devices

Ensure that extension cords, surge protectors, uninterruptible power supplies, and power strips that you use are rated to handle the electrical requirements of the product. Never overload these devices. If power strips are used, the load should not exceed the power strip input rating. Consult an electrician for more information if you have questions about power loads, power requirements, and input ratings.

Plugs and outlets



If a receptacle (power outlet) that you intend to use with your computer equipment appears to be damaged or corroded, do not use the outlet until it is replaced by a qualified electrician.

Do not bend or modify the plug. If the plug is damaged, contact the manufacturer to obtain a replacement.

Do not share an electrical outlet with other home or commercial appliances that draw large amounts of electricity; otherwise, unstable voltage might damage your computer, data, or attached devices.

Some products are equipped with a three-pronged plug. This plug fits only into a grounded electrical outlet. This is a safety feature. Do not defeat this safety feature by trying to insert it into a non-grounded outlet. If you cannot insert the plug into the outlet, contact an electrician for an approved outlet adapter or to replace the outlet with one that enables this safety feature. Never overload an electrical outlet. The overall system load should not exceed 80 percent of the branch circuit rating. Consult an electrician for more information if you have questions about power loads and branch circuit ratings.

Be sure that the power outlet you are using is properly wired, easily accessible, and located close to the equipment. Do not fully extend power cords in a way that will stress the cords.

Be sure that the power outlet provides the correct voltage and current for the product you are installing.

Carefully connect and disconnect the equipment from the electrical outlet.

Power supply statement



Never remove the cover on a power supply or any part that has the following label attached.



Hazardous voltage, current, and energy levels are present inside any component that has this label attached. There are no serviceable parts inside these components. If you suspect a problem with one of these parts, contact a service technician.

External devices

CAUTION:

Do not connect or disconnect any external device cables other than USB cable while the computer power is on; otherwise, you might damage your computer. To avoid possible damage to attached devices, wait at least five seconds after the computer is shut down to disconnect external devices.

General battery notice



DANGER

Batteries supplied by Lenovo for use with your product have been tested for compatibility and should only be replaced with approved parts. A battery other than the one specified by Lenovo, or a disassembled or modified battery is not covered by the warranty.

Battery abuse or mishandling can cause overheating, liquid leakage, or an explosion. To avoid possible injury, do the following:

- Do not open, disassemble, or service any battery.
- Do not crush or puncture the battery.
- Do not short-circuit the battery, or expose it to water or other liquids.
- Keep the battery away from children
- Keep the battery away from fire.

Stop using the battery if it is damaged, or if you notice any discharge or the buildup of foreign materials on the battery leads.

Store the rechargeable batteries or products containing the rechargeable batteries at room temperature, charged to approximately 30 to 50% of capacity. We recommend that the batteries be charged about once per year to prevent overdischarge.

Do not put the battery in trash that is disposed of in landfills. When disposing of the battery, comply with local ordinances or regulations.

Notice for built-in rechargeable battery



DANGER

Do not attempt to replace the built-in rechargeable battery. Replacement of the battery must be done by a Lenovo-authorized repair facility or technician.

Only recharge the battery strictly according to instructions included in the product documentation.

The Lenovo-authorized repair facilities or technicians recycle Lenovo batteries according to local laws and regulations.

Notice for non-rechargeable coin-cell battery



DANGER

If the coin-cell battery is incorrectly replaced, there is danger of an explosion. The battery contains a small amount of harmful substance.

Do not heat to more than 100°C (212°F).

The following statement applies to users in the state of California, U.S.A.

California Perchlorate Information:

Products containing manganese dioxide lithium coin-cell batteries may contain perchlorate.

Perchlorate Material - special handling may apply, See www.dtsc.ca.gov/hazardouswaste/perchlorate

Heat and product ventilation



DANGER

Computers, ac power adapters, and many accessories can generate heat when turned on and when batteries are charging. Notebook computers can generate a significant amount of heat due to their compact size. Always follow these basic precautions:

- When your computer is turned on or the battery is charging, the base, the palm rest, and some other parts may become hot. Avoid keeping your hands, your lap, or any other part of your body in contact with a hot section of the computer for any extended length of time. When you use the keyboard, avoid keeping your palms on the palm rest for a prolonged period of time. Your computer generates some heat during normal operation. The amount of heat depends on the amount of system activity and the battery charge level. Extended contact with your body, even through clothing, could cause discomfort or even a skin burn. Periodically take breaks from using the keyboard by lifting your hands from the palm rest; and be careful not to use the keyboard for any extended length of time.
- Do not operate your computer or charge the battery near flammable materials or in explosive environments.
- Ventilation slots, fans and/or heat sinks are provided with the product for safety, comfort, and reliable operation. These features might inadvertently become blocked by placing the product on a bed, sofa, carpet, or other flexible surface. Never block, cover, or disable these features.
- When the ac power adapter is connected to an electrical outlet and your computer, it generates heat. Do not place the adapter in contact with any part of your body while using it. Never use the ac power adapter to warm your body. Extended contact with your body, even through clothing, may cause a skin burn.

For your safety, always follow these basic precautions with your computer:

- Keep the cover closed whenever the computer is plugged in.
- Regularly inspect the outside of the computer for dust accumulation.
- Remove dust from vents and any perforations in the bezel. More frequent cleanings might be required for computers in dusty or high-traffic areas.
- Do not restrict or block any ventilation openings.

- Do not operate your computer inside furniture, as this might increase the risk of overheating.
- Airflow temperatures into the computer should not exceed 35°C (95°F).

Electrical current safety information



Electric current from power, telephone, and communication cables is hazardous.

To avoid a shock hazard:

- Do not use your computer during a lightning storm.
- Do not connect or disconnect any cables or perform installation, maintenance, or reconfiguration of this product during an electrical storm.
- Connect all power cords to a properly wired and grounded electrical outlet.
- Connect to properly wired outlets any equipment that will be attached to this product.
- Whenever possible, use one hand only to connect or disconnect signal cables.
- Never turn on any equipment when there is evidence of fire, water, or structural damage.
- Disconnect all attached cables and disable batteries before opening any accessible device covers unless instructed otherwise in the installation and configuration procedures.
- Do not use your computer until all internal parts enclosures are fastened into place. Never use the computer when internal parts and circuits are exposed.



Connect and disconnect cables as described in the following procedures when installing, moving, or opening covers on this product or attached devices.

To connect:

1. Turn everything OFF.
2. First, attach all cables to devices.
3. Attach signal cables to connectors.
4. Attach power cords to outlets.
5. Turn devices ON.

To disconnect:

1. Turn everything OFF.
2. First, remove power cords from outlets.
3. Remove signal cables from connectors.
4. Remove all cables from devices.

The power cord must be disconnected from the wall outlet or receptacle before installing all other electrical cables connected to the computer.

The power cord may be reconnected to the wall outlet or receptacle only after all other electrical cables have been connected to the computer.



During electrical storms, do not perform any replacement and do not connect the telephone cable to or disconnect it from the telephone outlet on the wall.

Liquid crystal display (LCD) notice

CAUTION:

The liquid crystal display (LCD) is made of glass, and rough handling or dropping the computer can cause the LCD to break. If the LCD breaks and the internal fluid gets into your eyes or on your hands, immediately wash the affected areas with water for at least 15 minutes; if any symptoms are present after washing, get medical care.

Using headphones or earphones

CAUTION:

Excessive sound pressure from earphones and headphones can cause hearing loss. Adjustment of the equalizer to maximum increases the earphone and headphone output voltage and the sound pressure level. Therefore, to protect your hearing, adjust the equalizer to an appropriate level.

Excessive use of headphones or earphones for a long period of time at high volume can be dangerous if the output of the headphone or earphone connectors do not comply with specifications of EN 50332-2. The headphone output connector of your computer complies with EN 50332-2 Sub clause 7. This specification limits the computer's maximum wide band true RMS output voltage to 150 mV. To help protect against hearing loss, ensure that the headphones or earphones you use also comply with EN 50332-2 (Clause 7 limits) for a wide band characteristic voltage of 75 mV. Using headphones that do not comply with EN 50332-2 can be dangerous due to excessive sound pressure levels.

If your Lenovo computer came with headphones or earphones in the package, as a set, the combination of the headphones or earphones and the computer already complies with the specifications of EN 50332-1. If different headphones or earphones are used, ensure that they comply with EN 50332-1 (Clause 6.5 Limitation Values). Using headphones that do not comply with EN 50332-1 can be dangerous due to excessive sound pressure levels.

Additional safety information

Plastic bag notice



DANGER

Plastic bags can be dangerous. Keep plastic bags away from babies and children to avoid danger of suffocation.

Glass parts notice

CAUTION:

Some parts of your product may be made of glass. This glass could break if the product is dropped on a hard surface or receives a substantial impact. If glass breaks, do not touch or attempt to remove it. Stop using your product until the glass is replaced by trained service personnel.

Chapter 1. Product overview

This chapter provides information about the locations of connectors, locations of important product labels, computer features, specifications, operating environment, and preinstalled programs.

This chapter contains the following topics:

- “Locating computer controls, connectors, and indicators” on page 1
- “Locating important product information” on page 8
- “Features” on page 10
- “Specifications” on page 11
- “Operating environment” on page 11
- “Lenovo programs” on page 12

Locating computer controls, connectors, and indicators

This section introduces the computer hardware features to give you the basic information you will need to start using the computer.

Front view

Note: Depending on the model, your computer might look different from the following illustration.



1 Microphones	2 Camera
3 Ambient light sensor	4 Fingerprint reader
5 System-status indicator	6 Trackpad

7 TrackPoint® buttons (available on some models)	8 TrackPoint pointing stick
9 Windows® button	10 Multi-touch screen

1 Microphones

The microphones capture sound and voice when used with a program capable of handling audio.

2 Camera

Use the camera to take pictures or hold a video conference. For more information, see “Using the camera” on page 44.

3 Ambient light sensor

The ambient light sensor detects the surrounding light conditions. Then the computer adjusts the screen brightness accordingly.

4 Fingerprint reader (available on some models)

Fingerprint authentication technology provides simple and secure user access by associating your fingerprint with a password. For more information, see “Using the fingerprint reader” on page 61.

5 System-status indicator

The illuminated dot in the ThinkPad® logo functions as a system-status indicator. For more information, see “Status indicators” on page 6.

ThinkPad pointing device

6 Trackpad

7 TrackPoint buttons

8 TrackPoint pointing stick

The keyboard contains the ThinkPad pointing device. Pointing, selecting, and dragging are all part of a single process that you can perform without moving your fingers from a typing position. For more information, see “Using the ThinkPad pointing device” on page 32.

9 Windows button

Press the Windows button to open the Start menu; or press the Windows button to wake up the computer from sleep mode.

10 Multi-touch screen

Your computer comes with a multi-touch screen. For more information, see “Using the multi-touch screen” on page 29.

Right-side view

Note: Depending on the model, your computer might look different from the following illustration.

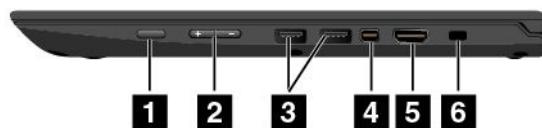

1 Power button	2 Volume-control buttons
3 USB 3.0 connectors	4 Mini DisplayPort connector
5 High-Definition Multimedia Interface (HDMI™) connector	6 Security-lock slot

1 Power button

Press the power button to turn on the computer or put the computer into sleep mode. For information about how to turn off the computer, see “Frequently asked questions” on page 15.

If your computer is unresponsive, you can turn off the computer by pressing and holding the power button for four or more seconds. If the computer cannot be turned off, see “Computer stops responding” on page 93 for more information.

You also can define what the power button does. For example, by pressing the power button, you can turn off the computer or put the computer into sleep or hibernation mode. To change what the power button does, do the following:

1. From the desktop, click the battery-status icon in the Windows notification area on the taskbar.
2. Click **More power options** → **Choose what the power buttons do**.
3. Follow the instructions on the screen.

2 Volume-control buttons

The volume-control buttons enable you to adjust the volume while you are using your computer in the tablet mode.

3 USB 3.0 connectors

The Universal Serial Bus (USB) 3.0 connectors are used for connecting USB-compatible devices, such as a USB keyboard or a USB mouse.

Attention: When you attach a USB cable to this connector, ensure that the USB mark is facing upward. Otherwise the connector might get damaged.

4 Mini DisplayPort connector

Use the mini DisplayPort® connector to connect your computer to a compatible projector, external monitor, or high-definition television. This compact connector enables a plug-and-play setup and supports adapters that can plug into Digital Visual Interface (DVI), Video Graphics Array (VGA), or High-Definition Multimedia Interface (HDMI™) connectors. The mini DisplayPort connector of your computer supports audio as well as video streaming. For more information, see “Using an external display” on page 34.

5 HDMI connector

Use the High-Definition Multimedia Interface (HDMI) connector to connect the computer to an HDMI-compatible audio device or video monitor, such as a high-definition television (HDTV).

6 Security-lock slot

To protect your computer from theft, purchase a security cable lock, usually a Kensington-style cable lock, that fits this security-lock slot to lock your computer to a stationary object.

Note: You are responsible for evaluating, selecting, and implementing the locking device and security feature. Lenovo makes no comments, judgments, or warranties about the function, quality, or performance of the locking device and security feature.

Left-side view

Note: Depending on the model, your computer might look different from the following illustration.



1 ac power connector	2 OneLink+ connector
3 Always On USB connector (USB 3.0 connector)	4 Audio connector
5 Media-card slot	6 ThinkPad Pen Pro (available on some models)

1 ac power connector

Connect the ac power adapter to the power connector to provide ac power to the computer and charge the battery.

2 OneLink+ connector

Use the OneLink+ connector to connect to the ThinkPad OneLink+ Dock or to connect to the OneLink+ Ethernet Adapter. With the OneLink+ Ethernet Adapter, you can connect the computer to a local area network (LAN).



To avoid the risk of electrical shock, do not connect the telephone cable to the Ethernet connector on the OneLink+ Ethernet Adapter. You can only connect an Ethernet cable to this connector.

Depending on the country or region of delivery, a OneLink+ Ethernet Adapter might be a part of the shipping contents that come with your computer. If your computer does not come with the OneLink+ Ethernet Adapter, you can purchase one from Lenovo at:
<http://www.lenovo.com/accessories/services/index.html>

The Ethernet connector on the OneLink+ Ethernet Adapter has two network status indicators. When the green indicator is on, the computer is connected to a LAN. When the yellow indicator blinks, data is being transmitted.

For instructions on how to use the ThinkPad OneLink+ Dock, see “ThinkPad OneLink+ Dock” on page 47.

3 Always On USB connector (USB 3.0 connector)

By default, the Always On USB connector enables you to charge some mobile digital devices and smartphones when your computer is in the following situations:

- When your computer is on or in sleep mode
- When your computer is in hibernation mode or is turned off, but connected to ac power

To charge these devices when the computer is in hibernation mode or turned off, and the computer is not connected to ac power, do the following:

- **For Windows 7:** Start the Power Manager program, click the **Global Power Settings** tab, and then follow the instructions on the screen.
- **For Windows 10:** Start the Lenovo Settings program, click **POWER**, and then follow the instructions on the screen.

For instructions on how to open the Lenovo Settings program, see “Accessing Lenovo programs” on page 12.

Attention: When you attach a USB cable to the connector, ensure that the USB mark is facing upward. Otherwise the connector might get damaged.

4 Audio connector

Connect headphones or a headset that has a 3.5-mm (0.14-inch) 4-pole plug to the audio connector to listen to the sound from the computer.

Notes:

- If you are using a headset with a function switch, do not press this switch while using the headset. If you press it, the headset microphone will be disabled, and the integrated microphones on the computer will be enabled instead.
- The audio connector does not support a conventional microphone. For more information, see “Using audio features” on page 43.

5 Media-card slot

Your computer is equipped with a media card reader, which provides a media-card slot. Insert your flash media card into the media-card slot to read the data on the card. For more information about the supported cards, see “Using a flash media card” on page 45.

6 ThinkPad Pen Pro (available on some models)

Depending on the model, your computer might have a ThinkPad Pen Pro installed. Use the ThinkPad Pen Pro to interact with your computer. For more information, see “ThinkPad Pen Pro” on page 26.

Bottom view

Note: Depending on the model, your computer might look different from the following illustration.



1 Emergency-reset hole	2 Speakers
-------------------------------	-------------------

1 Emergency-reset hole

If the computer stops responding and you cannot turn it off by pressing the power button, remove the ac power adapter first. Then insert a needle or a straightened paper clip into the emergency-reset hole to reset the computer.

2 Speakers

Your computer is equipped with a pair of stereo speakers.

Rear view

Note: Depending on the model, your computer might look different from the following illustration.

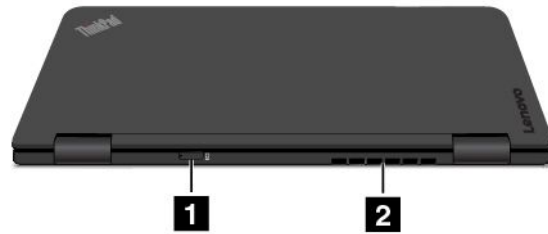

1 Micro-SIM-card slot (available on some models)

2 Fan louvers

1 Micro-SIM-card slot

If your computer supports the wireless Wide Area Network (wireless WAN) feature, a micro Subscriber Identification Module (SIM) card might be required to establish wireless WAN connections. Depending on the country or region of delivery, the micro SIM card might be already installed in this slot.

2 Fan louvers

The fan louvers and internal fan enable air to circulate in the computer and to ensure proper cooling, especially the cooling of the microprocessor.

Notes:

- To ensure proper airflow, do not place any obstacles in front of the fan louvers.
- The fan louvers of your computer might get too hot when the computer is running heavy tasks. When you are using or carrying the computer, take care to avoid direct contact to the fan louvers.

Status indicators

Your computer has six status indicators.

Note: Depending on the model, your computer might look different from the illustrations in this topic.

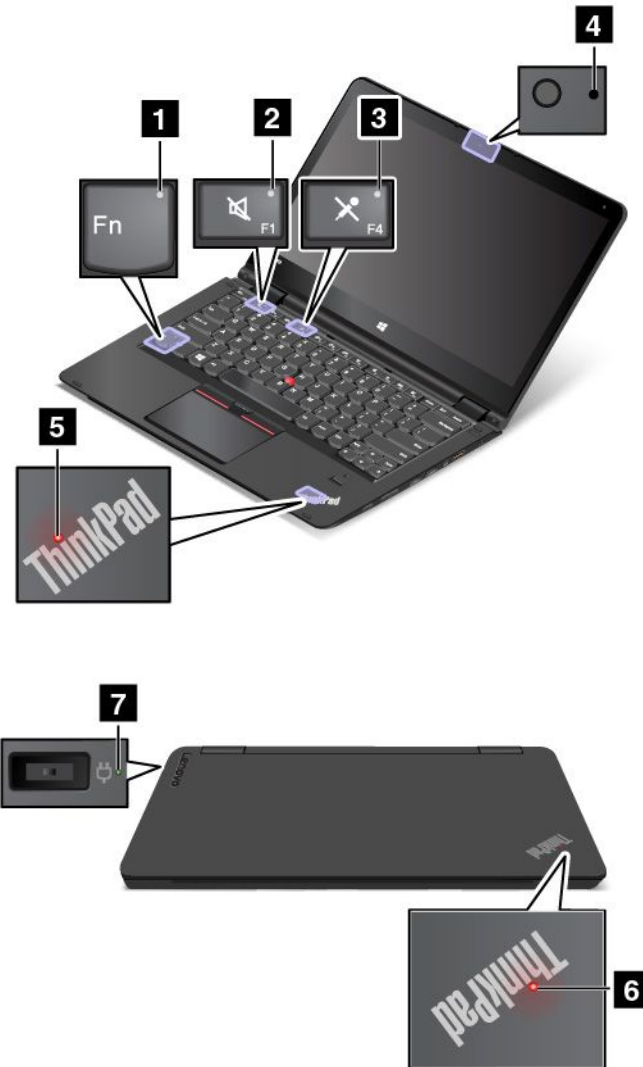

1 Fn Lock indicator

The Fn Lock indicator shows the status of the Fn Lock function. For more information, see “Using the special keys” on page 23.

2 Speaker-mute indicator

When the speaker-mute indicator is on, the speakers are muted.

3 Microphone-mute indicator

When the microphone-mute indicator is on, the microphones are muted.

4 Camera-status indicator

When the camera-status indicator is on, the camera is in use.

5 6 System-status indicators

There are two ThinkPad logos on your computer, one on the palm rest and the other on the outer lid. The illuminated dot in each ThinkPad logo works as a system-status indicator and helps you identify the status of your computer.

- **Blink for three times:** The computer is initially connected to power.
- **Blink fast:** The computer is entering hibernation mode.
- **Blink slowly:** The computer is in sleep mode.
- **Off:** The computer is off or in hibernation mode.
- **On:** The computer is on (in normal use).

7 ac power-status indicator

The ac power-status indicator shows the ac power charging status of the computer.

- **Green:** Connected to ac power (charging 80%-100%)
- **Amber:** Connected to ac power (charging 1%-80%)
- **Off:** Not connected to ac power (no charging)

Locating important product information

This section provides information to help you locate the machine type and model label, FCC ID and IC Certification information, and the Genuine Microsoft label.

Machine type and model label

The machine type and model label identifies your computer. When you contact Lenovo for help, the machine type and model information helps support technicians to identify your computer and provide faster service.

The following illustration shows the location of the machine type and model of your computer.



FCC ID and IC Certification information

The FCC and IC Certification information is identified by a label located on the computer base cover as shown in the following illustration.



For a preinstalled wireless module, this label identifies the actual FCC ID and IC certification number for the wireless module installed by Lenovo.

Note: Do not remove or replace a preinstalled wireless module by yourself. For module replacement, you must contact Lenovo service first. Lenovo is not responsible for any damage caused by unauthorized replacement.

Labels for the Windows operating systems

Windows 7 Certificate of Authenticity: Computer models preinstalled with the Windows 7 operating system have a Certificate of Authenticity label affixed to the computer cover or inside the battery compartment. The Certificate of Authenticity is your indication that the computer is licensed for a Windows 7 product and is preinstalled with a Windows 7 genuine version. In some cases, an earlier Windows version might be preinstalled under the terms of the Windows 7 Professional license downgrade rights. Printed on the Certificate of Authenticity is the Windows 7 version for which the computer is licensed and the Product ID. The Product ID is important in case you need to reinstall the Windows 7 operating system from a source other than a Lenovo product recovery disc set.

Windows 10 Genuine Microsoft label: Depending on your geographic location, the date when your computer was manufactured, and the version of Windows 8, Windows 8.1, or Windows 10 that is preinstalled, your computer might have a Genuine Microsoft label affixed to its cover. See <http://www.microsoft.com/en-us/howtotell/Hardware.aspx> for illustrations of the various types of Genuine Microsoft labels.

- In the People's Republic of China, the Genuine Microsoft label is required on all computer models preinstalled with any version of Windows 10.
- In other countries and regions, the Genuine Microsoft label is required only on computer models licensed for Windows 10 Pro.

The absence of a Genuine Microsoft label does not indicate that the preinstalled Windows version is not genuine. For details on how to tell whether your preinstalled Windows product is genuine, refer to the information provided by Microsoft at <http://www.microsoft.com/en-us/howtotell/default.aspx>.

Unlike Windows 7 products, there are no external, visual indicators of the Product ID or Windows version for which the computer is licensed. Instead, the Product ID is recorded in the computer firmware. Whenever

a Windows 10 product is installed, the installation program checks the computer firmware for a valid, matching Product ID to complete the activation.

In some cases, an earlier Windows version might be preinstalled under the terms of the Windows 8 Pro, Windows 8.1 Pro, or Windows 10 Pro license downgrade rights.

Features

The computer features introduced in this section cover a variety of models. For your specific model, some features might vary or not apply.

Processor

Microprocessor

- To view the microprocessor information of your computer, do the following:
 - **For Windows 7:** Open the Start menu, right-click **Computer**, and then click **Properties**.
 - **For Windows 10:** Do either of the following:
 - Open the Start menu and then click **Settings**. If **Settings** is not displayed, click **All apps** to display all programs, and then click **Settings → System → About**.
 - Right-click the Start button  and then select **System**.

Memory

Up to 8 GB DDR3L (double data rate 3 low voltage) RAM (random access memory)

Storage device

Depending on the model:

- 2.5-inch form factor, 7-mm height hard disk drive
- 2.5-inch form factor, 7-mm height solid-state drive
- 2.5-inch form factor, 7-mm height hybrid drive
- M.2 solid-state drive for cache only

Display

- Multi-touch screen
- Display size: 355.6 mm (14 inches)
- Display resolution: 1920 x 1080 pixels or 2560 x 1440 pixels, depending on the model
- Color display with the thin-film transistor (TFT) technology
- Brightness control
- Integrated camera and microphones on the computer display

Keyboard

- Function keys
- Keyboard frame travel function
- Six-row backlight keyboard
- ThinkPad pointing device

Interface

- ac power connector
- Always On USB 3.0 connector
- Audio connector
- OneLink+ connector
- 4-in-1 media-card slot
- HDMI connector
- Mini DisplayPort connector
- Two USB 3.0 connectors
- Volume-control buttons
- Windows button

Wireless features

- Bluetooth
- Wireless LAN
- Wireless WAN (available on some models)

Security feature

- Trusted Platform Module (TPM) (available on some models)
- Fingerprint reader (available on some models)

Specifications

This section lists the physical specifications for your computer.

Size

- Width: 338 mm (13.3 inches)
- Depth: 236.3 mm (9.3 inches)
- Height: 19.9 mm (0.78 inch)

Heat output

- 45 W (154 Btu/hr) maximum
- 65 W (222 Btu/hr) maximum

Power source (ac power adapter)

- Sine-wave input at 50–60 Hz
- Input rating of the ac power adapter: 100-240 V ac, 50-60 Hz

Operating environment

Environment:

- Maximum altitude without pressurization: 3048 m (10 000 ft)
- Temperature
 - At altitudes up to 2438 m (8000 ft)
 - Operating: 5.0°C (41°F) to 35.0°C (95°F)

- Storage: 5.0°C (41°F) to 43.0°C (109°F)
- At altitudes above 2438 m (8000 ft)
 - Maximum temperature when operating under the unpressurized condition: 31.3°C (88°F)

Note: When you charge the battery pack, its temperature must be at least 10°C (50°F).

- Relative humidity:
 - Operating: 8%-80%
 - Storage: 5%-95%

If possible, place your computer in a well-ventilated and dry area without direct exposure to sunshine.

Keep electrical appliances such as an electric fan, a radio, an air conditioner, and a microwave oven away from your computer. The strong magnetic fields generated by these appliances can damage the monitor and data on the hard disk drive or hybrid drive.

Do not place any beverages on top of or beside the computer or other attached devices. If liquid is spilled on or in the computer or an attached device, a short circuit or other damage might occur.

Do not eat or smoke over your keyboard. Particles that fall into your keyboard can cause damage.

Lenovo programs

Your computer comes with Lenovo programs to help you work easily and securely.

Note: The available programs are subject to change without notice.

To learn more about the programs and other computing solutions offered by Lenovo, go to:
<http://www.lenovo.com/support>

Accessing Lenovo programs

To access Lenovo programs on your computer, do the following:

1. Click the Start button to open the Start menu. Locate a program by the program name.
2. If the program is not displayed on the Start menu, click **All programs** (Windows 7) or **All apps** (Windows 10) to display all programs.
3. If you still do not find the program in the program list, search for the program in the search box.

Note: Note: If you are using the Windows 7 operating system, some Lenovo programs are ready to be installed. You cannot find these programs through the above methods unless you have installed them first. To install these Lenovo programs, access the Lenovo PC Experience program, click **Lenovo Tools**, and then follow the instructions on the screen.

An introduction to Lenovo programs

This topic provides a brief introduction to Lenovo programs. Depending on your computer model, some of the programs might not be available.

Access Connections™	The Access Connections program is a connectivity assistant program for creating and managing location profiles. Each location profile stores all the network and Internet configuration settings needed for connecting to a network infrastructure from a specific location such as a home or an office.
(Windows 7)	By switching between location profiles as you move your computer from place to place, you can quickly and easily connect to a network with no need to manually reconfigure your settings and restart the computer each time.
Active Protection System™	The Active Protection System program protects your internal storage drive (such as hard disk drive) when the shock sensor inside your computer detects a condition that could damage the drive, such as system tilt, excessive vibration, or shock.
(Windows 7 and Windows 10)	The internal storage drive is less vulnerable to damage when it is not operating. This is because when the internal storage drive is not operating, the system stops it from spinning, and might also move the read and write heads of the drive to areas that do not contain data.
As soon as the shock sensor senses that the environment is stable again (minimal change in system tilt, vibration, or shock), it turns on the internal storage drive.	
Auto Scroll Utility	This program enhances your experience with window operation. The window position of a foreground application is automatically adjusted. The scroll bar on a user interface is also automatically adjusted.
(Windows 7)	
Communications Utility	The Communications Utility program enables you to configure settings for the integrated camera and audio devices.
(Windows 7)	
Lenovo Touch Fingerprint Software	If your computer comes with a fingerprint reader, the program enables you to enroll your fingerprint and associate it with your passwords. As a result, fingerprint authentication can replace your passwords and enable simple and secure user access.
(Windows 7)	
Hotkey Features Integration	Hotkey Features Integration is a utility package that enables you to select and install utility programs specifically for the special keys and buttons on your computer. The special keys and buttons are designed to meet accessibility and usability requirements. Installing related utility programs enables full functionality of the special keys and buttons.
(Windows 7 and Windows 10)	
Lenovo Companion	Your computer's best features and capabilities should be easy to access and understand. With Lenovo Companion, they are.
(Windows 10)	<p>Use Lenovo Companion to do the following:</p> <ul style="list-style-type: none"> • Optimize your computer's performance, monitor your computer's health, and manage updates. • Access your user guide, check warranty status, and view accessories customized for your computer. • Read how-to articles, explore Lenovo forums, and stay up-to-date on technology news with articles and blogs from trusted sources.
	Lenovo Companion is filled with exclusive Lenovo content to help you learn about what you can do with your computer.
Lenovo ID	The Lenovo ID program enables you to create and manage your Lenovo ID. With a Lenovo ID, you can connect to everything Lenovo through a single account. Use your Lenovo ID for quick and simple authentication and then enjoy the various services provided by Lenovo. Such services include online shopping, app download, personalized device support, special promotional offers, Lenovo forums, and so on.
(Windows 10)	

Lenovo PC Experience	The Lenovo PC Experience program helps you work more easily and securely by providing easy access to various programs, such as Active Protection System and Lenovo Solution Center.
(Windows 7 and Windows 10)	Note: On the Windows 10 operating system, this program cannot be found from the all program list or search box. To access this program, go to Control Panel. View Control Panel by Category, click Hardware and Sound → Devices and Printers , and then double-click the device with your computer name.
Lenovo Settings	The Lenovo Settings program enables you to enhance your computing experience by turning your computer into a portable hotspot, configuring camera and audio settings, optimizing your power settings, and creating and managing multiple network profiles.
(Windows 10)	
Lenovo Solution Center	The Lenovo Solution Center program enables you to troubleshoot and resolve computer problems. It combines diagnostic tests, system information collection, security status, and support information, along with hints and tips for optimal system performance.
(Windows 7 and Windows 10)	
Mobile Broadband Connect	The Mobile Broadband Connect program enables you to connect the computer to the mobile broadband network through a supported wireless WAN card.
(Windows 7 and Windows 10)	
Message Center Plus	The Message Center Plus program automatically displays messages to inform you about important notices from Lenovo, such as alerts on system updates and alerts on conditions that require your attention.
(Windows 7)	
Password Manager	The Password Manager program automatically captures and fills in authentication information for Windows programs and Web sites.
(Windows 7)	
Power Manager	The Power Manager program provides convenient, flexible, and complete power management for the computer. It enables you to adjust your computer power settings to achieve the best balance between performance and power saving.
(Windows 7)	
REACHit	REACHit enables you to manage all your files, no matter where they are stored, inside one single app. Connect your devices along with multiple cloud storage accounts for an easier and faster way to access your stuff.
(Windows 7 and Windows 10)	
Recovery Media	The Recovery Media program enables you to restore the contents of the hard disk drive to the factory default settings.
(Windows 7 and Windows 10)	
Rescue and Recovery®	The Rescue and Recovery program is a one-button recovery and restore solution. It includes a set of self-recovery tools to help you diagnose computer problems, get help, and recover from system crashes, even if you cannot start the Windows operating system.
(Windows 7)	
SHAREit	The SHAREit program enables you to share files easily and rapidly across devices such as computers and smartphones, even without any Internet connection. You can connect to your friends and send photos, folders, and other files through SHAREit. Every sharing is quick and simple.
(Windows 7 and Windows 10)	
System Update	The System Update program enables you to keep the software on the computer up-to-date by downloading and installing software packages, including device drivers, Unified Extensible Firmware Interface (UEFI) basic input/output system (BIOS) updates, and other third-party programs.
(Windows 7)	
WRITEit	WRITEit gives you instant handwriting input wherever you need it. You can write directly in any app and text field, edit text in real-time, see your full screen, and convert your handwriting into digital text.
(Windows 10)	

Chapter 2. Using your computer

This chapter provides information on using some of the computer components.

This chapter contains the following topics:

- “Registering your computer” on page 15
- “Frequently asked questions” on page 15
- “Using the tablet buttons” on page 23
- “Getting help about the Windows operating system” on page 16
- “Using the multi-touch screen” on page 29
- “Operating modes” on page 17
- “Using the keyboard” on page 27
- “Using the special keys” on page 23
- “Using the ThinkPad pointing device” on page 32
- “Power management” on page 36
- “Connecting to the network” on page 39
- “Using an external display” on page 42
- “Using the NVIDIA Optimus Graphics feature” on page 43
- “Using audio features” on page 43
- “Using the camera” on page 44
- “Using a flash media card” on page 45

Registering your computer

When you register your computer, information is entered into a database, which enables Lenovo to contact you in case of a recall or other severe problem. In addition, some locations offer extended privileges and services to registered users.

When you register your computer with Lenovo, you also will receive the following benefits:

- Quicker service when you call Lenovo for help
- Automatic notification of free software and special promotional offers

To register your computer with Lenovo, go to <http://www.lenovo.com/register> and follow the instructions on the screen to register your computer.

Frequently asked questions

The following are a few tips that will help you optimize the use of your computer.

To ensure that you receive the best performance from your computer, go to the following Web page to find information such as aids for troubleshooting and answers to frequently asked questions:
<http://www.lenovo.com/support/faq>

Can I get my user guide in another language?

- To download the user guide in another language, go to: <http://www.lenovo.com/support>. Then follow the instructions on the screen.

How to turn off my computer?

- **For Windows 7:** Open the Start menu, then click **Shut down**.
- **For Windows 10:** Open the Start menu, click  **Power**, and then click **Shut down**.

How do I access Control Panel?

- **For Windows 7:** Open the Start menu, then click **Control Panel**.
- **For Windows 10:** Right-click the Start button, then click **Control Panel**.

How do I use battery power more effectively when I am on the go?

- To conserve power, or to suspend operation without exiting applications or saving files, see “Power-saving modes” on page 38.
- To achieve the best balance between performance and power saving, create and apply power plans. See “Managing the battery power” on page 37.

How do I securely dispose of data stored on the storage drive?

- Study Chapter 5 “Security” on page 55 to find out how you can protect your computer from theft and unauthorized use.
- Use the Password Manager program to protect the data stored on your computer. For details, see the help information system of the program.
- Before you dispose of the data on the storage drive, be sure to read “Notice on deleting data from your storage drive” on page 64.

How do I give presentations or attach an external display?

- Ensure that you follow the procedure for “Using an external display” on page 42.
- With the Extend desktop function, you can display output on both the computer display and an external monitor.

I have been using the computer for some time already, and it is getting slower. What should I do?

- Follow the “General tips for preventing problems” on page 87.
- You can diagnose problems yourself by using the preinstalled diagnostic software.
- Check for recovery solutions in Chapter 9 “Recovery overview” on page 109.

Print the following sections and keep them with your computer in case you are unable to access this online user guide when necessary.

- “Installing the Windows 10 operating system” on page 68
- “Computer stops responding” on page 93
- “Power problems” on page 104

Getting help about the Windows operating system

The Windows help information system provides you with detailed information about using the Windows operating system to help you get the most of your computer. To access the Windows help information system, do one of the following:

- **For Windows 7:** Open the Start menu, and then click **Help and Support**.

- **For Windows 10:** Open the Start menu, and then click **Get started**. Additionally, you can search from the taskbar to find help, apps, files, settings, and so on.

Operating modes

This section provides information about the operating modes of your computer. Your computer provides the notebook mode, stand mode, tablet mode, and tent mode that enable you to work more conveniently in your working environment.

This section contains the following topics:

- “Enabling the operating modes” on page 17
- “Rotating the computer display” on page 17
- “Notebook mode” on page 18
- “Stand mode” on page 19
- “Tablet mode” on page 20
- “Tent mode” on page 21

Enabling the operating modes

To provide your computer the flexibility of being used in various operating modes, enable the operating modes first.

For the Windows 7 operating system, do one of the following to enable the operating modes:

- When you enter the Windows 7 operating system for the first time, the Enable sensors window is displayed. Then click **Enable this sensor**.
- Go to Control Panel. Click **All Control Panel Items** → **Location and Other Sensors**. Then select the check box for **STMicroelectronics Sensor Hub**.

For the Windows 10 operating systems, the operating modes are enabled by default.

Rotating the computer display

This topic provides instructions on how to rotate the display of your computer properly. This topic also provides information on the operating modes of your computer and corresponding display angle ranges.

You can open the computer display to any angle within a range of up to 360 degrees as shown in the following illustration.

Attention: Do not rotate the computer display with too much force, otherwise the computer display or hinges might get damaged. Do not apply too much force to the upper-right or upper-left corner of the computer display.

Note: Depending on the model, your computer might look different from the following illustration.



Display angle for each operating mode

The angle between the front of the computer display and the keyboard is different in each operating mode. The following table lists the angle range for each operating mode.

Table 1. Display angle for each operating mode

Notebook mode	Stand mode	Tablet mode	Tent mode
no more than 190 degrees	more than 190 degrees and less than 350 degrees	360 degrees	no less than 270 degrees and no more than 340 degrees

Notebook mode

You can use the computer in the notebook mode in scenarios that require using a keyboard and a mouse, such as editing documents and writing e-mails.

Attention: Do not rotate the computer display with too much force, otherwise the computer display or hinges might get damaged. Do not apply too much force to the upper-right or upper-left corner of the computer display.

Open the computer display slowly as shown in the following illustration. Your computer is now in the notebook mode.

Note: Depending on the model, your computer might look different from the following illustration.



In the notebook mode, the keyboard, the ThinkPad trackpad, and the TrackPoint pointing stick are automatically enabled.

Stand mode

You can use your computer in the stand mode in scenarios that require limited interaction with the screen, such as viewing photos and playing videos.

Attention: Do not rotate the computer display with too much force, otherwise the computer display or hinges might get damaged. Do not apply too much force to the upper-right or upper-left corner of the computer display.

If your computer is in the notebook mode, do the following to turn the computer from the notebook mode into the stand mode:

Note: Depending on the model, your computer might look different from the illustrations in this topic.

1. Slowly rotate the display clockwise until the back of the display is facing the base cover.



2. Position your computer as shown. Your computer is now in the stand mode.



In the stand mode, the keyboard, the ThinkPad trackpad, and the TrackPoint pointing stick are automatically disabled.

In the stand mode, you can use the special buttons to control your computer. For instructions on how to use the special buttons, refer to “Using the tablet buttons” on page 23.

Tablet mode

You can use the computer in the tablet mode in scenarios that require frequent interaction with the screen, such as browsing the Web site.

Attention: Do not rotate the computer display with too much force, otherwise the computer display or hinges might get damaged. Do not apply too much force to the upper-right or upper-left corner of the computer display.

If your computer is in the stand mode, do the following to turn the computer from the stand mode into the tablet mode:

Note: Depending on the model, your computer might look different from the illustrations in this topic.

1. Position your computer as shown and slowly rotate the computer display clockwise.



2. Position your computer as shown. Your computer is now in the tablet mode. By default, the autorotate feature is enabled.



In the tablet mode, the keyboard, the ThinkPad trackpad, and the TrackPoint pointing stick are automatically disabled. However, you can control some functions of your computer through the special buttons and the multi-touch screen, without the use of the keyboard and the touch pad. For more information, refer to “Using the tablet buttons” on page 23 and “Using the multi-touch screen” on page 29.

Tent mode

You can use your computer in the tent mode in scenarios that require limited interaction with the screen, such as viewing photos and making a presentation.

Attention: Do not rotate the computer display with too much force, otherwise the computer display or hinges might get damaged. Do not apply too much force to the upper-right or upper-left corner of the computer display.

If your computer is in the tablet mode, do the following to turn the computer from the tablet mode into the tent mode:

Note: Depending on the model, your computer might look different from the illustrations in this topic.

1. Slowly rotate your computer display anticlockwise to any angle within a range of 190 degrees to 359 degrees.

Note: The degrees refers to the angle degrees between the LCD and the keyboard.



2. Position your computer as shown. Your computer is now in the tent mode.



In the tent mode, the keyboard and the touch pad are automatically disabled. However, you can control some functions of your computer through the special buttons and the multi-touch screen, without the use of the keyboard and the touch pad. For more information, refer to “Using the tablet buttons” on page 23 and “Using the multi-touch screen” on page 29.

Using the special buttons

The computer is equipped with special buttons as shown in the following illustration. You can control some functions of your computer through the special buttons, without the use of the keyboard.

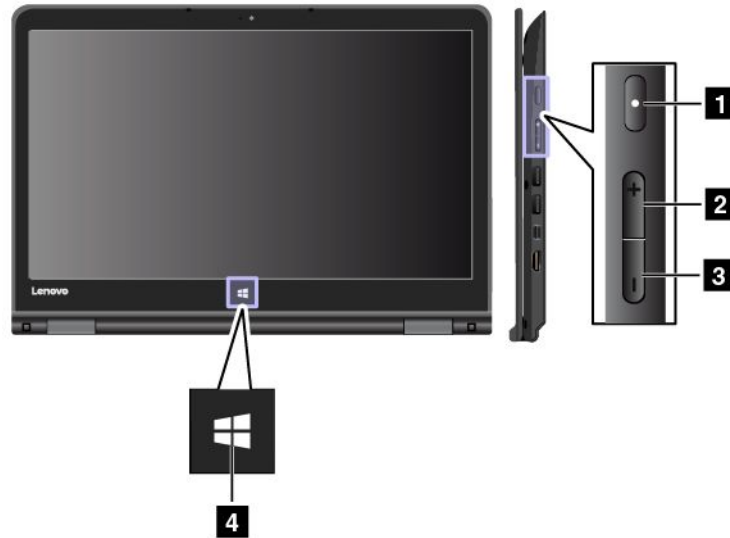

1 Power button: Press the power button to turn on the computer.

2 Volume-up button: Press the volume-up button to increase the speaker volume.

3 Volume-down button: Press the volume-down button to decrease the speaker volume.

4 Windows button: Press the Windows button to open the Start menu; or press the Windows button to wake up the computer from sleep mode.

Using the special keys

The keyboard has several special keys, which consist of the function keys **1**, the Fn key **2**, and the Windows key **3**.

Notes:

- Depending on the model, your computer might look different from the illustrations in this topic.
- In the notebook mode, the keyboard, the ThinkPad trackpad, and the TrackPoint pointing stick are automatically enabled. In the stand mode, tablet mode, and tent mode, the keyboard, the ThinkPad trackpad, and the TrackPoint pointing stick are automatically disabled.



1 Function keys

2 Fn key

You can configure the Fn key and function keys in the Keyboard Properties window by doing the following:



1. Go to Control Panel. Change the view of Control Panel from Category to Large icons or Small icons.
2. Click **Keyboard**. In the Keyboard Properties window, click the **Fn and function keys** or **ThinkPad F1–F12 keys** tab.
3. Select the options of your preference.



-  + : Press Fn+Esc to disable or enable the Fn Lock function.

When the Fn Lock function is disabled: The Fn Lock indicator is off (default mode). To initiate the special function printed as an icon on each key, press the function key directly. To input F1-F12, press the Fn key and the corresponding function key.

When the Fn Lock function is enabled: The Fn Lock indicator turns on. To input F1-F12, press the function keys directly. To initiate the special function printed as an icon on each key, press the Fn key and the corresponding function key.

- : Mutes or unmutes the speakers. When the speakers are muted, the speaker-mute indicator turns on.

If you mute the sound and turn off your computer, the sound will remain muted when you turn on your computer again. To turn on the sound, press the speaker mute key , the speaker volume-down key , or the speaker volume-up key .

- : Decreases the speaker volume.
- : Increases the speaker volume.
- : Mutes or unmutes the microphones. When the microphones are muted, the microphone-mute indicator turns on.

If you mute the microphones and turn off your computer, the microphones will remain muted when you turn on your computer again. To unmute the microphones, press the microphone mute key .

- : Darkens the display.

- : Brightens the display.

You can temporarily change the computer display brightness by pressing the two keys. To change the default brightness level, right-click the battery-status icon in the Windows notification area. Then click **Adjust screen brightness** and make changes as desired.

- : Switches the display output location between the computer display and an external monitor.

Note: You also can press Windows+P to switch between the computer display and an external monitor.

- : Enables or disables the wireless networking features. For more information on the wireless features, refer to “Wireless connections” on page 39.

-  + : Controls the keyboard backlight

- 

- For Windows 7: Opens **Control Panel**.
- For Windows 10: Opens the Settings window.

- 

- For Windows 7: Opens **Windows Search**.
- For Windows 10: Opens the Cortana® search box.

- : Views the programs that you have opened.

- 

- For Windows 7: Opens **Computer**.
- For Windows 10: Views all the programs.

- **Fn+Spacebar:** Controls the keyboard backlight. Press Fn+Spacebar to change the modes of the keyboard backlight.

Note: If your computer is installed with the Lenovo Settings 3.0 program or later version, there are four modes for the keyboard backlight: **Off**, **Low**, **High**, and **Auto**. Otherwise, there are three modes for the keyboard backlight: **Off**, **Low**, and **High**.

- **Fn+End:** Has the same function as the Insert key on a conventional keyboard.
- **Fn+B:** Has the same function as the Break key on a conventional keyboard.
- **Fn+K:** Has the same function as the ScrLK key on the conventional keyboard.
- **Fn+P:** Has the same function as the Pause key on the conventional keyboard.
- **Fn+S:** Has the same function as the SysRq key on the conventional keyboard.

3 Windows key

Press the Windows key to open the Start menu.

You also can use the Windows key together with another key to achieve other functions. For details, refer to the help information system of the Windows operating system.

ThinkPad Pen Pro

Some computer models are equipped with the ThinkPad Pen Pro (an electronic pen). The ThinkPad Pen Pro enables you to input text in a natural manner when you are taking notes, annotating Portable Document Format (PDF) files, or drawing graphics together with applications capable of editing and sketching. When you draw or write with the ThinkPad Pen Pro, keep the pen perpendicular to the display to achieve the best line quality.

Use the ThinkPad Pen Pro instead of your finger in conditions such as the following:

- You need precise and detailed input, such as drawing a picture or using the handwriting mode.
- Too many elements are crowded on the screen, for example, when you are playing games.
- You want to keep your screen free from smudges.
- You have long fingernails and it is difficult for you to type.

Notes:

- The ThinkPad Pen Pro is not waterproof. Take care not to soak it or dip it in water.
- If your computer does not come with a ThinkPad Pen Pro, your computer does not support the use of the pen.
- To purchase the ThinkPad Pen Pro, go to the Lenovo Support Web site:
<http://www.lenovo.com/accessories>

Using the ThinkPad Pen Pro

The following illustration shows the ThinkPad Pen Pro.

- 1** Tip
- 2** Eraser button
- 3** Click button

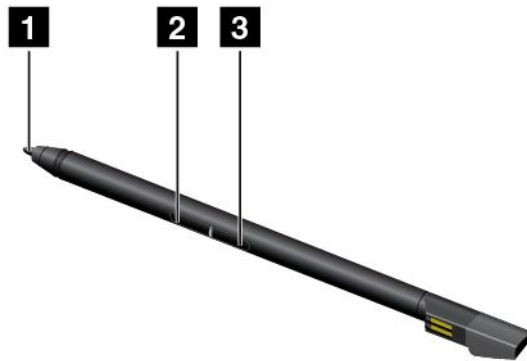

You can perform the following operations with the ThinkPad Pen Pro:

- To click or make a selection, tap the display once with the pen.
- To double-click, tap twice without pausing.
- To right-click, tap the tip **1** on the display and hold the pen there for one second, or press and hold the click button **3** while tapping the tip **1** on the display.
- To erase ink, press and hold the eraser button **2**, tap the tip **1** on the display, and drag the pen across the ink you want to erase.

The ThinkPad Pen Pro is stored in the slot on the bottom side of the computer. To remove the pen from the slot, slide the tab of the pen to the right side slightly, and then pull the pen out.



Charging the ThinkPad Pen Pro

To charge the pen, insert the pen slightly into the slot until it snaps into position. The pen will be 80% charged in about 15 seconds and 100% charged in about five minutes.

The following illustration is an example. You can insert the pen into the slot for charging no matter the computer is in the notebook mode, stand mode, tent mode, or tablet mode.

Note: Ensure that your computer is on or in sleep mode. Otherwise, the pen will not be charged.



Using the keyboard

Your computer keyboard features the frame travel function. This topic provides information on the behavior of the keyboard.

Notes:

- Depending on the model, your computer might look different from the illustrations in this topic.
- In the notebook mode, the keyboard, the ThinkPad trackpad, and the TrackPoint pointing stick are automatically enabled. In the stand mode, tablet mode, and tent mode, the keyboard, the ThinkPad trackpad, and the TrackPoint pointing stick are automatically disabled.

The following illustration shows the location of the keyboard.



Behavior of the keyboard

The frame of the keyboard travels upward when you rotate the computer display from 190 degrees to 360 degrees. The following are some scenarios for using the keyboard:

- The frame of the keyboard does not travel when you rotate the computer display from 10 degrees to 190 degrees. The following illustration shows the keyboard when the keyboard frame does not travel.



- When you rotate the computer display from 190 degrees to 360 degrees, the frame of the keyboard travels upward for about 2.0 mm (0.08 inch). The following illustration shows the keyboard after the keyboard frame travels upward.





Using the multi-touch screen



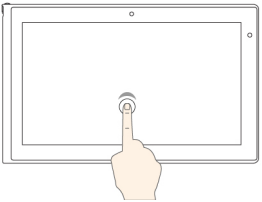

This topic provides instructions on how to use the multi-touch screen that is available on some models.

Notes:

- Your computer screen might look different from the following illustrations.
- Depending on the app you use, some gestures might not be available.

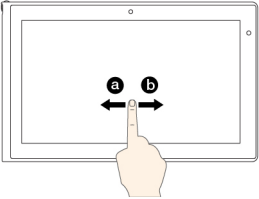
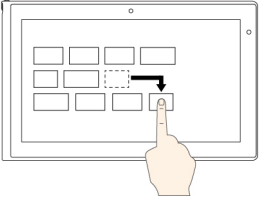
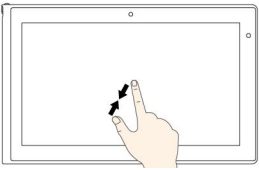
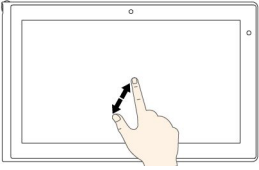
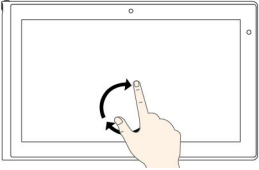
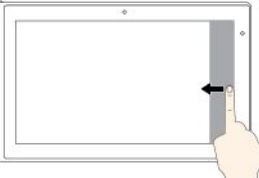
The following table introduces some frequently used gestures.

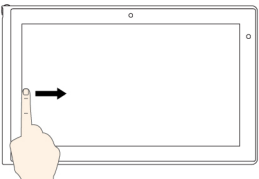
Touch gesture (touch models only)	Description
	<p>Touch: Tap.</p> <p>Mouse action: Click.</p> <p>Function: Open an app or perform an action on an open app, such as Copy, Save, and Delete, depending on the app.</p>
	<p>Touch: Tap and hold.</p> <p>Mouse action: Right-click.</p> <p>Function: Open a menu with multiple options.</p>

Touch gesture (touch models only)	Description
	<p>Touch: Slide.</p> <p>Mouse action: Scroll the mouse wheel, move the scroll bar, or click the scroll arrow.</p> <p>Function: Scroll through items, such as lists, pages, and photos.</p>
	<p>Touch: Drag an item to the desired location.</p> <p>Mouse action: Click, hold, and drag an item.</p> <p>Function: Move an object.</p>
	<p>Touch: Move two fingers closer together.</p> <p>Mouse action: Press the Ctrl key while scrolling the mouse wheel backward.</p> <p>Function: Zoom out.</p>
	<p>Touch: Move two fingers farther apart.</p> <p>Mouse action: Press the Ctrl key while scrolling the mouse wheel forward.</p> <p>Function: Zoom in.</p>
	<p>Touch: Put two or more fingers on an item and then rotate your fingers clockwise or counterclockwise.</p> <p>Mouse action: If the app supports rotation, click the rotation icon.</p> <p>Function: Rotate an item.</p>
	<p>Touch: Swipe in from the right edge.</p> <p>Mouse action: Click the action center icon  on the taskbar.</p> <p>Function: Open the action center to see your notifications and quick actions.</p>
	<p>Touch: Swipe in from the left edge.</p> <p>Mouse action: Click the task-view icon  on the taskbar.</p> <p>Function: View all your open windows in task view.</p>

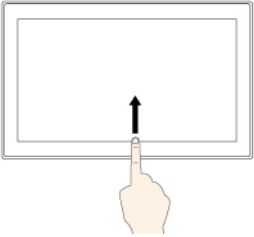
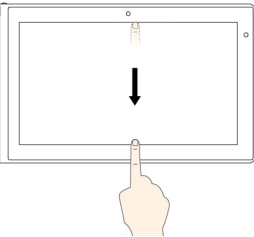
Touch gesture (touch models only)	Description
	<p>Touch: Swipe in from the bottom to top for full-screened app.</p> <p>Mouse action: Move your cursor to the Windows notification area at the bottom of the screen.</p> <p>Function: View the taskbar.</p> <p>Note: The full screen feature is available only on some apps. To open an app in full screen, click ↗ on the title bar.</p>
	<ul style="list-style-type: none"> • Short snap for full-screened app or when your computer is in tablet mode <p>Touch: Swipe downwards shortly from the top edge.</p> <p>Mouse action: Move your cursor to the top edge of the screen.</p> <p>Function: Show a hidden title bar.</p> • Long swipe when your computer is in tablet mode <p>Touch: Swipe in from the top edge to the bottom edge.</p> <p>Mouse action: From the top edge of the screen, click and hold, move the pointer to the bottom of the screen, and then release.</p> <p>Function: Close the current app.</p>

Tips on using the multi-touch screen

- The multi-touch screen is a glass panel covered with a plastic film. Do not apply pressure or place any metallic object on the screen, which might damage the touch panel or cause it to malfunction.
- Do not use fingernails, gloved fingers, or inanimate objects for input on the screen.
- Regularly calibrate the accuracy of the finger input to avoid a discrepancy.

Tips on cleaning the multi-touch screen

- Turn off the computer before cleaning the multi-touch screen.
- Use a dry, soft, and lint-free cloth or a piece of absorbent cotton to remove fingerprints or dust from the multi-touch screen. Do not apply solvents to the cloth.
- Gently wipe the screen using a top-down motion. Do not apply any pressure on the screen.

Using the ThinkPad pointing device

The ThinkPad pointing device enables you to perform all the functions of a traditional mouse, such as pointing, clicking, and scrolling. With the ThinkPad pointing device, you also can perform a variety of touch gestures, such as rotating and zooming in or out.

The ThinkPad pointing device consists of the following two devices:

- 1** TrackPoint pointing device
- 2** Trackpad



By default, both the TrackPoint pointing device and the trackpad are active with the touch gestures enabled. To change the settings, see “Customizing the ThinkPad pointing device” on page 35.

TrackPoint pointing device

The TrackPoint pointing device enables you to perform all the functions of a traditional mouse, such as pointing, clicking, and scrolling.

The TrackPoint pointing device consists of a TrackPoint pointing stick and a set of TrackPoint buttons:

- 1 TrackPoint pointing stick
- 2 Left-click button (primary-click button)
- 3 Right-click button (secondary-click button)
- 4 Scroll bar

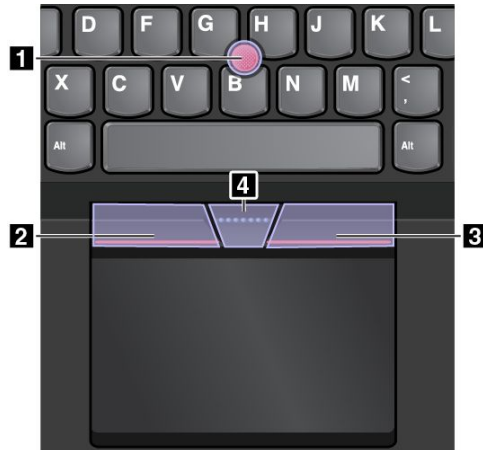

To use the TrackPoint pointing device, refer to the following instructions:

Note: Place your hands in the typing position and use your index finger or middle finger to apply pressure to the pointing-stick nonslip cap. Use either thumb to press the left-click button or right-click button.

- **Point**

Use the TrackPoint pointing stick **1** to move the pointer on the screen. To use the pointing stick, apply pressure to the pointing-stick nonslip cap in any direction parallel to the keyboard. The pointer moves accordingly but the pointing stick itself does not move. The speed at which the pointer moves depends on the amount of pressure you apply to the pointing stick.

- **Left-click**

Press the left-click button **2** to select or open an item.

- **Right-click**

Press the right-click button **3** to display a shortcut menu.

- **Scroll**

Press and hold the dotted scroll bar **4** while applying pressure to the pointing stick in the vertical or horizontal direction. Then you can scroll through the document, Web site, or apps.

Trackpad

The entire trackpad is sensitive to finger touch and movement. You can use the trackpad to perform all the pointing, clicking, and scrolling functions of a traditional mouse.

The trackpad can be divided into two zones:

- 1** Left-click zone (primary-click zone)
- 2** Right-click zone (secondary-click zone)



To use the trackpad, refer to the following instructions:

- **Point**
Slide one finger across the surface of the trackpad to move the pointer accordingly.
- **Left-click**
Press the left-click zone **1** to select or open an item.
You also can tap anywhere on the surface of the trackpad with one finger to perform the left-click action.
- **Right-click**
Press the right-click zone **2** to display a shortcut menu.
You also can tap anywhere on the surface of the trackpad with two fingers to perform the right-click action.
- **Scroll**
Put two fingers on the trackpad and move them in the vertical or horizontal direction. This action enables you to scroll through the document, Web site, or apps. Ensure that you position your two fingers slightly apart from each other.

With the trackpad, you also can perform a variety of touch gestures. For information about using the touch gestures, see “Trackpad touch gestures” on page 34.

Trackpad touch gestures

The entire trackpad surface is sensitive to finger touch and movement. You can use the trackpad to perform the same point and click actions as you would using a traditional mouse. You also can use the trackpad to perform a variety of touch gestures.

This topic introduces the frequently used touch gestures such as tapping, dragging, and scrolling. For more gestures, see the help information system of the ThinkPad pointing device.

Notes:

- When using two or more fingers, ensure that you position your fingers slightly apart.
- Some gestures are not available if the last action was done from the TrackPoint pointing device.
- Some gestures are only available when you are using certain apps.

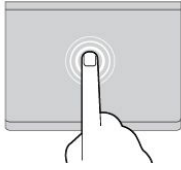

Tap
Tap anywhere on the trackpad with one finger to select or open an item.

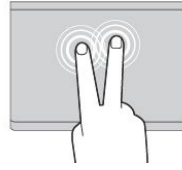

Two-finger tap
Tap anywhere on the trackpad with two fingers to display a shortcut menu.

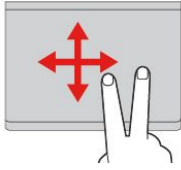

Two-finger scroll
Put two fingers on the trackpad and move them in the vertical or horizontal direction. This action enables you to scroll through the document, Web site, or apps.

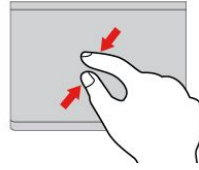

Two-finger zoom out
Put two fingers on the trackpad and move them closer together to zoom out.

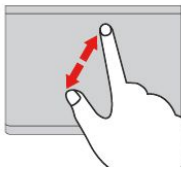

Two-finger zoom in
Put two fingers on the trackpad and move them farther apart to zoom in.

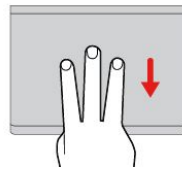

Swipe three fingers down
Put three fingers on the trackpad and move them down to show the desktop.

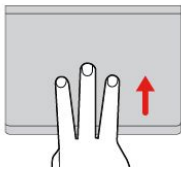

Swipe three fingers up
Put three fingers on the trackpad and move them up to open the task view to see all your open windows.

Customizing the ThinkPad pointing device

You can customize the ThinkPad pointing device so you can use it more comfortably and efficiently. For example, you can choose to enable the TrackPoint pointing device, the trackpad, or both. You also can disable or enable the touch gestures.

To customize the ThinkPad pointing device, do the following:

1. Go to Control Panel.
2. Click **Hardware and Sound** → **Mouse**. The Mouse Properties window is displayed.
3. In the Mouse Properties window, follow the instructions on the screen to complete the customization.

Replacing the cap of the TrackPoint pointing stick

The cap **1** on the end of the TrackPoint pointing stick is removable. After you use the cap for a period of time, you might consider replacing the cap with a new one.

Note: Ensure that you use a cap with grooves **a** as shown in the following illustration.

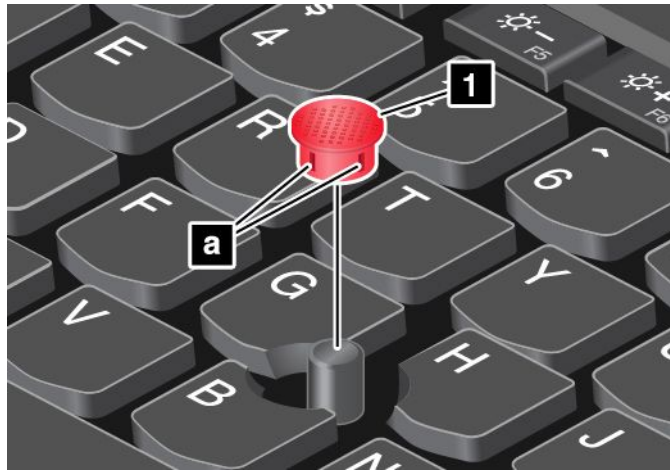

Power management

When you use your computer away from electrical outlets, you depend on battery power to keep your computer running. Different computer components consume power at different rates. The more you use the power-intensive components, the faster you consume battery power.

Spend more time unplugged with ThinkPad batteries. Mobility has revolutionized business by enabling you to take your work wherever you go. With ThinkPad batteries, you will be able to work longer without being tied to an electrical outlet.

Checking the battery status

Move your pointer to the battery-status icon in the Windows notification area to check the battery status. The battery-status icon displays the percentage of battery power remaining and how long you can use your computer before you must charge the battery.

The rate at which you use battery power determines how long you can use the batteries of your computer between charges. Because of different user habits and needs, it is difficult to predict how long a battery charge will last. There are two main factors:

- How much energy is stored in the battery when you begin to work.
- The way you use your computer. For example:
 - How often you access the storage drive.
 - How bright you make the computer display.
 - How often you use the wireless features.

Using the ac power

The power to run your computer can come either from the battery or from ac power. While you use ac power, the batteries charge automatically.

Your computer comes with an ac power adapter and a power cord.

- ac power adapter: Converts ac power for notebook computer use.
- Power cord: Connects the ac outlet and the ac power adapter.

Connecting to ac power

To connect the computer to ac power, do the following:

Attention: Using an improper power cord might cause severe damage to your computer.

Note: Ensure that you perform the actions in the order in which they are listed.

1. Connect the power cord to the ac power adapter.
2. Connect the ac power adapter to the power connector of the computer.
3. Connect the power cord into an electrical outlet.

Tips on using the ac power adapter

You can check the status of your battery at any time by looking at the battery meter at the bottom of your display.

- When the ac power adapter is not in use, disconnect it from the electrical outlet.
- Do not bind the power cord tightly around the ac power adapter transformer pack when it is connected to the transformer.
- Before you charge the battery, make sure that its temperature is at least 10°C (50°F).
- You can charge the battery when the ac power adapter is connected to the computer and the battery is installed. You need to charge the battery in any of the following conditions:
 - When you purchase a new battery
 - When the battery meter at the bottom of your display shows that the battery power remaining is low.
 - If the battery has not been used for a long time

Charging the battery

When you check battery status and find that the percentage of power remaining is low or when the power alarm alerts you that the remaining power is low, you need to charge your battery or replace it with a charged battery.

If an ac outlet is convenient, plug the ac power adapter into it, and then insert the connector into the computer. The battery will be fully charged in about three to six hours. This is affected by the battery size and the physical environment. The battery status indicator will let you know that the battery is charging, and will also notify you when the battery is fully charged.

Note: To maximize the life of the battery, the computer does not start recharging the battery if the remaining power is greater than 95%.

Maximizing the battery life

To maximize the life of the battery, do the following:

- Use the battery until the charge is completely depleted.
- Recharge the battery completely before using it. You can see whether the battery is fully charged from the battery-status icon in the Windows notification area.
- Always use power-saving modes, such as sleep mode, and hibernation mode.

Managing the battery power

To achieve the best balance between performance and power saving, adjust your power plan settings. To access power plan settings, do the following:

1. Click the battery-status icon from the Windows notification area.
2. Click **More power options → Change plan settings**.
3. Follow the instructions on the screen.

For more information, refer to the help information system of the program.

Power-saving modes

There are several modes that you can use at any time to conserve power. This section introduces each mode and gives tips on the effective use of battery power.

- **Screen blank mode (for Windows 7 only)**

The computer display requires considerable battery power. To turn off the power to the display and make the computer enter screen blank mode, right-click the battery-gauge icon in the windows notification area and select **Power off display**.

- **Sleep mode**

In sleep mode, your work is saved to memory, and then the solid-state drive, hard disk drive, or hybrid drive, and the computer display are turned off. When your computer wakes up, your work is restored within seconds.

To put your computer into sleep mode, press Fn+4.

You also can put the computer into sleep mode by doing the following:

- **For Windows 7:** Open the Start menu, then click the arrow next to the **Shut down** button. Click **Sleep** from the menu displayed.
- **For Windows 10:** Open the Start menu, click  **Power**, and then click **Sleep**.

For more information about the programs, see “Lenovo programs” on page 12.

- **Hibernation mode**

By using this mode, you can turn off your computer completely without saving files or exiting any programs that are running. When the computer enters hibernation mode, all open programs, folders, and files are saved to the storage devices, and then the computer turns off.

To put the computer into hibernation mode, do the following:

- **For Windows 7:** Open the Start menu, then click the arrow next to the **Shut down** button. Click **Hibernate** from the menu displayed.
- **For Windows 10:** Define what the power button does first, then press the power button to put the computer into hibernation mode.

If you put your computer into hibernation mode with the wake-up function disabled, the computer does not consume any power. The wake-up function is disabled by default. If you put your computer into hibernation mode with the wake-up function enabled, the computer consumes a small amount of power.

To enable the wake-up function, do the following:

1. Go to Control Panel and click **System and Security**.
2. Click **Administrative Tools**.
3. Click **Task Scheduler**. If you are prompted for an administrator password or confirmation, type the password or provide confirmation.
4. From the left pane, select the task folder for which you want to enable the wake-up function. The scheduled tasks are displayed.
5. Click a scheduled task, and then click the **Conditions** tab.
6. Under **Power**, select the check box for **Wake the computer to run this task**.

- **Wireless off**

When you are not using the wireless features, such as Bluetooth or wireless LAN, turn them off. This helps conserve power. To turn off the wireless features, press the wireless-radios control key .

Connecting to the network

Your computer has one or more network cards that enable you to connect your computer to the Internet and other network connections.

Ethernet connections

You can connect your computer to a local network or a broadband connection through the OneLink+ Ethernet Adapter or a supported ThinkPad OneLink+ Dock.



To avoid the risk of electrical shock, do not connect the telephone cable to the Ethernet connector on the OneLink+ Ethernet Adapter or the ThinkPad OneLink+ Dock.

Wireless connections

Wireless connection is the transfer of data without the use of cables but by means of radio waves only.

In the Airplane mode, all wireless features are disabled. To disable the Airplane mode, open the Start menu and then click **Settings**. If **Settings** is not displayed, click **All apps** to display all programs, and then click **Settings** → **Network & Internet** → **Airplane mode**, and then slide the control to the left.

Depending on the wireless devices installed on your computer, you might be able to use the following wireless networks:

- Wireless-LAN connection
- Wireless-WAN connection
- Bluetooth connection

Using the wireless LAN connection

A wireless local area network (LAN) covers a relatively small geographic area, such as an office building or a house. Devices based on the 802.11 standards can connect to this type of network.

Your computer comes with a built-in wireless network card and a configuration utility to help you establish wireless connections and monitor the connection status. This enables you to stay connected to your network while you are at the office, in a meeting room, or at home, with no need for a wired connection.

To establish a wireless LAN connection, do the following:

1. Click the wireless-network-connection-status icon in the Windows notification area. A list of available wireless networks is displayed.
2. Double-click a network to connect to it. Provide required information if needed.

The computer automatically connects to an available wireless network when the location changes. For more information, refer to the Windows help information system.

Tips for using the wireless LAN feature

To achieve the best connection, use the following guidelines:

- Place your computer so that there are as few obstacles as possible between the wireless LAN access point and the computer.
- Open your computer display to an angle of slightly more than 90 degrees.





- If you use the wireless feature (the 802.11 standards) of your computer simultaneously with a Bluetooth option, the data transmission speed can be delayed and the performance of the wireless feature can be degraded.

Checking the wireless-LAN connection status



You can check the wireless-LAN connection status through the wireless-network-connection-status icon in the Windows notification area. The more bars encompassed, the better the signal is.

For the Windows 7 operating system, you also can check the Access Connections gauge, the Access Connections status icon, or the Access Connections wireless status icon in the Windows notification area.







Access Connections gauge:

-  Power to the wireless radio is off or no signal.
-  Power to the wireless radio is on. The signal strength of the wireless connection is poor. To improve signal strength, move your computer closer to the wireless access point.
-  Power to the wireless radio is on. The signal strength of the wireless connection is marginal.
-  Power to the wireless radio is on. The signal strength of the wireless connection is excellent.

Access Connections status icon:

-  No location profile is active or none exists.
-  Current location profile is disconnected.
-  Current location profile is connected.

Access Connections wireless status icon:

-  Power to the wireless radio is off.
-  Power to the wireless radio is on. No association.
-  Power to the wireless radio is on. No signal.
-  Power to the wireless radio is on. The signal strength of the wireless connection is excellent.
-  Power to the wireless radio is on. The signal strength of the wireless connection is marginal.
-  Power to the wireless radio is on. The signal strength of the wireless connection is poor. To improve signal strength, move your computer closer to the wireless access point.

Using the wireless WAN connection

Wireless wide area network (WAN), which uses cellular networks for data transmission, enables you to establish wireless connections over remote public or private networks. These connections can be maintained over a large geographical area, such as a city or an entire country, by use of multiple antenna sites or satellite systems maintained by wireless service providers.

Some ThinkPad notebook computers come with a built-in wireless WAN card integrated with some wireless WAN technologies, such as 1xEV-DO, HSPA, 3G, GPRS, or LTE. By using the built-in wireless WAN card and the configuration utility that comes with your computer, you can establish wireless WAN connections and monitor the connection status.

Note: The wireless WAN service is provided by authorized service providers in some countries.

Tips for using the wireless WAN feature

To achieve the best connection, use the following guidelines:





- Keep your computer away from your body.
- Place your computer on a flat surface and open your computer display to an angle of slightly more than 90 degrees.
- Place your computer away from concrete or brick walls that might dampen cellular signals.
- Best reception will be available near windows and other locations where cellular phone reception is the strongest.

Checking the wireless-WAN connection status



You can check the wireless-WAN connection status through the wireless-network-connection-status icon in the Windows notification area. The more bars encompassed, the better the signal is.

For the Windows 7 operating system, you also can check the Access Connections gauge, the Access Connections status icon, or the Access Connections wireless status icon in the Windows notification area.







Access Connections gauge:

-  No signal
-  Weak signal
-  Medium signal
-  Strong signal

Access Connections status icon:

-  No location profile is active or none exists.
-  Current location profile is disconnected.
-  Current location profile is connected.

Access Connections wireless status icon:

-  Power to the WAN radio is off
-  No association
-  No signal
-  Weak signal
-  Medium signal
-  Strong signal

Using the Bluetooth connection

Bluetooth can connect devices a short distance from one another, and is commonly used for connecting peripheral devices to a computer, transferring data between hand-held devices and a personal computer, or remotely controlling and communicating with devices such as mobile phones.

Depending on the model, your computer might support the Bluetooth feature. To transfer data through the Bluetooth feature, do the following:

Note: If you use the wireless feature (the 802.11 standards) of your computer simultaneously with a Bluetooth option, the data transmission speed can be delayed and the performance of the wireless feature can be degraded.

1. Ensure that the Bluetooth feature is enabled. Then do one of the following:
 - Open the Start menu and then click **Settings**. If **Settings** is not displayed, click **All apps** to display all programs, and then click **Settings → Devices → Bluetooth**. Turn on the Bluetooth feature.
 - Open the Start menu and then click **Settings**. If **Settings** is not displayed, click **All apps** to display all programs, and then click **Settings → Network & Internet → Airplane mode**. Turn on the Bluetooth feature.
2. Right-click the data that you want to send.
3. Select **Send To → Bluetooth Devices**.
4. Select a Bluetooth device, and then follow the instructions on the screen.

For more information, refer to the Windows help information system and the Bluetooth help information system.

Using an external display

You can use an external display such as a projector or a monitor to give presentations or to expand your workspace. This topic introduces how to connect an external display, choose display modes, and change display settings.

For more information about the external display, refer to the manuals provided with it.

Connecting an external display

You can use either a wired display or a wireless display. The wired display can be connected to the HDMI connector by a cable. The wireless display can be added through the Wi-Di or Miracast function.

- **Connecting a wired display**

Note: When you connect an external monitor, a video interface cable with a ferrite core is required.

1. Connect the external display to an appropriate video connector on your computer.
2. Connect the external display to an electrical outlet.
3. Turn on the external display.

If your computer cannot detect the external display, do the followings:

- For Windows 7: Right-click on the desktop, then click **Screen resolution → Detect**.
- For Windows 10: Right-click on the desktop, then click **Display settings → Detect**.

- **Connecting a wireless display**

Note: To use a wireless display, ensure that both your computer and the external display support the Wi-Di or Miracast feature.

- **For Windows 7**

Start the Intel® Wi-Di program. Select the desired wireless display in the list and follow the instructions on the screen.

- **For Windows 10**

Do one of the following:

- Open the Start menu and then click **Settings**. If **Settings** is not displayed, click **All apps** to display all programs, and then click **Settings → Devices → Connected devices → Add a device**.
- Click the action center icon  in the Windows notification area. Click **Connect**. Select the desired wireless display and follow the instructions on the screen.

For more information, see the Windows help information systems.

Choosing a display mode

You can display your desktop and apps on the computer display, the external display, or both. To choose how to display the video output, press the display-mode switching key  and then select a display mode you prefer.

There are four display modes:

- **Disconnect:** Displays the video output only on your computer screen.

Note: Depending on the situation, you might see **Disconnect**, **PC screen only**, **Computer only**, or **Disconnect projector**.

- **Duplicate:** Displays the same video output on both your computer screen and an external display.
- **Extend:** Extends the video output from your computer display to an external display. You can drag and move items between the two displays.
- **Projector only:** Shows the video output only on an external display.

Note: Depending on the situation, you might see **Projector only** or **Second screen only**.

Note: If you show DOS or programs using DirectDraw or Direct3D® in full-screen mode, only the main display shows the video output.

Changing display settings

You can change the settings for both the computer display and the external display. For example, you can define which one is the main display and which one is the secondary display. You also can change the resolution and orientation.

To change display settings, do the following:

1. Right-click on the desktop and select **Screen Resolution** (Windows 7) or **Display settings** (Windows 10).
2. Select the display that you want to configure.
3. Change display settings as you want.

Using the NVIDIA Optimus Graphics feature

Some ThinkPad notebook computers support NVIDIA Optimus Graphics.

To achieve the best balance between the computer performance and a long battery life, depending on the graphics quality demand of the running program and power plan settings that you use, the NVIDIA Optimus Graphics feature automatically switches between High Performance Graphics and Energy Saving Graphics, with no need to restart your computer, close programs, or intervene manually.

Using audio features

Your computer is equipped with the following:

- Microphones

Note: The left microphone and right microphone automatically switch between each other when the computer screen rotates.

- Speakers

Note: The left speaker and right speaker automatically switch between each other when the computer screen rotates.

- Combo audio connector, 3.5 mm (0.14 inch) in diameter

Your computer also has an audio chip that enables you to enjoy various multimedia audio features, such as the following:

- Compliant with Intel High Definition Audio
- Playback of Musical Instrument Digital Interface (MIDI) and Moving Picture Experts Group Audio Layer-3 (MP3) files
- Recording and playback of pulse-code modulation (PCM) and Waveform Audio File Format (WAV) files
- Recording from various sound sources, such as a headset attached

Note: The combo audio connector does not support a conventional microphone.

The following table shows which functions of the audio devices attached to the connectors on your computer or the supported ThinkPad OneLink+ Dock are supported.

Table 2. Audio feature list

Connector	Headset with a 3.5 mm (0.14-inch), 4-pole plug	Conventional headphone	Conventional microphone
Combo audio connector	Headphone and microphone functions supported	Headphone function supported	Not supported

Configuring for sound recording

To configure the microphone for optimal sound recording, use the Conexant HD Audio Manager program. To start the program, go to Control Panel and click **Hardware and Sound** → **Conexant HD Audio Manager**.

Using the camera

If your computer has a camera, you can use the camera to preview your video image and take a snapshot of your current image.

To start the camera, do the following:

- **For Windows 7:** Start the Communications Utility program. See “Accessing Lenovo programs” on page 12.
- **For Windows 10:** Open the Start menu, and click **Camera** from the all apps list.

When the camera is started, the green camera-in-use indicator turns on.

You also can use the integrated camera with other programs that provide features such as photographing, video capturing, and video conferencing. To use the camera with other programs, open one of the programs and start the photographing, video capturing, or video conferencing function. Then, the camera starts automatically and the green camera-in-use indicator turns on. For more information about using the camera with a program, refer to the help information system of the program.

Configuring camera settings

You can configure the camera settings to meet your needs, such as adjusting the quality of the video output.

To configure the camera settings, do one of the following:

- Open the **Camera** app, click the options button in the upper-left corner, and then select **Settings**. Follow the instructions on the screen to configure the camera settings as desired.
- Open the **Camera** app, click the settings icon in the upper-right corner. Follow the instructions on the screen to configure the camera settings as desired.

Using a flash media card

Your computer has a media card slot, it supports the following cards:

- MultiMediaCard (MMC) module
- Secure Digital eXtended-Capacity(SDXC) card
- Secure Digital (SD) card
- Secure Digital High-Capacity (SDHC) card

Note: Your computer does not support the CPRM feature for the SD card.

Attention: While transferring data to or from a flash media card, such as an SD card, do not put your computer into sleep or hibernation mode before the data transfer completes; otherwise, your data could become damaged.

Installing a flash media card

Attention:

- Before you start installing a card, touch a metal table or a grounded metal object. This action reduces any static electricity from your body. Static electricity could damage the card.

To install a flash media card, do the following:

1. Ensure that the card is correctly oriented.
2. Insert the card firmly into the slot of the 4-in-1 media card reader.

If the plug-and-play feature is not enabled for the installed flash media card, do the following to enable the feature:

1. Go to Control Panel.
2. Click **Hardware and Sound**.
3. Click **Device Manager**. If you are prompted for an administrator password or confirmation, type the password or provide confirmation.
4. From the **Action** menu, select **Add legacy hardware**. The Add Hardware Wizard starts.
5. Follow the instructions on the screen.

Removing a flash media card

Attention:

- Before removing a card, stop the card first. Otherwise, data on the card might get damaged or lost.
- Do not remove a card while the computer is in sleep mode or hibernation mode. Otherwise, the system might not respond when you try to resume operation.

To remove a card, do the following:

1. Click the triangular icon on the windows notification area to show hidden icons. Then, right-click the **Safely Remove Hardware and Eject Media** icon.
2. Select the item you want to remove to stop the card.

3. Press the card to eject it from your computer.
4. Remove the card and store it safely for future use.

Note: If you do not remove the card from your computer after you eject the card from the Windows operating system, the card can no longer be accessed. To access the card, you must remove it first, then insert it again.

Chapter 3. Enhancing your computer

This chapter provides instructions on how to use hardware devices to expand your computer capabilities.

- “Finding ThinkPad options” on page 47
- “ThinkPad OneLink+ Dock” on page 47

Finding ThinkPad options

If you want to expand the capabilities of your computer, Lenovo has a number of hardware accessories and upgrades to meet your needs. Options include storage devices, network cards, port replicators, batteries, power adapters, printers, scanners, keyboards, mice, and more.

You can shop at Lenovo 24 hours a day, 7 days a week directly over the World Wide Web. All you need is an Internet connection and a credit card.

To shop at Lenovo, go to:
<http://www.lenovo.com/essentials>

ThinkPad OneLink+ Dock

The ThinkPad OneLink+ Dock (hereafter referred to as dock) is an optional device that Lenovo designed specifically for your computer. The dock provides convenience and makes your computer easier to use for work, study, and entertainment. If your computer does not come with the dock, you can purchase one from Lenovo at <http://www.lenovo.com/accessories>.

This topic provides basic information about the dock. For detailed information about using the dock, refer to the documentation that comes with the dock.

Note: Depending on the model, your dock might look slightly different from the illustrations in this topic.

Front view



1 Security-lock slot: To protect your dock from theft, purchase a security cable lock, usually a Kensington-style cable lock, that fits this security-lock slot to lock your dock to a stationary object.

2 Audio connector: Used to connect headphones or a headset that has a 3.5-mm (0.14-inch), 4-pole plug.

3 USB 3.0 connector: Used to connect devices that are compatible with USB 3.0 and USB 2.0.

4 Always On USB connector: By default, the Always On USB connector enables you to charge some mobile digital devices and smartphones when the dock is in the following situations:

- When the dock is in sleep or hibernation mode
- When the dock is turned off

For more information, refer to the documentation that comes with the dock.

5 Power button: The power button on the dock functions the same as the one on the computer.

6 System-status indicator: The indicator on the illuminated ThinkPad logo functions the same as the ones on the computer. For details, see “Status indicators” on page 6.

Rear view



1 USB 2.0 connectors: Used to connect devices that are compatible with USB 2.0.

2 DisplayPort connectors: Used to attach a high-performance monitor, a direct-drive monitor, or other devices that use a DisplayPort connector.

3 Ethernet connector: Used to connect the dock to an Ethernet LAN.

4 USB 3.0 connectors: Used to connect devices that are compatible with USB 3.0 and USB 2.0.

5 VGA connector: Used to connect the computer to a VGA-compatible video device, such as a VGA monitor.

6 Power connector: Used to connect the ac power adapter.

7 OneLink+ connector: Connect the OneLink+ connector to the computer.

Chapter 4. You and your computer

This chapter provides information about accessibility, comfort, and traveling with your computer.

- “Accessibility and comfort” on page 49
- “Traveling with your computer” on page 53

Accessibility and comfort

Good ergonomic practice is important to get the most from your personal computer and to avoid discomfort. Arrange your workplace and the equipment you use to suit your individual needs and the kind of work that you perform. In addition, use healthy work habits to maximize your performance and comfort while using your computer.

The following topics provide information about arranging your work area, setting up your computer equipment, and establishing healthy work habits.

Lenovo is committed to providing the latest information and technology to our customers with disabilities. Refer to our accessibility information which outlines our efforts in this area. See “Accessibility information” on page 50.



Ergonomic information

Working in the virtual office might mean adapting to frequent changes in your environment. Following some simple rules will make things easier and bring you the maximum benefits of your computer. Keeping in mind such basics as good lighting and proper seating, for example, can help you improve your performance and achieve greater comfort.

This example shows someone in a conventional setting. Even when not in such a setting, you can follow many of these tips. Develop good habits, and they will serve you well.



General posture: Make minor modifications in your working posture to deter the onset of discomfort caused by long periods of working in the same position. Frequent short breaks from your work also help to prevent minor discomfort associated with your working posture.

Display: Position the display to maintain a comfortable viewing distance of 510-760 mm (20-30 inches). Avoid glare or reflections on the display from overhead lighting or outside sources of light. Keep the display screen clean and set the brightness to levels that enable you to see the screen clearly. Press the brightness-down key  or the brightness-up key  to adjust display brightness.

Head position: Keep your head and neck in a comfortable and neutral (vertical, or upright) position.

Chair: Use a chair that gives you good back support and seat height adjustment. Use chair adjustments to best suit your desired posture.

Arm and hand position: If available, use chair arm rests or an area on your working surface to provide weight support for your arms. Keep your forearms, wrists, and hands in a relaxed and neutral (horizontal) position. Type with a soft touch without pounding the keys.

Leg position: Keep your thighs parallel to the floor and your feet flat on the floor or on a footrest.

What if you are traveling?

It might not be possible to observe the best ergonomic practices when you are using your computer while on the move or in a casual setting. Regardless of the setting, try to observe as many of the tips as possible. Sitting properly and using adequate lighting, for example, will help you maintain desirable levels of comfort and performance.

Questions about vision?

The visual display screens of ThinkPad notebook computers are designed to meet the highest standards and to provide you with clear, crisp images and large, bright displays that are easy to see, yet easy on the eyes. Of course, any concentrated and sustained visual activity can be tiring. If you have questions on eye fatigue or visual discomfort, consult a vision care specialist for advice.

Comfort

Observe the following guidelines to achieve greater comfort and improve performance.

Active sitting and rest breaks: The longer you sit and work with your computer, the more important it is to observe your working posture. Follow “Ergonomic information” on page 49 and practice “active sitting” to avoid discomfort associated with your working postures. Making minor voluntary postural changes and taking short frequent work breaks are the key ingredients for healthy computing. Your computer is light and mobile; you can easily reposition your working surface to accommodate many posture modifications.

Work area setup options: Familiarize yourself with all of your office furniture so that you know how to adjust your work surface, seat, and other work tools to accommodate your preferences for comfort. If your work area is not in an office setting, be sure to take special note of employing active sitting and taking work breaks. Many ThinkPad product solutions are available to help you modify and expand your computer to best suit your needs. Access the following Web site to view some of these options: <http://www.lenovo.com/essentials>. Explore your options for docking solutions and external products that provide the adjustability and features that you want.

Accessibility information

Lenovo is committed to providing users who have hearing, vision, and mobility limitations with greater access to information and technology. This section provides information about the ways to help these users get the most out of their computer experience. You also can get the most up-to-date accessibility information from the following Web site:

<http://www.lenovo.com/accessibility>

Ease of Access Center

Ease of Access Center on the Windows operating system enables users to configure their computers to suit their physical and cognitive needs.

To use Ease of Access Center, do the following:

1. Click the Start button to open the Start menu.

2. Click **Control Panel → Ease of Access → Ease of Access Center**.
3. Follow the instructions on the screen.

Ease of Access Center mainly includes the following tools:

- **Magnifier**
Magnifier is a useful utility that enlarges the entire screen or part of the screen so that you can see the words and images better.
- **Narrator**
Narrator is a screen reader that reads what is displayed on the screen aloud and describes events like error messages.
- **On-Screen Keyboard**
If you prefer to type or enter data into your computer without using a physical keyboard, you can use On-Screen Keyboard. On-Screen Keyboard displays a visual keyboard with all the standard keys. You can select keys using the mouse or another pointing device, or you can tap to select the keys if your computer supports multi-touch screen.
- **High Contrast**
High Contrast is a feature that heightens the color contrast of some text and images on your screen. As a result, those items are more distinct and easier to identify.
- **Personalized keyboard**
Adjust keyboard settings to make your keyboard easier to use. For example, you can use your keyboard to control the pointer and make the keyboard easier to type certain key combinations.
- **Personalized mouse**
Adjust mouse settings to make your mouse easier to use. For example, you can change the pointer appearance and make your mouse easier to manage windows.

Speech Recognition

Speech Recognition enables you to control your computer by voice.

Using only your voice, you can start programs, open menus, click objects on the screen, dictate text into documents, and write and send e-mails. Everything you do with the keyboard and mouse can be done with only your voice.

To use Speech Recognition, do the following:

1. Click the Start button to open the Start menu.
2. Click **Control Panel → Ease of Access → Speech Recognition**.
3. Follow the instructions on the screen.

Screen-reader technologies

Screen-reader technologies are primarily focused on software program interfaces, help information systems, and various online documents. For additional information about screen readers, see the following:

- Using PDFs with screen readers:
<http://www.adobe.com/accessibility.html?promoid=DJGVE>
- Using the JAWS screen reader:
<http://www.freedomscientific.com/jaws-hq.asp>
- Using the NVDA screen reader:
<http://www.nvaccess.org/>

Screen resolution

You can make the text and images on your screen easier to read by adjusting the screen resolution of your computer.

To adjust the screen resolution, do the following:

1. Right-click an empty area of the desktop and select **Display settings** → **Advanced display settings**.
2. Select your preferred setting under **Resolution**.

Note: Setting a resolution too low might prevent some items from fitting on the screen.

Keyboard shortcuts

The following table contains keyboard shortcuts that can help make your computer easier to use.

Note: Some keyboard shortcuts might not be available on your computer.

Keyboard shortcut	Function
Windows logo key + U	Open Ease of Access Center
Right Shift for eight seconds	Turn on or turn off Filter Keys
Shift five times	Turn on or turn off Sticky Keys
Num Lock for five seconds	Turn on or turn off Toggle Keys
Left Alt+Left Shift+Num Lock	Turn on or turn off Mouse Keys
Left Alt+Left Shift+PrtScn (or PrtSc)	Turn on or turn off High Contrast

For more information, go to <http://windows.microsoft.com/>, and then type any of the following keywords for searching: keyboard shortcuts, key combinations, shortcut keys.

Zoom

You can use the zoom feature to enlarge or reduce the size of text, pictures, maps, or other objects.

- From the keyboard:
 - Zoom in: Press the Windows logo key + the plus-sign key (+) to enlarge the size of text, pictures, maps, or other objects.
 - Zoom out: Press the Windows logo key + the minus-sign (-) key to reduce the size of text, pictures, maps, or other objects.
- From the touch screen:
 - Zoom in: Move two fingers farther apart on the touch screen to enlarge the size of text, pictures, maps, or other objects.
 - Zoom out: Move two fingers closer together on the touch screen to reduce the size of text, pictures, maps, or other objects.

Industry-standard connectors

Your computer provides industry-standard connectors that enable you to connect assistive devices.

For more information about the location and function of the connectors, see “Locating computer controls, connectors, and indicators” on page 1.

Documentation in accessible formats

Lenovo provides electronic documentation in accessible formats, such as properly tagged PDF files or HyperText Markup Language (HTML) files. Lenovo electronic documentation is developed to ensure

that visually impaired users can read the documentation through a screen reader. Each image in the documentation also includes adequate alternative text so that visually impaired users can understand the image when they use a screen reader.

Traveling with your computer

This topic provides information to help you work with your computer when you are traveling.

Travel tips

Use the following travel tips to travel more confidently and efficiently with your computer.

- Although it is safe to allow your computer to go through the x-ray machines at airport security stations, it is important to keep your eyes on the computer at all times to prevent theft.
- Consider bringing an electrical adapter for use in an airplane or automobile.
- If you carry an ac power adapter, detach the ac cord from it to avoid damaging the cord.

Travel tips on airplanes

If you carry your computer into an airplane, take note of the following tips:

- If you intend to use your computer or wireless services (such as Internet and Bluetooth), check with the airline for restrictions and availability of services before boarding the airplane. If there are restrictions on the use of computers with wireless features on the airplane, you must abide by those restrictions. If necessary, enable the Airplane mode before boarding. In the Airplane mode, all wireless features are disabled. To enable the Airplane mode, open the Start menu and then click **Settings**. If **Settings** is not displayed, click **All apps** to display all programs, and then click **Settings** → **Network & Internet** → **Airplane mode**, and then slide the control to the right.
- Be careful about the seat in front of you on airplanes. Angle your computer display so that it does not get caught when the person in front of you leans back.
- When taking off, remember to turn off your computer or put it into hibernation mode.

Travel accessories

The following is a checklist of items to consider packing when you are going to travel:

- ThinkPad ac power adapter
- ThinkPad AC/DC combo adapter
- External mouse (if you are accustomed to using one)
- A quality carrying case that provides adequate cushion and protection
- External storage device
- HDMI cable
- OneLink+ Ethernet Adapter
- ThinkPad OneLink+ Dock
- ThinkPad OneLink+ to VGA/RJ45 Adapter

If you are traveling to another country, you might need to consider an ac power adapter for the country to which you are traveling.

To purchase travel accessories, go to <http://www.lenovo.com/accessories>.

Chapter 5. Security

This chapter provides information about how to protect your computer from theft and unauthorized use.

- “Using passwords” on page 55
- “Hard disk security” on page 59
- “Setting the security chip” on page 60
- “Using the fingerprint reader” on page 61
- “Notice on deleting data from your storage drive” on page 64
- “Using firewalls” on page 64
- “Protecting data against viruses” on page 64

Using passwords

You can help prevent your computer from unauthorized use by using passwords. Once you set a password, a prompt is displayed on the screen each time you turn on the computer. Enter your password at the prompt. You cannot use the computer unless you type the correct password.

If you have set a power-on password, a supervisor password, or a hard disk password, it unlocks automatically when the computer resumes from sleep mode.

Note: If a Windows password has been set, you will be prompted to enter it.

Typing passwords



When this icon is displayed, type a power-on password or a supervisor password.



When this icon is displayed, type a user hard disk password. To type a master hard disk password, press F1. When the icon changes to , type the master hard disk password



Note: To return to the icon , press F1 again.

Power-on password

You can set a power-on password to help protect your computer against unauthorized access.

If you set a power-on password, the password prompt is displayed on the screen whenever you turn on the computer. You must enter the correct password to start using the computer.

Setting, changing, or removing a power-on password

Before you start, print these instructions.

To set, change, or remove a power-on password, do the following:

1. Turn off your computer. Wait for about five seconds, and then turn on the computer again.
2. When the logo screen is displayed, press F1 to start the ThinkPad Setup program.
3. Select **Security** → **Password** → **Power-on Password** by using the directional keys.

4. Depending on your need, do one of the following:
 - To set a password, do the following:
 - a. In the **Enter New Password** field, type a desired password and press Enter.
 - b. In the **Confirm New Password** field, retype the password and press Enter.
 - To change a password, do the following:
 - a. In the **Enter Current Password** field, type the current power-on password and press Enter.
 - b. In the **Enter New Password** field, type the new power-on password and press Enter; then retype the password in the **Confirm New Password** field and Press Enter.
 - To remove a password, do the following:
 - a. In the **Enter Current Password** field, type the current power-on password and press Enter.
 - b. Leave the **Enter New Password** and **Confirm New Password** fields blank. Press Enter twice.
5. A Setup Notice window is displayed. Press Enter to continue.
6. Press F10. A Setup Confirmation window is displayed. Select **Yes** to save the configuration changes and exit.

Note: You might want to record your password and store it in a safe place. Otherwise, if you forget the password, you have to take your computer to a Lenovo reseller or a marketing representative to have the password canceled.

Supervisor password

The supervisor password protects the system information stored in the ThinkPad Setup program. If you have set a supervisor password, no one can change the configuration of the computer without the password. It provides the following security features:

- If only a supervisor password is set, a password prompt is displayed when you try to start the ThinkPad Setup program. Unauthorized users cannot access the ThinkPad Setup program without the password.
- The system administrator can use the supervisor password to access a computer even if the user of that computer has set a power-on password. The supervisor password overrides the power-on password.
- If both a supervisor password and a power-on password are set, you can do the following only if you have the supervisor password:
 - Changing or deleting the power-on password
 - Changing or deleting the supervisor password
 - Changing date and time
 - Specifying the minimum length for power-on password and hard disk password
 - Changing the setting for the security chip
 - Enabling or disabling the following features:
 - Lock UEFI BIOS Settings
 - Password at unattended boot
 - Boot Device List F12 Option
 - Boot Order Lock
 - Flash BIOS Updating by End-Users
 - Internal network device
 - Internal wireless device
 - Internal Bluetooth device

- Internal Network Option ROM
- Security mode

Notes:

- The system administrator can set the same supervisor password on many ThinkPad notebook computers to make administration easier.
- When **Lock UEFI BIOS Settings** option is enabled, all BIOS settings cannot be changed. To change the settings, a supervisor password is required.

Setting, changing, or removing a supervisor password

Before you start, print these instructions.

Only a system administrator can set, change, or remove a supervisor password. To set, change, or remove a supervisor password, do the following:

1. Turn off your computer. Wait for about five seconds, and then turn on the computer again.
2. When the logo screen is displayed, press F1 to start the ThinkPad Setup program.
3. Select **Security** → **Password** → **Supervisor Password** by using the directional keys.
4. Depending on your needs, do one of the following:
 - To set a password, do the following:
 - a. In the **Enter New Password** field, type a desired password and press Enter.
 - b. In the **Confirm New Password** field, retype the password and press Enter.
 - To change a password, do the following:
 - a. In the **Enter Current Password** field, type the current supervisor password and press Enter.
 - b. In the **Enter New Password** field, type the new supervisor password and press Enter; then retype the password in the **Confirm New Password** field and press Enter.
 - To remove a password, do the following:
 - a. In the **Enter Current Password** field, type the current supervisor password and press Enter.
 - b. Leave the **Enter New Password** and **Confirm New Password** fields blank. Press Enter twice.
5. A Setup Notice window is displayed. Press Enter to continue.
6. Press F10. A Setup Confirmation window is displayed. Select **Yes** to save the configuration changes and exit.

Note: You might want to record your password and store it in a safe place. The next time you open the ThinkPad Setup program, you will be prompted to type your supervisor password to proceed. If you forget your supervisor password, Lenovo cannot reset your password. You must take your computer to a Lenovo reseller or a Lenovo marketing representative to have the system board replaced. Proof of purchase is required, and a fee will be charged for parts and service.

Hard disk passwords

The following two types of hard disk passwords can help protect the information stored on the hard disk drive or hybrid drive:

- **User hard disk password**

If a user hard disk password has been set, but no master hard disk password has been, the user must enter the user hard disk password to access files and applications on the hard disk drive or hybrid drive.

- **Master hard disk password**

The master hard disk password also requires a user hard disk password. The master hard disk password is usually set and used by a system administrator. It enables the administrator to access any hard disk drive or hybrid drive in a system like a master key. The administrator sets the master password; then assigns a user password for each computer in the network. The user can then change the user password as desired, but the administrator still can get access by using the master password.

When a master hard disk password is set, only the administrator can remove the user hard disk password.

Setting a hard disk password

Before you start, print these instructions.

To set a hard disk password, do the following:

1. Turn off your computer. Wait for about five seconds, and then turn on the computer again.
2. When the logo screen is displayed, press F1 to start the ThinkPad Setup program.
3. Select **Security** → **Password** → **Hard disk 1 Password** by using the directional keys.
4. A password window is displayed. You are prompted to select **User** or **User + Master**. Select **User** if you want to set only one hard disk password. Select **User + Master** if you want to set a user hard disk password and a master hard disk password, for example if you are an administrator or a supervisor.
 - If you select **User**, do the following:
 - a. When a window for typing the new password opens, type your new password in the **Enter New Password** field and press Enter.
 - b. In the **Confirm New Password** field, retype the password you just entered and press Enter.
 - If you select **User + Master**, do the following:
 - a. First, set a user hard disk password. When a message window prompts you to set the user hard disk password, press Enter to continue. Type your new user hard disk password in the **Enter New Password** field and press Enter. Retype the password in the **Confirm New Password** field and press Enter.
 - b. Then, set a master hard disk password. When a message window prompts you to set the master hard disk password, press Enter to continue. Type your new master hard disk password in the **Enter New Password** field and press Enter. Retype the password in the **Confirm New Password** field and press Enter.
5. A Setup Notice window is displayed. Press Enter to continue.
6. Press F10. A Setup Confirmation window is displayed. Select **Yes** to save the configuration changes and exit.

The next time you turn on your computer, type the user or master hard disk password to start your computer and access the operating system.

Changing or removing a hard disk password

To change or remove the hard disk password, do the following:

- If you are in **User + Master** hard disk mode, you can select either **User HDP** or **Master HDP** to change the password, depending on your needs.
 - If you select **User HDP** mode, follow the following steps to change the user hard disk password:
 1. Type the current user hard disk password in the **Enter Current Password** field and press Enter.
 2. Type the new password in the **Enter New Password** field and press Enter; then retype the password in the **Confirm New Password** field and press Enter.
 3. A Setup Notice window is displayed. Press Enter again to continue. The user hard disk password is changed.

Note: The hard disk password cannot be removed in **User HDP** mode.

- If you select **Master HDP** mode, follow the following steps to change the master hard disk password:
 1. Type the current master hard disk password in the **Enter Current Password** field and press Enter.
 2. Type the new master hard disk password in the **Enter New Password** field and press Enter; then retype the new password you just entered in the **Confirm New Password** field and press Enter.
 3. A Setup Notice window is displayed. Press Enter to continue. The master hard disk password is changed.

Note: If you leave the **Enter New Password** and **Confirm New Password** fields blank and press Enter twice, both the user and master hard disk passwords are removed.

- If you are in **User** hard disk mode, follow the following steps to change the user hard disk password:
 1. Follow steps 1 through 7 in “Setting a hard disk password” on page 58, typing your password to start the ThinkPad Setup program.
 2. Type the current user hard disk password in the **Enter Current Password** field and press Enter.
 3. Type the new password in the **Enter New Password** field and press Enter; then retype the new password in the **Confirm New Password** field and press Enter.
 4. A Setup Notice window is displayed. Press Enter again to continue. The user hard disk password is changed.

Note: If you leave the **Enter New Password** and **Confirm New Password** fields blank and press Enter twice, the user hard disk password is removed.

Tips on using the hard disk passwords

- You can set the minimum length of a hard disk password through the **Security** menu.
- If you set a hard disk password of over seven characters, the hard disk drive or hybrid drive can be used only with a computer that can recognize a hard disk password of over seven characters. If you then install the hard disk drive or hybrid drive in a computer that cannot recognize a hard disk password that contains more than seven characters, you cannot access the drive.
- Record your password and store it in a safe place. If you forget the user hard disk password, or both user and master hard disk passwords, Lenovo cannot reset your passwords or recover data from the hard disk drive or hybrid drive. You must take your computer to a Lenovo reseller or a marketing representative to have the hard disk drive or hybrid drive replaced. Proof of purchase is required, and a fee will be charged for parts and service.

Notes: The eDrive storage drives or Trusted Computing Group (TCG) Opal-compliant storage drives provide self-encryption capabilities to secure your data.

- If a TCG Opal-compliant storage drive and a TCG Opal management software program are installed, and the TCG Opal management software program is activated, the hard disk password is not available.
- If an eDrive storage drive is installed in your computer, and your computer is preinstalled with the Windows 10 operating system, the hard disk password is not available.

Hard disk security

To protect passwords from unauthorized security attacks, refer to the following tips to maximize security:

- Set a power-on password as well as a hard disk password for your internal solid-state drive, hard disk drive or hybrid drive. Refer to the procedures in “Power-on password” on page 55 and “Hard disk passwords” on page 57. For security, a longer password is recommended.
- To provide reliable security for UEFI BIOS, use the security chip and a security application with a Trusted Platform Module (TPM) management feature. Refer to “Setting the security chip” on page 60.

- If a Disk Encryption hard disk drive, an Encryption solid-state drive, or a Disk Encryption hybrid drive is installed in your computer, be sure to protect the contents of your computer memory from unauthorized access by use of drive encryption software, such as Microsoft Windows BitLocker® Drive Encryption. Refer to “Using Windows BitLocker Drive Encryption” on page 60.
- Before you dispose of, sell, or hand over your computer, be sure to delete data stored on it. For more information, refer to “Notice on deleting data from your storage drive” on page 64.

Note: The hard disk drive or hybrid drive built into your computer can be protected by UEFI BIOS.

Using Windows BitLocker Drive Encryption

To help protect your computer against unauthorized access, be sure to use drive encryption software, such as Windows BitLocker Drive Encryption.

Windows BitLocker Drive Encryption is an integral security feature of some editions of the Windows operating system. It can help you protect the operating system and data stored on your computer, even if your computer is lost or stolen. BitLocker works by encrypting all user and system files, including the swap and hibernation files.

BitLocker uses a Trusted Platform Module to provide enhanced protection for your data and to ensure early boot component integrity. A compatible TPM is defined as a V1.2 TPM.

To check the BitLocker status, go to Control Panel, and click **System and Security → BitLocker Drive Encryption**.

For more information about Windows BitLocker Drive Encryption, see the help information system of the Windows operating system, or search for “Microsoft Windows BitLocker Drive Encryption Step-by-Step Guide” on the Microsoft Web site.

Disk Encryption hard disk drive, Encryption solid-state drive, and Disk Encryption hybrid drive

Some models contain the Disk Encryption hard disk drive, the Encryption solid-state drive, or the Disk Encryption hybrid drive. This feature helps to protect your computer against security attacks on media, NAND flash or device controllers by use of a hardware encryption chip. For the efficient use of the encryption feature, be sure to set a hard disk password for the internal storage device.

Setting the security chip

Strict security requirements are imposed on network client computers that transfer confidential information electronically. Depending on the options you ordered, your computer might have an embedded security chip, a cryptographic microprocessor. With the security chip, you can do the following:

- Protect your data and system
- Strengthen access controls
- Secure communications

Setting the security chip

The choices offered on the **Security Chip** submenu under the **Security** menu of ThinkPad Setup are as follows:

- **Security Chip:** Activate, inactivate, or disable the security chip.
- **Security Reporting Options:** Enable or disable each security reporting option.
- **Clear Security Chip:** Clear the encryption key.

Before you start, print these instructions.

To set an item on the **Security Chip** submenu, do the following:

1. Turn off your computer. Wait for about five seconds, and then turn on the computer again.
2. When the logo screen is displayed, press F1 to start the ThinkPad Setup program.
3. Select **Security** → **Security Chip** by using the directional keys.
4. Press Enter. The **Security Chip** submenu opens.
5. Move to an item you want to set by using the directional keys. When the item is highlighted, press Enter.
6. Set other items that you want to set.
7. Press F10. A Setup Confirmation window is displayed. Select **Yes** to save the configuration changes and exit.

Tips on using the security chip

- Ensure that the supervisor password has been set in ThinkPad Setup. Otherwise anyone can change the settings for the security chip.
- If the security chip is removed or replaced, or a new one has been added, the computer will not start. You will hear four cycles of four beeps each, or you will see error message 0176 or 0192.
- If the security chip is inactive or disabled, the **Clear Security Chip** option will not be displayed.
- When you clear the security chip, turn off your computer and then turn it on again after you set the security chip to **Active**. Otherwise, the **Clear Security Chip** option is not displayed.

Using the fingerprint reader

Depending on the model, your computer might have a fingerprint reader. Fingerprint authentication can replace your passwords, such as the Windows password, power-on password, and hard disk password. In this way, you can log on to your computer simply and securely. To enable fingerprint authentication, enroll your fingerprints first.

Enrolling your fingerprints

To enroll your fingerprints on the Windows 10 operating system, do the following:

1. Open the Start menu and then click **Settings**. If **Settings** is not displayed, click **All apps** to display all programs, and then click **Settings** → **Accounts** → **Sign-in options**.
2. Follow the instructions on the screen to finish the enrollment.

Note: It is recommended that you enroll more than one fingerprint in case of any injuries to your fingers.

Swiping your finger over the fingerprint reader

To swipe your finger over the reader, do the following:

1. Place the top joint of your finger on the sensor.

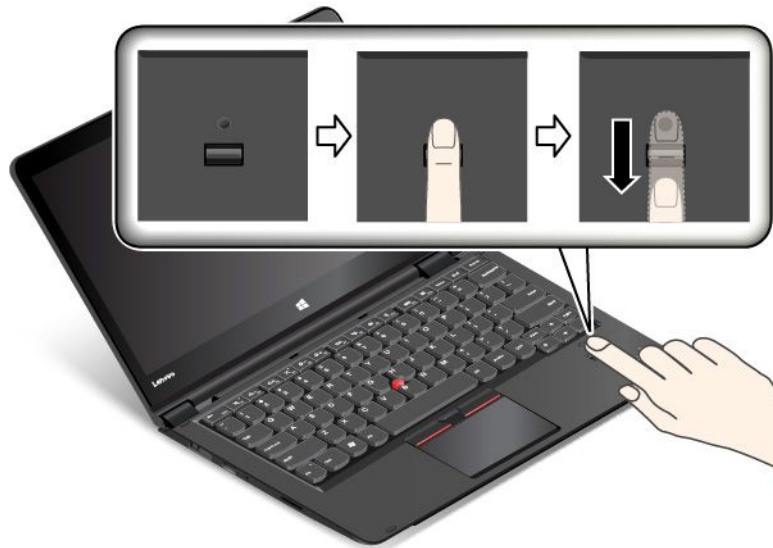

2. Apply light pressure and swipe your finger toward you across the reader in one smooth motion. Do not lift your finger when you are swiping it.

Indicator behavior of the fingerprint reader

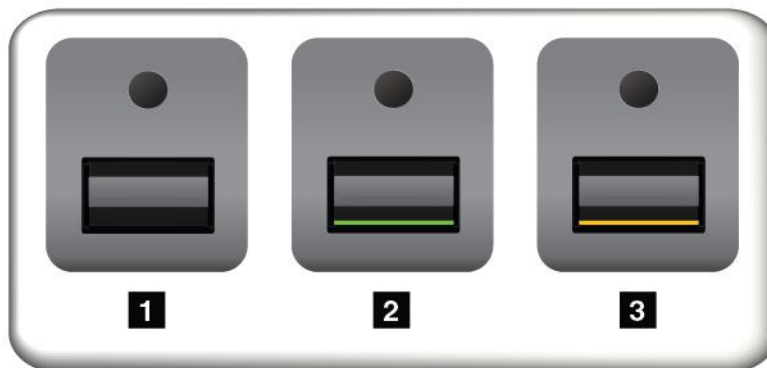

Indicator behavior	Description
1 Off	The fingerprint reader is not ready for swiping.
2 Solid green	The fingerprint reader is ready for swiping.
3 Amber, blinking	The fingerprint cannot be authenticated.

Associating your fingerprints with your power-on password and hard disk password

To associate your fingerprints with your power-on password and hard disk password, do the following:

1. Turn off and then turn on the computer.
2. When prompted, swipe your finger on the fingerprint reader.
3. Enter your power-on password, hard disk password, or both as required. The connection is created.

When you start the computer again, you can use your fingerprints to log on to the computer with no need to enter your Windows password, power-on password, and hard disk password.

Attention: If you always use your fingerprint to log on to the computer, you might forget your passwords. Write down your passwords, and keep them in a safe place. If you forget your power-on password, you must take your computer to a Lenovo authorized servicer or a marketing representative to have the password canceled. If you forget your hard disk password, Lenovo cannot reset your password or recover data from the storage drive. You must take your computer to a Lenovo authorized servicer or a marketing representative to have the storage drive replaced. Proof of purchase is required, and a fee will be charged for parts and service.

Setting the fingerprint reader

You can change some advanced settings in the ThinkPad Setup program, see “Using the ThinkPad Setup program” on page 70.

You can set the following configurations in the ThinkPad Setup program:

- **Predesktop Authentication:** Enables or disables fingerprint authentication before the operating system is loaded.
- **Reader Priority:** Defines the priority for the fingerprint readers if an external fingerprint reader is attached.
- **Security Mode:** Specifies the settings of the security mode.
- **Password Authentication:** Enables or disables the password authentication.

Note: This item is displayed only if **High security** mode is enabled.

- **Reset Fingerprint Data:** Select this item to erase all of the fingerprint data stored in either the internal or external fingerprint reader.

Maintaining the fingerprint reader

The following actions could damage the fingerprint reader or cause it not to work properly:

- Scratching the surface of the reader with a hard, pointed object.
- Scraping the surface of the reader with your fingernail or anything hard.
- Using or touching the reader with a dirty finger.

If you notice any of the following conditions, gently clean the surface of the reader with a dry, soft, lint-free cloth:

- The surface of the reader is dirty or stained.
- The surface of the reader is wet.
- The reader often fails to enroll or authenticate your fingerprint.

If your finger has any of the following conditions, you might not be able to register or authenticate it:

- Your finger is wrinkled.
- Your finger is rough, dry, or injured.
- Your finger is stained with dirt, mud, or oil.
- The surface of your finger is different from when you enrolled your fingerprint.
- Your finger is wet.
- A finger is used that has not been enrolled.

To improve the situation, try the following:

- Clean or wipe your hands to remove any excess dirt or moisture from the fingers.
- Enroll and use a different finger for authentication.

Notice on deleting data from your storage drive

Some of the data stored on storage drive might be sensitive. Handing your computer over to someone else without deleting the installed software, such as operating systems and application software, might even violate license agreements. Be sure to delete data stored on the storage drive before you dispose of, sell, or hand over your computer.

You can use the following methods to delete data from the storage drive:

- Move the data to the Recycle Bin, and then empty the Recycle Bin.
- Delete the data.
- Format the storage drive, using the software for initializing it.
- Use the recovery program provided by Lenovo to bring the storage drive back to the factory default settings.

These operations, however, only change the file location of the data; they do not delete the data itself. In other words, the data retrieval processing is disabled under an operating system such as Windows. The data is still there, even though it seems to be lost. Thus, it is sometimes possible to read the data by use of special software for data recovery. There is a risk that people of bad faith might read and misuse the critical data on the storage drive for unexpected purposes.

To prevent leakage of data, it is important that you delete all the data from the hard disk drive or hybrid drive when you dispose of, sell, or hand over your computer. You can destroy the data physically by smashing the hard disk drive or hybrid drive with a hammer, or magnetically by means of strong magnetic power, thus making the data unreadable. But it is recommended that you use the software (payware) or service (pay service) developed for that purpose. The process might take several hours.

For disposing of data on the solid-state drive, Lenovo provides the Drive Erase Utility for Resetting the Cryptographic Key and Erasing the Solid State Drive tool. For disposing of data on the hard disk drive or hybrid drive, Lenovo provides the Secure Data Disposal™ tool. Go to <http://www.lenovo.com/support> to download these tools.

If an Encryption solid-state drive, a Disk Encryption hard disk drive, or a Disk Encryption hybrid drive is supported and installed in your computer, you can logically dispose of all the data on the drive in a short time by erasing the cryptographic key. The data encrypted with the old key is not physically erased but remains on the drive; however, it cannot be decrypted without the old key. This feature is also available with the Drive Erase Utility for Resetting the Cryptographic Key and Erasing the Solid State Drive tool.

Using firewalls

If your system is preinstalled with a firewall program, it protects against computer Internet security threats, unauthorized accesses, intrusions, and Internet attacks. It also protects your privacy.

For more information about how to use the firewall program, refer to the help information system that comes with the program.

Protecting data against viruses

Your computer is preinstalled with an antivirus program so you can detect and eliminate viruses. The antivirus program is designed to help you detect and eliminate viruses.

Lenovo provides a full version of antivirus software on your computer with a free 30-day subscription. After 30 days, you must renew the license to continue receiving the antivirus software updates.

For more information about how to use your antivirus software, refer to the help information system of your antivirus software.

Chapter 6. Advanced configuration

While it is important to protect files, data, and settings that are on the storage drive, you also might need to install a new operating system, install new device drivers, update your system UEFI BIOS, or recover preinstalled software. This information will help you handle your computer with proper care and keep it in top working shape.

- “Installing the Windows 10 operating system” on page 68
- “Installing device drivers” on page 69
- “Using the ThinkPad Setup program” on page 70
- “Using system management” on page 85

Installing a new operating system

In some situations, you might need to install a new operating system. This topic provides instructions on how to install a new operating system.

Installing the Windows 7 operating system

Before you start, print these instructions.

Attention: The process of installing a new operating system deletes all the data on your storage devices, including the data that were stored in a hidden folder.

To install the Windows 7 operating system, do the following:

1. Copy all the subdirectories and files in the C:\SWT00LS directory to a removable storage device.
 - The supplement files for the Windows 7 operating system are in the C:\SWT00LS\0SFIXES directory.
 - The device drivers are in the C:\SWT00LS\DRIVERS directory.
 - The preinstalled programs are in the C:\SWT00LS\APPS directory.
 2. Start the ThinkPad Setup program. See “Using the ThinkPad Setup program” on page 70.
 3. Select **Startup → Boot** to display the **Boot Priority Order** submenu.
 4. Select the drive that contains the operating system installation program, for example, **USB HDD**. Then press Esc.
 5. Select **Startup → UEFI/Legacy Boot**. Then do one of the following:
 - To install the Windows 7 (32-bit) operating system, select **Legacy Only** or **Both**.
 - To install the Windows 7 (64-bit) operating system in Legacy mode, select **Legacy Only**.
 - To install the Windows 7 (64-bit) operating system in UEFI mode, select **UEFI Only**.
- Note:** For computers with a non-volatile memory (NVM) Express drive, you can install the Windows 7 operating system onto the drive only in UEFI mode. In this case, ensure that you always select **UEFI Only**.
6. Press F10 to exit the ThinkPad Setup program.
 7. Insert the Windows 7 operating system installation DVD into the optical drive, and restart the computer.

Notes:

- If you are starting the installation DVD image from an external USB device or if your computer has an NVM Express drive installed, do additional configurations before you start. For more information, go to: <http://www.lenovo.com/support/installwin7viausb3>.
 - If an NVM Express drive is installed, additional drivers also are required. For more information, go to <https://support.microsoft.com/en-us/kb/2990941>.
8. Restore the C:\SWTOOLS directory that you backed up before installing the Windows 7 operating system.
 9. Install the device drivers. See “Installing device drivers” on page 69.
 10. Install the Windows 7 fix modules. You can find the Windows 7 fix modules in the C:\SWTOOLS\OSFIXES\ directory. For more information, go to the Microsoft Knowledge Base home page at: <http://support.microsoft.com/>
 11. Install the registry patches, for example the Enabling Wake on LAN from Standby for ENERGY STAR patch. To download and install the registry patches, go to the Lenovo Support Web site at: <http://www.lenovo.com/support>

Note: After installing the operating system, do not change the initial **UEFI/Legacy Boot** setting in the ThinkPad Setup program. Otherwise the operating system will not start correctly.

When you install the Windows 7 operating system, you might need one of the following country or region codes:

Country or region	Code	Country or region	Code
China	SC	Netherlands	NL
Denmark	DK	Norway	NO
Finland	FI	Spain	SP
France	FR	Sweden	SV
Germany	GR	Taiwan and Hong Kong	TC
Italy	IT	United States	US
Japan	JP		

Installing the Windows 10 operating system

In some situations, you might need to install a new operating system. This topic provides instructions on how to install a Windows 10 operating system.

Before you start, print these instructions.

Attention:

- The process of installing a new operating system deletes all the data on your storage drive, including the data that were stored in a hidden folder.
- If your computer is equipped with both a hard disk drive and an M.2 solid-state drive, do not use the M.2 solid-state drive as a bootable device. The M.2 solid-state drive is used for “cache” function.

To install the Windows 10 operating system, do the following:

1. Start the ThinkPad Setup program. See “Using the ThinkPad Setup program” on page 70.
2. Select **Startup** → **Boot** to display the **Boot Priority Order** submenu.
3. Select the drive that contains the operating system installation program, for example **USB HDD**. Then press Esc

4. Select **Restart** and ensure that **OS Optimized Defaults** is enabled. Then press the F9 key to load default settings.
5. Press the F10 key to exit the ThinkPad Setup program.
6. Connect the drive that contains the operating system installation program to the computer, and restart the computer.
7. Install the device drivers and necessary programs. See “Installing device drivers” on page 69.
8. After installing the device drivers, apply Windows Update to get the latest modules, for example the security patches.
9. Depending on your preference, install Lenovo programs. For information about Lenovo programs, see “Lenovo programs” on page 12

Note: After installing the operating system, do not change the initial **UEFI/Legacy Boot** setting in the ThinkPad Setup program. Otherwise, the operating system will not start correctly.

When you install the Windows 10 operating system, you might need one of the following country or region codes:

Country or region	Code	Country or region	Code
China	SC	Netherlands	NL
Denmark	DK	Norway	NO
Finland	FI	Spain	SP
France	FR	Sweden	SV
Germany	GR	Taiwan and Hong Kong	TC
Italy	IT	United States	US
Japan	JP		

Installing device drivers

Device driver is the program that operates a particular hardware device of the computer. If a device does not perform well or you install a new device, you need to install or update the corresponding device driver. For example, if you use the Windows 7 operating system, to use the USB 3.0 connector, you need to download and install the USB 3.0 driver.

To download the latest device drivers, do the following:

1. Go to <http://www.lenovo.com/ThinkPadDrivers>.
2. Select your product name to view all the device drivers for your computer.
3. Select the device drivers you that you need, and follow the instructions on the screen.

Attention: Do not download the device drivers from the Windows Update Web. Always download the device drivers from:

<http://www.lenovo.com/ThinkPadDrivers>

If you use the Windows 7 operating system, you also can find the device drivers in the C:\SWTOOLS\DRIVERS directory on your storage devices. For more information, see “Reinstalling preinstalled programs and device drivers” on page 112.

Using the ThinkPad Setup program

The ThinkPad Setup program enables you to select various setup configurations for your computer through configuring the BIOS.

To configure the BIOS of your computer, do the following:

1. Restart the computer. When the logo is displayed, press F1. The ThinkPad Setup program starts.

Note: If you are required to enter the supervisor password, enter the correct password. You also can press Enter to skip the password prompt and start the ThinkPad Setup program. If you do not enter the password, you cannot change the configurations that are protected by the supervisor password. For more information, refer to “Using passwords” on page 55.

2. Use the pointer keys to select a tab; or use the pointer keys to locate an item and press Enter to select it. Then a submenu is displayed.

Note: Some menu items are displayed only if the computer supports the corresponding features.

3. Set the value of an item by doing one of the following:

- Press the F6 key to change to a higher value.
- Press the F5 key to change to a lower value.

Note: Default values are in **boldface**.

4. To change other configurations, press the Esc key to exit the submenu and return to the parent menu.
5. When you complete the configuration, press the F10 key to save and exit. You also can select the **Restart** tab in the ThinkPad Setup menu, and restart your computer with one of the provided options.

Note: You can press the F9 key to restore to the default settings.

Main menu

When you enter the ThinkPad Setup program, you will first see the **Main** menu as follows:

- **UEFI BIOS Version**
- **UEFI BIOS Date**
- **Embedded Controller Version**
- **ME Firmware Version**
- **Machine Type Model**
- **System-unit serial number**
- **System board serial number**
- **Asset Tag**
- **CPU Type**
- **CPU Speed**
- **Installed memory**
- **UUID**
- **MAC Address (Internal LAN)**
- **Preinstalled OS License**
- **UEFI Secure Boot**
- **OA3 ID**
- **OA2**

Config menu

To change the configuration of your computer, select **Config** tab from the ThinkPad Setup menu.

The following table lists the **Config** menu items. Default values are in **boldface**. The menu items might change without notice. Depending on the model, the default value might vary.

Attention: The default configurations are already optimized for you. Improper change of the configurations might cause unexpected results.

Table 3. Config menu items

Menu item	Submenu item	Selection	Comments
Network	Wake On LAN	<ul style="list-style-type: none"> • Disabled • AC Only • AC and Battery 	<p>Enable the computer to power on when the Ethernet controller receives a magic packet (a special network message).</p> <p>If you select AC Only, Wake on LAN is enabled only when the ac power adapter is attached.</p> <p>If you select AC and Battery, Wake on LAN is enabled with any power sources.</p> <p>Notes:</p> <ul style="list-style-type: none"> • The magic packet type Wake on LAN requires ac power. • The Wake on LAN function does not work when a hard disk password is set.
	UEFI IPv4 Network Stack (for UEFI Only boot mode or Both with UEFI first)	<ul style="list-style-type: none"> • Disabled • Enabled 	Enable or disable Internet Protocol Version 4 (IPv4) network stack for the UEFI environment.
	UEFI IPv6 Network Stack (for UEFI Only boot mode or Both with UEFI first)	<ul style="list-style-type: none"> • Disabled • Enabled 	Enable or disable Internet Protocol Version 6 (IPv6) network stack for UEFI environment.
	UEFI PXE Boot Priority (for Both with UEFI first boot mode, and IPv6 and IPv4 stacks are both enabled.)	<ul style="list-style-type: none"> • IPv6 First • IPv4 First 	Select network stack priority for UEFI PXE boot.

Table 3. Config menu items (continued)

Menu item	Submenu item	Selection	Comments
USB	USB UEFI BIOS Support	<ul style="list-style-type: none"> • Disabled • Enabled 	Enable or disable boot support from USB storage devices.
	Always On USB	<ul style="list-style-type: none"> • Disabled • Enabled 	<p>Enable or disable the function of charging external devices in low-power states (standby, hibernation or shutdown). If the system runs in battery mode, this function will work only in standby state.</p> <p>If you select Enabled, your computer can charge external devices in low-power states.</p> <p>If you select Disabled, your computer cannot charge external devices in low-power states.</p>
	Always On USB Charge in Battery Mode	<ul style="list-style-type: none"> • Disabled • Enabled 	<p>Note: This item is available only when the Always On USB is set as Enabled.</p> <p>Enable or disable the function of charging external devices when your computer is in hibernation mode or is turned off without connecting to ac power.</p> <p>If you select Enabled, your computer can charge external devices when your computer is in hibernation mode or is turned off without connecting to ac power.</p> <p>If you select Disabled, your computer cannot charge external devices when your computer is in hibernation mode or is turned off without connecting to ac power.</p>
Keyboard/Mouse	Fn and Ctrl Key swap	<ul style="list-style-type: none"> • Disabled • Enabled 	<p>Enable exchanges of Fn and Ctrl key action at the bottom-left of the keyboard.</p> <p>Disabled: Fn key and Ctrl key behavior is as printed on the keyboard.</p> <p>Enabled: Fn key works as Ctrl key. Ctrl key works as Fn key.</p>
	F1–F12 as primary function	<ul style="list-style-type: none"> • Disabled • Enabled 	<p>Enable the F1-F12 function or the special function printed as an icon on each key as the primary function.</p> <p>Enabled: Executes the F1-F12 function.</p>

Table 3. Config menu items (continued)

Menu item	Submenu item	Selection	Comments
			<p>Disabled: Executes the special function.</p> <p>To temporarily switch the above two options, press Fn+Esc to enable FnLock. The FnLock indicator is on when FnLock is enabled.</p>
	Fn Sticky key	<ul style="list-style-type: none"> • Disabled • Enabled 	<p>When the option is enabled, you can press the Fn key to keep it in a pressed condition; then press the desired function key. The action is equivalent to pressing the required key simultaneously with the Fn key. When you press the Fn key twice, the state is locked until you press the Fn key again.</p>
Display	Boot Display Device	<ul style="list-style-type: none"> • ThinkPad LCD • DisplayPort • HDMI • Display on dock 	<p>Select a video device for boot.</p> <p>DisplayPort: Mini DisplayPort(TM) connector on ThinkPad.</p> <p>HDMI: HDMI connector on ThinkPad.</p> <p>Display on dock: Display connectors on dock.</p> <p>Boot screen is cloned to all displays on dock.</p>
	Shared Display Priority	<ul style="list-style-type: none"> • HDMI or WiGig • Display on dock 	<p>Select the priority between shared display outputs. HDMI, WiGig and Dock displays share a single display output. This option chooses which one is prioritized.</p>
	Total Graphics Memory	<ul style="list-style-type: none"> • 256 MB • 512 MB 	<p>Allocate the total memory which Intel internal graphics shares.</p> <p>Note: If you select 512 MB, the maximum usable memory might be reduced on 32-bit operating system.</p>
	Boot Time Extension	<ul style="list-style-type: none"> • Disabled • 1 second • 2 seconds • 3 seconds • 5 seconds • 10 seconds 	<p>This option defines the amount of time to extend the boot process, in seconds.</p> <p>The system cannot detect some external monitors during boot because they need a few seconds to be ready. Try this option if the monitor being used does not display the boot screen.</p>

Table 3. Config menu items (continued)

Menu item	Submenu item	Selection	Comments
Power	Intel(R) SpeedStep® technology	<ul style="list-style-type: none"> • Disabled • Enabled 	<p>Enable or disable the Intel SpeedStep technology.</p> <p>If you select Enabled, the processor can work at lower speed to save power.</p> <p>If you select Disabled, the processor always works at the highest speed.</p>
	Adaptive Thermal Management	<p>Scheme for AC</p> <ul style="list-style-type: none"> • Maximize Performance • Balanced <p>Scheme for Battery</p> <ul style="list-style-type: none"> • Maximize Performance • Balanced 	<p>If you select Maximize Performance, it reduces CPU throttling. If you select Balanced, it balances the fan sound, the computer temperature, and the computer performance.</p>
	CPU Power Management	<ul style="list-style-type: none"> • Enabled • Disabled 	<p>Enable or disable the power-saving feature that stops the microprocessor clock automatically when there are no computer activities. Normally, it is not necessary to change the setting.</p>
	Power On with AC Attach	<ul style="list-style-type: none"> • Enabled • Disabled 	<p>If enabled, the system is powered on when AC is attached. When the system is in hibernate state, the system resumes. If disabled, the system is not powered On nor resumed when AC is attached.</p>
	Disable Built-in Battery		<p>Use this feature to temporarily disable the built-in battery. The system will be automatically powered off after you select this item. Then the computer is ready to be serviced.</p> <p>Note: The ac power adapter must be disconnected to perform this operation. The built-in battery will be automatically enabled when the ac power adapter is reconnected.</p>

Table 3. Config menu items (continued)

Menu item	Submenu item	Selection	Comments
Beep and Alarm	Password Beep	<ul style="list-style-type: none"> • Disabled • Enabled 	Enable this option to have a beep sound when the system is waiting for a power-on, hard disk, or supervisor password. Different beeps will be sounded when the entered password matches or does not match the configured password.
	Keyboard Beep	<ul style="list-style-type: none"> • Disabled • Enabled 	Enable or disable the keyboard beep when unmanageable key combinations are pressed.
Intel AMT	Intel AMT Control	<ul style="list-style-type: none"> • Disabled • Enabled • Permanently Disabled 	<p>This option enables or disables Intel (R) Active Management Technology (AMT) function.</p> <p>If you select Enabled, Intel Active Management Technology (AMT) is configured and additional setup items are provided in Management Engine BIOS Extension (MEBx) Setup.</p> <p>If you select Permanently Disabled, you will never be able to enable it again. Be cautious when you want to use this option.</p> <p>Note: You can enter the MEBx Setup menu by pressing the Ctrl+P key combination in the Startup Interrupt Menu window. To display the Startup Interrupt Menu window, press the black button or Enter key during the power-on self-test (POST).</p>
	CIRA Timeout	<p>0-255</p> <p>Note: The default value is 60 seconds.</p>	<p>Set the timeout option for CIRA connection to be established. Selectable second values are from 1 to 254.</p> <p>If you select 0, use 60 seconds as the default timeout value.</p> <p>If you select 255, the waiting time for establishing a connection is unlimited.</p>
	Console Type	<ul style="list-style-type: none"> • PC ANSI • VT100+ • PC-ANSI • VT-UTF8 	<p>Select the console type for AMT.</p> <p>Note: This console type should match the Intel AMT remote console.</p>

Date and Time menu

To change the date or time of your computer, select the **Date/Time** tab from the ThinkPad Setup menu. Then do the following:

1. Use the pointer keys to select **System Date** or **System Time**.
2. Type a date or time.

Security menu

To change the security settings of your computer, select the **Security** tab from the ThinkPad Setup menu.

The following table lists the **Security** menu items. Default values are in **boldface**. The menu items might change without notice. Depending on the model, the default value might vary.

Attention: The default configurations are already optimized for you. Improper change of the configurations might cause unexpected results.

Table 4. Security menu items

Menu item	Submenu item	Selection	Comments
Password	Supervisor Password	<ul style="list-style-type: none"> • Disabled • Enabled 	Refer to “Supervisor password” on page 56.
	Lock UEFI BIOS Settings	<ul style="list-style-type: none"> • Disabled • Enabled 	Enable or disable the function that protects items in the ThinkPad Setup program from being changed by unauthorized users. By default, this is set to Disabled . If you set the supervisor password and enable this function, no one but you can change the items in the ThinkPad Setup program.
	Password at Unattended Boot	<ul style="list-style-type: none"> • Disabled • Enabled 	If you select and enable Password at unattended boot , a password prompt will be displayed when the computer is turned on, from either a power-off or hibernation state. If you select Disabled , no password prompt will be displayed; the computer goes ahead and loads the operating system. To prevent unauthorized access, you can set the user authentication on the operating system.
	Password at Restart	<ul style="list-style-type: none"> • Disabled • Enabled 	If you select and enable Password at restart , a password prompt will be displayed when you restart the computer. If you select Disabled , no password prompt will be displayed; the computer goes ahead and loads the operating system. To prevent unauthorized access, you can set the user authentication on the operating system.
	Password at Boot Device List	<ul style="list-style-type: none"> • Disabled • Enabled 	If the Security password is set, this option is used to specify whether the Security password must be entered to display the F12 boot device list.

Table 4. Security menu items (continued)

Menu item	Submenu item	Selection	Comments
			Select Enabled to prompt for the Security password. Select Disabled to proceed without any user action required.
	Password Count Exceeded Error	<ul style="list-style-type: none"> • Disabled • Enabled 	Select Enabled to show the POST 0199 error and prompt for the Security password. Select Disabled to hide the POST 0199 error and proceed without any user action needed.
	Set Minimum Length	<ul style="list-style-type: none"> • Disabled • x characters (4≤x≤12) 	Specify a minimum length for power-on password and hard disk passwords. If you set the supervisor password and specify a minimum length for passwords, no one but you can change the length.
	Power-On Password	<ul style="list-style-type: none"> • Disabled • Enabled 	Refer to “Power-on password” on page 55.
	Hard Disk1 Password	<ul style="list-style-type: none"> • Disabled • Enabled 	Refer to “Hard disk passwords” on page 57.
Fingerprint	Predesktop Authentication	<ul style="list-style-type: none"> • Disabled • Enabled 	If you select Enabled , authentication by a fingerprint is enabled at predesktop. If you select Disabled , authentication by a fingerprint is disabled at predesktop.
	Reader Priority	<ul style="list-style-type: none"> • External->Internal • Internal Only 	<p>If you select External, an external fingerprint reader is used. If an external reader is not present, an internal reader is used.</p> <p>If you select Internal, an internal fingerprint reader is used. If an internal reader is not present, an external reader is used.</p>
	Security Mode	<ul style="list-style-type: none"> • Normal • High 	If you select Normal , the Power-On Password or Supervisor Password must be entered to boot a system when no fingerprint is authenticated. If you select High , the Supervisor password must be entered to boot a system when no fingerprint is authenticated. Power-On Password is not accepted.
	Password Authentication	<ul style="list-style-type: none"> • Disabled • Enabled 	<p>Note: This item is available only when the Security Mode is set as High.</p> <p>If you select Enabled, authentication by password is enabled. Users are authenticated by passwords when fingerprints are not available. If you select Disabled, authentication by password is disabled. Users are not</p>

Table 4. Security menu items (continued)

Menu item	Submenu item	Selection	Comments
			authenticated by passwords. Note that administrators are authenticated by a Supervisor Password.
	Reset Fingerprint Data		This option is used to erase all fingerprint data stored in the fingerprint reader and reset settings to the factory state (ex. Power-on security, LEDs, etc.) As a result, any power-on security features previously enabled will not be able to work until they are re-enabled in the fingerprint software.
Security Chip	Security Chip Selection	<ul style="list-style-type: none"> • Discrete TPM • Intel PTT 	<p>Choose Discrete TPM to use a discrete TPM chip with TPM 1.2 mode.</p> <p>Choose Intel PTT to use Intel(R) Platform Trusted Technology with TPM 2.0 mode.</p> <p>Note: Intel(R) PTT can be used with Microsoft® Windows 8 (R) or later operating system.</p>
	Security Chip (If Security Chip Selection is Discrete TPM)	<ul style="list-style-type: none"> • Active • Inactive • Disabled 	<p>Note: This item is available only when the Security Chip is set as Discrete TPM.</p> <p>If you select Active, the security chip will be functional. If you select Inactive, the Security Chip option will be visible, but the security chip will not be functional. If you select Disabled, the Security Chip option will be hidden and the security chip will not be functional.</p>
	Security Chip (If Security Chip Selection is Intel PTT)	<ul style="list-style-type: none"> • Enabled • Disabled 	<p>Note: This item is available only when the Security Chip is set as Intel PTT.</p> <p>If you select Enabled, the security chip will be functional. If you select Disabled, the Security Chip option will be hidden and the security chip will not be functional.</p>
	Security Reporting Options		<p>Enable or disable the following security reporting options:</p> <ul style="list-style-type: none"> • BIOS ROM Strings Reporting: BIOS text string • SMBIOS Reporting: SMBIOS string • CMOS Reporting • NVRAM Reporting

Table 4. Security menu items (continued)

Menu item	Submenu item	Selection	Comments
			Note: This item is available when Security Chip is set as Active .
	Clear Security Chip	Enter	This option is used to clear encryption keys. It will not be possible to access already-encrypted data after these keys are cleared. Note: This item is available when Security Chip is set as Active .
	Intel(R) TXT Feature	<ul style="list-style-type: none"> • Disabled • Enabled 	Enable or disable the Intel Trusted Execution Technology (TXT) feature. Intel TXT is a hardware-based security technology that establishes a root of trust to protect information from software-based attacks. Note: The Intel (R) TXT Feature item is only available on models that support the Intel vPro™ technology.
	Intel(R) TXT Feature (Unselectable when Intel PTT is enabled.)	<ul style="list-style-type: none"> • Disabled 	Unselectable for Intel PPT.
	Physical Presence for Provisioning	<ul style="list-style-type: none"> • Disabled • Enabled 	This option enables or disables confirmation of a user physical presence when provisioning the security chip. If you select Enabled , a user confirmation screen will be displayed when provisioning the security chip. If you select Disabled , no user confirmation screen will be displayed when provisioning the security chip.
	Physical Presence for Clear	<ul style="list-style-type: none"> • Disabled • Enabled 	This option enables or disables confirmation of a user physical presence when clearing the security chip. If you select Enabled , a user confirmation screen will be displayed when clearing the security chip. If you select Disabled , no user confirmation screen will be displayed when clearing the security chip.

Table 4. Security menu items (continued)

Menu item	Submenu item	Selection	Comments
UEFI BIOS Update Option	Flash BIOS Updating by End-Users	<ul style="list-style-type: none"> • Disabled • Enabled 	If you select Enabled , all users can update the UEFI BIOS. If you select Disabled , only the person who knows the supervisor password can update the UEFI BIOS.
	Secure RollBack Prevention	<ul style="list-style-type: none"> • Disabled • Enabled 	<p>If you select Disabled, you can flash to an earlier version of the UEFI BIOS.</p> <p>If you select Enabled, you cannot flash to an earlier version of the UEFI BIOS.</p> <p>Note: This item is set as Disabled by default when the OS Optimized Defaults on the Restart menu is set as Disabled. This item is set as Enabled by default when the OS Optimized Defaults is set as Enabled.</p>
Memory Protection	Execution Prevention	<ul style="list-style-type: none"> • Disabled • Enabled 	Some computer viruses and worms cause memory buffers to overflow. By selecting Enabled you can protect your computer against attacks by such viruses and worms. If you find that an application program does not run correctly after choosing Enabled , select Disabled and reset the setting.
Virtualization	Intel(R) Virtualization Technology	<ul style="list-style-type: none"> • Disabled • Enabled 	If you select Enabled , a Virtual Machine Monitor (VMM) can utilize the additional hardware capabilities provided by Intel Virtualization Technology.
	Intel(R) VT-d Feature	<ul style="list-style-type: none"> • Disabled • Enabled 	<p>Intel VT-d stands for Intel Virtualization Technology for directed I/O. When enabled, a VMM can utilize the platform infrastructure for I/O virtualization.</p> <p>Note: This item is available when the processor of your computer supports this feature.</p>

Table 4. Security menu items (continued)

Menu item	Submenu item	Selection	Comments
I/O Port Access	Ethernet LAN	<ul style="list-style-type: none"> • Disabled • Enabled 	<p>Select whether to enable or disable Ethernet LAN Device.</p> <p>If you select Enabled, you can use the Ethernet LAN Device.</p> <p>If you select Disabled, you can use the Ethernet LAN Device and keeps it disabled in the OS environment.</p>
	Wireless LAN	<ul style="list-style-type: none"> • Disabled • Enabled 	If you select Enabled , you can use the Wireless LAN device.
	Wireless WAN	<ul style="list-style-type: none"> • Disabled • Enabled 	If you select Enabled , you can use the Wireless WAN device.
	Bluetooth	<ul style="list-style-type: none"> • Disabled • Enabled 	If you select Enabled , you can use the Bluetooth device.
	USB Port	<ul style="list-style-type: none"> • Disabled • Enabled 	If you select Enabled , you can use the USB connectors.
	Memory Card Slot	<ul style="list-style-type: none"> • Disabled • Enabled 	If you select Enabled , you can use the memory card slot for an SD card or a MultiMediaCard.
	Integrated Camera	<ul style="list-style-type: none"> • Disabled • Enabled 	If you select Enabled , you can use the camera.
	Microphone	<ul style="list-style-type: none"> • Disabled • Enabled 	If you select Enabled , you can use the microphone (internal, external, or line-in).
	Fingerprint Reader	<ul style="list-style-type: none"> • Disabled • Enabled 	If you select Enabled , you can use the Fingerprint Reader.
Anti-Theft	Computrace	<ul style="list-style-type: none"> • Enabled • Disabled • Permanently Disabled 	<p>Enable or disable the UEFI BIOS interface to activate the computrace feature. The computrace feature enables you to track and secure your computer.</p> <p>Note: If you set the Computrace item as Permanently Disabled, it cannot be enabled again.</p>
Secure Boot	Secure Boot	<ul style="list-style-type: none"> • Disabled • Enabled 	<p>Enable or disable the Secure Boot feature.</p> <p>If you enable the Secure Boot, the following item settings on the Startup menu also will change automatically:</p> <ol style="list-style-type: none"> 1. The UEFI/Legacy Boot setting will change to UEFI Only. 2. The CSM Support setting will change to No.

Table 4. Security menu items (continued)

Menu item	Submenu item	Selection	Comments
			<p>Select Enable to prevent unauthorized operating systems from running at boot time.</p> <p>Select Disabled to allow any operating systems to run at boot time.</p> <p>Note: This item is set as Disabled by default when the OS Optimized Defaults on the Restart menu is set as Disabled. This item is set as Enabled by default when the OS Optimized Defaults is set as Enabled.</p>
	Platform Mode	<ul style="list-style-type: none"> • User Mode • Setup Mode 	Specify the system operating mode.
	Secure Boot Mode	<ul style="list-style-type: none"> • Standard Mode • Custom Mode 	Specify the Secure Boot mode.
	Reset to Setup Mode	<ul style="list-style-type: none"> • Yes • No 	This option is used to clear the current platform key and put the system into setup mode. You can install your own platform key and customize the Secure Boot signature databases in setup mode. Secure Boot mode will be set to custom mode.
	Restore Factory Keys		This option is used to restore all keys and certificates in Secure Boot databases to factory defaults. Any customized Secure Boot settings will be erased, and the default platform key will be re-established along with the original signature databases including certificate for Windows 10 operating system.
	Clear All Secure Boot Keys		This option is used to clear all keys and certificates in Secure Boot databases. You can install your own keys and certificates after selecting this option.

Startup menu

To change the startup settings of your computer, select the **Startup** tab from the ThinkPad Setup menu.

Attention:

- After you change the startup sequence, ensure that you select a correct device during a copy, a save, or a format operation. Otherwise your data might be erased or overwritten.
- If you are using the BitLocker drive encryption, do not change the startup sequence. BitLocker drive encryption locks the computer from starting once detects the change of startup sequence.

To change the startup sequence temporarily so that the computer starts from a desired drive, do the following:

1. Restart the computer. When the ThinkPad logo is displayed, press F12.
2. Select the device that you want the computer to start from.

Note: The **Boot** menu will be displayed if the computer cannot start from any devices, or the operating system cannot be found.

The following table lists the **Startup** menu items. Default values are in **boldface**. The menu items might change without notice. Depending on the model, the default value might vary.

Note: Some items are displayed on the menu only if the computer supports the corresponding features.

Table 5. Startup menu items

Menu item	Selection	Comments
Boot		Select the boot device when you press the power button to turn on the computer.
Network Boot	<ul style="list-style-type: none"> • USB CD • USB FDD • ATA HDD0 • USB HDD • PCI LAN 	Select top priority of the Boot Priority Order when waking from LAN.
UEFI/Legacy Boot	<ul style="list-style-type: none"> • Both • UEFI Only • Legacy Only <p>UEFI/Legacy Boot Priority</p> <ul style="list-style-type: none"> • Legacy First • UEFI First <p>CSM Support</p> <ul style="list-style-type: none"> • No • Yes 	<p>Select system boot capability.</p> <ul style="list-style-type: none"> • Both: The system boots by the following UEFI/Legacy Boot Priority setting. • UEFI Only: The system boots from the UEFI enabled operating system. • Legacy Only: The system boots from any operating system other than the UEFI enabled one. <p>Note: If you select UEFI Only, the system cannot boot from the bootable devices that do not have the UEFI enabled operating system.</p> <p>Compatibility Support Module (CSM) is required for booting the legacy operating system. If you select UEFI Only, CSM Support will be selectable. For Both or Legacy Only mode, CSM Support will not be selectable.</p> <p>Note: The Both and the CSM Support selections are available when the OS Optimized Defaults on the Restart menu is set as Disabled, the UEFI Only selection is available when the OS Optimized Defaults on the Restart menu is set as Enabled.</p>

Table 5. Startup menu items (continued)

Menu item	Selection	Comments
Boot Mode	<ul style="list-style-type: none"> • Quick • Diagnostics 	<p>Quick: The diagnostic splash screen will not be displayed unless you press Esc during starting the system.</p> <p>Diagnostics: The diagnostic splash screen is always displayed during starting the system.</p>
Option Key Display	<ul style="list-style-type: none"> • Enabled • Disabled 	Choose whether to show the option key message when the system is started.
Boot Device List F12 Option	<ul style="list-style-type: none"> • Enabled • Disabled 	<p>If you select Enabled, a pop-up boot device List will be displayed when you press F12 key.</p> <p>Note: Only the person who knows the supervisor password can change the setting of this option.</p>
Boot Order Lock	<ul style="list-style-type: none"> • Disabled • Enabled 	If you select Disabled , your computer will boot using the default priority. If you select Enabled , your computer will boot using the priority you have customized.

Restart menu

To exit the ThinkPad Setup program and restart the computer, select **Restart** from the ThinkPad Setup menu.

The following submenu items are displayed:

- **Exit Saving Changes:** Save the changes and restart the computer.
- **Exit Discarding Changes:** Discard the changes and restart the computer.

Notes: The changes of the following submenu items will not be discarded and can be reset in ThinkPad Setup menu:

- Date & Time
- Supervisor password
- Power-on password
- Hard disk password

- **Load Setup Defaults:** Restore to the factory default settings.

Notes: The changes of the following submenu items will not be discarded and can be reset in ThinkPad Setup menu:

- Date & Time

Note: Enable **OS Optimized Defaults** to meet the Windows 10 certification requirements. When you change this setting, some other settings are changed automatically, such as **CSM Support**, **UEFI/Legacy Boot**, **Secure Boot**, and **Secure RollBack Prevention**. Ensure that you do not enable the **OS Optimized Defaults** if your computer is only installed with the Windows 7 operating system.

- **Discard Changes:** Discard the changes.

Notes: The changes of the following submenu items will not be discarded and can be reset in ThinkPad Setup menu:

- Date & Time
- Supervisor password
- Power-on password
- Hard disk password

- **Save Changes:** Save the changes.

Updating the UEFI BIOS

The UEFI BIOS is the first program that the computer runs when the computer is turned on. The UEFI BIOS initializes the hardware components, and loads the operating system and other programs.

You can update the UEFI BIOS by starting your computer from a flash update optical disc or a flash update program running in the Windows environment. When you install a new program, a device driver, or hardware, you might be informed to update the UEFI BIOS.

For instructions on how to update the UEFI BIOS, go to:
<http://www.lenovo.com/ThinkPadDrivers>

Using system management

This topic is primarily intended for the network administrators.

Your computer is designed for manageability, so that you can redirect more resources to better meet your business objectives.

This manageability, known as Total Cost of Ownership (TCO), enables you to remotely operate client computers in the same way as you operate your own computer, such as turning on a client computer, formatting a hard disk drive or hybrid drive, and installing a program.

Once the computer is configured and operational, you can manage it by using the software and the manageability features that are already integrated into the client computer and the network.

Desktop Management Interface

The UEFI BIOS of your computer supports an interface called System Management BIOS (SMBIOS) Reference Specification, version 2.7.1. SMBIOS provides information about the hardware components of your computer. It is the responsibility of the UEFI BIOS to provide information about itself and the devices on the system board. This specification documents the standards for getting access to this BIOS information.

Preboot eXecution Environment

The Preboot eXecution Environment (PXE) technology makes the computer more manageable by enabling the computer to start from a server. Your computer supports the personal computer functions that PXE requires.

Note: The Remote Initial Program Load (RIPL or RPL) function cannot be used with your computer.

Asset ID EEPROM

The Asset ID EEPROM contains information about the computer configuration and the serial numbers of the key components. It also includes a number of blank fields where you can record information about the end users in your network.

Chapter 7. Preventing problems

An important part of owning a ThinkPad notebook computer is maintenance. With proper care, you can avoid common problems. The chapter provides information that can help you keep your computer running smoothly.

- “General tips for preventing problems” on page 87
- “Making sure device drivers are current” on page 88
- “Taking care of your computer” on page 89

General tips for preventing problems

This topic provides the following tips to help you prevent computing problems:

- If your computer is equipped with both a hard disk drive and an M.2 solid-state drive, you are not recommended to use the M.2 solid-state drive as a bootable device. The M.2 solid-state drive is designed and developed for “cache” function purpose only. If you use the M.2 solid-state drive as a bootable device, its reliability is not guaranteed.
- Check the capacity of your hard disk drive or hybrid drive from time to time. If the hard disk drive or hybrid drive gets too full, the Windows operating system will slow down and might produce errors.

To check the internal storage drive capacity, do the following:

- Windows 7: Click **Start** → **Computer**.
- Windows 10: Open the File Explorer and click **This PC**.
- Empty your recycle bin on a regular basis.
- Use disk defragment tool regularly on your hard disk drive or hybrid drive to improve data seek and read times.
- To free up disk space, uninstall unused application programs.

Note: You also might want to look for program duplication or overlapping versions.

- Clean out your Inbox, Sent, and Trash folders from your e-mail client program.
- Back up your data at least once a week. If critical data is present, it is a good idea to perform a daily backup operation. Lenovo has many backup options available for your computer. Rewritable optical drives are available for most machines and are easily installed.
- Schedule system restore operations to take a system snapshot periodically. For more information about system restore, see Chapter 9 “Recovery overview” on page 109.
- Update device drivers and the UEFI BIOS when needed.
- Profile your machine at <http://www.lenovo.com/support> to keep up to date with current drivers and revisions.
- Keep up to date for device drivers on other non-Lenovo hardware. You might want to read the device driver information release notes prior to updating for compatibility or known issues.
- Keep a log book. Entries might include major hardware or software changes, driver updates, minor issues you have experienced, and how you resolved the minor issues.
- If you ever need to run a recovery on your computer to return the preinstalled contents onto the machine, the following tips might help along the way:
 - Remove all external devices such as the printer, keyboard, and so on.
 - Make sure that your battery is charged and your computer has the ac power connected.

- Access ThinkPad Setup and load the default settings.
- Restart the computer and start the recovery operation.
- If your computer uses discs as the recovery media, do not remove the disc from the drive until prompted to do so.
- For suspected hard disk drive or hybrid drive issues, refer to “Diagnosing problems” on page 93 and run a diagnostic test for the drive before you call the Customer Support Center. If your computer does not start up, download the files to create a bootable self-test medium from <http://www.lenovo.com/hddtest>. Run the test and record any messages or error codes. If the test returns any failing error codes or messages, call the Customer Support Center with the codes or messages and the computer in front of you. A technician will assist you further.
- If required, you can find the contact information about the Customer Support Center for your country or region at <http://www.lenovo.com/support/phone>. When calling the Customer Support Center, make sure that you have your machine model type, serial number, and the computer in front of you. Also, if the computer is producing error codes, it is helpful to have the error screen on or the messages written down.

Making sure device drivers are current

Device drivers are programs that contain instructions for the operating system about how to operate or “drive” a certain piece of hardware. Each hardware component on your computer has its own specific driver. If you add a new component, the operating system needs to be instructed on how to operate that piece of hardware. After you install the driver, the operating system can recognize the hardware component and understand how to use it.

Note: Because drivers are programs, like any other file on your computer, they are susceptible to corruption and might not perform correctly if corruption occurs.

It is not always necessary to download the latest drivers. However, you should download the latest driver for a component if you notice poor performance from that component or if you added a new component. This might eliminate the driver as the potential cause of a problem.

Getting the latest drivers from the Web site

You can download and install updated device drivers from the Lenovo Web site by doing the following:

1. Go to <http://www.lenovo.com/ThinkPadDrivers>.
2. Select the entry for your computer and then follow the instructions on the screen to download and install necessary software.

Getting the latest drivers using System Update

The System Update program helps you keep the software on your computer up-to-date. Update packages are stored on Lenovo servers and can be downloaded from the Lenovo Support Web site. Update packages can contain applications, device drivers, UEFI BIOS flashes, or software updates. When the System Update program connects to the Lenovo Support Web site, the System Update program automatically recognizes the machine type and model of your computer, the installed operating system, and the language of the operating system to determine what updates are available for your computer. The System Update program then displays a list of update packages and categorizes each update as critical, recommended, or optional to help you understand the importance. You have complete control of which updates to download and install. After you select the update packages you want, the System Update program automatically downloads and installs the updates without any further intervention from you.

The System Update program is preinstalled on your computer and is ready to run. The only prerequisite is an active Internet connection. You can start the program manually, or you can use the schedule feature to enable the program to search for updates automatically at specified intervals. You also can predefine

scheduled updates to search by severity (critical updates, critical and recommended updates, or all updates) so the list you choose from contains only those update types that are of interest to you.

For more information about how to use the System Update program, refer to the help information system of the program.

Taking care of your computer

Although your computer is designed to function reliably in normal work environments, you need to use common sense in handling it. By following the important tips in this topic, you will get the most use and enjoyment out of your computer.

Be careful about where and how you work

- Store packing materials safely out of the reach of children to prevent the risk of suffocation from plastic bags.
- Keep your computer away from magnets, activated cellular phones, electrical appliances, or speakers (more than 13 cm or 5 inches).
- Avoid subjecting your computer to extreme temperatures (below 5°C/41°F or above 35°C/95°F).
- Some appliances, such as certain portable desktop fans or air purifiers, can produce negative ions. If a computer is close to such an appliance, and is exposed for an extended time to air containing negative ions, it might become electrostatically charged. Such a charge might be discharged through your hands when you touch the keyboard or other parts of the computer, or through connectors on I/O devices connected to the computer. Even though this kind of electrostatic discharge (ESD) is the opposite of a discharge from your body or clothing to the computer, it poses the same risk of a computer malfunction.

Your computer is designed and manufactured to minimize any effects of electrostatic charge. An electrostatic charge above a certain limit, however, can increase the risk of ESD. Therefore, when using the computer close to an appliance that can produce negative ions, give special attention to the following:

- Avoid directly exposing your computer to the air from an appliance that can produce negative ions.
- Keep your computer and peripherals as far as possible from such an appliance.
- Wherever possible, ground your computer to facilitate safe electrostatic discharge.

Note: Not all such appliances cause a significant electrostatic charge.

Be gentle with your computer

- Avoid placing any objects (including paper) between the display and the keyboard or the palm rest.
- Do not turn your computer over while the ac power adapter is plugged in. This could break the adapter plug.

Carry your computer properly

- Before moving your computer, be sure to remove any media, turn off attached devices, and disconnect cords and cables.
- When picking up your open computer, hold it by the bottom. Do not pick up or hold your computer by the display.

Handle storage media and drives properly

- When installing the storage drive, follow the instructions shipped with your hardware, and apply pressure only where needed on the device.
- Turn off your computer before you replace the storage drive.
- After you replace the primary storage drive, reattach the cover of the drive slot.

- Store your external and removable hard disk drives or optical drives in appropriate containers or packaging when they are not being used.
- Before you install a memory card such as an SD card, SDHC card, SDXC card, and a MultiMediaCard, touch a metal table or a grounded metal object. This action reduces any static electricity from your body. Static electricity could damage the device.
- When transferring data to or from a flash media card, such as an SD card, do not put your computer in sleep or hibernation mode before the data transfer is complete; otherwise, your data could become damaged.

Taking care in setting passwords

- Remember your passwords. If you forget a supervisor or hard disk password, Lenovo will not reset it, and you might have to replace the system board or the storage drive.

Registering your computer

- Register your ThinkPad computer with Lenovo at <http://www.lenovo.com/register>. For more information, see “Registering your computer” on page 15.

Be sure not to modify your computer

- Only an authorized ThinkPad repair technician should disassemble and repair your computer.
- Do not modify or tape the latches to keep the display open or closed.

Cleaning the cover of your computer

Occasionally clean your computer by doing the following:

1. Prepare a mixture of a gentle kitchen-use detergent (one that does not contain abrasive powder or strong chemicals such as acid or alkaline). Use 5 parts water to 1 part detergent.
2. Absorb the diluted detergent into a sponge.
3. Squeeze excess liquid from the sponge.
4. Wipe the cover with the sponge, using a circular motion and taking care not to let any excess liquid drip.
5. Wipe the surface to remove the detergent.
6. Rinse the sponge with clean running water.
7. Wipe the cover with the clean sponge.
8. Wipe the surface again with a dry, soft, lint-free cloth.
9. Wait for the surface to dry completely and remove any fibers from the cloth.

Cleaning your computer keyboard

To clean the computer keyboard, do the following:

1. Apply some isopropyl rubbing alcohol to a soft, dust-free cloth.

Note: Avoid spraying cleaner directly onto the display or the keyboard.

2. Wipe each keytop surface with the cloth. Wipe the keys one by one; if you wipe several keys at a time, the cloth might hook onto an adjacent key and possibly damage it. Ensure that no liquid drips onto or between the keys.
3. Allow to dry.
4. To remove any crumbs or dust from beneath the keys, you can use a camera blower with a brush or cool air from a hair dryer.

Cleaning your computer display

To clean the computer display, do the following:

1. Gently wipe the display with a dry, soft lint-free cloth. If you see a scratchlike mark on your display, it might be a stain transferred from the keyboard or the TrackPoint pointing stick when the cover was pressed from the outside.
2. Wipe or dust the stain gently with a soft, dry cloth.
3. If the stain remains, moisten a soft, lint-free cloth with water or a 50-50 mixture of isopropyl alcohol and water that does not contain impurities.

Note: Avoid spraying cleaner directly onto the display or the keyboard.

4. Wring out as much of the liquid as you can.
5. Wipe the display again; do not let any liquid drip into the computer.
6. Be sure to dry the display before closing it.

Chapter 8. Troubleshooting computer problems

This chapter provides information on what to do if you experience a problem with your computer.

This chapter contains the following topics:

- “Diagnosing problems” on page 93
- “Troubleshooting” on page 93

Diagnosing problems

If you experience problems with your computer, use the Lenovo Solution Center program as a starting point for solving them.

The Lenovo Solution Center program enables you to troubleshoot and resolve computer problems. It combines diagnostic tests, system information collection, security status, and support information, along with hints and tips for maximum system performance.

Notes:

- The Lenovo Solution Center program also is available for download at:
<http://www.lenovo.com/diags>.
- If you are using other Windows operating system rather than Windows 7 or Windows 10, you can find the latest information about diagnostics for your computer at:
<http://www.lenovo.com/diagnose>

When you are setting up your computer, the Lenovo Solution Center program prompts you to create recovery media, which you can use to restore the internal storage drive to the factory default state. For more information, see “Performing backup and recovery operations” on page 110.

To run the Lenovo Solution Center program, see “Lenovo programs” on page 12.

For additional information, refer to the Lenovo Solution Center help system.

Note: If you are unable to isolate and repair the problem yourself after running Lenovo Solution Center program, save and print the log files created by the program. You will need the log files when you speak to a Lenovo technical support representative.

Troubleshooting

If your computer has an error, it typically displays a message or an error code, or a beep sounds when you turn it on. When you experience a problem, refer to the corresponding sections in this topic to try to solve the problem by yourself.

Computer stops responding

Print these instructions now and keep the instructions with your computer for reference later.

If your computer is completely unresponsive (you cannot use the TrackPoint pointing device or the keyboard), do the following:

1. Press and hold the power button for four seconds or more to turn off the computer, and then restart the computer by pressing the power button.

Note: If you cannot turn off your computer, or if you cannot restart it, continue with step 2.

2. Remove the ac power adapter from the computer, and reset the system by inserting a straightened paper clip into the emergency-reset hole. To locate the reset hole, refer to “Bottom view” on page 5. Reattach the ac power adapter.

Notes:

- a. If the computer does not turn on, continue with step 3.
 - b. If the computer starts with ac power but does not start when ac power is disconnected, call the Customer Support Center for support. Go to <http://www.lenovo.com/support/phone> for the latest list of support phone numbers for your country or region.
3. Remove all external devices that are attached to your computer (keyboard, mouse, printer, scanner, and so on). Repeat step 2.

If the computer still does not start up, call the Customer Support Center and a Customer Support Specialist will assist you.

Spills on the keyboard

With a mobile computer, there are increased chances of spilling liquids on the keyboard. Because most liquids conduct electricity, liquid spilled on the keyboard could create numerous short circuits, potentially causing irreparable damage to your computer.

If you spill something on your computer:

Attention: Ensure that no liquid creates a short circuit between you and the ac power adapter (if in use). Although you might lose some data or work by turning off the computer immediately, leaving the computer on might make your computer unusable.

1. Carefully unplug the ac power adapter immediately.
2. Turn off the computer immediately. The more quickly you stop the current from passing through the computer the more likely you will reduce damage from short circuits.
3. Wait until you are certain that all the liquid is dry before turning on your computer.

Note: If you want to replace your keyboard, you can purchase a new one.

Error messages

- **Message:** 0177: Bad SVP data, stop POST task.
Solution: Checksum of the supervisor password in the EEPROM is not correct.
- **Message:** 0183: Bad CRC of Security Settings in EFI Variable. Enter ThinkPad Setup.
Solution: Checksum of the Security settings in the EFI Variable is not correct. Enter ThinkPad Setup to check the Security settings, Press F10 and then press Enter to restart the system. If you still have a problem, have the computer serviced.
- **Message:** 0187: EAIA data access error.
Solution: Enter ThinkPad Setup to check the Security settings. Press F10 and then press Enter to restart the system.
- **Message:** 0188: Invalid RFID Serialization Information Area.
Solution: The EEPROM checksum is not correct (block # 0 and 1). Reset the block # 0 and 1, for example the box Serial Number, and/or block # 4 and 5, for example the UUID.

- **Message:** 0189: Invalid RFID configuration information area.
Solution: The EEPROM checksum is not correct (block # 4 and 5). Reset the block # 0 and 1, for example the box Serial Number, and/or block # 4 and 5, for example the UUID.
- **Message:** 0190: Critical low-battery error.
Solution: The computer turns off, because the battery is low. Connect the ac power adapter to the computer and charge the battery.
- **Message:** 0191: System Security - Invalid remote change requested.
Solution: Bad system configuration change request has been detected, for example, the BootBlock update has failed or unknown request packet has been detected. To clear the error, enter the ThinkPad Setup program.
- **Message:** 0199: System Security - Security password retry count exceeded.
Solution: This message is displayed if you enter a wrong supervisor password more than three times. Confirm the supervisor password and try again. To clear the error, enter the ThinkPad Setup program.
- **Message:** 1802: Unauthorized network card is plugged in - Power off and remove the network card.
Solution: The wireless network card is not supported on this computer. Remove it.
- **Message:** 0251: System CMOS checksum bad.
Solution: The system CMOS might have been corrupted by an application program. The computer uses the default settings. Run ThinkPad Setup to reconfigure the settings. If you still see the same error code, have the computer serviced.
- **Message:** 0271: Real Time Clock Error - Check Date and Time settings.
Solution: Neither the date nor the time is set in the computer. Enter ThinkPad Setup to set the date and time.
- **Message:** 2000: ThinkVantage Active Protection sensor diagnostics failed.
Solution: ThinkVantage® Active Protection sensor is not working correctly. Have the computer serviced.
- **Message:** 2100: Detection error on HDD0 (Main HDD).
Solution: The hard disk drive or hybrid drive is not working. Have the hard disk drive or hybrid drive serviced.
- **Message:** 2102: Detection error on HDD2 (M.2 SATA)
Solution: The M.2 SATA device is not working. Have the M.2 SATA device serviced.
- **Message:** 2110: Read error on HDD0 (Main HDD)
Solution: The main hard disk drive or hybrid drive is not working. Have the main hard disk drive or hybrid drive serviced.
- **Message:** 2112: Read error on HDD2 (M.2 SATA)
Solution: The M.2 SATA device is not working. Have the M.2 SATA device serviced.
- **Message:** 2200: Machine Type and Serial Number are invalid.
Solution: Machine Type and Serial Number are invalid. Have the computer serviced.
- **Message:** 2201: Machine UUID is invalid.

Solution: Machine UUID is invalid. Have the computer serviced.

- **Message:** Fan error

Solution: Cooling fan has failed. Have the computer serviced.

- **Message:** Thermal sensing error

Solution: The thermal sensor is not functioning correctly. Shut down the computer immediately and have the computer serviced.

Beep errors

Table 6. Beep errors

Beeps	Solution
One short beep, pause, three short beeps, pause, three more short beeps, pause, and one short beep (1-3-3-1 beeps)	Memory problem. Shut down the computer immediately and have the computer serviced.
One long and two short beeps	Video problem. Shut down the computer immediately and have the computer serviced.
Three short beeps, pause, one short beep, pause, one short beep, pause, and three more short beeps (3-1-1-3 beeps)	PCI resource problem. Shut down the computer immediately and have the computer serviced.
Four cycles of four short beeps	TCG*-compliant functionality-related problem (might be the TPM initialization failure). Shut down the computer immediately and have the computer serviced. * TCG is the abbreviation for Trusted Computing Group.
Five short beeps	System board problem. Shut down the computer immediately and have the computer serviced.
Five short beeps, pause, five more short beeps, and pause	TCG-compliant functionality-related problem (might be the BIOS code validation failure). Shut down the computer immediately and have the computer serviced.

Memory module problems

Print these instructions now and keep the instructions with your computer for reference later.

If your memory module is not operating properly, check the following items:

1. Check for error messages during startup.
Follow the appropriate corrective actions for power-on self-test (POST) error messages.
2. Verify that the latest UEFI BIOS for your model has been installed.
3. Verify the proper memory configuration and compatibility including the maximum memory size and the memory speed.
4. Run the Lenovo Solution Center program.

Networking problems

The following are the most common networking problems:

Ethernet problems

- **Problem:** The computer cannot connect to the network.

Solution: Make sure that:

- The supported dock is connected correctly to your computer.
- The cable is installed correctly.

The network cable must be securely connected to the RJ45 connector of the supported dock. The maximum allowable distance from the computer to the hub is 100 meters (328 feet). If the cable is connected and the distance is within the limit but the problem persists, try a different cable.

- You are using the correct device driver. To install the correct driver, do the following:
 1. Open Control Panel and click **Hardware and Sound → Device Manager**. If you are prompted for an administrator password or confirmation, type the password or provide confirmation.
 2. If the exclamation mark ! is displayed next to the adapter name under **Network adapters**, you might not be using the correct driver or the driver might have been disabled. To update the driver, right-click the highlighted adapter.
 3. Click **Update Driver Software**, and then follow the instructions on the screen.
- The switch connector and the adapter have the same duplex setting.

If you configured the adapter for full duplex, make sure that the switch connector also is configured for full duplex. Setting wrong duplex mode can degrade performance, cause data loss, or result in lost connections.
- You have installed all networking software that is necessary for your network environment.

Check with your LAN administrator for the necessary networking software.

- **Problem:** The adapter stops working for no apparent reason.

Solution: The network driver files might be corrupt or missing. Update the driver by referring to the previous solution for the procedure to make sure that the correct device driver is installed.

- **Problem:** My computer is a Gigabit Ethernet model and I use a speed of 1000 Mbps, but the connection fails or errors occur.

Solution:

- Use Category 5 wiring and make sure that the network cable is securely connected.
- Connect to a 1000 BASE-T hub/switch (not 1000 BASE-X).

- **Problem:** The Wake On LAN feature is not working.

Solution: Ensure that Wake On LAN is enabled in ThinkPad Setup. If it is, check with your LAN administrator for the necessary settings.

- **Problem:** My computer is a Gigabit Ethernet model, but the computer cannot connect to the network at 1000 Mbps. Instead, it connects at 100 Mbps.

Solution:

- Try another cable.
- Make sure that the link partner is set to auto-negotiate.
- Make sure that the switch is 802.3ab-compliant (gigabit over copper).

A wireless LAN problem

Problem: I cannot connect to the network using the built-in wireless network card.

Solution: Make sure that:

- The Airplane mode is off.
- Your wireless LAN driver is the latest version.

- Your computer is within range of a wireless access point.
- The wireless radio is enabled.

Note: If you are using the Windows 7 operating system, click **Show hidden icons** on the taskbar. The Access Connections icon is displayed. For more information about the icon, refer to the Access Connections help information system.

For the Windows 7 operating system, check the Network Name (SSID) and your encryption information. Use the Access Connections program to verify this case-sensitive information.

A wireless WAN problem

Problem: A message is displayed indicating that an unauthorized WAN card is installed.

Solution: The WAN card is not supported on this computer. Remove the WAN card.

Note: Some models do not have a wireless WAN card.

Bluetooth problems

Note: Check your connection anytime and make sure that no other Bluetooth-enabled device is searching for the device to which you want to connect. Simultaneous searching is not allowed in the Bluetooth connection.

- **Problem:** Sound does not come from the Bluetooth headset/headphone but comes from the local speaker even though the Bluetooth headset/headphone is connected using a Headset profile or AV profile.

Solution: Do the following:

1. Exit the application that uses the sound device (for example, Windows Media Player).
2. Open Control Panel and click **Hardware and Sound** → **Sound** → **Playback**.
3. If you are using a Headset profile, select **Bluetooth Hands-free Audio** and click the **Set Default** button. If you are using an AV profile, select **Stereo Audio** and click the **Set Default** button.
4. Click **OK** to close the Sound window.

- **Problem:** PIM items sent from the Windows 7 operating systems cannot be received correctly into the address book of any other Bluetooth-enabled device.

Solution: The Windows 7 operating system sends PIM items in XML format, but most Bluetooth-enabled devices handle PIM items in vCard format. If another Bluetooth-enabled device can receive a file through Bluetooth, a PIM item sent from the Windows 7 might be saved as a file with the extension .contact.

Problems with the keyboard and other pointing devices

The following are the most common problems with keyboards and other pointing devices.

TrackPoint pointing device problems

- **Problem:** The pointer drifts when the computer is turned on or after it resumes normal operation.

Solution: The pointer might drift when you are not using the TrackPoint pointing device during normal operation. This is a normal characteristic of the TrackPoint pointing device and is not a defect. Pointer drifting might occur for several seconds under the following conditions:

- When the computer is turned on
- When the computer resumes normal operation
- When the TrackPoint pointing device is kept pressed for a long time
- When the temperature changes

- **Problem:** The TrackPoint pointing device or ThinkPad trackpad does not work.

Solution: Ensure that the TrackPoint pointing device or ThinkPad trackpad is enabled in the ThinkPad pointing device setting window.

Keyboard problems

- **Problem:** All or some keys on the keyboard do not work.

Solution: If an external numeric keypad is connected:

1. Turn off the computer.
2. Remove the external numeric keypad.
3. Turn on the computer and try using the keyboard again.

If the keyboard problem is resolved, carefully reconnect the external numeric keypad and the external keyboard. Ensure that you have seated the connectors correctly.

If the problem persists, ensure that the correct device driver is installed by doing the following:

1. Open **Control Panel**. Change the view of Control Panel from Category to Large icons or Small icons.
2. Click **Keyboard**.
3. Select the **Hardware** tab. In the **Device Properties** pane, ensure that you see this message: Device Status: This device is working properly.

If keys on the keyboard still do not work, have the computer serviced.

- **Problem:** All or some keys on the external numeric keypad do not work.

Solution: Ensure that the external numeric keypad is correctly connected to the computer.



Problems with the display and multimedia devices

This topic includes the most common problems with displays and multimedia devices, including the computer display, the external monitor, and audio devices.

Computer screen problems

- **Problem:** The screen is blank.

Solution: Do the following:

- Press the display mode-switching key  to bring up the image.
- If you are using the ac power adapter, or using the battery and the battery gauge shows that the battery is not depleted, press the brightness-up key  to make the screen brighter.
- If your computer is in sleep mode, press Fn to resume from the sleep mode.
- If the problem persists, follow the solution for the following problem.

- **Problem:** Incorrect characters are displayed on the screen.

Solution: Did you install the operating system or application program correctly? If they are installed and configured correctly, have the computer serviced.

- **Problem:** The screen stays on even after you turn off your computer.

Solution: Press and hold the power button for four seconds or more to turn off your computer; then turn it on again.

- **Problem:** Missing, discolored, or bright dots appear on the screen every time you turn on your computer.

Solution: This is an intrinsic characteristic of the TFT technology. Your computer display contains multiple thin-film transistors (TFTs). A small number of missing, discolored, or bright dots on the screen might exist all the time.

- **Problem:** My screen keeps blanking when I do not want it to.

Solution: If your computer is preinstalled with the Windows 7 operating system, you can disable any system timers, such as the LCD turn-off timer or the blank timer by doing the following:

1. Start Power Manager.
2. Click the **Power plan** tab, and then select **Maximum Performance** from the predefined power plans.

If your computer is preinstalled with the Windows 10 operating system, do the following:

1. Go to Control Panel, and ensure that you view Control Panel by Category.
2. Click **Hardware and Sound → Power Options → High performance**.
3. Show the additional plans, then choose **High performance**.

- **Problem:** When I turn on the computer, nothing is displayed on the screen and the computer does not beep while starting up.

Note: If you are not sure whether you heard any beeps, turn off the computer by pressing and holding the power button for four seconds or more. Turn it on and listen again.

Solution: Ensure that:

- The battery is installed correctly.
- The ac power adapter is connected to the computer and the power cord is plugged into a working electrical outlet.
- The computer is turned on. (Turn the power button on again for confirmation.)

If a power-on password is set:

- Press any key to display the prompt for the power-on password. If the brightness level of the screen is low, increase it by pressing the brightness-up key .
- Type the correct password and press Enter.

If these items are correctly set, and the screen remains blank, have the computer serviced.

- **Problem:** When I turn on the computer, only a white pointer is displayed on a blank screen.

Solution: If you have modified a partition on your hard disk drive or hybrid drive by using partition software, information about that partition, or the master boot record might have been destroyed.

1. Turn off the computer, and then turn it on again.
2. If you still see only the pointer on the screen, do the following:
 - If you have used the partition software, examine the partition on the hard disk drive or hybrid drive by using the software, and recover the partition if required.
 - Use the recovery solutions to restore the system.

If the problem persists, have the computer serviced.

External monitor problems

- **Problem:** The external monitor is blank.

Solution: To bring up the image, press the display mode-switching key  and select the desired monitor. If the problem persists, do the following:

1. Connect the external monitor to another computer to ensure that it works.
2. Reconnect the external monitor to your computer.
3. Refer to the manual shipped with the external monitor to check the resolutions and refresh rates that are supported.
 - If the external monitor supports the same resolution as the computer display or a higher resolution, view output on the external monitor or on both the external monitor and the computer display.

- If the external monitor supports a lower resolution than the computer display, view output on the external monitor only. (If you view output on both the computer display and the external monitor, the external monitor screen will be blank or distorted.)
 - **Problem:** You cannot set a higher resolution than the present one on your external monitor.
Solution: Make sure that the monitor type and other information is correct. If necessary, update the monitor driver. See “Using an external display” on page 42.
 - **Problem:** The screen is unreadable or distorted.
Solution: Make sure that:
 - The monitor information is correct and the appropriate monitor type is selected. Refer to the solution to the above problem.
 - Make sure that an appropriate refresh rate is selected by doing the following:
 1. Connect the external monitor to the monitor connector, and then connect the monitor to an electrical outlet.
 2. Turn on the external monitor and the computer.
 3. Right-click on the desktop, and do the following:
 - For Windows 7: Click **Screen resolution**.
 - For Windows 10: Click **Display settings**, show the displayed window in full screen, and then click **Advanced display settings**.

Note: If your computer cannot detect the external monitor, click the **Detect** button.
 - 4. Click the icon for the desired monitor (the **Monitor-2** icon is for the external monitor).
 - 5. Do the following:
 - For Windows 7: Click **Advanced settings**.
 - For Windows 10: Click **Display adapter properties**.
 - 6. Click the **Monitor** tab.
 - 7. Select the correct screen refresh rate.
- **Problem:** Wrong characters are displayed on the screen.
Solution: Did you follow the correct procedure when installing the operating system or application program? If you did, have the external monitor serviced.
- **Problem:** The Extend desktop function does not work.
Solution: Enable the Extend desktop function by doing the following:
 1. Connect the external monitor to the monitor connector, and then connect the monitor to an electrical outlet.
 2. Turn on the external monitor and the computer.
 3. Right-click on the desktop, and click **Screen resolution**.
 4. Click the **Monitor-2** icon.
 5. Select **Extend these displays** for multiple displays.
 6. Click the **Monitor-1** icon (for the primary display, the computer display).
 7. Set the resolution for the primary display.
 8. Click the **Monitor-2** icon (for the external monitor).

9. Set the screen resolution for the secondary display.
10. Set the relative position of each monitor by dragging its icon. You can set the monitors in any relative position, but the icons must touch each other.
11. Click **OK** to apply the changes.

Note: To change the color settings, right-click on the desktop, and click **Screen resolution**. Click **Advanced Settings**, select the **Monitor** tab, then set **Colors**.

- **Problem:** If you use the Extend desktop function, you cannot set a higher resolution or higher refresh rate on the secondary display.

Solution: Change the resolution and the color depth to lower settings for the primary display. Refer to the solution to the above problem.

- **Problem:** Display switching does not work.

Solution: If you use the Extend desktop function, disable it, and change the display output location. If a DVD movie or a video clip is playing, stop the playback, close the application, and then change the display output location.

- **Problem:** The screen position on the external monitor is incorrect when that monitor is set for a high resolution.

Solution: Sometimes, when you use a high resolution such as 1600x1200, the image is shifted to left or right on the screen. To correct this, first ensure that your external monitor supports the display mode (the resolution and the refresh rate) that you have set. If it does not, set a display mode that the monitor supports. If it does support the display mode you have set, go to the setup menu for the monitor itself and adjust the settings there. Usually the external monitor has buttons for access to the setup menu. For details, see the documentation that comes with the monitor.

Audio problems

- **Problem:** Wave or MIDI sound does not play correctly.

Solution: Ensure that the built-in audio device is configured correctly.

1. Open Control Panel.
2. Click **Hardware and Sound**.
3. Click **Device Manager**. If you are prompted for an administrator password or confirmation, type the password or provide confirmation.
4. Double-click **Sound, video and game controllers**.
5. Make sure that the Conexant HD Audio driver is enabled and configured correctly.

- **Problem:** Recordings made using the microphone input are not loud enough.

Solution: Ensure that the Microphone Boost function is turned on and set by doing the following:

1. Open Control Panel.
2. Click **Hardware and Sound**.
3. Click **Sound**.
4. Click the **Recording** tab in the Sound window.
5. Select **Microphone**, and click the **Properties** button.
6. Click the **Levels** tab, and move the Microphone Boost slider upwards.
7. Click **OK**.

Note: For details about controlling volume, refer to your Windows online help.

- **Problem:** A volume or balance slider cannot be moved.

Solution: The slider might be grayed out. This means that its position is fixed by the hardware and cannot be changed.
- **Problem:** The volume sliders do not stay in place when some audio applications are used.

Solution: It is normal for the sliders to change position when certain sound applications are used. The applications are aware of the settings in the Volume Mixer window and are allowed to change the settings themselves. An example is the Windows Media Player. Usually the application has sliders available to control the sound from within the application.
- **Problem:** The balance slider cannot completely mute one channel.

Solution: The control is designed to compensate for minor differences in balance and does not completely mute either channel.
- **Problem:** There is no volume control for MIDI sound in the Volume Mixer window.

Solution: Use the hardware volume control. This is because the built-in synthesizer software does not support the control.
- **Problem:** The sound cannot be turned off completely even if you set the Volume Mixer at minimum.

Solution: You still can hear some sound even though you have set the Volume Mixer control at minimum. To turn off the sound completely, go to the Volume Mixer by clicking the speaker icon in the windows notification area, then click **Mixer**. Click the **Mute Speaker** icon.
- **Problem:** When you connect a headphone to your computer while playing sound, a speaker does not produce sound in the MULTI-STREAM mode at Conexant HD Audio Manager.

Solution: Once the headphone is attached, the streaming is automatically redirected to it. If you want to listen to sound from the speakers again, be sure to set those speakers as the default device. The procedure is as follows:

 1. Open Control Panel. Click **Hardware and Sound**.
 2. Click the **Conexant HD Audio Manager** icon. The Conexant HD Audio Manager window opens.
 3. Look at the tabs of playback devices. If you have attached a headphone, the headphone will be automatically set as the default device, and the headphone tab icon will be checked.
 4. To set a different device as the default, click the speaker tab. Click the **Set Default Device** drop down list box. Select **Set Default Device**. That speaker tab icon will now have a check mark.
 5. Play any sound by use of a music program such as Windows Media Player. Ensure that sound comes from the speakers.

For details, refer to the help information system for Conexant HD Audio Manager.

Battery and power problems

This topic contains instructions on troubleshooting battery and power problems.

Battery problems

- **Problem:** The built-in battery cannot be fully charged in the standard charge time when the computer is powered off.

Solution: The battery might be over-discharged. Do the following:

 1. Turn off the computer.
 2. Connect the ac power adapter to the computer and let it charge.

If a quick charger is available, use it to charge the over-discharged built-in battery.

If the built-in battery cannot be fully charged in 24 hours, call Lenovo Customer Service Center to have it serviced.

- **Problem:** Your computer shuts down before the battery-status icon shows that the battery is empty, or the computer operates after the battery-status icon shows that the battery is empty.

Solution: Discharge and recharge the built-in battery.

- **Problem:** The operating time for a fully charged built-in battery is short.

Solution: Discharge and recharge the built-in battery. If your battery operating time is still short, call Lenovo Customer Service Center to have it serviced.

- **Problem:** The computer does not operate with a fully charged built-in battery.

Solution: The surge protector in the built-in battery might be active. Turn off the computer for one minute to reset the protector; then turn on the computer again.

- **Problem:** The built-in battery cannot be charged.

Solution: You cannot charge the battery when it is too hot. Turn off the computer and allow it to cool to room temperature. After it cools, recharge the battery. If it still cannot be charged, call Lenovo Customer Service to have it serviced.

An ac power adapter problem

Problem: The ac power adapter is connected to the computer and the working electrical outlet, but the power adapter (power plug) icon is not displayed on the windows notification area. Also the system-status indicator does not blink.

Solution: Do the following:

1. Ensure that the connection of the ac power adapter is correct. For instructions on connecting the ac power adapter, see *Safety, Warranty, and Setup Guide* that comes with your computer.
2. If the connection of the ac power adapter is correct, turn off the computer, then disconnect the ac power adapter.
3. Reconnect the ac power adapter, then turn on the computer.
4. If the power adapter icon still is not displayed on the windows notification area and the system-status indicator does not blink, have the ac power adapter and your computer serviced.

Note: To display the power adapter (power plug) icon, click **Show hidden icons** on the windows notification area.

Power problems

Print these instructions now and keep the instructions with your computer for reference later.

If your computer is getting no power at all, check the following items:

1. Verify the power button. Refer to “Status indicators” on page 6. The power button is lit whenever the computer is on.
2. Check all power connections. Remove any power strips and surge protectors to connect the ac power adapter directly to the ac power outlet.
3. Inspect the ac power adapter. Check for any physical damage, and ensure that the power cable is firmly attached to the adapter brick and the computer.
4. Verify the ac power source is working by attaching another device to the outlet.

If your computer does not run on battery power, do the following:

1. If the battery runs out of power, attach ac power adapter to recharge the battery.
2. If the battery is charged but the computer does not run, call Lenovo Customer Service Center to have it serviced.

A power button problem

Problem: The system does not respond, and you cannot turn off the computer.

Solution: Turn off the computer by pressing and holding the power button for 4 seconds or more. If the system is still not reset, remove the ac power adapter and reset the system by inserting a straightened paper clip into the emergency-reset hole. To locate the emergency-reset hole, refer to “Bottom view” on page 5.

Boot problems

Print these instructions now and keep them with your computer for reference later.

If you receive an error message before the operating system loads, follow the appropriate corrective actions for POST error messages.

If you receive an error message while the operating system is loading the desktop configuration after the POST is completed, check the following items:

1. Go to the Lenovo Support Web site at <http://www.lenovo.com/support> and search for the error message.
2. Go to the Microsoft Knowledge Base homepage at <http://support.microsoft.com/> and search for the error message.

Sleep and hibernation problems

- **Problem:** The computer enters sleep mode unexpectedly.

Solution: If the microprocessor overheats, the computer automatically enters sleep mode to allow the computer to cool and to protect the microprocessor and other internal components. Check the settings for sleep mode.

- **Problem:** The computer enters sleep mode (the sleep indicator turns on) immediately after the power-on self-test.

Solution: Ensure that:

- The battery is charged.
- The operating temperature is within the acceptable range. Refer to “Operating environment” on page 11.

If the battery is charged and the temperature is within range, have the computer serviced.

- **Problem:** A critical low-battery error occurs, and the computer immediately turns off.

Solution: The battery power is getting low. Connect the ac power adapter to the computer and plug it into an electrical outlet.

- **Problem:** The computer display remains blank after you press Fn to return from sleep mode.

Solution: Check whether an external monitor was disconnected or turned off while the computer was in sleep mode. If you disconnected or turned off the external monitor, connect it or turn it on before resuming the computer from the sleep mode. When resuming the computer from the sleep mode without attaching the external monitor or turning it on, and the computer display remains blank, press the display mode-switching key  to bring up the computer display.

- **Problem:** The computer does not return from sleep mode, or the system-status indicator (illuminated ThinkPad logo) blinks slowly and the computer does not work.

Solution: If the system does not return from sleep mode, it might have entered sleep or hibernation mode automatically because the battery is depleted. Check the system-status indicator (illuminated ThinkPad logo).

- If the system-status indicator (illuminated ThinkPad logo) blinks slowly, your computer is in sleep mode. Connect the ac power adapter to the computer; then press Fn.
- If the system-status indicator (illuminated ThinkPad logo) is off, your computer is in power-off state or in hibernation mode. Connect the ac power adapter to the computer; then press the power button to resume operation.

If the system still does not return from sleep mode, your system might stop responding and you might not be able to turn off the computer. In this case, you need to reset the computer. If you have not saved your data, it might be lost. To reset the computer, press and hold the power button for 4 seconds or more. If the system is still not reset, remove the ac power adapter and reset the system by inserting a straightened paper clip into the emergency-reset hole. To locate the emergency-reset hole, refer to “Bottom view” on page 5.

- **Problem:** Your computer does not enter sleep or hibernation mode.

Solution: Check whether any option has been selected to disable your computer from entering sleep or hibernation mode.

If your computer tries to enter sleep mode but the request is rejected, the device attached to the USB connector might have been disabled. If this occurs, do a hot-unplug-and-plug operation for the USB device.

- **Problem:** The battery discharges slightly while the computer is in hibernation mode.

Solution: If the wakeup function is enabled, the computer consumes a small amount of power. This is not a defect. For details, refer to “Power-saving modes” on page 38.

Problems with drives and other storage devices

This section includes hard disk drive or hybrid drive problems and solid-state drive problems.

hard disk drive or hybrid drive problems

- **Problem:** The hard disk drive or hybrid drive makes a rattling noise intermittently.

Solution: The rattling noise might be heard:

- When the hard disk drive or hybrid drive begins or finishes getting access to data.
- When you carry the hard disk drive or hybrid drive.
- When you carry your computer.

This is a normal characteristic of a hard disk drive or hybrid drive and is not a defect.

- **Problem:** The hard disk drive or hybrid drive does not work.

Solution: On the **Boot** menu of ThinkPad Setup, ensure that the hard disk drive or hybrid drive is on the **Boot priority order** list. If it is on the **Excluded from boot order** list, it is disabled. Select the entry for it on the list and press the Shift+1 key. This moves the entry to the **Boot priority order** list.

- **Problem:** After setting a hard disk password on the hard disk drive or hybrid drive of the computer, you moved the drive to another computer. Now you cannot unlock the hard disk password.

Solution: Your computer supports an enhanced password algorithm. Computers older than yours might not support such a security function.

A solid-state drive problem

Problem: When you compress files or folders by use of the data compression function in Windows, and then decompress them, the process of writing to or reading from the files or folders is slow.

Solution: Apply the disk defragmentation tool in Windows for faster access to the data.

A software problem

Problem: An application does not run correctly.

Solution: Ensure that the problem is not being caused by the application.

Check that your computer has the minimum required memory to run the application. Refer to the manuals supplied with the application.

Check the following:

- The application is designed to operate with your operating system.
- Other applications run correctly on your computer.
- The necessary device drivers are installed.
- The application works when it is run on some other computer.

If an error message is displayed while you are using the application program, refer to the manuals supplied with the application.

If the application still does not run correctly, contact your place of purchase or a service representative for help.

Problems with ports and connectors

The following are the most common problems with ports and connectors.

A USB problem

Problem: A device connected to the USB connector does not work.

Solution: Open the Device Manager window. Ensure that the USB device setup is correct, and that the assignment of computer resource and the installation of the device driver are correct. To open the Device Manager window, go to Control Panel and click **Hardware and Sound → Device Manager**. If you are prompted for an administrator password or confirmation, type the password or provide confirmation.

Refer to “Diagnosing problems” on page 93 for a diagnostic test of the USB connector.

A ThinkPad Pen Pro problem

Problem: The ThinkPad Pen Pro does not perform well.

Solution: If the pen does not perform well, insert the pen into the pen slot to charge it for about five minutes.

Note: Ensure that your computer is on or in sleep mode. Otherwise, the pen will not be charged.

Chapter 9. Recovery overview

This chapter provides information about the recovery solutions provided by Lenovo.

This chapter contains the following topics:

- “Recovery overview for the Windows 7 operating system” on page 109
- “Recovery overview for the Windows 10 operating system” on page 114

Recovery overview for the Windows 7 operating system

This section provides information about the recovery solutions provided by Lenovo on the Windows 7 operating system.

Notes:

- There are a variety of methods to choose from when considering how to recover in the event of a software-related or hardware-related problem. Some methods vary depending on the type of your operating system.
- The product on the recovery media might be used only for the following purposes:
 - Restore the product preinstalled on your computer
 - Reinstall the product
 - Modify the product using the Additional Files

To prevent potential performance risks or unexpected behavior that might be caused by the new hard disk drive technology, it is recommended that you use one of the following back-up software programs:

- Rescue and Recovery version 4.52 or later
- Acronis True Image 2010 or later
- Paragon Backup & Recovery 10 Suite or later, Paragon Backup & Recovery 10 Home or later

Creating and using recovery media

You can use recovery media to restore the storage devices to the factory default settings. Recovery media are useful if you transfer the computer to another area, sell the computer, recycle the computer, or put the computer in an operational state after all other methods of recovery have failed. As a precautionary measure, it is important to create recovery media as early as possible.

Note: The recovery operations you can perform using recovery media vary depending on the operating system from which the recovery media were created. The recovery media might contain a boot medium and a data medium. Your Microsoft Windows license permits you to create only one data medium, so it is important that you store the recovery media in a safe place after you have made them.

Creating recovery media

This section provides instructions on how to create recovery media.

Note: On the Windows 7 operating system, you can create recovery media using discs or external USB storage devices.

To create recovery media, click **Start → All Programs → Lenovo PC Experience → Lenovo Tools → Factory Recovery Disks**. Then, follow the instructions on the screen.

Using recovery media

On the Windows 7 operating system, you can use recovery media to restore the computer to the factory default settings only. You can use recovery media to put the computer in an operational state after all other methods of recovery have failed.

Attention: When you use recovery media to restore the computer to the factory default settings, all the files currently on the storage devices will be deleted and replaced by the factory default settings.

To use recovery media on the Windows 7 operating system, do the following:

1. Depending on the type of your recovery media, connect the boot medium (memory key or other USB storage device) to the computer, or insert the boot disc into the optical drive.
2. Repeatedly press and release F12 when turning on the computer. When the Boot Menu window opens, release F12.
3. Select the desired startup device and press Enter. The restore process begins.
4. Follow the instructions on the screen to complete the operation.

Note: After restoring your computer to the factory default settings, you might have to reinstall device drivers for some devices. See “Reinstalling preinstalled programs and device drivers” on page 112.

Performing backup and recovery operations

The Rescue and Recovery program enables you to back up all your storage devices contents including the operating system, data files, software programs, and personal settings. You can designate where the Rescue and Recovery program stores the backup:

- In a protected area of your storage devices
- On the secondary the storage devices if there is one.
- On an attached external USB hard disk drive
- On a network drive
- On recordable discs (a recordable optical drive is required for this option)

After you have backed up the contents on the storage devices, you can restore the complete contents of the storage devices, restore only the selected files, or restore only the Windows operating system and programs.

Performing a backup operation

To perform a backup operation using the Rescue and Recovery program on the Windows 7 operating system, do the following:

1. From the Windows desktop, click **Start → All Programs → Lenovo PC Experience → Lenovo Tools → Enhanced Backup and Restore**. The Rescue and Recovery program opens.
2. In the Rescue and Recovery main window, click the **Launch advanced Rescue and Recovery** arrow.
3. Click **Back up your hard drive** and select backup operation options. Then, follow the instructions on the screen to complete the backup operation.

Performing a recovery operation

To perform a recovery operation using the Rescue and Recovery program on the Windows 7 operating system, do the following:

1. From the Windows desktop, click **Start → All Programs → Lenovo PC Experience → Lenovo Tools → Enhanced Backup and Restore**. The Rescue and Recovery program opens.
2. In the Rescue and Recovery main window, click the **Launch advanced Rescue and Recovery** arrow.
3. Click the **Restore your system from a backup** icon.

4. Follow the instructions on the screen to complete the recovery operation.

For more information about performing a recovery operation from the Rescue and Recovery workspace, see “Using the Rescue and Recovery workspace” on page 111.

Using the Rescue and Recovery workspace

The Rescue and Recovery workspace resides in a protected, hidden area of your storage devices that operates independently from the Windows operating system. It enables you to perform recovery operations even if you cannot start the Windows operating system. You can perform the following recovery operations from the Rescue and Recovery workspace:

- **Rescue files from your storage devices or from a backup**

The Rescue and Recovery workspace enables you to locate files on your storage devices and transfer them to a network drive or other recordable media, such as a USB device or a disc. This solution is available even if you did not back up your files or if changes were made to the files since your last backup operation. You also can rescue individual files from a Rescue and Recovery backup located on your local hard disk drive, solid-state drive, hybrid drive, a USB device, or a network drive.

- **Restore your storage devices from a Rescue and Recovery backup**

If you have backed up your storage devices using the Rescue and Recovery program, you can restore the storage devices from a Rescue and Recovery backup, even if you cannot start the Windows operating system.

- **Restore your storage devices to the factory default settings**

The Rescue and Recovery workspace enables you to restore the complete contents of your storage devices to the factory default settings. If you have multiple partitions on your storage devices, you have the option to restore the factory default settings to the C: partition and leave the other partitions intact. Because the Rescue and Recovery workspace operates independently from the Windows operating system, you can restore the factory default settings even if you cannot start the Windows operating system.

Attention: If you restore the storage devices from a Rescue and Recovery backup or restore the storage devices to the factory default settings, all files on the primary the storage devices partition (usually drive C:) will be deleted in the recovery process. If possible, make copies of important files. If you are unable to start the Windows operating system, you can use the rescue files feature of the Rescue and Recovery workspace to copy files from your storage devices to other media.

To start the Rescue and Recovery workspace, do the following:

1. Make sure that the computer is turned off.
2. Repeatedly press and release F11 when turning on the computer. When you hear beeps or see a logo screen, release F11.
3. If you have set a Rescue and Recovery password, type your password when prompted. The Rescue and Recovery workspace opens after a short delay.

Note: If the Rescue and Recovery workspace fails to open, see “Solving recovery problems” on page 113.

4. Do one of the following:

- To rescue files from your storage devices or from a backup, click **Rescue files** and follow the instructions on the screen.
- To restore your storage devices from a Rescue and Recovery backup or to restore the storage devices to the factory default settings, click **Restore your system** and follow the instructions on the screen.

For more information about the features of the Rescue and Recovery workspace, click **Help**.

Note: After restoring your storage devices to the factory default settings, you might have to reinstall device drivers for some devices. See “Reinstalling preinstalled programs and device drivers” on page 112.

Creating and using a rescue medium

With a rescue medium, such as a disc or a USB hard disk drive, you can recover the computer from failures that prevent you from gaining access to the Rescue and Recovery workspace on your hard disk drive.

Notes:

1. The recovery operations you can perform using a rescue medium vary depending on the operating system.
2. The rescue disc can be started in all types of optical drives.

Creating a rescue medium

To create a rescue medium on the Windows 7 operating system, do the following:

1. From the Windows desktop, click **Start → All Programs → Lenovo PC Experience → Lenovo Tools → Enhanced Backup and Restore**. The Rescue and Recovery program opens.
2. In the Rescue and Recovery main window, click the **Launch advanced Rescue and Recovery** arrow.
3. Click the **Create Rescue Media** icon. The Create Rescue and Recovery Media window opens.
4. In the **Rescue Media** area, select the type of the rescue medium you want to create. You can create a rescue medium using a disc, a USB hard disk drive, or a secondary internal hard disk drive.
5. Click **OK** and follow the instructions on the screen to create a rescue medium.

Using a rescue medium

This section provides instructions on how to use the rescue medium you have created.

- If you have created a rescue medium using a disc, use the following instructions to use the rescue medium:
 1. Turn off your computer.
 2. Repeatedly press and release F12 when turning on the computer. When the Boot Menu window is displayed, release F12.
 3. In the Boot Menu window, select the desired optical drive as the first boot device. Then, insert the rescue disc into the optical drive and press Enter. The rescue medium starts.
- If you have created a rescue medium using a USB hard disk drive, use the following instructions to use the rescue medium:
 1. Attach the USB hard disk drive to one of the USB connectors on your computer.
 2. Repeatedly press and release F12 when turning on the computer. When the Boot Menu window opens, release F12.
 3. In the Boot Menu window, select the USB hard disk drive as the first boot device and press Enter. The rescue medium starts.
- If you have created a rescue medium using the secondary internal hard disk drive, set the secondary internal hard disk drive as the first boot device in the startup device sequence to start the rescue medium.

When the rescue medium starts, the Rescue and Recovery workspace opens. The help information for each feature is available from the Rescue and Recovery workspace. Follow the instructions to complete the recovery process.

Reinstalling preinstalled programs and device drivers

Your computer has provisions that enable you to reinstall selected factory-installed programs and device drivers.

Reinstalling preinstalled programs

To reinstall selected programs, do the following:

1. Turn on your computer.
2. Go to the C:\SWTOOLS directory.
3. Open the APPS folder. The folder contains several subfolders named for the various preinstalled applications.
4. Open the subfolder for the program you are reinstalling.
5. Double-click **Setup**, and then follow the on-screen steps to reinstall the program.

Reinstalling preinstalled device drivers

Attention: When you reinstall device drivers, you are changing the current configuration of your computer. Reinstall device drivers only when it is necessary to correct a problem with your computer.

To reinstall a device driver for a factory-installed device, do the following:

1. Turn on your computer.
2. Go to the C:\SWTOOLS directory.
3. Open the DRIVERS folder. The folder contains several subfolders named for the various devices installed in your computer (for example, AUDIO and VIDEO).
4. Open the subfolder for the device.
5. Reinstall the device driver by one of the following methods:
 - In the subfolder for the device, look for a text file (a file with the extension .txt). The text file contains information on how to reinstall that device driver.
 - If the subfolder for the device contains a file of setup information (a file with the extension .inf), you can use the Add New Hardware program (in the Windows Control Panel) to reinstall the device driver. Not all device drivers can be reinstalled by use of this program. In the Add New Hardware program, when prompted for the device driver you want to install, click **Have Disk** and **Browse**. Then select the device driver file from the device subfolder.
 - In the subfolder for the device, look for the executable file (a file with the extension .exe). Double-click the file, and follow the instructions on the screen.

Attention: If you need updated device drivers for your computer, do not download them from the Windows Update Web site. Obtain them from Lenovo. For more information, see “Making sure device drivers are current” on page 88.

Solving recovery problems

If you are unable to access the Rescue and Recovery workspace or the Windows environment, do one of the following:

- Use a rescue medium to start the Rescue and Recovery workspace. See “Creating and using a rescue medium” on page 112.
- Use recovery media if all other methods of recovery have failed and you need to restore the storage devices to the factory default settings.

Note: If you are unable to access the Rescue and Recovery workspace or the Windows environment from a rescue medium or recovery media, you might not have the rescue device (an internal hard disk drive, solid-state drive, hybrid drive, a disc, a USB hard disk drive, or other external devices) set as the first boot device in the startup device sequence. You must first make sure that your rescue device is set as the first boot device in the startup device sequence in the Setup Utility program. See “Startup menu” on page 82 for detailed information about temporarily or permanently changing the startup device sequence. For more information about the Setup Utility program, see “Using the ThinkPad Setup program” on page 70.

It is important to create a rescue medium and a set of recovery media as early as possible and store them in a safe place for future use.

Recovery overview for the Windows 10 operating system

The Windows recovery programs enable you to reset your computer or use advanced startup options.

It is recommended that you create a recovery USB drive as early as possible. Store the recovery USB drive as a backup or replacement for the Windows recovery programs.

For more information, see “Creating and using a recovery USB drive” on page 115.

Resetting your computer

If your computer does not perform well, you might consider resetting your computer. In the resetting process, you can choose to keep your files or remove them, and then reinstall the Windows operating system.

To reset your computer, do the following:

Note: The graphical user interface (GUI) items of the operating system might change without notice.

1. Open the Start menu and then click **Settings**. If **Settings** is not displayed, click **All apps** to display all programs, and then click **Settings → Update & security → Recovery**.
2. In the **Reset this PC** section, click **Get started**.
3. Follow the instructions on the screen to reset your computer.

Using advanced startup options

With advanced startup options, you can change the firmware settings of the computer, change the startup settings of the Windows operating system, start the computer from an external device, or restore the Windows operating system from a system image.

To use advanced startup options, do the following:

Note: The GUI items of the operating system might change without notice.

1. Open the Start menu and then click **Settings**. If **Settings** is not displayed, click **All apps** to display all programs, and then click **Settings → Update & security → Recovery**.
2. In the **Advanced startup** section, click **Restart now → Troubleshoot → Advanced options**.
3. Select a desired startup option, then follow the instructions on the screen.

Recovering your operating system if Windows 10 fails to start

The Windows recovery environment on your computer is capable of operating independently from the Windows 10 operating system. This enables you to recover or repair the operating system even if the Windows 10 operating system fails to start.

After two consecutive failed boot attempts, the Windows recovery environment starts automatically. Then you can choose repair and recovery options by following the instructions on the screen.

Note: Ensure that your computer is connected to ac power during the recovery process.

Creating and using a recovery USB drive

You can create a recovery USB drive as a backup for the Windows recovery programs. With the recovery USB drive, you can troubleshoot and fix the problems even if the preinstalled Windows recovery programs are damaged.

Creating a recovery USB drive

The USB drive that you use to create the recovery USB drive must be at least 16 GB of storage. The actual USB capacity that is required depends on the size of the recovery image.

Attention: The creation process deletes anything stored on the USB drive. To avoid data loss, make a backup copy of all the data that you want to keep.

To create a recovery USB drive, do the following:

Note: Ensure that your computer is connected to ac power during the following process.

1. Connect a proper USB drive (at least 16 GB of storage).
2. Type *recovery* in the search box on the taskbar. Then click **Create a recovery drive**.
3. Click **Yes** in the User Account Control window to allow the Recovery Media Creator program to start.
4. In the Recovery Drive window, follow the on-screen instructions to create a recovery USB drive.

Using the recovery USB drive

If you cannot start your computer, refer to the corresponding information in the topic “Troubleshooting” on page 93 to try to solve the problem by yourself. If you still cannot start your computer, use the recovery USB drive to recover your computer.

To use a recovery USB drive, do the following:

Note: Ensure that your computer is connected to ac power.

1. Connect the recovery USB drive to the computer.
2. Turn on or restart the computer. Before the Windows operating system starts, repeatedly press the F12 key. The Boot Menu window opens.
3. Select the recovery USB drive as the boot device.
4. Select a preferred keyboard layout.
5. Click **Troubleshoot** to display the optional recovery solutions.
6. Select a corresponding recovery solution according to your situation. Then follow the instructions on the screen to complete the process.

Chapter 10. Replacing devices

This chapter provides instructions on how to install or replace hardware for your computer.

- “Static electricity prevention” on page 117
- “Disabling the built-in battery” on page 117
- “Installing or replacing the micro SIM card” on page 118
- “Replacing the keyboard” on page 120
- “Replacing the base cover assembly” on page 124
- “Replacing the memory module” on page 127
- “Replacing the internal storage drive” on page 129
- “Replacing the button I/O card” on page 131
- “Replacing the ac power card” on page 133
- “Replacing the speaker assembly” on page 137
- “Replacing the coin-cell battery” on page 139

Static electricity prevention

Static electricity, although harmless to you, can seriously damage computer components and options. Improper handling of static-sensitive parts can cause damage to the part. When you unpack an option or a CRU, do not open the static-protective package that contains the part until the instructions direct you to install the part.

When you handle options or CRUs, or perform any work inside the computer, take the following precautions to avoid static-electricity damage:

- Limit your movement. Movement can cause static electricity to build up around you.
- Always handle components carefully. Handle adapters, memory modules, and other circuit boards by the edges. Never touch exposed circuitry.
- Prevent others from touching components.
- When you install a static-sensitive option or CRU, touch the static-protective package that contains the part to a metal expansion-slot cover or other unpainted metal surface on the computer for at least two seconds. This reduces static electricity in the package and your body.
- When possible, remove the static-sensitive part from the static-protective package and install the part without setting it down. When this is not possible, place the static-protective package on a smooth, level surface and place the part on the package.
- Do not place the part on the computer cover or other metal surface.

Disabling the built-in battery

Before replacing any hardware component except the removable battery, ensure that you have disabled the built-in battery by doing the following:

For Windows 10, disable Fast Startup before disabling the built-in battery.

To disable Fast Startup for Windows 10, do the following:

1. From the desktop, type Power in the search box on the taskbar, and select **Power Options**.

2. Click **Change what the power buttons do** on the left pane.
3. Click **Change settings that are currently unavailable** at the top.
4. If prompted by User Account Control (UAC), click **Yes**.
5. Clear the **Turn on fast startup** check box, and then click **Save changes**.

To disable the built-in battery, do the following:

1. Turn off your computer and disconnect the ac power adapter and all cables from the computer.
2. Turn on your computer. When the logo screen is displayed, immediately press F1 to enter ThinkPad Setup.
3. Select **Config → Power**. The **Power** submenu is displayed.
4. Select **Disable built-in battery** and press Enter.
5. Select **Yes** in the Setup Confirmation window. The built-in battery is disabled and the computer turns off automatically. Wait three to five minutes to let the computer cool.

Installing or replacing the micro SIM card

Before you start, print these instructions. Read the important safety information first. See “Important safety information” on page vi.

If your computer supports wireless WAN connections, your computer might require a micro SIM card to establish wireless WAN connections. Depending on the country or region of delivery, you might need to purchase a micro SIM card, or a micro SIM card might already be installed in your computer, or is part of the shipping contents that come with your computer.

Attention: When installing or removing the micro SIM card, do not touch the micro SIM card metal connectors. Always hold the tablet in your hand before you install or remove the micro SIM card to avoid electrostatic discharges.

To install or replace the micro SIM card, do the following:

1. Turn off the computer or put the computer into hibernation mode. Then disconnect the ac power adapter and all cables from the computer.
2. Locate the micro-SIM-card tray at the rear of the computer.

3. Insert a straightened paper clip into the hole in the micro-SIM-card tray **1**. The micro-SIM-card tray ejects **2**. Then, slide the micro-SIM-card tray out of the computer.

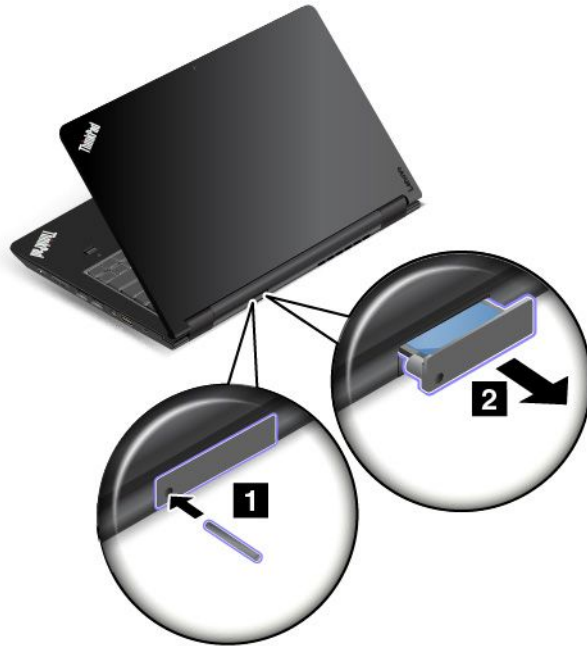

4. Gently take the micro SIM card out of the tray.

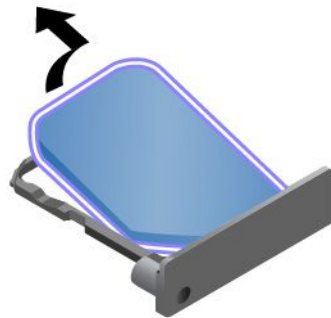

5. Install a new micro SIM card into the micro-SIM-card tray.

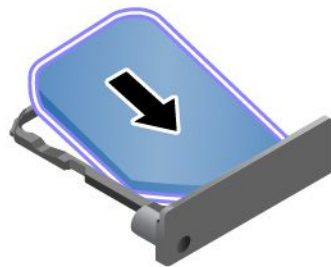

6. Insert the tray into the computer.



7. Reconnect the ac power adapter and all cables.

Replacing the keyboard

Before you start, print these instructions. Read the important safety information first. See “Important safety information” on page vi.

Removing the keyboard

To remove the keyboard, do the following:

Note: Your computer might look different from the illustrations in this topic.

1. Disable the built-in battery. See “Disabling the built-in battery” on page 117.
2. Disconnect the ac power adapter and all cables from the computer. Wait several minutes to let the computer cool.
3. Close the computer display and turn the computer over.

4. Remove the screws that secure the keyboard.

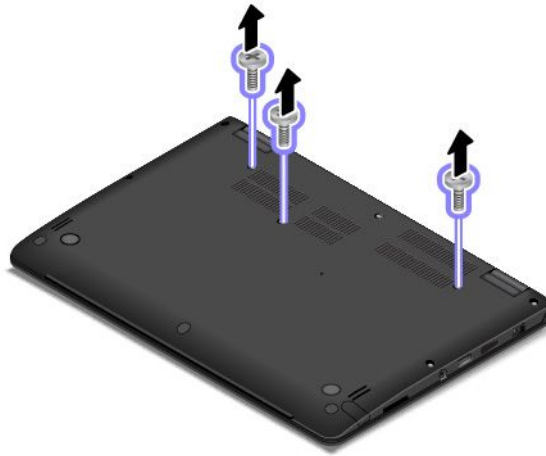

5. Push hard in the direction shown by the arrows to unlatch the front edge of the keyboard (the edge that is close to you).



- Pivot the keyboard slightly upward as shown by arrow **1**. Then turn the keyboard over as shown by arrow **2**.



- Detach the connectors and remove the keyboard.



Installing the new keyboard

To install the new keyboard, do the following:

1. Attach the connectors and then turn the keyboard over.



2. Insert the keyboard as shown by the arrows. Ensure that the rear edge of the keyboard (the edge that is close to the computer display) is under the frame of the keyboard bezel.



3. Slide the keyboard in the direction shown by the arrows until the latches of the keyboard are hidden under the keyboard bezel.



4. Turn the computer over and reinstall the screws.

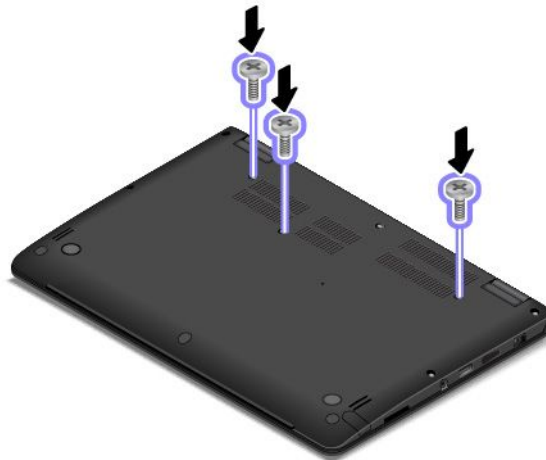

5. Turn the computer over again. Connect the ac power adapter and all cables to the computer.

Replacing the base cover assembly

Before you start, print these instructions. Read the important safety information first. See “Important safety information” on page vi.

To replace the base cover assembly, do the following:

1. Disable the built-in battery. See “Disabling the built-in battery” on page 117.
2. Close the computer display, and turn the computer over.

3. Remove the screw caps **1** and the screw **2**.

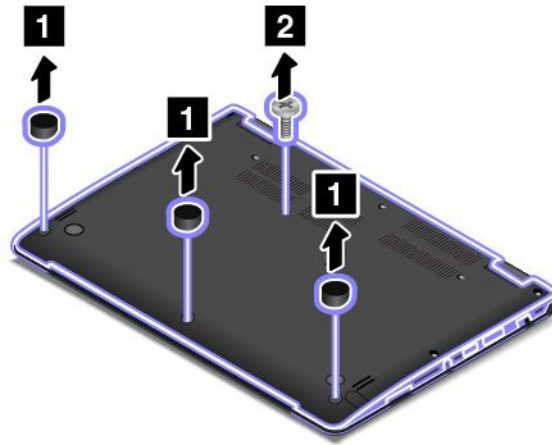

4. Loosen the rest of the screws that secure the base cover assembly.

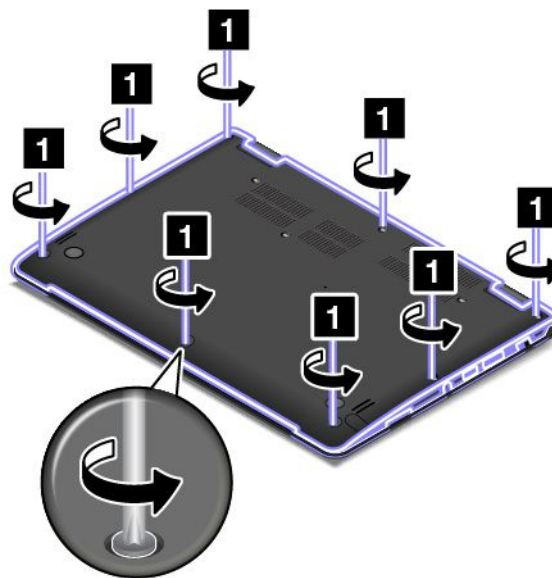

5. Pry up the latches and then remove the base cover assembly.

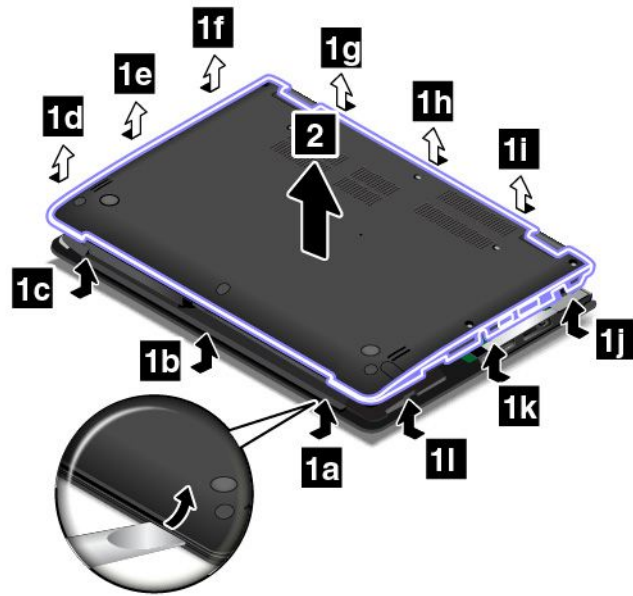

6. Install the new base cover assembly in place.

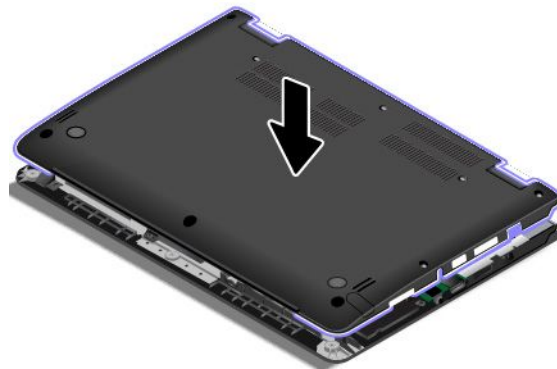

7. Tighten the screws to secure the base cover assembly.

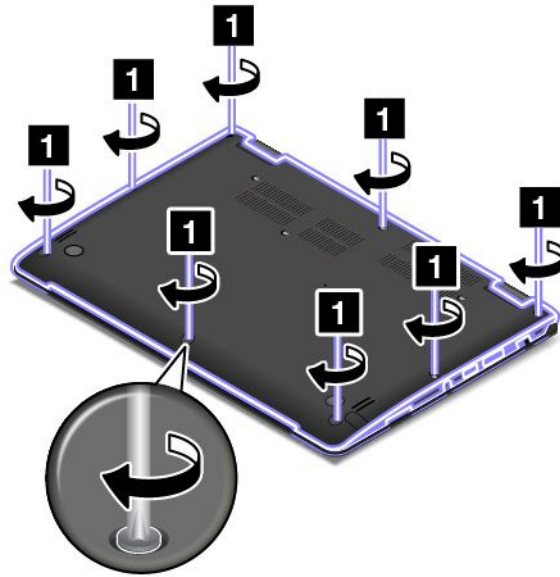

8. Reinstall the screw **1** and the screw caps **2**.

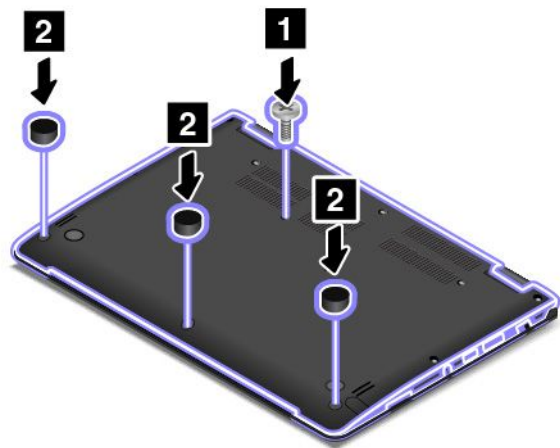

9. Turn the computer over again. Connect the ac power adapter and all cables.

Replacing the memory module

Before you start, print these instructions. Read the important safety information first. See “Important safety information” on page vi.

Increasing memory capacity is an effective way to make programs run faster. To replace the memory module, read the following prerequisites, and then the instructions.

Note: The operating speed of the memory module has dependency on the system configuration. In some conditions, the memory module in your computer might not be able to operate at the maximum speed.

Attention: Before you start installing a memory module, touch a metal table or a grounded metal object. This action reduces any static electricity from your body. Static electricity could damage the memory module.

Replacing the memory module

To replace the memory module, do the following:

1. Disable the built-in battery. See “Disabling the built-in battery” on page 117.
2. Close the computer display, and turn the computer over.
3. Remove the base cover assembly. See “Replacing the base cover assembly” on page 124.
4. Open the latches on both sides of the memory slot at the same time **1**, and then remove the memory module **2**.

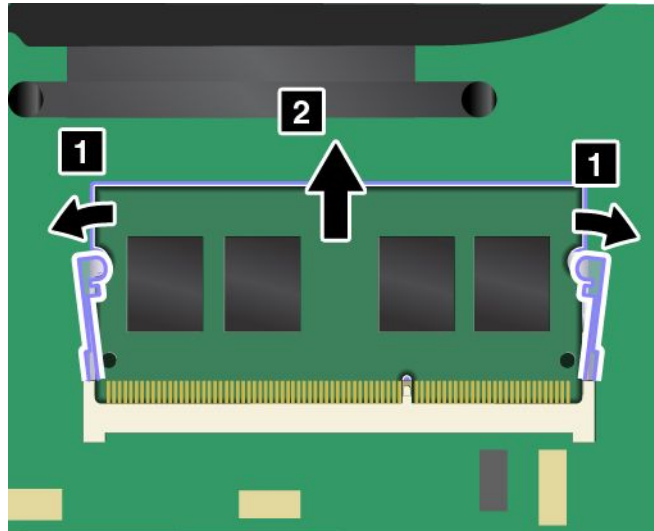

5. Place the notched end of the new memory module toward the contact edge side of the memory slot. Insert the memory module into the memory slot at an angle of about 20 degrees **1**. Pivot the memory module downward until it snaps into place **2**. Ensure that the memory module is firmly installed in the memory slot and cannot be moved easily.

Attention: Do not touch the contact edge of the memory module. Otherwise the memory module might get damaged.

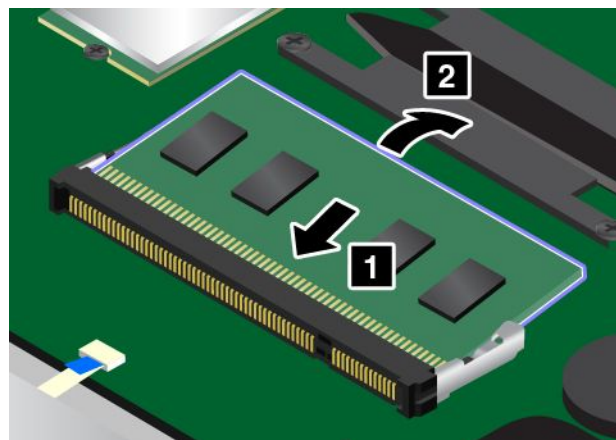

6. Reinstall the base cover assembly.
7. Turn the computer over again. Connect the ac power adapter and all cables to the computer.

Replacing the internal storage drive

Before you start, print these instructions. Read the important safety information first. See “Important safety information” on page vi.

Attention: The internal storage drive (hard disk drive, solid-state drive, or hybrid drive) is sensitive. Incorrect handling can cause damage and permanent loss of data. Observe the following guidelines:

- Replace the storage drive only if you upgrade it or have it repaired. The connectors and slot of the storage drive are not designed for frequent changes, or drive swapping.
- Do not drop the drive or subject it to physical shocks. Put the drive on a material, such as soft cloth, that absorbs any physical shocks.
- Do not apply pressure to the cover of the drive.
- Do not touch the connector.
- Before removing the storage drive, make a backup copy of all the information on it, and then turn off the computer.
- Never remove the drive while the computer is operating, in sleep mode, or in hibernation mode.

To replace the storage drive, do the following:

1. Disable the built-in battery. See “Disabling the built-in battery” on page 117.
2. Close the computer display, and turn the computer over.
3. Remove the base cover assembly. See “Replacing the base cover assembly” on page 124.
4. Detach the connector.

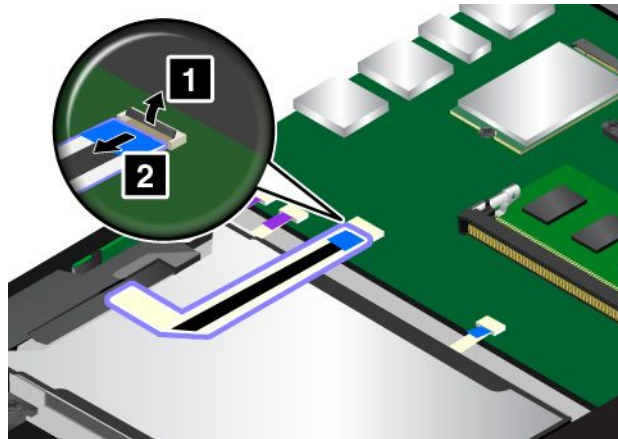

5. Take the drive tab and lift the drive. Then take the drive out of the drive bay.

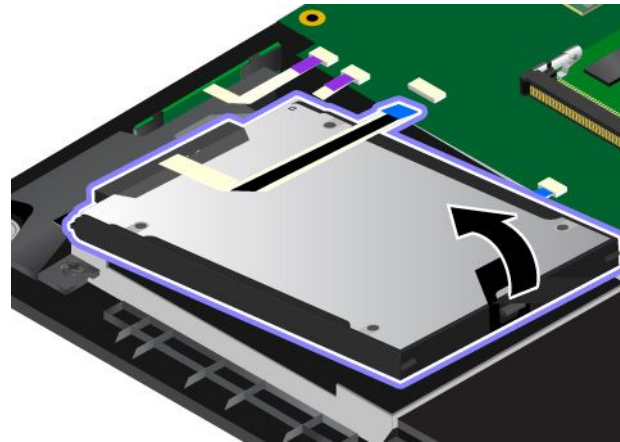

6. Disconnect the drive cable from the storage drive.

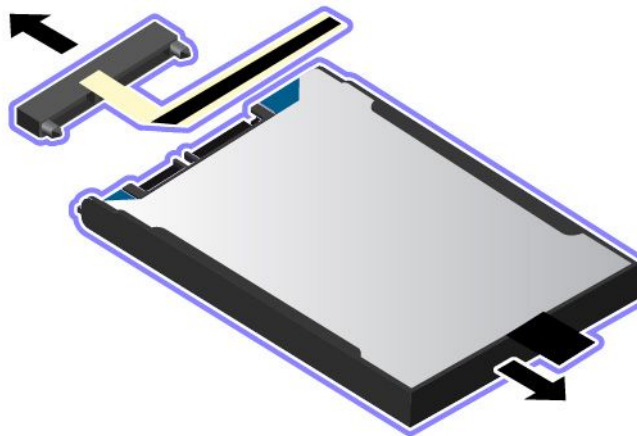

7. Reconnect the drive cable to the new storage drive.

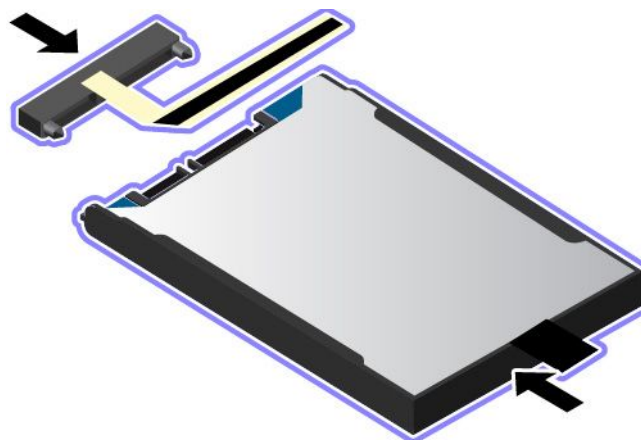

8. Place the new drive into the drive bay.

Note: Ensure that the tiny tabs **a** on the storage drive bracket are correctly secured by the corresponding hooks of the storage-drive retaining frame.

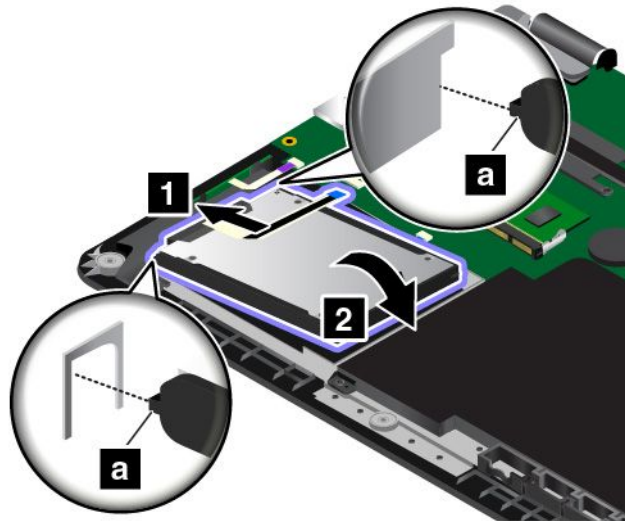

9. Attach the connector.

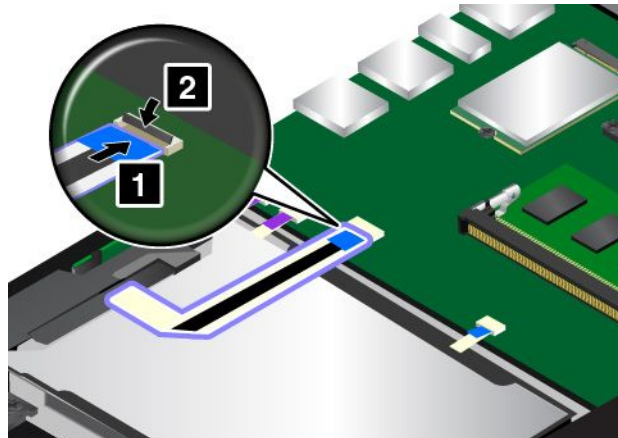

10. Reinstall the base cover assembly.

11. Turn the computer over again. Connect the ac power adapter and all cables to the computer.

Replacing the button I/O card

Before you start, print these instructions. Read the important safety information first. See “Important safety information” on page vi.

To replace the button I/O card, do the following:

Attention: Sensitive components are mounted on the button I/O card. Avoid any kind of rough handling during the replacement.

1. Disable the built-in battery. See “Disabling the built-in battery” on page 117.
2. Close the computer display, and turn the computer over.
3. Remove the base cover assembly. See “Replacing the base cover assembly” on page 124.

4. Detach the connector.

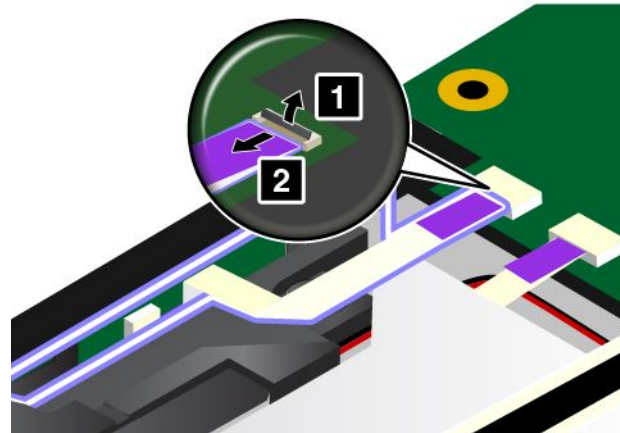

5. Remove the button I/O card as shown.

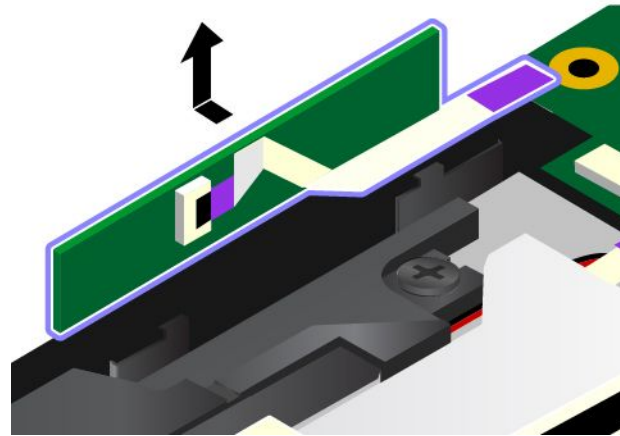

6. Insert the new button I/O card.

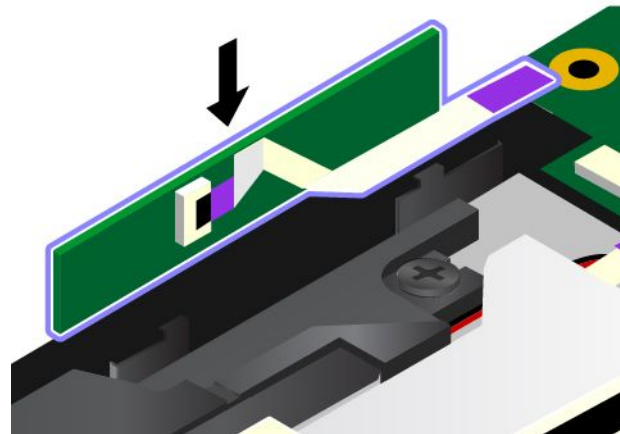

7. Attach the connector.

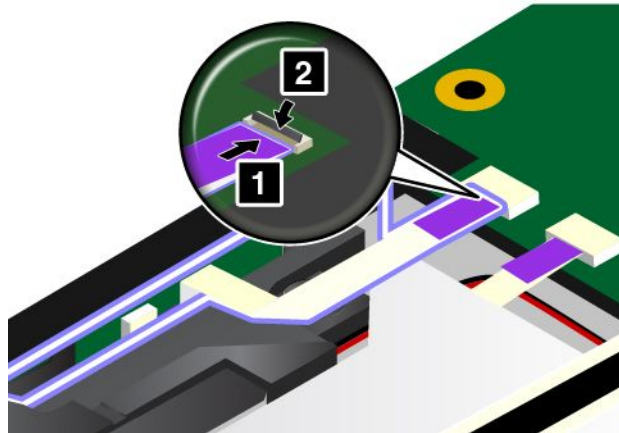

8. Reinstall the base cover assembly.

9. Turn the computer over again. Connect the ac power adapter and all cables to the computer.

Replacing the ac power card

Before you start, print these instructions. Read the important safety information first. See “Important safety information” on page vi.

Note: Depending on the model, your computer might look slightly different from the illustrations in this topic.

To replace the ac power card, do the following:

Attention: Sensitive components are mounted on the card. Avoid any kind of rough handling during the replacement.

1. Disable the built-in battery. See “Disabling the built-in battery” on page 117.
2. Close the computer display, and turn the computer over.
3. Remove the base cover assembly. See “Replacing the base cover assembly” on page 124.

4. Disconnect the cable from the ac power card.

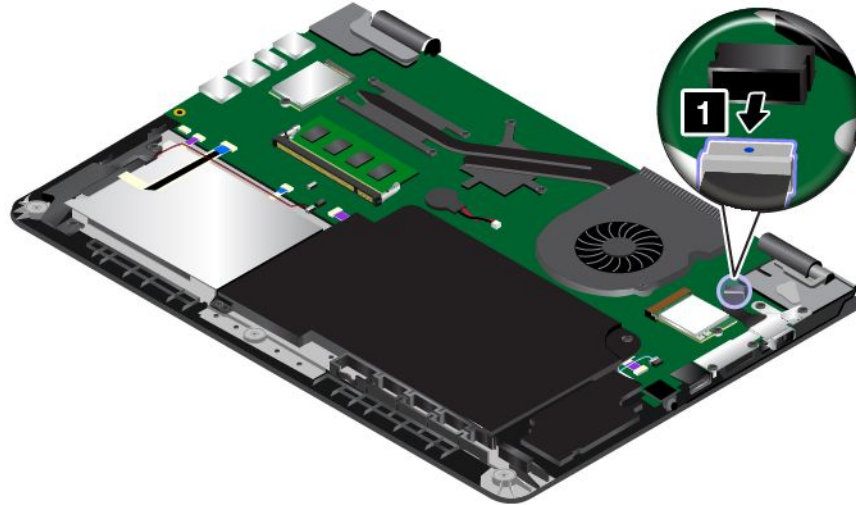

5. Remove the screws that secure the ac power card.

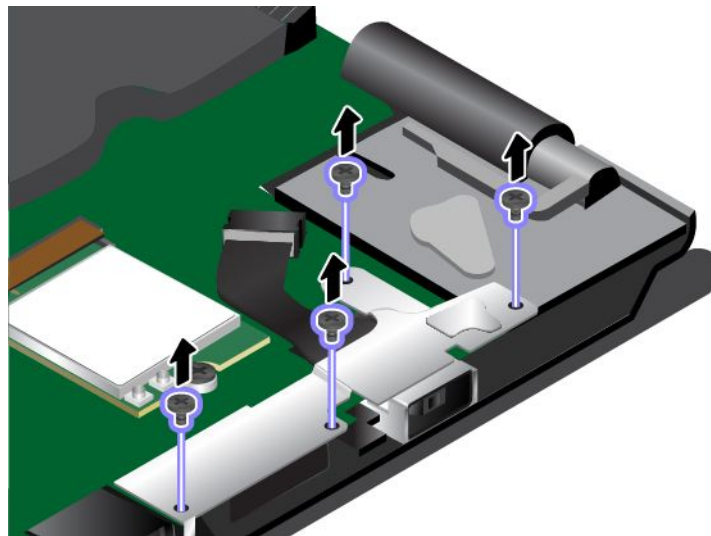

6. Remove the dc-in bracket.

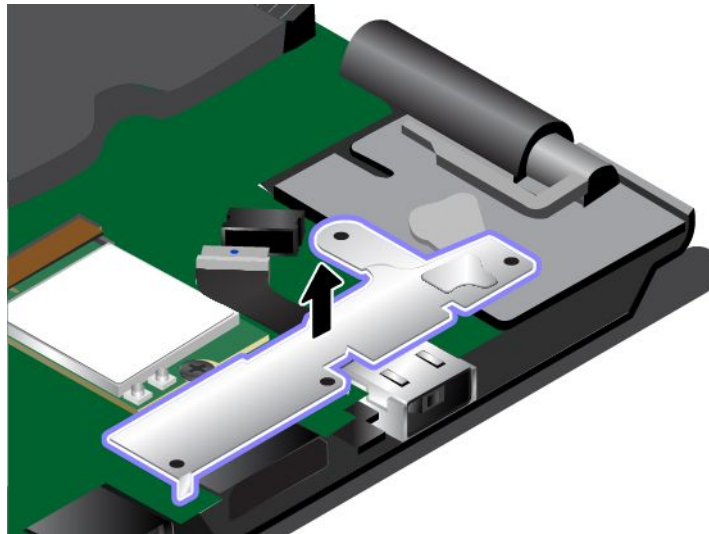

7. Remove the ac power card.

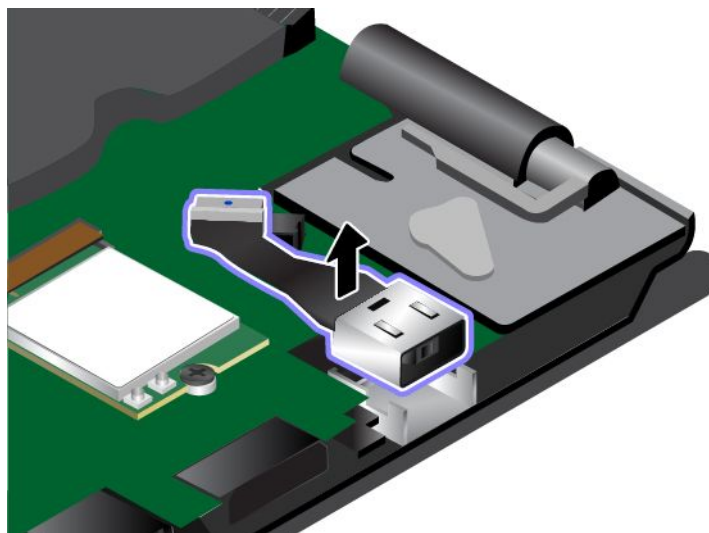

8. Install the new ac power card in place.

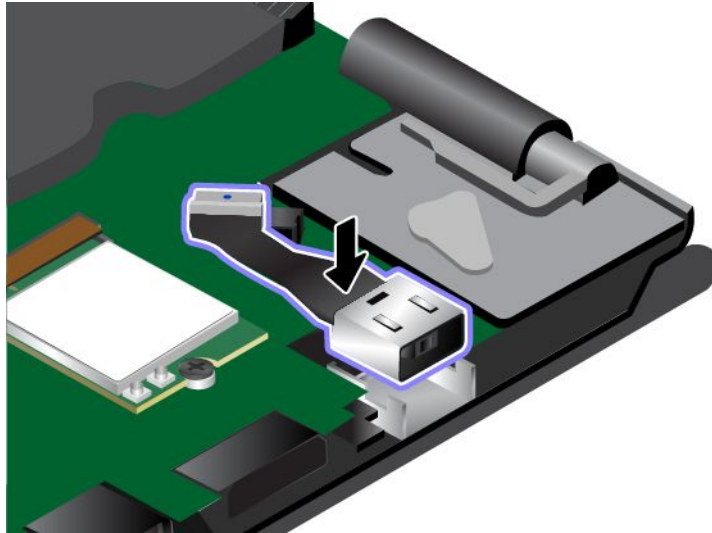

9. Install the dc-in bracket in place.

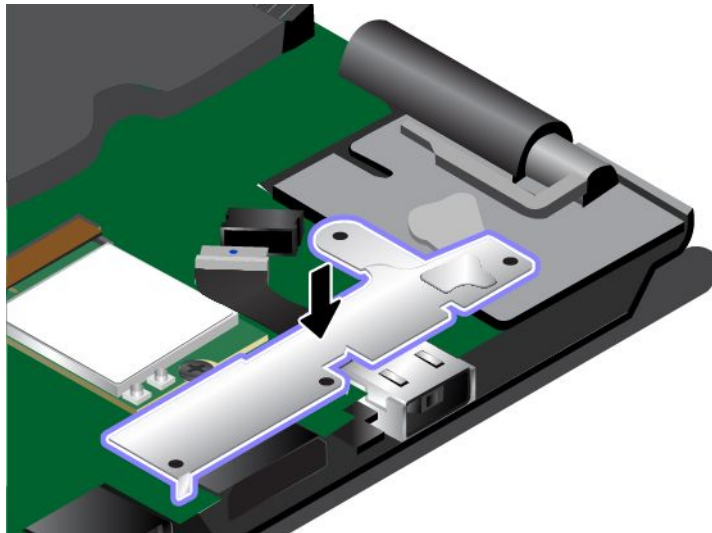

10. Reinstall the screws to secure the ac power card.

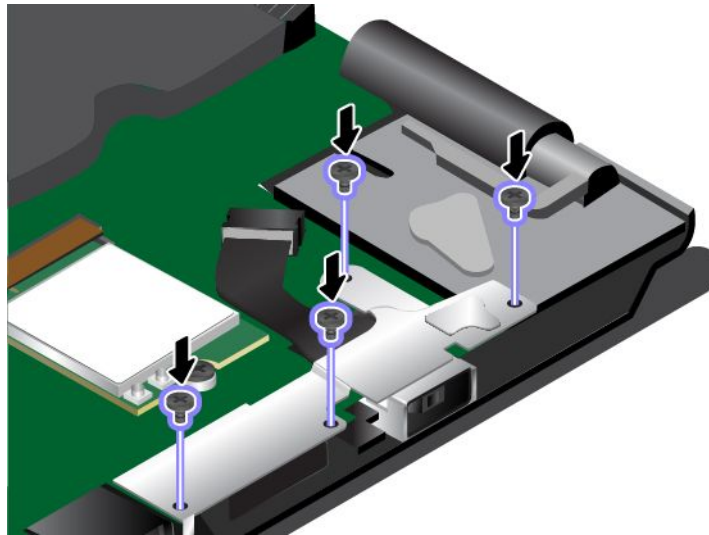

11. Reconnect the cable.

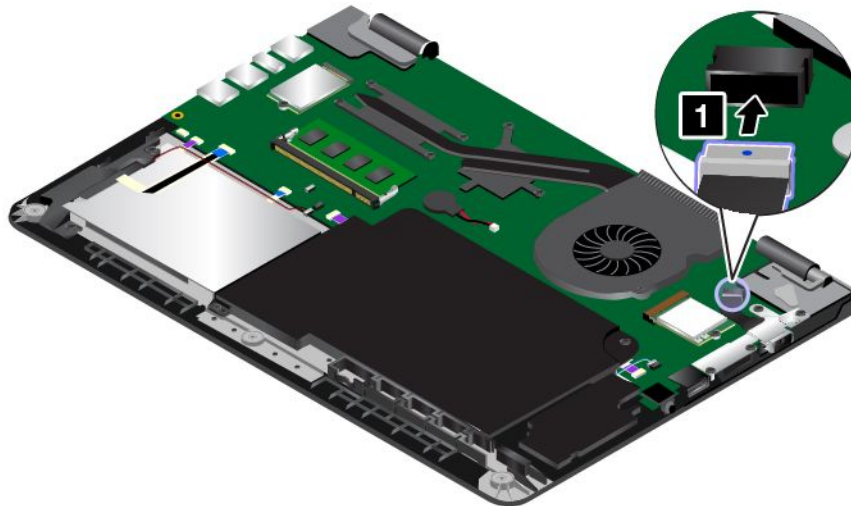

12. Reinstall the base cover assembly.

13. Turn the computer over again. Connect the ac power adapter and all cables to the computer.

Replacing the speaker assembly

Before you start, print these instructions. Read the important safety information first. See “Important safety information” on page vi.

Note: Depending on the model, your computer might look slightly different from the illustrations in this topic.

To replace the speaker assembly, do the following:

1. Disable the built-in battery. See “Disabling the built-in battery” on page 117.
2. Close the computer display, and turn the computer over.

3. Remove the base cover assembly. See “Replacing the base cover assembly” on page 124.
4. Remove the button I/O card. See “Replacing the button I/O card” on page 131.
5. Detach the connectors.

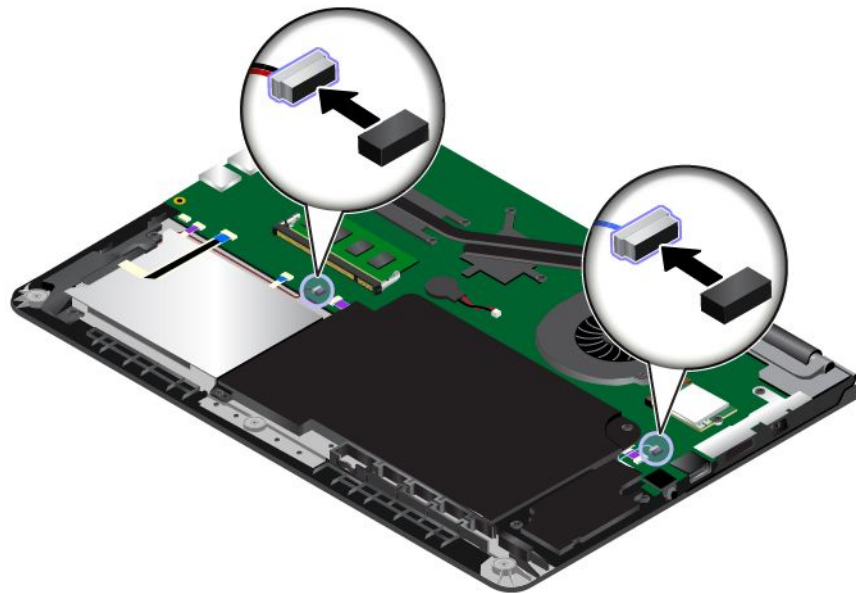

6. Remove the screws. Then remove the speaker assembly.

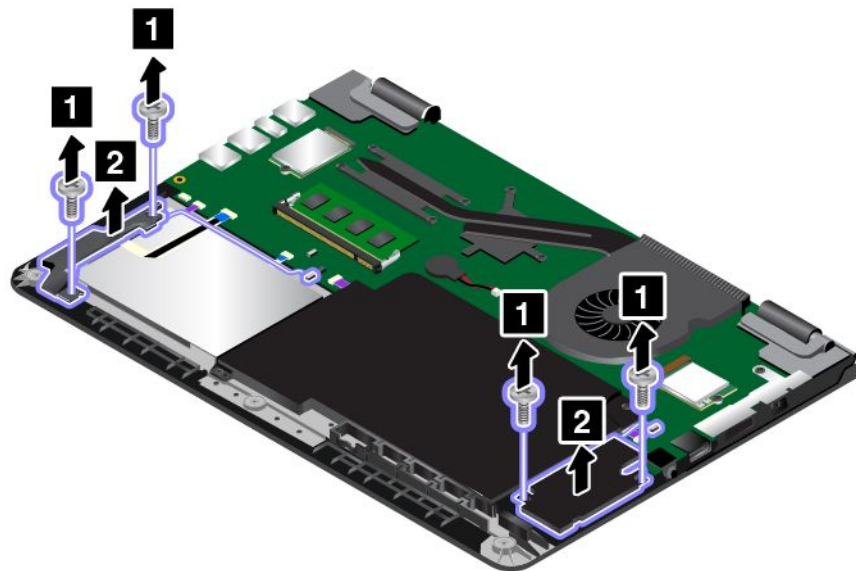

7. Install the new speaker assembly in place. Then install the screws to secure the speaker assembly.

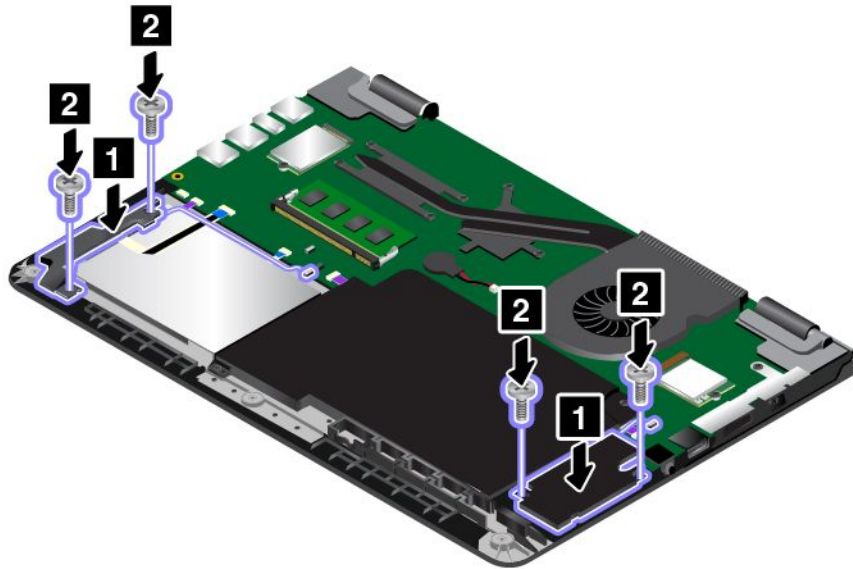

8. Reattach the connectors.

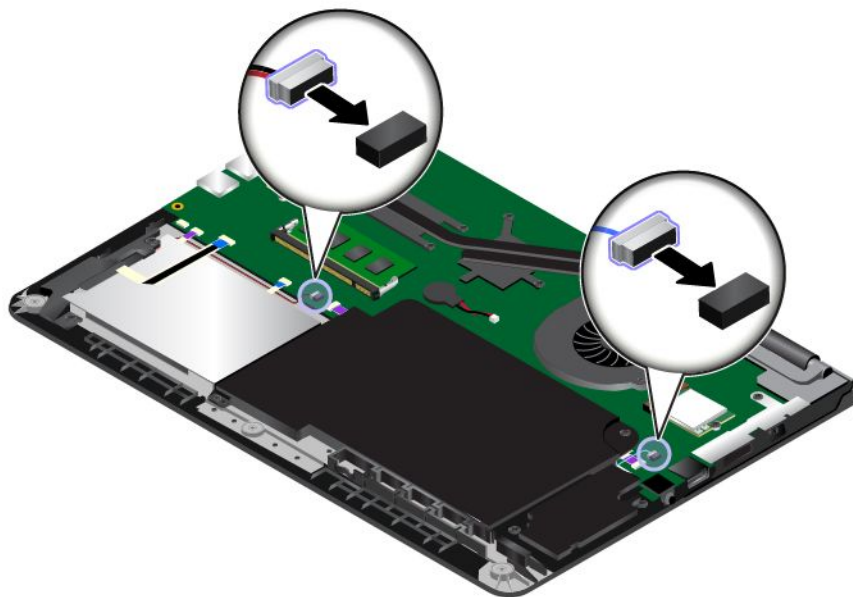

9. Reinstall the button I/O card. See “Replacing the button I/O card” on page 131.

10. Reinstall the base cover assembly.

11. Turn the computer over again. Connect the ac power adapter and all cables to the computer.

Replacing the coin-cell battery

Before you start, print these instructions. Read the important safety information first. See “Important safety information” on page vi.

 **DANGER**

If the coin-cell battery is incorrectly replaced, there is danger of an explosion. The coin-cell battery contains a small amount of harmful substances. To avoid possible injury:

- Replace only with a battery of the type recommended by Lenovo.
- Keep the battery away from fire.
- Do not expose it to excessive heat.
- Do not expose it to water or rain.
- Do not short-circuit it.
- Do not drop, crush, puncture the battery, or make it subject to strong forces. Battery abuse or mishandling can cause the battery to overheat, which can cause gasses or flame to “vent” from the coin-cell battery.

To replace the coin-cell battery, do the following:

1. Disable the built-in battery. See “Disabling the built-in battery” on page 117.
2. Close the computer display, and turn the computer over.
3. Remove the base cover assembly. See “Replacing the base cover assembly” on page 124.
4. Detach the connector **1**, and then remove the coin-cell battery **2**.

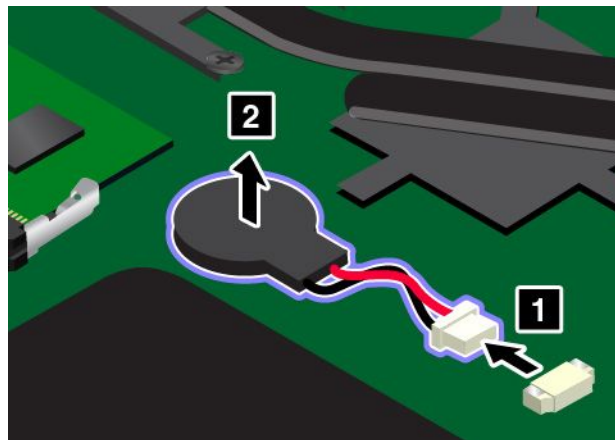

5. Install the new coin-cell battery **1**, and then attach the connector **2**.

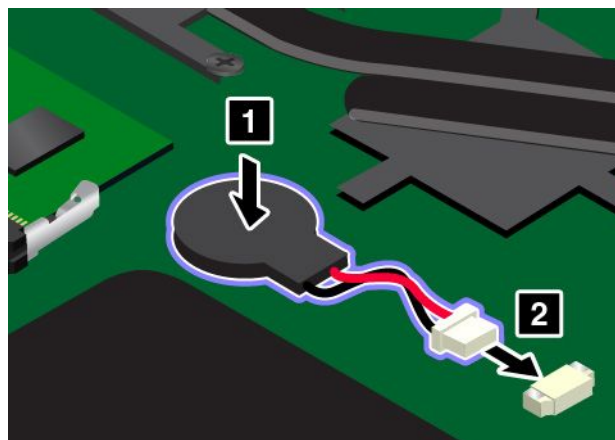

6. Reinstall the base cover assembly.

7. Turn the computer over again. Connect the ac power adapter and all cables to the computer.

Chapter 11. Getting support

This chapter provides information about getting help and support from Lenovo.

- “Before you contact Lenovo” on page 143
- “Getting help and service” on page 143
- “Purchasing additional services” on page 145

Before you contact Lenovo

Often, you can solve your computer problems by referring to the information in the explanations of error codes, running diagnostic programs, or by consulting the Lenovo Web site.

Registering your computer

Register your computer with Lenovo. For more information, see “Registering your computer” on page 15.

Downloading system updates

Downloading updated software might resolve problems you experience with your computer.

To download updated software, go to the following Web site and follow the instructions on the screen:
<http://www.lenovo.com/support>

Recording information

Before you talk to a Lenovo representative, record the following important information about your computer.

Recording problem symptoms and details

Collect the answers to the questions below before you call for help. Then, you will be able to get help as quickly as possible.

- What is the problem? Is it continuous or intermittent?
- Is there an error message? What is the error code, if any?
- What operating system are you using? Which version?
- Which software applications were running at the time of the problem?
- Can the problem be reproduced? If so, how?

Recording system information

The serial number label is on the bottom of your computer. Record the machine type and the serial number.

- What is the name of your Lenovo product?
- What is the machine type?
- What is the serial number?

Getting help and service

If you need help, service, technical assistance, or just want more information about Lenovo products, you will find a wide variety of sources available from Lenovo to assist you. This section contains information about where to go for additional information about Lenovo and our products, what to do if you experience a problem with your computer, and whom to call for service should it be necessary.

Information about your computer and preinstalled software, if any, is available in the documentation that comes with your computer. That documentation includes printed books, online books, readme files, and help files. In addition, information about Lenovo products is available on the World Wide Web.

Microsoft Service Packs are the latest software source for Windows product updates. They are available through Web download (connection charges might apply) or through disc. For more specific information and links, go to <http://www.microsoft.com>. Lenovo offers technical assistance with installation of, or questions related to, Service Packs for your Lenovo-preloaded Microsoft Windows product. For information, contact the Customer Support Center.

Using diagnostic programs

Many computer problems can be solved without outside assistance. If you experience a problem with your computer, the first place to start is the troubleshooting information of your computer documentation. If you suspect a software problem, see the documentation, including readme files and help information systems, which comes with the operating system or application program.

ThinkPad notebook computers come with a set of diagnostic programs that you can use to help you identify hardware problems. See “Diagnosing problems” on page 93 for instructions on using the diagnostic programs.

The troubleshooting information or the diagnostic programs might tell you that you need additional or updated device drivers or other software. You can get the latest technical information and download device drivers and updates from the Lenovo Web site at <http://www.lenovo.com/support>.

Lenovo Support Web site

Technical support information is available on the Lenovo Support Web site at:
<http://www.lenovo.com/support>

This Web site is updated with the latest support information such as the following:

- Drivers and software
- Diagnostic solutions
- Product and service warranty
- Product and parts details
- User guides and manuals
- Knowledge base and frequently asked questions

Calling Lenovo

If you have tried to correct the problem yourself and still need help, during the warranty period, you can get help and information by telephone through the Customer Support Center. The following services are available during the warranty period:

- Problem determination - Trained personnel are available to assist you with determining if you have a hardware problem and deciding what action is necessary to fix the problem.
- Lenovo hardware repair - If the problem is determined to be caused by Lenovo hardware under warranty, trained service personnel are available to provide the applicable level of service.
- Engineering change management - Occasionally, there might be changes that are required after a product has been sold. Lenovo or your reseller, if authorized by Lenovo, will make selected Engineering Changes (ECs) that apply to your hardware available.

The following items are not covered:

- Replacement or use of parts not manufactured for or by Lenovo or non-warranted parts

Note: All warranted parts contain a 7-character identification in the format FRU XXXXXXXX or a 10-character identification in the format FRU XXXXXXXXXXXX.

- Identification of software problem sources
- Configuration of UEFI BIOS as part of an installation or upgrade
- Changes, modifications, or upgrades to device drivers
- Installation and maintenance of network operating systems (NOS)
- Installation and maintenance of application programs

For the terms and conditions of the Lenovo Limited Warranty that applies to your Lenovo hardware product, see “Warranty information” in the *Safety, Warranty, and Setup Guide* that comes with your computer.

If possible, be near your computer when you make your call in case the technical assistance representative needs to help you resolve a computer problem. Ensure that you have downloaded the most current drivers and system updates, run diagnostics, and recorded information before you call. When calling for technical assistance, have the following information available:

- Machine type and model
- Serial numbers of your computer, monitor, and other components, or your proof of purchase
- Description of the problem
- Exact wording of any error messages
- Hardware and software configuration information for your system

Telephone numbers

For a list of the Lenovo Support phone numbers for your country or region, go to <http://www.lenovo.com/support/phone> or refer to the *Safety, Warranty, and Setup Guide* that comes with your computer.

Note: Phone numbers are subject to change without notice. The latest phone numbers are available at <http://www.lenovo.com/support/phone>. If the number for your country or region is not provided, contact your Lenovo reseller or Lenovo marketing representative.

Purchasing additional services

During and after the warranty period, you can purchase additional services, such as support for Lenovo and non-Lenovo hardware, operating systems, and application programs; network setup and configuration services; upgraded or extended hardware repair services; and custom installations services. Service availability and service name might vary by country.

For more information about these services, go to:
<http://www.lenovo.com/essentials>

Appendix A. Regulatory information

The latest compliance information is available at <http://www.lenovo.com/compliance>.

Location of the UltraConnect wireless antennas

ThinkPad notebook computers feature an UltraConnect™ wireless antenna system built into the display for optimal reception, which enables you to establish wireless communications wherever you are.

Note: Depending on the model, your computer might look different from the following illustration.

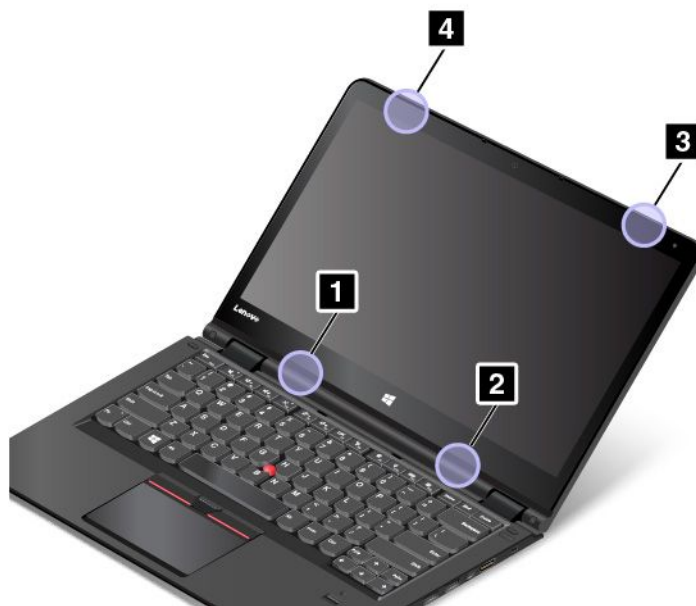

- 1** Wireless-LAN antenna (auxiliary)
- 2** Wireless-LAN antenna (main)
- 3** Wireless-WAN antenna (main) (available on some models)
- 4** Wireless-WAN antenna (auxiliary) (available on some models)

Wireless related information

Wireless interoperability

The wireless LAN card is designed to be interoperable with any wireless LAN product that is based on DSSS, CCK, and/or OFDM radio technology, and is compliant to:

- The 802.11b/g Standard, 802.11a/b/g, 802.11n, or, 802.11ac on Wireless LANs, as defined and approved by the Institute of Electrical and Electronics Engineers.
- The WiFi certification as defined by the Wi-Fi Alliance.

A Bluetooth device is designed to be interoperable with any Bluetooth product that is compliant to Bluetooth Specification 4.0 as defined by the Bluetooth SIG. The following profiles are supported by the Bluetooth devices:

Note: Depending on the Bluetooth card and the operating system you use, some profiles might not be available.

- Advanced Audio Distribution Profile (A2DP)
- Audio/Video Control Transport Protocol (AVCTP)
- Audio/Video Distribution Transport Protocol (AVDTP)
- A/V Remote Control Profile (AVRCP)
- Basic Imaging Profile (BIP)
- Basic Printing Profile (BPP)
- Dial-Up Networking Profile (DUN)
- File Transfer Profile (FTP)
- Generic Access Profile (GAP)
- Generic A/V Distribution Profile (GAVDP)
- Hardcopy Cable Replacement Profile (HCRP)
- Headset Profile (HSP)
- Hands-Free Profile (HFP)
- Human Interface Device Profile (HID)
- Message Access Profile (MAP)
- Object Exchange Protocol (OBEX)
- Object Push Profile (OPP)
- Personal Area Networking Profile (PAN)
- Phone Book Access Profile (PBAP)
- Service Discovery Protocol (SDP)
- Synchronization Profile (SYNC)
- Video Distribution Profile (VDP)
- Generic Attribute Profile (GATT)
- Proximity Profile
- Find Me Profile
- Immediate Alert Profile
- Battery Status Profile

Usage environment and your health

Integrated wireless cards emit radio frequency electromagnetic energy like other radio devices. However, the level of energy emitted is far much less than the electromagnetic energy emitted by wireless devices like for example mobile phones.

Due to the fact that integrated wireless cards operate within the guidelines found in radio frequency safety standards and recommendations, Lenovo believes they are safe for use by consumers. These standards and recommendations reflect the consensus of the scientific community and result from deliberations of panels and committees of scientists who continually review and interpret the extensive research literature.

In some situation or environment, the use of integrated wireless cards might be restricted by the proprietor of the building or responsible representatives of the organization. These situations and areas might for example include:

- Using the integrated wireless cards on board of airplanes, in hospitals or near petrol stations, blasting areas (with electro-explosive devices), medical implants or body-worn electronic medical devices, such as pace makers.
- In any other environment where the risk of interference to other devices or services is perceived or identified as harmful.

If you are uncertain of the policy that applies to the use of wireless devices in a specific organization (such as airport or hospital), you are encouraged to ask for authorization to use integrated wireless cards prior to turning on the computer.

Wireless-radio compliance information

Computer models equipped with wireless communications comply with the radio frequency and safety standards of any country or region in which it has been approved for wireless use.

Brazil wireless-radio compliance information

Este equipamento opera em caráter secundário, isto é, não tem direito a proteção contra interferência prejudicial, mesmo de estações do mesmo tipo, e não pode causar interferência a sistemas operando em caráter primário.

This equipment is a secondary type device, that is, it is not protected against harmful interference, even if the interference is caused by a device of the same type, and it also cannot cause any interference to primary type devices.

Mexico wireless-radio compliance information

Advertencia: En Mexico la operación de este equipo está sujeta a las siguientes dos condiciones: (1) es posible que este equipo o dispositivo no cause interferencia perjudicial y (2) este equipo o dispositivo debe aceptar cualquier interferencia, incluyendo la que pueda causar su operación no deseada.

Locating wireless regulatory notices

For more information about the wireless regulatory notices, refer to the *Regulatory Notice* shipped with your computer.

If your computer is shipped without the *Regulatory Notice*, you can find it on the Web site at:
<http://www.lenovo.com/UserManuals>

Certification related information

The following table contains information of the product name, compliance ID, and machine types.

Product name	Compliance ID	Machine types
ThinkPad P40 Yoga®	TP00079A	20GR, 20GQ
ThinkPad S3	TP00079A	20G0, 20G1
ThinkPad Yoga 14	TP00079A	20FY
ThinkPad Yoga 460	TP00079A	20EL, 20EM

Export classification notice

This product is subject to the United States Export Administration Regulations (EAR) and has an Export Classification Control Number (ECCN) of 5A992.c . It can be re-exported except to any of the embargoed countries in the EAR E1 country list.

Electronic emission notices

Federal Communications Commission Declaration of Conformity

The following information refers to the ThinkPad P40 Yoga, machine types 20GR, 20GQ; ThinkPad S3, machine types 20G0, 20G1; ThinkPad Yoga 14, machine type 20FY; ThinkPad Yoga 460, machine types 20EL, 20EM.

This equipment has been tested and found to comply with the limits for a Class B digital device, pursuant to Part 15 of the FCC Rules. These limits are designed to provide reasonable protection against harmful interference in a residential installation. This equipment generates, uses, and can radiate radio frequency energy and, if not installed and used in accordance with the instructions, may cause harmful interference to radio communications. However, there is no guarantee that interference will not occur in a particular installation. If this equipment does cause harmful interference to radio or television reception, which can be determined by turning the equipment off and on, the user is encouraged to try to correct the interference by one or more of the following measures:

- Reorient or relocate the receiving antenna.
- Increase the separation between the equipment and receiver.
- Connect the equipment into an outlet on a circuit different from that to which the receiver is connected.
- Consult an authorized dealer or service representative for help.

Lenovo is not responsible for any radio or television interference caused by using other than specified or recommended cables and connectors or by unauthorized changes or modifications to this equipment. Unauthorized changes or modifications could void the user's authority to operate the equipment.

This device complies with Part 15 of the FCC Rules. Operation is subject to the following two conditions: (1) this device may not cause harmful interference, and (2) this device must accept any interference received, including interference that may cause undesired operation.

Responsible Party:

Lenovo (United States) Incorporated

1009 Think Place - Building One

Morrisville, NC 27560

Phone Number: 919-294-5900



Industry Canada Class B emission compliance statement

CAN ICES-3(B)/NMB-3(B)

European Union - Compliance to the Electromagnetic Compatibility Directive

This product is in conformity with the protection requirements of EU Council Directive 2004/108/EC on the approximation of the laws of the Member States relating to electromagnetic compatibility. Lenovo cannot accept responsibility for any failure to satisfy the protection requirements resulting from a non-recommended modification of the product, including the installation of option cards from other manufacturers.

This product has been tested and found to comply with the limits for Class B Information Technology Equipment according to European Standard EN 55022. The limits for Class B equipment were derived for typical residential environments to provide reasonable protection against interference with licensed communication devices.

EU contact: Lenovo, Einsteinova 21, 851 01 Bratislava, Slovakia



German Class B compliance statement

Deutschsprachiger EU Hinweis:

Hinweis für Geräte der Klasse B EU-Richtlinie zur Elektromagnetischen Verträglichkeit

Dieses Produkt entspricht den Schutzanforderungen der EU-Richtlinie 2004/108/EG (früher 89/336/EWG) zur Angleichung der Rechtsvorschriften über die elektromagnetische Verträglichkeit in den EU-Mitgliedsstaaten und hält die Grenzwerte der EN 55022 Klasse B ein.

Um dieses sicherzustellen, sind die Geräte wie in den Handbüchern beschrieben zu installieren und zu betreiben. Des Weiteren dürfen auch nur von der Lenovo empfohlene Kabel angeschlossen werden. Lenovo übernimmt keine Verantwortung für die Einhaltung der Schutzanforderungen, wenn das Produkt ohne Zustimmung der Lenovo verändert bzw. wenn Erweiterungskomponenten von Fremdherstellern ohne Empfehlung der Lenovo gesteckt/eingebaut werden.

Deutschland:

Einhaltung des Gesetzes über die elektromagnetische Verträglichkeit von Betriebsmitteln

Dieses Produkt entspricht dem „Gesetz über die elektromagnetische Verträglichkeit von Betriebsmitteln“ EMVG (früher „Gesetz über die elektromagnetische Verträglichkeit von Geräten“). Dies ist die Umsetzung der EU-Richtlinie 2004/108/EG (früher 89/336/EWG) in der Bundesrepublik Deutschland.

Zulassungsbescheinigung laut dem Deutschen Gesetz über die elektromagnetische Verträglichkeit von Betriebsmitteln, EMVG vom 20. Juli 2007 (früher Gesetz über die elektromagnetische Verträglichkeit von Geräten), bzw. der EMV EG Richtlinie 2004/108/EC (früher 89/336/EWG), für Geräte der Klasse B.

Dieses Gerät ist berechtigt, in Übereinstimmung mit dem Deutschen EMVG das EG-Konformitätszeichen - CE - zu führen. Verantwortlich für die Konformitätserklärung nach Paragraf 5 des EMVG ist die Lenovo (Deutschland) GmbH, Meitnerstr. 9, D-70563 Stuttgart.

Informationen in Hinsicht EMVG Paragraf 4 Abs. (1) 4:

Das Gerät erfüllt die Schutzanforderungen nach EN 55024 und EN 55022 Klasse B.

Korea Class B compliance statement

B급 기기(가정용 방송통신기자재)
이 기기는 가정용(B급) 전자파적합기기로서 주로 가정에서 사용하는 것을 목적으로 하며, 모든 지역에서 사용할 수 있습니다

Japan VCCI Class B compliance statement

この装置は、クラスB情報技術装置です。この装置は、家庭環境で使用することを目的としていますが、この装置がラジオやテレビジョン受信機に近接して使用されると、受信障害を引き起こすことがあります。
取扱説明書に従って正しい取り扱いをして下さい。 VCCI-B

Japan compliance statement for products which connect to the power mains with rated current less than or equal to 20 A per phase

日本の定格電流が 20A/相 以下の機器に対する高調波電流規制
高調波電流規格 JIS C 61000-3-2 適合品

Japan notice for ac power cord

The ac power cord shipped with your product can be used only for this specific product. Do not use the ac power cord for other devices.

本製品およびオプションに電源コード・セットが付属する場合は、それぞれ専用のものになっていますので他の電気機器には使用しないでください。

Lenovo product service information for Taiwan

台灣 Lenovo 產品服務資訊如下：
荷蘭商聯想股份有限公司台灣分公司
台北市內湖區堤頂大道二段89號5樓
服務電話：0800-000-702

Eurasian compliance mark



Brazil audio notice

Ouvir sons com mais de 85 decibéis por longos períodos pode provocar danos ao sistema auditivo.

Appendix B. WEEE and recycling statements

Lenovo encourages owners of information technology equipment to responsibly recycle their equipment when it is no longer needed. Lenovo offers a variety of programs and services to assist equipment owners in recycling their IT products. For information about recycling Lenovo products, go to <http://www.lenovo.com/recycling>. The latest environmental information about our products is available at <http://www.lenovo.com/ecodeclaration>.

Important WEEE information

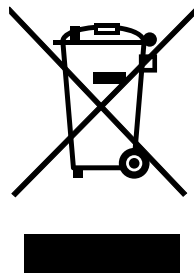

The WEEE marking on Lenovo products applies to countries with WEEE and e-waste regulations (for example, the European WEEE Directive, India E-Waste Management & Handling Rules, 2011). Appliances are labeled in accordance with local regulations concerning waste electrical and electronic equipment (WEEE). These regulations determine the framework for the return and recycling of used appliances as applicable within each geography. This label is applied to various products to indicate that the product is not to be thrown away, but rather put in the established collection systems for reclaiming these end of life products.

Users of electrical and electronic equipment (EEE) with the WEEE marking must not dispose of end of life EEE as unsorted municipal waste, but use the collection framework available to them for the return, recycle, and recovery of WEEE and to minimize any potential effects of EEE on the environment and human health due to the presence of hazardous substances. For additional WEEE information go to: <http://www.lenovo.com/recycling>

Japan recycling statements

Collecting and recycling a disused Lenovo computer or monitor

If you are a company employee and need to dispose of a Lenovo computer or monitor that is the property of the company, you must do so in accordance with the Law for Promotion of Effective Utilization of Resources. Computers and monitors are categorized as industrial waste and should be properly disposed of by an industrial waste disposal contractor certified by a local government. In accordance with the Law for Promotion of Effective Utilization of Resources, Lenovo Japan provides, through its PC Collecting and Recycling Services, for the collecting, reuse, and recycling of disused computers and monitors. For details, visit the Lenovo Web site at: http://www.lenovo.com/services_warranty/jp/ja/recycle/pcrecycle/.

Pursuant to the Law for Promotion of Effective Utilization of Resources, the collecting and recycling of home-used computers and monitors by the manufacturer was begun on October 1, 2003. This service is provided free of charge for home-used computers sold after October 1, 2003. For details, go to http://www.lenovo.com/services_warranty/jp/ja/recycle/personal/.

Disposing of Lenovo computer components

Some Lenovo computer products sold in Japan may have components that contain heavy metals or other environmental sensitive substances. To properly dispose of disused components, such as a printed circuit board or drive, use the methods described above for collecting and recycling a disused computer or monitor.

Disposing of disused lithium batteries from Lenovo computers

A button-shaped lithium battery is installed inside your Lenovo computer to provide power to the computer clock while the computer is off or disconnected from the main power source. If you need to replace it with a new one, contact your place of purchase or contact Lenovo for service. If you need to dispose of a disused lithium battery, insulate it with vinyl tape, contact your place of purchase or an industrial-waste-disposal operator, and follow their instructions.

Disposal of a lithium battery must comply with local ordinances and regulations.

Disposing of a disused battery pack from Lenovo notebook computers

Your Lenovo notebook computer has a lithium ion battery pack or a nickel metal hydride battery pack. If you are a company employee who uses a Lenovo notebook computer and need to dispose of a battery pack, contact the proper person in Lenovo sales, service, or marketing, and follow that person's instructions. You also can refer to the instructions at <http://www.lenovo.com/jp/ja/environment/recycle/battery/>.

If you use a Lenovo notebook computer at home and need to dispose of a battery pack, you must comply with local ordinances and regulations. You also can refer to the instructions at <http://www.lenovo.com/jp/ja/environment/recycle/battery/>.

Recycling information for Brazil

Declarações de Reciclagem no Brasil

Descarte de um Produto Lenovo Fora de Uso

Equipamentos elétricos e eletrônicos não devem ser descartados em lixo comum, mas enviados à pontos de coleta, autorizados pelo fabricante do produto para que sejam encaminhados e processados por empresas especializadas no manuseio de resíduos industriais, devidamente certificadas pelos órgãos ambientais, de acordo com a legislação local.

A Lenovo possui um canal específico para auxiliá-lo no descarte desses produtos. Caso você possua um produto Lenovo em situação de descarte, ligue para o nosso SAC ou encaminhe um e-mail para: reciclar@lenovo.com, informando o modelo, número de série e cidade, a fim de enviarmos as instruções para o correto descarte do seu produto Lenovo.

Battery recycling information for the European Union

EU

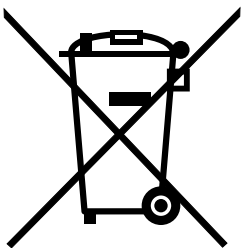

Notice: This mark applies only to countries within the European Union (EU).

Batteries or packaging for batteries are labeled in accordance with European Directive 2006/66/EC concerning batteries and accumulators and waste batteries and accumulators. The Directive determines the framework for the return and recycling of used batteries and accumulators as applicable throughout the European Union. This label is applied to various batteries to indicate that the battery is not to be thrown away, but rather reclaimed upon end of life per this Directive.

In accordance with the European Directive 2006/66/EC, batteries and accumulators are labeled to indicate that they are to be collected separately and recycled at end of life. The label on the battery may also include a chemical symbol for the metal concerned in the battery (Pb for lead, Hg for mercury, and Cd for cadmium). Users of batteries and accumulators must not dispose of batteries and accumulators as unsorted municipal waste, but use the collection framework available to customers for the return, recycling, and treatment of batteries and accumulators. Customer participation is important to minimize any potential effects of batteries and accumulators on the environment and human health due to the potential presence of hazardous substances. For proper collection and treatment, go to:
<http://www.lenovo.com/recycling>

Battery recycling information for Taiwan



廢電池請回收

Battery recycling information for the United States and Canada



US & Canada Only

Recycling information for China

《废弃电器电子产品回收处理管理条例》提示性说明

联想鼓励拥有联想品牌产品的用户当不再需要此类产品时，遵守国家废弃电器电子产品回收处理相关法律法规，将其交给当地具有国家认可的回收处理资质的厂商进行回收处理。更多回收服务信息，请点击进入<http://support.lenovo.com.cn/activity/551.htm>

Appendix C. Restriction of Hazardous Substances Directive (RoHS)

The latest environmental information is available at <http://www.lenovo.com/ecodeclaration>.

European Union RoHS

This Lenovo product, with included parts (cables, cords, and so on) meets the requirements of Directive 2011/65/EU on the restriction of the use of certain hazardous substances in electrical and electronic equipment (“RoHS recast” or “RoHS 2”).

For more information about Lenovo worldwide compliance on RoHS, go to:
http://www.lenovo.com/social_responsibility/us/en/RoHS_Communication.pdf

China RoHS

产品中有害物质的名称及含量

部件名称	铅 (Pb)	汞 (Hg)	镉 (Cd)	六价铬 (Cr (VI))	多溴联苯 (PBB)	多溴二苯醚 (PBDE)
印刷电路板组件	X	0	0	0	0	0
硬盘	X	0	0	0	0	0
光驱	X	0	0	0	0	0
LCD 面板 (LED 背光源)	X	0	0	0	0	0
键盘	X	0	0	0	0	0
内存	X	0	0	0	0	0
电池	X	0	0	0	0	0
电源适配器	X	0	0	0	0	0
底壳、顶盖和扬声器	X	0	0	0	0	0

注：

本表依据SJ/T 11364的规定编制。

0：表示该有害物质在该部件所有均质材料中的含量均在 GB/T 26572 标准规定的限量要求以下。

X：表示该有害物质至少在该部件的某一均质材料中的含量超出 GB/T 26572 标准规定的限量要求。标有“X”的部件，皆因全球技术发展水平限制而无法实现有害物质的替代。印刷电路板组件包括印刷电路板（PCB）及其组件、集成电路（IC）和连接器。某些型号的产品可能不包含上表中的某些部件，请以实际购买机型为准。

图示：



在中华人民共和国境内销售的电子信息产品上将印有“环保使用期限”（EUP）符号。圆圈中的数字代表产品的正常环保使用期限。

Turkish RoHS

The Lenovo product meets the requirements of the Republic of Turkey Directive on the Restriction of the Use of Certain Hazardous Substances in Waste Electrical and Electronic Equipment (WEEE).

Türkiye AEEE Yönetmeliğine Uygunluk Beyanı

Bu Lenovo ürünü, T.C. Çevre ve Orman Bakanlığı'nın "Atık Elektrik ve Elektronik Eşyalarda Bazı Zararlı Maddelerin Kullanımının Sınırlandırılmasına Dair Yönetmelik (AEEE)" direktiflerine uygundur.

AEEE Yönetmeliğine Uygundur.

Ukraine RoHS

Цим підтверджуємо, що продукція Леново відповідає вимогам нормативних актів України, які обмежують вміст небезпечних речовин

India RoHS

RoHS compliant as per E-Waste (Management & Handling) Rules, 2011.

Appendix D. ENERGY STAR model information



ENERGY STAR® is a joint program of the U.S. Environmental Protection Agency and the U.S. Department of Energy aimed at saving money and protecting the environment through energy efficient products and practices.

Lenovo is proud to offer our customers products with the ENERGY STAR qualified designation. You might find an ENERGY STAR mark affixed on the computer or displayed on the power settings interface. Lenovo computers of the following machine types, if carry an ENERGY STAR mark, have been designed and tested to conform to the ENERGY STAR program requirements for computers.

20EM, 20EL, 20FY, 20G0, 20G1, 20GR, and 20GQ

By using ENERGY STAR qualified products and taking advantage of the power-management features of your computer, you can help reduce the consumption of electricity. Reduced electrical consumption can contribute to potential financial savings, a cleaner environment, and the reduction of greenhouse gas emissions.

For more information about ENERGY STAR, go to:
<http://www.energystar.gov>

Lenovo encourages you to make efficient use of energy an integral part of your day-to-day operations. To help in this endeavor, Lenovo has preset the following power-management features to take effect when your computer has been inactive for a specified length of time:

Power plan: Default

- Turn off the display: After 10 minutes
- Put the computer into sleep: After 20 minutes

To awaken your computer from sleep mode, press the Fn key on your keyboard. For more information about these settings, see the Windows help information on your computer.

The Wake on LAN function is enabled when your Lenovo computer is shipped from the factory, and the setting remains valid even when the computer is in sleep mode. If you do not need to have Wake on LAN enabled while your computer is in sleep mode, you can reduce the power consumption and prolong the time in sleep mode, by disabling the setting of Wake on LAN for sleep mode. To disable the setting of Wake on LAN for sleep mode, do the following:

1. Go to Control Panel.
2. Click **Hardware and Sound** → **Device Manager**.
3. In the Device Manager window, expand **Network adapters**.
4. Right-click your network adapter device, and click **Properties**.
5. Click the **Power Management** tab.

6. Clear the **Allow this device to wake the computer** check box.
7. Click **OK**.

Appendix E. Notices

Lenovo may not offer the products, services, or features discussed in this document in all countries. Consult your local Lenovo representative for information on the products and services currently available in your area. Any reference to a Lenovo product, program, or service is not intended to state or imply that only that Lenovo product, program, or service may be used. Any functionally equivalent product, program, or service that does not infringe any Lenovo intellectual property right may be used instead. However, it is the user's responsibility to evaluate and verify the operation of any other product, program, or service.

Lenovo may have patents or pending patent applications covering subject matter described in this document. The furnishing of this document does not give you any license to these patents. You can send license inquiries, in writing, to:

*Lenovo (United States), Inc.
1009 Think Place - Building One
Morrisville, NC 27560
U.S.A.
Attention: Lenovo Director of Licensing*

LENOVO PROVIDES THIS PUBLICATION "AS IS" WITHOUT WARRANTY OF ANY KIND, EITHER EXPRESS OR IMPLIED, INCLUDING, BUT NOT LIMITED TO, THE IMPLIED WARRANTIES OF NON-INFRINGEMENT, MERCHANTABILITY OR FITNESS FOR A PARTICULAR PURPOSE. Some jurisdictions do not allow disclaimer of express or implied warranties in certain transactions, therefore, this statement may not apply to you.

This information could include technical inaccuracies or typographical errors. Changes are periodically made to the information herein; these changes will be incorporated in new editions of the publication. Lenovo may make improvements and/or changes in the product(s) and/or the program(s) described in this publication at any time without notice.

The products described in this document are not intended for use in implantation or other life support applications where malfunction may result in injury or death to persons. The information contained in this document does not affect or change Lenovo product specifications or warranties. Nothing in this document shall operate as an express or implied license or indemnity under the intellectual property rights of Lenovo or third parties. All information contained in this document was obtained in specific environments and is presented as an illustration. The result obtained in other operating environments may vary.

Lenovo may use or distribute any of the information you supply in any way it believes appropriate without incurring any obligation to you.

Any references in this publication to non-Lenovo Web sites are provided for convenience only and do not in any manner serve as an endorsement of those Web sites. The materials at those Web sites are not part of the materials for this Lenovo product, and use of those Web sites is at your own risk.

Any performance data contained herein was determined in a controlled environment. Therefore, the result obtained in other operating environments may vary significantly. Some measurements may have been made on development-level systems and there is no guarantee that these measurements will be the same on generally available systems. Furthermore, some measurements may have been estimated through extrapolation. Actual results may vary. Users of this document should verify the applicable data for their specific environment.

Trademarks

The following terms are trademarks of Lenovo in the United States, other countries, or both:

- Lenovo
- Lenovo logo
- Active Protection System
- Secure Data Disposal
- ThinkPad
- ThinkPad logo
- TrackPoint
- UltraConnect
- Yoga

Intel, Intel SpeedStep, and Intel vPro are trademarks of Intel Corporation in the U. S. and/or other countries.

BitLocker, Microsoft, and Windows are trademarks of the Microsoft group of companies.

The terms HDMI and HDMI High-Definition Multimedia Interface are trademarks or registered trademarks of HDMI Licensing LLC in the United States and other countries.

Other company, product, and service names may be trademarks or service marks of others.

Lenovo[™]