

**MX370111A/MX269911A
WLAN IQproducer™
Operation Manual
and
MX283027A-001
WLAN Test Software
Operation Manual
(WLAN IQproducer™)**

Sixth Edition

- For safety and warning information, please read this manual before attempting to use the equipment.
- Additional safety and warning information is provided within the MG3700A Vector Signal Generator Operation Manual (Mainframe), MG3710A Vector Signal Generator MG3740A Analog Signal Generator Operation Manual (Mainframe), MS2690A/MS2691A/MS2692A Signal Analyzer Operation Manual (Mainframe Operation), or MS2830A Signal Analyzer Operation Manual (Mainframe Operation). Please also refer to either of these documents before using the equipment.
- Keep this manual with the equipment.

ANRITSU CORPORATION

Safety Symbols

To prevent the risk of personal injury or loss related to equipment malfunction, Anritsu Corporation uses the following safety symbols to indicate safety-related information. Ensure that you clearly understand the meanings of the symbols BEFORE using the equipment. Some or all of the following symbols may be used on all Anritsu equipment. In addition, there may be other labels attached to products that are not shown in the diagrams in this manual.

Symbols used in manual

 **DANGER** This indicates a very dangerous procedure that could result in serious injury or death if not performed properly.

 **WARNING** This indicates a hazardous procedure that could result in serious injury or death if not performed properly.

 **CAUTION** This indicates a hazardous procedure or danger that could result in light-to-severe injury, or loss related to equipment malfunction, if proper precautions are not taken.

Safety Symbols Used on Equipment and in Manual

The following safety symbols are used inside or on the equipment near operation locations to provide information about safety items and operation precautions. Ensure that you clearly understand the meanings of the symbols and take the necessary precautions BEFORE using the equipment.



This indicates a prohibited operation. The prohibited operation is indicated symbolically in or near the barred circle.



This indicates an obligatory safety precaution. The obligatory operation is indicated symbolically in or near the circle.



This indicates a warning or caution. The contents are indicated symbolically in or near the triangle.



This indicates a note. The contents are described in the box.



These indicate that the marked part should be recycled.

MX370111A/MX269911A WLAN IQproducer™ Operation Manual and
MX283027A-001 WLAN Test Software Operation Manual (WLAN IQproducer™)

22 April 2011 (First Edition)

25 November 2014 (Sixth Edition)

Copyright © 2011-2014, ANRITSU CORPORATION.

All rights reserved. No part of this manual may be reproduced without the prior written permission of the publisher.

The contents of this manual may be changed without prior notice.

Printed in Japan

Equipment Certificate

Anritsu Corporation guarantees that this equipment was inspected at shipment and meets the published specifications.

Anritsu Warranty

- During the warranty period, Anritsu Corporation will repair or exchange this software free-of-charge if it proves defective when used as described in the operation manual.
- The warranty period is 6 months from the purchase date.
- The warranty period after repair or exchange will remain 6 months from the original purchase date, or 30 days from the date of repair or exchange, depending on whichever is longer.
- This warranty does not cover damage to this software caused by Acts of God, natural disasters, and misuse or mishandling by the customer.

In addition, this warranty is valid only for the original equipment purchaser. It is not transferable if the equipment is resold.

Anritsu Corporation shall assume no liability for injury or financial loss of the customer due to the use of or a failure to be able to use this equipment.

Anritsu Corporation Contact

In the event that this equipment malfunctions, contact an Anritsu Service and Sales office. Contact information can be found on the last page of the printed version of this manual, and is available in a separate file on the CD version.

Notes On Export Management

This product and its manuals may require an Export License/Approval by the Government of the product's country of origin for re-export from your country.

Before re-exporting the product or manuals, please contact us to confirm whether they are export-controlled items or not.

When you dispose of export-controlled items, the products/manuals need to be broken/shredded so as not to be unlawfully used for military purpose.

Software End-User License Agreement (EULA)

Please read this Software End-User License Agreement (hereafter this EULA) carefully before using (includes executing, copying, registering, etc.) this software (includes programs, databases, scenarios, etc., used to operate, set, etc., Anritsu electronic equipment). By reading this EULA and using this software, you are agreeing to be bound by the terms of its contents and Anritsu Corporation (hereafter Anritsu) hereby grants you the right to use this Software with the Anritsu-specified equipment (hereafter Equipment) for the purposes set out in this EULA.

1. Grant of License and Limitations

1. Regardless of whether this Software was purchased from or provided free-of-charge by Anritsu, you agree not to rent, lease, lend, or otherwise distribute this Software to third parties and further agree not to disassemble, recompile, reverse engineer, modify, or create derivative works of this Software.
2. You may make one copy of this Software for backup purposes only.
3. You are not permitted to reverse engineer this software.
4. This EULA allows you to install one copy of this Software on one piece of Equipment.

2. Disclaimers

To the extent not prohibited by law, in no event shall Anritsu be liable for personal injury, or any incidental, special, indirect or consequential damages whatsoever, including, without limitation, damages for loss of profits, loss of data, business interruption or any other commercial damages or losses, arising out of or related to your use or inability to use this Software.

3. Limitation of Liability

- a. If a fault (bug) is discovered in this Software, preventing operation as described in the operation manual or specifications whether or not the customer uses this software as described in the manual, Anritsu shall at its own discretion, fix the bug, or exchange the software, or suggest a workaround, free-of-charge. However, notwithstanding the above, the following items shall be excluded from repair and warranty.
 - i) If this Software is deemed to be used for purposes not described in the operation manual or specifications.
 - ii) If this Software is used in conjunction with other non-Anritsu-approved software.
 - iii) Recovery of lost or damaged data.
 - iv) If this Software or the Equipment has been modified, repaired, or otherwise altered without Anritsu's prior approval.
 - v) For any other reasons out of Anritsu's direct control and responsibility, such as but not limited to, natural disasters, software virus infections, etc.
- b. Expenses incurred for transport, hotel, daily allowance, etc., for on-site repairs by Anritsu engineers necessitated by the above faults shall be borne by you.
- c. The warranty period for faults listed in article 3a above covered by this EULA shall be either 6 months from the date of purchase of this Software or 30 days after the date of repair, whichever is longer.

4. Export Restrictions

You may not use or otherwise export or re-export directly or indirectly this Software except as authorized by Japanese and United States law. In particular, this software may not be exported or re-exported (a) into any Japanese or US embargoed countries or (b) to anyone on the Japanese or US Treasury Department's list of Specially Designated Nationals or the US Department of Commerce Denied Persons List or Entity List. By using this Software, you warrant that you are not located in any such country or on any such list. You also agree that you will not use this Software for any purposes prohibited by Japanese and US law, including, without limitation, the development, design and manufacture or production of missiles or nuclear, chemical or biological weapons of mass destruction.

5. Termination

Anritsu shall deem this EULA terminated if you violate any conditions described herein. This EULA shall also be terminated if the conditions herein cannot be continued for any good reason, such as violation of copyrights, patents, or other laws and ordinances.

6. Reparations

If Anritsu suffers any loss, financial or otherwise, due to your violation of the terms of this EULA, Anritsu shall have the right to seek proportional damages from you.

7. Responsibility after Termination

Upon termination of this EULA in accordance with item 5, you shall cease all use of this Software immediately and shall as directed by Anritsu either destroy or return this Software and any backup copies, full or partial, to Anritsu.

8. Dispute Resolution

If matters of dispute or items not covered by this EULA arise, they shall be resolved by negotiations in good faith between you and Anritsu.

9. Court of Jurisdiction

This EULA shall be interpreted in accordance with Japanese law and any disputes that cannot be resolved by negotiation described in Article 8 shall be settled by the Japanese courts.

Cautions against computer virus infection

- Copying files and data
Only files that have been provided directly from Anritsu or generated using Anritsu equipment should be copied to the instrument.
All other required files should be transferred by means of USB or CompactFlash media after undergoing a thorough virus check.
- Adding software
Do not download or install software that has not been specifically recommended or licensed by Anritsu.
- Network connections
Ensure that the network has sufficient anti-virus security protection in place.

Protection Against Computer Virus Infections

Prior to the software installation

Before installing this software or any other software recommended or approved by Anritsu, run a virus scan on your computer, including removable media (e.g. USB memory stick and CF memory card) you want to connect to your computer.

When using this software and connecting with the measuring instrument

- Copying files and data

On your computer, do not save any copies other than the following:

- Files and data provided by Anritsu
- Files created by this software
- Files specified in this document

Before copying these files and/or data, run a virus scan, including removable media (e.g. USB memory stick and CF memory card).

- Connecting to network

Connect your computer to the network that provides adequate protection against computer viruses.

Cautions on Proper Operation of Software

This software may not operate normally if any of the following operations are performed on your computer:

- Simultaneously running any software other than that recommended or approved by Anritsu
- Closing the lid (Laptop computer)
- Turning on the screen saver function
- Turning on the battery-power saving function (Laptop computer)

For how to turn off the functions, refer to the operation manual that came with your computer.

CE Conformity Marking

Anritsu affixes the CE conformity marking on the following product(s) in accordance with the Council Directive 93/68/EEC to indicate that they conform to the EMC and LVD directive of the European Union (EU).

CE marking



1. Product Model

Software: MX370111A/MX269911A WLAN IQproducer™

Software: MX283027A-001 WLAN Test Software

2. Applied Directive and Standards

When the MX370111A/MX269911A WLAN IQproducer™ or MX283027A-001 WLAN Test Software is installed in the MG3710A, MS2690A/MS2691A/MS2692A, or MS2830A, the applied directive and standards of this software conform to those of the MG3710A, MS2690A/MS2691A/MS2692A, or MS2830A main frame.

PS: About main frame

Please contact Anritsu for the latest information on the main frame types that MX370111A/MX269911A or MX283027A-001 can be used with.

C-tick Conformity Marking

Anritsu affixes the C-tick mark on the following product(s) in accordance with the regulation to indicate that they conform to the EMC framework of Australia/New Zealand.

C-tick marking



1. Product Model

Software: MX370111A/MX269911A WLAN IQproducer™

Software: MX283027A-001 WLAN Test Software

2. Applied Directive and Standards

When the MX370111A/MX269911A WLAN IQproducer™ or MX283027A-001 WLAN Test Software is installed in the MG3710A, MS2690A/MS2691A/MS2692A, or MS2830A, the applied directive and standards of this software conform to those of the MG3710A, MS2690A/MS2691A/MS2692A, or MS2830A main frame.

PS: About main frame

Please contact Anritsu for the latest information on the main frame types that MX370111A/MX269911A or MX283027A-001 can be used with.

About This Manual

■Associated Documents

The operation manual configuration of the MX370111A/MX269911A WLAN IQproducer MX283027A-001 WLAN Software (WLAN IQproducer) is shown below.

■If using MG3700A or MG3710A:

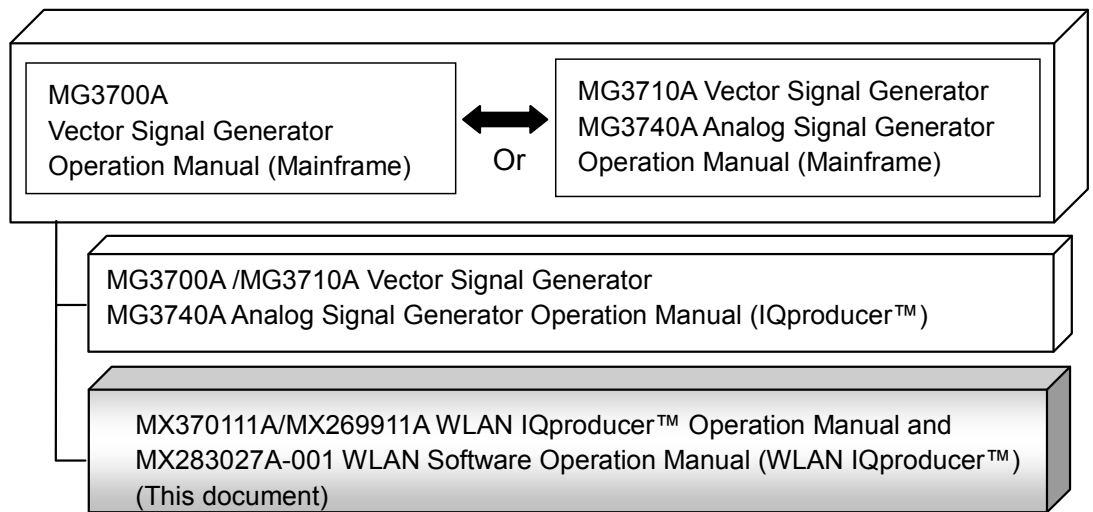

- MG3700A Vector Signal Generator Operation Manual (Mainframe)

This describes basic operations, maintenance procedure, and remote functions of the MG3700A Vector Signal Generator.



- MG3710A Vector Signal Generator MG3740A Analog Signal Generator Operation Manual (Mainframe)

This describes basic operations, maintenance procedure, and remote functions of the MG3710A Vector Signal Generator and the MG3740A Analog Signal Generator.

- MG3700A/MG3710A Vector Signal Generator MG3740A Analog Signal Generator Operation Manual (IQproducer™)

This describes the functions and how to use the IQproducer, which is Windows software for the Vector Signal Generator and the Analog Signal Generator.

- MX370111A/MX269911A WLAN IQproducer™ Operation Manual and MX283027A-001 WLAN Software Operation Manual (WLAN IQproducer™) (This document)

This describes basic operations and functions of the WLAN IQproducer™

■If using MS2690A/MS2691A/MS2692A or MS2830A without MX283027A-001:

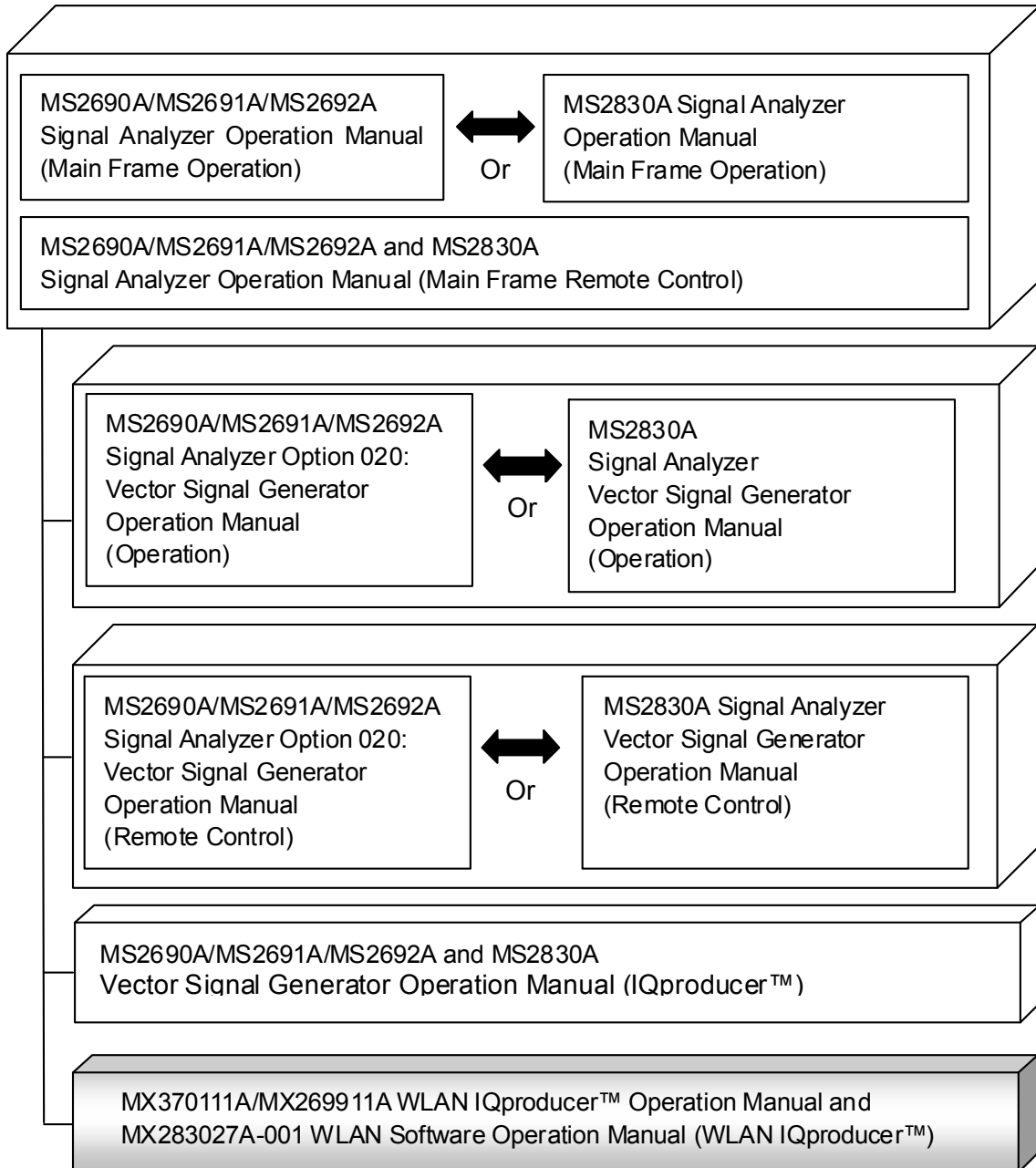

- MS2690A/MS2691A/MS2692A Signal Analyzer Operation Manual (Mainframe, Operation)

This describes basic operations, maintenance procedure, common functions and common remote functions of the MS2690A/MS2691A/MS2692A.



- MS2830A Signal Analyzer Operation Manual (Mainframe, Operation)

This describes basic operations, maintenance procedure, common functions and common remote functions of the MS2830A.

-
- MS2690A/MS2691A/MS2692A and MS2830A Signal Analyzer Operation Manual (Mainframe, Remote Control)

These describe basic operations, maintenance procedure, common functions and common remote functions of the MS2690A/MS2691A/MS2692A or MS2830A.

-
- MS2690A/MS2691A/MS2692A Signal Analyzer Option 020: Vector Signal Generator Operation Manual, Operation

This describes the functions and how to use the Vector Signal Generator option.



- MS2830A Vector Signal Generator Operation Manual, Operation

This describes the functions and how to use the Vector Signal Generator option.

-
- MS2690A/MS2691A/MS2692A Signal Analyzer Option 020: Vector Signal Generator Operation Manual, Remote Control

This describes how to remotely control the Vector Signal Generator option.



- MS2830A Vector Signal Generator Operation Manual, Remote Control

This describes how to remotely control the Vector Signal Generator option.

-
- MS2690A/MS2691A/MS2692A and MS2830A Vector Signal Generator Operation Manual (IQproducer™)

This describes the functions and how to use the IQproducer, which is Windows software for the Vector Signal Generator option.

-
- MX370111A/MX269911A WLAN IQproducer™ Operation Manual and MX283027A-001 WLAN Software Operation Manual (WLAN IQproducer™) (This document)

This describes basic operations and functions of the WLAN IQproducer™.

■ If using MS2830A or MX283027A-001:

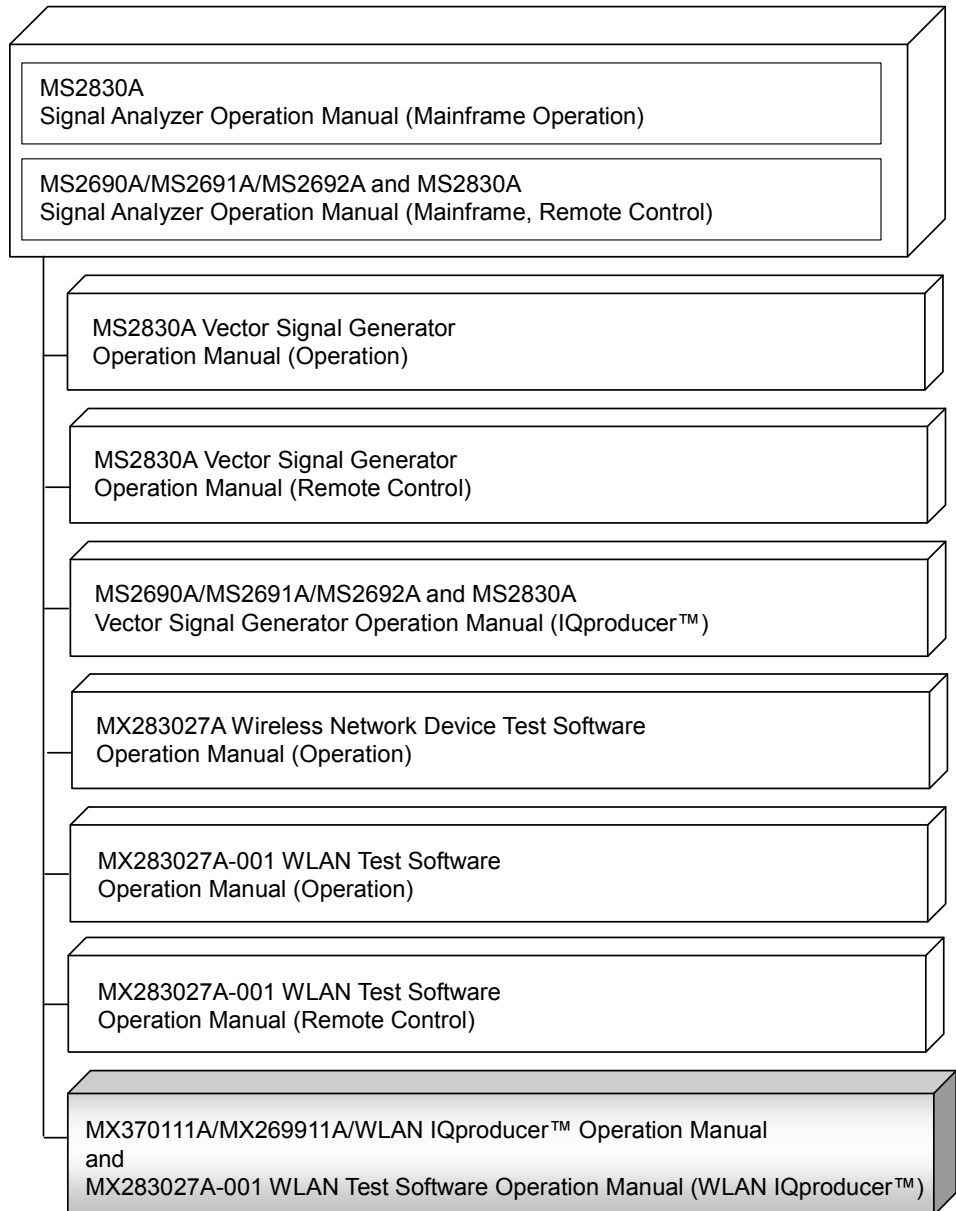

- MS2830A Signal Analyzer Operation Manual (Mainframe Operation)

This describes basic operations, maintenance procedure, common functions and common remote functions of the MS2830A.

-
- MS2690A/MS2691A/MS2692A and MS2830A Signal Analyzer Operation Manual (Mainframe, Remote Control)

These describe basic operations, maintenance procedure, common functions and common remote functions of the MS2690A/MS2691A/MS2692A or MS2830A.

- MS2830A Vector Signal Generator Operation Manual (Operation)

This describes the functions and how to use the Vector Signal Generator option.

- MS2830A Vector Signal Generator Operation Manual (Remote Control)

This describes how to remotely control the Vector Signal Generator option.

- MS2690A/MS2691A/MS2692A and MS2830A Vector Signal Generator Operation Manual (IQproducer™)

This describes the functions and how to use the IQproducer, which is Windows software for the Vector Signal Generator option.

- MX283027A Wireless Network Device Test Software Operation Manual (Operation)

This describes basic operations and functions of the MX283027A Wireless Network Device Test Software.

- MX283027A-001 WLAN Test Software Operation Manual (Operation)

This describes the functions and how to use the MX283027A-001 WLAN Test Software.

- MX283027A-001 WLAN Test Software Operation Manual (Remote Control)

This describes the remote operation of MX283027A-001 WLAN Test Software.

- MX370111A/MX269911A/WLAN IQproducer™ Operation Manual and MX283027A-001 WLAN Test Software Operation Manual (WLAN IQproducer™) <This document>

This describes basic operations and functions of the WLAN IQproducer.

Table of Contents

About This Manual.....	I
Chapter 1 Overview.....	1-1
1.1 Product overview	1-2
1.2 Product Composition.....	1-3
1.3 Options.....	1-4
Chapter 2 Preparation.....	2-1
2.1 Operating Environment.....	2-2
2.2 Installation/Uninstallation	2-3
2.3 Starting up and exiting the software	2-4
Chapter 3 Normal Setup Screen	3-1
3.1 Screen Details.....	3-2
3.2 Waveform Pattern Generation Procedure	3-66
3.3 Saving/Reading Parameters	3-72
3.4 User File Reading Screen.....	3-75
3.5 Graph Display	3-77
3.6 Auxiliary Signal Output.....	3-83
Chapter 4 Easy Setup Screen	4-1
4.1 Basic Operation	4-2
4.2 Screen Details.....	4-5
4.3 Graph Display	4-37
4.4 Auxiliary Signal Output.....	4-38
Chapter 5 How to Use Waveform Patterns	5-1
5.1 For MG3700A or MG3710A.....	5-2
5.2 For MS2690A/MS2691A/MS2692A or MS2830A.....	5-6

Appendix A Error Messages..... A-1

Appendix B User File Format B-1

Index Index-1

1
2
3
4
5
Appendix
Index

Chapter 1 Overview

This chapter provides an overview of the WLAN IQproducer™.

1.1	Product overview	1-2
1.2	Product Composition	1-3
1.3	Options.....	1-4

1.1 Product overview

WLAN IQproducer™ (hereinafter referred to as (hereinafter referred to as “this software”) is software used to generate waveform patterns conforming to the IEEE Std 802.11-2007 and IEEE Std 802.11n-2009 specifications. Also, adding an option enables the software to generate waveform patterns conforming to the IEEE P802.11ac/D2.0, January 2012.

This software requires either of the following environment:

- MG3710A Vector Signal Generator
- MS2690A/MS2691A/MS2692A or MS2830A Signal Analyzer with Vector Signal Generator option mounted
- Personal computer (hereinafter, “PC”)

This software generates waveform patterns that support the specifications of IEEE 802.11a/b/g/j/n/p with various characteristics. This is made possible by the editing/customizing of parameters according to its use. Also, adding the MX370111A-001/-002/MX269911A-001 to generate waveform patterns conforming to the IEEE P802.11ac.

A waveform pattern created by this software can be output using an RF signal after being downloaded into the MG3700A Vector Signal Generator, MG3710A Vector Signal Generator, or an MS2690A/MS2691A/MS2692A Signal Analyzer with Vector Signal Generator option installed (collectively referred to as “mainframe”, or “this equipment”).

Note:

To use waveform patterns generated by IQproducer Version 14.01 or later on the MG3710A Vector Signal Generator, use the MG3710A Package V2.01.00 or later.

1.2 Product Composition

The following table lists the model name and specifications of this software according to the equipment.

Table 1.2-1 Restrictions

Mainframe Restrictions	MG3700A	MG3710A	MS2690A MS2691A MS2692A	MS2830A
Software name	MX370111A		MX269911A	MX269911A/ MX283027A-001
Maximum Size of Waveform Patterns	256 M sample 512 M sample* ¹	64 M sample 128 M sample* ⁵ 256 M sample* ⁶ 512 M sample* ⁷	256 M sample	64 M sample 256 M sample* ⁴
Transmission method of Waveform Patterns	LAN, CompactFlash Card	External device such as LAN, USB memory* ²	USB Memory and other external device * ²	USB Memory and other external device * ²
Installation of this software to this equipment	N/A	Possible	Possible * ³	Possible * ³

*1: The ARB memory expansion 512M sample (optional) must be installed into the MG3700A to use waveform patterns that exceed 256 M samples.

*2: Transferring waveform patterns is not required if the waveform patterns are created on the equipment using this software.

*3: Although this software can be installed and run in the MS2690A/MS2691A/MS2692A or MS2830A, the measurement functions of the MS2690A/MS2691A/MS2692A or MS2830A are not guaranteed while this software runs.

*4: The ARB memory expansion 256M sample (optional) must be installed into the Vector Signal Generator option to use waveform patterns of 64 M samples or more.

*5: The Combination of Baseband Signal (optional) must be installed into the MG3710A to use waveform patterns of maximum 128 M samples.

*6: The ARB memory expansion 256M sample (optional) must be installed into the MG3710A to use waveform patterns of maximum 256 M samples.

*7: To use waveform patterns of maximum 512 M samples, either of the following must be installed into MG3710A:

- ARB memory expansion 1024 M sample (optional)
- ARB memory expansion 256 M (optional) and Combination of Baseband Signal (optional)

■Notes on waveform pattern conversion

The waveform patterns generated with this software varies according to the main unit type. If using the waveform pattern to the different main unit, you need to convert the waveform pattern.

For details about how to convert a waveform pattern, refer to each one of the following manuals.

- *MG3700A/MG3710A Vector Signal Generator MG3740A Analog Signal Generator Operation Manual (IQproducer™)*
4.5 “File Conversion on Convert Screen”
- *MS2690A/MS2691A/MS2692A and MS2830A Vector Signal Generator Operation Manual (IQproducer™)*
4.5 “File Conversion on Convert Screen”

1.3 Options

Table 1.3-1 shows the options for this application.

Table 1.3-1 Options

Model/Symbol	Product name	Remarks
MX370111A-001	802.11ac(80MHZ) Option	For MG3700A, Generates waveform patterns for IEEE802.11ac.
MX269911A-001	802.11ac(80MHZ) Option	For MS269xA/MS2830A Generates waveform patterns for IEEE802.11ac.
MX370111A-002	802.11ac(160MHZ) Option	For MG3710A Generates waveform patterns for IEEE802.11ac.

Chapter 2 Preparation

This chapter describes the operating environment for the MX370111A/MX269911A.

2.1	Operating Environment.....	2-2
2.2	Installation/Uninstallation	2-3
2.3	Starting up and exiting the software	2-4
2.3.1	Starting Software: When installed on other than MG3710A	2-4
2.3.3	Starting Software: When installed on MG3710A	2-6
2.3.4	Exiting Software.....	2-7

2.1 Operating Environment

The following environment is required for operating the MX370111A/MX269911A.

- (1) PC that meets the following conditions

OS	Windows XP/Windows Vista/Windows 7
CPU	Pentium III 1 GHz equivalent or faster
Memory	512 MB or more
Hard disk space	5 GB or more free space in the drive where this software is to be installed. The free hard disk space necessary to create waveform pattern varies depending on the waveform pattern size. The free disk space of 27 GB or greater is required to create four maximum (512 M sample) waveform patterns.

- (2) If viewing on PC, displays with a resolution of 1024 × 768 pixels are best viewed using a small font setting.

2.2 Installation/Uninstallation

This software is included in the IQproducer™ installer. It is automatically installed by installing the IQproducer™ that is supplied with this equipment or this software. When using a waveform pattern created using this software in the equipment, the license file must be installed in advance.

■ Installing/Uninstalling IQproducer™

For how to install IQproducer™, refer to each of the following manuals:

- *MG3700A/MG3710A Vector Signal Generator MG3740A Analog Signal Generator Operation Manual (IQproducer™)*
Chapter 2 “Installation”
- *MS2690A/MS2691A/MS2692A and MS2830A Vector Signal Generator Operation Manual (IQproducer™)*
Chapter 2 “Installation”

■ Installing/Uninstalling IQproducer™ license file

For how to install license file to MG3700A/MG3710A, refer to the following manual:

- *MG3700A/MG3710A Vector Signal Generator MG3740A Analog Signal Generator Operation Manual (IQproducer™)*
5.1 “Installing License File”

For how to uninstall license file from MG3700A/MG3710A, refer to each one of the following manuals:

- *MG3700A Vector Signal Generator Operation Manual (Mainframe)*
3.10.10 “Install”
- *MG3710A Vector Signal Generator MG3740A Analog Signal Generator Operation Manual (Mainframe)*
9.4.4 “Install”

Refer to the following manual for details of how to install/uninstall license file to MS2690A/MS2691A/MS2692A or MS2830A with Vector Signal Generator option.

- *MS2690A/MS2691A/MS2692A and MS2830A Vector Signal Generator Operation Manual (IQproducer™)*
2.2 “Installation/Uninstallation”

2.3 Starting up and exiting the software

This section explains how to start and stop this software.

Note:

The following explanation assumes the use of Windows XP. The screen image may differ slightly if not using Windows XP.

2.3.1 Starting Software: When installed on other than MG3710A

Start this software using the following procedure.
The example assumes that it is a PC operation.

<Procedure>

1. Click **Start** on the task bar, and point to **All Programs**. Next, point to **Anritsu Corporation**, point to **IQproducer**, and then click **IQproducer**.
2. When IQproducer™ starts, the **Select instrument** screen is displayed.

On the **Select instrument** screen, select the model of the main unit that uses the waveform patterns created by IQproducer™.

Notes:

- This software does not support MG3740A.
- To hide this screen and to start with the selected mainframe's screen from the next time, select the **Don't show this window next time** check box.

- The common platform screen is displayed when OK is clicked in the Select instrument screen.

The common platform screen is a screen used to select each function of the IQproducer™.

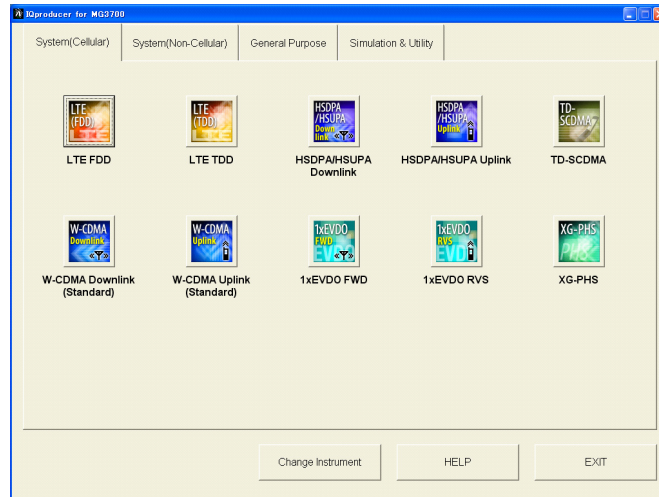

Figure 2.3.1-1 Common Platform Screen

- Click the System (Non-Cellular) tab on the common platform screen, to show the System (Non-Cellular) selection screen that supports each telecommunication system.

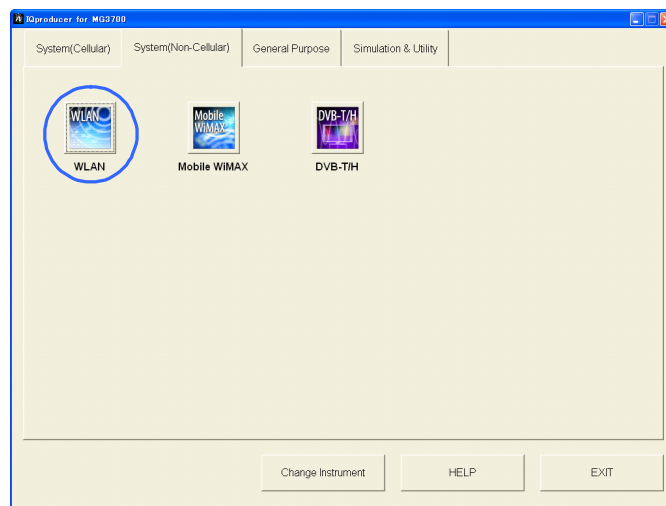

Figure 2.3.1-2 System (Non-Cellular) Selection Screen

- Click WLAN to display the main screen. For details of the main screen, refer to Chapter 3 “Normal Setup Screen”.

Note:

If **Change Instrument** is clicked, the **Select instrument** screen will appear each time the software is loaded.

2.3.2 Starting Software: When installed on MG3710A

Start this software using the following procedure.

<Procedure>

1. Press  on the MG3710A front panel to display the common platform screen.

The common platform screen is a screen used to select each function of the IQproducer™.

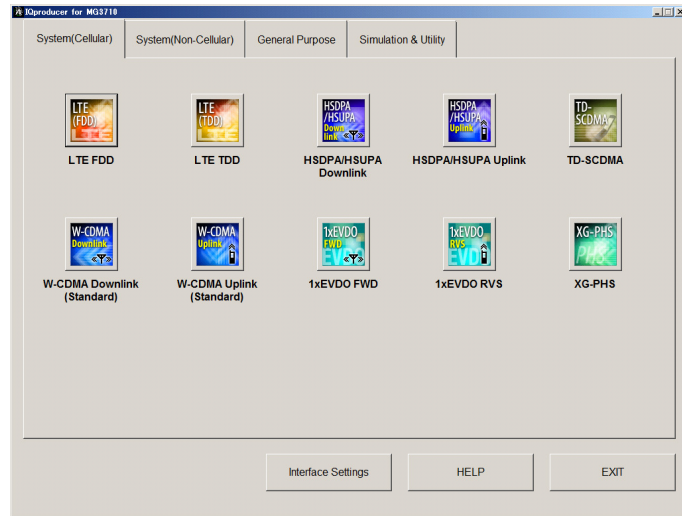

Figure 2.3.2-1 Common Platform Screen

2. Click the **System (Non-Cellular)** tab on the common platform screen, to show the **System (Non-Cellular)** selection screen that supports each telecommunication system.

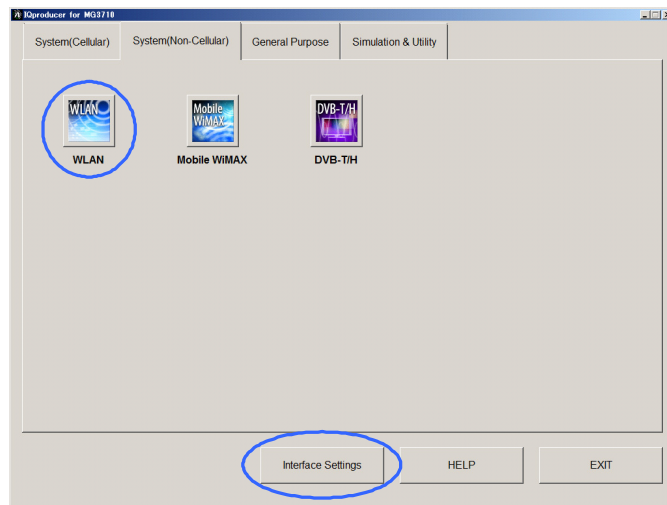

Figure 2.3.2-2 System (Non-Cellular) Selection Screen

- Click **WLAN** to display the main screen. For details of the main screen, refer to Chapter 3 “Normal Setup Screen”.

Note:

When this software is installed on MG3710A, **Change Instrument** displays instead of **Interface Settings**. Clicking **Interface Settings** displays the Interface Setting dialog box.

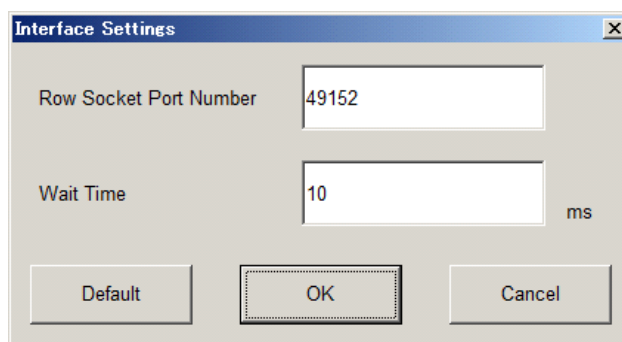

Figure 2.3.2-3 Interface Settings Dialog Box

Here, you can configure interface-related settings of IQproducer and MG3710A. To return to factory defaults, click **Default**.



- Row Socket Port Number
Sets Row Socket port number. Set the same value as that for MG3710A.
- Wait Time
Sets the wait time between commands.

2.3.3 Exiting Software

Stop this software using the following procedure.

■When exiting only this software

To exit only this software without closing the Common Platform screen, or other IQproducer™ tools, do one of these below:

- Click the Exit button () on the tool bar.
- Select Exit from the File menu.
- Click the  button on the upper right screen.

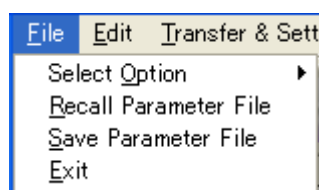

Figure 2.3.3-1 Exiting Software

The operation of the three screen buttons is explained below.

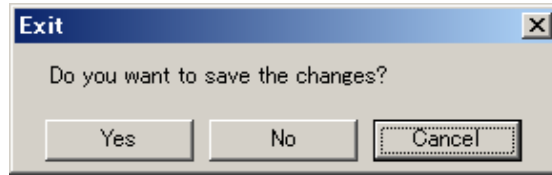



Figure 2.3.3-2 Exit Confirmation Window

- **Yes** Saves current parameters to file and stops this software.
- **No** Stops this software without saving current parameters to file.
- **Cancel** or  Cancels the process and returns to the main screen.

When stopping this software using the **Yes** button, the saved parameters are read at the next start and reset for each parameter.

■When exiting entire IQproducer™ application

To exit all tools of IQproducer™ that are running, select **Exit** on the Common Platform Screen. In this case, a dialog is displayed to confirm stopping of each running tool.

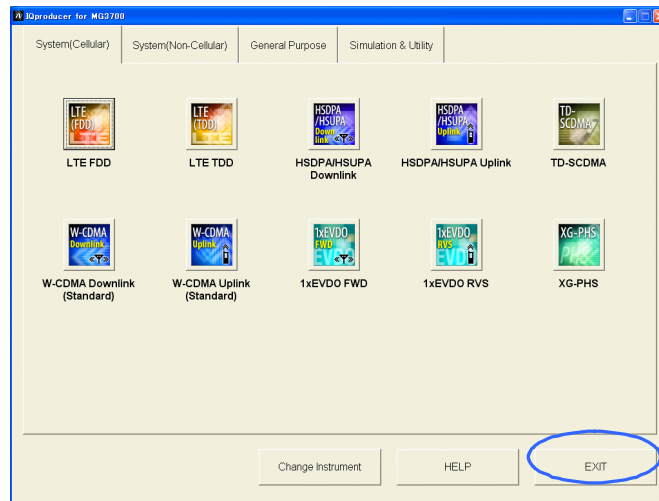

Figure 2.3.3-3 Exiting IQproducer™

Chapter 3 Normal Setup Screen

This chapter describes the detailed functions when this software is used on Normal Setup screen.

Notes:

- The examples and screens used throughout this chapter are based on the assumption that the IQproducer™ is activated with the MG3700A.
- The MG3710A, MS2690A/MS2691A/MS2692A, and MS2830A functions are described as notes in each item.

3.1	Screen Details.....	3-2
3.1.1	Menu and tool button.....	3-2
3.1.2	Tree view	3-10
3.1.3	List of Common Parameter	3-12
3.1.4	PHY/MAC parameters	3-32
3.1.5	Export File screen.....	3-55
3.1.6	Calculation screen	3-61
3.1.7	Calculation & Load	3-63
3.1.8	Calculation & Play	3-64
3.2	Waveform Pattern Generation Procedure	3-66
3.2.1	IEEE 802.11n waveform.....	3-66
3.2.2	IEEE 802.11ac waveform.....	3-69
3.3	Saving/Reading Parameters.....	3-72
3.3.1	Saving a parameter file	3-72
3.3.2	Reading a parameter file	3-73
3.4	User File Reading Screen.....	3-75
3.5	Graph Display	3-77
3.6	Auxiliary Signal Output	3-83

3.1 Screen Details

3.1.1 Menu and tool button

On common platform screen, click the **System (Non-Cellular)** tab, and then click **WLAN** to display the main screen.

“System=Other than 11ac” and “System=11ac” can be switched by System in the common parameter list.

For details, see 3.1.3 “List of Common Parameter”.

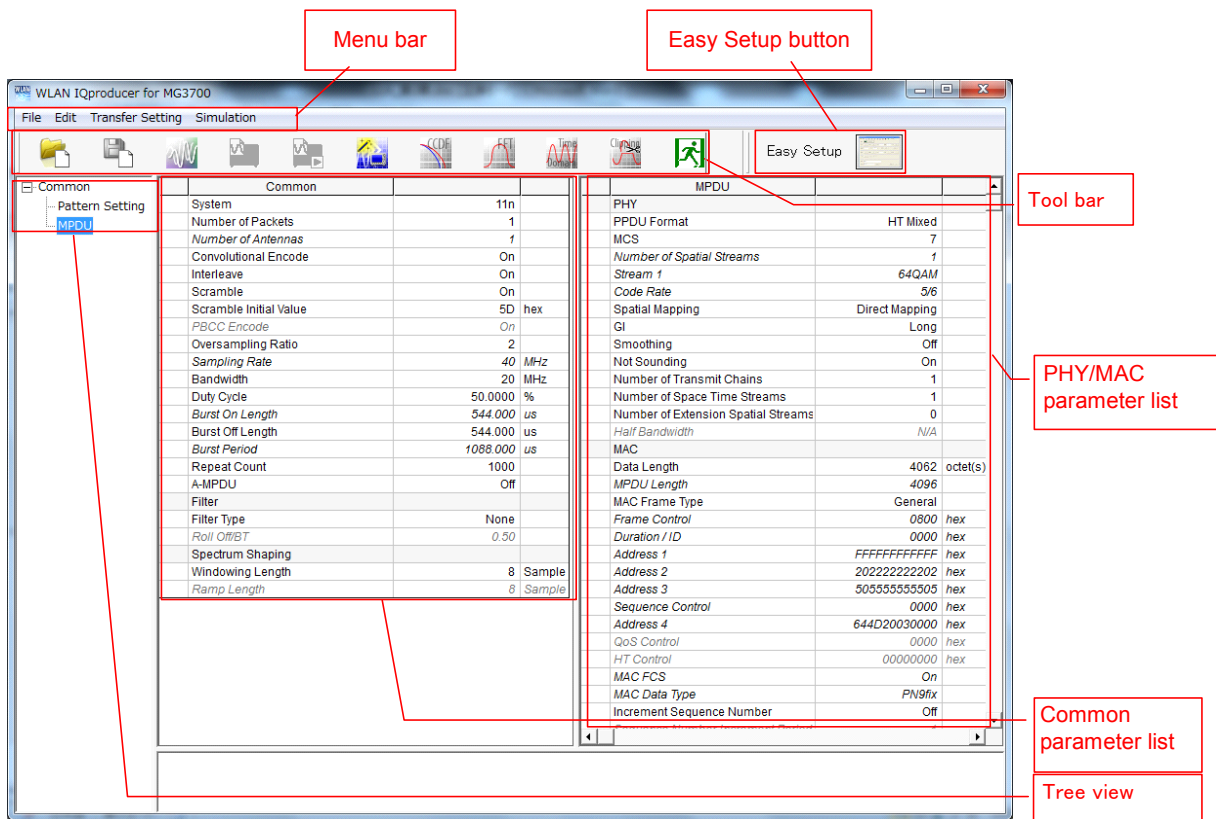

Figure 3.1.1-1 Main screen (except 11ac)

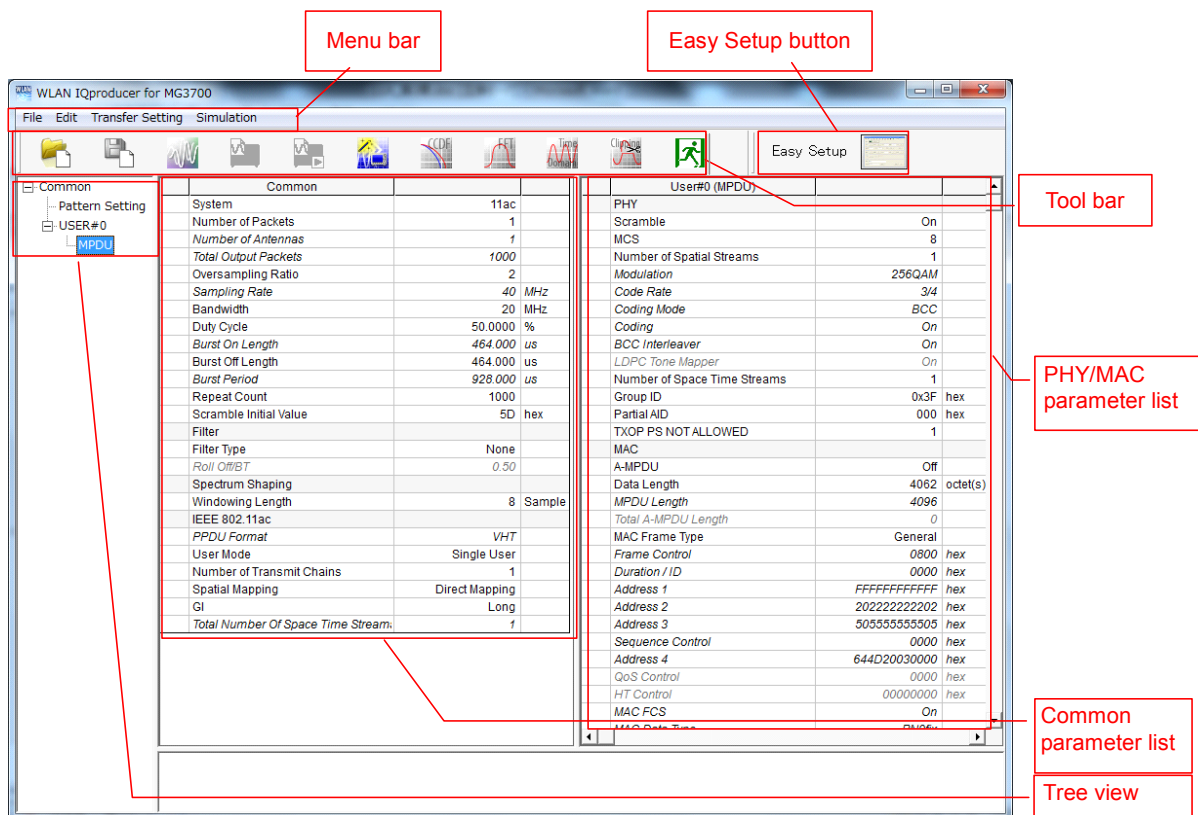
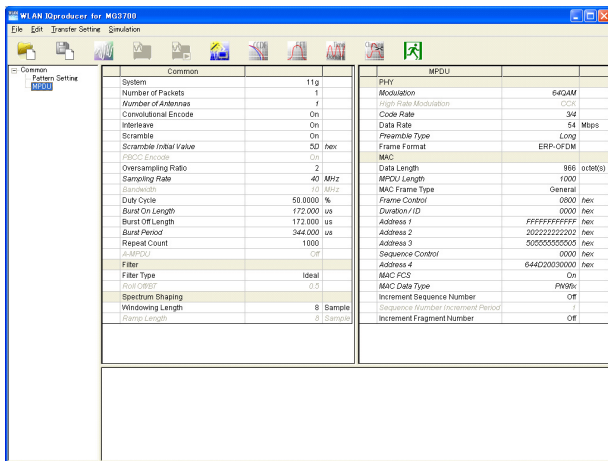

Figure 3.1.1-2 Main screen (11ac)

- Basic operations of the main screen
 - The window can be maximized, minimized, expanded, and reduced.
 - For the fields of the tree view, common parameter list, PHY/MAC parameter list, splitting position can be changed by dragging their boundaries.
 - The leftmost symbol of each item in the tree view is - when the integrated items are open, or + when they are closed. Clicking the mark changes the status.
 - The items in italic cannot be changed. These items are automatically set. The state of each item may change depending on the setting for other items.
 - The grayed out items indicate the parameters not related to the generated waveforms in the current setting and cannot be changed. The state of each item may change depending on the setting for other items.

■ Screen transition

Figure 3.1.1-3 shows transition from the main screen that is displayed when the WLAN IQproducer™ is started up to other screens (Export File and Calculation screens). For details on each of the screens, refer to the sections shown below the corresponding screen.



Main screen

Calculation

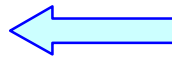
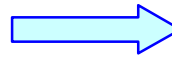

Cancel

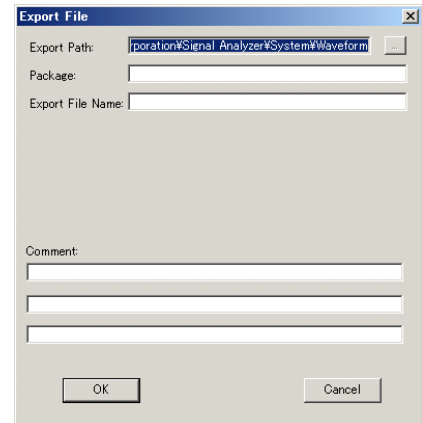

Export File screen
(Refer to 3.1.5 "Export File screen.")

Calculation completed:
OK button
During calculation:
Cancel button

OK

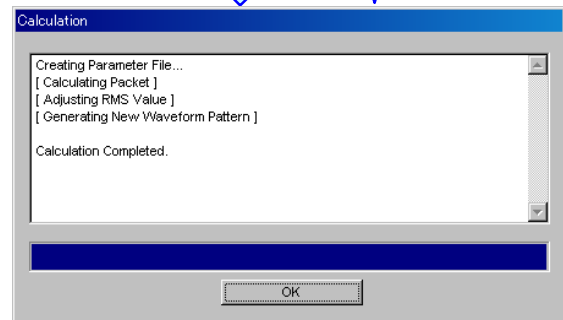

Calculation screen for waveform generation
(Refer to 3.1.7 "Calculation & Load".)

Figure 3.1.1-3 Screen transition

- File menu

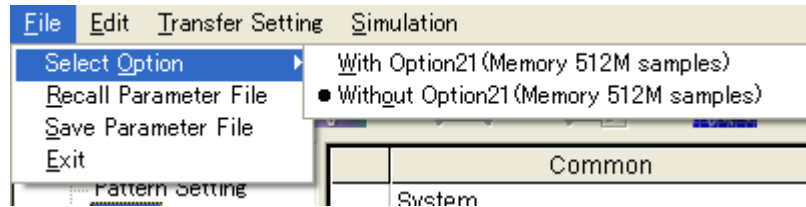

Figure 3.1.1-4 File menu

- Select Option

Notes:

- This function is available only when **MG3700**, **MG3710** or **MS2830** is selected in the **Select instrument** screen.
- ARB Memory Expansion (option) is not available for MS269xA. Only Memory 256M samples, 1 GB is available.

- When using MG3700A or MS2830A

Select whether the ARB memory expansion option 256Msamples is installed. Selecting **With Option21 (Memory 512M samples)/With Option27 (Memory 256M samples)** supports creation of larger waveform patterns. If the ARB memory expansion option is not installed, the generated waveform pattern may not be able to be used. Waveform patterns cannot be created with a size greater than 256Msamples or 64M samples when **Without Option21 (Memory 512M samples)/Without Option27 (Memory 256M samples)** is selected. Select either according to the presence of ARB memory expansion option.

Table 3.1.1-1 Available Options for MG3700A or MS2830A

Model	Items	ARB Memory Expansion
MG3700A	With Option21 (Memory 512M samples)	1 GB × 2 memory
	Without Option21 (Memory 512M samples):	512 MB × 2 Memories
MS2830A	With Option27 (Memory 256M samples)	1 GB
	Without Option27 (Memory 256M samples)	256 MB

■ When using MG3710A

The presence/absence of the ARB Memory Expansion (option) and Baseband Signal Combination Function (option) is selected. Selecting the ARB Memory Expansion (option) and the Baseband Signal Combination Function (option) generates a bigger waveform pattern, while selecting the Baseband Signal Combination Function (option) generates a waveform pattern. If an uninstalled option is selected, sometimes the created waveform pattern may not be usable.

Set the combination of installed options based on the following setting items.

Table 3.1.1-2 Available Options for MG3710A

Items	Combinations of Options
Memory 64M samples	None
Memory 64M samples × 2	Option48 and Option 78
Memory 256M samples	Option45 or Option 75
Memory 256M samples × 2	Option 45 and Option 48 or Option 75 and Option 78
Memory 1024M samples	Option46 or Option 76
Memory 1024M samples × 2	Option 46 and Option 48 or Option 76 and Option 78

The maximum size of the generated waveform pattern for each of the setting items is shown below.

Table 3.1.1-3 Waveform Pattern Maximum Size

Items	Maximum Size
Memory 64M samples	64M samples
Memory 64M samples × 2 (With Option48, 78)	128M samples
Memory 256M samples	256M samples
Memory 256M samples × 2 (With Option48, 78)	512M samples
Memory 1024M samples	512M samples
Memory 1024M samples × 2 (With Option48, 78)	512M samples

- **Recall Parameter File**
Loads the parameter files saved by the Save Parameter File menu. When the parameter file is loaded, the settings when it was loaded are recovered.
 - **Save Parameter File**
Saves the current setting parameters to a file.
 - **Exit**
Exits from this application.
- **Edit Menu**

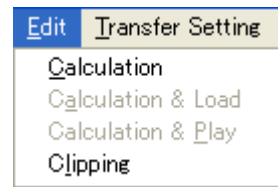

Figure 3.1.1-5 Edit menu

- **Calculation**
Generates waveform patterns.
- **Calculation & Load**
Note:
This function is available only when this software is used on MG3710A.

After waveform generation is finished, the created waveform pattern is loaded into the MG3710A waveform memory.
- **Calculation & Play**
Note:
This function is available only when this software is used on MG3710A.

After waveform generation is finished, the created waveform pattern is loaded and selected at the MG3710A waveform memory.
- **Clipping**
Displays the Clipping setting screen. In this screen, clipping and filtering processing can be performed for a generated waveform pattern.

■ **Transfer Setting Menu**

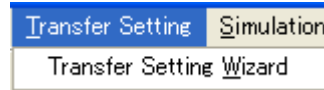

Figure 3.1.1-6 Transfer Setting menu

● **Transfer Setting Wizard**

Note:

This function is available only when **MG3700** or **MG3710** is selected in the **Select instrument** screen.

Displays the Transfer Setting Wizard screen. Every operation ranging from connecting the PC and MG3700A/MG3710A and transferring the waveform pattern to the MG3700A/MG3710A, to loading the waveform pattern into the MG3700A/MG3710A ARB memory is performed at this screen.

■ **Simulation menu**



Figure 3.1.1-7 Simulation menu

● **CCDF**

Displays the CCDF Graph Monitor screen.

In this screen, the CCDF of the generated waveform pattern is displayed in a graph.

● **FFT**

Displays the FFT Graph Monitor screen. In this screen, the FFT-processed spectrum of the generated waveform pattern is displayed in a graph.

● **Time Domain**

Displays the Time Domain screen. In this screen, the time domain waveform of a generated waveform pattern is displayed in a graph.

■ Tool buttons

Notes:

- Transfer&Setting Wizard is available only when **MG3700** or **MG3710** is selected in the **Select instrument** screen.
- Calculation & Load and Calculation & Play are available only when this software is used on MG3710A.

	Recall Parameter File
	Save Parameter File
	Calculation
	Calculation & Load
	Calculation & Play
	Transfer & Setting Wizard
	CCDF
	FFT
	Time Domain
	Clipping
	Exit
	Easy Setup

Clicking a tool button operates the same as the corresponding commands in the menu.

3.1.2 Tree view

The tree view displays the parameter that belongs to the waveform pattern to be created in the hierarchy structure.

- System = other than 11ac

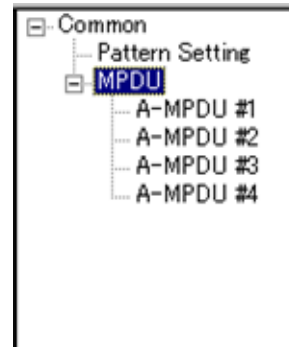

Figure 3.1.2-1 Tree view

- Right-clicking **MPDU** or **A-MPDU** opens a pop-up menu that contains the following items:
 - Add MPDU: Adds A-MPDU.
 - Delete MPDU: Deletes A-MPDU.
- The PHY/MAC parameter list shows the A-MPDU parameter list for the items selected in the tree view.
- Adding and deleting A-MPDU is effective only when A-MPDU is On.

■ System=11ac

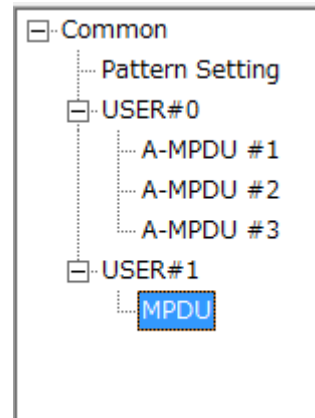

Figure 3.1.2-2 Tree view

User#

Up to four users from USER#0 to #3 can be set. However, a new User# cannot be added when the Total Number of Space Time Streams and the Number of Transmit Chains match. MPDU/A-MPDU# are displayed under each User#. Right-click to display menu to add and delete user#.

- Adding and deleting user# is effective only when the user mode is Multi User.

MPDU/A-MPDU#

Up to sixteen A-MPDUs from A-MPDU#1 to #16 can be set. The main screen is updated each time MPDU/A-MPDU# is selected. Right-click to display menu to add and delete MPDU/A-MPDU#.

- The PHY/MAC parameter list shows the parameter list of MPDU/A-MPDU# that belong to the user# selected in the tree view.
- The setting items for Common and IEEE802.11ac are always displayed on the left of the main screen.
- Adding and deleting A-MPDU is effective only when A-MPDU is On.

3.1.3 List of Common Parameter

The items displayed in the common parameter list are described below. Parameters that require setting are listed in the common parameter list. The common parameters are displayed under Common.

System

[Function] Sets System standard.
[Default] 11g
[Setting range] 11a, 11ac, 11b, 11g, 11j, 11n, 11p
[Remarks] Switching the system standard changes the common parameter list and the PHY/MAC parameter list on display.

3.1.3.1 Common parameter list (System = other than 11ac)

Number of Packets

[Function] Sets the number of packets to be generated.
[Default] 1
[Setting range] 1 to the maximum capacity of waveform memory

Number of Antennas

[Function] Displays the number of antennas.
[Default] 1
[Display range] 1 to 4
[Remarks] Displays the same value of Number of Transmit Chains in the following conditions:
When System=11n, and PPDU Format=HT Mixed/HT Greenfield
The setting is fixed to 1 when the System is other than 11n.

Convolutional Encode

[Function] Enables/disables convolutional encoding.
[Default] On
[Setting range] On, Off

Interleave

[Function] Enables/disables interleave processing.

[Default] On

[Setting range] On, Off

[Remarks] This is available in the following conditions:
System=11a, 11j, 11n, 11p,
When System=11n, and Frame
Format=DSSS-OFDM/ERP-OFDM

Scramble

[Function] Enables/disables scramble processing.

[Default] On

[Setting range] On, Off

Scramble Initial Value

[Function] Sets the initial value of scramble processing.

[Default] 0x5D

[Setting range] 0x00 to 0x7F

[Remarks] Available only for 11a, 11n, and 11ac.

PBCC Encode

[Function] Enables/disables PBCC encoding.

[Default] On

[Setting range] On, Off

[Remarks] This is available in the following conditions:
System=11b and High Rate Modulation=PBCC
System=11g and Frame Format=ERP-PBCC

Oversampling Ratio

[Function] Sets oversampling ratio.

[Default] 2

[Setting range] 2, 4, 8

[Remarks] The setting range for each system is as follows:
System=11b: 4, 8
System=11a, 11g, 11j, 11n, 11p : 2,4,8
Note, however, that the setting range is 4 and 8 if System
= 11g and Data Rate = 1, 2, 5.5, 11, 22, 33 Mbps
Note, however, that the setting range is 2 and 4 if System
= 11n and Bandwidth = 40 MHz.

Sampling Rate

[Function] Displays the sampling rate.

[Remarks] The following table shows the corresponding sampling rate for each system:

System	Sampling rate
System=11a	20 MHz × Oversampling Ratio
System=11b	11 MHz × Oversampling Ratio
System=11g (Data Rate=1,2,5.5,11 Mbps)	11 MHz × Oversampling Ratio
System=11g (Data Rate=other than 1,2,5.5,11 Mbps)	20 MHz × Oversampling Ratio
System=11j	20 MHz × Oversampling Ratio
System=11n (BW=20 MHz)	20 MHz × Oversampling Ratio
System=11n (BW=40 MHz)	40 MHz × Oversampling Ratio
System=11p	10 MHz × Oversampling Ratio

Bandwidth

[Function] Set bandwidth.

[Default] The default value for each System is as follows:

System	Default
System=11a	20 MHz
System=11j	20 MHz
System=11n	20 MHz
System=11p	10 MHz

[Setting range] The setting range for each system is as follows:

System	Setting Range
System=11a	20 MHz
System=11j	20 MHz
System=11n	20 MHz or 40 MHz
System=11p	10 MHz

[Remarks] Not available when System=11b, 11g.

Duty Cycle

[Function] Sets the On/Off ratio of the burst signal.

[Default] 50.0000 [%]

[Setting range] 0.1000 to 99.0000 [%]

[Resolution] 0.0001

[Remarks] When Duty Cycle is set, Burst Off Length and Burst Period is automatically calculated. When Burst On length and Burst Off Length is changed, Duty Cycle is automatically calculated.
The setting range is automatically calculated according to the Common, PHY, MAC parameter settings, so it is not always from 0.1000 to 99.0000 [%].

Burst On Length

[Function] Displays Burst On Length [μ s].

[Display range] Displays the calculated value.

[Resolution] 0.001

[Remarks] The calculated result is rounded to a multiple of $1/\text{Sampling Rate}$ [μ s].
Automatically calculated by PHY/MAC parameter setting.

Burst Off Length

[Function] Displays Burst Off Length [μ s].

[Setting range] The setting range is decided by the maximum and minimum values of Duty Cycle and the calculated value of Burst On Length.

[Resolution] 0.001

[Remarks] When setting Burst Off Length, Duty Cycle and Burst Period are automatically calculated.
Also, Burst Off Length is calculated from the values of Duty Cycle and Burst On Length as below.

Burst Off Length=

$$\text{Burst On Length} \times (100.0 - \text{Duty Cycle}) / \text{Duty Cycle}$$

Burst Period

[Function] Displays Burst Period [μ s].

[Display range] Displays the calculated value.

[Remarks] The following figure shows the relationships among Duty Cycle, Burst On Length, Burst Off Length, and Burst Period:

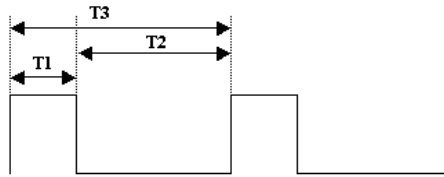

T1 : Burst On Length

T2 : Burst Off Length

T3 : Burst Period

T1/T3 : Duty Cycle

Repeat Count

[Function] Sets the repeat count of packet to be transmitted.

[Default] 1000

[Setting range] 1 to 32767

[Remarks] This setting is void if **MS269x** or **MS2830A** is selected in the **Select instrument** dialog box.

A-MPDU

[Function] Enables/disables A-MPDU.

[Default] Off

[Setting range] On, Off

[Remarks] Available in the following conditions:
System=11n and PPDU Format=HT Mixed, or HT Greenfield

Filter

Filter Type

- [Function] Sets the filter type.
 [Default] The default value for each System is as follows:
 System=11b or,
 System=11g, and when Frame Format is NOT
 ERP-OFDM/DSSS-OFDM: Gaussian
 Other than above: None
 [Setting range] None, Gaussian, Root Nyquist, Nyquist, Ideal

Roll Off/BT

- [Function] Sets the roll-off factor or BT product.
 [Default] 0.50
 [Setting range] 0.01 to 1.00
 [Resolution] 0.01
 [Remarks] The setting is not available when Filter Type is set to
 Ideal or None.

Spectrum shaping

Windowing Length

- [Function] Sets the windowing length.
 [Default] 8 Sample
 [Setting range] 0 to $32 \times$ Oversampling Rate
 [Remarks] This setting is not available in the following conditions:
 System=11b
 System=11g, and when Frame Format is NOT
 ERP-OFDM/DSSS-OFDM

Ramp Length

- [Function] Sets the ramp length.
 [Default] 8 Sample
 [Setting range] 0 to $16 \times$ Oversampling Rate
 [Remarks] Available in the following conditions:
 System=11b
 System=11g, and when Frame Format is NOT
 ERP-OFDM/DSSS-OFDM

3.1.3.2 Common parameter list (System = 11ac)

Number of Packets

- [Function] Sets the number of packets to be generated.
- [Default] 1
- [Setting range] 1 to the maximum number of packets for the waveform memory.

Number of Antennas

- [Function] Displays the number of antennas.
- [Default] 1
- [Setting range] 1 to 8
- [Remarks] Displays the same value of Number of Transmit Chains.

Total Output Packets

- [Function] Displays the total number of packets (Number of Packets × Repeat Count).
- [Default] 1000
- [Remarks] The setting is void if MS269x or MS2830 is selected in the **Select instrument** dialog box.

Oversampling Ratio

- [Function] Sets the oversampling ratio.
- [Default] 2
- [Setting range] 2, 4, 8
- [Remarks] Bandwidth=40 MHz: 2,4,
Bandwidth=80 MHz / 80+80 MHz: 2 only.
Bandwidth = 160 MHz: invalid.

Sampling Rate

- [Function] Displays sampling rate.
- [Remarks] Bandwidth MHz × Oversampling Ratio
When the bandwidth is 160 MHz, the sampling rate is fixed to 200 MHz.

Bandwidth

- [Function] Sets the bandwidth.
- [Default] 20 MHz
- [Setting range] 20 MHz, 40 MHz, 80 MHz, 160 MHz, 80+80 MHz
- [Remarks] 160 MHz is not settable if **MG3700A**, **MS269x**, or **MS2830** is selected in the **Select instrument** dialog box.

Duty Cycle

[Function] Sets the On/Off ratio of the burst signal.

[Default] 50.0000 [%]

[Setting range] 0.1000 to 99.0000 [%]

[Resolution] 0.0001

[Remarks] When setting Duty Cycle, Burst Off Length and Burst Period are automatically calculated. Also, when Burst On Length or Burst Off Length is changed, Duty Cycle is automatically calculated.

The setting range is automatically calculated according to the Common, PHY, MAC parameter settings, so it is not always from 0.1000 to 99.0000 [%].

Burst On Length

[Function] Displays the burst on length [μ s].

[Display range] Displays the calculated value.

[Resolution] 0.001

[Remarks] The calculated result is rounded to a multiple of $1/\text{Sampling Rate}$ [μ s].

Automatically calculated by PHY/MAC parameter setting.

Burst Off Length

[Function] Sets the burst off length [μ s].

[Setting range] The setting range is decided by the maximum and minimum values of Duty Cycle and the calculated value of Burst On Length.

[Resolution] 0.001

[Remarks] When setting Burst Off Length, Duty Cycle and Burst Period are automatically

Also, Burst Off Length is calculated from the values of Duty Cycle and Burst On Length as below.

Burst Off Length=

$$\text{Burst On Length} \times (100.0 - \text{Duty Cycle}) / \text{Duty Cycle}$$

Burst Period

[Function] Displays the burst period [μ s].

[Display range] Displays the calculated value.

[Remarks] The following figure shows the relationships among Duty Cycle, Burst On Length, Burst Off Length, and Burst Period.

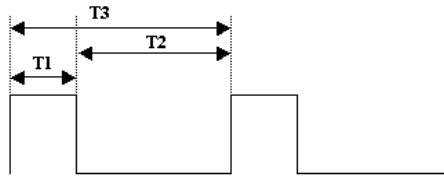

T1 : Burst On Length

T2 : Burst Off Length

T3 : Burst Period

T1/T3 : Duty Cycle

Repeat Count

[Function] Sets the repeat count of packet to be transmitted.

[Default] 1000

[Setting range] 1 to 65535

[Remarks] The setting is void if **MS269x** or **MS2830** is selected in the Select instrument dialog box.

Scramble Initial Value

[Function] Sets the initial value of scramble processing.

[Default] 0x5D

[Setting range] 0x00 to 0x7F

Filter

Filter Type

[Function] Sets the filter type.

[Default] None

[Setting range] None, Gaussian, Root Nyquist, Nyquist, Ideal

Roll Off/BT

[Function] Sets the roll-off factor or BT product.

[Default] 0.50

[Setting range] 0.01 to 1.00

[Resolution] 0.01

[Remarks] The setting is fixed when Filter Type is set to Ideal or None.

Spectrum shaping

Windowing Length

- [Function] Sets the windowing length.
 [Default] 8 Sample
 [Setting range] 0 to $32 \times$ Oversampling Rate
 [Remarks] The setting range is 0 to 32 when the bandwidth is 160 MHz.

IEEE 802.11ac

PPDU Format

- [Function] Displays the PPDU format.
 [Default] VHT
 [Display range] VHT

User Mode

- [Function] Sets the user mode.
 [Default] Single User
 [Setting range] Single User, Multi User

Number of Transmit Chains

- [Function] Sets the number of transmit chain.
 [Default] 1
 [Setting range] 1 to 8
 [Remarks] Number of Transmit Chains cannot be set to equal to or under Total Number of Space Time Streams.

Spatial Mapping

- [Function] Sets the spatial mapping.
 [Default] Direct Mapping
 [Setting range] Direct Mapping, Spatial Expansion, Edit Mode
 [Remarks] This function can be used in the following cases:
 Direct Mapping is available only when Number of Space Time Streams matches Number of Transmit Chains.
 When Number of Transmit Chains is 1, only Direct Mapping is available.

Edit Mode

- [Function] Sets the value of Spatial Mapping Matrix.
 [Setting range] $-1.00000-j1.00000$ to $1.00000+j1.00000$
 [Resolution] The setting resolution is 0.00001 for both real and imaginary parts.

Spatial Mapping Matrix

When selecting Spatial Expansion in setting Spatial Mapping, the values in Table 3.1.3.2-2 to 3.1.3.2-8 are used in calculation. In this case, by using the formula (1) to (28), the stream is expanded from Total Number of Space Time Streams to Transmit Chains.

- (1) Number of Transmit Chains =2, Total Number of Space Time Streams=1

$$\frac{1}{\sqrt{2}}[1 \ 1]^T$$

- (2) Number of Transmit Chains =3, Total Number of Space Time Streams=1

$$\frac{1}{\sqrt{3}}[1 \ 1 \ 1]^T$$

- (3) Number of Transmit Chains =4, Number of Space Time Streams=1

$$\frac{1}{2}[1 \ 1 \ 1 \ 1]^T$$

- (4) Number of Transmit Chains =5, Total Number of Space Time Streams=1

$$\frac{1}{\sqrt{5}}[1 \ 1 \ 1 \ 1 \ 1]^T$$

- (5) Number of Transmit Chains =6, Total Number of Space Time Streams=1

$$\frac{1}{\sqrt{6}}[1 \ 1 \ 1 \ 1 \ 1 \ 1]^T$$

- (6) Number of Transmit Chains =7, Number of Space Time Streams=1

$$\frac{1}{\sqrt{7}}[1 \ 1 \ 1 \ 1 \ 1 \ 1 \ 1]^T$$

- (7) Number of Transmit Chains =8, Total Number of Space Time Streams=1

$$\frac{1}{2\sqrt{2}}[1 \ 1 \ 1 \ 1 \ 1 \ 1 \ 1 \ 1]^T$$

- (8) Number of Transmit Chains =3, Total Number of Space Time Streams=2

$$\sqrt{\frac{2}{3}} \begin{bmatrix} 1 & 0 \\ 0 & 1 \\ 1 & 0 \end{bmatrix}$$

- (9) Number of Transmit Chains =4, Total Number of Space Time Streams=2

$$\frac{1}{\sqrt{2}} \begin{bmatrix} 1 & 0 \\ 0 & 1 \\ 1 & 0 \\ 0 & 1 \end{bmatrix}$$

- (10) Number of Transmit Chains =5, Total Number of Space Time Streams=2

$$\sqrt{\frac{2}{5}} \begin{bmatrix} 1 & 0 \\ 0 & 1 \\ 1 & 0 \\ 0 & 1 \\ 1 & 0 \end{bmatrix}$$

- (11) Number of Transmit Chains =6, Total Number of Space Time Streams=2

$$\frac{1}{\sqrt{3}} \begin{bmatrix} 1 & 0 \\ 0 & 1 \\ 1 & 0 \\ 0 & 1 \\ 1 & 0 \\ 0 & 1 \end{bmatrix}$$

- (12) Number of Transmit Chains =7, Total Number of Space Time Streams=2

$$\sqrt{\frac{2}{7}} \begin{bmatrix} 1 & 0 \\ 0 & 1 \\ 1 & 0 \\ 0 & 1 \\ 1 & 0 \\ 0 & 1 \\ 1 & 0 \end{bmatrix}$$

- (13) Number of Transmit Chains =8, Total Number of Space Time Streams=2

$$\frac{1}{2} \begin{bmatrix} 1 & 0 \\ 0 & 1 \\ 1 & 0 \\ 0 & 1 \\ 1 & 0 \\ 0 & 1 \\ 1 & 0 \\ 0 & 1 \end{bmatrix}$$

- (14) Number of Transmit Chains =4, Total Number of Space Time Streams=3

$$\frac{\sqrt{3}}{2} \begin{bmatrix} 1 & 0 & 0 \\ 0 & 1 & 0 \\ 0 & 0 & 1 \\ 1 & 0 & 0 \end{bmatrix}$$

(15) Number of Transmit Chains =5, Total Number of Space Time Streams=3

$$\sqrt{\frac{3}{5}} \begin{bmatrix} 1 & 0 & 0 \\ 0 & 1 & 0 \\ 0 & 0 & 1 \\ 1 & 0 & 0 \\ 0 & 1 & 0 \end{bmatrix}$$

(16) Number of Transmit Chains =6, Total Number of Space Time Streams=3

$$\frac{1}{\sqrt{2}} \begin{bmatrix} 1 & 0 & 0 \\ 0 & 1 & 0 \\ 0 & 0 & 1 \\ 1 & 0 & 0 \\ 0 & 1 & 0 \\ 0 & 0 & 1 \end{bmatrix}$$

(17) Number of Transmit Chains =7, Total Number of Space Time Streams=3

$$\sqrt{\frac{3}{7}} \begin{bmatrix} 1 & 0 & 0 \\ 0 & 1 & 0 \\ 0 & 0 & 1 \\ 1 & 0 & 0 \\ 0 & 1 & 0 \\ 0 & 0 & 1 \\ 1 & 0 & 0 \end{bmatrix}$$

(18) Number of Transmit Chains =8, Total Number of Space Time Streams=3

$$\sqrt{\frac{3}{8}} \begin{bmatrix} 1 & 0 & 0 \\ 0 & 1 & 0 \\ 0 & 0 & 1 \\ 1 & 0 & 0 \\ 0 & 1 & 0 \\ 0 & 0 & 1 \\ 1 & 0 & 0 \\ 0 & 1 & 0 \end{bmatrix}$$

(19) Number of Transmit Chains =5, Total Number of Space Time Streams=4

$$\frac{2}{\sqrt{5}} \begin{bmatrix} 1 & 0 & 0 & 0 \\ 0 & 1 & 0 & 0 \\ 0 & 0 & 1 & 0 \\ 0 & 0 & 0 & 1 \\ 1 & 0 & 0 & 0 \end{bmatrix}$$

(20) Number of Transmit Chains =6, Total Number of Space Time Streams=4

$$\frac{2}{\sqrt{6}} \begin{bmatrix} 1 & 0 & 0 & 0 \\ 0 & 1 & 0 & 0 \\ 0 & 0 & 1 & 0 \\ 0 & 0 & 0 & 1 \\ 1 & 0 & 0 & 0 \\ 0 & 1 & 0 & 0 \end{bmatrix}$$

(21) Number of Transmit Chains =7, Total Number of Space Time Streams=4

$$\frac{2}{\sqrt{7}} \begin{bmatrix} 1 & 0 & 0 & 0 \\ 0 & 1 & 0 & 0 \\ 0 & 0 & 1 & 0 \\ 0 & 0 & 0 & 1 \\ 1 & 0 & 0 & 0 \\ 0 & 1 & 0 & 0 \\ 0 & 0 & 1 & 0 \end{bmatrix}$$

(22) Number of Transmit Chains =8, Total Number of Space Time Streams=4

$$\frac{1}{\sqrt{2}} \begin{bmatrix} 1 & 0 & 0 & 0 \\ 0 & 1 & 0 & 0 \\ 0 & 0 & 1 & 0 \\ 0 & 0 & 0 & 1 \\ 1 & 0 & 0 & 0 \\ 0 & 1 & 0 & 0 \\ 0 & 0 & 1 & 0 \\ 0 & 0 & 0 & 1 \end{bmatrix}$$

(23) Number of Transmit Chains =6, Total Number of Space Time Streams=5

$$\sqrt{\frac{5}{6}} \begin{bmatrix} 1 & 0 & 0 & 0 & 0 \\ 0 & 1 & 0 & 0 & 0 \\ 0 & 0 & 1 & 0 & 0 \\ 0 & 0 & 0 & 1 & 0 \\ 0 & 0 & 0 & 0 & 1 \\ 1 & 0 & 0 & 0 & 0 \end{bmatrix}$$

(24) Number of Transmit Chains =7, Total Number of Space Time Streams=5

$$\sqrt{\frac{5}{7}} \begin{bmatrix} 1 & 0 & 0 & 0 & 0 \\ 0 & 1 & 0 & 0 & 0 \\ 0 & 0 & 1 & 0 & 0 \\ 0 & 0 & 0 & 1 & 0 \\ 0 & 0 & 0 & 0 & 1 \\ 1 & 0 & 0 & 0 & 0 \\ 0 & 1 & 0 & 0 & 0 \end{bmatrix}$$

(25) Number of Transmit Chains =8, Total Number of Space Time Streams=5

$$\sqrt{\frac{5}{8}} \begin{bmatrix} 1 & 0 & 0 & 0 & 0 \\ 0 & 1 & 0 & 0 & 0 \\ 0 & 0 & 1 & 0 & 0 \\ 0 & 0 & 0 & 1 & 0 \\ 0 & 0 & 0 & 0 & 1 \\ 1 & 0 & 0 & 0 & 0 \\ 0 & 1 & 0 & 0 & 0 \\ 0 & 0 & 1 & 0 & 0 \end{bmatrix}$$

(26) Number of Transmit Chains =7, Total Number of Space Time Streams=6

$$\sqrt{\frac{6}{7}} \begin{bmatrix} 1 & 0 & 0 & 0 & 0 & 0 \\ 0 & 1 & 0 & 0 & 0 & 0 \\ 0 & 0 & 1 & 0 & 0 & 0 \\ 0 & 0 & 0 & 1 & 0 & 0 \\ 0 & 0 & 0 & 0 & 1 & 0 \\ 0 & 0 & 0 & 0 & 0 & 1 \\ 1 & 0 & 0 & 0 & 0 & 0 \end{bmatrix}$$

(27) Number of Transmit Chains =8, Total Number of Space Time Streams=6

$$\sqrt{\frac{3}{4}} \begin{bmatrix} 1 & 0 & 0 & 0 & 0 & 0 \\ 0 & 1 & 0 & 0 & 0 & 0 \\ 0 & 0 & 1 & 0 & 0 & 0 \\ 0 & 0 & 0 & 1 & 0 & 0 \\ 0 & 0 & 0 & 0 & 1 & 0 \\ 0 & 0 & 0 & 0 & 0 & 1 \\ 1 & 0 & 0 & 0 & 0 & 0 \\ 0 & 1 & 0 & 0 & 0 & 0 \end{bmatrix}$$

(28) Number of Transmit Chains =8, Total Number of Space Time Streams=7

$$\sqrt{\frac{7}{8}} \begin{bmatrix} 1 & 0 & 0 & 0 & 0 & 0 & 0 \\ 0 & 1 & 0 & 0 & 0 & 0 & 0 \\ 0 & 0 & 1 & 0 & 0 & 0 & 0 \\ 0 & 0 & 0 & 1 & 0 & 0 & 0 \\ 0 & 0 & 0 & 0 & 1 & 0 & 0 \\ 0 & 0 & 0 & 0 & 0 & 1 & 0 \\ 0 & 0 & 0 & 0 & 0 & 0 & 1 \\ 1 & 0 & 0 & 0 & 0 & 0 & 0 \end{bmatrix}$$

When selecting **Edit Mode**, a window as Figure 3.1.3.2-1 or 3.1.3.2-2 appears and allows editing each element. Selecting an element on the matrix displays Input Complex Data window and allows entering numerical values. The number of the elements on the matrix and their defaults depend on Number of Transmit Chains.

(Refer to Table 3.1.3.2-1 to 3.1.3.2-8.)

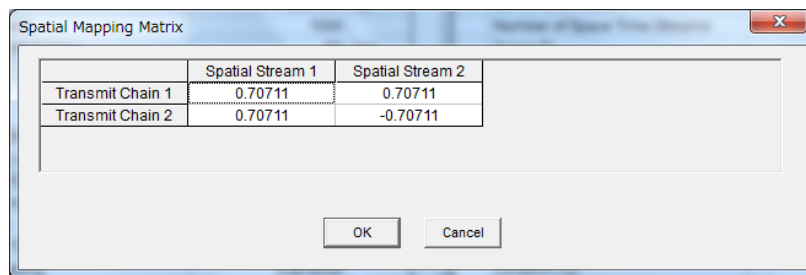

Figure 3.1.3.2-1 Spatial Mapping Matrix Setting Window (Number of Transmit Chains= 2)

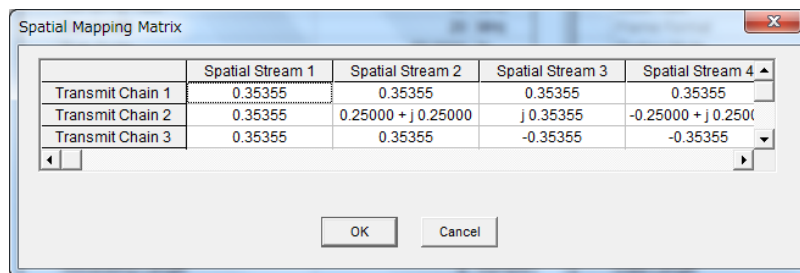

Figure 3.1.3.2-2 Spatial Mapping Matrix Setting Window (Number of Transmit Chains= 8)

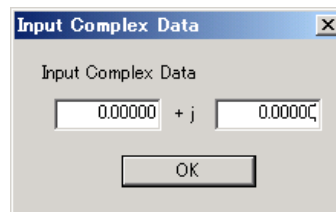

Figure 3.1.3.2-3 Input Complex Data Window

Table 3.1.3.2-1 Relationship between Number of Transmit Chains and the Displayed Element Count

Number of Transmit Chains	Displayed Element Count
2	2 × 2 matrix
3	3 × 3 matrix
4	4 × 4 matrix
5	5 × 5 matrix
6	6 × 6 matrix
7	7 × 7 matrix
8	8 × 8 matrix

Table 3.1.3.2-2 Default of elements when Number of Transmit Chains =2

	Spatial Stream 1	Spatial Stream 2
Transmit Chain 1	0.70711	0.70711
Transmit Chain 2	0.70711	-0.70711

Table 3.1.3.2-3 Default of elements when Number of Transmit Chains =3

	Spatial Stream 1	Spatial Stream 2	Spatial Stream 3
Transmit Chain 1	0.57735	0.57735	0.57735
Transmit Chain 2	0.57735	-0.28868 + j 0.5	-0.28868 - j 0.5
Transmit Chain 3	0.57735	-0.28868 - j 0.5	-0.28868 + j 0.5

Table 3.1.3.2-4 Default of elements when Number of Transmit Chains =4

	Spatial Stream 1	Spatial Stream 2	Spatial Stream 3	Spatial Stream 4
Transmit Chain 1	0.5	0.5	0.5	0.5
Transmit Chain 2	0.5	j 0.5	-0.5	-j 0.5
Transmit Chain 3	0.5	-0.5	0.5	-0.5
Transmit Chain 4	0.5	-j 0.5	-0.5	j 0.5

Table 3.1.3.2-5 Default of elements when Number of Transmit Chains =5

	Spatial Stream 1	Spatial Stream 2	Spatial Stream 3	Spatial Stream 4	Spatial Stream 5
Transmit Chain 1	0.44721	0.44721	0.44721	0.44721	0.44721
Transmit Chain 2	0.44721	0.13820 + j 0.42533	-0.36180 + j 0.26287	-0.36180 - j 0.26287	0.13820 - j 0.42533
Transmit Chain 3	0.44721	-0.36180 + j 0.26287	0.13820 - j 0.42533	0.13820 + j 0.42533	-0.36180 - j 0.26287
Transmit Chain 4	0.44721	-0.36180 - j 0.26287	0.13820 + j 0.42533	0.13820 - j 0.42533	-0.36180 + j 0.26287
Transmit Chain 5	0.44721	0.13820 - j 0.42533	-0.36180 - j 0.26287	-0.36180 + j 0.26287	0.13820 + j 0.42533

3

Table 3.1.3.2-6 Default of elements when Number of Transmit Chains =6

	Spatial Stream 1	Spatial Stream 2	Spatial Stream 3	Spatial Stream 4	Spatial Stream 5	Spatial Stream 6
Transmit Chain 1	0.40825	0.40825	0.40825	0.40825	0.40825	0.40825
Transmit Chain 2	0.40825	0.20412 + j 0.35355	-0.20412 + j 0.35355	-0.40825	-0.20412 - j 0.35355	0.20412 - j 0.35355
Transmit Chain 3	0.40825	-0.20412 + j 0.35355	-0.20412 - j 0.35355	0.408248	-0.20412 + j 0.35355	-0.20412 - j 0.35355
Transmit Chain 4	0.40825	-0.40825	0.40825	-0.40825	0.40825	-0.40825
Transmit Chain 5	0.40825	-0.20412 - j 0.35355	-0.20412 + j 0.35355	0.408248	-0.20412 - j 0.35355	-0.20412 + j 0.35355
Transmit Chain 6	0.40825	0.20412 - j 0.35355	-0.20412 - j 0.35355	-0.40825	-0.20412 + j 0.35355	0.20412 + j 0.35355

Normal Setup Screen

Table 3.1.3.2-7 Default of elements when Number of Transmit Chains =7

	Spatial Stream 1	Spatial Stream 2	Spatial Stream 3	Spatial Stream 4	Spatial Stream 5	Spatial Stream 6	Spatial Stream 7
Transmit Chain 1	0.37796	0.37796	0.37796	0.37796	0.37796	0.37796	0.37796
Transmit Chain 2	0.37796	0.23566 + j 0.29550	-0.08411 + j 0.36849	-0.34053 + j 0.16399	-0.34053 - j 0.16399	-0.08411 - j 0.36849	0.23566 - j 0.29550;
Transmit Chain 3	0.37796	-0.08411 + j 0.36849	-0.34053 - j 0.16399	0.23566 - j 0.29550	0.23566 + j 0.29550	-0.34053 + j 0.16399	-0.08411 - j 0.36849
Transmit Chain 4	0.37796	-0.34053 + j 0.16399	0.23566 - j 0.29550	-0.08411 + j 0.36849	-0.08411 - j 0.36849	0.23566 + j 0.29550	-0.34053 - j 0.16399
Transmit Chain 5	0.37796	-0.34053 - j 0.16399	0.23566 + j 0.29550	-0.08411 - j 0.36849	-0.08411 + j 0.36849	0.23566 - j 0.29550	-0.34053 + j 0.16399
Transmit Chain 6	0.37796	-0.08411 - j 0.36849	-0.34053 + j 0.16399	0.23566 + j 0.29550	0.23566 - j 0.29550	-0.34053 - j 0.16399	-0.08411 + j 0.36849
Transmit Chain 7	0.37796	0.23566 - j 0.29550	-0.08411 - j 0.36849	-0.34053 - j 0.16399	-0.34053 + j 0.16399	-0.08411 + j 0.36849	0.23566 + j 0.29550

Table 3.1.3.2-8 Default of elements when Number of Transmit Chains =8

	Spatial Stream 1	Spatial Stream 2	Spatial Stream 3	Spatial Stream 4	Spatial Stream 5	Spatial Stream 6	Spatial Stream 7	Spatial Stream 8
Transmit Chain 1	0.35355	0.35355	0.35355	0.35355	0.35355	0.35355	0.35355	0.35355
Transmit Chain 2	0.35355	0.25 + j 0.25	j 0.35355	-0.25 + j 0.25	-0.35355	-0.25 - j 0.25	- j 0.35355	0.25- j 0.25
Transmit Chain 3	0.35355	j 0.35355	-0.35355	- j 0.35355	0.353553	j 0.35355	-0.35355	- j 0.35355
Transmit Chain 4	0.35355	-0.25 + j 0.25	- j 0.35355	0.25 + j 0.25	-0.35355	0.25 - j 0.25	j 0.35355	-0.25 - j 0.25
Transmit Chain 5	0.35355	-0.35355	0.353553	-0.35355	0.353553	-0.35355	0.35355	-0.35355
Transmit Chain 6	0.35355	-0.25 - j 0.25	j 0.35355	0.25 - j 0.25	-0.35355	0.25 + j 0.25	- j 0.35355	-0.25 + j 0.25
Transmit Chain 7	0.35355	-0.35355	-0.35355	j 0.35355	0.353553	- j 0.35355	-0.35355	j 0.35355
Transmit Chain 8	0.35355	0.25 - j 0.25	- j 0.35355	-0.25 - j 0.25	-0.35355	-0.25 + j 0.25	j 0.35355	0.25 + j 0.25

GI
[Function] Sets the guard interval.
[Default] Long
[Setting range] Short, Long

Total Number of Space Time Streams
[Function] Displays the total number of space time stream.
[Default] 1
[Display range] 1 to 8
[Remarks] Displays the total number of space time streams under each User#



3.1.4 PHY/MAC parameters

The items displayed in the PHY/MAC parameter list are described below.

3.1.4.1 PHY parameters(System = other than 11ac)

When MPDU or A-MPDU is selected in the tree view, the following items are displayed in the PHY/MAC parameter list.

All PHY parameter values are the same for MPDU and A-MPDU.

PPDU Format

[Function] Sets the PPDU format.
[Default] HT Mixed
[Setting range] Non-HT, HT Mixed, HT Greenfield
[Remarks] This function can be used in the following case:
System = 11n

MCS

[Function] Sets the MCS.
[Default] 7
[Setting range] 0 to 76
[Remarks] Available in the following conditions:
System=11n and PPDU Format=HT Mixed/HT Greenfield,
Or system=11ac.
Details about the parameters when MCS is set are defined in IEEE Std 802.11n-2009 20.6.

Number of Spatial Streams

[Function] Displays the Number of Spatial Streams.
[Default] 1
[Display range] 1 to 4
[Remarks] Available in the following conditions:
System=11n and PPDU Format=HT Mixed/HT Greenfield
The displayed value varies according to MCS.

High Rate Modulation

- [Function] Sets the modulation scheme during direct diffusion.
- [Default] CCK
- [Setting range] CCK, PBCC
- [Remarks] Available in the following conditions:
 System=11b
 System=11g, and Frame Format=ERP-CCK/ERP-PBCC
 CCK/PBCC is selectable when Data Rate=5.5 Mbps/11 Mbps.
 Note that Frame Format is automatically set to:
 ERP-CCK when High Rate Modulation is CCK.
 ERP-PBCC when High Rate Modulation is PBCC.
 Only PBCC can be set when Data Rate=22 Mbps/33 Mbps.

Modulation

- [Function] Displays the PSDU modulation scheme.
- [Default] The default value for each System is as follows:
 System=11a, 11g, 11j, 11p, 11n (PPDU Format=Non-HT):
 64QAM
- [Display range] BPSK, QPSK, 16QAM, 64QAM, DBPSK, DQPSK
- [Remarks] This is not available when System=11b and Data Rate=5.5, or, System=11g and Data Rate=5.5, 11, 22, 33 Mbps
 This is not available when System=11n and PPDU Format=HT Mixed/HT Greenfield

Code Rate

- [Function] Displays the code rate.
- [Default] 3/4
- [Setting range] 1/2, 2/3, 3/4, 5/6
- [Remarks] This is not available when System=11b or System=11g, and Data Rate=1, 2, 5.5, 11, 22, 33 Mbps.
 Display only when System=11n and PPDU Format=HT Mixed/HT Greenfield

Data Rate

[Function] Sets the data rate.

[Default] The default value for each System is as follows:
 System=11a, 11g, 11j: 54 Mbps
 System=11b: 11 Mbps
 System=11p: 27 Mbps

[Setting range] 1, 2, 3, 4.5, 5.5, 6, 9, 11, 12, 18, 22, 24, 27, 33, 36, 48, 54

[Remarks] This setting is not available in the following conditions:
 System=11n and PPDU Format=HT Mixed/HT Greenfield
 When System=11n and PPDU format=Non-HT,
 the setting range is the same as System=11a.

Table 3.1.4.1-1 Available options when System=11a, 11j

Data Rate	Frame Format	Modulation	High Rate Modulation	Code Rate
6 Mbps	N/A	BPSK	N/A	1/2
9 Mbps		BPSK		3/4
12 Mbps		QPSK		1/2
18 Mbps		QPSK		3/4
24 Mbps		16QAM		1/2
36 Mbps		16QAM		3/4
48 Mbps		64QAM		2/3
54 Mbps		64QAM		3/4

Table 3.1.4.1-2 Available options when System=11b

Data Rate	Frame Format	Modulation	High Rate Modulation	Code Rate
1 Mbps	N/A	DBPSK	N/A	N/A
2 Mbps		DQPSK	N/A	
5.5 Mbps		N/A	CCK, PBCC	
11 Mbps		N/A	CCK, PBCC	

Table 3.1.4.1-3 Available options when System=11g

Data Rate	Frame Format	Modulation	High Rate Modulation	Code Rate
1 Mbps	ERP-DSSS	DBPSK	N/A	N/A
2 Mbps	ERP-DSSS	DQPSK	N/A	N/A
5.5 Mbps	ERP-CCK ERP-PBCC	N/A	CCK, PBCC	N/A
6 Mbps	ERP-OFDM, DSSS-OFDM	BPSK	N/A	1/2
9 Mbps	ERP-OFDM, DSSS-OFDM	BPSK	N/A	3/4
11 Mbps	ERP-CCK ERP-PBCC	N/A	CCK, PBCC	N/A
12 Mbps	ERP-OFDM, DSSS-OFDM	QPSK	N/A	1/2
18 Mbps	ERP-OFDM, DSSS-OFDM	QPSK	N/A	3/4
22 Mbps	ERP-PBCC	N/A	PBCC	N/A
24 Mbps	ERP-OFDM, DSSS-OFDM	16QAM	N/A	1/2
33 Mbps	ERP-PBCC	N/A	PBCC	N/A
36 Mbps	ERP-OFDM, DSSS-OFDM	16QAM	N/A	3/4
48 Mbps	ERP-OFDM, DSSS-OFDM	64QAM	N/A	2/3
54 Mbps	ERP-OFDM, DSSS-OFDM	64QAM	N/A	3/4

Table 3.1.4.1-4 Available options when System=11p

Data Rate	Frame Format	Modulation	High Rate Modulation	Code Rate
3 Mbps	N/A	BPSK	N/A	1/2
4.5 Mbps		BPSK		3/4
6 Mbps		QPSK		1/2
9 Mbps		QPSK		3/4
12 Mbps		16QAM		1/2
18 Mbps		16QAM		3/4
24 Mbps		64QAM		2/3
27 Mbps		64QAM		3/4

Preamble Type

- [Function] Sets the preamble type.
- [Default] Long
- [Setting range] Long, Short
- [Remarks] Available in the following conditions:
 System=11b
 System=11g
 Only Long can be set when System=11g, and Frame Format=ERP-DSSS, and Data Rate=1 Mbps.
 Only Long can be set when System=11g, and Frame Format=ERP-OFDM.
 Only Long can be set when System=11b, and Data Rate=1 Mbps.

Frame Format

- [Function] Sets the secondary modulation scheme of the header and payload.
- [Default] ERP-OFDM
- [Setting range] ERP-OFDM, DSSS-OFDM, ERP-DSSS, ERP-CCK, ERP-PBCC
- [Remarks] Available in the following conditions:
 System=11g
 Note that Frame Format is automatically set to:
 ERP-CCK when High Rate Modulation is CCK.
 ERP-PBCC when High Rate Modulation is PBCC.

Spatial Mapping

- [Function] Sets the spatial mapping mode.
 [Default] Direct Mapping
 [Setting range] Direct Mapping, Spatial Expansion, Edit Mode
 [Remarks] Available in the following conditions:
 System=11n and PPDU Format=HT Mixed/HT Greenfield
 Direct Mapping is available only when: Number of Space Time Streams=Number of Transmit Chains
 Direct Mapping can be set only when: Number of Transmit Chains=1

Edit Mode

- [Function] Sets Spatial Mapping Matrix.
 [Setting range] $-1.00000 - j1.00000$ to $1.00000 + j1.00000$
 [Resolution] The setting resolution is 0.00001 for both real and imaginary parts.

Spatial Mapping Matrix

If Spatial Expansion is selected for Spatial Mapping, the values shown in Figures 3.1.4.1-1 to 3.1.4.1-3 are applied for calculation. In this case, the stream is extended from Space Time Streams to Transmit Chains by using expressions (1) to (6).

- (1) Number of Transmit Chains =2, Number of Space Time Streams=1

$$\frac{1}{\sqrt{2}}[1 \ 1]^T$$

- (2) Number of Transmit Chains =3, Number of Space Time Streams=1

$$\frac{1}{\sqrt{3}}[1 \ 1 \ 1]^T$$

- (3) Number of Transmit Chains =4, Number of Space Time Streams=1

$$\frac{1}{2}[1 \ 1 \ 1 \ 1]^T$$

- (4) Number of Transmit Chains =3, Number of Space Time Streams=2

$$\sqrt{\frac{2}{3}} \begin{bmatrix} 1 & 0 \\ 0 & 1 \\ 1 & 0 \end{bmatrix}$$

- (5) Number of Transmit Chains =4, Number of Space Time Streams=2

$$\frac{1}{\sqrt{2}} \begin{bmatrix} 1 & 0 \\ 0 & 1 \\ 1 & 0 \\ 0 & 1 \end{bmatrix}$$

(6) Number of Transmit Chains =4, Number of Space Time Streams=3

$$\frac{\sqrt{3}}{2} \begin{bmatrix} 1 & 0 & 0 \\ 0 & 1 & 0 \\ 0 & 0 & 1 \\ 1 & 0 & 0 \end{bmatrix}$$

If **Edit Mode** is selected for Spatial Mapping, one of the Spatial Mapping Matrix windows shown in Figures 3.1.4.1-1 to 3.1.4.1-3 is displayed, on which the spatial mapping can be edited. Selecting an element on the matrix displays the Input Complex Data window shown in Figure 3.1.4.1-4, on which numerical values can be entered. The number of elements on the matrix depends on the value set for Number of Transmit Chains. Refer to Table 3.1.4.1-5.

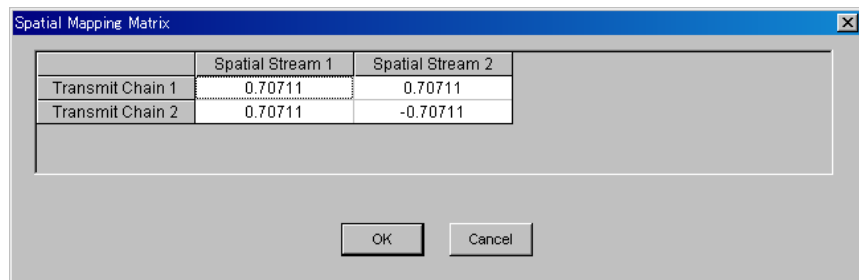

Figure 3.1.4.1-1 Spatial Mapping Matrix setting window (Number of Transmit Chains= 2)

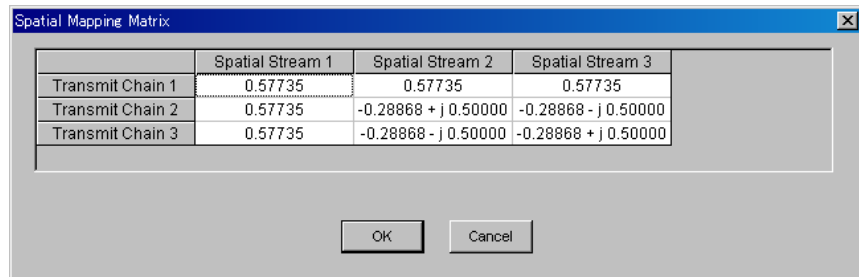

Figure 3.1.4.1-2 Spatial Mapping Matrix setting window (Number of Transmit Chains= 3)

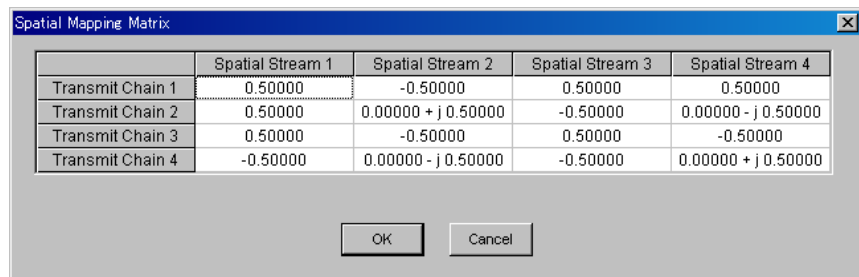

Figure 3.1.4.1-3 Spatial Mapping Matrix setting window (Number of Transmit Chains= 4)

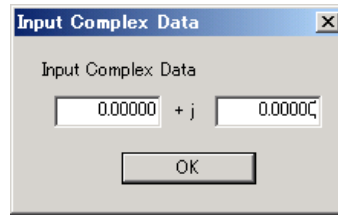

Figure 3.1.4.1-4 Input Complex Data window

Table 3.1.4.1-5 Relationship between Number of Transmit Chains and the Displayed Element Count

Number of Transmit Chains	Displayed Element Count
1	Does not display
2	2 × 2 matrix
3	3 × 3 matrix
4	4 × 4 matrix

GI

- [Function] Sets the guard interval.
- [Default] Long
- [Setting range] Short, Long
- [Remarks] Available in the following conditions:
System=11n and PPDU Format=HT Mixed/HT Greenfield

Smoothing

- [Function] Enables/disables smoothing processing.
- [Default] Off
- [Setting range] On, Off
- [Remarks] Available in the following conditions:
System=11n and PPDU Format=HT Mixed/HT Greenfield

Not Sounding

- [Function] Enables/disables Not Sounding processing.
- [Default] On
- [Setting range] On, Off
- [Remarks] Available in the following conditions:
System=11n and PPDU Format=HT Mixed/HT Greenfield

Number of Transmit Chains

[Function] Sets Number of Transmit Chains.

[Default] 1

[Setting range] 1 to 4

[Remarks] Available in the following conditions:
System=11n and PPDU Format=HT Mixed/HT Greenfield
A value equal to or greater than that set for Number of Space Time Streams can be set for Number of Transmit Chains.

Number of Space Time Streams

[Function] Sets the number of space time streams.

[Default] 1

[Setting range] 1 to 4

[Remarks] Available in the following conditions:
System=11n and PPDU Format=HT Mixed/HT Greenfield
A value equal to or greater than that set for Number of Spatial Streams can be set for Number of Space Time Streams.

Number of Extension Spatial Streams

[Function] Sets Number of Extension Spatial Streams.

[Default] 0

[Setting range] 0 to (Number of Transmit Chains – Number of Space Time Streams)

[Remarks] Available in the following conditions:
System=11n and PPDU Format=HT Mixed/HT Greenfield

Half Bandwidth

[Function] Sets the carrier arrangement when Bandwidth = 40 MHz.

[Default] N/A

[Setting range] Lower Mode, Upper Mode, N/A

[Remarks] This is available only when System=11n and Bandwidth=40 MHz. Only N/A can be set when in MCS32.
Only the lower 20 MHz of a 40 MHz channel is transmitted when Lower Mode is specified, while only the upper 20 MHz of a 40 MHz channel is transmitted when Upper Mode is specified. N/A transmits 40 MHz channel as is.

3.1.4.2 MAC parameters(System = other than 11ac)

When MPDU or A-MPDU is selected in the tree view, the following items are displayed in the PHY/MAC parameter list. MAC parameter settings can be different between MPDU and A-MPDU.

Data Length

[Function] Sets the data wavelength.

[Default] The default value for each System is as follows:
 System=11a, 11g (Frame Format=DSSS-OFDM, ERP-OFDM), 11j, 11p:
 966 [octet(s)]
 System=11b, 11g (Frame Format=ERP-DSSS, ERP-PBCC, ERP-CCK):
 990 [octet(s)]
 System=11n:
 4062 [octet(s)]
 System=11n and PPDU Format=Non-HT:
 4061 [octet(s)]
 System=11n and
 PPDU Format=HT Mixed/HT Greenfield:
 4062 [octet(s)]

[Setting range] The setting range for each system is as follows:
 System=11a, 11b, 11g, 11j, 11p, or System=11n and PPDU
 format=Non-HT:
 1 to (4095-Diff)
 When System=11n, and PPDU Format=HT Mixed/HT
 Greenfield:
 1 to (65535-Diff)

[Remarks] Diff refers to a value (octets) obtained by subtracting the value of Total Length (MAC header + FCS) from the total number of MAC parameters that are set to Off in the MAC Frame Format setting window.
 Total Length=40 [octet(s)]

MPDU Length

- [Function] Displays the MPDU length.
- [Default] The default value for each System is as follows:
 System=11a, 11g (Frame Format=DSSS-OFDM, ERP-OFDM), 11j, 11n, 11p:
 1000 [octet(s)]
 System=11b, 11g (Frame Format=ERP-DSSS, ERP-PBCC, ERP-CCK):
 1024 [octet(s)]
 System=11n and PPDU Format=Non-HT:
 4095 [octet(s)]
 System=11n and
 PPDU Format=HT Mixed/HT Greenfield:
 4096 [octet(s)]
- [Display range] The display range for each system is as follows:
 System=11a, 11b, 11g, 11j, 11p, or System=11n and PPDU
 format=Non-HT:
 (Diff+1) to 4095
 When System=11n, and PPDU Format=HT Mixed/HT
 Greenfield:
 (Diff+1) to 65535
 When System=11n, and A-MPDU=ON: (Diff+1) to 4095

MAC Frame Type

- [Function] Sets the MAC Frame type.
- [Default] General
- [Remarks] MAC information can be set.

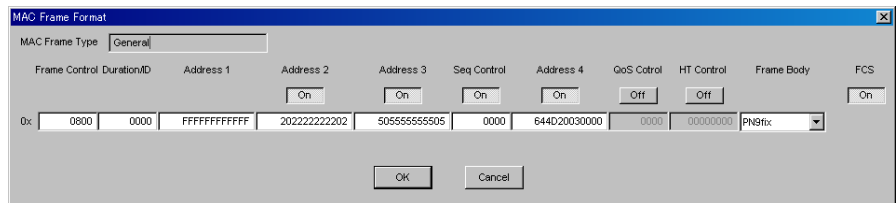

Figure 3.1.4.2-1 MAC Frame Format setting window (when System = 11n)

MAC Data Type

- [Function] Sets the type of data assigned to the MAC frame body.
 [Default] PN9fix
 [Setting range] PN9fix, PN15fix, 16bit repeat, User File

Data Type Repeat Data

- [Function] Sets 16-bit data to be assigned to the MAC frame body.
 [Default] 0x0000
 [Setting range] 0x0000 to 0xFFFF
 [Remarks] This parameter is displayed only when 16 bit repeat is selected for MAC Data Type.

Data Type User File

- [Function] Sets a user file to be assigned to the MAC frame body.
 [Setting range] Any file can be selected.
 [Remarks] This parameter is displayed only when User File is selected for MAC Data Type.
 Refer to Appendix B “User File Format” for details on the user file format.

Frame Control

- [Function] Sets the Frame Control.
 [Default] 0x0800
 [Setting range] 0x0000 to 0xFFFF

Duration/ID

- [Function] Sets the Duration/ID.
 [Default] 0x0000
 [Setting range] 0x0000 to 0xFFFF

Address1

- [Function] Sets the Address1.
 [Default] 0xFFFF FFFF FFFF
 [Setting range] 0x0000 0000 0000 to 0xFFFF FFFF FFFF

Address2

[Function] Sets the Address2.
[Default] 0x2022 2222 2202
[Setting range] 0x0000 0000 0000 to 0xFFFF FFFF FFFF
[Remarks] Available in the following condition:
System=11n and Address2 SW = On.

Address2 SW

[Function] Enables/disables the MAC Address2.
[Default] On
[Setting range] On, Off

Address3

[Function] Sets the Address3.
[Default] 0x5055 5555 5505
[Setting range] 0x0000 0000 0000 to 0xFFFF FFFF FFFF
[Remarks] Available in the following condition:
System=11n and Address3 SW = On.

Address3 SW

[Function] Enables/disables the MAC Address3.
[Default] On
[Setting range] On, Off

Sequence Control

[Function] Sets the Sequence Control.
[Default] 0x0000
[Setting range] 0x0000 to 0xFFFF
[Remarks] Available in the following condition:
System=11n and Sequence Control SW = On.

Sequence Control SW

[Function] Enables/disables the Sequence Control.
[Default] On
[Setting range] On, Off

Address4
[Function] Sets the Address4.
[Default] 0x644D 2003 0000
[Setting range] 0x0000 0000 0000 to 0xFFFF FFFF FFFF
[Remarks] Available in the following condition:
System=11n and Address4 SW=On.

Address4 SW
[Function] Enables/disables the MAC Address4.
[Default] On
[Setting range] On, Off

QoS Control
[Function] Sets the QoS Control.
[Default] 0x0000
[Setting range] 0x0000 to 0xFFFF
[Remarks] Available in the following condition:
System=11n and QoS Control SW=On.

QoS Control SW
[Function] Enables/disables the QoS Control.
[Default] Off
[Setting range] On, Off
[Remarks] Available in the following condition:
System=11n

HT Control
[Function] Sets the HT Control.
[Default] 0x0000 0000
[Setting range] 0x0000 0000 to 0xFFFF FFFF
[Remarks] Available in the following condition:
System=11n and HT Control SW=On.

HT Control SW
[Function] Enables/disables the HT Control.
[Default] Off
[Setting range] On, Off
[Remarks] Available in the following condition:
System=11n

MAC FCS

[Function] Enables/disables the MAC FCS.

[Default] On

[Setting range] On, Off

Increment Sequence Number

[Function] Enables/disables the Increment Sequence Number.

[Default] Off

[Setting range] On, Off

[Remarks] If set to On, the count-up operation starts from the upper 12 bits of the value specified for Sequence Control, incrementally at each interval specified by Sequence Number Increment Period.

Sequence Number Increment Period

[Function] Sets the interval to count up the sequence number.

[Default] 1

[Setting range] 1 to 15

[Remarks] This is available when Increment Sequence Number or Increment Fragment Number is set to On.

Increment Fragment Number

[Function] Enables/disables the Increment Fragment Number.

[Default] Off

[Setting range] On, Off

[Remarks] If set to On, the count-up operation starts from the lower 4 bits of the value specified for Sequence Control, incrementally for each packet at each interval specified by Sequence Number Increment Period.

3.1.4.3 PHY parameter (System=11ac)

When MPDU or A-MPDU under User# is selected in the tree view, the following items are displayed in the PHY/MAC parameter list.

All PHY parameter values for each User# are the same for MPDU and A-MPDU.

Scramble

[Function] Enables/disables scramble processing.
 [Default] On
 [Setting range] On, Off

MCS

[Function] Sets the MCS.
 [Default] 8
 [Setting range] 0 to 9
 [Remarks] The setting range of MCS changes depending on the setting of Bandwidth, Number of Spatial Streams. Details about the parameters when MCS is set are defined in IEEE P802.11ac/D2.0, January 2012 22.5.

Number of Spatial Streams

[Function] Sets the number of spatial streams.
 [Default] 1
 [Setting range] 1 to 8
 [Remarks] The setting range is 1 to 4 when the user mode is Multi User.

Modulation

[Function] Displays the modulation scheme of PSDU.
 [Default] 256QAM
 [Display range] BPSK, QPSK, 16QAM, 64QAM, 256QAM
 [Remarks] The value depends on MCS.

Code Rate

[Function] Displays the code rate.
 [Default] 3/4
 [Display range] 1/2, 2/3, 3/4, 5/6
 [Remarks] The value depends on MCS.

Coding

[Function] Sets of the coding is On or Off.
[Setting range] On
[Remarks] Fixed to On for System=11ac.

Coding Mode

[Function] Sets the coding mode.
[Setting range] BCC
[Remarks] Fixed to BCC for System=11ac.

BCC Interleaver

[Function] Enables/disables BCC Interleaver.
[Setting range] On
[Remarks] Fixed to On for System=11ac.

LDPC Tone Mapper

[Function] Enables/disables .
[Default] On
[Setting range] On, Off
[Remarks] Void for System=11ac.

Number of Space Time Streams

[Function] Sets the number of space time stream.
[Default] 1
[Setting range] The same value as Number of Spatial Stream,
Number of Spatial Stream×2
[Remarks] Number of Spatial Streams×2 is settable only when
Number of Spatial Streams×2 ≤ Number of Transmit
Chains.
When the user mode is set to Multi User, Number of
Spatial Streams×2 is not settable unless Number of
Spatial Streams ≤ 2 for each User#.

Group ID

[Function] Sets the group ID.
[Default] 0x3F (User Mode = Single User)
0x01 (User Mode = Multi User)
[Setting range] 0x00, 0x3F (User Mode = Single User)
0x01 to 0x3E (User Mode = Multi User)

Partial AID

[Function] Sets Partial AID.

[Default] 0x000

[Setting range] 0x000 to 0x1FF

[Remarks] Void when User Mode = Multi User.

TXOP PS NOT ALLOWED

[Function] Sets TXOP PS NOT ALLOWED.

[Default] 1

[Setting range] 0, 1

3.1.4.4 MAC parameter (System=11ac)

When MPDU or A-MPDU under User# is selected in the tree view, the following items are displayed in the PHY/MAC parameter list.

All PHY parameter values for each User# are the same for MPDU and A-MPDU.

A-MPDU

[Function] Enables/disables A-MPDU for each User#.
 [Default] Off
 [Setting range] On, Off
 [Remarks] If A-MPDU is set to Off in one A-MPDU#, all MPDU/A-MPDU# under other User#s are all set to Off.

Data Length

[Function] Set the data length.
 [Default] 4062 [octet(s)]
 [Setting range] 1 to (65535-Diff) (A-MPDU=Off)
 1 to (16384-Diff) (A-MPDU=On)
 [Remarks] Diff=Total Length(Mac Header+FCS)
 -(Sum of MAC parameters [octet(s)] that are Off on MAC Frame Format setting window.)
 Total Length=40 [octet(s)]
 When Oversampling Ratio=8, Bandwidth=20 MHz, MCS=0, Number of Spatial Streams=1, A-MPDU=Off:
 1 to (42500-Diff)
 When the setting range is changed from 1 to (65535-Diff) to 1 to (42500-Diff), the setting of MAC parameter are automatically initialized.

MPDU Length

[Function] Displays the MPDU length.
 [Default] 4096 [octet(s)]
 [Display range] (Diff+1) to 65535 (A-MPDU=Off)
 (Diff+1) to 16384 (A-MPDU=On)
 [Remarks] When Oversampling Ratio=8, Bandwidth=20 MHz, MCS=0, Number of Spatial Streams=1, A-MPDU=Off:
 (Diff+1) to 42500

Total A-MPDU Length

[Function] Displays the total A-MPDU Length directly under each User#.

[Display range] 1 to 262140

[Remarks] Void when A-MPDU is Off.
When Oversampling Ratio=8, Bandwidth=20 MHz,
MCS=0, Number of Spatial Streams=1:
1 to 42500

MAC Frame Type

[Function] Sets the type of MAC Frame.

[Default] General

[Remarks] Sets the MAC information.

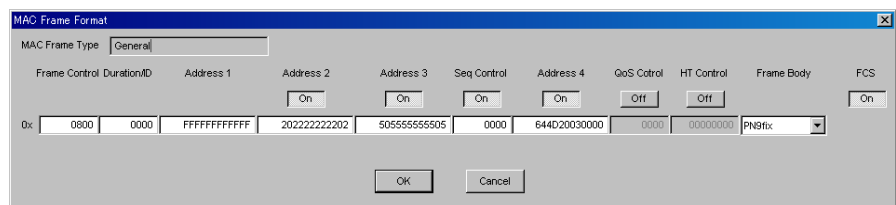

Figure 3.1.4.4-1 MAC Frame Format setting window (System = 11ac)

MAC Data Type

[Function] Sets the data type to be inserted into Mac Frame body.

[Default] PN9fix

[Setting range] PN9fix, PN15fix, 16bit repeat, User File

Data Type Repeat Data

[Function] Sets the 16 bit data to be inserted into Mac Frame body.

[Default] 0x0000

[Setting range] 0x0000 to 0xFFFF

[Remarks] This parameter is displayed only when 16 bit repeat is selected for MAC Data Type.

Data Type User File

[Function] Sets the user file to be inserted into Mac Frame body.

[Setting range] Any file can be selected.

[Remarks] This parameter is displayed only when User File is selected for MAC Data Type.
Refer to Appendix B “User File Format” for details on the user file format.

Frame Control

[Function] Sets the frame control.

[Default] 0x0800

[Setting range] 0x0000 to 0xFFFF

Duration/ID

[Function] Sets Duration/ID.

[Default] 0x0000

[Setting range] 0x0000 to 0xFFFF

Address1

[Function] Sets MAC Address1.

[Default] 0xFFFF FFFF FFFF

[Setting range] 0x0000 0000 0000 to 0xFFFF FFFF FFFF

Address2

[Function] Sets MAC Address2.

[Default] 0x2022 2222 2202

[Setting range] 0x0000 0000 0000 to 0xFFFF FFFF FFFF

[Remarks] Available in the following condition:
Address2 SW = On

Address2 SW

[Function] Enables/disables MAC Address2.

[Default] On

[Setting range] On, Off

Address3

[Function] Sets MAC Address3.

[Default] 0x5055 5555 5505

[Setting range] 0x0000 0000 0000 to 0xFFFF FFFF FFFF

[Remarks] Available in the following condition:
Address3 SW = On

Address3 SW

[Function] Enables/disables MAC Address3.

[Default] On

[Setting range] On, Off

Sequence Control

[Function] Sets the Sequence Control.
 [Default] 0x0000
 [Setting range] 0x0000 to 0xFFFF
 [Remarks] Available in the following condition:
 Sequence Control SW = On

Sequence Control SW

[Function] Enables/disables the Sequence Control.
 [Default] On
 [Setting range] On, Off

Address4

[Function] Sets MAC Address4.
 [Default] 0x644D 2003 0000
 [Setting range] 0x0000 0000 0000 to 0xFFFF FFFF FFFF
 [Remarks] Available in the following condition:
 Address4 SW = On

Address4 SW

[Function] Enables/disables MAC Address4.
 [Default] On
 [Setting range] On, Off

QoS Control

[Function] Sets the QoS Control.
 [Default] 0x0000
 [Setting range] 0x0000 to 0xFFFF
 [Remarks] Available in the following condition:
 QoS Control SW = On

QoS Control SW

[Function] Enables/disables the QoS Control.
 [Default] Off
 [Setting range] On, Off

HT Control

[Function] Sets the HT Control.
 [Default] 0x0000 0000
 [Setting range] 0x0000 0000 to 0xFFFF FFFF
 [Remarks] Available in the following condition:
 HT Control SW = On

HT Control SW

[Function] Enables/disables the HT Control.

[Default] Off

[Setting range] On, Off

MAC FCS

[Function] Enables/disables the MAC FCS.

[Default] On

[Setting range] On, Off

Increment Sequence Number

[Function] Enables/disables the Increment of Sequence Number.

[Default] Off

[Setting range] On, Off

[Remarks] If the Increment of Sequence Number sets to On, the count-up operation starts from the upper 12 bits of the value specified for Sequence Control, incrementally at each interval specified by Sequence Number Increment Period.

Sequence Number Increment Period

[Function] Sets the interval to count up the sequence number.

[Default] 1

[Setting range] 1 to 15

[Remarks] This is available when Increment Sequence Number or Increment Fragment Number is set to On.

Increment Fragment Number

[Function] Enables/disables the Increment Fragment Number.

[Default] Off

[Setting range] On, Off

[Remarks] If Increment Fragment Number sets to On, the count-up operation starts from the lower 4 bits of the value specified for Sequence Control, incrementally for each frame at each interval specified by Sequence Number Increment Period.

3.1.5 Export File screen

When “Calculation” is selected from the **Edit** menu or the  tool button is clicked on the main screen, the Export File screen is displayed. The Export File screen is displayed when generating a waveform pattern. In this screen, the output destination folder, package name, file name, and comment for the waveform pattern to be generated can be specified.

When MG3710 or MG3700 is selected in the Select instrument screen, the **Package (Combination File)** box is displayed as well.

When the system is 11ac and the bandwidth is other than 80+80 MHz, the waveform files as many as the specified antenna number are generated.

If the antenna number is 2 or more, the file to be generated has an underscore and antenna number at its name end as “Tx_Antenna_0”. When the system is 11ac and the bandwidth is 80+80 MHz, “Low” is added to the end of the waveform file name of SG1 and “Up” to that of SG2.

Note:

The number of waveform patterns (Antenna Port items) to be generated and the Export File screen change depending on the setting of Number of Antennas. See Figures 3.1.5-1 to 3.1.5-6.

Note:

When launching IQproducer on the MG3710, the **Package (Combination File)** box (shown in Figures 3.1.5-1 and 3.1.5-3—3.1.5-6) is displayed if the version is earlier than 14.01, but is not displayed if the version is 14.01 or later.

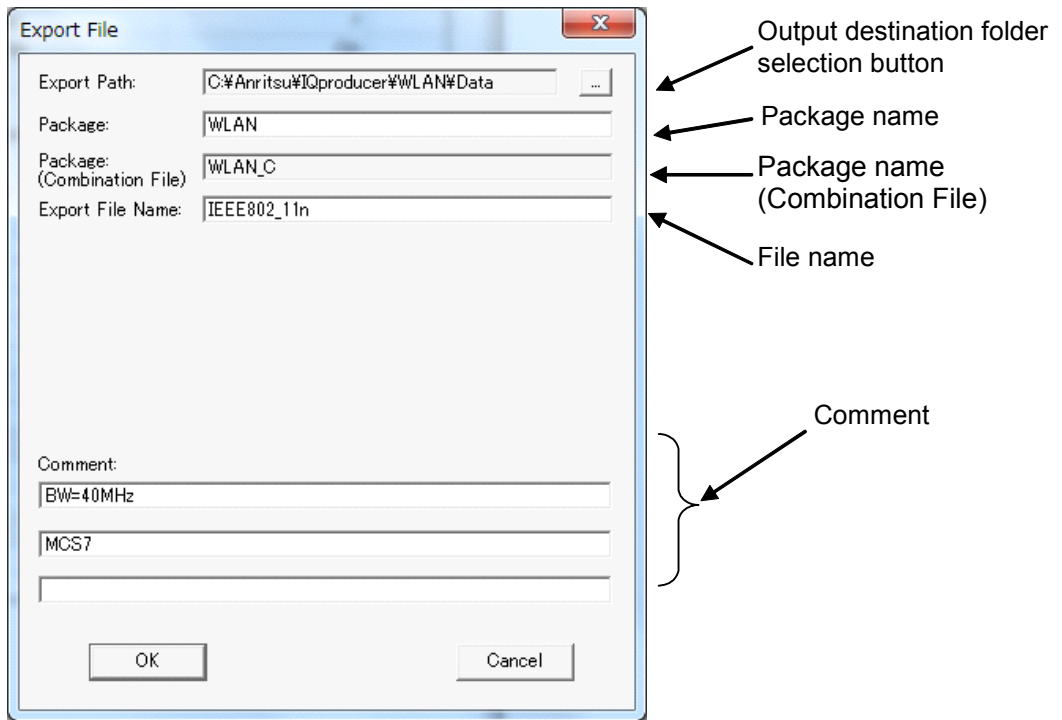

Figure 3.1.5-1 Export File screen (Select instrument = MG3710 or MG3700)

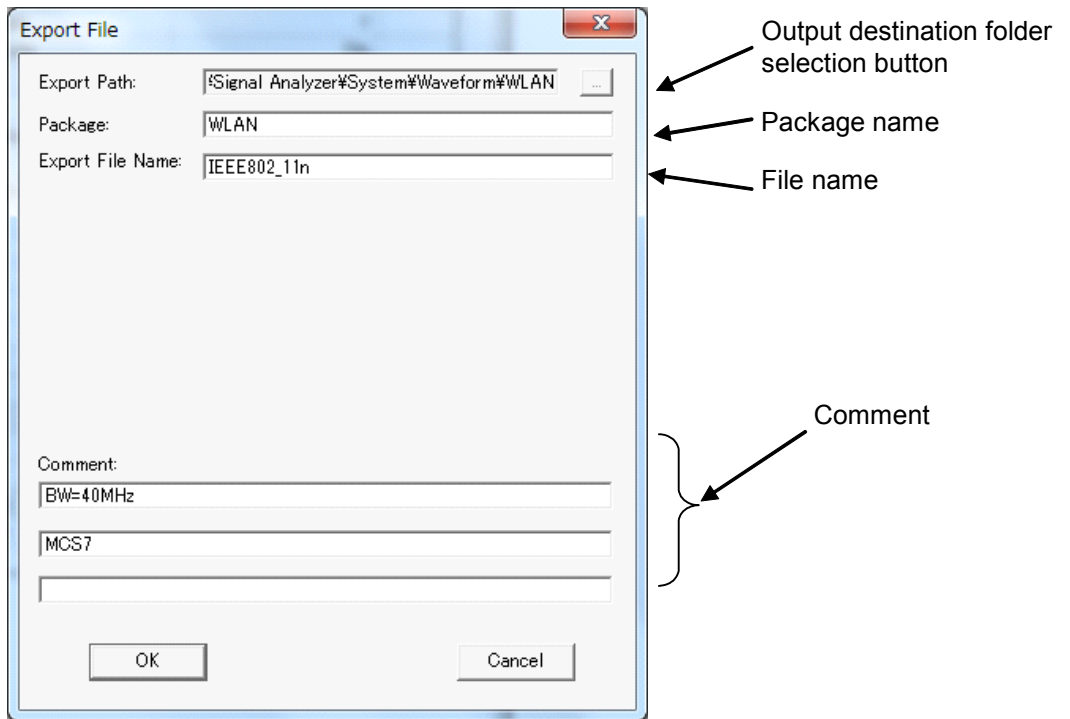

Figure 3.1.5-2 Export File screen (Select instrument=MS269x or MS2830)

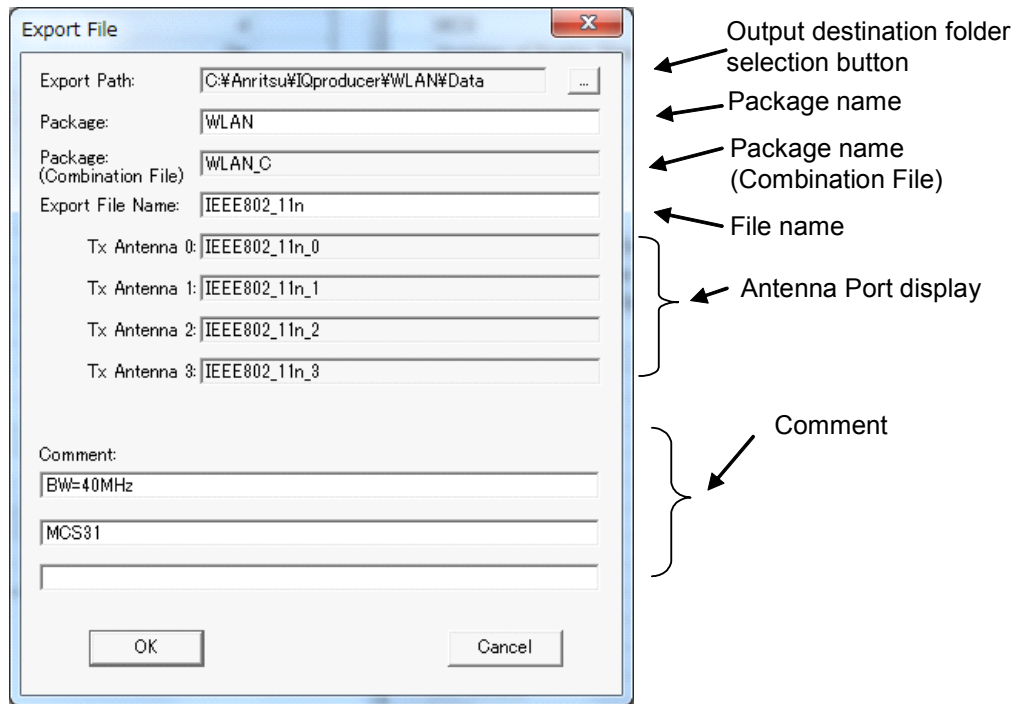

Figure 3.1.5-3 Export File screen (when Number of Antennas = 4)

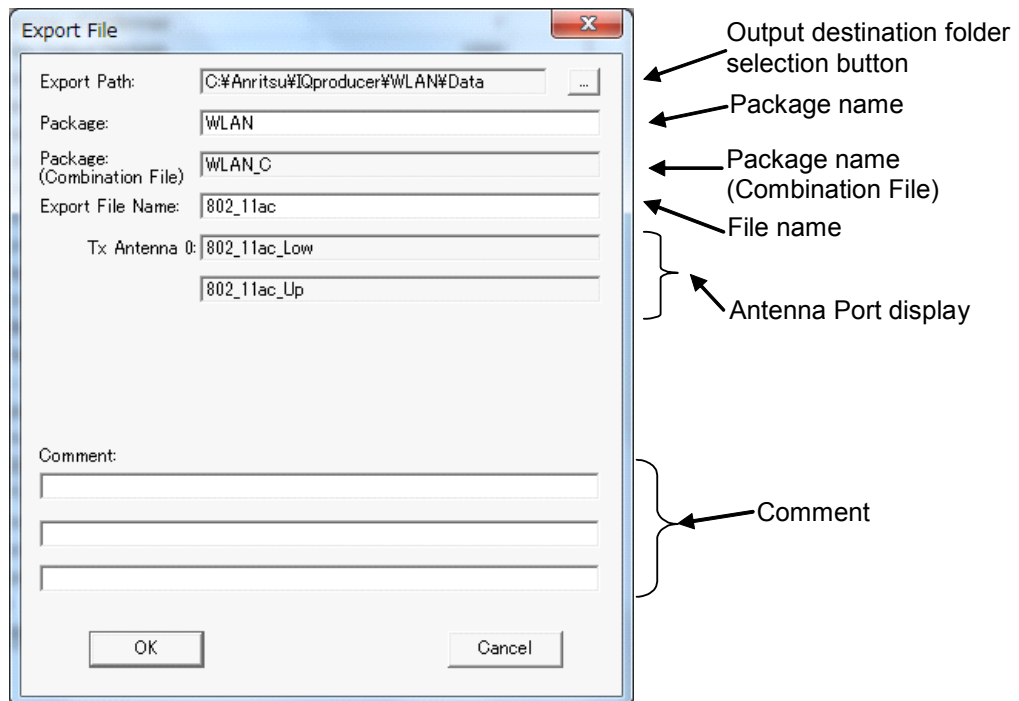

Figure 3.1.5-4 Export File screen (IEEE 802.11ac and Bandwidth =80+80 MHz)

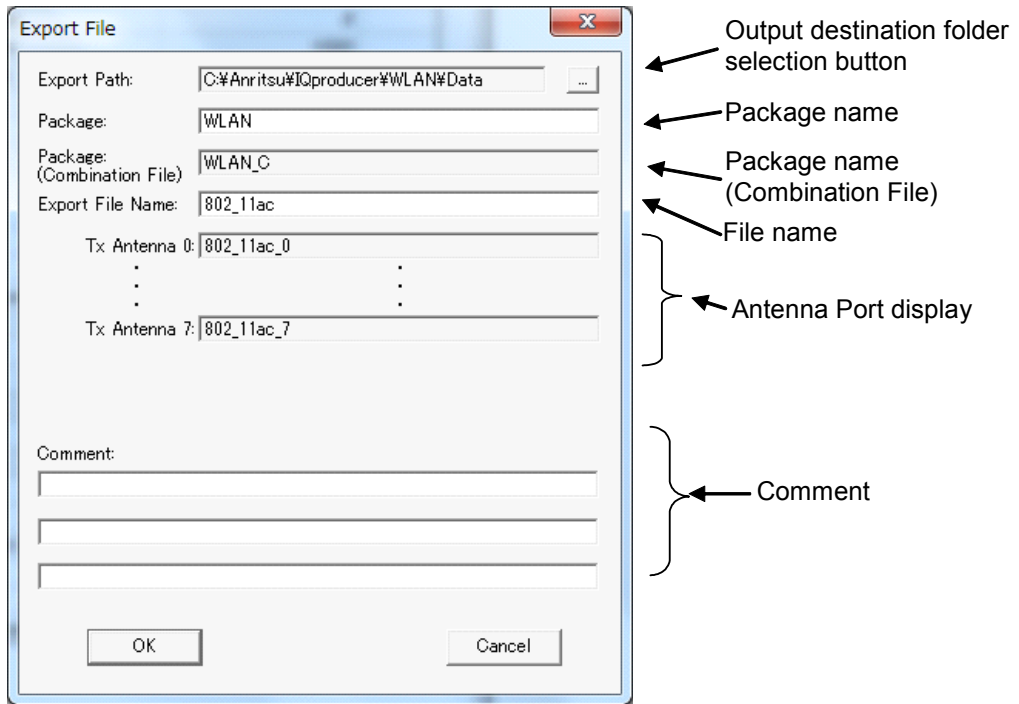

Figure 3.1.5-5 Export File screen (IEEE 802.11ac and Number of Antennas = 8)

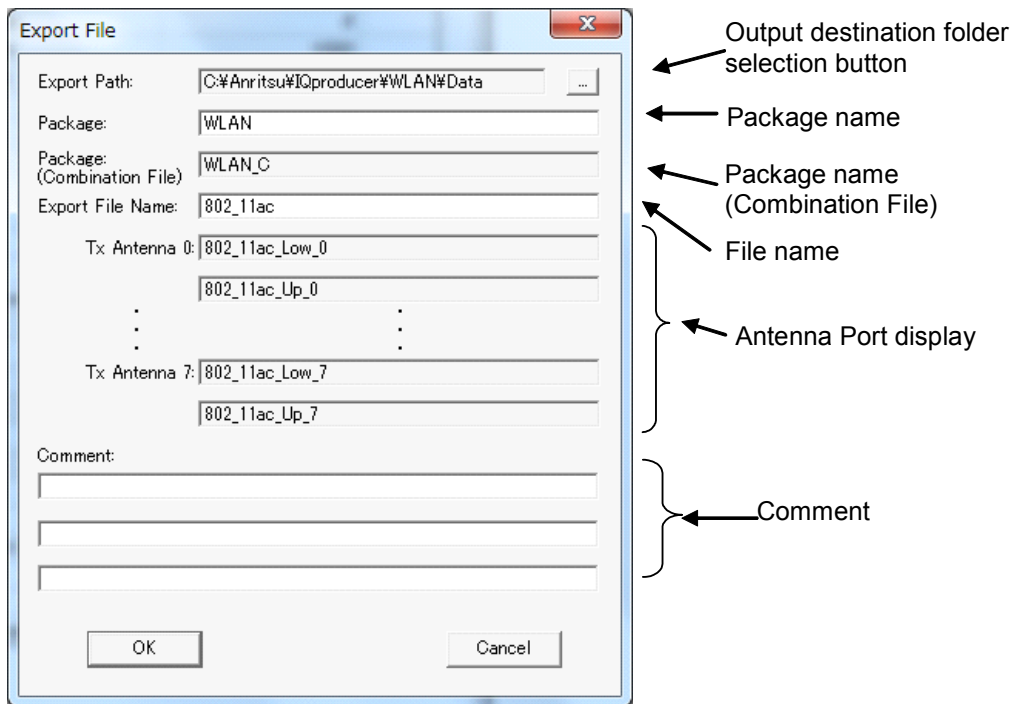

Figure 3.1.5-6 Export File screen (IEEE 802.11ac, Bandwidth =80+80MHz and Number of Antennas = 8)

Only 1-byte alphanumeric characters and the following symbols can be used for a file name.

! % & () + = ' { } _ - ^ @ []

After setting the package name, file name, and comment for the waveform pattern to be generated, click **OK** on the Export File screen. The Calculation screen shown in Figure 3.1.6-1 is displayed and waveform pattern generation starts (the package name and file name must be set to start waveform pattern generation).

When started with MS269x or MS2830A and when MS269x or MS2830 is selected in the in the Select instrument screen, waveform pattern files generated by this application are saved in the following directory:

Installed OS	Export destination folder
Windows Embedded Standard 7	C:\Anitsu\Signal Analyzer\System\Waveform
Other than above	C:\Program Files\Anritsu Corporation\Signal Analyzer\System\Waveform

When used with MG3710A, the files are saved in the following directory:
C:\Anritsu\MG3710A\User Data\Waveform

In other cases, the output destination folder can be selected from the Browse for Folder screen shown in Figure 3.1.5-7, which is displayed by clicking the output destination folder selection button on the Export File screen.

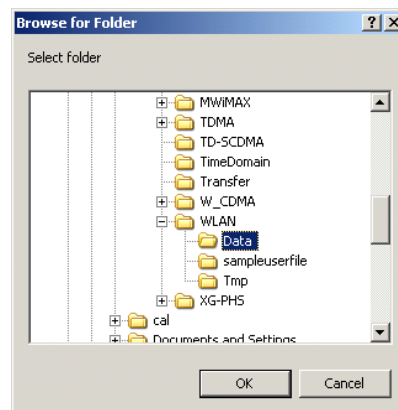

Figure 3.1.5-7 Browse for Folder screen

If an export destination folder is not selected, the generated waveform pattern will be saved in the following folder:

X:\IQproducer\WLAN\Data

(“X:\IQproducer” indicates the folder where the IQproducer™ is installed.)

3.1.6 Calculation screen

Clicking **Calculation & Load**, **Calculation & Play**, or the **OK** button on the Export File screen will start the waveform generation.

The Calculation screen is displayed while a waveform pattern is being generated. On this screen, the progress bar is displayed indicating the generation process of the waveform pattern and the progress of the waveform pattern generation. The generation of the waveform pattern can be stopped by clicking the Cancel button. When cancelled, it returns to the main screen.

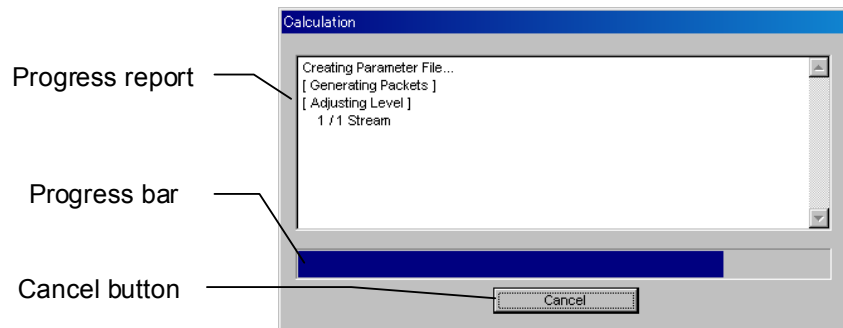

Figure 3.1.6-1 Calculation Screen (In Progress)

After waveform pattern generation is finished, the message “Calculation Completed.” is displayed in the progress window and the **Cancel** button changes to the **OK** button.

When the generation is complete, you can return to the setting screen by clicking the **OK** button. After waveform generation, two files with .wvi and .wvd extension are output.

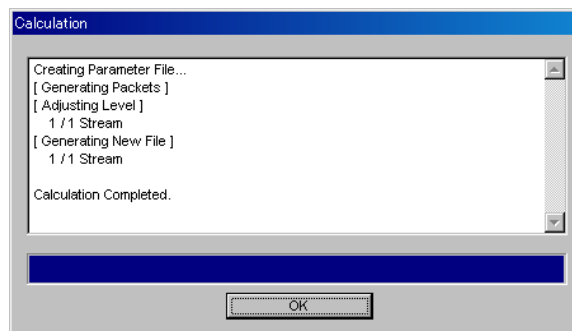

Figure 3.1.6-2 Calculation Screen (Completed)

Note:

When using this software on MG3710A, and selecting **Calculation & Load** or **Calculation & Play**, the waveform generation ends without displaying the above screen.

When performing **Calculation & Load** with System=11ac and Bandwidth = 80+80MHz, the waveforms are loaded to the both SG1(Low) and SG2(Up) and four files are output.

3.1.7 Calculation & Load

Note:

This function is available only when this software is used on MG3710A.

When the 2nd Vector Signal Generator (option) is installed and **Calculation & Load** is selected, the Select SG screen is displayed after the completion of waveform generation.

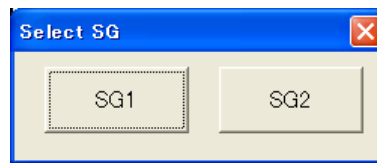

Figure 3.1.7-1 Select SG Screen

Select the loading destination on Select SG screen to start loading of the generated waveform pattern.

However, when Bandwidth is 80+80 MHz, the loading of the waveform pattern starts without displaying Select SG screen.

Note:

To exit this screen without loading the waveform pattern, click the **Cancel** button in the Load Setting screen.

When performing Calculation & Load on normal setup screen for plural waveform patterns generated with 2 or more Number of Antennas, load the file of the waveform pattern with the biggest order number. However, when the bandwidth is 80+80MHz, Calculation & Load is not applicable for plural waveform patterns generated with 2 or more Number of Antennas.

If the version of IQproducer is earlier than 14.01, the sequence file (wvc file) of the waveform pattern with the biggest order number is loaded when plural waveform patterns are generated with 2 or more Number of Antennas.

3.1.8 Calculation & Play

Note:

This function is available only when this software is used on MG3710A.

When **Calculation & Play** is selected, after waveform creation is completed, the created waveform is loaded into memory, selected and output.

When the 2nd Vector Signal Generator (option) is installed, the Select SG screen is displayed before the start of waveform generation. This screen is used to select the signal generator for outputting the created waveform pattern.

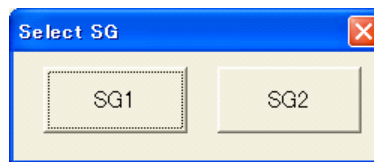

Figure 3.1.8-1 Select SG Screen

However, when the system is 11ac and the bandwidth is 80+80 MHz, SG Setting screen appears instead of Select SG screen and the waveforms are loaded to SG1 and SG2 simultaneously. At that time, SG1 and SG2 move to trigger stand-by state to match the timing of waveform outputs of SG1 and SG2.

On this screen, the frequency and amplitudes are settable for SG1 and SG2 separately.

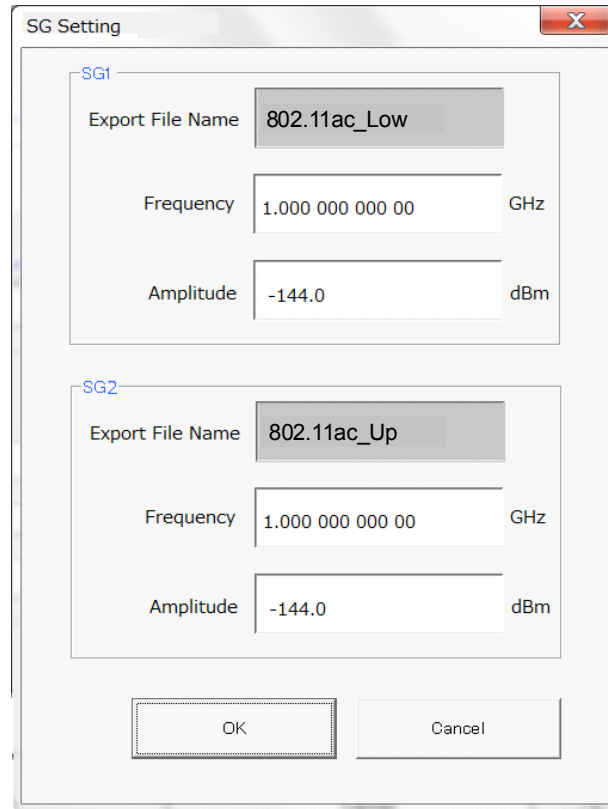

Figure 3.1.8-2 SG Setting screen

Note:

When performing Calculation & Play on normal setup screen for plural waveform patterns generated with 2 or more Number of Antennas, select the file of the waveform pattern with the biggest order number. However, when the bandwidth is 80+80MHz, Calculation & Play is not applicable for plural waveform patterns generated with 2 or more Number of Antennas.

If the version of IQproducer is earlier than 14.01, select the sequence file (wvc file) of the waveform pattern with the biggest order number when plural waveform patterns are generated with 2 or more Number of Antennas.

3.2 Waveform Pattern Generation Procedure

3.2.1 IEEE 802.11n waveform

This section shows a procedure for creating a waveform pattern, using an IEEE 802.11n waveform pattern as an example.

<Procedure>

1. Start the software.
2. Set the common parameters as shown in Table 3.2.1-1. The parameters that are not shown below are used with their default values, or are automatically set according to other parameter settings.

Table 3.2.1-1 Settings for common parameters

Common	
System	11n
Number of Packets	1
Number of Antennas	1
Scramble Initial Value	0x5D
Oversampling Ratio	2
Sampling Rate	40 MHz
Bandwidth	20 MHz
Duty Cycle	50.00%
Burst On Length	544 μ s
Burst Off Length	544 μ s
Burst Period	1088 μ s
Repeat Count	1000
A-MPDU	Off
Filter	
Filter Type	None
Spectrum Shaping	
Windowing Length	8

3. Click MPDU in the tree view and set the PHY/MAC parameters as shown in Table 3.2.1-2 and 3.2.1-3.

Table 3.2.1-2 Settings for PHY

PHY	
PPDU Format	HT Mixed
MCS	7
Number of Spatial Streams	1
Modulation	64QAM
Code Rate	5/6
Spatial Mapping	Direct Mapping
GI	Long
Smoothing	Off
Not Sounding	On
Number of Transmit Chains	1
Number of Space Time Streams	1
Number of Extension Spatial Streams	0

Table 3.2.1-3 Settings for MAC

MAC	
Data Length	4062
MPDU Length	4096
MAC Frame Type	General
Frame Control	0x0800
Duration/ID	0x0000
Address1	0x FFFF FFFF FFFF
Address2	0x 2022 2222 2202
Address3	0x 5055 5555 5505
Sequence Control	0x0000
Address4	0x 644D 2003 0000
MAC FCS	On
MAC Data Type	PN9fix
Increment Sequence Number	Off
Increment Fragment Number	Off

4. Click **Calculation** to open the Export File screen, and specify the output destination with Export Path. Next, select WLAN for Package and specify MCS7_MIX_20M for Export File Name, and then click **OK**.
5. The Calculation screen is displayed and waveform pattern generation starts. After the calculation is completed, click **OK** to finish the waveform generation.
6. The MCS7_MIX_20M.wvi, MCS7_MIX_20M.wvd and MCS7_MIX_20M.xml files are output to the folder selected on the Export File screen (described in Section 3.1.5).

If IQproducer is started in the MG3700A mode, the MCS7_MIX_20M_.wvi, MCS7_MIX_20M_.wvd, and MCS7_MIX_20M.wvc files are also output in addition to these files. The wvc file is a scenario file used to specify how many times to repeatedly output the waveform patterns, as well as to specify the combination of waveform patterns. If a wvc file that is output from the MG3700A is selected, the waveform patterns are output the number of times set by Repeat Count (Common parameter).

For details of operation, refer to each one of the following:

- *MG3700A Vector Signal Generator Operation Manual (Mainframe)*
3.5.2 (3) “To execute continuous operations in Defined mode”
- *MG3710A Vector Signal Generator MG3740A Analog Signal Generator Operation Manual (Mainframe)*
7.3.2 “Pattern generation mode”

3.2.2 IEEE 802.11ac waveform

This section describes the waveform pattern generation procedure, using the IEEE 802.11ac waveform pattern as an example.

<Procedure>

1. Start the software.
2. Set the common parameters as Table 3.2.2-1. The parameters that are not listed below are used with their default values, or are automatically set according to other parameter settings. For Burst On Length, Burst Off Length, and Burst Period, their values calculated after setting the PHY and MAC parameters are set.

Table 3.2.2-1 Settings for common parameters

Common	
System	11ac
Number of Packets	1
Number of Antennas	1
Total Output Packets	1000
Oversampling Ratio	2
Sampling Rate	160 MHz
Bandwidth	80 MHz
Duty Cycle	50.00%
Burst On Length	128 μ s
Burst Off Length	128 μ s
Burst Period	256 μ s
Repeat Count	1000
Scramble Initial Value	0x5D
Filter	
Filter Type	None
Spectrum Shaping	
Windowing Length	8

Table 3.2.2-2 Settings for IEEE802.11ac

IEEE802.11ac	
PPDU Format	VHT
User Mode	Single User
Number of Transmit Chains	1
Spatial Mapping	Direct Mapping
GI	Long
Total Number of Space Time Streams	1

3. Click User0/MPDU in the tree view and set the PHY/MAC parameters as Table 3.2.2-3 and 3.2.2-4.

Table 3.2.2-3 Settings for PHY

PHY	
Scramble	On
MCS	9
Number of Spatial Streams	1
Modulation	256QAM
Code Rate	5/6
Coding Mode	BCC
Coding	On
BCC Interleaver	On
Number of Space Time Streams	1
Group ID	0x3F
Partial AID	000
TXOP PS NOT ALLOWED	1

Table 3.2.2-4 Settings for MAC

MAC	
A-MPDU	Off
Data Length	4062
MPDU Length	4096
MAC Frame Type	General
Frame Control	0x0800
Duration/ID	0x0000
Address1	0x FFFF FFFF FFFF
Address2	0x 2022 2222 2202
Address3	0x 5055 5555 5505
Sequence Control	0x0000
Address4	0x 644D 2003 0000
MAC FCS	On
MAC Data Type	PN9fix
Increment Sequence Number	Off
Increment Fragment Number	Off

4. Click the Calculation button to display the Export File screen. Specify the output destination with Export Path. Next, select WLAN for Package and specify MCS9_80M for Export File Name, and then click OK.
5. The Calculation screen is displayed and waveform pattern generation starts. After the calculation is completed, click OK to finish the waveform generation.
6. The MCS9_80M.wvi, MCS9_80M.wvd and MCS9_80M.xml files are output to the folder selected on 3.1.5 “Export File screen”.

If IQproducer is started in the MG3700A mode, the MCS9_80M_.wvi, MCS9_80M_.wvd, MCS9_80M.wvc files are also output in addition to these files.

The wvc file is a scenario file used to specify how many times to repeatedly output the waveform patterns, as well as to specify the combination of waveform patterns. If a wvc file that is output from the MG3700A is selected, the waveform patterns are output the number of times set by Repeat Count (Common parameter).

For details of operation, refer to each one of the following:

- *MG3700A Vector Signal Generator Operation Manual (Mainframe)*
3.5.2 (3) “To execute continuous operations in Defined mode”
- *MG3710A Vector Signal Generator MG3740 Analog Signal Generator Operation Manual (Mainframe)*
7.3.2 “Pattern generation mode”

3.3 Saving/Reading Parameters

The numeric values and settings for each item can be saved in a parameter file by using the software.

3.3.1 Saving a parameter file

When running on PC, MS2690A/MS2691A/MS2692A, or MS2830A

1. Select **Save Parameter File** from the **File** menu or click the  tool button to display the parameter file saving screen.

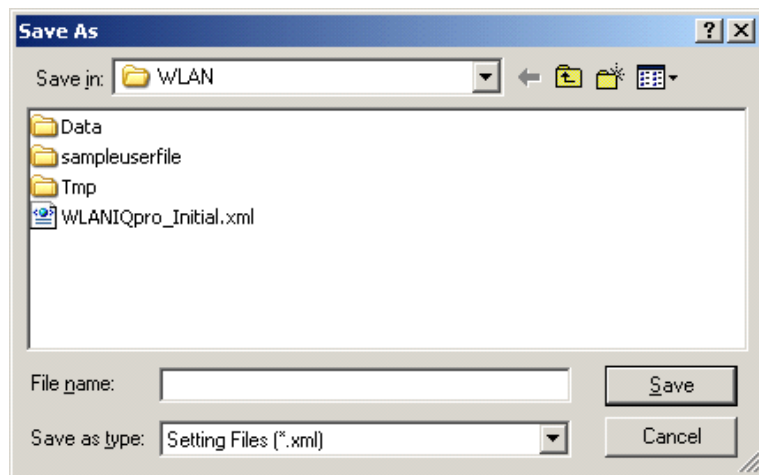

Figure 3.3.1-1 Parameter file saving screen

2. Specify **Save in**, enter a file name in the **File name** text box, and click **Save** to save the parameter file.

When running on MG3710A

1. Click the **Save Parameter File** button in **File** menu or click the  button to display the parameter file saving screen.

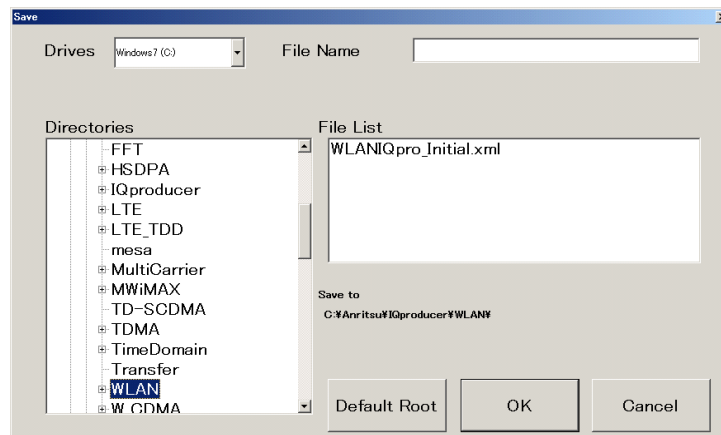



Figure 3.3.1-2 Parameter file saving screen (MG3710A)

2. Select the folder to store the file in the **Directories** field, and then enter the name of the file using the **File Name** box. Click **OK** to save the parameter file. To initialize the setting in the **Directories** field, click the **Default Root** button.

3.3.2 Reading a parameter file

When running on PC, MS2690A/MS2691A/MS2692A, or MS2830A

1. Select **Save Parameter File** from the **File** menu or click the  tool button to display the parameter file saving screen.

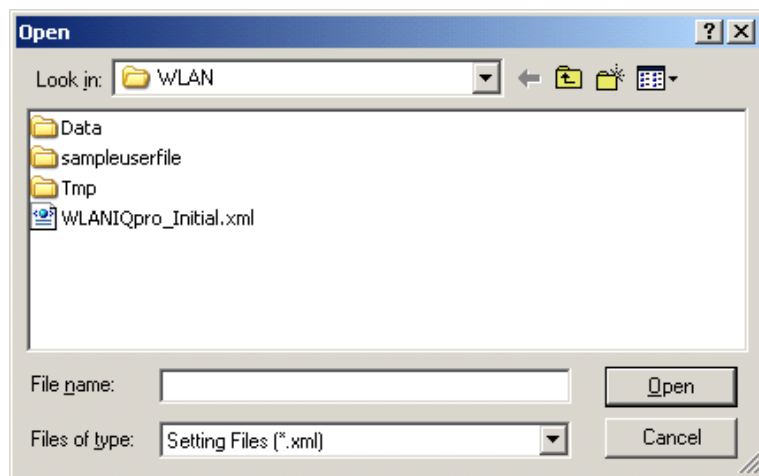



Figure 3.3.2-1 Parameter file reading screen

2. Select a parameter file to be read from the file list, and then click **Open** to read the selected parameter file.

X:\IQproducer\WLAN\sampleuserfile

The sample parameter files for creating a wave pattern are stored in this folder (X:\IQproducer is the IQproducer™ installation folder).

When running on MG3710A

1. Select **Recall Parameter File** from the **File** menu or click the  tool button to display the parameter file reading screen.

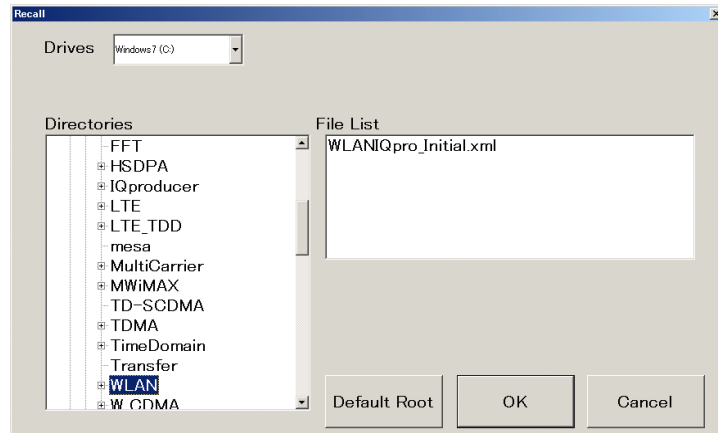

Figure 3.3.2-2 Parameter file reading screen (MG3710A)

- (2) Select the directory where the files to be loaded is stored in the **Directories** field. Click the desired file from the **File List**, and click **OK**. To initialize the setting in the **Directories** field, click the **Default Root** button.

3.4 User File Reading Screen

When running on PC, MS2690A/MS2691A/MS2692A, or MS2830A

1. When **User File** is selected in each layer, the User File reading screen.

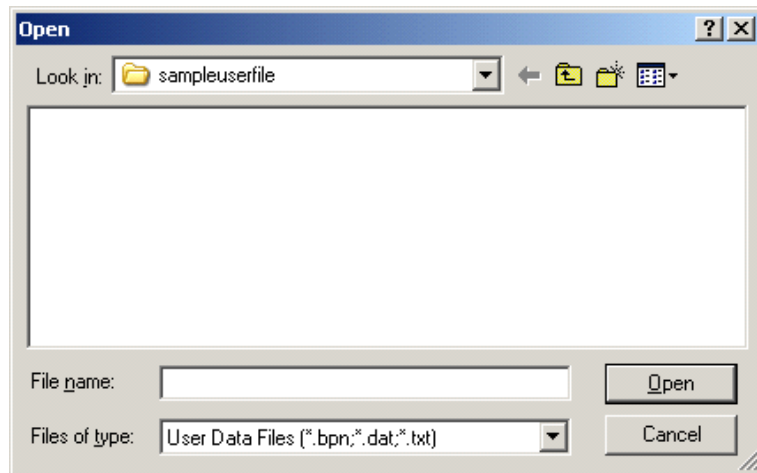

Figure 3.4-1 User file reading screen

2. Select a user file to be read from the file list, and then click **Open** to read the selected user file.

If an unsupported User File is selected, an error is displayed. Refer to Appendix B “User File Format” for details on the user file format.

When running on MG3710A

1. When **User File** is selected for **MAC Data Type** setting in the Channel Setting screen, the user file reading screen is displayed.

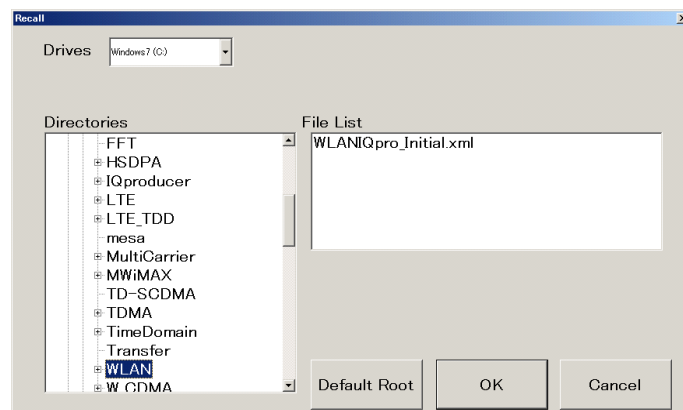

Figure 3.4-2 User file reading screen (MG3710A)

2. Select the directory where the user files to be loaded is stored in the **Directories** field. Click the desired file from the **File List**, and click **OK**. To initialize the setting in the **Directories** field, click the **Default Root** button.

If an unsupported User File is selected, an error is displayed. Refer to Appendix B “User File Format” for details on the user file format.

3.5 Graph Display

The generated waveform pattern can be displayed in a CCDF, FFT, and Time Domain graph by using this software. For details of each graph display, refer to each one of the following:

When making a graph from the waveform patterns generated with the system 11ac and the bandwidth 80+80 MHz, a lower waveform is selected automatically.

- *MG3700/MG3710A Vector Signal Generator MG3740A Analog Signal Generator Operation Manual (IQproducer™)*
4.3 “CCDF Graph Display”, 4.4 “FFT Graph Display”, 4.13 “Time Domain Graph Display”
- *MS2690A/MS2691A/MS2692A or MS2830A Vector Signal Generator Operation Manual (IQproducer™)*
4.3 “CCDF Graph Display”, 4.4 “FFT Graph Display”, 4.9 “Time Domain Graph Display”

Displaying CCDF graph

1. Generate a waveform pattern menu by executing “Calculation”.
2. Select **CCDF** from the **Simulation** menu or click the  tool button. The CCDF Graph Monitor screen shown in Figure 3.5-1 is displayed with the trace of the generated waveform pattern.

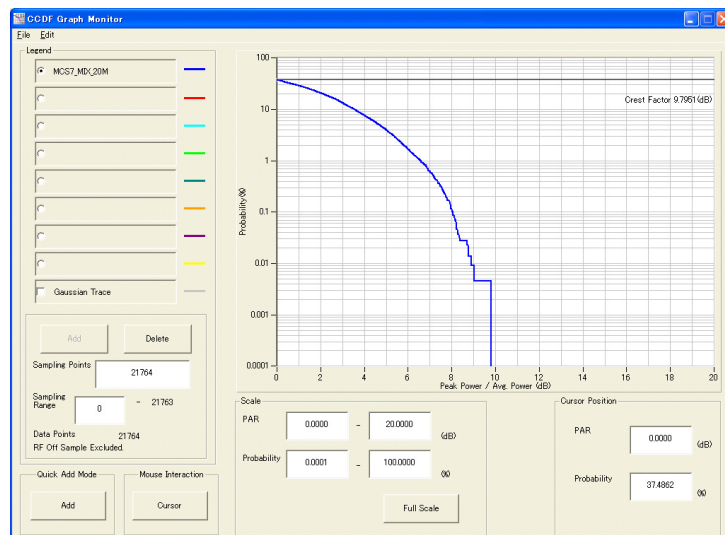

Figure 3.5-1 CCDF Graph Monitor screen

When a waveform pattern is generated by changing parameters and executing “Calculation” while other traces are displayed in the CCDF Graph Monitor screen, the trace of the waveform pattern newly generated can be displayed in either of the following two methods:

- Displaying the new trace in the same screen as the previous traces
- Deleting the previous traces to display the new trace

Note:

The CCDF, FFT, and Time Domain graphs cannot be generated at the same time. When displaying one graph while another graph is being displayed, execute the graph generation of the former after that of the latter is completed.



- Displaying the new trace in the same screen as the previous traces
 1. Set **Add** for **Quick Add Mode** on the lower-left of the CCDF Graph Monitor screen.
 2. When **CCDF** is clicked in the **Simulation** menu or  is clicked, a trace of the newly generated waveform pattern is added to the CCDF Graph Monitor screen.
Up to eight traces can be displayed by repeating this procedure.
- When deleting the previous traces to display a new trace:
 1. Set **Clear** for **Quick Add Mode** on the lower-left of the CCDF Graph Monitor screen.
 2. Select **CCDF** from the **Simulation** menu or click the  tool button. The confirmation message shown in Figure 3.5-2 below appears:



Figure 3.5-2 Confirmation message

Click **Yes**. The previous traces are deleted, and the trace of the waveform pattern newly generated is displayed.

Displaying FFT graph

1. Generate a waveform pattern by executing “Calculation”.
2. Select **FFT** from the **Simulation** menu or click the  tool button. The FFT Graph Monitor screen shown in Figure 3.5-3 is displayed with the trace of the generated waveform pattern.

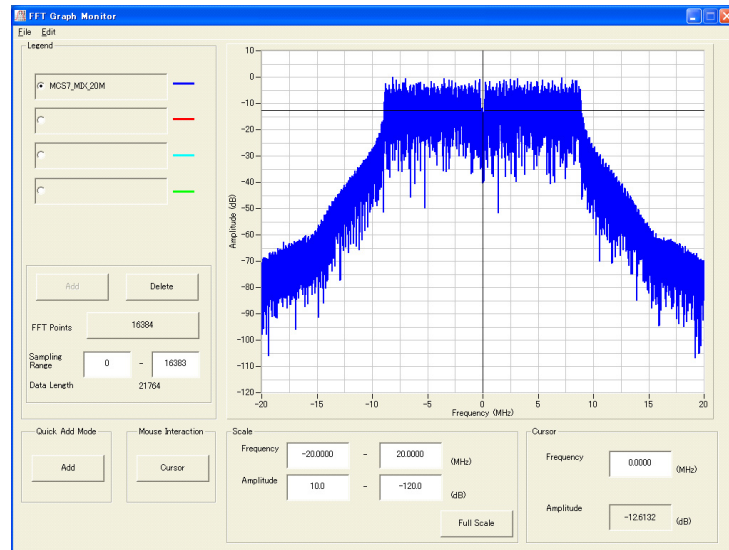



Figure 3.5-3 FFT Graph Monitor screen

When a waveform pattern is generated by changing parameters and executing “Calculation” while other traces are displayed in the FFT Graph Monitor screen, the trace of the waveform pattern newly generated can be displayed in either of the following two methods:

- Displaying the new trace in the same screen as the previous traces
- Deleting the previous traces to display the new trace

Note:

The CCDF, FFT, and Time Domain graphs cannot be generated at the same time. When displaying one graph while another graph is being displayed, execute the graph generation of the former after that of the latter is completed.

- Displaying the new trace in the same screen as the previous traces
 1. Set **Add** for **Quick Add Mode** on the lower-left of the FFT Graph Monitor screen.
 2. When **FFT** is clicked in the **Simulation** menu or  is clicked, a trace of the newly generated waveform pattern is added to the FFT Graph Monitor screen.



Up to four traces can be displayed by repeating this procedure.
- When deleting the previous traces to display a new trace:
 1. Set **Clear** for **Quick Add Mode** on the lower-left of the FFT Graph Monitor screen.
 2. Select **FFT** from the **Simulation** menu or click the  tool button. The confirmation message shown in Figure 3.5-4 below appears:



Figure 3.5-4 Confirmation message

Click **Yes**. The previous traces are deleted, and the trace of the waveform pattern newly generated is displayed.

Displaying the Time Domain graph

1. Generate a waveform pattern by executing “Calculation”.
2. When **Time Domain** is clicked in the **Simulation** menu or  is clicked, the Time Domain graph screen shown in Figure 3.5-5 is displayed, along with a trace of the generated waveform pattern.

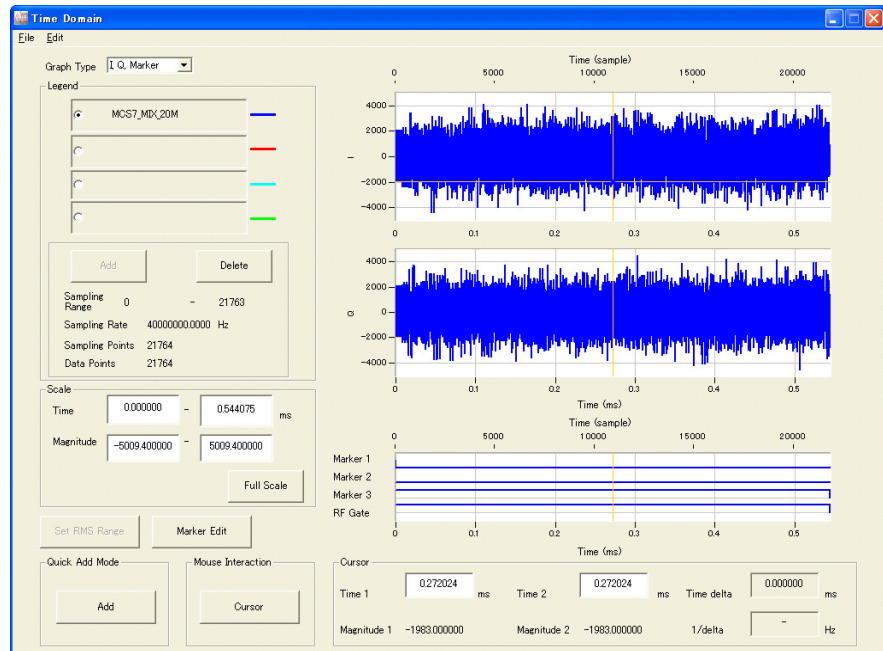



Figure 3.5-5 Time Domain screen

When a waveform pattern is generated by changing parameters and executing “Calculation” while other traces are displayed in the Time Domain Graph Monitor screen, the trace of the waveform pattern newly generated can be displayed in either of the following two methods:

- Displaying the new trace in the same screen as the previous traces
- Deleting the previous traces to display the new trace

Note:

The CCDF, FFT, and Time Domain graphs cannot be generated at the same time. When displaying one graph while another graph is being displayed, execute the graph generation of the former after that of the latter is completed.

- Displaying the new trace in the same screen as the previous traces
 1. Set **Add** for **Quick Add Mode** on the lower-left of the Time Domain Graph Monitor screen.
 2. When **Time Domain** is clicked in the **Simulation** menu or  is clicked, a trace of the newly generated waveform pattern is added to the Time Domain graph screen.
Up to four traces can be displayed by repeating this procedure.

- When deleting the previous traces to display a new trace:
 1. Set **Clear** for **Quick Add Mode** on the lower-left of the Time Domain Graph Monitor screen.
 2. When **Time Domain** is clicked in the **Simulation** menu or  is clicked, a message such as that shown in Figure 3.5-6 is displayed.



Figure 3.5-6 Confirmation message

Click **Yes**. The previous traces are deleted, and the trace of the waveform pattern newly generated is displayed.

3.6 Auxiliary Signal Output

Select a waveform pattern generated by the WLAN IQproducer™ on this equipment to output the marker that is synchronized with the RF signal as an auxiliary signal from the AUX on the rear panel of this equipment. When creating waveform patterns, markers can be set automatically in the waveform pattern as shown below.

A waveform pattern with edited markers can be created using the Marker Edit function for Time Domain graphs.

For details of Marker Edit function, refer to each one of the following:

- *MG3700A/MG3710A Vector Signal Generator MG3740A Analog Signal Generator Operation Manual (IQproducer™)*
4.13.12 “Marker edit function”
- *MS2690A/MS2691A/MS2692A or MS2830A Vector Signal Generator Operation Manual (IQproducer™)*
4.9.12 “Marker edit function”

For details of the error range of the auxiliary signals against the RF output, refer to each one of the following:

- *MG3700A/MG3710A Vector Signal Generator MG3740A Analog Signal Generator Operation Manual (IQproducer™)*
4.5.6 “Input file format”
- *MS2690A/MS2691A/MS2692A or MS2830A Vector Signal Generator Operation Manual (IQproducer™)*
4.5.6 “Input file format”

Chapter 4 Easy Setup Screen

This chapter explains the Easy Setup screens that are displayed when this software is installed and running on the MG3710A. The Easy Setup screens support touch-panel operations.

Note:

In the operation explanations in this chapter, touching the touch panel and clicking the mouse are both described as “click”.

4.1	Basic Operation	4-2
4.1.1	Data input method	4-2
4.2	Screen Details.....	4-5
4.2.1	Menu and tool buttons.....	4-5
4.2.2	Tool bar	4-7
4.2.3	Save/Recall	4-8
4.2.4	Export File screen.....	4-9
4.2.5	Calculation screen	4-10
4.2.6	Calculation & Load	4-10
4.2.7	Calculation & Play	4-10
4.2.8	Select Option	4-11
4.2.9	Common Tab.....	4-12
4.2.10	PHY Tab	4-17
4.2.11	MAC Tab	4-30
4.3	Graph Display	4-37
4.4	Auxiliary Signal Output	4-38

4.1 Basic Operation

4.1.1 Data input method

The measurement item selections, numeric data, alphabetic characters, etc., are input at the panel displayed on the screen.

The displayed panel differs according to the input data type.

■ Numeric keypad

Clicking the numeric input text box displays numeric input panel. The displayed keys, units and input range differ according to the data.

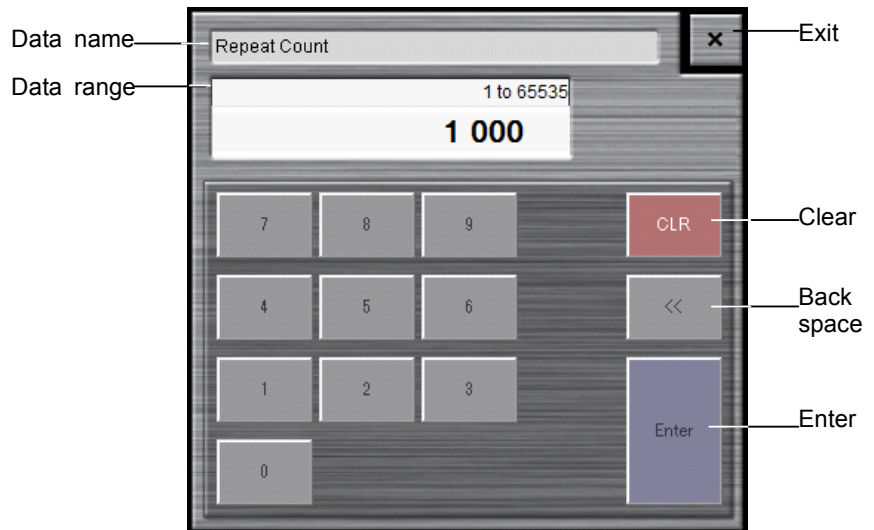

Figure 4.1.1-1 Numeric Keypad

■ Hexadecimal keypad

Clicking the Mac Frame Format field displays the hexadecimal keypad.



Figure 4.1.1-2 Hexadecimal Keypad

■ Software keyboard

Character data such as file names are input by clicking the character input text box. Characters are input by clicking the keys of the soft keyboard shown in Figure 4.1.1-2. Click the **Shift + Caps** keys to lock the keyboard; click them again to unlock the keyboard.

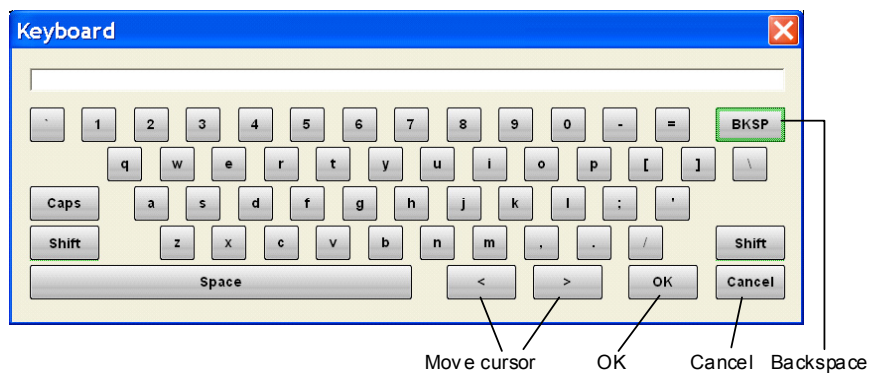

Figure 4.1.1-3 Software Keyboard

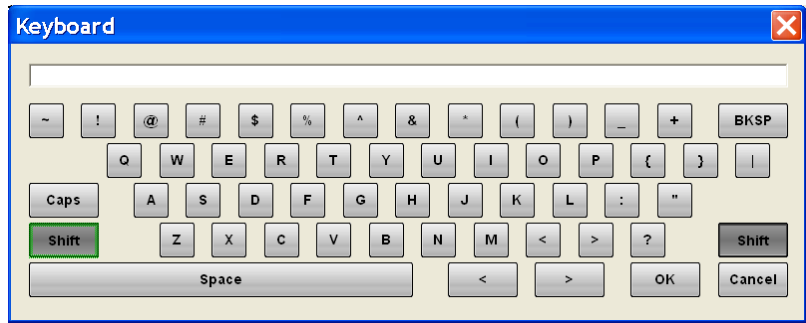

Figure 4.1.1-4 Software Keyboard (With Shift Key Locked)

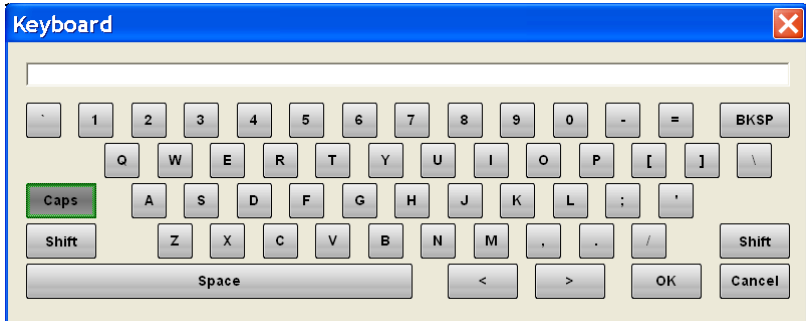
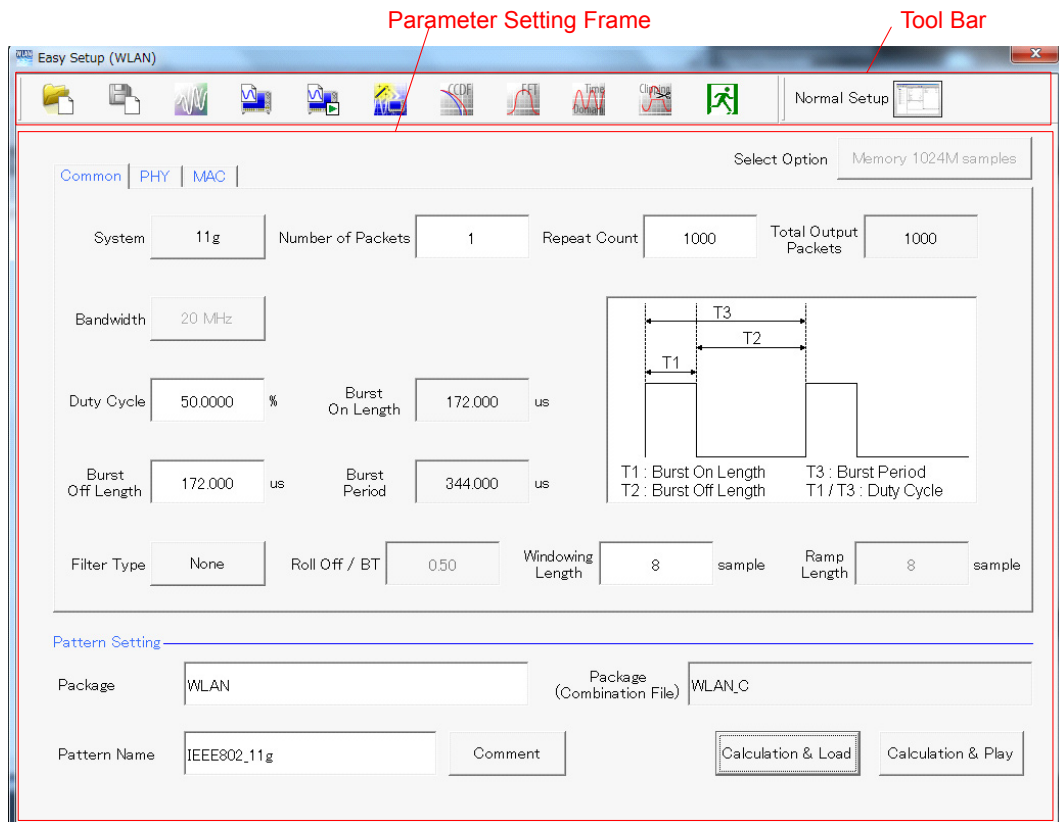

Figure 4.1.1-5 Software Keyboard (With Caps Key Locked)

4.2 Screen Details

4.2.1 Menu and tool buttons

On common platform screen, select the **System (Cellular)** tab, and then select **WLAN** to display the main screen.



4

Easy Setup Screen

Figure 4.2.1-1 Main Screen (Easy Setup (Common))

Note:

When this software is running on PC, the **Calculation & Load** button in the **Pattern Setting** field changes to **Calculation**, and the **Calculation & Play** button changes to **Exit**, respectively.

When launching IQproducer on the MG3710, the **Package (Combination File)** box is not displayed if the version is 14.01 or later.

■ Screen transition

The screen hierarchy from the Main screen to (Easy Setup) the sub-screens (Normal Setup and Calculation) after WLAN IQproducer starts is shown below.

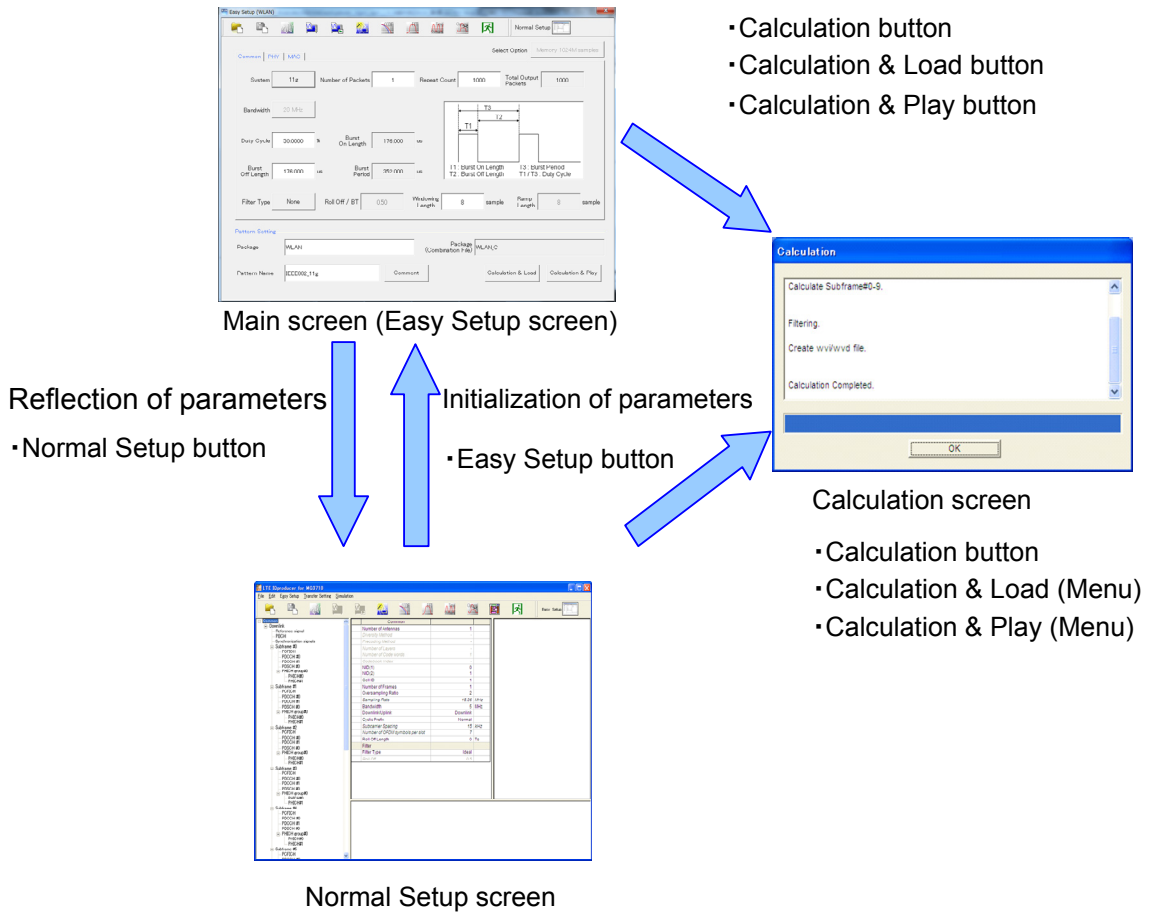

Figure 4.2.1-2 Screen Transition

4.2.2 Tool bar

The tool bar ribbon at the top of the Main screen has various operation buttons.

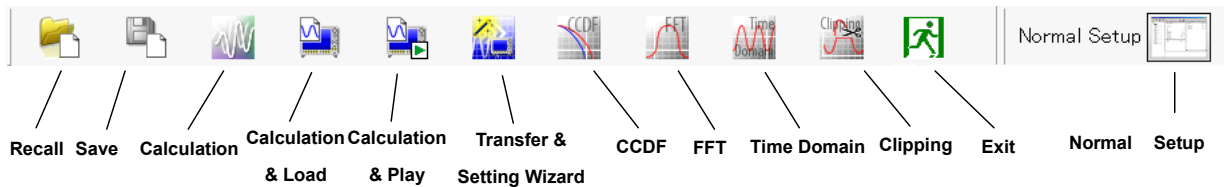













Figure 4.2.2-1 Tool Bar

■ Buttons on Tool Bar

Button	Name	Description
	Recall Parameter File	Displays Recall dialog for loading parameter file (Figure 4.2.3-2)
	Save Parameter File	Displays Save dialog for saving parameter file (Figure 4.2.3-1)
	Calculation	Performs waveform pattern generation.
	Calculation & Load	After waveform generation is finished, the created waveform pattern is loaded into the MG3710A waveform memory.
	Calculation & Play	After waveform generation is finished, the created waveform pattern is loaded and selected at the MG3710A waveform memory.
	Transfer & Setting Wizard	Every operation ranging from connecting the PC and MG3700A/MG3710A and transferring the waveform pattern to the MG3700A/MG3710A, to loading the waveform pattern into the MG3700A/MG3710A ARB memory is performed at this screen.
	CCDF	Fetches CCDF graph screen and displays CCDF of created waveform pattern.
	FFT	Fetches FFT graph screen and displays spectrum of FFT transformed waveform data.
	Time Domain	Displays the Time Domain screen. In this screen, the time domain waveform of a generated waveform pattern is displayed in a graph.
	Clipping	Displays the Clipping setting screen. In this screen, clipping and filtering processing can be performed for a generated waveform pattern.
	Exit	Quits software.
	Normal Setup	Switches GUI to Normal Setup mode; for details of Normal Setup, refer to Chapter 3 “Normal Setup Screen”.

Note:

Transfer&Setting Wizard is available only when **MG3700** or **MG3710** is selected in the Select instrument screen.

Calculation & Load button and Calculation & Play button become active only when operated on MG3710A.

4.2.3 Save/Recall

Clicking **Save** opens the Save dialog box (Figure 4.2.3-1), where you can enter a parameter name. Note that the screen keyboard is used to enter a character string on the MG3710A mainframe.

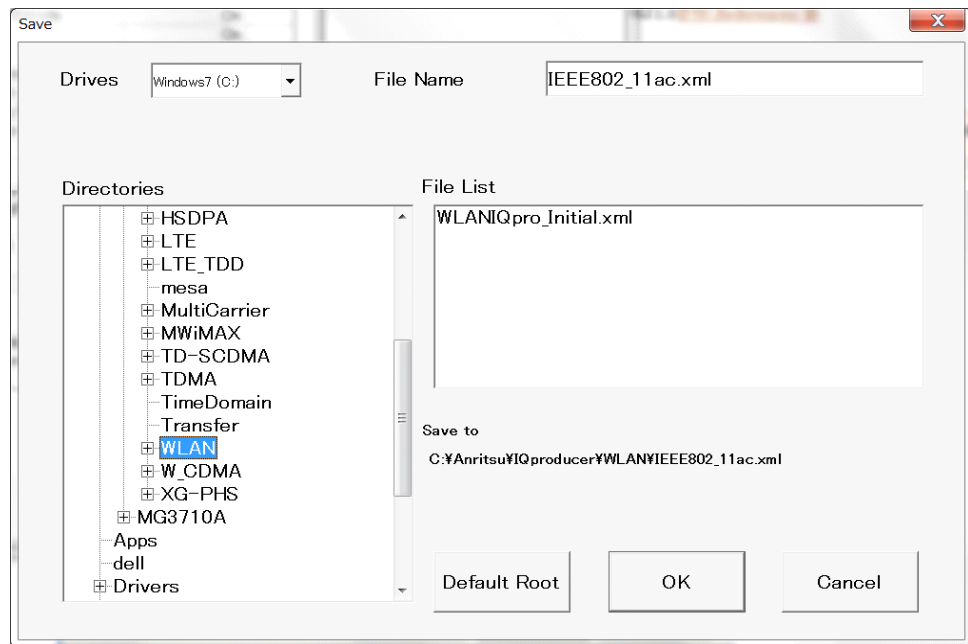

Figure 4.2.3-1 Save Dialog Box

Clicking **Recall** opens the Recall dialog box (Figure 4.2.3-2), where you can select a parameter file, on the MG3710A mainframe.

Loading the parameter file stored in the Sample userfile folder can set the same parameters as the reference waveform patterns.

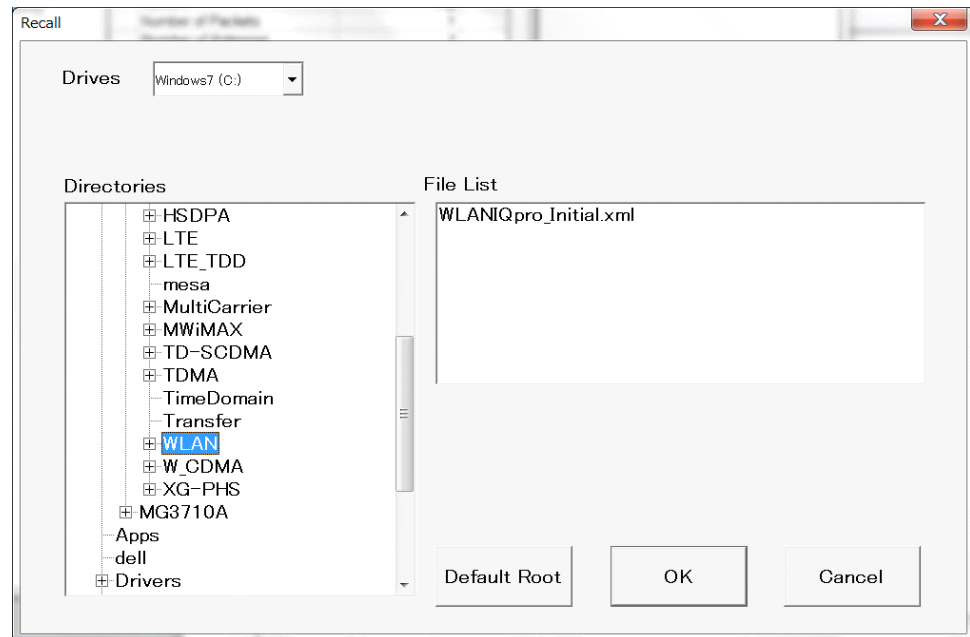



Figure 4.2.3-2 Recall Dialog Box

Note:

The Normal Setup and Easy Setup parameter files are different. When the Normal Setup parameter file is loaded on the Easy Setup screen, the screen switches to the Normal Setup screen.

4.2.4 Export File screen

When **Calculation** is selected from the Edit menu or the  tool button is clicked on the main screen, the Export File screen is displayed.

For details on the Export File screen, refer to 3.1.5 “Export File screen”.

4.2.5 Calculation screen

Clicking **Calculation & Load** and **Calculation & Play** in the Easy Setup screen or **OK** in the Export File dialog box starts waveform generation.

For details on the Calculation screen, refer to 3.1.6 “Calculation screen”.

4.2.6 Calculation & Load

Note:

This function is available only when this software is used on MG3710A.

Clicking **Calculation & Load** starts waveform generation. The Load Setting screen is displayed after completion of waveform generation.

For details, refer to 3.1.7 “Calculation & Load”.

4.2.7 Calculation & Play

Note:

This function is available only when this software is used on MG3710A.

Clicking **Calculation & Play** selects and outputs the generated waveform pattern after completion of waveform generation.

For details, refer to 3.1.8 “Calculation & Play”.

4.2.8 Select Option

Note:

This function is not available when this software is used on MG3710A or **MS269x** is selected in the Select instrument screen.

To change the Select Option, click **Select Option** to display the Select Option screen, where you can set the select option information. The Select Option screen depends on the mode as shown in Figures 4.2.8-1, 4.2.8-2, and 4.2.8-3.

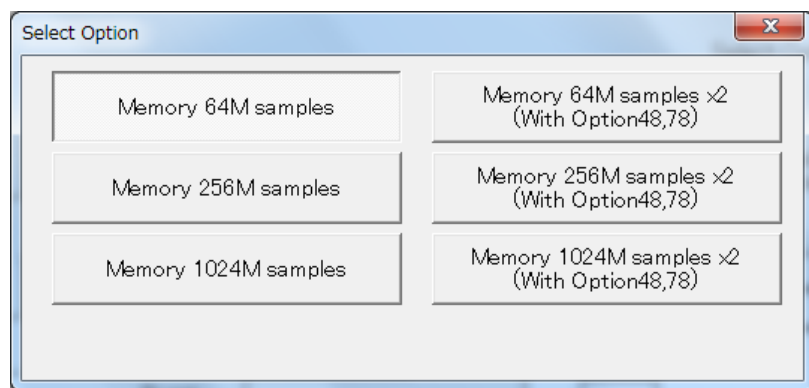

Figure 4.2.8-1 Select Option Screen (MG3710)

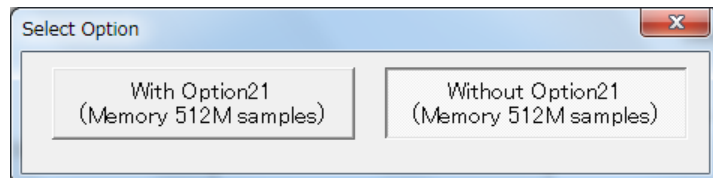

Figure 4.2.8-2 Select Option Screen (MG3700)

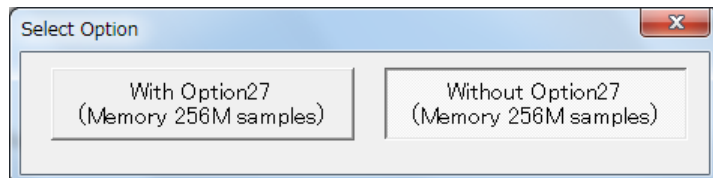

Figure 4.2.8-3 Select Option Screen (MS2830)

4.2.9 Common Tab

This subsection describes the parameters in the Common tab.

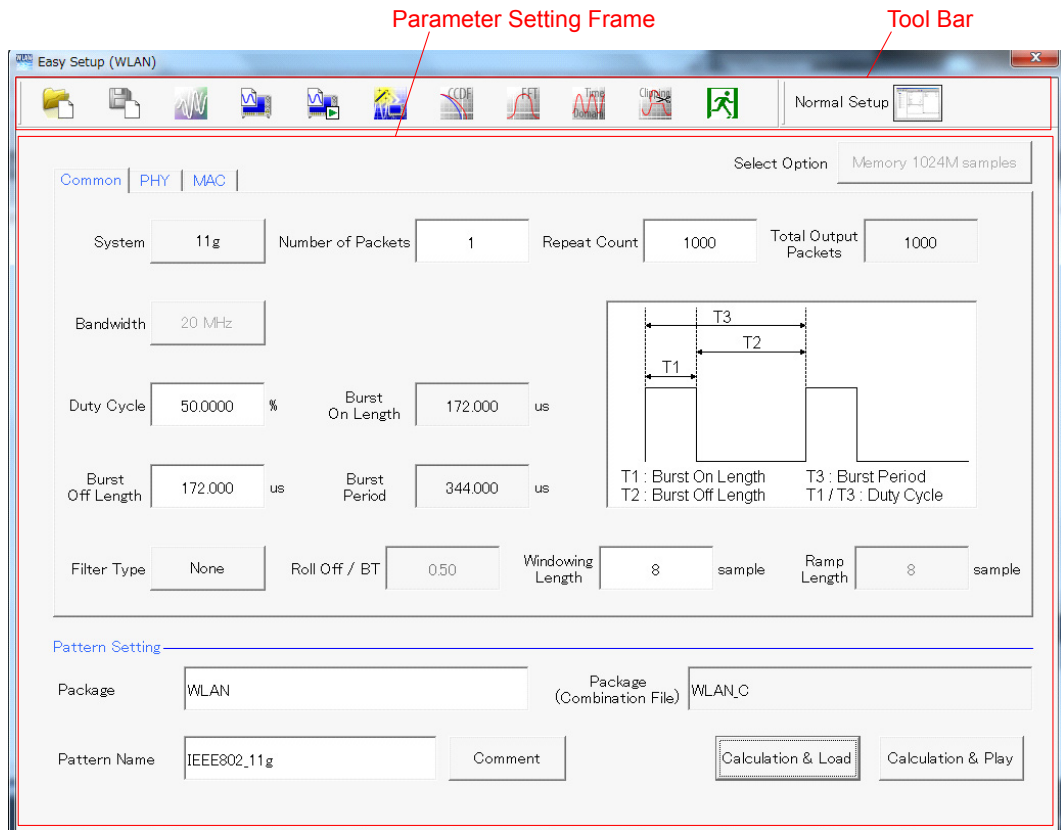

Figure 4.2.9-1 Common Tab

System

[Function] Sets the system.

[Default] 11g

[Setting range] 11a, 11ac, 11b, 11g, 11j, 11n, 11p

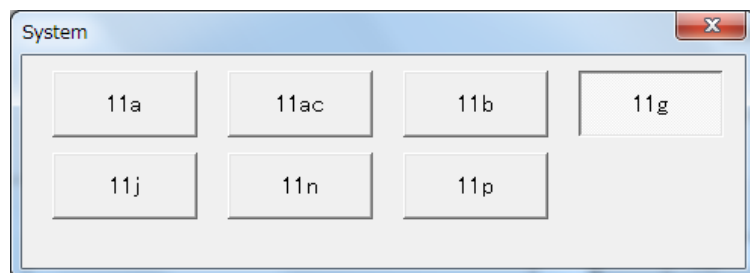

Figure 4.2.9-2 System Setting Screen

Number of Packets

- [Function] Sets the number of packets to be generated.
 [Default] 1
 [Setting range] 1 to the maximum number of packets for the waveform memory
 [Remarks] Set the value using the numeric keypad.

Repeat Count

- [Function] Sets the repeat count of packet to be transmitted.
 [Default] 1000
 [Setting range] 1 to 32767
 [Remarks] The setting is void if MS269x or MS2830 is selected in the Select instrument dialog box.
 Set the value using the numeric keypad.

Total Output Packets

- [Function] Displays the total number of packets
 (Number of Packets × Repeat Count).
 [Remarks] The display is void if MS269x or MS2830 is selected in the Select instrument dialog box.

Bandwidth

- [Function] Sets the bandwidth.
 [Default] The default for each system is as follows:

System	Default
System=11a	20 MHz
System=11j	20 MHz
System=11n	20 MHz
System=11p	10 MHz
System=11ac	20 MHz

- [Setting range] The setting range for each system is as follows:

System	Setting range
System=11a	20 MHz
System=11j	20 MHz
System=11n	20 MHz or 40 MHz
System=11p	10 MHz
System=11ac	20 MHz, 40 MHz, 80 MHz, 160 MHz, 80+80 MHz *160 MHz is not settable if MG3700A/MS2830A/MS269xA is selected in the Select instrument dialog box.

[Remarks] This function is disabled when System is set to 11b or 11g.

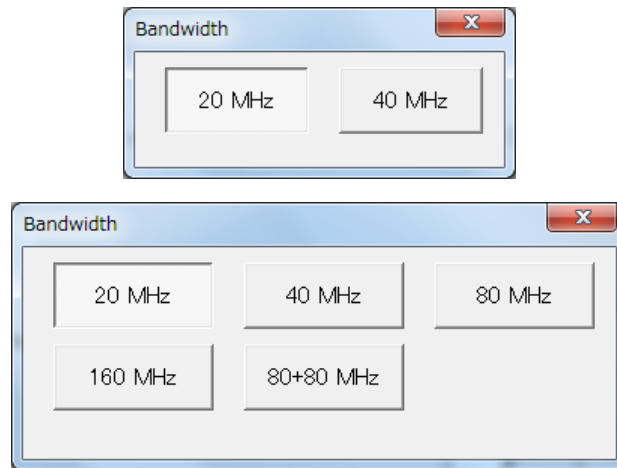

Figure 4.2.9-3 Bandwidth Setting Screen

Duty Cycle

[Function] Sets the On/Off ratio of the burst signal.

[Default] 50.0000 [%]

[Setting range] 0.1000 to 99.0000 [%]

[Resolution] 0.0001

[Remarks] When setting Duty Cycle, Burst Off Length and Burst Period are automatically calculated. Also, when Burst On Length or Burst Off Length is changed, Duty Cycle is automatically calculated.

The setting range is automatically calculated according to the Common, PHY, MAC parameter settings, so it is not always from 0.1000 to 99.0000 [%].

Burst On Length

[Function] Displays the burst on length [μs].

[Setting range] Displays the calculated value.

[Resolution] 0.001

[Remarks] The calculated result is rounded to a multiple of 1/Sampling Rate [μs]. Automatically calculated by PHY/MAC parameter setting.

Burst Off Length

[Function] Sets the burst off length [μs].

[Setting range] The setting range is decided by the maximum and minimum values of Duty Cycle and the calculated value of Burst On Length.

[Resolution] 0.001

- [Remarks] When setting Burst Off Length, Duty Cycle and Burst Period are automatically calculated.
Also, Burst Off Length is calculated from the values of Duty Cycle and Burst On Length as below.
Burst Off Length= Burst On Length ×
(100.0 – Duty Cycle) / Duty Cycle

Burst Period

[Function] Display the burst period [μs].

[Display range] Displays the calculated value.

[Remarks] The following figure shows the relationships among Duty Cycle, Burst On Length, Burst On Length, and Burst Period.

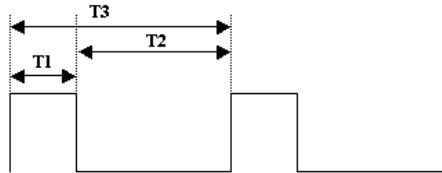

T1 : Burst On Length
T2 : Burst Off Length
T3 : Burst Period
T1/T3 : Duty Cycle

Filter Type

[Function] Sets the filter type.

[Default] The default for each system is as follows:

When System is set to 11b or when System is set to 11g
and Frame Format is other than ERP-OFDM or
DSSS-OFDM: Gaussian

Others: None

[Setting range] None, Gaussian, Root Nyquist, Nyquist, Ideal

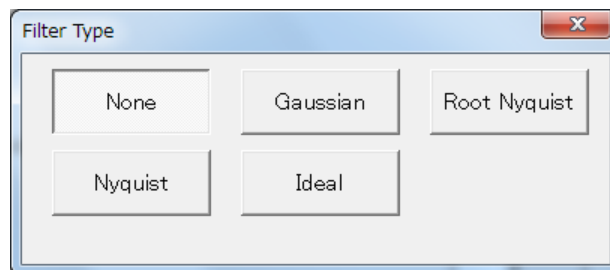

Figure 4.2.9-4 Filter Type Setting Screen

Roll Off/BT

- [Function] Sets the roll-off factor or BT product.
- [Default] 0.50
- [Setting range] 0.10 to 1.00
- [Resolution] 0.01
- [Remarks] The setting is fixed when Filter Type is set to Ideal or None.

Windowing Length

- [Function] Sets the windowing length.
- [Default] 8 Samples
- [Setting range] 0 to $32 \times$ Oversampling Rate
- [Remarks] This function cannot be set in the following cases:
 - Where System is set to 11b.
 - Where System is set to 11g and Frame Format is set to other than ERP-OFDM or DSSS-OFDM.
 - The setting range is 0 to 32 when System is set to 11ac and Bandwidth is set to 160 MHz.

Ramp Length

- [Function] Sets the ramp length.
- [Default] 8 Samples
- [Setting range] 0 to $16 \times$ Oversampling Rate
- [Remarks] This function can be set in the following cases:
 - Where System is set to 11b.
 - Where System is set to 11g and Frame Format is set to other than ERP-OFDM or DSSS-OFDM.

4.2.10 PHY Tab

This subsection describes the parameters in the PHY tab.

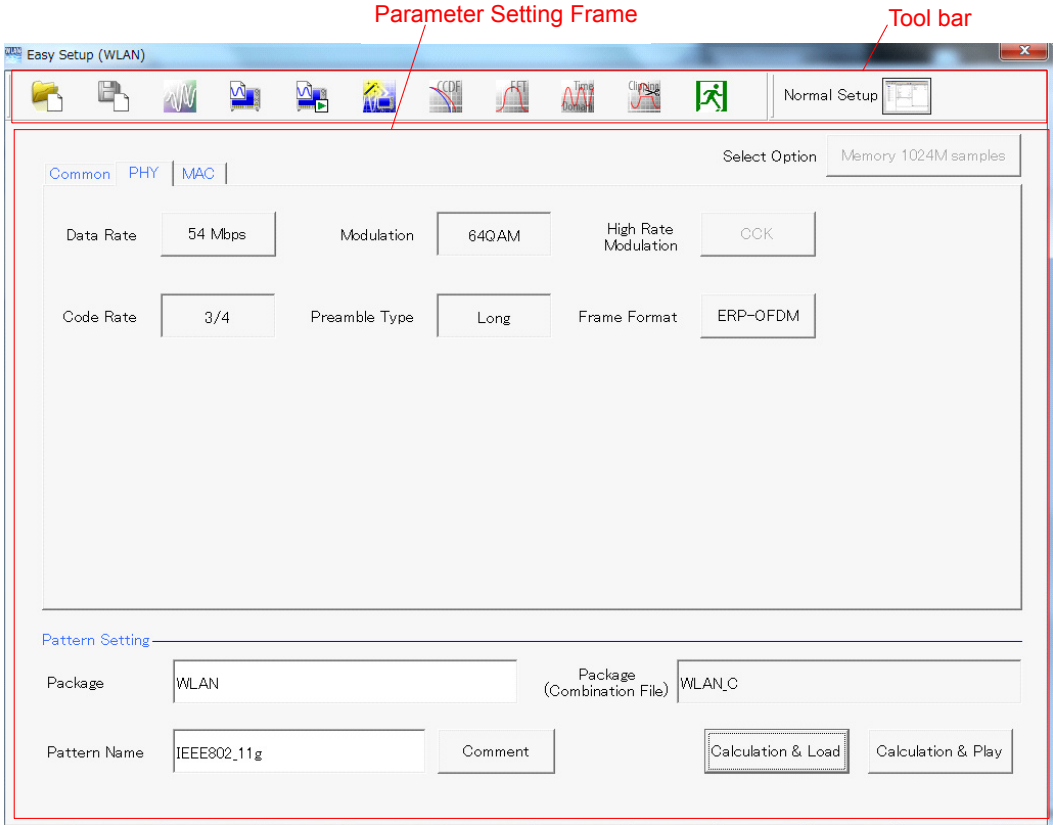

Figure 4.2.10-1 PHY Tab (When System is Set to Other Than 11n or 11ac)

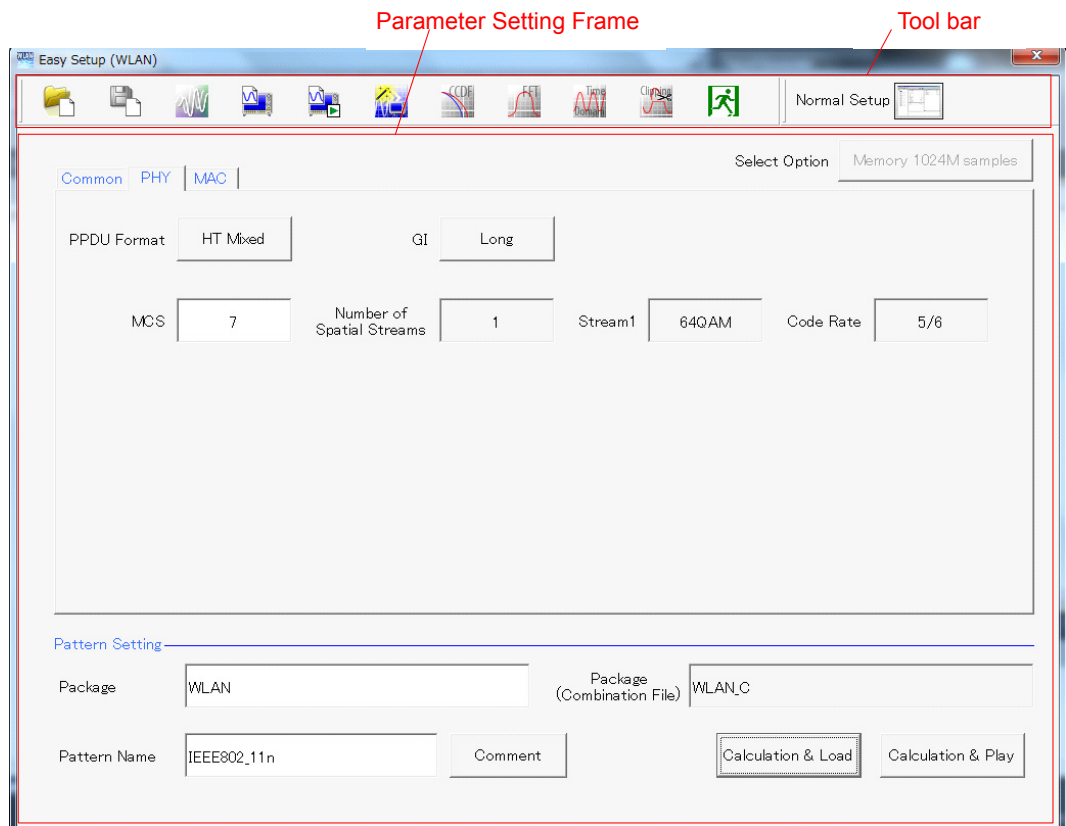

Figure 4.2.10-2 PHY Tab (When System is Set to 11n and PDU Format is Set to HT Mixed or HT-GreenField)

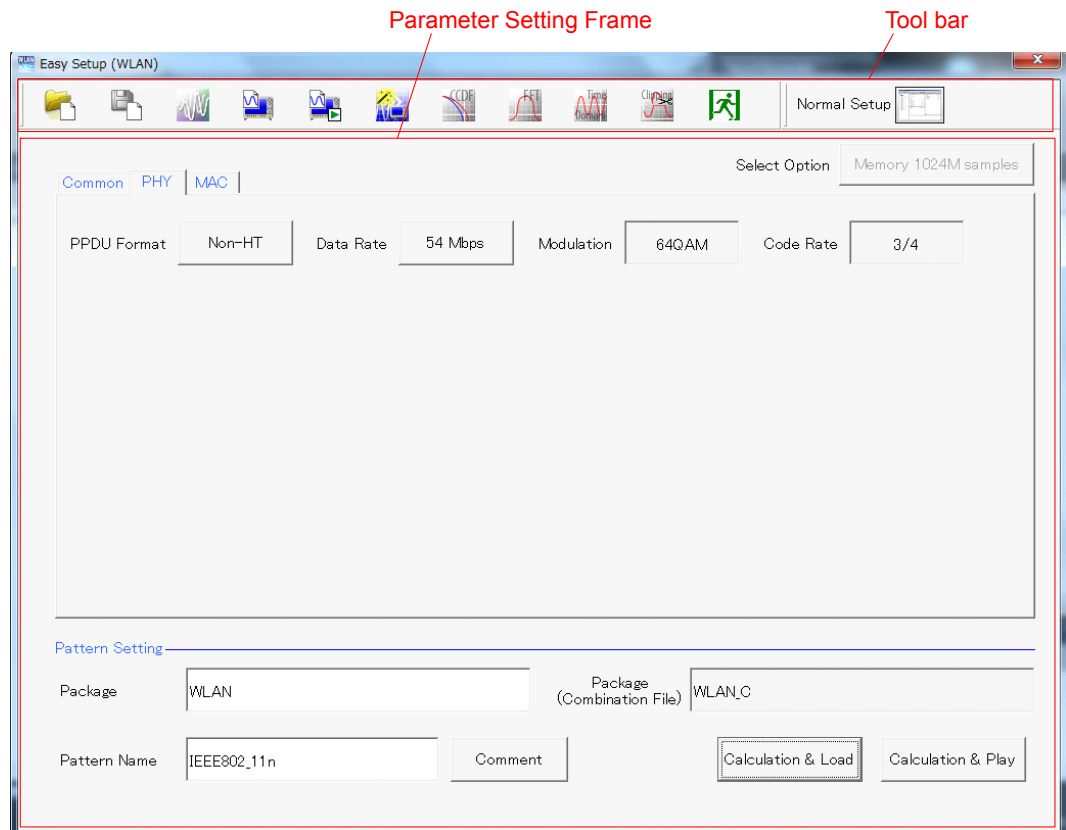

Figure 4.2.10-3 PHY Tab (When System is Set to 11n and PPDU Format is Set to Non-HT)

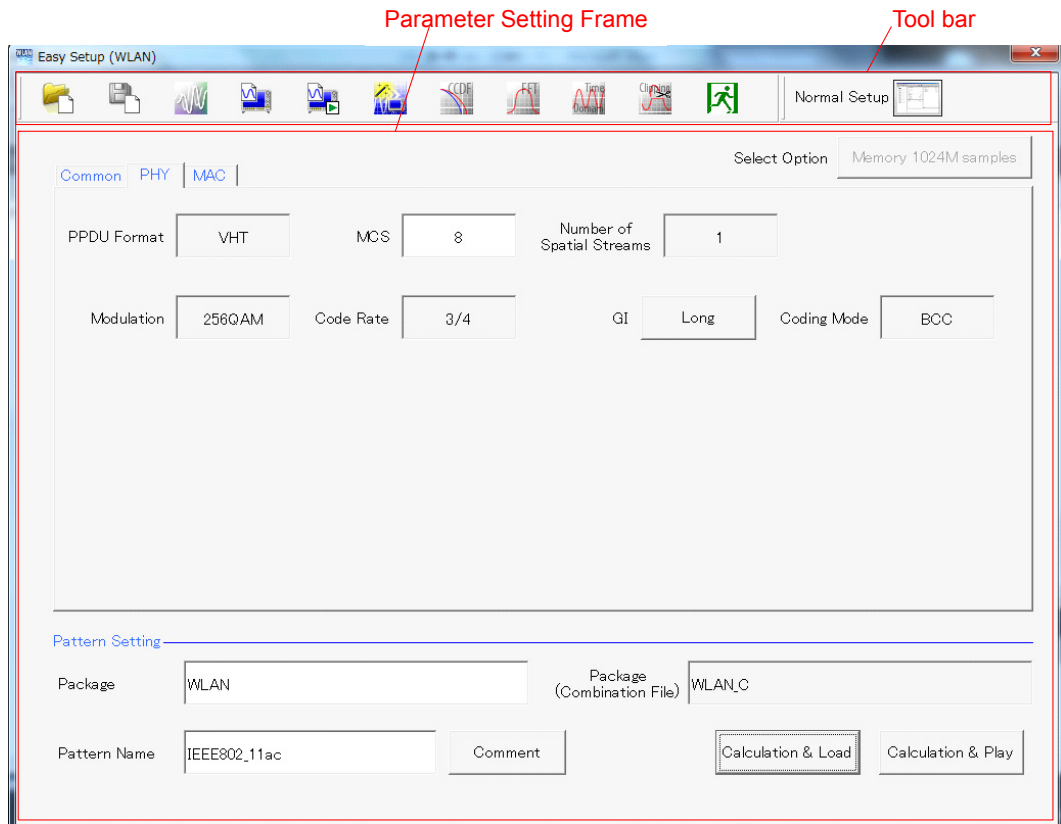

Figure 4.2.10-4 PHY Tab (When System is Set to 11ac)

PPDU Format

[Function] Sets the PPDU Format.

[Default] The default for each system is as follows:

When System is set to 11n: HT Mixed

When System is set to 11ac: VHT

[Setting range] The setting range for each system is as follows:

When System is set to 11n: Non-HT, HT-Mixed, and HT-Greenfield

When System is set to 11ac: VHT

[Remarks] This function can be set in the following cases:

Where System is set to 11n or 11ac.



Figure 4.2.10-5 PPDU Format Setting Screen

MCS

- [Function] Sets the MCS.
- [Default] The default for each system is as follows:
When System is set to 11n: 7
When System is set to 11ac: 8
- [Setting range] The setting range for each system is as follows:
When System is set to 11n: 0 to 7
When System is set to 11ac: 0 to 9
- [Remarks] This function can be set in the following cases:
Where System is set to 11n and PPDU Format is set to HT Mixed or HT-GreenField or where System is set to 11ac.
Parameters for MCS setting is defined in IEEE Std 802.11n-2009 - Chapter 20.6 and IEEE P802.11ac/D2.0, January 2012 - Chapter 22.5.

Number of Spatial Streams

- [Function] Sets the number of streams.
- [Default] 1
- [Setting range] 1
- [Remarks] This function can be used when System is set to 11n and PPDU Format is set to HT Mixed or HT-Greenfield or when System is set to 11ac.

Data Rate

- [Function] Sets the data rate.
- [Default] The default for each system is as follows:
When System is set to 11a, 11g, or 11j: 54 Mbps
When System is set to 11b: 11 Mbps
When System is set to 11p: 27 Mbps
- [Setting range] 1, 2, 3, 4.5, 5.5, 6, 9, 11, 12, 18, 22, 24, 27, 33, 36, 48, 54
- [Remarks] This function cannot be set in the following cases:
Where System is set to 11n and PPDU Format is HT Mixed or HT-Greenfield or where System is set to 11ac.
When System=11n and PPDU format=Non-HT, the setting range is the same as System=11a.

Table 4.2.10-1 Alternatives When System is set to 11a or 11j, 11n(PPDU format=Non-HT)

Data Rate	Frame Format	Modulation	High Rate Modulation	Code Rate
6 Mbps	N/A	BPSK	N/A	1/2
9 Mbps		BPSK		3/4
12 Mbps		QPSK		1/2
18 Mbps		QPSK		3/4
24 Mbps		16QAM		1/2
36 Mbps		16QAM		3/4
48 Mbps		64QAM		2/3
54 Mbps		64QAM		3/4

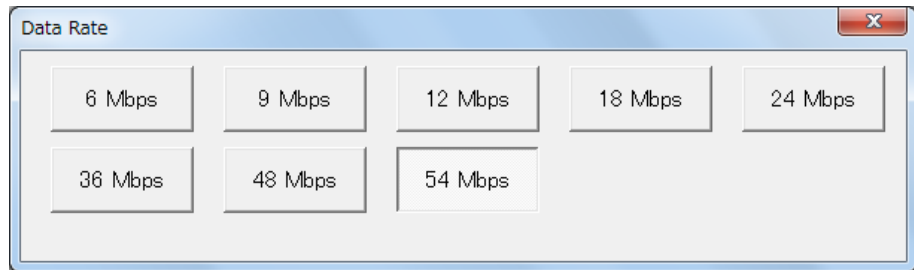

Figure 4.2.10-6 Data Rate Setting Screen (When System is Set to 11a, 11j)

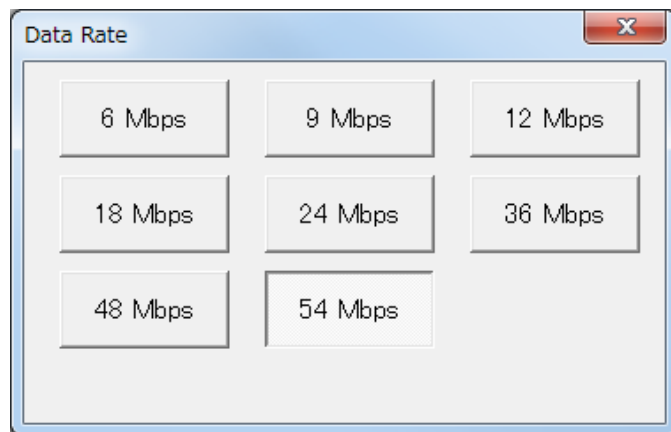

Figure 4.2.10-7 Data Rate Setting Screen (When System is Set to 11n(PPDU format=Non-HT))

Table 4.2.10-2 Alternatives When System is Set to 11b

Data Rate	Frame Format	Modulation	High Rate Modulation	Code Rate
1 Mbps	N/A	DBPSK	N/A	N/A
2 Mbps		DQPSK	N/A	
5.5 Mbps		N/A	CCK, PBCC	
11 Mbps		N/A	CCK, PBCC	

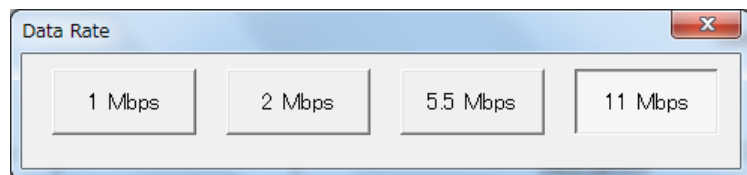

Figure 4.2.10-8 Data Rate Setting Screen (When System is Set to 11b)

Table 4.2.10-3 Alternatives When System is Set to 11g

Data Rate	Frame Format	Modulation	High Rate Modulation	Code Rate
1 Mbps	ERP-DSSS	DBPSK	N/A	N/A
2 Mbps	ERP-DSSS	DQPSK	N/A	N/A
5.5 Mbps	ERP-CCK ERP-PBCC	N/A	CCK, PBCC	N/A
6 Mbps	ERP-OFDM, DSSS-OFDM	BPSK	N/A	1/2
9 Mbps	ERP-OFDM, DSSS-OFDM	BPSK	N/A	3/4
11 Mbps	ERP-CCK ERP-PBCC	N/A	CCK, PBCC	N/A
12 Mbps	ERP-OFDM, DSSS-OFDM	QPSK	N/A	1/2
18 Mbps	ERP-OFDM, DSSS-OFDM	QPSK	N/A	3/4
22 Mbps	ERP-PBCC	N/A	PBCC	N/A
24 Mbps	ERP-OFDM, DSSS-OFDM	16QAM	N/A	1/2
33 Mbps	ERP-PBCC	N/A	PBCC	N/A
36 Mbps	ERP-OFDM, DSSS-OFDM	16QAM	N/A	3/4
48 Mbps	ERP-OFDM, DSSS-OFDM	64QAM	N/A	2/3
54 Mbps	ERP-OFDM, DSSS-OFDM	64QAM	N/A	3/4

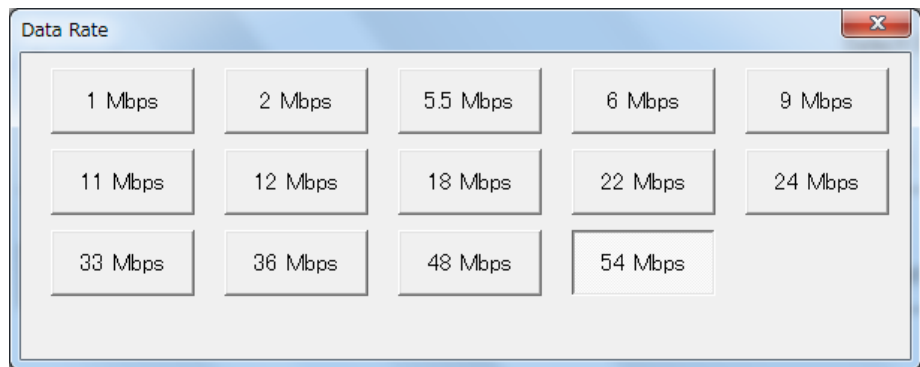

Figure 4.2.10-9 Data Rate Setting Screen (When System is Set to 11g)

Table 4.2.10-4 Alternatives When System is Set to 11p

Data Rate	Frame Format	Modulation	High Rate Modulation	Code Rate
3 Mbps	N/A	BPSK	N/A	1/2
4.5 Mbps		BPSK		3/4
6 Mbps		QPSK		1/2
9 Mbps		QPSK		3/4
12 Mbps		16QAM		1/2
18 Mbps		16QAM		3/4
24 Mbps		64QAM		2/3
27 Mbps		64QAM		3/4

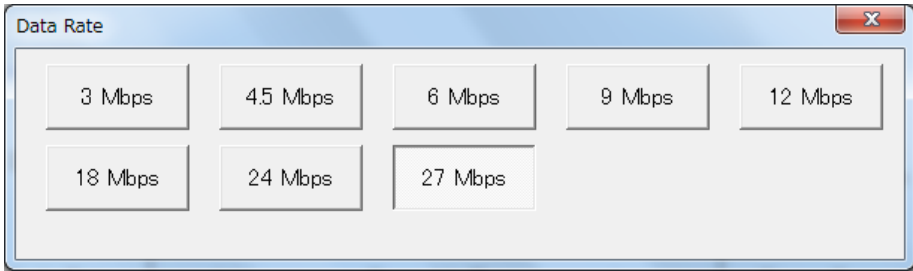

Figure 4.2.10-10 Data Rate Setting Screen (When System is Set to 11p)

Modulation

[Function] Displays the PSDU modulation method.

[Default] The default for each system is as follows:
When System is set to 11a, 11g, 11j, 11p or 11n (PPDU Format is Non-HT): 64QAM
When System is set to 11ac: 256QAM

[Display range] BPSK, QPSK, 16QAM, 64QAM, 256QAM, DBPSK, DQPSK

[Remarks] This function is disabled when System is set to 11b and Data Rate is set to 5.5, 11 Mbps or when System is set to 11g and Data Rate is set to 5.5, 11, 22, 33 Mbps.
This function is disabled when System is set to 11n and PPDU Format is set to HT Mixed or HT-Greenfield.

High Rate Modulation

[Function] Sets the modulation method for direct sequence spread spectrum.

[Default] CCK

[Setting range] CCK, PBCC

[Remarks] This function can be set in the following cases:
Where System is set to 11b.
Where System is set to 11g and Frame Format is set to ERP-CCK or ERP-PBCC.
Both CCK and PBCC can be selected where Data Rate is set to 5.5 Mbps or 11 Mbps.
Note that Frame Format is automatically set to:
ERP-CCK when High Rate Modulation is CCK.
ERP-PBCC when High Rate Modulation is PBCC.
Only PBCC can be selected where Data Rate is set to 22Mbps or 33 Mbps.
Only PBCC can be selected where Data Rate is set to 22Mbps or 33 Mbps.

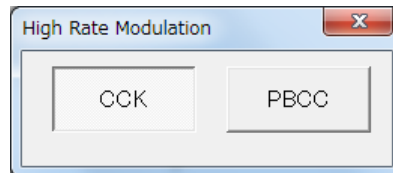

Figure 4.2.10-11 High Rate Modulation Setting Screen

Code Rate

[Function] Displays the coding rate.

[Default] 3/4

[Display range] 1/2, 2/3, 3/4, 5/6

[Remarks] This function is disabled when System is set to 11b or 11g and Data Rate is set to 1, 2, 5.5, 11, 22, 33 Mbps.

Preamble Type

[Function] Sets the preamble type.

[Default] Long

[Setting range] Long, Short

[Remarks] This function can be set in the following cases:

- Where System is set to 11b.
- Where System is set to 11g.

Only **Long** is available where all the following conditions are satisfied:

- Where System is set to 11g.
- Where Frame Format is set to ERP-DSSS.
- Where Data Rate is set to 1 Mbps.

Only **Long** is available where both of the following conditions are satisfied:

- Where System is set to 11g.
- Where Frame Format is set to ERP-OFDM.

Also, only **Long** is available where System is set to 11b and Data Rate is set to 1 Mbps.

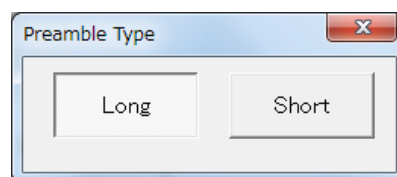

Figure 4.2.10-12 Preamble Type Setting Screen

Frame Format

[Function] Sets the secondary modulation method for header and payload.

[Default] ERP-OFDM

[Setting range] ERP-OFDM, DSSS-OFDM, ERP-DSSS, ERP-CCK, ERP-PBCC

[Remarks] This function can be set in the following cases:
Where System is set to 11g.

Also, Frame Format is automatically set to:

- ERP-CCK when High Rate Modulation is CCK.
- ERP-PBCC when High Rate Modulation is PBCC.

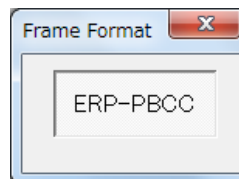
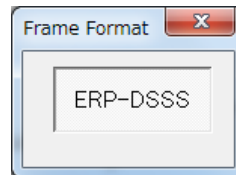
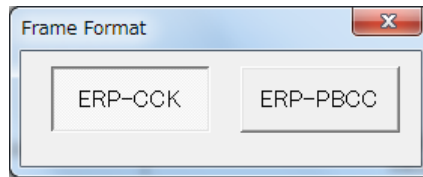

Figure 4.2.10-13 Frame Format Setting Screen

GI	
[Function]	Sets the guard interval length.
[Default]	Long
[Setting range]	Short, Long
[Remarks]	This function can be set in the following cases: Where System is set to 11n and PPDU Format is HT Mixed or HT-Greenfield or where System is set to 11ac.

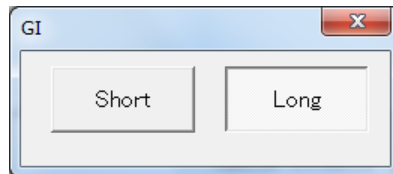

Figure 4.2.10-14 Frame Format Setting Screen

Coding Mode	
[Function]	Sets the coding mode.
[Default]	BCC
[Remarks]	This function can be set in the following cases: Where System is set to 11ac.

4.2.11 MAC Tab

This subsection describes the parameters in the MAC tab.

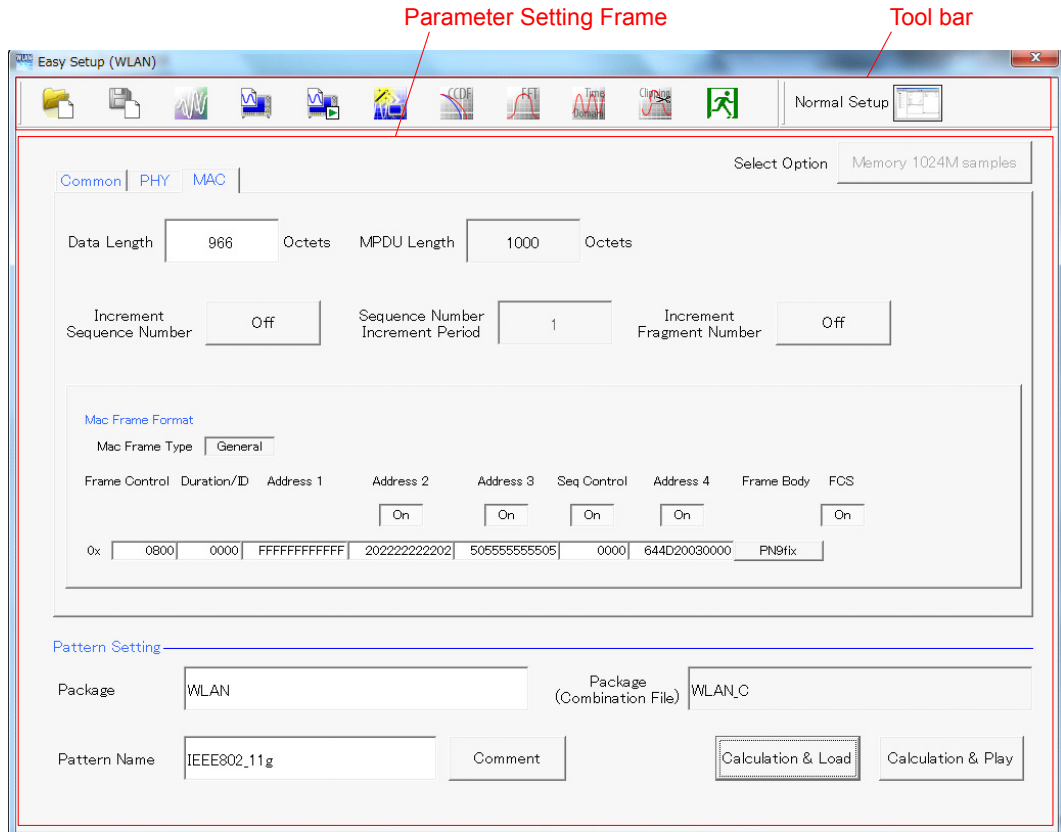

Figure 4.2.11-1 MAC Tab (When System is Set to Other Than 11n or 11ac)

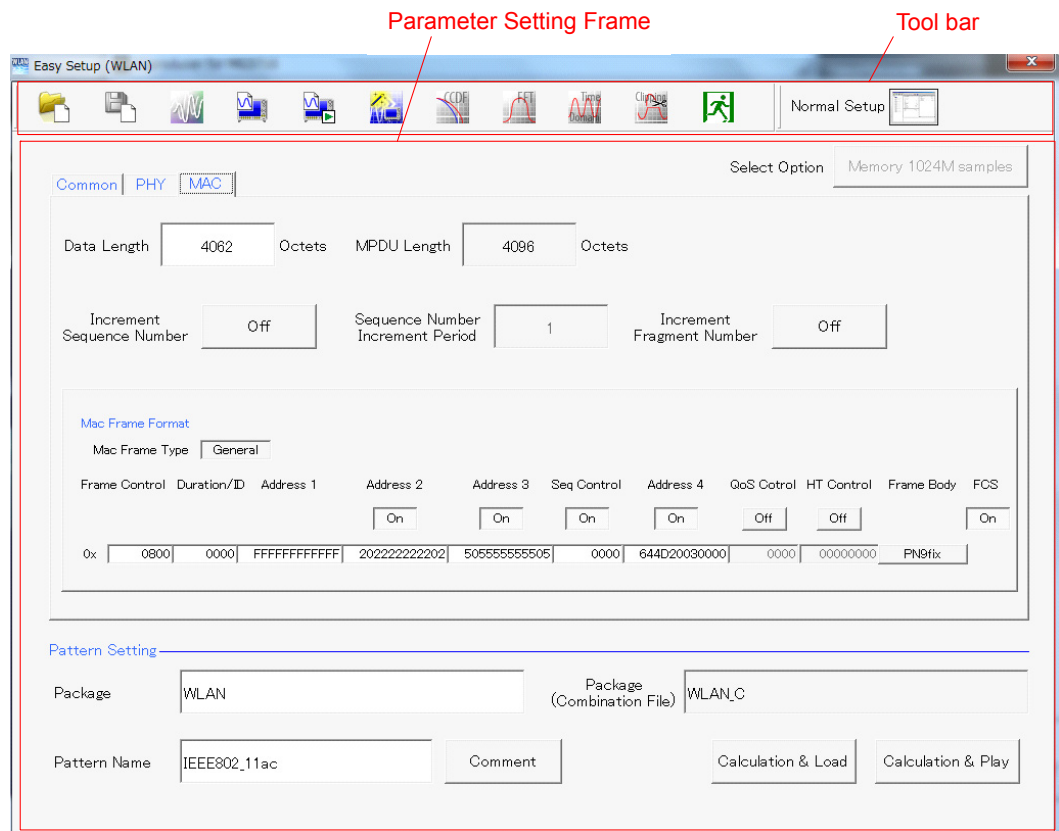

Figure 4.2.11-2 MAC Tab (When System is Set to 11n or 11ac)

Data Length

[Function]

Sets the data length.

[Default]

The default for each system is as follows:

When System is set to 11a, 11g (with Frame Format set to DSSS-OFDM or ERP-OFDM), 11j or 11p: 966 [octet(s)]

When System is set to 11b or 11g (with Frame Format set to ERP-DSSS, ERP-PBCC or ERP-CCK): 990 [octet(s)]

When System is set to 11n and Frame Format is set to Non-HT: 4061 [octet(s)]

When System is set to 11n and PPDU Format is set to HT Mixed or HT Greenfield: 4062 [octet(s)]

When System is set to 11ac: 4062 [octet(s)]

[Setting range] The setting range for each system is as follows:

When System is set to 11a, 11b, 11g, 11j or 11p or when System is set to 11n and PPDU Format is set to Non-HT: 1 to (4095 – Diff) [octet(s)]

When System is set to 11n and PPDU Format is set to HT Mixed or HT Greenfield: 1 to (65535 – Diff) [octet(s)]

When System is set to 11ac: 1 to (65535 – Diff) [octet(s)]

[Remarks]	Set the value using the numeric keypad. Diff = Total Length (Mac Header + FCS) – (Sum of the MAC parameters set to Off in the Frame Format setting screen [octet(s)]) Total Length=40 [octet(s)]
MPDU Length	
[Function]	Displays the MPDU length.
[Default]	The default for each system is as follows: When System is set to 11a, 11g (with Frame Format set to DSSS-OFDM or ERP-OFDM), 11j, 11n or 11p: 1000 [octet(s)] When System is set to 11b or 11g (with Frame Format set to ERP-DSSS, ERP-PBCC or ERP-CCK): 1024 [octet(s)] When System is set to 11n and Frame Format is set to Non-HT: 4095 [octet(s)] When System is set to 11n and Frame Format is set to HT-Mixed or HT-Greenfield or when System is set to 11ac: 4096 [octet(s)]
[Display range]	The display range for each system is as follows: When System is set to 11a, 11b, 11g, 11j or 11p or when System is set to 11n and PPDU Format is set to Non-HT: (Diff+1) to 4095 [octet(s)] When System is set to 11n and PPDU Format is set to HT Mixed or HT Greenfield: (Diff+1) to 65535 [octet(s)] When System is set to 11n and A-MPDU is set to ON: (Diff+1) to 4095 [octet(s)] When System is set to 11ac: (Diff+1) to 65535 [octet(s)]

MAC Data Type

- [Function] Sets the type of data assigned to the MAC frame body.
 [Default] PN9fix
 [Setting range] PN9fix, PN15fix, 16bit repeat, User File
 [Remarks] Clicking **Frame Body** in the MAC Frame Format section displays the screen as shown below.

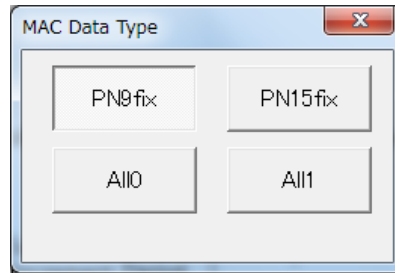

Figure 4.2.11-3 MAC Data Type Setting Screen

Frame Control

- [Function] Sets the frame control.
 [Default] 0x0800
 [Setting range] 0x0000 to 0xFFFF
 [Remarks] Set the value using the hexadecimal keypad.

Duration/ID

- [Function] Sets the Duration/ID.
 [Default] 0x0000
 [Setting range] 0x0000 to 0xFFFF
 [Remarks] Set the value using the hexadecimal keypad.

Address1

- [Function] Sets the MAC Address1.
 [Default] 0xFFFF FFFF FFFF
 [Setting range] 0x0000 0000 0000 to 0xFFFF FFFF FFFF
 [Remarks] Set the value using the hexadecimal keypad.

Address2

- [Function] Sets the MAC Address2.
 [Default] 0x2022 2222 2202
 [Setting range] 0x0000 0000 0000 to 0xFFFF FFFF FFFF
 [Remarks] Set the value using the hexadecimal keypad.
 This function is available in the following case:
 Address2 SW=On.

Address2 SW

[Function] Enables/disables the MAC Address2.
[Default] On
[Setting range] On, Off

Address3

[Function] Sets the MAC Address3.
[Default] 0x5055 5555 5505
[Setting range] 0x0000 0000 0000 to 0xFFFF FFFF FFFF
[Remarks] Set the value using the hexadecimal keypad.
This function is available in the following case:
Address3 SW=On

Address3 SW

[Function] Enables/disables the MAC Address3.
[Default] On
[Setting range] On, Off

Sequence Control

[Function] Sets the Sequence Control.
[Default] 0x0000
[Setting range] 0x0000 to 0xFFFF
[Remarks] Set the value using the hexadecimal keypad.
This function is available in the following case:
Sequence Control SW=On

Sequence Control SW

[Function] Enables/disables the Sequence Control.
[Default] On
[Setting range] On, Off

Address4

[Function] Sets the MAC Address4.
[Default] 0x644D 2003 0000
[Setting range] 0x0000 0000 0000 to 0xFFFF FFFF FFFF
[Remarks] Set the value using the hexadecimal keypad.
This function is available in the following case:
Address4 SW=On

Address4 SW

[Function] Enables/disables the MAC Address4.
[Default] On
[Setting range] On, Off

QoS Control

- [Function] Sets the QoS control.
[Default] 0x0000
[Setting range] 0x0000 to 0xFFFF
[Remarks] Set the value using the hexadecimal keypad.
This function is available in the following case:
System=11n or,
System=11ac and QoS Control SW=On.

QoS Control SW

- [Function] Sets the QoS control.
[Default] On
[Setting range] On, Off
[Remarks] This function is available in the following case:
System=11n or System=11ac

HT Control

- [Function] Sets the HT control.
[Default] 0x0000 0000
[Setting range] 0x0000 0000 to 0xFFFF FFFF
[Remarks] Set the value using the hexadecimal keypad.
This function is available in the following case:
System=11n or,
System=11ac and HT Control SW=On.

HT Control SW

- [Function] Enables/disables the HT Control.
[Default] On
[Setting range] On, Off
[Remarks] This function is available in the following case:
System=11n or System=11ac

Increment Sequence Number

- [Function] Sets whether to increment the sequence number.
[Default] Off
[Setting range] On, Off
[Remarks] Set the value using the toggle button.
When Increment Sequence Number is set to On, the sequence number is incremented at the interval set by Sequence Number Increment Period, considering the high-order 12 bits of the Sequence Control as an initial value.

Sequence Number Increment Period

- [Function] Sets the interval to increment the sequence number.
- [Default] 1
- [Setting range] 1 to 15
- [Remarks] Set the value using the numeric keypad.
This can be set when Increment Sequence Number is set to On or when Increment Fragment Number is set to On.

Increment Fragment Number

- [Function] Sets whether to increment the Fragment Number.
- [Default] Off
- [Setting range] On, Off
- [Remarks] Set the value using the toggle button.
When Increment Fragment Number is set to On, the frame number of each packet is incremented at the interval set by Sequence Number Increment Period, considering the low-order 4 bits of the Sequence Control as an initial value.

FCS

- [Function] Sets whether to enable the MAC check sum function.
- [Default] On
- [Setting range] On, Off

4.3 Graph Display

The generated waveform pattern can be displayed in a CCDF, FFT, and Time Domain graph by using this software.

To display CCDF graph:

- (1) Generate a waveform pattern menu by executing “Calculation”.
- (2) Click  on the tool bar to display the CCDF graph screen and the generated waveform pattern trace.

Displaying FFT graph

- (1) Generate a waveform pattern menu by executing “Calculation”.
- (2) Click  on the tool bar to display the FFT graph screen and the generated waveform pattern trace.

Displaying the Time Domain graph

- (1) Generate a waveform pattern menu by executing “Calculation”.
- (2) Click  on the tool bar to display the Time Domain graph screen and the generated waveform pattern trace.

For details of the graph screens, refer to sections 4.3 “CCDF Graph Display”, 4.4 “FFT Graph Display” and 4.13 “Time Domain Graph Display” in the *MG3700A/MG3710A Vector Signal Generator MG3740A Analog Signal Generator Operation Manual (IQproducer™)*.

4.4 Auxiliary Signal Output

Select a waveform pattern generated by the WLAN IQproducer™ on the mainframe to output the marker that is synchronized with the RF signal as an auxiliary signal from the AUX Input/Output on the rear panel of the mainframe. Markers described below are automatically set for the waveform patterns when they are generated. By using the Marker Edit function which is a peripheral function of the Time Domain graph, a waveform pattern can be generated with these markers edited. For Marker Edit function, refer to 4.13.12 “Marker edit function” in *MG3700A/MG3710A Vector Signal Generator MG3740A Analog Signal Generator Operation Manual (IQproducer™)*.

Chapter 5 *How to Use Waveform Patterns*

The following operations are required to output a modulated signal from this equipment using the waveform pattern generated by this software:

- Transferring waveform pattern to internal hard disk
- Loading waveform patterns from the hard disk to the waveform memory
- Selecting a waveform pattern to be output from this equipment

This chapter explains the details of these operations.

5.1	For MG3700A or MG3710A.....	5-2
5.1.1	Transferring waveform pattern to internal hard disk	5-2
5.1.2	Loading to Waveform Memory	5-4
5.1.3	Selecting Waveform Pattern.....	5-5
5.2	For MS2690A/MS2691A/MS2692A or MS2830A.....	5-6
5.2.1	Transferring waveform pattern to internal hard disk	5-6
5.2.2	Loading to Waveform Memory	5-6
5.2.3	Selecting Waveform Pattern.....	5-7

5.1 For MG3700A or MG3710A

This section describes how to download a waveform pattern created for the MG3700A/MG3710A to the hard disk of the MG3700A/MG3710A and output the pattern.

5.1.1 Transferring waveform pattern to internal hard disk

The waveform pattern created with this software can be transferred to the internal hard disk in the following ways:

Note:

This operation is not necessary if you are using MG3710A and have generated waveform patterns on MG3710A.

For MG3700A

- LAN
- CompactFlash Card

For MG3710A

- LAN
- External device such as USB Memory

■ Transferring from PC via LAN (MG3700A, MG3710A)

Two IQproducer™ tools can be used to transfer a waveform pattern to the MG3700A/MG3710A via a LAN.

- Transfer & Setting Wizard

Start this wizard by clicking the **Transfer & Setting Wizard** button of this software or by selecting **Simulation & Utility** tab → **Transfer & Setting Wizard** from the IQproducer™ after creating a waveform pattern. For details, refer to Section 4.7 “File Transfer and Loading to Memory Using Transfer & Setting Wizard” in the *MG3700A/MG3710A Vector Signal Generator MG3740A Analog Signal Generator Operation Manual (IQproducer™)*.

Transferring a waveform pattern to the internal hard disk of the MG3700A/MG3710A, loading the waveform from the hard disk to the waveform memory, and then outputting the waveform pattern can be done using this wizard.

- **Transfer & Setting Panel**

This function is loaded by selecting **Transfer & Setting Panel** in the **Simulation & Utility** tab of the IQproducer™. For details, refer to Section 5.2 “Transferring Waveform Pattern” in the *MG3700A/MG3710A Vector Signal Generator MG3740A Analog Signal Generator Operation Manual (IQproducer™)*.

Specify the folder that contains the waveform pattern to transfer to the MG3700A/MG3710A in the PC-side tree of **Transfer & Setting Panel**.

- **Transferring using a CF card (MG3700A)**

Copy the waveform pattern (*.wvi and *.wvd files) to be downloaded to the MG3700A to the root directory of a CF card.

Insert the CF card into the card slot on the front panel of the MG3700A, and then copy the file to the hard disk. For details about how to use a CF card to transfer a waveform pattern, refer to (1) “Loading waveform file in memory” in Section 3.5.2 of the *MG3700A Vector Signal Generator Operation Manual (Mainframe)*.

- **Transferring via external device such as USB memory (MG3710A)**

For details about how to transfer a waveform pattern created using this software to the hard disk of the MG3710A, refer to Section 7.3.6 “Copying external waveform pattern: Copy” in the *MG3710A Vector Signal Generator MG3740A Analog Signal Generator Operation Manual (Mainframe)*.

5.1.2 Loading to Waveform Memory

To output a modulated signal using a waveform pattern, it is necessary to load the waveform pattern that was transferred to the internal hard disk of the MG3700A/MG3710A (described in Section 5.1.1 “Transferring waveform pattern to internal hard disk”) to the waveform memory. A waveform pattern can be loaded into the waveform memory in the following two ways.

■Configuring using the mainframe

A waveform pattern can be loaded into the waveform memory by using the instruction panel of the MG3700A/MG3710A or by using a remote command.

For operation using the front panel, refer below:

- Section 3.5.2 (1) “Loading waveform file in memory” in the *MG3700A Vector Signal Generator Operation Manual (Mainframe)*
- Section 7.3.4 “Loading waveform pattern: Load” in the *MG3710A Vector Signal Generator MG3740A Analog Signal Generator Operation Manual (Mainframe)*

For operation using remote commands, refer below:

- Chapter 4 “Remote Control” in the *MG3700A Vector Signal Generator Operation Manual (Mainframe)*
- Section 7.3.4 “Loading waveform pattern: Load” in the *MG3710A Vector Signal Generator MG3740A Analog Signal Generator Operation Manual (Mainframe)*

■Using Transfer & Setting Panel of IQproducer™

A waveform pattern can be loaded from the LAN-connected PC to the memory by using **Transfer & Setting Panel**, which can be opened from the **Simulation & Utility** tab. For details, refer to Section 4.6 “File Transfer and Loading to Memory Using Transfer & Setting Panel” in the *MG3700A/MG3710A Vector Signal Generator MG3740A Analog Signal Generator Operation Manual (IQproducer™)*.

5.1.3 Selecting Waveform Pattern

Select a waveform pattern to use for modulation from the waveform patterns loaded into the waveform memory of the MG3700A/MG3710A according to Section 5.1.2 “Loading to Waveform Memory”. A waveform pattern can be selected in the following two ways.

■Configuring using the MG3700A/MG3710A

Waveform patterns to be used for modulation can be selected by operating the equipment panel or by using a remote command.

For operation using the front panel, refer below:

- Section 3.5.2 (4) “Outputting pattern loaded in Memory A for modulation in Edit mode” in the *MG3700A Vector Signal Generator Operation Manual (Mainframe)*
- Section 7.3.5 “Selecting output waveform pattern: Select” in the *MG3710A Vector Signal Generator MG3740A Analog Signal Generator Operation Manual (Mainframe)*

For operation using remote commands, refer below:

- Chapter 4 “Remote Control” in the *MG3700A Vector Signal Generator Operation Manual (Mainframe)*
- Section 7.3.5 “Selecting output waveform pattern: Select” in the *MG3710A Vector Signal Generator MG3740A Analog Signal Generator Operation Manual (Mainframe)*

■Using Transfer & Setting Panel of IQproducer™

A waveform pattern can be loaded from the LAN-connected PC to the memory, and also selected for modulation. This is done by using **Transfer & Setting Panel**, which can be opened from the **Simulation & Utility** tab. For details, refer to Section 4.6 “File Transfer and Loading to Memory Using Transfer & Setting Panel” in the *MG3700A/MG3710A Vector Signal Generator MG3740A Analog Signal Generator Operation Manual (IQproducer™)*.

5.2 For MS2690A/MS2691A/MS2692A or MS2830A

This section describes how to download a waveform pattern created for the MS2690A/MS2691A/MS2692A or MS2830A to the hard disk of the MS2690A/MS2691A/MS2692A or MS2830A and output the pattern.

5.2.1 Transferring waveform pattern to internal hard disk

For details about how to transfer a waveform pattern created using this software to the hard disk of the MS2690A/MS2691A/MS2692A or MS2830A, refer below:

- Section 2.4.4 “Copying waveform file(s) to hard disk” in the *MS2690A/MS2691A/MS2692A Signal Analyzer Option 020: Vector Signal Generator Operation Manual (Operation)*
- Section 2.4.4 “Copying waveform file(s) to hard disk” in the *MS2830A Signal Analyzer Vector Signal Generator Operation Manual (Operation)*

Note:

Transferring waveform patterns is not required if the patterns are created using this software.

5.2.2 Loading to Waveform Memory

In order to output a modulated signal using the waveform pattern, it is necessary to load the waveform patterns stored in the internal hard disk to the waveform memory.

■ Loading to Waveform Memory

Waveform patterns can be loaded to waveform memories by operating the panel or by using a remote command.

For operation using the front panel, refer below:

- Section 2.4.1 “Loading waveform file in memory” in the *MS2690A/MS2691A/MS2692A Signal Analyzer Option 020: Vector Signal Generator Operation Manual (Operation)*
- Section 2.4.1 “Loading waveform pattern(s) to memory” in the *MS2830A Signal Analyzer Vector Signal Generator Operation Manual (Operation)*

For operation using remote commands, refer below:

- *MS2690A/MS2691A/MS2692A Signal Analyzer Option 020: Vector Signal Generator Operation Manual (Remote Control)*
- *MS2830A Signal Analyzer Vector Signal Generator Operation Manual (Remote Control)*

5.2.3 Selecting Waveform Pattern

Select waveform patterns to be used for modulation from those loaded in the waveform memory as described in Section 5.2.1 “Transferring waveform pattern to internal hard disk” above.

■ Selecting waveform pattern

Waveform patterns to be used for modulation can be selected by operating the equipment panel or by using a remote command.

For operation using the front panel, refer below:

- Section 2.4.2 “Loading waveform file in memory” in the *MS2690A/MS2691A/MS2692A Signal Analyzer Option 020: Vector Signal Generator Operation Manual (Operation)*
- Section 2.4.2 “Loading waveform pattern(s) to memory” in the *MS2830A Signal Analyzer Vector Signal Generator Operation Manual (Operation)*

For operation using remote commands, refer below:

- *MS2690A/MS2691A/MS2692A Signal Analyzer Option 020: Vector Signal Generator Operation Manual (Remote Control)*
- *MS2830A Signal Analyzer Vector Signal Generator Operation Manual (Remote Control)*

Appendix

Appendix A	Error Messages.....	A-1
Appendix B	User File Format	B-1

Appendix A Error Messages

A list of error messages is shown below. In this list, x , n_1 , and n_2 indicate a numeric value, and s indicates a character string.

Table A-1 Error messages

Error Message	Description
Calculation cannot start because of setting error.	—
Cannot open file	—
Cannot read file	—
Cannot read file(“ s ”)	—
Cannot write file	—
Cannot write file(“ s ”).	—
Burst On Length is too short.	—
Input Export File Name.	—
Input Package Name.	—
Invalid file format	When loading complex data, this message is also displayed if binary data is loaded by mistake.
Invalid value is set.	—
The Setting value is out of range.(“ $s = x(n_1 - n_2)$ ”)	The value of x set in parameter s is out of the setting range between n_1 and n_2 .
The sum of Data Length for each MPDU is out of range. (xxxxxx)	For System=11n, the sum of Data Length exceeds 65535 (maximum value). For System=11ac, Total A-MPDU Length exceeds 65535 (maximum value). For System=11ac and when Oversampling Ratio=8, Bandwidth=20 MHz, MCS=0, Number of Spatial Streams=1, Total A-MPDU Length exceeds 42500 (maximum value).
Memory option cannot be turned on in MS269x mode.	—
Operation disabled when 2nd SG (Opt-062, 064, 066) not installed.	—.
Operation disabled when Bandwidth is 80+80 MHz and Number of Antennas is not 1.	—

A list of warning message is shown below.

Table A-2 Warning message

Warning Message	Description
Clipping was done.	—

Appendix B User File Format

This section shows examples of the two user file formats that can be used in this software. A user file must be a text file. It is not necessarily required to specify an extension to user files. Note that an error occurs if a user file that does not conform to the format is read.

Be sure to write an unmodulated binary sequence into a user file. An error occurs if a user file that contains characters other than 0, 1, line feed, comma, period, and space is read. All line feeds, commas, periods, and spaces in a user file are ignored when the user file is read. A user file format example is shown below.

User file format example

```
111111110000011110111110001011100110010000010010100111011010001
111001111100110110001010100100011100011011010101110001001100010
00100000000100001000110000100111001010101100001101111010011011
10010001010000101011010011111011001001001011011111100100110101
00110011000000011000110010100011010010111111010001011000111010
110010110011110001111101110100000110101101101110110000010110101
111101010101000000101001010111100101110111000000111001110100100
111101011101010001001000011001110000101111011011001101000011101
1110000
```

0s and 1s in a user file are sequentially read from the leftmost of the first line.

When the number of data to be processed is larger than that in the user file, the user file is read again from the top. If the user file contains more data than that to be processed, data reading terminates halfway.

References are to page numbers.

A

Add MPDU..... 3-10
Address 3-43, 3-52, 4-33
A-MPDU..... 3-16, 3-50
A-MPDU#..... 3-11
Auxiliary Signal Output 3-83

B

Band Width..... 3-18
Bandwidth 3-14, 4-13
BCC Interleaver 3-48
Burst Off Length 3-15, 3-19, 4-14
Burst On Length 3-15, 3-19, 4-14
Burst Period..... 3-16, 3-20, 4-15

C

Calculation & Load 3-63
Calculation & Play 3-64, 4-10
Calculation screen 3-61
Code Rate..... 3-33, 3-47, 4-27
Coding 3-48
Coding Mode 3-48, 4-29
Convolutional Encode 3-12

D

Data Length..... 3-41, 3-50, 4-31
Data Rate..... 3-34, 4-21
Data Type Repeat Data..... 3-43, 3-51
Data Type User File 3-43, 3-51
Delete MPDU..... 3-10
Displaying CCDF graph..... 3-77
Displaying FFT graph..... 3-79
Displaying the Time Domain graph..... 3-81
Duration/ID 3-43, 3-52, 4-33
Duty Cycle 3-15, 3-19, 4-14

E

Edit Mode..... 3-21, 3-37
Export File screen 3-55

F

FCS..... 4-36

Filter Type..... 3-17, 3-20, 4-15
Frame Control 3-43, 3-52, 4-33
Frame Format..... 3-36, 4-28

G

GI..... 3-31, 3-39, 4-29
Graph Display..... 3-77
Group ID 3-48

H

Half Bandwidth 3-40
Hexadecimal keypad..... 4-3
High Rate Modulation..... 3-33, 4-26
HT Control 3-45, 3-53, 4-35

I

IEEE 802.11ac waveform 3-69
IEEE 802.11n waveform 3-66
Increment Fragment Number 3-46, 3-54, 4-36
Increment Sequence Number 3-46, 3-54, 4-35
Installation..... 2-3
Interleave 3-13

L

LDPC Tone Mapper 3-48

M

MAC Data Type 3-43, 3-51, 4-33
MAC FCS 3-46, 3-54
MAC Frame Type 3-42, 3-51
MAC parameter 3-50
MAC parameters 3-41
MCS 3-32, 3-47, 4-21
Menu and tool button 3-2
Modulation 3-33, 3-47, 4-26
MPDU Length..... 3-42, 3-50, 4-32

N

Not Sounding 3-39
Number of Antennas 3-12, 3-18
Number of Extension Spatial Streams 3-40
Number of Packets 3-12, 3-18, 4-13
Number of Space Time Streams 3-40, 3-48

Index

Number of Spatial Streams 3-32, 3-47, 4-21
Number of Transmit Chains..... 3-21, 3-40
Numeric keypad 4-2

O

Operating Environment..... 2-2
Oversampling Ratio 3-13, 3-18

P

Parameter file
 Reading..... 3-73
 Saving..... 3-72
Partial AID 3-49
PBCC Encode..... 3-13
PHY parameter 3-47
PHY parameters..... 3-32
PHY/MAC parameters 3-32
PPDU Format 3-21, 3-32, 4-20
Preamble Type 3-36, 4-27
Product Composition 1-3
Product overview 1-2

Q

QoS Control 3-45, 3-53, 4-35

R

Ramp Length 3-17, 4-16
Repeat Count 3-16, 3-20, 4-13
Roll Off/BT 3-17, 3-20, 4-16

S

Sampling Rate 3-14, 3-18
Scramble 3-13, 3-47
Scramble Initial Value 3-13, 3-20
Screen Details..... 3-2
Select Option 4-11
Sequence Control..... 3-44, 3-53, 4-34
Sequence Number Increment
 Period..... 3-46, 3-54, 4-36
Smoothing..... 3-39
Software keyboard..... 4-3
Spatial Mapping 3-21, 3-37
Spatial Mapping Matrix 3-22, 3-37
System..... 3-12, 4-12

T

Total A-MPDU Length 3-51
Total Number of Space Time Streams 3-31
Total Output Packets 3-18, 4-13
Tree view 3-10
TXOP PS NOT ALLOWED 3-49

U

Uninstallation..... 2-3
User File
 Reading..... 3-75
User# 3-11

W

Waveform Memory
 Loading to..... 5-4, 5-6
Waveform pattern..... 5-1
 Selecting 5-5, 5-7
 Transferring to internal hard disk..... 5-2, 5-6
Windowing Length 3-17, 3-21, 4-16