

Cuisinart®

INSTRUCTION AND RECIPE BOOKLET



**14-Cup (3.5 L) Cuisinart® Elite Collection
2.0 Food Processor**

FP-14NC SERIES

For your safety and continued enjoyment of this product, always read the instruction book carefully before using.

RECOMMENDED MAXIMUM WORK BOWL CAPACITIES

FOOD	CAPACITY 14-CUP (3.5 L) WORKBOWL	CAPACITY 4.5-CUP (1.12 L) WORKBOWL
Sliced or shredded fruit, vegetables or cheese	14 cups (3.5 L)	N/A
Chopped fruit, vegetables or cheese	12 cups (3 L)	3 cups (750 ml)
Puréed fruit, vegetables or cheese	12 cups (3 L) cooked 8 cups (2 L) puréed	3 cups (750 ml) cooked 1½ cups (375 ml) puréed
Chopped or puréed meat, fish, seafood	2¼ pounds (1 kg)	½ pound (226 g)
Thin liquid* (e.g. dressing, soups, etc.)	10 cups (2.5 L)	3 cups (700 ml)
Cake Batter	Two 9-inch (23 cm) cheesecakes Four 8-inch (20 cm) homemade layers (2 boxes 18.5 oz. cake mix)	N/A
Cookie dough	8 dozen (based on average chocolate chip cookie recipe)	N/A
White bread dough	6 cups (1.5 L) flour	N/A
Whole wheat bread dough	4 cups (1 L) flour	N/A
Nuts for nut butter	4 cups (1 L)	1½ cups (375 ml)

* When processing egg-based liquids, like a custard base for quiche, reduce maximum capacity by 2 cups (500 ml).

IMPORTANT UNPACKING INSTRUCTIONS

This package contains a Cuisinart® Elite Collection 2.0 14-Cup (3.5 L) Food Processor and the accessories for it: 14- and 4.5-cup (3.5 L and 1.12 L) work bowls, work bowl cover, large and small metal chopping/mixing blades, dough blade, adjustable slicing disc, reversible shredding disc, stem adapter, large and small pushers, spatula, accessory storage case, and instruction/recipe book.

CAUTION: THE CUTTING TOOLS HAVE VERY SHARP EDGES. To avoid injury when unpacking the parts, please follow these instructions.

- Place the box on a low table or on the floor next to the kitchen counter where you intend to keep the food processor. Be sure the box is right side up.
- Open top flaps—there will be a rectangular block of foam that holds the processor parts, each fitted into a cavity in the foam.
- Remove the instruction/recipe book and bowl cover (A) from one side of the foam block. Lift out the large and small pushers.
- Lift out the work bowls (B) and spatula (C) from the other side of the foam block.
- Remove the foam block and the cardboard frame.
- Remove the housing base (D) from one side of the bottom of the box. Assemble the work bowls on the base by placing them over the shaft using the handle to turn the work bowl counterclockwise to lock it.
- Place the food processor on the countertop or table. Read the Assembly Instructions thoroughly before using the machine.
- The storage case (E) is on the other side of the bottom of the box.
- Lift out the storage case, unlock the cover and remove the foam block; the small metal chopping/mixing blade (F), dough blade (G), large metal chopping/mixing blade (H), and stem adapter (I), are each in a cavity. **CAREFULLY REMOVE THE METAL CHOPPING/MIXING BLADE BY GRASPING THE CENTER HUB AND LIFTING IT STRAIGHT UP. NEVER TOUCH THE BLADES, AS THEY ARE RAZOR SHARP.**

- Pull out the drawer to the storage case with the adjustable slicing disc (J), and **CAREFULLY REMOVE IT BY USING THE PLASTIC HUB. DO NOT TOUCH THE BLADE, IT IS VERY SHARP.** The reversible shredding disc (K) is also in the drawer. Carefully remove the slicing disc and shredding disc by using the plastic hub. Remember to lock the parts in the storage case when not in use.
- Save the shipping cartons and plastic foam blocks. You will find them very useful if you need to repack the processor for moving or other shipment.

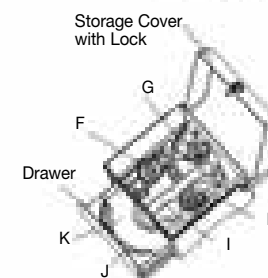
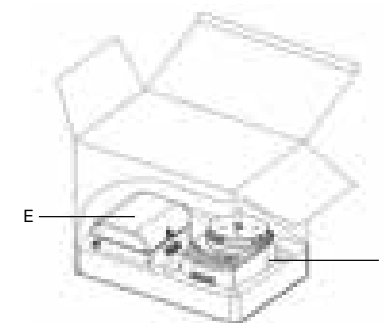
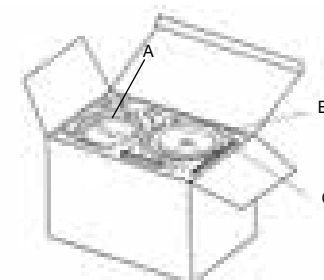

IMPORTANT SAFEGUARDS

Always follow these safety precautions when using this appliance.

Getting Ready

1. Read all instructions.
2. **Blades and discs are sharp.** Handle them carefully.
3. **Always unplug from outlet when not in use, before putting on or taking off parts, before removing food and before cleaning. To unplug, grasp plug and pull from electrical outlet. Never pull cord.**
4. Do not use outdoors.
5. Do not let cord hang over edge of table or counter, or touch hot surfaces.
6. Do not operate any appliance with a damaged cord or plug, or after appliance has been dropped or damaged in any way. Return appliance to the nearest authorized service facility for examination, repair or electrical or mechanical adjustment.

Operation

1. Keep hands as well as spatulas and other utensils away from moving blades or discs while processing food, to prevent the possibility of severe personal injury or damage to food processor. A plastic scraper may be used, but only when the food processor motor is stopped.
2. Avoid contact with moving parts. Never push food down by hand when slicing or shredding. Always use pusher.
3. Make sure motor has completely stopped before removing cover. (If machine does not stop within 4 seconds after you remove the pusher assembly, call 1-800-472-7606 for assistance. Do not use the machine.)
4. Never store any blade or disc on the motor shaft. To reduce the risk of injury, no blade or disc should be placed on the shaft except when the bowl is properly locked in place and the processor is in use. Store blades and discs, as you would sharp knives, out of reach of children.
5. Be sure cover and feed tube are securely locked in place before operating food processor.
6. Never try to override or tamper with cover interlock mechanism.

Cleaning

To protect against risk of electrical shock, do not put base in water or other liquids.

General

1. This appliance should not be used by or near children or individuals with certain disabilities.
2. Do not operate this, or any other motor-driven appliance, while under the influence of alcohol or other substances that affect your reaction time or perception.
3. This food processor is CUL listed for household use. Use it only for food preparation as described in the accompanying recipe and instruction book. Do not use this appliance outside of its intended use.
4. The use of attachments not recommended or sold by Cuisinart may cause fire, electrical shock or personal injury, or damage to your food processor.
5. To avoid possible malfunction of work bowl switch, never store processor with pusher assembly in locked position.
6. Maximum rating of 13 amperes is based on attachment that draws greatest current. Other recommended attachments may draw significantly less current.
7. Do not operate your appliance in an appliance garage or under a wall cabinet. **When storing in an appliance garage always unplug the unit from the electrical outlet.** Not doing so could create a risk of fire, especially if the appliance touches the walls of the garage or the door touches the unit as it closes.

SAVE THESE INSTRUCTIONS FOR HOUSEHOLD USE ONLY

WARNING: RISK OF FIRE OR ELECTRIC SHOCK



The lightning flash with arrowhead symbol within an equilateral triangle is intended to alert the user to the presence of uninsulated, dangerous voltage within the product's enclosure that may be of sufficient magnitude to constitute a risk of fire or electric shock to persons.



The exclamation point within an equilateral triangle is intended to alert the user to the presence of important operating and maintenance (servicing) instructions in the literature accompanying the appliance.

SPECIAL CORD SET INSTRUCTIONS

NOTICE

A short power-supply cord is provided to reduce the risks resulting from becoming entangled in or tripping over a longer cord.

Longer extension cords are available and may be used if care is exercised in their use. If a long extension cord is used, the marked electrical rating of the extension cord must be at least as great as the electrical rating of the appliance, and the longer cord should be arranged so that it will not drape over the countertop or tabletop where it can be pulled on by children or tripped over.

NOTICE

This appliance has a polarized plug (one blade is wider than the other). To reduce the risk of electric shock, this plug will fit into a polarized outlet only one way. If the plug does not fit fully into the outlet, reverse the plug. If it still does not fit, contact a qualified electrician. Do not modify the plug in any way.

CONTENTS

Important Unpacking Instructions.....	3
Important Safeguards.....	4
Features and Benefits	6
Assembly Instructions	8
Machine Controls	9
Machine Functions	9
User Guide and Capacity Chart.....	12
Cleaning and Maintenance	16
For Your Safety.....	16
Technical Data.....	17
Troubleshooting.....	17
Warranty Information.....	19
Recipes.....	20



WARNING

RISK OF FIRE OR ELECTRIC SHOCK
DO NOT OPEN



WARNING: TO REDUCE THE RISK OF FIRE OR ELECTRIC SHOCK,

DO NOT REMOVE COVER (OR BACK)

NO USER-SERVICEABLE PARTS INSIDE

REPAIR SHOULD BE DONE BY AUTHORIZED SERVICE PERSONNEL ONLY

FEATURES AND BENEFITS

1. Die-Cast Metal Housing Base and Motor

Housing Base and Motor

With a vertically projecting motor shaft, this powerful base will process through a variety of recipes with 1300 watts of peak power.

2. Touchpad Control Panel

These easy-to-clean, electronically controlled buttons feature On, Off, Dough and Pulse options for every food processing function. The contemporary blue LED bar will indicate when the unit is powered on.

3. Work Bowls

Designed with maximum versatility, the work bowl should be selected based on task appropriateness.

These nested bowls feature SealTight® Advantage technology, which maximizes each bowl's processing capacity, ensures safe handling, and keeps all the ingredients contained in the bowl you're using. The bowls also include a locking feature to prevent them from coming out of position when pouring, and finger recesses (a) for user-friendliness.

The large and small work bowls are both made of durable material with convenient measurement markings (b), removable seal and pour spout (c).

4. Work Bowl Cover with Feed Tube

Work bowl cover with SealTight® Advantage feature allows for maximum bowl capacity during processing and pouring. To remove the work bowl cover, push in the release buttons (a) on either side of the handle interlock (b). Seal can be removed and washed in the top rack of the dishwasher or by hand.

The Supreme® Wide-Mouth feed tube (c) accommodates larger ingredients and saves precutting time.

5. Pusher Assembly

Secured with a snap-fit, the small pusher (a) inside the large pusher (b) allows you to accommodate ingredients of all sizes. The large pusher lock (c), located on the handle, enables it to be pulled out to lock and pushed in to unlock — this feature should be used when processing heavy loads.

6. Small Chopping/Mixing Blade

This small stainless steel blade will chop or mix anything in your small work bowl and features the BladeLock System, which enables the blade to stay in place to prevent leaking, while providing optimal pouring.

7. Large Chopping/Mixing Blade

Stainless steel in construction, this heavy-duty blade will process a variety of food in your large work bowl.

8. Dough Blade

Designed for our exclusive dough speed control, this blade will knead through all types of dough. The dough blade can be used only in the large bowl.

9. Adjustable Slicing Disc

The versatile disc allows for thin to thick slices with 0 to 10 mm indicators. This disc can only be used with the large bowl.

10. Reversible Shredding Disc

Provides the option of either fine or medium shredding for optimal results. This disc can only be used with the large bowl.

11. Stem Adapter

This user-friendly tool easily attaches to either disc or small chopping/mixing blade to engage the motor shaft.

12. Spatula

Uniquely designed for use with either work bowl.

13. Retractable Cord (not shown)

The retractable cord system allows you to pull as much cord as needed, and then store it back in the housing when not in use.

Note: The end of the cord is wrapped with red tape to prevent over-pulling.

14. Accessory Storage Case

This convenient storage case with safety lock holds all of the blades and discs that are included with your new food processor.

15. BPA Free (not shown)

All materials that come in contact with food or liquid are BPA free.

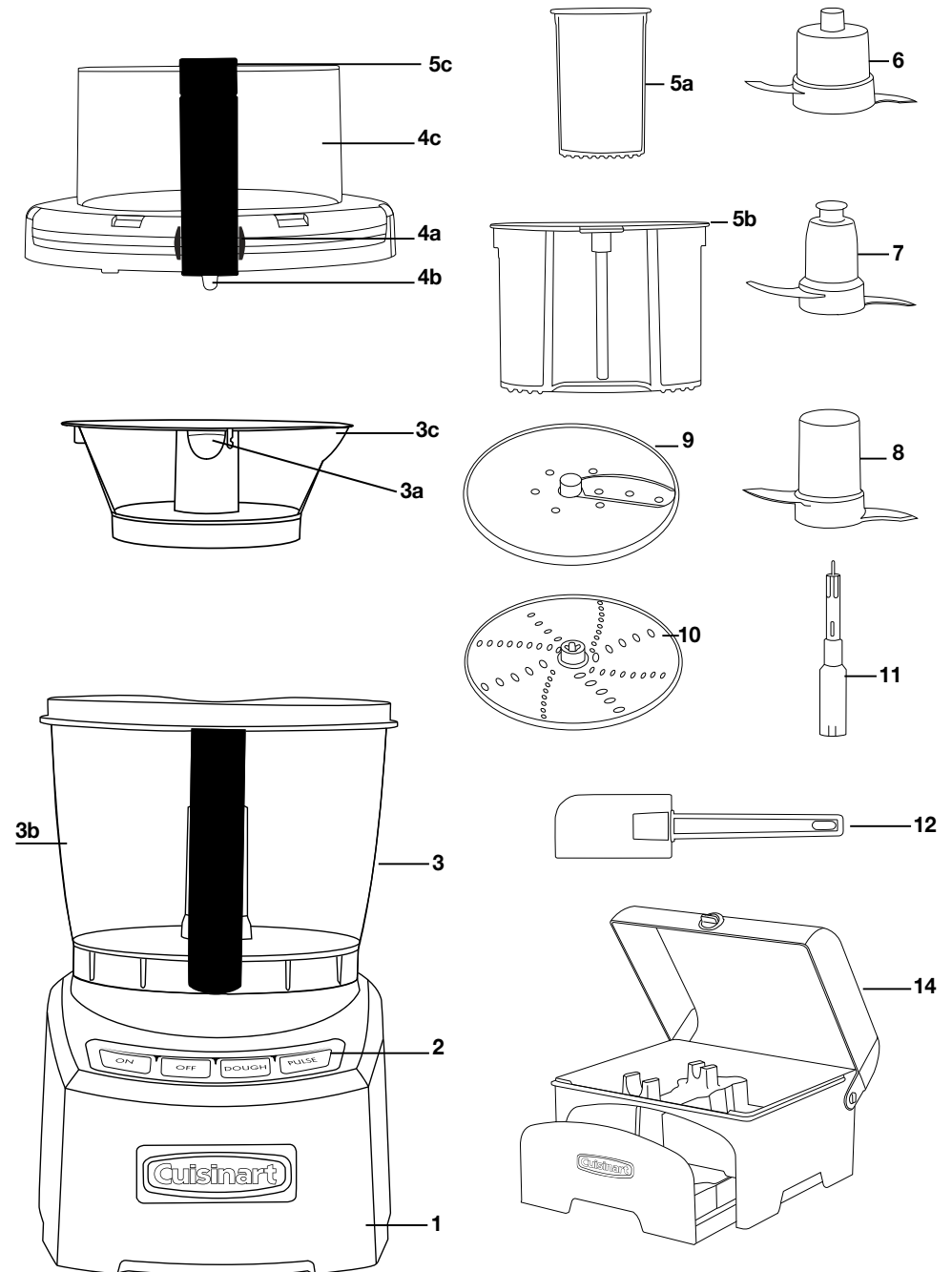

ASSEMBLY INSTRUCTIONS

Before First Use

Before using your Cuisinart® Elite Collection 2.0 14-Cup (3.5 L) Food Processor for the first time, wash the work bowls, work bowl cover, pusher assembly, blades, discs, and spatula (see Cleaning and Maintenance Instructions on page 16).

1. Place the food processor base on a dry, level countertop with the controls facing toward you. Do not plug the unit in until it is fully assembled.

Note: To use the small bowl it must be nested in the large bowl for operation.

2. With the large bowl on the base, use the handle to turn the work bowl counterclockwise to lock it onto the housing base.

To use the small bowl, place your thumbs in the finger recesses and align the large bowl with the pour spout facing opposite the handle. Push down to lock.

Large Bowl & accessories

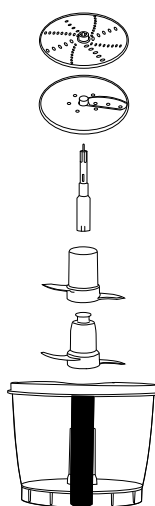

Small Bowl & accessories

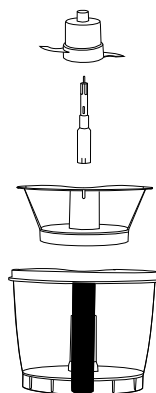

Blade Operation

The BladeLock feature is designed to keep the blade in place during processing, pouring, lifting, and handling tasks — but is not permanently attached. **Handle with care. Always check to be sure the blade is securely locked before turning the bowl upside down.**

Note: The chopping/mixing blades should not be removed with liquid contents above the hub of the blade in the bowls, as this will defeat the SealTight® system.

Large Blade Operation

With your large work bowl assembled on the base, grasp the large chopping/mixing blade by its hub, align it over the center of the bowl, place it onto the shaft and turn it until it slides into place. Firmly push down to lock. **Always check to be sure the blade is securely locked before turning the bowl upside down.** (To remove, first take the bowl off the base and put it on a flat surface. Rest the heel of your hand on the rim of the bowl and pull up gently and carefully.)

Dough Blade Operation

For use with the large bowl. Carefully lift and place the dough blade on the shaft and turn it until it slides into place.

Small Blade Operation

With both work bowls assembled on the base, position the stem adapter over the center of the bowls, place it on the shaft and turn it until it slides into place. Grasp the small chopping/mixing blade by its hub, place it on the stem adapter, turning it until it slides into place, and push down firmly to lock. **Always check to be sure the blade is securely locked before turning the bowl upside down.** (To remove, first take the bowl off the base and put it on a flat surface. Rest the heel of your hand on the rim of the bowl and pull up gently and carefully.)

Disc Operation

When using the large bowl, position the stem adapter over the center of the bowl, place it on the shaft and turn it until it slides into place. If using the adjustable slicing disc, use the rotating hub and indicator markings to select slicing thickness. Using the plastic hub, align and insert the disc over the stem adapter.

If using the reversible shredding disc, determine whether the fine or medium side will be used and use the plastic hub to twist into position on the stem adapter. The plastic hub may be used for removal of this disc.

Cover Operation

Place the work bowl cover onto the work bowl by positioning it directly over the bowls, and push down on the front and back to lock into place.



Another way to put the cover on is by latching the back on first and then pushing down on the front to lock into place. Be sure both front and back locks are fully engaged.

To remove the cover, push in both sides of the release button (located on the cover interlock) and lift up to remove.

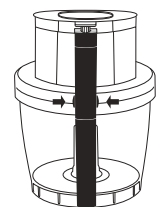

Note: The work bowl cover fits, locks and seals on the large bowl and with the nested bowl combination. The work bowl cover will become easier to engage with repeated use.

Align pusher assembly and activating rod with the feed tube opening on the work bowl cover and slide it down completely.

Plug the food processor into a proper electrical outlet. It is now ready for use.

Note: The bowl, lid and pushers must be securely in place for the unit to operate.

MACHINE CONTROLS

ON Button

The ON control is a continuous button that allows the machine to run until OFF is selected.

1. Properly assemble and engage the machine. The blue LED bar will light up.
2. Add ingredients to the work bowl, either through the feed tube or directly into the bowl.
3. Press the ON button. The blue LED bar will blink and the motor will start.
4. Press the OFF button when finished.

Pulse Button

The PULSE control is a momentary button that allows the machine to run only while it is being pressed. This capability provides more accurate control of the duration and frequency of processing. Unless otherwise specified, a pulse is about one second.

With the machine properly assembled and engaged, and ingredients in the work bowl, press the PULSE button repeatedly as needed. The blue LED bar will blink upon each activation.

Dough Button

1. Prepare the dough ingredients and place in work bowl fitted with the dough blade.
2. Assemble and engage the work bowl cover and pusher.
3. Press the DOUGH button and the blue LED bar will blink.
4. Then press the ON button to knead the dough.
5. Press the OFF button when finished.

Note: Kneading dough should only be done in the large work bowl.

WORK BOWLS

Two nested work bowls are provided for a versatile processing experience. We recommend using the work bowls in a manner that will optimize efficiency. For example, if your recipe requires using multiple bowls, begin with the small bowl to minimize cleaning. This way the small bowl can serve as a prep bowl to reserve chopped ingredients for a recipe.

Note that the bowls lock into place to pour while nested. The convenient finger recesses can be used to remove the small bowl with ingredients, or the bowls can remain nested during pouring or food removal.

Chopping certain foods may scratch or cloud the work bowl; this will not affect the functionality of your work bowl.

MACHINE FUNCTIONS

Chopping (using the Chopping Blade)

- For raw ingredients: peel, core and/or remove seeds and pits. Food should be cut into even, ½- to 1-inch (1.25 to 2.5 cm) pieces. Foods cut into same size pieces produce the most even results.

- Pulse food in 1-second increments to chop. For the finest chop, either hold the PULSE down or press ON to run the machine continuously. Watch ingredients closely to achieve desired consistency and scrape the work bowl as necessary.

Puréeing (using the Chopping Blade)

- To purée fresh fruits or cooked fruits/vegetables: Ingredients should be cut into 1-inch (2.5 cm) pieces; a smooth purée is achieved easiest when all the pieces are equal in size. Pulse to initially chop and then process ON until food is puréed; scrape the work bowl as necessary. Do not use this method to purée cooked white potatoes. (See Mashed Potatoes recipe on page 53.)
- To purée solids for a soup or sauce: Strain the solids from the liquid and process the solids alone. Add cooking liquid to process as needed.

Kneading (using the Dough Blade or the Chopping Blade with Dough Speed)

- The exclusive dough control processes pastry doughs, batters and kneads yeast bread doughs. The chopping blade is ideal for pastry doughs, while the dough blade is specifically designed for kneading yeast doughs.
- The pusher lock is recommended to be in the locked position when kneading dough to avoid it from moving around — some vibration is still normal.
- Dough kneading should be done in the large bowl only.

Slicing (using the Adjustable Slicing Disc)

- Always pack food in the feed tube evenly to slice. For smaller amounts of food, use the smaller feed tube. For cheese slicing, always use the large feed tube. The food will dictate the amount of pressure: Use light pressure for soft foods, medium pressure for medium foods, and firm pressure for harder foods. Always process with even pressure.
- For Julienne or Matchstick Cuts. Place food horizontally in the feed tube and process with even pressure to create long, plank-like slices. Place stack of slices in the small feed tube vertically and process again using even pressure. These will result in short julienne cuts.

- For round fruits or vegetables: Remove a thick slice on the bottom of the food so that it sits upright in the feed tube. If food does not fit in the feed tube, cut in half or quarters to fit. Process with even pressure.
- For small ingredients, like mushrooms, radishes or strawberries: Trim the ends so the food sits upright in the feed tube. Take advantage of the smaller feed tube if appropriate.
- When slicing cheese, be sure that the cheese is well chilled before slicing.

Shredding (using the Reversible Shredding Disc)

- Always pack food in the feed tube evenly to shred. For smaller amounts of food, use the smaller feed tube. For cheese shredding, always use the large feed tube. The food will dictate the amount of pressure: Use light pressure for soft foods, medium pressure for medium foods and firm pressure for harder foods. Always process with even pressure.
- To shred leafy vegetables like lettuce or spinach: Roll leaves together and stand up in feed tube. Process with even pressure.
- When shredding cheese, be sure that the cheese is well chilled before shredding.

ACCESSORY STORAGE CASE

Operating the Lock

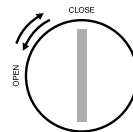

To unlock, turn counterclockwise. Gently lift up the transparent cover. Do not force the cover open when the knob is in the locked position. To lock, gently close the cover and turn the knob clockwise.

Inserting Accessories

The Accessory Storage Case houses the (A) large metal blade in the right cavity, the (B) dough blade in the back cavity, and the (C) small metal blade in the left cavity. Hold each piece carefully by the center hub. **WARNING: DO NOT TOUCH METAL BLADES, AS DOING SO MAY RESULT IN INJURY.** The (D) stem adapter fits in the long center opening. Insert the stem adapter with the thinner, plastic end toward the back.

Icons embossed on the inside surface of the Accessory Storage Case show proper placement of the blades.

The discs are housed in the drawer at the lower end of the Accessory Storage Case. The (E) reversible shredding disc gets inserted first (on either side). Then the (F) adjustable slicing disc rests over the shredding disc with the plastic hub facing up. The words “shredding” and “slicing” are printed in the drawer as a reminder of the correct disc positions.

Carefully hold discs by center hub for inserting and removing from the storage case.

WARNING: CUTTING EDGES OF FOOD PROCESSOR DISCS ARE VERY SHARP. ALWAYS KEEP FINGERS AWAY FROM SHARP SIDE.

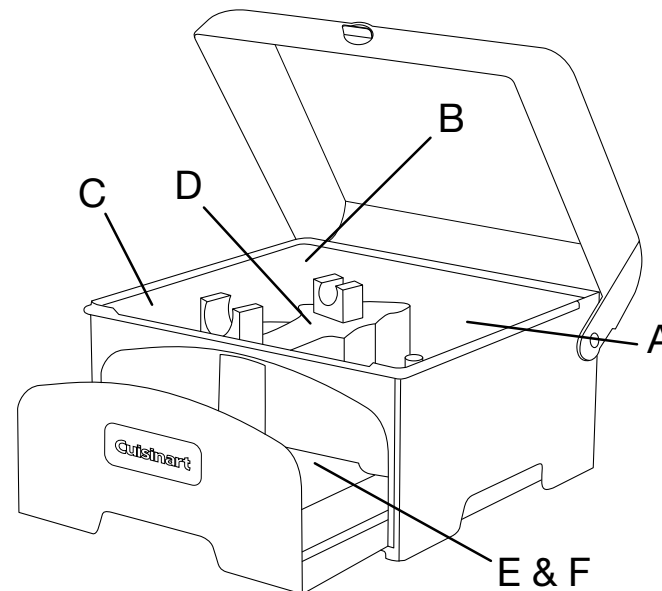

USER GUIDE & CAPACITY CHART

FOOD	TOOL	PROCESS	YIELD	DIRECTIONS
FRUITS Apples	Metal Blade	Chop	1 pound = 3 cups (750 ml)	Cut into 1-inch (2.5 cm) pieces; pulse to chop – process for fine chop. Process to purée cooked and peeled apples for applesauce. Medium pressure Medium pressure
	Metal Blade	Purée	1 pound = 3 cups (750 ml)	
	Slicing Disc Shredding Disc	Slice Shred	1 apple = ¾ cup (175 ml) 1 apple = ¾ cup (175 ml)	
Avocados	Metal Blade	Chop	1 medium = 1 cup (250 ml)	Cut into 1-inch (2.5 cm) pieces; pulse to chop. Cut into 1-inch (2.5 cm) pieces; process to purée.
	Metal Blade	Purée	1 medium = 1 cup (250 ml)	
Bananas	Metal Blade	Purée	3 medium = 1 cup (250 ml)	Process to purée ripe bananas. Light pressure for firm bananas.
	Slicing Disc	Slice	1 pound = 2 cups (500 ml)	
Berries	Metal Blade	Purée	1 pint fresh = 2 cups (500 ml); 10 ounce-bag frozen = 1½ cups (375 ml)	Process until puréed. Strain to remove seeds. Thaw frozen berries before processing. Strawberries: remove stems; stack berries on their side. Medium pressure.
	Slicing Disc	Slice	1 pint = 2 cups (500 ml)	
Coconuts	Metal Blade	Chop	1 medium = 4 cups (1 L)	Cut flesh into 1-inch (2.5 cm) pieces; pulse to chop. Process to finely chop. Cut flesh to fit feed tube, medium pressure.
	Shredding Disc	Shred	1 medium = 4 cups (1 L)	
Kiwis	Slicing Disc	Slice	2 kiwis = ¾ cup (175 ml)	Chill and peel; light pressure.
Mangoes	Metal Blade	Chop	1 medium = ¾ to 1 cup (175 ml-250 ml)	Cut into 1-inch (2.5 cm) pieces; pulse to chop. Cut into 1-inch (2.5 cm) pieces; process to purée.
	Metal Blade	Purée	1 medium = ¾ to 1 cup (175 ml-250 ml)	
Peaches/ Nectarines	Metal Blade	Chop	1 lb = 2 to 2½ cups (500-625 ml)	Cut into 1-inch (2.5 cm) pieces; pulse to chop. Cut into 1-inch (2.5 cm) pieces; peel and process to purée. Remove pit, light pressure.
	Metal Blade	Purée	1 lb = 2 to 2½ cups (500-625 ml)	
	Slicing Disc	Slice	1 lb = 2 to 2½ cups (500-625 ml)	
Citrus Fruits; Lemons, Limes & Oranges	Metal Blade	Chop	For medium fruit: 1 lemon = 2 to 3 teaspoons (10-15 ml) zest; 1 lime = 1 tsp (5 ml) zest; 1 orange = 1½ tablespoons (25 ml) zest	Zest: use vegetable peeler to remove rind; process. For the finest chopped zest, add small amount of sugar to chop with zest Trim ends; place upright in feed tube. Medium pressure.
	Slicing Disc	Slice		
Dried (sticky) Fruits	Metal Blade	Chop	1 pound = 2½ cups (625 ml)	Chill fruit. Add some flour from recipe to work bowl. Process using short pulses until desired consistency.
VEGETABLES Beans - Green, Wax	Metal Blade	Purée	1 cup (250 ml) = ½ cup (125 ml) purée	Process to purée cooked beans. "French-cut": trim beans; stack in feed tube horizontally. Light pressure.
	Slicing Disc	Slice	1 pound = 3 cups (750 ml)	
Broccoli/ Cauliflower	Metal Blade	Chop	1 pound raw = 2 cups (500 ml)	Cut into 1-inch (2.5 cm) pieces; pulse to chop. Cut into 1-inch (2.5 cm) pieces; process to purée. Peel and trim stems. Medium pressure. Peel and trim stems. Medium pressure.
	Metal Blade	Purée	1 pound cooked = 1 cup (250 ml)	
	Slicing Disc Shredding Disc	Slice Shred	Broccoli stems only Broccoli stems only	
Cabbage	Metal Blade	Chop	2 pounds = 8 cups (2 L)	Cut into 1-inch (2.5 cm) pieces; pulse to chop to desired consistency. Cut in wedges to fit feed tube; remove centre core. Light to no pressure. Use slicing disc for coleslaw. Use shredding disc for extra-fine needs.
	Slicing Disc	Slice	2 pounds = 8 cups (2 L)	
	Shredding Disc	Shred	2 pounds = 8 cups (2 L)	

FOOD	TOOL	PROCESS	YIELD	DIRECTIONS
Celery	Metal Blade	Chop	2 medium stalks = ½ cup (125 ml)	Cut into 1 inch (2.5 cm) pieces; pulse to chop to desired consistency. Trim; place upright in feed tube. Medium pressure.
	Slicing Disc	Slice	2 medium stalks = ½ cup (125 ml)	
Cucumbers	Metal Blade	Chop	1 medium = 1½ cups (375 ml)	Cut into 1-inch (2.5 cm) pieces; pulse to chop. Rounds: trim; place upright in feed tube. Medium pressure. Long slices: trim; place horizontally in feed tube. Medium pressure. Shreds: trim; place upright in feed tube. Medium pressure. Long shreds: trim; place horizontally in feed tube. Medium pressure.
	Slicing Disc	Slice	1 medium = 1½ cups (375 ml)	
	Shredding Disc	Shred	1 medium = 1½ cups (375 ml)	
Garlic	Metal Blade	Chop	1 head = 12 to 16 cloves; 1 medium clove = ½ teaspoon (2 ml)	Peel; with machine running, drop cloves through feed tube to finely chop.
Ginger	Metal Blade	Chop	1-inch (2.5 cm) pieces = 1 tablespoon (15 ml)	Peel; cut into ½-inch (1.25 cm) pieces. With machine running, drop through feed tube to finely chop. Peel; place upright in feed tube. Medium pressure. Peel; place upright in feed tube. Medium pressure.
	Slicing Disc Shredding Disc	Slice Shred	4 ounces = ½ cup (125 ml) 4 ounces = ½ cup (125 ml)	
Herbs - Fresh	Metal Blade	Chop	1 cup (250 ml) loosely packed = ⅓ cup (75 ml)	Herbs, work bowl and blade should be clean and completely dry. Pulse to roughly chop. Process to finely chop. Keep up to 10 days in airtight bag in refrigerator.
Jalapeño	Metal Blade	Chop	1 medium pepper = 3 tablespoons (45 ml)	Remove seeds and stem. With machine running, drop halved pepper through feed tube to chop. Remove seeds and stem. Cut stem end flat to slice into rings; medium pressure. Place upright in feed tube for narrow slices, horizontally for longer slices.
	Slicing Disc	Shred	1 medium pepper = ¼ cup (50 ml)	
Leeks	Metal Blade	Chop	1 pound = 2 cups (500 ml)	Clean leeks; trim, discard dark green parts. Cut into 1-inch (2.5 cm) pieces; pulse to chop. Clean leeks as above. Place upright in feed tube; medium pressure. Long slices: trim; place lengthwise in feed tube. Medium pressure.
	Slicing Disc	Slice	1 pound = 2 cups (500 ml)	
Mushrooms	Metal Blade	Chop	1 pound = 6 cups (1.5 L)	Cut into even pieces; pulse to chop. Pack feed tube. Light pressure. Pack feed tube. Light pressure.
	Slicing Disc	Slice	1 pound = 5 cups (1.25 L)	
	Shredding Disc	Shred	1 pound = 5 cups (1.25 L)	
Onions	Metal Blade	Chop	1 pound = 4½ to 5 cups (1.1-1.25 L)	Cut into 1-inch (2.5 cm) pieces; pulse to chop. Trim; place in feed tube. Medium pressure.
	Slicing Disc	Slice	1 medium = ¾ to 1 cup (175-250 ml)	
Peppers - Bell	Metal Blade	Chop	1 pound = 4½ to 5 cups (1.25 L)	Cut into 1-inch (2.5 cm) pieces; pulse to chop. Remove seeds and stem. Cut stem end flat to slice into rings; medium pressure. Halve or quarter and place upright in feed tube for narrow slices, horizontally for longer slices.
	Slicing Disc	Slice	1 pound = 3 cups (750 ml)	
Pickles	Metal Blade Slicing Disc	Chop Slice	1 medium = ¾ cup (175 ml) 1 medium = ¾ cup (175 ml)	Cut into 1-inch (2.5 cm) pieces; pulse to chop. Place upright in feed tube for rounds; horizontally for longer slices. Medium pressure.

FOOD	TOOL	PROCESS	YIELD	DIRECTIONS
Potatoes	Metal Blade Metal Blade Slicing Disc Shredding Disc	Chop Purée Slice Shred	1 pound = 3½ to 4 cups (875 ml-1 L) 1 cup (250 ml) cooked (1-inch (2.5 cm) pieces) = ½ cup (125 ml) 1 pound = 3½ to 4 cups (875 ml-1 L) 1 pound = 3½ to 4 cups (875 ml-1 L)	Raw potatoes: cut into 1-inch (2.5 cm) pieces; pulse to chop. Sweet potatoes/yams: cut into 1-inch (2.5 cm) pieces; pulse to chop. Trim end flat; cut to fit into feed tube. Light to medium pressure for white potatoes; firm pressure for sweet potatoes/yams; light pressure for partially cooked potatoes. Trim end flat; cut to fit into feed tube. Light to medium pressure for white potatoes. Note: keep sliced or shredded raw potatoes in cold water to avoid discoloration; dry well before using. Mashed potatoes: process cooked white potatoes through medium shredding disc to avoid a gluey consistency.
Carrots	Metal Blade Metal Blade Slicing Disc Shredding Disc	Chop Purée Slice Shred	1 pound (6 med) = 3 cups (750 ml) 2 med cooked = ½ cup (125 ml) purée 1 pound (6 med) = 3 cups (750 ml) 1 pound (6 med) = 2½ cups (625 ml)	Cut into 1-inch (2.5 cm) pieces; pulse to chop to desired consistency. Process to purée. Small rounds: trim; place upright in feed tube. Long slices: trim; place horizontally in feed tube. Medium to firm pressure. Small shreds: trim; place upright in feed tube. Long shreds: trim; place horizontally in feed tube. Medium to firm pressure.
Egg Whites	Metal Blade	Chop	8 egg whites = 1 cup (250 ml) firm whites	Egg whites should be room temperature; add 1 teaspoon (5 ml) lemon juice or vinegar per white. Process in an absolutely clean bowl for 1 to 2½ minutes until surface develops ridges and mass of whites almost stops moving. These egg whites should not be used in meringues. For whipped egg whites with volume, whip with whisk or electric mixer.
Meat, Poultry & Fish	Metal Blade Metal Blade Slicing Disc	Chop Purée Slice	2¼ pound boneless = 4½ cups (1 L) 1 pound boneless = 2 cups (500 ml) 1 pound boneless = 2 cups (500 ml)	Cut <i>very</i> cold raw or cooked meat/poultry/fish into 1-inch (2.5 cm) pieces; pulse to chop. Process for a few seconds at a time for a finer chop. Check texture often to avoid overprocessing. Cut <i>very</i> cold raw or cooked meat/poultry/fish into 1-inch (2.5 cm) pieces; pulse to chop. Process continuously until desired texture. Slicing cooked meat/poultry: be sure it is <i>very</i> cold. Use a single chunk of meat at a time. Slicing raw meat/poultry: cut to fit feed tube; wrap in plastic to briefly freeze. Raw meat is ready to slice when hard to the touch but can easily be pierced with tip of a sharp knife.
Milk Shakes/Smoothies	Metal Blade	Chop/ Purée	Can make up to 16 8-ounce (227 g) servings.	Milkshakes: add ice cream first; process and add milk through feed tube. Smoothies: add fruit first, then add the liquid while processing.

FOOD	TOOL	PROCESS	YIELD	DIRECTIONS
Nuts	Metal Blade Metal Blade Slicing Disc Shredding Disc	Chop Purée Slice Shred (fine/med.)	¾ pound = 3 cups (750 ml) ¼ pound = 1 cup (250 ml) ¼ pound = 1 cup (250 ml) ¼ pound = 1 cup (250 ml)	Pulse to chop. Hardness of nut dictates amount and time of processing. If either flour or sugar is added to nuts during processing, they can be processed as long as possible without becoming butter. Coarsely chopped nuts: 6 to 8 pulses. Finely chopped nuts: pulse 2 to 3 times, then process 20 to 30 seconds, watching carefully for desired consistency. Nut butter: process nuts 2 to 3 minutes, scraping bowl as necessary. For smoothest consistency, add some oil to nuts while processing. Medium pressure; nuts will have a coarse texture. Medium pressure; nuts will have a fine/medium texture.
Granulated Sugar (to make extra super-fine sugar)	Metal Blade	Chop	1 pound = 2 cups (500 ml)	Process 1 minute, or until fine.
Tofu	Metal Blade	Purée	10 ounces = ¾ cup (175 ml)	Drain; process 2 minutes or until smooth.
Whipping Cream	Metal Blade	Chop	1 cup (250 ml) = ½ cup (125 ml) whipped	Process well-chilled cream until cream begins to thicken. Add sugar as desired; process continuously until cream reaches desired consistency (about 3 to 4 minutes).
DOUGHS Pastry Dough	Metal Blade	Mix		Pulse mixture until it has consistency between cornmeal and small pebbly crumbs. Add water, 1 tablespoon (15 ml) at a time; pulse until a dough forms.
Batters Quick Bread, Cake & Cookies	Metal Blade	Mix		First sift dry ingredients together by processing; remove and reserve. Process the fats and sugars together and then add any remaining liquid ingredients. Pulse in reserved dry ingredients. Any ingredients that need to be coarsely chopped can be added with dry ingredients. For finely chopped ingredients, chop separately in small work bowl and then add to batter at the end.
Yeast Dough Breads	Metal Blade Dough Blade	Mix Knead		TIPS: Use ¾ cup (175 ml) warm liquid to proof 2¼ teaspoons (11.25 ml) dry active yeast. Sugar/honey aids in activating yeast, so add a small amount, about 1 teaspoon (5 ml), to the warm liquid/yeast mixture when proofing. Food processor can handle up to 6 cups (1.5 L) white flour for a yeast bread dough. The dough should have a soft, pliable texture and feel only slightly tacky.*
Sweet Dough Breads & Coffee Cakes	Metal Blade Dough Blade	Mix Knead		See TIPS above, but keep in mind that sweet doughs will be rich and sticky and may not clean sides of bowl; bowl may need to be scraped. Sweet doughs require less kneading once the ingredients are mixed.*

Note: Use dough blade for kneading dough in the large bowl only. The small bowl may not be used for dough.

* See troubleshooting for additional direction and techniques.

CLEANING AND MAINTENANCE

Keep your Cuisinart® Elite Collection 2.0 14-Cup Food Processor ready to use on the kitchen counter. When not in use, leave it unplugged.

This food processor includes a storage case with lock for safekeeping of blades and discs. Keep the blades and discs out of the reach of children.

All parts except the housing base are dishwasher safe, and we recommend washing them in the dishwasher on the **top rack only**. Due to intense water heat, washing the work bowl, cover and accessories on the bottom rack may cause damage over time. Insert the cover with the feed tube facing up to ensure proper cleaning. (Note: The seal is removable for dishwashing or hand-washing.) Insert the work bowl and pushers upside down for drainage. Remember to unload the dishwasher carefully wherever you place sharp blades and discs.

To simplify cleaning, rinse the work bowl, cover, seal, pusher assembly and blade or disc immediately after use so food won't dry on them. Be sure to place the pushers upside down for drainage. If food lodges in the pusher, remove it by running water through it, or use a bottle brush.

If further cleaning of the cover is necessary after dishwashing or hand-washing, remove the seal and run faucet water pressure directly through the holes in the cover.

If you wash blades and discs by hand, do it carefully. When handling, use the plastic hubs on the blades and discs. Avoid leaving them in soapy water where they may disappear from sight. To clean the metal blade, fill the work bowl with soapy water, hold the blade by its plastic center and move it rapidly up and down on the center shaft of the bowl. Use of a spray attachment is also effective. If necessary, use a brush.

The work bowls are made of durable plastic that is shatter resistant and heat resistant. They should not be placed in a microwave oven.

The housing base may be wiped clean with a soapy, nonabrasive material. Be sure to dry once clean.

Four rubber feet on the underside keep the base from moving on most work surfaces when the machine is processing heavy loads. If the feet leave spots on the counter, spray them with a spot remover and wipe with a damp sponge. If any trace of the spot remains, repeat the procedure and wipe the area with a damp sponge and nonabrasive cleaning powder.

The Accessory Storage Case is made of a high-impact plastic that has a smooth, easy-to-clean surface. Occasionally, wipe your Accessory Storage Case with a cloth or sponge that has been dipped in warm, soapy water. To remove stubborn spots, use a mild soap solution, then wipe with a damp sponge. **Do not put the Accessory Storage Case in the dishwasher.** Blades, stem adapter and discs should always be clean when they are put into the Accessory Storage Case. The Accessory Storage Case is not meant for temporary storage of soiled blades between periods of use.

IMPORTANT: Never store any blade or disc on the motor shaft. No blade or disc should be placed on the shaft except when the processor is about to be used.

MAINTENANCE: Any other servicing should be performed by an authorized service representative.

FOR YOUR SAFETY

Like all powerful electrical appliances, a food processor should be handled with care. Follow these guidelines to protect yourself and your family from misuse that could cause injury.

Handle and store metal blades and discs carefully. Their cutting edges are very sharp.

Always place the stem adapter on the motor shaft before assembling the discs.

Never put blades or discs on the motor shaft until the work bowl is locked in place.

Always be sure that the blade or disc is down on the motor shaft as far as it will go.

Always insert chopping blade and dough blade in the work bowl before putting ingredients in bowl.

When slicing or shredding food, always use the pusher. Never put your fingers or spatula into feed tube.

Always wait for the blade or disc to stop spinning before you remove the pusher assembly or cover from the work bowl.

Always unplug the unit before removing food, cleaning, or putting on or taking off parts.

Always remove work bowl from base of machine before you remove chopping blade or dough blade.

TECHNICAL DATA

The motor in your food processor operates on standard line operating current. The appropriate voltage and frequency for your machine are shown on a label on the bottom of the base.

An automatic, temperature-controlled circuit breaker in the motor ensures complete protection against motor burnout. If the processor runs for an exceptionally long time when chopping, mixing or kneading a thick or heavy mixture in successive batches, the motor may overheat. If this happens, the processor will stop. Turn it off and wait for the motor to cool before proceeding. It will usually cool within 10 minutes. In extreme cases, it could take up to an hour. Safety switches prevent the machine from operating when the work bowl or the cover is not locked into position. The motor stops within seconds when the motor is turned off; and when the pusher assembly is removed, a fast-stop circuit also enables the motor to stop within seconds. Cuisinart offers a Limited Three-Year Warranty on the entire machine.

TROUBLESHOOTING

Food Processing

- Problem:** The food is unevenly processed.
Solution:
 - The ingredients should be cut evenly into ½- to 1-inch (1.25 to 2.5 cm) pieces before processing.
 - Process in batches to avoid overloading.
- Problem:** Slices are uneven or slanted.
Solution:
 - Place evenly cut food into the feed tube.
 - Apply even pressure on the pusher.
- Problem:** Food falls over in feed tube.
Solution:
 - Large feed tube must be packed full for best results. If processing smaller quantities, use the small feed tube.
- Problem:** Some food remains on top of the disc.
Solution:
 - It is normal for small pieces to remain; cut remaining bits by hand and add to processed ingredients.

Dough Processing

- Problem:** Motor slows down.
Solution:
 - Amount of dough may exceed maximum capacity of your food processor. Remove half and process in two batches.

- Problem:** Dough may be too wet (see number 9). If motor speeds up, continue processing. If not, add more flour, 1 tablespoon (15 ml) at a time, until the motor speeds up. Process until dough cleans the sides of the work bowl.
- Problem:** Blade doesn't incorporate ingredients.
Solution:
 - Always start the food processor before adding liquid. Add liquid in a slow, steady stream, allowing the dry ingredients to absorb it. If too much liquid is added, wait until ingredients in the work bowl have mixed, then add remaining liquid slowly (do not turn off the machine). Pour liquid onto dough as it passes under feed tube opening; do not pour liquid directly onto bottom of the work bowl.
- Problem:** Blade rises in work bowl.
Solution:
 - Blade may not have been pushed down into the lock position before starting the process.
 - Excessively sticky dough can cause blade to rise. Reinsert blade and immediately add 2 tablespoons (30 ml) of flour through the feed tube while the machine is running.
- Problem:** The large pusher moves when processing dough or other heavy loads.
Solution:
 - The pusher lock feature, located above the handle, should be pulled out (some vibration is normal).
- Problem:** Dough doesn't clean inside of the work bowl.
Solution:
 - Amount of dough may exceed maximum capacity of your food processor. Remove half and process in two batches.
 - Dough may be too dry (see number 8).
 - Dough may be too wet (see number 9).
- Problem:** Nub of dough forms on top of blade and does not become uniformly kneaded.
Solution:
 - Stop machine, carefully remove dough, divide it into 3 pieces and redistribute them evenly in the work bowl.
- Problem:** Dough feels tough after kneading.
Solution:
 - Divide dough into 2 or 3 pieces and redistribute evenly in bowl. Process 10 seconds or until uniformly soft and pliable.

8. **Problem:** Dough is too dry.

Solution:

- While machine is running, add water, 1 tablespoon (15 ml) at a time, until dough cleans the inside of the bowl.

9. **Problem:** Dough is too wet.

Solution:

- While machine is running, add flour, 1 tablespoon (15 ml) at a time, until dough cleans the inside of the bowl.

Technical

1. **Problem:** The motor does not start.

Solution:

- There is a safety interlock to prevent the motor from starting if it is not properly assembled. Make sure the work bowl and work bowl cover are securely locked into position.
- If you are slicing or shredding and the above solution does not work, make sure that the food contents in the feed tube are cut below the maximum fill line so that activation rod can engage the motor.
- If the motor still will not start, check the power cord and outlet.

2. **Problem:** The food processor shuts off during operation.

Solution:

- The cover may have become unlocked; check to make sure it is securely in position.
- A safety protector in the motor prevents the motor from overheating, which is caused by excessive strain. Press the Off control button and wait 10 to 15 minutes to allow the food processor to cool off before resuming.

3. **Problem:** The food processor cover becomes unlatched in the back and/or makes a loud noise.

Solution:

- The back of the cover becoming unlatched, and any related noise, will not prevent the unit from working. Simply push down to lock the back into position.

4. **Problem:** The motor slows down during operation.

Solution:

- This is normal as some heavier loads (e.g., slicing/shredding cheese) may require the motor to work harder. Simply reposition the food in the feed tube and try again.
- The maximum load capacity may have been exceeded. Remove some of the ingredients and continue processing.

5. **Problem:** It is difficult to remove the chopping/mixing blade from the work bowl.

Solution:

- These innovative blades have been designed to lock in the work bowl to prevent them from falling out when emptying the contents of the bowl. Using extreme care, use a little extra force to remove the blade.

6. **Problem:** The food processor vibrated/moved around the countertop during processing.

Solution:

- Make sure the rubber feet at the bottom of the unit are clean and dry. Also make sure that the maximum load capacity is not being exceeded.
- This is normal as some heavier loads (e.g., slicing/shredding cheese) may require the motor to work harder.

7. **Problem:** The large pusher falls out when the cover is turned upside down.

Solution:

- The pusher lock feature, located above the handle, should be pulled out.

WARRANTY

FULL TWENTY-YEAR MOTOR WARRANTY

LIMITED THREE-YEAR WARRANTY

We warrant that this Cuisinart product will be free of defects in material or workmanship under normal home use for 3 years from the date of original purchase. This warranty covers manufacturer's defects including mechanical and electrical defects. It does not cover damage from consumer abuse, unauthorized repairs or modifications, theft, misuse, or damage due to transportation or environmental conditions. Products with removed or altered identification numbers will not be covered.

This warranty is not available to retailers or other commercial purchasers or owners. If your Cuisinart product should prove to be defective within the warranty period, we will repair it or replace it if necessary. For warranty purposes, please register your product online at www.cuisinart.ca to facilitate verification of the date of original purchase and keep your original receipt for the duration of the limited warranty. This warranty excludes damage caused by accident, misuse or abuse, including damage caused by overheating, and it does not apply to scratches, stains, discoloration or other damage to external or internal surfaces that does not impair the functional utility of the product. This warranty also expressly excludes all incidental or consequential damages.

Your Cuisinart product has been manufactured to the strictest specifications and has been designed for use only in 120 volt outlets and only with authorized accessories and replacement parts. This warranty expressly excludes any defects or damages caused by attempted use of this unit with a converter, as well as use with accessories, replacement parts or repair service other than those authorized by Cuisinart.

If the appliance should become defective within the warranty period, do not return the appliance to the store. Please contact our Customer Service Centre:

Toll-free phone number:
1-800-472-7606

Address:

Cuisinart Canada
100 Conair Parkway
Woodbridge, Ont. L4H 0L2

Email: consumer_Canada@conair.com

Model: FP-14NC Series

To facilitate the speed and accuracy of your return, please enclose:

- \$10.00 for shipping and handling of the product (cheque or money order) to Cuisinart Canada
- Return address and phone number
- Description of the product defect
- Product date code*/copy of original proof of purchase
- Any other information pertinent to the product's return

* Product date code can be found on the underside of the base of the product. The product date code is a 4 or 5 digit number. Example, 90630 would designate year, month & day (2009, June 30th).

Note: We recommend you use a traceable, insured delivery service for added protection. Cuisinart will not be held responsible for in-transit damage or for packages that are not delivered to us.

To order replacement parts or accessories, call our Customer Service Centre at 1-800-472-7606.

For more information, please visit our website at www.cuisinart.ca

RECIPES

To help your Cuisinart® Elite Collection 2.0 14-Cup (3.5 L) Food Processor feel right at home in your kitchen, we've assembled a variety of delicious recipes to get you started, from quick and easy to more complex gourmet dishes. Breakfast and brunch through dinner and dessert, these easy-to-follow recipes make sure every meal is covered.

Look for the chef's whisks above the ingredients for the degree of difficulty (1=easy, 2=medium, 3=challenging), and the convenient clock icons that point you to each recipe's time commitment so you can allocate your time accordingly.

In addition, the detailed nutritional information lets you know exactly what you're eating! Bon appétit!

BASICS

Basic Fresh Breadcrumbs 23

BUTTERS

Gorgonzola Butter 24

Peanut Butter 24

MARINADES & DRESSINGS

Sweet and Sour Marinade 25

Herbed Vinaigrette 25

Basic Mayonnaise 26

SAUCES

Basil Pesto 27

Simple Tomato Sauce 28

Hollandaise Sauce 29

Tartar Sauce 29

DOUGHS

Pizza Dough 30

Pasta Dough 31

Basic Flaky Pastry Dough 32

Pâte Brisée 33

Pâte Sucrée 34

BREAKFAST & BRUNCH

Traditional Scones 35

Leek, Sausage and Fontina Quiche 36

APPETIZERS

Artichoke and Herb Yogurt Dip 37

Chunky Guacamole 38

Hummus 39

Three-Tomato Salsa 40

Classic Bruschetta 41

Caramelized Onion, Steak and Gruyère Quesadillas 42

SOUPS

Lightened Broccoli and Potato Soup 43

Tomato Soup 44

Roasted Butternut Squash Soup 45

French Onion Soup 46

SALADS

Chopped Salad 47

Classic Coleslaw 48

ENTRÉES

Eggplant Parmesan 49

Classic Meatballs 50

Crab Cakes 51

SIDES

Stuffed Roasted Peppers 52

Mashed Potatoes 53

BREADS

Classic White Bread 54

Classic Wheat Bread 55

Sesame Dinner Rolls 56

Popovers 57

DESSERTS

Classic Cheesecake & Graham Cracker Crust	58-59
Apple Crumb Pie & Crumb Pie Topping	59-60
Banana Cream Pie & Chocolate Cookie Crust	60-61
Pastry Cream	62
Deep Chocolate Layer Cake	63
Dessert Crêpes with Berries	64
Raspberry Sauce	65

BASIC FRESH BREADCRUMBS

There is no need to buy breadcrumbs when you can make them in no time with your Cuisinart® Food Processor.



8 SLICES WHITE BREAD

Makes 1½ cups (325 ml)

⌚ Approximate preparation time: Less than one minute, plus 35 minutes for baking

Preheat oven to 325°F (160°C). Bake slices of bread in a single layer for about 20 minutes or until bread is completely dried out.

Insert the large metal chopping blade into the large work bowl of the Cuisinart® Food Processor. Break toasted bread up into pieces and pulse about 10 times and then process until breadcrumbs are fine, about 25 seconds.

TIP: For seasoned breadcrumbs, add ¼ teaspoon (1 ml) each dried oregano, dried basil, garlic powder, and ground onion flakes.

Nutritional information per serving [2 tablespoons (30 ml)]:

Calories 60 (11% from fat) | carb. 11g | pro. 2g | fat 1g | sat. fat 0g | chol. 0mg | sod. 90mg | calc. 10mg | fiber 1g

Trademarks or service marks of their respective owners.

GORGONZOLA BUTTER

All of these butters are a tastier alternative to store-bought brands.



- 8 TABLESPOONS [½ CUP (125 ML); 1 STICK] UNSALTED BUTTER, ROOM TEMPERATURE
- ¼ CUP (50 ML) GORGONZOLA, CRUMBLED
- PINCH FRESHLY GROUND BLACK PEPPER

Makes 1 roll compound butter, 16 slices

⌚ Approximate preparation time: 5 minutes

Insert the large metal chopping blade into the large work bowl of the Cuisinart® Food Processor. Add the butter and Gorgonzola and process for 60 seconds until smooth, scraping the bowl as necessary.

Remove butter from bowl and place on a sheet of waxed paper. With the aid of the paper, form the butter into a log. Roll and wrap well in plastic. Butter can either be refrigerated or frozen.

Nutritional information per serving [1 tablespoon (15 ml)]:

Calories 52 (96% from fat) | carb. 0g | pro. 0g | fat 6g | sat. fat 4g | chol. 16 mg | sod. 5mg | calc. 2mg | fiber 0g

PEANUT BUTTER



- 5 CUPS (1.25 L) DRY ROASTED PEANUTS

Makes 2½ cups (625 ml)

⌚ Approximate preparation time: 4½ minutes

Insert the large metal chopping blade into the large work bowl of the Cuisinart® Food Processor. Pulse peanuts about 10 times and then process until drops of oil are visible and the mixture is very smooth, about 4½ minutes.

TIP: Any nut can be substituted in this recipe.

Nutritional information per serving [1 tablespoon (15 ml)]:

Calories 100 (71% from fat) | carb. 4g | pro. 4g | fat 9g | sat. fat 1g | chol. 0mg | sod. 1mg | calc. 9mg | fiber 1g

SWEET AND SOUR MARINADE

This marinade pairs well with poultry and pork.



- 4 GARLIC CLOVES
- ½ CUP (125 ML) DARK CORN SYRUP
- ½ CUP (125 ML) EXTRA VIRGIN OLIVE OIL
- ½ CUP (125 ML) BALSAMIC VINEGAR
- 1 TABLESPOON (15 ML) PLUS 1 TEASPOON (5 ML) PAPRIKA
- 2 TEASPOONS (10 ML) DRY MUSTARD POWDER
- 2 TEASPOONS (10 ML) DRIED THYME
- 1 TEASPOON (5 ML) CHILI POWDER
- 1 TEASPOON (5 ML) KOSHER SALT

Makes 1 cup (250 ml)

⌚ Approximate preparation time: 5 minutes

Insert the small metal chopping blade into the small work bowl of the Cuisinart® Food Processor. Add the garlic and process to finely chop. Add the remaining ingredients. Process again until well mixed, about 45 seconds.

Nutritional information per serving [1 tablespoon (15 ml)]:

Calories 97 (62% from fat) | carb. 10g | pro. 0g | fat 7g | sat. fat 1g | chol. 0mg | sod. 152mg | calc. 4mg | fiber 0g

HERBED VINAIGRETTE

A classic vinaigrette –
toss with mixed greens or drizzle over grilled chicken.



- ¼ CUP (50 ML) RED WINE VINEGAR
- 1 TEASPOON (5 ML) DIJON-STYLE MUSTARD
- ¼ CUP (50 ML) FRESH PARSLEY
- ½ TEASPOON (2 ML) DRIED BASIL
- ½ TEASPOON (2 ML) DRIED THYME
- ½ TEASPOON (2 ML) DRIED MARJORAM
- ½ TEASPOON (2 ML) KOSHER SALT
- ¼ TEASPOON (1 ML) GROUND WHITE PEPPER
- ¾ CUP (175 ML) EXTRA VIRGIN OLIVE OIL

Makes 1 cup (250 ml)

⌚ Approximate preparation time: 5 minutes

Insert the small metal chopping blade into the small work bowl of the Cuisinart® Food Processor. Add the vinegar, mustard, parsley and remaining herbs and spices and process to combine. With machine running, slowly pour the olive oil through the feed tube until all ingredients are homogenous, about 45 to 60 seconds.

TIP: Dressing can easily be increased – use the large work bowl depending on the amount of dressing desired.

Nutritional information per serving [1 tablespoon (15 ml)]:

Calories 91 (99% from fat) | carb. 0g | pro. 0g | fat 11g | sat. fat 2g | chol. 0mg | sod. 76mg | calc. 2mg | fiber 0g

BASIC MAYONNAISE

Taste the difference in homemade mayonnaise.



- 2 **LARGE EGG YOLKS***
- ¼ **TEASPOON (1 ML) KO-SHER SALT**
- 1 **TABLESPOON (15 ML) DIJON-STYLE MUSTARD**
- 1 **TEASPOON (5 ML) FRESH LEMON JUICE OR WHITE WINE VINEGAR**
- 1 TO 1½ **CUPS (250-375 ML) VEGETABLE OR CANOLA OIL**

Makes about 1½ cups (375 ml)

 Approximate preparation time: 5 to 10 minutes

Insert the large metal chopping blade into the large work bowl of the Cuisinart® Food Processor. Process the egg yolks, salt, mustard and lemon juice until smooth, about 30 seconds.

With the machine running, very gradually drizzle the oil through the feed tube until mixture thickens. (Adding the oil through the drizzle hole located in the feed tube pusher will yield best results.) Taste and adjust seasoning accordingly.

For fresh herb mayonnaise: process ⅓ cup (75 ml) firmly packed fresh herbs (i.e., parsley, dill, tarragon, basil, etc.), stems removed, with the yolks before adding the oil.

* Raw egg warning:

Caution is suggested in consuming raw and lightly cooked eggs due to the slight risk of salmonella or other food-borne illness. To reduce this risk, we recommend you use only fresh, properly refrigerated, clean, grade A or AA eggs with intact shells, and avoid contact between the yolks or whites and the shell.

For lower-cholesterol mayonnaise, and to avoid using raw eggs, Egg Beaters® may be substituted for the egg yolks.

Nutritional information per serving [1 tablespoon (15 ml)]:

Calories 85 (98% from fat) | carb. 0g | pro. 0g | fat 10g | sat. fat 1g | chol. 17mg | sod. 38mg | calc. 2mg | fiber 0g

BASIL PESTO

If you have other herbs or nuts, use them in place of some of the basil and pine nuts.



- 4 **OUNCES (115 G) REGGIANO PARMIGIANO CHEESE, CUT INTO ½-INCH (1.25 CM) CUBES**
- 4 **GARLIC CLOVES**
- ¾ **CUP (175 ML) PINE NUTS OR WALNUTS, LIGHTLY TOASTED**
- 6 **CUPS (1.5 L) TIGHTLY PACKED FRESH BASIL LEAVES, UNBLEMISHED (ABOUT 20 OUNCES)**
- ½ TO ¾ **TEASPOON (2 ML- 3.75 ML) KOSHER OR SEA SALT**
- ⅓ TO ¾ **CUP (175-250 ML) EXTRA VIRGIN OLIVE OIL**

Makes about 2½ cups (625 ml)

 Approximate preparation time: 5 minutes

Insert the large metal chopping blade into the large work bowl of the Cuisinart® Food Processor. With the machine running, drop the cheese and garlic through the small feed tube to process until finely chopped, about 30 seconds. Add the nuts and pulse to chop, about 5 to 6 pulses. Add the basil leaves and pulse to chop, 10 to 15 times; scrape the bowl. Add the salt. With the machine running, add the olive oil in a slow, steady stream through the small feed tube, processing until combined and emulsion is formed, about 1 minute. Scrape the work bowl.

To store the pesto, transfer to a glass jar or bowl, tap to remove all air bubbles, even out the surface. Float a layer of olive oil on top; cover with plastic wrap and refrigerate. The pesto will keep for 5 days in the refrigerator, or it may be frozen.

Nutritional information per serving [1 tablespoon (15 ml)]:

Calories 51 (87% from fat) | carb. 1g | pro. 1g | fat 5g | sat. fat 1g | chol. 1mg | sod. 88mg | calc. 34mg | fiber 0g

SIMPLE TOMATO SAUCE

A simple marinara sauce for pasta, or when reduced, a tasty topping for homemade pizzas.



- 1 **SMALL ONION (ABOUT 4 OUNCES (115 G)), CUT INTO 1-INCH (2.5 CM) PIECES**
- 1½ **TABLESPOON (25 ML) EXTRA VIRGIN OLIVE OIL**
- 6 **GARLIC CLOVES**
- 1 **TEASPOON (5 ML) DRIED OREGANO**
- 1 **CAN (35 OUNCES) PLUM TOMATOES, WITH JUICES**
- 2 **SPRIGS FRESH BASIL (10 TO 12 LARGE LEAVES)**
- ¼ **CUP (50 ML) DRY WHITE WINE**
- ½ **TEASPOON (2 ML) KOSHER SALT**
- ¼ **TEASPOON (1 ML) FRESHLY GROUND BLACK PEPPER**
- ½ TO 1 **TEASPOON (2-5 ML) RED PEPPER FLAKES (OPTIONAL, TO TASTE, FOR A SPICIER SAUCE)**

Makes 4 cups (1 L) tomato sauce for pasta / 2½ cups (625 ml) tomato sauce for pizza.

Approximate preparation time: 10 to 15 minutes, plus 1 hour cooking (cook an additional 40 minutes to make the reduced pizza sauce)

Insert the large metal chopping blade into the large work bowl of the Cuisinart® Food Processor. Add the onion and pulse to chop, about 10 times. Put the olive oil into a 6-quart saucepan over medium heat. When the oil shimmers across the pan, add the onion. With the processor running, drop the garlic through the feed tube to chop. Add the garlic and oregano to the pan. Cook until onion is softened and the garlic is fragrant. While the onion mixture is cooking, add the tomatoes to the work bowl and pulse to chop. Add the tomatoes to the pan with the basil, wine and salt. Bring to a boil and then reduce the heat to low; cover the pan loosely and simmer for 50 to 60 minutes. Turn off the heat and let cool in the pan for 10 minutes. Stir in the black pepper and optional red pepper flakes. Taste and adjust seasoning accordingly.

If you would like a sauce for pizza, continue to simmer, uncovered, for 40 additional minutes to reduce, stirring now and then. Transfer the reduced sauce to a bowl to cool before using as a pizza topping.

This sauce freezes well.

Nutritional information per serving [½ cup (125 ml)]:

Calories 46 (22% from fat) | pro. 2g | carb. 6g | fat 1g | sat. fat 0g | chol. 0mg | sod. 457mg | calc. 91mg | fiber 1g

*Nutritional information per serving [½ cup (125 ml)]:
reduced for pizza sauce*

*Calories 74 (22% from fat) | pro. 3g | carb. 10g | fat 2g | sat. fat 0g | chol. 0mg | sod. 732mg | calc. 91mg | fiber 2g
sat. fat 0g | chol. 0mg | sod. 732mg | calc. 91mg | fiber 2g*

HOLLANDAISE SAUCE

This sauce can be used in many dishes, including eggs Benedict and steamed vegetables.

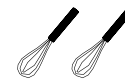

- ¾ **POUND [375 G (3 STICKS)] UNSALTED BUTTER**
- 3 **LARGE EGG YOLKS**
- ½ **TEASPOON (2 ML) KOSHER SALT**
- ¼ **TEASPOON (1 ML) FRESHLY GROUND BLACK PEPPER**
- 2 **TABLESPOONS (30 ML) FRESH LEMON JUICE**

Makes 3 cups (750 ml)

Approximate preparation time: 15 minutes

Place butter in a saucepan over low heat to melt.

Insert the large chopping blade into the large work bowl of the Cuisinart® Food Processor. Add the yolks, mustard, salt and pepper and process for 90 seconds. Once the butter is melted, turn heat up to bring the butter just to a boil. With the machine running, slowly drizzle the hot butter through the feed tube. Sauce will thicken to a mayonnaise consistency. When all butter has been incorporated, add the lemon juice and pulse to incorporate. Taste and adjust seasoning accordingly. Serve while still warm.

Nutritional information per serving [1 tablespoon (15 ml)]

Calories 108 (98% from fat) | carb. 0g | pro. 0g | fat 12g | sat. fat 7g | chol. 57mg | sod. 45mg | calc. 3mg | fiber 0g

TARTAR SAUCE

This tartar sauce is good not only with fish and shellfish, but also with steamed fresh vegetables.



- 2 **OUNCES (60 G) SHALLOTS OR GREEN ONIONS, TRIMMED AND CUT INTO 1-INCH (2.5 CM) PIECES**
- 3 **OUNCES (85 G) DRAINED SWEET GHERKIN PICKLES**
- ¼ **CUP (50 ML) FRESH ITALIAN PARSLEY**
- 1 **TABLESPOON (15 ML) DILL WEED**
- 1 **DIJON-STYLE MUSTARD**
- ½ **TEASPOON (2 ML) DRIED THYME**
- 3 **TABLESPOONS (45 ML) DRAINED CAPERS**
- 1½ **CUPS (375 ML) MAYONNAISE**
- ½ **CUP (125 ML) NONFAT PLAIN YOGURT, DRAINED* OVERNIGHT**
- ⅛ **TEASPOON (0.5 ML) FRESHLY GROUND BLACK PEPPER**

Makes about 2 cups (500 ml)

Approximate preparation time: 5 minutes

Insert the small metal chopping blade into the small work bowl of the Cuisinart® Food Processor. Add the shallots, gherkins and parsley and pulse to chop, about 15 pulses. Add the dill, mustard, thyme, and capers and pulse 5 times to chop. Add the mayonnaise, yogurt and black pepper; pulse to combine, 5 times – do not overprocess. Refrigerate until ready to use.

* To drain yogurt, place in a strainer lined with a coffee filter or a yogurt strainer. Cover and let drain until desired thickness is reached.

Nutritional information per serving [1 tablespoon (15 ml)]:

Calories 72 (88% from fat) | carb. 2g | pro. 0g | fat 7g | sat. fat 1g | chol. 13mg | sod. 86mg | calc. 10mg | fiber 0g

PIZZA DOUGH

Once you see how simple pizzas are to make, you will never order one to be delivered again.

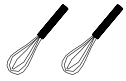

- 1 PACKAGE ACTIVE DRY YEAST
- 1 TEASPOON (5 ML) GRANULATED SUGAR
- 1¼ CUPS (300 ML) WARM WATER [105° TO 115°F (41° TO 46°C.)]
- 3⅓ CUPS (825 ML) UNBLEACHED, ALL-PURPOSE FLOUR
- ½ TABLESPOON (7 ML) KOSHER SALT
- 2 TEASPOONS (10 ML) EXTRA VIRGIN OLIVE OIL

Makes 1¾ pounds (795 g) dough (six 7-inch (18 cm) crusts or three 12-inch (30 ml) crusts) / 6 servings

Approximate preparation time: 5 to 10 minutes, plus 55 minutes rising and resting, 5 minutes assembly and 10 minutes baking

In a 2-cup (500 ml) liquid measure, dissolve yeast and sugar in warm water. Let stand until foamy, about 3 to 5 minutes. Insert the dough blade into the large work bowl of the Cuisinart® Food Processor and add the flour and salt.

With machine running on dough speed, pour the liquid slowly through the small feed tube as fast as the flour will absorb it. Once a dough ball forms and cleans the sides of the work bowl, process for an additional 30 seconds to knead dough. Dough may be slightly sticky. Coat dough evenly with extra virgin olive oil and transfer to a plastic food storage bag and seal the top. Let dough rise in a warm place for about 45 minutes.

Place dough on a lightly floured surface; punch down and let rest 5 to 10 minutes. Roll into desired crust sizes and place on baking pans lightly sprayed with vegetable oil cooking spray. Follow pizza recipe.

Nutritional information per serving [1 ounce (30 g)]:

Calories 112 (2% from fat) | carb. 24g | pro. 3g | fat 0g | sat. fat 0g | chol. 0mg | sod. 134mg | calc. 0mg | fiber 1g

PASTA DOUGH

Fresh pasta is a special treat. While it is best served right away, you can freeze it after it has been rolled and cut.



- 2 CUPS (500 ML) UNBLEACHED, ALL-PURPOSE FLOUR
- 1 CUP (250 ML) SEMOLINA FLOUR
- 1 TABLESPOON (15 ML) KOSHER SALT
- 4 LARGE EGGS

Makes 1½ pounds (750 g), about 10 servings

Approximate preparation time: 5 minutes

Insert the large metal chopping blade into the large work bowl of the Cuisinart® Food Processor. Add both flours and salt to work bowl and pulse 5 to 6 times to combine. With the machine running, add 1 egg at a time until a dough ball forms. Once dough ball forms, allow machine to run for 30 seconds to knead. Divide dough into 4 equal parts and pass through a pasta roller machine.

Nutritional information per serving [2 ounces (60 g)]:

Calories 165 (12% from fat) | carb. 30g | pro. 7g | fat 2g | sat. fat 1g | chol. 85mg | sod. 668mg | calc. 11mg | fiber 1g

BASIC FLAKY PASTRY DOUGH

This recipe makes ample crust for a 9- to 11-inch (23-28 cm) regular or deep-dish pie or tart.

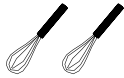

FOR A ONE-CRUST PIE:

- 1½ CUPS (375 ML) UNBLEACHED, ALL-PURPOSE FLOUR
- ¼ TEASPOON (1 ML) TABLE SALT
- ⅛ TEASPOON (0.5 ML) BAKING POWDER
- 8 TABLESPOONS (120 ML) UNSALTED BUTTER, CUT INTO ½-INCH (1.25 CM) PIECES, WELL CHILLED
- 2 TABLESPOONS (30 ML) VEGETABLE SHORTENING (PREFERABLY NON-HYDROGENATED), CUT INTO ½-INCH (1.25 CM) PIECES, WELL CHILLED
- 2 TO 4 TABLESPOONS (30-45 ML) ICE WATER

FOR A TWO-CRUST PIE:

- 3 CUPS (750 ML) UNBLEACHED, ALL-PURPOSE FLOUR
- ½ TEASPOON (2 ML) TABLE SALT
- ¼ TEASPOON (1 ML) BAKING POWDER
- 16 TABLESPOONS (240 ML) UNSALTED BUTTER, CUT INTO ½-INCH (1.25 CM) PIECES, WELL CHILLED
- 4 TABLESPOONS (60 ML) VEGETABLE SHORTENING (PREFERABLY NONHYDROGENATED), CUT INTO ½-INCH (1.25 CM) PIECES, WELL CHILLED
- 5 TO 8 TABLESPOONS (75-120 ML) ICE WATER

Approximate preparation time: 10 minutes, plus 90 minutes resting time

Insert the large metal chopping blade into the large work bowl of the Cuisinart® Food Processor. Add the flour, salt and baking powder and process for 10 seconds to sift. Add the well-chilled butter and shortening. Use short, quick pulses until the mixture resembles coarse corn meal and no pieces of butter larger than a pea remain visible, 15 to 20 pulses. Sprinkle half the maximum ice water on the flour and butter mixture, then pulse 5 or 6 times on the dough speed setting. The dough will be crumbly, but should begin to hold together when a small amount is picked up and pressed together. Add more water, a teaspoon (5 ml) [two (10 ml) for the two-crust recipe] at a time, with 2 to 3 quick pulses on the dough speed setting after each addition, adding just enough water for the dough to hold together easily when pressed into a ball. Do not allow the dough to form a ball in the processor! Add the liquid sparingly so that the dough is not sticky. Do not overprocess or the pastry will be tough, not tender and flaky.

Turn the dough out onto a lightly floured surface. Press together into a ball, then flatten into a disk about 6 inches (15 cm) in diameter (two disks for the two-crust recipe). Wrap in plastic wrap and refrigerate for 1 hour before continuing. The dough will keep refrigerated for up to 3 days, or may be frozen (double-wrapped) for up to a month; thaw at room temperature for an hour before using. Use as directed in recipe.

To bake the pastry blind for a single-crust filled pie or tart, roll out pastry ⅛-inch (0.3 cm) thick to fit pan; crimp and seal edges. Prick bottom all over with a fork. Chill for 30 minutes. Preheat the oven to 400°F (200°C). Line the shell with a sheet of aluminum foil or parchment paper and fill with pie weights, dry rice or beans. Bake for 15 minutes.

Leftover pastry may be rolled out and cut into shapes to garnish the pie, or brushed with milk, sprinkled with sugar or cinnamon and sugar, and baked until lightly browned.

Nutritional information based on 12 servings per pie:

1-crust pie

Calories 138 (65% from fat) | pro. 1g | carb. 11g | fat 10g | sat. fat 1g | chol. 20mg | sod. 48mg | calc. 2mg | fiber 0g

Nutritional information based on 12 servings per pie:

2-crust pie

Calories 277 (65% from fat) | pro 3g | carb 22g | fat 20g | sat. fat 1g | chol. 40mg | sod. 104mg | calc. 2mg | fiber 0g

PÂTE BRISÉE

This versatile dough can be used for sweet or savoury treats.

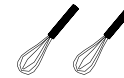

- 2 CUPS (500 ML) UNBLEACHED, ALL-PURPOSE FLOUR
- 1 TEASPOON (5 ML) TABLE SALT
- 16 TABLESPOONS (½ POUND (250 G); 2 STICKS) UNSALTED BUTTER, COLD AND CUT INTO ½-INCH (1.25 CM) CUBES
- ¼ CUP (50 ML) ICE WATER

Makes two single crust 9-inch (23 cm) tarts/pies or one double-crust pie, 24 servings

Approximate preparation time: 5 minutes

Insert the large metal chopping blade into the large work bowl of the Cuisinart® Food Processor. Add the flour and salt and process for 10 seconds to sift. Evenly add the butter and pulse until the mixture resembles coarse crumbs. Pour in water 1 tablespoon (15 ml) at a time, and pulse until mixture just forms a dough – you may not need all of the water. Divide dough equally into two pieces and form each into a flat disc; wrap in plastic and refrigerate until ready to use. This pastry also freezes well for up to 6 months as long as it is well wrapped.

Nutritional information per serving:

Calories 39 (6% from fat) | carb. 8g | pro. 1g | fat 0g | sat. fat 0g | chol. 0mg | sod. 98mg | calc. 2mg | fiber 0g

TIP: For a sweet Pâte Brisée, follow the same recipe as above except add 1½ tablespoons (25 ml) of granulated sugar to the dry ingredients in the work bowl.

Nutritional information per serving:

Calories 47 (5% from fat) | carb. 10g | pro. 1g | fat 0g | sat. fat 0g | chol. 0mg | sod. 98mg | calc. 2mg | fiber 0g

PÂTE SUCRÉE

Use this sweet dough for simple cookies.
Just roll and cut into your favourite shapes.



- 2 CUPS (500 ML) UNBLEACHED, ALL-PURPOSE FLOUR
- 2 TABLESPOONS (30 ML) GRANULATED SUGAR
- ½ TEASPOON (2 ML) TABLE SALT
- 12 TABLESPOONS [¾ CUP (175 ML)] UNSALTED BUTTER, ROOM TEMPERATURE
- 2 LARGE EGG YOLKS
- 1 TABLESPOON (15 ML) ICE WATER
- ¼ TEASPOON (1 ML) LEMON ZEST (OPTIONAL)
- ½ TEASPOON (2 ML) PURE VANILLA EXTRACT

Makes two 9-inch (23 cm) single tarts/pies, or one double-crust pie

⌚ Approximate preparation time: 5 minutes plus 30 minutes for resting

Insert the large metal chopping blade into the large work bowl of the Cuisinart® Food Processor. Add the flour, sugar and salt and process for 10 seconds to sift. Add the butter and process until combined. With the machine running on the dough speed setting, add the yolks, one at a time, and process until incorporated. Add the water, zest (if using) and vanilla; pulse 3 to 4 times, until combined.

Form dough into 2 flat discs. Wrap in plastic; chill in refrigerator until ready to use.

To make this an almond sucrée, substitute 1 cup (250 ml) of the all-purpose flour for toasted almonds. Finely grind the almonds, then add the remaining dry ingredients and follow instructions as stated above.

Nutritional information per serving:

Calories 92 (58% from fat) | carb. 8g | pro. 1g | fat 6g | sat. fat 4g | chol. 32mg | sod. 23mg | calc. 2mg | fiber 0g

For the almond sucrée:

Nutritional information per serving:

Calories 94 (63% from fat) | carb. 7g | pro. 1g | fat 7g | sat. fat 4g | chol. 32mg | sod. 23mg | calc. 5mg | fiber 0g

TRADITIONAL SCONES

The key to a delicate scone is to not overmix the dough. Always use a light hand and you will have delicious results.



- 2½ CUPS (625 ML) UNBLEACHED, ALL-PURPOSE FLOUR
- 4 TABLESPOONS (60 ML) GRANULATED SUGAR, DIVIDED
- 2 TEASPOONS (10 ML) BAKING POWDER
- 1 TEASPOON (5 ML) SALT
- 6 TABLESPOONS (90 ML) UNSALTED BUTTER, COLD AND CUT INTO SMALL CUBES
- ½ CUP (125 ML) PLUS 1 TABLESPOON (15 ML) BUTTERMILK
- ¼ TEASPOON (1 ML) PURE VANILLA EXTRACT
- 1 LARGE EGG
- ½ CUP (125 ML) CURRANTS
- 1 TABLESPOON (15 ML) HEAVY CREAM

Makes 8 scones

⌚ Approximate preparation time: 10 minutes plus 30 minutes for baking

Preheat oven to 375°F (190°C). Line a baking sheet with parchment paper.

Insert the large metal chopping blade into the large work bowl of the Cuisinart® Food Processor. Add the flour, 3 tablespoons (45 ml) granulated sugar, baking powder and salt and process for 15 seconds to combine. Add the butter and pulse to incorporate, about 8 pulses, until the butter pieces are about the size of peas. Stir the buttermilk, vanilla and egg together in a liquid measuring cup. With the machine running on the dough speed, slowly add the liquids through the feed tube until just combined; be very careful not to overmix. Add the currants and pulse until just combined, 2 to 3 pulses.

Pour dough onto a clean surface. Form into a long, flat rectangle and cut into 8 triangles. Place the scones, evenly spaced, on the baking sheet. Brush the tops with heavy cream and sprinkle with reserved sugar.

Bake for 30 to 35 minutes, until baked through and golden.

Nutritional information per scone:

Calories 180 (46% from fat) | carb. 23g | pro. 2g | fat 9g | sat. fat 6g | chol. 39mg | sod. 171mg | calc. 53mg | fiber 1g

LEEK, SAUSAGE AND FONTINA QUICHE

A perfect dish for Sunday brunch.



Makes 12 servings

Approximate preparation time: 20 minutes plus 40 minutes for baking

FILLING:

1 RECIPE PÂTE BRISÉE (PAGE 33)

Prepare Pâte Brisée according to recipe on page 33.

1 GARLIC CLOVE

While dough is chilling, preheat oven to 350°F (180°C).

1 SMALL LEEK, WHITE AND LIGHT GREEN PARTS ONLY, CUT INTO ½-INCH (1.25 CM) PIECES

Roll out one dough disc* to ⅛-inch (0.3 cm) thick to fit a 9-inch (23 cm) tart pan. Fit the dough into the pan. Chill in refrigerator for about 30 minutes.

6 OUNCES (170 G) PRE-COOKED CHICKEN APPLE SAUSAGE, CUT INTO SMALL DICE

While dough is chilling, preheat oven to 350°F (180°C).

1 TABLESPOON (15 ML) UNSALTED BUTTER

Using a fork, prick the dough evenly all over but make sure not to go entirely through the dough. Line the shell with parchment and weigh down with dried beans or rice. Bake in oven for 25 minutes, or until the dough underneath the parchment is no longer wet. Remove the beans/rice and parchment and continue baking until the shell is golden brown, about an additional 10 minutes. Remove and reserve.

¼ TEASPOON (1 ML) FRESHLY GROUND BLACK PEPPER, DIVIDED

While the quiche shell is baking, insert the small metal chopping blade into the small work bowl. Process the garlic until finely chopped. Add the leeks and pulse to chop, about 6 pulses.

2 OUNCES (60 G) FONTINA CHEESE

Place a skillet over medium heat and add the sausage; cook for about 3 minutes. Add the butter, garlic, leeks and a pinch of pepper. Stir over medium-low heat until vegetables are soft, about 2 to 3 minutes.

¾ CUP (175 ML) WHOLE MILK

Place the reversible shredding disc on the medium shredding side into the large work bowl and shred the fontina. Remove and reserve. Replace the shredding disc with the large metal chopping blade and add the milk, cream, eggs, yolks, salt, remaining pepper and half of the shredded fontina. Process to combine all ingredients, about 10 seconds.

¾ CUP (175 ML) HEAVY CREAM

To assemble the quiche: spread the sausage and leeks evenly along the bottom of the baked tart shell. Pour the egg mixture over the vegetables and scatter the remaining fontina on the top.

2 LARGE EGGS

Bake for 35 to 40 minutes until quiche is lightly browned and just set.

2 LARGE EGG YOLKS

Remove from oven and let sit for about 5 to 10 minutes before serving.

¼ TEASPOON (1 ML) KOSHER SALT

* The second dough disc may either be used within 3 days if refrigerated or it may be wrapped well and stored in the freezer until needed.

Nutritional information per serving (including pastry):

Calories 181 (83% from fat) | carb. 3g | pro. 4g | fat 17g | sat. fat 10g | chol. 116mg | sod. 301mg | calc. 62mg | fiber 0g

ARTICHOKE AND HERB YOGURT DIP

A delicious lowfat dip for crudité or chips.



Makes 4 cups (1 L)

Approximate preparation time: 6 minutes, plus optional 2 hours for resting

1 OUNCE (30 G) PARMESAN, CUT INTO ½-INCH (1.25 CM) CUBES

Insert the small metal chopping blade into the small work bowl of the Cuisinart® Food Processor. Process the Parmesan until finely chopped; remove work bowl and reserve. Add the fresh herbs to the work bowl; pulse to chop, about 5 pulses.

2 TABLESPOONS (30 ML) FRESH MINT

Add remaining ingredients, including reserved Parmesan; pulse 5 times to combine, and then process until all ingredients are incorporated.

¼ CUP (50 ML) FRESH BASIL

Allow dip to rest at least 2 hours in refrigerator for flavours to develop. Remove from refrigerator ½ hour before serving.

¼ CUP (50 ML) FRESH PARSLEY

2 JARS [12-OUNCE (340 G)] ARTICHOKE HEARTS

16 OUNCES (453 G) PLAIN LOW-FAT YOGURT

½ TEASPOON (2 ML) LEMON ZEST

Nutritional information per serving [¼ cup (50 ml)]:

Calories 41 (52% from fat) | carb. 3g | pro. 2g | fat 2g | sat. fat 1g | chol. 2mg | sod. 115mg | calc. 73mg | fiber 0g

½ TEASPOON (2 ML) FRESHLY GROUND BLACK PEPPER

¼ TEASPOON (1 ML) KOSHER SALT

⅛ TEASPOON (0.5 ML) FRESHLY GROUND NUTMEG

CHUNKY GUACAMOLE

Make our fresh guacamole for the Sunday game or serve alongside quesadillas for a fun dinner night.



Makes 6 cups (1.5 L)

Approximate preparation time: 10 minutes

Insert the large metal chopping blade into the large work bowl of the Cuisinart® Food Processor. With the machine running, drop the garlic through the small feed tube to finely chop. Add jalapeño to work bowl and pulse 5 times to chop. Add the onion and pulse 4 times to chop. Add the cilantro and pulse 3 times to chop. Add the tomatoes and pulse 3 times to chop. Scoop out the insides of the avocados directly into work bowl and add the lime juice and salt. Pulse until desired consistency is achieved, about 10 to 12 pulses.

Nutritional information per serving (¼ cup (50 ml)):

Calories 76 (73% from fat) | carb. 5g | pro. 1g | fat 7g | sat. fat 1g | chol. 0mg | sod. 104mg | calc. 8mg | fiber 3g

- 2 GARLIC CLOVES
- 1 JALAPEÑO PEPPER, CUT INTO 1-INCH (2.5 CM) PIECES
- ½ MEDIUM ONION, CUT INTO 1-INCH (2.5 CM) PIECES
- 2 TABLESPOONS (30 ML) FRESH CILANTRO
- ½ CUP (125 ML) GRAPE TOMATOES
- 6 RIPE AVOCADOS, HALVED, PITS REMOVED
- 2 TO 3 TABLESPOONS (30-45 ML) FRESH LIME JUICE
- 1 TEASPOON (5 ML) KOSHER SALT

HUMMUS

The food processor is a perfect tool for a creamy hummus.



Makes 4 cups (1 L)

Approximate preparation time: 10 minutes

Insert the large metal chopping blade into the large work bowl of the Cuisinart® Food Processor. Process the parsley, lemon zest, salt, and garlic together, about 6 seconds. Scrape bowl and repeat. Add remaining ingredients and process until smooth, about 1 minute. Scrape bowl and process again to fully incorporate all ingredients.

Nutritional information per serving (2 tablespoons (30 ml)):

Calories 55 (49% from fat) | carb. 5g | pro. 2g | fat 3g | sat. fat 0g | chol. 0mg | sod. 163mg | calc. 13mg | fiber 1g

- ½ CUP (125 ML) FRESH ITALIAN PARSLEY LEAVES
- 1 TEASPOON (5 ML) LEMON ZEST
- 1 TEASPOON (5 ML) KOSHER SALT
- 1 TO 2 GARLIC CLOVES
- 4 CANS [15½ OUNCES (440 G) EACH] CHICKPEAS, DRAINED
- ¼ CUP (125 ML) TAHINI
- ¼ CUP (125 ML) FRESH LEMON JUICE
- ⅓ CUP (75 ML) WATER
- 1 TEASPOON (5 ML) GROUND CUMIN
- ¼ CUP (50 ML) EXTRA VIRGIN OLIVE OIL

THREE-TOMATO SALSA

Serve warm tortilla chips alongside this fresh and tangy salsa.



- ½ BUNCH FRESH CILANTRO
- ½ LARGE VIDALIA ONION, CUT INTO 1-INCH (2.5 CM) PIECES
- 1 GARLIC CLOVE
- 1 SMALL JALAPEÑO PEPPER, SEEDED
- 2 TEASPOONS (10 ML) SEA SALT
- ½ POUND (250 G) RIPE PLUM TOMATOES, CUT INTO 1-INCH (2.5 CM) PIECES
- ½ POUND (250 ML) GREEN, HOTHOUSE TOMATOES, CUT INTO 1-INCH (2.5 CM) PIECES
- ½ POUND (250 G) YELLOW TOMATOES, CUT INTO 1-INCH (2.5 CM) PIECES
- 1 TEASPOON (5 ML) FRESH LIME JUICE

Makes 3 cups (750 ml)

Approximate preparation time: 10 minutes

Insert the large metal chopping blade into the large work bowl of the Cuisinart® Food Processor. Put half of the cilantro, half of the onion, garlic cloves, jalapeños, 1 teaspoon (5 ml) of salt and half the tomatoes into the work bowl and pulse to chop to desired consistency, about 8 to 10 quick pulses; repeat with the remaining half.

Combine the two batches in a large bowl and stir in the lime juice. Taste and adjust seasoning accordingly.

For better consistency, drain each batch in a strainer to remove excess liquid.

Serve with your favourite tortilla chips.

TIP: Salsa can be processed in one batch. However, a better consistency is achieved by processing the tomatoes in two batches.

Nutritional information per serving [¼ cup (50 ml)]:

Calories 13 (9% from fat) | carb. 3g | pro. 1g | fat 0g | sat. fat 0g | chol. 0mg | sod. 209mg | calc. 7mg | fiber 1g

CLASSIC BRUSCHETTA

Classic and delicious.



- 6 GARLIC CLOVES
- 2 CUPS (500 ML) FRESH BASIL
- 6 CUPS (1.5 L) TOMATOES, CUT INTO 1-INCH (2.5 CM) PIECES
- ½ TO ¾ TEASPOON KOSHER SALT
- ¼ TEASPOON (1 ML) FRESHLY GROUND BLACK PEPPER
- 3 TABLESPOONS (45 ML) OLIVE OIL
- 1 TABLESPOON (15 ML) FRESH LEMON JUICE
- 1 BAGUETTE, CUT INTO ½-INCH (1.25 CM) SLICES
- 2 SMASHED GARLIC CLOVES

Makes 50 bruschette

Approximate preparation time: 15 to 20 minutes, including toasting and assembly time

Insert the large metal chopping blade into the large work bowl of the Cuisinart® Food Processor and process the whole garlic cloves until finely chopped. Add the basil to the work bowl and pulse 5 to 6 times to roughly chop. Add the tomatoes and pulse to roughly chop. Strain mixture; put into a large mixing bowl and toss with the salt, pepper, oil and lemon juice. Taste and adjust seasoning accordingly.

Preheat oven to 400°F (200°C).

Rub the bread slices with the smashed garlic and place on a baking sheet. Bake in oven to toast, about 5 minutes.

Spoon ½ to 1 tablespoon (7 to 15 ml) of topping on each toasted slice and serve immediately.

Nutritional information per bruschetta:

Calories 80 (19% from fat) | carb. 14g | pro. 2g | fat 2g | sat. fat 0g | chol. 0mg | sod. 176mg | calc. 23mg | fiber 1g

CARAMELIZED ONION, STEAK AND GRUYÈRE QUESADILLAS

Enjoy these grown-up quesadillas at your next cocktail party. Serve with salsa, guacamole and sour cream for topping.

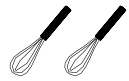

Makes 16 servings

Approximate preparation time: 1 hour

- 3 POUNDS YELLOW ONIONS
- ½ CUP (1 STICK) UNSALTED BUTTER
- ¼ TEASPOON (1 ML) KOSHER SALT
- ¼ TEASPOON (1 ML) FRESHLY GROUND BLACK PEPPER
- 8 OUNCES (226 G) GRUYÈRE CHEESE
- 1½ POUNDS (750 G) SIRLOIN STEAK
- 16 8-INCH (20 CM) FLOUR TORTILLAS

Insert the slicing disc, adjusted to 2 mm, into the large work bowl of the Cuisinart® Food Processor, and slice the onions. Place a large skillet over medium-low heat and add the butter. Once the butter is melted, add the onions with salt and pepper to the skillet and cook over low heat for about 1 hour, until onions are completely soft and caramel in color.

While onions are caramelizing, replace the slicing disc with the reversible shredding disc on the medium shredding side and process the Gruyère.

Grill or pan-roast the steaks until rare to medium-rare (steaks will continue to cook in the quesadillas). Allow steaks to cool and then thinly slice.

To assemble: evenly place ¼ cup (50 ml) of onions on a tortilla and top with 4 to 5 slices of steak, ⅓ cup (75 ml) of shredded cheese and then top with another tortilla. Repeat with remaining ingredients.

Preheat the Cuisinart® Griddler®, fitted with the griddle plates in the closed position, to 375°F (190°C). Brush the top and bottom tortillas lightly with oil and grill until the cheese is melted and the tortillas are golden and crisp, about 3 minutes.

Quesadillas can also be prepared in a 375°F (190°C) oven, baked on parchment lined baking trays.

To serve: Cut quesadillas into quarters and serve with guacamole and sour cream.

Note: The flavour of the caramelized onions is well-worth the time it takes to prepare them.

Nutritional information per ¼ quesadilla:

Calories 166 (44% from fat) | carb. 15g | pro. 8g | fat 8g | sat. fat 4g | chol. 28mg | sod. 208 mg | calc. 112mg | fiber 0g

LIGHTENED BROCCOLI AND POTATO SOUP

This soup is a delicious substitute for other cream soups.

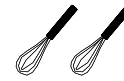

Makes about 10 cups (2.5 L)

Approximate preparation time: 25 to 30 minutes

- 4 OUNCES (115 G) CHEDDAR
- 2 GARLIC CLOVES
- 1 SMALL ONION, CUT INTO 1-INCH (2.5 CM) PIECES
- 2 TABLESPOONS (30 ML) EXTRA VIRGIN OLIVE OIL
- ½ TABLESPOON (7 ML) SEA OR KOSHER SALT, DIVIDED
- 1 TEASPOON (5 ML) FRESHLY GROUND BLACK PEPPER, DIVIDED
- 1 POUND (500 G) POTATOES
- 2 POUNDS (1 KG) BROCCOLI, STEMS PEELED AND FLORETS SEPARATED
- 2½ CUPS (625 ML) SHERRY
- 1 QUART (0.9 L) HOT VEGETABLE STOCK
- ¾ TEASPOON (3.75 ML) LEMON ZEST

Insert the reversible shredding disc assembly on the medium shredding side into the large work bowl of the Cuisinart® Food Processor and shred the cheese. Remove work bowl and reserve. Insert the large metal chopping blade into the large work bowl. With the machine running, drop the garlic cloves through the small feed tube to finely chop. Add the onion to the work bowl and pulse to chop, about 10 pulses.

Heat the olive oil in a large saucepan over low heat. Add the garlic and onion, with a pinch each of salt and pepper. Sauté until softened, about 8 to 10 minutes.

While vegetables are cooking, insert the adjustable slicing disc assembly, adjusted to the 4mm setting, into the large work bowl. Slice the potatoes and the broccoli stems.

Raise the heat to medium and add the potatoes, broccoli stems and a pinch each of the salt and pepper; sauté 2 to 3 minutes, and then add the sherry. Let the sherry cook down until almost evaporated. Add the stock and bring to a boil.

Reduce heat to medium-low and stir in the florets, lemon zest, ½ cup (125 ml) of Cheddar, and remaining salt and pepper. Simmer until vegetables are tender.

Strain the soup, reserving the liquid. Place the solids into the large work bowl with the large metal chopping blade and purée until completely smooth, about 1 minute.

Return the purée to the saucepan. Place over medium-low heat and stir in the reserved liquid until desired consistency is achieved. Stir in remaining Cheddar.

Taste and adjust seasoning accordingly.

TIP: This soup is very thick, so add more stock if a thinner consistency is desired.

Nutritional information per serving [1 cup (250 ml)]:

Calories 140 (39% from fat) | carb. 17g | pro. 5g | fat 7g | sat. fat 2g | chol. 5mg | sod. 680mg | calc. 71mg | fiber 4g

TOMATO SOUP

The ultimate comfort soup, our recipe takes it to the next level with its smoky bacon flavour.

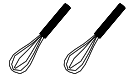

Makes about 8 cups (2 L)

Approximate preparation time: 50 minutes

- 8 OUNCES (226 G) THICK-CUT BACON, CUT INTO SMALL DICE
- 6 OUNCES (170 ML) GRAPE TOMATOES
- 1 MEDIUM ONION, CUT INTO 1-INCH (2.5 CM) PIECES
- 2 MEDIUM CARROTS, CUT INTO 1-INCH (2.5 CM) PIECES
- 1 CELERY STALK, CUT INTO 1-INCH (2.5 CM) PIECES
- 3 TABLESPOONS (45 ML) UNBLEACHED, ALL-PURPOSE FLOUR
- 5 CUPS (1.25 L) WHOLE PLUM TOMATOES IN PURÉE (FROM ABOUT 1½ 28-OUNCE CANS)
- 3 WHOLE SUN-DRIED TOMATOES
- PINCH BAKING SODA
- 3½ CUPS (875 ML) VEGETABLE STOCK
- 1½ TEASPOONS (7 ML) KOSHER SALT
- ¾ TEASPOON (3.75 ML) FRESHLY GROUND BLACK PEPPER

Put bacon into a 6-quart (5.7 L) saucepan and place over medium heat. Sauté until bacon is cooked through, about 10 to 15 minutes, and add the grape tomatoes to the pan. Cook until tomatoes are bursting, about 10 minutes. Remove and reserve the tomatoes and remove and discard the bacon or reserve for separate use.

While the bacon and tomatoes are cooking, insert the large metal chopping blade into the large work bowl of the Cuisinart® Food Processor. Add the onion and pulse to chop, about 10 pulses. Add the carrots and celery to the work bowl and pulse to chop, about 10 pulses.

Add the onion to the saucepan with the bacon fat and sauté 5 to 7 minutes, or until the onion is softened. Stir in the carrots and celery; sauté for 6 to 8 minutes, until tender. Stir in flour; cook for an additional minute.

Add tomatoes, with their juices, sun-dried tomatoes, reserved grape tomatoes, baking soda, stock and spices. Cover; bring to a slight boil. Reduce heat and uncover, let simmer about 20 minutes.

Carefully process soup until completely puréed. Return to saucepan to heat through.

Taste and adjust seasoning accordingly.

Nutritional information per serving [1 cup (250 ml)]:

Calories 160 (55% from fat) | carb. 16g | pro. 3g | fat 10g | sat. fat 5g | chol. 15mg | sod. 870mg | calc. 94mg | fiber 3g

ROASTED BUTTERNUT SQUASH SOUP

A hearty, warming soup for a winter evening.



Makes about 12 cups (3 L)

Approximate preparation time: 65 to 75 minutes

- 5 POUNDS (2 KG) BUTTERNUT SQUASH, HALVED AND SEEDS REMOVED [ABOUT TWO 2-POUND (1 KG) SQUASH]
- 1 TABLESPOON (15 ML) EXTRA VIRGIN OLIVE OIL
- 2 MEDIUM-LARGE ONIONS, CUT INTO 1-INCH (2.5 CM) PIECES
- 4 TABLESPOONS [60 ML (½ STICK)] UNSALTED BUTTER
- 2½ TEASPOONS (13 ML) KOSHER SALT, DIVIDED
- 1 TABLESPOON (15 ML) LIGHT OR DARK BROWN SUGAR
- ¼ CUP (50 ML) FINELY CHOPPED FRESH GINGER
- 2 QUARTS (1.9 L) VEGETABLE STOCK
- 1½ TEASPOONS (7 ML) GROUND NUTMEG
- ¾ TEASPOON (3.75 ML) FRESHLY GROUND BLACK PEPPER
- ½ TEASPOON (2 ML) FRESH THYME

Preheat oven to 375°F (190°C).

Place squash in a shallow roasting pan. Drizzle olive oil over flesh and into the pan. Turn squash flesh down. Bake until squash is tender, about 45 minutes.

Insert the large metal chopping blade into the large work bowl of the Cuisinart® Food Processor. Add the onions and pulse to chop, about 8 to 10 pulses.

Melt the butter in a 6-quart (5.7 L) saucepan over medium heat. Once the butter has melted, add the onions and ¼ teaspoon (1 ml) of salt. Sauté 5 to 7 minutes, or until the onions are softened. Stir in the brown sugar; sauté for an additional 10 minutes. Add the ginger; sauté until tender and aromatic, about 6 to 8 minutes.

Add stock, roasted squash, nutmeg, remaining salt and pepper to the pot. Cover; bring to a slight boil. Once boiling, uncover and let simmer for 15 to 20 minutes. Strain the soup, reserving the liquid. Place the solids into the large work bowl with the large metal chopping blade and purée until completely smooth, about 1 minute.

Return purée to the saucepan over medium-low heat and stir in the reserved liquid until desired consistency is achieved.

Adjust seasoning to taste and serve.

Nutritional information per serving [1 cup (250 ml)]:

Calories 200 (60% from fat) | carb. 19g | pro. 2g | fat 14g | sat. fat 4g | chol. 10mg | sod. 470mg | calc. 69mg | fiber 1g

FRENCH ONION SOUP

Homemade veal stock really adds to the flavour of the rich soup. But if you have a store-bought stock, make sure that it is a high-quality brand.



- 4 **POUNDS (1.8 KG) YELLOW ONIONS, PEELLED**
- 1 **CUP (250 ML) (½ POUND; 2 STICKS) UNSALTED BUTTER**
- 2 **TEASPOONS (10 ML) KOSHER SALT, DIVIDED**
- 1 **TEASPOON (5 ML) FRESHLY GROUND BLACK PEPPER, DIVIDED**
- 20 **OUNCES (567 G) GRUYÈRE**
- 2 **TABLESPOONS (30 ML) UNBLEACHED, ALL-PURPOSE FLOUR**
- 3 **QUARTS (2.8 L) BEEF OR VEAL STOCK**
- 2 **TABLESPOONS (30 ML) FRESH THYME**
- 2 **BAY LEAVES**
- 2 **CUPS (500 ML) DRY SHERRY**
- 1 **BAGUETTE, CUT INTO ½-INCH (1.25 CM) SLICES**

Makes 20 servings

Approximate preparation time: about 2½ hours

Insert the slicing disc assembly, adjusted to 4mm, into the large work bowl of the Cuisinart® Food Processor and slice the onions.

Melt the butter in an 8-quart (7.6 L) stockpot placed over low heat. Once the butter has melted, add the onions and ¼ teaspoon (1 ml) of both the salt and pepper. Let the onions cook until deeply caramelized, about 1½ hour.

While the onions are cooking, replace the slicing disc with the reversible shredding disc on the medium shredding side to shred the Gruyère; reserve in the bowl.

Once onions have cooked, stir in the flour and cook for about 1 to 2 minutes. Add the stock, thyme and bay leaves.

Increase the temperature to medium high and bring the mixture to a simmer. Add the sherry and return to a simmer. Reduce the temperature to low and let cook for 50 minutes. Stir in remaining salt and pepper. Taste and adjust seasoning accordingly.

While soup is cooking, lightly toast the baguette slices under a broiler; reserve. Once soup is ready, place in individual, ovenproof crocks and place the bread slices over soup and top with the reserved Gruyère. Broil until the cheese is completely melted and browned. Serve immediately.

Nutritional information per serving [1 cup (250 ml)]:

Calories 311 (53% from fat) | carb. 21g | pro. 13g | fat 19g | sat. fat 11g | chol. 54mg | sod. 806mg | calc. 318mg | fiber 2g

CHOPPED SALAD

This delicious, garden-fresh salad is always a big hit.



- 3 **CELERY STALKS, CUT INTO 1-INCH (2.5 CM) PIECES**
- 3 **MEDIUM CARROTS (ABOUT 4 OUNCES (115 G)), CUT INTO 1-INCH (2.5 CM) PIECES**
- 1 **RED ONION, CUT INTO 1-INCH (2.5 CM) PIECES**
- 1 **CUP (250 ML) FLAT-LEAF PARSLEY**
- 8 **SCALLIONS, TRIMMED AND CUT INTO 1-INCH (2.5 CM) PIECES**
- 1 **CUCUMBER (ABOUT 12 OUNCES (340 G)), CUT INTO 1-INCH (2.5 CM) PIECES**
- 1 **POUND (500 G) RIPE TOMATOES, CUT INTO 1-INCH (2.5 CM) PIECES**
- 2 **CUPS (500 ML) CORN, FRESH OR FROZEN (THAWED)**
- 1 **CAN [19 OUNCES (540 G)] CHICKPEAS**
- ¾ **TEASPOON (3.75 ML) KOSHER SALT**
- ½ **TEASPOON (2 ML) FRESHLY GROUND BLACK PEPPER**
- ¼ **CUP (50 ML) HERBED VINAIGRETTE (SEE PAGE 25)**

Makes 12 cups (2.7 L)

Approximate preparation time: 20 to 25 minutes, including vinaigrette

Insert the large metal chopping blade into the large work bowl of the Cuisinart® Food Processor. Add the celery, carrots, onion, parsley and scallions and pulse to chop, about 10 pulses. Remove and place vegetables into a large mixing bowl. Add the cucumber to the work bowl and pulse to roughly chop, 5 pulses, and add to mixing bowl. Roughly chop the tomatoes by pulsing them with 5 pulses and add to the mixing bowl with the corn and chickpeas. Toss all ingredients together with salt, pepper and vinaigrette. Taste and adjust seasoning accordingly. Serve immediately.

Nutritional information per serving (1 cup (250 ml)):

Calories 140 (28% from fat) | carb. 23g | pro. 5g | fat 5g | sat. fat 1g | chol. 0mg | sod. 342mg | calc. 53mg | fiber 5g

CLASSIC COLESLAW

The Cuisinart® Food Processor makes the preparation of this picnic favourite a breeze



- 1 HEAD GREEN CABBAGE, CORED AND QUARTERED
- ½ HEAD RED CABBAGE, CORED AND HALVED
- 1 POUND (500 G) CARROTS
- 1 FENNEL BULB
- 2½ TEASPOONS (13 ML) KOSHER SALT
- 1 CUP (250 ML) MAYONNAISE
- ¾ TEASPOON (3.75 ML) FRESHLY GROUND BLACK PEPPER
- ½ TEASPOON (2 ML) GRANULATED SUGAR

Makes 12 cups (2.7 L)

⌚ Approximate preparation time: 5 to 10 minutes, plus 1 hour for resting time

Insert the slicing disc assembly, adjusted to 4mm, into the large work bowl of the Cuisinart® Food Processor and slice both cabbages. Remove and place in a large mixing bowl. Replace the slicing disc with the reversible shredding disc on the medium shredding side and shred the carrots and fennel. Toss well with the cabbage and the salt. Let vegetables sit for 1 hour and then squeeze out any moisture and drain. Toss with remaining ingredients. Taste and adjust seasoning accordingly.

Nutritional information per serving [1 cup (250 ml)]:

Calories 177 (74% from fat) | carb. 10g | pro. 2g | fat 15g | sat. fat 2g | chol. 7mg | sod. 597mg | calc. 65mg | fiber 4g

EGGPLANT PARMESAN

Every step of this recipe can be done in the food processor!

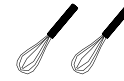

- NONSTICK COOKING SPRAY
- 2½ POUNDS (1.1 KG) EGGPLANT
- 2 CUPS (500 ML) UNBLEACHED, ALL-PURPOSE FLOUR
- 6 TO 7 LARGE EGGS, LIGHTLY BEATEN
- 3 CUPS (750 ML) HERBED BREADCRUMBS (PAGE 23)
- ½ CUP (125 ML) OLIVE OIL
- 1 OUNCE (28 G) PARMESAN CHEESE
- 8 OUNCES (227 G) MOZZARELLA, WELL CHILLED
- 4 CUPS (1 L) SIMPLE TOMATO SAUCE (PAGE 28)

Makes 2 pans, 13 x 9 inches (33 x 23 cm), 16 servings

⌚ Approximate preparation time: 10 to 15 minutes plus 20 minutes for roasting eggplant and 20 minutes for baking the assembled dish

Preheat oven to 400°F (200°C). Line two baking sheets with parchment paper and spray two 13 x 9-inch (33 x 23 cm) pans with nonstick cooking spray.

Insert the slicing disc, adjusted to 4 mm, into the large work bowl of the Cuisinart® Food Processor. Slice the eggplant into rounds.

Put the flour, eggs, and breadcrumbs in shallow individual containers. Dredge each slice of eggplant first in the flour, then in the eggs, and then in the breadcrumbs. After dredging in each ingredient, tap the eggplant to remove any excess. Drizzle the prepared baking sheets with olive oil and arrange eggplant in single layers on both sheets. Bake in oven for 20 minutes, flipping eggplant halfway through the baking time.

While eggplant is baking, replace the slicing disc with the fine shredding disc and shred the Parmesan. Reverse the shredding disc to the medium side and shred the mozzarella. Mix with a spatula to combine the cheeses.

Remove the eggplant from the oven and reduce oven temperature to 375°F (190°C). Place 1 cup (250 ml) of tomato sauce on the bottom of each of two 13 x 9-inch (33 x 23 cm) pans. Layer the eggplant equally in the pans. Spread each with an additional ¾ to 1 cup (175-250 ml) of sauce and then distribute the cheeses equally on top. Bake in the oven for 15 to 20 minutes until warmed through and cheese is melted and golden.

Nutritional information per serving:

Calories 258 (45% from fat) | carb. 29g | pro. 11g | fat 15g | sat. fat 4g | chol. 92mg | sod. 353mg | calc. 142mg | fiber 5g

CLASSIC MEATBALLS

A classic recipe to use for meatballs and meatloaf.



Makes approximately 32 meatballs

Approximate preparation time (meatballs): 10 minutes plus 25 minutes for cooking

1 MEDIUM ONION [ABOUT 3 OUNCES (85 G)] QUARTERED

Approximate preparation time (meatloaf): 10 minutes plus 90 minutes for cooking

½ CUP (125 ML) FRESH PARSLEY LEAVES

Insert the large metal chopping blade into the large work bowl of the Cuisinart® Food Processor. Put the onion, parsley, bread, meat, dry milk and spices into the work bowl; pulse 4 to 6 times and then process until finely chopped. Add the eggs and water and pulse until *just* combined; be careful not to overprocess.

2 SLICES DAY-OLD FIRM BREAD, TORN INTO PIECES

1 POUND (500 G) BONELESS CHUCK, CUT INTO 1-INCH (2.5 CM) PIECES

Shape the mixture into balls, 2 tablespoons (30 ml) each. Arrange them in a single layer in a baking dish and bake at 375°F (190°C) for 25 minutes or simmer in tomato sauce until cooked through.

1 POUND (500 G) BONELESS PORK, CUT INTO 1-INCH (2.5 CM) PIECES

¼ CUP (50 ML) NONFAT DRY MILK

To make meatloaf: Pack the mixture into a 9 x 5 x 3-inch (22 x 12 x 7 cm) loaf pan and bake at 375°F (190°C) for about 90 minutes, until the top is well browned and the internal temperature registers 160°F (71°C).

1½ TEASPOONS (7 ML) KOSHER SALT

½ TEASPOON (2 ML) GROUND NUTMEG

Nutritional information per serving (1 meatball):

Calories 78 (55% from fat) | carb. 2g | pro. 7g | fat 5g | sat. fat 2g | chol. 31mg | sod. 125mg | calc. 20mg | fiber 0g

¼ TEASPOON (1 ML) DRIED THYME

2 LARGE EGGS

⅓ CUP (75 ML) COLD WATER

Nutritional information per serving [11-inch (28 cm) slice meatloaf]:

Calories 376 (55% from fat) | carb. 10g | pro. 31g | fat 22g | sat. fat 8g | chol. 151mg | sod. 601mg | calc. 95mg | fiber 1g

CRAB CAKES

A delicious treat that is easy to make for any occasion.



Makes twelve 3-ounce (85 g) cakes

Approximate preparation time: 10 minutes plus 20 minutes cooking time

16 NONSTICK COOKING SPRAY
16 OUNCES (454 G) LUMP CRABMEAT

Look through crabmeat to make sure there are no shells; reserve in refrigerator. Preheat oven to 400°F (200°C). Coat a baking sheet with nonstick cooking spray.

1 GARLIC CLOVE

Insert the large metal chopping blade into the large work bowl of the Cuisinart® Food Processor. With the machine running, drop the garlic through the small feed tube to chop. Add the peppers, green onion and parsley and pulse to coarsely chop, about 10 to 12 pulses.

1 RED BELL PEPPER, ABOUT 7 OUNCES (200 G), CUT INTO 2-INCH (5 CM) PIECES

3 GREEN ONIONS, CUT INTO 1-INCH (2.5 CM) PIECES

Put the oil into a large skillet placed over medium heat. Cook chopped vegetables with salt and pepper until soft, about 5 to 7 minutes. Remove and reserve in a large mixing bowl.

½ CUP (125 ML) PARSLEY

1 TEASPOON (5 ML) EXTRA VIRGIN OLIVE OIL

Once vegetables have cooled slightly, add the crab, eggs, breadcrumbs, mayonnaise, Worcestershire, Old Bay, Dijon and a dash or two of hot sauce if using to the mixing bowl. Mix thoroughly but carefully, so not to break up the crab too much. Form mixture into 2-inch (5 cm) round cakes.

¼ TEASPOON (1 ML) KOSHER SALT

¼ TEASPOON (1 ML) FRESHLY GROUND PEPPER

2 LARGE EGGS, LIGHTLY BEATEN

Place on prepared baking sheet and bake until crabcakes are evenly golden, about 15 to 20 minutes.

1 CUP (250 ML) BASIC FRESH BREADCRUMBS (PAGE 23)

TIP: Substitute cooked fish fillet for the crab to make tasty fishcakes.

½ CUP (125 ML) MAYONNAISE

1 TEASPOON (7 ML) WORCESTERSHIRE SAUCE

Nutritional information per serving (2 crab cakes):

1½ TEASPOONS (7 ML) OLD BAY SEASONING

Calories 123 (33% from fat) | carb. 11g | pro. 11g | fat 5g | sat. fat 2g | chol. 77mg | sod. 912mg | calc. 54mg | fiber 1g

2 TEASPOONS (10 ML) DIJON-STYLE MUSTARD

HOT SAUCE, OPTIONAL

STUFFED ROASTED PEPPERS

These hearty peppers can also be served as a main course. Serve them with our Simple Tomato Sauce (page 28).

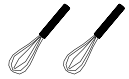

Makes 6 peppers

Approximate preparation time: 65 to 70 minutes, including bake time

Preheat oven to 325°F (160°C). Lightly coat a 13 x 9-inch (33 x 23 cm) pan with nonstick cooking spray.

Insert the large metal chopping blade into the large work bowl of the Cuisinart® Food Processor. With the machine running, drop the garlic through the feed tube to chop. Add the onion, dry milk, parsley, basil, celery seed, salt and pepper and pulse to chop, about 8 to 10 pulses. Remove work bowl and reserve.

Insert the large metal chopping blade into the large work bowl. Add the pork and pulse 10 times, then run machine to finely chop, about 35 seconds.

Place olive oil in large skillet over medium heat. Once oil is heated, add the onion mixture to the skillet, cook until softened, about 5 minutes. Stir in the pork and cook until cooked through, about 10 to 15 minutes; reserve. Stir the breadcrumbs into meat mixture with eggs; combine well. Fill the peppers equally and place in prepared pan. Bake peppers in oven until soft and lightly browned, about 40 to 45 minutes.

Nutritional information per serving:

Calories 324 (42% from fat) | carb. 20g | pro. 27g | fat 15g | sat. fat 4g | chol. 120mg | sod. 631mg | calc. 81mg | fiber 3g

- 4 NONSTICK COOKING SPRAY
- 4 GARLIC CLOVES
- 1 LARGE RED ONION, CUT INTO 1-INCH (2.5 CM) PIECES
- 2 TABLESPOONS (30 ML) NONFAT DRY MILK
- 1 TEASPOON (5 ML) FRESH ITALIAN PARSLEY
- 1 TEASPOON (5 ML) DRIED BASIL
- 1 TEASPOON (5 ML) CELERY SEED
- 2 TEASPOONS (10 ML) KOSHER SALT
- ½ TEASPOON (10 ML) FRESHLY GROUND BLACK PEPPER
- 2¼ POUNDS (1 KG) PORK SHOULDER, CUT INTO 1-INCH 2.5 CM) PIECES
- 3 TABLESPOONS (45 ML) OLIVE OIL
- 5 OUNCES (145 G) [ABOUT 1¼ CUP (300 ML)] BREADCRUMBS, (SEE RECIPE PAGE 23)
- 2 LARGE EGGS
- 10 MEDIUM MULTI-COLOURED PEPPERS, CORED WITH SEEDS REMOVED
- 1 RECIPE SIMPLE TOMATO SAUCE (PAGE 28)

MASHED POTATOES

Try this rich, but not too sinful version of traditional mashed potatoes.



Makes 7½ (1.7 L) cups, fifteen ½-cup (125 ml) servings

Approximate preparation time: 35 minutes

Place the potatoes in a large saucepan and cover with water. Bring to a boil and simmer until potatoes are tender.

Insert the small metal chopping blade into the small work bowl of the Cuisinart® Food Processor. Pulse the chives to finely chop; reserve.

Insert the reversible shredding disc on the fine shredding side into the large work bowl and shred the Parmesan. Reverse the disc to the medium shredding side. Once the potatoes are tender, shred the potatoes. Replace the shredding disc with the large metal chopping blade. Add the butter, salt, and pepper and pulse to combine. Add the milk through the feed tube while pulsing, until incorporated. Add the mascarpone and chives and pulse until just combined. Taste and adjust seasoning accordingly.

Nutritional information per serving:

Calories 160 (35% from fat) | carb. 21g | pro. 5g | fat 6g | sat. fat 4g | chol. 18mg | sod. 211mg | calc. 75mg | fiber 3g

- ¾ POUNDS (1.7 KG) YUKON GOLD POTATOES, PEELED AND CUT INTO 1-INCH (2.5 CM) PIECES
- ¼ BUNCH CHIVES, TRIMMED, DRIED WELL AND CUT INTO 1-INCH (2.5 CM) PIECES
- 1½ OUNCES (43 G) PARMESAN, CUT INTO ½-INCH (1.25 CM) PIECES
- ¼ CUP (50 ML) UNSALTED BUTTER
- ¾ TEASPOON (3.75 ML) KOSHER SALT
- ¾ TEASPOON (3.75 ML) FRESHLY GROUND BLACK PEPPER
- ¾ CUP (175 ML) WHOLE MILK
- ¾ CUP (175 ML) MASCARPONE CHEESE, ROOM TEMPERATURE

CLASSIC WHITE BREAD

Spoil your family with homemade bread.



- 2¼ **TEASPOONS (11 ML)
ACTIVE DRY YEAST**
- 1 **TABLESPOON (15 ML)
GRANULATED SUGAR**
- ⅓ **CUP (75 ML) WARM WATER
(105° TO 110°F (40° TO
43°C))**
- 6 **CUPS (1.5 L) UNBLEACHED,
ALL-PURPOSE FLOUR**
- 6 **TABLESPOONS (90 ML)
UNSALTED BUTTER, CUT
INTO 1-INCH (2.5 CM)
PIECES**
- 2½ **TEASPOONS (13 ML) SALT**
- 1⅔ **CUPS (400 ML)
COLD WATER**
**NONSTICK
COOKING SPRAY**

Makes 24 servings [two 9 x 5-inch (23 x 13 cm) loaves,
1½ pounds (750 g) each]

Approximate preparation time: 10 to 15 minutes, plus
2½ hours rising and resting, 35 minutes baking, and 1 hour or
longer cooling

Dissolve the yeast and sugar in warm water in a large liquid
measuring cup. Let sit until foamy, about 5 minutes.

Insert the dough blade into the large work bowl of the
Cuisinart® Food Processor. Add the flour, butter and salt and
process on the dough speed until combined, about 10 to
15 seconds. Add the cold water to yeast mixture. With the
machine running on dough speed, pour the liquid through the
feed tube as fast as the flour absorbs it. Once the dough
cleans the sides of the work bowl and forms a ball, process for
45 seconds to knead the dough. Dough should be smooth
and elastic.

Place the dough in a lightly floured plastic food storage bag
and seal. Allow to rest in a warm place until doubled in size,
about 1 to 1½ hours.

Lightly coat two 9 x 5-inch (23 x 13 cm) loaf pans with nonstick
cooking spray. Place dough on a lightly floured surface and
punch down; let rest 5 to 10 minutes. Divide dough into two
equal pieces and shape each into a loaf. Place in prepared
pans and cover lightly with plastic wrap. Let rise until dough is
just above the tops of the pans, about 45 minutes to 1 hour.

Preheat oven to 400°F (200°C).

Bake until the tops are browned and loaf sounds hollow when
tapped, about 30 to 35 minutes. Remove from pans and cool
on wire rack.

Nutritional information per slice:

*Calories 139 (19% from fat) | carb. 25g | pro. 3g | fat 3g |
sat. fat 2g | chol. 8mg | sod. 243mg | calc. 30mg | fiber 1g*

CLASSIC WHEAT BREAD

The nutty flavour of whole wheat makes this bread a favourite.



- 2¼ **TEASPOONS (11.25 ML)
ACTIVE DRY YEAST**
- 1 **TABLESPOON (15 ML) PLUS
1 TEASPOON (5 ML)
GRANULATED SUGAR**
- ⅓ **CUP (75 ML) WARM WATER
(105° TO 110°F (40° TO
43°C))**
- 2 **CUPS (500 ML)
UNBLEACHED,
ALL-PURPOSE FLOUR**
- 2 **CUPS (500 ML) WHOLE
WHEAT FLOUR**
- 4 **TABLESPOONS (60 ML)
UNSALTED BUTTER, CUT
INTO 1-INCH (2.5 CM)
PIECES**
- ½ **TABLESPOON (7 ML) SALT**
- 1 **CUP (250 ML) COLD WATER**
NONSTICK COOKING SPRAY

Makes 12 servings (one 9 x 5-inch (23 x 13 cm) loaf)

Approximate preparation time: 10 to 15 minutes, plus
2½ hours rising and resting, 35 minutes baking, and 1 hour or
longer cooling

Dissolve the yeast and sugar in warm water in a large liquid
measuring cup. Let sit until foamy, about 5 minutes.

Insert the dough blade into the large work bowl of the
Cuisinart® Food Processor. Add the flours, butter and salt and
process until combined, about 10 to 15 seconds. Add the
cold water to the yeast mixture. With the machine running,
pour the liquid through the feed tube as fast as the flour
absorbs it. Once the dough cleans the sides of the work bowl
and forms a ball, process for 45 seconds to knead dough.
Dough should be smooth and elastic.

Place the dough in a lightly floured plastic food storage bag
and seal. Allow to rest in a warm place until doubled in size,
about 1 to 1½ hours.

Lightly coat a 9 x 5-inch (23 x 13 cm) loaf pan with nonstick
cooking spray. Place dough on a lightly floured surface and
punch down; let rest 5 to 10 minutes. Shape the dough into a
loaf. Place in prepared pan and cover lightly with plastic wrap.
Let rise until dough is just above the tops of the pans, about
45 minutes to 1 hour.

Preheat oven to 400°F (200°C).

Bake until the top is browned and loaf sounds hollow when
tapped, about 30 to 35 minutes. Remove from pan and cool
on wire rack.

Nutritional information per serving (1 slice):

*Calories 135 (20% from fat) | carb. 23g | pro. 4g | fat 3g |
sat. fat 2g | chol. 8mg | sod. 244mg | calc. 30mg | fiber 3g*

SESAME DINNER ROLLS

Fresh from the oven, warm rolls make any dinner extra special.

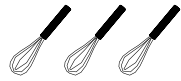

- 1¼ CUPS [300 ML (12-OUNCE CAN)] EVAPORATED LOW-FAT MILK
- 4½ TEASPOONS (23 ML) ACTIVE DRY YEAST
- 3 TABLESPOONS (45 ML) GRANULATED SUGAR
- 2 LARGE EGGS, BEATEN
- 5¾ CUPS (1.3 L) UNBLEACHED, ALL-PURPOSE FLOUR
- 1 STICK PLUS 6 TABLESPOONS (90 ML) UNSALTED BUTTER, CUT INTO 1-INCH (2.5 CM) PIECES
- 2 TEASPOONS (10 ML) KOSHER SALT
- NONSTICK COOKING SPRAY
- 1 LARGE EGG
- 1 TEASPOON (5 ML) WATER
- 2 TEASPOONS (10 ML) SESAME SEEDS

Makes 32 rolls

 Approximate preparation time: 20 to 25 minutes, plus 2½ hours rising, 40 minutes baking, and 10 to 15 minutes cooling

In a small saucepan over medium heat, warm milk to 105° to 110°F (41° to 43°C). Remove from heat. Add yeast and sugar; stir to dissolve and let sit until foamy, about 5 minutes. Add beaten eggs; stir gently to combine. Transfer to a 2-cup (500 ml) measuring cup and reserve.

Insert the dough blade into the large work bowl of the Cuisinart® Food Processor. Add the flour, butter and salt and process on dough speed until combined, about 15 to 20 seconds. With the machine running on dough speed, pour the yeast mixture through the feed tube in a steady stream as fast as the flour absorbs it. After the dough forms a ball, process 45 seconds to knead. Dough should be smooth and elastic.

Place the dough in a lightly floured plastic food storage bag and seal. Let rise until doubled in size, about 1 to 1½ hours.

Lightly coat three 8-inch (20 cm) round baking pans with nonstick cooking spray. Place dough on a lightly floured surface and punch down; let rest 5 to 10 minutes. Divide dough into 32 equal pieces (each about 1 ounce (30 g)) and shape each piece into a ball. Place 16 balls, just touching, into each pan. Cover loosely with plastic and let rise 1 hour.

Preheat oven to 350°F (180°C).

Combine egg and water. Brush over rolls and sprinkle with sesame seeds. Bake in preheated oven until golden, about 35 to 40 minutes. Cool on wire rack.

Nutritional information per serving roll:

Calories 150 (36% from fat) | carb. 20g | pro. 4g | fat 6g | sat. fat 3g | chol. 34mg | sod. 164mg | calc. 30mg | fiber 1g

POPOVERS

Eat the popovers hot out of the oven to fully appreciate their delicious texture.



- 2¼ CUPS (550 ML) UNBLEACHED, ALL-PURPOSE FLOUR
- 2½ CUPS (625 ML) EVAPORATED MILK
- 6 LARGE EGGS
- 3 TABLESPOONS (45 ML) UNSALTED BUTTER, MELTED
- 1 TEASPOON (5 ML) SEA SALT
- BUTTER OR NONSTICK COOKING SPRAY FOR PAN

Makes 18 popovers

 Approximate preparation time: 5 minutes plus 45 minutes for resting and 50 minutes for baking

Insert the large metal chopping blade into the large work bowl of the Cuisinart® Food Processor. Add the flour, milk, eggs, butter and salt and process ingredients together until completely smooth, about 20 to 30 seconds. Transfer to a large mixing bowl and allow to rest at room temperature for about 30 to 45 minutes.

Preheat oven to 450°F (230°C) (use convection bake if available). With butter or nonstick cooking spray, heavily butter or coat eighteen 5-ounce ramekins or muffin cups and place on two baking sheets. Fill each ramekin with about ⅓ cup (75 ml) of batter. Place in oven and bake for 30 minutes. Lower the heat to 350°F (180°C) and bake for an additional 20 minutes. Remove from oven and carefully remove popovers from ramekins. Serve immediately.

Nutritional information per popover:

Calories 136 (39% from fat) | carb. 14g | pro. 6g | fat 6g | sat. fat 3g | chol. 87mg | sod. 188mg | calc. 98mg | fiber 0g

CLASSIC CHEESECAKE

This simple recipe produces perfect cheesecake every time.

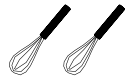

- BUTTER TO PREPARE THE PAN**
- 1 **RECIPE GRAHAM CRACKER CRUST (BELOW)**
- 24 **OUNCES (680 G) CREAM CHEESE, ROOM TEMPERATURE**
- 1½ **CUPS (375 ML) GRANULATED SUGAR**
- ½ **TEASPOON (2 ML) SALT**
- 4 **LARGE EGGS, ROOM TEMPERATURE**
- 1 **TEASPOON (5 ML) PURE VANILLA EXTRACT**
- ¾ **CUP (175 ML) RICOTTA, ROOM TEMPERATURE**
- ¾ **CUP (175 ML) SOUR CREAM, ROOM TEMPERATURE**

Makes one 9-inch (23 cm) cake, 12 servings

⌚ Approximate preparation time: 15 minutes, plus 3 hours baking/resting and 6-plus hours cooling

Preheat oven to 325°F (160°C). Place a large roasting pan on bottom rack of oven and fill with 1 to 2 inches (2.5 to 5 cm) of water.

Butter one 9-inch (23 cm) springform pan.

Prepare the graham cracker crust according to recipe below.

Press the graham cracker crust evenly into the prepared pan. Insert the large metal chopping blade into the large work bowl of the Cuisinart® Food Processor. Cut each block of cream cheese into 6 pieces and place into the work bowl; pulse 10 times and then process for 45 seconds. Scrape the bowl and add the sugar and salt; process for an additional 30 to 45 seconds until smooth. With the machine running, add the eggs one at a time with the vanilla, until *just* incorporated. Add the ricotta and sour cream and pulse until all ingredients are *just* incorporated and homogenous, scraping the bowl as necessary.

Pour filling evenly into the prepared pan and bake in the middle of the oven. Add more water to roasting pan if any has evaporated. Bake for 1 hour. Turn the oven off and let the cake rest in the oven. Do not open the oven door until 2 hours have elapsed.

Remove cheesecake and place on a cooling rack. Once completely cool, wrap well with plastic and refrigerate for at least 6 hours before serving.

Serve with fresh berries and Raspberry Sauce (page 58).

Nutritional information per serving:

Calories 456 (60% from fat) | carb. 38g | pro. 8g | fat 31g | sat. fat 18g | chol. 154mg | sod. 391mg | calc. 72mg | fiber 1g

GRAHAM CRACKER CRUST



- 9 **OUNCES (255 G) GRAHAM CRACKERS (ABOUT 2 SLEEVES)**
- 1 **TEASPOON (5 ML) GROUND CINNAMON**
- ¼ **CUP (125 ML) GRANULATED SUGAR**
- 6 **TABLESPOONS (90 ML) UNSALTED BUTTER, MELTED**

Makes one 9-inch (23 cm) pie crust, 12 servings

⌚ Approximate preparation time: 2 minutes

Insert the large metal chopping blade into the large work bowl of the Cuisinart® Food Processor. Break crackers in fours and place in the work bowl; pulse until finely chopped, about 10 to 12 long pulses. Add the cinnamon and sugar and process for 15 seconds. Add the butter and process until ingredients are well combined, about 45 seconds.

Press even amounts of crust into a 9-inch (23 cm) pie or cake plate.

Nutritional information per serving:

Calories 78 (44% from fat) | carb. 10g | pro. 1g | fat 4g | sat. fat 2g | chol. 8mg | sod. 64mg | calc. 4mg | fiber 0g

APPLE CRUMB PIE

The adjustable slicing disc makes preparing this pie a breeze.



- ½ **RECIPE SWEET PÂTE BRISÉE DOUGH (PAGE 33)**
- 5 **LARGE APPLES (GOLDEN DELICIOUS, GINGER GOLD, OR OTHER SIMILAR APPLES), PEELED, CORED AND HALVED**
- JUICE OF 2 LEMONS**
- 1 **TEASPOON (5 ML) VANILLA PASTE**
- ½ **CUP (125 ML) GRANULATED SUGAR**
- 2 **TABLESPOONS (30 ML) APRICOT JAM**
- 1 **RECIPE CRUMB PIE TOPPING (BELOW)**

Makes one 9-inch (23 cm) deep-dish pie, 8 to 12 servings

⌚ Approximate preparation time: 55 to 65 minutes, including baking time

Preheat oven to 350°F (180°C).

Roll out dough into a 10-inch (25 cm) disc. Fit into an ungreased, 9-inch (23 cm), 1½-quart (1.4 L) ceramic pie baker. Chill in refrigerator for about 20 minutes.

Insert the slicing disc assembly, adjusted to 4mm, into the large work bowl of the Cuisinart® Food Processor and slice the apples.

In a large bowl, toss the apples, lemon juice, vanilla paste, and sugar together. Carefully spread the jam on the bottom of the chilled pie shell, then fan the apples in layers.

Top the pie evenly with the crumb topping and bake for 40 to 50 minutes, or until the top of the pie is a dark golden brown.

Nutritional information per serving (based on 12 servings):

Calories 166 (8% from fat) | carb. 36g | pro. 3g | fat 1g | sat. fat 0g | chol. 36mg | sod. 225mg | calc. 10mg | fiber 2g

CRUMB PIE TOPPING

Pair this topping with our Apple Crumb Pie recipe, or any fruit-filled pie.



- 1/3 CUP (75 ML) TOASTED PECANS
- 3/4 CUP (175 ML) UNBLEACHED, ALL-PURPOSE FLOUR
- 1/3 CUP (175 ML) UNSALTED BUTTER, COLD AND CUT INTO CUBES
- 1 1/4 TEASPOONS (6 ML) GROUND CINNAMON
- 1/4 TEASPOON (1 ML) SALT

Makes enough crumb topping for one pie

Approximate preparation time: 3 minutes

Insert the small metal chopping blade into the small work bowl of the Cuisinart® Food Processor. Add the pecans and pulse to roughly chop. Add remaining ingredients and pulse until mixture is well combined – mixture should resemble crumbs.

Nutritional information per serving (based on 12 servings):

Calories 89 (69% from fat) | carb. 6g | pro. 1g | fat 7g | sat. fat 3g | chol. 13mg | sod. 44mg | calc. 5mg | fiber 1g

BANANA CREAM PIE

Everyone will love this Southern-inspired dessert.



- 1 RECIPE CHOCOLATE COOKIE CRUST (BELOW)
- 4 MEDIUM BANANAS
- 1/4 TEASPOON (1 ML) GROUND CINNAMON
- 1 RECIPE LIGHTER PASTRY CREAM (PAGE 60)

Makes one 9-inch (23 cm) pie, 16 servings

Approximate preparation time: 50 minutes, including pastry cream; allow 2 hours for chilling

Preheat oven to 375°F (190°C).

Prepare Chocolate Cookie Crust according to recipe below.

Insert the slicing disc, adjusted to 4mm, into the large work bowl of the Cuisinart® Food Processor and slice the bananas.

Gently fold the bananas and cinnamon into the prepared lightened pastry cream. Pour the banana pastry cream equally into the baked, cooled cookie crust and chill for at least 2 hours before serving.

Nutritional information per serving:

Calories 315 (52% from fat) | carb. 35g | pro. 4g | fat 19g | sat. fat 11g | chol. 111mg | sod. 177mg | calc. 61mg | fiber 2g

CHOCOLATE COOKIE CRUST

We love this with our Banana Cream Pie, but it also makes a cheesecake even more decadent.



- 24 CHOCOLATE WAFERS, ABOUT 1/2 BOX
- 2 TEASPOONS GRANULATED SUGAR
- 1/4 CUP (50 ML) UNSALTED BUTTER, MELTED

Makes 1 cup (250 ml), 12 servings

Approximate preparation time: 1 minute plus 15 minutes for baking time

Insert the large metal chopping blade into the large work bowl of the Cuisinart® Food Processor. Add the cookies and pulse 10 times. Add the sugar and pulse an additional 5 times. With the machine running, drizzle in the melted butter until incorporated.

Press crust into a 9-inch (23 cm) pie or cake plate and bake in a 375°F (190°C) oven for 15 minutes before filling.

Nutritional information per serving:

Calories 85 (55% from fat) | carb. 9g | pro. 1g | fat 5g | gras sat. fat 3g | chol. 10mg | sod. 65mg | calc. 3mg | fiber 0g

PASTRY CREAM

This all-purpose pastry cream is a great foundation for fresh fruit tarts – the food processor makes it easy.



- 1½ CUPS (375 ML) MILK
- ½ CUP (125 ML) HEAVY CREAM
- ½ CUP (125 ML) GRANULATED SUGAR, DIVIDED
- ½ TEASPOON (2 ML) SALT
- ½ TABLESPOON (7 ML) PURE VANILLA EXTRACT
- 4 LARGE EGG YOLKS
- 2 TABLESPOONS (30 ML) CORNSTARCH

FOR A LIGHTER PASTRY CREAM:

- ½ CUP (125 ML) HEAVY CREAM
- 1½ TABLESPOONS (25 ML) CONFECTIONERS' SUGAR

Makes about 2¼ (550 ml) cups

 Approximate preparation time: 25 minutes, including cooking time

Put the milk, cream, ¼ cup (50 ml) sugar, salt and vanilla into a saucepan over medium heat. Bring mixture to a heavy simmer.

Insert the large metal chopping blade into the large work bowl of the Cuisinart® Food Processor. Add the yolks, cornstarch and remaining sugar; process for 1 minute until mixture is light and thick.

With the machine running, pour ¾ to 1½ cups (175 to 375 ml) of the milk mixture slowly through the feed tube and process mixture for about 1 minute.

Return mixture to the saucepan over medium heat. Bring to a boil and cook while whisking continuously for about 2½ minutes until thickened. Strain mixture through a fine mesh strainer into the large work bowl fitted with the large metal chopping blade. Process for 5 minutes. Pour mixture into a clean mixing bowl; cover directly with plastic wrap and cool before using.

For a lighter pastry cream: whip the ½ cup (125 ml) of heavy cream to medium peaks with 1½ tablespoons (25 ml) of confectioners' sugar. Fold into pastry cream once completely cool.

Nutritional information per serving [2 tablespoons (30 ml)]:

Calories 72 (50% from fat) | carb. 8g | pro. 1g | fat 4g | sat. fat 2g | chol. 58mg | sod. 72mg | calc. 32mg | fiber 0g

DEEP CHOCOLATE LAYER CAKE

Frost this deep and rich chocolate cake with Cream Cheese Frosting (following page).



- BUTTER TO PREPARE THE PANS**
- 2 CUPS (500 ML) UNBLEACHED, ALL-PURPOSE FLOUR
- ¾ TEASPOON (3.75 ML) BAKING SODA
- ½ TEASPOON (2 ML) BAKING POWDER
- ½ TEASPOON (2 ML) SALT
- ¾ CUP (175 ML) GRANULATED SUGAR
- ¾ CUP (175 ML) BROWN SUGAR
- 5 OUNCES (145 G) BITTERSWEET CHOCOLATE, CHOPPED
- ¾ CUP (175 ML) UNSWEETENED COCOA POWDER
- ½ TABLESPOON (7 ML) ESPRESSO POWDER
- 1 CUP (250 ML) BOILING WATER
- 1 CUP (250 ML) [½ POUND (250 G) ; 2 STICKS] UNSALTED BUTTER, MELTED AND COOLED
- ¾ CUP (175 ML) BUTTERMILK
- 3 LARGE EGGS
- ½ TABLESPOON (7 ML) PURE VANILLA EXTRACT

Makes two 9-inch (23 cm) cakes (one 2- or 4-layer cake), 12 servings

 Approximate preparation time: 15 minutes, plus 50 minutes to bake, plus cooling time

Preheat oven to 350°F (180°C). Coat two 9-inch (23 cm) round pans with butter and cut rounds of parchment paper to fit the bottoms of each pan.

Insert the large metal chopping blade into the large work bowl of the Cuisinart® Food Processor. Add the flour, baking soda, baking powder, salt and sugars and pulse 10 times and then process for 20 seconds to sift.

Place the bittersweet chocolate, cocoa powder and espresso powder into a small bowl and pour the boiling water over ingredients and stir to combine; reserve.

With the machine running, slowly pour the butter through the feed tube. Continue pouring the buttermilk, eggs, and vanilla through the feed tube until ingredients are just combined. Pour the chocolate mixture evenly over the batter and pulse to completely incorporate.

Divide the batter evenly between the two prepared pans. Bake in oven for 45 to 50 minutes, until a cake tester comes out just clean.

Let pans rest on cooling racks for 15 minutes. Remove cake from pans but leave on the racks until completely cool. Once cool, cut each layer in half horizontally to frost with Cream Cheese Frosting and build a four-layer cake, or leave the layers as is and make a thick two-layer cake.

Nutritional information per serving:

Calories 258 (23% from fat) | carb. 49g | pro. 6g | fat 7g | sat. fat 3g | chol. 54mg | sod. 224mg | calc. 38mg | fiber 3g

DESSERT CRÊPES WITH BERRIES

Crêpe-making takes some practice, but once you get the technique down, it is all worth it.



Makes 6 servings

Approximate preparation time: 25 minutes, not including resting the batter

SWEET CRÊPE BATTER:

- 3 LARGE EGGS
- ¾ CUP (175 ML) UNBLEACHED, ALL-PURPOSE FLOUR
- ½ TEASPOON (2 ML) SALT
- 2 TABLESPOONS (30 ML) GRANULATED SUGAR
- 1 TEASPOON (5 ML) PURE VANILLA EXTRACT
- 1 CUP (250 ML) WHOLE MILK
- ¼ CUP (50 ML) (½ STICK) UNSALTED BUTTER, MELTED

Insert the large metal chopping blade into the large work bowl of the Cuisinart® Food Processor. With the machine running, add the eggs to the work bowl. Stir together the flour, salt and sugar and add to the work bowl and mix until just combined.

With the machine running, add the vanilla, milk and butter together and process until homogenous. Transfer mixture to a container; cover and let rest in the refrigerator for 2 hours or overnight.

Insert the small metal chopping blade into the small work bowl and add the berries, orange zest and sugar. Process until completely puréed. Strain the purée through a fine mesh strainer and discard the seeds; reserve.

BERRIES:

- 2 CUPS (500 ML) MIXED FRESH BERRIES
- ¼ TEASPOON (1 ML) ORANGE ZEST
- 2 TEASPOONS (10 ML) GRANULATED SUGAR

Insert the large metal chopping blade into the clean large work bowl and add the mascarpone cream ingredients; process until all ingredients are well incorporated, about 15 seconds. Reserve.

Prepare the crêpes. Place an 8-inch (20 cm) skillet over medium heat and preheat for 5 minutes. Once the pan is heated, add the butter. Once melted, wipe the butter around the pan with a paper towel. Add a scant 3 tablespoons (45 ml) of batter to the preheated pan. Working very quickly, move the batter around so it just coats the bottom. You want the pan to be coated thinly and evenly. After about 1 minute, when the crêpe is set and lightly browned, flip the crêpe with a heatproof spatula and cook for an additional minute on the second side. Reserve on a plate. Continue with the remaining batter, stacking the crêpes as you go. When all of the crêpes are prepared, cover plate with foil – to keep crepes warm, place plate over a skillet containing some water over medium-low heat.

To serve crêpes: spread ½ tablespoons (25 ml) of mascarpone cream and about 1 tablespoon (15 ml) of the puréed berries on each crêpe and fold into thirds. Place three crêpes on each plate and dust with confectioner's sugar and reserved berry purée.

Nutritional information per serving:

Calories 393 (56% from fat) | carb. 35g | pro. 9g | fat 25g | sat. fat 15g | chol. 172mg | sod. 342mg | calc. 98mg | fiber 1g

RASPBERRY SAUCE

This raspberry sauce works well with many desserts.



Makes 2 cups (500 ml)

Approximate preparation time: 5 minutes

- 3 CUPS (750 ML) FROZEN RASPBERRIES, THAWED
- 1 CUP (250 ML) FRESH RASPBERRIES
- 2 TABLESPOONS (30 ML) GRANULATED SUGAR
- PINCH SALT
- ¼ TEASPOON (1 ML) ORANGE-ZEST

Insert the large metal chopping blade into the large work bowl of the Cuisinart® Food Processor. Add both raspberries and process for 15 seconds. Add remaining ingredients and process for an additional 45 seconds. Strain through a fine mesh strainer and discard the seeds. Taste and adjust sugar amount to personal preference.

Nutritional information per 2 tablespoons (30 ml) :

Calories 21 (0% from fat) | carb. 6g | pro. 0g | fat 0g | sat. fat 0g | chol. 0mg | sod. 0mg | calc. 6mg | fiber 2g

Cuisinart®



Food
Processors



Juicers



Coffeemakers



Cookware



Tools and
Gadgets

Cuisinart™ offers an extensive assortment of top quality products to make life in the kitchen easier than ever. Try some of our other countertop appliances and cookware, and Savour the Good Life®.

www.cuisinart.ca

©2016 Cuisinart Canada
100 Conair Parkway,
Woodbridge, Ontario L4H 0L2
Consumer Call Centre E-mail:
Consumer_Canada@Conair.com

Printed in China

15CC018118

Trademarks or service marks of third parties referred to herein are the trademarks or service marks of their respective owners.

IB-13083-CAN