

# Roof Curbs, Extensions and Equipment Supports



BUILDING VALUE IN AIR.



November  
2019

## Table of Contents

Model GPI Construction Features . . . . .	3	Sound Curbs . . . . .	6
Model Number Code . . . . .	4	Pitched and Ridged Curbs . . . . .	6
Roof Curb Models . . . . .	4	Dimensional Data . . . . .	7
Special Purpose Roof Curbs . . . . .	5	Typical Installation . . . . .	8
Equipment Supports and Curb Extensions . . . . .	5		



Prefabricated roof curbs reduce installation time and costs by ensuring compatibility between the fan, curb and roof opening. A wide variety of roof curbs are available including: flanged, straight-sided, canted, pitched, ridged, vented, and sound-absorbing.

Extensions raise the fan discharge and can provide an accessible mounting location for dampers. Insect screen bases and vented extensions are also available.

### Enjoy Greenheck's extraordinary service, before, during and after the sale.



Greenheck offers added value to our wide selection of top performing, energy-efficient products by providing several unique Greenheck service programs.

- Our Quick Delivery Program ensures shipment of our in-stock products within 24 hours of placing your order. Our Quick Build made-to-order products can be produced in 1-3-5-10-15-20 or 25-day production cycles, depending upon their complexity.
- eCAPS® online selection guides you to choose the best value product for your building projects. It includes fan, louver and dedicated outdoor air systems (DOAS) selection, as well as a damper guide, and toolbox.
- Greenheck's free Computer Aided Product Selection program (CAPS®), rated by many as the best in the industry, helps you conveniently and efficiently select the right products for the challenge at hand.
- Greenheck continues to take an industry-wide leadership position to affect positive global sustainability. We believe that providing education on products we offer contributes to reducing energy consumption and improving healthier indoor environments.
- Our 3D service allows you to download, at no charge, easy-to-use AutoDesk® Revit® 3D drawings for many of our ventilation products.

Find out more about these special Greenheck services at [greenheck.com](http://greenheck.com)

# Model GPI Construction Features



**Construction** - Curb sizes under 50 inches (1270 mm) square are 18-gauge galvanized steel or 0.063 aluminum. Curb sizes 50 inches (1270 mm) square and greater are 16-gauge galvanized steel or 0.080 aluminum.

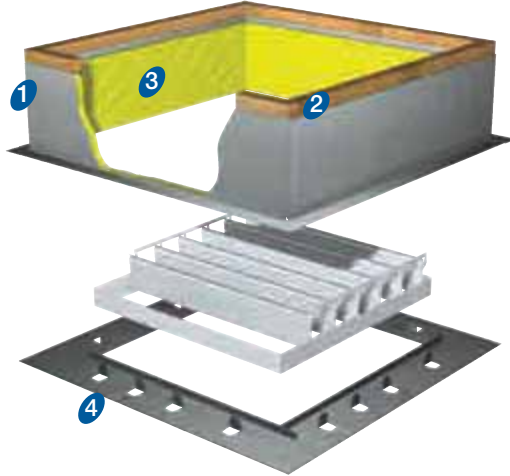

- 1 Formed Body Curb** - Curbs are formed and welded to ensure a strong square curb.
- 2 Lap Joints** - Wood nailers attached to GPI curbs consist of notched and lapped joints to ensure strength and durability.
- 3 Insulation** - Ridged fiberglass insulation is standard on all GPI curbs. Three pound density insulation is available in 1 or 1½ inch (25 or 38 mm) thicknesses.
- 4 Optional Damper Tray** - Designed to hold a standard Greenheck damper. The design includes flanges, which allow the damper to be placed in the tray and fastened.

**Optional Security Bars** - Security bars are available up to 72 by 72 inches (1829 x 1829 mm) to prevent unlawful entry. The bars consist of 2 inch (51 mm) 12-gauge flat steel bar, slotted and welded 6 inches (152 mm) apart from one another.

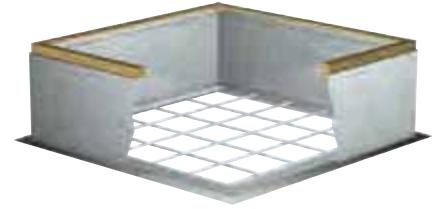

**Optional Liner (Double Shell)** - Available for installations where it is not desirable for insulation to be exposed to the airstream.

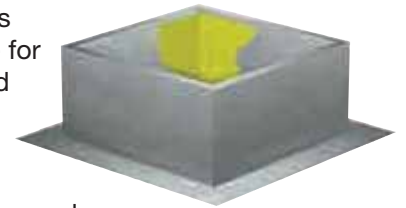

### Optional Coatings -

A wide variety of coatings and colors are available. Decorative coatings are available in seven standard colors. Protective coatings are available in four electrostatically applied powders providing a selection for most environments.



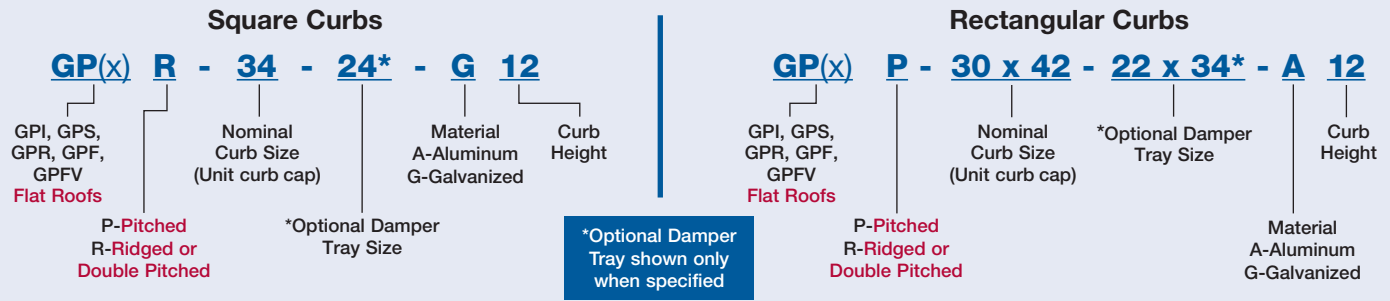

*All coatings and relative resistance charts can be found in Greenheck's Product Application Guide, Performance Coatings for Ventilation Products.*

FEATURE AVAILABILITY		MATERIAL AVAILABILITY		INSULATION (INCHES)	DAMPER TRAY	SECURITY BARS	LINER (DOUBLE SHELL)	CURB SEAL	COATINGS
		GALVANIZED	ALUMINUM						
FLAT ROOF	GPI / GPF / GPS / GPR	✓	✓	1, 1½	✓	✓	✓	✓	✓
FLAT ROOF - VENTED	GPFV	✓	✓	-	-	-	-	✓	✓
FLAT ROOF - HEAVY DUTY	GPFHD	✓	-	1	✓	-	✓	✓	✓
FLAT ROOF - HEAVY LOAD	GPFHL	✓	✓	1	✓	-	✓	✓	✓
FLAT ROOF - SOUND CURB	ATS / ATR / ATI	✓	✓	1, 1½	STANDARD	-	-	✓	✓
PITCHED OR RIDGED ROOF	GPIP / GPIR / GPPF	✓	✓	1, 1½	✓	-	✓	✓	✓
	GPFRR	✓	✓	1, 1½	✓	-	-	✓	✓
PITCHED OR RIDGED ROOF - SOUND CURB	ATIP / ATIR	✓	✓	1, 1½	-	-	-	✓	✓
CURB EXTENSION - EXTENDED BASES MOUNTS BETWEEN THE FAN AND ROOF CURB	GPE	✓	✓	-	STANDARD	-	-	✓	✓
	ATE	✓	✓	-	STANDARD	-	-	✓	✓
	VCE	✓	✓	-	-	-	-	✓	✓
	ISB	✓	✓	-	-	-	-	✓	✓
	GPEX	✓	✓	-	-	-	-	✓	✓
EQUIPMENT SUPPORTS	GESS / GESR	✓	✓	-	-	-	-	✓	✓
ADAPTER	ADAPTER	✓	✓	-	-	-	-	✓	✓



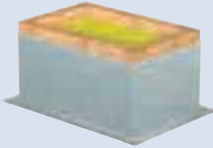
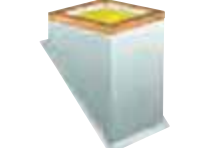
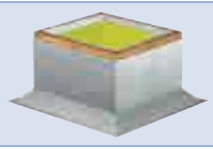
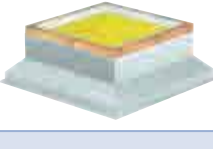
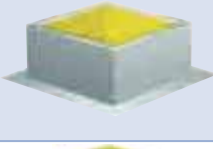



All curbs featured on this page are standard 18-gauge steel and mount directly to the roof deck structure. Roofing material to be sealed to the top of the wood nailer for weather tightness or sealed to the flashing flange of the curb. See page three for additional construction and available accessory features for all Greenheck curb models.

Roof Curbs	Description	1 inch (25 mm) Insulation	Lap-Jointed Wooden Nailer	Flashing Flange	Available Heights Inches (mm)
	<b>GPI</b> for flat roofs. Fully formed on three sides with a single, fully welded seam when dimension is (L+Wx2) <118 inches (2997 mm). Larger sizes are a fully welded assembly.	✓	✓	2 inches 51 mm	12 to 42 (305 to 1067)
	<b>GPIP</b> for pitched roofs <b>GPIR</b> for ridged or double pitch roofs Fully welded on all four sides.	✓	✓	2 inches 51 mm	12 to 24 (305 to 610)
	<b>GPS</b> for flat roofs. Canted design is recommended when smaller roof openings are desired and aids in transition of roof material from the deck to the wood nailer. Fully welded on all four sides.	✓	✓	1½ inch 28.58 mm	8 to 20 (203 to 508)
	<b>GPR</b> with raised cant for flat roofs. Raised cant is available up to 6 inches (152 mm) in height for deck insulation. Cant provides transition from surface insulation to wood nailer. Fully welded on all four sides.	✓	✓	1½ inch 28.58 mm	8 to 20 (203 to 508)
	<b>GPF</b> for flat roofs. Curbs are used for high wind/seismic applications - see fan details for more information. Fully formed on three sides with a single, fully welded seam when dimension (L+Wx2) <118 inches (2997 mm). Larger sizes are a fully welded assembly.	✓	-	5 inches 127 mm	8 to 42 (203 to 1067)
	<b>GPFV</b> for pitched roofs <b>GPFV</b> for ridged or double pitch roofs Used for high wind/seismic applications - see fan details for more information. Fully welded on all four sides.	✓	-	5 inches 127 mm	8 to 24 (203 to 610)
	<b>GPFV</b> vented roof curb for flat roofs for kitchen applications. Vents allow hot air and gases to escape between the ductwork and roof curb. Curb is designed to provide the required 40 inch (1016 mm) minimum discharge height above the roof line per NFPA 96. Curb is fully formed on three sides with a single, fully welded seam when dimension is (L+Wx2) <118 inches (2997 mm). Larger sizes are fully welded.	-	-	5 inches 127 mm	Available in nine sizes.

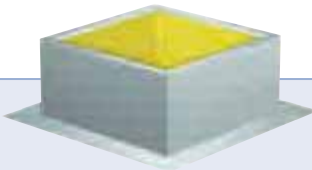
# Special Purpose Roof Curbs, Equipment Supports, Curb Extensions

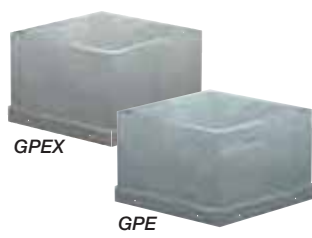
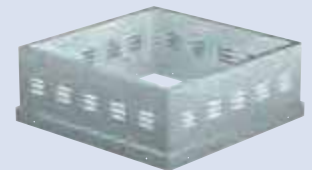

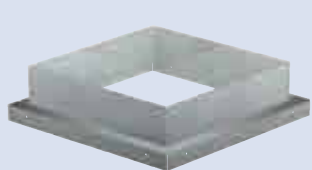

Special Purpose Roof Curbs	Description	1 inch (25 mm) Insulation	Flashing Flange	Available Heights Inches (mm)
	<p><b>GPFHL for heavy load applications.</b> Its construction is intended to support compression loads exceeding 1,000 pounds (454 kg). GPFHL is mounted directly to the roof deck structure, and the roofing material is brought to the vertical surface and sealed to the flashing flange. Additional standard construction features include 14-gauge galvanized steel and internal vertical support members.</p>	✓	5 inches 127 mm	12 to 24 (305 to 610)
	<p><b>GPFHD for supporting heavy load equipment in severe duty, high wind and seismic applications.</b> The double thick flashing flange provides an extremely durable surface to secure the curb to the building structure. The roofing material is brought to the vertical surface and sealed to the flashing flange. Additional standard construction features include 12-gauge galvanized steel and internal vertical support members.</p>	✓	Double Thick 5 inches 127 mm	12 to 24 (305 to 610)
Equipment Supports	Description	Available Heights and Widths		
	<p><b>GESS and GESR.</b> These equipment supports are designed for use on both insulated (GESR) and non-insulated (GESS) flat roof decks. They are mounted directly to the deck structure, then roofed and flashed for weather tightness. Models GESS and GESR are available in welded aluminum or galvanized steel.</p>	<p>Heights of 8, 12 and 14 inches (203, 305 and 356 mm)</p> <p>Widths of 4, 6 and 8 inches (102, 152 and 203 mm)</p>		
Curb Extensions	Description			
	<p><b>GPE and GPEX.</b> The extended base models mount between the fan and roof curb. Models consist of welded aluminum or galvanized steel. The GPE is designed with an access door to provide easy access to the damper and damper actuator as well as fulfilling additional height requirements. The GPEX is also designed to provide additional height.</p>		<p>Heights of 12 to 24 inches (305 to 610 mm) in ½ inch (13 mm) increments.</p>	
	<p><b>VCE.</b> A vented curb extension is typically used in kitchen applications where the vents allow hot air and gases to escape between the ductwork and the roof curb. Designed for use with an 8 inch (203 mm) high roof curb and Greenheck fan models CUBE, CUE or USGF to provide the required 40 inch (1016 mm) minimum discharge height above the roof line per NFPA 96. Model VCE consists of galvanized steel or welded aluminum.</p>			
	<p><b>ISB.</b> Insect screen bases are available for applications where the building must be completely free of insects, as in food processing operations. Insect screen bases mount between the fan and the roof curb and provide an additional 6 inches (152 mm) of height. Two bolted access doors are provided for removal and cleaning of the screen. Model ISB is constructed of galvanized steel or aluminum with a fine mesh screen made of aluminum or stainless steel.</p>			
	<p><b>Adapters and Reducers.</b> Use to adapt or reduce the standard fan curb cap dimensions to a non-standard specified curb size. Adapters available to match a curb size within 20 inches (508 mm) of standard. Reducers available to match a curb size within 10 inches (254 mm) of standard. Adapters and reducers are most commonly used to match new fans to existing roof curbs. Construction consists of welded galvanized steel or aluminum.</p>			

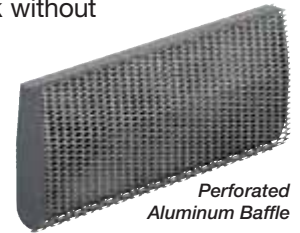
**AT Sound Curbs** are designed to reduce fan generated sound from traveling down ductwork without adversely affecting fan performance. Air passes between the streamlined baffles allowing fan sound to be absorbed and dissipated within the curb area preventing it from entering the building. Each perforated aluminum baffle section is filled with fiberglass wool. Spring steel wire holding clips secure the aluminum baffle. Assembly is a rigid, durable section which will not warp or twist out of shape. Permanently constructed baffles are easy to remove for access to dampers or for occasional cleaning. No tools are required. Slight pressure is required to spread the spring wire to release it.

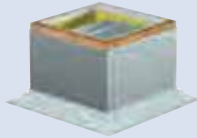
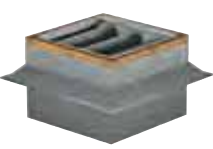
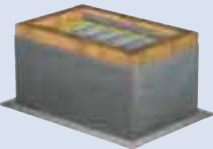

Standard construction features for sound curbs are 18-gauge steel and one inch (25 mm) insulation. Sound curbs mount directly to the roof deck structure. Roofing material to be sealed to the top of the lap-jointed wooden nailer for weather tightness.

Sound Curbs	Description	Flashing Flange	Available Heights
	<b>ATS for flat roofs.</b> The canted design is recommended when smaller roof openings are desired and aid in the transition of roofing material from deck to the wood nailer. Fully welded on all four sides.	1 1/8 inch 28.58 mm	18 inches (457 mm)
	<b>ATR for flat roofs.</b> Curb body is recessed into the roof achieving a lower overall height. Roof openings must be as large as the curb body. Canted design aids in the transition of roofing material from deck to the wood nailer. Fully welded on all four sides.	1 1/8 inch 28.58 mm	18 inches (457 mm) OVERALL HEIGHT Mounted nine inches (229 mm) above roof deck and nine inches (229 mm) below roof deck
	<b>ATI for flat roofs.</b> ATI is fully formed on three sides with a single, fully welded seam when dimension (L+Wx2) <118 inches. Larger sizes are a fully welded assembly. <b>ATIP for pitched roofs.</b> <b>ATIR for ridged (double pitched) roofs.</b> ATIP and ATIR are fully welded on all four sides.	2 inches 51 mm	18 inches (457 mm)
<b>Extension</b>			
	<b>ATE sound attenuating curb extensions.</b> Designed to reduce fan generated sound traveling down the ductwork. ATE is an extension to be mounted between the fan and the roof curb.		18 to 24 inches (457 to 610 mm)

## Pitched and Ridged Curbs

To order, the following information is required:

1. Specify pitched or ridged.
2. Include roof rise and run (see diagrams). This will be represented as a ratio (rise:run) with run always expressed as 12 units. Units of measure must be the same (inches, centimeters, etc.).

**Example:** The **Pitch** of a roof with a **Rise of 3 inches** and a **Run of 12 inches** equals a ratio of **3:12** (A comparable metric rise and run ratio is presented as 7.62/30.485 cm).

Another option is to select by pitch percentage from the horizontal.

3. When specifying a rectangular curb, note whether the slope runs in the direction of the short side or the long side of the curb.

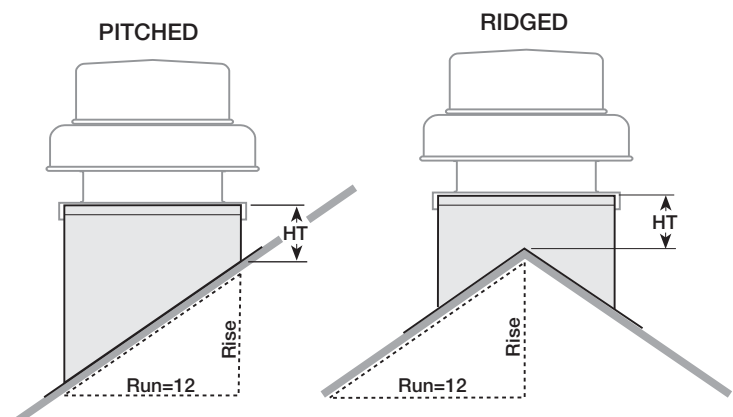

## Basic Adapter and Reducer Dimensional Information

Adapter/Reducer curb width and length is actual.  
 Amount of over sizing must be defined.

Curbs without wood nailers =  
 For adapted curb cap - plan for width and length to be ½ inch (13 mm) larger than the curb AD dimension.

Curbs with wood nailers =  
 For adapted curb cap - plan for width and length to be 1½ inch (38 mm) larger than the curb AD dimensions.

### Adapters

Minimum adapted amount =  
 1½ inch (38 mm)

Maximum adapted amount =  
 20 inches (508 mm)

### Reducers

Minimum reduced amount =  
 1½ inch (38 mm)

Maximum reduced amount =  
 10 inches (254 mm)

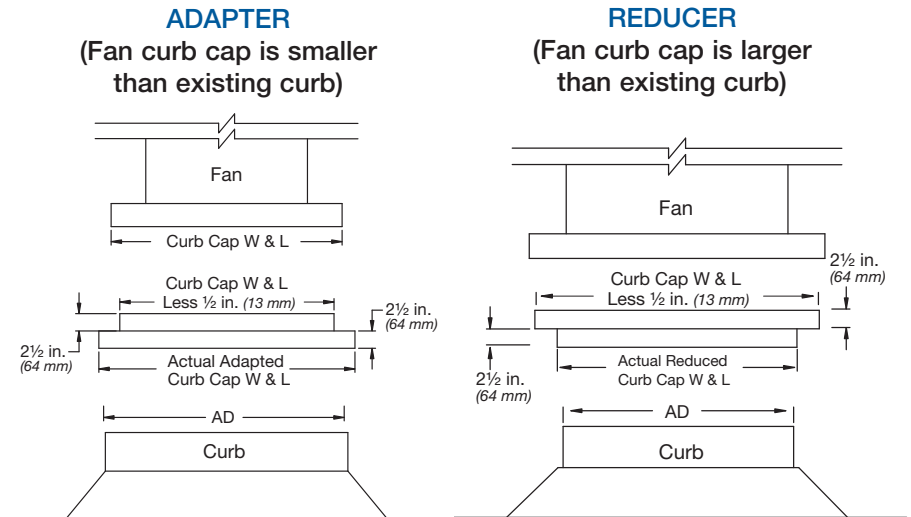

## Basic Curb Dimensional Information

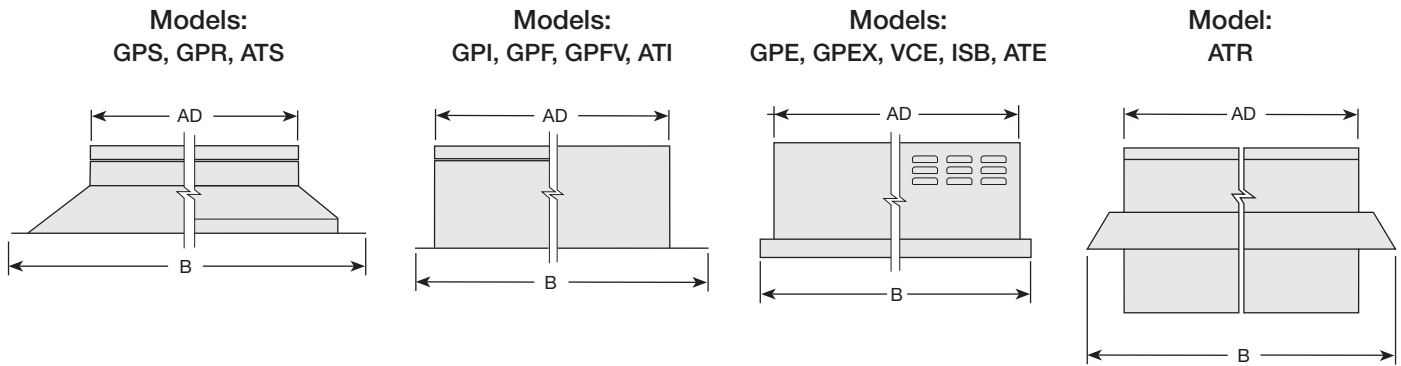

Model	Dimensions
GPI, GPS, GPR, ATS, ATR, ATI nominal wood nailer curbs	AD (actual) = 1½ inch (38 mm) less than unit curb cap
GPF, GPFV, GPEX, VCE, ATE nominal flanged curbs	AD (actual) = 1¼ inch (32 mm) less than unit curb cap
ISB nominal flanged curbs	AD (actual) = 1½ inch (38 mm) less than unit curb cap
GPS, GPR, ATS, ATR	B = AD Dimension + 8¼ inches (210 mm)
GPI, ATI	B = AD Dimension + 4 inches (102 mm)
GPF, GPFV	B = AD Dimension + 10 inches (254 mm)
GPE, GPEX, VCE, ATE	B = AD Dimension + 1½ inch (38 mm)
ISB	B = Same as unit curb cap dimensions

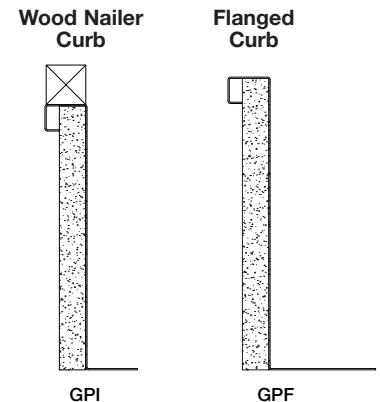

Note: AD is the actual width and length of the roof curb. Roof curbs are typically ordered using the nominal dimension which is equivalent to the unit curb cap dimension.

# Typical Installation

Greenheck's straight-sided roof curbs are designed for general exhaust or supply applications.

## General Flashed Roof Installation:

Remove roofing material where roof penetration is to be made and provide a 10 inch (254 mm) wide clearance around perimeter of hole in roof.

1. Apply roofing cement around roof opening.
2. Place and center roof curb over hole in roof so it sits on roofing cement. Make sure the roof curb is placed over an adequate support structure to handle the weight and wind load of curb and fan assembly.
3. Secure roof curb to roof deck using a minimum of three lag screws, anchor bolts, or suitable metal fasteners per side and two per corner (fasteners by others).
4. Install insulation if required.
5. Field flash – flashing should extend at least 4 inches (102 mm) beyond the horizontal flange on roof curb. Flashing should also extend over the top flange surface where there is a wood nailer for a leak resistant installation.
6. Apply curb seal (rubber gasket) to the top of roof curb to seal fan or ventilator to curb to prevent air leaks and water penetration and to reduce the transmission of vibration from fan to building.
7. Place fan or ventilator onto roof curb and center. In cases where the gap between the two components is larger than  $\frac{3}{4}$  of an inch (19 mm), install a wood filler strip on all four sides between the fan curb cap and the roof curb.
8. Secure fan's curb cap to the roof curb using a minimum of two lag screws, anchor bolts, or suitable metal fasteners per side (fasteners by others).
9. Install guy-wires from the fan to the roof deck to increase stability if needed.

### Notes:

- For rubber roofs, refer to roof manufacturer for roof curb installation.
- No replacement parts available.
- For installation of specialty curbs and high wind curbs, see CAPS for installation details.



## Building Value in Air

Greenheck delivers value to mechanical engineers by helping them solve virtually any air quality challenges their clients face with a comprehensive selection of

top quality, innovative air-related equipment. We offer extra value to contractors by providing easy-to-install, competitively priced, reliable products that arrive on time.

And building owners and occupants value the energy efficiency, low maintenance and quiet dependable operation they experience long after the construction project ends.



## Our Commitment

As a result of our commitment to continuous improvement, Greenheck reserves the right to change specifications without notice.

Specific Greenheck product warranties are located on [greenheck.com](http://greenheck.com) within the product area tabs and in the Library under Warranties.

