

5G - New Waveform Signal Analysis

UF-OFDM, FBMC and GFDM are under investigation worldwide as promising candidates of the New Waveform for 5G mobile communication systems. This paper describes features of their signal processing technologies and issues. New Waveform analysis environment is also introduced. Impact of each waveform to existing system can be estimated quickly by the environment.

1 - Introduction

Preparations for the migration from LTE/LTE-Advanced to next-generation mobile communications systems (5G) are progressing in various regions worldwide^{1,2,3,4,5}. In particular, the European METIS⁶ and 5GNOW⁷ projects have advanced the research of new waveforms meeting 5G requirements. LTE/LTE-Advanced currently uses Cyclic Prefix Orthogonal Frequency Division Multiplexing (CP-OFDM) as the wireless signal multiplexing method, because it has high spectrum efficiency as well as high tolerance against multipath propagation and fading.

On the other hand, CP-OFDM signal requires high linearity to output power amplifiers according to its high peak to average power ratio (PAPR). As a result, the power amplifier efficiency is low, increasing the User Equipment (UE) battery power consumption. Consequently, there are problems with shortened hours to receive wireless services. Moreover, the CP-OFDM spectrum has high out-of-band (OOB) sidelobes, causing problem with lowered spectrum efficiency when many UEs are operating at one location.

Improving CP-OFDM is under way⁸ to solve these problems that constitute barriers to 5G system deployment. Currently, use of the Filtered Multi-carrier technology is examined to reduce the OOB sidelobes and is recognized as "New Waveform". Various different methods have been proposed for implementing the Filtered Multi-carrier technology. These methods offer to improve CP-OFDM using sub-carrier filtering but each filtering method is different.

Since these new waveforms are different from the CP-OFDM waveform used in LTE/LTE-Advanced, PAPR and spectrum shape are also different. As a result, devices with designs optimized for CP-OFDM are no longer optimum for the new waveforms.

Therefore, RF devices, UEs and Base Stations for 5G systems will require new test instruments to generate and receive new waveforms for their various performance evaluations.

2 - Example of New Waveforms

This chapter explains proposed main methods of the Filtered Multi-carrier technology, in particular UF-OFDM (Universal Filtered Orthogonal Frequency Multiplex), FBMC (Filter Bank Multi-Carrier), and GFDM (Generalized Frequency Division Multiplexing).

2.1 UF-OFDM

UF-OFDM is a method for improving OOB characteristics by filtering each block⁹⁾.

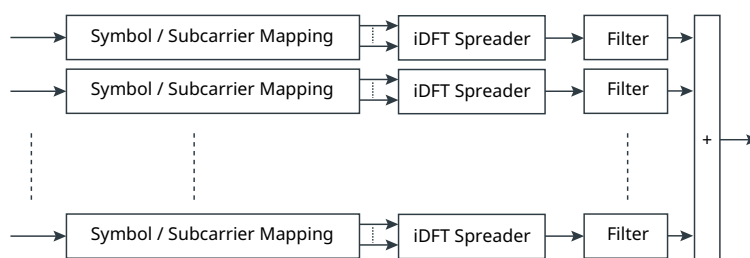

Figure 1: UF-OFDM Modulation Function Block Diagram

Figure 1 shows the UF-OFDM modulation function block diagram. The mapped signal is allocated to a predetermined number of blocks and number of sub-carriers for each block. The data for each block are calculated using Inverse Discrete Fourier Transform (iDFT) and converted to time sequence data equal to the total number of sub-carriers.

As a consequence, the UF-OFDM signal becomes a time series with a length extended by (the filter tap number - 1). The length can be set equal to the length of cyclic prefix (CP) of CP-OFDM signal. Therefore UF-OFDM has higher compatibility with the CP-OFDM.

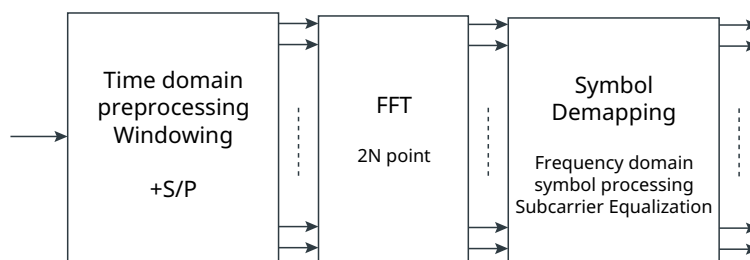

Figure 2: UF-OFDM Demodulation Function Block Diagram

Figure 2 shows the FFT based demodulation function block of UF-OFDM. The time series signal

from modulation side is pre-processed for filtering interference and S/P converted, demodulation is performed by FFT of twice the number of total sub-carriers. The demodulated signal is demapped to each symbol group after radio channel correction for each sub-carrier.

Other demodulation methods such as ZF (Zero-Forcing), MF (Matched Filter), and MMSE (Minimum Mean Square Error) have also been discussed. Transmission distortion, receiver performance in the mobile environment and circuit scale, etc. will be key factors for their adoption.

Figures 3, 4, and 5 show the simulation results based on the above transmitting and receiving block diagram using the parameters listed in Table 1.

Figure 3 shows an example of the UF-OFDM spectrum. The OOB sidelobes have been significantly improved, being better by about 40 dB than those of CP-OFDM. Although UF-OFDM improves the OOB by filtering each block, its performance is affected by the inserted filter which causes the amplitude and phase distortion.

Figure 4 shows the constellation without correction of the filter distortion. The constellation is scattered in each block in the direction of amplitude and phase due to the filter characteristics.

A UF-OFDM signal (time series length of $N + L - 1$) using a filter with L taps is longer than the OFDM signal with the same number of sub-carriers (N). However, demodulation of the UF-OFDM signal could be desired to be performed by N point-FFT instead of $2N$ point-FFT, as well as that of the OFDM signal.

Figure 5(a) shows the demodulation characteristics of the UF-OFDM signal when removing an end portion of the data to the total number of sub-carriers N at the receiver side, while Figure 5(b) shows the demodulation characteristics when not removing. Since the constellation in Figure 5(b) converges at each point of a quadrant, the results show that complete demodulation of UF-OFDM requires the length of time series length of $N + L - 1$.

Simulation Parameters	
Parameter	Value
Subcarrier Number (N)	1024
Subcarrier Number/Block	12
Allocated subcarrier number	144 (Fig 3)/60 (Fig 4,5)
Sub-band Filter	Dolph-Chebyshev Sidelobe ATT -40 dB
Filter Length (L)	74
Mapper	QPSK
Demodulation	FFT-based

Table 1: Simulation Parameters

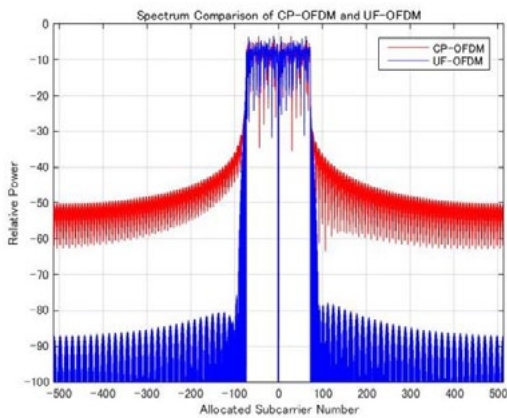

Figure 3 UF-OFDM Spectrum Characteristics (Simulation Results)

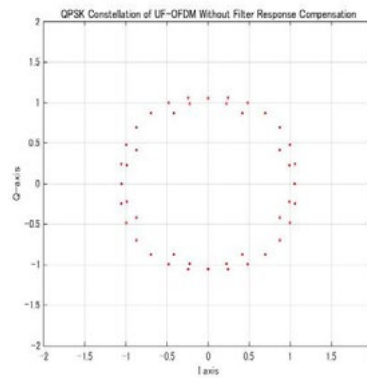

Figure 4 UF-OFDM Constellation (Uncorrected)

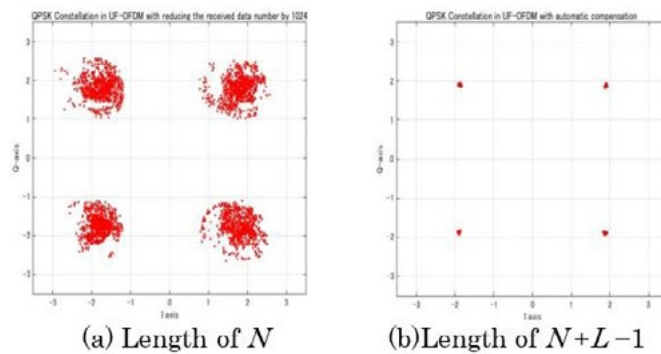

Figure 5 QPSK Demodulation Characteristics

2.2 FBMC

Unlike UF-OFDM, since FBMC is a method for improving OOB characteristics by filtering each sub-carrier, it is also expected to improve the Inter-Carrier Interference (ICI) characteristics.

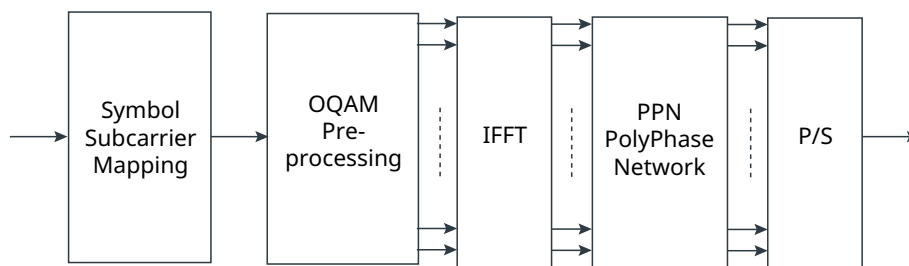

Figure 6: FBMC Modulation Function Block Diagram

Figure 6 shows the FBMC modulation function block diagram. When a PHYDAS¹⁰⁾ filter is selected as the FBMC filter, orthogonality between the Offset-QAM (OQAM) sub-carriers is fully assured.

Since narrowband filter is used for the FBMC sub-carriers, the number of digital filter taps can be larger than the total sub-carrier number. This filter method can be implemented in two ways—in the frequency domain, or in the time domain. To fix the iFFT length to the same total sub-carrier number, time domain processing method is suitable and Poly Phase Network (PPN) is used.

FBMC using this narrowband filtering has greatly improved OOB characteristics. On the other hand, the number of filter taps required to improve the characteristics is about four times the total sub-carrier number, creating a four times processing latency in a PPN configuration. Accordingly, although FBMC is problem-free for bitpipe communications such as video streaming, it has lower transmission efficiency for short packets.

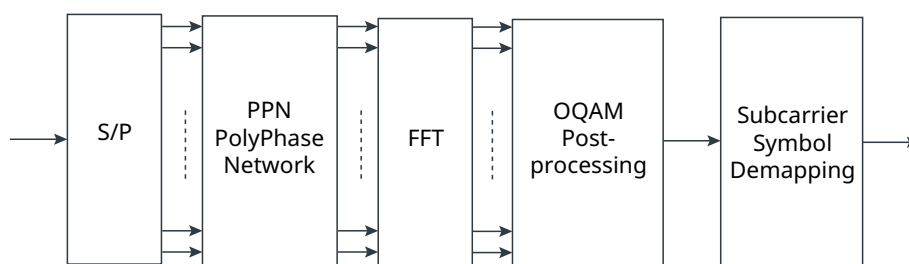

Figure 7: FBMC Demodulation Function Block Diagram

Figure 7 shows the demodulation function block diagram. In the actual application, besides these blocks, there is additional processing such as equalization for each sub-carrier and filtering to remove interference caused by transmission distortion.

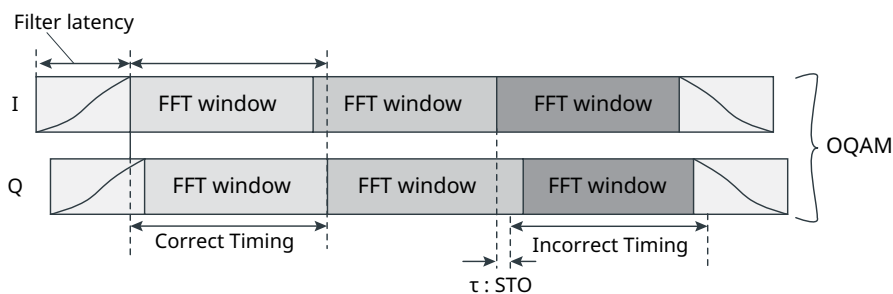

Figure 8: FBMC Symbol and FFT Window Relationship

Figure 8 shows the relationship between the FBMC symbol and FFT window. When sampling the FBMC I and Q time series signals at interval T_s , the modulation accuracy is greatly degraded due to dependence on the accuracy of FFT window segmentation position ($|\tau| < T_s$).

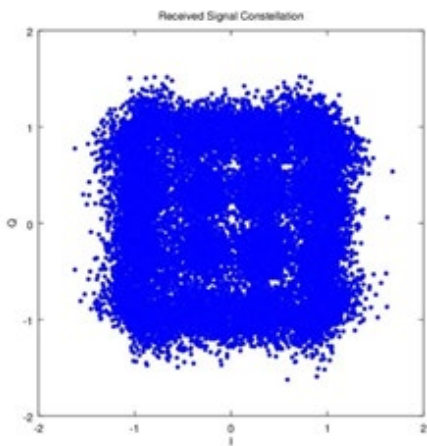

Figure 9: STC Correction Processing ($\tau = 0.2 T_d$)

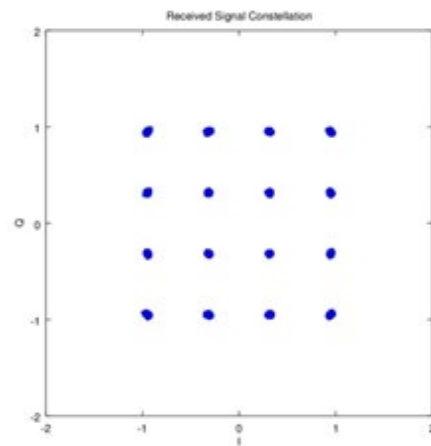

Figure 10: STC Correction Processing ($\tau = 0.01 T_d$)

Figures 9 and 10 show the different constellations with correction processing for two values of τ (with 16QAM as mapper).

2.3 GFDM

GFDM is a new concept method in which conventional OFDM is generalized, and it is based on the block oriented Filtered Multi-carrier method following the Gabor principle¹¹⁾. Symbol configuration of GFDM is composed of time - frequency blocks made up of a number of sub-carriers K and a number of sub-symbols M with high flexibility.

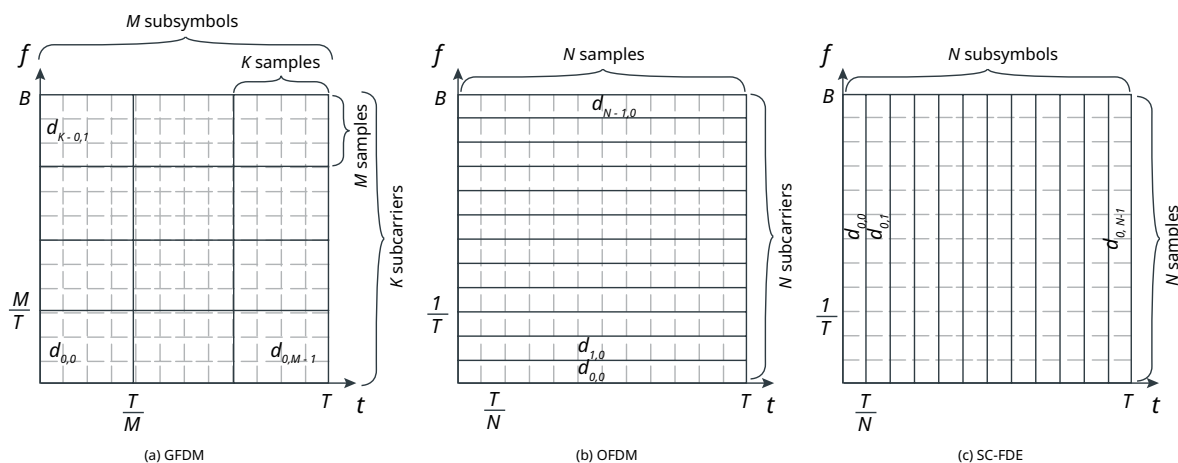

Figure 11: Partitioning of Time and Frequency

Figure 11 shows images of the time and frequency partitioning for each of the GFDM, OFDM, and Single Carrier Frequency Domain Equalization (SC-FDE) methods¹³⁾. By changing the number of sub-symbols M and sub-carriers K , either of the following two configuration can be possible. One is OFDM

like configuration bundling many narrowband sub-carriers, and the other is SC-FDE like configuration bundling smaller number of independent wideband sub-carriers.

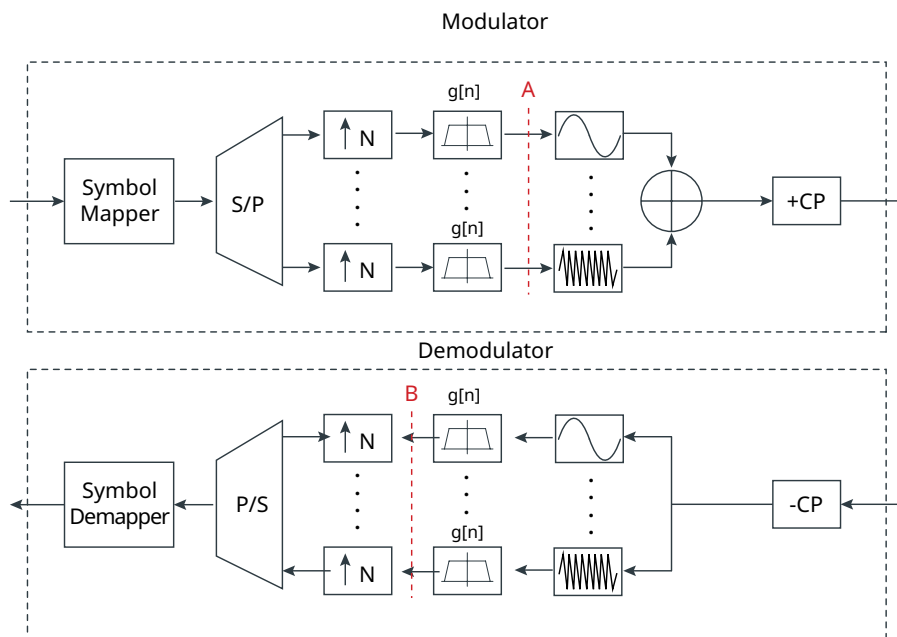
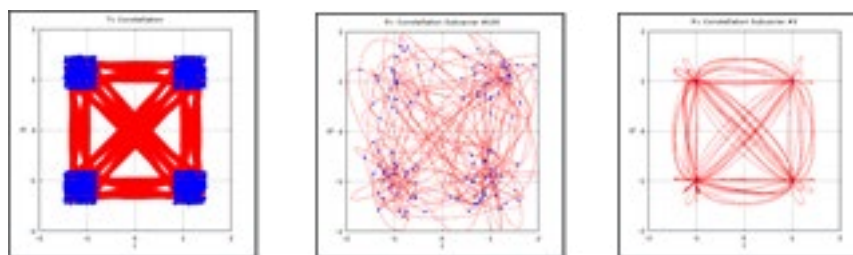

Figure 12: GFDM Modulation/Demodulation Function Block Diagram

Figure 12 shows the GFDM modulation/demodulation function block diagram. The modulation filter processing uses pulse-shaping filter $g[n]$ for each sub-carrier and is implemented using cyclic convolution processing. The demodulation filter processing is performed using the same filter as modulation processing and reduces the Inter-Symbol Interference (ISI)¹³⁾. This filtering for each sub-carrier improves the GFDM OOB characteristics but generates ISI and ICI¹²⁾ and insertion of an interference canceler is being investigated to reduce ISI and ICI caused by this filtering¹³⁾.



a) All subcarriers at A b) Subcarrier #30 at B c) Subcarrier #100 at B

Figure 13: Example of Constellation Caused by ICI

Parameters		
Parameter	Notation	Value
Subcarrier Count	K	128
Samples per Symbol	N	128
Used Subcarrier No.	#	1,2,3,...30,31,32, 98,100,102,...124,126,128
Symbols per Block	M	16
Pulse-Shaping Filter	g	Root raised cosine 0.5
Mapper	-	QPSK

Table 2: Parameters

Figure 13 shows an example of the modulation and demodulation simulation results obtained using the parameters listed in Table 2. Figure 13(a) shows the constellation for all sub-carriers for point A shown in Figure 12. Figures 13(b) and (c) show the constellation for sub-carrier (SC) #30 and SC#100 at point B in Figure 12. In Figure 13(b), the symbol constellation is not converged at one point due to the effect of ICI through using SC#29 and #31. On the other hand, in Figure 13(c), since SC#99 and SC#101 are not used, no ICI is generated in the SC#100 constellation and the constellation is converged at one point. These results are one example of using a root raised cosine filter (RRCF). The OOB characteristics and degree of ICI and ISI generation change according to the selected pulse-shaping filter¹³. Since the GFDM waveform has the same cyclic prefix (CP) as the OFDM waveform, the OOB characteristics are worse than the new waveform which does not have CP as explained previously. Consequently, to improve the OOB characteristics, guard symbol GFDM (GS-GFDM) method, which inserts a guard symbol between sub-symbols, and windowed GFDM (W-GFDM), which performs window processing in the time domain, are being investigated¹⁴. On the other hand, as the same synchronization technology is used as in OFDM¹⁶, GFDM can realize synchronization more easily than other new waveforms without CP.

Although GFDM is considered more complex to implement, its usefulness is attracting attention now. It is expected to offer flexible frame design in both time and frequency domains to applications such as IoT requiring low latency.

3 - New Waveform Analysis Environment

The previous sections describe the investigation results of the new waveforms that are studied as 5G PHY-layer candidates. R&D activity for the new technologies requires versatile engineering tool that can provide seamless use of communication system simulation and verification by actual equipments. This chapter introduces evaluation environment configured and its testing examples.

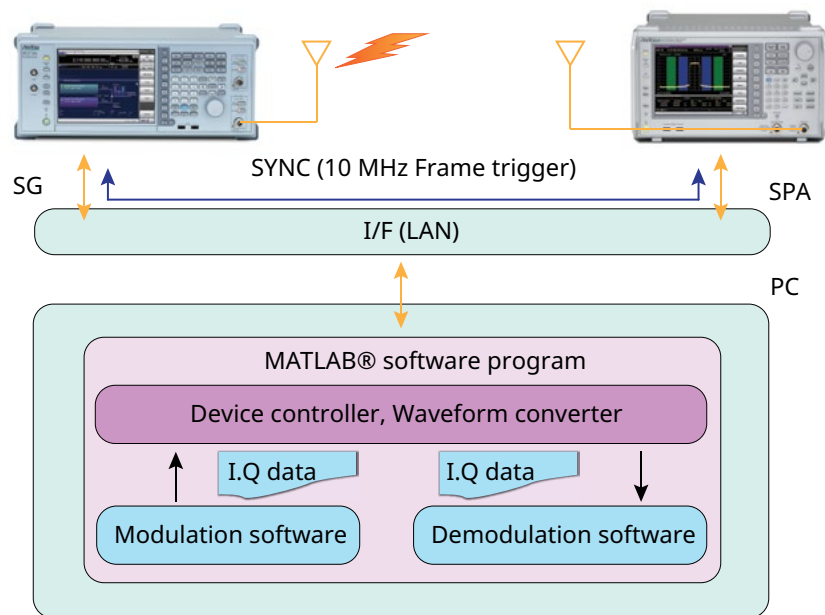

Figure 14: New Waveform Analysis Environment

Figure 14 shows the configured new waveform analysis environment including MG3710A Signal Generator with AWG (Arbitrary Waveform Generator), MS2692A Signal Analyzer for waveform capture and MATLAB® program for generation and analysis of transmitted and received waveforms. By using MATLAB®, which is commercially available and widely used, building user-friendly GUI and testing various wireless systems become easy, quick and flexible.

3.1 New Waveform Interference Evaluations

In the study of 5G waveform candidates, it is a key to identify waveforms to realize good spectrum efficiency of unused frequency bands. This section explains how to evaluate the impact from 5G waveform candidate to existing system waveform by using the new waveform analysis environment.

In this evaluation, CP-OFDM waveform with band gap is defined as an existing system waveform and UF-OFDM waveform is defined as a candidate 5G waveform. And the impact of interference is evaluated when the defined waveforms are located side by side in the frequency domain. MG3710A can easily output desired and undesired signals by using add baseband function to synthesize and output two modulated signals from one RF signal (Figure. 15). This evaluation uses the capability to generate and synthesize CP-OFDM and UF-OFDM waveforms, and analyze the signal by MS2692A Signal Analyzer. Thus giving and receiving interference evaluation is realized.



Figure 15: MG3710A Synthesized Dual-Wave Function



Figure 16: Each Waveform Spectrum

Figure 16 shows the spectrum of the CP-OFDM waveform having band gap and the UF-OFDM waveform. The purple trace and the blue trace correspond to the CP-OFDM and the UF-OFDM respectively. OOB sidelobe of CP-OFDM and excellent UF-OFDM OOB characteristics are shown in Figure 16. Figure 17 shows the output spectrum of the synthesized two waveforms.

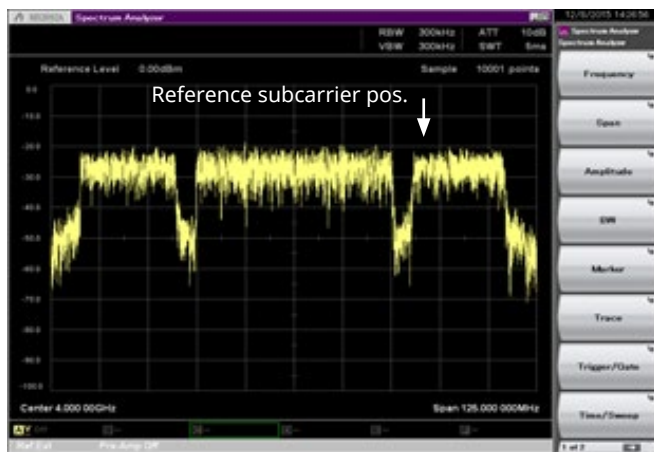

Figure 17: Synthesized Dual-Wave Spectrum

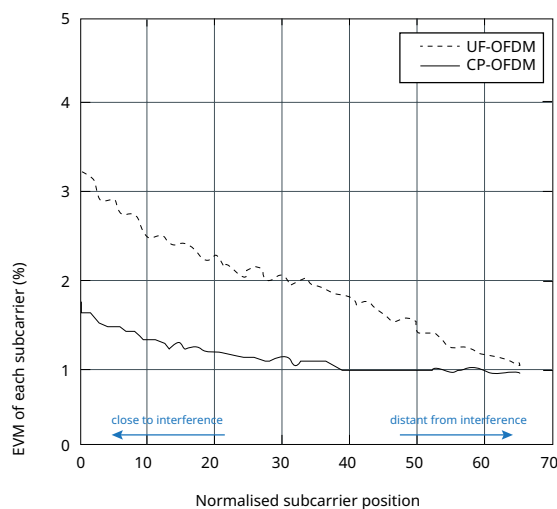

Figure 18: Interference evaluation by EVM

Figure 18 shows the impact of interference on CP-OFDM. Undesired signal is injected to the band gap of CP-OFDM and EVM (Error Vector magnitude) of individual sub-carrier at the higher frequency side is evaluated. The horizontal axis indicates normalized sub-carrier position and the vertical axis indicates EVM of each sub-carrier. The two traces in Figure 18 correspond to UF-OFDM and CP-OFDM used as interference. It is clearly seen in Figure 18 that UF-OFDM results in lower EVM for all sub-carriers. Thus it

is confirmed that UF-OFDM has better OOB characteristics than that of CP-OFDM.

Interference evaluations based on the adding waveform at baseband of MG3710A have been described. By using this analysis environment with preparation of multiple 5G waveform candidates, OOB characteristics of each waveform, interference caused by them and spectrum allocation adequacy can be evaluated easily.

4 - Conclusion

Regarding the 5G waveform candidates, we have presented performance evaluations by simulation and fore-casted problems in the actual operation. It is presumed that these waveforms will be integrated into a flexible multi-carrier system supporting various use cases, frequency bands and radio wave environments. We will continue to research to provide optimum solutions for the complex multi-carrier waveform measurements.

5 - References

1. W. Chin, F. Zhong, R. Haines, "Emerging technologies and research challenges for 5G wireless networks," *IEEE Wireless Commun.*, vol. 21, no. 2, pp. 106–112, Apr 2014.
2. J. Andrews, S. Buzzi, W. Choi, S. Hanly, A. Lozano, A. Soong, J. Zhang, "What will 5G be?" *IEEE J. Select. Areas Commun.*, vol. 32, no. 6, pp. 1065–1082, Jun 2014.
3. A. S. ahin, I. G" uvenc, H. Arslan, "A survey on multi-carrier communications: Prototype filters, lattice structures, and implementation aspects," *IEEE Commun. Surveys Tutorials*, vol. 16, no. 3, pp. 1312–1338, Aug 2014.
4. P. Banelli, S. Buzzi, G. Colavolpe, A. Modenini, F. Rusek, A. Ugolini, "Modulation formats and waveforms for 5G net-works: Who will be the heir of OFDM?: An overview of alternative modulation schemes for improved spectral effi-ciency," *IEEE Signal Process. Mag.*, vol. 31, no. 6, pp. 80–93, Nov 2014.
5. 3GPP, "Technical specification 36.212," *Tech. Rep.*, Jun 2015, v12.5.0.
6. <https://www.metis2020.com> Mobile and Wireless Communications Enablers for the 2020 Information society.
7. <http://www.5gnow.eu> 5th Generation Non-Orthogonal wave forms for asynchronous Signaling
8. A. Loulou, M. Renfors, "Enhanced OFDM for fragmented spectrum use in 5G systems", *Trans. Emerging Tel. Tech.*, vol. 26, pp. 31–45, 2015) F. Schaich, T. Wild, Y. Chen, "Waveform contenders for 5G suitability for short packet and low latency transmissions, *IEEE Veh. Technology Conference Spring*, pp. 1–5, Apr 2014.
9. <http://www.ict-phydyas.org> Physical layer for dynamic spectrum access and cognitive radio
10. G. Matz, H. Bölcskei, F. Hlawatsch, "Time-Frequency Foundations of Communications," *IEEE Signal*

Processing Mag., vol. 30, no. 6, pp. 87–96, Nov 2013.

11. G. Fettweis, M. Krondorf, S. Bittner, "GFDM - Generalized Frequency Division Multiplexing," IEEE Vehicular Technology Conference, Apr 2009.
12. R. Datta, N. Michailow, M. Lentmaier, G Fettweis, "GFDM Interference Cancellation for Flexible Cognitive Radio PHY Design," IEEE Vehicular Technology Conference, Sep 2012.
13. N. Michailow, M. Matthe, I. Gaspar, L. Caldevilla, A. Mendes, G. Festag, G. Fettweis, "Generalized Frequency Division Multiplexing for 5th Generation Cellular Networks," IEEE Transactions on Communications, vol. 62, issue 9, Sep 2014.
14. R.vanNee,R.Prasad,"OFDMforwirelessmultimediacommunications",ArtechHousePublishers,2000.

Authors

Sunao Ronte

Technical Headquarters
Advanced Technology
Development Center

Masaaki Fuse

Technical Headquarters
Advanced Technology
Development Center

Ken Shioiri

Technical Headquarters
Advanced Technology
Development Center

Publicly available