

SIEMENS

Installation Manual

SIMATIC NET

Rugged Ethernet Switches

RUGGEDCOM RSG2200

Edition

04/2021

<https://www.siemens.com>

SIEMENS

SIMATIC NET

Rugged Ethernet Switches RUGGEDCOM RSG2200

Installation Manual

| | |
|--------------------------|---|
| Preface | |
| Introduction | 1 |
| Installing the Device | 2 |
| Device Management | 3 |
| Communication Ports | 4 |
| Technical Specifications | 5 |
| Certification | 6 |

Legal Information

Warning Notice System

This manual contains notices you have to observe in order to ensure your personal safety, as well as to prevent damage to property. The notices referring to your personal safety are highlighted in the manual by a safety alert symbol, notices referring only to property damage have no safety alert symbol. These notices shown below are graded according to the degree of danger.

| |
|---|
|  DANGER |
|---|

| |
|---|
| indicates that death or severe personal injury will result if proper precautions are not taken. |
|---|

| |
|--|
|  WARNING |
|--|

| |
|--|
| indicates that death or severe personal injury may result if proper precautions are not taken. |
|--|

| |
|--|
|  CAUTION |
|--|

| |
|--|
| indicates that minor personal injury can result if proper precautions are not taken. |
|--|

| |
|---|
|  NOTICE |
|---|

| |
|--|
| indicates that property damage can result if proper precautions are not taken. |
|--|

If more than one degree of danger is present, the warning notice representing the highest degree of danger will be used. A notice warning of injury to persons with a safety alert symbol may also include a warning relating to property damage.

Qualified Personnel

The product/system described in this documentation may be operated only by **personnel qualified** for the specific task in accordance with the relevant documentation, in particular its warning notices and safety instructions. Qualified personnel are those who, based on their training and experience, are capable of identifying risks and avoiding potential hazards when working with these products/systems.

Proper Use of Siemens Products

Note the following:

| |
|--|
|  WARNING |
|--|

| |
|--|
| Siemens products may only be used for the applications described in the catalog and in the relevant technical documentation. If products and components from other manufacturers are used, these must be recommended or approved by Siemens. Proper transport, storage, installation, assembly, commissioning, operation and maintenance are required to ensure that the products operate safely and without any problems. The permissible ambient conditions must be complied with. The information in the relevant documentation must be observed. |
|--|

Trademarks

All names identified by ® are registered trademarks of Siemens AG. The remaining trademarks in this publication may be trademarks whose use by third parties for their own purposes could violate the rights of the owner.

Disclaimer of Liability

We have reviewed the contents of this publication to ensure consistency with the hardware and software described. Since variance cannot be precluded entirely, we cannot guarantee full consistency. However, the information in this publication is reviewed regularly and any necessary corrections are included in subsequent editions.

Table of Contents

| | |
|--|-----------|
| Preface | v |
| Related Documents | v |
| Accessing Documentation | v |
| Registered Trademarks | v |
| Warranty | v |
| Training | vi |
| Customer Support | vi |
| Contacting Siemens | vii |
| 1 Introduction | 1 |
| 1.1 Feature Highlights | 1 |
| 1.2 Description | 2 |
| 1.3 Required Tools and Materials | 3 |
| 1.4 Decommissioning and Disposal | 3 |
| 1.5 Cabling Recommendations | 4 |
| 1.5.1 Protection On Twisted-Pair Data Ports | 4 |
| 1.5.2 Gigabit Ethernet 1000Base-TX Cabling Recommendations | 4 |
| 1.5.3 Supported Fiber Optic Cables | 5 |
| 2 Installing the Device | 7 |
| 2.1 General Procedure | 8 |
| 2.2 Unpacking the Device | 8 |
| 2.3 Mounting the Device | 8 |
| 2.3.1 Mounting the Device to a Rack | 9 |
| 2.3.2 Mounting the Device on a DIN Rail | 10 |
| 2.3.3 Mounting the Device to a Panel | 11 |
| 2.4 Connecting the Failsafe Alarm Relay | 12 |
| 2.5 Connecting Power | 13 |
| 2.5.1 Connecting AC or DC Power | 14 |
| 2.5.2 Wiring Examples | 16 |
| 3 Device Management | 21 |
| 3.1 Connecting to the Device | 21 |
| 3.2 Configuring the Device | 22 |
| 4 Communication Ports | 23 |
| 4.1 Copper Ethernet Ports | 24 |
| 4.2 Fiber Optic Ethernet Ports | 25 |
| 4.3 SFP Transceivers | 26 |
| 4.4 GBIC Optic Ethernet Ports | 26 |

| | | |
|----------|--|-----------|
| 4.4.1 | Installing a GBIC Optical Port | 27 |
| 4.4.2 | Removing a GBIC Optical Port | 28 |
| 5 | Technical Specifications | 31 |
| 5.1 | Power Supply Specifications | 31 |
| 5.2 | Failsafe Relay Specifications | 31 |
| 5.3 | Supported Networking Standards | 31 |
| 5.4 | Copper Ethernet Port Specifications | 32 |
| 5.5 | Fiber Optic Ethernet Port Specifications | 33 |
| 5.6 | Operating Environment | 34 |
| 5.7 | Mechanical Specifications | 34 |
| 5.8 | Dimension Drawings | 35 |
| 6 | Certification | 39 |
| 6.1 | Approvals | 39 |
| 6.1.1 | CSA | 39 |
| 6.1.2 | European Union (EU) | 39 |
| 6.1.3 | FCC | 40 |
| 6.1.4 | FDA/CDRH | 40 |
| 6.1.5 | ISED | 40 |
| 6.1.6 | ISO | 41 |
| 6.1.7 | RoHS | 41 |
| 6.1.8 | Other Approvals | 41 |
| 6.2 | EMC and Environmental Type Tests | 41 |

Preface

This guide describes the RUGGEDCOM RSG2200. It describes the major features of the device, installation, commissioning and important technical specifications.

It is intended for use by network technical support personnel who are responsible for the installation, commissioning and maintenance of the device. It is also recommended for use by network and system planners, system programmers, and line technicians.

Related Documents

Other documents that may be of interest include:

| Document Title | Link |
|------------------------------------|---|
| RUGGEDCOM ROS Configuration Manual | https://support.industry.siemens.com/cs/ww/en/view/109737234 |
| RUGGEDCOM SFP Transceiver Catalog | https://support.industry.siemens.com/cs/ca/en/view/109482309 |

Accessing Documentation

The latest user documentation for RUGGEDCOM RSG2200 is available online at <https://support.industry.siemens.com> . To request or inquire about a user document, contact Siemens Customer Support.

Registered Trademarks

RUGGEDCOM®, ROS®, RCDP®, and RUGGEDCOM Discovery Protocol® are registered trademarks of Siemens Canada Ltd.

Other designations in this manual might be trademarks whose use by third parties for their own purposes would infringe the rights of the owner.

Warranty

Siemens warrants this product for a period of five (5) years from the date of purchase, conditional upon the return to factory for maintenance during the warranty term. This product contains no user-serviceable parts. Attempted service by unauthorized personnel shall render all warranties null and void. The warranties set forth in this article are exclusive and are in lieu of all other warranties, performance guarantees and conditions whether written or oral, statutory, express or implied

(including all warranties and conditions of merchantability and fitness for a particular purpose, and all warranties and conditions arising from course of dealing or usage or trade). Correction of nonconformities in the manner and for the period of time provided above shall constitute the Seller's sole liability and the Customer's exclusive remedy for defective or nonconforming goods or services whether claims of the Customer are based in contract (including fundamental breach), in tort (including negligence and strict liability) or otherwise.

For warranty details, visit <https://www.siemens.com> or contact a Siemens customer service representative.

Training

Siemens offers a wide range of educational services ranging from in-house training of standard courses on networking, Ethernet switches and routers, to on-site customized courses tailored to the customer's needs, experience and application.

Siemens' Educational Services team thrives on providing our customers with the essential practical skills to make sure users have the right knowledge and expertise to understand the various technologies associated with critical communications network infrastructure technologies.

Siemens' unique mix of IT/Telecommunications expertise combined with domain knowledge in the utility, transportation and industrial markets, allows Siemens to provide training specific to the customer's application.

For more information about training services and course availability, visit <https://www.siemens.com> or contact a Siemens Sales representative.

Customer Support

Customer support is available 24 hours, 7 days a week for all Siemens customers. For technical support or general information, contact Siemens Customer Support through any of the following methods:



Online

Visit <http://www.siemens.com/automation/support-request> to submit a Support Request (SR) or check on the status of an existing SR.

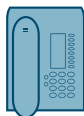

Telephone

Call a local hotline center to submit a Support Request (SR). To locate a local hotline center, visit https://w3.siemens.com/aspa_app/?lang=en.



Mobile App

Install the Industry Online Support app by Siemens AG on any Android, Apple iOS or Windows mobile device and be able to:

- Access Siemens' extensive library of support documentation, including FAQs and manuals

- Submit SRs or check on the status of an existing SR
- Contact a local Siemens representative from Sales, Technical Support, Training, etc.
- Ask questions or share knowledge with fellow Siemens customers and the support community

Contacting Siemens

| | |
|------------------|--|
| Address | Siemens AG Industry Sector 300 Applewood Crescent Concord, Ontario Canada, L4K 5C7 |
| Telephone | Toll-free: 1 888 264 0006 Tel: +1 905 856 5288 Fax: +1 905 856 1995 |
| E-Mail | ruggedcom.info.i-ia@siemens.com |
| Web | https://www.siemens.com |

Introduction

The RUGGEDCOM RSG2200 is a rugged, fully managed, modular Ethernet switch specifically designed to operate reliably in electrically harsh and climatically demanding utility substation, railway and industrial environments. The RUGGEDCOM RSG2200's superior rugged hardware design coupled with the embedded Rugged Operating System (ROS) provides improved system reliability and advanced cyber security and networking features, making it ideally suited for creating Ethernet networks for mission-critical, real-time, control applications.

The RUGGEDCOM RSG2200 's modular flexibility offers 1000BaseX fiber and 10/100/1000BaseTX copper port combinations. Optional front or rear mount connectors make the RUGGEDCOM RSG2200 highly versatile for any application and can support multiple fiber connectors (SFP, GBIC, LC, SC) without loss of port density. The RUGGEDCOM RSG2200 is packaged in a rugged galvanized steel enclosure with industrial grade DIN, panel, or 48 cm (19 in) rack-mount mounting options.

1.1 Feature Highlights

Ethernet Ports

- Up to 9 x Gigabit Ethernet ports (copper and fiber)
- Up to 9 x 100Base-FX Fiber Fast Ethernet ports
- 2-port modules for tremendous flexibility
- Non-blocking, store and forward switching
- Supports many types of fiber (multimode, single mode, bidirectional single strand)
- Full compliance with IEEE: 802.3, 802.3u & 802.3z
- Full duplex operation and flow control (IEEE 802.3x)
- Long haul optics allow Gigabit at distances up to 70 km
- Industry standard fiber optic connectors: LC, SC, SFP, GBIC

Rated for Reliability in Harsh Environments

- Immunity to EMI and heavy electrical surges
- Zero-Packet-Loss™ technology
- -40 to 85 °C (-40 to 185 °F) operating temperature (no fans)
- Conformal coated printed circuit boards (optional)
- 18 AWG galvanized steel enclosure

Universal Power Supply Options

- Fully integrated, dual-redundant (optional) power supplies
- Universal high-voltage range: 88-300 VDC or 85-264 VAC
- Popular low voltage ranges: 24 VDC (10-36 VDC), 48 VDC (36-72 VDC)
- Screw or pluggable terminal blocks for reliable, maintenance-free connections
- CSA/UL 62368-1 safety approved to 85 °C (185 °F)

1.2 Description

The RUGGEDCOM RSG2200 features various ports, controls and indicator LEDs on the display panel for connecting, configuring and troubleshooting the device. The display panel can be located on the rear, front or top of the device, depending on the mounting configuration.

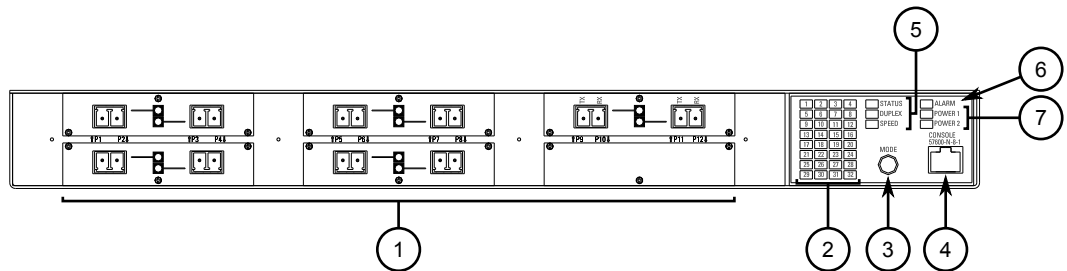

- ① Fiber or Copper Ethernet Ports
- ② Port Status Indicator LEDs
- ③ Mode Button
- ④ RS-232 Serial Console Port (RJ45)
- ⑤ Display Mode Indicator LEDs
- ⑥ Alarm Indicator LED
- ⑦ Power Module Indicator LEDs

Figure 1.1 RUGGEDCOM RSG2200

| | |
|-----------------------------------|--|
| Communication Ports | Ports for communicating with other devices or accessing the RUGGEDCOM RSG2200 operating system are described in " Communication Ports (Page 23) ". |
| Port Status Indicator LEDs | Port status indicator LEDs indicate the operational status of each port, dependent on the currently selected mode. |

| Mode | Color/State | Description |
|--------|------------------|------------------|
| Status | Green (Solid) | Link detected |
| | Green (Blinking) | Link activity |
| | Off | No link detected |
| Duplex | Green | Full duplex mode |
| | Orange | Half duplex mode |
| | Off | No link detected |

| Mode | Color/State | Description |
|-------|------------------|------------------|
| Speed | Green (Solid) | 100 Mbps |
| | Green (Blinking) | 1000 Mbps |
| | Orange (Solid) | 10 Mbps |
| | Off | No link detected |

| | |
|------------------------------------|--|
| Display Mode Indicator LEDs | The display mode indicator LEDs indicate the current display mode for the port status indicator LEDs (i.e. Status, Duplex or Speed). |
| Mode Button | The Mode button sets the display mode for the port status indicator LEDs (i.e. Status, Duplex or Speed). It can also be used to reset the device if held for 5 seconds. |
| Alarm Indicator LED | The alarm indicator LED illuminates when an alarm condition exists. |
| Power Module Indicator LEDs | The power module indicator LEDs indicate the status of the power modules. <ul style="list-style-type: none"> • Green – The power supply is supplying power • Red – Power supply failure • Off – No power supply is installed |
| RS-232 Console Port | The serial console port is for interfacing directly with the device and accessing initial management functions. For information about connecting to the device via the serial console port, refer to " Connecting to the Device (Page 21) ". |

1.3 Required Tools and Materials

The following tools and materials are required to install the RUGGEDCOM RSG2200:

| Tools/Materials | Purpose |
|------------------------|---|
| AC power cord (16 AWG) | For connecting power to the device. |
| CAT-5 Ethernet cables | For connecting the device to the network. |
| Flathead screwdriver | For mounting the device to a DIN rail. |
| Phillips screwdriver | For mounting the device to a panel. |
| 4 x #8-32 screws | For mounting the device to a panel. |

1.4 Decommissioning and Disposal

Proper decommissioning and disposal of this device is important to prevent malicious users from obtaining proprietary information and to protect the environment.

Decommissioning

This device may include sensitive, proprietary data. Before taking the device out of service, either permanently or for maintenance by a third-party, make sure it has been fully decommissioned.

For more information, refer to the associated *Configuration Manual*.

Recycling and Disposal

For environmentally friendly recycling and disposal of this device and related accessories, contact a facility certified to dispose of waste electrical and electronic equipment. Recycling and disposal must be done in accordance with local regulations.

1.5 Cabling Recommendations

Before connecting the device, be aware of the recommendations and considerations outlined in this section.

1.5.1 Protection On Twisted-Pair Data Ports

All copper Ethernet ports on RUGGEDCOM products include transient suppression circuitry to protect against damage from electrical transients and conform with IEC 61850-3 and IEEE 1613 Class 1 standards. This means that during a transient electrical event, communications errors or interruptions may occur, but recovery is automatic.

Siemens also does not recommend using copper Ethernet ports to interface with devices in the field across distances that could produce high levels of ground potential rise (i.e. greater than 2500 V), during line-to-ground fault conditions.

1.5.2 Gigabit Ethernet 1000Base-TX Cabling Recommendations

The IEEE 802.3ab Gigabit Ethernet standard defines 1000 Mbit/s Ethernet communications over distances of up to 100 m (328 ft) using all 4 pairs in category 5 (or higher) balanced, unshielded twisted-pair cabling. For wiring guidelines, system designers and integrators should refer to the Telecommunications Industry Association (TIA) TIA/EIA-568-A wiring standard that characterizes minimum cabling performance specifications required for proper Gigabit Ethernet operation. For reliable, error-free data communication, new and pre-existing communication paths should be verified for TIA/EIA-568-A compliance.

The following table summarizes the relevant cabling standards:

| Cabling Category | 1000Base-TX Compliant | Required Action |
|------------------|-----------------------|--|
| < 5 | No | New wiring infrastructure required. |
| 5 | Yes | Verify TIA/EIA-568-A compliance. |
| 5e | Yes | No action required. New installations should be designed with Category 5e or higher. |
| 6 | Yes | No action required. |
| > 6 | Yes | Connector and wiring standards to be determined. |

Follow these recommendations for copper data cabling in high electrical noise environments:

- Data cable lengths should be as short as possible, preferably 3 m (10 ft) in length. Copper data cables should not be used for inter-building communications.
- Power and data cables should not be run in parallel for long distances, and should be installed in separate conduits. Power and data cables should intersect at 90° angles when necessary to reduce inductive coupling.
- Shielded/screened cabling can be used when required. Care should be taken to avoid the creation of ground loops with shielded cabling.

1.5.3 Supported Fiber Optic Cables

The following fiber optic cable types are supported under the stated conditions.

| Cable Type | Wavelength (nm) | Modal Bandwidth (MHz·km) | Distance (m) | | |
|---------------------------|-----------------|--------------------------|--------------|-------------|------------|
| | | | 100Base-FX | 1000Base-SX | 10GBase-SR |
| OM1 (62.5/125) | 850 | 200 | — | 275 | 33 |
| | 1300 | 500 | 2000 | — | — |
| OM2 (50/125) | 850 | 500 | — | 550 | 82 |
| | 1300 | 500 | 2000 | — | — |
| OM3 (50/125) ^a | 850 | 1500 | — | 550 | 300 |
| | 1300 | 500 | 2000 | — | — |
| OM4 (50/125) ^a | 850 | 3500 | — | 550 | 400 |
| | 1300 | 500 | 2000 | — | — |

^a Laser optimized.

Installing the Device

The following sections describe how to install the device, including mounting the device, installing/removing modules, connecting power, and connecting the device to the network.



⚠ DANGER

Electrocution hazard – risk of serious personal injury and/or damage to equipment.

Before performing any maintenance tasks, make sure all power to the device has been disconnected and wait approximately two minutes for any remaining energy to dissipate.



⚠ WARNING

Radiation hazard – risk of serious personal injury

This product contains a laser system and is classified as a *CLASS 1 LASER PRODUCT*. Use of controls or adjustments or performance of procedures other than those specified herein may result in hazardous radiation exposure.

⚠ NOTICE

This product contains no user-serviceable parts. Attempted service by unauthorized personnel shall render all warranties null and void.

Changes or modifications not expressly approved by Siemens AG could invalidate specifications, test results, and agency approvals, and void the user's authority to operate the equipment.

⚠ NOTICE

This product should be installed in a *restricted access location* where access can only be gained by authorized personnel who have been informed of the restrictions and any precautions that must be taken. Access must only be possible through the use of a tool, lock and key, or other means of security, and controlled by the authority responsible for the location.

2.1 General Procedure

The general procedure for installing the device is as follows:

| |
|------------------|
| IMPORTANT |
|------------------|

| |
|--|
| The user is responsible for the operating environment of the device, including maintaining the integrity of all protective conductor connections and checking equipment ratings. Make sure to review all operating and installation instructions before commissioning or performing maintenance on the device. |
|--|

1. Review the relevant certification information for any regulatory requirements. For more information, refer to "[Approvals \(Page 39\)](#)".
2. Mount the device.
3. Connect the failsafe alarm relay.
4. Connect power to the device and ground the device to safety Earth.
5. Connect the device to the network.
6. Configure the device.

2.2 Unpacking the Device

When unpacking the device, do the following:

1. Inspect the package for damage before opening it.
2. Visually inspect each item in the package for any physical damage.
3. Verify all items are included.

Note

If any item is missing or damaged, contact Siemens for assistance.

2.3 Mounting the Device

The RUGGEDCOM RSG2200 is designed for maximum mounting and display flexibility. It can be equipped with connectors that allow it to be installed in a 48 cm (19 in) rack, 35 mm (1.4 in) DIN rail, or directly on a panel.

| |
|---|
|  NOTICE |
|---|

| |
|---|
| Heat generated by the device is channeled outwards from the enclosure. As such, it is recommended that 2.5 cm (1 in) of space be maintained on all open sides of the device to allow for some convectional airflow. |
|---|

| |
|--|
| Forced airflow is not required. However, any increase in airflow will result in a reduction of ambient temperature and improve the long-term reliability of all equipment mounted in the rack space. |
|--|

Note

For detailed dimensions of the device with either rack, DIN rail or panel hardware installed, refer to "[Dimension Drawings \(Page 35\)](#)".

2.3.1 Mounting the Device to a Rack

The RUGGEDCOM RSG2200 can be secured to a standard 48 cm (19 in) rack using separately purchased rack mount adapters. The adapters can be installed at the front or rear of the chassis.

Each adapter kit includes four adapters.

 NOTICE**Vibration hazard – risk of damage to the device**

In high-vibration or seismically active locations, always install four rack mount adapters (two at the front of the chassis and two at the rear).

 NOTICE**Electrical/mechanical hazard – risk of damage to the device**

Before installing the device in a rack, make sure of the following:

- When installing the device in a closed or multi-device rack, be aware the operating ambient temperature of the rack may be higher than the ambient temperature of the room. Make sure the rack is installed in a suitable environment that can withstand the maximum ambient temperature generated by the rack.
- Make sure each device in the rack is separated by at least one rack-unit of space, or 44 mm (1.75 in), to promote convectional airflow. Forced airflow is not required. However, any increase in airflow will result in a reduction of ambient temperature and improve the long-term reliability of all equipment mounted in the rack space.
- Do not exceed the maximum number of devices or weight restrictions specified by the rack manufacturer.
- Do not overload the supply circuit. Refer to the over-current protection and power supply ratings specified by the rack manufacturer.
- Make sure the rack and all devices have a proper ground-to-Earth connection. Pay particular attention to power supply connections other than direct connections to the branch circuit (e.g. power strips).

To secure the device to a standard 48 cm (19 in) rack, do the following:

Note

The device can be ordered with the communication ports located at the front or rear of the device. Placing the ports at the rear allows all data and power cabling to be installed and connected at the rear of the rack.

1. Make sure the rack mount adapters are installed on the correct side of the chassis.
 - To make the modules and ports accessible, install the rack mount adapters at the rear of the chassis
 - To make the management ports and LEDs accessible, install the rack mount adapters at the front of the chassis

Note

The chassis features multiple mounting holes, allowing the rack mount adapters to be installed up to 25 mm (1 in) from the face of the device.

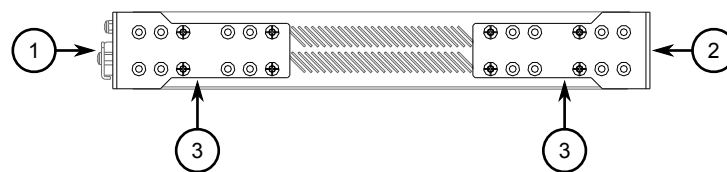

- ① Rear
- ② Front
- ③ Rack Mount Adapter

Figure 2.1 Rack Mount Adapters

2. If required, install adapters on the opposite side of the device to protect from vibrations.
3. Insert the device into the rack.
4. Secure the adapters to the rack using the supplied hardware.

2.3.2 Mounting the Device on a DIN Rail

For DIN rail installations, the RUGGEDCOM RSG2200 can be equipped with panel/DIN rail adapters pre-installed on each side of the chassis. The adapters allow the device to be slid onto a standard 35 mm (1.4 in) DIN rail.

| |
|---|
|  NOTICE |
| DIN rail mounting is not recommended for constant vibration environments. |

To mount the device to a DIN rail, do the following:

1. Align the adapters with the DIN rails and slide the device into place.

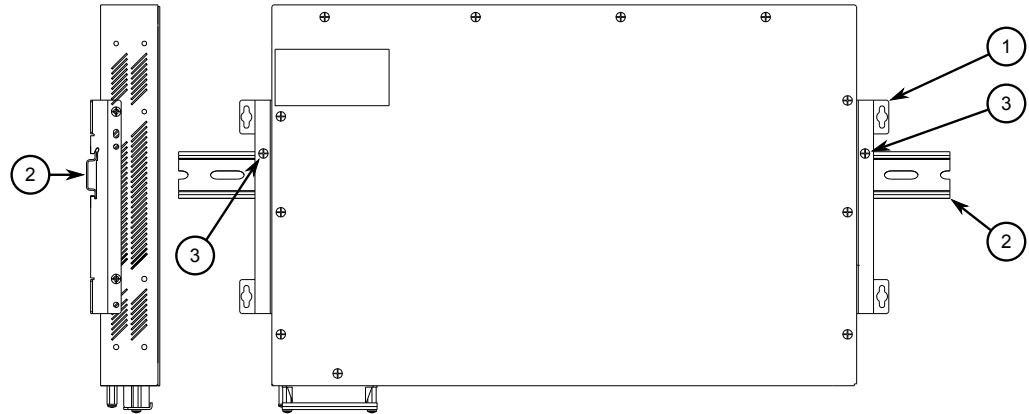

- ① Panel/DIN Rail Adapter
- ② DIN Rail
- ③ Screw

Figure 2.2 DIN Rail Mounting

2. Install one of the supplied screws on either side of the device to secure the adapters to the DIN rails.

2.3.3 Mounting the Device to a Panel

For panel installations, the RUGGEDCOM RSG2200 can be equipped with panelDIN rail adapters pre-installed on each side of the chassis. The adapters allow the device to be attached to a panel using screws.

To mount the device to a panel, do the following:

1. Place the device against the panel and align the adapters with the mounting holes.

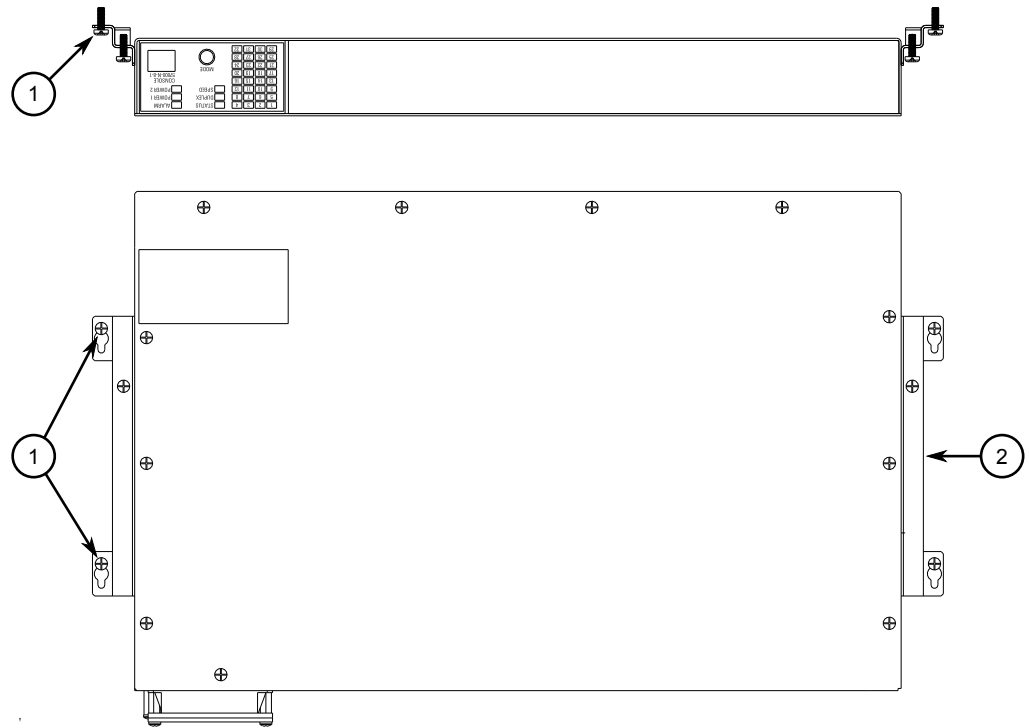

- ① Screw
- ② Panel/DIN Rail Adapter

Figure 2.3 Panel Mounting

2. Install the supplied screws to secure the adapters to the panel.

2.4 Connecting the Failsafe Alarm Relay

The failsafe relay can be configured to latch based on alarm conditions. The NO (Normally Open) contact is closed when the unit is powered and there are no active alarms. If the device is not powered or if an active alarm is configured, the relay opens the NO contact and closes the NC (Normally Closed) contact.

Note

Control of the failsafe relay output is configurable through RUGGEDCOM RSG2200 . One common application for this relay is to signal an alarm if a power failure occurs. For more information, refer to the *RUGGEDCOM ROS Configuration Manual* for the RUGGEDCOM RSG2200.

The following shows the proper relay connections.

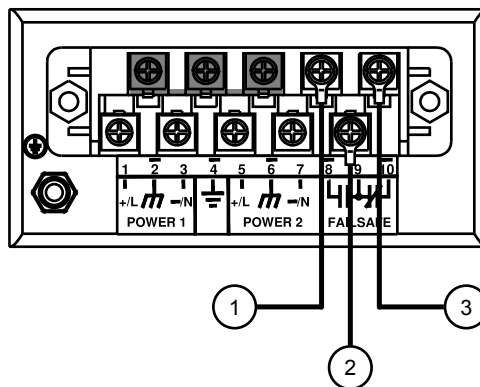

- ① Normally Open
- ② Common
- ③ Normally Closed

Figure 2.4 Failsafe Alarm Relay Wiring

2.5 Connecting Power

The RUGGEDCOM RSG2200 supports a single or dual redundant AC and/or DC power supplies.

The RUGGEDCOM RSG2200 can be equipped with either a screw-type or pluggable terminal block, which provides power to both power supplies. The screw-type terminal block is installed using Phillips screws and compression plates, allowing either bare wire connections or crimped terminal lugs. Use #6 size ring lugs for secure, reliable connections under severe shock or vibration.

⚠ NOTICE

Electrical hazard – risk of damage to the device

Make sure power input to the device is within the specified input range. For information about the nominal input range for the device, refer to ["Power Supply Specifications \(Page 31\)"](#).

Note

- For maximum redundancy in a dual power supply configuration, use two independent power sources.
- Use minimum #16 gage copper wiring when connecting terminal blocks.
- For 100-240 VAC rated equipment, an appropriately rated AC circuit breaker must be installed.
- For 125/250 VDC rated equipment, an appropriately rated DC circuit breaker must be installed.
- A circuit breaker is not required for 12, 24 or 48 VDC rated power supplies.

- It is recommended to provide a separate circuit breaker for each power supply module.
 - Equipment must be installed according to applicable local wiring codes and standards.
-

2.5.1 Connecting AC or DC Power

To connect a single high AC, high DC or low DC power supply to the device, do the following:

| |
|--|
|  NOTICE |
| Electrical hazard – risk of damage to equipment |
| Before testing the dielectric strength (HIPOT) in the field, remove the metal jumper. This metal jumper connects transient suppression circuitry to chassis ground and must be removed in order to avoid damage to transient suppression circuitry during testing. |

| |
|--|
|  NOTICE |
| Electrical hazard – risk of damage to equipment |
| Do not connect AC power cables to a 24 or 48 VDC power supply. Damage to the power supply may occur. |

| |
|---|
| IMPORTANT |
| Each internal power module is labeled POWER 1 or POWER 2. Make sure to connect the power supply to the corresponding internal power module. |

1. Remove the terminal block cover.
2. Identify the internal power module (POWER 1 or POWER 2) appropriate for the power supply (AC or DC).
3. Use these screws along with #6 ring lugs to secure the wires to the terminal block.

Note

For wiring options, refer to ["Wiring Examples \(Page 16\)"](#).

- Connect the positive wire from the power source to the positive/live (+/L) terminal on the terminal block.

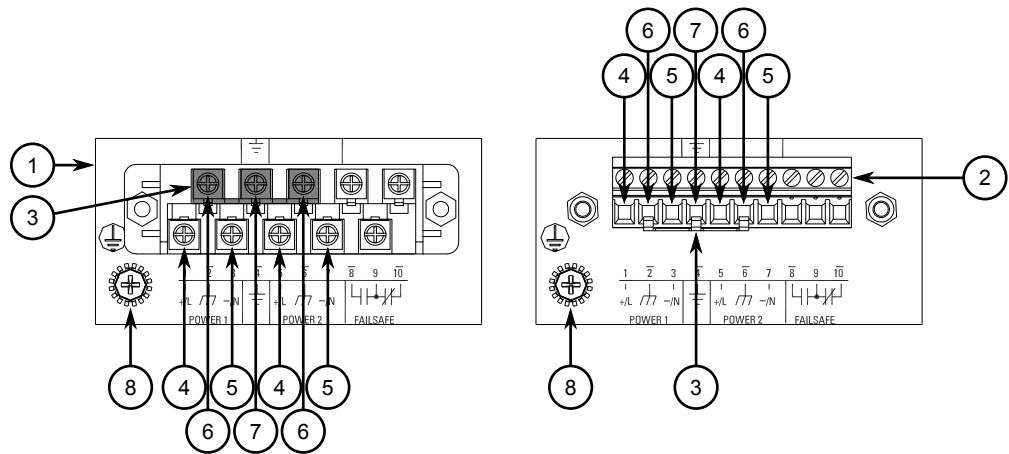

- Screw-Type Terminal Block
- Pluggable Terminal Block
- Jumper
- Positive/Live (+/L) Terminal
- Negative/Neutral (-/N) Terminal (-/N)
- Surge Ground Terminal
- Chassis Ground Terminal
- Chassis Ground Connection

Figure 2.5 Terminal Block Wiring

- Connect the negative wire from the power source to the negative/neutral (-/N) terminal on the terminal block.
- Install the supplied metal jumper between terminals 2, 4 and 6 to connect the surge ground terminals to the chassis ground terminal. The surge ground terminals are used as the ground conductor for all surge and transient suppression circuitry internal to the unit.

- Using a #6 ring lug and #6-32 screw, secure the ground terminal on the power source to the chassis ground connection on the device. Make sure the lug is tightened to 1.7 N·m (15 lbf-in).

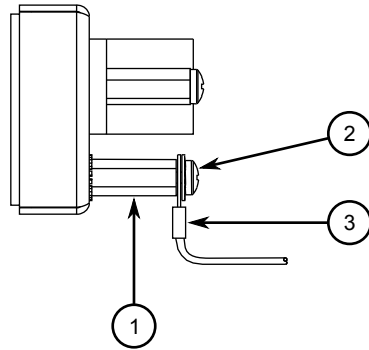

- ① Stainless Steel Stud
- ② #6-32 Screw
- ③ #6 Ring Lug

Figure 2.6 Chassis Ground Connection

| |
|--|
| ⚠ DANGER |
| Electrocution hazard – risk of death, serious personal injury and/or damage to the device |
| Make sure the supplied terminal block cover is always installed before the device is powered. |

- Install the terminal block cover.

2.5.2 Wiring Examples

The following illustrate how to connect power to single and dual power supplies.

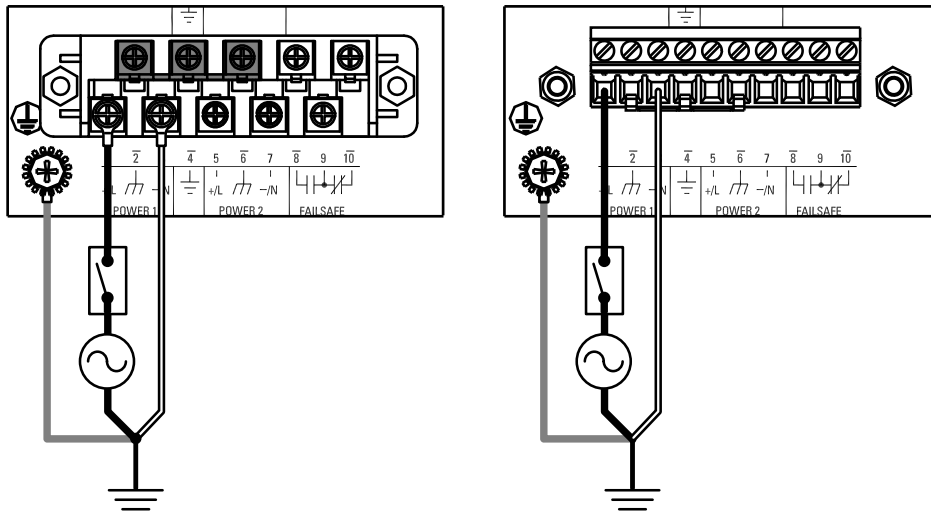

Figure 2.7 Single AC Power Supply

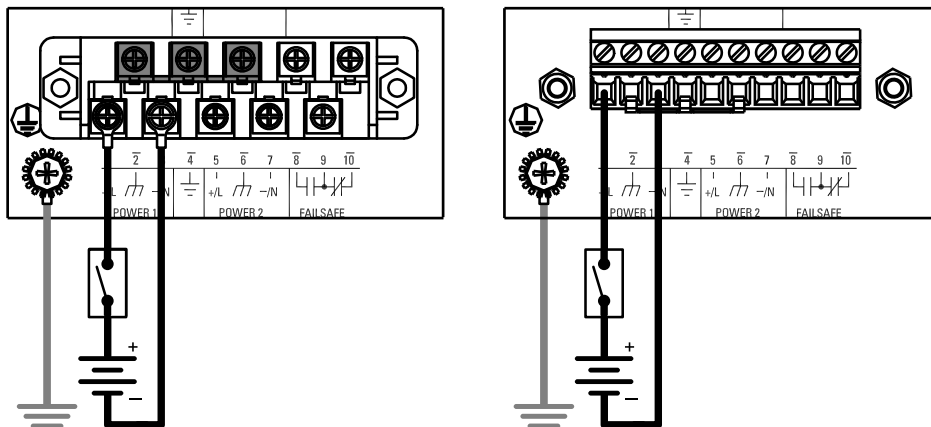

Figure 2.8 Single DC Power Supply

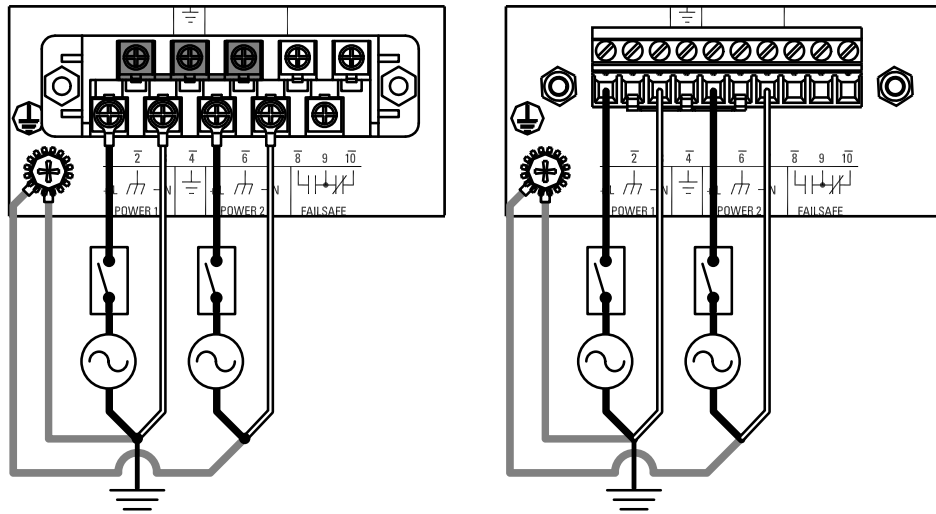

Figure 2.9 Dual AC Power Supply

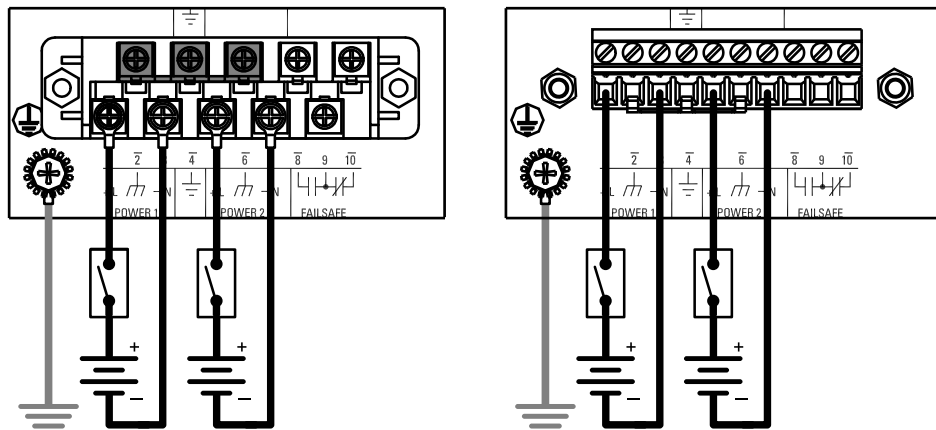

Figure 2.10 Dual DC Power Supply

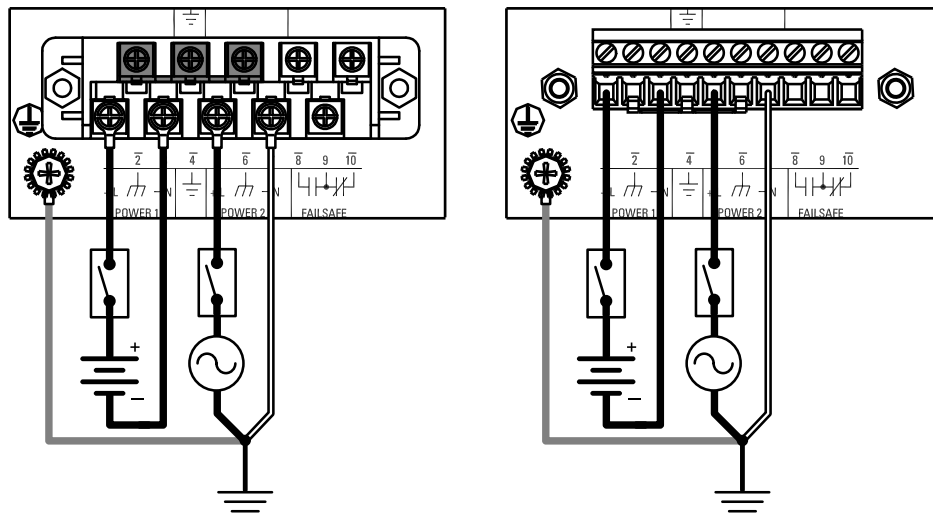

Figure 2.11 Dual AC/DC Power Supply

Device Management

This section describes how to connect to and manage the device.

3.1 Connecting to the Device

The following describes the various methods for accessing the RUGGEDCOM RSG2200 console and Web interfaces on the device. For more detailed instructions, refer to the *RUGGEDCOM ROS Configuration Manual* for the RUGGEDCOM RSG2200.

RS232 Console Port

Connect a workstation directly to the RS232 console port to access the boot-time control and RUGGEDCOM RSG2200 interfaces. The console port provides access to RUGGEDCOM RSG2200's console and Web interfaces.

NOTICE

The serial console port is intended to be used only as a temporary connection during initial configuration or troubleshooting.

Connection to the console port is made using an RJ45-to-DB9 console cable. The following is the pin-out for the console port:

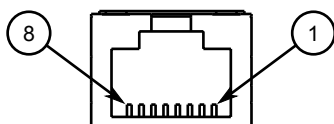

Figure 3.1 RJ45 Console Port Pin Configuration

| Pin | | Name | Description | Comment |
|-----------|------------|------------------|--------------------------|---------------------------|
| RJ45 Male | DB9 Female | | | |
| 1 | 6 | DSR ^a | Data Set Ready | |
| 2 | 1 | DCD ^a | Carrier Detect | Reserved (Do Not Connect) |
| 3 | 4 | DTR ^a | Data Terminal Ready | |
| 4 | 5 | GND | Signal Ground | |
| 5 | 2 | RxD | Receive Data (to DTE) | |
| 6 | 3 | TxD | Transmit Data (from DTE) | |
| 7 | 8 | CTS ^b | Clear to Send | |
| 8 | 7 | RTS ^b | Read to Send | |

3.2 Configuring the Device

| Pin | | Name | Description | Comment |
|-----------|------------|-----------------|----------------|---------|
| RJ45 Male | DB9 Female | | | |
| 1 | 9 | RI ^c | Ring Indicator | |

^a The DSR, DCD and DTR pins are connected together internally.

^b The CTS and RTS pins are connected together internally.

^c RI is not connected.

Communication Ports

Connect any of the available Ethernet ports on the device to a management switch and access the RUGGEDCOM RSG2200 console and Web interfaces via the device's IP address. For more information about available ports, refer to "[Communication Ports \(Page 23\)](#)".

3.2 Configuring the Device

Once the device is installed and connected to the network, it must be configured. All configuration management is done via the RUGGEDCOM RSG2200 interface. For more information about configuring the device, refer to the *RUGGEDCOM ROS Configuration Manual* associated with the installed software release.

Communication Ports

The RUGGEDCOM RSG2200 can be equipped with various types of communication ports to enhance its abilities and performance. With five available slots, the RUGGEDCOM RSG2200 supports a variety of one- or two-port fiber or copper Ethernet module of various speeds with up to nine Gigabit Ethernet (1 Gbps) ports.

Module Assignment

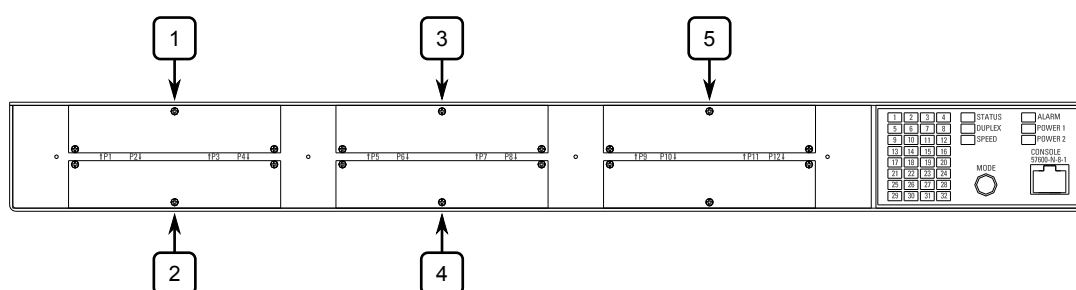

Figure 4.1 Module Assignment

Each type of module has a specific location in the RUGGEDCOM RSG2200 chassis:

- Slot 5 supports a one-port fiber or copper Ethernet module up to 1 Gbps
- All other ports support any combination of fiber or copper Ethernet connectors up to 1 Gbps

The exact configuration of the device can be determined by reading the factory data file through the RUGGEDCOM RSG2200 user interface. For more information about how to read the factory data file, refer to the *RUGGEDCOM ROS Configuration Manual* for the RUGGEDCOM RSG2200.

Port LEDs

Each communication port is equipped with an LED that indicates the link/activity state of the port.

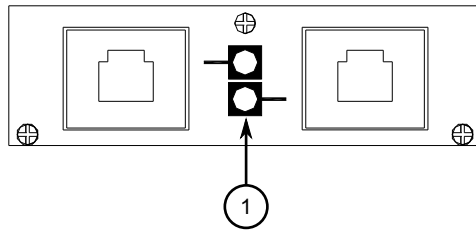

| LED State | Description |
|-------------------|------------------|
| Yellow (Solid) | Link established |
| Yellow (Blinking) | Link activity |
| Off | No link detected |

① Port LED

Figure 4.2 Port LEDs

4.1 Copper Ethernet Ports

The RUGGEDCOM RSG2200 supports several 10/100/1000Base-TX Ethernet ports that allow connection to standard Category 5 (CAT-5) unshielded twisted-pair (UTP) cables with either RJ45 male connectors. The RJ45 connectors are directly connected to the chassis ground on the device and can accept CAT-5 shielded twisted-pair (STP) cables.

| | |
|---|----------------|
| | WARNING |
| Electric shock hazard – risk of serious personal injury and/or equipment interference | |
| <p>If shielded cables are used, make sure the shielded cables do not form a ground loop via the shield wire and the RJ45 receptacles at either end. Ground loops can cause excessive noise and interference, but more importantly, create a potential shock hazard that can result in serious injury.</p> | |

Pin-Out

The following is the pin-out description for the RJ45 connectors:

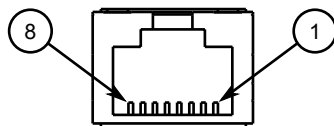

Figure 4.3 RJ45 Ethernet Port Pin Configuration

| Pin | Name | | Description |
|-----|---------------|-------------|---|
| | 10/100Base-TX | 1000Base-TX | |
| 1 | RX+ | BI_DA+ | Receive Data+ or Bi-Directional Pair A+ |
| 2 | RX- | BI_DA- | Receive Data- or Bi-Directional Pair A- |

| Pin | Name | | Description |
|-----|---------------------------|-------------|--|
| | 10/100Base-TX | 1000Base-TX | |
| 3 | TX+ | BI_DB+ | Transmit Data+ or Bi-Directional Pair B+ |
| 4 | Reserved (Do Not Connect) | BI_DC+ | Transmit Data+ or Bi-Directional Pair C+ |
| 5 | Reserved (Do Not Connect) | BI_DC- | Receive Data- or Bi-Directional Pair C- |
| 6 | TX- | BI_DB- | Transmit Data- or Bi-Directional Pair B- |
| 7 | Reserved (Do Not Connect) | BI_DD+ | Receive Data- or Bi-Directional Pair D+ |
| 8 | Reserved (Do Not Connect) | BI_DD- | Receive Data- or Bi-Directional Pair D- |

Specifications

For specifications on the available copper Ethernet ports, refer to "[Copper Ethernet Port Specifications \(Page 32\)](#)".

4.2 Fiber Optic Ethernet Ports

Fiber optic Ethernet ports are available with either LC (Lucent Connector), SC (Standard or Subscriber Connector) or ST (Straight Tip) connectors. Make sure the Transmit (Tx) and Receive (Rx) connections of each port are properly connected and matched to establish a proper link.

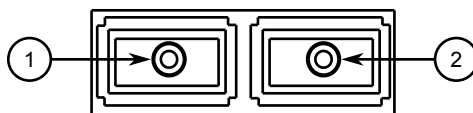

- ① Tx Connector
- ② Rx Connector

Figure 4.4 SC Port

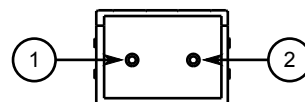

- ① Tx Connector
- ② Rx Connector

Figure 4.5 LC Port

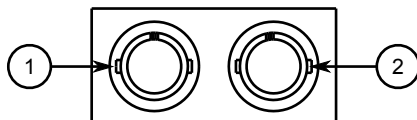

- ① Tx Connector
- ② Rx Connector

Figure 4.6 ST Port

For specifications on the available fiber optic Ethernet ports, refer to "[Fiber Optic Ethernet Port Specifications \(Page 33\)](#)".

4.3 SFP Transceivers

The RUGGEDCOM RSG2200 supports up to two Small Form-Factor Pluggable (SFP) transceiver sockets, which are compatible with a wide array of SFP transceivers available from Siemens.

LEDs

Each socket features an LED that indicates its link state.

| State | Description |
|-------------------|------------------|
| Yellow (Solid) | Link established |
| Yellow (Blinking) | Activity |
| Off | No link detected |

Compatible SFP Transceivers

For more information about which SFP transceivers are compatible with the RUGGEDCOM RSG2200, as well as instructions for ordering and installation/removal, refer to the [RUGGEDCOM SFP Transceiver Catalog \[https://support.industry.siemens.com/cs/ca/en/view/109482309\]](https://support.industry.siemens.com/cs/ca/en/view/109482309).

IMPORTANT
Only use SFP transceivers approved by Siemens for RUGGEDCOM products. Siemens accepts no liability as a result of performance issues related in whole or in part to third-party components.

4.4 GBIC Optic Ethernet Ports

GBIC (Gigabit Interface Converter) optic Ethernet ports are available with SC (Standard or Subscriber Connector) connectors.

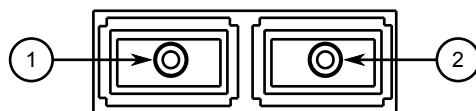

- ① Tx Connector
- ② Rx Connector

Figure 4.7 SC Port

4.4.1 Installing a GBIC Optical Port

To install a GBIC optical port, do the following:

 **NOTICE**

Electrical hazard – risk of damage to equipment

Use only components certified by Siemens with RUGGEDCOM products. Damage to the module and device may occur if compatibility and reliability have not been properly assessed.

 **NOTICE**

Electrical hazard – risk of damage to equipment

Make sure all electrostatic energy is dissipated before installing or removing components from the device. An electrostatic discharge (ESD) can cause serious damage to the component once it is outside the chassis.

 **NOTICE**

Only install GBIC optical ports that are compatible with the RUGGEDCOM RSG2200.

1. Make sure all potential electrostatic build-up has been properly discharged to prevent electrostatic discharges (ESD). This can be accomplished by wearing an ESD-preventive wrist strap connected to either the chassis ground connector or a bare metal surface on the router/switch.
2. Remove the dust cover from the port opening in the module.
3. Remove the port from its packaging.

 **NOTICE**

Mechanical hazard – risk of component damage

GBIC optical ports are designed to insert in only one orientation. Do not force the port into the module.

4. Remove the dust plug from the socket and store for future use.

4.4.2 Removing a GBIC Optical Port

5. Squeeze the latches on either side of the port and insert the port into the socket.

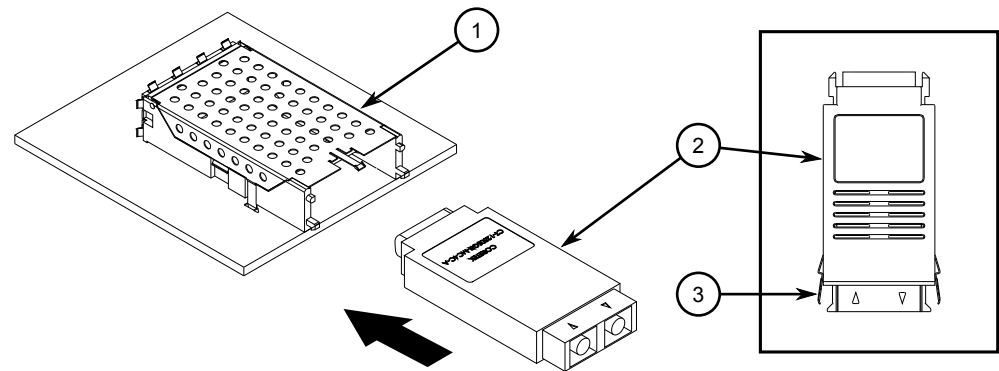

- ① GBIC Optical Port Module
- ② Socket
- ③ Locking Latch

Figure 4.8 Installing a GBIC Optical Port

6. Release the latches and make sure the port is locked in place.

⚠ NOTICE
 Only remove the dust plug when ready to connect a cable to the GBIC optical port.

7. Remove the dust cover from the port and store for future use.
8. Remove the dust cap from the cable and immediately connect it to the port.
9. Connect the cable to a network and observe the LED associated with the port. For more information about the LED, refer to "[Communication Ports \(Page 23\)](#)".

4.4.2 Removing a GBIC Optical Port

To remove an GBIC optical port, do the following:

⚠ NOTICE
Electrical hazard – risk of damage to equipment
 Make sure all electrostatic energy is dissipated before performing installing or removing components from the device. An electrostatic discharge (ESD) can cause serious damage to the component once it is outside the chassis.

1. Make sure all potential electrostatic build-up has been properly discharged to prevent an electrostatic discharge (ESD). This can be accomplished by wearing an ESD-preventive wrist trap connected to either the chassis ground connector or a bare metal surface on the router/switch.

2. Disconnect the cable from the port and install the dust cap to the cable end.
3. Squeeze the latches on either side of the port and pull it from the socket.

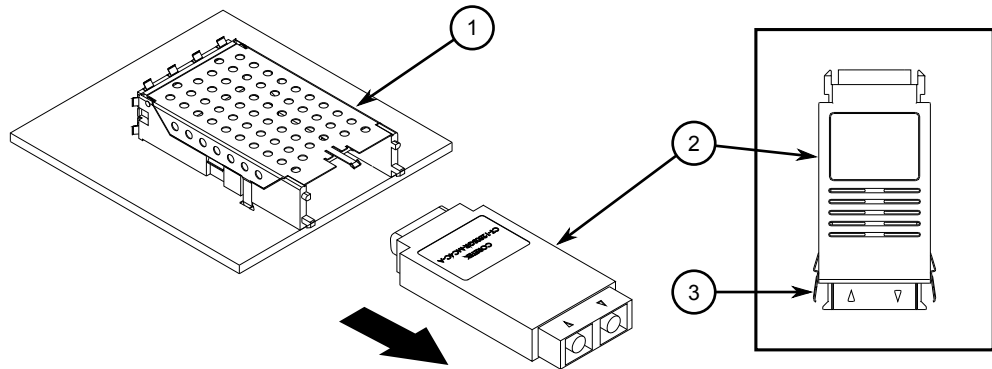

- ① Socket
- ② GBIC Optical Port
- ③ Locking Latch

Figure 4.9 Removing a GBIC Optical Port

4. Store the port in an ESD-safe bag or other suitable ESD-safe environment, free from moisture and stored at the proper temperature (-40 to 85 °C or -40 to 185 °F).
5. Insert a dust plug into the socket opening to prevent the ingress of dust and dirt.

Technical Specifications

This section details the specifications and operating conditions of the device.

5.1 Power Supply Specifications

The RUGGEDCOM RSG2200 can be equipped with the following power supplies:

| |
|---|
|  NOTICE |
| Electrical hazard – risk of damage to the device |
| Make sure power input to the device is within the specified input range. |

| Power Supply Type | Input Range | | Internal Fuse Rating ^{ab} | Maximum Power Consumption ^c |
|-------------------------------|-------------|---------|------------------------------------|--|
| | Minimum | Maximum | | |
| 24 VDC | 10 VDC | 36 VDC | 6.3 A(F) | 28 W |
| 48 VDC | 36 VDC | 72 VDC | 3.15 A(T) | |
| HI (125/250 VDC) ^d | 88 VDC | 300 VDC | 2 A(T) | |
| HI (110/230 VAC) ^d | 85 VAC | 264 VAC | 2 A(T) | |

^a (F) denotes fast-acting fuse

^b (T) denotes time-delay fuse.

^c Power consumption varies based on configuration. 10/100Base-TX ports consume roughly 1 W less than fiber optic ports.

^d The HI power supply is the same power supply for both AC and DC.

5.2 Failsafe Relay Specifications

| | |
|----------------------------|---|
| Maximum Switching Voltage | 250 VAC, 125 VDC |
| Rated Switching Current | 2 A @ 250 VAC, 0.15 A @ 125 VDC, 2 A @ 30 VDC |
| Maximum Switching Capacity | 150 W, 500 VA |

5.3 Supported Networking Standards

| Standard | 10 Mbps Ports | 100 Mbps Ports | 1000 Mbps Ports | Description |
|-------------|---------------|----------------|-----------------|---------------------|
| IEEE 802.3u | | ✓ | | 100BaseTX/100BaseFX |

5.4 Copper Ethernet Port Specifications

| Standard | 10 Mbps Ports | 100 Mbps Ports | 1000 Mbps Ports | Description |
|------------------------------------|---------------|----------------|-----------------|--|
| IEEE 802.3x | ✓ | ✓ | ✓ | Flow Control |
| IEEE 802.3z | | | ✓ | 1000BaseLX |
| IEEE 802.3ab | | | ✓ | 1000BaseTx |
| IEEE 802.3ad | | | ✓ | Link Aggregation |
| IEEE 802.1D | ✓ | ✓ | ✓ | MAC Bridges |
| IEEE 802.1D | ✓ | ✓ | ✓ | Spanning Tree Protocol (STP) |
| IEEE 802.1p | ✓ | ✓ | ✓ | Class of Service (CoS) |
| IEEE 802.1Q | ✓ | ✓ | ✓ | VLAN (Virtual LAN) Tagging |
| IEEE 802.1w | ✓ | ✓ | ✓ | Rapid Spanning Tree Protocol (RSTP) |
| IEEE 802.1x | ✓ | ✓ | ✓ | Port-Based Network Access Control |
| IEEE 802.1Q-2005 (formerly 802.1s) | ✓ | ✓ | ✓ | Multiple Spanning Tree Protocol (MSTP) |

5.4 Copper Ethernet Port Specifications

The following details the specifications for copper Ethernet ports that can be ordered with the RUGGEDCOM RSG2200.

Note

- Maximum segment length is greatly dependent on factors such as fiber quality, and the number of patches and splices. Consult a Siemens sales associate when determining maximum segment distances.
- All optical power numbers are listed as dBm averages.
- F51 transceivers are rated for -40 to 85 °C (-40 to 185 °F).

| | |
|-------------------------------------|-----------------|
| Connector | RJ45 |
| Speed | 1000 Mbps |
| Duplex^a | FDX/HDX |
| Cable Type^b | > CAT-5 |
| Wiring Standard^c | TIA/EIA T568A/B |
| Maximum Distance^d | 100 m (328 ft) |
| Isolation^e | 1.5 kV |

^a Auto-Negotiating

^b Shielded or unshielded.

^c Auto-crossover and auto-polarity.

^d Typical distance. Dependent on the number of connectors and splices.

^e RMS 1 minute.

5.5 Fiber Optic Ethernet Port Specifications

The following details the specifications for fiber Ethernet ports that can be ordered with the RUGGEDCOM RSG2200.

Fast Ethernet (10/100 Mbps) Optical Specifications

| Mode | Connector Type | Cable Type (μm) | Tx λ (nm) ^a | Tx (dBm) | | Rx Sensitivity (dBm) | Rx Saturation (dBm) | Distance (km) ^b | Power Budget (dB) |
|------|----------------|-----------------|------------------------|----------|---------|----------------------|---------------------|----------------------------|-------------------|
| | | | | Minimum | Maximum | | | | |
| MM | ST | 62.5/125 | 1308 | -19 | -14 | -31 | -14 | 2 | 12 |
| MM | ST | 50/125 | 1308 | -22.5 | -14 | -31 | -14 | 2 | 8.5 |
| MM | SC | 62.5/125 | 1308 | -19 | -14 | -31 | -14 | 2 | 12 |
| MM | SC | 50/125 | 1308 | -22.5 | -14 | -31 | -14 | 2 | 8.5 |
| MM | LC | 62.5/125 | 1310 | -19 | -14 | -32 | -14 | 2 | 13 |
| MM | MTRJ | 62.5/125 | 1308 | -19 | -14 | -31 | -14 | 2 | 12 |
| MM | MTRJ | 50/125 | 1308 | -22.5 | -14 | -31 | -14 | 2 | 8.5 |
| SM | ST | 9/125 | 1310 | -15 | -8 | -32 | -3 | 20 | 17 |
| SM | SC | 9/125 | 1300 | -15 | -8 | -31 | -7 | 20 | 16 |
| SM | LC | 9/125 | 1310 | -15 | -8 | -34 | -7 | 20 | 19 |
| SM | SC | 9/125 | 1310 | -5 | 0 | -34 | -3 | 50 | 29 |
| SM | LC | 9/125 | 1310 | -5 | 0 | -35 | -3 | 50 | 30 |
| SM | SC | 9/125 | 1310 | 0 | 5 | -37 | 0 | 90 | 37 |
| SM | LC | 9/125 | 1310 | 0 | 5 | -37 | 0 | 90 | 37 |

^a Typical.

^b Typical distance. The maximum distance is greatly dependent on factors such as cable type, the number of connectors and number of splices. Consult a Siemens sales associates when determining maximum distances.

Gigabit Ethernet (1 Gbps) Optical Specifications

Note

These transceivers utilize a distributed feedback (DFB) type laser and are rated for -20 to 85 °C (-4 to 185 °F) operation only.

| Mode | Connector Type | Cable Type (μm) ^a | Tx λ (nm) ^b | Tx (dBm) ^c | | Rx Sensitivity (dBm) ^c | Rx Saturation (dBm) ^c | Distance (km) ^d | Power Budget (dB) |
|------|----------------|------------------------------|------------------------|-----------------------|---------|-----------------------------------|----------------------------------|----------------------------|-------------------|
| | | | | Minimum | Maximum | | | | |
| MM | LC | 50/125 | 850 | -9 | -2.5 | -20 | 0 | 0.5 | 11 |
| MM | LC | 62.5/125 | 850 | -9 | -2.5 | -20 | 0 | 0.5 | 11 |
| SM | SC | 9/125 | 1310 | -10 | -3 | -20 | -3 | 10 | 10 |
| SM | LC | 9/125 | 1310 | -9.5 | -3 | -21 | -3 | 10 | 11.5 |
| SM | SC | 9/125 | 1310 | -5 | 0 | -20 | -3 | 25 | 15 |
| SM | LC | 9/125 | 1310 | -7 | -3 | -24 | -3 | 25 | 17 |

^a All cabling is duplex type unless specified otherwise.

^b Typical.

^c All optical power numbers are listed as dBm averages.

5.6 Operating Environment

^d Typical distance. The maximum segment length is greatly dependent on factors such as fiber quality, and the number of patches and splices. Consult a Siemens sales associates when determining maximum segment distances.

GBIC Gigabit (1 Gbps) Transceiver Specifications

Note

GBIC transceivers have a temperature range of -40 to 85 °C (-40 to 185 °F), unless specified otherwise.

| Mode | Connector Type | Cable Type (µm) ^a | Tx λ (nm) ^b | Tx (dBm) ^c | | Rx Sensitivity (dBm) ^c | Rx Saturation (dBm) ^c | Distance (km) ^d | Power Budget (dB) |
|-----------------|----------------|------------------------------|------------------------|-----------------------|---------|-----------------------------------|----------------------------------|----------------------------|-------------------|
| | | | | Minimum | Maximum | | | | |
| SM | SC | 9/125 | 1310 | -9.5 | -3 | -21 | -3 | 10 | 11.5 |
| SM | SC | 9/125 | 1310 | -7 | -3 | -24 | -3 | 25 | 17 |
| SM ^e | SC | 9/125 | 1550 | 0 | 5 | -23 | -3 | 70 | 23 |

^a All cabling is duplex type unless specified otherwise.

^b Typical.

^c All optical power numbers are listed as dBm averages.

^d Typical distance. The maximum segment length is greatly dependent on factors such as fiber quality, and the number of patches and splices. Consult a Siemens sales associates when determining maximum segment distances.

^e Operating temperature range of -25 to 85 °C (-13 to 185 °F).

5.6 Operating Environment

The RUGGEDCOM RSG2200 is rated to operate under the following environmental conditions.

| | |
|--|-----------------------------|
| Ambient Operating Temperature^{a b} | -40 to 85°C (-40 to 185 °F) |
| Ambient Storage Temperature | -40 to 85°C (-40 to 185 °F) |
| Ambient Relative Humidity^c | 5% to 95% |
| Maximum Altitude | 2000 m (6562 ft) |

^a Measured from a 30 cm (12 in) radius surrounding the center of the enclosure.

^b Operating temperature may vary based on the limitations of installed SFPs. Refer to the *RUGGEDCOM SFP Transceivers Catalog* for SFP temperature ratings.

^c Non-condensing

5.7 Mechanical Specifications

| | |
|---------------------------|-------------------------|
| Weight | 4.8 kg (10.6 lbs) |
| Ingress Protection | IP30 |
| Enclosure | 18 AWG Galvanized Steel |

5.8 Dimension Drawings

Note

All dimensions are in millimeters, unless otherwise stated.

Note

Dimensional tolerances are in accordance with ISO 2768-mK, unless otherwise stated.

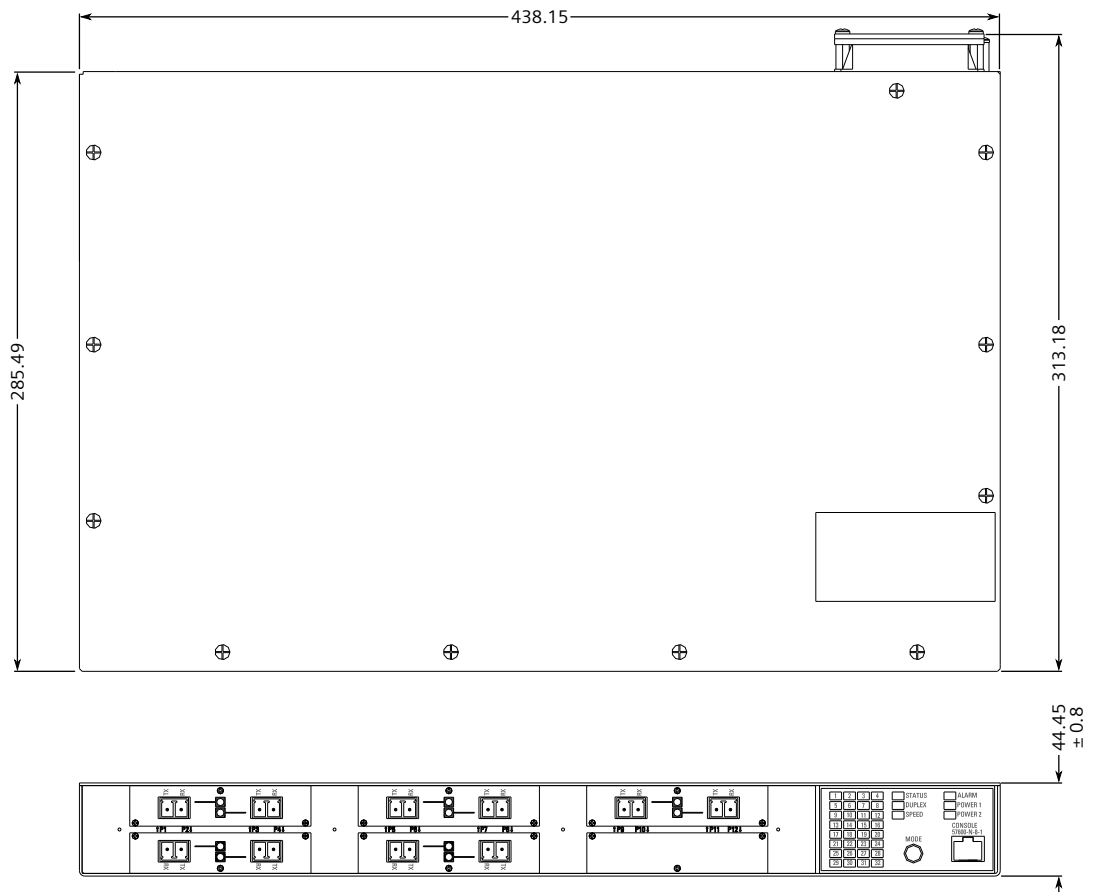

Figure 5.1 Overall Dimensions

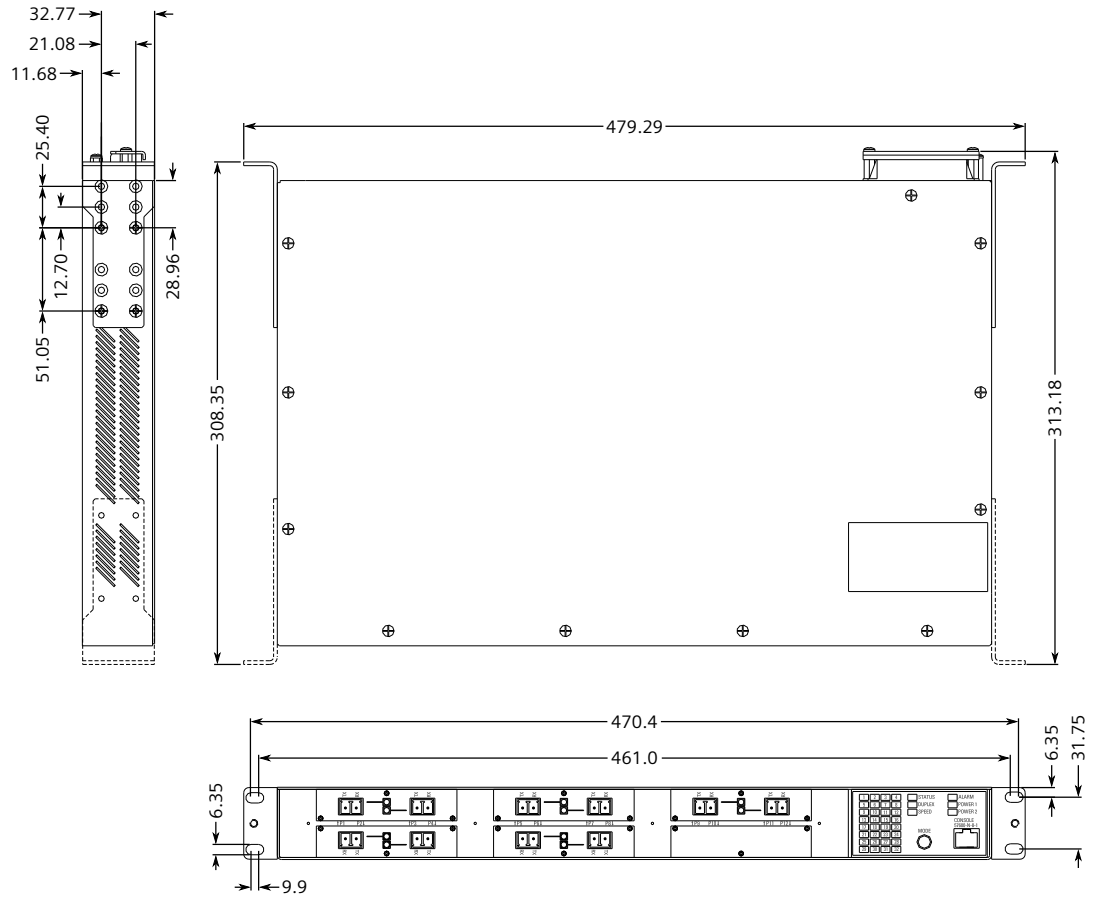

Figure 5.2 Rack Mount Dimensions

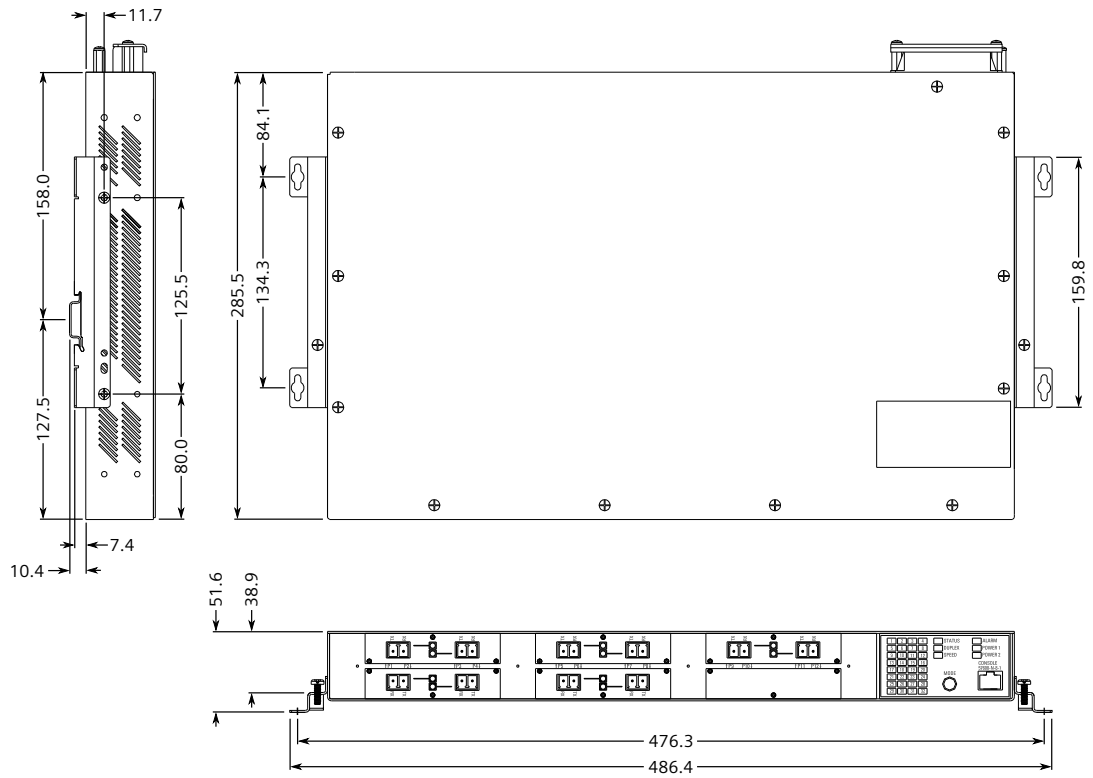

Figure 5.3 Panel and DIN Rail Mount Dimensions

Certification

The RUGGEDCOM RSG2200 device has been thoroughly tested to guarantee its conformance with recognized standards and has received approval from recognized regulatory agencies.

6.1 Approvals

This section details the standards to which the RUGGEDCOM RSG2200 complies.

6.1.1 CSA

This device meets the requirements of the following Canadian Standards Association (CSA) standards under certificate 16.70068356:

- **CAN/CSA-C22.2 No. 62368-1**
Information Technology Equipment – Safety – Part 1: General Requirements (Bi-National Standard, with UL 62368-1)
- **UL 62368-1**
Information Technology Equipment – Safety Part 1: General Requirements

6.1.2 European Union (EU)

This device is declared by Siemens AG to comply with essential requirements and other relevant provisions of the following EU directives:

- **EN 62368-1**
Information Technology Equipment – Safety – Part 1: General Requirements
- **EN 61000-6-2**
Electromagnetic Compatibility (EMC) – Part 6-2: Generic Standards – Immunity for Industrial Environments
- **EN 60825-1**
Safety of Laser Products – Equipment Classification and Requirements
- **EN 50581**
Technical Documentation for the Assessment of Electrical and Electronic Products with Respect to the Restriction of Hazardous Substances

- **EN 55022**

Information Technology Equipment – Radio Disturbance Characteristics – Limits and Methods of Measurement

The device is marked with a CE marking and can be used throughout the European community.



A copy of the CE Declaration of Conformity is available from Siemens AG. For contact information, refer to "[Contacting Siemens \(Page vii\)](#)".

6.1.3 FCC

This device has been tested and found to comply with the limits for a Class A digital device, pursuant to Part 15 of the FCC Rules. These limits are designed to provide reasonable protection against harmful interference when the equipment is operated in a commercial environment.

This device generates, uses and can radiate radio frequency energy and, if not installed and used in accordance with the instruction manual, may cause harmful interference to radio communications. Operation of this equipment in a residential area is likely to cause harmful interference in which case users will be required to correct the interference at their own expense.

| |
|---|
|  NOTICE |
| Changes or modifications not expressly approved by the party responsible for compliance could void the user's authority to operate this device. |

6.1.4 FDA/CDRH

This device meets the requirements of the following U.S. Food and Drug Administration (FDA) standard:

- Title 21 Code of Federal Regulations (CFR) – Chapter I – Sub-chapter J – Radiological Health

6.1.5 ISED

This device is declared by Siemens AG to meet the requirements of the following ISED (Innovation Science and Economic Development Canada) standard:

- CAN ICES-3 (A)/NMB-3 (A)

6.1.6 ISO

This device was designed and manufactured using a certified ISO (International Organization for Standardization) quality program that adheres to the following standard:

- **ISO 9001:2015**
Quality management systems – Requirements

6.1.7 RoHS

This device is declared by Siemens AG to meet the requirements of the following RoHS (Restriction of Hazardous Substances) directives for the restricted use of certain hazardous substances in electrical and electronic equipment:

- **China RoHS 2**
Administrative Measure on the Control of Pollution Caused by Electronic Information Products

A copy of the Material Declaration is available online at <https://support.industry.siemens.com/cs/ww/en/view/109738831>.

6.1.8 Other Approvals

This device meets the requirements of the following additional standards:

- **IEEE 1613**
IEEE Standard Environmental and Testing Requirements for Communications Networking Devices in Electric Power Substations
- **IEC 61000-6-2**
Electromagnetic Compatibility (EMC) – Part 6-2: Generic Standards – Immunity for Industrial Environments
- **IEC 61850-3**
Communication Networks and Systems in Substations – Part 3: General Requirements

6.2 EMC and Environmental Type Tests

The RUGGEDCOM RSG2200 has passed the following Electromagnetic Compatibility (EMC) and environmental tests.

EMC Type Tests per IEC 61850-3

Note

- In the case of an all fiber port configuration, this product meets all Class 2 requirements. Otherwise, all Class 1 requirements are met for copper ports.
- If the unit contains copper ports, the IEC 1613 conformance is Class 1, during which disturbance errors may occur but recovery is automatic.
- If the unit contains all fiber ports, the IEC 1613 conformance is Class 2, during which no disturbance errors will occur.

| Test | Description | | Test Levels | Severity Levels |
|----------------|-----------------------------|-----------------------|---|-------------------|
| IEC 61000-4-2 | ESD | Enclosure Contact | ±8 kV | 4 |
| | | Enclosure Air | ±15 kV | |
| IEC 61000-4-3 | Radiated RFI | Enclosure Ports | 20 V/m | Note ^a |
| IEC 61000-4-4 | Burst (Fast Transient) | Signal Ports | ±4 kV @ 2.5 kHz | Note ^a |
| | | DC Power Ports | ±4 kV | 4 |
| | | AC Power Ports | | |
| | | Earth Ground Ports | | |
| IEC 61000-4-5 | Surge | Signal Ports | ±4 kV Line-to-Ground, ±2 kV Line-to-Line | 4 |
| | | DC Power Ports | ±2 kV Line-to-Ground, ±1 kV Line-to-Line | 3 |
| | | AC Power Ports | ±4 kV Line-to-Ground, ±2 kV Line-to-Line | 4 |
| IEC 61000-4-6 | Induced (Conducted) RFI | Signal Ports | 10 V | 3 |
| | | DC Power Ports | | |
| | | AC Power Ports | | |
| | | Earth Ground Ports | | |
| IEC 61000-4-8 | Magnetic Field | Enclosure Ports | 40 A/m Continuous | Note ^a |
| | | | 1000 A/m for 1 s | 5 |
| IEC 61000-4-11 | Voltage Dips and Interrupts | AC Power Ports | 30% for 1 period 60% for 50 periods 100% for 5 periods 100% for 50 periods | |
| IEC 61000-4-12 | Damped Oscillatory | Signal Ports | 2.5 kV Common | 3 |
| | | DC Power Ports | 1 kV Differential Mode @1 MHz | |
| | | AC Power Ports | | |
| IEC 61000-4-16 | Mains Frequency Voltage | Signal Ports | 30 V Continuous | 4 |
| | | AC and DC Power Ports | 300 V for 1s | |

| Test | Description | | Test Levels | Severity Levels |
|----------------|-----------------------------|----------------|---|-----------------|
| IEC 61000-4-17 | Ripple on DC Power Supply | DC Power Ports | 10% | 3 |
| IEC 61000-4-29 | Voltage Dips and Interrupts | DC Power Ports | 30% for 0.1 s 60% for 0.1 s 100% for 0.05 s | |
| IEC 60255-5 | Dielectric Strength | Signal Ports | 2 kV (Fail-Safe Relay Output) | |
| | | DC Power Ports | 2 kV | |
| | | AC Power Ports | 2 kV | |
| | HV Impulse | Signal Ports | 5 kV (Fail-Safe Relay Output) | |
| | | DC Power Ports | 5 kV | |
| | | AC Power Ports | | |

^a Siemens-specified severity levels

EMC Immunity Type Tests per IEEE 1613

Note

The RUGGEDCOM RSG2200 meets Class 2 requirements for an all-fiber configuration and Class 1 requirements for copper ports. Class 1 allows for temporary communication loss, while Class 2 requires error-free and interrupted communications.

| Description | | Test Levels |
|----------------|--------------------|---|
| ESD | Enclosure Contact | ±2 kV ±4 kV ±8 kV |
| | Enclosure Air | ±4 kV ±8 kV ±15 kV |
| Radiated RFI | Enclosure Ports | 35 V/m |
| Fast Transient | Signal Ports | 4 kV @ 2.5 kHz |
| | DC Power Ports | 4 kV |
| | AC Power Ports | 4 kV |
| | Earth Ground Ports | 4 kV |
| Oscillatory | Signal Ports | 2.5 kV Common Mode @ 1 MHz |
| | DC Power Ports | 2.5 kV Common 1 kV differential mode @ 1 MHz |
| | AC Power Ports | 2.5 kV Common 1 kV differential mode @ 1 MHz |
| HV Impulse | Signal Ports | 5 kV (Fail-Safe Relay Output) |
| | DC Power Ports | 5 kV |
| | AC Power Ports | 5 kV |

6.2 EMC and Environmental Type Tests

| | Description | Test Levels |
|-----------------------------------|-----------------|-------------|
| Dielectric Strength | Signal Ports | 2 kV |
| | DC Power Ports | 2 kV |
| | AC Power Ports | 2 kV |
| Damped Oscillatory Magnetic Field | Enclosure Ports | 100 A/m |

Environmental Type Tests

| Test | Description | | Test Levels |
|----------------|------------------------------|---------|---|
| IEC 60068-2-1 | Cold Temperature | Test Ad | -40 °C (-40 °F), 16 Hours |
| IEC 60068-2-2 | Dry Heat | Test Bd | 85 °C (185 °F), 16 Hours |
| IEC 60068-2-30 | Humidity (Damp Heat, Cyclic) | Test Db | 95% (Non-Condensing), 55 °C (131 °F), 6 Cycles |
| IEC 60068-21-1 | Vibration | | 2g @ 10-150 Hz |
| IEC 60068-21-2 | Shock | | 30 g @ 11 ms |

Further Information

Siemens RUGGEDCOM
<https://www.siemens.com/ruggedcom>

Industry Online Support (service and support)
<https://support.industry.siemens.com>

Industry Mall
<https://mall.industry.siemens.com>

Siemens AG
Digital Industry
Process Automation
Postfach 48 48
90026 NÜRNBERG
GERMANY