

DEUS II

Fast Simultaneous Multi Frequency



eXPLore like
never before !

 MADE IN FRANCE





Congratulations on purchasing your

DEUS II

DEUS, ten years of development

In 2010, XP Metal Detectors invented DEUS and revolutionized the world of detecting. The unique DEUS wireless technology, its performance, its telescopic stem, its updates and many upgrades, HF coils, connected MI-6 Pinpointer, X35 coils and more has made it a top seller throughout the world.

Now discover **DEUS II**, a new revolution !

Today, XP is once more pushing the limits by creating **DEUS II**, the first wireless, multi-frequency metal detector with unique features and performance :

- FMF® Fast Multi Frequency: Simultaneous multi-frequencies with rapid target response.
- Ultra efficient.
- Totally wireless.
- Lightest and most ergonomic (from 750g).
- Designed for both land and sea.
- Three optional wireless headphones.
- Innovative, waterproof bone conduction headphones as per IP68 - 20 m.
- Waterproof coil and remote control as per IP 68 - 20 m - Target display indicates when submerged
- Shockproof remote control entirely encased in rubber.
- Better identification of targets in the ground.
- Upgraded audio interface: Choice of tones, four amplified audio outputs, multi-band equalizer adjustable on each output: Loud speaker, wireless and wired headphones, bone conduction headphones.
- A product designed to last: Five-year warranty parts and labor, USB updates.

DEUS II : discover a unique environment

- Audio headphones developed and manufactured by XP in France, designed specifically to meet detecting requirements: no audio latency, automatic On/Off, sophisticated processor with resonances and equalizer that can be configured by the user from the remote control.
- Wireless headphones WS6 with removable module that can become the master in place of the remote control (RC).
- **DEUS II WS6 MASTER (+WSA II)**: The WS6 has a graphic screen and virtually all the controls available on **DEUS II RC**.
- Remote control that can be unclipped and positioned in an armband or on the belt for extreme lightness.
- 5 telescopic ergonomic stem that can be collapsed or extended in an instant as there are no wires.

eXPlore like never before !

Please refer to the online manual for the latest improvements. Certain functions may have changed since this manual was printed.



INTRODUCTION	3
DEUS II RANGE	7
PRACTICAL INFORMATION	8
Advice	8
Optimize your searching	8
Locating a target	9
DEUS II	9
Box contents	9
Assembly (coil, remote, etc.)	10
Remote control	11
Factory programs	12 - 13
MENU	14
Discrimination	14
• Tones (EXPERT)	15
• Pitch (EXPERT)	15
• Full Tones (EXPERT)	16
• B.Caps (EXPERT)	16
• Notch (EXPERT)	16
• Multi-Notch (EXPERT)	16 - 17
• Silencer (EXPERT)	17
IAR Discrimination	17
Threshold	17
Sensitivity	17
Salt Sens	18
Frequencies	18 - 19
Iron Volume	20
Reactivity	20 - 21
Audio Response	21
GROUND	22
General	22
• Grab	22
• Manual	23
• Tracking	23
Magnetic soil	23
Ground stabilizer	24
Gold Field & Relic special features	24
Pinpoint	25
OPTION	26
Audio	26
• Audio output	26
• Equalizer	26
• Audio Type	27
Settings	28
Diving mode	28
Display	28
• Backlight	28
• Contrast	28
• Brightness	28
Language	28
Hour	28
Profile	29
• Standard screen	29
• X - Y screen	29
• X - Y zoom	29
Go Terrain	30
Frequency Scan	30
Update	30
Info	30

OPTION ...	31
Programs	31
Save program	31
Delete program	31
Pairing	31
Pair coil	31
Delete coil	32
Pair wireless headphones	32
Delete wireless headphones	32
Pair MI-6 Pinpointer	32
Delete MI-6 Pinpointer	32
WS6	33
• Configuration	33
• WS6 Master/Slave	33
• Menu	34
• Option	34
WSA II and WSA II XL	34
BH-01	35
• Positioning	35
• Storage/Cleaning	35
MI-6 Pinpointer	36
MI-6 active display screen	36
Sensitivity MI-6	36
Tones MI-6	36
Audio Pitch/Audio Pulse	36
Programs/Save	36
Recover a lost MI-6	36

BATTERIES	37
Battery life	37
Charging time	37
Coil flashing LED	37
Charge	38
Battery life	38
Replacing batteries	39
Safety precautions	39
Power adaptor	39

DIVING & SEALING	40
Cap choices	40
Cleaning after use	40
Aerial antenna assembly	41

GENERAL	42
Problems and solutions	42
Specifications	43
Accessories	44
Spare parts	45
Factory programs spec	46
Recommendation/law	47
Declaration EU - FCC IC - UKCA	47
Radio waves safety	48
Recycling waste	48
Precautions for use	48
XP Warranty	49
Battery Air transport spec.	49



DEUS II RANGE

DEUS II RC



DEUS II WS6 MASTER



3 options available for the WS6 MASTER

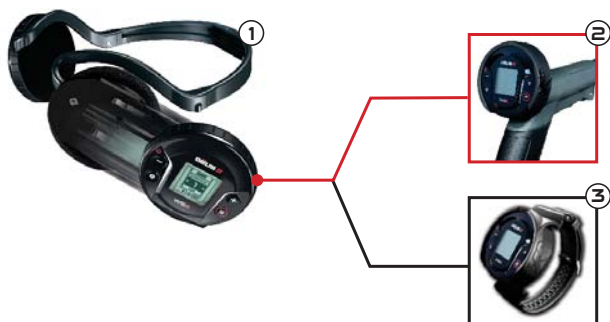

- ① WS6 module on the backphones.
- ② WS6 module on the stem + headphones of your choice.
- ③ WS6 module on the wrist strap + headphones of your choice.

PRACTICAL INFORMATION

Advice

Metal detecting is a fascinating hobby that can bring you huge satisfaction. However, some basic learning is necessary to get the most enjoyment out of it. Begin by familiarizing yourself with your equipment and its operation on suitable practise ground.

We recommend that you take an assortment of different objects - coins, everyday items, metal rubbish, etc. Then find a patch of ground relatively free from metal pollution and well away from any electromagnetic interference (high voltage power lines, electric fences, domestic appliances, etc.). For instance, your garden would probably be one of the most unsuitable places to begin as there is too much domestic waste in the vicinity.

To test whether the site is suitable for practising, sweep the coil over the ground as if detecting. Move somewhere else if you hear a multitude of sounds. Once you have found a suitable spot, arrange your objects on the ground, spacing them approximately two coil widths apart. Before placing an object, use the device to check that there is no metal already in the ground.

Spend a little time watching your device's reactions when it passes over each target. You can then sort them according to the sound response type and try and understand what makes them similar or different. If you feel comfortable with this exercise, you can also try out some of the pre-configured settings.

Optimize your searching

When detecting, it is important to sweep the coil parallel to the ground, using wide movements, as close as possible to the surface (without actually touching it). Proximity to the ground will increase the likelihood of detecting a deep target and will enable the smallest objects to be identified more easily. Avoid knocking the coil, as although it is designed to withstand this kind of treatment, careful handling will prolong the life of the device and guarantee better perception of targets.

When you are detecting, the rate at which you move is up to you. For example, covering a zone at high speed while detecting will certainly give you a global 'snapshot' of the site. However, clearly this method of detecting will also leave large swathes of ground unexplored between each sweep. So, if you really want to scrutinise every inch of ground closely, make sure that each sweep slightly overlaps the previous one so that the zone not scanned by your coil is as small as possible.

Bear in mind also that you will increase your chances of finding and identifying a target further by sweeping more slowly. This particularly applies in metal-infested ground (when there are more targets to be investigated) or when you are searching for deeper targets.

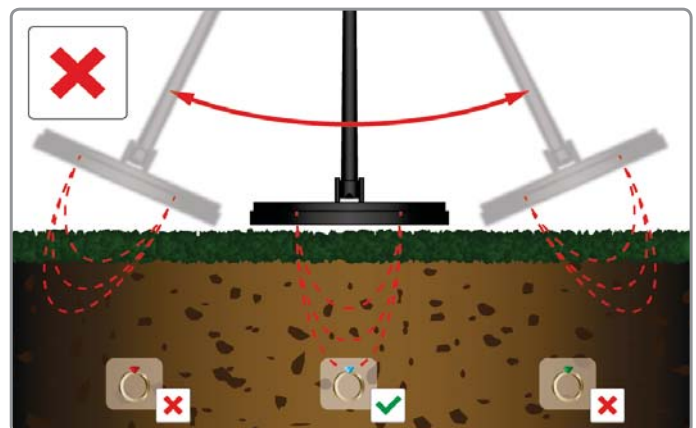
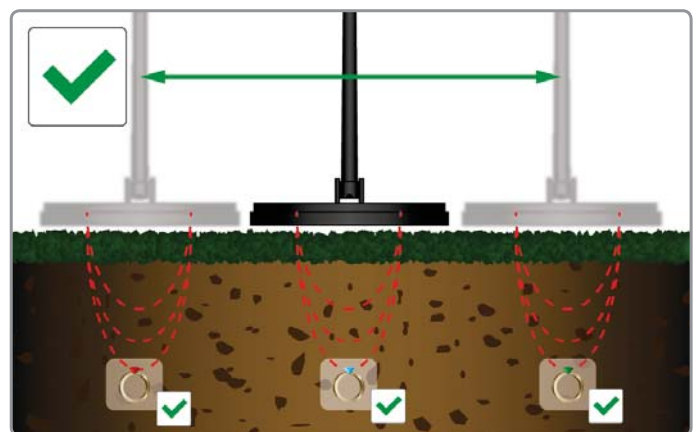

Locating a target using crossed sweeps

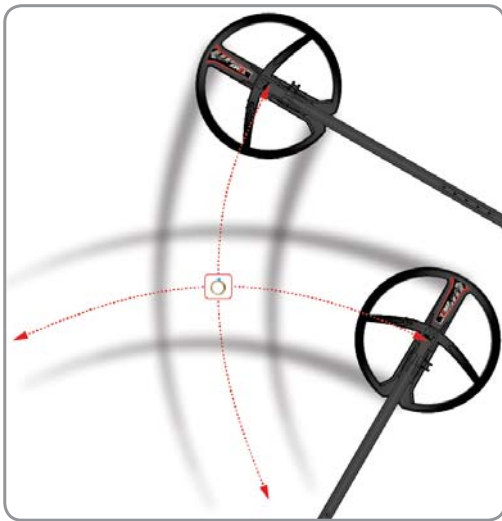

Once the detector has indicated the approximate presence of a target in Motion mode, sweep the place where you heard the sound if you are having difficulty locating the target. Slowly reduce the amplitude of your movements and make a mental note of the spot where the sound is loudest. If necessary, indicate it with a mark on the ground. Then move a quarter turn around the spot and begin sweeping again in the same way (at 90° to the first sweep). You should then locate the precise zone containing your target at the intersection of the two sweeps, where the sound is loudest. Continue with crossed sweeps over the target. The loudest and highest pitched audio signal indicates the centre of the coil and therefore the position of the target.

You can also use non-motion mode, where the coil does not need motion to register the target (see Chapter PINPOINT).

LIST OF PARTS

Box contents



- 1 1 remote + hipmount case.
- 2 1 set of wireless headphones with storage case (depending on version purchased).
- 3 1 search coil with coil cover (depending on version).
- 4 1 coil fitting kit.
- 5 1 aerial antenna to use underwater + clip.
- 6 1 gray cap on the remote + 1 red cap for diving (see DIVING & SEALING).
- 7 1 S-TELESCOPIC Stem + lower stem (depending on version).
- 8 1 mains adaptor (depending on Country).
- 9 1 charging cable for three components and remote updates.
- 10 1 coil connection clamp.

ASSEMBLY

FMF Coil

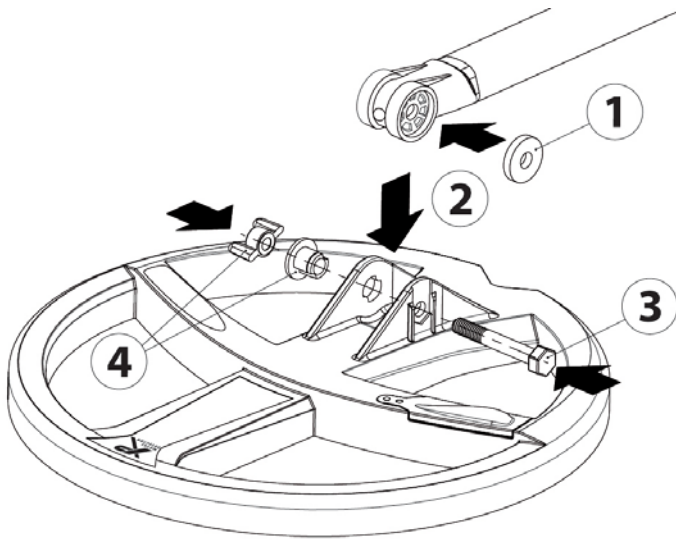

- ① Insert the rubber washer inside the lower stem.
- ② Position the lower stem on the coil.
- ③ Position the screw.
- ④ Add spacer and gently tighten.

Remote assembly



- ① Remove the protective cap.



- ② Insert the remote.

Adjust arm rest



- ① Remove the screw.



- ② Adjust the arm rest (s-telescopic only) to one of the three positions and replace screw.

Scale of target conductivity
Grayed out zones = rejected zones

Ferrous / Non ferrous display

Clock and battery levels alternate display with Ground level

ON/OFF (Long press)
Access to OPTION Configuration/Program...

Change program
Decrease values
Long press: shortcut to Audio

Program name (change program with - or +)

Program no.

Ground mineralization (Phase measured).

Your ground effect correction.

Access to MENU.
Long press: send the target indication to the smartphone with Go Terrain.

Access to GROUND SETTING (G.B).
Long press: Shortcut to Automatic Freq. Scan

Change the program.
Increase values.
Long press: Shortcut to Audio.

Pinpoint (non-motion mode).
Long press: GRAB (ground capture).

* alternative screen:



Digital scale of target conductivity from 0 to 99.

Mineralization strength.

XP Connector multi-features

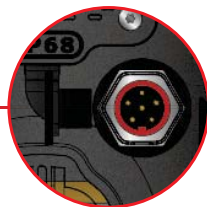

- Battery level**
- Update software**
- wired headset (Optional)**
- Bone conduction headphones BH-01 (Optional)**

FACTORY PROGRAMS

DEUS II has the advantage of offering a wide range of programs suitable for all ground and search conditions. Unlike some multi-frequency detectors that offer fixed multiple frequencies, **DEUS II** uses different high and low frequency combinations depending on the programs. For example, some use low to medium frequencies e.g. 4 to 14 kHz and other programs include higher frequencies up to 24 kHz or 40 kHz. Program-specific signal processing is applied to these frequency combinations and to the ground in the best possible way. These frequencies can then be subtracted to remove electrically-conductive soils or added together to help locate a wider range of targets. The processing platform information used for each program is displayed in the title bar. Read the data for each program carefully to get the most out of your **DEUS II**!

(See also the comparison table at the end of the manual to better understand the different parameters each program has to offer).

Prg. 1 - GENERAL

FMF • Max. freq. ☹ 40kHz • Conductive soil subtraction

GENERAL uses low and high frequencies and gives an excellent assessment of targets in the soil. It suits both beginners and experienced users.

It offers an excellent target/false signal ratio in the ground, as it rejects the moisture in the soils, which can cause halos and false sounds when passing over holes, for example. You will therefore have more confidence on deep targets. This damp / wet soil subtraction thus attenuates the very low electric conductors like coke (coal, and conductive stone) and to a lesser extent certain very thin targets like aluminum foil.

- Very effective, test it in the soil, not in the air.
- Set the Reactivity to 2 for more efficiency in cleaner soil or to 3 for polluted/mineralized soil.

Prg. 2 - SENSITIVE

FMF • Max. freq. ☹ 40kHz • Frequency addition

SENSITIVE uses low and high frequencies up to about 40 kHz. Highly efficient on all targets, it will be very effective in mineralized and polluted ground when searching for the smallest targets.

• Thanks to the high precision that the **DEUS II** carries, coke and humidity can be classified with higher accuracy than with a mono-frequency metal detector. A very narrow notch zone is thus activated within frequencies 23 to 25 (see Notch > Expert)

• Reduce the Reactivity to 2 for more efficiency in cleaner ground or increase it to 3 for polluted or mineralized ground.

Prg. 3 - SENSI FT

FMF • Max. freq. ☹ 40kHz • Frequency addition

SENSITIVE FULL TONES is based on the same platform as Prg. 2 - **SENSITIVE**, but it is configured using Full Tone audio mode, with Reactivity at 3 instead of 2.5. It offers a very rich and informative sound identification that requires a little more experience, as each target index generates a different tone in proportion to conductivity (see Discr > Full Tones). Very efficient in highly-polluted ferrous and mineralized ground.

Prg. 4 - FAST

FMF • Max. freq. ☹ 40kHz • Frequency addition

FAST is based on the same platform as Prg. 2 - **SENSITIVE**, but the audio is set to Pitch mode with Reactivity at 3 instead of 2.5 and uses the square audio feature. These three settings combined allow the machine to work fast in ferrous-polluted and mineralized ground.

Prg. 5 - PARK

FMF • Max. freq. ☹ 24kHz • Frequency addition

PARK is adjusted for searching recreational area's such as, parks, dry sand beach, etc., sites that are normally polluted.

- A notch is active from 23 to 36 to reject aluminum foil. Increase it if necessary.
- B.Caps is set to 5 to reject most rusty ferrous caps.

Prg. 6 - DEEP HC

FMF • Max. freq. ☹ 14kHz • Frequency addition

DEEP HIGH CONDUCTOR adds together very low and medium frequencies up to 14 kHz.

Designed to better locate good conductivity targets, it is ideal for clusters of coins whilst maintaining excellent sensitivity to isolated coins using its 14 kHz frequency.

• Ground Stability is set to 1 and soils above your setting will therefore sound to provide you with the best performance for specific deep searches (see Ground). Adjust the Ground by Grabbing but If you are experiencing too many false signals, adjust GND Stability at 2 to reject all the soils, ferrites and shocks.

Prg. 7 - DEUS MONO

MONOFREQUENCY adjustable from 4 to 45kHz

DEUS MONO works on a single frequency like **DEUS 1**, but combines the advantages of **DEUS II**, such as its expanded frequency range to 45 kHz, improved performance, audio quality, better EMI rejection, etc. There is more likelihood of connecting with an unstable frequency while using several simultaneous frequencies than with just one and the **DEUS MONO** could help you in these situations.

- Ground above your ground effect setting will sound like the **DEUS 1**. Adjust the ground by automatic acquisition (see Ground >Grabbing), but if you are experiencing too many false signals, adjust it manually to 88-90 to reject all the ground including, ferrite and shocks.

Prg. 8 - GOLD FIELD

FMF • Max. freq. ☉ 40kHz • Frequency addition

GOLD FIELD is intended for highly-mineralized gold-bearing ground. Gold nuggets are often seen as the ground or ferrous items in these tricky environments. It is set to "all metal" for deeper detection and only rejects the localised ground to which you should regularly adjust by Grabbing (see Ground). It will accept ground above and below your Ground setting.

- Discriminate the surface ferrous items with the IAR Discrimination setting (see Discrimination > IAR).
- Increase the Reactivity when searching strong mineralization for greater stability.

Prg. 9 - RELIC

FMF • Max. freq. ☉ 24kHz • Frequency subtraction

RELIC is processed in the same way as **Prg. 8 - GOLD FIELD**, but uses lower subtracted frequencies to search for large masses. It is configured for "all metal" with low Reactivity and only rejects the localised ground to which you should regularly adjust by Grabbing (see Ground). It will then accept ground above and below this ground setting.

- To search for deep large masses: Sweep well above the ground, e.g. 15 or 20 cm, to avoid being hindered by shallow ferrous items and above all the ground effects that may distort deeper signals. You will then be able to identify deep masses by the longer sounds. Depending on the ground and your patience, reducing the Reactivity to 0 will offer a huge advantage in order to gain greater depth.

Prg. 10 - DIVING

FMF • Max. freq. ☉ 14kHz • Conductive soil subtraction

DIVING is the first and most stable of three programs intended for submerging in saltwater environments or simply on wet sand. Its very low and medium subtracted frequencies will better locate valuable targets such as rings and coins, whilst naturally being less responsive to low conductive targets like aluminum foil compared to the more sensitive Beach 11 and 12 programs. It can thus save time and be more effective in difficult diving conditions.

- Do not hesitate to activate B.Caps if there are troublesome rusty ferrous caps.
- Select an inland program preferably for fresh water diving.

Prg. 11 - BEACH

FMF • Max. freq. ☉ 24kHz • Conductive soil subtraction

BEACH uses higher frequencies up to 24 kHz and thus is more sensitive to small targets compared to Diving. It is well suited to wet zones.

- Sweep parallel without raising the coil at the end of each pass. If you can not maintain an even sweep and notice instability, you can reduce Salt sens (see Menu) to reduce the Salt water sensitivity.
- Increase the Reactivity if you experience instability or pollution.
- Do not hesitate to activate B.Caps if there are troublesome rusty ferrous caps.
- Beach can also be used while diving but the response may be more unsettled.

Prg. 12 - BEACH SENS

FMF • Max. freq. ☉ 40kHz • Conductive soil subtraction

BEACH SENS incorporates frequencies up to about 40 kHz offering excellent sensitivity to the smallest targets without losing performance on bigger targets. This is the deepest beach program for wet conditions but also the most reactive.

- Sweep parallel without raising the coil at the end of each pass. If you can not maintain an even sweep and notice instability :

- Reduce Salt sens (see Menu) to reduce the Salt water sensitivity.
- Increase the Reactivity to 1, 2 or 2.5.
- Reduce the Audio Response.

- Activate B.Caps if there are troublesome rusty ferrous caps.

MENU



- Configure the main detection settings. Press **MENU**. Scroll through the menu with **▼**.
- Exit with **←** to return to the main menu.

Discrimination and target identification (T.ID)



Adjust the Discrimination level from -6.4 to 99 using + and - .

Increase the discrimination to gradually reject targets with a lower conductivity than the setting. Example :

- Adjust to 10 to reject items with a target ID lower than 10.
- Adjust to 40 to reject most small aluminum foil.

To reject unwanted targets with a higher conductivity (aluminum tabs, lead, copper cartridges, etc.), you will have to accept losing certain desirable metal targets. A more satisfactory alternative is to continue using a low discrimination level (e.g. discrim. at 8) and use preferably:

- The visual target display for visual discrimination.
- Multi-tone mode for audio discrimination.
- The B.CAPS function (bottle caps) to reject the rusty ferrous caps effectively (Discr > Expert).

Display T.ID (Target Identification)



DEUS II displays deep targets more precisely through its multi-frequency processing that removes a large proportion of the troublesome ground effects.

The metal target conductivity scale below from -6.4 to 99 will give you an idea of the display and discrimination range :

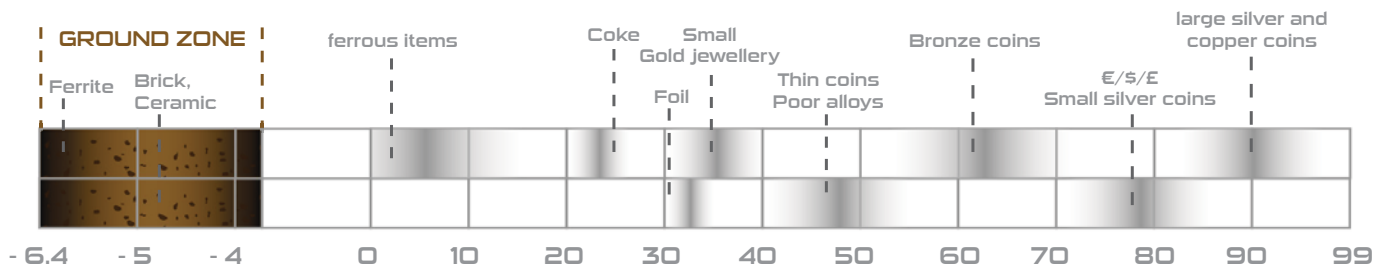

One of the advantages and special features of **DEUS II** is its programs, as they use different combinations of simultaneous frequencies while adapting to multiple ground types (see Programs).

However, a few ferromagnetic targets will generate specific displays on certain programs. These targets cannot be generalized due to their ferrous components, otherwise there will be a risk of falsifying the display of all the other targets. E.g. one or two euro coins (ferromagnetic ring + copper center) will display 75 in the Diving and Relic programs but 80 in all the other programs. Diving and Relic use fairly low detecting frequencies from about 4 to 13 kHz, whereas the others include higher frequencies such as 40 kHz.

You can access advanced functions from the DISCRIMINATION menu by pressing **EXPERT**.

Tones

2 tones - 3 tones - 4 tones - 5 tones



Press **MENU** > **DISCRI** > **EXPERT** to access the TONES screen.

Choose: 2 Tones - 3 Tones - 4 Tones - 5 Tones using **-** or **+**.

Use the Multi-tones menu to sort targets into categories according to their conductivity, by assigning a specific audio tone to each category (low, medium, high, etc.). Take some time to become familiar with the Tone modes using different targets, such as iron, nails, aluminum foil, different coins, etc. The lowest pitched tone is assigned to iron. If you do not wish to hear it, select "Iron Volume" from the menu and reduce its volume to 0.

If you are in the 2 Tone mode (low/medium tone) and you reduce the iron level (low-pitched tone) to 0, you then find yourself in 1 tone mode (medium), which is why there is no 1 tone mode in this scrolling menu.

Tones - Threshold and tones settings



Press **MENU** > **DISCRI** > **EXPERT**. Choose 2 Tones - 3 Tones - 4 Tones - 5 Tones. Press **EXPERT** to access the MULTI TONES screen.

Customize the sound partitioning of the discrimination range. A sound frequency (comparatively low- or high-pitched) is assigned to each part of the discrimination range, E.g. a low-pitched sound (161 Hz) is assigned to the signals from 0 to 6.0, then a medium sound (518 Hz) from 6.0 to 76, a medium/high sound (644 Hz) from 76 to 84 and finally a high-pitched sound (725 Hz) from 84 to 99.

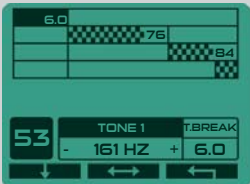

Press **↓** to choose the Tone. With **↔**, select the TONE BREAK (T. BREAK) and set it using **+** and **-**.

If a coin type is registered by your device as 58 on the conductivity index and signals "medium low" (518 Hz) and you wish it to be signalled "medium high" (644 Hz), simply lower the tone break from 60 to 57 or less. All coins with this conductivity value will now register at 644 Hz. Thresholds are also known as tone breaks.

- The black bar showing the index of the target helps you to adjust the threshold.
- Tone break 1 separating the low-pitched tone (tone 1) from the medium tone (tone 2) is the same as the Discrimination value. These are the same settings.

Pitch



Pitch mode does not take into account the target's conductivity: The strength of the signal generates an audio sound that varies both in volume and height (audio frequency). This means that a more distant or smaller targets will generate a low-pitched, weak sound whereas a closer target will generate a high-pitched, strong sound. Pitch mode gives a dynamic signal. It also makes the detector appear more reactive. However, it does not fundamentally affect reactivity, just the audio.

The lower tones of PITCH mode, i.e. that of the farthest or smallest targets, can be modified from 150 to 603 Hz. Press **EXPERT** and adjust it with **-** or **+**.

When the PITCH is selected, a new THRESHOLD option becomes available in the menu list.

DISCRIMINATION > EXPERT

Full tones



Full Tones assigns tones specific to each target index in proportion to its conductivity.

The higher the conductivity index of a target, the higher the signal.

E.g. aluminum foil (TID 30) will generate a 350 Hz tone, whereas a large silver coin (TID 95) will generate a 900 Hz tone.

Lower the discrimination to hear the ferrous items and ground with low tone in proportion to their conductivity.

B.Caps (except Prg. 7/8/9)



B.Caps rejects the rusty beer and fizzy drink bottle caps effectively. Make sure you activate it on the beach, in parks and polluted zones.

Adjust the rejection from 0 to 5 with **-** and **+**.

The caps will be rejected better when using a slower sweep. If in doubt, occasionally slow down the sweep speed over a suspicious target this will help to better identify.

Notch



The Notch complements the discrimination: it enables a "target window" to be rejected whereas discrimination rejects all targets below a selected threshold. For example, if you detect an undesirable target in the ground, you can decide simply to reject the corresponding conductivity group and continue to detect targets with a conductivity higher or lower than those in the rejected group.

If the reference target has a conductivity of 37, adjust with **-** and **+** the Notch at 34-40. All targets with a conductivity of between 34 and 40 will then be silenced.

By default, the width of the rejection window is 6 points.

Multi-Notch



Select **NOTCH** inside **MENU** > **DISCRI** and press **EXPERT**.

This advanced notch function enables you to widen the rejection window in the event that the undesirable target(s) have a wider conductivity range than the standard 6-point window. For example, if the undesirable target is generating an ID ranging from 28 to 46, you can use this option to lower the value of Threshold 1 to 28 and increase Threshold 2 to 46.

You will notice that the factory programs SENSITIVE, SENSI. FT et FAST, have a rejection window of 23 to 25. The very precise multi-frequency processing of **DEUS II** can subtly notch the wet zones in the soil which generate instabilities, Cokes or false sounds above holes with no target.

Multi-Notch ...

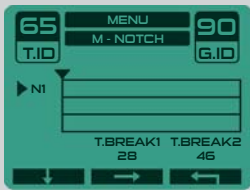

Select Tone break 1 or 2 with **→**.
Adjust the values **-** and **+**.

If several targets with different conductivity levels are a problem, you can activate two other notches: N2 and N3. Use **↓** to select N2 or N3 and adjust as for N1.

You will notice that the notched zones are grayed out in the conductivity bar on the main search screen.

Silencer



A few large iron objects or unusual shapes are often more difficult to discriminate. Iron objects often generate a few audible remnants of broken or inconsistent signals (crackling). Increasing the silencer applies a filter which eliminates the crackling caused by ferrous items.

IAR Discrimination (Prg. 8 / 9)



Programs 8 GOLD FIELD and 9 RELIC FIELD use another discrimination method, called IAR (Iron Amplitude Rejection). This allows rejection of ferrous items according to their distance from the coil.

0 = no rejection **3** = Shallow Ferrous rejection **5** = Shallow and deeper Ferrous rejection

Gold nuggets or relics items buried deeply in mineralized ground can generate a similar signal to a ferrous item, so in this case it is better to reduce the IAR discrimination level.

Threshold (Only with Pitch mode ON)

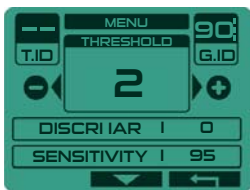

This feature is used to set the amplitude of the background sound threshold.

Adjust it from 0 to 20.

Sensitivity (general sensitivity)



Determines the device's sensitivity level from 0 to 99.

The most commonly used sensitivity levels range from 70 to 90. Reduce the level in trashy areas or close to power lines, fences, radio-relay stations, etc.

Do not test your device indoors as there is considerable electromagnetic and metal interference in urban environments (EMI).

SALT SENS (Salt water sensitivity ; prg DIVING - BEACH - BEACH SENS)



In addition to the general sensitivity setting, the «SALT SENS» setting has the advantage of reducing false signals, typically linked to seawater, unlike the general sensitivity which acts on all targets and all signals. When searching wet sand or surf, always use the SALT SENS setting as a priority rather than the general sensitivity. The general sensitivity should be reserved for cases where the instabilities come from electromagnetic interference (EMI).

Adjust SALT SENS from 1 to 9 (9 being the highest sensitivity level).

If EMI is a problem, remember to start with a frequency scan first (see Freq Scan). When using higher levels of SALT SENS, low conductive targets that register around TID 30 may also be slightly attenuated, this setting will not effect higher conductive targets.

Frequency

DEUS II offers a wide choice of programs using different frequency configurations :

- Eleven simultaneous multi-frequency programs, each with different combinations of frequencies and internal parameter settings (see chapter Programs for the specific features of each one).
- One single frequency program (no. 7 DEUS MONO) built around seven main frequencies: 4.5 - 7.5 - 13 - 17.6 - 25 - 32 - 40.5 kHz, each one with seven wide offset increments, i.e. 49 frequencies in all.

Range of available frequencies of 4 kHz to 45 kHz :

4.08 to 4.76 kHz - 6.94 to 8.08 kHz - 10.39 to 15.15 kHz - 15.62 to 20.75 kHz
22.06 to 28.57 kHz - 29.41 to 35.32 kHz - 36.36 to 45.45 kHz

Remember that generally all frequencies detect all targets, but a high frequency such as 45 kHz will detect a far greater proportion of small targets than low frequency like 4 kHz, above all if the ground is mineralized. Conversely, a high frequency will sometimes be less efficient on a large mass or on grouped coins than a low frequency. The best option is therefore to use DEUS II on its simultaneous programs as a priority, to make the most of an extended range of frequencies and thus maintain sensitivity to a wider range of targets.

Program no. 7 Mono can be useful if the multi-frequency programs are hampered by a severe electromagnetic environment or if you prefer to focus on a particular target category.

Type of target detected is largely dependent on the frequency:

These graphics illustrate the sensitivity and the ability to discriminate ferrous items depending on the frequency as well as the advantage of multi-frequency programs as they cover a wide spectrum of targets. This is a simplified schematic diagram that can vary depending on the programs and ground conditions.

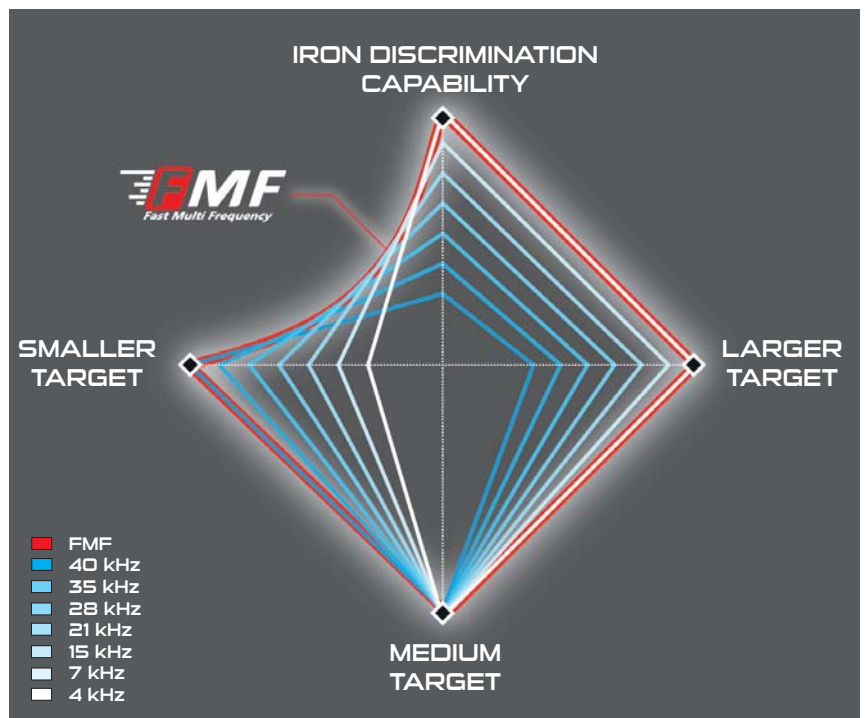

FMF multi frequency programs

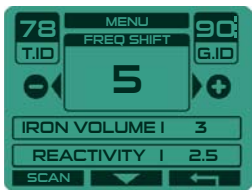

Manual : Press **-** or **+** to shift the frequencies and find the quietest band.

Automatic : Press **SCAN** to start an automatic scan.

Mono-frequency program

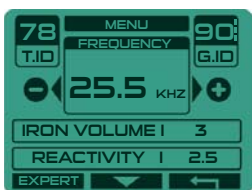

Press **-** or **+** to select one of the 7 main frequencies.

If you are experiencing too much interference:

Press **EXPERT** then shift the main frequency with **-** and **+** or start an automatic frequency scan by pressing **SCAN**.

4 kHz

Large, mainly ferrous and non-ferrous masses, coins grouped together or high conductivity coins.

8 kHz

General use. Coins and large masses, militaria. Medium and small targets in low-mineralized ground.

12 to 20 kHz

General use, small coins. Coins of all sizes in moderately to highly mineralized ground.

30 to 45 kHz

Small coins with low conductivity and fine jewellery, gold nuggets on highly mineralized ground. Discriminates (distinguishes) coke more easily with a precise target identification (~25). More unstable on wet ground, non-magnetic.

MENU

Iron volume

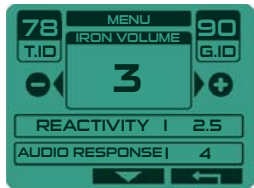

Adjust the volume of the low-pitched tone which has a lower value than the discrimination setting, which normally means iron.

0 = cut-off low tones

5 = maximum low tone level

Reactivity



DEUS II is a fast and selective detector! Reactivity is a vital setting that determines the detector's performance in terms of how quickly it analyzes the signal from detected objects and its ability to separate the signal response from two or several targets located close together. This is also known as Recovery speed. If the soil contains a great deal of iron, hot rocks or other mineralized debris, soil penetration can be drastically reduced as can the ability of a detector to locate non-ferrous targets next to ferrous targets. In these conditions, select a high degree of reactivity which will help to speed up the signal analysis. On the other hand, if the ground is "clean", it is better to reduce the Reactivity, to make the

machine more sensitive to deep targets.

On a beach, as the targets are most often well away from each other, the low Reactivity levels like 0 or 1 will be very efficient. But if you encounter tricky conditions, such as polluted beaches made up of magnetic black sand or beaches with variable salinity, increase the Reactivity to 2.5 or 3, thereby becoming more selective and more stable, which will make it far easier for you to interpret the targets.

Recommended settings :

0 to 1	Large masses and coins, in ground not contaminated by ferrous items.
2 to 2.5	General use, ground with little iron contamination.
3 to 5	iron-contaminated and/or mineralized ground.



E.g. Passing the coil over an iron object close to the surface then over a good metal target (ring).

R0 - R1

No
sound



With a low Reactivity level, the iron is detected for longer and completely hides the ring.

R2 - R3

Short
sound



With a medium Reactivity level, you begin to detect the ring. The audio signal partially indicates the target.

R4 - R5

Full
sound



A high Reactivity level enables you to distinguish the ring completely from the iron. The audio signal fully indicates the target.

Reactivity ...

In terms of pure performance, the greatest detection ranges are obtained with low reactivity levels. However, you will find more targets and will detect deeper on mineralized ground with medium or high reactivity levels. So do not just rely on performance in the air!

Depending on the reactivity level, the length of the audio signal varies when it passes over a target, the length of crackling of ferrous items is also in proportion. You are therefore advised not to keep changing the performance settings, as this may hinder you from distinguishing good and bad sounds.

Low reactivity (0 to 2) = long sound



High reactivity (2.5 to 5) = Short sound



Audio Response



Audio Response enables you to amplify the volume of deep targets. It gives the impression of greater power, but does not provide any additional depth as this setting only affects the sound curve (the dynamic range of sounds). Lower Audio response levels give a good perception of depth.

0 = Weak Audio Response

7 = Maximum Audio Response

Be aware that by increasing the Audio Response too much:

- You also amplify the small false signals and mask sounds from a good target.
- You compress the dynamics and reduce the assessment of the distance of a target.

GROUND

Ground



Level of the mineralization. The higher it is the more the ground is mineralized. Pump the coil on the ground several times to assess it with more precision.

Your actual current ground effect setting.

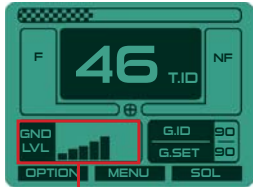

Ground mineralization index (measured constantly as a guide).

Soil mineralization can affect the detector efficiency. It can be of natural magnetic origin like iron oxides and ferrite, often linked to old human settlements.

On the coast, depending on the regions, mineralization can go from magnetic grade (black sands) to electrically conductive grade (salt water).

Illustration of the soil zone in the inland programs :

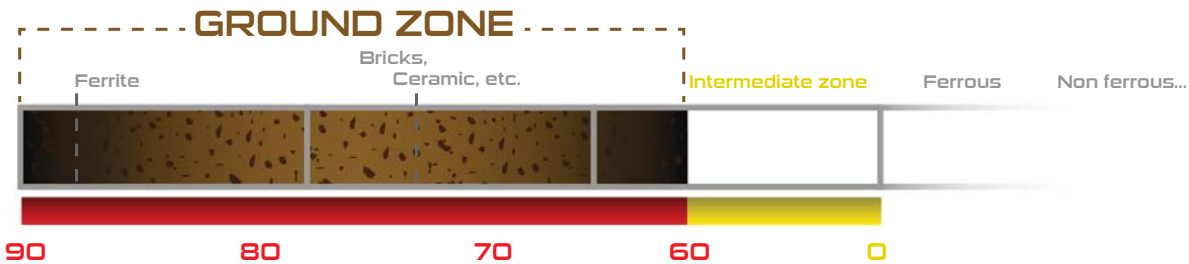

Press **G.B**

Adjustable from 60 to 90 on inland programs and from 0 to 90 on the 3 Beach programs.

3 ground setting modes are available: GRAB, MANUAL or TRACKING. GRAB is advised, as it is quick and accurate. (MANUAL mode only available on the DEUS MONO program).

When entering the Ground page, **DEUS II** moves into an all metal mode, unlike **DEUS I**. This is practical for listening to the ground and its response during the adjustment, but also gives you a quick insight to the ground at any time, for example a clean zone or identifying a mix of ferrous and non-ferrous targets.

Grab Mode



From any menu, you can calibrate the ground effect at any time by holding the **G.B** key down while you pump the coil on the soil until the ground audio signal is attenuated and the value is stabilized.

Caution, a short press will take you into the Pinpoint page.

Manual Mode (prg DEUS MONO only)

Read the numeric value displayed by the mineralization index when you pump the coil on the ground for a few seconds, then adjust the ground effects manually with **-** and **+** to achieve the same values.

Manual mode is not available in multi-frequency programs, as it would be tedious to set each frequency independently. The Grab mode advantageously allows to capture the ground value of each frequency simultaneously.

Tracking Mode

Tracking is an automatic ground correction mode. It questions the ground continuously to determine its average value. This mode can be useful if the ground mineralization is relatively uniform and changes slowly. This mode is not suitable in ground where mineralization has been generated by old human settlements due to the discrepancies in the ground effects. In just one sweep, a number of ground events in succession can be too varied, so that an average value will not be conclusive. Therefore use the GRAB mode as a preference.

Magnetic ground (prg DIVING / BEACH / BEACH SENS only)



When searching magnetic ground such as black sand, deep targets may be masked because their values are similar the soil values. The Magnetic Ground setting allows you to accept low tones generated by the ground, ferrite, meteorites as well as distant targets that are usually masked.

REJECT: Black sand, ferrite and meteorites are rejected, this is the default mode and the most stable.

ACCEPT: Black sand, ferrite, meteorites and good deep targets are accepted with a positive sound.

GROUND

Ground Stabilizer (Inland programs only)



This setting than can be adjusted from 1 to 3 and is used to define the level of ground instability / feedback you are prepared to tolerate.

1 = Most unstable level

3 = Most stable level

- **LEVEL 1:** The zone above the ground value grabbed is accepted, e.g. if you set the GROUND to 75 by grabbing or manually, then all the ground with a value greater than 75 will react, for example : bricks (~ 78), ferrite and coil shocks (~ 88). This level is reserved for experts in order to locate the deepest signals that can be masked by the mineralization.

Note that this “Expert” zone is often masked in the majority of detectors and can never be activated.

- **LEVEL 2:** The zone above the Ground setting value is rejected, but a multi-frequency analysis is implemented to signal certain targets through mineralized soils.
- **LEVEL 3:** More stable compared to Level 2.

Prg. 7 DEUS MONO does not have the Ground Stabilizer menu, which is fixed at LEVEL 1. Like DEUS I, it sounds by default on ground with a value higher than your setting. Adjust it to 90 if you are looking for stability.

Even if you choose modes 2, 3, where the ground is greater than the set value, for example it does not sound, it is nevertheless very useful to adjust the ground effects by Grabbing to improve certain DEUS II internal settings and adjustments, including display reliability.

Special feature of programs no. 8 Gold Field and no. 9 Relic

Targets buried very deep can take on values close to the surrounding ground, to the point that they are most often rejected as the ground itself. The Gold Field and Relic programs allow you to go deeper when searching for native gold in mineralized ground or for large masses at depth, as they only reject the local ground to which you have adjusted precisely by Grabbing. Ground compensation is therefore a priority in both these programs. Occasional ground variations and large mineralized stones with a different value from the surrounding soil may make the device react. Set them aside for future reference.

Pinpoint (Target localisation)

PINPOINT mode is used to operate the coil motionless above a target. It is useful for locating metal targets inside houses and cellars and is also widely used to follow underground metal pipes.



Access to PINPOINT screen, then update the detecting threshold with a quick press (Re-Tune manual).

AUTO-TUNE ON/OFF: Choose a threshold reset in Automatic mode or Manual mode:

A.T ON (default mode) : The audio detection threshold is automatically calibrated to the metal environment or to the soil. With every sweep over the target, the threshold is lowered in proportion to the level of the target to reduce its detection zone and thus localise it better in the following pass.

Conversely, if you remain far away from the target for a few seconds, the threshold will rise again gradually until the next pass over the target.

A.T OFF: The audio detection threshold is re-calibrated manually by pressing key  briefly (Manual Re-Tune).

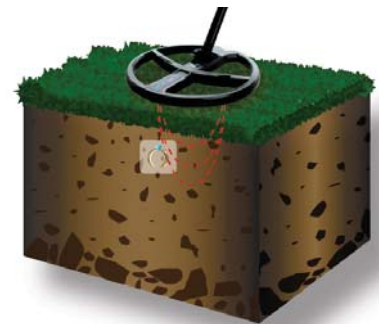
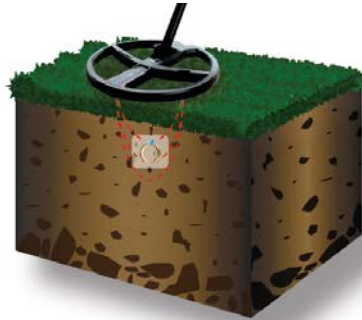
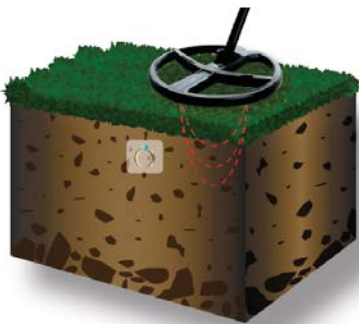

Position the coil barely off the ground and to the side of the target. Press  to calibrate the threshold.

Move the coil slowly across the target. The loudest sound and highest audio pitch indicates the target position.

To narrow the field of detection and improve the target location: Position the coil close to the target but not on the center. Press  to re-tune the threshold then locate the target as step 1.

OPTION/AUDIO

One of the many innovations of **DEUS II** incorporates the very latest in audio processing. You can now alter the volume, set an equalizer to adjust the audio quality in your ear and your headphones, you can also choose the type of sound you would like for your detecting sessions from a sound library.

Audio Out



Press **OPTION** > **AUDIO** .

Select the Audio output and your desired volume with **→** .

SPEAKER - WIRELESS HEADPHONES - BH01 - WIRED HEADPHONES

Alter the volume with **-** and **+** .



The wireless headphone volume is controlled by the remote control or the + and - keys on the headphones.

Note that you can use the following audio outputs at the same time :

- wireless headset + speaker
- wireless headset + wired headset
- wireless headset + BH-01 headset

The remote control battery life is 30 h on the wireless headphones output, but drops to 15 h with the loud speaker or active BH-01 headphones, even at level 1. Disable the unused outputs by moving them to 0 to increase battery life.

From the home page adjust the Volume, Audio Output and Equalizer by pressing **-** or **+** for 2 sec.

To alter the wireless headphone volume from the remote control or hear the beep from the remote control keys in the headphones, it is essential that a search coil is paired.

Equalizer

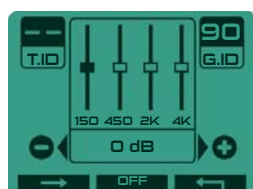

Over and above a simple low/high audio setting, the equalizer can correct the acoustics of the loud speaker and headphones over four bands to match them to your hearing preferences. You can thus set the low tones to around 150 Hz, the medium low to around 450 Hz, the medium high to around 2000 Hz and the high to around 4000 Hz.

Press **OPTION** > **AUDIO** > **EQUALIZER** > **SELECT**

Choose the audio frequency range that you wish to alter with **→** , increase or decrease the level.

ON/OFF: You can compare your settings quickly by switching OFF the Equalizer.

Audio Type

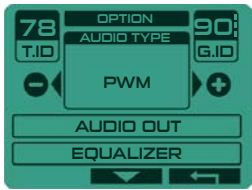

DEUS II gives you a wide choice of sounds and sound offsets. You can use totally different audio types depending on your preferences and the surrounding environment. For example, certain audio types will suit tricky, polluted ground better by softening the low signals caused by interference, whereas others will discern the target distance better through a changing dynamic scale that mixes different sounds based on the target depth or size.

As DEUS II can be upgraded, please refer to the online manual for the latest improvements. Audio types may have changed since this manual was printed.

PWM

PWM is the traditional XP sound that you would have known on DEUS I or the wired range. It is dynamic and informative through its wealth of harmonics that vary according to the amplitude of the signal and therefore giving the operator a good indication of the depth or size of a target.

SQUARE

Square has fewer, softer and fixed harmonics, i.e. the harmonics do not vary according to the amplitude of the signal, only its volume changes in relation to the depth or size of the target.

OPTION/SETTINGS

Adjust the main remote control setting.

Press **OPTION** choose **SETTINGS** then **SELECT** .

Diving mode



During deep dives, the water pressure may compress the keys on your remote control. Activate this mode to lock the keypad in diving mode as soon as you reach about 8 to 10 metres. This will ensure that touching a key will not disrupt your program at depth. To disable this mode, press the left-hand key, the central key and the right-hand key in succession.

Please refer to the chapter Diving and SEALING for further information.

Display

Backlight



OFF - 3s - 10s - 60s - 120s - ON

You can leave the backlight on permanently as this function uses very little power (~10%).

Contrast

To improve legibility in all lighting conditions, adjust the contrast.

Brightness

Adjust the display luminosity.

Language



Choose your language.

Clock setting



Adjust the clock settings (displayed on the main menu).

Profile

Choose the main screen for each program (2 choices available) :

Standard Screen



Standard multi-information display, with target index in bold + the F/NF (ferrous/non-ferrous) graph indicating also the intensity of the target to assess the depth.

X - Y screen

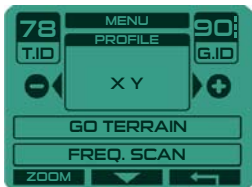

The target signature is displayed as an oscilloscope. The XY screen provides visual assistance and may improve the identification of difficult targets. For example: The identification of targets that do not have a precise signature (some ferrous items, cans, etc.).

Alternating display between programs/battery level, hour

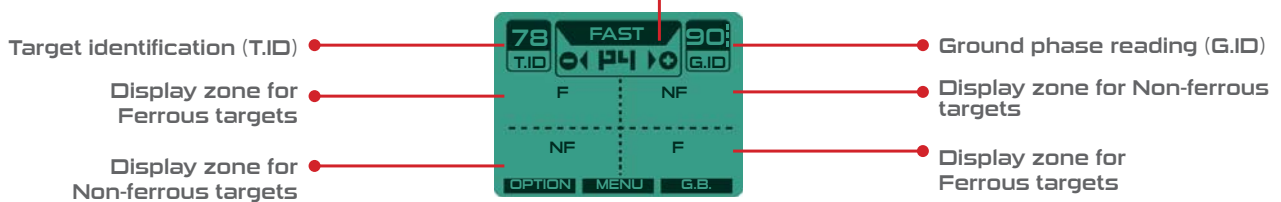

XY screen target examples:



Non ferrous
E.g. Coins

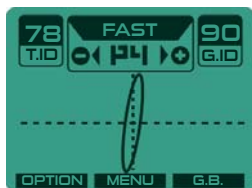

Non ferrous
E.g. Foil

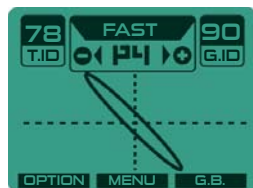

Rejected
Ferrous items



Ferrous cans and difficult to reject large ferrous items.

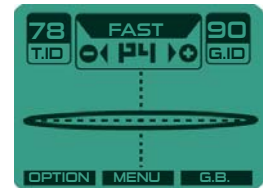

Ground signature, ferrite and ceramics.

X - Y Zoom

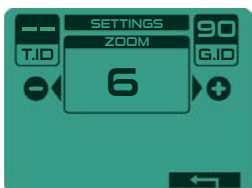

OPTION > CONFIGURATION > XY PROFILE > ZOOM .

The resolution of the X-Y path has 10 adjustable levels via the Zoom feature.

Adjust the zoom with **-** and **+** . A lower zoom number will only activate the display on stronger targets

OPTION

GO TERRAIN



The XP GO TERRAIN smartphone app. receives data from DEUS on the type of target in real time. Map a zone detected using the GPS on your smartphone and display all the targets detected the length of your routes, share your routes and findings with those close to you.

AUTO: Activates automatic transmission of information about the type of target to your smartphone in real time.

PUSH: Activates manual transmission of information on the type of target to your smartphone in real time (long press on Menu key when displaying a target on the screen)

Further information on our site : www.xpmetaldetectors.com heading GO TERRAIN

Frequency Scan



This function activates an automatic scan of the detecting frequencies and Indicates a clear channel with the least interference at every change of program or every change of frequency in the MONO program. The frequency scan is particularly fast on **DEUS II**, however it will slow your navigation by 2 sec. when changing program.

Update

The software can be updated via the DEUS USB interface and an Internet connection. Full information is available on our website: www.xpmetaldetectors.com

This menu will be available by following instructions from our website when first update ready.

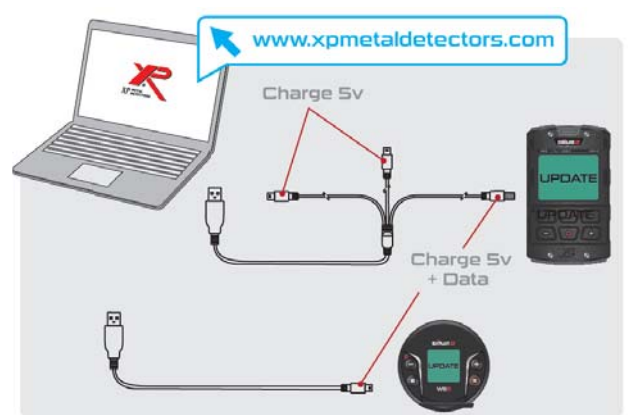
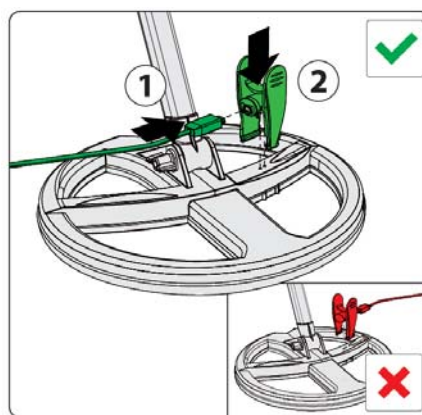

- To update the remote control, use the round connector (data) on the 3 link charging cable.
- The **DEUS II** wireless headphones are updated by wired link only via the short cable with a single USB output (data).

Info

Information about remote control, model and certifications.

Programs



The 12 factory programs (1 to 12) can be modified to create 12 additional user programs from 13 to 24.

All 12 factory programs will return to their original value every time the remote is turned off and restarted.

Save or modify the name of program

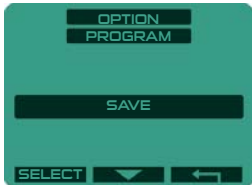

Save a program with **OPTION** > **PROGRAM** > **SAVE**.
Select an unused slot with **SELECT** then **SELECT**.
Enter the name of new program and **VALID**.

To alter the name:

OPTION > **PROGRAM** > **EDIT NAME** > **SELECT** > alter the name then **VALID**.

Delete a program

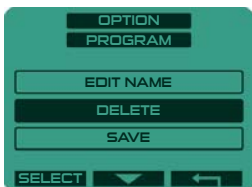

On the main menu, select the program that you want to delete from 13 to 24 with **-** or **+**.

Then **OPTION** > **PROGRAM** > **DELETE** > **SELECT** > **YES**.

Pairing

Choose the accessory (coil, wireless headphones, MI-6) using **+** or **-**, then press **SELECT**.

New coil pairing



Choose the coil already paired from the list and press **SELECT** to use it or pair a new coil.

Press **OPTION** choose PAIRING with **SELECT** then the coil logo with **-** and **+**, press **SELECT**.

Automatic Pairing (recommended) :

- Go to the empty slot (-----) with **SELECT** and press **EDIT**.
- Put the coil on charge with the clamp.
- The serial number will be displayed on the screen and the new coil is switched ON.

Manual Pairing :

- Go to the empty slot (-----), press **EDIT**.
- With **-** and **+** choose the digit and press **RIGHT** to move on.
- After you have entered the sixth digit press **VALID**.



The remote control now adds this new coil to its list; the new coil is switched ON and flashes every second and the previous coil is switched OFF and flashes every 4 seconds.

OPTION/PAIRING coil/wireless headphones/pinpointer

Delete a coil from the list

Choose the coil to delete then **EDIT** . Delete all digits with **←** then add 6 zeros "000000". Press **VALID** and confirm with **YES** .

Pairing XP wireless headphones



AUTOMATIC: If no wireless headphones are paired, choose the wireless headphone logo when starting the remote control. The remote control will invite you to pair it by pressing the **⏻** key on the headphone module for two seconds.

MANUAL: Press **OPTION** > **PAIRING** , with **-** or **+** . Choose the headphone then press **SELECT** and switch on the headphones by holding the **⏻** key down for 8 s.

It is impossible to pair a second set of headphones if there is one already paired. In this case, simply delete the original set of headphones from the remote control beforehand.

Delete XP wireless headphones



Press **OPTION** > **PAIRING** , with **-** or **+** choose the headphone, then **SELECT** > **UNPAIR** > **SELECT** > **YES** .

Pairing the MI-6 Pinpointer



Press **OPTION** then **PAIRING** with **▼** . Choose Pinpointer logo with **+** then **SELECT** .

Switch on the MI-6 whilst holding its button down for eight seconds. You will see the serial number of your pinpointer displayed on the remote control. Then switch on the MI-6 so that it works with **DEUS II** and its wireless headphones.

When pairing, the MI-6 automatically switches to program 7. This program will only work with the detector and headphones. In this program the MI-6 will not generate any sound or vibration through it's own speaker (MI-6 manual).

Delete the MI-6 from the remote control



OPTION > **PAIRING** , Pinpointer logo choose **UNPAIR** , then **SELECT** and finally **YES** .

To use the MI-6 without the **DEUS II** , select programs 1 to 6 on the MI-6 menu. To change program : Switch MI-6 on - press the button for 5 seconds, an audio chime indicates that you have entered the program selection mode. Press to correspond with the desired program number (e.g. press twice for program 2). After 2 seconds the audio chime indicates the MI-6 has returned to search mode.

WS6



Full WS6 manual at www.xpmetaldetectors.com

The WS6 are not just wireless audio headphones. Without the remote control, they can be a stand alone unit and connect with the coil for an extremely ergonomic and lightweight configuration. The WS6 Module can be unclipped and mounted on the stem to make the most of the control screen, the target display and all the settings. It is then ideally supplemented by the WSA II or WSAII XL wireless headphones.

WS6 - 3 Configurations



WS6 SLAVE

WS6 slave of the remote.
(965g with coil 22cm)

The remote control is master and controls the coil, the functions and the settings

Note: The WS6 can be replaced by the WSAII/WSA II XL/BH-01 and FX03 headphones



WS6 MASTER

(+ wireless headphones)

WS6 Master in a comfortable configuration (810g with coil 22cm)

The WS6 controls the coil, adjusts all the settings and displays the targets.

- Identical performance.
- Very detailed graphic screen.
- Connect the headphones WSA II/ WSAII XL/Wired, etc. to the WS6



WS6 MASTER

(WS6 only)

WS6 module clipped to the backphones (750g with coil 22 cm).

The WS6 controls the coil, adjusts all the settings and displays the targets.

- Identical performance.
- Very detailed graphic screen.

WS6 SLAVE

When the WS6 is slave, only the volume can be adjusted, using **-** and **+**.

To pair the remote control when using it for the first time, please refer to the chapter "Pairing headphones"

WS6 MASTER

To move the WS6 from slave to master, it has to be re-started with the remote control switched OFF. It will then operate as a master with your paired coil. Dont forget to pair them to the coil first. OPTION > PAIRING COIL (see WS6 manual online).

Alternates coil charging level and WS6

Name & Program No. (change with + -)

Decrease programs and values
Long press from main screen : SHORTCUT to VOLUME

OPTIONS: Volume/Config.
In Option long press: EXPERT Mode
In Menu: Back
Long press from main screen : SHORTCUT to GRAB

Indicates the link with the coil

- Manual switch ON

- and **+** manual Switch OFF

Increase programs and values
Long press from main screen: SHORTCUT GO TERRAIN PUSH

MENU : DISCRI/SENS/...
• Long press from menus: EXPERT mode
• Long press from main screen: PIN-POINT MODE
• From Option: backwards

F/NF (ferrous/non-ferrous) and target strength

USB min. B charge and update.

The remote control programs are separate from the internal WS6 programs. When using the WS6 independently as a master (without remote control), the WS6 finds its original user programs, i.e. the remote control programs are never transferred to the WS6.

WIRELESS HEADPHONES

Headphone Menu



Use to scroll down the menus (Discri., Sensitivity, Frequency, Iron Volume, Reactivity, Ground).
Adjust values with and .

Access the EXPERT modes by using a long press on various menus offer this feature.
You will gain access to: Grab, Scan, Multi-tone modes, B.Caps, Notch, Silencer...

Exit with .

Headset Option



Use to scroll down the options (Volume, Audio type, Configuration, Programs, Pairing).
Adjust with and .

Access the EXPERT modes using a long press on from the various menus offering.
You will gain access to: Program Save, Equalizer, Update, Contrast, Go Terrain.

Exit with .

WSA II and WSA II XL



WSA II
Foldable and lightweight



WSA II XL
Foldable and insulating

WSA II and WSA II XL are sophisticated wireless receiver headphones. Manufactured in France by XP specially for our detectors, they function with the **DEUS II** remote control or with the WS6 Master, i.e. when the WS6 is used as control.

- Once paired with the remote control or the WS6 Master, they switch on and off automatically (In manual press - to switch on and + - to switch off the headphones). If no connection, they turn off after 5 minutes.
- You can adjust their volume from the remote control (or the WS6 Master) or directly with their + - keys.
- They also incorporate four-band audio equalization processing, once again adjustable from the remote control (or WS6 Master) to match them to your hearing (see Audio). *NOT compatible with Deus 1

Battery level : After the fast switching on process, the headphones will indicate their battery level by one to three long flashes in succession in line :



The WSA II and WS6 modules unclip to change /replace the backphone band but above all to insert them onto the Stem Support or wrist strap (see Accessories page).

XP are proud to present the first bone conduction headphone designed for metal detecting, **BH-01**. Made in France by XP, it is waterproof IP68 - 20 m so that you can dive with your **DEUS II**.



BH-01

Why a bone conduction headphones ?

Using ordinary waterproof headphones underwater, the ear fills with water and hearing is often lessened. **BH-01** sits in front of the ears on the cheekbone and transmits sound to the inner ear directly through vibrations applied to the bones, without straining the eardrums. Your ears are therefore free. In disturbed or noisy water, you can dive usefully with ear plugs to avoid infection or simply to isolate yourself better from noise. You will thus hear the sound perfectly by bone conduction whilst protecting your ears. You can also use these headphones on land with the freedom of being able to hear your surroundings or, conversely,

to isolate yourself from noisy surroundings, once again with ear plugs.

Warning : When diving use only dedicated earplugs that allow pressure balancing, never use standard earplugs as they may damage the ear when diving.



BH-01 also allows the hearing impaired to feel the vibrations generated by the targets towards the cochlea, or simply the vibrations depending on the type of alteration of the hearing system. Adjusting the audio frequencies downwards (100 to 300 Hz) could further improve perception depending on the disorder.

BH-01 Positioning

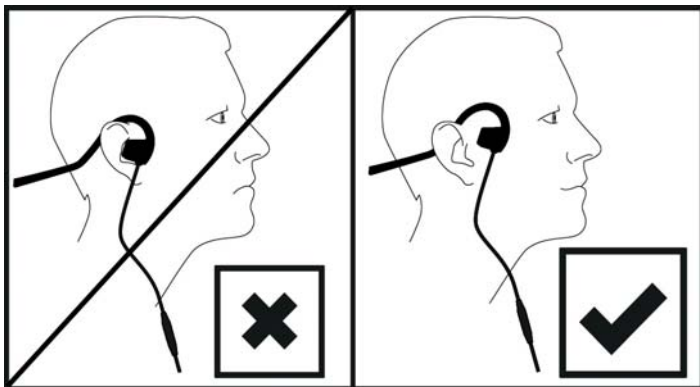

>100 dB!

Caution, these bone conduction headphones are not designed to sit on the ears but in front of them, on the cheekbones as indicated opposite. These headphones can seriously damage your high-level hearing if sat on the ears. To limit the risk, the remote control sets the volume to 5 at every start-up.

BH-01 Storage and cleaning



BH-01 is supplied with a storage bracket.

The headphones can keep their shape to sit snugly on your cheekbones and thus transmit the sound better. It also avoids protruding and angular contact with your cheekbones !

⚠ After use in salt water, protect the connectors by tightening the waterproof cap. If salt water or sand has penetrated the connectors, rinse thoroughly with fresh water and dry before closing the plug for storage. Do the same thing if salt water or sand has penetrated the remote control socket.



PINPOINTER



When connected, the MI-6 pinpointer transmits its audio signal directly to DEUS II; a new menu will now be available with extended functions. (refer to the MI-6 Manual)

MI-6 active display screen

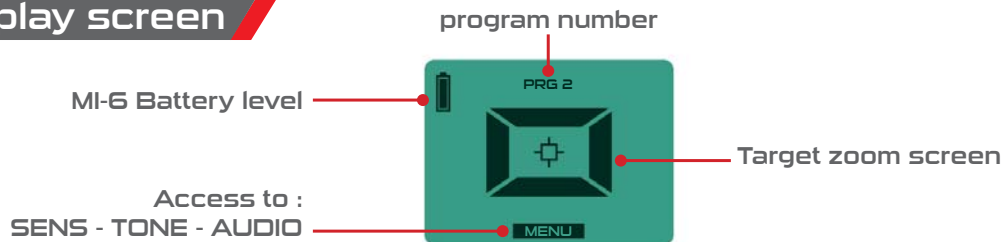

Sensitivity



The MI-6 has 50 levels of sensitivity via the remote control. Press **-** **+** to increase or decrease the MI-6 sensitivity.

RETUNE: Recalibrate the MI-6 threshold regularly by pressing its button very briefly, keeping away from any metallic source.

 Improve localisation and reduce sensitivity on the fly: Recalibrate near the object when it sounds; you will automatically reduce the detection zone and localise far better. Retrieve full sensitivity by pressing briefly away from metal. On mineralized soil, recalibrate on contact with the soil.

Tone



Modify the low/high audio tone of the PULSE Mode from 100 to 1582 Hz.

Press **-** or **+** to adjust the tone.

Audio PITCH/Audio PULSE



Audio PITCH : The sound varies in tone and intensity, it is the default mode and offers fast target location.

Audio PULSE : Has a higher sound, intended for noisy environments. Target location, PULSE is not as precise as PITCH mode. Pitch and Pulse modes both have the same performance.

Press **-** or **+** to switch from one mode to another.

Programs and Save

Choose from one of the 3 factory pre-set programs in the menu to create your own custom program which can then be saved as (prg 4).

Choose the program that you want modified, press **-** or **+**.

Press **MENU**, modify your settings and save them by pressing **SAVE**. Prg. 4 is created.

The 4 programs on the remote control are separate from the programs inside the pinpointer. When used independently the MI-6 (unpaired) will always use its factory programs.

Recover a lost MI-6

In Option > Pairing > Pinpointer > Select, choose **RECOVER** and press **SELECT**.

The Pinpointer will ring and flash within a radius of 25 meters, even if switched off and missing after several weeks.

Battery life

Remote control	With wireless audio output	With speaker output or BH-01
Battery life	30 h	15 h
WS6 Headphones		
Battery life	14 h	-
WSA II/WSA II XL		
Battery life	17 h	-
Coil in Multi-frequency	Prg. 1, 2, 3, 4, 5, 7, 8, 9, 11, 12	Prg. 6 DEEP HC/Prg. 10 DIVING
Battery life	12 h	8 h
Coil in mono-frequency (P7)	Depending frequency	
Battery life	⌚ 10 to 20 h	

The remote control battery life is 30 h on the wireless headphone output, but drops to 15 h with the loud speaker or active BH-01 headphones, even with a volume level at 1. Deactivate the unused outputs by moving them to 0 to increase battery life.

Deus II is regulated to prevent any drop in performance, even when the battery level is low

Charging time: ~3 Hours

The LiPo (lithium polymer) batteries have no memory effect, meaning that you can charge them at any time without waiting for them to go flat.

Coil LED flashing and meanings

- Coil on charge: Constant LED
- Switching on: Rapid flashes followed by three to 1 long flashes depending on battery level*.
- In operation: One flash per second
- On stand-by: one flash every four seconds
- On deep stand-by seriously discharged: one flash every thirty seconds
- Switching off: three to one long flashes depending on battery level*
- When switching on the MI-6 pinpointer: the coil LED flashes rapidly.

* = 100% = 60% = 30%

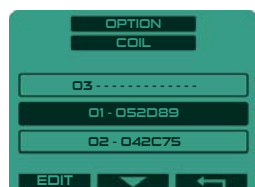

To switch off the coil LED and wireless headphones during use: In OPTION > COIL pairing, select your coil of choice as opposite and press the key for four seconds. When switched off, this mode becomes deactivated and the LED return to normal operation.

POWER SUPPLY - BATTERIES

Charge

The coil, remote control and headphones are powered by a Lithium battery (LiPo). Please use the mains unit supplied that can charge the three components simultaneously using the lead-output cable.



The three components (coil/remote control/headphones) can be charged by any USB mains unit 5 V/1 A minimum. Watch out for the quality of the charger and counterfeits, use a certified model from a reputable brand carrying the following certification symbols:



Under no circumstances can XPLORER (XP METAL DETECTORS) be held liable for damage or loss generated by using a defective charger or failing to comply with the certification standards in force.

- Connect the USB plug to the power supply.
- Plug the round connector into the remote control and the two USB min. B to the headphone and charging clamp.

The coil is charged using the clamp supplied. Connect it along the ribs of the coil cover to ensure the correct connecting direction and avoid a reverse polarity. The clamp output must be facing towards the center of the coil as indicated below.

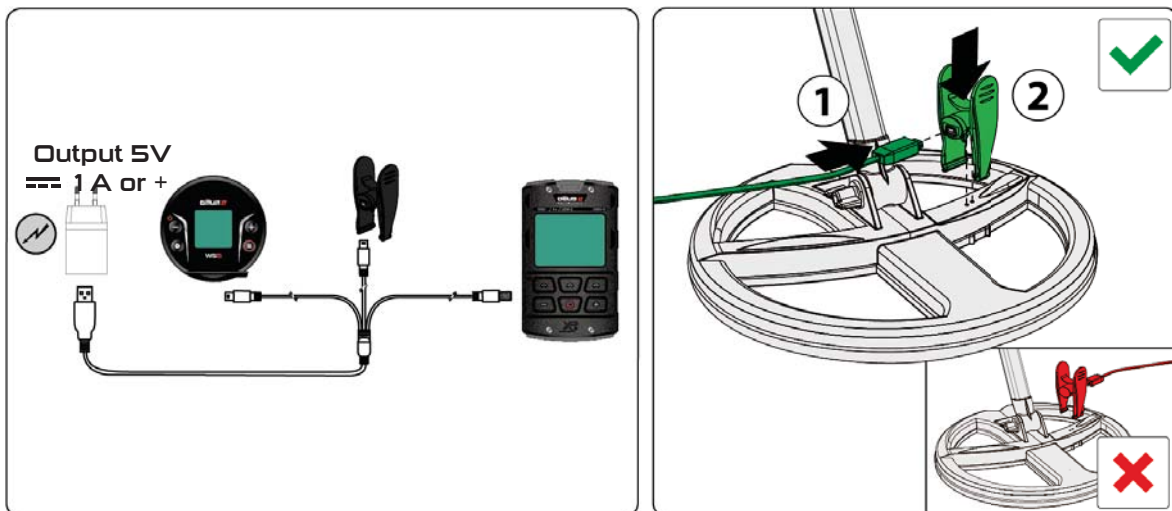

Lithium Polymer (LiPo) battery lifetime

A well-maintained LiPo battery can last ten years in your XP detector !

The Lithium Polymer batteries (LiPo) are designed to withstand hundreds of charges, thereby generating significant battery savings. As a guide, a ten-year lifetime can be envisaged when they are used correctly on a weekly basis.

Battery lifetime is in your hands !

To extend the life of your batteries well beyond five years, do not store them either flat or fully charged for a long time. Keep them half charged between 40 and 80%.

If you do not use your detector for several months, check them every two months by letting them go flat and then charging them to 40-80%.

Replacing batteries

The batteries for the wireless headphones (ref battery : GMB452230 - ref XP : DO88WS-WTUBE) and the remote control (ref battery : GMB721945 - ref XP : DO88M-WTUBE) are easy to replace. Unscrew the rear/lower cap of the headphones or remote control / Remove the speaker from the Remote / Unclip the battery and change it. Then screw the cap (taking care of the O-rings and speaker).

⚠ We highly recommend that you go through an authorized XP dealer to replace any of the detectors batteries. breakages or defects (sealing, ...) caused by changing a battery or opening any part of the detector will void the XP warranty.

BATTERY REPLACEMENT (ref battery : GMB721945 - ref XP : DO88M-WTUBE) : The search coil battery is sealed for obvious reasons - safety and impermeability. It must be returned to our service department or an XP distributor for replacement.

- Remove the coil cover. Using a cutter, cut the battery cover along the inside groove, the battery cover is the one with the battery logo ⚠.
- Disconnect the out-of-service battery and remove it. Lithium batteries must be recycled appropriately or returned to your retailer.
- Connect the new battery and inject silicon from the syringe onto the battery's white connector.
- Spread the adhesive from the kit on the compartment surround, insert the battery/cover assembly and stick it down. Keep the cover in place with the clamp.
- Turn the coil over and make sure it is horizontal so that the liquid silicon can complete the seal. Leave to dry for 24 hours.
- Lastly, deburr the surplus glue and reposition the coil cover.

A video explaining how to replace the battery can be viewed on the XP Internet site. The batteries carry a two-year parts and labour warranty.

Safety precautions

Acceptable ambient temperature during charging: From 0°C to + 40°C maximum.
Recommended storage temperature: 25°C.

Batteries:

- The batteries are fitted with internal protection systems which shield them from extreme overloads and discharges. They must not be dismantled or short-circuited, which is dangerous and could destroy the protection systems, explode or cause the batteries to ignite.
- Do not leave batteries on charge unnecessarily and disconnect the power adaptor when the charge cycle is complete or after 3 hrs.
- If you notice any perforation, odour or other anomaly, please return the battery to the retailer in a sealed plastic bag and do not try to charge again (risk of destroying the protection systems, explosion or causing the batteries to ignite).
- Never dispose of lithium batteries with your household waste: return them to your XP retailer or take them to a designated collection point.
- Do not place the batteries near heat sources and never throw them onto a fire.
- Never perforate the battery cover or try to weld/solder the battery.
- Risk of explosion if battery is incorrectly replaced. Replacing the battery with another of the incorrect type can lead to a risk of explosion. Only use LiPo batteries supplied by XP (ref.: DO88M-WTUBE).
- If you notice abnormal overheating of components on charge, disconnect the mains unit immediately and do not try to charge further.

Power adaptor

- Always connect your power adaptor in an accessible, visible place to ensure that it can be unplugged quickly in the event of overheating or other problems.
- Do not charge unattended close to inflammable parts.
- The power adaptor is only designed for indoor use and should not be exposed to water or humidity.
- Do not charge the devices during a thunderstorm and unplug the power adaptor from the supply.
- XP only guarantees electrical safety with the original mains unit or a certified USB mains unit :



Xplorer cannot be held liable for any consequences arising from a failure to comply with the precautions for use.

DIVING & SEALING

DEUS II is designed with robust materials that can withstand salt environments. For example, the connectors, fastenings and coil charging contacts are made from marine grade stainless steel. However, precautions must be taken as with any diving equipment:

- ⚠️ Rinse your detector with fresh water after using it on the beach and before unscrewing the connector or plug.
- ⚠️ Tighten the plugs systematically to prevent any ingress of salt water or sand in the connectors on the remote control or BH-01 headphone at the risk of corroding the internal contacts. If salt water or sand has penetrated, rinse the male and female contacts and the connector thoroughly with fresh water and leave to dry.
- ⚠️ Never leave the remote control in direct sunlight, for example: in a hot car, especially if it is fitted with the red plug, as this may damage the loud speaker.

Cap choices

GRAY PLUG No. 1 = 1 m max.

This is the plug for **common use** on land or for a submerged remote control up to 1 m.

A sealed membrane lets the air through but withstands 1 m depth. It balances the internal pressure to prevent the remote control from swelling during a variation in T° or altitude.

RED PLUG No. 2 = 20 m max.

Reserved for **underwater use exclusively**.

On land the red plug will not balance the internal pressure,

which could cause the flexible keypad to swell or the loud speaker to stick during variations in T°. If this happens and you are aware of poor sound from the loud speaker, insert the gray plug and blow through your mouth onto the loud speaker grille to get it going again.

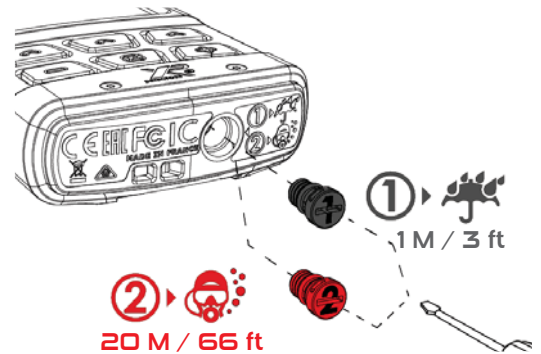

Mandatory cleaning after using underwater

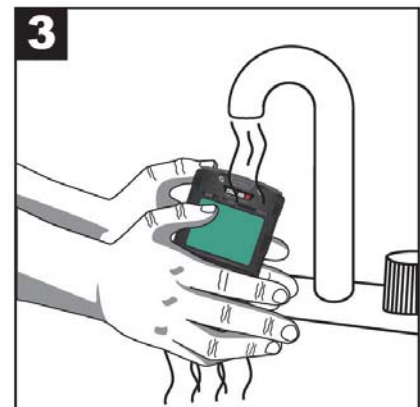
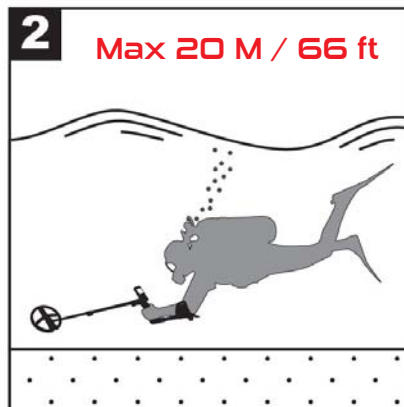

- 1** Before submerging more than 1 m deep, screw in the red plug no. 2.
- 2** Max. depth 20 m / 66ft.
- 3** Rinse the entire detector with fresh water.
- 4** Dry the detector with a towel.
- 5** Insert the gray plug no. 1 for all land use and up to 1 m deep water for the remote control.

Diving greater than 20 meters deep ?

At a depth greater than 20 m, the screen may darken slightly in the center due to the pressure exerted by the glass on the crystals. This can be reversed when ascending. However, the screen can break at a depth of about 35 m/115 ft, so be careful.

Aerial Antenna assembly

This aerial antenna ensures a perfect connection of radiowaves between the coil and the remote control or the WS6 when submerged **DEUS II**. There is no need for this if you only submerge the coil by a few centimeters.

The aerial antenna comprises:

- 1 coaxial cable.
- 1 elastic band to fix the other end of the aerial antenna cable to the coil.
- 2 self-gripping tapes to attach the cable to the stem quickly and effectively.
- 1 plastic clip to attach the cable to the **DEUS II** remote control.

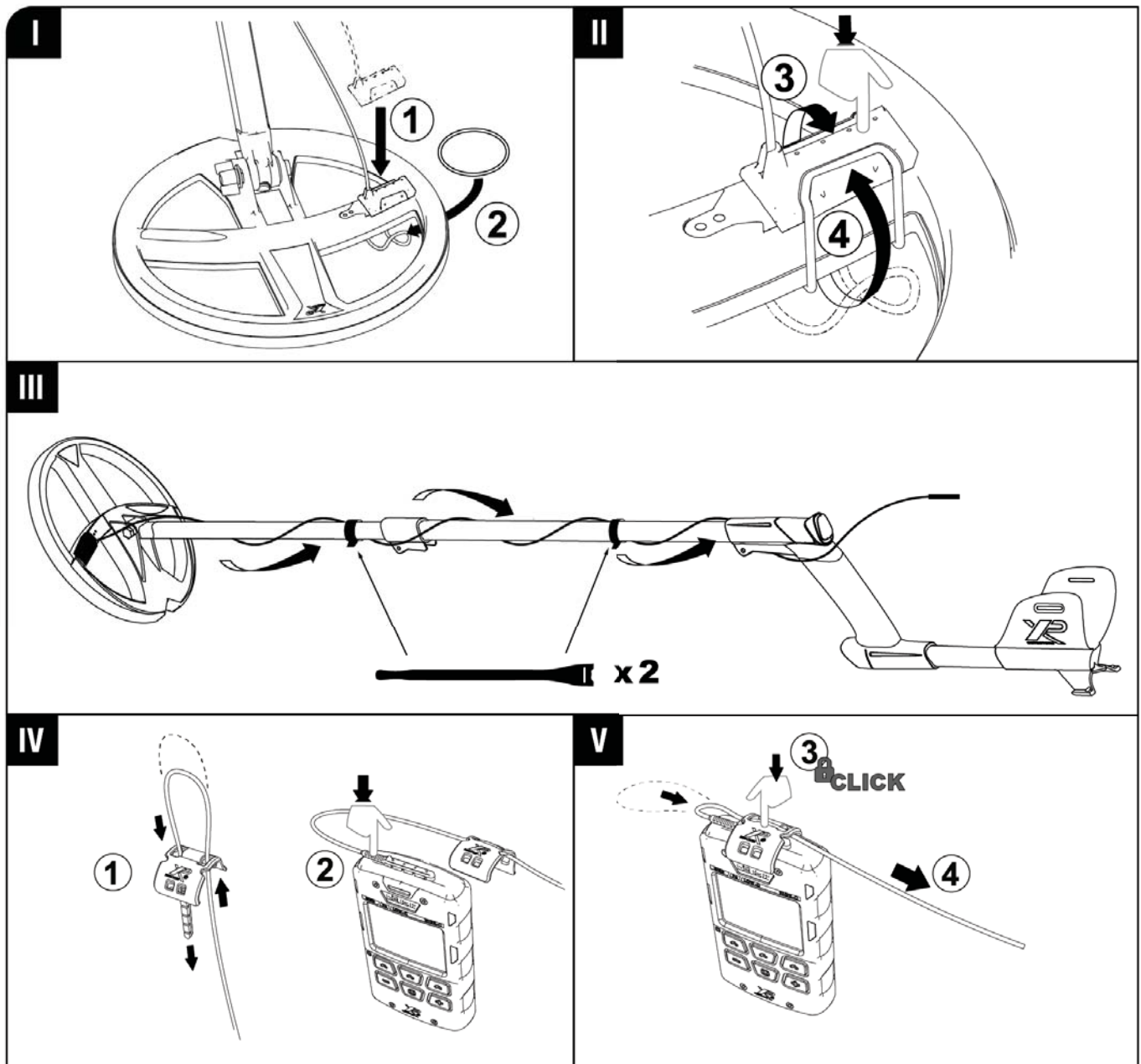

PROBLEMS and SOLUTIONS

You become aware of abnormal performance, instability, false signals or interference, for no apparent reason

CAUSES	SOLUTIONS
The machine is over sensitive.	Lower the sensitivity.
You are in a high EMI zone with a great deal of interference (high-voltage power lines, electric transformer, electric fence).	Lower the sensitivity, change or shift frequency. Move to a different zone.
There is a storm nearby and the electromagnetic discharges of lightning appears to be interfering with the detector.	Switch off and wait for the storm to pass. Never detect in a lightning storm.
You are close to other working metal detectors.	Change or shift the frequency.
Soil effects are adjusted incorrectly.	Adjust automatically (GRAB).
The ground is heavily infested with iron and other metals.	Find a less infested place - lower sensitivity Do not practise in your garden !

The coil does not switch on, unlike the remote control and the headphones

CAUSES	SOLUTIONS
You have the wrong coil selected in the menu: OPTION/PAIRING COIL.	Select the correct coil.
The serial number of the coil that you have entered in the remote control was incorrect or was changed inadvertently.	Check the coil serial number entered or pair it again automatically (see coil > pairing).
The battery is discharged.	Recharge it. - check charging source.
The coil is defective.	Contact your retailer.

There is no detection sound in the headphones despite them being switched on
(and pressing the buttons generates an audible beep)

CAUSES	SOLUTIONS
If you are using the WS6 Master (without remote control) you may have chosen an incorrect coil in OPTION > COIL.	Select the correct coil.
The headphone has not been paired with the remote control. If you are using the WS6 Master (without remote control), the headphones have not been paired with the coil.	Pair them.

There is no sound in the headphones when passing over a target and pressing the buttons generates no audible beep

CAUSES	SOLUTIONS
The backphones are not working.	The module has come away slightly from the headband. Clip it back in. Or Change headband, it is easy to replace.
The module maybe faulty.	Contact your retailer.

Radio

Link	XP Link, Digital wireless	
Channels	36 automatic channels	
Radio Frequency specification	FREQUENCY	POWER
Radio link	2.40 à 2.48 GHz	<2.1 dBm
Detection	3.9 à 135.7 KHz	<72dBµA/m at 10m

Features/Settings

Detection frequencies	Simultaneous Multi Frequency (40dBµA/m at 10m) or between the 49 single frequencies from 4 to 45 kHz.
Sensitivity	99 levels
Sound type	Different sound options: PWM, SQUARE, etc.
Audio Volume	10 levels for each audio output
Reactivity	9 levels (0/0.5/1/1.5/2/2.5/3/4/5)
Audio Response	8 levels
Iron Volume	6 levels
Multi Tones	1, 2, 3, 4, 5, Pitch and Full Tones 1 and 2 + EXPERT modes
Ground balance	Tracking, Grab, Manual
Multi-Notch	Yes, with adjustable window width
Non-motion mode - Pinpoint	Yes, with and without Autotune - Audio and visual
Discrimination	Audio and visual/ferrous bottle cap rejection on 5 levels/Silencer
Threshold	Threshold and Audio frequency adjustable
Equalizer	4 Bands configurable on each audio output
Programs	12 factory programs + 12 users
Backlight	20 levels adjustable, very low power consumption

General Features

Display screen	8192 pixels
Software updates	Yes, by USB/Internet connection
Wireless Headphones optional	WS6 (rainproof) - WSAII (rainproof) - WSAII XL (IP 68-1m)
Wireless coil optional	DD 22.5cm-9"/28 cm-11"/34x28cm-13"x11" (fully waterproof 20m - 66 ft)
Coil cover	Yes
Hip mount remote control case	Yes
Headphones storage case	Yes (WS6, WSA II)
Stem	Fully telescopic, S-shaped
Batteries	Remote/Coil: 700 mAh - Headphones: 320 mAh
Battery level indicator	Yes: Remote/Headphones/Coil/MI-6
Wireless Remote Control battery life	~ 15 to 30H depending on audio output activated
Wireless Headphone battery life	~ 15H WSAII/WS6
Wireless Coil battery life	8H to 20H depending on programs and frequencies
Mains power charger	Depending on version, Input 100-220V 50/60Hz, Output 5V- 1A max
Cigarette lighter charger	Optional
Bone conduction headphones	Waterproof IP68 - 20m - 66 ft (optional)
Charging time	~3 h
Total detector weight with batteries	See product page for details on each version
Stem weight	370 g (S-Telescopic) - 305 g (S-Telescopic lite)
Remote weight with battery	150 g
Headphone weight with battery	WS6: 82 g - WSA II: 72 g - WSA II XL: 250 g
Coil weight	22.5cm- 9": 345 g - 28 cm-11": 470 g - 34x28cm-13"x11": 570 g
Length of folded stem	58 cm
Length of extended stem	130 cm
Operating T°	0 to + 40°C
Max ambient T° during charging	0 to + 40°C
Recommended storage T°	25°C
Waterproof coil	IP 68 - 20m - 66 ft, *optional antenna required when the coil is submerged
Warranty	Five years parts and labor. Batteries, chargers and connectors have a two-year warranty
Patents	US 7940049 B2 - EP 1990658 B1 and patents pending

ACCESSORIES AND OPTION



DEUS II
(XPRSW)



22.5cm-9" FMF
(FMF22)



28cm-11" FMF
(FMF28)



34x28cm -13"x11"
FMF (FMF3428)



WS6
(XPWS6)



WSA II
(XPWSA2)



WSA II XL
(XPWSA2)



FX-03



BH-01



MI-6
(XPMI61)



MI-4
(XPMI61)



CLIP
PINPOINTER



LANYARD



HOLSTER
PINPOINTER



HIPMOUNTDE-
US II



WS6
SUPPORT



WS6
Wrist-Band



CLIP JACK
ADAPTOR



RC JACK
ADAPTOR



S-TELESCOPIC STEM



S-TELESCOPIC LITE STEM



CAR CHARGER



XP BACKPACK
280



XP BACKPACK
240



XP FINDS
POUCH



AERIAL
ANTENNA



XP CASE



GOLD PAN
STARTER



GOLD PAN
PREMIUM



GOLD BATEA



GOLD PAN
VS1 SLUICE

TELESCOPIC STEM

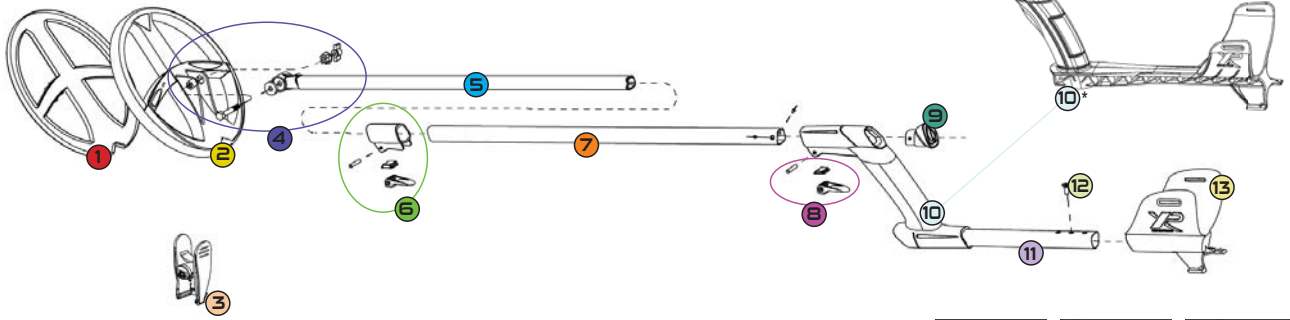

- 1 COIL COVER
- 2 COIL
- 3 D0894
- 4 D038D
- 5 LOWER STEM
- 6 D041
- 7 D05B-A
- 8 D04
- 9 D06/DO6BLACK *
- 10 D061
- 11 D042
- 12 D072
- 13 D07



DEUS II

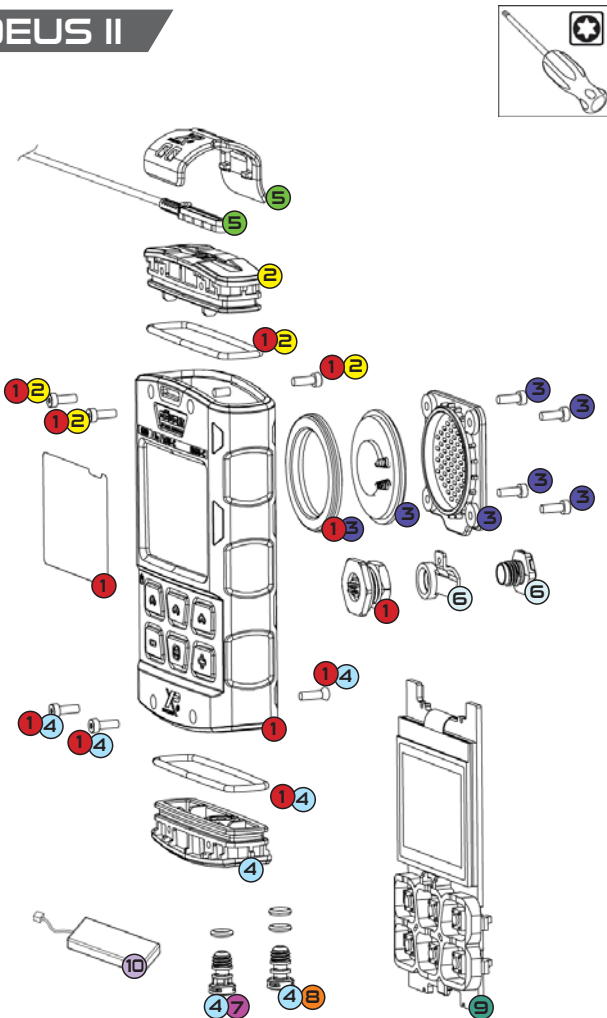

- 1 D2-RC1-MAIN
- 2 D2-RC1-TOP
- 3 D2-RC1-SPEAKER
- 4 D2-RC1-BOTTOM
- 5 D2-RC1-WAVE
- 6 D2-RC1-PLUG
- 7 D2-RC1-GREY1M
- 8 D2-RC1-RED20M
- 9 D2-RC1-PCBLCD (without battery)
- 10 D088M-WTUBE (battery)

WS6

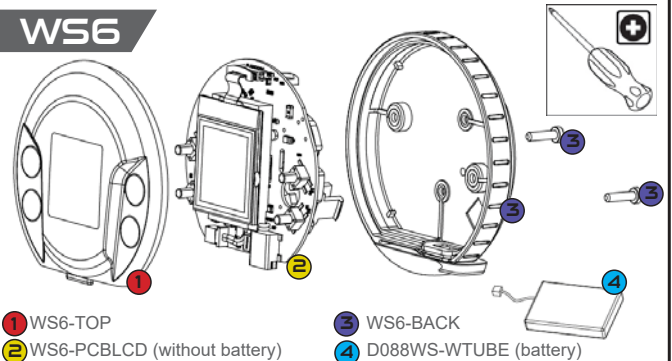

- 1 WS6-TOP
- 2 WS6-PCBLCD (without battery)
- 3 WS6-BACK
- 4 D088WS-WTUBE (battery)

WS AUDIO II

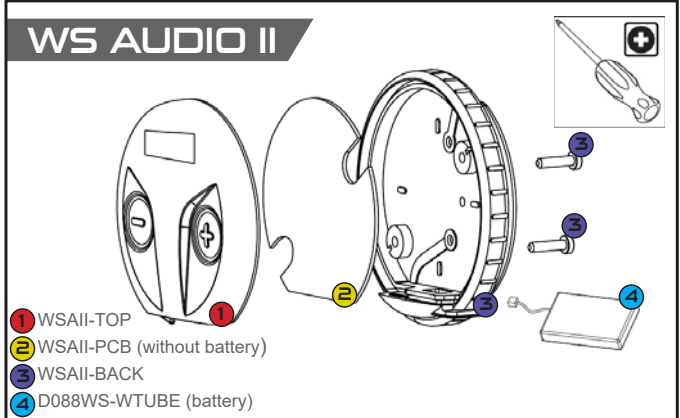

- 1 WSAIL-TOP
- 2 WSAIL-PCB (without battery)
- 3 WSAIL-BACK
- 4 D088WS-WTUBE (battery)

MI-6/MI-4

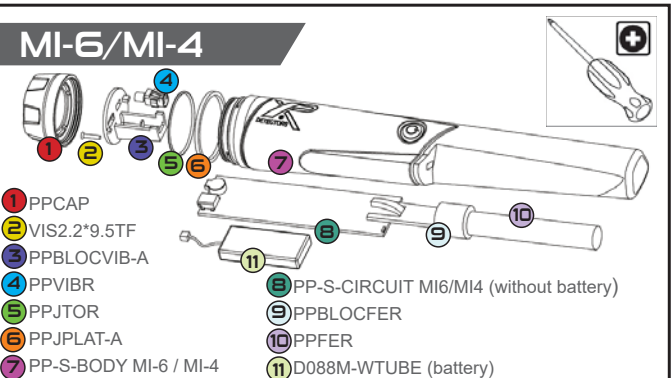

- 1 PPCAP
- 2 VIS2.2*9.5TF
- 3 PPBLOCVIB-A
- 4 PPVIBR
- 5 PPJTOR
- 6 PPJPLAT-A
- 7 PP-S-CIRCUIT MI6/MI4 (without battery)
- 8 PPBLOCFER
- 9 PPFER
- 10 D088M-WTUBE (battery)
- 11 D088M-WTUBE (battery)

FACTORY PROGRAMS SPEC

GENERAL SENSITIVE SENSIF T FAST PARK DEEP HC DEUS MOND GOLD FIELD RELIC DIVING BEACH BEACH SENS

		Prg 1	Prg 2	Prg 3	Prg 4	Prg 5	Prg 6	Prg 7	Prg 8	Prg 9	Prg 10	Prg 11	Prg 12
MENU													
Discr	-6.4 to 99	7.0	6.8	6.8	6.8	10	6.0	6.1	-	-	8.0	8.0	8.0
1 tones	100 to 993 Hz	202	202	-	-	202	202	202	-	-	202	202	202
2 tones		518	518	-	-	518	644	518	-	-	518	518	518
3 tones		644	644	-	-	644	-	644	-	-	644	644	644
4 tones		-	-	-	-	-	-	-	-	-	-	-	-
5 tones		-	-	-	-	-	-	-	-	-	-	-	-
PITCH	150 to 603 Hz	-	-	-	362	-	-	-	-	-	-	-	-
Full Tones	ON /OFF	-	-	ON	-	-	-	-	-	-	-	-	-
B.caps	0 to 5	0	0	0	0	5	0	-	-	-	0	0	0
Notch 1	00-00 to 99-99	00-00	23-25	23-25	23-25	23-36	00-00	00-00	00-00	00-00	00-00	00-00	00-00
Notch 2		-	-	-	-	-	-	-	-	-	-	-	-
Notch 3		-	-	-	-	-	-	-	-	-	-	-	-
Discr IAR	0 to 5	-	-	-	-	-	-	-	0	0	-	-	-
Silencer	0 to 6	1	1	1	1	3	2	0	-	-	0	0	0
Sensitivity	0 to 99	95	90	90	90	90	93	90	95	95	93	95	95
Salt Sens	1 to 9										9	9	7
Freq Shift	0 to 6	-	-	-	-	-	-	-	-	-	-	-	-
Frequency	FMF or 4 to 45 kHz	FMF	FMF	FMF	FMF	FMF	FMF	16.5	FMF	FMF	FMF	FMF	FMF
Iron Volume	0 to 5	3	3	-	3	3	3	3	3	3	3	3	3
Reactivity	0 to 5	2.5	2.5	3	3	2.5	2	2.5	2	1	0	0	0
Audio Response	0 to 7	5	4	4	4	4	5	4	3	5	5	5	5
Threshold	0 to 20	-	-	-	-	-	-	-	0	0	-	-	-
GROUND													
Grab / Manual	60 to 90	-	-	-	-	-	-	-	-	-	-	-	-
Tracking		OFF											
Ground Stability	1 to 3	2	2	2	2	3	1	-	-	-	-	-	-
Magnetic ground	Accept / Reject	-	-	-	-		-	-	-	-	REJECT	REJECT	REJECT
Audio Type	PWM/ SQUARE	PWM	PWM	PWM	SQUARE	PWM	PWM	PWM	SQUARE	SQUARE	PWM	PWM	PWM
PINPOINT	ON /OFF	AT ON											
GO TERR.	PUSH/ AUTO	PUSH											
FREQ SCAN	MANUAL / AUTO	MANUAL											

Detecting is an activity that, like most leisure activities, requires a few general guidelines. These recommendations will allow everyone to enjoy their hobby to the full while respecting laws, locations, environment and people.

Respect the law!

- Find out about existing metal detecting laws in your country.
- Ask permission from the owner or custodian of the land before searching.
- Respect the natural environment in which you are searching and the locations you will find yourself crossing.
- Fill your holes systematically so as to leave the locations in the state in which you found them.
- Keep any waste you have been able to extract with you and dispose of it correctly.
- Avoid searching in combat zones of recent wars. Be extremely cautious of any suspicious object that may look like ammunition, grenade, mine, shell or bomb etc.
- Report any suspicious object that you have discovered to the relevant authorities.

Remember that you are a detecting ambassador, it is important that you represent us in the correct way.

DECLARATION OF COMPLIANCE EU - FCC - IC - UKCA

This declaration is made under the responsibility of the manufacturer :

XPLORER SARL - 8 rue du Développement - F-31320 CASTANET-TOLOSAN

We, XPLORER, hereby certify that this detector complies with the essential requirements of European Directives RED 2014/53/EU, SECURITY 2014/35/EU and EMC 2014/30/EU which aim to harmonize legislation in Member States on the use of the radio spectrum, electromagnetic compatibility and electrical safety. The device's compliance was assessed in accordance with the essential requirements of this Directive and the harmonized standards:

- EMF: EN 62311 :2008
- DETECTION EU: ETSI EN 303454 V1.1.1
- RADIO EU: EN 300440 v2.1.1 ; ETSI EG 203367 V1.1.1
- RADIO USA: FCC 47 CFR part 15: 2019
- RADIO CANADA: RSS-210_Issue 9: 08/2016 (Amended 2017)
- SAFETY: IEC 60950-1: 12/2005/AC1: 2006/A1: 2009/A2: 2013; IEC 62368-1: 2014
- EMC: ETSI EN 301489-1:2019 V2.2.3; ETSI EN 301489-9: 2019 V2.1.1; Draft ETSI EN 301489-17: 2019 V3.2.2

Compliance informations access on the Remote control : START > OPTION > CONFIGURATION > INFO .

A copy of the certificate can be supplied upon request from:

XPLORER SARL - 8 rue du Développement - F-31320 CASTANET-TOLOSAN

FCC: This device complies with part 15 of the FCC Rules. Operation is subject to the following two conditions:

- (1) This device may not cause harmful interference, and
- (2) This device must accept any interference received, including interference that may cause undesired operation.

NOTE: The grantee is not responsible for any changes or modifications not expressly approved by the party responsible for compliance. Such modifications could void the user's authority to operate the equipment

IC : This device contains licence-exempt transmitter(s)/receiver(s) that comply with Innovation, Science and Economic Development Canada's licence-exempt RSS(s). Operation is subject to the following two conditions:

- (1) This device may not cause interference.
- (2) This device must accept any interference, including interference that may cause undesired operation of the device.



SAFETY/RECYCLING/PRECAUTIONS

Safety relating to electromagnetic radio waves

This product complies with standards for user safety with regard to electromagnetic waves. The strength of the radio signals used is considerably weaker and on a much smaller scale than those emitted by mobile telephones (2,000 to 4,000 times weaker). Moreover, when the complete system is used, the audio headphones only act as a passive radio receiver.

Warning: The accessories delivered with this detector can vary; similarly, the menus and certain functionalities described in this manual can differ slightly from the purchased product.

This detector is not suitable for searching for hazardous targets such as ammunition, mines, etc.

Recycling of electrical and electronic waste in the European Union and the other countries/regions in accordance with selective waste sorting procedures



If this symbol is displayed on the product or its packaging, it means that the product must not be disposed of with your household waste. It must be taken to a designated collection point for recycling electrical and electronic waste. This selective waste sorting and recycling helps to preserve natural resources and avoid any potential risks for human health and the environment that could result from inappropriate scrapping, due to the possible presence of hazardous substances in the electric and electronic equipment. For more information on places for disposing of electrical waste, please contact the shop where you purchased this product. Alternatively you can return it to your supplier, or directly to XP. The same is true for the lithium batteries which must be recycled appropriately.

© 2021 Xplorer sarl

This document contains information that is protected by existing legislation on copyright, brands and royalties. Any reproduction, even partial, of this document, the logos or the XP and Dêus brands is prohibited without the consent of:

XPLORER SARL - 8 rue du Développement - F-31320 CASTANET-TOLOSAN

PRECAUTIONS FOR USE

DÊUS II is a sensitive piece of electrical equipment, designed to be as robust as possible. Despite this, it is important to take care of it and exercise certain precautions in order to prolong its life :

- Do not store your device for long periods with flat batteries.
- Ideally you should discharge/recharge the batteries at least once a month and if possible store them at 40 to 80% charged to extend their lifetime beyond five years.
- Do not expose your detector to extreme temperatures, particularly inside a car in full sun.
- Do not expose your detector to the sun without reason when it is not being used.
- Use the storage case that is supplied with the headphones and never carry them at the bottom of a bag without protection.
- Use the case that is supplied with the remote control to protect it in adverse conditions and when the detector is stored away.
- Depending on how you use your detector, it may be advisable to clean its elements regularly. A damp cloth can be used to clean the non-waterproof parts
- In a salt environment, rinsing with fresh water is mandatory for the remote control, coil and BH-01 headphone. Do not use solvent or alcohol.
- After use, remove any dirt from the stem's locking mechanisms.
- The mains power unit is intended for inside use only. Connect it in a visible and accessible location. Unplug it after use, if overheating or during another suspicious event.
- The equipment must be recharged using a SELV LPS power supply.

XP DEUS II - 5 YEARS LIMITED WARRANTY

In addition to the legal warranty resulting from Articles 1641 *et seq.* of the Civil Code and Articles L. 211-1 *et seq.* of the Consumer Code, due in any case on defects and hidden faults, XP provides this contractual warranty for the **DEUS II** detector of five years with effect from the date of purchase by the initial purchaser.

This warranty does not cover :

- Breakage caused by falls, impacts or accidental damage
- Damage caused by abnormal use or resulting from non-compliance with the conditions of use stipulated in the device's instructions.
- Using without coil cover, or using defective coil cover.
- Alteration of the electronic circuit by any unauthorized person.
- Corrosion of electronic circuits, due to water ingress.
- A reduction in battery life due to battery ageing.
- Breakage of cables or wires.

Spare parts are not covered by the 5 year warranty:

- Coil cover, headphone earpieces, foams, coil bolts and fittings, hipmount and transport case, etc. (These parts must be replaced in case of wear and tear, in such a way to avoid damaging the device).
- Batteries, chargers and connectors carry a two-year warranty.

In the event of any fault or malfunction please contact your XP dealer for advice. Any part needing to be returned to the dealer or the distributor must be accompanied by a note explaining the fault. Carriage/shipping costs are the customer's responsibility. Proof of Purchase is required to make a claim under this warranty. If a faulty device has been replaced by a new or reconditioned one, the warranty will continue from the original purchase date.

Contacts

Site: www.xpmetaldetectors.com
 e-mail: contact@xpmetaldetectors-media.com

XPLORER sarl
 8 rue du développement
 F-31320 CASTANET TOLOSAN
 Tel.: 05.34.43.10.52
 Fax: 05.34.43.10.53

XP and D eus are trademarks of Xplorer sarl.

Xplorer reserves the right to modify its detectors' characteristics or specifications without notice.

Battery specifications for air transport

	Qty.	Type	Power	Weight
Coils FMF	1	700 mAh	2.60 watts/hour	12 g
Remote control DEUS II	1	700 mAh	2.60 watts/hour	12 g
WS6/WSA II/WSA II XL	1	320 mAh	1.11 watts/hour	6 g
MI-6 Pinpointer	1	630 mAh	2.30 watts/hour	11 g
MI-4 Pinpointer	1	630 mAh	2.30 watts/hour	11 g





After charging your device !

Switch ON

1 Switch on the remote, press 1 second the button 



2 Choose the audio output

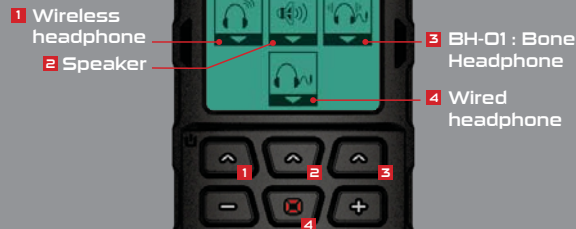

3 The WS6 turns on automatically if paired to RC. Otherwise, to switch on the headphones press 2 seconds  (WS6 / WSA II / WSA II XL)



NOTE: a headset paired with the remote control will turn on and off automatically.

The flashing led indicates the awakening of the coil it flashes every second.

By default the DEUS II starts in the factory program N ° 1 GENERAL.

Use   to select one of the optional 12 factory programs.



Switch OFF

Press the button on top left   for 2 seconds to switch off the remote control.

The wireless XP headphones switch off automatically (otherwise force it off by pressing  and ).

If you wish to change the main detection settings:

Press , scroll through the functions, set with   and press  to return to the main menu.



3 665994 005065